

DRAKE'S CYCLOPEDIA

of

RADIO

and

ELECTRONICS

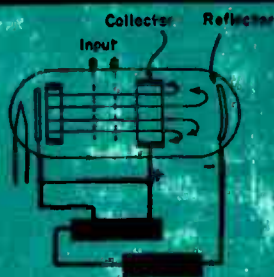
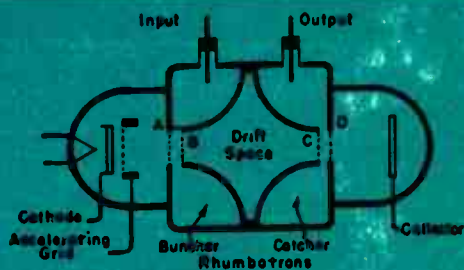

DRAKE'S
CYCLOPEDIA
OF
RADIO
AND
ELECTRONICS
—
MANLY AND GORDER

DRAKE'S CYCLOPEDIA
of
RADIO and ELECTRONICS

A REFERENCE AND INSTRUCTION BOOK

RADIO SOUND SYSTEMS TELEVISION
PHOTOELECTRICITY ELECTRONIC TUBES
ELECTRONICS IN INDUSTRY

Originally compiled

By

HAROLD P. MANLY

Technical Editor

Engineering Trade Manuals

and

L. O. GORDER

Director of Training

American Television Laboratories

FOURTEENTH EDITION

CHICAGO, ILLINOIS
FREDERICK J. DRAKE & CO.
Publishers

C-1
Copyright, 1958, by
FREDERICK J. DRAKE & CO.

Printed in the United States of America

PREFACE

To the Fourteenth Edition

For more than twenty years, with a total issue now more than one hundred thousand copies, "Drake's Cyclopedia" has kept pace with the growth of radio—from the days of regenerative detectors to present developments in television, f-m radio, and electronics in industry.

Major additions have been made to sections on television, frequency modulation, and high-frequency practice in general. In addition to material on industrial tubes and applications, much new information has been included on designs for hyper-frequency operation, on all kinds of oscillators, on phototubes, and on all rectifiers in general use. As in former editions, material which has become obsolete has either been taken out of the text or else reduced to the few essentials which are valuable as reference material.

It will be found that explanations, even in the more advanced subjects, still are simple and easily understood—this having been a chief characteristic of Drake's Cyclopedia since its inception. In each section there are complete cross references to all related subjects, allowing any line of investigation to be followed all the way back to elementary principles if desired. There is notable absence of mathematics, other than simple arithmetic, with formulas written in words and with extensive tables of condensed information. All illustrations have been especially drawn for this book, to further clarify in simplest manner the principles and practices explained in the text.

The rapid growth and expansion of radio and electronics have tended to separate the field into many specialized branches, making it difficult for newcomers and those changing their interests to find the entire story in a single volume. Fortunately, the long and continuing process of developing Drake's Cyclopedia with growth of the industry itself has made it possible to retain all the essentials in proper perspective, making this one of the few modern books with well balanced treatment of everything from simplest beginnings to most advanced applications.

THE PUBLISHERS

DRAKE'S CYCLOPEDIA OF RADIO AND ELECTRONICS

A

A-BATTERY.—See *Battery, A*—

ABBREVIATIONS.—Following are the generally accepted meanings of abbreviations used in radio and electrical work. Writers are not in complete agreement on the use of certain abbreviations and some departures from the following list will be found. See also *Symbols, Radio and Electrical*.

A.	area	d.	deci-
a.	ampere	db	decibel
A.C., a.c.	alternating current	D.C., d.c.	direct current
or a-c		or d-c	
A.F., a.f.	audio frequency	D.C.C.	double cotton covered
or a-f		D.S.C.	double silk covered
A.W.G.	American wire gage	DX	distant
B.	magnetic flux density	E.	effective voltage
b.	susceptance in mhos	e.	instantaneous voltage
B.T.U.	British thermal unit	E _a	filament or heater
B.W.G.	Birmingham wire gage		supply voltage
C.	capacity, capacitance	E _b	plate supply voltage
c.	centi-	E _c	grid bias supply
C _t	cathode or filament		voltage
	capacitance	E.C.	enamel covered
C _g	grid capacitance	E _d	screen supply voltage
C _{gf}	grid-filament cap'nce	E _f	filament voltage
C _{gk}	grid-cathode cap'nce	E _g	grid bias voltage
C _{gp}	grid-plate capacitance	E _h	heater voltage
C.G.S.	centimeter-gram-	E _m	maximum voltage
	second	e.m.f.	electromotive force
cm.	centimeter	E _p	plate voltage
c.p.	candlepower	E _s	screen voltage
C _p	plate capacitance	F	magnetomotive force
C _{pf}	plate-filament cap'nce		or luminous flux
C _{pk}	plate-cathode cap'nce	f	frequency
c.p.s.	cycles per second	G or g	conductance or elec-
C.W. or	continuous wave		trostatic stress
cw		G _m	mutual conductance
D.	dielectric flux density	H	magnetizing force

ABSORPTION, DIELECTRIC

h	henry (inductance)	P_m	maximum power
h-f	high frequency	Q	quantity (coulombs or ampere-hours)
I	effective current	R or r	resistance
i	instantaneous current	R.F., r.f.,	radio frequency
icw	interrupted continuous wave	or r-f	
i.f. or i-f	intermediate frequency	R_f	filament resistance
I_f	filament current	R_g	grid resistance
I_g	grid current	r-m-s	root-mean-square
I_h	heater current	R_o	output resistance
I_m	maximum current	R_p	plate resistance
I_p	plate current	S	elastance, also photo-cell sensitivity
I_s	emission or saturation current	S.S.C.	single cotton covered
K	dielectric constant	S.C.E.	single cotton over enamel
k.	coefficient of coupling or other constant, also kilo-	SOS	radio distress signal
kc	kilocycle	S.S.C.	single silk covered
kw	kilowatt	S.S.E.	single silk over enamel
L	self-inductance	S.U.	sensation unit
l	length	T.	period
l-f	low frequency	t.	time
M	mutual inductance or mega-	TRF	tuned radio frequency
m.	meter (of length), also milli-	T.U.	transmission unit
mfd.	microfarad	u.p.o.	undistorted power output
mm.	millimeter	V.	potential difference
nimfd.	micro-microfarad	v.	velocity or volt
mv.	millivolt	VT	vacuum tube
N or n	number of (turns, etc.)	W.	work or energy
P	average power (watts)	w.	watt
p	instantaneous power	X or x	reactance
p.d.	potential difference	X_C	capacitive reactance
PEC	photoelectric cell	X_L	inductive reactance
p.f.	power factor	Y or y	admittance
		Z or z	impedance
		Z_g	grid impedance
		Z_p	plate impedance

ABSORPTION, DIELECTRIC.—With a condenser having an imperfect dielectric the first rush of charging current is followed by the flow into the condenser of a small and slowly decreasing current which may continue for some time if charging voltage is steadily applied. Upon discharge of the condenser the first rush of current is followed by a small and decreasing current. These currents appear to be absorbed by the condenser's dielectric and then to be released. The effect is called dielectric absorption.

ACOUSTICS.—The science of sound. See *Sound*.

AERIAL.—See *Antenna*.

AIR.—For use wherever its insulating ability is sufficient for the applied voltages air is a nearly ideal dielectric, since it introduces none of the energy losses which occur with solid and liquid dielectrics. The dielectric constant of air usually is assumed to be 1.00. The constant increases by about one per cent for each 300 pounds per square inch increase in pressure.

The insulating ability or dielectric strength of air is indicated by the accompanying graph, which shows breakdown voltages for various gap lengths between spheres of one-centimeter diameter and between sharply pointed needles. The breakdown voltage increases with increase of air pressure.

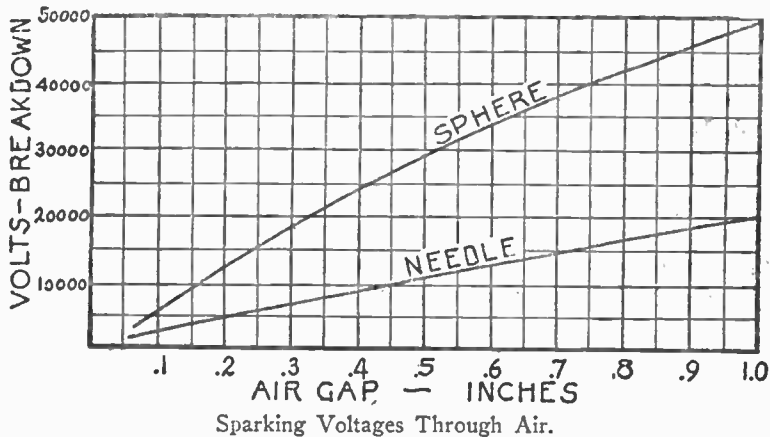

AIRCRAFT RADIO.—See *Aviation, Radio in*.

AIR CELL BATTERY.—See *Battery, Air Cell*.

ALTERNATING CURRENT.—See *Current, Alternating*.

ALUMINUM.—The resistance of an aluminum conductor is about 1.67 times that of an annealed copper conductor of the same size and length. However, aluminum weighs only about 0.30 times as much as copper, so an aluminum conductor of given current-carrying capacity or of given resistance is lighter, but larger, than a copper conductor of equal capacity. The surface of aluminum normally is covered with a thin layer of oxide which has rather high resistance.

AMMETER.—See *Meters, Ampere and Volt*.

AMPERE.—A unit of rate of flow of electric current. A rate of one coulomb of electricity per second, which is equal to a flow of 6,280,000,000,000,000 electrons per second past a given point in a circuit. One ampere is the rate of current flow in a

AMPERE

resistance of one ohm when there is a potential difference of one volt across the ends of the resistance. A rate of electric flow measured in amperes is similar to a rate of water flow measured in gallons per minute.

AMPERE-HOUR.—A unit of quantity of electricity. The quantity that passes when a flow rate of one ampere is continued for one hour; equal to the product of current in amperes by time in hours. One ampere-hour is equal to 3,600 coulombs of electricity.

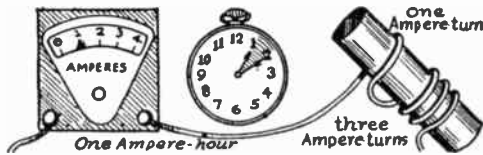

Ampere-Hour and Ampere-Turn.

AMPERE-TURN.—A unit of magnetomotive force, which is the force that causes magnetic flux or magnetic lines of force to appear in a magnetic material or a magnetic circuit. One ampere-turn is the force produced by a flow rate of one ampere of current in one turn of a coil winding. Total ampere-turns are equal to the flow in amperes multiplied by the number of turns through which the flow takes place.

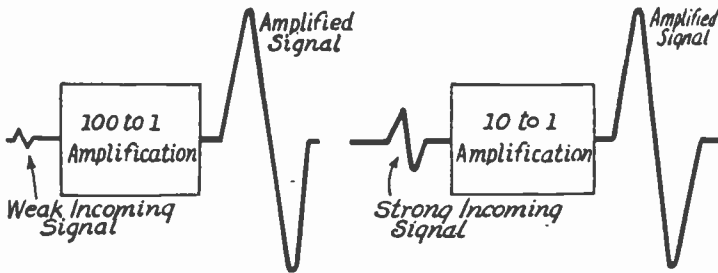

The Effect of Amplification on Signal Strength.

AMPLIFICATION.—Amplification refers to the increase in voltage, current, or power that occurs between the input and output circuits of an electronic tube or of any other device or apparatus in which there may be such an increase. The amplification factor or ratio is equal to the output value divided by the input value as measured in the same unit.

AMPLIFICATION, CASCADE.—A system of amplification in which the output voltage of one electronic tube circuit is used as the input voltage for a following tube circuit, or in which

AMPLIFICATION

plate voltage changes caused by one tube are used as grid voltage changes for a following tube. Each tube and its circuits are called one stage of amplification.

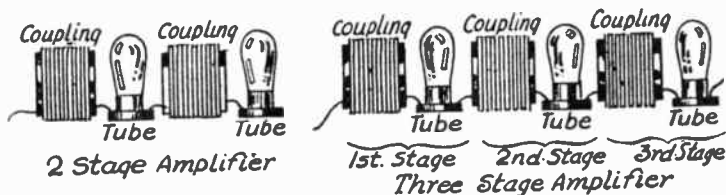

A Two-Stage and a Three-Stage Cascade Amplifier.

AMPLIFICATION, FACTOR OF.—A measure of the relative effect of changes in control grid voltage and of changes in plate voltage in producing equal changes of plate current in an electronic tube. It is the ratio of a change of plate voltage to a change of grid voltage, both of which result in an equal variation of plate current when all other applied voltages remain constant. It is the ratio of the alternating voltage appearing in the plate circuit load to the alternating voltage applied to the control grid when the load impedance is infinite. The symbol is the Greek letter mu.

AMPLIFICATION, VOLTAGE AND POWER.—The amplification or gain here considered is that which occurs between the control grid circuit of an amplifying tube and the load in the plate circuit of the same tube, or it is the ratio of the voltage or power appearing in the plate circuit load to the voltage or power applied between the control grid and cathode.

For an example, consider the tube whose plate characteristics are shown by the accompanying graph. On the graph has been drawn a load line for a 15,000-ohm plate circuit load and a plate supply potential of 300 volts. Should the alternating voltage applied to the control grid vary from 2.5 to 7.5 volts negative, there will be a change of grid potential amounting to 5.0 volts. Then, as shown by the load line, the plate current at -2.5 grid volts will be 9.1 milliamperes, and at -7.5 grid volts will be 3.4 milliamperes.

With 9.1 milliamperes (or 0.0091 ampere) flowing in the 15,000-ohm load the voltage drop in the load will be equal to $15,000 \times 0.0091 = 136.5$ volts. With 3.4 milliamperes (or 0.0034 ampere) the drop in the load will be equal to $15,000 \times 0.0034 = 51.0$ volts. The change of voltage in the load will be equal to $136.5 - 51.0 = 85.5$ volts. The 5.0-volt change of control grid voltage has caused a change of 85.5 volts in the load, so the amplification or gain of voltage is equal to $85.5 \div 5.0 = 17.1$. For other values of plate load resistance and of plate supply voltage there would be different values of voltage amplification or gain, any of which might be computed by drawing appropriate load lines on the graph of plate characteristics.

The greater the resistance or impedance of the plate circuit load the greater will be the gain. With the tube represented by the accompanying graph the maximum possible gain is 38.0, which is the amplification factor of the tube. But this gain could be attained only with infinitely great re-

AMPLIFICATION

sistance or impedance in the plate circuit, and, of course, infinitely small plate current. The amplification factor of a tube represents the maximum theoretical gain, and always is greater than any actual gain which may be attained in practice.

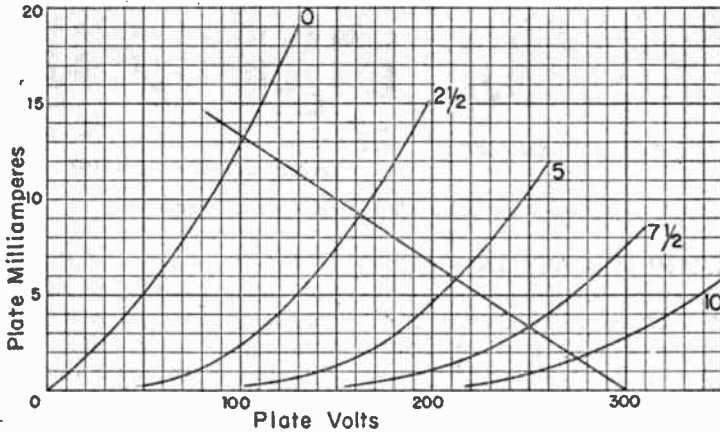

Load Line Used for Computing Voltage Amplification.

Power amplification is the ratio of the power in watts or milliwatts that appears in the plate circuit load to the power measured in the same unit that is used in the control grid circuit, or it is the ratio of output power to input power.

AMPLIFIER.—A device which increases the voltage or power of a signal by furnishing additional power from itself through the use of electronic tubes is called an amplifier. The input signal which controls the local power may come from an antenna, a microphone, a phonograph pickup, a photocell, a detector tube or a transmission line. The output power may feed another transmission line or amplifier, or it may operate a loud speaker or other reproducer for the signal.

AMPLIFIER, AUDIO FREQUENCY

AMPLIFIER, AUDIO FREQUENCY.—Any amplifier which increases the voltage or power of signals at audio frequency is called an audio frequency amplifier. These devices may be classified according to the source of input signal or according to the kind of coupling employed between the vacuum tubes.

Classed according to input there are microphone amplifiers, line amplifiers, photocell amplifiers, phonograph amplifiers, receiver amplifiers, etc. According to coupling there are direct coupled, impedance coupled, parallel feed, push-pull, resistance coupled and transformer coupled amplifiers. The classification according to coupling is the one employed in the following pages wherein are described the features of the various types.

AMPLIFIER, AUDIO FREQUENCY, DIRECT COUPLED.—The amplifier here described uses a type of resistance coupling in which the plate of one tube is conductively connected to the control grid of the following tube and in which a single coupling resistor is included both in the plate circuit and in the grid circuit.

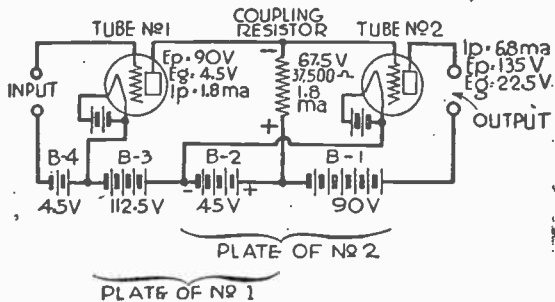

Fig. 1.—Simple Form of Direct Coupled Amplifier.

The action of this type of direct coupled amplifier depends upon the fact that in any one tube, considered by itself, the performance is a result of potential differences between plate and cathode and between control grid and cathode in that tube. This performance is not affected by these potentials with reference to ground or with reference to any other tube.

The principle of direct resistance coupling for an amplifier may be understood from an examination of Fig. 1 in which all plate currents are furnished by batteries connected as shown. It may be seen here that the plate of the first tube is connected directly to the grid of the second tube.

Tracing the plate circuit of the first tube, it is seen to include the coupling resistor and the batteries B-2 and B-3. The grid circuit of the second tube includes the coupling resistor and battery B-2. Thus the coupling resistor is included both in the plate circuit of the first tube and in the grid circuit of the second tube. This coupling resistor of 37,500 ohms carries the 1.8-milliampere current for the first tube, consequently there is a drop of 67.5 volts across this unit, with the upper end at the lower voltage.

A plate potential of 135 volts for the second tube is furnished by bat-

AMPLIFIER, AUDIO FREQUENCY, DIRECT COUPLED

series *B-1* and *B-2* in series. In this tube's grid circuit there is the 45-volt battery *B-2*, also the coupling resistor with its 67.5-volt drop. The polarities of the battery and of the resistor are opposed, so the grid bias for the second tube is equal to the difference between the resistance drop and the battery voltage, or to 22.5 volts.

Plate potential for the first tube is furnished by 157.5 volts from batteries *B-2* and *B-3* in series, from which is subtracted the drop of 67.5 volts across the coupling resistor, leaving 90 volts for this plate. Grid bias for the first tube is furnished by the separate 4.5-volt battery *B-4*.

Thus it is seen that both tubes are supplied with potentials suitable for all their elements. In this particular example there is no plate potential higher than 135 volts, yet there is required a total of 252 volts in the batteries. This requirement of excess voltage is the chief disadvantage of this method of amplification.

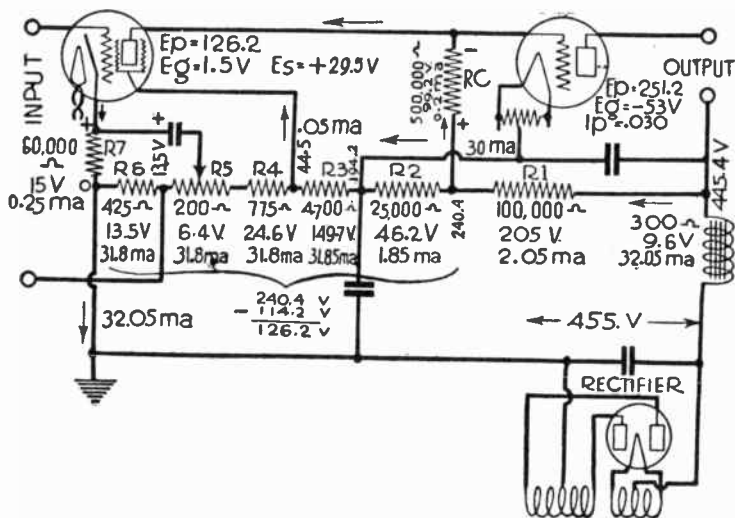

FIG. 2.—The Loftin-White Amplifier.

If a voltage is applied to the input terminals of Fig. 1 in such direction that the grid of the first tube is made more positive, then the plate current of this tube will be increased. The increased plate current flows through the coupling resistor and produces a greater voltage drop across this unit. Since this drop determines the grid bias for the second tube, and since the greater drop makes the bias more negative, there is a decrease of plate current in the second tube. This plate current change in a direction opposite to the grid voltage change causing it is a characteristic of these amplifiers. The addition of another similar stage would again reverse the plate current and the increase of grid voltage at the input would be accompanied by an increase of plate current in a third tube.

The circuits for a Loftin-White direct coupled amplifier are shown in Fig. 2. All values are marked and the direction of current flow is indicated by arrows near the conductors.

Plate voltage for the second tube in Fig. 2 is equal to the drop of 205 volts across resistor *R-1* plus the drop of 46.2 volts across *R-2*, totaling

AMPLIFIER, AUDIO FREQUENCY, IMPEDANCE COUPLED

251.2 volts between plate and filament center tap. A negative grid bias of 53 volts for this tube is derived from the 99.2 volts drop across the coupling resistor $R-c$ minus the 46.2 volts drop across $R-2$, the polarities being opposed in these two resistors.

For the first tube the plate voltage is provided by the combined drops across resistors $R-2$ to $R-6$ inclusive, all of these being between plate and cathode and totaling 240.4 volts. From this 240.4 volts is subtracted the sum of the voltage drops across the resistors $R-c$ and $R-7$, totaling 114.2 volts and leaving a net plate potential of 126.2 volts. Screen voltage for this tube is equal to the sum of the voltage drops in resistors $R-4$, $R-5$ and $R-6$ (44.5 volts) from which is subtracted the opposed 15 volts from resistor $R-7$, leaving a net screen potential of 29.5 volts.

The input for the circuit of Fig. 2 is applied between the tube's grid and a point between resistors $R-5$ and $R-6$. The control grid bias then is equal to the difference between the drops in $R-7$ and $R-6$, or is 1.5 volts negative for the screen grid tube.

Resistor $R-5$ is a voltage divider or potentiometer which provides a hum bucking voltage opposed in phase to the ripple voltage in this circuit. Suitable bypass condensers are provided and are shown. These latter features have nothing in particular to do with the coupling system. See also *amplifier, Direct Current and Amplifier, Audio Frequency, Resistance Coupled*.

AMPLIFIER, AUDIO FREQUENCY, IMPEDANCE COUPLED.—Impedance coupling or choke coupling employs a coil of high inductance and impedance to provide coupling between the plate circuit of one tube and the grid circuit of a following tube. The principle is illustrated by the diagram in Fig. 1.

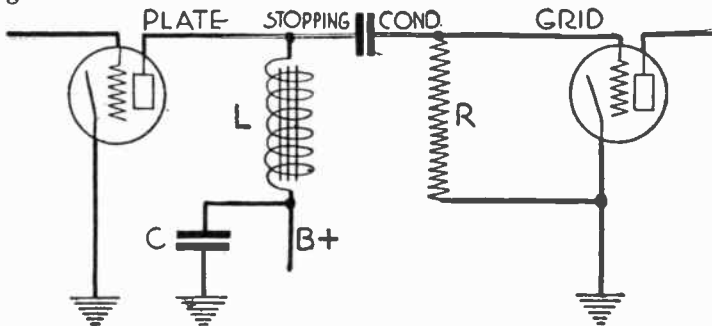

FIG. 1.—Principle of Impedance Coupling.

The plate circuit for audio frequency changes in the left hand tube includes impedance coil L , bypass condenser C and the ground connection to the cathode. The grid circuit of the right hand tube includes the stopping condenser, the coil L , bypass C and the ground connection to this tube's cathode. Thus the coil L is included both in the first plate circuit and the second grid circuit. Signal voltages developed across this impedance by the first tube are applied to the following grid circuit.

The stopping condenser isolates the negatively biased second grid from the positive potential in the first plate circuit and also completes the second grid circuit through coil L . Grid leak R allows escape of excess negative charges from the second grid and allows application of a suitable direct current bias to this grid. The action of this coupling system is similar to that in resistance coupling.

AMPLIFIER, AUDIO FREQUENCY, IMPEDANCE COUPLED

Inductance Required in Chokes.—In order to produce distortionless amplification the impedance of the choke coils or impedance units must be large for reasons which will be explained.

The power in the plate circuit of a tube is divided between the internal resistance of the tube and the external impedance which is furnished by the choke coil. The drop of voltage across the choke is transmitted to the grid of the following tube with but slight loss and it is this voltage applied to the following tube's grid which builds up the signal. The voltage drop across the resistance in the tube is lost so far as amplification is concerned.

In actual practice it is found that with the number of ohms in the external impedance twice as great as the tube resistance in ohms ninety per cent of the tube's maximum possible voltage amplification will be available for amplification by the next tube. With a choke whose impedance is three times that of the tube resistance we will obtain ninety-five per cent of the possible voltage across the choke. With a choke impedance four times that of the tube resistance we will obtain ninety-seven per cent of the possible maximum voltage.

The impedance of the choke changes with frequency, becoming greater as the frequency increases. If we start with an impedance only twice as great as the tube resistance, the changing frequency representing the changing sounds being amplified may cause amplification difference of between ninety per cent

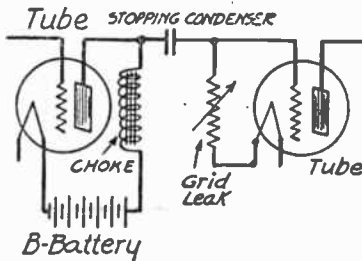

FIG. 2.—The Impedance Coupled Audio Amplifier.

and one hundred per cent, which is ten per cent, a considerable distortion. If we increase the choke impedance to three times the value of the tube resistance the greatest change due to changes of frequency can be only the difference between ninety-five per cent and one hundred per cent, or five per cent. This, of course, is less distortion. Now if we increase the impedance of the choke to four times the value of the tube resistance, which gives ninety-seven per cent of the possible voltage across the choke, the greatest change that can occur between high and low pitched sounds is the difference between ninety-seven per cent and one hundred per cent. This is a difference of only three per cent between the amplification of very low frequencies and of the highest frequencies. A difference as small as this means practically perfect amplification.

The plate resistance of ordinary audio frequency amplifying tubes is in the neighborhood of 10,000 to 12,000 ohms. If we wish an impedance in the choke equal to three times the plate resistance in ohms we must have between 30,000 and 35,000 ohms in the choke and if we want an impedance equal to four times the value of the tube resistance we must have an impedance of 40,000 to 50,000 ohms in the choke. This choke impedance should be figured at the lowest frequencies to be amplified.

In most amplifiers a frequency of fifty cycles is the low limit but in some of the better types frequencies of thirty or even twenty-five cycles are well amplified.

The impedance of the choke coil is composed of inductive reactance due to the choke's inductance, of capacitive reactance due to the distributed ca-

AMPLIFIER, AUDIO FREQUENCY, IMPEDANCE COUPLED

capacity of the choke's winding, and of resistance in the wire of the choke winding. The inductance is the chief factor in this impedance. The distributed capacity reduces the useful impedance and the wire resistance helps the useful impedance provided this wire resistance is not so large that it greatly reduces flow of current in the plate circuit. The effect of the wire's resistance is the same at all frequencies. The useful effect of the inductance increases with increase of frequency and the harmful effect of the distributed capacity also increases with increase of frequency.

The ideal choke would consist of pure inductance, without either distributed capacity or resistance. Some of the well built chokes come reasonably close to this ideal while some of the poorer coupling chokes come far from it.

The lower the internal resistance or plate resistance of the tube the less impedance is required in the choke to produce satisfactory and uniform amplification of all frequencies. The plate resistance of any tube may be lowered by increasing the plate voltage. But no amount of voltage that safely may be applied to a small dry-cell tube will make it the equal of a real power tube. Under most favorable operating conditions the smallest tubes have plate resistances around 15,000 ohms. The ordinary voltage amplifying tubes have plate resistances around 11,000 ohms while power tubes have plate resistances as low as 2,000 ohms in some cases.

The following table shows the inductance in henries required to provide various degrees of uniformity in amplification of sounds having minimum frequencies of twenty-five cycles and of fifty cycles when using tubes having plate resistances of 2000 ohms, 5000 ohms and 10,000 ohms. The great saving in choke size when using power tubes is shown very clearly. The table assumes that the chokes are formed of pure inductance, the capacity and resistance being neglected.

Inductances in henries are given at the intersections of the lines for plate resistance and the columns for percentage of uniformity in amplification. See also *Distortion*.

INDUCTANCES REQUIRED IN IMPEDANCE COUPLING COILS

Tube Plate Resistance in Ohms	Lowest Note—25-cycle Frequency			Lowest Note—50-cycle Frequency		
	90%	95%	97%	90%	95%	97%
	<i>Uniformity</i>	<i>Uniformity</i>	<i>Uniformity</i>	<i>Uniformity</i>	<i>Uniformity</i>	<i>Uniformity</i>
2,000	25	38	50	13	17	25
5,000	65	95	125	31	42	63
10,000	125	190	250	63	84	125

AMPLIFIER, AUDIO FREQUENCY, PUSH-PULL

AMPLIFIER, AUDIO FREQUENCY, PUSH-PULL.—

A push-pull amplifier employs two similar tubes working together in a single stage of amplification. This system is used generally where high quality, high power output is required and is found in radio receivers, in transmitters, in public address systems and in sound picture amplifiers.

A simplified diagram of grid and plate connections for push-pull amplification is shown in Fig. 1. The secondary winding of the input transformer is provided with a center tap connected to the tube filaments or cathodes. The outer ends of this winding are connected to the control grids of the two tubes. The primary winding of the output transformer is similarly center tapped, the tap leading (through the B-supply) to the tube filaments, while the outer ends are connected to the tube plates.

A signal current in the primary of the input transformer induces a corresponding voltage in the secondary winding. It may be assumed that at one instant the upper end of the secondary becomes positive while the

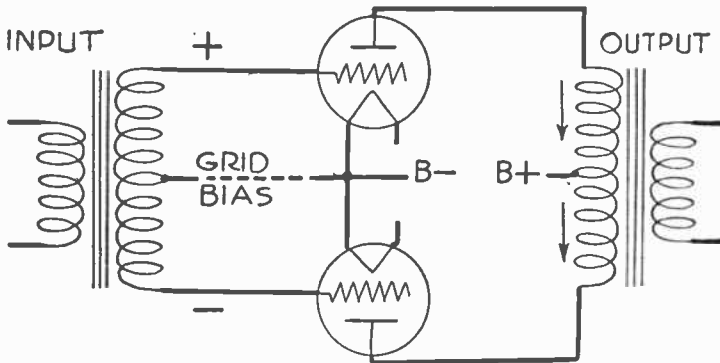

FIG. 1.—Elementary Push-pull Circuit.

lower end becomes negative as indicated in Fig. 1. Then, with reference to the filaments, the upper grid becomes more positive and the lower one becomes more negative. This results in an increase of plate current through the upper tube and in a decrease of plate current through the lower tube. The effective combined result of these current changes is indicated by the arrows alongside the primary of the output transformer. This change of current in the output transformer primary induces a corresponding voltage and current in the secondary of this transformer, which may be connected to a loud speaker, a transmission line or any other load circuit.

It is apparent from Fig. 1 that the signal changes in the two tubes are combined in the output circuit. This is illustrated in the form of a graph by Fig. 2. Here the applied grid voltage and the resulting plate current for one tube are indicated by the full line curves and those for the other tube by broken line curves. The combination of plate currents is effected in the output transformer so that, as indicated at the extreme right hand side of Fig. 2, the total output is much greater than the output from either tube working alone.

The usual power output from a push-pull stage is twice or slightly more than twice the power secured from one similar tube working alone.

AMPLIFIER, AUDIO FREQUENCY, PUSH-PULL

By using about double the usual grid bias with carefully matched tubes it is possible to secure much more than double the power output of one tube, but with all ordinary push-pull applications there is only a doubling of output power. Inasmuch as a similar doubling of power output may be had with simpler connections by using two tubes in parallel, this increase of power is not the chief reason for using push-pull circuits.

The real reasons for employing push-pull amplification include a reduction of harmonic distortion and of amplitude distortion, a

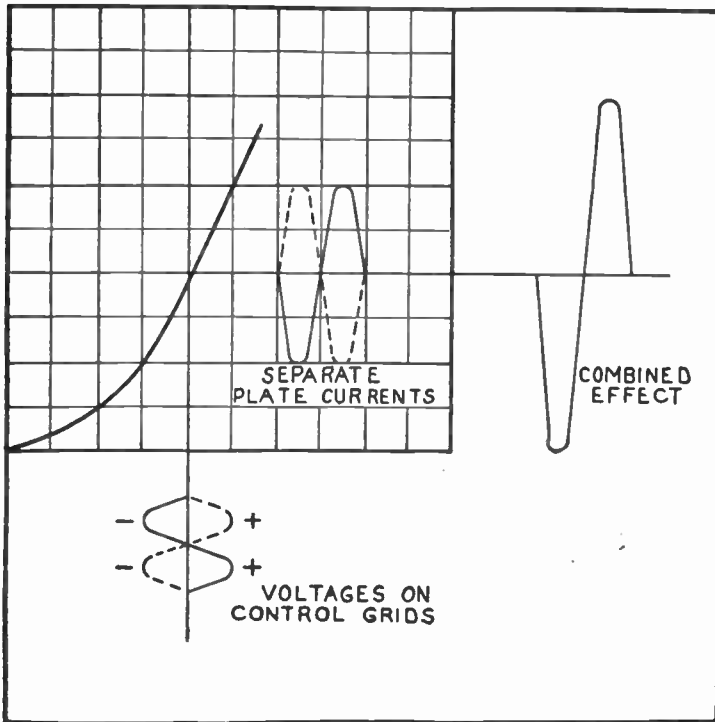

FIG. 2.—Combining Plate Currents in Push-pull Amplifier.

lessening of resistance feedbacks in power supply circuits, a lessened hum pickup and the possibility of simplified filtering in the plate power supply.

The flow of direct plate current through the primary winding of the output transformer is indicated by the arrows in Fig. 3. This direct current flows one way through half the winding and in the opposite direction through the other half. Thus the magnetizing effect of this direct current on the core iron cancels out, and no matter how great the direct plate current it cannot cause saturation of the iron. Large signal currents can then

AMPLIFIER, AUDIO FREQUENCY, PUSH-PULL

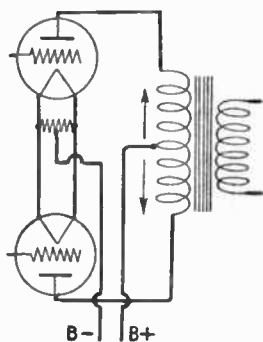

FIG. 3.—D.C. In Output Transformer Primary.

at *b*. The currents add as shown at *c* where it is apparent that the inequalities have disappeared.

produce proportionate changes in magnetic flux rather than being cut off by a saturation bend in the magnetization curve of the iron.

Operation of a single tube on the lower bend of the grid-voltage, plate-current characteristic would cause great harmonic distortion. In a push-pull stage the resulting unequal amplification of positive and negative signal impulses is compensated for as shown in Fig. 4. Again the voltage and current curves for one tube are shown in full lines and those for the other tube in broken lines. At *a* the separate plate currents are indicated and it may be seen that the lower loops are smaller than the upper ones. These large and small plate currents combine their effects in the output, both working together as indicated

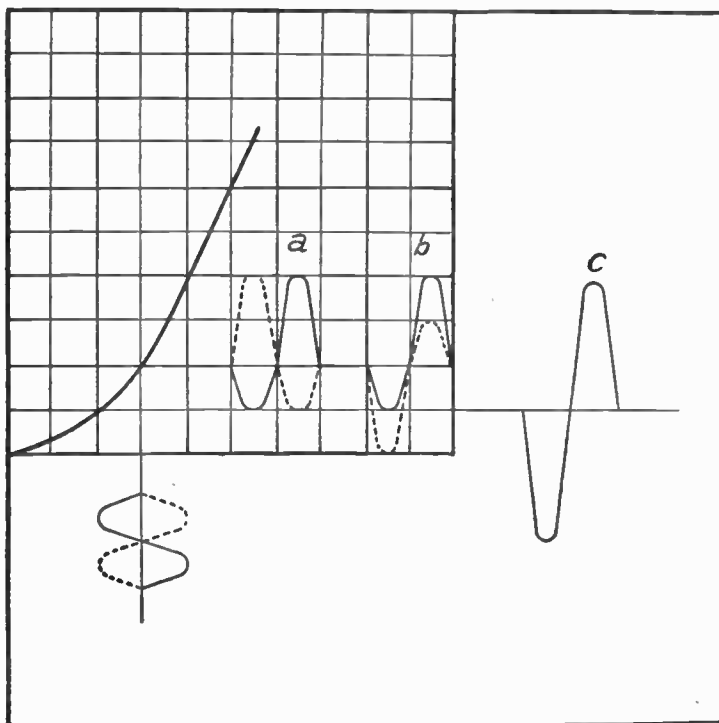

FIG. 4.—Balancing Unequal Changes of Plate Current.

AMPLIFIER, AUDIO FREQUENCY, PUSH-PULL

The elimination of harmonic distortion shown in Fig. 4 actually takes place only when the grid bias or the operating point comes at the middle of a horizontal projection of the curved portion of the characteristic and only when this curved portion is part of a parabola. This point is marked "low bias" in Fig. 5. Any other bias point causes distortion, even with matched tubes. Consequently with commercial push-pull amplification it is not permissible to employ excessive grid bias to allow application of voltages higher than usual in the signal input.

The grid bias for push-pull tubes should be the same as the usual bias for a single tube of similar type *b* in Fig. 5. That is, the

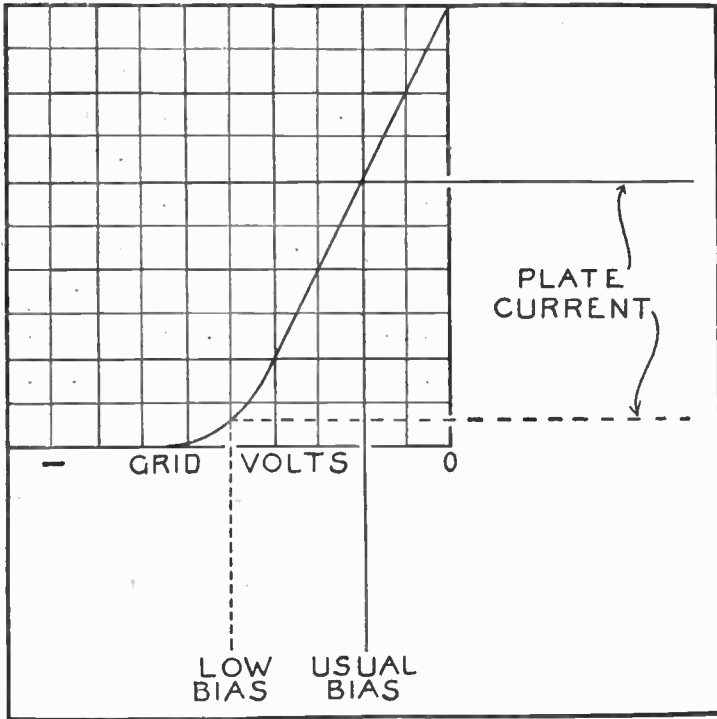

FIG. 5.—Biasing Points on Characteristic Curve.

grid should be so biased as to cause operation at the middle of the straight portion of the grid-voltage, plate current curve, on the negative side of the zero bias line.

Biasing half way down on the bend would mean about double the usual bias, would allow application of about double the usual signal voltage and would result in a far greater power output. This bias on the bend allows each tube to handle only one alternation of the signal wave, the other tube then working down past its point of plate current cutoff and doing no useful work.

AMPLIFIER, AUDIO FREQUENCY, PUSH-PULL

With correct design and layout and with correct operation of a push-pull stage the second harmonic and all other even harmonics are almost completely cancelled in the output. However, the odd harmonics do not cancel and the most serious distortion comes from the third harmonic rather than from the second as with a single tube. The total harmonic

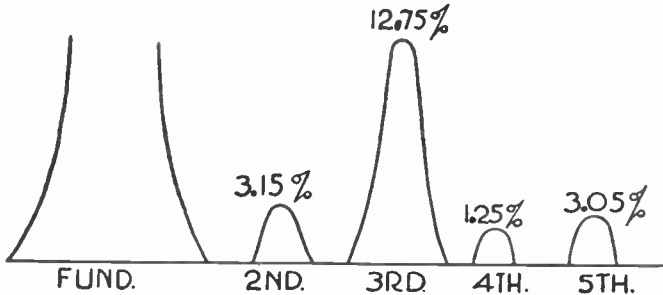

FIG. 6.—Harmonics with Push-pull Amplification.

distortion with push-pull amplification is about one-fifth that with a single similar tube when both systems are operated with optimum loads and voltages. The average relative values of harmonics from the second to the fifth are shown in Fig. 6 for push-pull systems operated with excessive inputs to purposely produce harmonic distortion for measurement purposes.

The various cancellations which take place in push-pull circuits allow use of plate current having much less filtering than is required with other amplifying circuits.

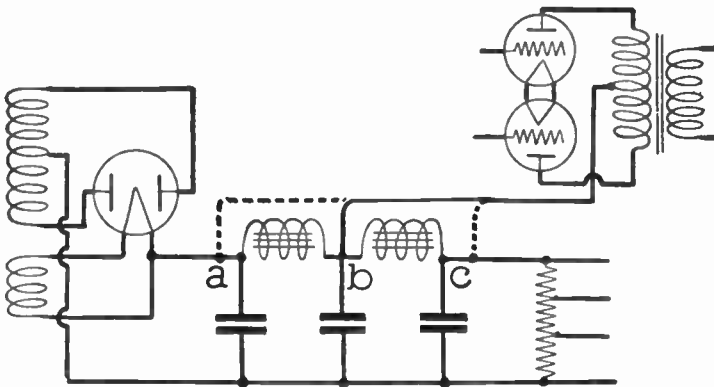

FIG. 7.—Connections of Plate Circuit to Filter.

An ordinary power unit filter system is illustrated in Fig. 7. At point *a* the rectified current has had no filtering, at *b* the current has been filtered by one section and at *c* it has been filtered by both sections. Ordinarily a single power tube is supplied with practically pure direct current for its plate from point *c*. But with push-pull systems it is found possible to take

AMPLIFIER, AUDIO FREQUENCY, PUSH-PULL

the plate supply from point *b* in almost all cases and in some push-pull devices unfiltered rectified current is taken from point *a*. The heavy current for the power tube plates does not pass through any parts of the filter at the right of the take-off point, consequently any filter chokes at the right may be of comparatively small size.

Hum voltages or ripple voltages induced by pickup of magnetic fields in amplifier parts following the push-pull input transformer will cancel in the output because such pickup energy will affect both sides of the circuit equally. However, any ripple picked up in the input transformer or in parts preceding it in the electrical system will be amplified and reproduced.

Cancelling of various distortion effects depends to a great extent on the use of two push-pull tubes which have the same operating characteristics. The tubes should have the same slopes in their grid-voltage, plate-current curves, should have the same mutual conductance and should carry equal plate currents.

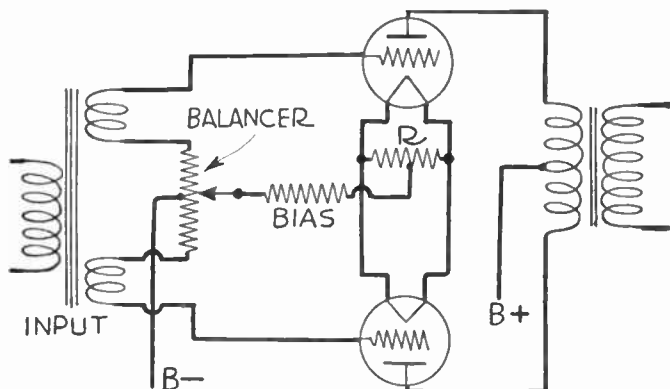

FIG. 8.—Equalizing Plate Currents in Push-pull Tubes.

Even though tubes are well matched when first placed in service, their characteristics change during use and the matching is no longer effective after a short time. Sometimes it is considered desirable to provide means for maintaining equality of plate currents, which may be measured with a milliammeter during service adjustments.

One method of plate current adjustment is illustrated in Fig. 8 where the secondary of the input transformer is in two parts and has a voltage divider between the parts. The center of this divider or potentiometer is permanently connected to B-minus, while the sliding contact connects through the bias resistor to the filament center tapped resistor. Moving the slider increases the bias on one tube while decreasing it on the other, thus allowing equalizing of the two plate currents.

The most serious difficulty encountered with push-pull amplification is that of oscillation at frequencies above audibility. This oscillation results in excessive plate current and in a reduction of useful output power. The greatest tendency toward this form of oscillation is found with tubes having high values of mutual conductance.

AMPLIFIER, AUDIO FREQUENCY, PUSH-PULL

Oscillation is due to tuned circuits formed by inductance and capacity in the amplifier circuits. The capacity may be that between the tube electrodes or it may be the distributed capacity of the transformer windings. The inductance usually is that of the wiring, not that of the transformer windings. In rare cases the transformer winding inductance may tune with the distributed capacity of the winding to tune both the grid circuit and plate circuit, whereupon there is a feedback through the tube capacity to cause oscillation.

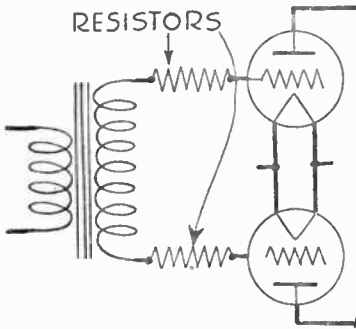

FIG. 9.—Oscillation Prevention.

Oscillation may be suppressed in various ways. One effective method places fixed resistors of from 10,000 to 50,000 ohms or more in both the grid leads as shown in Fig. 9. Unbalancing in push-pull circuits causes troubles which may be remedied by any one or more of the methods illustrated in Fig. 10. Either one or both halves of the input transformer secondary may be bypassed with a condenser or with a resistor and at the same time it may be necessary to insert either a choke coil or a 50,000-ohm resistor in the lead from the center tap of the input transformer to the biasing point or the C-minus connection.

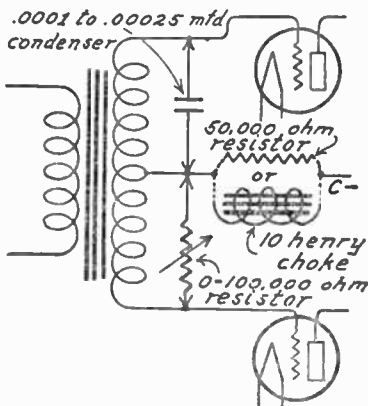

FIG. 10.—Remedies for Unbalance.

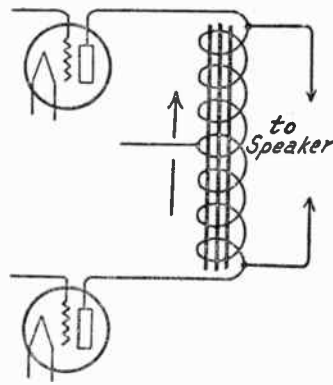

FIG. 11.—Push-pull Output Choke.

In place of the output transformer which generally is employed with push-pull tubes it sometimes is possible to use an output choke connected as in Fig. 11. The two ends of the choke are connected to the tubes' plates and also to the loud speaker or other load. The choke's center tap connects to the plate power supply. Signal voltages combine and direct current effects cancel in the choke just as they do in the transformer primary.

AMPLIFIER, AUDIO FREQUENCY, PUSH-PULL

An output choke cannot be used to match tube impedances which differ widely from load impedances as can an output transformer. For this reason the choke is used only when the tube plate resistance is from 80 to 125 per cent of the load impedance in ohms. Any greater variation calls for the use of an impedance matching transformer.

The load impedance across the outer ends of an output transformer primary or across an output choke is double that which would be used with a single tube rather than the push-pull tubes. That is, each half of a transformer primary or each half of the choke has the same impedance that would be provided in an output transformer primary for a single similar tube.

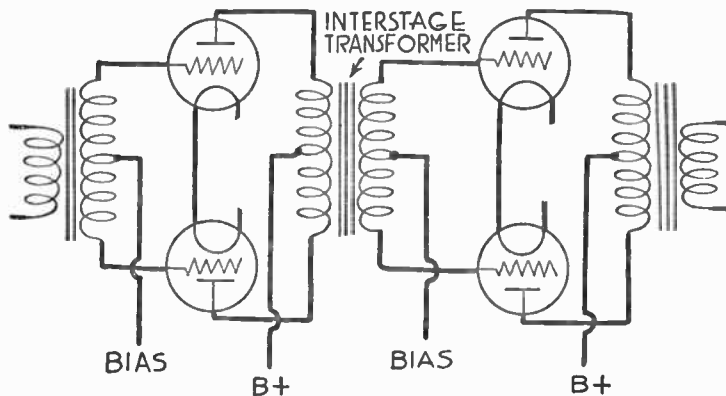

FIG. 12.—Dual Push-pull Amplification.

When large power tubes are used in a push-pull stage they require a signal input of high voltage if the full power output is to be obtained. When a signal sufficiently great cannot be developed with a single tube it is customary to use another push-pull stage preceding the push-pull power stage.

This dual push-pull system requires the use of an interstage transformer having both the primary and the secondary center tapped. The circuit connections can be seen in Fig. 12 where it is shown that the special interstage transformer is the only variation from a single stage of push-pull amplification.

AMPLIFIER, AUDIO FREQUENCY, RESISTANCE COUPLED

AMPLIFIER, AUDIO FREQUENCY, RESISTANCE COUPLED.—Resistance coupling, or resistance-capacity coupling, develops signal voltage changes across a resistor in the plate circuit of one tube and applies these changes through a condenser to the grid circuit of a following tube. Connections for resistance-capacity coupling are shown in Fig. 1.

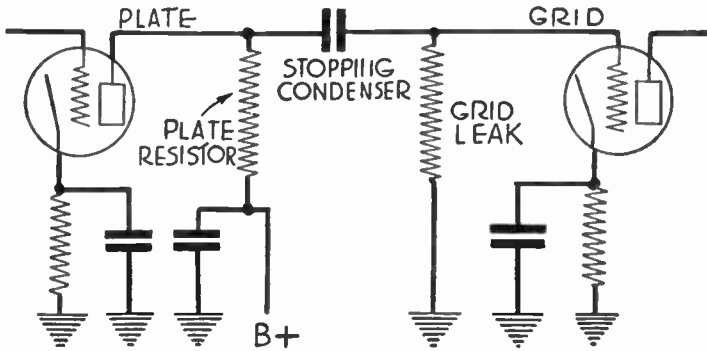

FIG. 1.—Resistance-capacity Coupled Amplifier.

The plate resistor carries direct current plate supply for the first tube, also the plate current variations resulting from a signal applied to the grid of this tube. The stopping condenser, sometimes called the blocking condenser or coupling condenser, transfers the signal variations to the following grid circuit and at the same time keeps the high voltage direct current plate supply of the first tube from affecting the grid of the second tube. The grid leak allows maintaining a suitable grid bias on the second tube.

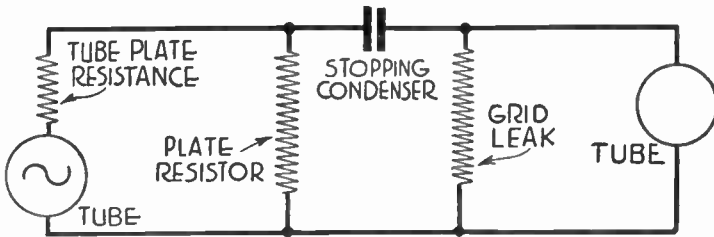

FIG. 2.—Simplified Diagram of Resistance Coupling.

The performance of this circuit may be investigated by somewhat simplifying the diagram as has been done in Fig. 2. Since both the plate supply and the grid biasing arrangements are bypassed they have no effect on the signal currents and may be omitted from further consideration. The first tube is represented in Fig. 2 as a generator of signal voltage in series with its own

AMPLIFIER, AUDIO FREQUENCY, RESISTANCE COUPLED

plate resistance. The second tube is considered simply as a load across which the amplified signal voltage changes are to be applied. It will be found that the voltage applied through a resistance coupling to the grid of the second tube never can be as great as the voltage developed in the plate circuit of the first tube. The amplification of a resistance coupled stage, including its tube, is less than the amplification factor of the tube alone.

In Fig. 3 it may be seen that the voltage applied to the grid of the second tube is that developed across the grid leak, also that the stopping condenser is in series with this leak. The voltage developed across the plate resistor is applied to the stopping condenser and the grid leak in series, therefore this voltage divides between the condenser and the leak. If the condenser reactance is low in comparison with the leak resistance most of the available voltage will appear across the grid leak and will be applied to the second tube.

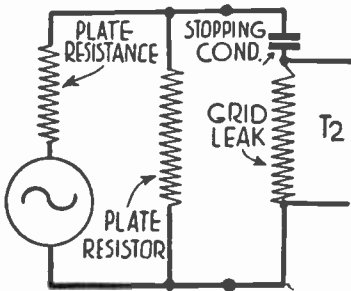

FIG. 3.—Condenser and Grid Leak in Series.

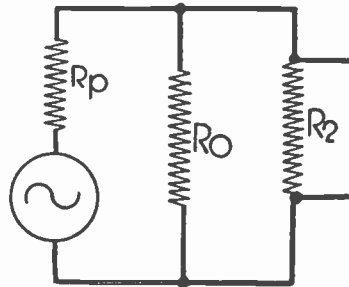

FIG. 4.—Coupling Circuit without Condenser.

The portion of the first tube's plate voltage variations actually applied to the second tube is called the coupling factor and is found from the following formula :

$$\text{coupling factor} = \frac{\text{grid leak resistance in ohms}}{\sqrt{\text{grid leak}^2 \text{ ohms} + \text{stopping condenser}^2 \text{ reactance in ohms}}}$$

This coupling factor will be 0.9 or more unless the capacity of the stopping condenser is made so small that its reactance at the frequency considered becomes equal to more than half the grid leak resistance in ohms. At a frequency of 100 cycles or more this coupling factor of 0.9 or a 90 per cent coupling efficiency, always will be exceeded when the condenser capacities are no smaller than those given below for various grid leak values:

Grid leak in ohms	Capacity in mfd.	Grid leak in ohms	Capacity in mfd.
1,000,000	0.0315	300,000	0.0095
750,000	0.0235	250,000	0.0078
500,000	0.0157	200,000	0.0063

AMPLIFIER, AUDIO FREQUENCY, RESISTANCE COUPLED

By using a suitable capacity the stopping condenser reactance may be made of such small value that it may be neglected, the plate resistor and grid leak then being considered as in parallel with the circuit of Fig. 4, whereupon the effective resistance in the tube's external plate circuit is equal to:

$$\frac{\text{plate resistor ohms} \times \text{grid leak ohms}}{\text{plate resistor ohms} + \text{grid leak ohms}} = \text{effective circuit resistance}$$

Then the nominal amplification of the entire resistance coupled stage, including the tube, is found from the following formula:

$$\text{Stage amplification} = \frac{\text{amplification factor of tube} \times \text{coupling factor} \times \text{effective circuit resistance}}{\text{tube's plate resistance} + \text{effective circuit resistance}}$$

The amplification factor and the plate resistance of the tube may be learned from published characteristics. The effective circuit resistance and the coupling factor are calculated from preceding formulas.

Typical unit values in a resistance coupled stage are shown in Fig. 5, for which the stage amplification may be calculated. To find the coupling factor it is necessary to use the reactance of the stopping condenser at the frequency to be considered. At a frequency of 100 cycles, for example, the reactance of the 0.01 mfd. stopping condenser is approximately 159,000 ohms. Placing this value, and the 500,000 ohms of the grid leak, in the first formula the coupling factor is found to be about 0.953. The effective circuit resistance is calculated from the values of the plate resistor and the grid leak with the second formula and is found to be 115,385 ohms.

Then the nominal stage amplification may be calculated from the third formula by substituting the known values. The amplification is found to be 7.273. Since the amplification of the tube is 8.2, that of the coupling alone must be 7.273 divided by 8.2, which is 0.887 and represents a step-down of voltage.

In determining stage amplification it is highly important that the tube amplification factor and the plate resistance be those actually existing under the operating conditions. Both of these characteristics change quite rapidly with changes in applied plate voltage and grid bias.

It would seem that the reactance of the stopping condenser should be made as small as possible by employing a large capacity. Actually, however, it is found that the capacity of this condenser should be no greater than necessary in obtaining a satisfactory coupling factor at the lowest frequency to be efficiently handled. It is true that a large capacity in the stopping condenser improves the low frequency amplification, but it also may increase the time constant of the combination of stopping condenser and grid leak to such a value that the second tube will block and cease to amplify because its plate current is dropped to zero.

Blocking of the second tube is due to excessive collection of negative electrons on its grid when a large charge is accumulated by the large capacity in a stopping condenser. The blocking will continue until the

AMPLIFIER, AUDIO FREQUENCY, RESISTANCE COUPLED

excess negative charge can pass away from the grid by way of the grid leak to the cathode or filament. Thus, to allow use of a large capacity stopping condenser without danger of blocking it becomes necessary to use with it a low resistance grid leak to allow sufficiently rapid dissipation of the grid's negative charges.

Examination of the formulas for coupling factor and for effective circuit resistance shows that a lower resistance grid leak lowers both of these factors. For example, were the grid leak of Fig. 5 to be made 100,000 ohms instead of 500,000 ohms the coupling factor would drop to about 0.532 instead of its original value of 0.953, and the circuit resistance would drop to 60,000 ohms instead of its former value of 115,385 ohms. These lowered values would bring the stage amplification down to 3.88 from its former value of 7.273. Thus it becomes apparent that use of a low resistance grid leak results in a serious decrease of amplification.

The values of stopping condenser and grid leak actually chosen must represent a compromise between amplification and danger of blocking. The condenser is made of as small capacity as will allow satisfactory low frequency response. Then the grid leak is made of the highest resistance which will not cause blocking of the tube.

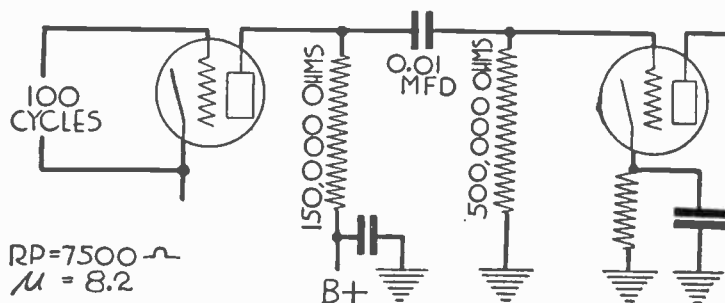

FIG. 5.—Typical Values for Resistance Coupling.

Both the plate resistor and the stopping condenser must be of construction suited to their work. The plate resistor must carry the tube's plate current without overheating. As an example, a tube might require a plate current of 6 milliamperes through a resistor of 50,000 ohms which would mean a power dissipation of 1.8 watts. Allowing the usual safety factor of twice the actual dissipation, this resistor would require a rating of at least 3.6 or probably 4.0 watts.

The voltage drop across the plate resistor must be added to the actual plate voltage to find the voltage required from the source. In the example of Fig. 5 the tube may be assumed to require a plate current of 1.0 milliamperere or 0.001 ampere through the resistance of 150,000 ohms which results in a drop of 150 volts. If the tube requires a plate potential of 65 volts (plate to cathode) the plate power supply must furnish 150 plus 65 or a total of 215 volts, of which all but 65 volts is dropped across the plate resistor.

The stopping condenser must have a high resistance to direct current. Any appreciable amount of direct current passing through this condenser will flow through the grid leak as shown in Fig. 6, making the grid end of

AMPLIFIER, AUDIO FREQUENCY, RESISTANCE COUPLED

the leak more positive, opposing the effect of the regular grid bias, and in extreme cases making the grid bias positive with reference to the cathode. A positive bias or reduced negative bias prevents correct operation of the tube as an amplifier.

The actual operation of a resistance coupled amplifier is seriously affected at the higher audio frequencies by the capacities

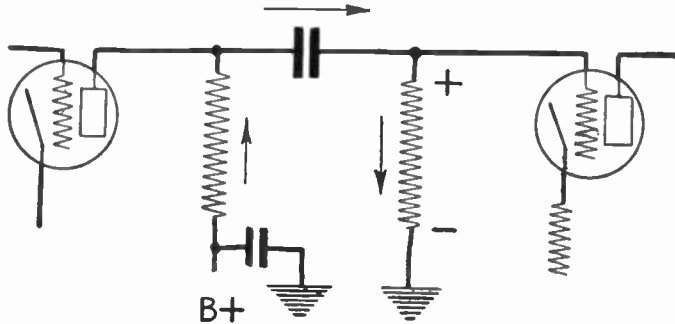

Fig. 6.—Effect of Leakage Through Stopping Condenser.

existing between the tube elements. In commonly used types of tubes the capacity between the grid and the cathode or filament runs between 5 and 7 micro-microfarads, the capacity between plate and filament or cathode is between 5 and 12 mmfds., and in tubes other than screen grid types the grid-plate capacity will range between 5 and 10 mmfds.

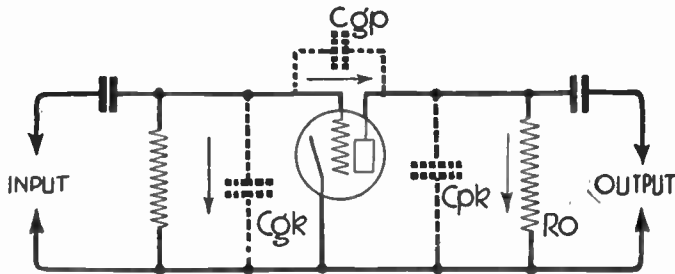

FIG. 7.—Tube Capacities Affecting Amplification.

The plate-cathode and grid-cathode capacities are effectively in parallel with the plate resistor and with the grid leak. Since the reactance of any capacity falls with increase of frequency, the impedances of these parallel combinations of capacity and resistance will fall off with increase of frequency.

The actual bypassing effect of the tube capacities on signal currents is greatly increased by the voltage amplifying action of the tube. The effective input capacity of a tube is not simply the grid-cathode capacity, but is of

AMPLIFIER, AUDIO FREQUENCY, RESISTANCE COUPLED

a value determined by this grid-cathode capacity, by the grid-plate capacity, by the tube's amplification factor and by the resistance or impedance in the tube's plate circuit. The paths for escape of signal currents are indicated by the arrows in Fig. 7.

With tube capacities between 5 and 10 micro-microfarads the effective input capacities of tubes generally employed runs between 50 and 100 mmfds. The decreasing reactance of a 50-mmfd. capacity with increase of frequency from 100 to 30,000 cycles is shown by the reactance curve in Fig. 8. This capacity is in parallel with the resistance of the grid leak so that the impedance of the combination drops with increasing frequency about as shown by the impedance curve in Fig. 8 if the grid leak is of 500,000 ohms resistance. The result is that stage amplification shows a marked falling off toward the higher frequencies.

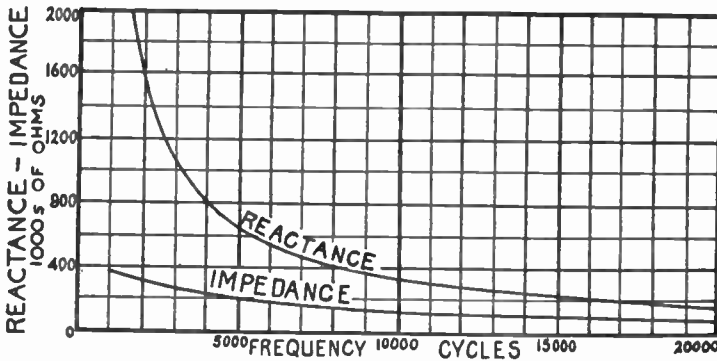

FIG. 8.—Effect of Frequency on Reactance and Impedance.

Non-uniform amplification of frequencies is minimized by using tubes having low plate resistance, but such tubes always have comparatively small amplification factors and thus reduce the amplification at all frequencies. If only one resistance coupled stage is used in an amplifier the load in the plate circuit of the following tube generally will be inductive (a transformer or choke) rather than purely resistive and the high frequency amplification will be improved. Some improvement is made by using a plate resistor having no greater resistance than really necessary, such value being slightly more than twice the plate resistance of the tube.

Screen grid tubes, in which there is but an exceedingly small capacity between control grid and plate, are successfully used in resistance-capacity coupled amplifiers. With suitable plate resistors and stopping condensers it is possible for amplifiers employing these tubes to effectively amplify even the highest audio frequencies.

AMPLIFIER, AUDIO FREQUENCY, TRANSFORMER

AMPLIFIER, AUDIO FREQUENCY, TRANSFORMER COUPLED.—The transformer coupled audio amplifier is more commonly used than any of the other types. In this amplifier the coupling between tubes is formed by an iron-core transformer having separate and insulated primary and secondary windings as in Fig. 1. The cores provide closed magnetic circuits. Audio frequency transformers have step-up turn ratios of from one and one-half to one up to ten to one. The operating characteristics and various details relating to these units are taken up under the heading of *Transformer, Audio Frequency*, which may be referred to. Here are considered only the uses of such transformers in a practical amplifier unit.

As a general rule better and more uniform amplification will be obtained when using low turn ratios rather than high turn ratios in the transformers. Unless the transformers are of large size and have large cores of high grade steel it is not advisable to use ratios greater

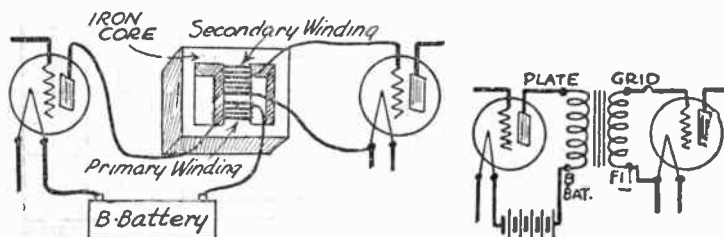

FIG. 1.—Transformer Coupling for Audio Frequency Amplifier.

than three and one-half to one or four to one. Greater volume on some notes may be obtained with ratios as high as six to one or even ten to one but this volume is obtained only on certain frequencies and the amplification at higher and lower notes is far from good.

Factors Affecting Amplification.—The amplification of a transformer coupled stage often is assumed as being equal to the amplification factor of the tube multiplied by the turns ratio of the transformer. Such amplification is not realized in practice because of numerous modifying factors. These factors include the change in transformer primary inductive reactance with change of frequency, the input impedance of the following tube connected to the secondary winding, the transformer leakage reactance, the resistance of the windings and the distributed capacity of the windings. Some of the factors may be allowed for in calculating stage gain, but others cannot be arrived at with any degree of certainty.

An approximation of stage gain in an amplifier such as that of Fig. 2 is given by the following formula:

AMPLIFIER, AUDIO FREQUENCY, TRANSFORMER

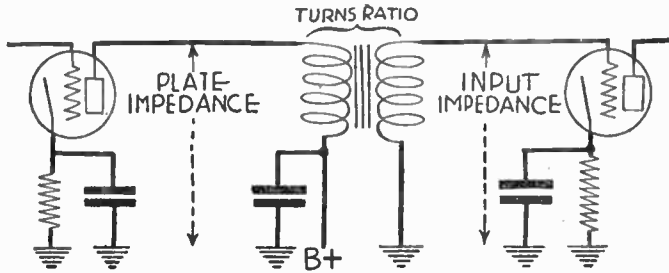

FIG. 2.—Circuit for Transformer Coupling.

$$\text{Stage gain} = \text{tube amplification factor} \times \frac{\text{input impedance} \times \text{turns ratio}}{\text{input impedance} + (\text{turns}^2 \times \text{tube plate resistance})}$$

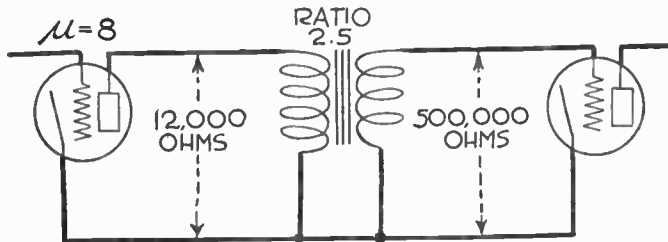

FIG. 3.—Simplified Diagram of Transformer Coupling.

This formula makes no allowance for the effect of frequency on transformer reactance nor does it allow for such factors as leakage reactance and distributed capacity.

Omitting from consideration the plate current supply and the grid biasing resistors, both of which are bypassed to prevent their having any effect on signal currents, the amplifier of Fig. 2 may be redrawn as in

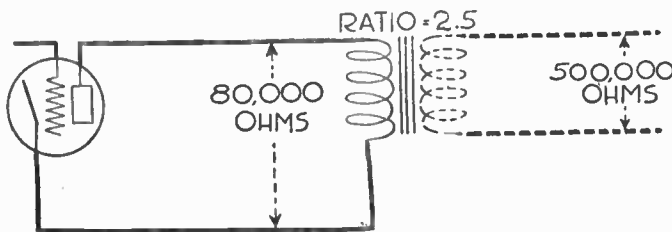

FIG. 4.—Secondary Load as Reflected in Primary.

AMPLIFIER, AUDIO FREQUENCY, TRANSFORMER

Fig. 3 where common values have been assigned for the terms used in the formula. The stage gain calculated from these values is approximately 17.4, whereas the product of the amplification factor (8) and the transformer ratio (2.5) would show a gain of 20.

If the primary inductive reactance be neglected then the apparent resistance of the primary winding depends on the secondary load which, in this case, is the input impedance of the following tube. This reflected value of impedance as it appears in the primary is equal to the following input

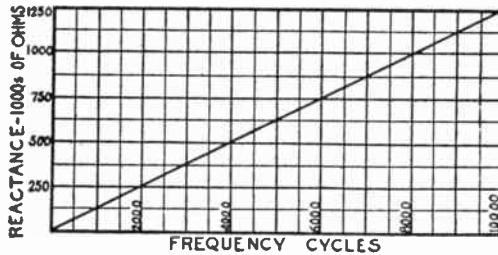

Fig. 5.—Frequency Effect on Inductive Reactance.

impedance divided by the square of the turns ratio. For the values assumed in Fig. 3 the apparent primary resistance is equal to 500,000 ohms divided by the square of 2.5, or is 80,000 ohms as indicated in Fig. 4.

This apparent primary resistance actually is in parallel with the primary's inductive reactance, and this reactance varies directly with frequency. The reactance is small at low frequencies and becomes steadily larger as the operating frequency is increased. The variation of reactance with change of frequency from 100 cycles to 10,000 cycles for a primary inductance of 20 henrys is shown in Fig. 5. This reactance and the apparent resistance in parallel result in a plate circuit resistance which always will

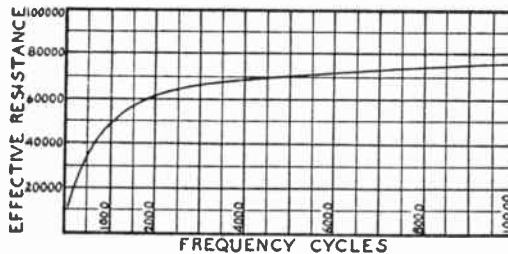

Fig. 6.—Frequency Effect on Apparent Resistance.

be less than the value of either the resistance or the reactance alone. The change in plate circuit resistance with change of frequency is shown in Fig. 6. The small resistance at low frequencies causes a great reduction of amplification at these frequencies.

At high audio frequencies the bypassing effect of the distributed capacity in the transformer secondary winding becomes important. As indicated in Fig. 7 this distributed capacity is in parallel with the input circuit for the following tube and in parallel with this

AMPLIFIER, AUDIO FREQUENCY, TRANSFORMER

same circuit is the inter-electrode capacity of the tube itself. Since the reactance of a capacity falls rapidly with increase of frequency, the impedance of the load across the transformer secondary drops off at the higher frequencies and the high frequency amplification is correspondingly reduced.

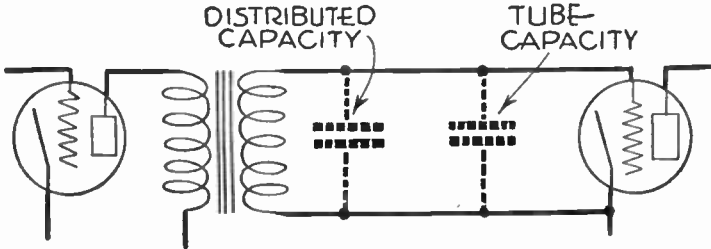

FIG. 7.—Capacities in Transformer Secondary Circuit.

The effect of primary reactance on low frequencies and of secondary reactance on high frequencies is shown by the gain curves of Fig. 8 which are plotted from transformer coupled amplifying stages. At frequencies just below those at which occurs the final falling off in amplification there is a "resonance peak" in both curves. This peak is caused by the transformer's inductance and distributed capacity tuning together to make a circuit which is resonant at these high frequencies. The secondary cur-

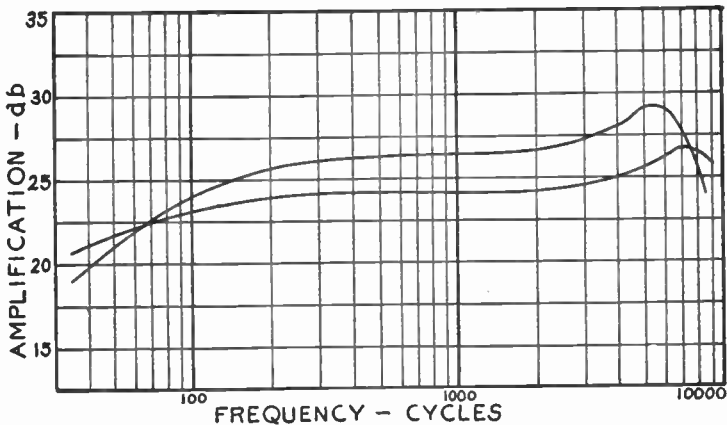

FIG. 8.—Amplification with Transformer Coupling.

rent is increased by this resonance effect at and near one particular frequency and the amplification shows a sudden rise and fall around this frequency.

Transformer coupled audio frequency amplifiers sometimes are subject to oscillation at high audio frequencies or at frequencies above audibility. The result is a reduction in useful power output

AMPLIFIER, AUDIO FREQUENCY, TRANSFORMER

of the tubes, an increase of plate current, and possibly a high pitched heterodyne whistle. Such oscillation generally is due to tuning of the various distributed capacities and tube capacities with inductances in windings and wiring. A remedy consists of placing one or more bypass condensers across the various grid circuits as shown in Fig. 9.

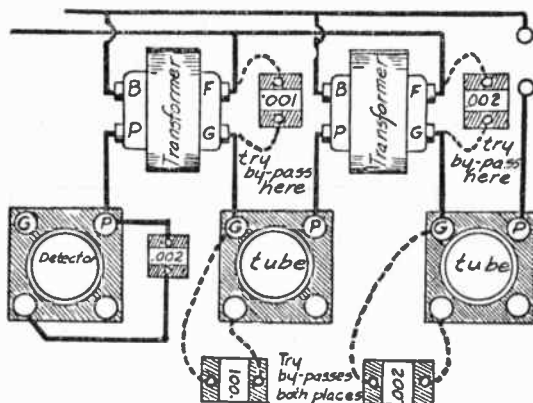

FIG. 9.—Remedies for Oscillation.

Parallel Feed Audio Amplifier.—In the usual connection scheme for transformer coupling the direct current for the plate circuit flows through the primary winding of the transformer. In an alternative design, called parallel plate feed, the direct current for the plate of the preceding tube is carried through an additional choke as in Fig. 10, or through a resistor as in Fig. 11. The plate circuit of the tube is then coupled to the transformer primary through a coupling condenser.

Alternating current or audio frequency changes in the plate circuit then have a choice between two parallel paths; one path being the resistor or choke, the other being the coupling condenser and primary winding of the transformer. The impedance of the choke or the resistance of the resistor is made high in value. The impedance of the path through the coupling condenser and transformer is made reasonably low, at least no greater than the impedance of the choke. Audio frequency current changes then divide, part taking each path. Because of the condenser in one circuit, no direct current can take this path and only alternating current flows through the transformer primary. Relieving the transformer primary of the direct current load avoids the danger of core saturation which exists in small transformers and in those having core material of very high permeability.

The arrangement at the top in Fig. 10 shows the connections when using an ordinary transformer with two separate windings. The regular plate terminal of the transformer is connected to the bias voltage and the grid terminal is connected to the following tube. The regular B-supply terminal and the regular filament or biasing terminal are both connected to the coupling condenser or else are connected together and to the coupling condenser.

AMPLIFIER, AUDIO FREQUENCY, TRANSFORMER

In the lower part of Fig. 10 the transformer with separate windings has been replaced with an auto-transformer with an electrically continuous winding. It will be seen that similarly lettered transformer terminals in the two diagrams are similarly connected. The effect is to increase the turns ratio and the voltage step-up ratio of the transformer. In the upper drawing, were the transformer used in the usual manner with the primary and secondary winding circuits entirely separate, the ratio would be two to one with a secondary having twice as many turns as in the primary. With the auto-transformer connection or with the ordinary transformer connected as in the upper drawing, the primary winding is that part between the coupling condenser and the biasing terminal, while the secondary portion includes the entire winding between the plate terminal and the grid terminal. Thus, the secondary winding, in the case assumed, would have three times the number

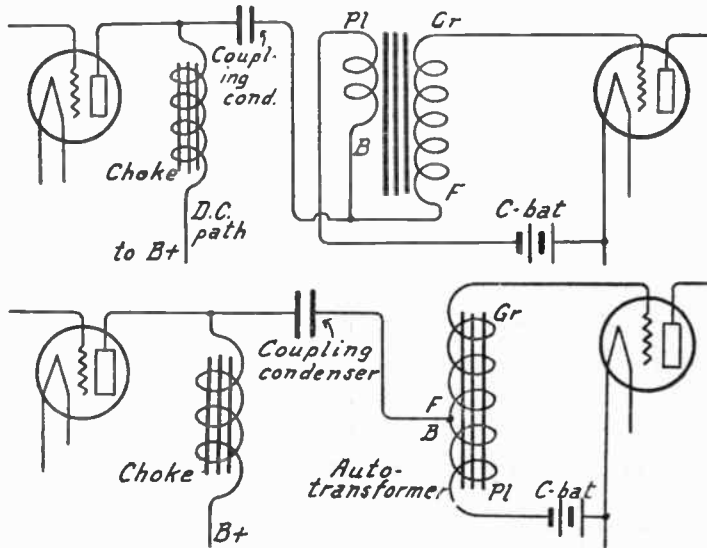

FIG. 10—Parallel Feed Connections for Choke and Ordinary Audio Frequency Transformer.

of turns that are included in the primary portion and the two-to-one ratio transformer becomes one with a three-to-one turns ratio.

Most audio frequency transformers may be connected as indicated at the top of Fig. 10. However, a few units of this kind have their windings reversed from usual practice and in such cases the terminal marked *B* would be connected to the biasing voltage and the terminal marked *Pl* would be connected to the coupling condenser. The transformer may be tried with both connections, the one giving the greatest amplification or volume being that which is correct.

With choke feed to the plate circuit, the choke coil should have an inductance of fifty henrys or more and must be wound with wire large enough to carry the plate current. Speaker coupling chokes and amplifying chokes may be used here. The coupling transformer may be of any value between 0.01 mfd. and 1.0 mfd. depending on whether it is desired to provide a tuned circuit employing the primary of the transformer as the inductance.

AMPLIFIER, AUDIO FREQUENCY, TRANSFORMER

A parallel plate feed through a resistor in place of a choke is shown in Fig. 11. The auto-transformer connections of Fig. 10 might be used here. Direct current for the plate circuit flows only through the resistor while the audio frequency current changes flow through both the resistor and the coupling condenser with its connected primary winding.

The use of a resistor, as in Fig. 11, requires that the power unit B-voltage be greater than when using a choke coil since the resistance of the resistor to direct current is many times greater than the resistance of the choke. In either case the voltage applied to the plate of the tube, as measured between the plate terminal of the tube and B-minus, should be that normally used with the tube being employed. The resistance generally required is some value between 75,000 ohms and 100,000 ohms. The greater the resistance, the more audio frequency energy will be sent through the transformer and the less wasted through the resistance. On the other hand, the higher the resistance, the greater will be the loss of plate supply energy in forcing the direct current for the plate circuit through the higher resistance. The resistance connection is suited only to voltage amplifying types of tubes in which there is a comparatively small plate current. It is not suited to power tubes carrying many milliamperes of direct current for the plate circuit.

With parallel feed it is possible to tune the plate circuit to resonance at some low frequency at which extra amplification is desired. At the resonant frequency there will be a decided increase of audio frequency plate current

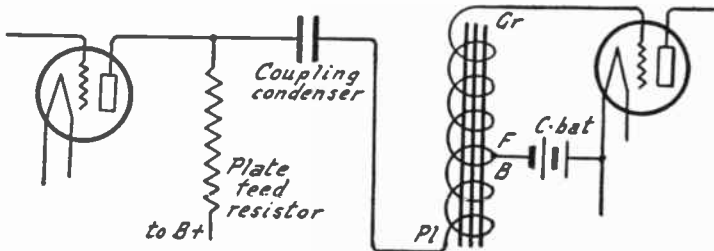

FIG. 11.—Parallel Feed with Resistor and Transformer.

with a corresponding increase of amplification at and near this frequency. The low frequency end of the amplification curve may be thus brought up to the level of the balance of the curve or the low frequencies may even be accentuated.

The coupling condenser and the transformer primary provide capacity and inductance for a series resonant circuit. The reactance of the condenser increases as the frequency drops while the reactance of the primary winding decreases with drop of frequency. Resonance will be obtained at the frequency for which the two reactances become equal. The transformer primary reactance depends not only on the apparent inductance of this winding but also on other factors such as the reactance due to leakage flux. With windings of ordinary proportion the tuning condenser will lie between 0.01 and 0.05 microfarads for resonance between fifty and eighty cycles. If it is not desired to make the circuit resonant at a low frequency, the coupling transformer may have a capacity of from one-half to two microfarads which will increase the amplification at all frequencies over that obtained with the small capacities.

AMPLIFIER CLASSIFICATION

AMPLIFIER CLASSIFICATION.—A “class A amplifier” is one in which the grid bias and exciting grid voltage are so chosen that plate current flows at all times. A theoretically perfect “class A amplifier” produces an alternating component in the plate load which is an exact reproduction of the exciting grid voltage in form, but not necessarily in amplitude. The characteristics of such an amplifier are low efficiency and output.

Class A operation is obtained by choosing a negative grid bias, for a given plate voltage, sufficient to operate the tube at the mid-point of the lower straight portion of its mutual conductance curve. The amplitude of the exciting grid voltage must not exceed a value which would cause the instantaneous grid voltage to fall outside of the confines of this straight portion of the curve.

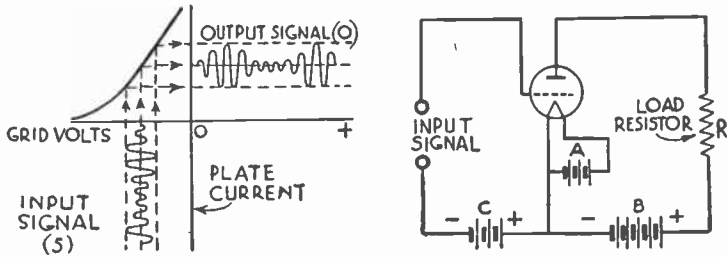

FIG. 1-A.—Class A Operating Characteristics.

B.—Circuit Connections for Class A Operation.

In general, all radio frequency amplifier stages in radio receivers and the majority of audio frequency amplifier stages are of the class A type. When designed correctly, distortion is at a minimum. Where large power output is required, a number of stages are used, terminating in so-called power output tubes operating at high voltage. No current flows in the grid circuit of a class A amplifier, thus preventing a change of input impedance. Inasmuch as no current flows in the grid circuit, it is impossible to rate such an amplifier as to its power conversion gain. The low efficiency is due to the fact that the normal plate dissipation, i.e., $E_p \times I_p$, may be many times greater than the actual output power.

A “class B amplifier” is one in which a grid bias is chosen which just reduces the plate current to zero, with no signal voltage excitation. Plate current flows for 180 degrees of the excitation signal voltage. A perfect “class B amplifier” is one in which the plate wave shape is identical with the half cycle of excitation grid voltage which drives the grid less negative and on the opposite alternation, zero plate current flows. The characteristics of a “class B amplifier” are medium efficiency and output.

When used in audio amplifier circuits two tubes must always

AMPLIFIER CLASSIFICATION

be used in each stage, so connected that their grids are excited 180 degrees out of phase. Each tube amplifies one alternation of the signal voltage, recombination occurring in the common output circuit. A single tube can be used as a "class B amplifier" in tuned radio frequency circuits, the "fly wheel" effect of the tuned circuit serving to supply the missing alternation.

The excitation signal voltage generally drives the grid positive during the conducting alternation, resulting in a flow of grid current. Power is dissipated in the grid circuit, requiring a preceding "driver" stage for full excitation of the class B stage.

The high efficiency of class B amplifiers results from the zero plate power dissipation with no exciting grid voltage. This places a fluctuating demand on the power supply system which requires special treatment of the rectifier and filter. The amplifier is capable of producing large amounts of output power with relatively low plate dissipation. For this reason its advantage is apparent where plate power is derived from a battery source.

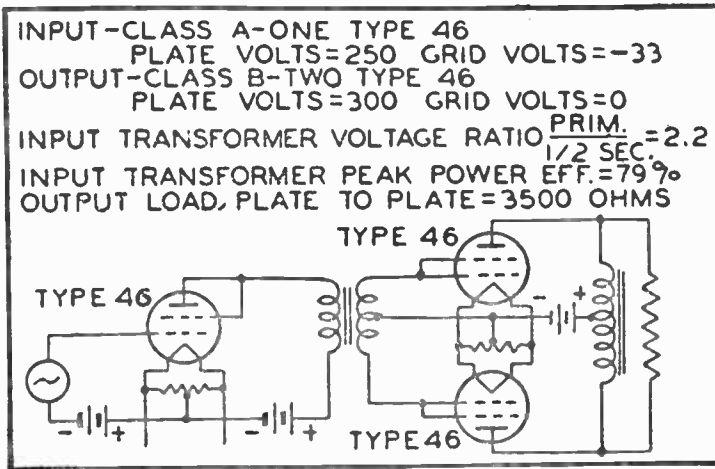

FIG. 2.—Class B Output Amplifier Driven by a Class A Stage.

Noticeable distortion is apparent when a true class B stage is operated at low signal input levels. This is because of the non-linear characteristic of the mutual conductance curve near the zero plate current region. It is not possible to self bias a vacuum tube to cut-off, consequently the grid bias must be taken from an auxiliary voltage source. Tubes are available specifically designed for class B use in which plate current cut-off occurs near the zero grid bias region. The theoretical maximum efficiency of this type of amplifier is approximately 78 per cent. A class B

AMPLIFIER CLASSIFICATION

stage is referred to as a linear amplifier because of the linear relation shown between the excitation grid voltage and plate current.

A "class C amplifier" is one in which the grid bias is appreciably

DYNAMIC TRANSFER CHARACTERISTICS CLASS B OPERATION

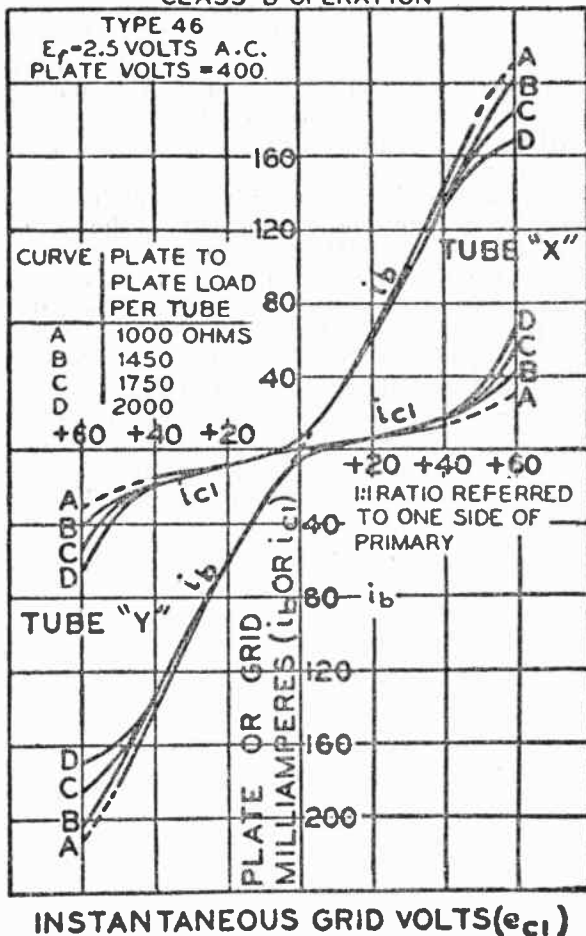

FIG. 3.—Dynamic Transfer of Characteristics of a Class B Amplifier.

ciably beyond the value necessary to prevent plate current flow (generally twice cut-off) and plate current flows for appreciably less than 180 degrees of the excitation grid voltage. The output

AMPLIFIER CLASSIFICATION

plate wave shape and the input signal excitation depart considerably from similarity. The characteristics of the "class C amplifier" are high plate current efficiency and high power output.

Class C amplifiers are used in radio telegraph and telephone transmitters. In a telegraph transmitter all stages are generally operated in this manner, while in telephone transmitters only the modulated amplifier and stages preceding it are operated as class C stages. Excitation is such as to drive the grid so far positive that saturation plate current flows. The efficiency of a class C stage may reach 90 per cent or over in the larger size tubes. These amplifiers are not met with in receiving circuits.

Class AB and BC amplifiers are commonly operated as partially class "A and B" as well as "B and C."

A class AB amplifier is one in which the grid bias and exciting grid voltage are such that plate current flows during more than 180 degrees, but less than 360 electrical degrees of the exciting grid voltage. This is sometimes referred to as class A prime or double A prime. This type of amplifier combines the characteristics of both class A and B.

A "class BC amplifier" is an amplifier in which the grid bias and the exciting grid voltage are such that the plate current flows during less than 180 degrees of the exciting grid voltage, but the bias is not as great as for a class C stage. The characteristics of a "class BC amplifier" are intermediate in efficiency and output to those of class B and class C stages. These amplifiers are not met with in practice.

AMPLIFIER, DIRECT CURRENT

AMPLIFIER, DIRECT CURRENT.—A direct current amplifier is an amplifier containing one or more tubes so operated that application of a steady voltage or a direct current to its input results in a proportionate but larger steady voltage or direct current in the output circuit or load circuit. Direct current amplifiers are capable of magnifying all frequencies from zero up through the audio frequency and intermediate frequency ranges, but are not used for radio frequencies. Other amplifiers especially designed to work at audio, intermediate and radio frequencies are not ordinarily capable of magnifying an unchanging or steady voltage and all are relatively inefficient at frequencies below about twenty cycles. Direct current amplifiers are useful chiefly for experimental work, for laboratory measurements of small quantities, and for television amplification.

Since a direct current will not pass through either a transformer or a condenser in a manner to provide coupling, the connection between tubes in a direct current amplifier may include neither of these elements but must consist of resistances only.

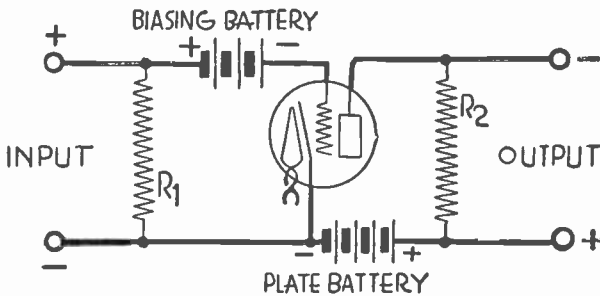

FIG. 1.—Simple Form of Direct Current Amplifier.

The simplest direct current amplifier employs a single tube connected as in Fig. 1 and having its control grid negatively biased to a point that allows the smallest plate current obtainable with operation on the straight portion of the grid-voltage, plate-current curve for the tube. The grid circuit includes the biasing battery and resistor R_1 . The plate circuit includes the plate battery and resistor R_2 .

Application of a steady direct voltage to the input terminals of Fig. 1 causes current to flow downward through resistor R_1 , thus making the upper end or grid end of this resistor become more positive. Since this upper end is connected to the tube's control grid, the grid becomes more positive and causes an increase of plate current through resistor R_2 . This larger current produces a greater voltage drop in R_2 and the lower end of this resistor becomes more positive with reference to the upper end. If R_2 has sufficiently high resistance and if the applied voltage is not so great as to make the control grid positive, then the increase of voltage across R_2 will be greater than the voltage applied to the input and each change of applied voltage will cause a proportionate increase of voltage across R_2 . That is, any voltage applied to the input will be multiplied by a constant factor.

AMPLIFIER, DIRECT CURRENT

Should greater amplification be required a second stage may be added as in Fig. 2 where resistor R_2 , already in the plate circuit of the first tube, now is included also in the grid circuit of the second tube. Since the upper end of R_2 is connected to the second tube's control grid and the lower end to this tube's cathode, the voltage drop across R_2 will apply a negative bias to the second tube. This voltage drop ordinarily is greater than the voltage required for biasing, so part of the voltage in R_2 is balanced out by the second biasing battery which is connected with its positive terminal toward the control grid. Then, for example, were the drop across R_2 to be 25 volts and the second biasing battery one of 22.5 volts potential, there would be the difference of 2.5 volts for negative grid bias.

With a second amplifying stage as in Fig. 2, application of a voltage across the input terminals of the first tube will cause more current to flow in R_2 and will increase the voltage drop in this resistor. This results in

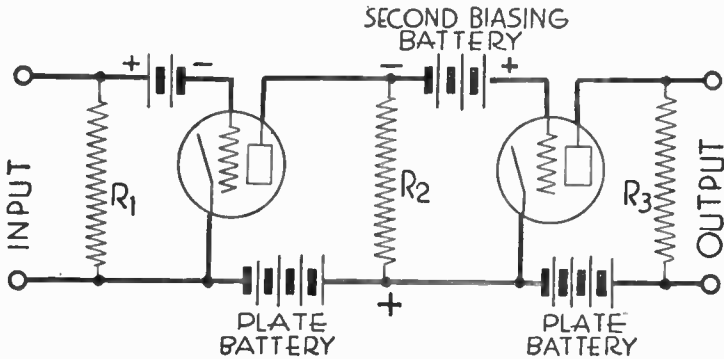

FIG. 2.—Two-Stage Direct Current Amplifier.

the bias on the grid of the second tube becoming more negative which, in turn, reduces this tube's plate current flowing through resistor R_3 . This decreased plate current lessens the voltage drop across R_3 , so it becomes apparent that a voltage applied to the input of the two-stage amplifier results in a decreased voltage at the output. Because of this effect the second tube is provided with a grid bias of such value as to cause operation near the top of the straight portion of the characteristic curve. This means that there is the maximum possible plate current without making the grid positive. The normal action of the two-stage amplifier causes this maximum plate current to be decreased upon application of voltage to the input.

With any odd number of amplifying stages an increase of input voltage causes an increase of output voltage. But with any even number of stages an increase of input voltage causes a decrease of voltage at the output. The control grids of the first, third and other odd numbered tubes are biased to allow minimum plate current, while the second, fourth and other even numbered tubes are biased to allow maximum plate current when no voltage is being applied to the input.

AMPLIFIER, DIRECT CURRENT

The steady plate current and steady direct voltage in the last stage of any direct current amplifier generally are balanced out so that the only voltage applied to a measuring instrument or other load is the change of voltage in this plate circuit, and does not include the voltage drop caused by the steady plate current.

One balancing method is shown in Fig. 3 where the load circuit includes a meter, a balancing battery and a balancing resistor, all connected in series across the output resistor which might be resistor R3 of Fig. 2. Voltage across the amplifier's output resistor is applied to the meter in such a direction as to cause meter current to flow with the full line arrow which is drawn near the meter. The balancing battery is connected so that it causes current to flow in the opposite direction through the meter, as shown by the broken line arrow. The balancing resistor is adjusted so that, with no voltage applied to the amplifier's input, the meter reads zero for an odd number of stages or has a maximum reading if there are an even number of amplifying stages. Then any voltage applied to the amplifier input will cause the meter reading to change proportionately to the applied voltage.

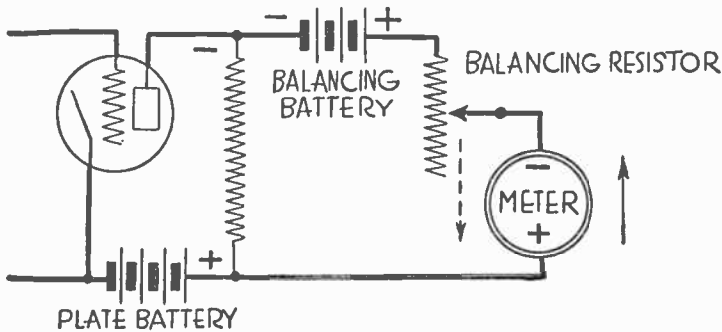

FIG. 3.—Balancing the Plate Resistor Voltage.

It is possible to construct a direct current amplifier to operate without batteries by taking all plate voltages and biasing voltages from suitable taps on a single voltage divider. This method is similar to that described for a direct coupled amplifier under *Amplifier, Audio Frequency, Direct Coupled*.

AMPLIFIER

AMPLIFIER, INTERMEDIATE FREQUENCY.—An intermediate frequency amplifier is that portion of a superheterodyne receiver which has for its input the beat frequency produced by combination of the signal frequency and the oscillator frequency. The amplified beat frequency or intermediate frequency then forms the input for the second detector. See *Receiver, Superheterodyne*.

AMPLIFIER, PHONOGRAPH.—A phonograph amplifier may be any audio frequency amplifier especially arranged to operate with a phonograph pickup as a source of signal voltages. The amplifier may be the audio frequency portion of a radio receiver, or the detector and audio amplifier together, or it may be a separate unit having no other source of input voltage than the phonograph pickup. The operating characteristics of phonograph pickups are described under *Phonograph*.

AMPLIFIER, RADIO FREQUENCY, TUNED IMPEDANCE COUPLED.—The operating principle of the tuned impedance coupled radio frequency amplifier is the same as that of the impedance coupled audio frequency amplifier. In both these types of amplifiers we obtain a drop of voltage across an impedance or a resistance in the plate circuit of one tube, and, through a fixed condenser used as a stopping condenser, we apply the changes in voltage across this impedance or resistance to the grid of the following tube.

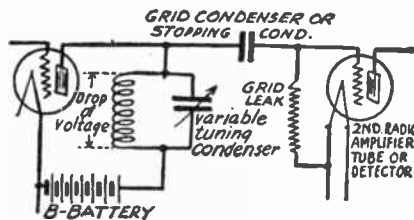

Tuned Impedance Coupling for Radio Amplifier.

The circuit of a tuned impedance coupled amplifier is shown in the diagram. The coupling device consists of a coil and condenser in parallel and placed between the plate of the tube and power unit. By varying the capacity of the condenser the combination is tuned to resonance with the frequency to be received and amplified.

With the coil and condenser tuned to resonance they offer maximum impedance and there is maximum amplification at the tuned frequency. The plate circuit voltages are transferred through the grid condenser to the grid circuit of the following tube.

AMPLIFIER, RADIO FREQUENCY

AMPLIFIER, RADIO FREQUENCY, TUNED TRANSFORMER COUPLED.—A radio frequency amplifier using tuned transformer coupling provides transfer of signal voltage from the plate circuit of one tube to the grid circuit of a following tube by inductive coupling between one winding in the plate circuit and another winding in the grid circuit. Typical connections are shown in Fig. 1.

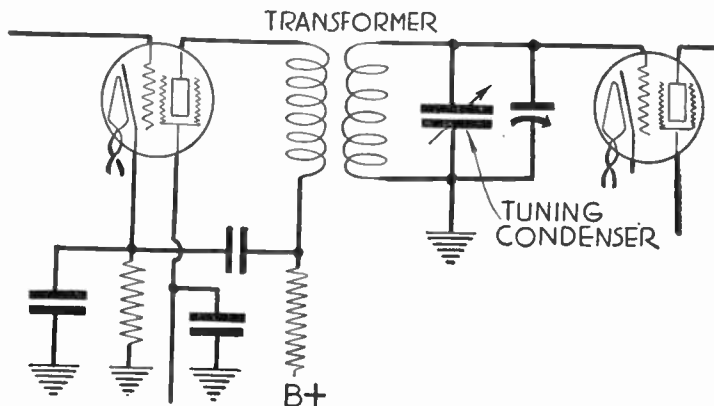

FIG. 1.—Transformer Coupling for Radio Frequencies.

The two windings form the primary and secondary of an air-core transformer, the secondary being tuned to resonance at the frequency to be handled by means of a variable condenser connected across the ends of the winding. In some cases the primary also is tuned either by a variable or a fixed condenser.

The voltage amplification obtained from a stage of tuned transformer coupling depends in the first tube's mutual conductance, on its plate resistance and on the effective resistance offered to signal currents in this tube's plate circuit. The following formula may be used:

AMPLIFIER, RADIO FREQUENCY, TUNED TRANSFORMER

$$\text{Voltage amplification} = \text{mutual conductance} \times \frac{\text{tube plate resistance} \times \text{effective plate circuit resistance}}{\text{tube plate resistance} + \text{effective plate circuit resistance}}$$

Since the tube's mutual conductance is equal to its amplification factor divided by its plate resistance these two factors may be used in place of mutual conductance in the preceding formula which then takes the form:

$$\text{Voltage amplification} = \frac{\text{amplification factor} \times \text{effective plate circuit resistance}}{\text{tube plate resistance} + \text{effective plate circuit resistance}}$$

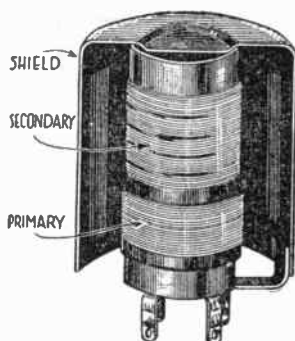

FIG. 2.—Shielded Radio Frequency Transformer.

If the various values are those actually existing together in a circuit both formulas will yield the same result.

The mutual conductance, the amplification factor and the plate resistance may be measured or taken from published specifications. The effective

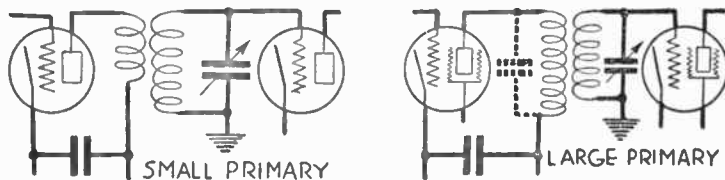

FIG. 3.—Primaries of High and Low Frequency.

plate circuit resistance depends upon the operating frequency, on the high frequency resistance of the transformer winding, and on the turns ratio of the transformer. The following formula gives a value of effective resistance which may be used in ordinary calculations:

AMPLIFIER, RADIO FREQUENCY, TUNED TRANSFORMER

$$\text{Effective plate circuit resistance} = \frac{\left(0.00628 \times \text{frequency in kilocycles} \right)^2 \times \left(\frac{\text{secondary inductance}}{\text{microhenrys}} \right)^2}{\text{secondary high frequency ohms} \times (\text{turns ratio})^2}$$

As an example the amplification may be calculated for the following conditions: Frequency, 1,000 kilocycles. Secondary inductance, 250 microhenrys. High frequency resistance, 15 ohms. Turns ratio, 4 to 3 (secondary to primary) Tube plate resistance, 400,000 ohms. Amplification factor, 400.

Substituting these values in the formula for effective plate circuit resistance the result is approximately 92,500 ohms. This value for plate circuit resistance now may be used in the formula for voltage amplification and the calculation shows a gain of about 75.13 for the stage. This calculated value would be modified in practice by the input impedance and the inter-electrode capacities in the following tube, of which the grid-cathode is connected across the secondary of the tuned transformer.

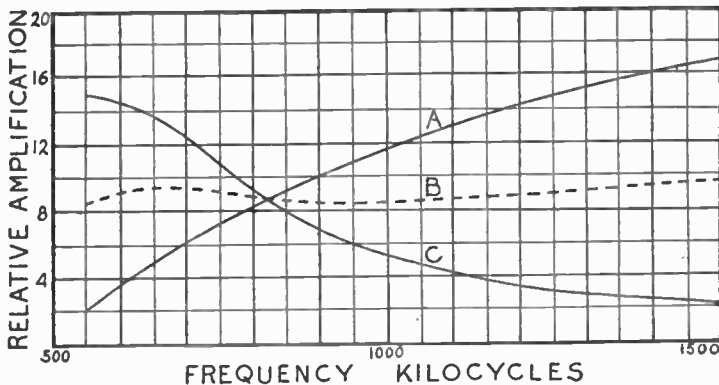

FIG. 4.—Effect of Primary Frequency on Amplification.

These calculations for stage gain assume that the transformer primary winding is untuned and is not resonant at any frequency to be handled. However, in many amplifiers the primary actually is tuned to make the amplification more uniform throughout the operating range of frequencies. If the transformer has no such correction for frequency response the amplification will increase with increase of frequency because the plate load is inductive in such transformers and the inductive reactance increases directly with frequency. This inductive reactance forms the major portion of the plate circuit's effective resistance.

Modern amplifiers employing tuned transformer coupling for radio frequency amplification use screen grid tubes or some modification of these tubes, thus avoiding nearly all of the feedback through tube capacities which was so difficult to overcome with earlier designs using three-element tubes. The transformers generally are placed within individual shields as in Fig. 2 and all of the parts in one stage of amplification are completely shielded from parts in other stages. Conductors common to more than one stage

AMPLIFIER, RADIO FREQUENCY, TUNED TRANSFORMER

are isolated by filtering and bypassing the high frequency currents so that feedbacks external to the tubes are reduced to a value at which self-sustained oscillation is avoided.

The natural tendency with any coupling system which employs inductances is for the amplification to increase with increase of frequency because of the rise occurring in the reactance of any inductance as the applied frequency is made higher. This increase of amplification occurs regardless of the degree of coupling. The variation of amplification is greater with screen grid tubes than with three-element tubes.

At the left hand side of Fig. 3 the transformer primary is of small inductance. Its natural frequency is high, much higher than any frequency to be amplified. The increase of amplification with increase of frequency in such a stage will be about as shown by curve *A* in Fig. 4.

The natural frequency of the transformer primary may be lowered until it is below any frequency to be amplified, this result being secured by the

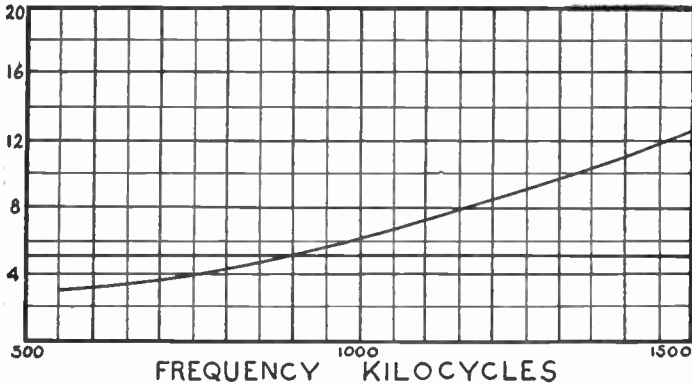

FIG. 5.—Sideband Widths at Various Carrier Frequencies.

use of more primary inductance or by the use of tuning in the primary circuit as indicated at the right hand side of Fig. 3. Now the response of the primary alone will be about as indicated in curve *B* of Fig. 4. The voltage developed across the primary decreases with rise of frequency because this rising frequency departs more and more from the natural frequency or resonant frequency of the primary. The falling off of voltage in the primary, combined with the rise of voltage in the remainder of the coupling system, then will give an amplification curve like that marked *C* in Fig. 4, the gain being nearly constant over most of the tuning range.

The change in primary natural frequency may be applied either to the coupling between tubes as in Fig. 3 or to a transformer in the antenna circuit. An antenna circuit primary tunes with the capacity of the aerial-ground system and with the primary's distributed capacity.

With a small primary or one naturally resonant at high frequencies the plate circuit load acts as an inductive reactance. Feedback of energy through the tube capacity then is in phase with voltages in the grid circuit, the grid voltages are reinforced and there is regeneration or possibly self-sustained oscillation. This

AMPLIFIER

effect may be counteracted by neutralizing or by using any of the methods adapted to reduction of feedback.

If the primary has large inductance and tunes to a frequency lower than the frequency amplified, then the plate circuit load acts as a capacitive reactance and the feedback is in opposite phase to grid circuit voltages. The feedback voltage now opposes the grid voltage and there is a reduction in amplification. Compensation for this effect may be had by allowing a certain amount of in-phase feedback or by allowing regeneration.

The selectivity of any radio frequency circuit depends chiefly on the circuit's high frequency resistance, the greater the resistance, the poorer the selectivity or the broader the tuning. This kind of resistance becomes rapidly larger as the operating frequency is increased, and the tuning becomes broader. The change in broadness of tuning with increase of frequency in a typical radio frequency stage is indicated by the curve of Fig. 5. Ten-kilocycle separation is shown by the horizontal line, and it may be seen that in this particular example it is impossible to attain this degree of selectivity at any frequency above 850 kilocycles, while the tuning below this frequency is so sharp as to cause side band cutting.

AMPLITUDE.—The maximum value of an alternating voltage or current in either direction from zero.

AMPLITUDE DISTORTION.—See *Distortion*.

ANGLE, ELECTRICAL.—The difference in time or in phase between alternating voltages or currents, as measured in a fraction of a cycle called a degree. A complete cycle consists of 360 electrical degrees, just as a circle consists of 360 degrees, and any fraction of a cycle may be specified as a certain number of degrees.

ANGLE OF LAG OR LEAD.—See *Phase*.

ANION.—A negative ion. An atom or molecule which, during ionization, has gained one or more negative electrons and thus acquires a negative charge.

ANODE.—A terminal or an electrode through which an electric current enters an electrolyte, a vacuum or any other medium on its

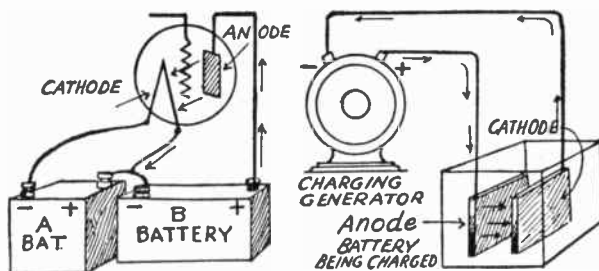

Anodes and Cathodes in Electric Circuits.

ANTENNA

way to the negative side of the source. The anode is therefore the positive terminal of an electric source such as a battery, or is the electrode connected to this positive terminal. In a vacuum tube the plate is the anode while the filament is the cathode. See also *Cathode*.

ANTENNA.—The antenna includes the wires or conductors which extend outside of the receiver proper and which are affected

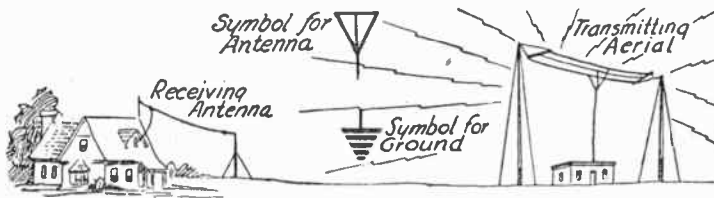

FIG. 1.—Relation of the Antenna and Aerial.

by the signals coming from a radio transmitter or broadcasting station. The type of antenna now being considered consists of one or more wires elevated some distance above the ground as in Fig. 1.

These wires form one plate of a large condenser whose other plate is the ground or earth. The antenna and ground have the air between them acting as the dielectric of this condenser.

Between antenna and ground connections in the receiver there is always an inductance, a coil. The inductance of the coil together

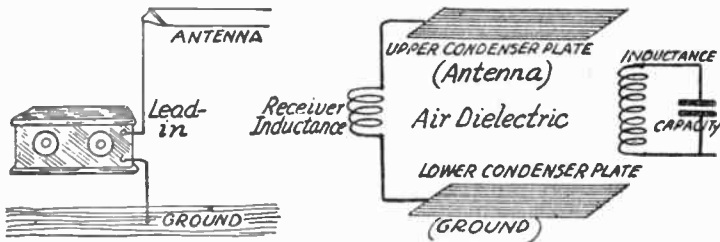

FIG. 2.—The Principle of the Capacity Antenna.

with the capacity of the antenna form an oscillatory circuit which responds to the frequency of the radio waves coming through the air from a broadcasting station. Oscillating currents are set up through the antenna, the coil and the ground. The inductance in the receiver is coupled to the tuning device, to the radio frequency amplifier or to the detector so that the signals coming in on the antenna are detected and amplified in the receiver.

The form of antenna which is generally used is called an open antenna, a capacity antenna or a plate antenna. Under the head-

ANTENNA, CAPACITY AND INDUCTANCE

ing *Loop, Antenna Action of* is considered a form of antenna which does not form a capacity or a condenser. The principle of the capacity type of antenna is shown in Fig. 2. All wave antenna—See Receiver Short Wave.

ANTENNA, CAPACITY AND INDUCTANCE OF.—

The antenna system consists of the horizontal wires or antenna proper and the vertical wires or lead-in. Considering only the horizontal portion, the capacity of the antenna increases almost directly with its length up to about one hundred feet but increases less rapidly for greater lengths. This might be expected since an increase of antenna length increases the size of the plates of the condenser which is formed by antenna and ground.

There is only a small change in capacity as the height of the antenna above the ground is increased above thirty feet. From a height of thirty feet up to a height of one hundred and twenty feet the decrease in capacity is only about seven per cent, but as the antenna is lowered under thirty feet the capacity increases quite rapidly. This effect also might be expected because lowering the antenna brings the plates of this big condenser closer together.

The capacity of a vertical lead-in wire increases directly with the length of the lead-in. The capacity of the lead-in must be added to that of the antenna to obtain the total capacity of the whole antenna system.

In the following tables the left hand columns give the height of the antenna in feet. The columns toward the right cover various lengths of antenna from thirty to one hundred feet. At the intersection of the vertical and horizontal lines will be found the capacity of the horizontal wires measured in micro-microfarads.

CAPACITY OF HORIZONTAL SINGLE WIRE ANTENNA

Antenna Height in Feet	Horizontal Portion of Antenna—Length in Feet				
	30 ft.	45 ft.	60 ft.	75 ft.	100 ft.
20 ft.	59 Mmfds	83 Mmfds	111 Mmfds	139 Mmfds	179 Mmfds
30 ft.	58 Mmfds	81 Mmfds	109 Mmfds	131 Mmfds	175 Mmfds
40 ft.	57 Mmfds	80 Mmfds	107 Mmfds	123 Mmfds	173 Mmfds
60 ft.	57 Mmfds	80 Mmfds	105 Mmfds	121 Mmfds	171 Mmfds
100 ft.	56 Mmfds	79 Mmfds	104 Mmfds	119 Mmfds	169 Mmfds

In the next table, which is similar to the preceding one, is given the capacity in micro-microfarads of the horizontal portion of the antenna and also the capacity of the vertical lead-in. Preceding the hyphen is the capacity in micro-microfarads of the horizontal portion and following the hyphen is the capacity of the vertical lead-in. Thus, for an antenna 60 feet long and 40 feet high the capacity of the horizontal portion is 107 micro-microfarads and of the vertical portion or lead-in is 71 micro-microfarads, a total of 178 micro-microfarads for the entire antenna system. The capacity of the lead-in must always be added to that of the antenna.

ANTENNA, CAPACITY AND INDUCTANCE

CAPACITY OF ANTENNA AND LEAD-IN—MICRO-MICROFARADS

Antenna Height in Feet	Length in Feet of Horizontal Portion of Antenna				
	30 ft. <i>Hor.-Vert.</i>	45 ft. <i>Hor.-Vert.</i>	60 ft. <i>Hor.-Vert.</i>	75 ft. <i>Hor.-Vert.</i>	100 ft. <i>Hor.-Vert.</i>
20 ft.	59-40	83-40	111-40	139-40	182-40
30 ft.	58-56	81-56	109-56	131-56	175-56
40 ft.	57-71	80-71	107-71	123-71	172-71
60 ft.	57-103	80-103	105-103	121-103	170-103
100 ft.	56-166	79-166	104-166	119-166	168-166

The effective capacity of the antenna system is somewhat greater at the higher frequencies or lower wavelengths used in broadcasting than at the other end of the scale. Taking the effective capacity at 1000 kilocycles or approximately 300 meters as represented by 100 per cent the following changes are found in practice: At 1500 kilocycles or 200 meters the capacity is 120 per cent and at 600 kilocycles or 500 meters it is 90 per cent of the value at 1000 kilocycles.

Inductance of Antenna.—The horizontal portion of the antenna and the vertical lead-in not only have capacity but also have inductance even though they are composed of straight wires. The following table is similar to the one preceding but gives the inductance in microhenries of the horizontal portion of the antenna and of the vertical lead-in. The number preceding the hyphen gives the inductance of the horizontal antenna and the number following the hyphen gives the inductance of the vertical lead-in.

INDUCTANCES IN ANTENNA SYSTEMS—MICROHENRIES

Antenna Height in Feet	Length in Feet of Horizontal Portion of Antenna				
	30 ft. <i>Hor.-Vert.</i>	45 ft. <i>Hor.-Vert.</i>	60 ft. <i>Hor.-Vert.</i>	75 ft. <i>Hor.-Vert.</i>	100 ft. <i>Hor.-Vert.</i>
20 ft.	20-10	30-10	41-10	50-10	68-10
30 ft.	20-15	30-15	41-15	51-15	69-15
40 ft.	20-21	30-21	42-21	52-21	71-21
60 ft.	20-34	31-34	42-34	53-34	72-34
100 ft.	20-61	31-61	42-61	53-61	73-61

The inductance of the antenna and the lead-in are not lumped inductances as found in coils but are distributed over the whole length of these wires. These distributed inductances are due to the ability of the wires to generate an electric field about them. For this reason the total inductance of antenna and of lead-in is not as great as the sum of their separate inductances as would be the case with lumped inductances in series. Nor is it as small as the inductances of the two in parallel. Practice shows that the approximate effective inductance of antenna and lead-in may be found by adding the two together and dividing their sum by three. Thus, for an antenna system forty-

ANTENNA, CIRCUIT OF

five feet long and forty feet high it is seen that the inductance of the horizontal portion is 30 microhenries and of the vertical portion 21 microhenries. Their sum is 51 microhenries and the approximate effective inductance is one third of 51 or 17 microhenries.

ANTENNA, CIRCUIT OF.—The antenna circuit includes the horizontal antenna wires, the lead-in and all the connections up to the receiver, the inductance or capacity which is inside the re-

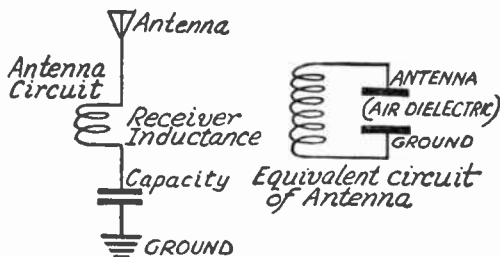

The Antenna Circuit and Its Electrical Equivalent.

ceiver, the ground lead from the receiver and the ground itself which forms the lower plate of the antenna system.

ANTENNA, CLOSED.—A loop antenna is called a closed antenna. See *Loop*.

ANTENNA, COIL TYPE.—In general a coil type of antenna is a loop antenna. See *Loop*. One end of a large coil of wire is sometimes connected to a receiver for use as an antenna, the other end of the coil being left open.

ANTENNA, CONDENSER FOR.—See *Condenser, Antenna*, also *Antenna, Tuned*.

ANTENNA, CONDENSER TYPE OF.—See *Antenna*.

ANTENNA, COUPLING OF.—The general custom in coupling the antenna to the first tuned circuit in the receiver is to use a very small coil of only a few turns of wire in series with the antenna as in Fig. 1. This small coil absorbs only a very little energy from the tuned circuit in the receiver and tuning is fairly sharp. However, the signal power with such an arrangement is not as strong as when the antenna itself is tuned to the frequency being received. The looser the coupling the sharper the tuning and the closer the coupling up to a certain point, the greater the amount of power or energy received from the antenna.

With the antenna coupled very loosely to the first tuned circuit the capacity and inductance of the antenna have but little effect on this first tuned circuit. As the degree of coupling is increased some of the antenna capacity and inductance are, in effect, added to the tuned circuit and if a variable condenser is used for tuning this circuit a lower setting or less capacity will be required because of the effect of the antenna which takes the place of part of the condenser's capacity. This is the reason why condenser settings for a certain frequency or wavelength will change when the antenna coupling is

ANTENNA, COUPLING OF

changed in receivers using variable antenna coupling to control the selectivity or sharpness of tuning.

The coupling of the antenna to the coil of the first tuned circuit may be reduced by reducing the number of turns in the antenna coil. It may be reduced by moving the antenna coil farther away from the coil which is tuned by the condenser or by turning the antenna coil and the tuned coil at greater and greater angles to each other. When they are at right angles the coupling is practically zero and the antenna's capacity and inductance will have very little effect on the tuning. All of these changes are shown in Fig. 1.

The form of antenna coupling shown in Fig. 2 provides maximum selectivity and very satisfactory operation in general. The antenna coil and the tuned coil are placed at right angles with each other and in line so that there is practically no inductive coupling between them. The antenna coil is composed of two windings, one having

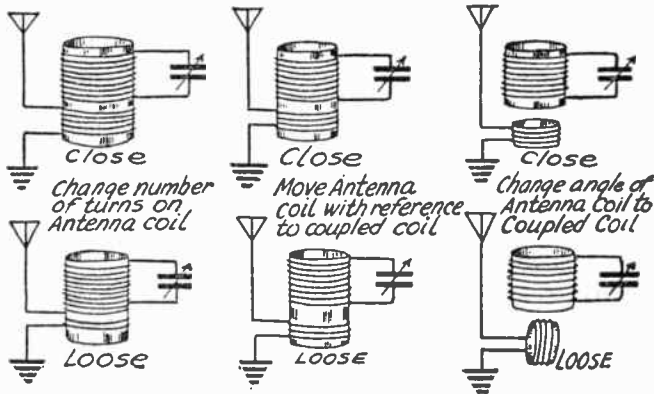

FIG. 1.—Close Coupling and Loose Coupling of Antenna Circuit.

four to six turns connected between the antenna and ground, the other having an equal number of turns in series with the tuning coil. The tuning condenser is connected across the two coils so that the entire winding of the large coil and the few series turns on the small one are both in the resonant circuit. The two windings on the antenna coil may be separated by one-quarter to one inch depending on the degree of selectivity required.

There is a certain best coupling for the antenna as far as signal strength is concerned. By starting with an extremely loose coupling secured with the antenna coil and tuned coil very far apart or at right angles to each other or by using but few turns in the antenna coil, the signal strength will be weak. By gradually increasing the degree of coupling the signal strength will become greater, although the tuning will become somewhat broader at the same time, until a maximum signal strength is reached. Then with still closer coupling, the signal strength will become less. There are two reasons for this effect. First, a very closely coupled antenna absorbs power from the first tuned circuit or places a load on this tuned circuit. Second, with very close

ANTENNA, DIRECTIONAL EFFECT

coupling the tuned coil and the antenna coil form a combination which responds not only to one frequency or wavelength but almost as well to another frequency or wavelength which is different from the first. The difference

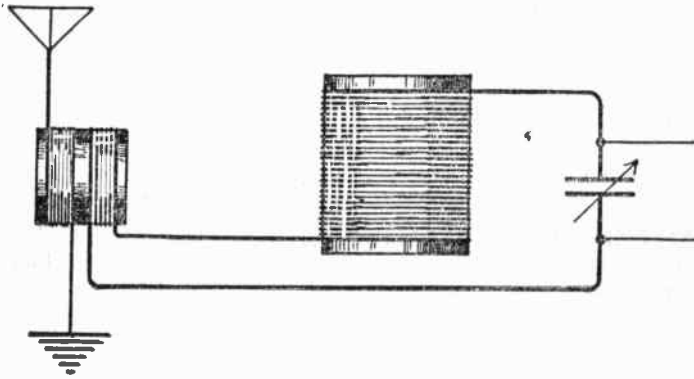

FIG. 2.—Separate Coupling Coil for Antenna Circuit.

between these two frequencies becomes greater as the coupling is increased and with very close coupling the antenna tuner will respond to either one of these frequencies. See *Coupling, Optimum*.

The use of a coupling tube to prevent antenna inductance and capacity from affecting the first tuned stage is found in some receivers.

The use of a tapped antenna coil or coupler to obtain various degrees of coupling is shown in Fig. 3. This changes the number of active turns in the antenna coil.

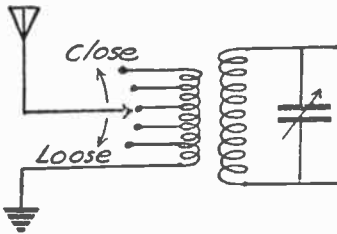

FIG. 3.—Tapped Coil for Antenna Coupling.

ANTENNA, DIRECTIONAL EFFECT OF.—It is often found that signals will be received best from a direction opposite to that in which the antenna runs from the receiver. If the antenna end points westward best reception may be from points to the east. Unless the antenna is at least one hundred feet long it will show no directional effects regardless of the direction it runs and will receive just as well from one point of the compass as from any other. Any apparent directional effects are due to local conditions such as interference of trees and buildings and antenna location in general.

ANTENNA, FORMS OF.—Receiving antennas of the outdoor type usually consist of a single straight wire open at one end and connected to the receiver at the other end. This is called an L-type antenna or an inverted L antenna. A connection is sometimes made to the center of the elevated wire rather than to one of its ends and the resulting antenna is called a T-type antenna.

ANTENNA, FRAME

Antennas placed indoors may be of the familiar type consisting of a single wire attached to the receiver or of the loop type. Both of these are described under their respective headings.

Transmitting stations use various forms of aerials that are seldom if ever duplicated as to form in receiver installations. A cage aerial or antenna consists of several parallel wires supported around the edge of frames so that they have somewhat the appearance of a squirrel cage. Umbrella aerials consist of a number of wires radiating from a central support and slanting downward toward the earth at their outer ends. The conductors of a fan or harp aerial radiate upward from a central point to a supporting wire across the top.

ANTENNA, FRAME.—Another name for a loop. See *Loop*.

ANTENNA, FUNDAMENTAL FREQUENCY OF.—The fundamental frequency of an antenna is the frequency to which the antenna's inductance and capacity are resonant in themselves. In an actual receiver installation the fundamental frequency of the entire antenna circuit is determined by the antenna's inductance and capacity together with the inductance of any coil and the capacity of any condenser placed in this circuit. The antenna system will respond best to frequencies below its natural frequency or to wavelengths above its natural wavelength.

The fundamental frequency of an antenna circuit may be found from the effective inductance and effective capacity in the system. These values for various heights and lengths of single wire antennas are given under *Antenna, Capacity and Inductance of*. The following formula is used:

$$\text{Antenna Frequency in Kilocycles} = \frac{159.3}{\sqrt{\text{Effective Inductance} \times \text{Effective Capacity}}}$$

The following table gives the approximate fundamental frequencies in kilocycles and the wavelengths in meters of antenna systems of various heights and lengths when there is no extra capacity or inductance placed in the antenna circuit by condensers or coils used in or with the receiver.

FUNDAMENTAL FREQUENCIES AND WAVELENGTHS OF ANTENNAS

Antenna Height in Feet	Length in Feet of Horizontal Portion of Antenna									
	30 ft.		45 ft.		60 ft.		75 ft.		100 ft.	
	<i>Kilo-C Meters</i>	<i>Meters</i>	<i>Kilo-C Meters</i>	<i>Meters</i>	<i>Kilo-C Meters</i>	<i>Meters</i>	<i>Kilo-C Meters</i>	<i>Meters</i>	<i>Kilo-C Meters</i>	<i>Meters</i>
20 ft.	5060	59	3940	76	3145	95	2650	113	2100	143
30 ft.	4360	69	3515	85	2875	104	2475	121	1980	151
40 ft.	3720	80	3085	97	2655	113	2325	128	1855	162
60 ft.	2950	102	2550	118	2200	136	1910	157	1625	185
100 ft.	2060	145	1840	163	1655	182	1530	196	1305	229

ANTENNA, HEIGHT AND LENGTH

If a concentrated inductance in the form of a coil is placed in the antenna circuit, its inductance is added to the effective inductance of the antenna and lead-in and the resulting total inductance is used in the preceding equation for antenna frequency. The two inductances are considered as in series and are added together.

If a fixed or variable condenser is used in series with the antenna and lead-in the capacity of this series condenser must be taken into account when using the formula for antenna frequency. For use in that equation the value of total capacity of antenna, lead-in and condenser is found as follows:

$$\text{Total Capacity} = \frac{\text{Capacity of Series Condenser} \times (\text{Capacity of Antenna} + \text{Capacity of Lead-in})}{\text{Capacity of Series Condenser} + \text{Capacity of Antenna} + \text{Capacity of Lead-in}}$$

All of the tables and equations for antenna fundamental frequencies and wavelengths assume that the antenna is free from the effects of objects such as trees, buildings and metal bodies in its field. It is seldom possible to erect an antenna system under such ideal conditions and the fundamentals of actual installations may vary widely from the figures given. The relations between frequencies for different lengths and heights of antennas will, however, remain in the same ratios to one another when conditions are similar for the installations.

ANTENNA, HEIGHT AND LENGTH OF.—The effective height of antenna is considered from the electrical and not the physical standpoint. The effective height is less than the physical height

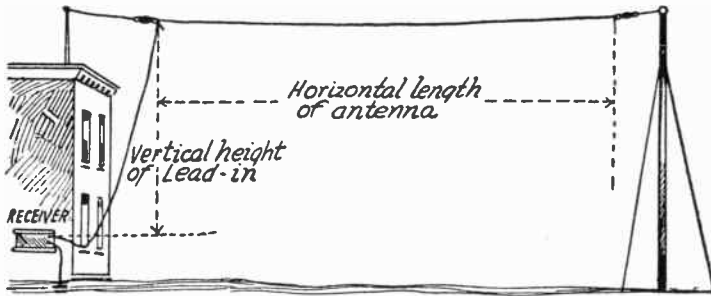

Physical Length of an Antenna and the Height of Its Lead-In.

because of objects in the antenna field. The higher and longer an antenna the more powerful will be the signals brought in, but unfortunately the louder will be all forms of interference as well. An antenna has no power of selection in itself and it takes exactly what the ether gives it.

A high antenna brings in lots of signal and also lots of interference, such as static. As the antenna is lowered the signal strength becomes less but it does not fall off as rapidly as the static, in other words, a low antenna gives a material gain in the ratio of signal to

ANTENNA, INDOOR TYPE

static. By a low antenna is meant one only five, ten or fifteen feet high, or at least one that is less than thirty feet high.

Of course this low antenna will not bring in such powerful signals but a good receiver will amplify its weaker signals to a point that is entirely satisfactory. There is a sort of superstition that thirty feet is the right height for an antenna. This is not based on any exact rule because the best height depends on particular conditions.

As a general rule it is best to have the horizontal or straight part of an antenna at least sixty to seventy-five feet long. This does not mean that excellent work cannot be done with fifty feet or less but seventy-five feet may be better. An antenna more than one hundred feet long, that is, with the straight horizontal part more than one hundred feet long, is not required by modern receivers. With many of the better sets the results will not be as good with one hundred and fifty to two hundred feet of antenna as with one hundred feet or less, considering selectivity, static interference and everything else that goes to make or mar satisfactory reception.

All of this advice applies to antennas used for broadcast receiving. Reception from long-wave commercial stations will require a much longer antenna, while short-wave reception among the amateurs will call for a much shorter antenna.

The best length of antenna depends on local conditions and on the type of receiver being employed. The following list gives lengths that are generally satisfactory. These lengths are the sum of the horizontal portion of the antenna, the lead-in to the receiver, and the ground connection from the receiver.

For receivers having six or more tubes.....	40 to 50 feet
For five tube, tuned radio frequency sets..	60 to 75 feet
For four tube sets with one radio stage....	80 to 100 feet
For three tube regenerative receivers....	100 to 120 feet
For one tube sets, crystal sets, etc.....	100 to 150 feet

ANTENNA, INDOOR TYPE.—An indoor antenna consists of twenty feet to one hundred feet of wire attached to the antenna terminal of a receiver and strung either in a straight line in the interior of a building or carried on various supports in various directions through the rooms of a building. This wire may be covered with insulation or it may be bare and supported on objects which are in themselves insulators.

An indoor antenna may be placed in a long room such as an attic with the use of the same insulators and supports employed in outdoor antenna construction. At the other extreme of construction we find a piece of wire laid along the picture moulding in one or more rooms with no extra precautions as to insulation. Either type will work but the more careful the construction the better will be the results.

An indoor antenna will not deliver as strong impulses to the receiver as would be delivered by an outdoor antenna of the same size but if the receiver has sufficient amplification the results may be surprisingly good. A receiver

ANTENNA, INDUCTANCE OF

with one stage of radio and two of audio frequency amplification operated with an indoor antenna will deliver loud speaker volume from stations two hundred miles away under favorable conditions. With two stages of radio frequency amplification this distance range will extend to about five hundred miles. An indoor antenna increases selectivity and reduces the effects of static and interference in general.

ANTENNA, INDUCTANCE OF.—See *Antenna, Capacity and Inductance of.*

ANTENNA, INSULATORS FOR.—The end of an antenna farthest from the receiver should be supported with an insulator made especially for this purpose. Good insulators are made of porcelain, glass, or of high grade moulded insulating materials. Glass is excellent but well glazed porcelain is probably as good as glass as long as the glaze is not chipped or cracked.

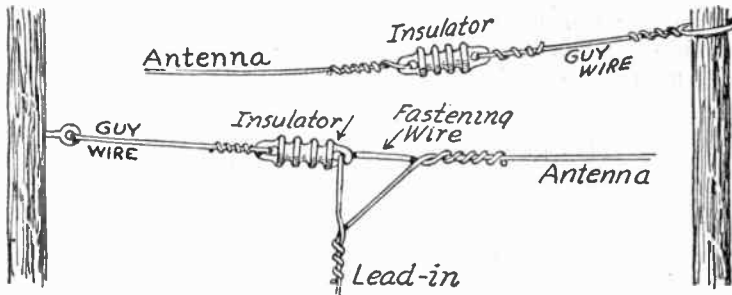

FIG. 1.—Installation of Antenna Insulators.

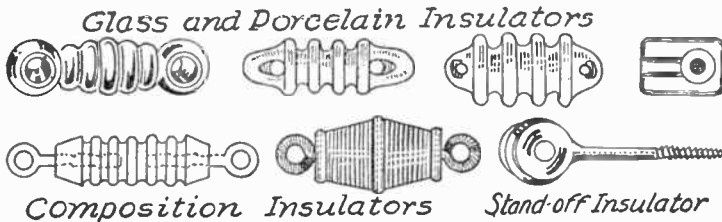

FIG. 2.—Types of Antenna Insulators.

The far end of the antenna should be fitted with one or two of these insulators as in Fig. 1. To the far end of the insulator should be attached at least five to ten feet of strong galvanized wire or any other strong wire. This is used for making the mechanical connection to whatever post or other support is used.

If it is necessary that the antenna turn any corners it should be held well away from walls or posts by using stand-off insulators as in Fig. 2. A stand-off insulator consists of a piece of glass or porcelain that holds the antenna wire and is itself held by a metal rod or flange that may be fastened to the wall, post or roof edge around which the antenna turns the corner. There should be at least two inches of insulating surface between the antenna wire and the nearest part of the metal support.

ANTENNA, LEAD-IN

Many stand-off insulators are made with a porcelain bushing, that is, a piece of porcelain with a hole through it, which is held in an eye formed on the metal bolt or screw. These are not as good as the form which provides a greater length of insulating surface between the antenna and the metal support.

ANTENNA, LEAD-IN FOR.—The lead-in includes all antenna circuit connections starting from the horizontal part of the antenna, running down into the building and to the receiving set. If there is anything more generally neglected than the antenna itself it is the lead-in. Too many radio enthusiasts seem to think that the chief purpose of the lead-in is to provide a final disposition for any scrap wire lying around the premises.

The first rule for the lead-in is to make it short. A lead-in, like an antenna, has inductance, capacity and resistance, but the inductance and capacity of the lead-in cannot be used to such good advantage as when in the antenna itself. To take an extreme case, a lead-in one hundred feet high used with an antenna only thirty feet long would have three times the inductance and capacity of the

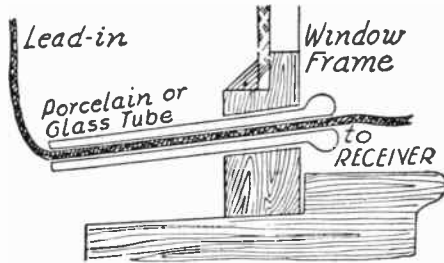

Antenna Lead-in Carried Through Tube.

antenna itself, but if the lead-in for this thirty-foot antenna were reduced to forty feet its inductance and capacity would be only about twenty per cent more than that of the antenna.

The lead-in is a part of the antenna circuit and within practical limits the lead-in should be kept away from everything. This does not mean that an entire pane of glass should be removed from a window to provide an opening into the building but it does mean to use stand-off insulators wherever they are required. Because insulated wire is used for a lead-in does not mean it may be dropped over the edge of a roof without any protection. There is no objection to using insulated wire for the lead-in if the wire is properly supported, but neither is there any advantage.

The lead-in wire from the antenna should be supported by insulators so that it is at least two or three inches away from all walls, ceilings, mouldings, etc., in the room through which it passes on the way to the receiver.

Sometimes the lead-in is connected near the center of the antenna rather than at one end. Then the effective length of the antenna is equal to about half its actual physical length or half that

ANTENNA, LIGHT AND POWER CIRCUIT

of an antenna of the same length in feet but having the lead-in at one end. Where the lead-in enters the building it should run through a porcelain or glass insulator. Such an insulator may be passed through a nine-sixteenths inch to three-quarter inch hole bored in the window frame.

The outer end of the lead-in wire should be scraped perfectly clean and a secure mechanical joint made between it and the end of the antenna wire, which also has been thoroughly cleaned of all insulation or oxide. This joint should then be thoroughly soldered. If it is impossible to solder the joint, wrap it tightly with tin foil, then cover the foil with a layer of rubber tape followed by a layer of friction or insulating tape. If rubber tape is not available use two layers of friction tape and cover the outside with a heavy coating of shellac.

If the lead-in wire enters a wall or window through a porcelain tube insulator, drill the hole for the insulator at a slant so that the outdoor end will tilt downward, thus preventing entrance of rain into the building.

In case it is objectionable to bore holes in window frames it will be best to open a window from the top, pass the bushing through this opening and push the window up against the bushing to hold it. If this lets in too much air, fit a piece of wood into the remaining part of the opening.

Various kinds of special lead-ins may be purchased. Some of these consist of a flat ribbon of copper encased in a covering of insulating fabric. Such a device may be laid over the window sill and the window closed tightly on it. The danger in this construction comes from the fact that the insulating covering may be broken through so that water from rain or snow will ground the antenna, which means weak signals or no signals in the receiver.

Never use a lead-in device in the ends of which wires are held by spring clips or similar devices. All such joints will corrode in wet weather and this means that beyond such a point the antenna might just about as well be disconnected. Every joint from the farthest end of the antenna to the binding post in the receiver must either be soldered or else solidly bolted and well shellacked to keep water from the joint.

After the lead-in has entered the building it will have to be carried along walls, base-boards or mouldings until it reaches the receiver. This inside part should be made of well insulated stranded copper wire. From the standpoint of appearance a silk covered wire is best, although any other insulated wire will be as good from the standpoint of radio reception. As a final precaution, bring the lead-in from the building entrance to the receiving set in the straightest line possible, in a line with the fewest possible turns.

ANTENNA, LIGHT AND POWER CIRCUIT FOR.—

The wiring of the light and power circuits of any public service company may be made to act as a fair antenna. Of course, it would not do to connect such wires directly to the antenna post of a receiver but by placing a fixed condenser between the light or power wires and a wire leading to the antenna post of the receiver, the radio impulses which are always present in such wires are carried into the receiver without interruption.

ANTENNA, MULTIPLE RECEIVER CONNECTION

ANTENNA, MULTIPLE RECEIVER CONNECTION TO.—A single outdoor antenna may be used as a source of signal energy for two or more receivers with circuits arranged to allow each receiver to select any desired station regardless of the stations

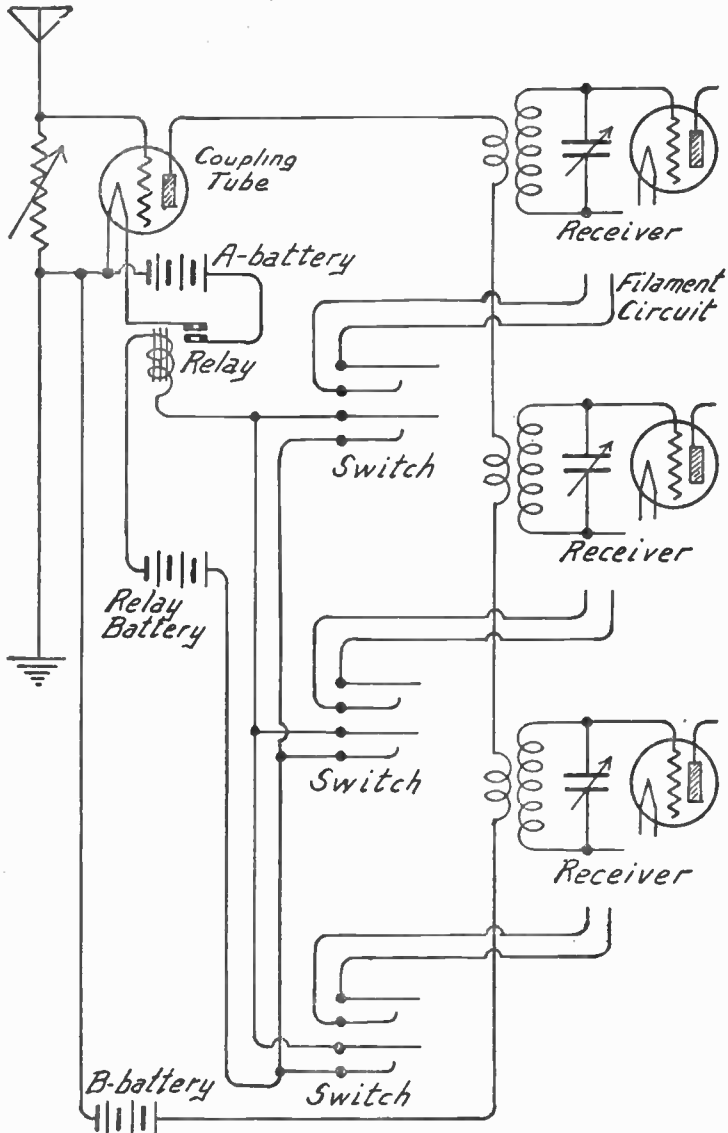

Connections for Operating Several Receivers from One Antenna.

ANTENNA, OPEN

tuned in by others using the same antenna. The connections are shown in the diagram.

Between the antenna and the ground is a variable high resistance and across this resistance is placed the grid circuit of a common coupling tube. The plate circuit of this coupling tube passes through any number of primary windings in radio frequency coupling coils of the separate receivers. The common plate circuit carries all signal frequencies reaching the antenna.

Each receiver uses the coupling coil as the primary winding of a radio frequency transformer in the first tuned circuit of the receiver. The balance of the receiver may consist of any combination of radio frequency amplifying stages, detector, and audio frequency amplifying stages.

Near each receiver is placed a double-pole, single-throw switch which is arranged to close the filament circuits or A-battery circuit of the receiver at the same time it closes an auxiliary circuit which lights the filament of the common coupling tube through a relay.

The coupling tube has its own filament battery which is connected to the contacts of a relay. The relay is connected to each of the double-pole switches at the receivers in the manner shown. Closing the switch at any receiver will light the tube filaments in the receiver and at the same time will energize the relay magnet so that the common coupling tube is placed in operation. The coupling tube will remain lighted as long as any receiver switch remains closed and will go out when the last receiver switch is opened.

While this arrangement allows simultaneous reception from one antenna at various frequencies, it greatly reduces the strength of signal in comparison with that received from the same antenna without the coupling tube in use. A great portion of the energy collected is allowed to leak away to ground through the resistance. If the resistance is made excessively high in an attempt to avoid this loss, the receivers connected to the circuit will become unstable and will have a noticeable tendency to pick up and amplify all kinds of interference, even that from power supply units which would be unnoticed ordinarily.

Reception from local and nearby stations is satisfactory with this scheme of coupling. There is an advantage in the fact that the effect of static disturbances is greatly reduced below their normal strength, the reduction of static being considerably greater than the reduction of signal so that the signal-static ratio is improved. The same method of antenna coupling is used in single control receivers to prevent the antenna inductance and capacity from affecting the first tuned circuit.

ANTENNA, OPEN.—A capacity type of antenna or an antenna consisting of one or more elevated wires and a ground between which is connected the receiver.

ANTENNA, RESISTANCE OF.—See *Resistance, Antenna.*

ANTENNA, TELEVISION

ANTENNA, TELEVISION.—Nearly every practical type of television antenna is either a half-wave dipole or some modification of this fundamental form. The principle of the half-wave dipole is illustrated by Fig. 1. Two conductors, usually pieces of metallic tubing, are supported horizontally in line with each other and at right angles to the direction of wave travel of the signals. During one instant of time, indicated at the left, the electric field of the electromagnetic wave is acting in one polarity. At a time one half-cycle later the

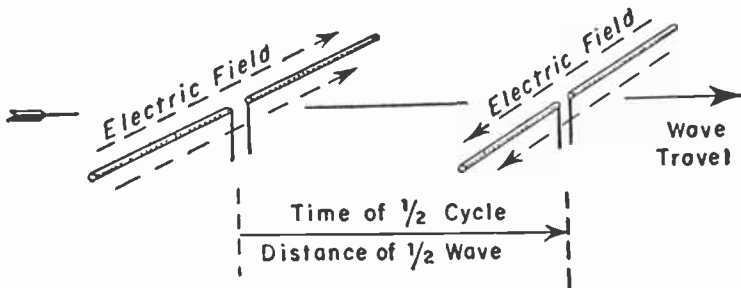

FIG. 1.—Induction of signal currents in a half-wave dipole antenna.

polarity of the electric field will have reversed, as at the right, and during this interval of time the wave will have traveled a distance of one half-wavelength.

Free electrons in the antenna conductors are caused to surge back and forth by reversals of the electric field. The antenna conductors are made of such overall length that concentrations or surges of electrons have just time to move from one end to the other during a half-wave of the signal or during a half-cycle of the signal frequency. When antenna length and signal wavelengths are thus suited to each other, the signal

ANTENNA, TELEVISION

will induce in the antenna maximum electron movements or maximum signal currents. With other relations between antenna length and signal wavelength the electron movements cannot remain in phase with changes of electric field in the signal, and currents induced in the antenna will be smaller.

Electron movements induced in the antenna conductors act through the transmission line and input circuits of the receiver. Fig. 2 shows the connections for a simple straight

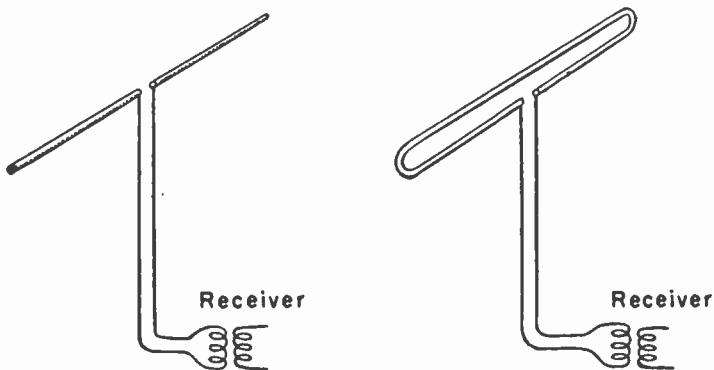

FIG. 2.—Connections to receiver input from a single straight dipole and from a folded dipole.

dipole at the left, and for the modified form called a folded dipole at the right.

The simple dipole and all its many modifications are resonant antennas which behave toward received signal energy like series resonant circuits tuned to the frequency at which a half-wavelength is equal to the effective length of the antenna conductors. At this frequency there is minimum impedance to signal currents, as shown by Fig. 3. For the simple half-wave dipole with straight conductors this impedance is approximately 72 ohms. The impedance of any half-wave antenna increases at all other frequencies, both lower and higher.

ANTENNA, TELEVISION

For any given strength of transmitted signal reaching the antenna, the strength of signal currents delivered from the antenna will be inversely proportional to antenna impedance. Consequently, the response always is maximum at the frequency for which a half-wavelength equals the effective length of the antenna. The response of the simple straight dipole is too sharply peaked to allow a single antenna to provide satisfactory reception for all channels in the low band or for all channels in the high band television ranges except in localities where signals are fairly strong. Modified forms of the dipole

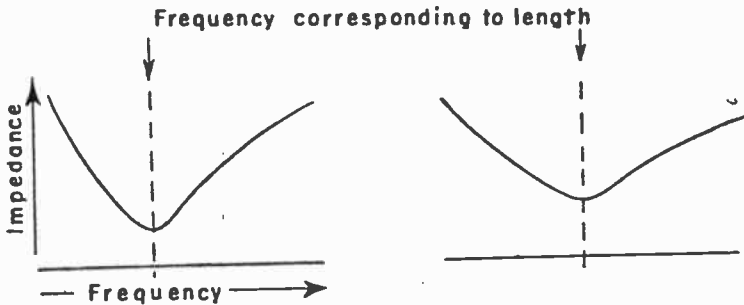

FIG. 3.—Half-wave dipole antennas act like series resonant circuits in their change of impedance with frequency.

antenna are employed for the purpose of obtaining broader frequency coverage without losing too much signal energy, for increasing the response to signals from one particular direction, and to lessen the pickup of interference by the antenna.

The modification which has been most generally employed is the half-wave folded dipole at the right in Fig. 2. This antenna consists of parallel rods or tubes joined at their outer ends, and with a gap of one to three inches midway of one side for connection of the transmission line going to the receiver. The folded dipole is mounted with its two sides in the same vertical plane. Spacing between upper and lower conductors usually is two to three inches. The effect of the looped

ANTENNA, TELEVISION

ends is to lessen the change of impedance with variations of received frequency either way from the resonant frequency. This allows fairly uniform response over a greater frequency range than with a straight dipole. The change of impedance with frequency in a folded dipole may be somewhat as shown at the right in Fig. 3, when the impedance of a straight dipole is as shown at the left. The impedance of the folded half-wave dipole is approximately 300 ohms at the frequency for which a half-wavelength is the length of the antenna.

Antennas which are variously called V-type, X-type, fan type, and by other names are illustrated by Fig. 4. Each of

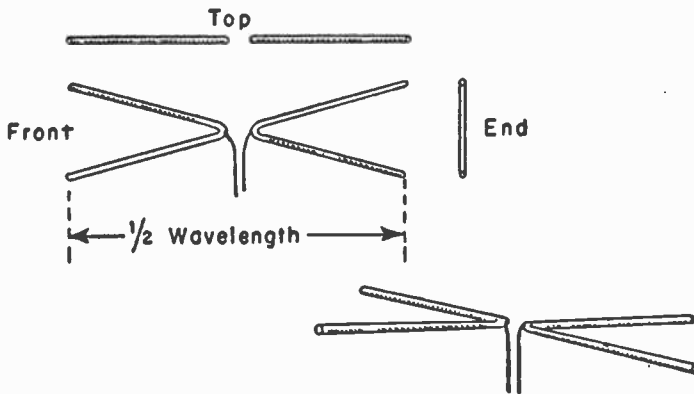

FIG. 4.—V-type or X-type antennas with conductors in a vertical plane (left) and in a horizontal plane (right).

the two conductors is bent into the form of a capital letter V. Center angles usually are between 15 and 30 degrees. At the upper left the two sides of the V's are in the same vertical plane. A less common arrangement, shown at the lower right, places the sides of the V's in the same horizontal plane. All these antennas have broader frequency coverage than the simple dipole. Impedance at the frequency corresponding to antenna length often is specified as 300 ohms, but in some

ANTENNA, TELEVISION

styles the actual impedance is more nearly 150 ohms at the resonant frequency.

Fig. 5 illustrates an antenna which would be of the V-type or X-type were all the conductors in a single vertical plane. Here, however, the opposite V's are at an angle with each other, inclined toward the direction from which maximum signal response is desired. In the construction shown there are three conductors on each side, with the middle conductors slightly longer than those above and below. Some-

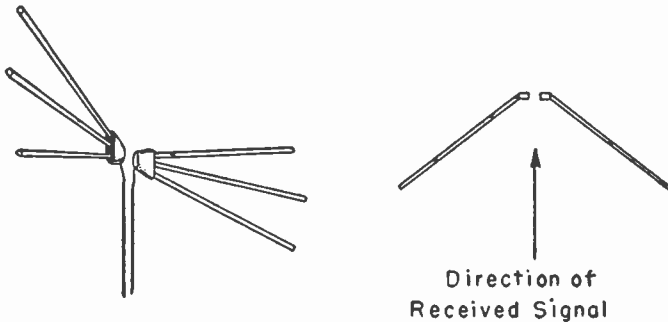

FIG. 5.—A modified V-beam or conical antenna, called also an inclined-V.

times the middle conductors are shorter than the others, and sometimes these middle conductors are omitted. Antennas of this general style, with the sides inclined forward, may be called V-beam types or conical types. Impedance at the frequency corresponding to antenna length usually is specified as 150 ohms.

Antenna Length.—The actual physical length of a half-wave antenna is such that electrical impulses in the antenna conductors will travel from one end to the other during the time of a half-cycle of signal frequency or during the time in which the signal moves forward by a half-wavelength. The approximate number of inches spanned by a full wavelength in space

ANTENNA, TELEVISION

may be determined from dividing 11,811 by the number of megacycles of signal frequency, and the inches for a half-wavelength by dividing 5,905 by the number of megacycles.

Signal impulses move somewhat more slowly along the antenna conductors than in free space. As a result, a half-wave antenna must be a little shorter than a half-wavelength in

ANTENNA LENGTHS AND WAVELENGTHS

CHANNEL	CENTER FREQUENCY, Mc	HALF-WAVE ANTENNA, INCHES	FREE SPACE Half-wave, Inches	DISTANCES Quarter-wave, Inches
2	57	95.3	103.6	51.8
3	63	86.2	93.8	46.9
4	69	78.8	85.6	42.8
5	79	68.8	74.8	37.4
6	85	64.0	69.6	34.8
7	177	30.7	33.4	16.7
8	183	29.7	32.3	16.1
9	189	28.7	31.3	15.6
10	195	27.9	30.3	15.2
11	201	27.0	29.4	14.7
12	207	26.2	28.5	14.3
13	213	25.5	27.7	13.9

space. It is assumed that the average velocity of signal impulses in antenna conductors is about 92 per cent of wave velocity in space. Taking this percentage of the figure used for a half-wavelength in space gives the following formula for length of any half-wave antenna.

$$\text{Antenna length, inches} = \frac{5433}{\text{frequency, megacycles}}$$

Antenna length may correspond to the center frequency of any channel. However, when a single antenna is used for all channels in a band it is usual practice to make the length correspond to a frequency at or slightly higher than the center of the band. This would be the center frequency of channel 4 in the low band, or of channel 10 in the high band. If signals are weakest in some one channel, the antenna length may be

ANTENNA, TELEVISION

made suitable for that channel in order to obtain maximum response. The accompanying table gives channel center frequencies, lengths for half-wave dipoles, and also actual distances covered by half-waves and quarter-waves in free space. These latter distances are useful when cutting line stubs for traps and impedance matching.

Antenna Impedance.—Several points should be kept in mind with reference to impedances which have been mentioned as characteristic in several types of antennas. First, these impedances can exist at only the resonant frequency, the frequency corresponding to antenna length. At this frequency the impedance consists of resistance alone, with reactances cancelling, but at lower and higher frequencies there is an excess of capacitive or inductive reactance. Then the impedance may increase to ten or more times its resonant value.

Second, these theoretical impedances are based on the assumptions that there are no nearby conductors or dielectrics, that there is only a single antenna element (no reflectors, directors, or stacking), and that the antenna is far above ground. Obviously, such conditions seldom will occur in practice.

Antenna impedance is important in relation to matching of the impedances of antenna, transmission line, and receiver. With exact matching there will be maximum energy transfer from antenna to receiver, and both high and low frequencies in the signals will be uniformly attenuated to allow good reproduction.

When an antenna is of a type which suffers little change of impedance with frequency it is classed as a broad band type. Broad band antennas respond quite uniformly to signals in many channels, but deliver to the receiver signals somewhat weaker in any given channel than could be obtained from an antenna more sharply resonant to frequencies in that particular channel.

ANTENNA, TELEVISION

Directional Effects.—At *A* in Fig. 6 is shown the directional pattern for a half-wave dipole antenna when receiving signals at and near the frequency corresponding to the length of the antenna. If signals from all directions arrive at the antenna with equal strengths, the energy pickup from the various signals will be proportional to lengths of the arrows from different directions. There is maximum response to sig-

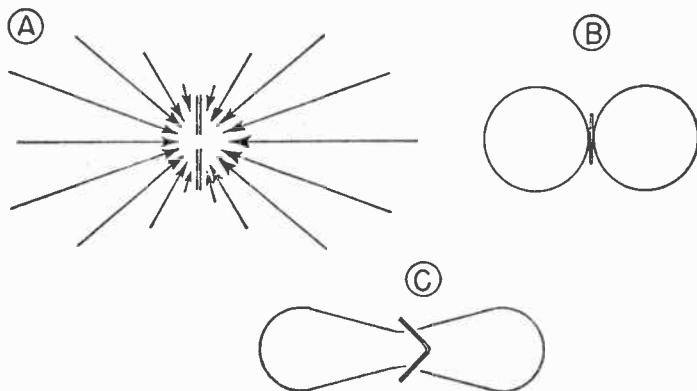

FIG. 6.—Directional patterns of a straight dipole and of an inclined V-dipole.

nals approaching along lines at right angles to the axis of antenna conductors, or with signals coming broadside toward the antenna. For instance, with antenna conductors extending north and south, signals from east and west will produce maximum response. As the signal direction varies from the right angle relation, the response falls off and becomes a theoretical zero for signals traveling in line with the antenna conductors. The same directional pattern may be shown more simply by two circles, as at *B*.

This response to signals from different directions is characteristic of the simple straight dipole, the folded dipole, and

ANTENNA, TELEVISION

the single-plane X-type or V-type antennas of Fig. 4. For antennas of modified V-beam or conical type, Fig. 5, the directional response is more as shown at C in Fig. 6.

There are changes of directional pattern when the received frequency is higher than that corresponding to the length of the antenna. Fig. 7 shows changes such as may occur with straight dipoles. At A is the directional pattern at low frequencies. At frequencies possibly one and one-half times as

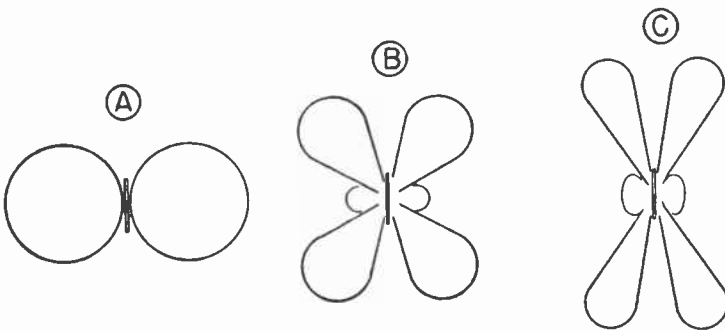

FIG. 7.—Changes of directional pattern of a straight dipole with increase of received frequency.

high the two response lobes change to four lobes as at B, with maximum response to signals from any of four different directions. At still higher frequencies the four principal lobes become narrower, as at C, and move more nearly into line with the antenna conductors.

Obviously, this shifting of the lobe positions makes it difficult to place the antenna in any one position which will allow maximum response to signals at both high and low frequencies when all signals come from the same general direction. One of the principal objects of the forward-V arrangement of Fig. 5 is to crowd the high-frequency lobes so close together that they occupy approximately the same positions as the two

ANTENNA, TELEVISION

low-frequency lobes. Then, with stations in the same general direction, a single antenna element may provide fairly uniform response to signals in both the low and high bands.

There are other types of antennas which accomplish much the same thing. One such type is illustrated at the top of Fig. 8. Small rods mounted on a simple straight dipole form V's, with the rods and the dipole conductors all in the same vertical plane. The length of the straight dipole is suited

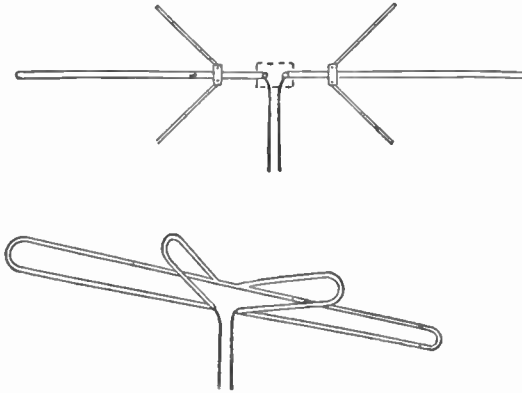

FIG. 8.—Antennas intended to have good response in both the low band and the high band.

for low-band channels. Down below is a straight folded dipole, of length suited to the low-band channels, with which is combined a short folded dipole whose sides are formed into a forwardly inclined V. All the antennas shown by Figs. 5 and 8 may be used for reception in the entire range of low and high bands where signals are reasonably strong.

Directional patterns may be utilized to good advantage by turning or "orienting" the antenna either for maximum response to desired signals, or for minimum response to interfering signals, or in a direction giving the best compromise between desired signals and interference.

ANTENNA, TELEVISION

As a general rule an antenna should be oriented to favor the weakest signal. The position giving best response to a weak signal is quite critical, but on strong signals there is little apparent change of response as the antenna is rotated through a wide angle. The position for minimum response is useful for reducing interference only when the interference is a transmitted r-f signal approaching along a line which is horizontal or very nearly so. When several desired signals come from directions so different as to make it impossible to receive all of them with an antenna in any one position, the remedy is additional antennas with switch control or else a single antenna which may be rotated to suit whatever signal is desired.

Reflectors and Directors.—A reflector is a conductor mounted parallel to the antenna conductors and behind the antenna with reference to the direction of desired signal waves. Such an arrangement is illustrated at the left in Fig. 9. At the

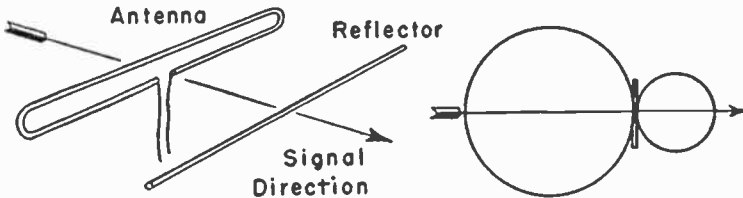

FIG. 9.—A reflector and the resulting directional pattern.

right is shown the approximate directional pattern for an antenna with reflector. The response to desired signals is increased as much as 30 to 40 per cent, while response to signals from the opposite direction is greatly reduced. There is a great increase of front-to-back signal ratio.

A reflector for any style antenna most often is a continuous straight length of tubing, although the reflector sometimes is of the same form as the antenna and may consist of two or even more than two pieces of conductor placed end to end.

ANTENNA, TELEVISION

There is no conductive electrical connection from the reflector to the antenna, the receiver, or anything else. The reflector may or may not be insulated from the mast.

The reflector most often is mounted a quarter-wavelength back of the antenna, making the distance from antenna to reflector equal to half the length of the antenna. With this separation between elements the reflector is made of the same length as the antenna. A reflector mounted closer to the antenna should be somewhat longer than the antenna conductors in order to allow maximum signal strength. The reflector length may be as great as that of a half-wave in free space according to the preceding table. A reflector may be mounted more than a quarter-wavelength back of the antenna, in which case the reflector should be somewhat shorter than the antenna to have maximum signal response. Closer spacing narrows the band of frequencies in which there is good response, while increasing the sensitivity at the frequency for which the antenna is cut. Greater spacings have opposite effects. Spacings of less than a quarter-wavelength tend to lessen the impedance of the antenna.

To make the antenna system even more sharply directional, a parallel director may be mounted in front of the antenna while the reflector remains back of the antenna. Director construction and mounting are like those for reflectors, but the director usually is only about one-tenth wavelength from the antenna conductors. With this separation the director is made the same length as the antenna, while with greater separation the director should be about five per cent shorter than the antenna. A director not only makes the antenna more directional, it also reduces the frequency coverage and has some tendency to reduce the impedance of the antenna at the resonant frequency. Mounting the director farther than one-tenth wavelength from the antenna tends to leave the frequency band a little wider.

When spacing between an antenna and a reflector or director

ANTENNA, TELEVISION

is specified as a fraction of a wavelength, this spacing changes with every change of received frequency. A separation of 13 inches is about a quarter-wavelength for channel 13, but is about $\frac{1}{15}$ wavelength for channel 2. At lower frequencies the reflector or director moves closer to the antenna so far as wavelength fractions are concerned, and at higher frequencies these elements move farther from the antenna. Whether an element mounted parallel to an antenna acts as a reflector or as a director depends on the spacing in fractions of a wavelength. At spacings of more than $\frac{1}{6}$ wavelength the element tends to act as a reflector, while at lesser spacings it tends to become a director. For an element to remain a director for channel 13 the spacing would have to be no more than 8 inches. This close spacing would prevent the extra element from doing any appreciable good on channel 2. It is for this reason that directors are not used to any extent with all-channel antennas.

In order that a reflector may not act as a director for any channel it must not come closer to the antenna than about $\frac{1}{6}$ wavelength in channel 2. This minimum separation is about 30 inches. With less separation, and with an antenna suited for low band reception, the directional pattern could reverse at lowest frequencies.

Dual Antennas.—One antenna of a length suited to low-band channels and another suited to high-band channels may be mounted one above the other on a single mast as in Fig. 10. As illustrated, each array consists of a folded dipole and a straight reflector. Any other style of antenna may be used, either with or without reflector and director. One style, such as a simple dipole, may be used for low-band channels and a different style, as a folded dipole, for high-band channels. Usually the shorter antenna for high-band reception is mounted above the longer one for low-band reception, but this order may be reversed.

When a single transmission line is used for dual antennas

ANTENNA, TELEVISION

the line may go from the receiver first to the high-band antenna and from there to the low-band antenna, or the line may go to the low-band element and then to the high-band element, or the two antennas may be connected together through a phasing link with the transmission line connected to some point along this link.

With the antenna structure of Fig. 10 it is possible to orient the high-band array for best reception from stations in this frequency range and to turn the low-band array at some

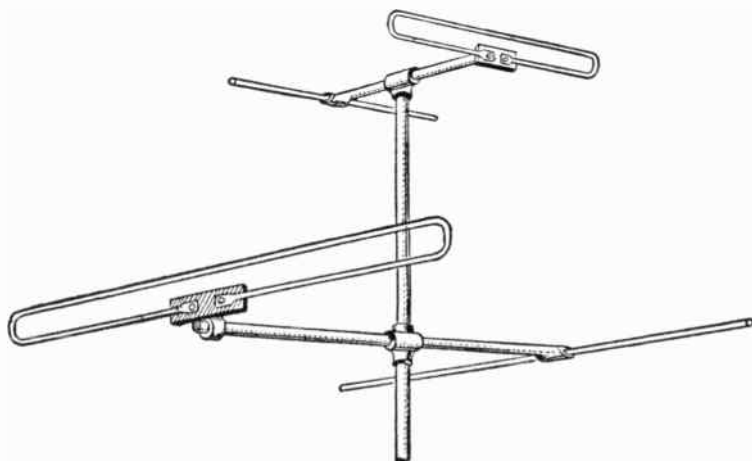

FIG. 10.—High-band and low-band antennas mounted on the same mast.

different angle for best reception at the lower frequencies. If all transmitters are in approximately the same direction from the receiver, or in any case where high-band and low-band arrays may be turned the same direction it is possible to use the structure shown by Fig. 11. Out in front is the high-band folded dipole. Next is the low-band dipole which picks up its own signals and also acts as a reflector for the high-band element. At the back of the assembly is a long reflector for the low-band element.

ANTENNA, TELEVISION

Instead of connecting the same transmission line to both arrays of a dual antenna there may be two lines, one for the high-band and another for the low-band elements, with both lines extending all the way to antenna terminals on the receiver. Then a switch operated with the channel selector or built as part of the channel selector changes the receiver input circuits to suit the band selected. This avoids undesirable interaction between the two antennas, as may occur with a single line unless the link between high-band and low-band

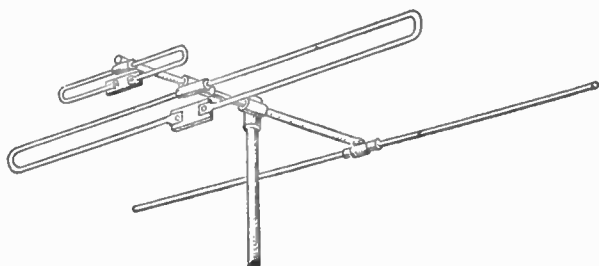

FIG. 11.—High-band and low-band antennas mounted in line with each other.

elements is constructed and installed in exact conformance with instructions furnished by makers of the particular antenna.

Antenna Gains.—The primary object of most of the antenna structures which have been described is extension of the frequency range so that response will be fairly uniform throughout either the low-band or high-band channels, or, with some designs, throughout all the channels in the very-high frequency range. Such uniform frequency response is desirable wherever a number of stations may be received. In localities where signal strength is weak it often is necessary to install an antenna whose primary object is increased energy pickup.

Relative responses or relative abilities of antennas to pick up signal energy is called gain. Gain usually is given in num-

ANTENNA, TELEVISION

bers of decibels that signal energy to the receiver is increased by the antenna in question when compared with signal energy made available by some other antenna as a reference. Theoretical gain may be computed on the basis of a theoretical reference antenna having uniform sensitivity in all directions, or having a circular directional pattern. Measured gains of single elements or arrays often are in comparison with signal strength from a simple straight half-wave dipole. Where two or more similar arrays are used together and connected together as a stacked array, the gain may be in comparison with one of the arrays used alone.

Antennas should not be compared on the basis of stated relative gains unless it is known that the reference is the same in both cases and that testing methods are identical. Useful information is, however, given by gains obtained from the same antenna at different signal frequencies or with reception in different channels or bands.

Stacked Antennas.—The usual method for obtaining large increases of gain or of signal pickup is to mount two or more similar arrays one above the other or side by side in order that a greater area of the wavefront will be intercepted by antenna conductors. Such an arrangement is called a stacked antenna or a stacked array. The name array usually means one active antenna element (connected to the receiver) and a reflector, a director, or both a reflector and one or more directors. Reflectors and directors may be spoken of as parasitic elements. Each array which is stacked may be called a bay. A stacked antenna may consist of two or more bays. All the bays in a stacked antenna are of similar type and size, and all have the same frequency coverage. The antenna of Fig. 10 is not stacked, because its arrays are not alike.

Arrays of any type may be stacked. At the left in Fig. 12 two simple straight dipoles are stacked one above the other. At the center are shown two folded dipoles similarly stacked. At the right are two V-type or X-type elements formed into

ANTENNA, TELEVISION

a stacked antenna. Reflectors and directors may or may not be used, or may be used on one bay and not on the other. As a general rule, reflectors are used on all bays because weak signal conditions which make it desirable to employ a stacked antenna make it desirable also to have the extra gain provided by reflectors.

Stacked antennas have sharper directional properties than single arrays, and give the effect of broader frequency coverage at the same time because there is increased gain in all channels. A worth-while advantage of stacked antennas in

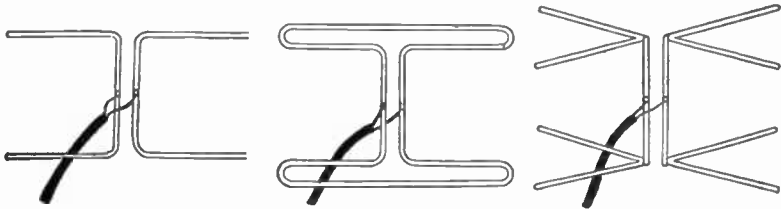

FIG. 12.—Several types of stacked antennas.

places where there is severe electrical interference is reduction of this interference coming from either above or below the antenna structure. Each array seems to act as a shield for the other.

Vertical separation between bays in a stacked antenna designed for reception of a single channel usually is made by a half-wavelength for the middle frequency of that channel. With a stacked antenna for reception throughout either the low-band or high-band the vertical separation would be a half-wavelength at the middle frequency of the band. The fractional wavelength for vertical separation is with reference to the length of the vertical link which connects the top and bottom bays, or with reference to the time required for electrical impulses to move in the connecting link while remaining in phase with the signal. If the link is formed of air insu-

ANTENNA, TELEVISION

lated tubing or rod, as in Fig. 12, its length should be about five per cent more than the half-wavelengths specified for antennas in a preceding table. If the link is made of transmission line it should be five or six per cent shorter than a half-wave antenna. Spacing of less than a half-wavelength causes some reduction in gain, and greater spacing up to about one wavelength allows increased gain over the half-wavelength separation.

When a stacked antenna is used for reception throughout both the low-band and high-band channels the vertical separation usually is a quarter-wavelength or somewhat greater length at the middle frequency of the low band. Then, because wavelengths are much shorter in the high-band channels, there is greater effective separation for high-band reception and the result is to provide somewhat more gain on the high channels. A quarter-wavelength for channel 4 equals about seven-tenths wavelength on channel 10, and a quarter-wavelength for channel 2 is nearly a full wavelength for channel 13.

To obtain still greater gain than is possible with two bays in a stacked antenna it is possible to stack four bays as illustrated by Fig. 13. At the left are four similar straight dipoles. At the right are four similar V-type or X-type arrays. The diagrams show also two different methods of connecting the transmission line to the four sections in order to have such phase relations of signal impulses as will add the effects for maximum output from the antenna rather than allowing potentials induced in some sections to partially oppose the potentials in other sections. Either of the phasing connections illustrated might be used with any style of arrays, simple dipoles, folded dipoles, flat or forwardly inclined V- or X-dipoles, and other types. Note that when the takeoff is from a link between the two center arrays, as at the left, the links to the top and bottom arrays are transposed. When the takeoff is divided, as at the right, none of the connections are transposed.

As compared with the same type of array used alone, em-

ANTENNA, TELEVISION

ploying two such arrays in a stacked arrangement usually gives an average gain of about three decibels in low-band channels and about five decibels in high-band channels. Using

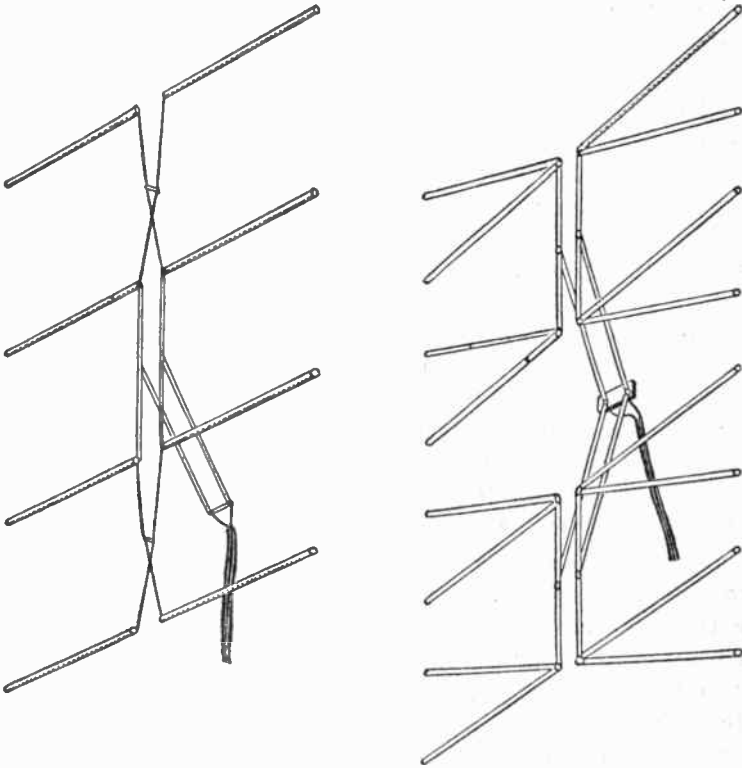

FIG. 13.—Connections for stacked antennas with four bays.

four stacked arrays gives an average gain of about seven decibels in all channels, as compared with a single array of the same kind.

Antenna Installation.—An outdoor antenna should be erected as high above ground level as is possible without adding too

ANTENNA, TELEVISION

greatly to the labor cost for installation. An additional six or eight feet of elevation often makes the whole difference between satisfactory and unsatisfactory reception. The antenna should be mounted as far as possible from electrical machinery and switching apparatus, and from automobile traffic, in order to lessen interference. Usually it is better to select a location reasonably free from interference even though this means using an additional 40 to 50 feet of transmission line. Transmission lines in excess of 100 feet long are to be avoided unless absolutely necessary, since there is considerable attenuation of signal energy in very long lines.

An antenna should clear all large metal objects by a distance at least as great as the length of the antenna conductors, this being a half-wavelength at the frequency for which the antenna is cut. Metal to be avoided includes gutters, downspouts, roof vents, all large pipes and beams, and metal roofs. The location chosen for the antenna must permit reasonably easy erection of the mast, also of guy wires when the mast is more than six or eight feet high and of ordinary tubular construction.

After a tentative location has been chosen for the antenna it is necessary to conduct tests of actual reception before making a permanent installation. In localities of very high signal strength it would be possible to connect a microammeter and crystal diode rectifier directly to the antenna or to a length of transmission line and obtain meter indications of relative signal strengths. But in any locality where all possible signal strength is desired, the weak currents or voltages from the antenna must be amplified to make comparisons of any real value. The most readily available amplifier is the television receiver which is to be operated from the antenna, or some receiver used especially for the purpose of determining the best positions and orientation for antennas.

The receiver must be in first class alignment and in generally good operating condition. The channel selector should be

ANTENNA, TELEVISION

tuned for a station known to be transmitting, preferably with a test pattern rather than a regular program. If there is any choice, the tests should be made in a channel where reception is known to be difficult or weakest. Of course, all stations or all channels should be tested before the installation is considered as finished.

One method of installation requires the services of two men, one at the antenna and the other at the receiver to note results of all changes. It may be possible to talk or shout back and forth, but usually it is necessary to use some kind of telephonic equipment. The simplest method of communication is with a pair of self-powered or sound-powered phones which require no batteries or other external power for their operation. The phones sometimes are connected through the transmission line which will be used between antenna and receiver. This is not too objectionable with the low-impedance 72-ohm lines but may cause difficulty in picture reception when the connection is made through 300-ohm twin-conductor line. In order to have maximum evidence of the effect of all changes at the antenna, the contrast control of the receiver should be kept as low as allows noting details of pattern or pictures.

When positioning and orienting of the antenna must be completed by one person it is necessary to have either a complete television receiver at the antenna and connected to the antenna, or to have a meter at the site of the antenna with a long wire connection running to the receiver. Portable receivers are manufactured especially for this class of work, with a microammeter connected into some amplifier circuit between video detector and picture tube.

A practical and convenient method of using a meter is shown by Fig. 14. The meter should be a d-c microammeter with full-scale range preferably no more than 100 microamperes. This meter is connected through any required length of any kind of two-conductor cable to a detector probe or high frequency probe at the receiver. A highly sensitive probe

ANTENNA, TELEVISION

may be made up with a crystal diode for rectifier. Capacitors C_a and C_f are 0.005 mfd mica types. Resistance at R_o should be anything from 1 to 5 megohms, and at R_f is 10,000 ohms. The probe input is shown connected across the video detector load resistor, but the connection may be made from plate to B— or ground on any video amplifier tube or may be from

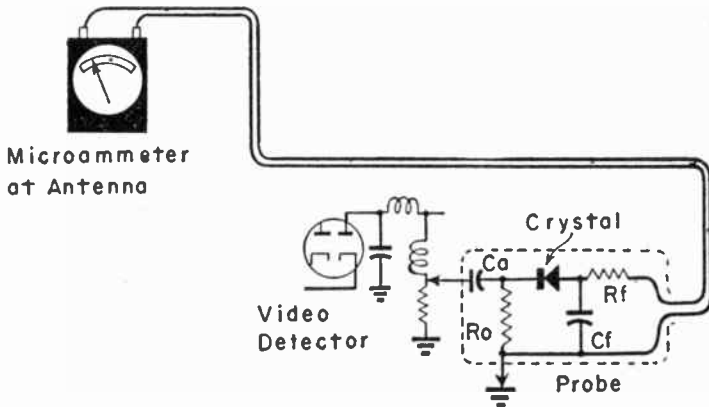

FIG. 14.—Connections for a meter used to indicate signal strengths during orientation of an antenna.

the picture tube input electrode (grid or cathode) to B— or ground. Connecting the probe to points beyond the video detector will increase the meter readings for any given antenna input.

Since there are variations of direct current and voltage in the video detector load resistor the d-c microammeter might be used without the rectifying probe. The probe, however, keeps high-frequency alternating currents from the connecting cable and removes the effect of the cable from the receiver circuits. As the antenna is rotated and moved from place to place, the meter reading will increase as signals become stronger and decrease for weakening of the signals. For best

ANTENNA, TELEVISION

results, the automatic gain control of the receiver should be overridden to allow accurate indication of signal peaks.

The meter will indicate nothing but changes of signal strength during positioning and orienting of the antenna, it will give no indications of whether the picture is good or poor, nor will it indicate the presence of interference. Observation of a picture or pattern at the receiver will show quality as well as signal strength.

When whatever type of signal indication is employed has been arranged and made ready for use, the antenna should be placed in a likely spot and rotated so that its conductors are at right angles to the probable direction of signal wave travel. If other receiving antennas are in sight it is advisable to commence by using the same orientation employed for most of the others. Then rotate the antenna very slowly one way and the other to obtain the best pattern or maximum meter reading. If construction of the antenna allows it, try tilting the conductors away from the horizontal. The antenna should be moved to all the readily accessible positions to find the one where best pattern or highest meter reading is obtained.

With any straight antenna it should be kept in mind that the directional pattern may not be the same for all channels or all stations. This was discussed in relation to Fig. 7. Results should be checked on at least one channel in the low band and one channel in the high band. It may be necessary to use a compromise position for the best average of results in both bands.

Any antenna mast which consists of two or more sections coupled together, and any ordinary tubing type of mast more than six to eight feet high, should be securely supported with at least three guy wires. Otherwise there is almost sure to be swaying with wind, which causes pictures of varying brightness and contrast, and may cause such sudden changes of signal strength as to upset synchronization. Consideration must be given to probable loads imposed by rain, snow, and

ANTENNA, TELEVISION

ice. Guy wires which come as close to the antenna as the length of the antenna conductors are preferably broken up, electrically, with insulators of glass or glazed porcelain within about two feet of the antenna conductors.

Every antenna should be equipped with a lightning arrester approved by the Underwriters. Many suitable types are listed in parts and supply catalogs. They come with instructions for correct installation. Failure to use a lightning arrester constitutes a serious fire hazard, and is likely to allow damage in the receiver even though no fire is started. A high metallic antenna mast is an invitation for lightning to strike it. Consequently, every such mast should be connected to ground through a good ground clamp on the mast and a length of copper wire or cable of no less than number 10 gage size leading to a cold water pipe or else to a steel pipe driven into earth to a depth of three or more feet. Atmospheric electrical charges will pass harmlessly to ground through such a wire, and the mast will be made into a protection for the building rather than a hazard.

Antennas should be installed commercially or in a service capacity only when you are familiar with current requirements of the National Electrical Code, with any restrictions imposed by local ordinances, and with prohibitions which may be in the leases for apartment houses and other buildings. These restrictions relate to heights, permissible locations, types of supports, protection of other electrical conductors, and installation methods in general.

Indoor Antennas.—Indoor or portable antennas, generally similar to the one at the left in Fig. 15, may be placed on the receiver cabinet or anywhere in the same room and connected to the receiver through a suitable length of transmission line. The conductor arms telescope to allow adjusting the length for different channels or bands, and are pivoted or hinged to allow setting them horizontally or at any angle found to provide best reception. To obtain the best possible

ANTENNA, TELEVISION

picture the antenna should be rotated to various positions, the arms should be extended for low-band channels and retracted for high-band channels, and the arms should be tried at various angles to obtain the widest frequency coverage. Sometimes it is necessary to alter the adjustments when changing from one channel to another.

A temporary indoor antenna may be made in the form of a folded dipole as at the right in Fig. 15. The horizontal dipole section is made from a piece of 300-ohm twin-conductor transmission line with its conductors shorted together at both ends. The conductor on one side is opened at the center, and the cut ends are soldered to the conductors of another piece

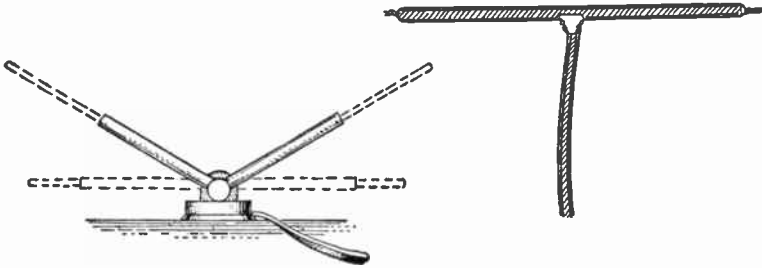

FIG. 15.—Two types of indoor antennas.

of transmission line which is run to the receiver. To determine the correct length for the horizontal dipole section, divide 5160 by the number of megacycles frequency at which the antenna is to act as a half-wave element.

Only in rare instances will an indoor antenna or a built-in antenna provide satisfactory reception from stations as much as 15 miles distant, and as a general rule these antennas work well only within eight to ten miles from transmitters. Unsatisfactory reception will result also from any of the following conditions: Nearby tall buildings, tanks, stacks, or hills. Receiver and antenna in a basement, below ground level. Placing

ANTENNA, TELEVISION

the antenna near radiators, near pipes for water, steam or gas, or near metal rods for curtains or drapes. Antenna located in a steel frame building, near walls containing steel beams, metal lath, metal foil types of heat insulation, near metal window or door frames, or near metal Venetian blinds. Metal roofs make difficult reception with antennas in attics or on top floors. Indoor antennas work best when near a window and when mounted as high as possible.

Indoor and built-in antennas are more adversely affected than outdoor types by interference from electrical appliances and machines, by sparking which results from switching and from defects in fixtures or building wiring, and by automotive traffic. Reception is affected when people come too close to these antennas. Reflections or ghosts may be troublesome because of the many surfaces of all kinds which are near the antenna.

Built-in Antennas.—Many television receivers of recent design have antennas mounted in or on the cabinets. All such built-in antennas are subject to the limitations previously mentioned in connection with indoor antennas. There are two major problems in obtaining satisfactory performance. First, unless the entire receiver is to be moved in order to orient the antenna for signals in different directions there must be provision for either physical or electrical rotation of the built-in antenna while the cabinet remains stationary. Second, in order to have good reception in all channels there must be some means for altering the electrical length of the antenna so that it will be resonant in each of the bands.

In some receivers the antenna is mounted on a disc or plate which may be rotated within the cabinet for best orientation. Most receivers employ some switching device which provides the electrical equivalent of rotation. Two methods are illustrated by Fig. 16. In each case there are four antenna strips in the form of a cross made up of two dipoles at right angles to each other. In the design at the left the transmission line

ANTENNA, TELEVISION

from antenna terminals of the receiver connects to opposite metallic segments on a rotor which may be turned by the operator. With the rotor in the position shown, antenna strips *a* and *c* are active, and might be oriented for directions such north-east and south-west. Other positions of the rotor activate strips *b* and *d*, or *a* and *b* may be connected together at the same time that *c* and *d* are connected together. The rotor is moved to whatever position gives best reception for each station, each band, or the entire range of television frequencies in both bands.

At the right in Fig. 16 the four antenna strips again are in the form of two crossed dipoles. Each of the antenna strips

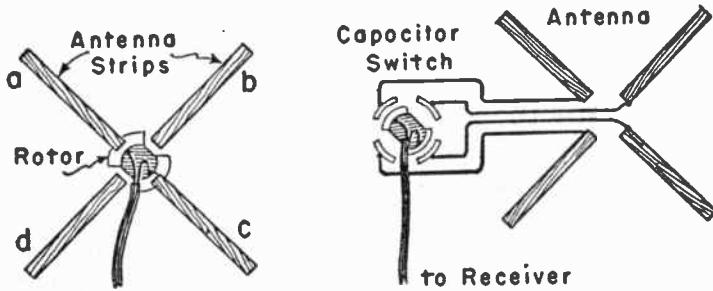

FIG. 16.—Methods for electrical rotation of built-in antennas.

is connected to one of four separate stators of a four-section adjustable capacitor. The two rotor segments of this capacitor are connected to the antenna terminals of the receiver. Turning the rotor support to various positions allows capacitive coupling to the antenna strips in various combinations which provide directional response as required for the received station.

Tuning a built-in antenna for resonance in the low band presents difficulties because there is not room in a cabinet for the five to eight foot length of a low-band dipole. Consequently, it is usual practice to mount within the cabinet a

ANTENNA, TELEVISION

dipole of such overall length as suits high-band frequencies and to tune this short dipole or modify it in some manner which permits reasonably good response in low-band frequencies. Effective length is added by turning the ends to allow more actual length in a given cabinet, by flaring the ends or adding open sections, and by other expedients.

Small adjustable capacitors are used for tuning many types of built-in antennas to resonance at various channel frequencies. Some methods are shown in principle by Fig. 17. At 1

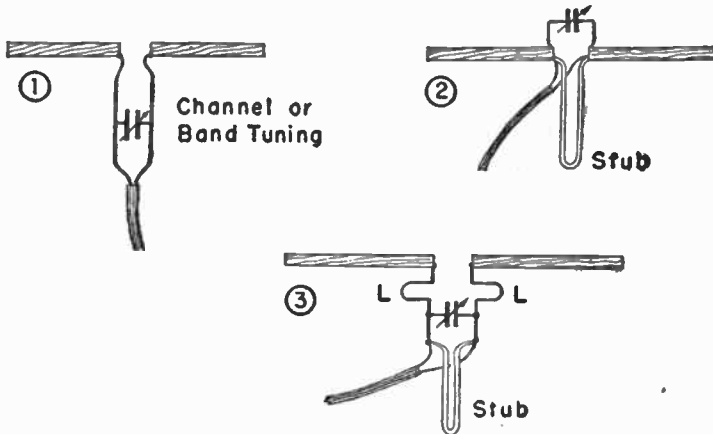

FIG. 17.—Methods for electrically changing the length of built-in antennas.

the adjustable capacitor is between the dipole conductors and across the short transmission line which goes to the receiver. At 2 there is added a shorted stub in parallel with the tuning capacitor. When the length of the stub is less than a quarter-wavelength it adds inductance, and when between a quarter- and a half-wavelength the stub adds capacitance. At 3 there are small inductive loops at *L-L* in addition to the tuning capacitor and the shorted stub. The tuning capacitors are ad-

ANTENNA, TELEVISION

justable from the front panel, being operated in the same general manner as a fine tuning control to attain best possible reception.

A shorted stub cut to a quarter-wavelength at some mid-frequency tends to lessen the change of antenna impedance at lower and higher frequencies. At lower frequencies the antenna reactance becomes capacitive, but the stub then has an effective length less than a quarter-wavelength and acts like added inductance. At higher frequencies the antenna becomes inductive but the stub becomes capacitive as its effective length exceeds a quarter-wavelength.

Any built-in antenna must be completely disconnected from the receiver input circuit when an outdoor antenna is substituted. Some receivers have jumpers which may be removed to disconnect the built-in antenna. Most common troubles with built-in antennas include loose or dirty connections, or enough slack or looseness in antenna sections to allow their movement when the cabinet is jarred or to allow them to come too close to other metallic parts of the receiver. Lengths, spacings, and relative positions of all conductors are critical at the carrier frequencies which act in built-in antennas. Every short piece of wire and foil has enough inductance and capacitance to form important fractions of inductances and capacitances being used for tuning.

ANTENNA, TUNED

ANTENNA, TUNED.—An antenna may be tuned by placing a large capacity variable condenser in series with the lead-in or in series with the antenna circuit inside the receiver. Such a series condenser should have a capacity of .001 microfarad. The connections are shown in Fig. 1. Even with this large capacity condenser it may be found difficult to tune an antenna of ordinary size over the entire band of broadcasting frequencies now in use.

A better method of tuning the antenna is with a variometer in series with the antenna circuit. This makes the antenna act as a fixed capacity while the variometer acts as a variable inductance with which the antenna circuit may be tuned to resonance at any desired frequency. The capacity of the antenna will generally be too great to allow the entire inductance range of an ordinary variometer to be used in tuning over the broadcast frequency band. The

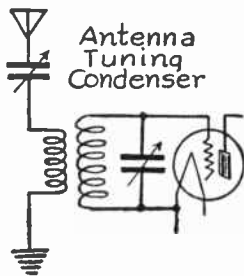

FIG. 1.—Connection of Series Condenser for Antenna Tuning.

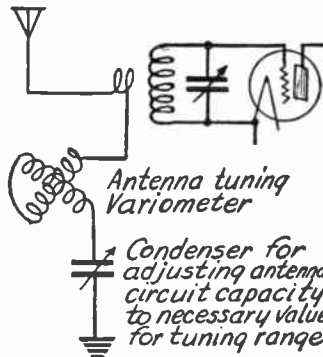

FIG. 2.—Use of Variometer for Antenna Tuning.

entire broadcast band will be covered by using only a part of the variometer's total change of inductance and only a part of the tuning dial scale will be employed. In such a case the capacity of the antenna system may be reduced by inserting a variable series condenser as shown in Fig. 2. This condenser may be adjusted to such a value that the variometer will tune to resonance over the entire range of frequencies to be received and use all of its tuning dial. This method provides great distance getting ability together with satisfactory selectivity. The construction using this plan is shown under *Receiver, Tuned Radio Frequency*.

When the antenna circuit is tuned to the same frequency as that to which the grid circuit of the first tube is tuned it will be found that a moderate degree of coupling between the antenna circuit and the grid circuit of the first tube places a heavy load on the grid circuit of this tube. In order for the first tube to oscillate it must develop power enough to set the entire antenna circuit into oscillation. This requires more power than is generally available.

Consequently, while a tuned antenna circuit will make the antenna more responsive to the tuned frequency and will bring more powerful signals into the receiver, the additional load of the antenna circuit prevents the first tube

ANTENNA, UNDERGROUND

from oscillating readily at the tuned frequency. Of course, even with the antenna tuned, the first tube will oscillate provided the coupling between its grid circuit and the antenna circuit is made very loose. A loosely coupled tuned antenna places very little load on the grid circuit of the first tube and oscillation is comparatively easy.

ANTENNA, UNDERGROUND.—Because of the fact that radio waves penetrate for a little depth into the earth it is possible to use a buried wire as an antenna in place of the usual elevated wire type. An underground antenna has a better signal to static ratio and is more selective than the elevated type. The buried wire also has a more pronounced directional effect. To offset these advantages the signal strength with the underground antenna is only a fraction of the strength with the usual constructions and it is necessary to use at least two tubes to obtain headphone reception.

The wire should be of copper, number 14 gauge or larger. It must be well insulated with rubber covering. To obtain satisfactory life and length of service from a buried antenna the wire should have live rubber covering about one-quarter inch thick. For broadcast reception the buried portion of the antenna should be about seventy-five feet long and may be buried from six inches to two feet deep. The more moist the earth the better will be the results with this method of reception.

ANTENNA, WAVELENGTH OF.—See *Antenna, Fundamental Frequency of*.

ANTENNA, WIRE FOR.—For antenna wire first choice is stranded enameled copper or phosphor bronze. The second choice is a solid wire, enamel covered. The third and fourth choices would be bare stranded wire, then bare solid wire. Iron or steel wire do not enter into radio construction. To this last statement there is a possible exception in that steel-cored copper wire would form a satisfactory antenna and would have greater mechanical strength than a wire of solid copper or bronze. Antenna wire should be of number 14 or number 12 gauge.

Radio impulses in the antenna travel almost wholly on the surface of the wire and the inside of the wire might just as well be hollow, in fact it would be better if it were hollow.

The great majority of antennas are found covered with corrosion. This corrosion is formed by the combination of oxygen in the air with the copper of the wire and, unlike a covering of enamel or other properly applied insulation, the corrosion becomes a part of the wire itself, in other words the outside of the antenna is no longer copper but is copper oxide.

Copper is the best of all conductors for radio impulses but copper oxide is very poor. Since radio impulses travel on the surface of the wire, if this surface is composed of the high resistance copper oxide such an antenna has lost much of its effectiveness as a conductor of signals.

ANTI-CAPACITY SWITCH.—See *Switch, Anti-Capacity Type*.

ANTINODE.—A point in a wave where the greatest motion, amplitude or field strength exists. A point midway between two nodes. See *Node*.

ANTI-RESONANCE.—Another name for parallel resonance. See *Resonance, parallel*.

APERIODIC

APERIODIC.—Not resonant at any one frequency; un-tuned. An aperiodic circuit is one in which oscillations are not maintained, the resistance serving to damp out oscillatory effects. A circuit is aperiodic when the resistance squared is greater than four times the inductance in henrys divided by the capacity in farads.

ARC.—A luminous discharge accompanied by flow of current across a space between electrodes, the conduction being due to ionization of gases in the space.

ARGON RECTIFIER.—A hot cathode gaseous conduction rectifier using argon gas in the bulb.

ARMATURE.—A part carrying conductors in which induction results in production of electromotive force. Also a piece of iron forming part of a magnetic circuit.

ARRESTER, LIGHTNING.—A radio antenna has no more tendency to attract lightning than is found in other metal parts such as eaves troughs, rain spouts, wire clothes lines, etc. Should lightning strike an antenna directly no antenna construction and

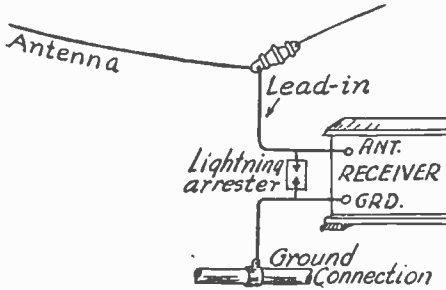

FIG. 1.—Connection of Lightning Arrester to Antenna and Ground.

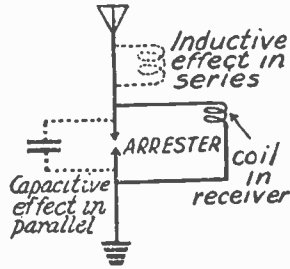

FIG. 2.—Effect of Inductance and Capacity in a Lightning Arrester.

no form of lightning arrester would stand the great strain. During atmospheric storms a certain amount of electrical charge will collect on the antenna. There is also some charge collected during rain storms and snow storms. Such charges, if not too large, may leak off gradually over the connections and supports of the antenna. They will also discharge through the receiver, causing static noises.

All receiver installations should have some form of lightning arrester placed as shown in Fig. 1 between the antenna or lead-in and the ground wire. An electrical charge of such volume as to damage coils, condensers and other parts in the receiver will jump across the small gap in the lightning arrester and pass harmlessly to ground. A lightning arrester consists of two points or electrodes supported a little distance from each other and placed between the antenna and ground with one point connected to the antenna and the other to the ground. The points are placed such a distance apart that

ARRESTER, LIGHTNING

500 volts or more will jump through the air or vacuum from the point connected to the antenna to the point connected to the ground. The purpose of a lightning arrester is to protect the parts of the receiving set.

Certain requirements for the construction and action of lightning arresters have been laid down in the National Electric Code. Following is a summary: The spark gap may be located in a vacuum, in a gas-filled tube, or in air. Electrodes in air shall be of brass, phosphor bronze, carbon or some other non-corroding material. If in a vacuum or gas-filled tube the electrodes may be of any conducting material. There must be a dust-proof enclosure for the gap and if the arrester is to be placed out of doors this enclosure must also be weather-proof. Any lightning arrester must allow an arc to form and a discharge to pass between the electrodes when an alternating voltage of 500 or more volts is applied.

The foregoing requirements are specified from the standpoint of protection from electrical discharges but it is also necessary to consider lightning arresters from the standpoint of radio reception. As with anything else pertaining to radio the lightning arrester has resistance, capacity and inductance. Too low a resistance bypasses the signals around the receiver and to ground. The capacity of a lightning arrester is in parallel with the capacity of an antenna and is added to the antenna capacity. Any inductance in the arrester is in series with the antenna. This is shown in Fig. 2. Both the capacity and inductance of the arrester will raise the natural wavelength or lower the natural frequency to which the antenna responds.

Fire Underwriters' rules require a lightning arrester in each radio installation. A lightning arrester approved by the Fire Underwriters is satisfactory from the fire prevention standpoint but may be unsatisfactory in its effect on radio signals. The resistance of an arrester should be as high as possible to avoid bypassing signals around the receiver. The capacity and inductance should be as small as possible to avoid affecting the tuning and operation of the receiver. The installation of a lightning arrester between antenna and ground reduces the voltage through the receiver and reduces the signal strength. This cannot be avoided unless the receiver has a tuned antenna circuit. With a tuned antenna a lightning arrester has comparatively little effect on signal strength.

Many types of construction are found in lightning arresters. Some are built with carbon electrodes separated by a thin sheet of mica. Unless well protected there is danger that dirt or moisture will short circuit this type. Many arresters are built with brass or copper electrodes sealed into a tube for protection. Since an arc-over must occur at 500 volts there can be only small separation between these electrodes. Another type of arrester has its electrodes sealed into a vacuum tube. Here it is possible to use a greater gap because the vacuum reduces the resistance. This type is satisfactory as long as the enclosing tube remains tight and does not admit air or moisture.

The electrostatic capacity of lightning arresters varies between five and thirty-five micro-microfarads. The addition of thirty-five micro-microfarads to the antenna capacity may have a decided effect on tuning. Lightning arresters having carbon electrodes separated by sheet mica generally have high capacity because the carbon electrodes are very close together.

ARTICULATION

ARTICULATION.—A measure of distortion in a transmission line. The percentage of detached speech syllables which may be correctly understood as they are transmitted forms the measure of articulation.

ASTATIC COIL.—See *Coil, Closed Field Type*.

ATMOSPHERICS.—A form of static. See *Static*.

ATTENUATION.—Radio attenuation is the decrease in strength of signals due to absorption in the atmosphere and various objects in the wave path. Attenuation increases with distance from the transmitter.

AUDIBILITY.—A measure of the strength of a signal as it affects the ear of a listener. The ratio of the strength of a signal as received to the strength of a signal which may barely be heard.

AUDIO FREQUENCY.—See *Frequency, Audio*.

AUDIO FREQUENCY AMPLIFIER.—See *Amplifier, Audio Frequency*.

AUDIO FREQUENCY OSCILLATOR.—See *Oscillator, Audio Frequency*.

AUDIO FREQUENCY TRANSFORMER.—See *Transformer, Audio Frequency*.

AUDION.—A trade name for vacuum tubes.

AUDITION.—The act of hearing or of listening to sounds, signals, a program, etc.

AURAL RADIO BEACON.—See *Aviation, Radio in*.

AURORA.—The aurora borealis or the aurora australis; luminous effects appearing respectively in the northern and in the southern skies, due to electrical effects in the ionized gases in the upper parts of the atmosphere.

AUTODYNE RECEPTION.—See *Receiver, Superheterodyne*.

AUTOFORMER.—An *Auto-transformer*, which see.

AUTOMATIC TUNING.—Tuning which is accomplished by electrical or mechanical operation of the controls in a receiver by means other than manual operation of a dial or knob in the usual manner. Certain frequencies are tuned in by keys, by a series of press buttons, etc. See *Tuning, Automatic*.

AUTOMATIC VOLUME CONTROL.—Control of receiver output power by the effect of input signal, the result being to maintain a nearly constant output with varying input. The output is automatically made inversely proportional to the input power. See *Volume, Control of*.

AUTOMOBILE RECEIVER.—See *Receiver, Automobile*.

AUTO-TRANSFORMER.—See *Transformer, Auto-*

AVERAGE VALUE.—See *Value, Average and Effective*.

AVIATION, RADIO IN

AVIATION, RADIO IN.—Radio communication between the ground and an airplane allows transmission of all forms of intelligence, and is especially useful in giving directional guidance, weather information and necessary instructions to pilots and navigators. Both radio telegraphy and radio telephony are in use, but other than for communication over long distances or where atmospheric conditions interfere with clear reception, telephone communication is replacing telegraph methods.

Usual methods of aircraft guidance depend chiefly on the directional properties of certain forms of loop antennas. Maximum signal strength from a loop receiving antenna results when its plane lies in the line of wave travel as explained under *Loop, Directional Effect of*. Using a loop as a transmitting antenna, maximum signal strength is radiated in a line lying in the loop's plane.

Directional transmitters and receivers have been employed in several different systems. In Fig. 1 there is a non-directional transmitter on the ground, radiating signals with approximately equal strength in all directions.

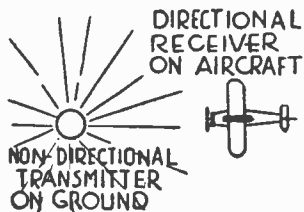

FIG. 1.—Ground Transmitter and Airplane Receiver.

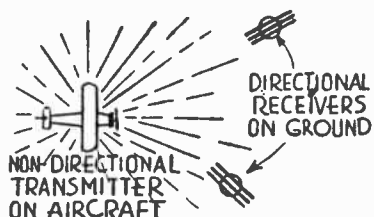

FIG. 2.—Airplane Transmitter and Ground Receivers.

A directional receiver, with loop antenna, on an aircraft then determines the position of the transmitter with reference to the ship. The loop antenna may be rotated on its support or else the loop may be fixed in position and the entire body of the aircraft may be turned in the direction from which signals are coming. The latter system is objectionable in forcing the ship to turn from its course in many cases.

In Fig. 2 the aircraft carries a non-directional transmitter from which signals are received by two or more ground stations, equipped with directional antennas, and in communication with one another. The angles from which signals come to the ground stations allow determination of the ship's position and this position is communicated to the ship by radio telephony or telegraphy.

A third system, generally called the radio beacon system, places directional transmitters on the ground. These transmitters emit signals having maximum and minimum strengths in certain definite directions, and these signals have characteristics which allow the pilot or navigator on a ship to follow a desired course.

By using the Bellini-Tosi direction finder system illustrated in Fig. 3 it is possible to avoid the necessity for rotating a loop antenna. Two fixed loops are mounted at right angles to each other and are connected to a goniometer consisting of two fixed

AVIATION, RADIO IN

coils within which is a search coil movable on its vertical axis. The radio field affecting the two outside loops is reproduced within the coils of the goniometer and the search coil then is rotated within the coils just as a revolving loop antenna would be rotated in determining the direction of wave travel. The search coil is connected to receiving equipment which indicates maximum and minimum signal strengths.

The radio field existing around a loop antenna affects the antenna conductors not only in their function as a loop but also as a capacity antenna at the same time, and when the loop is turned to the position of minimum signal the capacity antenna effect still exists. An auxiliary capacity antenna may be used to induce in the loop a signal voltage in opposite phase to the voltage from the loop's capacity effect, thus balancing out the remaining signal and allowing a sharp reading of minimum strength.

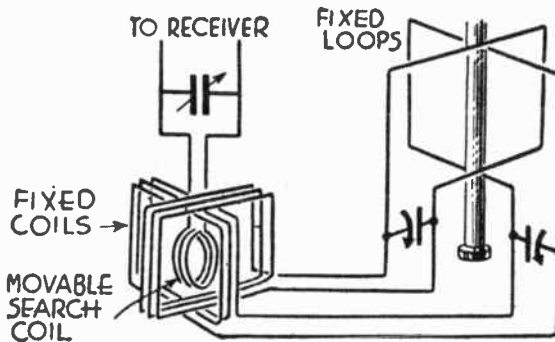

FIG. 3.—Bellini-Tosi Direction Finder.

The system of Fig. 3 may be fitted with a "sense finder" circuit to make it more responsive to signals coming from one direction than to those of equal strength from the diametrically opposite direction, thus enabling the operator to determine from which of the two possible directions a signal really is coming.

Identification of Courses.—A loop transmitting antenna placed as at the left hand side of Fig. 4 emits maximum signal strength in the directions of the full line arrows and minimum strength in the directions of the broken line arrows. The field pattern is indicated approximately by the circles. If two loops are placed at right angles, as at the right hand side of Fig. 4, and if each is excited by signals of different kind but of equal strength, the directions of maximum strength are as shown by the arrows and the field patterns overlap as shown by the circles. The two signals may be designated by the letters *A* and *N*, and it becomes apparent that these signals are delivered in equal intensity along the heavy lines. That is, along any one of the heavy lines there will be both an *A*-signal and an *N*-signal with their intensities equal.

AVIATION, RADIO IN

One of these "equisignal zones" might be shown as in Fig. 5. One of the loops may be sending the code letter "A" consisting of a dot and dash (- —) while the other sends the code letter "N" consisting of a dash and dot (— ·). Suitable timing allows the two signals to interlock along the equisignal zone and to form one long dash. The dash of the N-signal

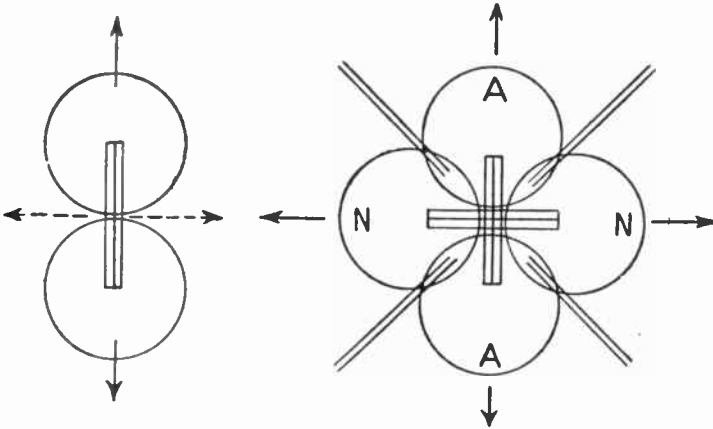

FIG. 4.—Radiation from Loop Antennas.

comes between the dot and dash of the A-signal, while the dash of the A-signal comes between the dash and dot of the N-signal.

As long as the course of an aircraft is maintained within two or three degrees either side of the equisignal line the long dash remains, but any greater deviation causes one letter or the other to become distinctly predominant. Other code letters used in similar interlocking signals may consist of the pair B (— · · ·) and V (— · — ·) or else the pair D (— · ·) and U (— · — ·). These code signals are listened to with earphones and this method is called the aural system.

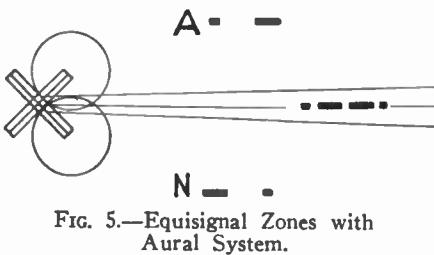

FIG. 5.—Equisignal Zones with Aural System.

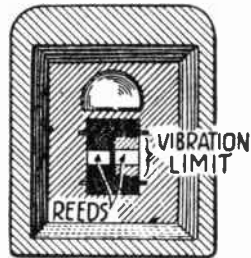

FIG. 6.—Reed Indicator.

Visual Signals.—There is also a visual system employing the principle of the equisignal zone. The radio frequency carrier waves from the two loops are modulated with two different low frequencies, one of these being 65 cycles and the other 86.7 cycles. In the receiving system carried by the aircraft these two modulating frequencies operate two vibrating reeds, one tuned to the

AVIATION, RADIO IN

lower frequency and the other tuned to the higher frequency. The appearance of such a visual reed indicator is shown in Fig. 6.

With a ship traveling along the equisignal course both reeds vibrate with equal amplitudes but if there is a deviation from the course the reed for the side toward which the aircraft swings will increase its travel while the movement of the other reed becomes less in extent. The tips of the reeds are white and their background is dark, consequently any variation in amplitude is very noticeable.

Fig. 7 shows two loops furnishing signals at 65 cycles and at 86.7 cycles, also an airplane flying from right to left. With the airplane approaching this beacon the 65-cycle signal will be on the pilot's right and the 86.7-cycle signal will be on his left. But, as shown in the diagram, the positions of the frequencies are reversed as the airplane passes over the transmitter and travels away from it. To overcome this difficulty the indicator is provided with a plug-in connection so that it may be pulled out of its fastening, turned upside down and replaced as the beacon is passed. The indication of direction then is the same on both sides of the beacon. The plug-in arrangement also allows use of the one reed indicator on different courses by placing it in an appropriate position for any given course.

Since the amount of deflection or amplitude of reed movement will increase very decidedly as the aircraft approaches the beacon transmitter, it is necessary to employ a volume control, usually of the automatic type,

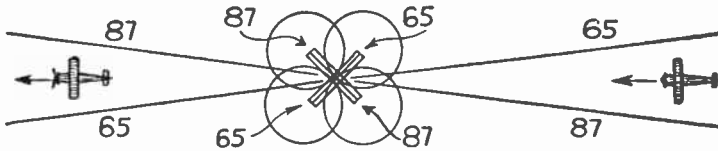

FIG. 7.—Reversal of Signals as Beacon Is Passed.

in order to keep the reeds within proper limits. Automatic volume control is not used with the aural system because it would reduce to equal intensity the two code signals which must be compared in strength.

In some designs it is possible to vary the movement of one reed by changing the resistance in its circuit so that the two have equal amplitude when an aircraft is traveling on one side or the other of the regular course, thus allowing the ship to follow a course slightly different from that of the regular direction.

A modification of the reed indicator provides a zero center current indicating meter in which the pointer remains vertical while the ship is on its course and swings to the right or the left when there is any deviation. A voltage coil is energized by each reed, the voltages from the coils being fed to rectifying units and then opposed at the terminals of the zero-center meter. To avoid the danger which would arise were a beacon transmitter out of operation, whereupon the pointer would remain vertical, a volume indicating device is used with this system.

Directing the Signal Beams.—Examination of any airways map, such as that in Fig. 8, shows that regularly traveled courses radiate from cities in various numbers and at irregular angles. Thus it becomes necessary to provide means for bringing the radiated beacon signals into line with the direction of the airways actually traveled.

AVIATION, RADIO IN

In the aural type of radio range the two loops are excited alternately, radiation taking place first from one and then from the other. The field pattern from each loop may be represented by two circles such as those marked *A* and those marked *N* in Fig. 4, the resulting courses then being indicated by the heavy lines drawn through the intersections of adjacent circles. If the field strength of one loop be reduced, as by insertion of resistance in its circuit, the circles will change to some such relative size as in Fig. 9. The courses no longer are at right angles. The degree of change in angle between courses depends on the relative power in the two loop antennas and such a change in power forms one means of adjusting the angles of courses.

Another method of shifting the angles of the courses consists of using a vertical antenna in connection with the regular loop antennas, the combination of the radiation fields from the two antennas serving to effectively bend the courses to desired angles.

The conditions with the visual beacon system are not the same as those with the aural system because in the visual method both



FIG. 8.—Typical Angles Between Air Routes.

signals are being transmitted all the time rather than alternately. With the aural system there are four courses while with the visual system there are naturally only two courses when the currents in the antennas are in phase with each other. In order to provide four courses with the visual system the current in one system must be ninety degrees out of phase with current in the other system.

With a transmitter for the visual beacon the radiation fields for one side of the loops may be considered as indicated in Fig. 10. The fields for the side bands carrying the two modulation frequencies are shown by the broken line circles and their radiations are in the directions of the broken line arrows. But the carrier frequencies, being the same in both loops, will combine and produce a field somewhat as indicated by the full line

AVIATION, RADIO IN

figure. Radiation from the combined carriers then is in the direction of the full line arrow.

The equisignal zones or courses may be bent to match the actual airway directions by varying the amplitude of modulation in one of the systems to change the power with an effect similar to that indicated in Fig. 9. Change also may be made by combining the circular radiation from a vertical antenna with either one or both of the radiations from the loop systems.

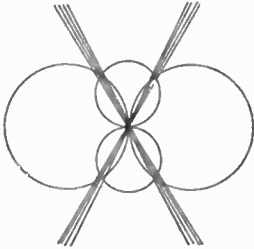

FIG. 9.—Effect of Field Strength on Beams.

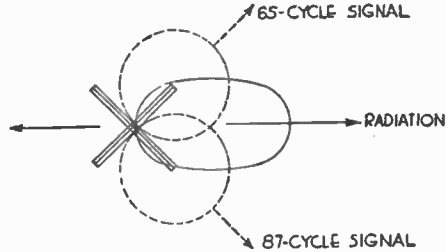

FIG. 10.—Radiation from Visual Beacon Transmitter.

Variation also results from changing the phase relation in time between the two modulations. For particular effects various combinations of all these methods may be employed.

Radiation from the beacon transmitter takes place from two large loops placed at right angles to each other, these loops being connected to a goniometer system in the general manner shown by Fig. 11. The addition of a third stator, rotor and modulating element to the two shown in Fig. 11 produces the triple modulation

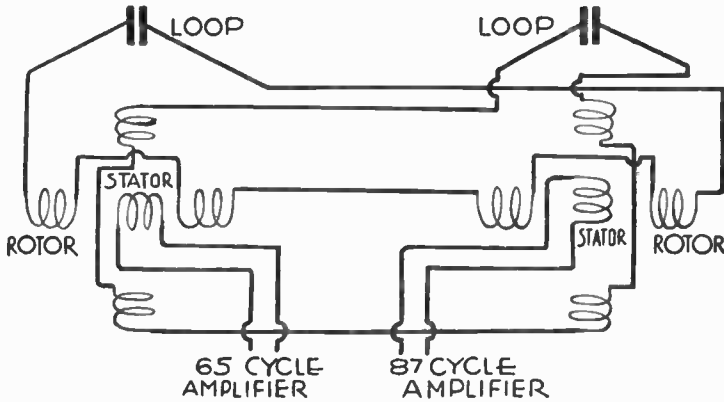

FIG. 11.—Circuit for Beacon Loops.

beacon with which are used three modulating frequencies; 65 cycles, 86.7 cycles and 108.3 cycles.

The triple modulation beacon provides twelve courses which may be adjusted to any desired angles so that they coincide with directions of the

AVIATION, RADIO IN

airways. With this twelve-course beacon is used a visual indicator having three reeds, each tuned to one of the modulating frequencies. A combination of two reeds is used when following a course identified by the two corresponding frequencies. The reed indicator is provided with a shutter which may be placed to expose the particular pair of reeds required for following a desired course.

In the system shown by Fig. 11 the loop antennas are fixed in position but the direction of their radiation is not wholly determined by physical position. Just as the receiving system illustrated by Fig. 3 reproduces the effect of the external field, so the transmitting system produces a field determined in space by positions of the stator and rotor windings. Each stator and rotor element of Fig. 11 causes production of a field equivalent to that which would be produced by one ordinary loop antenna. This imaginary antenna is called a phantom antenna, and the plane in which it has maximum radiation is positioned according to the plane of the stator winding when the rotor has zero setting. If the rotor is turned the radiation field turns or rotates correspondingly in space.

Rotating Beacon.—A system with which the operator of an aircraft is informed of true geographical direction is called the rotating radiobeacon. This type of beacon serves any course within its distance range but it requires considerable time for determinations and also involves some effort on the part of an observer.

The ground transmitter of the rotating beacon uses a loop antenna revolving at the rate of one revolution per minute so that the points of maximum and minimum intensities rotate in space. The observer in an airplane receives a special signal when the point of minimum intensity passes through north and again when it passes through east. He places a special stop watch in operation when the north signal is received and shuts it off when the minimum signal reaches him. The number of seconds on the watch, multiplied by six, then gives the aircraft's true direction in degrees from north. The watch also may be calibrated so that the position of its hand when the minimum signal is received indicates directly the bearing in degrees.

Special Beacon Signals.—In addition to range or beacon transmitters which define the airway courses there are numerous marker beacons placed at the ending of one and the beginning of another course, and also placed to indicate obstructions or other special conditions. These markers are of low power and are intended to have a range of only about five miles.

The distance of an aircraft from the beacon is shown by a special distance indicating meter operating in conjunction with the automatic volume control for the receiver on the ship. As the distance to a transmitter becomes less the signal strength becomes greater and the automatic volume control must provide more and more negative grid bias. This bias is provided by sending more current through the biasing resistors in the control grid circuits of amplifying tubes. The distance indicating meter carries this biasing current which is inversely proportional to distance, a greater current indicating less distance.

In the region directly over the antenna of a transmitter the field intensity is zero. Therefore, when an aircraft reaches this zero-signal zone

AVIATION, RADIO IN

the instruments indicate that the beacon has been reached since their readings drop to minimum value.

Altitude Indicators.—The principles of radio and electricity are employed in several ways to indicate the height of aircraft above the ground. Such devices are called altimeters. The capacity altimeter makes use of the fact that the electrostatic capacity between two metal plates changes in value as these plates approach or recede from a third conductor. The third conductor is the earth below the aircraft and measurement of the capacity variation between the first two plates forms an indication of height above the earth's surface. Such altimeters are of greatest usefulness when used at distances not more than 200 feet above the ground.

Other altimeters depend on the principle of radio wave reflection from the surface of the earth. The phase relation of the returning or reflected wave to that of the transmitted wave depends on the distance of transmitting antenna and aircraft above the ground. If the returning or reflected wave is in phase with the transmitted waves their effects are aiding and the frequency of the transmitter oscillator will increase. If the

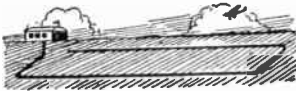

FIG. 12.—Leader Cable at Landing Field.

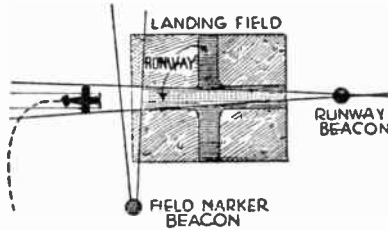

FIG. 13.—Runway and Boundary Markers.

waves are in opposite phase the frequency will be lowered. The change in frequency may be made to operate either a visible or audible indicator.

For each even multiple of wavelength in distance the phase relations will repeat and in order to determine which of several possible distances really exists, the strength of the returning wave may be measured, this strength becoming less with increase of distance traveled.

Blind Flying.—Numerous devices have been developed to enable a pilot to locate a landing field and make a safe landing without the aid of direct vision. These devices allow determination of field boundaries and of runway location, and they also allow following a suitable path in coming down to the earth's surface.

A conductor which is called a leader cable may be buried in the ground around a landing field as shown in Fig. 12 to allow correct approach to the field and to show the direction and location of runways. Induction signals from the cable are followed by the aircraft in coming in for a landing. The strength of these signals also gives some indication of the ship's height.

A system of locating the field and determining the runway direction is shown in Fig. 13. This system employs a marker beacon having a region of minimum signal extending along the edge of the field, this minimum

AVIATION, RADIO IN

Informing the pilot that he is passing the boundary. A second beacon has its radiation directed along the runway or along one axis of the field, from which runway direction may be known. By picking up the signal from this second beacon the travel of the aircraft may be correctly aligned.

A landing at a suitable gliding angle may be effected with the help of a signal called a landing beam and an indicating instrument called a glidometer which indicates the output of rectified current from a receiver operated from the beam signal. The general outline of such a beam, viewed in a vertical plane, is shown in Fig. 14. The beam slants upward and the aircraft follows along the region of constant intensity which exists along the lower part of the beam. This path is shown by the broken line in Fig. 14. The signal output of the receiver is rectified and passed through a microammeter. By maintaining the meter reading at a constant point it is possible to follow the constant intensity path which gradually levels off as the ground is approached.

There are practical means available by which an aircraft may follow the correct path from the time of takeoff at one field to the landing at another without its being necessary to see the ground at any time. To further increase the safety of flying "blind" it has been proposed that ships carry small transmitters and receivers, both tuned permanently to a suitable frequency on which would be transmitted a warning signal. With close approach of two aircraft so equipped the intensity of the signal would inform both pilots of possible danger.

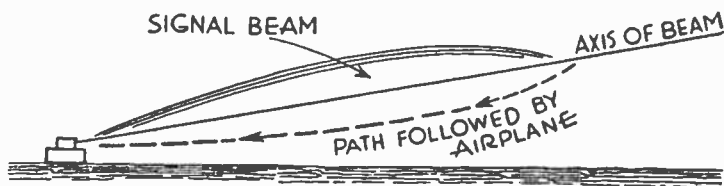

FIG. 14.—Landing Beam.

Certain forms of errors lessen the dependability of radio guidance. The angle at which a plane may be traveling with reference to a beacon course may introduce a slight error. There is also an effect of the sky wave which causes the radio beam to waver and the equisignal zone to shift to some extent, this being called the night effect.

Aircraft Receivers.—Radio receivers for aircraft use generally are of the tuned radio frequency type with three radio frequency amplifying stages, a detector and one or two audio frequency stages. Reception, of course, is with headphones. The set must be so designed as to allow installing it in any convenient and accessible location, this usually requiring the use of a remote control for tuning. The setting to receive a given frequency, such as that for an equisignal zone, may be semi-permanent and locked in, while a remote vernier control allows slight variations of tuning by easy manipulation on the operator's part.

Aircraft receivers must have great mechanical strength to prevent harm from vibration. In addition to being provided with cushion mountings it is the practice to employ tubes which are not microphonic, certain types having been especially developed for this class of work. Complete shielding

AVIATION, RADIO IN

prevents pickup of interference or of any signals except those coming through the antenna system, and suitable mechanical enclosure insures tightness against moisture and dust.

Volume control must be of the remotely operated type, must be operated with greatest ease and must be thoroughly effective at all frequencies used. The low frequency response must be uniform from about 40 to 120 cycles for beacon signals, and the voice fidelity must be satisfactory between about 200 and 3,000 cycles. To operate the course indicators the low frequency output must be 10 volts into an impedance of 5,000 to 6,000 ohms. These requirements call for high sensitivity (about five microvolts per meter) because of the small and relatively inefficient aircraft antenna systems and the necessity of receiving at distances as great as 150 miles from transmitters of about two-kilowatt rating. Good selectivity is required because of the rather close spacing between channel frequencies in aviation service.

One of the major problems in reception is that of preventing interference from the ignition system of the aircraft. The magneto is completely enclosed in a metal box or the ignition distributor is completely covered. All wiring is covered with copper braid, the high tension leads

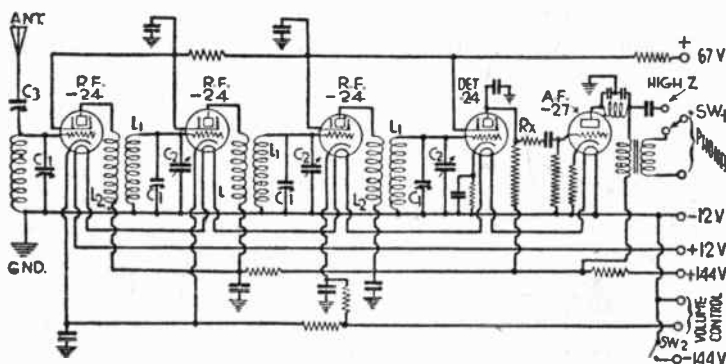

FIG. 15.—Circuits of Typical Airplane Receiver.

having also an inner protective tubing of aluminum. The wiring also may be enclosed within rigid tubes of metal. Spark plugs are individually shielded with metal covers and parts such as the ignition switch are completely protected.

The circuit diagram of a typical aircraft receiver is shown in Fig. 15.

Antennas for Aircraft.—Antenna systems used on large airplanes and on dirigible airships may be modifications of the commonly employed T-antenna. The first antenna specially developed for use with small aircraft is that called a trailing wire antenna. This type is being generally replaced with a short vertical pole. Antennas of the dipole type also are used, these consisting of two similar parts on either side of a coupling coil.

The trailing wire antenna consists of a long, flexible conductor having a weight attached to the free end and fed out through a guide called the fairlead in the fuselage of the ship. The length of the exposed conductor, and its inclination (determined by speed) affect the resonant frequency of the system. The inclination of such an antenna may introduce an error

AVIATION, RADIO IN

called airplane effect into direction finding, and the directional effect of this type makes it unreliable for beacon signal work.

The vertical pole antenna consists of a rigid metal tube six to ten feet in height erected on the fuselage of the aircraft. Such an antenna is affected by a vertically polarized wave whereas the horizontally disposed types of antennas are affected by horizontally polarized waves. This fact allows easy differentiation between two signals by the use of both types of antenna on one ship as shown in Fig. 16.

The antenna system is completed by using the metal parts of the body of the aircraft as a counterpoise. To secure satisfactory operation, with minimum noise in reception and maximum radiation in transmission, it is essential that all metal parts entering into the counterpoise be thoroughly bonded together with secure connections and low resistance conductors.

Power Sources.—Electric power for radio use on aircraft is generally furnished by suitable forms of generators or dynamotors driven either by the engine or by the force of the moving air from the propeller or around the ship. These machines may be of the high-voltage direct-current type for plate supply or they may generate alternating current of rather high frequency which is stepped up in voltage by a transformer, is rectified and filtered to provide direct current.

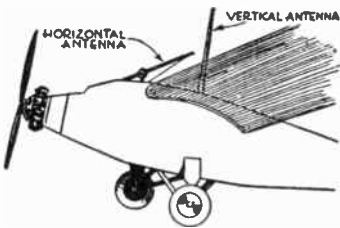

FIG. 16.—Airplane Antennas.

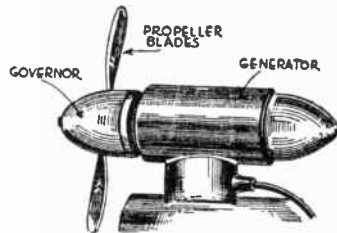

FIG. 17.—Wind Driven Generator.

Generators driven from the engine must furnish constant voltage. They are provided either with a voltage regulator allowing constant potential with variable speed, or they are provided with a speed control which maintains a constant rate of rotation for the generator with varying speeds of the airplane engine.

The wind driven generator, one of which is illustrated in Fig. 17, may have a built-in centrifugal governor which alters the pitch of the propeller blades with changing air velocity or with changing load on the generator so that the speed and voltage remain practically constant. If the generator speed is not controlled, the machine is provided with any suitable form of regulator to maintain constant voltage. If such a generator is located in the slip stream from the propeller it will operate either with the ship in flight or with it on the ground provided the engine is kept running.

A dynamotor is a machine which acts as a generator when driven by mechanical power and which acts as an electric motor when furnished with electric current. Such devices are used in

AVIATION, RADIO IN

connection with a storage battery. When the dynamotor is driven either from the engine or by the air stream it charges the battery, and by means of separate windings it may furnish at the same time direct current for operation of radio devices. When no mechanical driving power is available the unit is operated by current drawn from the storage battery, one set of windings acting as a motor while the second set functions as a generator and produces radio operating currents. The dynamotor and battery combination allows operation of radio apparatus even when the aircraft is stationary with the engine idle.

Emergency or auxiliary radio power sometimes is obtained through operation of a generator from a small, high speed gasoline engine. The engine may be arranged to run at a constant speed to insure a steady voltage. Hand driven generators, of about 50-watt rating, may be operated by one man as a source of emergency power.

The power requirement for transmitters such as used on aircraft generally runs in the neighborhood of 600 to 800 watts for the plate and filament supplies combined. Receivers of usual design require 30 to 60 watts of power for their operation.

B

B. b.—Symbols for magnetic induction. Susceptance in mhos.

BACK COUPLING.—See *Feedback*.

BACK VOLTAGE.—See *Electromotive Force*.

BAKELITE.—See *Phenol Compounds*; also *Resistance, Insulation*.

BALANCED ARMATURE SPEAKER.—See *Speaker, Loud*.

BALANCING.—The grid and plate of a tube form a capacity through which energy from the plate circuit may feed back

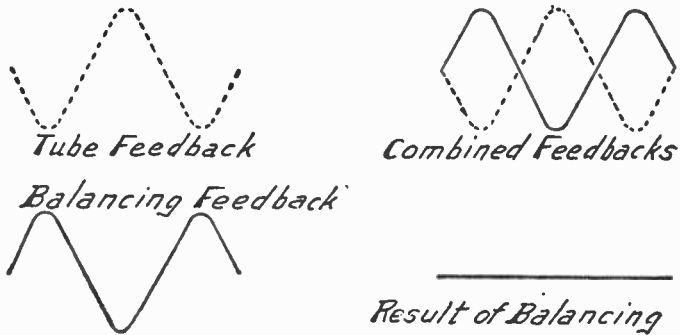

FIG. 1.—Combining the Feedbacks for Balancing.

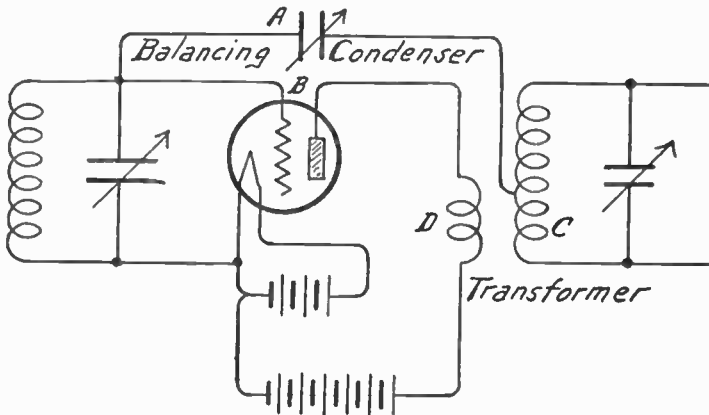

FIG. 2.—Neutrodyne Method of Balancing.

BALANCING

to the grid circuit unless balanced by an external condenser feeding back an equal amount of energy in opposite phase. Fig. 1.

Fig. 2 shows the neutrodyne method of balancing. A tap on the secondary of the plate transformer connects through the balancing

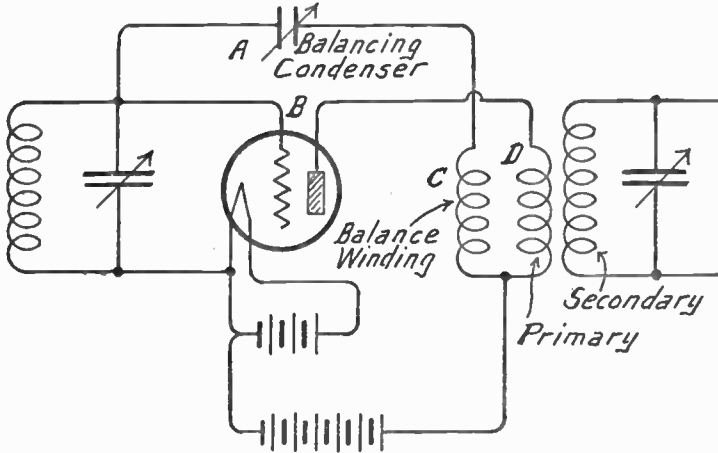

FIG. 3.—Roberts Circuit for Balancing.

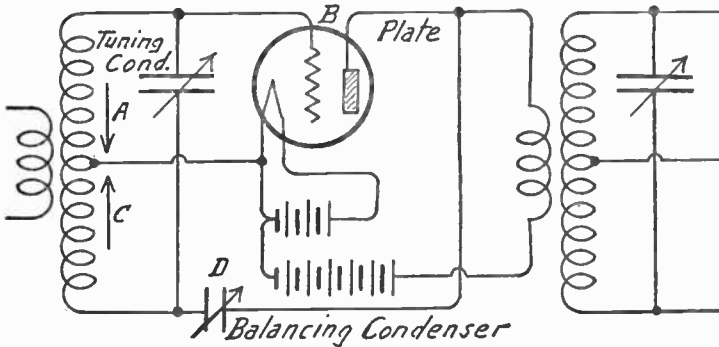

FIG. 4.—Rice Method of Balancing.

condenser to the grid circuit. Fig. 3 shows the Roberts circuit in which energy in opposite phase comes from a winding coupled to the plate coil. With the Rice method, Fig. 4, a balancing condenser connects one end of the center-tapped grid coil to the tube plate.

BALANCING

To balance a tube proceed as follows: Set the balancing condenser at about half capacity, tune in a fairly weak signal at maximum volume, open the filament or cathode circuit of the tube, then adjust the balancing condenser to reduce the volume as much as possible. Using a different tube will require rebalancing.

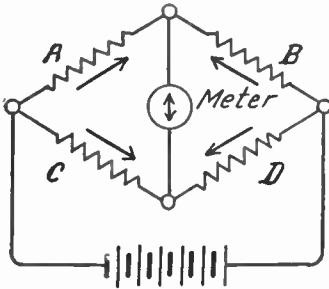

FIG. 5.—Balancing Principle of the Wheatstone Bridge.

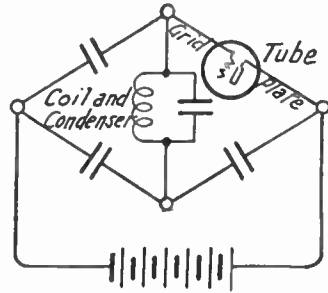

FIG. 6.—Position of Tube Capacity in a Bridge Circuit for Balancing.

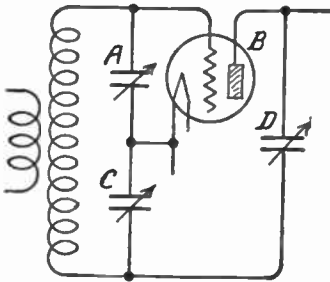

FIG. 7.—The Isofarad Method of Balancing.

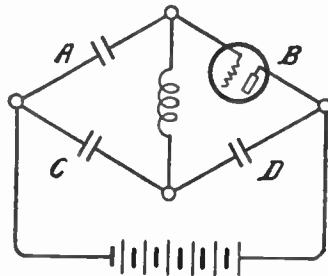

FIG. 8.—The Isofarad Balanced Circuit in Bridge Form.

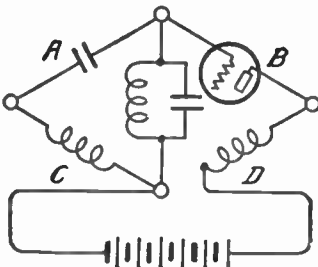

FIG. 9.—The Neutrodyne Balanced Circuit in Bridge Form.

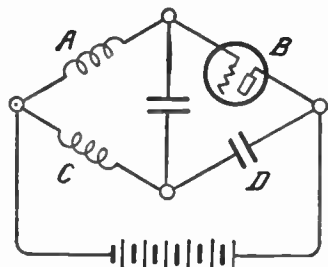

FIG. 10.—The Rice Balanced Circuit in Bridge Form.

BALANCING

Balancing circuits are in reality bridge circuits in which, across the source, there are two parallel paths with intermediate points between which is bridged an indicating element as in Fig. 5. The tube position is shown by Fig. 6. The Isofarad balancing system of Fig. 7 is redrawn as a bridge circuit in Fig. 8. Fig. 9 is a neutrodyne circuit drawn in bridge form, while Fig. 10 is a Rice circuit similarly redrawn.

BALLAST TUBE.—See *Tube, Ballast*.

BAND SELECTOR.—See *Circuit, Band Selector*.

BAND, WAVE.—A series of radio frequencies or wavelengths set aside as one of the channels of transmission from stations engaged in sending out radio signals.

In the broadcasting field, wave bands are usually ten kilocycles "wide." As an example one wave band extends from 795 kilocycles to 805 kilocycles. A transmitter using this wave band would send out a carrier wave at 800 kilocycles. Modulation of this carrier

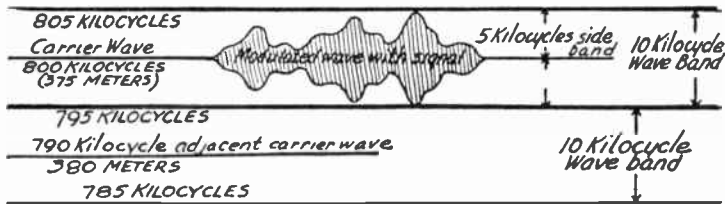

Relation of Wave Bands to Each Other.

wave would cause the side bands to extend five kilocycles on each side of the carrier, thus using the entire wave band of ten kilocycles from 795 kilocycles to 805 kilocycles.

Wave bands are not necessarily ten kilocycles wide, either a greater or less width may be used, for instance a wave band for broadcasting on 800 kilocycles might be made twenty kilocycles in width, from 790 kilocycles to 810 kilocycles. This would give a greater separation and less danger of interference between transmitters operating in adjacent wave bands or on adjacent assigned wavelengths.

BARRIER LAYER PHOTOCELL.—See *Cell, Photovoltaic*.

BATTERY, A-.—Any battery which furnishes potential and current for filaments or heaters of tubes. Portable receivers employ dry cell batteries or sealed types of storage battery for this purpose.

BATTERY, AIR CELL.—This is a non-rechargeable primary battery for furnishing filament current to low filament voltage tubes. The construction is shown by Fig. 1. Fig. 2 shows how this battery drops its terminal voltage by only about 0.15 volt per cell during the useful life. Depolarization is accomplished by absorption of oxygen from surrounding air through a carbon electrode which is the positive plate. The negative plate is zinc,

TABLE 1. EVEREADY AIR CELL "A" BATTERY — APPROXIMATE SERVICE DATA

Estimated Service for Various Closure Periods*

Constant Milli- Drain in Amp. Amperes	1 Hr. per Day			3 Hrs. per Day			6 Hrs. per Day			12 Hrs. per Day			24 Hrs. per Day		
	Hours	Hours	Days	Hours	Hours	Days	Hours	Hours	Days	Hours	Hours	Days	Hours	Hours	Days
25	20	800	800	60	2400	800	120	4800	800	240	9600	800	450	18000	750
50	39	790	790	115	2300	765	230	4600	765	435	8700	725	720	14400	600
100	78	780	780	220	2200	735	430	4300	715	695	6950	580	735	7350	305
200	154	770	770	425	2130	710	640	3200	535	680	3400	283	710	3550	148
300	225	755	755	600	2000	665	650	2165	360	660	2200	183	675	2250	94
400	300	740	740	625	1560	520	630	1575	263	635	1590	133	635	1590	66
500	360	720	720	615	1230	410	615	1230	205	615	1230	102	615	1230	51
600	420	700	700	605	1010	335	605	1010	168	605	1010	84	605	1010	42
650	445	685	685	600	925	310	600	925	154	600	925	77	600	925	39

BATTERY, AIR CELL

*The service values are estimated on the basis of probable battery performance at a constant temperature of 21° C. to a 1.8 volt cut-off.

Shelf depreciation, severity of drain and length of closure periods are major factors affecting battery efficiency as indicated by ampere hour out-put. For example, very poor efficiency is shown for the 25 milli-ampere drain at one hour per day, whereas superior performance can be expected at 100 milli-amperes on 24 hours per day closure.

BATTERY

and the electrolyte is a solution of caustic soda. The battery is shipped dry, and is placed in operation by adding water to the cells.

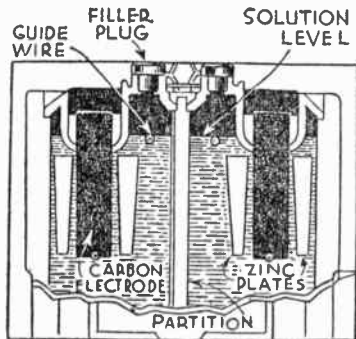

FIG. 1.—Air Cell Battery Construction.

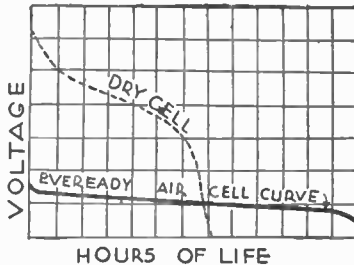

FIG. 2.—Dry Cell Air Cell Life Comparison Chart.

Open circuit terminal voltage is 1.4 volts per cell at ordinary room temperatures. The battery is designed to deliver about 600 ampere-hours when the current does not exceed 0.65 ampere. More current drain shortens the life of the battery.

BATTERY, B.—Any battery which furnishes potential and current for the plate circuits or anode circuits of tubes. Most B-batteries are of the dry cell type, although small storage cell types sometimes are employed.

Dry cell B-batteries are assembled with a number of small dry cells connected together in series and sealed within a case. The nominal battery voltage is equal to $1\frac{1}{2}$ times the number of cells. Commonly used B-battery voltages are $22\frac{1}{2}$, 45, and 90, although other and higher voltages are used for special purposes.

BATTERY, C.—Any battery which furnishes a potential for the grid bias of tubes.

BATTERY, DRY CELL.—A dry cell battery consists of a number of individual cells connected together in series to provide a total nominal voltage equal to $1\frac{1}{2}$ (volts per cell) times the number of cells. The case or can of each cell is of zinc, which forms the negative electrode or terminal. In the center is a rod of carbon, usually with a metallic cap, which is the positive electrode or terminal. Individual dry cells have diameters from $\frac{7}{16}$ to $2\frac{1}{2}$ inches, and heights over the can of $\frac{1}{2}$ to 6 inches. The sizes are designated by letters.

Battery terminals may be screw types, spring clips, or plug-in arrangements. There may be a single terminal of one polarity and two more of the opposite polarity, allowing more than one

BATTERY

potential to be secured from the battery. Outer jackets may be of cardboard or of metal, and sometimes are waterproofed.

Standard discharge tests are made through a 4-ohm resistance. The intermittent test consists of a 5-minute discharge every 24 hours until voltage per cell drops to 0.75. The continuous test is a steady discharge to the same end voltage. Following are the numbers of intermittent tests and the minutes of continuous test that various dry cells should withstand.

Type	Diameter — Length In Inches	Intermittent, Number of Tests	Continuous, Minutes
A	$\frac{5}{8} \times 1 \frac{7}{8}$	12	25
B	$\frac{3}{4} \times 2 \frac{1}{8}$	26	65
C	$1\frac{1}{16} \times 1 \frac{13}{16}$	42	90
D	$1 \frac{3}{4} \times 2 \frac{1}{4}$	100	380
E	$1 \frac{3}{4} \times 2 \frac{7}{8}$	150	550
F	$1 \frac{3}{4} \times 3 \frac{7}{16}$	180	800

BATTERY, PLATE.—See *Battery, B*.

BATTERY, STORAGE TYPE.—Storage batteries consist of a number of cells. Each cell is made up of several positive plates and several negative plates. All of the positives are connected together and all of the negatives are connected together as in Fig. 1.

The positive and negative plates alternate with each other in position and are kept apart by separators of wood, celluloid or hard rubber. The plates themselves are made of lead alloys and chemical compounds of lead. The plates and their separators are immersed in a bath of sulphuric acid diluted with water, this liquid being called the electrolyte. The electrolyte and the plates are carried in a jar made of glass, hard rubber or other insulating material.

One cell of a storage battery, regardless of its size, shape or construction will deliver only two volts pressure, but its ability to deliver current or amperage depends upon the size of the plates, the quantity of material in the plates and the amount of electrolyte in the cell.

A battery is made up of a sufficient number of cells to give the required voltage. The cells are connected in series with each other as in Fig. 2 so that the voltage of the battery is equal to the number of cells times two, since each cell will give two volts.

Both positive and negative plates are formed of metallic lead frames called grids. Spaces in the grids are filled with active material formed from com-

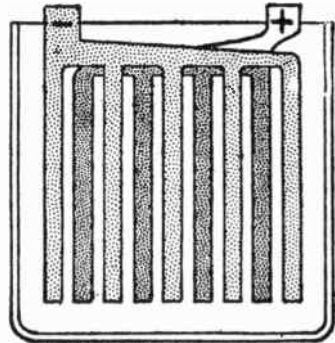

FIG. 1.—How Positive and Negative Plates Alternate in Storage Battery Cell.

BATTERY, STORAGE TYPE

pounds of lead. After manufacture the plates are given several charges and discharges, called forming. This forming turns the active material in the positive plate to peroxide of lead, which is reddish brown in color. The material in the negative plates becomes sponge lead, dull gray in color.

When the battery is connected to the receiver and the filament switch turned on an action immediately begins to take place between the plates and the electrolyte. A part of the sulphuric acid in the liquid combines with the lead in the plates to form lead sulphate and the surfaces of both plates gradually become covered with this sulphate. The percentage of water in the electrolyte is increased because of the combining of part of the acid

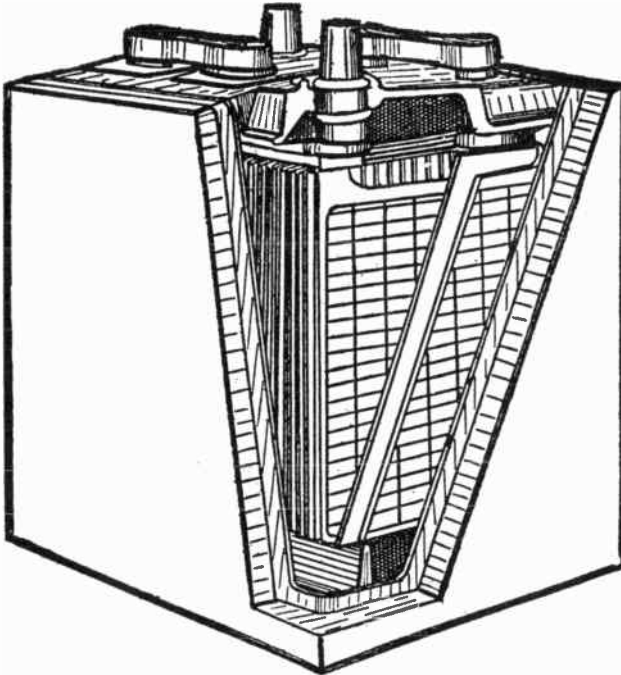

FIG. 2.—The Complete Storage Battery with Cells in Series.

with the lead of the plates, leaving water in the electrolyte. The surfaces of the plates thus change slowly to lead sulphate, while the liquid becomes more nearly pure water.

When the battery is recharged, the sulphate of the plates combines with part of the hydrogen and oxygen in the electrolyte to form more sulphuric acid. The positive plate then becomes peroxide of lead and the negative is left as sponge lead. This transformation continues until the sulphate is completely reduced, and the battery is then said to be charged.

The capacity or current delivering ability of a storage battery is measured in ampere-hours (see *Ampere-Hour*). The larger the plates the greater will be the ampere-hour capacity of the battery; that is, the greater the height, width and thickness of the plates the more capacity they will have.

Radio types of storage batteries generally have plates about five thirty-seconds to one-quarter of an inch in thickness. This comparatively thick

BATTERY, STORAGE TYPE

plate makes for long life and durability. The demand for current is very small in radio work so that a great number of plates is not required.

Testing Storage Batteries.—In the operation of a storage battery the discharge must not go so far that the voltage becomes abnormally low. Under no conditions should discharge be continued when the voltage drops to 1.7 volts per cell. If the current flow from the battery is continued at this voltage serious and permanent damages will result from over-sulphation of the plates.

From the explanation given of the action that takes place during charge and discharge, it will be seen that the proportion of acid in the electrolyte will give an indication of the condition of the battery,

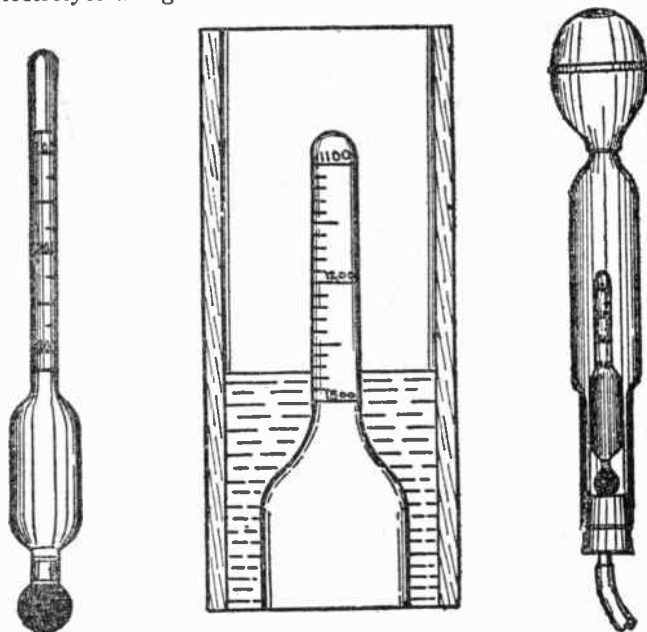

FIG. 3.—A Hydrometer, Its Scale, and a Hydrometer Syringe for Storage Battery Tests.

whether it is properly charged or nearly discharged. The acid is much heavier than water, and as the proportion of acid in the liquid becomes greater, the weight of the electrolyte becomes greater. Therefore, the heavier the electrolyte, the more nearly charged the battery is known to be.

To find the condition of the battery by testing the liquid, a hydrometer is used. The hydrometer is a glass tube having a hollow bulb with a weight at one end and a thin tube with a numbered scale at the other end. When this instrument is allowed to float in the electrolyte liquid from the battery cells, the point on the scale to which it sinks indicates the weight of the liquid. The hydrometer

BATTERY, STORAGE TYPE

will not sink so deeply into the heavy liquid having a large proportion of acid as into the lighter liquid when almost all water. The hydrometer scale is graduated according to specific gravity, which is the weight of the liquid compared to that of pure water.

On the stem of the hydrometer appear numbers from 1.100, near the top, to 1.300 near the bottom. This is shown in Fig. 3.

The hydrometer itself is usually carried in a larger tube with a small nozzle at the lower end and with a bulb at the upper end so that some of the electrolyte may be drawn from each of the cells for purposes of test. In the top of each cell of every battery is a small plug. This plug may be unscrewed or released from its lock and will leave an opening into the interior of the cell. Through this opening the electrolyte or the tops of the plates may be seen. With a plug removed, the hydrometer syringe, as the tube and bulb are called, is inserted into the cell, the bulb is squeezed and allowed to expand whereupon some of the liquid will be drawn up into the tube and the hydrometer will float in this liquid. After all pressure has been released from the bulb the specific gravity of the liquid is the reading on the hydrometer scale at the point where the instrument rises above the surface of the electrolyte. After the gravity is read the liquid should be carefully returned to the same cell from which it was drawn. The same method is used to find the specific gravity of each cell.

If this gravity is between 1.250 and 1.300, the cell is well charged. If the gravity is between 1.200 and 1.250, the cell is at least half, but not fully, charged. Gravity between 1.150 and 1.200 indicates that the cell is nearly discharged, while gravity of 1.150 or below means that the cell is discharged to a point at which no further discharge should be allowed. The gravity is often mentioned in "points," the difference between 1.200 and 1.250 being fifty points.

If the battery is in good condition, the gravity will be within twenty-five points of the same in all cells. If there is a greater difference than this it usually indicates trouble in the low cells.

Care of Storage Batteries.—It is essential that a storage battery have certain attention at regular intervals. The most important item in the care of a battery is that of adding pure water to each cell at least once a month. Water is added through the holes left with the vent plugs removed and may be easily handled by using the hydrometer syringe. A sufficient quantity of water should be placed in each cell to bring the surface of the liquid from one-quarter to one-half inch above the tops of the plates, this point being indicated in many batteries by a rim that may be seen at the bottom of the hole from which the plug was removed.

The water used for filling cells must be distilled water or else perfectly clean rain water. Tap water or water that has been kept in metal containers must never be used. Except when some of the electrolyte has been spilled from one or the cells, nothing but pure water should ever be added. In no case should undiluted sulphuric acid or strong electrolyte be used. Such work should be done only by a battery service station.

BATTERY, SWITCH FOR

Care should be used when testing not to spill electrolyte on top of the battery, as it will cause corrosion at the terminals and partial short-circuiting of the cells. The level of the liquid in the cells should not be made so high that overflow results from the gases evolved as the battery is charged.

At the time of testing or adding water to the battery the terminals should be carefully examined for looseness or breakage. No copper wires should be attached directly at the lead battery posts, as the copper will be eaten by the action of the acid. Lead covered lugs or lead covered spring clips are used for all connections at the battery itself. If the connections are found covered with corrosion or verdigris, they should be washed with ammonia or with baking soda and water and covered with a coat of vaseline to prevent further action by the acid. If the battery case is wet or if the inside of the battery compartment is wet, the moisture should be wiped away with a cloth slightly wet with ammonia water.

BATTERY, SWITCH FOR.—See *Switch, Battery or Filament*.

BATTERY, TESTING OF.—See *Battery, Dry Cell Type; Battery, Storage Type*.

BATTERY, WET.—See *Battery, Storage Type*.

BEACON, AVIATION.—Radio beacons and ranges are treated under *Aviation, Radio in*.

BEACON, RADIO.—A radio beacon is a transmitting station on or near the shore of a navigable body of water. Signals are sent out by the beacon to be picked up by ships. The navigators of such ships are able to determine their location with reference to two or more of the radio beacons from which they receive signals.

Radio beacons generally send out certain distinctive signals. These signals are sent at definite intervals like the signals from a lighthouse and the intervals of time together with the kind of signal allow the ship's navigator to tell what beacon is heard. The system is also in use whereby a ship may call a shore station which takes the ship's bearings, and at the same time has bearings taken by other shore stations. One of the shore stations then calculates the ship's position from the bearings and transmits the information to the navigator. See also *Compass, Radio*.

BEAM TUBE.—See *Tube, Beam Power*.

BEAT FREQUENCY.—See *Beats, Formation of*.

BEAT FREQUENCY OSCILLATOR.—See *Oscillator, Beat Frequency*.

BEATS, FORMATION OF.—An alternating current of one frequency may be combined with another alternating current of a different frequency to produce an entirely new frequency which will be lower than either of the first two. This effect may be understood by an examination of the diagram.

The upper part represents the rise and fall of voltage in an alternating current having an assumed frequency of 500 cycles while the curves immediately below represent the rise and fall of voltage in another alternating current having a frequency of 400 cycles.

At the instant represented by the vertical line *A-A* the positive voltage of the 500 cycle frequency combines with the negative voltage of the 400 cycle frequency and, since their amplitudes are nearly

BEESWAX

equal, the result is a very small amplitude in the new current. This new current is represented by the third curve from the top which shows the varying amplitudes of the combined currents or voltage waves.

At the instant represented by the vertical line *B-B* the negative voltage of the 500 cycle current and the negative of the 400 cycle current have combined with each other to form a much greater negative amplitude in the combined curve.

At the instant represented by the vertical line *C-C* the positive voltage peaks of the two upper frequencies have combined to form a new positive peak of much greater amplitude. Between point *A-A* and point *C-C* the voltage of the combined currents rises steadily from minimum to maximum amplitude. Then from point *C-C* to point *D-D* the combined voltage steadily falls to minimum value again.

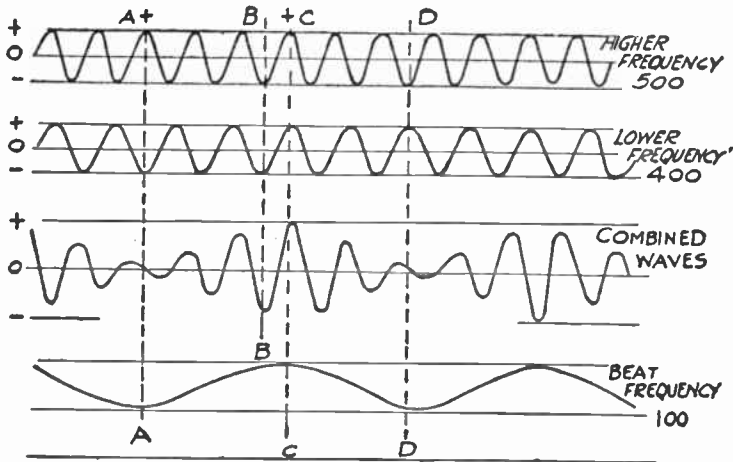

The Formation of a Beat Frequency from Two Higher Frequencies.

This repeated rise and fall in voltage or amplitude is represented by the bottom curve where it is seen that the new frequency of 100 cycles has been formed. Any two frequencies may thus be combined when introduced into the same circuit and they will give rise to a new frequency which will be equal to the difference between the two which were combined. Thus, a frequency of 300 kilocycles may be combined with one of 310 kilocycles to produce a new frequency of 10 kilocycles which is the difference between 310 and 300 kilocycles. This principle of forming a beat frequency is the foundation of the superheterodyne method of amplification.

BEESWAX.—See *Waxes, Insulating*.

BELL WIRE.—See *Wire, Bell*.

BIAS, GRID

BIAS, GRID.—Grid bias is the potential of the control grid of a tube with reference to the potential of the cathode, considered as zero, when no signal is being applied to the grid. If the grid return is connected directly to the cathode there is said to be zero bias. If the grid is more negative than the cathode there is negative bias, and if more positive than the cathode there is positive bias.

Fig. 1 shows the variation of plate current in a tube whose control grid has zero bias and is receiving a 3-volt signal. When the signal becomes three volts negative it makes the grid three volts more negative than the

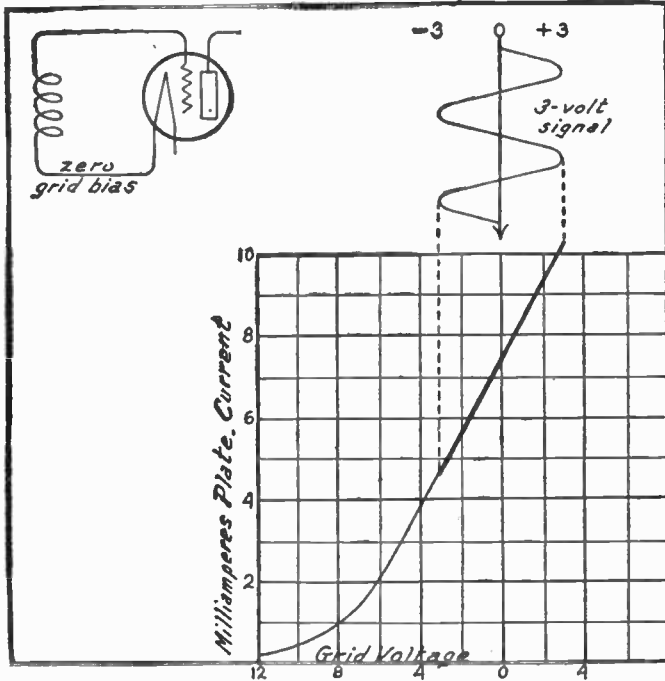

FIG. 1.—Effect of Zero Grid Bias, Distortion.

cathode or filament, and when the signal is three volts positive it makes the grid three volts positive with reference to the cathode or filament. Whenever a control grid is positive with reference to the cathode or filament, current flows in the grid circuit and flows from grid to cathode inside the tube. Changes of plate current then are not proportional to changes of grid signal voltage, and there will be distortion if the tube is an amplifier.

In Fig. 2 the grid bias has been made three volts negative, and the same 3-volt signal is applied to the grid. Now, when the signal voltage becomes three volts positive it just balances the 3-volt negative bias, and the grid becomes of zero potential with reference to the cathode or filament. When the signal becomes three volts negative its voltage is added to the 3-volt negative bias, and the grid is made six volts negative with reference to the cathode or filament.

BIAS, GRID

In Fig. 3 the grid bias has been increased to six volts negative. When the signal goes three volts negative the grid becomes nine volts negative and operation is on the lower bend of the plate current curve. This means that decreases of plate current will be less than the increases of plate current when the signal voltage changes are equal, and since the plate current changes are not proportional to signal voltage changes there will be distortion if the tube is used as a class A amplifier.

If grid bias is less than the maximum signal voltage the grid will become positive at some instants, and there will be flow of grid current. With the negative bias equal to the maximum signal voltage the grid will remain

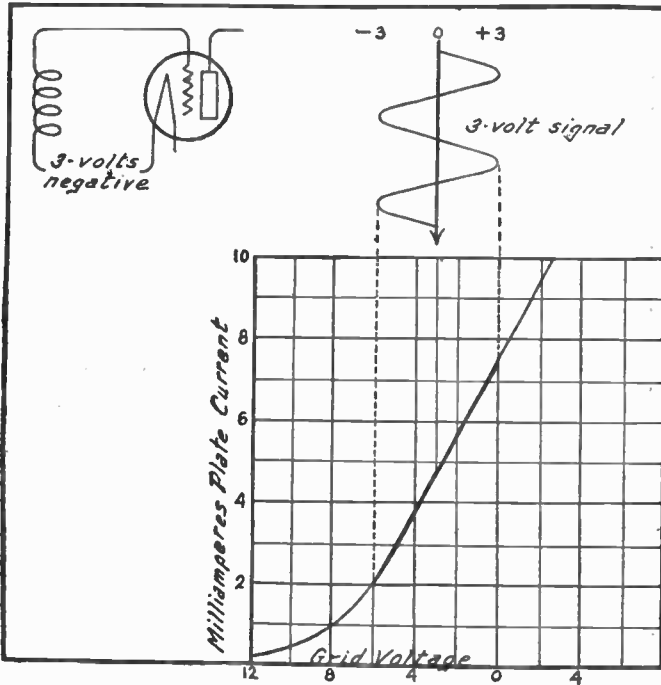

FIG. 2.—Negative Grid Bias Equal to Signal Voltage, No Distortion.

negative at all times and no grid current will flow. With still greater negative bias there will be distortion in a class A amplifier if the signal voltage is great enough to work the tube on the lower bend of the plate current curve.

Fig. 4 illustrates plate current flow, with no grid current, when the grid bias is sufficiently negative to maintain the grid negative with reference to the cathode at all times. Fig. 5 shows how current flows in the grid circuit when the relations between grid bias and signal voltage are such that the control grid becomes positive at some instants, and then carries current just as does a positive plate. Conditions shown here with batteries as the potential supply would be the same were the supply of the usual rectified direct-current type.

BIAS, GRID

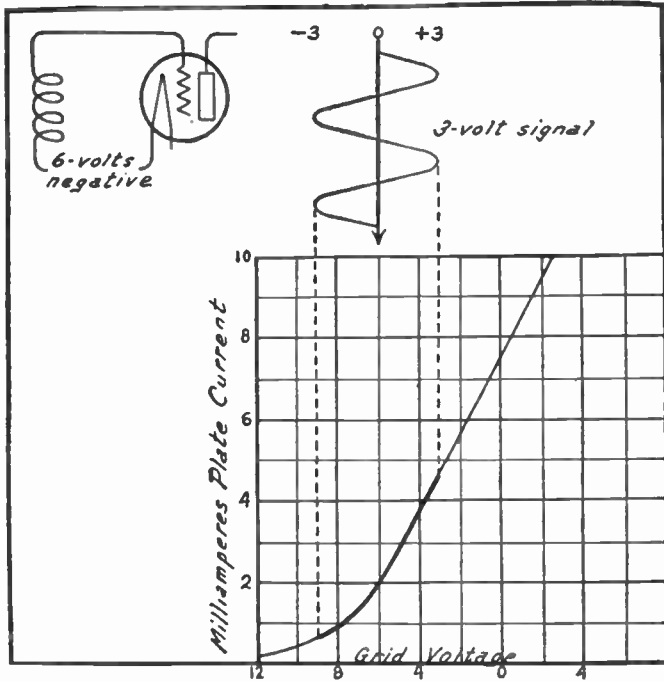

FIG. 3.—Too Much Negative Grid Bias, Distortion.

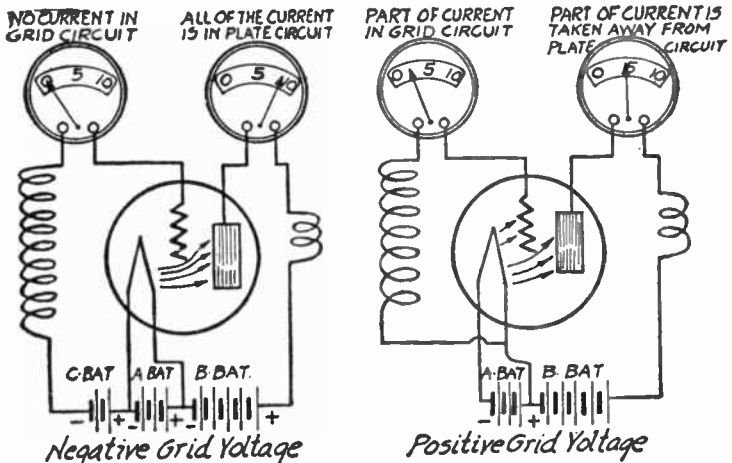

FIG. 4.—Electron Flow with Negative Grid Bias Voltage.

FIG. 5.—Current in Grid Circuit with Positive Bias.

BIAS, GRID

Methods of Obtaining Bias.—In tubes having an indirectly heated cathode the grid bias is equal to the potential difference between the control grid and the cathode. In tubes having filaments carrying alternating current the grid bias is the difference of potential between the control grid and the center of the filament, which is the same as the difference between the grid and the electrical center of a resistor or a coil winding connected across the ends of the filament. With a battery heated filament the bias is the potential difference between the control grid and the negative end of the filament.

Biasing methods for tubes with indirectly heated cathodes are shown in Fig. 6 where the control grids are connected to points having lower voltage than the cathodes. At the left a biasing resistor is connected between cathode and ground and is bypassed with a condenser having low reactance to frequencies amplified by the tube. Flow of plate current is indicated by the arrows and as this current flows downward through the biasing resistor the voltage drop maintains the upper end of this resistor at higher voltage than the lower end. The upper end of the resistor is connected to the cathode and the lower end is connected through ground to the control grid return, thus making the control grid negative with reference to the cathode.

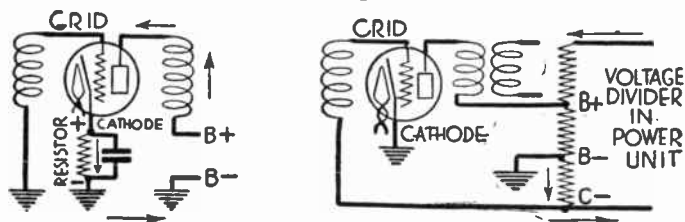

FIG. 6.—Biasing for Heater Tubes.

In the right hand diagram of Fig. 6 the tube's cathode is connected directly to ground and the control grid return is connected to a point in the voltage divider system at which the potential is lower than that of ground, thus again making the control grid negative with reference to the cathode.

Biasing for alternating current filament tubes is shown in Fig. 7. At the left the direction of plate current is indicated by the arrows as it passes through the filament leads, to the center tap of the transformer winding and through the biasing resistor to ground. The voltage drop in the resistor makes the end connected to the filament center tap become positive with reference to the ground end, and since the control grid return is connected to ground the grid itself is made negative with reference to the filament.

At the right hand side of Fig. 7 there is a center tapped resistor connected across the filament, the tap being connected to ground. The grid return is connected to a point on the voltage divider system at which the voltage is lower than ground potential, so that the control grid is made negative with reference to the filament center.

The number of ohms required in any biasing resistor is equal

BINDERS

to the required grid bias in volts divided by the current in amperes which flows through the resistor. This current is equal to the combined currents in plate circuits, screen circuits and all other circuits for additional electrodes except the filament or heater and the control grid. The current for resistance calculation must

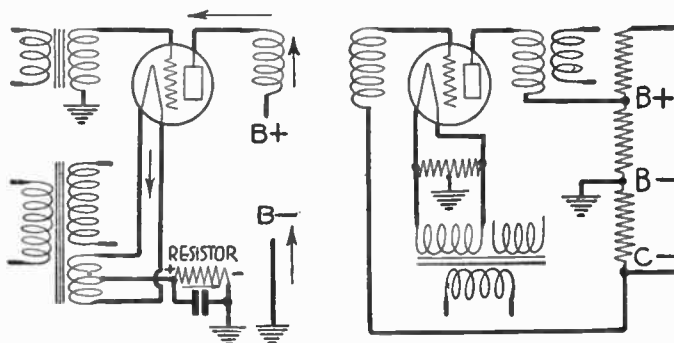

FIG. 7.—Biasing for Filament Tubes.

be that which actually flows when the proposed working voltages and grid biases are in use. The reactance of the bypassing condenser at the lowest frequency amplified should be no greater in ohms than the resistance in the biasing unit.

BINDERS.—Various materials are used as coating of coils for the purpose of adding mechanical strength, of holding the wires together and in place, and of making the coils moisture proof. The most generally used binders include collodion, paraffine, shellac, insulating varnish and specially prepared cements marketed under various trade names.

While all forms of binders or cements improve a coil from the standpoint of permanence and unchanging performance, all of them likewise do more or less harm from the standpoint of electrical efficiency. The principal objection is that the binder adds a certain amount of distributed capacity to the coil and this distributed capacity causes a loss of energy. The amount of harm done is in direct proportion to the amount of binder used, therefore any cementing material should be used sparingly and spread thinly. It should be used only where really needed on the coil.

A good coil cement may be made from collodion dissolved in a mixture of one-half acetone and one-half amyl acetate. The collodion may be secured by washing the coating from photographic films in warm water. Collodion is composed of pyroxylin or gun cotton dissolved in ether and alcohol.

Collodion, paraffine wax and many of the prepared coil cements add so little distributed capacity at the frequencies used in broadcasting that the gain

in permanence and reliability of performance is almost always of greater value than the very slight loss in efficiency. Shellac and ordinary insulating varnish cause a considerable loss in coils coated with these materials and their use should be avoided.

The effect of different binders on the effective resistance of coils used at broadcasting frequencies is shown in the curves. All of the coils are wound

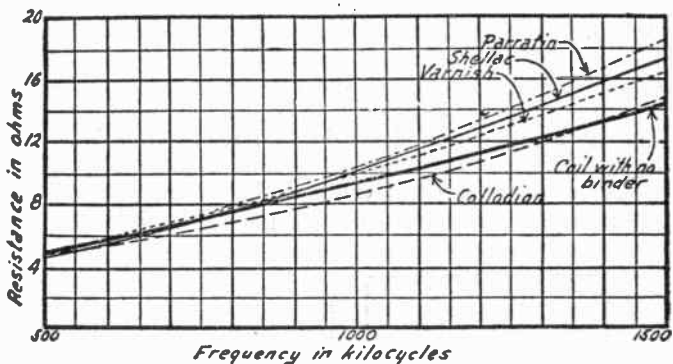

Effect of Binders on High Frequency Resistance of Coils.

with number 28 wire on hard rubber forms. It will be seen that the resistance of the coil having collodion as a binder is actually less than a similar coil with no binder of any kind. All other binders increase the resistance from twelve to twenty-two per cent at high frequencies.

BINOCULAR COIL.—See *Coil, Closed Field Type*.

BLANKETING.—The effect of a powerful signal from a nearby station because of which a receiving set is unable to receive signals from other stations operating at frequencies near that of the blanketing station. The nearby station forces the receiving circuits to oscillate at its frequency by means of shock excitation whenever the receiving circuits are tuned to resonance. See *Selectivity*.

BLOCKING LAYER PHOTOCELL.—See *Cell, Photo-voltaic*.

BLOCKING OSCILLATOR.—See *Oscillator, Relaxation*.

BLOOPER.—A radiating receiver. See *Re-radiation*.

BLUE GLOW.—See *Tube, Ionization in*.

BODY CAPACITY.—See *Capacity, Body*.

BOUND CHARGE.—See *Induction, Electrostatic*.

BRASS.—Brass is a metal made by alloying copper and zinc in various proportions. Its electrical resistance varies with the composition. The more copper the less the resistance and the less the mechanical strength or hardness. Resistances vary from 1.1 times to 2.5 times that of copper of equal cross sectional area.

BRIDGE CIRCUIT

Various radio receiver parts are made of brass, these parts including brackets, condenser parts, tube socket parts, screws, etc. Brass may be easily soldered and it is comparatively easy to drill, thread and bend into various shapes. Brass corrodes when used near storage batteries and oxidizes slowly in the air. To prevent oxidation brass parts are often lacquered. See also *Shielding*.

BRIDGE CIRCUIT.—See *Balancing*.

BRIDGE, MEASUREMENTS BY.—Various forms of the Wheatstone bridge may be used for making quick and easy measurements of unknown resistances, inductances and capacities used in radio work. The principle of the Wheatstone bridge, or Wheatstone balance as it is sometimes called, is shown in Fig. 1. Four arms of the bridge are connected as shown in Fig. 1, the arms being designated by the letters *A*, *B*, *X* and *S*. Points *c* and *d* are connected to a battery or other source of voltage. Between points *e* and *f* is connected a sensitive galvanometer or a pair of headphones.

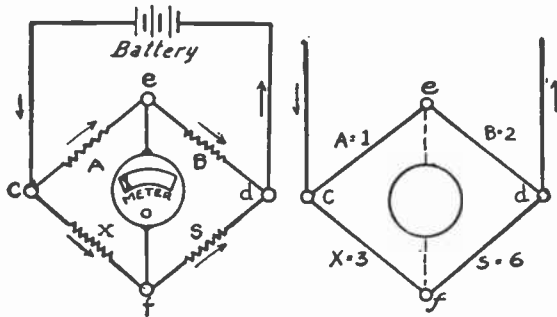

FIG. 1.—Principle of the Wheatstone Bridge.

FIG. 2.—Obtaining a Balance in the Bridge.

Current flows from the battery or other source to *c*, then divides and flows by way of the two parallel paths *A-B* and *X-S* to point *d* and back to the source. If the values in the four arms are such that they conform to the proportion

$$\frac{A}{B} = \frac{X}{S}$$

then the voltage drop from *c* to *e* will be the same as the drop from *c* to *f* and points *e* and *f* will be at equal voltages. Since there is no difference between the voltage at *e* and that at *f*, there will be no flow of current through the meter or phones and the bridge is then said to be balanced.

A balanced bridge is shown in Fig. 2 where arm *A* has a value of 1, arm *B* has a value of 2, arm *X* a value of 3 and arm *S* a value of 6. Substituting these values in the above proportion or equation we have,

$$\frac{A}{B} = \frac{X}{S} \quad \text{or} \quad \frac{1}{2} = \frac{3}{6}$$

BRIDGE, MEASUREMENTS BY

Under such a condition arm *A* contains one-third the total resistance of side *A-B*, while the corresponding arm *X* contains one-third the total resistance of side *X-S*. Since the ratio is the same on both sides of the bridge, points *e* and *f* will be at the same voltage and a balance is secured.

As shown in Fig. 3, arms *A* and *B* are called the "ratio arms" since they form the first part of the proportion $A:B::X:S$. Arm *X* is formed by the unit of unknown value which is to be measured. Arm *S* is formed by a known value which may be adjusted to such a point that the bridge is balanced.

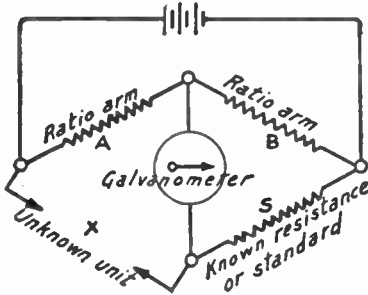

FIG. 3.—Functions of the Arms in a Bridge.

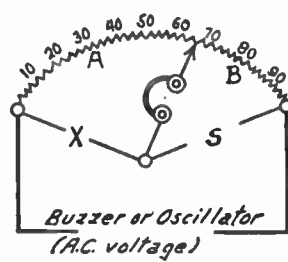

FIG. 4.—Principle of the Slide Wire Bridge.

If *S* cannot be gradually varied to secure a balance, then the ratio arms *A* and *B* are changed until the bridge is balanced.

Slide Wire Bridge.—A form of bridge in which the ratio arms *A* and *B* are continuously variable is shown in Fig. 4, this being one of the most convenient forms for radio measurements. A "slide wire bridge," made according to the principle shown in Fig. 4, is

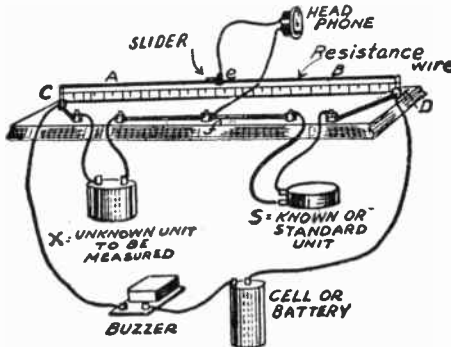

FIG. 5.—Practical Form of Slide Wire Bridge.

illustrated in Fig. 5 as actually constructed in practice. The two ratio arms are formed by a single resistance wire of uniform cross section and of any convenient length which is mounted between two posts which correspond to points *c* and *d*. A scale, such as a long ruler, is mounted directly underneath the slide wire and a slider or sliding contact which corresponds to point *e* is arranged

BRIDGE, MEASUREMENTS BY

to be moved along the wire while remaining in contact with it at all times. Arms *X* and *S* are left open for the unknown and known units respectively. Between point *f* and the slider or point *e* are connected the headphones or a galvanometer. The source of voltage and current may be a dry cell and buzzer for tests of inductance and capacity or simply a dry cell alone for resistance tests. When using only a dry cell without the buzzer a galvanometer must be used as the headphones will not give any sound.

An excellent source of voltage for making all measurements of resistance, inductance and capacity is the audio frequency oscillator described under *Oscillator, Audio Frequency*. The terminals of the oscillator are connected to points *c* and *d* of the bridge. The alternating voltage of the buzzer allows measurements of inductances and capacity which cannot be made with a battery as a source of current.

Tests made with this bridge are shown in Figs. 6, 7 and 8. Determination of the resistance of a rheostat is shown in Fig. 6. The rheostat is connected in arm *X* while a known fixed resistance of 60 ohms is used in arm *S*. The known value, whether it be resist-

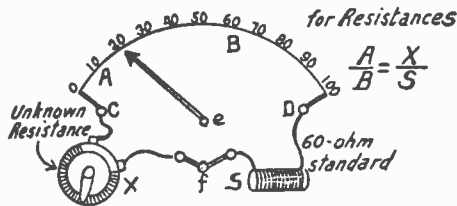

FIG. 6.—Resistance Measurement with Bridge.

since, inductance or capacity, should be selected as somewhere near the probable value of the unknown unit. The slider is moved across the wire until the bridge is balanced, which will be indicated by the galvanometer reading becoming zero or by no sound of the buzzer or oscillator being heard in the headphones. The part of the wire at the left of the slider then forms value *A* of the ratio and the part of the wire at the right of the slider forms the value *B* of this ratio.

In Fig. 6 we find 20 parts of the wire forming value *A* and the remaining 80 parts forming value *B*. Consequently we have the ratio 20/80 which is the same as $\frac{1}{4}$. This must be equal to X/S and since we know *S* to be 60 the second part of the proportion becomes $X/60$. Now 20/80 equals $X/60$, which gives the value of *X* as 15 ohms.

Fig. 7 shows the use of the bridge for determining the value of an unknown inductance. Here we use a known inductance of 300 microhenries as arm *S* and when no sound of the buzzer or oscillator is heard in the phones the arm is found to rest at 40, giving 40 as the value of arm *A* and leaving the remaining 60 parts of the wire as the value of arm *B*. Then, substituting the known value of 300 microhenries as *S* in the proportion A/B equals X/S we have 40/60

BRIDGE, MEASUREMENTS BY

equals $X/300$ and solving this proportion gives the value of X , the unknown inductance, as 200 microhenries.

In Fig. 8 the bridge is being used to find the value of an unknown capacity. The unknown value condenser is connected in arm X and a known capacity of 1000 micro-microfarads is used as arm S . When no sound is heard in the phones the arm is at 66 on the wire and scale. In measuring capacity we do not use the direct ratio that was used for both resistance and inductance measure-

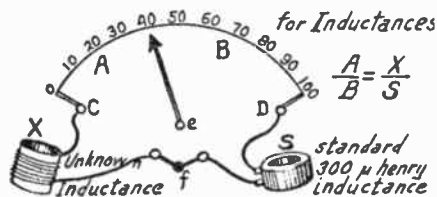

FIG. 7.—Inductance Measurement with Bridge.

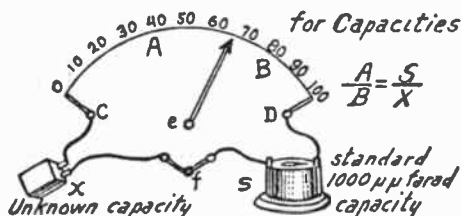

FIG. 8.—Capacity Measurement with Bridge.

ments but now use the inverse ratio, A/B equals S/X . Substituting the known values in this proportion we have $66/33$ equals $1000/X$. The fraction $66/33$ is close enough to the true values $66/34$ and is used because it forms a comparatively simple ratio equal to $2/1$. Solving this equation ($66/33$ equals $1000/X$) gives 500 micro-microfarads as the capacity of the unknown condenser.

BRIDGE RECTIFIER.—See *Rectifier, Full-wave*.

BROADCASTING

BROADCASTING.—The transmission of entertainment and other matters of public interest by means of radio waves which may be picked up by any receiver within range of the signals is called broadcasting. Speech was sent out from arc transmitters as early as 1907 and from continuous wave vacuum tube transmitters in 1915. However, modern broadcasting generally is considered to have begun with the sending out of the Harding-Cox election returns from station KDKA at Pittsburgh on November 2nd, 1920.

The earliest commercially manufactured broadcast receivers were marketed in 1921 in the form of crystal detector sets and single tube regenerative detector sets. At this time all entertainment and music was transmitted on the single wavelength of 360 meters, while weather and crop reports were on 485 meters. A year later the 400-meter wavelength was allowed for certain high quality stations. In 1923 broadcasting spread through the wavelengths from 230 meters to 545 meters with ten-kilocycle separation between channels, transmitters were moved out of thickly settled

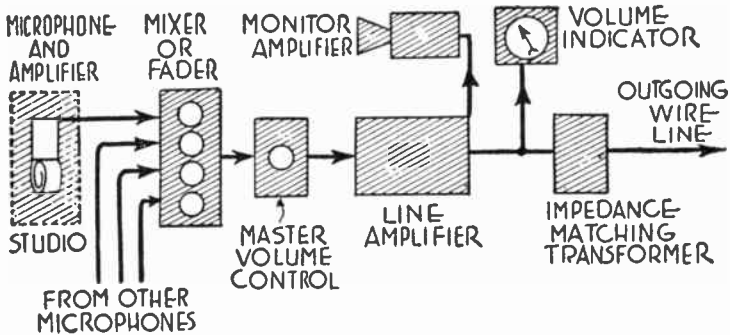

FIG. 1.—Speech Input Equipment for Broadcasting.

districts and connected by wire to their studios, and chain broadcasting began.

Broadcasting transmitters may be simple or complex in their makeup, but since the highly developed and high power stations include everything that is used in the smaller equipments it is possible to gain a good conception of this kind of work by examination of the elements of a large plant.

Speech Input Equipment.—The parts used at a local studio are shown in Fig. 1. Several microphones, each having its own microphone amplifier, are connected to a mixer. The mixer allows pickup of various strengths of signal from the several microphones, allows blending of these signals in any desired proportion, or allows any of the microphones to be cut out of the active circuit. Audio frequency currents from the mixer generally go to a master volume control which determines the intensity of the blended signal which shall be passed on to the local amplifier or line ampli-

BROADCASTING

fier. This latter unit is a high quality, high gain audio frequency amplifier. Part of the output from the line amplifier is taken to a monitor amplifier which operates one or more loud speakers to allow aural observation of the quality and general characteristics of the signal. At this point is also found a volume indicator which allows visual observation of the power or voltage of the signal. The impedance of the preceding apparatus then is matched to the impedance of the outgoing wire line by means of a transformer. The outgoing wire line may lead to the transmitter.

Microphones are described under the heading of *Microphone*; mixers, faders and volume controls are described under *Volume, Control of*; and the volume indicator is described under *Indicator, Volume*.

The wire line from the speech input equipment is shown entering the transmitter in the block diagram of Fig. 2. The signal passes first to the line equalizer and filter in which correction is made for over- or under-

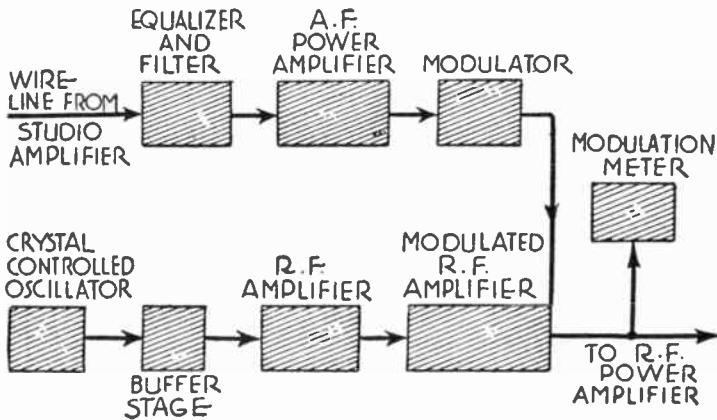

FIG. 2.—Low Power Equipment for Amplifying.

emphasis of any frequencies. Such discrimination is apt to occur in the transmission line. Next comes the audio frequency power amplifier at which the output tube or tubes form the modulator. Modulation and modulators are described under *Modulation*. The modulator ends the audio frequency portion of the broadcasting equipment.

Radio Frequency Equipment.—The radio frequency portion of the broadcaster's circuits begins with the crystal controlled oscillator in which the station's carrier frequency is fixed at an exact value. Frequency control with crystal oscillators is described under *Crystal, Frequency Control by*. The buffer stage of radio frequency amplification isolates the oscillator from the following radio frequency amplifier so that the amplifier cannot react on the oscillator to disturb the frequency setting. The radio frequency amplifier shown in Fig. 2 operates in connection with the audio frequency modulator so that the audio signal is impressed

BROADCASTING

on the carrier current at this point in the process. A modulation meter of any type may be connected to the output of the modulated radio frequency amplifier or may be used later on, nearer the antenna, so that the station's maximum allowable percentage modulation is not exceeded.

The output of the modulated radio frequency amplifier in Fig. 2 forms the input for the radio frequency power amplifiers shown as the first unit in the diagram of Fig. 3. The output of this power amplifier determines the output power or antenna power of the transmitter. Next in order comes the harmonic reducer which is a filter system designed to greatly attenuate frequencies other than those contained in the modulated carrier, especially the second harmonic of the carrier frequency. At this point there may be provided a monitor to rectify, amplify and reproduce the station's signal. The output of the transmitter may here be switched either to the regular

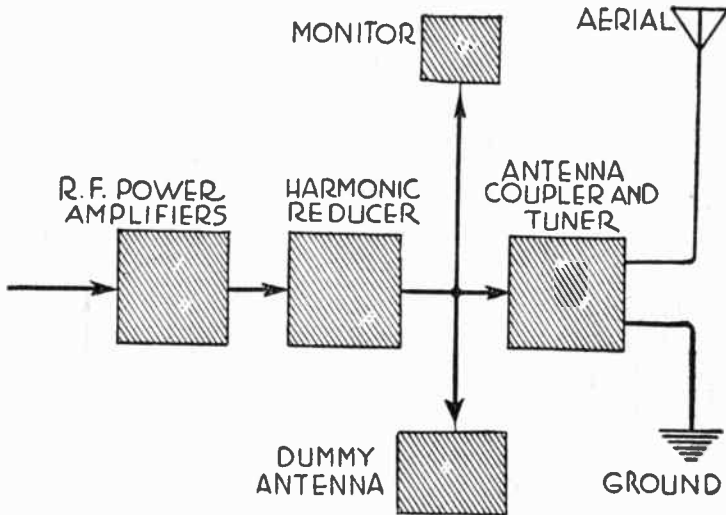

FIG. 3.—High Power Equipment Used at Transmitter.

radiating antenna system or to a dummy antenna in which the power is dissipated as heat rather than as radiation during periods of warming up and testing the equipment. When switched to the radiating antenna the output passes through tuning and coupling circuits which fix the operating frequency of the antenna system at or near the carrier frequency.

Chain Broadcasting.—In chain broadcasting the studio or the station at which a program originates may be at a considerable distance from the transmitter or transmitters which finally put the signals on the air. When the wire lines between these points are long it becomes necessary to use intermediate amplifiers, the general makeup of which is shown in Fig. 4. Here there is an equalizer to correct frequency discrimination occurring in the lines, a local audio frequency amplifier to restore the signal power

BROADCASTING

to the required level, and a monitor to allow observation of the signal. Although not indicated in the diagram, all such repeating equipments have impedance matching transformers at their input and again at their output.

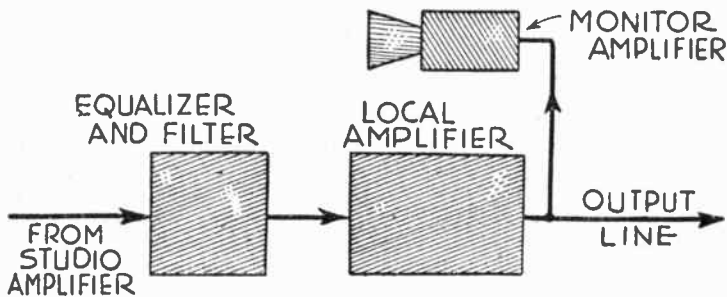

FIG. 4.—Equipment at Repeater Station.

A single program often is delivered to a number of broadcast transmitters, division of the signal being made at bridging points consisting of the elements shown in Fig. 5. The wire line terminates in an impedance matching transformer from which the signal goes to the usual equalizer

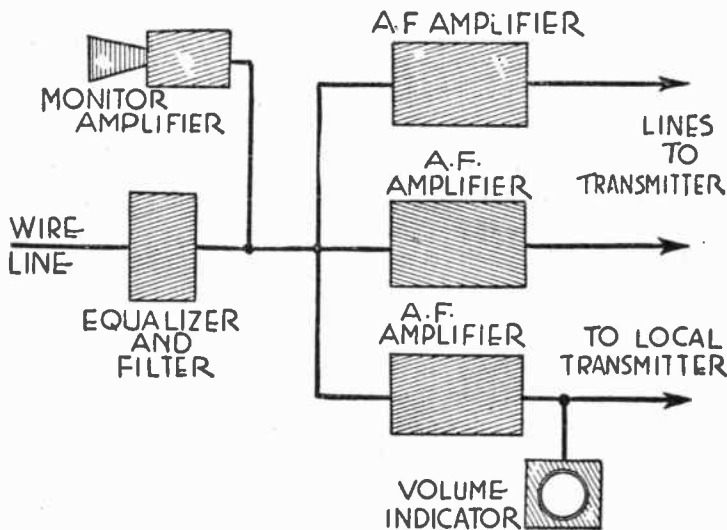

FIG. 5.—Bridging System Used in Chain Broadcasting.

and filter circuits, then a portion of the signal is taken off by a monitoring amplifier. Any required number of audio frequency amplifiers may be fed with the incoming signal and from these amplifiers lines run to the several transmitters. In Fig. 5 delivery is shown to a local transmitter, a volume indicator being fitted at this point.

BROADCASTING

The foregoing outline gives a general view of the principal units entering into the handling of a broadcast program. The complete apparatus includes also such accessory parts as switching arrangements allowing the instant substitution of spare elements in case of breakdown, switching devices for selection of programs, safety interlocking controls for handling the large amounts of power involved, suitable meters for measuring currents and voltages, also complete signalling equipment with indicating lamps and intercommunicating telephone systems

It may be noted that the parts shown in Fig. 1 and in the upper part of Fig. 2 handle audio frequencies. Parts in the lower part of Fig. 2 handle radio frequencies. Parts shown in Fig. 3 handle modulated radio frequencies, in which are combined the audio frequency signal and the radio frequency carrier.

The broadcast studio presents numerous problems in acoustics. The walls, the floor and the ceiling are faced with materials offering considerable damping to sound waves in order to avoid objectionable echoes and allow such control of reverberation as will promote naturalness in the signal and allow effective emphasis on certain sound frequencies. Movable drapings are provided so that compensation may be made for the sound absorbing effect of varying numbers of persons who may be present. The artists and the microphones must be placed in such relative positions that there is no concentration of sound waves at some points and no blasting in the microphones. See *Sound*.

Microphones.—While double button carbon microphones have been popular in the past, the condenser microphone with its greater fidelity and the electrodynamic microphone now are found in a majority of studios. The power output of the condenser microphone is far below that of the double-button type and in order to bring the condenser's level up to a value which may be handled by the usual transmission lines it is customary to place a microphone amplifier in the same housing with the microphone or to connect such an amplifier directly to the sound pickup unit. The outputs of the microphone amplifiers are handled by the switching connections and the mixer, then going to the line amplifier. The output of a double button carbon microphone, or of the condenser microphone amplifier, is down from 60 to 40 decibels from the broadcast reference level.

This microphone power is brought up to zero level in a high gain audio frequency amplifier having a very flat frequency response over the entire audio range from about 50 to 10,000 cycles. The circuits for one such amplifier are shown in Fig. 6.

The standard zero level or reference level for broadcasting is a power of 10.0 milliwatts, which is equal to a potential difference of 2.45 volts across a resistance of 600 ohms or to a current of 4.08 milliamperes through the same resistance.

BROADCASTING

Volume or Gain Control.—The control room operator observes the volume indicator and monitor loud speaker while operating the master volume control of Fig. 1 to maintain the power level within limits which can be handled by the wire lines and other equipment. To avoid danger of cross talk the transmission line seldom is worked with a power level greater than plus five or six decibels. To allow a margin of safety for line variations with temperature, weather, etc., the line output actually is maintained below two or three decibels. The level of unavoidable noises from all kinds of interference is found at about minus 25 decibels. Thus there is permissible a power level range of from minus 25 to plus 3 decibels. Under favorable conditions a range of 30 decibels is allowable, and within this the operator must hold the power level.

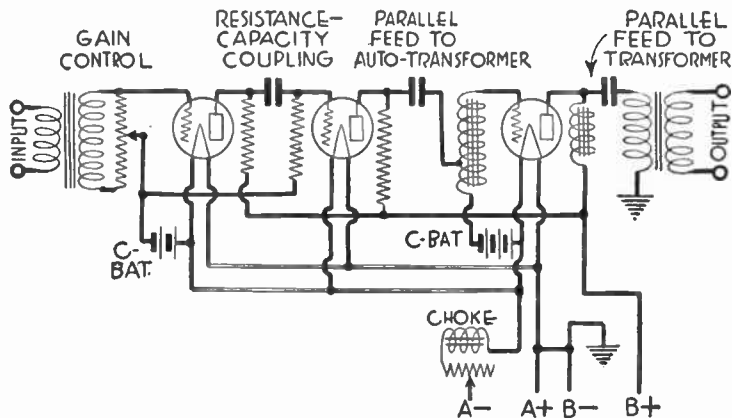

FIG. 6.—Speech Amplifier for Audio Frequencies.

Large orchestras, as one example of sound source, have a range of 60 decibels or even more and this range must be compressed by the volume control within the 30-decibel range of permissible transmission. The volume control is used to raise the level of the weaker passages and lower the level of the most intense sounds. Previous rehearsals, or the help of a trained musician, may be used to assist the operator in knowing when and how to handle the volume control or gain control. Some stations use automatic volume control to prevent overloading the lines.

The volume indicator allows control of power level and the monitor loud speaker allows observation of the general quality of the signals. The usefulness of the monitoring equipment is limited by the judgment of the listener, whose hearing may be entirely normal or else may be deficient in some frequency ranges. The loud speaker, or sometimes two or more loud speakers, are placed in a room of moderate size which has been acoustically treated to have a suitable reverberation period and which is protected from outside sounds. A view of the studio and the artists is provided through windows.

BROADCASTING

Wire lines, line equalizers and filters are discussed under *Public Address Systems*, all of the principles there explained applying also to the transmission circuits used between the elements of a broadcasting system. Where the lines are run in the open on elevated pole cross arms the amplifying and equalizing stations are needed at intervals of 150 to 250 miles. With underground cable lines as used in city districts the repeaters are used every 10 to 15 miles. The amplifiers provide sufficient gain to hold the signal above the line noise level and the equalizers compensate for the unequal transmission of certain frequencies.

Station Interference.—One of the major problems of broadcasting is that of interference between the carriers of transmitting stations. Operating channels are separated by 10 kilocycles or 10,000 cycles, each channel being 10,000 cycles wide. With a carrier frequency in the center of this channel the side frequencies may go as high as 5,000 cycles without encroaching on the adjacent channels. Thus, as indicated in Fig. 7, the 1000-kilocycle

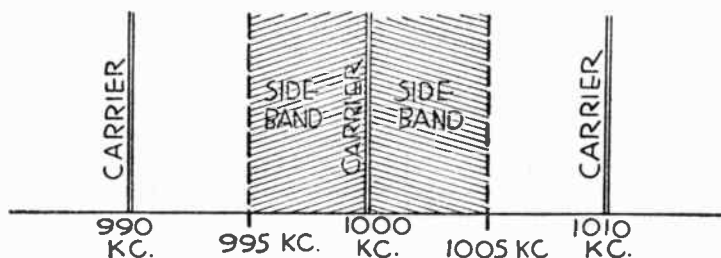

FIG. 7.—Relation of Side Bands to Carrier.

channel extends from 995 kilocycles to 1005 kilocycles and all other channels are similarly arranged.

In the past it has been required that transmitters maintain their carrier frequency within 500 cycles of the specified value. Under this permissible variation a station on one channel might be 500 cycles low in frequency and another station on the next channel 500 cycles high at the same time. Were this to occur in the 990-kilocycle and the 1000-kilocycle channels there would be carrier frequencies of 990,500 cycles and of 999,500 cycles. In a receiver the two carriers would produce a beat note of the difference in frequencies, or a note of 9,000 cycles. See *Beats, Formation of*. This is the lowest beat note which could be produced by the carriers and since it is a frequency well above the cutoff point of practically all receivers it causes little real trouble.

The case of two stations operating on the same channel leads to greater difficulties. If the two transmitters operate with exactly the same carrier frequency there will be no beat note or zero beat. Should one carrier be the maximum of 500 cycles low and the other one 500 cycles high the beat note will be 1,000 cycles, a frequency which is well reproduced by all receivers. Any carrier frequency deviation within the limit of 500 cycles either way then will result in beat notes anywhere between zero

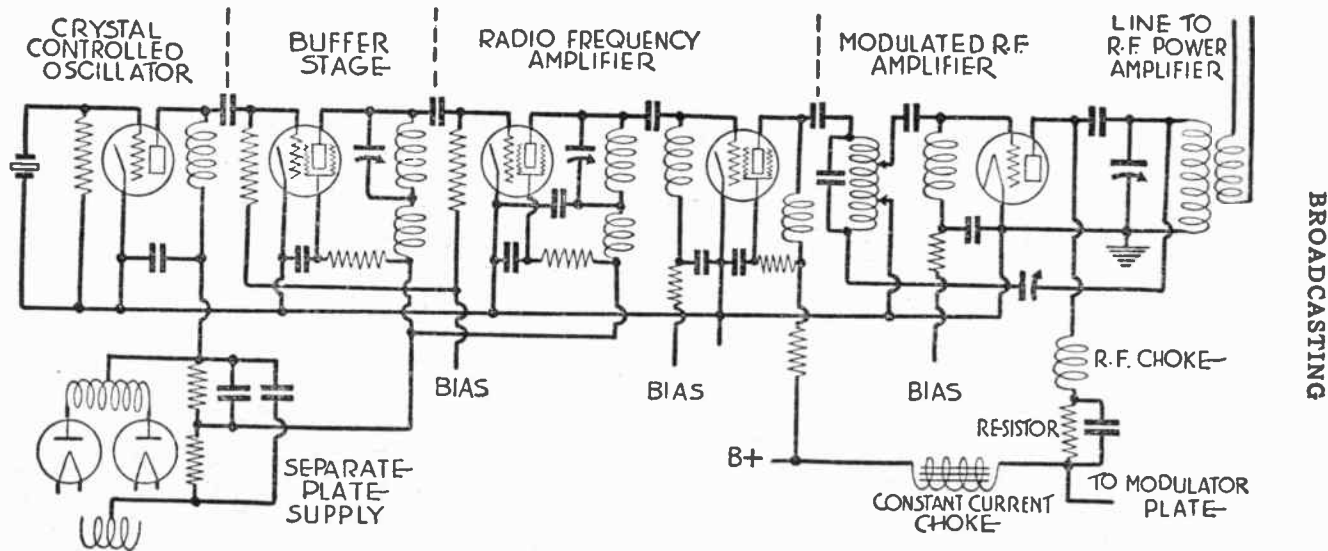

FIG. 8.—Radio Frequency Amplifier at Transmitter.

BROADCASTING

and 1,000 cycles. In order that the beat frequency be held as low as 100 cycles, which is below the reproducing ability of most receivers, the frequency deviation on the carriers must be held within limits of 50 cycles either way. On the lowest broadcast frequency, 550 kilocycles, this would mean a deviation of 0.009 per cent and on the highest frequency of 1,500 kilocycles a deviation of only 0.003 per cent. It is highly important that the carrier frequency of a station be held as nearly as possible to the assignment and various types of apparatus have been employed for this work.

Carrier Frequency Control.—Most of the earlier devices for frequency maintenance were master oscillators, designed and built with greatest care and operated under the most careful supervision to prevent change in circuit constants. Such an oscillator will give good control of frequency. Other frequency controls include electrically operated tuning forks connected to harmonic amplifiers which increase the fork frequency to the carrier frequency. In all frequency controls it is necessary to guard against harmful effects of moisture and other atmospheric effects, also to maintain uniform temperatures and loads. The method of frequency maintenance adopted in nearly all modern broadcast transmitters is that which employs a piezo-electric resonator or quartz crystal as described under *Crystal, Frequency Control* by. Such a device is capable of holding a carrier frequency within 50 cycles or less of the desired value provided the apparatus is properly operated.

The radio frequency amplifying circuits which follow the crystal controlled oscillator in a large transmitter are shown in Fig. 8, these parts corresponding to those indicated in the lower part of the block diagram of Fig. 2. The crystal controlled tube has an untuned plate circuit with condenser connection to the buffer tube which is biased sufficiently to avoid appreciable load on the crystal tube. The two tubes in the radio frequency amplifier raise the power to a point which insures full output from the last radio frequency amplifier, which is modulated. To prevent reaction between the units there is a separate plate power supply and a separate grid bias supply for the crystal stage, buffer stage and first radio frequency amplifier.

The plate supply for the remaining tubes in Fig. 8 is taken from the rectifier and filter system which also handles the audio frequency amplifier and the modulator. Direct currents for filament circuits, also the biasing voltages, are supplied by motor-generator sets. The output of the modulated radio frequency amplifier of Fig. 8 is delivered through a transmission line to the radio frequency power amplifier.

Modulation.—The constant current system of modulation is shown in Fig. 8. Plate current for the modulator tube and for the modulated radio frequency tube comes through the constant current choke. The bypassed voltage dropping resistor is shown in the lead to the radio frequency tube, this arrangement allowing the modulator to work at a higher voltage than the modulated tube so that the transmitter may operate with a modulation of one hundred per cent as explained under *Modulation*.

Power Amplifier.—A three-stage radio frequency power amplifier circuit is shown in Fig. 9. In each of the first two

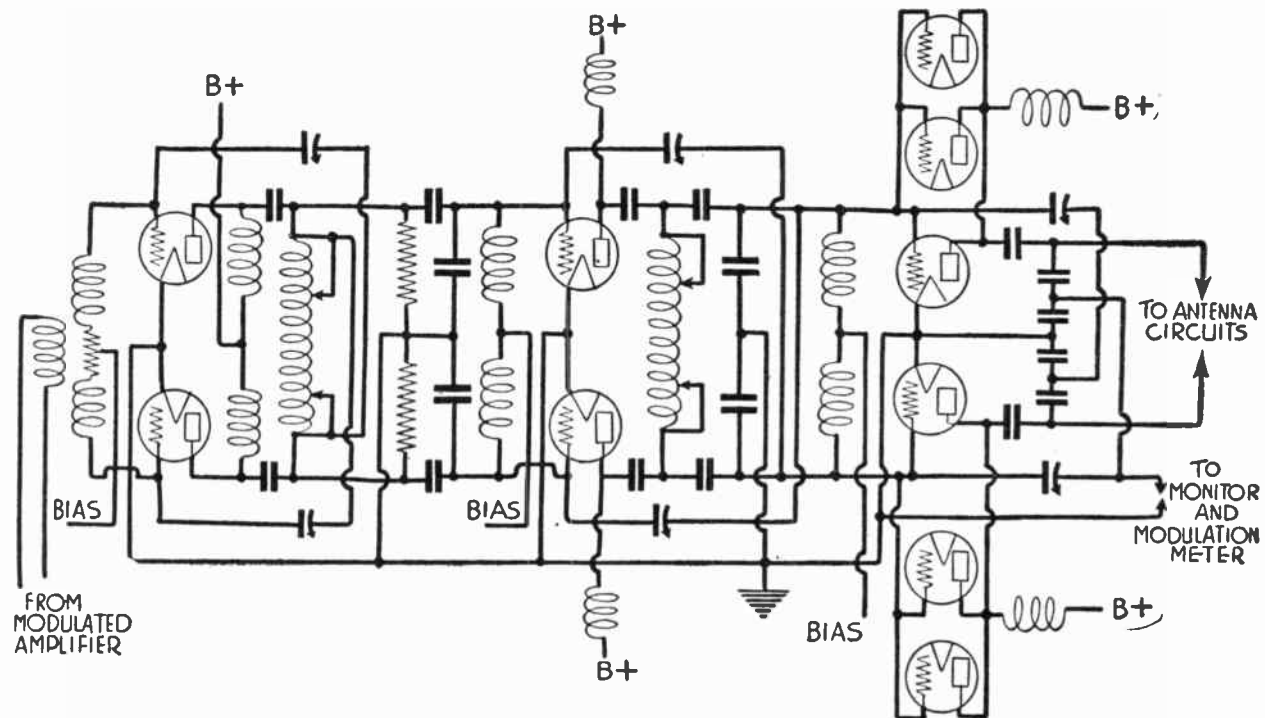

FIG. 9.—Power Amplifier Used at Transmitter.

BROADCASTING

stages there are two tubes connected in push-pull. The third stage uses six tubes in a push-pull circuit with three tubes in parallel on each side. All stages are neutralized with cross connections between the plates on one push-pull circuit and the grids on the opposite side of the same circuit.

The input for such a power amplifier as that in Fig. 9 is formed by the output of the preceding modulated radio frequency amplifier. The output of the power amplifier goes to the harmonic filters, the antenna coupler and tuning circuits which are shown in Fig. 10. A small portion of the output of the power amplifier of Fig. 9 is diverted to a separate circuit for the monitor and for whatever means of modulation measurement may be employed.

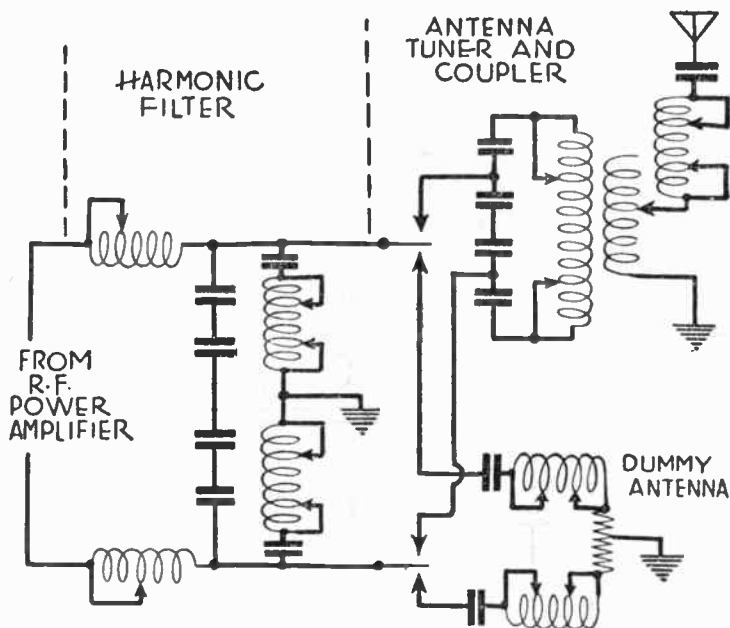

FIG. 10.—Antenna System and Harmonic Filter.

Antenna System.—The harmonic filter in Fig. 10 provides tuned circuits allowing a low impedance path to ground for second harmonics of the carrier frequency. Radiation of these harmonics is further prevented by very complete shielding of all inductance coils and connections carrying such currents. Efficient and economical operation of the tubes in the radio frequency amplifiers results in the production of quite powerful harmonics and these undesired frequencies must be eliminated in the output circuits.

At a distance of one mile from the antenna of a broadcasting transmitter no harmonic should exceed 0.05 per cent of the fundamental carrier

BROADCASTING

frequency with a maximum limit under any conditions of 500 microvolts per meter field strength. The limit observed is whichever of these measurements is the smaller. Because of second harmonic radiation it is customary to avoid having neighboring stations operate on such carrier frequencies that the second harmonic of either one falls on the other's carrier.

It may be noted in Fig. 10 that power from the harmonic filter may be put into either the regular aerial and ground circuit or into the dummy antenna circuit. The dummy antenna consists of capacities, inductances and resistances which may be adjusted to such values that this dummy antenna or artificial antenna provides a load equivalent to that of the aerial and ground system. Power put into this artificial antenna is dissipated as heat, and to prevent radiation its parts are shielded or are placed in a metal walled room. The artificial antenna is used during checks of frequency, of modulation or of other characteristics and is also employed during warming up periods or when new parts are being put into service.

Control Mechanism.—The power equipment of a large broadcasting plant operates with voltages which are dangerously high for human beings and it is necessary to provide automatic means for protection. High voltage apparatus is placed behind doors or gratings, the opening of which cuts off the power, or the doors may be held closed with electrically controlled latches which are released only while the power is off. The controls interlock so that all safety measures must be in effect before the station can operate.

So that no portions of the apparatus may be overloaded the operations of starting up and shutting down may be handled automatically with time delay relays and contactors. With such a system it is necessary only to press a single button or close a single switch by hand. A typical series of operations would be as follows: The pumps for water cooled tubes and the cooling fans go into operation first. The filament voltages then are applied gradually because the resistance of a cold filament is low. The next step applies plate voltages to the low power equipment and then the high power amplifiers are placed in operation. Such a series of events may be stopped at any point should conditions be other than normal.

The crystal controlled oscillator and its buffer stage often are kept continuously in operation to maintain a steady temperature; or at least the filaments of tubes in these stages are kept heated. This frequency control apparatus may be duplicated with complete extra sets to allow quick change of carrier frequency or to allow substitution of a perfect element upon failure of one in service.

In a complete broadcasting equipment provision is made for instant substitution of reserve units whenever there is any fault developed in the regular parts. Both the input and output sides of amplifiers, monitors and other elements are brought to jacks mounted in convenient patch panels. Flexible patch cords terminating in plugs are used to connect any of the parts to the live circuits.

Power in Broadcasting.—The power rating of a broadcast station generally is given as a certain number of kilowatts. A number of different methods have been used in determining this power. Some measurements determine maximum antenna current and the antenna's effective resistance and from these figures derive the power in watts. A more usual way is to take the product of the volts and amperes in the last tube plate circuits, then divide this

BROADCASTING

number by two if very close coupling is used or divide it by four for the more generally employed loose coupling.

The radiation of transmitters also may be specified in meter-amperes, the number of meter-amperes being equal to the antenna's maximum current in amperes multiplied by its effective height in meters. The effective radiation in watts may be taken as 1600 times the product of the square of the effective height in meters and the square of the maximum amperes on an antinode, divided by the square of the wavelength in meters.

The effective radiation ability of a transmitter as it affects receivers is measured in units of radio field intensity, usually in microvolts or millivolts per meter of height of a receiving antenna. Radio field intensity is found by taking the number of microvolts, millivolts or volts of potential developed by the transmitter's wave between the aerial and the ground of a receiver, and dividing this number by the effective height of the receiving antenna in meters. Thus, if a potential of 800 microvolts is produced in an antenna with an effective height of four meters the field strength at that point is one-fourth of 800 or is 200 microvolts per meter.

The field strength is not uniform at all points equally distant from a transmitter, but varies somewhat as shown in Fig. 11 where lines join the points at which there is equal strength. It has been proposed that the field strength of a transmitter be taken as the average of the intensities at eight points equally spaced around the circumference of a circle having a five-mile radius with the station at the center. Radio shadows are cast by a large structures in cities, while bodies of water reduce energy loss and extend a station's range.

Transmitters are located so that the field strength at the edge of the nearest thickly populated district is not greater than 100 millivolts per meter, this rule putting 5-kilowatt stations about two miles from such areas and 50-kilowatt stations about seven miles away. Because of the great amount of interference in cities it takes a field intensity of five to thirty millivolts per meter to provide high grade reception, while in country districts equally good service is provided by an intensity of 100 millivolts per meter or even less than this under favorable conditions.

Various methods are employed for measuring field intensities. The principle of one method is illustrated in Fig. 12 where the signal is received on a loop antenna which may be turned for either maximum or minimum signal strength from a transmitter. A receiver fitted with an output meter is excited from the loop and when the receiver is properly tuned the signal strength, which is proportional to field intensity, is indicated in any convenient units of measurement on the output meter. The loop then is turned for minimum or zero strength from the transmitter and is fed with modulated radio frequency voltage from a signal generator adjusted to the transmitter's carrier frequency. The generator output is set at a value which gives the same deflection on the output meter as was had with the station signal. The signal generator voltage, divided by the equivalent effective height of the loop, then gives the radio field intensity of the transmitter. The receiver requires no special calibration since its only

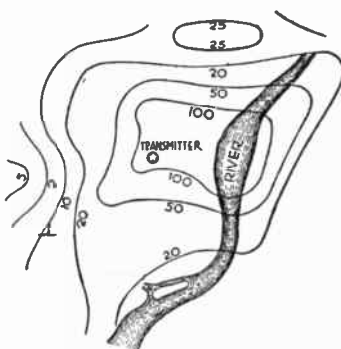

Fig. 11.—Variations in Radio Field Intensity.

BROADCASTING

purpose is to indicate equality of signal strength from generator and transmitting station.

Synchronized Broadcasting.—The lack of a sufficient number of broadcast channels to accommodate all the stations wishing to use them has led to the devising of numerous methods for allowing more transmitters within a given frequency band. One method is that of operating two or more transmitters at the same time with the same carrier frequency and the same program. Such a system allows full time operation of all the stations, avoids some kinds of fading because the several waves travel different paths and different distances to a given receiver, improves the reception in all areas except some districts in between the synchronized transmitters, and naturally extends the service areas because of the reduction of carrier interference.

Most of the work in the field of simultaneous operation on a common carrier frequency has been done by the transmission of a controlling frequency from a common point to all the stations, this frequency being used

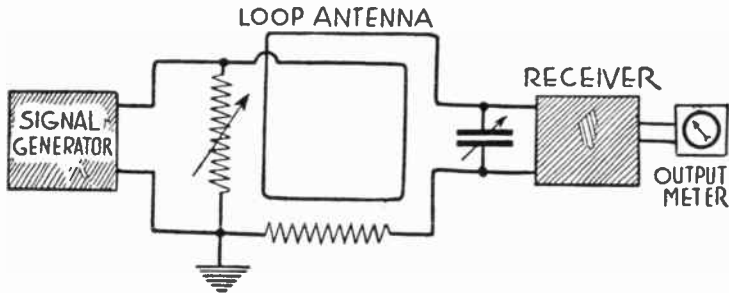

FIG. 12.—Method of Measuring Field Intensity.

to fix the carrier frequency by means of harmonic amplifiers or frequency multipliers at the transmitters. Successful operation also is being secured with stations using independent crystal controls held so closely to a common frequency that the deviation with time is as small as one part in 30,000,000, or one cycle in thirty seconds with a 1000-kilocycle carrier. Independent controls consisting of electrically driven tuning forks and harmonic amplifiers also have been used.

With the use of a base frequency one of the stations may contain the control apparatus or this apparatus may be at some intermediate position. The frequency is chosen to be above the audible range so that it may be carried by the same wire lines or cables which transmit chain programs. The control frequency must be some sub-multiple of the carrier frequency since it is to be multiplied to reach the carrier value. Filters separate the synchronizing frequency and the program audio frequencies.

The use of independent oscillators depends for success on the stability of these devices. Highly developed apparatus employing quartz plate oscillators is capable of maintaining a stability to within less than one part in 100,000,000. One station provides the reference frequency and any deviation in the other's carrier is corrected at frequent intervals.

BRONZE

BRONZE.—Bronze is a metal made by alloying copper and tin. Other metals sometimes are added to give the finished product certain desired qualities. The electrical properties of bronze are similar to those of brass. See *Brass*.

BURIED ANTENNA.—See *Antenna, Underground*.

BUS WIRE.—See *Wire, Bus*.

BUSHING, LEAD-IN.—See *Antenna, Lead-in for*.

BUZZER.—A source of alternating or pulsating current is convenient for many uses in radio work. Some source of such current is needed while making tests of capacity of inductance with a Wheat-

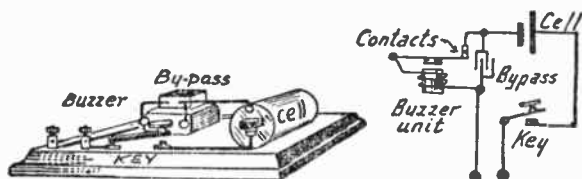

Construction and Circuit of Buzzer Exciter.

stone bridge, while adjusting crystal detectors, using frequency meters, etc. A convenient source of such energy is a buzzer and dry cell arranged as shown. The complete outfit includes a buzzer unit, a dry cell, a key and a bypass condenser. The arrangement of these parts on a board is shown at the left of the illustration while the circuit connections are shown on the right. The buzzer, the dry cell and the key are connected in series with each other. The bypass condenser is connected across the contacts of the buzzer. This outfit gives a pulsating direct current whose frequency or tone may be controlled within narrow limits by the adjustment of the buzzer armature. See also *Oscillator, Buzzer Type*.

B. W. G.—An abbreviation for Birmingham Wire Gauge.

BYPASS.—See *Condenser, Bypass; Filter; and Detector, Plate Bypass for*.

C

C.—Symbol for capacitance or electrostatic capacity.

CABLE.—See *Wire, Stranded.*

CAGE ANTENNA.—See *Antenna, Forms of.*

CAM SWITCH.—See *Switch, Cam Type.*

CAMBRIC INSULATION.—See *Cloth, Insulating.*

CAMBRIC TUBING.—See *Tubing, Insulating.*

CANDLEPOWER.—See *Light.*

CAPACITANCE.—Another name for capacity. See *Capacity.*

CAPACITIVE COUPLING.—See *Coupling, Capacitive.*

CAPACITIVE FEEDBACK.—See *Oscillation.*

CAPACITIVE REACTANCE.—See *Reactance.*

CAPACITY.—Capacity is the ability or power of anything to receive or to contain electricity. The capacity of a condenser or other device is the amount of electricity or the electric charge that it will receive and hold. The unit of measurement for capacity is the farad, but capacities used in radio work are so small that the practical unit in this field is the microfarad which is one millionth of a farad. A condenser which will receive and hold one coulomb of electricity when a pressure of one volt is applied to its terminals has a capacity of one farad.

A capacity effect exists between any two conductors which are at different voltages and between which there is an insulating medium or a dielectric. In radio work it is desired to concentrate or to lump all capacities in the condensers. It is not possible to do this because of the capacity effect existing between all conductors. See *Condenser, Capacity of.*

CAPACITY, ANTENNA.—See *Antenna, Capacity and Inductance of.*

CAPACITY, BODY.—There is a capacity effect between a person's body and parts of a radio receiver which are carrying high frequency currents. When any part of the body, such as the hand of the operator, is brought near a radio receiver the body capacity effect may change the tuning of the various circuits or may cause the circuits to start oscillating which results in howling and squealing.

The rotors and shafts of tuning condensers are generally connected to the negative or ground side of the tuned circuit. They are

CAPACITY, CONDENSER

at low potential and no effect is noticed when the operator's hand is drawn close to them.

Condensers used for control of feedback or for control of other high frequency currents have neither their stators nor rotors at low potential so that body capacity is very noticeable when they are being operated. This is also true of variometers used for tuning, for regeneration or for control.

The most successful method of eliminating body capacity in such cases is to avoid bringing the metal shaft of the condenser or variometer through the panel to the hand operated dial or knob. As shown in the illustration the shaft may be cut off and extended by means of a short length of hard rubber tubing placed over it with an extension shaft may be cut off and extended by the other end of the piece of tubing. This extension shaft may then be brought through the panel.

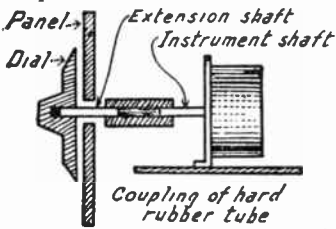

Extension Shaft for Avoiding Body Capacity Effect.

itself an inch or two back of the panel and extending its shaft through the coupling described.

When it is necessary to bring the live shafts of variometers, feedback condensers and similar devices through a panel so that the operator's hand will come close to them the effect of body capacity may be avoided by mounting the instrument

CAPACITY, CONDENSER.—See *Condenser, Capacity of.*

CAPACITY, DISTRIBUTED.—In addition to the concentrated or lumped capacity between the plates of condensers there is

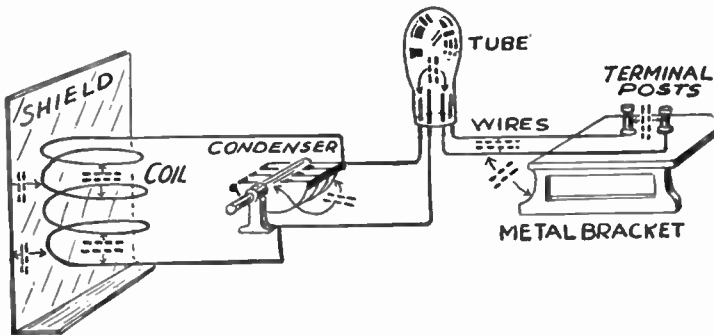

Distributed Capacities in a Receiver.

capacity between any two conductors which are at different voltages from each other. This latter capacity effect is called distributed capacity.

Distributed capacities may be found at many places in a receiver. There is a distributed capacity between a coil and any shields placed near the coil

CAPACITY, FREQUENCY EFFECT ON

and there is also distributed capacity between the turns of a coil. There is distributed capacity between the shaft and the plates of a condenser, there is distributed capacity between any two wires running near each other. This undesired capacity effect is also found between terminal posts or brackets and other parts. There is capacity between each element of a vacuum tube and all of the other elements; plate, grid and filament.

It is important in radio work, especially in designing, to think of all metal parts and all conductors as having capacity to each other so that high frequency currents can flow from one to the other. Figuring on this capacity will avoid a great deal of trouble. This distributed capacity is increased by larger surfaces, by their closeness to each other and by the voltages in the conductors and metal parts.

CAPACITY, FREQUENCY EFFECT ON.—The opposition of a capacity or condenser to flow of alternating current becomes less and less as the frequency increases. This is because the capacitive reactance decreases with increase of frequency. See *Reactance*.

The actual capacity of a condenser may change with change of frequency due to the changed distribution of potential which in turn is caused by skin effect in the plates of the condenser.

CAPACITY, INTERNAL OF TUBE.—See *Tube, Capacities, Internal*.

CAPACITY, MEASUREMENT OF.—See *Bridge, Measurements by*.

CAPACITY, RESONANCE VALUES OF.—See *Resonance, Inductance-Capacity Values for*.

CAPACITY, SPECIFIC INDUCTIVE.—Another name for dielectric constant. See *Constant, Dielectric*.

CAPACITY, UNITS OF.—One farad is the capacity of a condenser which is given a charge of one coulomb by a potential difference of one volt across its terminals. A coulomb is the quantity of electricity that passes through a circuit in one second when the flow is one ampere.

A microfarad is the one millionth part of one farad.

A micro-microfarad is the one millionth part of a microfarad. It has been proposed that the micro-microfarad be called a picofarad.

One centimeter of capacity is equal to 1.1124 micro-microfarads. A centimeter of capacity is the centimeter-gram-second or C. G. S. electrostatic unit of capacity.

CARBON.—Carbon in its various forms includes graphite, plumbago, lamp black, bone black, coal, coke and diamonds. Carbon is a fair conductor, rods such as used for electrodes and in arc lamps having resistances in the neighborhood of 0.0015 or 0.0016 ohm per cubic inch. The resistance of the graphite form of carbon is much less, being about 0.00033 ohm per cubic inch. The resistance of a cubic inch of copper is about 0.0000065 ohm so that carbon has a resistance roughly two hundred and thirty times that of copper while graphite has a resistance about fifty times that of copper.

CARBON

The resistance of carbon becomes less as its temperature rises. This is the opposite of the effect of temperature increase in metals, whose resistance increases with temperature. The effect is more pronounced in carbon than in graphite.

CARRIER CURRENT TELEPHONY.—See *Radio, Wired*.

CARRIER FREQUENCY.—The high frequency radiation from a transmitter, which may be modulated with signal frequencies. The component of a modulated wave that is of the same frequency as the original continuous or unmodulated wave.

CASCADE AMPLIFICATION.—See *Amplification, Cascade*.

CATHODE.—The electrode at which an electron flow enters a vacuum, a gas, an electrolyte, or other medium through which it passes to the anode. The cathode of a tube is its electron emitting surface, which may be a filament, a unit heated by a separate element, or a cold surface of solid metal or liquid mercury. The cathode of a battery cell is its positive electrode connected to the positive terminal for external circuits.

CATHODE-RAY OSCILLOSCOPE.—See *Oscilloscope*.

CATHODE-RAY TUBE.—See *Tube, Cathode-ray*.

CAVITY RESONATOR.—See *Resonator, Cavity*.

C-BATTERY.—See *Battery, C-*; also *Bias, Grid*.

CELL, BATTERY.—See *Battery, Storage Type*.

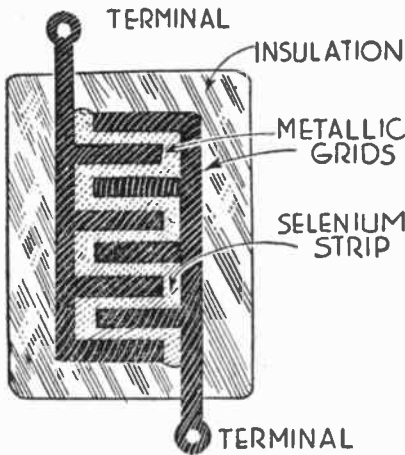

FIG. 1.—Photoconductive Element.

FIG. 2.—Photoconductive Cell.

CELL, PHOTOCONDUCTIVE.—A photoconductive cell is a form of photoelectric cell in which the electrical resistance becomes less when light strikes the cell's active material. The active material in most commercial forms of photoconductive cell

CELL, PHOTOCONDUCTIVE

is the element selenium, although some other elements and compounds have similar properties.

The physical arrangement of the conductive element in a selenium cell is shown in Fig. 1. The selenium forms a long, narrow strip between two metallic grids which usually are made of gold, platinum or nickel. This conductive element is supported on insulation of glass, quartz, porcelain, mica or other nonconductor. The selenium strip forms a layer only 0.0015 to 0.0025 inch thick. This thin layer provides a small cross sectional area of selenium between the metallic grids, maintaining a high value of resistance. At the same time a relatively large surface of the active element is exposed so that light may strike it and cause the characteristic change of resistance.

Selenium is an allotropic material, or a material capable of assuming different physical states without change in its chemical composition. The metal must be changed to a grey, crystalline, metallic form by the process of annealing before the light-sensitive property becomes prominent. Once the material is prepared it must be protected against absorption of moisture. Some cells, as shown in Fig. 2, are enclosed within a glass bulb

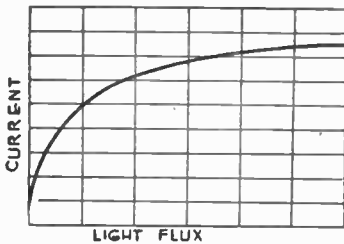

FIG. 3.—Current-illumination Characteristic of Photoconductive Cell.

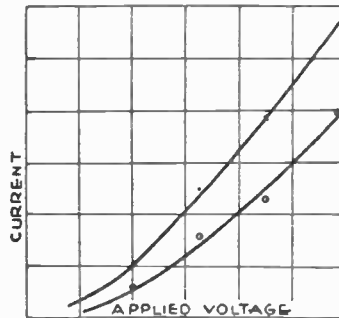

FIG. 4.—Current-voltage Curve of Selenium Cell.

from which air is removed. The interior of the bulb may be left with a vacuum or it may be filled with some inert gas.

When voltage is applied across the two terminals of a photoconductive cell a current flows. If no light is reaching the selenium its resistance is very high, commercial cells having dark resistances of 25,000 to 500,000 ohms or even several megohms resistance in some types. If light is allowed to reach the selenium its resistance drops suddenly at first and if the light continues the resistance will show some further decrease for several seconds. If the light is removed from the selenium its resistance rises very quickly at first, then with continued darkness the resistance continues to increase for some time.

Because the response of the photoconductive cell is not instantaneous with changes of light the frequency of light changes will materially affect the cell's operation. With increase of frequency the time intervals become shorter and the resistance has not time to change by the full amount that would be realized with longer periods between impulses. Although the

CELL, PHOTOCONDUCTIVE

response of the cell drops quite rapidly with frequency increase, types have been developed which operate successfully up to about 10,000 cycles per second.

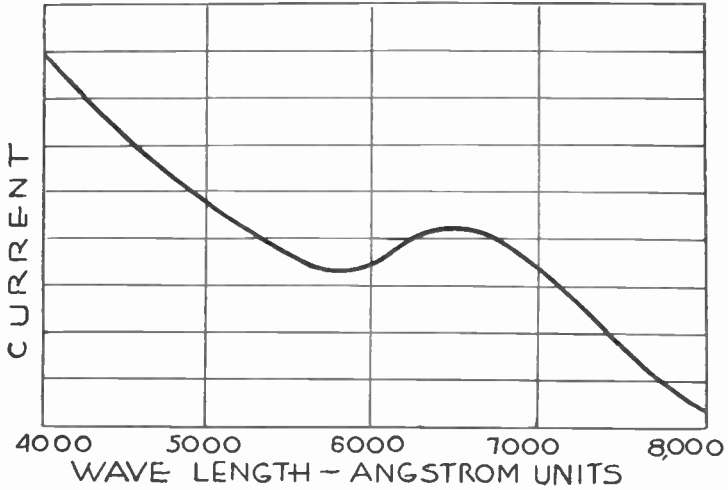

FIG. 5.—Color Sensitivity of Selenium Cell.

The current-illumination curve for a typical selenium cell is given in Fig. 3. It may be seen that much greater changes of current are secured with weak illuminations than with strong ones when the percentage change of illumination remains the same in both cases. Although the response of the cell is not linear with respect to illumination, it is possible to use either very weak or very strong light and obtain a response nearly pro-

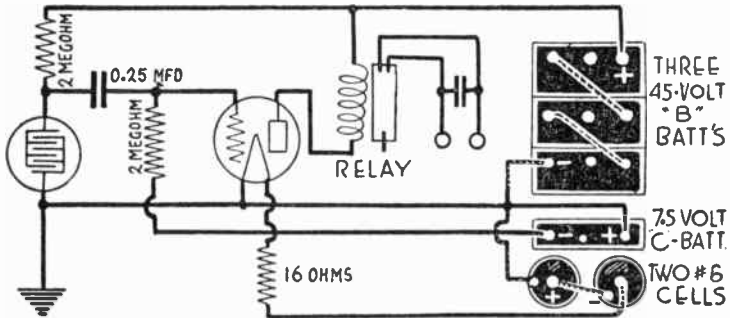

FIG. 6.—Photoconductive Cell Amplifier for Batteries.

portional to light when the illumination changes by only small amounts. As shown by the curves in Fig. 4 the current through a photoconductive cell increases at a rate greater than the rate of voltage increase.

CELL, PHOTOELECTRIC, USES OF

CELL, PHOTOELECTRIC, USES OF.—The uses of photoelectric cells of various types are already so numerous and are increasing so rapidly that a complete enumeration is impossible. These cells find important uses for reproduction of sound in sound picture work and in the pictorial arts including television, telephotography and photoengraving. Photocells are employed to give warnings of dangers and to operate safety devices of many kinds. They are quite generally used in automatic control of interior and outdoor lighting. Photoelectric devices are adapted to the control of traffic and to all manner of timing and counting operations. Manufacturing processes of the most varied types are handled by photocells, this work extending even into the fields of grading, sorting and matching of products. Measurement of light is one of the original uses and still is one of the most important.

The output of photocells, with or without amplification, may operate indicating instruments of either the visual or audible type, it may be arranged to actuate a recording mechanism, or to cause opening or closing of a relay which in turn controls any type of electric circuit.

Different methods might be adopted in classifying the uses of photoelectric cells, but one which is as logical as any is a classification according to the manner in which the light is changed as it falls upon the sensitive material in the cell.

The light is modulated, or is varied rapidly and continually, in sound picture reproduction where variations in light flux passing through the film sound track produce corresponding voltages at sound frequencies in the photocell circuit. Modulated light also is used in television and telephotography where the changes of light and shadow in the scanned object affect the photocell and produce in its circuit voltages which correspond to the gradations of shade in the object. Again modulation is employed in photoengraving where the picture to be reproduced is scanned by light which varies in intensity as it is reflected from the picture surface into the photocell whose output controls the cutting of the engraving tool.

A second group of photocell applications includes those which depend on a more or less gradual change in light intensity or flux between a minimum and a maximum value, without any complete stoppage of the light. The beam in its normal travel between source and photocell may be direct, or it may be reflected, refracted or transmitted through some medium other than air.

In this classification are fire alarms operating upon the appearance of flame to increase the illumination, or upon the appearance of smoke in the light beam to reduce the illumination. The density of smoke in a stack may operate a recording instrument to indicate the efficiency or lack of it with which a boiler is being fired throughout a period of time. Changes in amount of reflected light will indicate surface spots, flaws and other defects.

The gradual decrease or increase of daylight at different times will vary the illumination on a photocell and allow it to either turn on or turn off interior lamps, street lamps, window lamps and electric signs at suitable times. Similar applications may be made to operate aviation beacons of the visual type, lighthouses and all manner of signals which should become operative with the approach of outdoor darkness.

A record may be made of the cross section of a continuously manufactured article, such as wire, by allowing the changing size to shut off more or less of the light reaching a photocell. In a similar manner the change in reflected light with change in size of articles may be made to automatically sort objects into different shapes and sizes, all reflections greater than a certain amount operating a relay which in turn operates the sorting device.

If the light beam be passed through liquid solutions, through paper sheets or through any other semi-transparent material any change such as in liquid density or paper thickness may be made to alter the light flux and operate an alarm or correct an adjustment by means of the photocell and an amplifier.

Photocells which vary their output in strict proportionality to the intensity of light reaching them are used in photometry, the measurement and comparison of light sources with one another and with standards of light. Photometry is applied not only to man-made lamps, but also to the stars.

In a third group of photocell applications may be placed all those which depend on the light either reaching the cell in full volume, or being completely cut off. With such applications it is desired to have a sort of trigger action and the photocell need do nothing more than operate some form of relay. This method is so simple and positive that it has found an exceptionally large number of uses.

The relay action which is started by cutting off the light from a photocell is utilized to give warning when the contents of reservoirs, tanks and bins reach a certain height and interrupt the light beam. A similar action may be used in a safety stop for elevators, punch presses and other machinery so that any part of a person's body in a dangerous position interrupts the light beam and makes the device inoperative. The reverse action, where the light beam normally is shut off, may be used for detection of holes or breaks in materials being processed so that passage of light through an opening excites the cell and gives warning or stops the machinery.

A photoelectric cell relay is commonly employed for timing of races, for measurement of projectile velocity or for any measurement of time intervals, also for counting manufacturing operations, manufactured parts, and for counting persons or other traffic passing a given point. It is possible to arrange for registering the number of units entering and to subtract those leaving to allow continual indication of the number within a certain space at any instant. Any number of electric clocks may be controlled by impulses originated by interruption of a light beam when the pendulum of a master clock swings back and forth.

Almost any manufacturing process may be started, stopped or regulated by means of photoelectric devices. Machines may be set in motion, may be shut down or may be reversed in direction. Cutting and shearing operations may be made to occur at exact points or times. Labels may be affixed by having the position of a package affect a photocell. Pressure may be indicated or controlled through a manometer, by allowing the pressure to move a liquid held in the U-shaped tube into the path of a light beam. Doors may be opened or closed in elevators, garages, restaurants or other places either by the interruption of a light beam or by reflection of a beam. Heat controls may be operated from the expansion of any heated material, thus shutting off the light or reducing the light to a photocell.

CELL, PHOTOELECTRIC, USES OF

In some cases it is desired that a condition existing for only a moment shall set into action a signal or other device, the action continuing until it draws attention. An example might be a flashover on the commutator of an electric machine, or the passage of a train past a certain point. Here a photoglow tube may be used in which a light impulse causes formation of a conductive glow discharge that continues until the voltage is dropped.

The varying response of certain types of photoelectric cells to different wavelengths or colors of light allows the use of these cells in a great many important functions. By the use of several cells, each having a different color response, it is possible to construct apparatus which will accomplish nearly as much as the human eye and which in the ultra-violet and infra-red wavelengths will do things which are impossible for the eye.

It is possible to control the temperature of incandescent materials such as metals in furnaces because the color of the heated material has a definite relation to temperature. Materials which are of different colors or which are wrapped in different colored packages may be sorted. Colors may be matched, or a certain color may be recorded by its effect on one or more cells and then may be duplicated at some later time. Ultra-violet rays administered for their curative effects may be measured both as to intensity and wavelength so that treatments may be positively controlled.

See *Cell, Photoemissive*; *Cell, Photoconductive*; and *Cell, Photovoltaic*.

CELL, PHOTOEMISSIVE

CELL, PHOTOEMISSIVE.—The photoemissive cell, which commonly is called a phototube, consists of a cathode and an anode inside of an evacuated glass bulb. In most of the earlier types, and in some of those used today, the substance which forms the cathode is deposited on the inner surface of the bulb as shown by Fig. 1, with the anode a metallic wire or ring in the approximate center of the bulb. Light or other radiant energy enters the bulb through a portion called the window, which is left clear. The majority of general purpose phototubes now manufactured are constructed as shown by Fig. 2. The entire bulb is of clear glass. The cathode substance is coated on a semi-cylindrical metallic

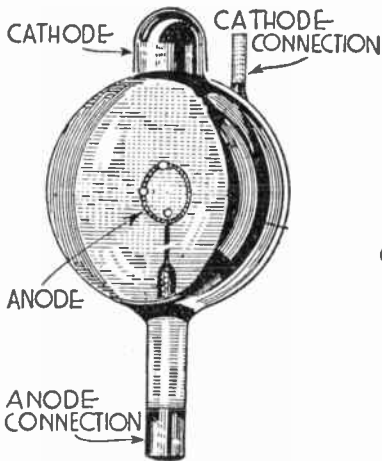

FIG. 1.—Phototube with Wall Type of Cathode.

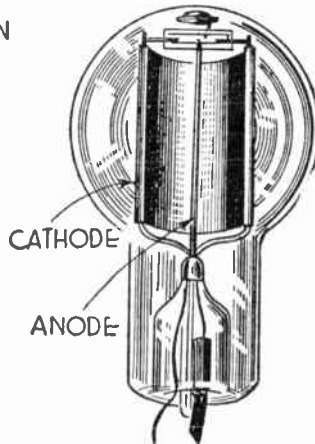

FIG. 2.—Phototube with Inserted Cathode.

element supported inside the bulb, and the anode is a straight vertical wire placed in front of the cathode surface.

The active surface of the cathode is of some material which, when subjected to the radiant energy of visible light or of ultra-violet or infra-red, emits electrons in quantity proportional to the energy of the received radiation. When the phototube is connected in series with a source of current and a resistor, as shown by Fig. 3, electrons emitted from the negative cathode are drawn to the positive anode and a current flows in the circuit so long as the cathode is reached by radiant energy. The electron emission and current increase and decrease with increase and decrease of the intensity of radiant energy on the cathode, and thus there is caused to flow in the resistor a current which varies with the radiant energy. The potential drop across the ends of the resistor varies with the current, and is proportional to the radiant energy received by the phototube cathode. The changes of potential may be applied to the control grid circuit of a following electronic tube and there amplified, or the changes of current may be used to directly operate ultra-sensitive relays which, in turn, will control electric circuits carrying more power.

CELL, PHOTOTUBE

Wavelength Sensitivity.—The rate of electron emission from the phototube cathode depends not only on the intensity of the radiation reaching the cathode, but also on the substance of which the cathode is made and on the wavelength of the radiation. In most of the present-day phototubes designed for general use the cathode material is the element caesium, prepared and treated

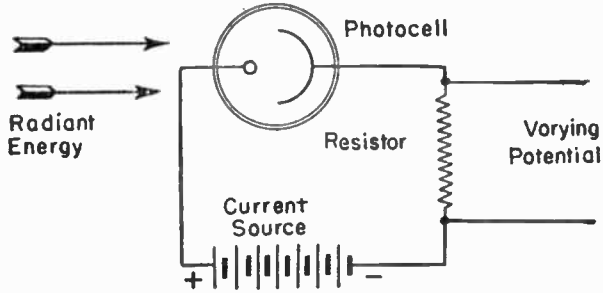

FIG. 3.—The Basic Phototube Circuit.

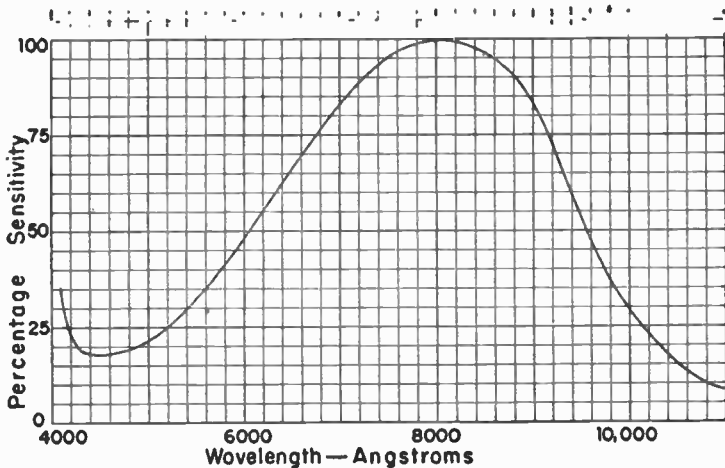

FIG. 4.—Wavelength Sensitivity of One Type of Phototube.

in various ways to give desirable characteristics. Other substances used for special purposes include rubidium, zirconium and thorium.

If a phototube having one particular variety of caesium cathode is operated at a constant voltage and load, and it then is subjected to radiation of different wavelengths, or to light of different colors, the electron emission and current will vary with wavelength of the radiation about as shown by

CELL, PHOTOTUBE

Fig. 4. Maximum emission and current occur with this particular tube at a wavelength of 8,000 Angstroms, which is in the infra-red region just beyond the deepest visible red. Minimum response is with a wavelength of about 4,500 Angstroms, which is blue light. The relative responses or sensitivities shown by the curve are those secured when the radiant flux is the same at all wavelengths. Sensitivity under usual operating conditions would be affected by the kind of radiation. For example, daylight would be strongest in the violet and blue wavelengths, and light from a tungsten lamp would be strongest in the red and infra-red regions.

Anode Characteristics.—The anode characteristics of a phototube are shown by a group of curves representing the anode current which flows with various anode potentials and various amounts of luminous flux as measured in lumens. Such characteristics for a typical tube with an evacuated envelope are shown by Fig. 5, where each curve applies to a certain luminous flux. For any given luminous flux on this vacuum type tube, a gradual

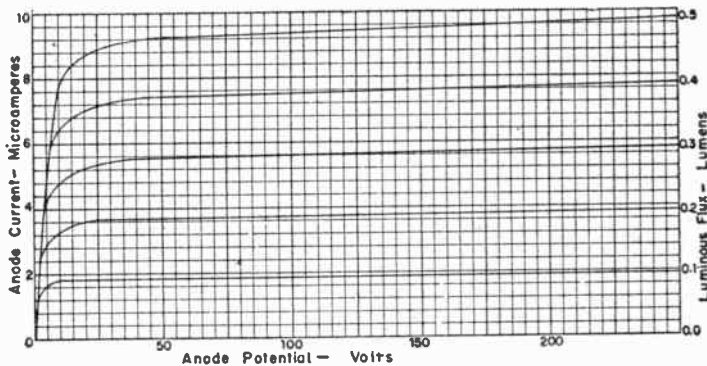

FIG. 5.—Anode Characteristics of a Typical Vacuum Type Phototube.

increase of anode potential causes an initial sharp rise of current which is followed by a leveling off to a practically constant current at potentials above 10 to 30 volts. Thus we find that the vacuum phototube is characterized by current which varies almost wholly with luminous flux and hardly at all with potential above a certain minimum potential.

Fig. 6 shows anode characteristics for a typical gas-filled or gaseous phototube. Such a tube is completely evacuated during manufacture, and then there is admitted to the bulb a small quantity of some inert gas such as helium or argon. When the cathode of the gas-filled tube receives a certain luminous flux, and when anode potential is gradually increased, the initial rise and leveling off of current is much like that in a vacuum phototube. But when anode potential reaches a value around 20 to 30 volts the current commences to increase as the potential is increased and the luminous flux held constant.

This increase of current in the gas-filled phototube results from ionization of the gas by electrons drawn from cathode to anode when the anode

CELL, PHOTOTUBE

potential reaches 20 to 30 volts. At higher and higher potentials there is increased ionization and a rapid rise of current. With more than a certain limiting potential, usually 90 volts, or with more than a limited light flux, ionization becomes so great as to cause a visible glow discharge in the tube. If such a glow discharge continues it destroys the cathode surface and ruins the tube. Once the glow commences it will continue even though light is cut off, and can be stopped only by cutting off the potential and current supply. Gas-filled cells must have in their circuit a resistance or impedance which prevents cell voltage from reaching the value at which glow discharge occurs with any luminous flux which may reach the cell.

Luminous Sensitivity.—The luminous sensitivity of a phototube is a measure of the change in anode current which is caused by a given change of luminous flux reaching the cathode. The

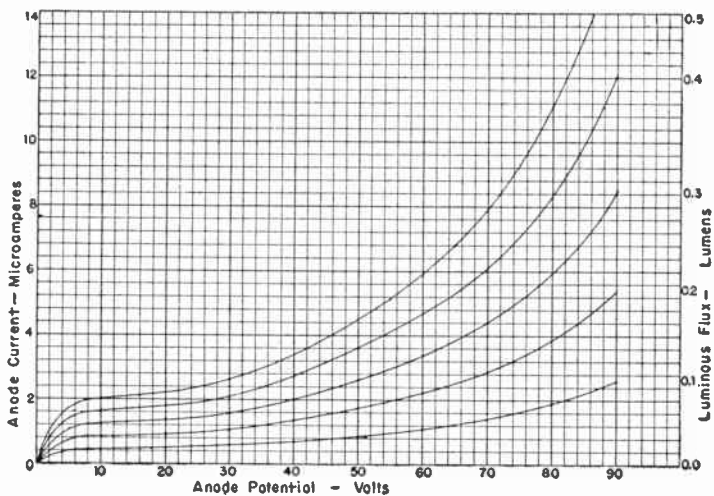

FIG. 6.—Anode Characteristics of a Gas-filled Type of Phototube.

usual unit is microamperes per lumen, which means the number of microamperes of current change per one lumen of flux change.

At the left-hand side of Fig. 7 is shown, for the vacuum phototube of Fig. 5, the relation between anode current and luminous flux with anode potentials of 250, 150 and 50 volts. There is but little difference between current for the upper line at 250 volts and the lower one at 50 volts, showing that current in the vacuum phototube is almost independent of anode potential so long as the potential is above 20 to 30 volts. Also, the current curves are straight lines, showing that changes of current are exactly proportional to changes of light flux.

At the right-hand side of Fig. 7 is shown, for the gas-filled phototube of Fig. 6, the relation between current and flux for potentials of 80, 50 and 20 volts. Here it becomes apparent that current in the gas-filled tube is greatly affected by anode potential. The curves for relatively high potential are not straight lines, showing that the changes of current in this type of phototube may not be exactly proportional to changes of flux.

CELL, PHOTOTUBE

Luminous sensitivities are found by dividing the microamperes of current by the lumens of flux. For the vacuum phototube at 250 volts the current is 9.8 microamperes at 0.5 lumen, and dividing 9.8 by 0.5 shows the sensitivity to be 19.6 microamperes per lumen. The sensitivity is about the same for other potentials and for other fluxes.

Luminous sensitivity for the gas-filled tube at 80 volts and 0.5 lumen is found, by dividing the 11 microamperes of current by 0.5 lumen of flux, to be 22 microamperes per lumen. But at 50 volts (middle curve of Fig. 7) the sensitivity is only 9 microamperes per lumen, and at 20 volts is but 4.4 microamperes per lumen. Sensitivities might be similarly computed from the anode characteristics of Figs. 5 and 6.

It should be kept in mind that the flux in lumens is that reaching the exposed area of the phototube cathode. Areas in various tubes may be anything from about 0.2 to 2.0 square inches. A

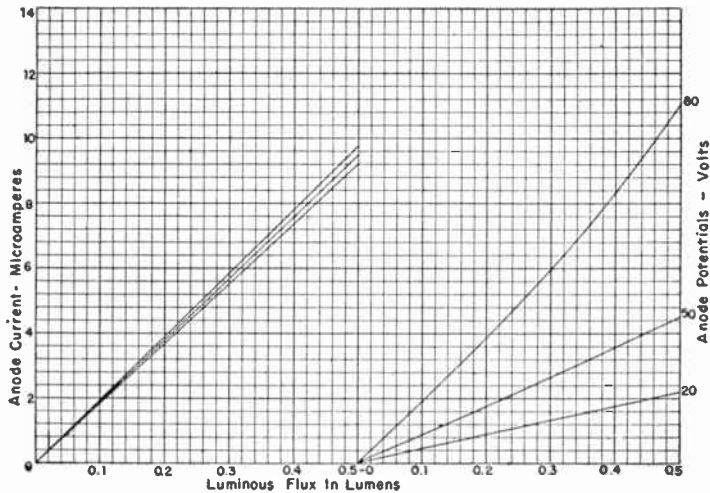

FIG. 7.—Relations between Current and Luminous Flux in Vacuum Phototube (left) and Gas-filled Tube (right).

flux of one lumen is equivalent to an illumination of one foot-candle on a total area of one square foot, or 1728 square inches. Then a flux of one lumen per square inch would mean an illumination of 1728 foot-candles, a flux of 0.5 lumen per square inch would mean an illumination of 864 foot-candles, and so on.

It may be seen that the illumination must be of rather high value in order to have even small currents in the phototube. The illumination from a 60-watt incandescent lamp at a distance of three feet is about 10 to 12 foot-candles in a horizontal plane on the center of the lamp. This means a luminous flux of only 10 to 12 lumens per square foot or about 0.006 lumen per square inch. Phototube sensitivities usually are measured with light from a Mazda projection lamp.

The number of lumens per square inch received from a source of light decreases as the square of the distance from the source when the light is

CELL, PHOTOTUBE

allowed to spread normally. To avoid the effects of such decrease it is common practice to employ lenses or reflectors, or both, at the light source, and to employ lenses at the phototube, as illustrated by Fig. 8. Small sources, such as automobile headlamp bulbs, then are effective over considerable distances.

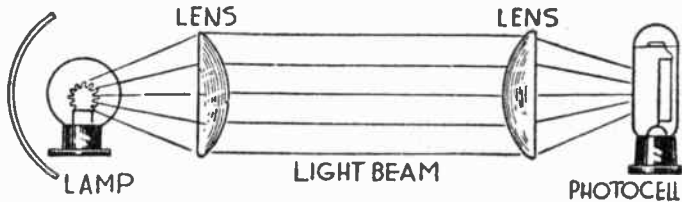

FIG. 8.—Reflector and Lenses Prevent Excessive Spread of Light.

Amplifiers for Phototubes.—The performance of a phototube in a circuit containing a source of potential and a load resistance or impedance may be shown by drawing load lines on the anode characteristics as has been done for a gas-filled tube in

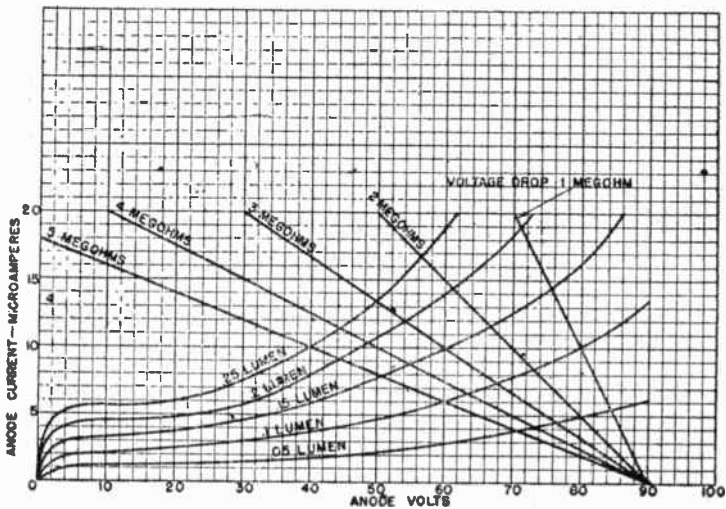

FIG. 9.—Load Lines Showing Phototube Performance.

Fig. 9. The load lines are laid out in exactly the same manner as on the plate characteristics for an amplifying tube.

Referring to Fig. 9, which is a typical example of performance, it may be seen that with various loads there are the following changes of anode current when the flux is changed from 0.2 to 0.1 lumen.

CELL, PHOTOTUBE

1-megohm	18.9 to 10.0 = 8.9 microamps. change
2 megohms	14.4 to 8.5 = 5.9 microamps. change
3 megohms	12.0 to 7.4 = 4.6 microamps. change
4 megohms	10.3 to 6.7 = 3.6 microamps. change
5 megohms	9.1 to 6.0 = 3.1 microamps. change

Thus it appears that the greater the resistance or impedance of the load the smaller is the change of current for a given change of luminous flux or of illumination, and the lower is the range of anode currents. If load lines are drawn on the anode characteristics of a vacuum phototube it will be found that the change of current for a given change of light is practically unaffected by changes of load resistance or impedance within the usual ranges of operation. Load resistances for gas-filled tubes ordinarily are no more than 10 megohms, while for vacuum types the load resistances may be as high as 50 megohms or even more.

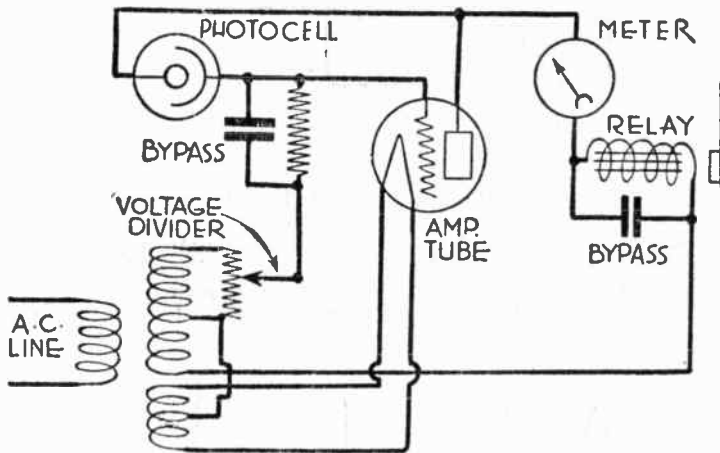

FIG. 10.—The Relay Closes upon Increase of Light.

Fig. 10 shows a circuit for a vacuum tube amplifier actuated from a photo-cell and operating a magnetic relay, all from an a-c line and transformer. On the a-c half-cycle which makes the photocell anode positive, current from the transformer flows through the relay winding to the photocell anode, through the photocell to the cathode, through the bypassed resistor and back to the transformer through the voltage divider. Potential drop across the bypassed resistor is applied between control grid and filament-cathode of the amplifying tube. Plate current for the amplifying tube flows from the transformer through the relay, through the tube, the center-tapped filament winding of the transformer and back to the upper winding. When there is an increase of light on the photocell there is an increase of current in the bypassed resistor and an increase of potential drop in such direction as to make the upper end of the resistor and the grid of the amplifying tube more positive. Thus the plate current is increased and the relay pulled in upon an increase of light.

Fig. 11 shows a circuit arranged so that the relay pulls in upon a decrease of light on the photocell. The anode of the photocell is connected to the grid of the amplifying tube. Phototube current flows upward through

CELL, PHOTOTUBE

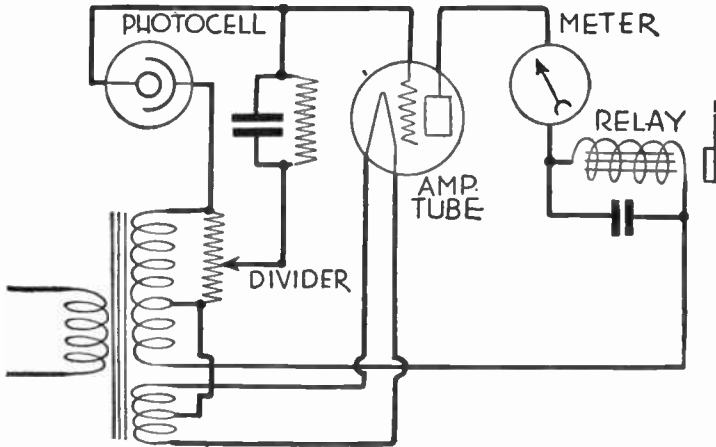

FIG. 11.—The Relay Opens upon Increase of Light.

the bypassed resistor, making the upper end of the resistor and the grid of the amplifying tube negative. Decrease of light lessens the phototube current, lessens the potential across the bypassed resistor, makes the amplifier grid less negative, and thus increases the amplifier plate current to pull in the relay. The meters of Figs. 10 and 11 need be connected into the circuits only until the voltage divider is adjusted to permit correct relay current.

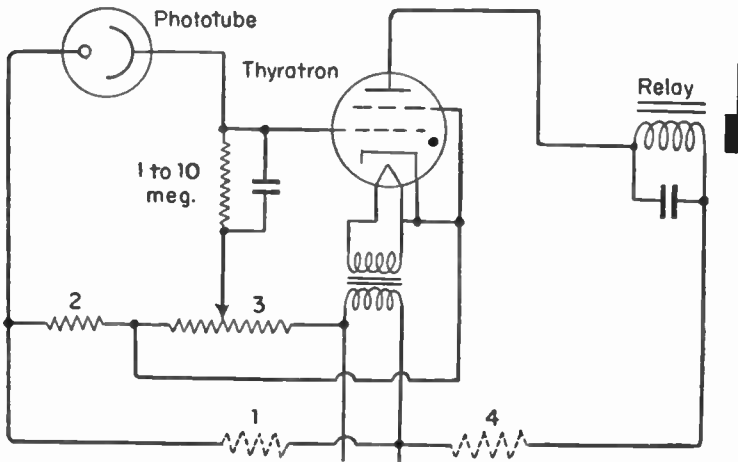

FIG. 12.—Phototube and Thyatron for Pull-in of Relay upon Increase of Light.

CELL, PHOTOTUBE

Fig. 12 shows a phototube relay circuit employing a screen grid thyatron instead of a vacuum tube for the amplifier. The relay pulls in upon increase of light on the phototube. The action is similar to that for Fig. 10. With a gas-filled phototube resistor 1, of about 10,000 ohms, is used to limit the phototube potential. Resistor 2 is of equal resistance, while 3 is a voltage divider of 1,000 to 2,000 ohms resistance. With a vacuum phototube, resistor 1 may be omitted and 2 made about 20,000 ohms. Resistor 4 is placed in series with the relay only if it is needed to reduce relay current to a desirable value or to a safe value for the relay winding.

Fig. 13 shows the thyatron amplifier circuit re-arranged so that the relay pulls in with a decrease of light on the phototube, the action being similar to that for Fig. 11. Again resistor 1, now of about 2,500 ohms, is used only with a gas-filled phototube, and resistor 2 is made of equal value. With a vacuum phototube resistor 1 is omitted, and 2 is made of about 5,000 ohms resistance. The resistance of the voltage divider 3 is made 100 to 200 ohms.

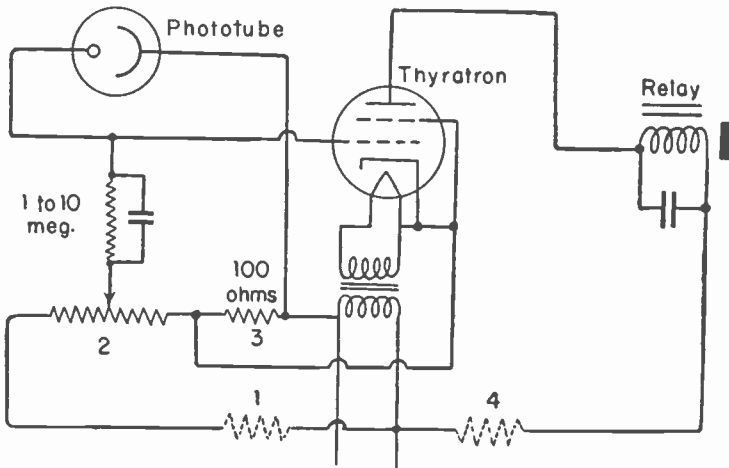

Fig. 13.—Phototube and Thyatron for Relay Pull-in upon Decrease of Light.

In the four amplifiers of Figs. 10 to 13 the bypassed resistor through which flows the phototube current forms the load in the phototube circuit. This resistor is made of one to ten megohms resistance, depending on the load desired in this circuit. The bypass condenser across the relay winding usually is needed to prevent chattering of the relay with alternating-current operation of the amplifier. This bypass may be of two microfarads, or more, capacitance.

Fig. 14 shows the circuit for a battery-operated amplifier employing a screen-grid vacuum tube. The relay pulls in with increase of light on the phototube. It is characteristic of all amplifiers with which the relay pulls in upon increase of light that the phototube cathode is connected to the grid of the amplifier tube. When the relay pulls in with decrease of light the phototube anode is connected to the amplifier control grid.

CELL, PHOTOTUBE

Fig. 15 is a circuit for carrier frequency amplification. The high-frequency photocell is subjected to carrier-frequency light impulses. In series is a low-frequency photocell, the light on which

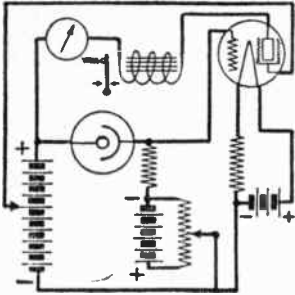

FIG. 14.—Screen Grid Amplifier for Phototube.

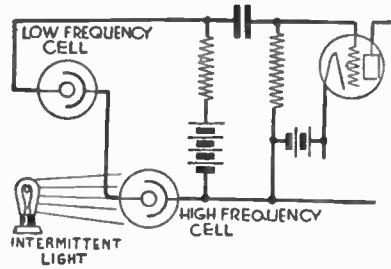

FIG. 15.—Phototube Amplification of Carrier Frequency.

is modulated or varied with the frequency or the signal which is to be transmitted on the carrier. The output of the two cells then is a high-frequency carrier modulated with a signal.

CELL, PHOTOVOLTAIC

CELL, PHOTOVOLTAIC.—Photovoltaic cells are devices which change the energy of light and of ultraviolet and infra-red radiation directly into electromotive force or potential. Cells at present in use are of the barrier layer or blocking layer type, consisting of a backing plate of metal on one side of which are deposited extremely thin films of other metals or of the oxide of the backing metal. Light which passes through these films releases electrons at the contact surface between the films and backing metal. It is this surface which is called the barrier layer, blocking layer, or barrier plane. The entire assembly is lacquered for protection against moisture. The construction principle is shown by Fig. 1.

There are two principal kinds of barrier layer cells. In one kind a base of copper is covered with an extremely thin film of copper oxide. Over the oxide is a transparent film of some conductive metal, and around the edge of this film is a ring of heavier metal for a current collector. Light passes through the conductive film and the oxide to release electrons at the barrier layer. An excess of electrons collects on the oxide side of the barrier,

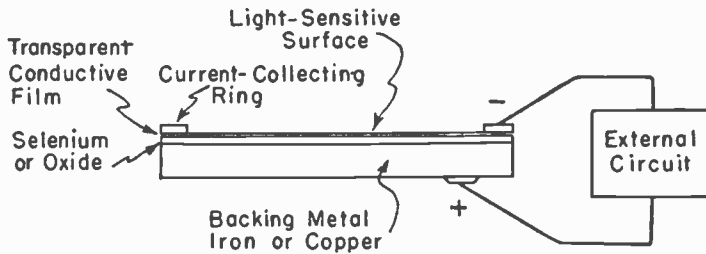

FIG. 1.—Principal Parts of Barrier Layer Photocells.

leaving the copper positive and making the oxide and conductive film negative. Current then will flow through an external circuit from the copper around to the metal ring on the front of the cell.

A more recently developed barrier layer cell consists of a backing plate of iron or steel on which is a film of selenium or a selenium alloy. The selenium is covered with thin, transparent, conductive films of a metal such as gold, silver or platinum. Around the edge of this conductive film is the current-collecting ring. Light passes through the transparent conductive film, releases electrons at the barrier layer, and the excess of electrons passes to the conductive film. Thus the iron backing plate becomes positive and the conductive film negative. Current will flow from the iron around to the conductive film through an external circuit.

The curves at the left-hand side of Fig. 2 show typical relations between current in microamperes and illumination in foot-candles for load resistances of 100, 500 and 1,000 ohms. The current is more nearly in exact proportion to illumination as the load resistance is decreased. At the right is shown a curve of open circuit electromotive force in millivolts for various illuminations. The open circuit emf would be greater at higher cell tempera-

CELL, PHOTOVOLTAIC

tures, and would be less with lower temperatures. The internal resistance of a barrier layer cell becomes less as the illumination is increased, and also becomes less when the external load resistance is increased.

Barrier layer cells are used to actuate sensitive current meters, which may be calibrated to read directly in light units. These cells are used also to operate ultra-sensitive relays which, in turn, operate power relays. They are commonly employed as light meters for measurement of illumination, also for many methods of control, sorting, counting, and alarm systems. The wavelength or color sensitivity is similar to that of the human eye,

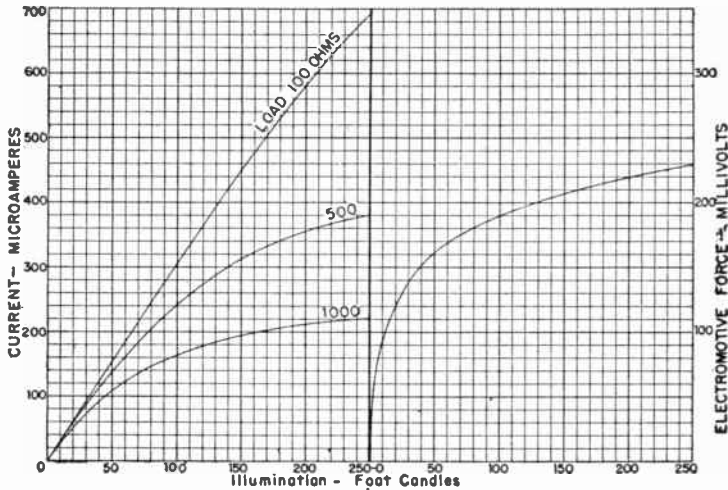

FIG. 2.—Current and Emf in Barrier Layer Photocells.

and with suitable filters may be made to almost exactly match that of the eye. The chief disadvantages of barrier layer cells are that their output is difficult to amplify by means of electronic tubes, and that their output falls rapidly with increase of frequency of light impulses on the cells. This is due chiefly to the high-frequency bypassing effect of the capacitances between films and backing plates in the cell.

In early types of photovoltaic cells there are two electrodes immersed in a liquid electrolyte. Either or both electrodes are electron-emitting when subjected to light. Release of electrons occurs at the contact surface between the lighted electrode and the liquid, this electrode becoming the cathode from which current flows to the external load circuit.

CELLULOID

CELLULOID.—Celluloid is a rather hard, but flexible substance made from gun cotton and oil of camphor. It may be transparent or colored in various ways. The dielectric strength of celluloid varies from 250 to 700 volts per thousandth of an inch thickness. Its dielectric constant also varies between wide limits, running from as low as 4.0 up to 6.0. Celluloid is highly inflammable. It may be softened in hot water and bent into almost any shape.

CELERON.—See *Phenol Compounds*.

CEMENT.—See *Binders*.

CENTIGRADE THERMOMETER SCALE.—See *Temperature, Scales of*.

CENTIMETER.—See *Metric System*.

CENTRALIZED SOUND SYSTEM. — See *Public Address System*.

CERESIN WAX.—See *Waxes, Insulating*.

CHAIN BROADCASTING.—See *Broadcasting*.

CHARACTERISTIC.—A quality or attribute of any device showing its behavior under certain conditions of use. For instance, characteristic curves of electronic tubes show relations between such things as control grid voltage and plate current, plate voltage and plate current, and so on.

CHARGE.—The electrons or electricity which represent an excess or a deficiency with reference to a neutral condition of a condenser or a dielectric. The unit of charge is the coulomb.

CHARGE, BOUND AND FREE.—See *Induction, Electrostatic*.

CHARGE, SPACE.—The term space charge usually refers to negative electrons which have been emitted from a cathode of a tube and which are in the space near the cathode or between the cathode and the anode or plate of the tube. The space charge is of great importance in the operation of nearly all types of tubes.

Because electrons emitted from the cathode are themselves negative charges, and because two negative charges repel each other, the space charge opposes the emission of additional electrons. When the anode or plate of a tube is made positive it attracts electrons from the space charge, and these electrons form the anode current. This action reduces the concentration of electrons in the space charge so that additional emission may take place.

In the normal operation of hot-cathode tubes used as rectifiers, amplifiers and oscillators, the heating of the cathode to rated temperature causes emission of enough electrons so that some space charge remains near the cathode, or so that there is a surplus of electrons over and above those being drawn to the anode so long as the anode potential is not made unduly high. However, if the anode potential is made excessively high the electrons will be drawn to it as rapidly as they are emitted and there will be no space charge. Also, if the cathode temperature is made much lower than normal, the rate of emission will drop to a value at which electrons are drawn to the anode as rapidly as they are emitted from the cathode.

When electrons are drawn to the anode as fast as emitted from the

CHARGE, SPACE

cathode the condition is called saturation, and the anode current or plate current is called saturation current. But if some space charge remains near the cathode, to oppose emission, the action is said to be space charge limited. Under this latter condition the plate current will vary with plate potential, because there is a surplus of electrons from which to draw. But when the plate potential is high enough to cause saturation, further increase of plate potential causes but little increase of plate current unless cathode temperature and resulting emission are increased.

In a tube having a control grid between cathode and anode the control grid is located in the space charge region. If the grid is made negative with reference to the cathode the negative charge of the grid adds its effect to the negative space charge, with the result that electron emission is reduced or, if the grid is made sufficiently negative, is stopped. This is the condition called plate current cutoff. A positive control grid attracts electrons from the space charge, they enter the grid to flow through its circuit as grid current, and the space charge is reduced to allow increased emission from the cathode.

In beam power tubes a negative space charge is produced in the region between the screen grid and the plate by a slowing down of electrons in this region and by the resulting increase of electron density. The electrons slow down and congregate when plate voltage drops below screen grid voltage, for then the acceleration of electrons from screen to plate is less than from cathode to screen.

When ionization occurs in a gas-filled tube the atoms or molecules of gas which have lost one or more electrons become positive ions. These ions are attracted toward the negative cathode, and in the space charge region they again pick up electrons to become neutral. The electrons taken from the space charge by the positive ions reduce the charge, and a high rate of emission is permitted. It is this reduction of space charge which is largely responsible for the very high rates of current flow during ionization in these tubes.

The positive ions which exist during ionization in a gas-filled tube may be called a positive space charge. Such ions exist throughout the inter-electrode space, and they collect in considerable density near any element which is negatively charged. See *Ionization and Tube, Gas-filled*.

CHASSIS, RECEIVER.—A name sometimes applied to the electrical parts and framework of a radio receiver.

CHOKE, AUDIO FREQUENCY.—See *Coil, Choke*.

CIRCUIT.—A complete conductive path, including a source of electromotive force, or connected between points which may have a difference of potential, so that current may flow in all parts of the path. Also a path in which magnetic flux may issue from one pole of a source of magnetomotive force and return to the other pole. The magnetic circuit may be composed either wholly or in part of magnetic materials.

CIRCUIT, ACCEPTOR.—A series resonant circuit in which a coil and condenser, tuned to resonance at a certain frequency, offer minimum impedance to currents at that frequency and so may be said to accept the tuned frequency.

CIRCUIT, ANTENNA

CIRCUIT, ANTENNA.—See *Antenna, Circuit of.*

CIRCUIT, APERIODIC.—See *Aperiodic.*

CIRCUIT, BAND SELECTOR.—A band selector consists of two tuned circuits, coupled together so that their reactance is low to an entire band of frequencies which it is desired to receive and is very high to all other frequencies.

A transmitter sending a signal on a carrier frequency of 800 kilocycles, for example, will modulate this frequency for the sending of music and speech with additional frequencies of 5,000 cycles or five kilocycles each side of 800 so that the entire band extends from 795 kilocycles to 805 kilocycles as explained under *Band, Wave.* Two such bands are indicated in Fig. 1. One is that portion of the broadcast spectrum occupied by a station operating at 800 kilocycles carrier frequency and the other is that of a station operating at 780 kilocycles. Each band occupies a width of ten kilocycles.

The response of broadly tuned and sharply tuned resonant circuits at various frequencies is shown in Fig. 2. With the broadly tuned circuit at the left,

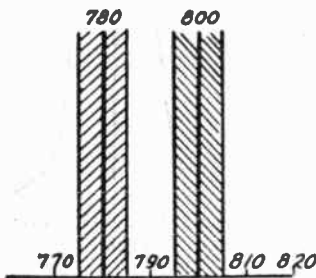

FIG. 1.—Frequency Bands.

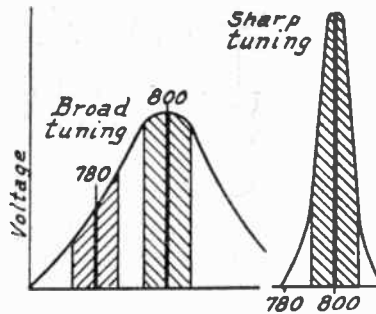

FIG. 2.—Response of Resonant Circuits

the voltage induced in the tuner is maximum for the tuned frequency, 800 kilocycles, but the response is also quite strong to frequencies as low as 775 kilocycles. Signals from another transmitter operating on the 780 kilocycle band will represent a considerable percentage of the signals received by such a broadly tuned circuit, the proportion of the wanted and unwanted signals being roughly indicated by the shaded portions of the frequency bands.

At the right hand side of Fig. 2 is shown the voltage response of a sharply tuned resonant circuit at a frequency of 800 kilocycles. It is seen that the response is only to the desired frequency with no interference from the unwanted signal on 780 kilocycles. From the standpoint of selectivity the sharply tuned circuit is satisfactory but from the standpoint of tone quality it is unsatisfactory. The voltage response peak of the sharply tuned circuit is so narrow that it does not take in the side bands which carry the audio frequency modulations. Only the lower audio frequencies, those lying close to the carrier frequency, are fully reproduced. The higher audio frequencies, which are the farthest above and below the carrier frequency, are not well reproduced by the sharply tuned circuit. From the left hand part of Fig. 2 it is apparent that the broadly tuned circuit gives satisfactory response to all the audio frequencies in the entire band.

CIRCUIT, BAND SELECTOR

A fairly satisfactory response to the entire audio frequency range, together with satisfactory selectivity, may be secured through the use of a number of successive broadly tuned stages of radio frequency amplification, by the use of the successive tuned intermediate stages in a superheterodyne receiver, or by the use of a band selector circuit in connection with a radio frequency amplifier.

One of the simplest band selector circuits depends upon a principle long known in radio, the principle that two coupled circuits, each separately tuned to the same frequency, will respond to two frequencies one of which is above and the other below the original tuned frequency. The application of this idea is shown in Fig. 3. In the plate circuit of the first tube is a resonant circuit including the tuning condenser $C1$ and the coil $L1$. The plate circuit is completed through the bypass condenser $C3$ and the direct plate current for the tube is supplied through the choke. In the grid circuit of the second tube is another resonant circuit including tuning con-

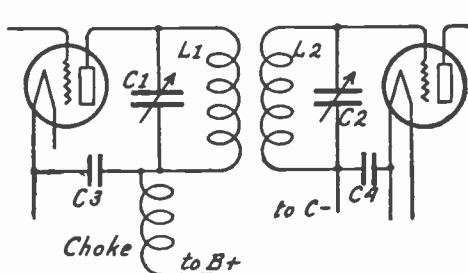

FIG. 3.—Band Selector with Tuned Plate and Tuned Grid Circuits.

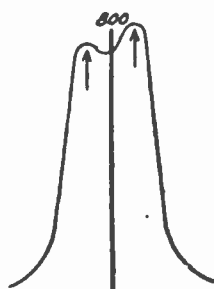

FIG. 4.—Double Resonance Peak.

denser $C2$ and the coil $L2$. The grid circuit is completed through bypass condenser $C4$.

The two resonant circuits are tuned to the same frequency, that of the carrier which it is desired to receive. The response curve, shown in Fig. 4, consists of two peaks slightly separated from each other so that quite uniform amplification is secured over a whole band of frequencies rather than over only a narrow peak as at the right in Fig. 2. Each circuit alone must be capable of producing a sharply peaked response, therefore the construction must include coils and condensers having the lowest possible resistance at radio frequencies. The coils and condensers are matched so that they tune alike with the two condensers operated from one control. The separation of the two peaks is determined by the frequency being received and by the degree of coupling between the circuits. See *Coupling, Coefficient of*.

As shown in Fig. 5, the closer the coupling the farther apart are the two peaks and the greater is the dip between them. This produces a receiver in which the response is less when tuned exactly to the desired frequency than when tuned slightly above or below that frequency. As shown in Fig. 6, the response curve is much broader at high frequencies or low wavelengths than at low frequencies or high wavelengths. Therefore the selectivity is better at the low frequencies.

CIRCUIT, BAND SELECTOR

In Fig. 7 is shown the principle of the Vreeland selector in which the two tuned circuits are coupled through a mutual inductance consisting of a third coil rather than by electromagnetic coupling between the two tuned coils as in Fig. 3. The resonant circuit in the plate circuit of the first tube consists of tuning condenser $C1$, coil $L1$ and coil $L3$. The resonant circuit for the grid circuit of the second

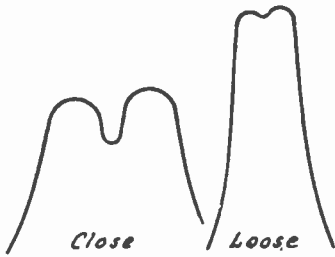

FIG. 5.—Peaks Secured with Changes in Coupling.

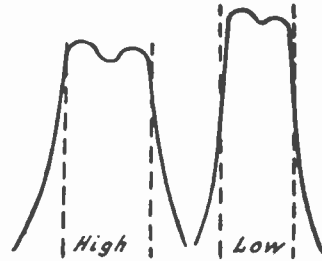

FIG. 6.—Effect of Frequency on Resonance Peaks.

tube consists of tuning condenser $C2$, coil $L2$, and coil $L3$. Coupling is by means of the coil $L3$. Bypass condensers complete the plate circuit, the grid circuit and the resonant circuits. In general, the action of this system is like that of the one first described.

In the two circuits so far described, the band selector feature is combined with the radio frequency amplifying circuits. In a third

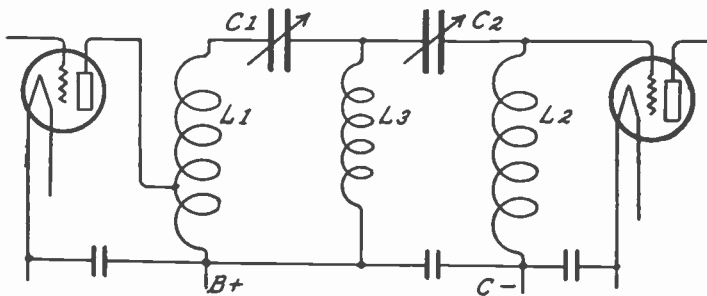

FIG. 7.—Circuit Arrangement of Vreeland Band Selector.

design, the Jones or Technidyne system, the band selector circuit is separate from and precedes the radio frequency amplifier, being placed between the antenna and the amplifier. The amplifier may then be of the untuned type.

In Fig. 8 are shown two tuned circuits; one including coil $L1$ and condenser $C1$ the other including coil $L2$ and condenser $C2$. The circuits are coupled together by the coil M , which is common to both and which forms

CIRCUIT, BAND SELECTOR

an inductance mutual to both tuned circuits. The two tuned circuits are made resonant at exactly the same frequency or are tuned exactly together. Were these circuits uncoupled, each would respond to a narrow band of frequencies and the bands would be alike as at the right hand side of Fig. 2.

When these two tuned circuits are coupled through the mutual inductance, they will respond well at a frequency slightly below the original one and at a frequency slightly higher than the original tuned frequency. The combined response is then like that shown in Fig. 4. The comparatively steep sides of the individual sharply tuned circuits have been retained, thus giving good selectivity because of slight response to frequencies outside the selected band. The top of the combined curve is now broad enough so that the entire frequency band with all the audio modulation is reproduced very well. In actual practice, a signal enters the band selector through circuit *I* of Fig. 8 which might be connected to an antenna, and leaves the selector through circuit *O*, which might lead to the grid of the first amplifying tube.

The selectivity of this circuit depends on the sharpness of tuning in the two tuned portions because sharp tuning preserves the steepness of the sides of the response curves. Sharpness of tuning depends on the use of high grade and carefully constructed parts throughout, on the reduction of high frequency resistance and on correct shielding of the circuits.

The broadness of the response depends on the degree of coupling used between the two tuned circuits, the closer the coupling the broader the response

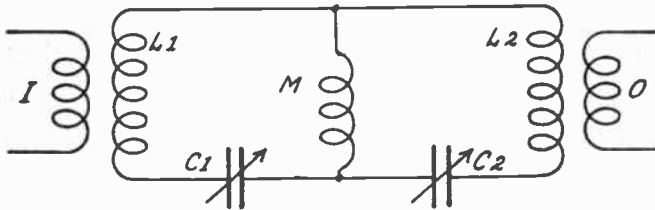

FIG. 8.—Mutual Coupling with Coil in Two Tuned Circuits.

curve. The width of the response curve depends also on the frequency being received, the curve being broader at high frequencies and narrower at low frequencies.

When using a coil for mutual inductance and coupling, the smaller the coil the smaller will be the coupling and the narrower the top of the response curve. Varying the number of turns in the coil or otherwise varying its inductance will make a corresponding variation in the width of the response.

The degree of coupling is determined by the amount of common reactance. The larger a coil, the greater will be its reactance at a given frequency.

When used with tuning coils of sizes generally employed for broadcast work, the coupling coil *M* need have only about one and one-half microhenries inductance, four to six turns of wire on a one inch diameter form being about right. The reactance of such a coil at 800 kilocycles would be approximately seven and one-half ohms.

A band selector circuit as used ahead of the first radio frequency amplifying tube is shown in Fig. 9. The antenna circuit passes through an adjustable condenser *Ca* which adjusts the natural frequency or the capacity of the antenna. The remainder of the antenna circuit includes the tuned circuit *L1-C1* in which the coil couples to coil *L2* of the band selector. Coil *L2* of the selector is

CIRCUIT, BAND SELECTOR

tuned with adjustable condenser $C2$. The coupling coil is marked M , and couples the first circuit of the selector to the second circuit consisting of coil $L3$ and tuning condenser $C3$. This second circuit is coupled to coil $L4$ which, in turn, is tuned with adjustable condenser $C4$ to form a resonant circuit connected to the grid of the first amplifying tube. The broken lines indicate shields. The antenna circuit and the first tuned circuit of the selector are enclosed

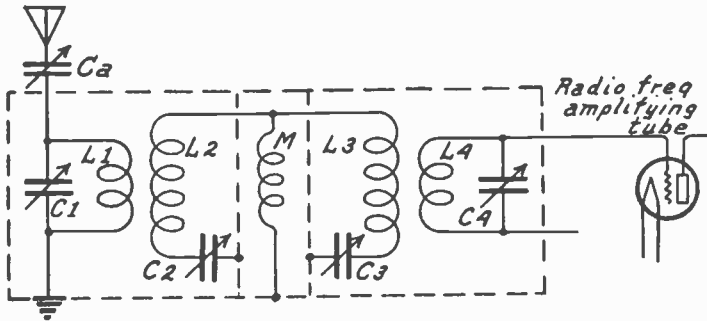

FIG. 9.—Circuit of Jones Pre-selector.

in one shield, the coupling coil in a second shield and the remaining two tuned circuits in a third shield. The first shield, for the antenna circuit, is sometimes omitted.

Capacitive coupling instead of inductive coupling may be used as shown in Fig. 10. This circuit should be compared with that shown in Fig. 8. Here the capacity M is common or mutual to both tuned circuits. The degree of coupling is changed by changing the capacity of condenser M . Increasing the condenser reactance by making its capacity smaller will increase the coup-

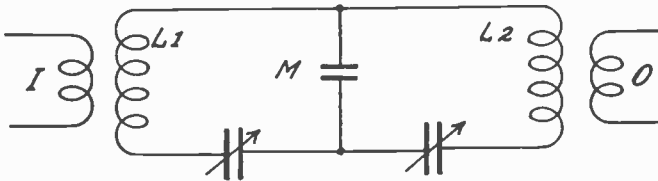

FIG. 10.—Mutual Coupling with Condenser.

ling and cause the response curve to become broader. The opposite effect is secured with a greater capacity and smaller reactance.

The reactance of a coupling coil increases with increase of frequency while the reactance of a coupling condenser decreases with increase of frequency. Therefore, the tendency of a coupling coil is to make broader tuning at high frequencies and the tendency of a coupling condenser is to make broader tuning at low frequencies. Since the lower frequencies naturally tune more sharply than the high frequencies, the effect of using a condenser for coupling is to compensate for the frequency effect with more uniform width of response curve for all frequencies.

CIRCUIT

CIRCUIT, GRID.—A control grid circuit includes the control grid, a conductive path from grid to cathode or filament (which may include coils or resistors), the cathode or filament, and the space between the cathode or filament and the control grid inside the tube. If the grid potential is positive with reference to the cathode or filament, current flows from grid to cathode inside the tube and from cathode back to grid in the external circuit. If grid potential is zero or negative there is no appreciable flow of current in this circuit.

CIRCUIT, MAGNETIC.—A magnetic circuit includes a permanent magnet or an electromagnet winding as a source of magnetomotive force, and a path through which there is magnetic flux or magnetic lines of force from one pole to the other of the source. The circuit may consist in whole or in part of either magnetic iron and steel or of nonmagnetic materials, including air. The field in an air gap is part of the magnetic circuit.

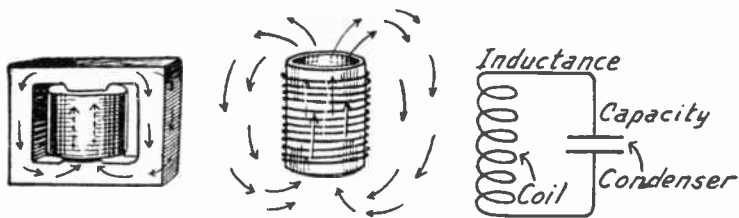

Magnetic Circuits in Iron Core
and in Air Core.

An Oscillatory Circuit.

CIRCUIT, OSCILLATORY.—A circuit which includes an inductance and a capacity, usually a coil and a condenser, which are in series with each other. Energy passes back and forth between the inductance and capacity, or oscillates. First the energy is stored as a magnetic field around the inductance. Collapse of this field induces a current flow which charges the capacity, whereupon the energy exists as an electrostatic field in the dielectric. The potential of this field causes a reverse current flow which again builds up a magnetic field around the inductance.

CIRCUIT, PARALLEL.—Two or more resistances or impedances connected across a single potential or current source are said to form a parallel circuit and to be in parallel with one another. See *Resistance, Parallel Circuit*.

CIRCUIT, PLATE.—A plate circuit or anode circuit includes the plate or anode of a tube, whatever resistance or impedance forms the output load for the tube, the source of potential and current for the plate, the cathode or filament of the tube, and the space between the cathode and plate inside the tube. Current

CIRCUIT

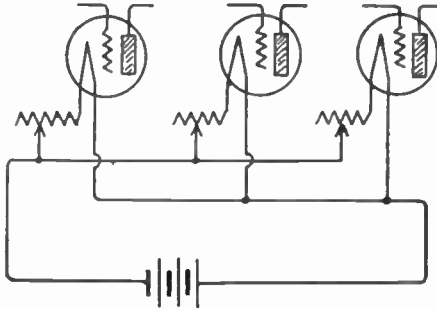
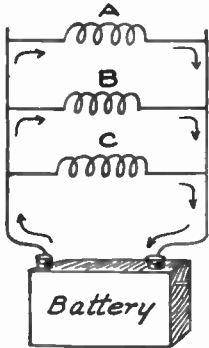

FIG. 1.—Parallel Circuits. FIG. 2.—Tube Filaments in Parallel Circuit.

flows from plate to cathode inside the tube, and from cathode back to the plate in the external circuit.

CIRCUIT, REJECTOR.—A parallel resonant circuit, formed by an inductance and capacity in parallel with each other and in series with the line, may be called a rejector circuit because it offers maximum impedance to line currents at the tuned frequency.

CIRCUIT, SERIES.—Two or more resistances or impedances connected end to end across a source of potential or current, or so connected and including the source, form a series circuit and the parts are said to be in series with one another. The same current flows in all the parts of a series circuit. See *Resistance, Series Circuit.*

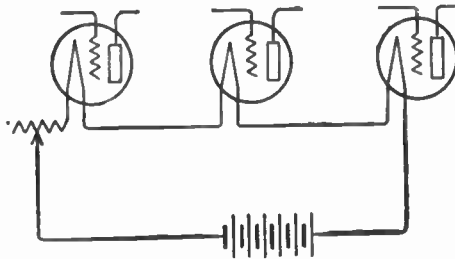
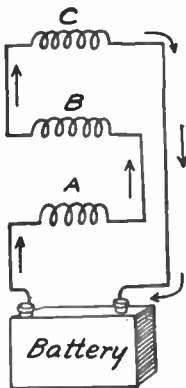
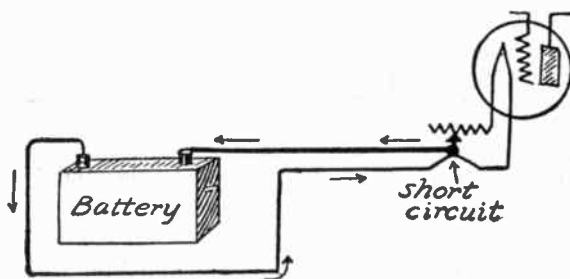

FIG. 1.—A Series Circuit.

FIG. 2.—Tube Filaments in Series Circuit.

CIRCUIT

CIRCUIT, SHORT.—An undesired conductive connection between circuit conductors at different potentials, allowing current to flow from the source and to return to the source without passing through the load, and causing such a decrease of impedance as to allow excessive flow of current between the source and the short circuited point.



A Short Circuit.

CIRCUIT, SHUNT.—A parallel circuit. See *Circuit, Parallel*.

CIRCULAR MIL.—See *Mil, Circular*.

CLAMP, GROUND.—A device arranged to clamp securely around a pipe or other grounding conductor leading to earth, and to provide a connection for circuits or elements which are to be grounded.

CLASS A, B, AND C AMPLIFIERS.—See *Amplifier Classification*.

CLOSE COUPLING.—See *Coupling, Close*.

CLOTH, INSULATING.—Varnished muslin and varnished cambric are made of cotton and linen treated with oils to increase their dielectric strength, which is from 500 to 1,000 volts per thousandth inch thickness. The dielectric constant is from 3.0 to 5.0. Empire cloth is in this general class.

CODE.—A system of signals used for radio or wire telegraphy is called a code. On the following page is shown the Continental or International Morse code, which differs from the one used in wire telegraphy. Various combinations of dots, dashes and spaces represent letters, numerals, punctuation and short phrases. In "speaking" the code a dot is called "dit" and a dash is called "dah." The dash is equal in length to three dots. Between parts of the same letter the interval is equal to one dot. At the end of each letter in a word is allowed a time interval equal in length to three dots before commencing the next letter. At the end of each word the interval is equal in length to five dots.

CODE

THE INTERNATIONAL MORSE CODE AND CONVENTIONAL SIGNALS

A	• —
B	— • • •
C	— • — •
D	— • •
E	•
F	• • — •
G	— — • •
H	• • • •
I	• •
J	• — — —
K	— • —
L	— • • •
M	— —
N	— •
O	— — —
P	• • — • •
Q	— • — —
R	• — • •
S	• • •
T	— •
U	• • • —
V	• • • •
W	• — — —
X	— • • — —
Y	— • • • —
Z	— — • • •
<hr/>	
Ä (German)	• • • —
À or Á (Spanish-Scandinavian)	• • — —
CH (German-Spanish)	— — — —
Ê (French)	• • — • •
Ñ (Spanish)	— — — • — —
Ö (German)	— — — — •
Ü (German)	• • — — —
<hr/>	
1	• — — — —
2	• • — — —
3	• • • — —
4	• • • • —
5	• • • • •
6	— • • • •
7	— — • • •
8	— — — • •
9	— — — — •
0	— — — — —

Semicolon.....	— • — • — •
Period	• — • • — •
Colon	— — — • • •
Interrogation	• • — — • •
Comma	— — — • • —
Apostrophe.....	• — — — — •
Hyphen.....	— • • • • —
Bar indicating fraction.	— • • — •
Parenthesis.....	— • — — — •
Inverted commas.....	• — • — — •
Underline.....	• • — — — —
Double dash.....	— — • • —
Distress Call (S.O.S.)..	• • • — — — • • •
Attention call to precede every transmission...	— • — — • —
General inquiry call (C.Q.)	— • — — • — — — —
From (de).....	— • • •
Invitation to transmit (go ahead) (K).....	— • • —
Warning—high power..	— — — • • — —
Question (please repeat after ...)—interrupting long messages ...	• • — — — • •
Wait.....	• — — • •
Break (Bk.) (double dash).....	— • • • —
Understand.....	• • • — •
Error.....	• • • • • •
Received (O.K.) (R) ..	• — — •
Position report (to precede all position messages).....	— • — • •
End of each message (cross).....	• — — — •
Transmission finished (end of work) (conclusion of correspondence).....	• • • — — —

COIL

COIL, ANGLE OF MOUNTING.—For air-core coils without shielding to have minimum coupling they should be mounted with their axes at right angles and intersecting, as in the drawing. The axis of one coil intersects that of the other at the center of winding length on the second coil.

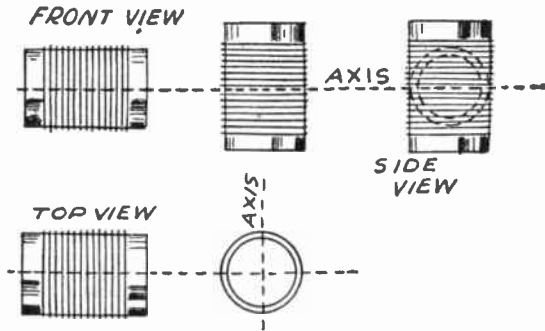

COIL, BANK WOUND.—Bank winding is a method for minimizing the potential differences between adjacent turns of a multi-layer winding, and of thus lessening the effects of distributed capacity. The left-hand drawing shows the order in which turns are wound onto a form when making a two-layer bank



winding. At the center is a two-layer plain winding wherein the greatest difference is between turns 1 and 13, while in the bank winding it is between 2 and 5, 4 and 7, and so on. The right-hand drawing shows positions of successively applied turns in a three-layer bank winding.

COIL, BASKET WOUND.—A basket wound coil is made by lacing the wire around vertical pins arranged in a circle, just as the cane or wicker is woven in a basket. The winding is cemented or laced to be self-supporting. The spaced turns lessen the effects of distributed capacity.

COIL, CHOKE

COIL, CHOKE.—A choke coil is a coil of great reactance or impedance whose purpose is to limit the flow of alternating or pulsating currents of certain frequencies through part of a circuit in which the choke is placed.

By means of various combinations of choke coils and condensers, a circuit containing currents of both high and low frequencies and also direct current may be so divided as to send the low frequency current through one path, the direct current through another path, and the high frequency current through a third path.

The plate circuit of the vacuum tube show in Fig. 1 carries both radio frequency (high frequency) current and direct current. If

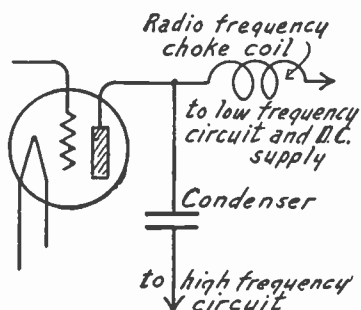

FIG. 1.—Separation of Frequencies with a Choke Coil.

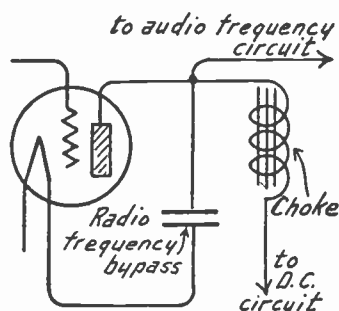

FIG. 2.—Separation of Direct and Alternating Currents with Choke Coil.

the tube should happen to be a detector, audio frequency (low frequency) currents are also taken from the plate circuit. If a radio frequency choke coil and a condenser are placed as shown in the plate circuit, the choke coil will oppose passage of radio frequency current through itself. But the radio frequency current will pass easily through the condenser since the condenser's reactance to high frequencies is very small. The condenser, however, forms an open circuit for the direct current of the B-battery. Consequently this direct current cannot pass through the condenser. The radio frequency choke has no iron core and is wound with comparatively large wire, therefore, it offers very little opposition to the low frequency audio current or to the direct current which flows freely through the choke. Audio frequency currents will pass through a radio frequency choke coil if the coil is properly designed to offer high reactance only at high frequencies.

The use of an iron-core choke coil is shown in Fig. 2. In this circuit the plate of the vacuum tube is carrying radio frequency or high frequency current, audio frequency or low frequency current

COIL, CHOKE

and direct current or battery current. The high frequency current finds a path of low reactance through the bypass condenser and returns to the tube filament. The direct current flows easily through the choke, leaving only the audio frequency current to pass to the audio frequency circuits. The bypass condenser is assumed to be of small capacity so that it offers high reactance to the audio frequency current and forms an open circuit for the direct current.

Wire Size in Chokes.—The wire must be of sufficient size to carry the current without overheating. This consideration is of importance in audio frequency chokes, also in filter chokes used for filament supply and for eliminating interference. In radio frequency circuits the maximum current is not over five milliamperes in the great majority of cases. In audio frequency circuits the maximum current is seldom more than twenty-five milliamperes for the lines in any one stage.

The wire size and the length used determine the direct current resistance of the choke. The resistance is one factor in impedance. The alternating current that will pass through any choke may be found by dividing the voltage by the impedance. The total current through the choke is the sum of the high frequency current, the low frequency current and the direct current. The wire is chosen to handle whatever total current will actually pass.

The following table shows the maximum allowable current in milliamperes for the different gauge sizes of copper wire used in choke coils of all types.

CURRENT CARRYING CAPACITY OF COPPER WIRE

Gauge Size	Current in Milliamperes	Gauge Size	Current in Milliamperes	Gauge Size	Current in Milliamperes
16	1700 to 2600	24	275 to 400	32	40 to 63
17	1300 to 2000	25	200 to 325	33	35 to 50
18	1100 to 1600	26	175 to 250	34	25 to 40
19	850 to 1300	27	125 to 200	35	20 to 32
20	675 to 1000	28	100 to 160	36	18 to 25
21	550 to 800	29	85 to 125	37	13 to 20
22	425 to 650	30	65 to 100	38	10 to 15
23	350 to 500	31	55 to 80	40	5 to 10

Proportions of Choke Coils.—A choke coil should contain the maximum possible inductance and the least possible resistance. The best ratio of resistance to inductance is obtained in solid layer-wound coils by making them of the following proportions:

With the length of the winding represented by 100, the thickness or depth of winding should be also represented by 100. The inside diameter of the winding, or the outside diameter of the winding form, should be represented by 266. The outside diameter of the winding should be represented by 466. As an example; supposing a choke coil were to be made one inch long. The length being 1.0 inch, the depth of winding should be 1.0 inch, the inside diameter of the winding should be 2.66 inches and the outside diameter should be 4.66 inches.

While the foregoing are the ideal proportions, chokes may vary widely from these dimensions and still be entirely satisfactory for their work.

COIL, CHOKE

Radio Frequency Chokes.—Choke coils designed to oppose only the flow of high frequency currents are usually of air-core type. They must be constructed to have the least possible distributed capacity since such capacity will pass the high frequency across the choke. The size of wire is of no particular importance, gauges from number 24 to number 32 being often employed. Larger sizes are equally satisfactory but they increase the bulk of the coil. Single cotton covered or double cotton covered wire is preferable to enameled wire because of the increased spacing and lower distributed capacity with the cotton covering. With double cotton covered wire the coil will be of considerably larger bulk than with single cotton in order to obtain the same inductance.

The radio frequency choke must oppose the passage of high frequencies but must not choke back the audio frequencies. Therefore, when only radio frequency currents are to be stopped the choke should not have an iron core unless the core is of very small size because the iron will give the coil so much inductance and reactance that some of the higher audio frequencies are quite likely to be lost.

If both radio frequencies and audio frequencies are to be choked by the same coil it is then necessary to use iron-core construction in order to obtain enough reactance to properly oppose the lower audio frequencies. Radio frequency currents will be choked effectively by any coil that will choke audio frequency.

An inductance of at least two and one-half millihenries is required for radio frequency chokes used in broadcast receivers. For almost complete stoppage of the radio frequency an inductance of five millihenries is better.

Honeycomb coils make excellent radio frequency chokes when there is space enough to allow their use. A honeycomb coil of 200 turns is the smallest that will prove reasonably effective. Coils of 250 or of 300 turns do very good work as chokes. A satisfactory radio frequency choke coil may be made by winding one thousand to fifteen hundred turns of number thirty-two single cotton covered wire on a form one inch long with a center formed by a five-sixteenth inch diameter wood or rubber rod or a fibre tube. Use no iron in the core.

Audio Frequency Choke Coils.—An audio frequency choke coil should offer a very high impedance at audio frequencies but should be of sufficiently low resistance so that direct current for the plate circuit is not unduly reduced.

Since the reactance of such chokes varies according to frequency, it is a rather difficult matter to obtain sufficient reactance to act as an effective stop for the very low audio frequencies. As an example, a choke to offer a certain reactance in ohms at twenty-five cycles would require eight times the inductance of a choke offering the same reactance at two hundred cycles. If the low frequencies are to be held back very large coils will be required for audio frequency chokes.

Audio frequency chokes always have an iron core. They are generally formed with layer windings of enameled wire, although single cotton covered is more satisfactory from the standpoint of low distributed capacity. The gauge of wire employed is determined by the maximum current as shown in the preceding table.

COIL, CHOKE

Audio frequency chokes are made with inductances of from twenty-five to five hundred henries. The inductance required depends on the circuit in which the choke is to act. The audio frequency current will divide in inverse proportion between two or more possible paths according to the impedances of the paths, the greater part of the current flowing through the path of less impedance.

If an audio frequency circuit is attached to a choke coil of 200 henries inductance and also to an audio frequency transformer of 100 henries inductance the current will divide approximately in inverse proportion to the inductances, two-thirds passing through the audio frequency transformer and one-third through the choke.

Chokes sold as audio frequency amplifier coupling chokes or impedances make satisfactory coils for this work in any part of a receiver where the current to be carried is not greater than allowed by the wire size used in these coils. Secondary windings of audio frequency transformers may be used as makeshift choke coils with the same limitation as to wire size.

Several points in the design of choke coils for handling low frequencies are taken up in following paragraphs on iron-core choke coils.

Filter Chokes.—Choke coils used in filters of power supply units and in filters for the elimination of power line hum are always of the iron-core type. These chokes are built to have twenty, twenty-five or thirty henries inductance in most cases. The wire used depends on the current the choke must carry without overheating. Suitable wire sizes are given in the preceding table showing the maximum carrying capacity of copper wires.

Iron-Core Chokes.—Iron-core choke coils are often used in circuits carrying both direct current and alternating current. The direct current tends to magnetize the iron with a polarity depending on the direction of current flow around the iron. To prevent saturation of the iron, one or more air gaps are always built into the core. The total air gap must be wide enough to prevent magnetic saturation, which would prevent normal or proper action of the alternating current, yet the gap must not be so wide as to reduce the inductance below the required minimum.

The air gap in the core may be divided into a number of small gaps or may consist of a single large gap. The minimum air gap that is generally found satisfactory may be calculated from the following formula:

$$\text{Air Gap in Inches} = \frac{\text{Number of Turns} \times \text{Current in Amperes} \times 2.2}{\text{Flux Density in Lines per Inch}}$$

The flux density allowed may be anywhere from 10,000 to 30,000 lines. The smaller the core used for a coil of given inductance the greater will be the density.

The cores of choke coils may be either of the shell type or core type of construction. The section of the iron over which the winding is placed may be conveniently made square, using dimensions of from one-half inch up to one inch on a side. The overall size of the core is made to accommodate the winding required for the inductance. Under *Wire, Turns per Inch* is a table which shows the number of turns per square inch of cross section of winding.

COIL, CLOSED FIELD

Following are the approximate inductances obtained when using windings in which the length is equal to one and one-half times the depth of wire between inside and outside diameters and which are wound on one leg of a rectangular core. The air gap is assumed to be of a size determined by the formula given in a preceding paragraph.

With core iron three-quarters of an inch square in cross section; twenty henries will require 7,600 turns, thirty henries will require 9,800 turns, forty henries will require 12,000 turns and fifty henries will require 14,500 turns.

With core iron one inch square in cross section; twenty henries will require 5,750 turns, thirty henries will require 7,500 turns, forty henries will require 9,350 turns and fifty henries will require 11,250 turns.

All of these figures assume the use of enameled wire of gauge sizes between numbers thirty and thirty-four.

Iron-core chokes for prevention of radio frequency currents may be of two and one-half to five millihenries inductance. The core may be straight, formed either of iron wires or of thin flat iron laminations. Radio frequency filter chokes may be called upon to carry large currents when used for the reduction of power line interference. Following are wire sizes to be used:

To carry 0.75 to 1.0 ampere	use number 18 gauge
To carry 1.0 to 1.75 ampere	use number 16 gauge
To carry 2.0 to 3.0 ampere	use number 14 gauge
To carry 3.0 to 5.0 ampere	use number 12 gauge
To carry 5.0 to 8.0 ampere	use number 10 gauge
To carry 8.0 to 15.0 ampere	use number 8 gauge

The inductance of iron core choke coils may be calculated from the following formula:

$$\text{Inductance} = \frac{\text{Core Area} \times (\text{Number of Turns})^2}{\text{Air Gap} \times 40,000,000}$$

This assumes the use of silicon steel transformer core iron, an air gap determined by the preceding formula and a flux density of about 20,000 lines. The inductance is in henries, the core area in square inches of cross section and the air gap in inches. The result is close enough for average construction work.

COIL, CLOSED FIELD TYPE.—A single coil, as at the left in Fig. 1, has a widely distributed magnetic field, while in double or four-part coils the field remains close to the windings.

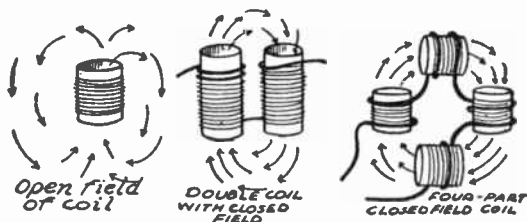

FIG. 1.—Coils with Open Fields and Closed Fields.

COIL, CLOSED FIELD, TOROID

COIL, CLOSED FIELD, TOROID.—The toroid coil of Fig. 1 has an almost completely closed field. There is a slight external field due to the fact that the whole coil acts like a single turn, as in Fig. 2. External radio waves reaching a toroid coil generate equal and opposite voltages in opposite halves of the ring. These voltages cancel.



*TOROID CLOSED
FIELD COIL*
FIG. 1.—Toroid
Type of Coil.

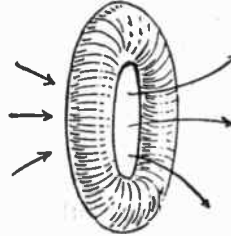

FIG. 2.—Magnetic Field of Toroid
Winding Acting as a Single Turn.

Fig. 4 shows how a toroid coil may be proportioned to obtain the best relation between resistance and inductance. The outside radius is the distance from the center of the ring formed by the coil to the center of the wire forming the outside of the turns. The inside radius is measured from the center of the ring to the center of the wire on the inside. Maximum inductance is obtained

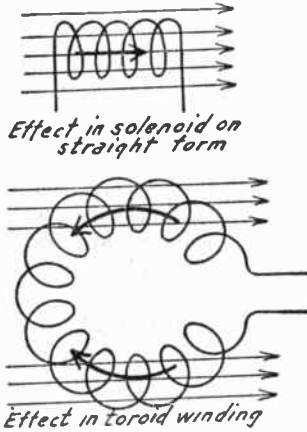
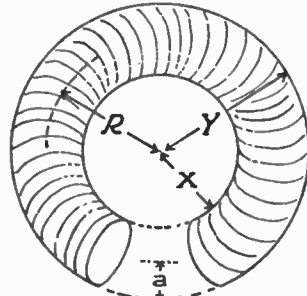

FIG. 3.—Opposing Voltages Set
Up in Toroid Winding.



a = winding radius
X = inside radius $\frac{Y}{X} = 2.6$
y = outside radius
R = mean radius

FIG. 4.—Measurements for Toroid
Coil Inductance Formula.

when the outside radius equals 1.7 times the inside radius, but the highest ratio of inductance to resistance is obtained with an outside radius equal to 2.6 times the inside radius. The diameter of the turns should be small and the number of turns large in order to keep the overall size within reasonable limits.

COIL, DESIGN

ADVANTAGES AND DISADVANTAGES IN COIL DESIGN

	Durability	Most Inductance	Least Resistance	Least Distributed Capacity	Small Field
<i>Type of Winding</i>					
Cylindrical, single layer, close wound.....	Best	Best	Best	Poor	Poor
single layer, space wound.....	Good	Poor	Good	Good	Poor
bank wound.....	Good	Good	Poor	Poor	Poor
honeycomb, duolateral, etc.....	Good	Good	Fair	Good	Good
basket wound.....	Fair	Fair	Good	Best	Fair
Flat, basket wound, diamond.....	Fair	Fair	Fair	Best	Good
flat wound, spiderweb.....	Good	Fair	Poor	Good	Good
<i>Shape of Winding</i>					
Open field type, cylindrical or circular....	Best	Good	Good	Fair	Fair
hexagon, octagon, etc.....	Good	Fair	Good	Fair	Fair
square, oblong, etc.....	Good	Poor	Fair	Fair	Fair
Closed field type, double, toroid, etc.....	Fair	Poor	Fair	Good	Best
<i>Proportion of Winding</i>					
Large diameter, short in length.....	Good	Best	Good	Poor	Fair
Small diameter, long winding.....	Good	Poor	Fair	Good	Fair
Diameter about half of length.....	Good	Good	Best	Fair	Good
<i>Wire Insulation</i>					
Air, bare wire.....	Poor	Fair	Fair	Good	Fair
Cotton, double covered.....	Good	Fair	Fair	Best	Fair
single covered.....	Fair	Good	Fair	Fair	Good
Silk, double covered.....	Good	Good	Good	Fair	Good
single covered.....	Fair	Best	Fair	Poor	Good
Enamel.....	Fair	Good	Fair	Poor	Good
cotton covered.....	Good	Good	Good	Good	Fair
<i>Wire Size</i>					
Small, No. 30 to No. 26.....	Good	Best	Fair	Best	Good
Medium, No. 24 to No. 20.....	Good	Good	Good	Good	Fair
Large, No. 18 to No. 14.....	Best	Fair	Best	Fair	Poor
<i>Material of Winding Form</i>					
Paraffined paper or cardboard.....	Poor	—	Good	Good	—
Fibre and "mud" dielectrics.....	Good	—	Poor	Poor	—
Dry paraffined wood.....	Good	—	Good	Good	—
Hard rubber.....	Fair	—	Best	Good	—
Phenol fibre, bakelite, etc.....	Best	—	Fair	Fair	—
Glass.....	Fair	—	Fair	Fair	—
<i>Design of Winding Form</i>					
Solid or continuous material.....	Best	—	Fair	Fair	—
Skeleton form.....	Good	—	Good	Good	—
No form, self-supporting coil.....	Poor	—	Best	Good	—
<i>Fastenings of Winding</i>					
Wire laced together or in place.....	Fair	—	Good	Good	—
Binder of collodion or coil cement.....	Good	—	Fair	Fair	—
Binder of varnish, glue, etc.....	Good	—	Poor	Poor	—

COIL

COIL, DESIGN.—The table on the adjoining page lists various structural features of air-core inductance coils, and shows which are desirable and undesirable from the standpoint of durability, most inductance, least high-frequency resistance and distributed capacity, and smallest size of field around the coil.

COIL, DISTRIBUTED CAPACITY IN.—The turns of a coil winding, also the leads, consist of conductors separated by insulation or dielectric, and so form capacities as shown by the illustration. Between each pair of adjacent turns there is a difference of potential equal to the total potential across the coil divided by the number of turns. Then there will be a leakage and a power loss due to these potential differences across the small capacities. The loss will increase with frequency.

Even though no condenser is connected to the coil, the combination of distributed capacity and inductance will make the coil itself act as a resonant circuit at some high frequency, and at this frequency there will be a great loss of power for maintaining oscillating currents in the coil. The distributed capacity of a coil acts, in effect, like a fixed capacity in parallel

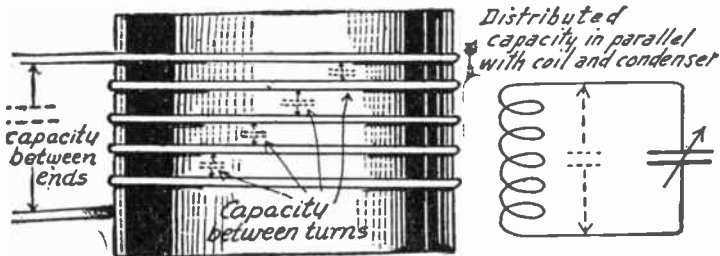

Distributed Capacity and Its Effect in a Coil.

with the capacity of a tuning condenser across the coil. The effect may be serious when the tuning condenser is adjusted for small capacity, for then the distributed capacity added to condenser capacity makes it impossible to have a total capacity small enough for resonance at high frequencies.

Distributed capacity is lessened by the following constructions: Relatively great length of winding in proportion to diameter; small diameter and large number of turns; wire insulation of kinds having low dielectric constant; wire of small diameter; supports or coil form made of material having a low dielectric constant.

COIL, EXPLORING.—A small inductance coil connected to headphones, a sensitive meter, or other indicator which responds to currents induced in the coil when it is moved into magnetic fields. The location, extent, and relative strengths of fields are thus determined.

COIL, INDUCTANCE OF.—The following formula applies to close wound cylindrical coils. Dimensions are in centimeters.

$$\text{Inductance in Microhenries} = \frac{\text{Number of Turns Squared} \times \text{Radius Squared} \times 0.04 \times K}{\text{Length of Winding}}$$

COIL, INDUCTANCE OF

The values for K are given in the following table. The number of turns is the total number in the winding. The radius and the length of winding are both in centimeters. The number 0.04 is an approximation for 0.039478 by which the multiplication may be made instead of by 0.04 if more accurate results are required. The radius is the distance from the center of the winding to the center of one of the wires in any turn.

When the measurements are all in inches the following formula may be used:

$$\text{Inductance in Microhenries} = \frac{\text{Number of Turns Squared} \times \text{Radius Squared} \times K}{10 \times \text{Length of Winding}}$$

Here again the values for K are found from the following table. The radius and the length of winding are in inches.

To find the proper value of the elongation factor, K , in the following table, divide the coil's diameter by its length and find the resulting number in the column headed "Ratio D/L." The value of K for this coil will be found at the right.

VALUES OF ELONGATION FACTOR "K"

Ratio D/L		Ratio D/L		Ratio D/L		Ratio D/L		Ratio D/L	
K		K		K		K		K	
100.0	.0350	14.0	.1605	5.4	.3050	2.9	.4370	0.95	.6995
90.0	.0381	13.0	.1692	5.2	.3122	2.8	.4452	.90	.7110
80.0	.0419	12.0	.1790	5.0	.3198	2.7	.4537	.85	.7228
70.0	.0467	11.0	.1903	4.8	.3279	2.6	.4626	.80	.7351
60.0	.0528	10.0	.2033	4.6	.3364	2.5	.4719	.75	.7478
50.0	.0611	9.5	.2106	4.4	.3455	2.4	.4816	.70	.7609
45.0	.0664	9.0	.2185	4.3	.3502	2.3	.4918	.65	.7745
40.0	.0728	8.5	.2272	4.2	.3551	2.2	.5025	.60	.7885
35.0	.0808	8.0	.2366	4.1	.3602	2.1	.5137	.55	.8033
30.0	.0910	7.5	.2469	4.0	.3654	2.0	.5255	.50	.8181
28.0	.0959	7.4	.2491	3.9	.3708	1.9	.5379	.45	.8337
26.0	.1015	7.2	.2537	3.8	.3764	1.8	.5511	.40	.8499
24.0	.1078	7.0	.2584	3.7	.3822	1.7	.5649	.35	.8666
22.0	.1151	6.8	.2633	3.6	.3882	1.6	.5795	.30	.8838
20.0	.1236	6.6	.2685	3.5	.3944	1.5	.5950	.25	.9018
19.0	.1284	6.4	.2739	3.4	.4008	1.4	.6115	.20	.9201
18.0	.1336	6.2	.2795	3.3	.4075	1.3	.6290	.15	.9391
17.0	.1394	6.0	.2854	3.2	.4145	1.2	.6475	.10	.9588
16.0	.1457	5.8	.2916	3.1	.4217	1.1	.6673	.05	.9791
15.0	.1527	5.6	.2981	3.0	.4292	1.0	.6884	.00	1.0000

In using the first formula for inductance it is convenient to know the number of turns per centimeter of coil length when using the various gauges of wire with their different insulations. The following table gives this information.

COIL, INDUCTANCE OF

WIRE TURNS PER CENTIMETER OF LENGTH

Wire Gauge	Single Cotton	Double Cotton	Single Silk	Double Silk
20	10.4	9.3	11.5	10.9
22	12.4	11.1	14.2	13.3
24	15.1	13.0	17.55	16.2
26	18.0	15.1	21.5	19.5
28	21.2	17.2	26.4	23.4
30	24.7	19.5	31.9	27.7

Effective Inductance.—There is an increase of effective or apparent inductance with increase of frequency at which a coil is used. For example, the apparent inductance of a certain single layer coil is found to be 298 microhenries at 500 kilocycles and 356 microhenries at 1500 kilocycles. This change is detrimental because it

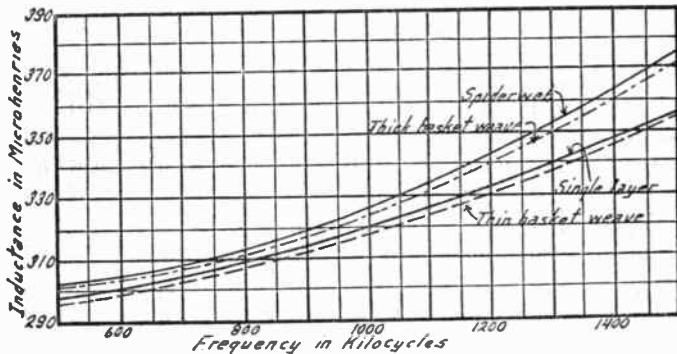

Change of Coil's Effective Inductance with Frequency.

calls for a greater change in the capacity of a variable tuning condenser to overcome the increasing inductance. To tune to higher frequencies either the capacity of the condenser, the inductance of the coil, or both capacity and inductance must be reduced. Inasmuch as the inductance of the coil increases with frequency, the capacity of the condenser must be still further reduced to tune to a given frequency. The change in inductance for several types of coils, all having a nominal inductance of 291 microhenries, is shown in the curves.

COIL

COIL, LOSSES IN.—Energy losses in coils operating at high frequencies are increased by distributed capacity, by increase of effective resistance due to eddy currents and skin effect, by dielectric absorption in the wire insulation and in the coil form or supports, by close proximity to metal parts, and by the use of cements and binders which have poor dielectric properties. Such losses not only waste energy, but they tend to broaden the tuning and to reduce selectivity.

COIL, Q OF.—See *Q-factor*.

COIL, SPACE WOUND.—A coil in which adjacent turns have an air space between them for the purpose of reducing the effects of distributed capacity at high frequencies. The leads to space wound coils should be well separated. A single-layer space winding may be made by running a heavy cord onto the winding form at the same time as the wire, securing the wire and then removing the cord. Coil forms sometimes have grooves like screw threads in which the wire is laid and thus held spaced between turns.

COIL, TUNING, SIZES REQUIRED FOR.—In order that a coil may be tuned to resonance at any frequency throughout a range of frequencies, the variation of capacity in the tuning condenser must be great enough to cover the range indicated in the table under *Resonance, Inductance-capacity Values for*.

The total maximum capacity of the resonant circuit will be more than the maximum capacity of the tuning condenser, because to the condenser capacity will be added the distributed capacity of the coil and of wires and connections in the circuit. Also, the minimum capacity of the circuit will be greater than the minimum of the condenser because of these extra fixed capacities.

Required coil inductance may be found by dividing the L-C value for the lowest frequency by the maximum rated capacity of the condenser, thus finding the inductance for this frequency. Then the L-C value for the highest frequency may be divided by the probable minimum capacity of the condenser to find the inductance for this high frequency. The required inductance usually will be between the two values thus computed, or, at least, this is the inductance with which may be made the first trials in determining whether the frequency range can be covered. If the coil and the circuit have large distributed capacities the required inductance will be somewhat less than the computed value, and since the distributed capacity cannot be adjusted it may be difficult or impossible to tune over the entire range of frequencies which is to be covered.

COLD-CATHODE TUBE.—See *Tube, Cold-cathode*.

COLLODION

COLLODION.—See *Binders*.

COMPASS, RADIO.—A radio compass consists essentially of a receiver mounted in a completely shielded cabinet and equipped with a directional loop as shown in Fig. 1. The receiver is not affected by radio waves or signals except those coming through the

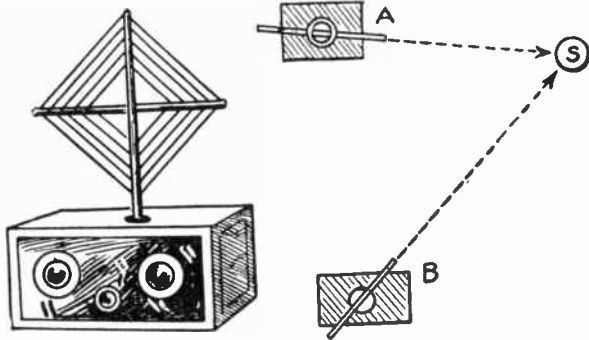

FIG. 1.—Elementary Principle of Radio Compass.

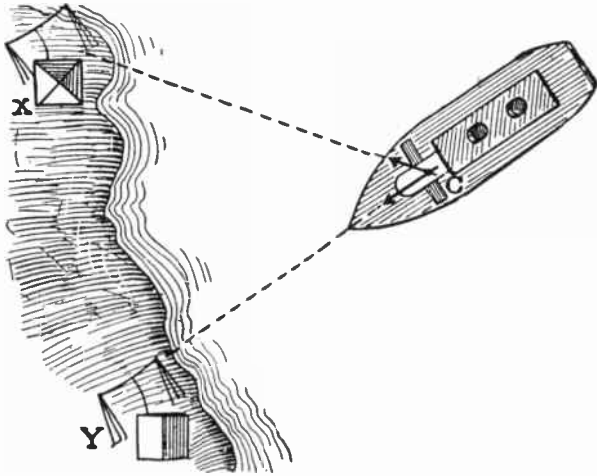

FIG. 2.—Determining Ship's Position with Radio Compass.

loop. By turning the loop it is possible to tell from which direction of the compass a signal is coming.

A transmitting station as at *S* in Fig. 1 may be located as to position with the aid of such a receiver. The receiver is tuned in on the station from two or more positions and the bearing of the loop is noted in each case. At the intersection of the bearings, such as those

CONDENSER

taken from positions *A* and *B* in the illustration, the location of the transmitter may be determined.

For use on shipboard the radio compass is in the form of a large loop carried usually above the pilot house of the ship. Compass signals are transmitted from two or more shore stations. These signals are distinguished from each other as received by the ship. The location of the shore stations is known to the navigators and the ship's position with reference to the shore stations may be determined. Such a position finding method is illustrated in Fig. 2, the ship's radio compass being designated as *C* and the shore stations as *X* and *Y*.

A form of apparatus used for locating transmitting stations uses a portable receiver, and is often called a radio direction finder although its principle is exactly the same as that of the radio compass. See also *Beacon, Radio* and *Goniometer*.

CONDENSER, ACTION OF.—All radio circuits consist principally of capacity, inductance and resistance as shown in Fig. 1. Capacity is the property of two electrical conductors, when separated by insulation or a dielectric, to receive and retain elec-



FIG. 1.—The Elements of a Radio Circuit Containing a Condenser.

tricity. Inductance is the property of conductors by which voltage and current are produced in them by movement of electromagnetic lines of force through the conductors. Resistance is the opposition to flow of electric current in conductors.

Inductance is found principally in the coils. Resistance is found in all conductors. The condenser is a device intended to have ca-

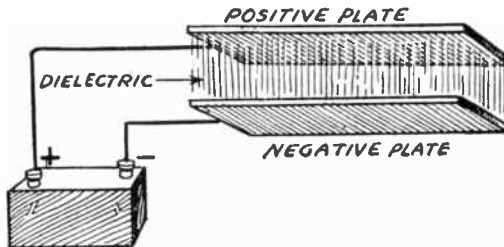

FIG. 2.—The Plates and Dielectric of a Condenser

capacity only. Electricity flows into the conductors or plates of the condenser, forming what is called the condenser's charge, and remains there until released.

A condenser consists of two principal parts, considered from the electrical standpoint. One of these parts is formed by metal plates which receive and hold the charge. The other part is the dielectric

CONDENSER, ACTION OF

or insulation which separates the plates and is between them. The dielectric may be air, mica, paper, glass, oil or any other electrical insulator. The dielectric is whatever is between the plates. This is shown in Fig. 2.

There are two kinds of plates, positive and negative. In construction they are usually similar to each other. A condenser may consist of only two plates, one positive and one negative, or it may consist of many plates as in Fig. 3. Approximately half will be positive and the other half negative. All positive plates are connected with each other and all negatives are connected together. This makes all the positive plates the equivalent of one large plate and makes the negatives the equivalent of a second large plate.

Charge of Condenser.—When a source of electricity or electrical pressure is connected to a condenser with the positive side of the source connected to one set of plates and the negative of the source connected to the other set of plates, the condenser will be charged. That means, the electricity will flow from the positive of the source into the positive plates attached to it. There will be a flow of negative electricity away from the condenser plates connected to the negative of the source. The positive plates are then at a higher electrical pressure than are the negatives.

With one of the plates or sets of plates at a positive voltage or potential and the other at a negative voltage or potential, there is what we call an electrostatic pressure or strain placed on the dielectric between the plates. In this strained condition the dielectric stores electrical energy.

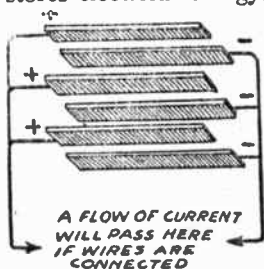

FIG. 3.—A Condenser May Have Many Plates.

The condition is much the same as if a piece of elastic rubber were either compressed or stretched out between pieces of metal. The strain thus put upon the rubber would cause it to store or contain mechanical energy. This energy in the rubber would tend to return the metal pieces to their original positions as soon as the strain was relieved. The electrostatic strain set up in the material of the dielectric does likewise; tends to return the plates to their original condition of no voltage difference as before receiving the charge.

After a condenser absorbs a certain amount of charge with a certain impressed voltage it will take no more and the flow of current ceases. If the source is then disconnected from the condenser plates and nothing else is connected between them the charge will remain on the plates. If a wire or any other electrical conductor is now connected between the plates of the condenser they will discharge and there will be a flow of current from the positive to the negative plates through the conductor.

The capacity, also the amount of charge the condenser holds depends on the four things shown in Fig. 4. First, the higher the voltage used to charge the condenser the more electricity it will hold. Second, the larger the area of the

CONDENSER, ACTION OF

plates and the greater the number of plates, the more electricity will be held. Third, the closer the plates are to each other, that is, the closer together are the positive and negative plates, the greater will be the charge. Fourth, certain kinds of dielectric allow the condenser to hold a greater charge than other kinds. For instance a condenser using mica for a dielectric will take more than twice the charge of a condenser otherwise exactly alike but using paper for a dielectric. The relative value of dielectrics is called their dielectric constant and is indicated by the capital letter "K." See *Constant, Dielectric*. The thickness of the plates has no effect on capacity.

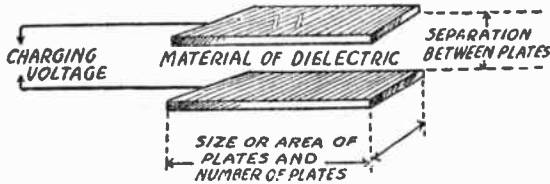

FIG. 4.—The Four Factors Affecting a Condenser's Charge.

The charge of a condenser is measured in the unit of electrical quantity called the coulomb. One coulomb is the amount of electricity that flows through a circuit in one second when the rate of flow is one ampere. The condenser's charge in coulombs is equal to the number of volts applied to the condenser terminals multiplied by the capacity of the condenser in farads. See *Condenser, Capacity of*.

Stray Capacities.—From the explanation of a condenser just given it is easy to realize that any two electrical conductors separated by air or any other dielectric form a condenser. All wires in a radio receiver have capacity to each other, in other words, form an active condenser if they are at different alternating voltages. See *Capacity, Distributed*. A ball of metal as small as one inch in diameter has a measurable capacity to the walls of an ordinary room. A radio set is literally full of all kinds of small stray capacities which cannot be eliminated, although all radio work would be simplified beyond measure were such a thing possible.

In a condenser as actually constructed, in addition to the metal forming the plates, at least a part of the support for the plates is usually of metal. The insulating material between the plates forms the dielectric and does the useful work of the condenser, but other insulation is used for supporting and fastening together the various parts of the condenser and for insulating the positive plates from the negative plates.

Current Flow Through a Condenser.—Certain materials are known to be good insulators. For instance, a wire surrounded by a covering of silk or cotton is considered as being insulated from another nearby wire similarly covered. This is perfectly true of direct currents but not of alternating currents. When a current alternates its effect will pass through a condenser. The alternating current in house lighting systems has a very low frequency, usually only sixty cycles per second and such a low frequency is easily insulated. But in radio work we deal with frequencies running into the millions per second and electric currents at such tremendously high frequencies cannot be fully insulated.

CONDENSER, ACTION OF

If one end of a high frequency electric circuit is connected to one side of a condenser and the other end of the circuit is connected to the other side of the condenser, the condenser plates will absorb the positive voltage peaks during one alternation and will be discharged by the following negative alternation. A large condenser will absorb a large charge during each alternation and under such conditions the rapid charge and discharge of the condenser plates allows the effect of the current to pass right through the condenser.

This action may be understood by reference to Fig. 5 which shows a hydraulic comparison to an electric condenser. This illustration shows a reciprocating water pump whose piston moves up and down.

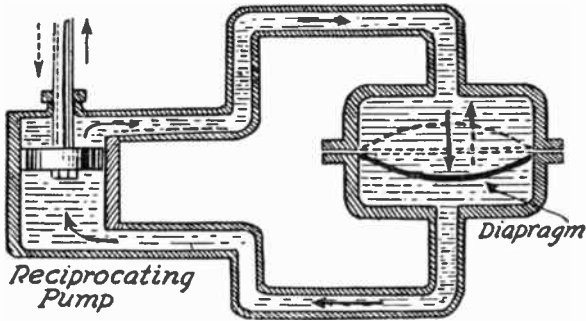

FIG. 5.—Hydraulic Explanation of Condenser Action.

This pump is connected through a circuit of water pipes to both sides of a hollow chamber containing a flexible rubber diaphragm. With movement of the pump piston upward, as shown by the full line arrows, the flow of water through the circuit will be in the direction of the full line arrows and the diaphragm will be stretched downward as shown. Upon the reverse motion of the piston, as shown by broken line arrows, the direction of water flow is reversed and the diaphragm is stretched upward. The motion of the water back and forth in the chamber is apparently carried right through the diaphragm, although no water actually passes through and only the effect is transmitted.

In Fig. 6 is an electric circuit containing an alternating current generator which sends electric current first one way, then the other way; just as the reciprocating water pump sends water first one way, then the other. The plates of the condenser are represented by the top and bottom halves of the chamber in the water circuit of Fig. 5 and the dielectric of the condenser is represented by the diaphragm in the chamber.

In the water circuit the pump places a strain on the diaphragm and the diaphragm then contains energy which would do the work of sending water through the circuit were the pump removed. In the electric circuit the generator places the condenser's dielectric under an electric strain and the energy then stored in the dielectric

CONDENSER

would send a flow of electric current through an external circuit were the generator disconnected.

Condensers always may be thought of as passing alternating current. They are not insulators for alternating current as for direct current. The greater the condenser capacity the more easily the alternating current effect passes through and the smaller the condenser capacity the harder it is for the alternating current to pass through it.

The higher the frequency of the current being handled the more easily it will pass through a condenser of given size or capacity. Also the more easily it will pass from one conductor to another, from one metal part to another when these parts are near each other. The radio frequency currents received by the antenna and carried through the receiver as far as the detector are at extremely high frequencies, consequently pass through condensers or between conductors very easily. The audio frequency currents from the detector to the loud speaker or headphones are at much lower frequency and their escape from one conductor into another is more easily prevented.

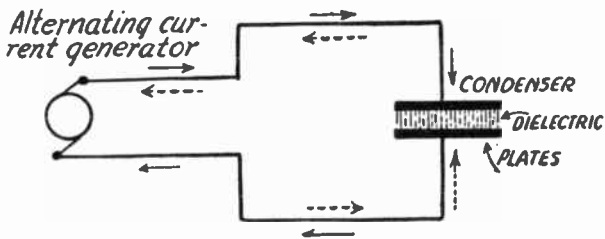

FIG. 6.—Flow of Alternating Current Through a Condenser.

The higher the frequency of the current the smaller need be a condenser that will pass a given amount of current through its circuit. The lower the frequency the larger will be the condenser required to allow the same amount of current to pass through. Direct current will not pass through a condenser at all.

CONDENSER, ANTENNA.—A condenser connected in shunt or parallel with the antenna, by attaching it between the antenna binding post and the ground binding post on the receiver, is called an antenna shunting condenser and will allow the antenna circuit of the receiver to be tuned to higher wavelengths or lower frequencies.

A condenser connected in series with the antenna by attaching it between the antenna lead-in and the antenna binding post of the receiver is called an antenna series condenser and it will allow the antenna circuit to be tuned to lower wavelengths or higher frequencies. These effects may be understood from Figs. 1, 2 and 3.

Fig. 1 shows an antenna and ground with an inductance coil of a receiver connected between them in the ordinary way. Since the antenna and the ground form the two plates of a condenser, this circuit may be represented as at the right hand side of Fig. 1; this being an equivalent circuit.

CONDENSER, ANTENNA

In Fig. 2, at the left, is shown the connection of a parallel or shunting antenna condenser P between the antenna A and the ground G . The equivalent circuit is shown at the right of Fig. 2 where the condenser formed by antenna and ground is represented by the condenser whose plates are marked A and G .

It will be seen that the condenser $A-G$ is in parallel with the condenser P . Two condensers in parallel add their capacities together

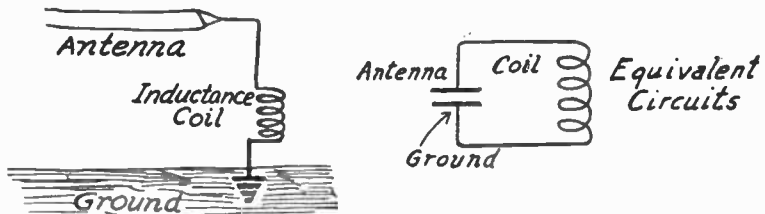

FIG. 1.—The Usual Outdoor Antenna Acts as a Condenser.

and this greater total capacity across the coil will allow resonance or tuning at lower frequencies or higher wavelengths.

In Fig. 3 is shown, at the left, an antenna series condenser S between the antenna and the inductance of the receiver. The equivalent circuit is shown at the right, the condenser with plates A and G representing the capacity of the antenna and ground while the condenser S represents the antenna series condenser. Now it will be seen that the two condensers $A-G$ and S are in series with each

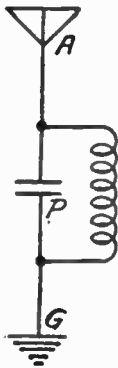

FIG. 2.—Connection of Parallel or Shunting Antenna Condenser.

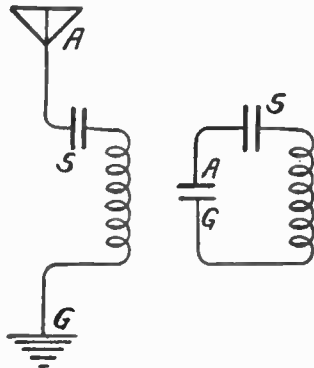

FIG. 3.—Connection of Series Antenna Condenser.

other. Any two condensers in series have a combined capacity less than the capacity of either one alone, therefore this lessened capacity used with the coil allows resonance or tuning at higher frequencies or lower wavelengths.

A receiver which cannot be tuned to the higher wavelengths may be helped by placing a small additional condenser (usually smaller than .00025 micro-

CONDENSER, BALANCING

farad capacity) from antenna terminal to ground terminal as in Fig. 2. A receiver which cannot be tuned to the lower wavelengths may have a fairly large condenser (.0001 to .0005 microfarad capacity) connected between the antenna lead-in and the antenna terminal of the set as in Fig. 3. It should be borne in mind that this expedient will help only the first tuned circuit in the receiver, the one coupled to or connected with the antenna. It will not help the other tuned circuits of a receiver using several tuned radio frequency stages. See also *Antenna, Tuning of*.

A single condenser, either variable or fixed, may be so connected that it can be placed first in series and then in parallel with the antenna. Such connections are shown under *Jacks and Switches, Uses of*, and under *Switch, Series-Parallel*.

CONDENSER, BALANCING.—A condenser used to balance the feedback effect of the capacity between the grid and plate of a tube is called a balancing condenser. A condenser used for this work is sometimes called a neutralizing condenser because it is used to neutralize the effect of the grid to plate capacity in the tube. See *Balancing*.

CONDENSER, BLOCKING.—See *Condenser, Stopping*.

CONDENSER, BYPASS.—A bypass condenser is a condenser which allows alternating or high frequency currents to pass around or away from parts through which the current should not flow. These parts may be of high impedance to such currents or they might produce coupling effects due to resistance or impedance.

In any radio receiver there are, among others, two circuits which it is especially desired to keep complete in themselves and separate from all other circuits. These two are the plate circuit and the grid circuit of each tube. These circuits are described under *Circuit, Grid* and *Circuit, Plate*.

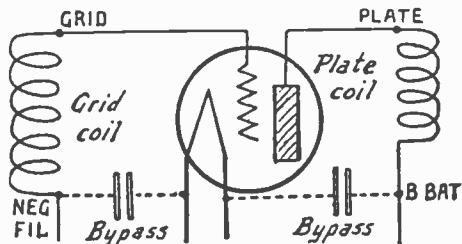

FIG. 1.—Grid Circuit and Plate Circuit Bypass Condensers.

Fig. 1 shows a vacuum tube with its plate circuit and its grid circuit completed through a plate bypass and a grid bypass condenser respectively. The complete grid circuit without the bypass condenser would pass not only through the grid coil, but also through a C-battery, rheostats, an A-battery and other parts. If any of these parts are also used in the circuits of other tubes as well as in the circuit of the tube being considered, then there will be the possibility of undesirable feedbacks and couplings which tend to produce distortion and to prevent the proper control of oscillation and regeneration. By the insertion of a grid bypass condenser as shown the grid circuit is completed directly from the return end of the grid coil to the filament of the tube so that the high frequency voltages affecting the grid find a complete circuit through the coil and the bypass without going through any of the other parts just mentioned. The chance of couplings and feedbacks is thus reduced to a minimum or eliminated.

CONDENSER, BYPASS

The plate circuit without the bypass condenser would be completed through the B-battery or other source of plate voltage back to the filament and this battery or voltage source would undoubtedly be used for other tubes as well as for the one considered. But here again, by connecting a condenser between the return end of the plate coil and the tube's filament, the plate circuit is completed for the high frequency currents without their having to pass through any other parts than those shown.

The grid bypass is connected from the negative filament terminal of the tube (usually marked —) to the grid return of the same tube, which may be a terminal of any coupling unit such as a radio frequency transformer, an antenna coupler, an audio frequency transformer, a choke, a resistance or whatever unit is used in the receiver. The plate bypass is connected from either the negative or positive filament terminal of the tube to the plate return of the same tube, which is the B-battery terminal of any of the coupling units just mentioned. This does away with the need of separate bypass condensers for batteries, rheostats, potentiometers, etc., since both plate and grid circuits have thus been completed independently.

Of the two bypasses, grid and plate, the plate condenser is of greater usefulness provided both kinds are not used. A plate bypass will greatly improve the quality of reception from any receiver. These bypasses as described should

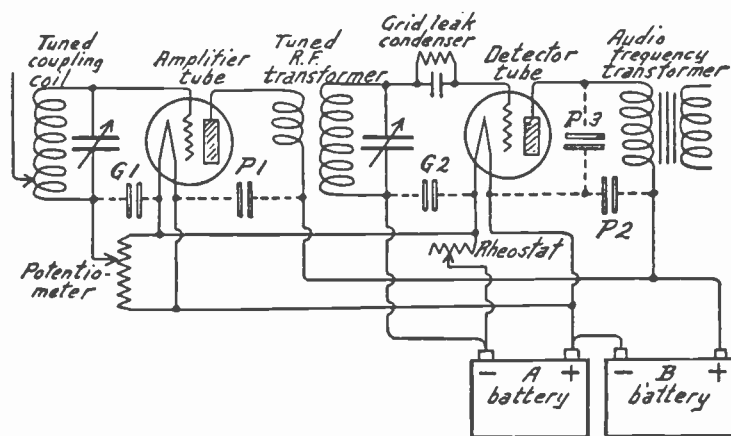

FIG. 2.—Bypass Condensers in a Receiver.

be used on all amplifier tubes, both radio frequency and audio frequency types, but the connection for the detector tube is slightly different as shown in Fig. 2.

Fig. 2 shows many of the parts and circuits of a complete receiver up to the detector tube and shows the proper use of grid and plate bypasses for each tube. For the first amplifier tube the grid bypass condenser is marked *G-1*. Without this bypass the grid return would be through the potentiometer whose high resistance in the grid circuit would broaden the tuning and reduce the volume. The plate bypass for this first tube is marked *P-1*. Without it the plate return would be through the B-battery to the tube filament.

The grid bypass for the detector tube is marked *G-2* and without it the detector grid return would be through the rheostat which is bypassed by condenser *G-2*.

Two bypasses are connected to the plate of the detector tube in Fig. 2. One of these, *P-2*, is the regular plate bypass already explained. It is connected from the B-battery terminal of the audio frequency transformer to

CONDENSER

the tube's filament terminal. The bypass marked *P-3* is for the purpose of bypassing the radio frequency currents around the high impedance of the audio frequency transformer with its iron core. Without this condenser there would be such great impedance to the radio frequency currents attempting to pass through the transformer winding that amplification and volume would be reduced to a fraction of their proper value. Bypass condenser *P-3* allows the radio frequency currents from the plate of the detector tube to return directly to the cathode of this tube, while the lower frequency audio currents pass through the winding of the transformer.

Sizes or Capacities of Bypass Condensers.—In the circuits of radio frequency amplifying tubes, grid bypasses may be of any capacity from .0005 microfarad up. Plate bypasses for these tubes may be from .001 microfarad up to any size available.

In the circuits of audio frequency amplifying tubes the grid bypasses should be of at least one-half microfarad capacity. The plate bypasses should be of at least one microfarad capacity. Any capacities greater than those mentioned may be used for either radio frequency or audio circuits and for either grid or plate returns.

The radio frequency bypass connected between the plate of the detector tube and this tube's filament must be large enough to bypass the radio frequency, but not so large as to freely bypass the audio frequency currents. At this point, indicated by *P-3* in Fig. 2, the condenser should not be smaller than .001 microfarad and not larger than .005 microfarad capacity. The best value for any particular receiver may be found by experimenting with different capacities until the greatest volume and best quality are secured.

All resistors which are a part of the rectified direct-current supply in a receiver or other unit should be bypassed when otherwise it would be necessary for radio-frequency or audio-frequency currents to flow through these units in completing the plate, grid, or cathode circuits. This precaution applies to all voltage divider resistors. Without adequate bypassing there will be undesirable feedbacks through resistance coupling.

CONDENSER, CAPACITY OF.—The capacity of a condenser is a measure of its ability to receive and hold an electric charge. The capacity is the relation between the charge that will be taken by a condenser and the voltage that is applied to give the charge.

The capacity depends on four things, (1) the surface area or size of the plates, (2) the number of plates in the condenser, (3) the separation of the plates or the thickness of the dielectric between them, and (4) the kind of dielectric or the nature of the material between the plates.

Capacity is increased by larger plates, by more plates, and by bringing the plates closer together. Capacity is decreased by using smaller plates, fewer of them, and by separating them more from one another. The capacity is also affected by the nature of the

CONDENSER, CAPACITY OF

dielectric. See *Constant, Dielectric*. The capacity is measured in microfarads, micro-microfarads, or centimeters of capacity. See *Capacity, Units of*.

The capacity in micro-microfarads of a multiple plate condenser with air for dielectric, such a condenser as used for tuning purposes, may be calculated from the formula:

$$\text{Capacity in Micro-microfarads} = \frac{0.225 \times \text{Area of One Side of One Plate} \times \left(\frac{\text{Total Number of Plates}}{\text{of Plates}} - 1 \right)}{\text{Separation between Plates}}$$

The area of one side of one plate is in square inches.

The thickness of the dielectric or separation of the plates is in inches.

The capacity of condensers using other dielectrics than air; such as mica condensers and paper condensers, may be found by multiplying the value given from the above formula by the number representing the dielectric constant of the material between the plates. The formula then becomes:

$$\text{Capacity in Micro-microfarads} = \text{Capacity with Air Dielectric} \times \text{Dielectric Constant}$$

in which all of the values are the same as in the first formula but with the addition of the dielectric constant *K*. Values of *K* are given in the table under the heading *Constant, Dielectric*.

As an example, take a variable air condenser of 14 plates, each plate having an area on one of its sides of 2.6 square inches and with a separation of 0.3 inches between plates. Using the first formula and substituting the values:

$$\text{Capacity} = \frac{0.225 \times 2.6 \times (14-1)}{0.3}$$

Solving this equation gives the capacity as 253.3 micro-microfarads. The condenser is undoubtedly intended to have a nominal capacity of 250 micro-microfarads or .00025 microfarads, one of the common sizes.

Were the dielectric of mica with a dielectric constant (*K*) of 6, in place of air, but with all other values and dimensions remaining the same, this condenser would have a capacity six times as great, 1519.8 micro-microfarads or approximately .0015 microfarad.

To find the capacity in micro-microfarads of a two-plate condenser such as a paper condenser the following formula is used:

$$\text{Capacity in Micro-microfarads} = \frac{0.225 \times \text{Area of One Side of One Plate} \times \text{Dielectric Constant}}{\text{Thickness of Dielectric}}$$

The area of one side of one of the two plates is measured in square inches. The dielectric constant is the constant of the material used between the plates. The thickness of the dielectric is measured in inches.

Condensers in Parallel.—Condensers connected in parallel add their capacities together thus:

$$\text{Total Capacity} = C^1 + C^2 + C^3, \text{ etc. for all so connected.}$$

Taking four condensers in parallel with capacities of .001, .0005, .0005 and .0002; they would be added:

CONDENSER, CAPACITY OF

.001
 .0005
 .0005
 .0002

making a total of .0022 microfarad in all.

Condensers in Series.—To obtain the value of a number of condensers connected in series it is necessary to add together the reciprocals of the capacities of the separate condensers which gives the reciprocal of the total capacity. The reciprocal of a number is 1 divided by the number.

$$\frac{1}{\text{Total Capacity}} = \frac{1}{C_1} + \frac{1}{C_2} + \frac{1}{C_3} + \frac{1}{C_4}, \text{ etc., for all so connected}$$

As an example, take the four condensers just considered as in parallel and connect them in series, using the capacities in micro-microfarads as 1000, 500, 500, and 200: these corresponding respectively to the values in microfarads of .001, .0005, .0005, .0002. The reciprocals then are:

$$\frac{1}{1000} + \frac{1}{500} + \frac{1}{500} + \frac{1}{200} = \frac{1}{C}$$

Adding these fractions gives the result as 10/1000 which is equal to 1/C. Then 1000/10 is equal to C/1, and C/1 is equal to C itself and the total capacity must be 100 micro-microfarads for the four condensers connected in series.

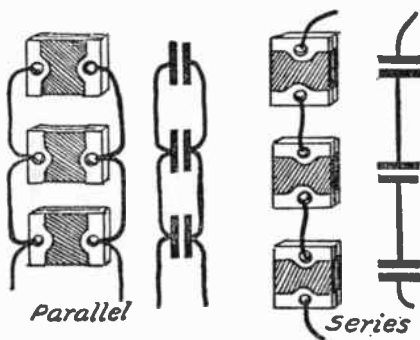

Condensers in Parallel and in Series.

The capacity of any two condensers in series is equal to the product of the two capacities divided by their sum. For example, with 0.2 and 0.05 mfd. the product is 0.010 and the sum is 0.250. Dividing the product by the sum gives 0.040 mfd. as the combined capacity. Similarly, 8 and 2 mfds. have a product of 16, a sum of 10, and 16/10 or 1.6 mfd. for their combined capacity.

CONDENSER, DESIGN

CONDENSER, DESIGN AND CONSTRUCTION OF.—

The principal parts of a typical single-unit tuning condenser are shown by Fig. 1. The condenser is supported from the chassis or a panel by its end plate or by a metal framework or enclosure attached to the end plate. The adjustable rotor plates are electrically connected to the end plates and shaft, while the stationary

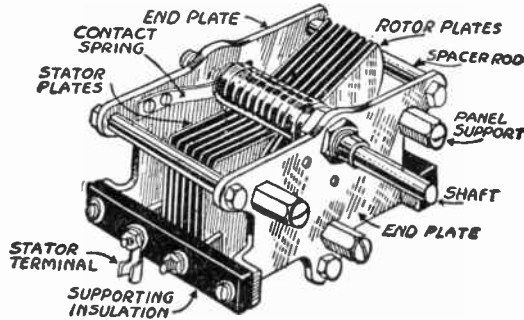

FIG. 1.—The Parts Considered in Design of a Typical Variable Condenser.

stator plates are supported on insulation attached to the end plates or framework. The plates usually are made of thin brass or aluminum, welded, brazed, soldered, or securely clamped to their supports.

The electrostatic field between the condenser plates is represented by arrows in Fig. 2. If supporting insulation is very close to the edges of the plates, part of the field which extends beyond

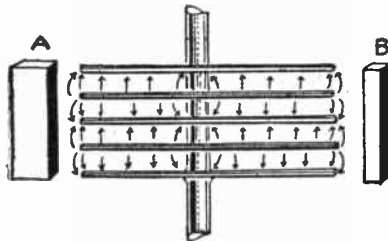

FIG. 2.—The Electrostatic Field Affecting Design of a Condenser.

the edges may be short-circuited through the insulation. Insulation of low dielectric constant has some advantages in this respect, especially when the body of the insulation has its greatest length parallel to the field lines. With the design of Fig. 3 the supporting insulation is somewhat farther from the electrostatic field than with the arrangement of Fig. 1. However, it would be difficult

CONDENSER, DESIGN

to note any appreciable difference of performance in actual practice.

As indicated by Fig. 4, the stator plates ordinarily are connected to the more sensitive side of the tuned circuit. When the tuned circuit is connected to the control grid of a tube it is the grid side of the circuit that is the more sensitive. When the tuned

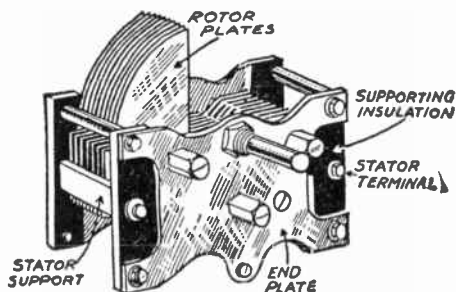

FIG. 3.—Terminal Positions Considered in Condenser Design.

circuit has a ground return the rotor plates are connected to the grounded side. The adjusting shaft, which is most closely approached by the hand of an operator, thus is maintained at ground potential.

Fig. 5 shows three basic shapes of rotor plates which may be used in tuning condensers. With the semi-circular plate at the upper left the effective capacity varies directly and proportionately

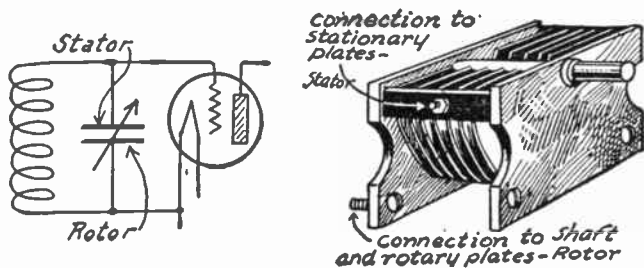

FIG. 4.—Connections to Rotor and Stator of Condenser.

to the degrees of dial rotation or plate rotation. When the plate shape is modified as shown at the upper right the capacity will change at a rate that causes variations of tuned wavelength to be proportional to the degrees of dial rotation. With the plate form shown at the bottom of Fig. 5 the change of capacity is such that variations of tuned frequency are proportional to degrees of dial rotation.

CONDENSER, DESIGN

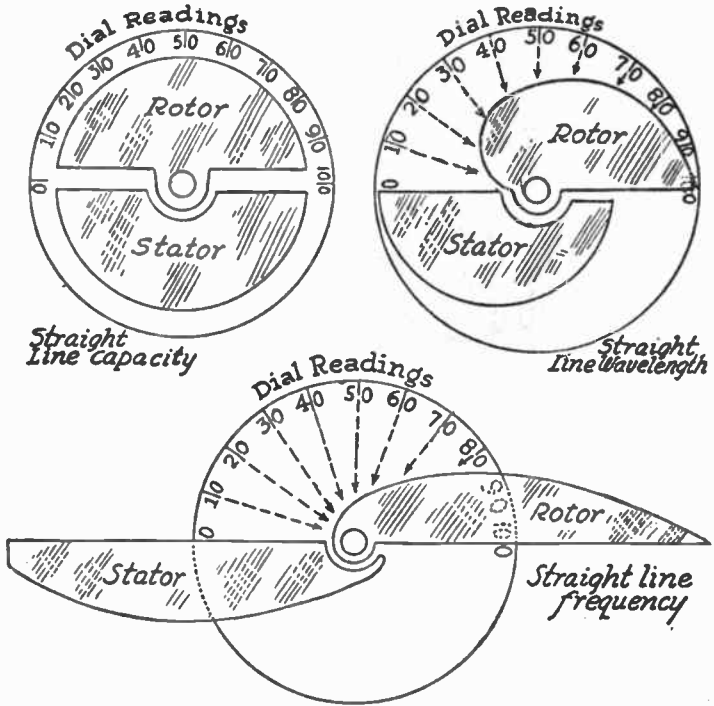

FIG. 5.—Basic Forms of Condenser Rotor Plates.

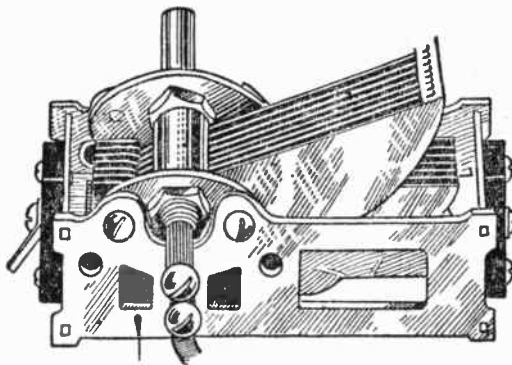

FIG. 6.—Modified Straight Line Frequency Condenser.

CONDENSER, DESIGN

The straight line capacity condensers are used in many testing and measurement instruments where capacity is to be uniformly varied, and were used in the earliest radio receivers. The straight line wavelength form is suitable for wavemeters, and was used in receivers during the period when station allocations were according to wavelength. The straight line frequency type came into

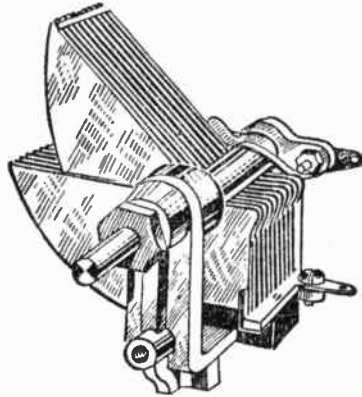

FIG. 7.—Increasing the Number of Plates Allows Decreasing the Width and Height of the Condenser.

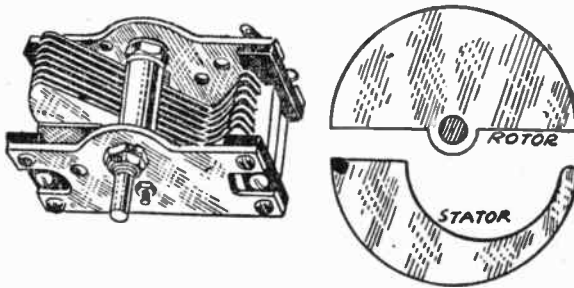

FIG. 8.—Stator Plates Shaped for Straight Line Tuning with Semicircular Rotor Plates.

use when allocations were changed to certain frequencies. The straight line frequency shape of Fig. 5 is too bulky for general use, so practical condensers have the uniform frequency spacing over only a portion of the entire rotation, usually at the lower frequency range. Figs. 6, 7 and 8 illustrate some of the modified plate forms that permit easy tuning with a reasonably compact design.

CONDENSER, ELECTROLYTIC

CONDENSER, ELECTROLYTIC.—In an electrolytic condenser there is a thin aluminum foil acting as one plate or electrode, a liquid electrolyte acting as the other plate or electrode, and on the aluminum a thin film of oxide acting as the dielectric. In wet electrolytic condensers the liquid electrolyte is sealed within a tight can of metal. In the so-called dry types the liquid is carried in layers of absorbent paper and cellulose gauze which are in contact with the dielectric film.

On one surface of the aluminum foil in a dry electrolytic condenser the dielectric film is formed by application of a potential difference during manufacture. The thickness of the film increases with applied potential. The thicker the film, the less is the capacity per unit of surface area. A film only 0.0000004 inch thick, as formed at around 30 volts, provides a capacity of about 0.13 microfarad per square inch of area. At ten times this potential the film becomes enough thicker to allow only about one-tenth as much capacity. The maximum working voltage of the condenser is only slightly higher than the voltage of formation. The increase of film thick-

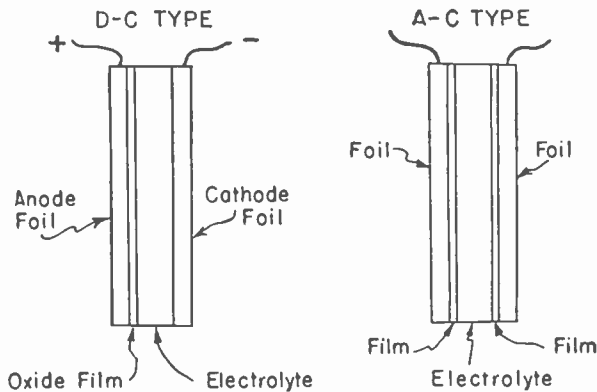

Elements Used in Electrolytic Condensers.

ness required for high working voltage means that high-voltage condensers are considerably larger than low-voltage units of equal capacity.

In contact with the dielectric film is the electrolyte-carrying absorbent material. On the opposite side of this material is a second aluminum foil which is not oxidized and which acts merely to provide electrical connection to the electrolyte in the absorbent material. A condenser such as described has high resistance to flow of current from the dielectric film to the electrolyte, but low resistance to flow in the opposite direction. Consequently, the unit may be used only with direct or pulsating potentials, and only with the positive side of the external circuit connected to the oxidized foil and the negative connected to the plain foil. The leads, terminals, or cases of these condensers are plainly marked or colored to indicate correct polarity of connections. Direct-current condensers of this kind may be called polarized electrolytic condensers.

In a wet electrolytic condenser the anode or positive electrode is inserted in a metallic can which contains the liquid electrolyte, and is insulated from and supported in the can by liquid-tight gaskets or grommets. The can itself forms the negative terminal or electrode for the external circuit.

CONDENSER, ELECTROLYTIC

To permit the use of electrolytic condensers on alternating-current circuits, where equal potentials act in both directions, there must be two dielectric films. Two separate d-c units may have their negative terminals connected together and their positive terminals connected to the a-c circuit. Single units for a-c service are made with two dielectric films on the facing surfaces of two aluminum foils, and with a common electrolyte carried in absorbent material between them. Such a type may be called non-polarized. Two units connected back-to-back have a combined capacity equal to only half that of a d-c type of equal size.

The dielectric films and electrolyte have only moderately high resistance to flow of current, even in the correct direction. Consequently, there is some flow of current in this direction whenever a potential difference is applied. This leakage current may normally exceed one-half milliamper. Potentials above the rated working voltages cause excessive leakage current, and when this current flows in the resistance of the condenser the resulting heating causes quick breakdown. Wet electrolytic condensers have higher resistance and less leakage than dry types. The capacity of electrolytic condensers drops quite rapidly as their temperature falls below 70° F., although it increases but little at higher temperatures. Capacity increases slightly, and leakage current shows a decrease, during the first few thousand hours of use.

Radio types of electrolytic condensers have capacities of from one to 50 microfarads in the units generally available. Rated working potentials for direct current run from 20 to as much as 500 volts. Maximum permissible peak or surge (instantaneous) voltages are 20 to 50 per cent higher than the d-c working voltages. These condensers are in general use for filter systems of d-c power supplies as well as for bypassing.

CONDENSER, FIXED.—A condenser whose capacity cannot be varied or adjusted. Fixed condensers of small capacity may have dielectrics of paper or mica. High-voltage types of medium capacity usually have paper dielectric. Large capacity medium voltage condensers usually are of the electrolytic type.

CONDENSER, LOSSES IN.—Energy losses in condensers are due chiefly to skin effect, eddy currents, surface and volume leakages, and dielectric absorption. There may be additional loss due to high ohmic resistance in defective connections and in loose or corroded joints.

Loss of energy due to skin effect and eddy currents increases with operating frequency. The loss due to dielectric absorption is similar to that caused in a conductor by heating, which represents a loss of the energy changed into heat. The energy losses in a tuning condenser increase in importance and effect as the condenser is used at lower capacities. It is undesirable to use tuning condensers whose plates must be turned almost completely out of mesh in order to reach high frequencies. Leakage losses occur principally by flow of current across the surfaces of insulation which is damp or coated with thin films of any foreign matter.

When a condenser having high dielectric absorption is used at high frequencies the condenser cannot be completely charged and discharged within the time between alternations, and the result is a reduction of effective capacity and a failure to return all of the charging energy to the circuit during discharge. Losses which act to oppose free flow of charging current

CONDENSER

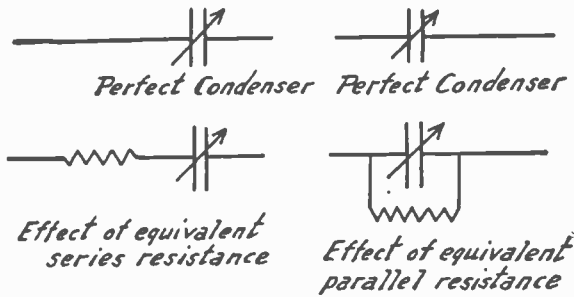

Equivalent Resistances in Condensers.

into and out of a condenser have the same effect as a resistance connected in series with the condenser, which is called the equivalent series resistance. Losses which permit current to flow through the condenser rather than acting only to build up a charge have the same effect as a resistance in parallel.

CONDENSER, TUNING.—A condenser whose capacity is adjusted so that it, in combination with the inductance of a coil, becomes resonant at a frequency to which the circuit is said to be tuned. With the condenser adjusted to its maximum capacity the tuning will be at the lowest frequency, and with minimum capacity the tuning will be at the highest frequency to which the

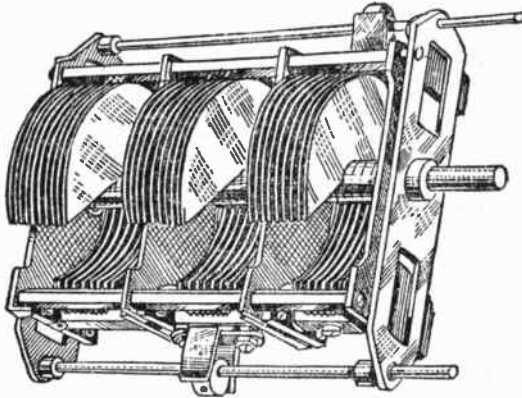

A Ganged Condenser for Tuning Three Circuits.

circuit may be made resonant. Because of distributed capacity in the coil and circuit conductors, a capacity which cannot be varied, the condenser usually requires a capacity range of at least ten to one to tune throughout a frequency range of three to one. The tuned inductance should be small enough so that the condenser need not be adjusted to its minimum capacity for the highest frequencies. See *Resonance, Inductance-Capacity Values* for.

CONDENSITE

CONDENSITE.—See *Phenol Compounds*.

CONDUCTANCE.—The ability of a conductor to carry an electric current is called conductance. It is measured in mhos and is the reciprocal of resistance.

CONDUCTANCE, MUTUAL, OF TUBE.—See *Tube, Mutual Conductance of*.

CONDUCTIVE COUPLING.—See *Coupling, Conductive*.

CONDUCTIVITY.—The conductance measured in mhos through a centimeter cube of a conductor is called the conductivity or specific conductance of that conductor. Conductivity is a measure of the current carrying ability of a certain size of conductor.

CONDUCTOR.—Any path through which an electric current may flow with comparatively little resistance is called a conductor. The best conductors are of metal. All wires used in radio work are conductors.

CONE SPEAKER.—See *Speaker, Loud*.

CONFINED FIELD.—See *Field, Stray and Confined*.

CONICAL HORN.—A horn which increases its diameter at a constant rate.

CONSERVATION OF ENERGY.—A principle stating that energy can neither be created nor destroyed but can only be changed from one form into another. Some of the energy may change to forms no longer useful.

CONSOLE.—An ornamental cabinet for a radio receiver or other device, the cabinet standing on legs.

CONSONANCE.—Either electrical or acoustical resonance occurring between bodies or circuits which are not connected directly with each other. See *Resonance*.

CONSTANT.—Any quantity which expresses a fixed value, condition or property.

CONSTANT CURRENT GENERATOR.—A generator which maintains an unchanging current output when there are changes in the connected load.

CONSTANT CURRENT MODULATION.—See *Modulation*.

CONSTANT, DIELECTRIC.—The capacity of a condenser depends upon the kind of dielectric used between the plates. If a certain condenser with air as the dielectric has a capacity of ten microfarads, substituting mica in place of the air for a dielectric will increase the capacity of the condenser. If the capacity is now measured and found to be sixty microfarads the capacity has been increased six times by using the mica in place of air as the dielectric. The dielectric constant of this mica is then said to be six.

The dielectric constant of any material is the number of times its use as a dielectric will increase the capacity over the use of air as a dielectric in the same condenser. Another name for dielectric constant is specific inductive capacity. A table of the values of dielectric constants of different materials follows.

CONSTANT, OSCILLATION

The dielectric constant of any material is a measure of its ability or power to carry the effect of electric charges through it between the plates. This term should not be confused with "dielectric strength" which refers to the strength of the material as an insulator, that is, its resistance to voltage.

The variations between low and high limits of the dielectric constants are due to the differences between grades and qualities of the materials. The constant depends to a great extent on how nearly free from moisture the material is made, since the presence of water will raise the constant materially. The values also depend on whether measurements are made with direct or alternating voltages and if alternating voltages are used the dielectric constant will change with change of frequency.

DIELECTRIC CONSTANTS			
Dielectric Material	Constant	Dielectric Material	Constant
Air (taken as standard)	1.0	Oil, neatsfoot	3.0 to 3.2
A reduction of pressure below that of the atmosphere lowers the constant		olive	3.0 to 3.3
Alcohol	15.0	petroleum	2.0 to 2.2
Bakelite, C	4.0 to 8.5	sperm	3.0 to 3.2
dielectro	5.0 to 7.5	transformer	2.4 to 2.7
micarta	4.5 to 6.0	turpentine	2.1 to 2.3
Beeswax	3.0 to 3.2	Paper, insulating, untreated	1.6 to 2.5
Celluloid	4.0 to 6.0	oiled or waxed	2.0 to 3.2
Ceresin Wax	2.5	cardboard, press-board	3.0
Collodion	3.7 to 4.0	blotting, porous	5.0
Cloth, oiled or varnished	3.0 to 5.0	Paraffine wax	2.0 to 2.5
Ebonite (see <i>Rubber, hard</i>)		Phenol composition, moulded	5.0 to 7.5
Fibre, uncolored	5.5	Porcelain	4.0 to 6.0
black	7.5	Quartz	4.5 to 5.0
red	5.0 to 8.0	Resin	2.5
Film, photographic	6.8	Rubber, gum	2.3
Gelatine	4.0 to 6.0	soft vulcanized	2.0 to 3.0
Glass, window	7.5 to 8.0	hard	2.0 to 3.5
plate	3.0 to 7.0	Shellac	3.0 to 3.6
heat resisting	5.0 to 6.0	Silk	4.6
Gutta percha	3.0 to 5.0	Slate, electrical	6.0 to 7.0
Isolantite	3.6	Sulphur	2.5 to 4.0
Marble	9.5 to 11.5	Varnish	4.5 to 5.5
Mica, sheet	3.0 to 6.0	Vaseline	2.0
built up	5.0 to 6.0	Water, distilled	81.0
Oil, castor	4.5 to 4.8	Wood: bass, cypress, fir	2.0 to 3.0
cottonseed	3.0 to 3.3	maple	2.5 to 4.5
		oak	3.0 to 6.0

CONSTANT, OSCILLATION.—The square root of the product of inductance and capacity which together are resonant at a frequency is the oscillation constant for that frequency. The oscillation constant for a frequency in kilocycles is equal approximately to 25,320 divided by the square of the number of kilocycles. For example, with a frequency of 200 kilocycles the square of 200, which is 40,000, is divided into 25,320, which gives the oscillation constant as 0.633 at this frequency.

If the oscillation constant for a certain frequency is divided by some number of microhenrys of inductance the result will be the microfarads of capacity which, with the chosen inductance, will be resonant at that fre-

CONSTANT, TIME

quency. Dividing by microfarads of capacity will give the microhenrys of inductance with which the capacity will resonate at that frequency. See also *Resonance, Inductance-capacity Values for*.

CONSTANT, TIME.—The time constant of a circuit containing only capacity and resistance in series is the number of seconds required for the capacity to receive 0.632 of its full charge at the applied voltage after this voltage has been applied to the circuit, and is also the time in seconds required for the capacity to lose 0.632 of its charge when discharged through the resistance.

The time constant of a circuit containing only inductance and resistance in series is the number of seconds required for current in the inductance to rise to 0.632 of its final value after application of voltage to the circuit, and is also the time in seconds required for the current to decrease to 0.368 of its maximum value after the inductance and resistance are short circuited.

The time constant in seconds for a capacity-resistance combination is equal to the number of microfarads of capacity multiplied by the number of megohms of resistance. The time constant in seconds for an inductance-resistance combination is equal to the inductance in henrys divided by the resistance in ohms.

The accompanying table shows condenser voltages during charge and discharge, also inductor currents during rise and fall of current, for various lengths of time. Times are given as numbers of time constants. One time constant, in seconds, is equal to microfarads times megohms for capacity-resistance, or is equal to henrys divided by ohms for inductance-resistance. The first step is to compute the time constant for the circuit considered. Then the actual length of time for which values are to be determined is divided by the time constants. The result is the number of time constants, which is found in the first column of the table.

The second column lists, opposite each number of time constants, the fraction of maximum condenser voltage which will have been reached during the charging of a condenser, or the fraction of maximum current which will have been reached with an inductor and resistor connected to a current source. That is, the second column shows the rates of increase of condenser voltage or inductor current. The third column lists the fraction of maximum voltage remaining on a condenser, or the fraction of maximum current still flowing in an inductor, at the various times in time constants after the condenser has commenced to discharge through the resistor, or after the inductor and resistor (in series) have been short circuited.

As an example, assume 0.01 microfarad capacity and 0.5 megohm resistance, a maximum voltage of 200, and a time of 0.008 second. The time constant (0.01×0.5) is 0.005 second. Dividing the actual time by the time constant ($0.008 \div 0.005$) gives 1.6 as the number of time constants. The voltage during increase is shown by the table to be 0.798 of maximum, and 0.798×200 gives 159.6 volts on the condenser at the end of 0.008 second after charging commences. During decrease, or discharge, the fraction is shown as 0.202, and 0.202×200 gives 40.4 volts as the condenser potential remaining at the end of 0.008 second after discharge commences.

For another example assume 20 henrys inductance and 5,000 ohms in series, maximum current of 0.4 ampere, and a time of 0.008 second. The time constant ($20 \div 5000$) is 0.004 second. Dividing the actual time by this time constant ($0.008 \div 0.004$) gives 2.0 as the number of time constants. The current during increase is shown by the table to be 0.865 of maximum, and 0.865×0.4 gives 0.346 ampere as the current at the end of 0.008 second

CONSTANT, TIME

after applying voltage. The current during decrease is shown as 0.135 of maximum, and 0.135×0.4 gives 0.054 ampere as the current at the end of 0.008 second after short circuiting.

CHANGES OF CONDENSER VOLTAGE AND INDUCTOR CURRENT WITH TIME

Number of Time Constants	Fraction of Maximum Condenser Voltage or Inductor Current		Number of Time Constants	Fraction of Maximum Condenser Voltage or Inductor Current	
	During Increase	During Decrease		During Increase	During Decrease
0.00	0.000	1.000	0.85	.573	0.427
.02	.020	.980	0.90	.593	.407
.04	.039	.961	0.95	.613	.387
.06	.058	.942	1.00	.632	.368
.08	.077	.923	1.05	.650	.350
.10	.095	.905	1.10	.667	.333
.12	.113	.887	1.20	.699	.301
.14	.131	.869	1.30	.727	.373
.16	.148	.852	1.4	.753	.247
.18	.165	.835	1.5	.777	.223
.20	.181	.819	1.6	.798	.202
.22	.197	.803	1.7	.817	.183
.25	.221	.779	1.8	.835	.165
.30	.259	.741	1.9	.850	.150
.35	.295	.705	2.0	.865	.135
.40	.330	.670	2.2	.889	.111
.45	.362	.638	2.4	.909	.0907
.50	.393	.607	2.6	.926	.0743
.55	.423	.577	2.8	.939	.0608
.60	.451	.549	3.0	.950	.0498
.65	.478	.522	3.5	.970	.0302
.70	.503	.497	4.0	.982	.0183
.75	.528	.472	5.0	.993	.0067
.80	.551	.449	6.0	.998	.0025

CONTACT RECTIFIER.—See *Rectifier, Contact*.

COPPER.—The resistance of annealed copper wire is 10.371 ohms per circular mil-foot at 68° F. Calculations usually are made with an assumed value of 10.4 ohms. Hard drawn copper wire has a resistance of 10.65 ohms per circular mil-foot. Standard resistances of annealed copper wire of all gages are given under *Wire, Copper*. The oxide coating that forms on the surface of copper exposed to air is of rather high resistance, so should be removed when making connections. The temperature coefficient of resistivity is 0.00218 per degree F. at 68° F. The specific weight of copper is 0.32 pound per cubic inch. Weights of sheets are given under *Shielding*. Copper melts at 1980° F.

COPPER OXIDE RECTIFIER.—See *Rectifier, Contact*.

CORE.—The central portion of an inductance coil in which is the greatest concentration of magnetic field is the core.

CORE

If the core of the coil contains sheets or laminations of steel or iron it is called an iron-core coil. If there is no iron in the core, even though insulation be present, the coil is an air-core type. Finely divided iron is used in the cores of some intermediate-frequency coils, which are said to have a dust core.

COULOMB.—A unit of quantity of electricity or of electric charge. A charge equal to that of 6,280,000,000,000,000 electrons. A rate of flow of one ampere is a rate of one coulomb per second.

COUNTER ELECTROMOTIVE FORCE.—See *Inductance, Self*.

COUNTERPOISE.—A counterpoise is a network of wires or other conductors carried underneath an antenna and used in place of a ground in the antenna circuit of a receiver. Considering the antenna system as a condenser, the antenna itself forms the upper plate and the counterpoise forms the lower plate with air as the dielectric between them. The counterpoise is connected to the ground terminal of the receiver. A counterpoise and its connections are shown in the illustration.

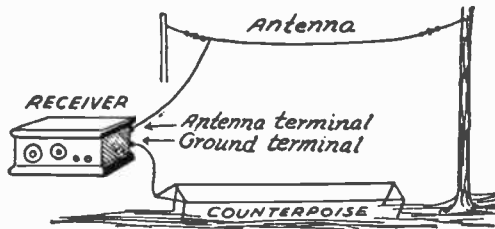

Use of Counterpoise in Place of Ground.

A counterpoise in shape and size should practically duplicate the antenna. It is still better if the space covered by the counterpoise is larger than that covered by the antenna. The counterpoise should be supported a foot or more above the ground and well insulated. If the receiver is in an upper floor of a tall building or if the earth is very dry a counterpoise may work better than a ground. A counterpoise must be protected with a grounded lightning arrester just as an antenna would be protected.

A counterpoise may be built out of doors or it may be placed under a floor, in a cellar or anywhere else underneath the antenna. The construction may be carried out according to the rules given for antenna construction. The counterpoise may be close to the ground or it may be ten feet or more above ground and work equally well.

COUNTERSINK.—See *Tools*.

COUPLER.—Any arrangement of inductance coils, condensers or resistances so placed with reference to each other that there is electromagnetic or electrostatic coupling between their circuits is called a coupler. See *Coupling*.

COUPLER, FIXED TYPE.—A fixed coupler consists of two windings, primary and secondary, which have a fixed relation or a

COUPLING

fixed coupling with each other. After such a coupler is constructed the primary and secondary cannot be moved with reference to each other. In the common type shown the secondary winding is on one end of a tubular form with the primary on the other end of the same form and separated from the secondary by a small space, generally of one-eighth to one-half an inch. The greater the separation the less the coupling. If the coupler is used for interstage coupling between tubes the outer end of the primary is connected to the plate of the preceding tube and the inner end is connected to the B-battery. In either case the inner end of the secondary is connected to the filament circuit and forms the grid return while the outer end of the secondary is connected to the grid of the following tube. See also *Transformer, Tuned Radio Frequency*.

COUPLER, LOOSE.—Any coupler that provides what is known as loose coupling is called a loose coupler. See *Coupling, Loose*.

COUPLING.—When any two circuits are arranged so that energy from one circuit passes into the other circuit the two are said to be coupled. Coupling is obtained whenever parts of a magnetic field or electrostatic field of one circuit pass through the field of the other circuit. Coupling is obtained when the two circuits have resistance, capacities or inductances in common with each other. See also *Radio, Principles of*.

COUPLING, ANTENNA.—See *Antenna, Coupling of*.

COUPLING, BACK.—See *Feedback*.

COUPLING, CAPACITIVE.—Capacitive coupling is coupling obtained by means of a condenser or an electrostatic field which is common to two circuits. This common capacity is called the mutual capacity. In the capacitive coupling illustrated the capacity C is mutual or common to circuit A and to circuit B .

COUPLING, CLOSE.—Any degree of coupling whose coefficient of coupling is greater than 0.5 is called close coupling. The closer the coupling, that is, the greater the coefficient of coupling, the more energy will be transferred from one circuit to the other. See *Coupling, Coefficient of*.

COUPLING, COEFFICIENT OF.—The coefficient of coupling between two circuits is a measure of the amount or degree of coupling between them. It is a measure of the ease with which energy may be transferred from one circuit to the other.

The coefficient of coupling is the ratio of the mutual inductance, capacity or resistance of both circuits to the square root of a number obtained by multiplying together the separate inductances, capacities or resistances of the two circuits. The coupling coefficient is represented by the letter K . The value of the coupling coefficient when two circuits are coupled by inductive coupling is represented by the formula on the following page.

COUPLING, COEFFICIENT OF

$$\text{Coefficient of Coupling} = \frac{\text{Mutual Inductance or Coupling Inductance}}{\text{Square Root of } \left(\text{Inductance of One Circuit} \times \text{Inductance of Other Circuit} \right)}$$

All inductances are in microhenries, all in millihenries or all in henries; the same unit being used for all three values.

If the mutual inductance is not known, the coefficient of coupling may be calculated from the diameters and lengths of the two coils when their axes coincide and when the centers of their lengths are together as at the left in the illustration. The formula for this value of coupling coefficient follows:

$$\text{Coefficient of Coupling} = \frac{\left(\text{Diameter of Smaller Coil} \right)^2 \times \left(\text{Length of Winding on Smaller Coil} \right)^2}{\left(\text{Diameter of Larger Coil} \right)^2 \times \left(\text{Length of Winding on Larger Coil} \right)^2}$$

If the axes of the coils are inclined to make an angle with each other but remain in the same plane as at the right in the illustration, the value of the coupling coefficient K is proportional to the cosine of the angle of inclination.

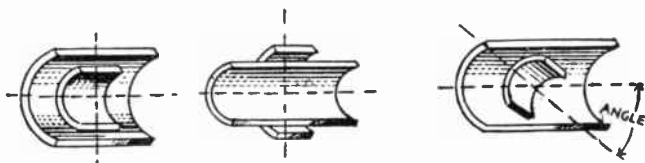

Effect of Coil Position on Coupling Coefficient.

The following table gives the proportional values of K for various angles of inclination. To find the actual value of coupling, multiply the value of K as found from the above formula by the decimal fraction given opposite the angle of inclination.

COUPLING WITH ANGLE OF INCLINATION

Angle Degrees	Decimal	Angle Degrees	Decimal	Angle Degrees	Decimal	Angle Degrees	Decimal
0	1.000	22½	.924	45	.707	67½	.383
2½	.999	25	.906	47½	.676	70	.342
5	.996	27½	.887	50	.643	72½	.301
7½	.991	30	.866	52½	.609	75	.259
10	.985	32½	.843	55	.574	77½	.216
12½	.976	35	.819	57½	.537	80	.174
15	.966	37½	.793	60	.500	82½	.131
17½	.954	40	.766	62½	.462	85	.087
20	.940	42½	.737	65	.423	87½	.044

If the two coils are moved bodily apart while their axes are kept in line the coefficient of coupling depends on the separation between the coils, becoming less as the separation is increased. The separation is measured be-

COUPLING, DIRECT

tween the ends of the windings which are toward each other, not from the center of one winding to the center of the other.

The following table shows the change in coupling when the coils are moved apart. The coupling with a separation of one inch is taken as 100. The two coils are assumed to be exactly alike in every respect.

CHANGE IN MUTUAL INDUCTANCE WITH SEPARATION OF TWO COILS

Separation in Inches	Per Cent Inductance	Separation in Inches	Per Cent Inductance	Separation in Inches	Per Cent Inductance
1.0	100.0	3.5	36.2	6.0	10.6
1.5	91.1	4.0	28.5	6.5	8.1
2.0	78.7	4.5	22.1	7.0	6.4
2.5	65.1	5.0	17.4	7.5	5.1
3.0	47.6	5.5	13.6	8.0	4.3

See also *Coupling, Optimum.*

COUPLING, CONDENSER TYPE.—See *Coupling, Capacitive.*

COUPLING, CONDUCTIVE.—Conductive coupling, which is also called direct coupling, is obtained through an inductance which is common to two circuits. This type of coupling is equivalent in

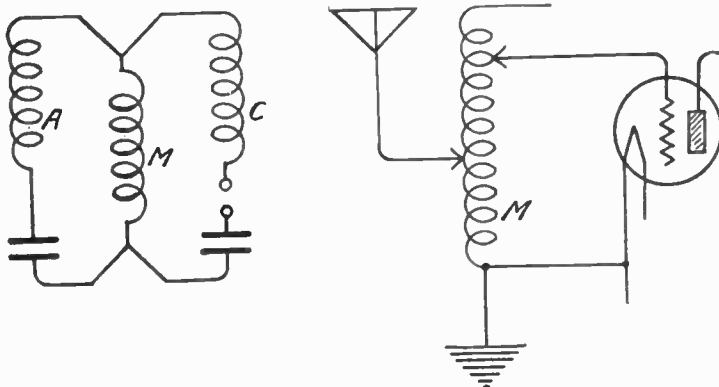

Conductive or Direct Coupling.

its effect to inductive coupling. One form of direct coupling as used in radio receivers is shown at the right of the drawing. An auto-transformer makes use of direct or conductive coupling.

COUPLING, DIRECT.—See *Coupling, Conductive.*

COUPLING, EFFECT ON RESONANCE.—When two tuned circuits are very closely coupled to each other it is found that resonance is obtained with two different adjustments of the tuning condenser or the tuning inductance. With the closest possible coupling the two points of resonance or the two resonance peaks are some distance apart.

COUPLING, ELECTROSTATIC

Close Coupling

Loose Coupling

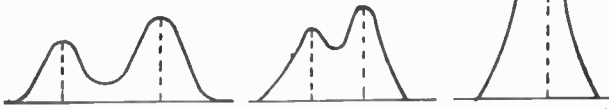

Effect of Coupling on Resonance.

As the coupling is made looser the two peaks keep coming closer and closer together until, with very loose coupling, they practically merge and form a single resonance peak of greater height or amplitude than either of the others alone. This explains the broadness of tuning when using very close coupling in radio frequency circuits.

COUPLING, ELECTROSTATIC.—See *Coupling, Capacitive*.

COUPLING, IMPEDANCE.—Impedance coupling is obtained through an impedance Z which is common to the two circuits A and B . The principle of impedance coupling as used in radio am-

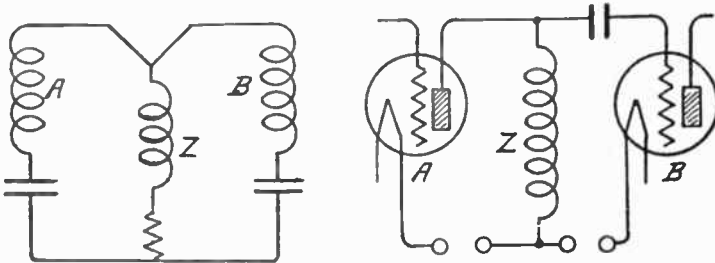

Impedance Coupling.

plifying circuits is shown at the right hand side of the drawing. See also *Amplifier, Audio Frequency, Impedance Coupled*.

COUPLING, INDUCTIVE.—Inductive coupling is obtained through parts of two magnetic fields which are common to two

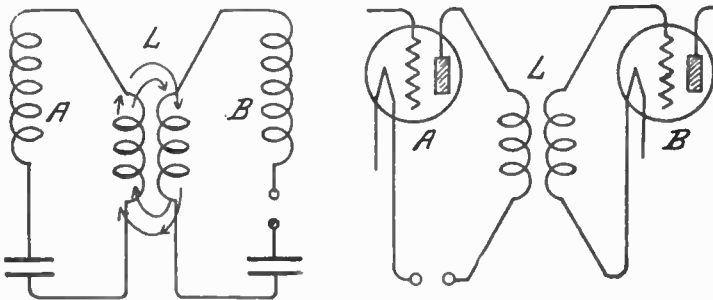

Inductive Coupling.

COUPLING, INTERSTAGE

circuits as in the drawing where the two inductance coils L have parts of the field of each passing through the field of the other. These two coupling coils are said to have mutual inductance and through this mutual inductance, coupling is obtained between circuits A and B. Inductive coupling as found in the commonly used transformer coupling of radio circuits is shown at the right hand side of the drawing.

COUPLING, INTERSTAGE.—Any form of coupling by means of which one stage of amplification is coupled to the following stage of amplification so that energy may pass from one stage to the next is called interstage coupling. The interstage coupling is obtained through a transformer, a resistance, an impedance or a reactance placed between the amplifying tubes in two stages.

COUPLING, LOOSE.—Any degree of coupling whose coefficient of coupling is 0.5 or less is generally called loose coupling. The looser the coupling the less energy is transferred from one circuit to the other and the less will be the effect of the inductance, the capacity or the resistance in one circuit on the other circuit. See *Coupling, Coefficient of*.

COUPLING, MAGNETIC.—See *Coupling, Inductive*.

COUPLING, OPTIMUM.—The optimum coupling between two circuits is that coupling with which there is the greatest transfer of energy from one circuit into the other. The optimum coupling is neither the closest nor the loosest coupling which may be used.

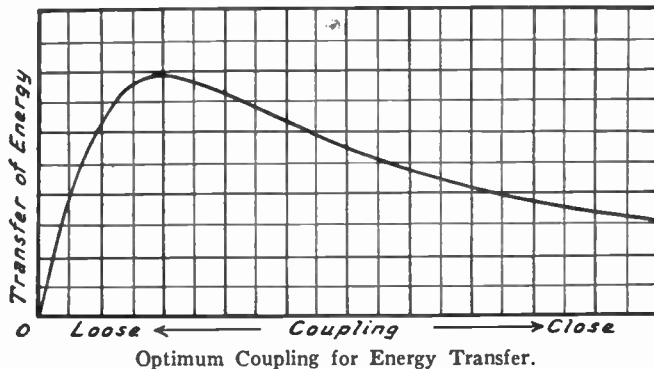

With circuits containing high resistance the optimum coupling may be a rather close coupling, a coupling whose coefficient is rather high. As the circuit resistance is reduced the greatest power transfer is secured with looser and looser coupling. This effect is shown in the curve which illustrates the rise in energy transferred as the coefficient of coupling is increased. It is seen that with zero coupling there is no energy transfer, that the transfer increases quite rapidly with increase of coupling up to the optimum point, then decreases gradually.

Optimum coupling and maximum possible transfer of energy are obtained when the values of frequency, mutual inductance and resistance satisfy the equation on the following page.

COUPLING, RESISTANCE

$$\left(\begin{array}{c} \text{Mutual Inductance} \\ \text{of Circuits} \end{array} \right)^2 \times \left(\begin{array}{c} \text{Frequency in} \\ \text{Kilocycles} \end{array} \times 6280 \right)^2 =$$

$$\left(\begin{array}{c} \text{Total Resistance} \\ \text{of One Circuit} \end{array} \right) \times \left(\begin{array}{c} \text{Total Resistance} \\ \text{of Other Circuit} \end{array} \right)$$

The resistances are the high frequency resistances measured at the frequency used in the first part of the equation. See *Resistance, High Frequency*.

COUPLING, RESISTANCE.—Resistance coupling is obtained by a resistance which is common to two circuits. In the drawing the common resistance R provides a coupling between cir-

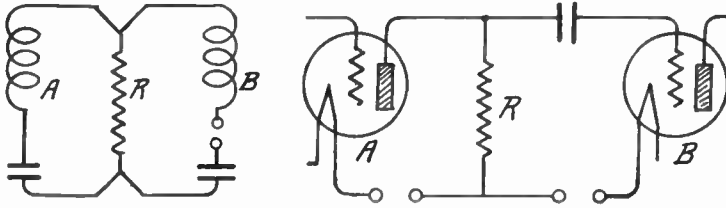

Resistance Coupling.

cuits A and B . The principle of resistance coupling as used in radio amplifying circuits is shown at the right hand side of the drawing. See also *Amplifier, Audio Frequency, Resistance Coupled*.

COUPLING, SELECTIVITY AFFECTED BY.—See *Selectivity*.

COUPLING, TIGHT.—See *Coupling, Close*.

COUPLING, TRANSFORMER.—Coupling from one stage of amplification to the following stage which is obtained through the mutual inductance of the two windings in a transformer is called transformer coupling. This is the most common type of interstage coupling. Tuned transformers are used for coupling in radio frequency circuits and untuned iron-core transformers are used for coupling between audio frequency circuits. See *Transformer*.

COUPLING TUBE.—A tube used between the antenna and first tuned circuit of a receiver.

CROSS MODULATION.—Rectification occurring in an amplifying tube which is so negatively biased as to cause operation on the lower bend of the plate-current, grid-voltage curve. The average plate current changes at the frequency of modulation of any strong signal so that this signal is applied to following stages, is finally detected and heard from the loud speaker along with a weaker signal which is amplified in the usual manner. Both signals are audible in the output.

CROSS TALK.—An effect due to magnetic or electrostatic induction between nearby conductors; signals in one conductor being reproduced also in the other one.

CRYSTAL DETECTOR.—See *Detector, Crystal*.

CRYSTAL, FREQUENCY CONTROL BY

CRYSTAL, FREQUENCY CONTROL BY.—A small plate of the mineral quartz may be used under certain conditions to control the operating frequency of a vacuum tube oscillator and connected circuits so that this frequency varies by less than one part in 100,000 from a desired value. Crystalline forms of quartz, rochelle salts and tourmalin exhibit the piezo-electric effect which makes possible this means of frequency control, but quartz is the substance universally used in practical applications.

Plates made from crystals having piezo-electric properties will develop electrostatic charges between opposite faces when the plates are compressed or twisted, and if placed between electrostatic charges of opposite polarity these plates are changed in dimensions. For any given plate this effect takes place most energetically at a certain definite frequency, the frequency depending upon the physical measurements of the plate and on the manner in which it is cut from the original crystal.

Quartz is a very elastic material. If a plate made from this mineral is subjected to pressure on opposite faces it becomes thinner and expands sidewise. Upon release of the pressure the quartz plate reacts by returning not only to its original dimensions, but by becoming thicker and shorter than before. The action then continues, with the plate becoming alternately thicker and thinner, or undergoing mechanical vibration at its natural frequency.

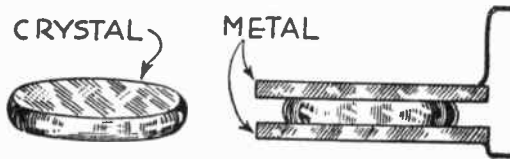

FIG. 1.—The Quartz Plate.

If such a piece of crystal is placed between two metal plates as in Fig. 1 and a potential difference is applied to the plates, the crystal is between two electric charges of opposite polarity. The crystal becomes thinner, wider and longer. Removal of the exciting voltage allows the crystal to commence vibrating and electric charges will be developed which reverse in polarity at the frequency of the crystal's vibration.

Characteristics of Quartz Plates.—Quartz plates are cut from a mother crystal of the form shown at the right in Fig. 2, the center line of which is called the Z-axis or the optical axis. A line drawn between diametrically opposite corners of the crystal and perpendicular to the Z-axis, is called an X-axis or an electric axis. A line drawn between opposite faces, perpendicular to the faces and to the Z-axis, is called a Y-axis or mechanical axis. A quartz plate cut from the crystal so that an X-axis is perpendicular to the face of the plate is said to be X-cut, face perpendicular cut, zero-angle cut or Curie cut, all these names meaning the same thing. If the plate is cut in such manner that its face is perpendicular to a Y-axis it is said to be Y-cut, face-parallel cut or thirty-degree cut.

The rate of vibration of a quartz plate, often called a piezo-electric res-

CRYSTAL, FREQUENCY CONTROL BY

onator, is specified according to the corresponding wavelength in meters divided by the dimension in millimeters along which vibration takes place, this wave constant being given as so many meters per millimeter. With an X-cut plate the wave constant is lower than with a Y-cut plate.

The thinner the resonator plate the higher is its frequency of vibration and the shorter the corresponding wavelength. Thus the frequency is inversely proportional to the thickness and the wavelength directly proportional to the thickness of the plate. Because of their different wave constants the X-cut plate for a given frequency is thicker than the Y-cut plate for the same frequency.

The accuracy with which these plates must be ground is indicated by the fact that a difference of 0.001 inch in thickness makes a frequency change of about 45,000 cycles in an X-cut plate and of about 30,000 cycles with the Y-cut plate. Opposite faces of the plate are made flat and parallel within one or two ten-thousands of an inch in most cases, although much greater differences will still allow vibration in some crystals.

The prepared resonators are supported in holders usually consisting of brass or copper plates having smooth, flat surfaces which rest against the resonator. A light spring pressure is applied to one side of the holder so

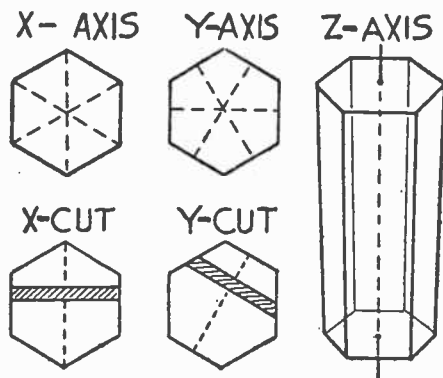

FIG. 2.—Methods of Cutting Quartz Plates.

that good contact with the resonator is insured. The holders are designed to maintain constant pressure and to keep the crystal resonator and the contact surfaces in the same relative positions at all times. A change of pressure will cause a change in the vibration frequency.

Circuits for Frequency Control.—As used for frequency control in a transmitter the crystal generally is placed in a circuit of the type shown in Fig. 3. The crystal resonator is connected between the control grid and cathode of the oscillator tube. The crystal is a dielectric, so in order to allow suitable grid bias there must be a direct current connection through the resistor and choke coil from grid to cathode. The plate circuit of this oscillator tube is tunable and is loosely coupled to the grid circuit of the amplifier tube in which the operating frequency is to be controlled.

The plate circuit load of the oscillator tube is inductive, so that energy losses in the crystal resonator are supplied by tube feedback. As the plate circuit is tuned toward the crystal's natural frequency, oscillation will commence and will be maintained until the tuned frequency of the plate

CRYSTAL, FREQUENCY CONTROL BY

circuit is very near the crystal's frequency. When the two frequencies come very close together the crystal will absorb so much power that oscillation will cease. Therefore the plate circuit is not tuned to the exact frequency of the resonator crystal but is kept at a point which allows continued vibration of the resonator. The grid circuit of the tube is then being supplied with oscillating currents at the vibration frequency of the resonator and the entire oscillator circuit operates at that frequency or very close to it.

The crystal resonator cannot be considered as the sole factor in determining the oscillator frequency. The entire circuit with all its capacities and inductances must be taken into account and consideration also must be given to the conditions under which the resonator plate is used. The tube voltages should be held constant, although slight changes in plate or filament potentials will make negligible changes in the operating frequency. Replacement of the oscillator tube with another of the same type will result in a slight change of frequency, and changing the type of tube will make a greater change in frequency. Vibration or jarring of the circuit elements will cause variation of frequency, and this trouble should be guarded against in mounting the parts. The crystal controlled tube should be operated at a low power level. It usually is coupled to a following amplifier tube which is operated with grid bias sufficiently negative to allow no current in its grid circuit, this together with a loose coupling

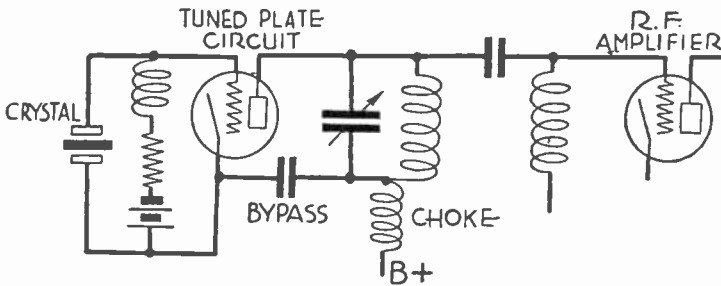

Fig. 3.—Circuit of Crystal Controlled Oscillator.

preventing loading of the plate circuit of the crystal controlled tube. Changes in tuning of the plate circuit will cause a considerable change in operating frequency.

Temperature Control.—The greatest variation in frequency is caused by changes in the temperature of the crystal itself and elaborate precautions are used to maintain a fixed and constant operating temperature. With X-cut plates an increase of temperature lowers the frequency while with Y-cut plates the temperature increase raises the frequency. Changes of temperature have a greater effect on the frequency of a Y-cut plate than on that of an X-cut plate.

The quartz plate or plates of which the temperature is to be controlled are placed within a small closed chamber fitted with a thermometer for temperature observation, and with a heating element and a thermostat which controls the heating element according to the amount of added heat which is required.

A typical temperature control box as illustrated in Fig. 4 contains an inner chamber about four inches square and three and one-half inches deep

CRYSTAL, FREQUENCY CONTROL BY

with its walls made of aluminum, a metal which evenly distributes heat. Surrounding the aluminum is a layer of asbestos. Then comes another enclosure of aluminum and this is covered with balsa wood for further heat insulation. The whole is placed within a walnut case.

The operating temperature is chosen well above ordinary room temperature so that control always may be had by adding heat. Were the operating temperature too low it might be necessary to cool the unit were it used in very warm climates. A temperature of 50 degrees centigrade (about 122 degrees Fahrenheit) has been adopted in many installations. Temperature control boxes will hold the plate within one-tenth degree centigrade of this value when the external temperature varies anywhere between 50 and 70 degrees Fahrenheit.

Oscillator Frequencies.—Some form of adjustment often is provided as a means of compensating for changes caused by variations in the elements of which the oscillator is composed. A commonly used adjustment is that of change in the air gap in the holder for the quartz plate, a change in spacing altering the capacitance of the holder. Frequency adjustment sometimes is made by

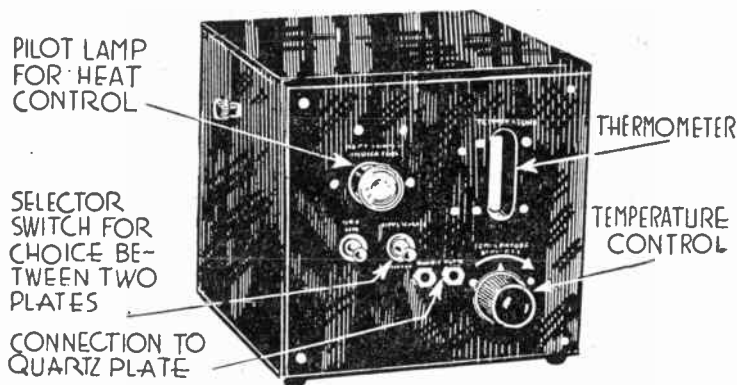

FIG. 4.—Temperature Control Box for Quartz Plates.

changing the temperature at which the resonator plate operates, such a change being made possible by the design of some temperature control devices. In order to bring the oscillator frequency to the exact value required there may be provided a small variable condenser connected across the terminals leading to the resonator plate.

Commercial quartz plates are available for frequencies between 15 and 4000 kilocycles, or wavelengths from 20,000 to 75 meters. Plates for higher frequencies or shorter wavelengths are extremely thin and are difficult to handle. When it is necessary to control frequencies higher than this value it is customary to employ frequency multipliers or harmonic amplifiers.

If the quartz plate is used in the grid circuit of an oscillator having its plate circuit tuned with a relatively large inductance and small capacity, and if this oscillator is operated with a high exciting voltage and highly

CRYSTAL RECEIVER

negative grid bias there will be generated in the plate circuit an extensive range of harmonic frequencies of which the resonator frequency is the fundamental. The fundamental frequency may be filtered out and the second or a higher harmonic amplified. Thus it becomes possible to use, for example, a 500-kilocycle quartz plate to control harmonic frequencies of 1000 kilocycles or even higher multiples of the crystal frequency. By the use of two or more frequency multipliers in cascade the original frequency may be multiplied to any required value.

The resonator plate itself will generate harmonics of its fundamental frequency and in many installations the crystal harmonics are used without employing a frequency multiplying circuit. It should be noted that the use of harmonics, however generated, will multiply any error in the fundamental frequency by the number of the harmonic employed. For example, the use of the fourth harmonic, with a crystal error of one-tenth per cent in frequency from its rating, results in a final error of four-tenths per cent.

CRYSTAL RECEIVER.—A receiver using a crystal detector.

CUPROUS OXIDE PHOTOCELL.—A type of photovoltaic cell employing a cathode of cuprous oxide and an inert anode immersed in the electrolyte carried by a sealed glass jar. See *Cell, Photovoltaic*.

CURIE CUT.—A method of cutting a quartz plate from a mother crystal. See *Crystal, Frequency Control*.

CURRENT.—The flow of electricity through a circuit is called the electric current and is measured in amperes. The current through a circuit is increased when the voltage is increased. It is decreased when the resistance is increased, other things remaining the same.

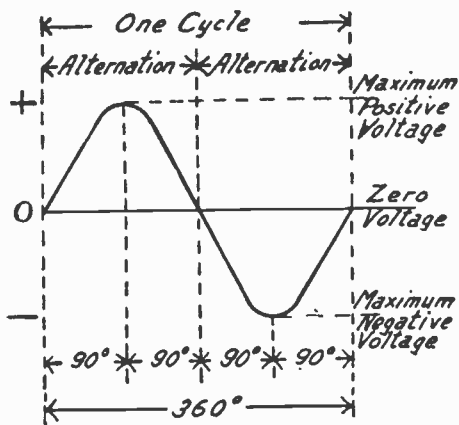

One Cycle of Alternating Current.

CURRENT, ALTERNATING.—In an alternating current the voltage rises from zero to its maximum value, whatever that may be, then falls back to zero and goes on below zero on the negative side just as far as it rose on the positive side. It then comes back

CURRENT, CALCULATION OF

to zero. This rise to positive and fall to negative which starts from zero and ends at zero is called one cycle. This is shown by the diagram.

The rise from zero to maximum positive voltage and the return to zero is one alternation. The drop below zero to the negative voltage peak and the return to zero is another alternation, therefore there are two alternations in one cycle.

One cycle is divided into 360 electrical degrees just as any circle may be divided into 360 degrees. Since one alternation is a half cycle it is 180 degrees. A quarter cycle is then 90 degrees. Any part of a cycle may thus be measured by the number of degrees covered.

Alternations which are maintained by alternating voltages steadily applied to a circuit are called forced alternations. Forced alternations may be maintained in any circuit. If the circuit is oscillatory, containing inductance and capacity, energy applied to the circuit will start alternations or oscillations at the natural or fundamental frequency of the circuit. These are called free alternations.

CURRENT, CALCULATION OF.—See *Law, Ohm's*.

CURRENT, DIELECTRIC.—The current that seems to pass into the dielectric of a condenser is called the dielectric current. See *Absorption, Dielectric*.

CURRENT, DIRECT OR CONTINUOUS.—An electric current which always flows in the same direction through conductors or a current which does not change its polarity is called a direct current or a continuous current. A direct current generally remains at constant voltage, that is, the voltage does not rise and fall. See also *Current, Alternating*.

CURRENT, DISPLACEMENT.—When there is a voltage difference impressed upon opposite sides of an insulator a slight amount of electricity moves in the insulator. This is called displacement current. See *Flux, Dielectric*.

CURRENT, EDDY.—Whenever there is a movement of electromagnetic lines of force through any piece of metal, electric currents are set up in the metal. These are called eddy currents. If

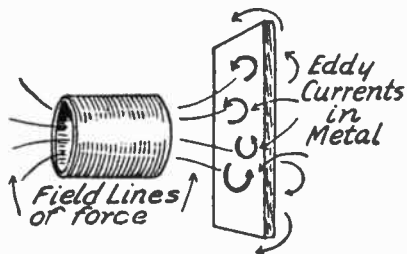

Formation of Eddy Currents in Metal.

the electromagnetic field caused by an alternating or oscillating current in a coil is allowed to pass through parts made of metal, eddy currents are caused to flow in these metal parts. Since it requires considerable energy to produce these eddy currents they place a load or an effective resistance on the circuit which produces them.

D

d.—The symbol for density.

DAMPED WAVE.—See *Wave, Damped*.

DAMPING.—The damping in an oscillating electric circuit determines the rate at which the voltages decrease. This is illustrated in the drawing. Damping is the ratio of one maximum amplitude, such as *A* in the drawing, to the one preceding it in the opposite direction, such as *B* in the drawing. To damp a circuit means to impede the oscillations. The coefficient of damping is equal to the effective resistance in the circuit divided by twice the inductance. Therefore, the damping of a circuit depends on its resistance, being greater the larger the resistance. Damping is also increased by distributed capacity in the inductance coil of an oscillating circuit.

Whenever energy is subtracted from a circuit by any cause that cause is said to introduce damping. All forms of losses in coils and all losses in condensers increase the damping in the circuit. See *Coil, Losses in*, also *Condenser, Losses in*. Any of these forms of damping reduce the voltage or amplitude of the oscillations.

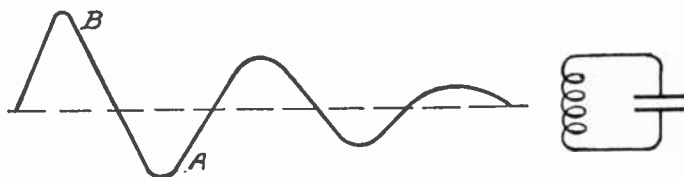

Effect of Damping.

The decrement of a circuit is the damping coefficient of that circuit multiplied by the time of one cycle. This is the logarithmic decrement that is generally called simply the decrement of the circuit.

If the damping effects in a circuit are exactly balanced by energy that is being added to the circuit, the amplitude of successive waves remains constant and there is no decrement or there is zero decrement. A continuous wave has zero decrement.

The decrement or damping in a circuit determines to a great extent the selectivity of that circuit because it determines the sharpness of resonance. Excessive damping of any kind will increase the range of frequencies to which a receiver will respond.

It is possible to have too little damping in a circuit. Tuning then becomes too sharp and the response curve of the receiver is not broad enough to take in a wave channel 10,000 cycles wide. When this condition exists the higher notes will be weakened or cut off.

It has been mentioned that damping is the ratio of the effective resistance to the inductance, being found by dividing the effective resistance by twice the inductance. Therefore, damping does not depend on resistance alone or on inductance alone, but on the ratio between the two.

In an attempt to reduce damping a larger size of wire might be used on a coil. But the larger wire would allow fewer turns per inch and would therefore reduce the inductance at the same time. Thus the resistance of the wire

D. C.

and the inductance would be reduced together and their ratio would show little if any change. Increasing the number of turns of the larger wire in order to regain the lost inductance would add to the wire length and its resistance. Thus the inductance and the resistance would increase together and their ratio would show little change. It is difficult to improve the ratio and reduce the damping, although either factor alone may be easily changed.

The damping so far spoken of is electrical damping but mechanical damping is also used in radio work. Mechanical damping impedes or hinders mechanical oscillatory motion such as the vibration of a loud speaker's diaphragm. Diaphragms used in loud speakers have a natural period or frequency at which they are resonant and they will respond much more strongly at this natural period than at any other period or frequency. Mechanical damping in the form of friction or clamping may be introduced to reduce the effect of this natural resonant period of the diaphragm.

Rooms of certain size and proportion are known to produce loud echoes of certain tones or notes. These echoes may be damped out by the use of heavy draperies or by the use of wall coverings of non-resonant material. This is an example of acoustical damping.

In building transformers it is generally found that the combination of inductance and distributed capacity will produce a stronger response at some one frequency than at other frequencies. This is called the resonance hump of the transformer. It may be reduced by the use of additional damping windings.

D. C.—An abbreviation for direct current. See *Current, Direct or Continuous*.

DECIBEL.—The decibel is a commonly employed unit for measurement of the ratio of the output voltage, current or power to the input voltage, current or power at an amplifier, transmission line or other electrical apparatus. If this ratio is greater than 1.0 it indicates amplification or gain, and if less than 1.0 it indicates attenuation or loss. When measuring power in watts the number of decibels is equal to ten times the common logarithm of the ratio. When measuring voltage or current the number of decibels is equal to twenty times this logarithm when the terminal impedances are equal.

One decibel is equal to one transmission unit and all values given in this latter unit under *Unit, Transmission* may be read as the same number of decibels.

DECOUPLING.—Prevention of feedback couplings by use of resistors, chokes and bypass condensers.

DECREMENT.—See *Damping*.

DECREMETER.—A tunable oscillatory circuit with a current indicating device allowing measurement of decrement.

DEGENERATION

DEGENERATION.—Degeneration means a feedback of energy from output to input of a tube or a circuit in such phase relation to the original signal input that the gain or amplification is reduced. Degeneration has an effect that is the opposite of the effect of regeneration, in which the feedback energy reinforces the original signal input. Degeneration is most often used in audio-frequency amplifiers and in modulated r-f amplifiers, where maximum fidelity is desired.

As an example of the effect of degeneration assume an amplifier with a normal gain of 100, wherein a 1-millivolt input causes a 100-millivolt output, and assume that 10 per cent of the output is fed back. This means that the original signal is opposed by a 10-millivolt feedback. To maintain a net input of one millivolt the original input signal now must be increased to 11 millivolts, which gives the necessary 1-millivolt in excess of the 10-millivolt degenerative feedback. The original overall gain was 100 to 1, and now it is 100 to 11.

Were the normal gain of the amplifier now reduced to 50, and the output maintained at 100 millivolts, the net input would have to be 2 millivolts. This is because 2 millivolts multiplied by a gain of 50 equals the required 100-millivolt output. The 10 per cent degenerative feedback still returns 10 millivolts to the input. To provide the needed net input of 2 millivolts the incoming signal now must be 12 millivolts, because this 12 millivolts minus the 10-millivolt opposing feedback leaves 2 millivolts net. Now, with a 12-millivolt input signal and a 100-millivolt output, the gain is 100 to 12, which is little different from the former 100 to 11 gain. Thus it appears that the overall amplification becomes fairly independent of amplifier gain.

If the amplifier system tends to over-amplify certain frequencies, or to have too much gain at certain frequencies, the degenerative feedback helps to maintain a relatively constant output, or to prevent the over-amplification of certain frequencies. Thus the fidelity is improved, although the overall gain is reduced. Degeneration also reduces tube noises, because some of the plate voltage variations that represent these noises are fed back in reversed phase, which reduces reamplification of the noise voltages.

DETECTOR, CRYSTAL.—A crystal detector consists of a piece of mineral, usually galena, on which rests a pointed metallic contact. The combination acts as a rectifier of currents at radio frequency, changing the alternating current which would come from a tuned circuit to pulsating direct current whose average variation is at the audio frequency of the modulation of the radio-frequency carrier. The diagram shows a circuit used with a crystal detector.

DETECTOR, DIODE.—A two-element vacuum tube or diode used for a detector acts as a rectifier, allowing radio-frequency voltages to produce high-frequency pulsating direct currents through the tube. The average value of the direct current varies at the modulation frequency or the audio frequency of the signal, and will produce audible signals in headphones, or may be amplified to operate a loud speaker. The diode section of double-diode tubes is used as the detector in many receivers. See *Tube, Double-diode*.

DETECTOR

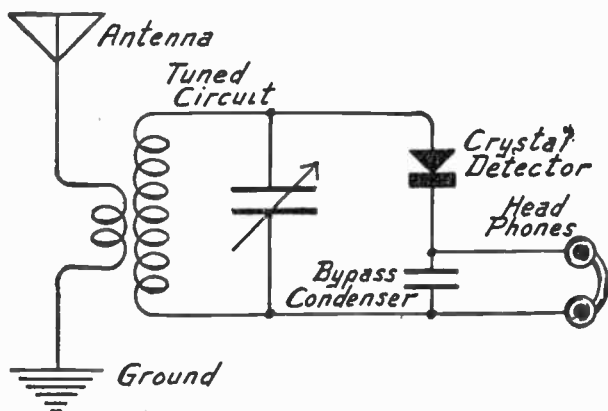

Receiver Circuit with Crystal Detector.

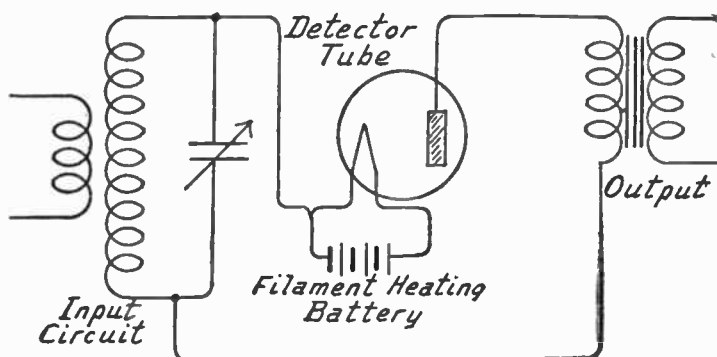

Elementary Principle of Diode Detector.

DETECTOR, GRID-LEAK.—A grid-leak detector, called also a grid current detector or a grid rectification detector, consists of a vacuum triode with a grid condenser between its grid and the tuned input circuit, and with a high-resistance “grid leak” resistor between the grid and cathode. The arrangement may be as in Fig. 1, or else the leak resistor may be connected across the ends of the grid condenser to provide a cathode connection through the coil of the tuned circuit.

High-frequency alternations of voltage in the tuned circuit are applied through the grid condenser to the grid-cathode circuit of the tube. The grid and cathode act as an anode and cathode of a diode rectifier. When alternations of signal voltage make the grid positive there will be flow of

DETECTOR

grid current as at the left in Fig. 2. This corresponds to electron flow as at the right. This direction of flow makes the upper end of the grid leak negative, and the side of the grid condenser which is toward the tube becomes negatively charged.

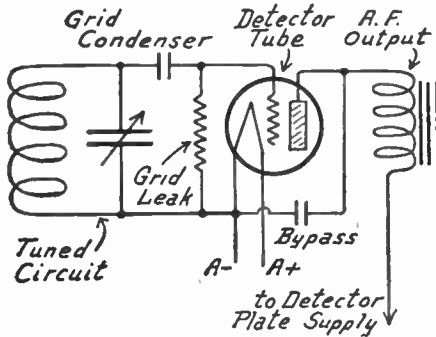

FIG. 1.—Typical Detector Tube Circuit with Grid Leak and Condenser.

Because the carrier is modulated, the amplitude of the high frequency voltages increases and decreases. During increases there is an increase of condenser charge and potential. During decreases there is no further charging of the condenser. At all times there is a slow leakage of the condenser charge through the high resistance of the grid leak, but the rate of leakage is not enough to prevent rise and fall of condenser charge and potential with rise and fall of carrier amplitude.

Since the varying amplitude of the high-frequency voltages corresponds to the audio-frequency modulation of the carrier, the varying charge and po-

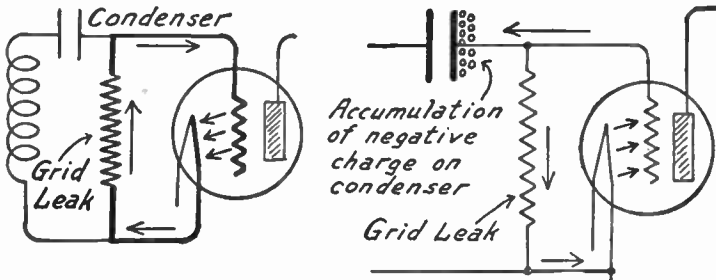

FIG. 2.—Action of a Grid Leak Detector. At the left is shown conventional current flow, positive to negative, while the grid is positive. At the right is the corresponding electron flow and charging of the grid condenser.

tential of the grid condenser follow the modulation. Because the triode grid is connected to the negative side of the grid condenser, the grid voltage varies with that of the grid condenser. Thus the grid is subjected to a negative potential which varies with audio-frequency modulation of the carrier. As shown in Fig. 3, the variations of grid voltage cause corresponding

DETECTOR

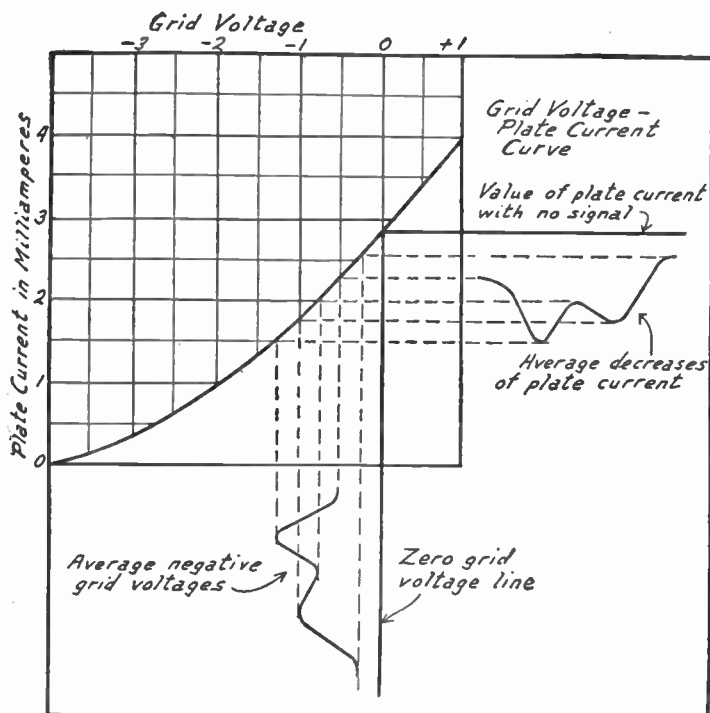

FIG. 3.—Action of the Grid Leak Detector. Variations of grid voltage cause corresponding variations of plate current, the latter decreasing in value as detection takes place.

variations of plate current or of output from the detector, and this output current is varied with audio-frequency modulation of the received carrier. Grid condensers commonly are of about 0.00025 mfd. capacity, and grid leaks of one or more megohms resistance. Their time constant must be much longer than the period of any frequency to be handled.

DETECTOR, PLATE-CURRENT.—A plate-current detector, called also a grid-bias detector, consists of a vacuum triode operated with a grid bias so highly negative that the negative alternations of grid signal voltage receive very little amplification, while the positive alternations are fully amplified. As shown by Fig. 1, this results in plate current with increases much greater than decreases from the value of current that exists with no signal applied to the grid.

Since the positive alternations of plate current are greater than the negative alternations, there is more current in the positive than in the negative direction and the effect is that of a pulsating positive current. The amplitude of signal voltages applied to the grid rises and falls with the modula-

DETECTOR

tion of the signal or carrier. Since changes of plate current follow changes of grid voltage, the average plate current rises and falls with modulation of the signal. This is shown by Fig. 2.

A typical detector circuit is shown by Fig. 3. Here the grid bias is provided by a biasing resistor with bypass condenser in series with the cathode. The plate of the detector tube is connected through a radio-frequency choke coil to the audio-frequency amplifier, and through a radio-frequency bypass condenser to the tube cathode. Thus the high-frequency component of the plate current is bypassed back to the cathode, while the average plate current changes, at modulated or audio frequency, go through the choke to the

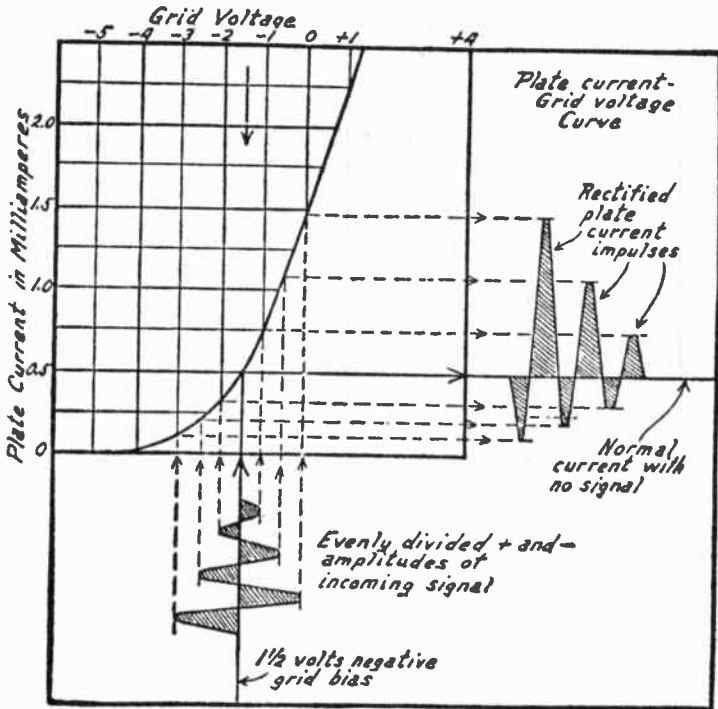

FIG. 1.—Action of Detector Using Grid Bias for Plate Current Rectification.

audio amplifier. The required negative bias may be provided also by a C-battery or by a negative tap on the voltage divider of the d-c power supply system.

The grid of a plate current detector is biased sufficiently negative to reduce plate current practically to zero when no signal is being received. Because of the strongly negative bias there is no appreciable current in the grid circuit, or input circuit, and the selectivity remains higher than with grid leak detection. With plate current detection there is amplification as well as detection in the tube circuit.

DETECTOR

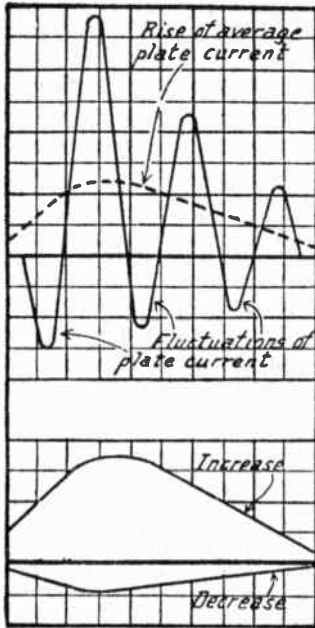

FIG. 2.—Current Change During Plate Current Detection.

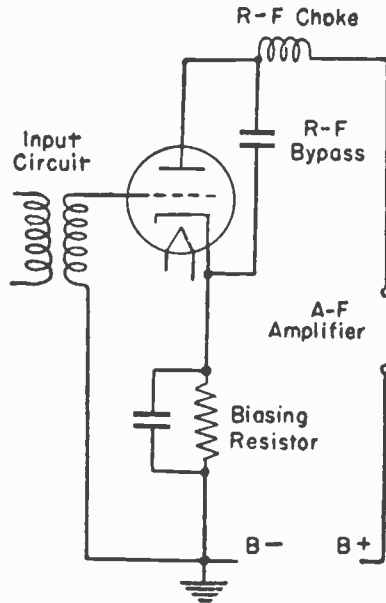

FIG. 3.—Typical Circuit for a Plate Current Detector.

DETUNING.—As the word implies, detuning is the opposite of tuning. Tuning consists of making such adjustments that the impedance of a circuit to currents of a certain frequency is reduced to the lowest possible point, and the circuit is then said to be tuned to this frequency.

When a circuit is detuned, either the capacity of a tuning condenser or the inductance of a tuning coil is changed so that the combination of capacity and inductance is no longer resonant or at lowest impedance to the frequency being received. In effect, impedance has been added for this frequency.

DIELECTRIC.—Any material through which electric force may act is a dielectric. All dielectrics are insulators, not conductors. A dielectric substance will allow the passage through it of induction, of magnetic lines of force, and of electrostatic lines of force.

Just as iron placed in a magnetic field will allow easier passage of the magnetic lines of force through itself, so will a dielectric placed in an electrostatic field allow easier passage of the electrostatic lines of force through itself. A dielectric placed in the electrostatic field of a condenser, between the plates of the condenser, will cause the field to become stronger and the condenser plates to become more

DIELECTRIC ABSORPTION

highly charged with the same impressed voltage than when air only is between the plates.

The power of the dielectric to thus increase the capacity of a condenser in which it is used is called the specific inductive capacity or the dielectric constant of the material. See *Constant, Dielectric*, under which heading are given the dielectric constants for most of the substances used in radio work.

The dielectric constant of a dielectric material is a measure of its ability to increase the capacity of a condenser. A substance may be a very good dielectric from the standpoint of increasing capacity, yet may be poor from the standpoint of radio work because of the losses it may introduce. The measure of a dielectric's value for radio work is its phase angle difference, that is, the amount it displaces the waves or oscillations passing through it.

The various properties and characteristics of the different dielectrics are discussed under the headings of the dielectric's name. Following are the most important which may be referred to:

<i>Air</i>	<i>Fibre</i>	<i>Porcelain</i>
<i>Celluloid</i>	<i>Glass</i>	<i>Quartz</i>
<i>Cloth, Insulating</i>	<i>Mica</i>	<i>Waxes</i>
<i>Binders</i>	<i>Oils, Insulating</i>	<i>Woods</i>
<i>Rubber</i>	<i>Paper</i>	<i>Insulation, Moulded</i>

All of these things are insulators as well as dielectrics. When they are considered from the standpoint of insulation, it is their resistance to voltage that is important. When they are considered from the standpoint of their dielectric properties, such as dielectric constant and phase angle, it is their effect on the electric force or electrostatic fields in radio that is of importance. Some materials are powerful dielectrics, others are strong insulators, and many fulfill both requirements at the same time.

Many parts of a radio receiver should be thought of from the standpoint of their dielectric properties. This applies to the insulation of wires and cables, which takes in cotton, silk, enamel and rubber. It also applies to all the insulating supports used in building condensers and coils, and to the sheets of insulation used for panels, sub-panels and cabinets; taking in such things as bakelite, hard rubber, fibre, glass, porcelain and woods. Then come the oils, waxes and binders used as insulators, and finally the mica and paper used because of their dielectric properties in condensers.

DIELECTRIC ABSORPTION.—See *Absorption, Dielectric*; also *Condenser, Losses In*.

DIELECTRIC CONSTANT.—See *Constant, Dielectric*.

DIELECTRIC CURRENT.—See *Current, Dielectric*.

DIELECTRIC HEATING.—See *Heating, Electrostatic*.

DIELECTRIC RESISTANCE.—See *Resistance, Dielectric*.

DIELECTRIC STRAIN.—See *Strain*.

DIELECTRIC STRENGTH.—See *Strength, Dielectric*.

DIELECTRIC STRESS.—See *Stress*.

DIFFRACTION.—An action by which waves of different frequencies are deflected or bent out of their original paths by differing amounts depending on their frequency. Long waves or low frequencies are diffracted or bent more easily than short waves. The long waves will pass around and almost completely envelope a small obstacle in their path while with short waves the obstacle will produce a comparatively "sharp shadow" because the waves pass on in almost straight lines.

DIODE

- DIODE.**—A tube having but two elements, filament and plate.
DIRECT COUPLED AMPLIFIER.—See *Amplifier, Audio Frequency, Direct Coupled.*
DIRECT COUPLING.—See *Coupling, Conductive.*
DIRECT CURRENT.—See *Current, Direct or Continuous.*
DIRECT CURRENT AMPLIFIER.—See *Amplifier, Direct Current.*

- DIRECTION FINDER.**—See *Compass, Radio.*
DIRECTIONAL ANTENNA.—See *Antenna, Directional Effect*; also *Loop, Directional Effect of.*

DISC RECORDING.—See *Sound Pictures*; also *Phonograph.*

DISTANCE, GEOGRAPHICAL.—The following list shows the approximate air line distances between principal cities in the United States, Canada and Mexico.

	Boston	Buffalo	Chicago	Cincinnati	Cleveland	Detroit	New York	Philadelphia	Pittsburgh	St. Louis	Washington
Ames, Iowa	1140	750	300	500	610	540	1000	965	720	285	900
Atlanta, Ga.	925	700	590	375	550	600	740	660	525	470	535
Atlantic City, N. J.	270	335	700	530	405	490	95	55	295	880	140
Baltimore, Md.	350	180	600	420	310	405	170	90	195	730	35
Beaumont, Texas	1510	1200	875	825	1035	1030	1325	1250	1050	645	1125
Birmingham, Ala.	1050	805	575	420	620	640	850	775	610	400	630
Boston, Mass.	—	400	835	725	540	600	190	265	475	1025	385
Bristow, Okla.	1400	1035	615	680	865	830	1235	1175	930	310	1065
Buffalo, N. Y.	400	—	450	390	175	215	295	285	180	650	295
Calgary, Canada	2080	1725	1380	1630	1650	1550	2000	1190	1750	1440	1950
Chicago, Ill.	835	450	—	250	300	235	705	655	415	255	590
Cincinnati, Ohio	725	390	250	—	220	225	555	495	255	315	400
Cleveland, Ohio	540	175	300	220	—	90	400	355	115	485	300
Columbus, Ohio	625	295	275	100	125	160	470	410	160	390	325
Dallas, Texas	1520	1180	795	800	1005	990	1350	1280	1060	545	1165
Davenport, Iowa	990	600	155	360	455	390	860	805	560	200	735
Denver, Colo.	1750	1350	900	1075	1205	1140	1600	1550	1300	775	1475
Des Moines, Iowa	1150	750	300	500	605	540	1010	965	705	260	890
Detroit, Mich.	600	215	235	225	90	—	475	440	210	450	395
Elgin, Ill.	870	480	30	275	330	265	735	685	445	255	620
Fort Worth, Texas	1550	1205	810	820	1025	1005	1375	1310	1085	560	1190
Galveston, Texas	1580	1270	945	890	1100	1100	1385	1315	1125	690	1200
Hartford, Conn.	90	325	750	630	460	525	150	175	375	960	300
Hastings, Neb.	1405	1005	560	735	860	795	1265	1210	960	445	1120
Havana, Cuba	1495	1390	1320	1100	1250	1320	1295	1270	1215	1165	1125
Hot Springs, Ark.	1280	945	575	550	765	745	1105	1030	820	340	925
Houston, Texas	1570	1260	925	890	1090	1085	1400	1315	1125	665	1200

DISTANCE, GEOGRAPHICAL

	Boston	Buffalo	Chicago	Cincinnati	Cleveland	Detroit	New York	Philadelphia	Pittsburgh	St. Louis	Washington
Indianapolis, Ind.....	790	425	160	100	255	235	630	575	325	235	480
Iowa City, Iowa.....	1045	650	200	405	510	435	910	855	605	210	785
Jefferson City, Mo.....	1130	750	325	420	585	540	975	910	665	110	810
Kansas City, Mo.....	1230	850	400	540	690	640	1075	1025	775	225	925
Lancaster, Pa.....	305	255	600	430	300	390	125	65	200	750	90
Lansing, Mich.....	675	275	170	235	170	80	550	520	285	400	470
Lincoln, Neb.....	1315	920	470	645	775	700	1175	1125	875	360	1145
Los Angeles, Cal.....	2550	2160	1725	1875	2015	1950	2425	2360	2115	1570	2255
Louisville, Ky.....	815	475	270	90	305	310	650	570	345	250	465
Madison, Wis.....	925	525	120	375	400	325	800	750	520	300	700
Memphis, Tenn.....	1125	800	475	410	625	615	950	875	650	240	750
Mexico City, Mexico.....	2300	2000	1680	1600	1800	1795	2125	2035	1860	1425	1850
Miami, Fla.....	1275	1185	1175	950	1080	1150	1100	1025	1015	1075	925
Milwaukee, Wis.....	840	450	80	325	335	250	725	685	450	320	625
Minneapolis, Minn.....	1110	725	355	600	625	540	1010	975	740	460	925
Montreal, Canada.....	260	320	740	700	490	515	340	400	475	975	490
Newark, N. J.....	195	285	700	550	390	470	8	75	300	875	195
New Orleans, La.....	1335	1075	825	700	915	930	1160	1075	910	605	950
New York City.....	190	295	705	555	400	475	—	80	305	870	200
Oakland, Cal.....	2650	2260	1825	2005	2125	2050	2525	2475	2230	1710	2400
Omaha, Neb.....	1260	875	425	625	735	660	1135	1080	835	350	1010
Ottawa, Canada.....	310	240	645	635	410	430	340	385	410	880	460
Philadelphia, Pa.....	265	285	655	495	355	440	80	—	250	800	120
Pittsburgh, Pa.....	475	180	415	255	115	210	305	250	—	560	190
Pontiac, Mich.....	615	230	225	240	110	20	490	450	225	450	410
Portland, Ore.....	2500	2120	1725	1960	2030	1935	2420	2375	2150	1745	2320
Providence, R. I.....	45	390	825	710	525	585	150	235	450	1000	355
Regina, Canada.....	1680	1325	1000	1250	1260	1160	1620	1600	1375	1095	1550
Rochester, N. Y.....	340	65	510	445	235	275	250	260	225	725	300
St. Louis, Mo.....	1025	650	255	315	485	450	870	800	560	—	705
Salt Lake City, Utah.....	2075	1675	1250	1440	1550	1475	1950	1900	1650	1150	1825
San Antonio, Texas.....	1735	1410	1035	1025	1235	1225	1565	1475	1275	765	1360
San Francisco, Cal.....	2640	2250	1815	1995	2115	2040	2515	2465	2220	1715	2390
Schenectady, N. Y.....	145	250	700	600	400	460	150	210	350	900	315
Scranton, Pa.....	245	230	615	490	315	390	100	105	230	790	200
Seattle, Wash.....	2460	2095	1710	1950	2000	1920	2385	2360	2115	1700	2300
Springfield, Mass.....	80	320	755	650	460	525	120	200	400	960	320
Tampa, Fla.....	1180	1050	1000	775	925	985	1000	925	865	860	815
Toronto, Canada.....	430	55	425	400	185	200	345	340	225	640	350
Troy, N. Y.....	135	265	710	605	415	475	140	205	360	910	325
Vancouver, Canada.....	2480	2115	1750	1990	2035	1945	2400	2375	2150	1745	2325
Waco, Texas.....	1585	1250	870	860	1075	1050	1400	1335	1125	615	1225
Washington, D. C.....	385	295	590	400	300	395	200	120	190	705	—
Winnipeg, Canada.....	1350	990	710	965	940	850	1285	1260	1050	850	1245
Zion, Ill.....	840	450	40	285	300	235	710	660	420	265	595

DISTORTION

DISTORTION.—Symptoms of distortion include the following: High notes weak. Consonant sounds suppressed in speech. Low notes weak, with good reproduction of higher notes. Drum-like or muffled reception. Shrill and excessively loud repro-

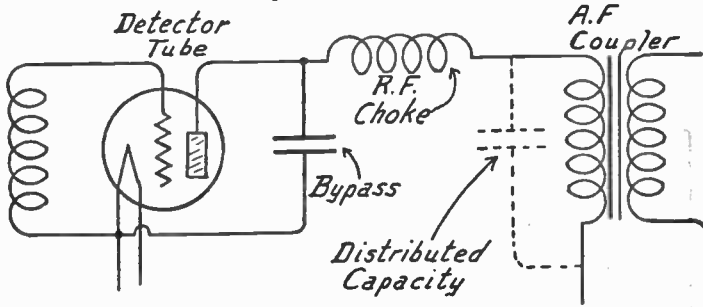

FIG. 1.—Detector Circuit with Bypass and Radio Frequency Choke to Prevent Distortion.

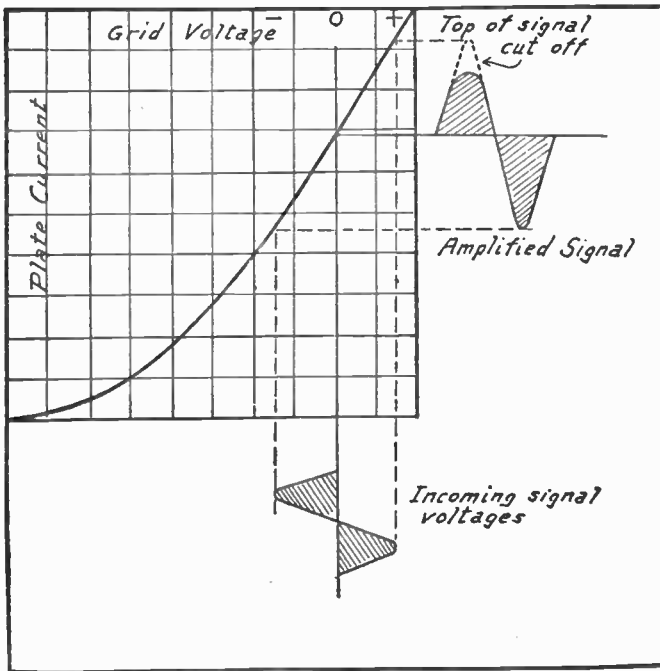

FIG. 2.—Distortion Caused by Zero Grid Bias.

DISTORTION

duction of certain notes. Harsh, rasping sounds on all signals (may be incorrect tuning).

If distortion exists when receiving only one station there may be temporary trouble at the station. Otherwise the fault is in the receiver, the antenna, or their connections. It will be necessary to check the radio frequency and intermediate frequency amplifiers, the converter, second detector, audio and power amplifiers, and loud speaker.

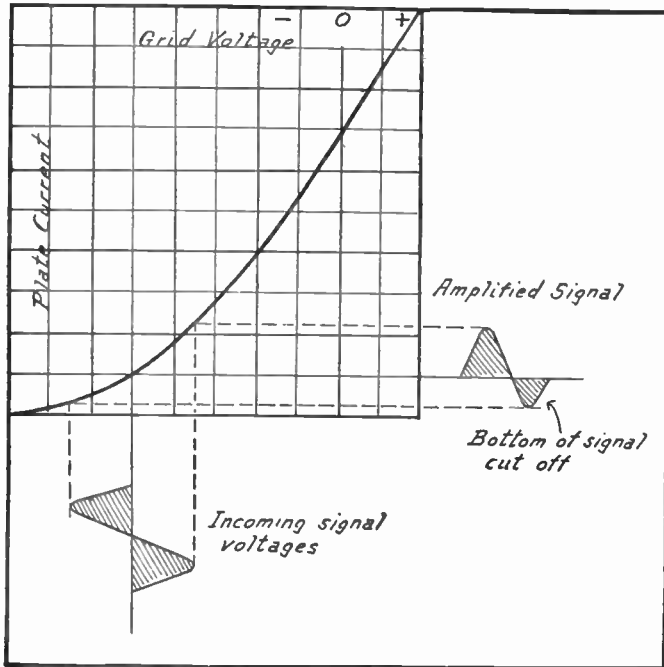

FIG. 3.—Distortion Caused by Excessive Negative Grid Bias.

Distortion due to cutting off of higher audio frequencies will result from too sharp tuning in radio and intermediate frequency stages. Strong signals may make the detector grid positive, which causes distortion. High frequency currents getting into audio amplifying stages overload the audio tubes. Such currents are bypassed with condensers (.001 to .005 mfd.) and held back with radio frequency chokes as in Fig. 1.

Insufficient bias or incorrect bias on audio frequency tubes causes distortion by cutting off one side of the signal as in Fig. 2. Excessive negative bias acts as shown by Fig. 3. Operation of all tubes at recommended plate voltages and grid biases prevents these troubles.

DISTORTION

Distortion results from using audio frequency transformers which are too small, or which have excessive distributed capacity that combines with their inductance to cause resonance at some high audio frequency. This causes an amplification peak as in Fig. 4. Small loud speakers distort signals which are too strong

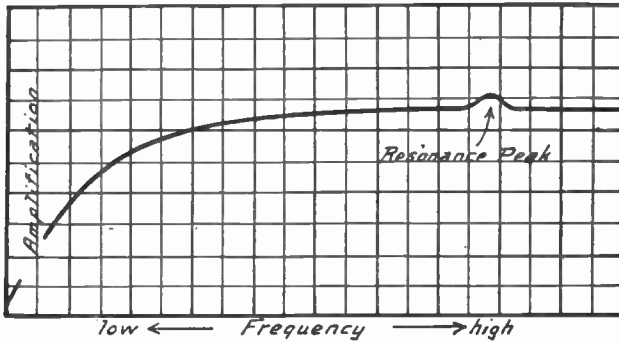

FIG. 4.—Resonance Peak Causing Distortion in Audio Frequency Coupler.

for them to reproduce. Audio frequency amplification varies somewhat at different frequencies, but if there is excessive amplification at some frequencies the result will be as in Fig. 5.

If some signal voltages are amplified more or less than others we have amplitude distortion with results as indicated at the cen-

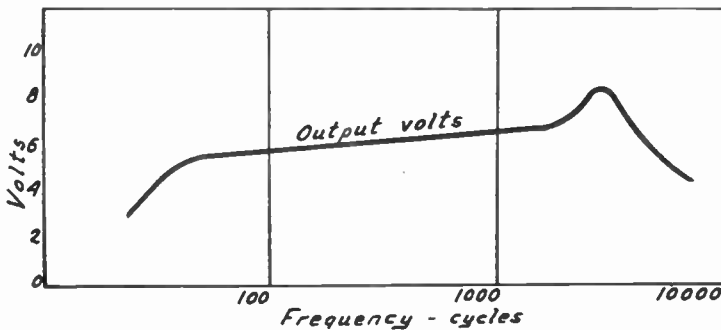

FIG. 5.—Result of Frequency Distortion in Amplifier.

ter and right-hand side of Fig. 6 for a signal correctly amplified as at the left. Relations between signal voltages and amplification ratio for a unit having amplitude distortion are shown in Fig. 7. Negative voltages receive less amplification than positive voltages. Such trouble results from overloaded tubes, or tubes operated at incorrect plate voltages and grid biases.

DISTRIBUTED CAPACITY

Other causes for distortion are as follows: Oscillation in any of the amplifying tubes. Incorrect bias for detector tubes. Energy feedback between grid and plate circuit connections running too close together. Omission of bypass condensers which should

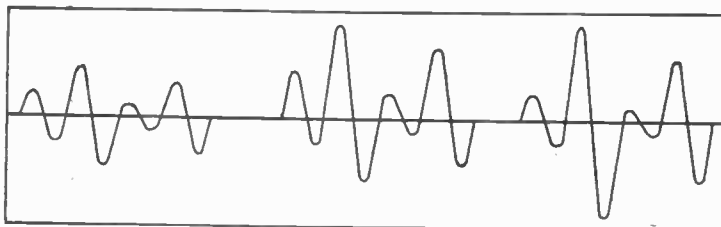

FIG. 6.—Result of Amplitude Distortion.

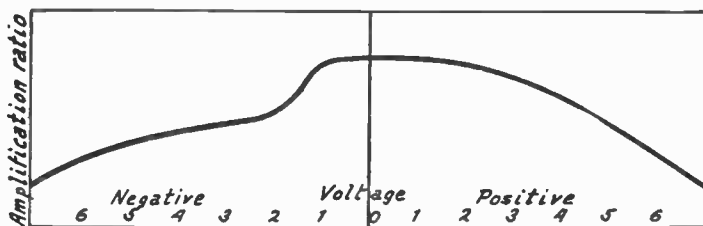

FIG. 7.—Variation of Amplification with Changes of Input Voltage.

be on the plate, screen, grid, cathode or other leads. These condensers bypass high frequency currents which otherwise overload some of the tubes, and they also prevent feedbacks. Heater or filament voltages may be too low to provide ample emission. Apparent distortion may result from interference.

DISTRIBUTED CAPACITY.— See *Capacity, Distributed*.

DIVIDER.— See *Tools*.

DOUBLE BUTTON MICROPHONE.— See *Microphone*.

DOUBLE-DIODE TUBE.— See *Tube, Double-diode*.

DRILLING

DRILLING.—In the construction and assembly of radio receivers it becomes necessary to drill holes in various kinds of metals and of insulating materials. The following paragraphs give information needed in doing this work:

Machine Screw Tap and Clearance Holes.—Different sizes of machine screws are used in radio work. The following table shows the number of the screws, the number of threads per inch, their diameter, and the drills to be used in making holes either for threading (tapping) or for allowing the screw to pass through freely (clearance). Further information on such screws is given under Screws and Bolts, Types of.

SIZES OF TAP AND CLEARANCE DRILLS

Screw Number	Threads per Inch	Drill Number		Screw Number	Threads per Inch	Drill Number	
		<i>For Tap</i>	<i>Clearance</i>			<i>For Tap</i>	<i>Clearance</i>
2	48	No. 50	No. 42	7	28	No. 32	No. 21
2	56	49	42	7	30	31	21
2	64	48	42	7	32	30	21
3	40	47	38	8	24, 30	30	17
3	48	45	38	8	32	29	17
3	56	44	38	9	24	29	13
4	32	43	31	9	28	28	13
4	36	42	31	9	30	27	13
4	40	41	31	9	32	25	13
5	30, 32	40	29	10	24	25	8
5	36	38	29	10	30	22	8
5	40	37	29	10	32	21	8
6	30, 32	35	26	12	20	19	1
6	36	33	26	12	22, 24	17	1
6	40	32	26	12	28	15	1

Drilling Metals.—All metal drilling is done with round twist drills which may be secured in sizes designated by numbers as in the foregoing table or in sizes designated by fractions of an inch varying by sixty-fourths. When drilling steel the drill should be lubricated with light machine oil as it enters the hole. Brass, aluminum and cast iron are drilled dry without lubricant of any kind.

Drilling Insulating Material.—Moulded and laminated phenol compositions such as Bakelite, Formica, Redmanol, Celoron, etc., are best drilled with the point of the drill ground to the usual sixty degree angle but with the front of the cutting edge ground straight or flat to remove the hook. With hand drills any speed within the ability of the operator will be satisfactory. With power drills for holes not larger than one-half inch diameter speeds up to 1500 revolutions per minute may be used. These materials may be drilled dry or a small quantity of light machine oil or lard oil may be used as a lubricant. All phenolic substances of this class are very hard

DRIVER

on drills and dull the points quickly. The hole may be found two or three thousandths of an inch smaller than the drill size should the work be done so rapidly as to heat the material being handled.

To prevent the hole breaking around the edges when the drill comes through the back it is advisable to hold a block of wood solidly against the rear surface of the material being drilled. To prevent the holes from running off from the true position as marked with a punch it is best to first drill a small hole, about one-sixteenth inch diameter. The larger drill to make the finished hole will then follow this small hole as a guide.

Hard rubber is drilled in much the same manner as the other insulating materials just mentioned. The rubber is much easier to work than are the phenolic substances. It is essential to drill small guide holes first and to back up the rubber with wood blocks to prevent its breaking through around the hole.

Drilling Glass.—Plate glass in thicknesses of five-sixteenths inch and greater may be drilled successfully if plenty of time is spent and plenty of work applied. The drilling is done with emery dust kept wet with turpentine. A piece of drill rod is secured of proper diameter for the finished hole and the end of the rod is ground off perfectly flat. The rod is rotated at a few hundred revolutions per minute and is held against the glass with moderate pressure while the emery dust and turpentine are applied in liberal amounts until the glass is literally worn through by the process.

Laying Out Drill Holes.—It is advisable to lay out the positions of all holes for screws and control shafts with a pencil on a sheet of heavy paper the exact size of the panel or base board being used. This paper template is then fastened to the panel with library paste. Each point for drilling is marked by placing a sharp prick punch on the mark and striking the punch a single light blow with a hammer. The paper is then removed and all punch marks gone over with a center punch, again striking but a single sharp blow to avoid the possibility of working the mark out of place with added blows. The work is then ready for drilling.

See also *Tools*.

DRIVER.—A source of high frequency alternating current used to supply energy to radio circuits is called a driver since it supplies the necessary driving force for the work to be done. See *Oscillator*.

DROP, VOLTAGE.—See *Potential, Difference of*.

DRY CELL.—See *Battery, Dry Cell Type*.

DRY CONDENSER.—See *Condenser, Electrolytic*.

DRY RECTIFIER.—See *Rectifier, Contact*.

DYNATRON.—See *Oscillator*.

DYNE.—A unit of physical force. It is the force exerted by a weight or mass of one milligram when acted upon by gravity. One milligram is equal to 1/454.545 pound.

E

e.—The symbol for electromotive force (instantaneous value).

E.—The symbol for electromotive force or voltage (effective value). See *Electromotive Force*.

EARTH.—See *Ground, Receiver*.

EBONITE.—See *Rubber, Hard*.

EDDY CURRENT.—See *Current, Eddy*.

EFFECTIVE RESISTANCE.—See *Resistance, Effective*.

EFFECTIVE VALUES.—See *Value, Average and Effective*.

ELASTANCE.—The reciprocal of the capacity of a condenser or anything having capacity is called the elastance of the condenser or other unit. The elastance is equal to 1 divided by the capacity in farads.

ELECTRIC EYE.—See *Cell, Photoelectric*.

ELECTRICITY.—The cause of all electric and magnetic effects is called electricity. Many theories have been advanced from time to time to explain the nature of electricity itself, the most recent being known as the electron theory which is explained under the heading *Electrons*. The effects and action of electricity are used in radio and all electrical sciences.

ELECTRICITY, PRODUCTION OF.—See *Induction, Electromagnetic; Battery; and Thermo-Electricity*.

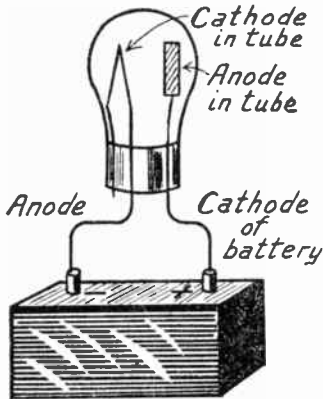

Electrodes of Tube and Battery.

electric currents and magnets. Electrodynamic is the science of electric currents or of electricity in motion.

ELECTRODE.—Either one of the terminals of an electric source is called an electrode. The terminal, connection or conductor through which electric current or an electron stream enters or leaves anything is called an electrode. The terminal through which the current enters is called the anode, the terminal through which the current leaves being called the cathode. See *Anode* and *Cathode*.

ELECTRODYNAMIC. — Related to or caused by the action of an electric current upon itself, by the action of two electric currents upon each other, or by the action between

electric currents and magnets. Electrodynamic is the science of electric currents or of electricity in motion.

ELECTRODYNAMIC SPEAKER.—See *Speaker, Loud*.

ELECTROLYTE.—A liquid or solution in which the passage of an electric current causes chemical and electrical changes is called an electrolyte. An electrolyte must be an electrical conductor

ELECTROLYTIC

whose atoms are broken up by the effect of the current. See also *Battery, Storage Type*.

ELECTROLYTIC CONDENSER.—See *Condenser, Electrolytic*.

ELECTROLYTIC RECTIFIER.—See *Rectifier, Electrolytic*.

ELECTROMAGNETIC FIELD.—See *Field, Magnetic and Electromagnetic*.

ELECTROMAGNETIC FLUX.—See *Flux, Electromagnetic*.

ELECTROMAGNETIC SPEAKER.—See *Speaker, Loud*.

ELECTROMAGNETISM.—See *Magnetism and Electromagnetism*.

ELECTROMOTIVE FORCE.—This is the force which will produce a flow of electric current in a conductor. Electromotive force is measured in volts. Its abbreviation is E. M. F.

Electromotive force acts when there is a difference of potential or difference of electric charge between two parts of a circuit. Electromotive force in an electrical circuit is similar to water pressure in a water circuit. Electromotive force may exist without there being a flow of current just as pressure may exist in a water system without there being any flow of water.

Electromotive force is produced by primary batteries which change the energy of their chemicals into electric pressure, by electric generators which turn mechanical energy into electric pressure, by thermocouples which turn heat into this pressure, and by certain crystals which turn mechanical pressure changes into voltages.

The term electromotive force means practically the same thing as either voltage or potential difference. Electromotive force is generally taken as meaning the total difference in electrical pressure throughout an entire circuit or the difference in pressure at the terminals of a source. Potential is generally used when mentioning the difference in pressure between two parts of a circuit. Voltage is often limited to designating the difference of pressure between a point and the earth which is assumed to be at zero voltage.

ELECTRON COUPLING.—See *Receiver, Superheterodyne*.

ELECTRON-RAY TUBE.—See *Tube, Electron-ray*.

ELECTRONS.—An electron is the smallest quantity of negative electricity that may move by itself between atoms of matter. The electron is a charge of negative electricity. All material substances as we know them are composed of molecules of the substance. Each molecule is made up of a number of atoms of the different elements which cannot be further subdivided into other substances. For instance, the finest division of water is a molecule of water; but this water molecule may be divided into atoms of hydrogen and

ELECTRONS

oxygen. Hydrogen and oxygen are elements and cannot be divided into anything else.

An atom of any substance contains both positive and negative electricity in equal amounts. When the smallest portion of some of this negative electric charge becomes detached from the atom, this detached charge is called an electron. An electron is not matter as we know it, nor has it any material substance of any kind. It is simply an electric charge.

An electron must be thought of as a charge of negative electricity rather than as any material form of matter of any kind. A study of electrons and their action is comparatively easy with an active imagination, otherwise it is difficult.

In a vacuum tube, electrons pass from the heated filament to the positively charged plate. The plate is positively charged because it is connected to the positive terminal of the B-battery or power unit. The number or amount of electrons flowing depends on several things. The hotter the filament the more will flow, the higher the plate voltage the more will flow, and the higher the degree of vacuum in the tube the more will flow. An increased flow of electrons is also caused by larger filaments and plates and by having the filament and plate closer together.

One reason for thinking of electrons only as charges of electricity is that no matter how long the electron flow continues from the filament to the plate, and no matter how great the flow, the plate never gains the slightest bit of weight.

The electrons are negative charges and flow toward a positively charged body such as the plate. That is, they flow from a point of lower voltage to another point of higher voltage. Electric current flows from a point of positive voltage to one of negative voltage. Therefore, in any circuit, the electron flow is in just the opposite direction to the current flow. The electrode from which the electrons flow is called the cathode. In the case of a radio tube the filament forms the cathode. The electrode to which the electrons flow is called the anode. In a vacuum tube the plate is the anode.

Atoms of matter of all kinds are composed of various numbers of electrons associated in the atom with a positive nucleus. The positive charge of the nucleus exactly balances the negative charge of the electrons. If one or more negative electrons are removed from an atom then the atom becomes positive. If the atom gains one or more negative electrons in addition to its normal number of electrons then it becomes negative or is negatively charged.

The flow of electrons from the filament in a tube when the filament is heated is often called the thermionic current. The amount of energy or voltage required to cause electrons to flow away from or leave the filament or cathode is called the equivalent voltage. The smaller the equivalent voltage for a certain cathode the larger will be the thermionic current which flows, that is to say, the less the energy that is required to cause electron flow the greater will

ELECTROSTATIC

be the flow. The equivalent voltage is a measure of the power required in heating the filament to cause a given electron flow.

When electrons leave the cathode and travel toward the anode they collide with the atoms of any gas which may be in the space between cathode and anode. Each time an electron collides with an atom it imparts some of its own energy to the atom.

The speed with which the electrons travel through the space is in proportion to the voltage between anode and cathode. The greater the voltage the greater the speed of the electrons. With high voltage the electron speed will be so great that enough energy is imparted to the atoms to detach some electrons from the atoms. The voltage at which this action takes place is called the ionization voltage and the process of breaking away of electrons from an atom by the collision or impact of other electrons is called ionization.

If the filament temperature or voltage in a tube is too high, ionization will be greatly increased and will be noticeable by a blue glow in the tube. This blue glow is caused by ionization due to the collisions of electrons with atoms. When ionization takes place under such conditions there is an excessive flow of thermionic current, this current being visible as the blue glow.

The movement or flow of electrons is always toward a positively charged body or toward a point of higher potential. That is, the electron flow is from negative to positive. Since electrons are themselves negative, they are attracted to and flow toward the positive or high voltage points. Before the electron theory was so widely accepted the convention was adopted which says the electric current flows from a positive point to a negative point in a circuit. Therefore, we find the electron flow from negative to positive and the current flow from positive to negative.

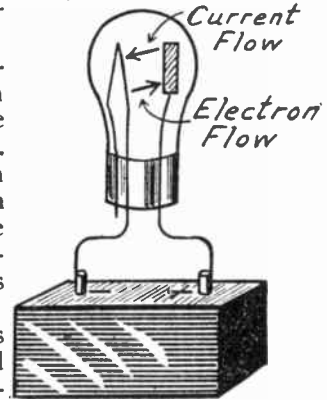

Electron Flow and
Current Flow.

ELECTROSTATIC.—Electricity may exist either in motion or at rest. Electricity in motion, either as an electric current or as a magnetic field, is studied under the names of induction and of electromagnetism. Electricity existing as a stationary charge, as it exists on the plates of a charged condenser, is studied under the name of electrostatics. Therefore, any action or effect that is associated with stationary charges of electricity is called an electrostatic or a capacitive action or effect. Any action or effect associated with the electric current is called an inductive or an electromagnetic action or effect.

An electrostatic field, such as that existing between the plates

ELECTROSTATIC CAPACITY

of a condenser and extending through the dielectric, is a stationary field. It exists between the positive charge of one plate and the negative charge on the other plate. The two charges are always of opposite polarity and of equal quantity. The electrostatic field is between stationary charges of electricity.

Whenever the word electrostatic is used it refers to effects, to causes or to conditions having to do with condensers or with the capacitive effect between conductors.

ELECTROSTATIC CAPACITY.—See *Capacity*.

ELECTROSTATIC CHARGE.—See *Charge*.

ELECTROSTATIC COUPLING.—See *Coupling, Capacitive*.

ELECTROSTATIC FIELD.—See *Field, Electrostatic*.

ELECTROSTATIC INDUCTION.—See *Induction, Electrostatic*.

ELECTROSTATIC HEATING.—See *Heating, Electrostatic*.

EMF.—An abbreviation for electromotive force. See *Electromotive Force*.

EMISSION, ELECTRON.—A flow of electrons from the surface of a solid or a liquid, due to additional energy imparted to free electrons in the material by the action of heat, light, or other radiant energy, or by the impact of other electrons on the surface. See *Electrons*.

EMISSION, SECONDARY.—See *Tube, Secondary Emission In*.

ENAMELLED WIRE.—See *Wire, Enamelled*.

ENERGY.—The ability to do work is called energy. While energy implies the ability or power to do work, this energy may not be in use but simply held available for use. There are many forms of energy such as electrical energy, mechanical energy, chemical energy, etc.

Kinetic energy is any form of energy contained in a body by virtue of the body's motion. The amount of kinetic energy contained in the body depends on its size and weight, also on its speed or velocity of motion. Thus a baseball thrown with speed contains more kinetic energy than is contained in a light feather dropping slowly through the air.

Potential energy is the energy contained in a body because of the body's position, shape, etc. Thus, a coiled spring contains potential energy because of its shape, a suspended weight contains potential energy because of its being held up in the air. If the spring is allowed to uncoil, its energy changes to kinetic energy and likewise if the weight is allowed to drop its energy changes from potential to kinetic energy. The magnetic field about a coil contains kinetic energy, the charge on the plates of a condenser is a form of potential energy.

ENERGY, TRANSFER OF.—See *Coupling*.

F

FACSIMILE TRANSMISSION.—Facsimile is the transmission by radio or by wired circuits of still pictures, or of maps, drawings and any other copy which is in black and white or in well defined colors. There may be shadings or intermediate tones. The copy which is to be transmitted is examined or scanned by passing across it from side to side, along a straight line, an intense light which is allowed to illuminate a height of only about $\frac{1}{100}$ inch on the copy. As soon as one line is thus scanned the light is shifted by $\frac{1}{100}$ inch and again is traversed across the copy on a line paralleling the first one. Thus the light is caused to scan the entire area of the copy, by successive movements of either the copy or the light with reference to each other.

Light reflected from the copy is focused on a phototube or photocell. The intensity of the reflected light varies with the shade or tone of the small area of the copy being illuminated from instant to instant, and this causes current and potential drop in the phototube circuit to vary with the shading of the copy. Changes of potential in the phototube circuit control an audio-frequency oscillator whose output is used to modulate the carrier of a radio transmitter.

With one method of facsimile reception the incoming signal is amplified and the amplifier output rectified to provide direct current that varies with the modulation. One side or one polarity of the d-c circuit is connected to a metal drum on which is placed a sheet of recording paper which has been chemically or photographically treated so that its coating is affected by changes of current passed through it. The other side of the d-c circuit is connected to a metal point or stylus that rests against the other side of the paper. The current which varies with modulation causes directly, or after photographic development, black lines or spots whose density or size is proportional to changes of current and to the modulation.

By means of a constant speed motor at the receiver the recording stylus is moved across the paper at exactly the same rate at which the light beam in the transmitter travels across the copy being scanned. Each time that the transmitter mechanism shifts the light spot downward to a new line there is transmitted to the receiver a very low frequency impulse or signal. As the end of a line is reached by the receiver stylus, the stylus is moved down to the next line and held there by a stop. At the same instant the output of the rectifier at the receiver is switched from the stylus and drum to an electromagnet. The low-frequency signal from the transmitter operates the electromagnet to release the stop, whereupon the recording proceeds across the new line in correct time relation to the scanning beam at the transmitter.

FADING.—Weakening of signals at a receiver is thought to be due largely to their irregular reflection from the Heaviside layer of ionized gases near the upper limit of the atmosphere.

Radio signals or impulses sent out from the aerial of a broadcasting or transmitting station may travel in every direction after leaving the aerial. They go east, west, north and south, also up and down. The waves that travel down are stopped by the earth, which is a conductor. That is to say, the waves do not penetrate the earth for any great distance. The waves that start out horizontally are absorbed by the atmosphere and various objects and

FADING

grow weaker and weaker as the distance from the transmitter increases.

The waves that travel upward continue until they strike the Heaviside layer and many of them are then reflected back toward the earth. Under some conditions the radio waves seem to slide along on the Heaviside layer for a tremendous distance before being reflected back to the earth. The signals coming to an antenna are a combination of those that travel directly through the atmosphere and those which have gone up to the Heaviside layer and have been reflected back.

In the daytime, due to the sunlight, the waves which go up in the air are absorbed and do not return and the only signals received are those called ground signals which come direct. But, at night both the ground wave and the wave from above come to a receiver which is comparatively near a transmitter, say within one hundred fifty to two hundred miles. It is evident that the signals which have gone up to the Heaviside layer and have then been reflected back have traveled a greater distance than those coming direct from the

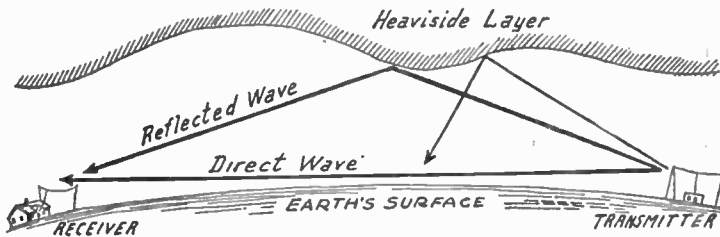

Effect of Heaviside Layer on Fading.

transmitter. Consequently the reflected signals may arrive just a little later than those coming direct. The combination may be such that the two waves balance each other out because the positive alternations of one arrive with the negative alternations of the other.

A shifting of the position or surface of the Heaviside layer will change this relation and signals may again be heard. This seems to be the most reasonable explanation of fading so far made. When at such a great distance from the transmitter that no ground wave is received fading is caused by movement of the Heaviside layer. The reflected waves are sometimes concentrated quite strongly and again are reflected hardly at all toward the antenna.

Fading is worst around 250 meters wavelength. Below this wavelength it is not so bad and above 400 meters there is very little fading and what does occur is not so pronounced as at low wavelengths. When within about one hundred fifty miles of a broadcaster the greater part of the signal strength is provided by the ground wave, both day and night, and fading is practically absent. Beyond this distance signals are received from the reflected wave more than from the ground wave and fading will take place. There is a certain distance from a broadcasting station where fading is worst for that one station. This distance generally runs between one hundred twenty-five and one hundred

FAHRENHEIT THERMOMETER SCALE

seventy-five miles. The signals from that one station will be received better at greater distances and also at less distances but there will be a band of comparatively dead spots forming a ring around the transmitter at some critical mileage. The critical mileage is sometimes called the skip distance.

Fading is noticed at night on distant reception because at night the overhead wave provides most of the signal strength from the distant stations, little coming from the ground wave. In the daytime the ground wave provides much of the strength and this part of the wave is not affected by fading. The worst fading of all seems to occur at sunrise in the morning and again at sunset in the evening.

Fading does not depend to any great extent upon the transmitter, the receiver, the weather, or anything under human control. When a signal fades there is nothing to be done about it until conditions change.

The following conclusions were drawn from tests on fading conducted by the Bureau of Standards and the American Radio Relay League. A changing barometer at the transmitting station does not affect the fading. The fading is greater when transmission takes place up or down the barometric gradient, although there seems to be no difference between transmission of signals traveling up and those traveling down. Waves which travel along the isobars or lines of equal barometric pressure produce stronger signals than waves crossing the lines. The same conclusions apply to transmission across and in line with the isotherms or lines of equal temperature. Best transmission is had when the signals can travel with a line of some one temperature.

It was concluded that clouds at the transmitting station have no effect on fading. Generally cloudy weather at and between the transmitter and receiver seems to increase the fading above the amount in clear weather. Clouds at the receiving station seem to cause stronger signals. When the signals are weak the fading is found to be slow and quite bad. Nearby wire lines were found to have no effect on fading.

FAHRENHEIT THERMOMETER SCALE.—See *Temperature, Scales of*.

FARAD.—The farad is the unit of measurement of electrical capacity. A condenser of one farad capacity would be of such size that a current of one ampere might flow into its plates for one second in charging the condenser to a pressure of one volt. A one farad condenser would be of tremendous proportions. Were the plates separated about three-eighths of an inch, with air for a dielectric, the two plates of this one farad condenser would each cover about three and four-tenths square miles. The practical units of capacity as used in radio work are the microfarad, which is equal to one millionth of a farad, and the micro-microfarad which is equal to one-millionth of a microfarad or the one-millionth part of a millionth of a farad.

FEEDBACK.—A transfer of energy from the plate circuit or output circuit of a vacuum tube back to the grid circuit or input of that same tube is called a feedback. Also, a passage of energy from any part of one stage of amplification to any part of the preceding stage or any other previous stage in a receiver is called a feedback. Feedbacks may take place from the parts of a receiver into the antenna of that receiver.

Regeneration is one form of feedback which is useful in radio. But an undesired feedback may so strengthen the impulses in the grid circuit of a tube as to cause local oscillations in the tube's circuits. Controlled feedbacks are useful while uncontrolled feedbacks are harmful.

FEEDBACK

Feedbacks may take place through any form of coupling, they may take place through condensers, through stray capacities or through the internal capacities of tubes; also through the electromagnetic couplings of coils or the windings of transformers and chokes. Feedbacks may take place through amplifying resistances or through the resistance of wiring and batteries.

Since the power in the output circuit is much greater than the power in an input circuit of a vacuum tube used as an amplifier, it is easier for this power to feed backward than for the desired forward progression to take place.

Couplings may occur across resistors (Figs. 1 and 2) as well as through inductive and capacity couplings. Feedback couplings

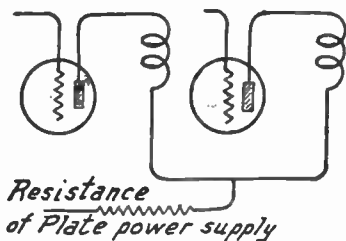

FIG. 1.—Feedback through Plate Supply Resistance to Cause Oscillation.

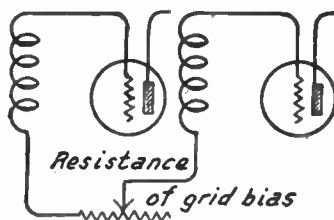

FIG. 2.—Feedback through Grid Bias Resistance to Cause Oscillation.

are lessened by bypass condensers, Fig. 3, and by arranging coils with their axes at right angles, Fig. 4. There may be electrostatic or capacity coupling between unshielded coils as in Fig. 5. Such coupling is reduced by transformers with small primaries as in Fig. 6.

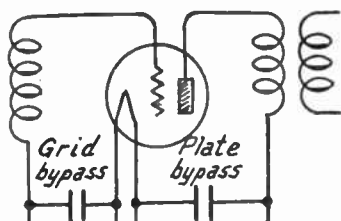

FIG. 3.—Bypass Condensers for Reducing Feedback Couplings and Oscillation.

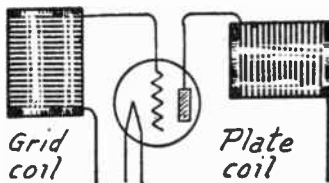

FIG. 4.—Coils Placed to Have Minimum Inductive Coupling in Reduction of Oscillation.

High frequency currents are kept out of audio frequency amplifiers by a radio frequency choke and bypass condenser in the detector plate circuit, Fig. 7. High frequency oscillation in low frequency tubes may be stopped by a small capacity bypass condenser as in Fig. 8.

Tendency to oscillate is increased by the following: Operation

FEEDBACK

at high frequencies. Use of high frequency amplifying stages. Well designed parts having low radio frequency resistance. Large coils and small condensers in tuned circuits. Close coupling in high frequency transformers. Loose antenna coupling. High plate and screen voltages, and highly negative grid bias. The opposite of all these reduces the tendency to oscillate.

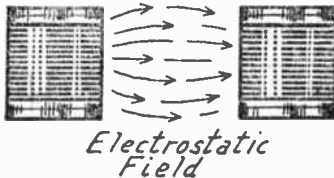

FIG. 5.—Capacity Effect between Coils Which Causes Oscillation.

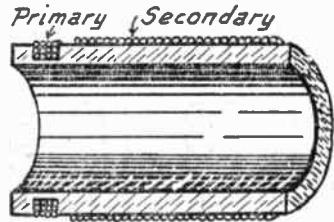

FIG. 6.—Primary and Secondary with Minimum Capacity Coupling to Reduce Oscillation.

Resistance and inductive feedbacks are lessened by the following: Bypass condensers in plate, screen and grid returns. Avoiding common returns for two or more grids. Using interstage shielding. Keeping wires for the two sides of any circuit close together.

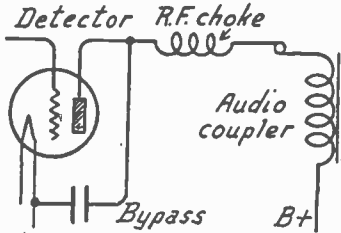

FIG. 7.—Radio Frequency Choke and Bypass on Detector for Prevention of Oscillation.

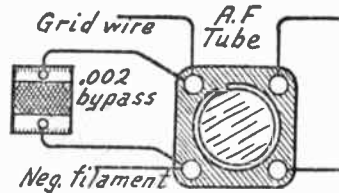

FIG. 8.—Bypass in Grid Circuit of Tube for Prevention of Oscillation.

Capacity feedbacks are lessened by the following: Using coils of small physical size. Avoiding parallel plate and grid leads. Using short leads to plates and grids. Using transformers with small primaries and little capacity coupling between windings. Avoiding excessively close inductive coupling in high frequency transformers.

Feedbacks in audio amplifiers are lessened by the following: Shortest possible wiring leads. Bypass condensers in all plate

FEEDBACK

returns, especially for detector tubes. Keeping loud speaker connections away from high frequency circuits and parts.

Oscillation increases the plate current of an amplifying tube, and often may be discovered by measuring and noting a difference between current measured with a d-c meter when the tube is amplifying and when its control grid is shorted to its cathode. Excessive use of regeneration will cause oscillation to occur.

See also *Regeneration, Action and Principle of* and *Oscillation*.

FIBRE.—Fibre is a hard, tough material made from paper and cellulose, compressed and dried into sheets, rods and tubes. This is called vulcanized fibre and comes as red fibre, black fibre or natural gray fibre according to the coloring matter that is added. Fibre absorbs moisture and upon drying it warps badly.

The dielectric constant of fibres ranges between 5.0 and 8.0. Its dielectric strength varies between 200 and 400 volts per thousandth of an inch thickness, consequently it is a good insulator. Fibre is an undesirable and altogether poor material to use in radio receiver construction as may be gathered from the fact that its phase angle difference is from three to five degrees.

Coils are sometimes wound on fibre tubing and spiderweb coils are often wound on flat fibre forms. Fibre is sometimes used for supports and for bushings. All of this indicates the cheapest and least efficient type of construction.

FIELD, ELECTROSTATIC.—Between any two electrically charged bodies there exist lines of electric force which form an electrostatic field between the two charged bodies. Any two bodies

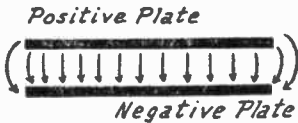

FIG. 1.—Electrostatic Field between Condenser Plates.

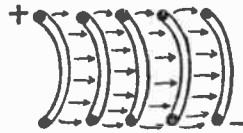

FIG. 2.—Electrostatic Field of a Coil Winding.

between which there is a difference of voltage are charged with reference to each other. The body at the higher voltage or positive voltage carries a positive charge and the one at the lower or negative voltage carries a negative charge. The space between them is placed

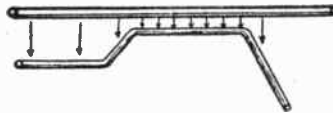

FIG. 3.—Electrostatic Field between Wires.

under a dielectric strain. Any insulating substance in this space forms a dielectric and the two bodies are then in effect the plates of a condenser.

The electrostatic field between two plates of a condenser is indicated by the arrows representing electrostatic lines of force in Fig. 1. The direction of

FIELD, MAGNETIC AND ELECTROMAGNETIC

these lines of force is assumed to be from the positively charged body to the negatively charged body.

In Fig. 2 is shown a cross section cut through the winding of a coil. If current is flowing through the coil there will be a drop in voltage from one turn to the next one. The wires forming the turns have therefore a voltage difference between them and electrostatic lines of force form small electrostatic fields between the turns.

Fig. 3 shows two wires which run parallel to each other through a part of their length. Assuming that the two wires are at different voltages there will be an electrostatic field between them as indicated by the arrows.

FIELD, MAGNETIC AND ELECTROMAGNETIC.—

The space in which are found the lines of force of a magnet is called the field of the magnet. If this field is produced by an electromagnet it is called an electromagnetic field, while if produced by a steel magnet or a permanent magnet it is called a magnetic field. There is no difference in the lines or in their action whether the field is produced by a permanent magnet or an electromagnet.

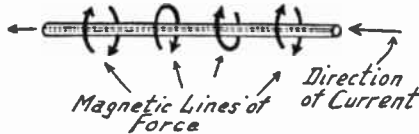

FIG. 1.—Electromagnetic Field Lines around a Conductor.

A conductor through which is flowing an electric current is surrounded by circular lines of force which whirl around the conductor as a center. These lines of force always travel around the conductor in one direction relative to the direction of current flow through the conductor as shown in Fig. 1. If the current flow is reversed through the conductor, the direction of the lines of force is also reversed

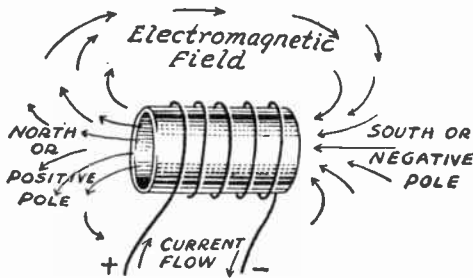

FIG. 2.—Electromagnetic Field around a Solenoid or Coil.

Should the conductor be made into a coil as shown in Figs. 2 and 3 the lines of force will not make complete circles around the turns of the conductor, but will pass completely through the coil, which is now a solenoid, and will then return in the other direction around the outside of the coil.

If a piece of iron be placed within the solenoid the lines of force that were traveling inside the coil will travel through the iron

FIELD, STRAY AND CONFINED

in the direction shown in Fig. 4, making the iron a magnet whose polarity corresponds to the direction in which current flows through the conductor. This combination of an iron core and a coil is called an electromagnet. The strength of the electromagnet depends on the number of amperes flowing through the coil and on the number of turns of the conductor around the iron core.

To produce a strong magnetic effect in iron or steel, the conductor is wound around the metal. The lines of force then go through the metal, called the core, and their direction through the core depends on the direction of current flow through the conductor and on the direction in which it is wound around the core.

The core of an electromagnet is made from soft iron, usually in thin sheets or lengths of wire in place of in a solid piece. Such a magnet retains its magnetism only as long as current flows through its winding. A small amount of magnetism remains in the core, no matter how soft the iron may be, and this remaining magnetism is called residual magnetism.

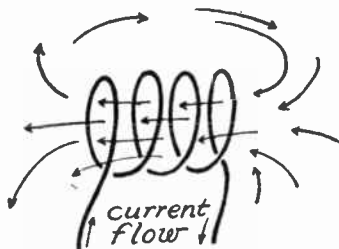

FIG. 3.—Electromagnetic Lines of Force around a Helix.

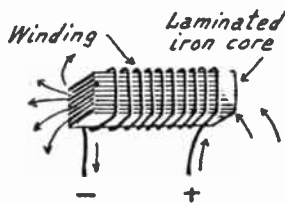

FIG. 4.—An Electromagnet with Its Field.

Every coil through which flows an electric current has around it an electromagnetic field. The coil may be wound around an iron core, it may be wound on an insulating tube, or it may be wound in the air; but the magnetic field exists nevertheless as long as current flows in the coil. The field rises out of the coil as the current starts, the field becomes stronger as the current becomes stronger, and then as the current drops away, the field lines of force shrink and recede back into nothing as the current stops. This action is called electromagnetic induction. See *Induction, Electromagnetic*. The same action takes place around any wire or other conductor in which current flows.

FIELD, STRAY AND CONFINED.—A stray field is either an electromagnetic or an electrostatic field which extends out to a considerable distance from its source of origin in a conductor carrying current or in conductors at different voltages. The stray field may interfere with the action of other parts of the receiver.

A confined field is an electromagnetic or an electrostatic field which is closely confined within a coil carrying current or between the plates of a charged condenser. Confined electromagnetic fields are such as found in closed field coils described under the heading *Coil, Closed Field Type*. Confined fields of any kind are closed fields.

FILAMENT

FILAMENT.—An electron-emitting tube cathode in the form of a wire or ribbon directly heated by flow of current through it; this heating current being separate from that which flows from the cathode to the anode.

FILAMENT CAPACITANCE.—The sum of direct capacitances between a filament and all other elements in a tube.

FILAMENT-CATHODE.—See *Filament*.

FILAMENT EMISSION.—See *Emission, Electron*.

FILAMENT RESISTOR.—Usually a fixed resistor connected in series with tube filaments to limit the maximum current. In battery-operated units the resistor may be a ballast automatically compensating to some extent for the excess of potential in new batteries.

FILAMENT RHEOSTAT.—An adjustable resistor connected in series with a filament circuit to limit current flow.

FILM GATE.—In the film system of sound pictures, the part of the mechanism that holds the film against the aperture plate.

FILM RECORDING.—See *Sound Pictures*.

FILTER.—A filter is a combination of condensers and coils that will separate direct current from alternating current or that will separate alternating current of one frequency from alternating current of a different frequency.

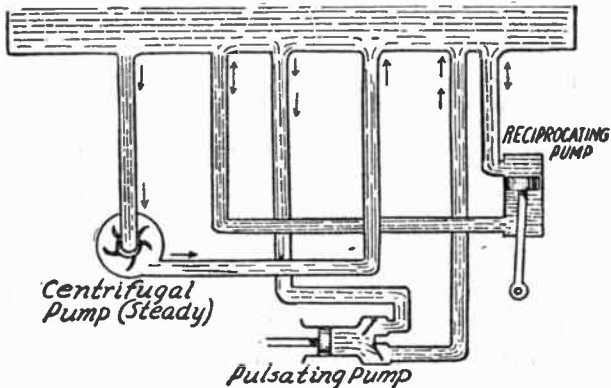

FIG. 1.—Three Water Circuits with One Common Tank.

It is possible to have a number of different currents flowing in the same wire at the same time. One wire or conductor may be common to almost any number of currents and may carry a part of many different electric circuits at the same time. This is illustrated by the water circuit in Fig. 1. Here is a large overhead tank partially filled with water and having six openings from the bottom. The centrifugal pump sends a steady flow of water in one direction through its pipe connections and the tank. The reciprocating pump sends water first one way and then the other through its piping and the tank. The pulsating pump sends water always in the same direction but in short pulses through its piping and the tank.

FILTER

All of the water circuits enter, pass through and leave the tank which is common to them all. Yet outside of the tank these circuits of the three pumps are separate and distinct.

In Fig. 2 are shown electric circuits similar to the water circuits of Fig. 1. The direct current generator sends a steady flow of electricity through its wiring connections and the common conductor. The alternator forces electricity first one way then the other through its wiring and the common conductor. The rectifier sends a pulsating direct current through its wiring and the common conductor. All of these electric circuits enter, pass through and leave the common conductor.

Between points *a* and *b* in the common conductor of Fig. 2 we find only direct current. Between *b* and *c* we find both direct and alternating current at the same time. Between *c* and *d* we have all three kinds of current. From *d* to *e* there is alternating current and also pulsating direct current. And between *e* and *f* there is only alternating current.

One side or one part of any number of electric circuits may be completed through one common wire or other conductor. It is the purpose of a filter to separate these currents at any desired point and to direct each of them separately into the conductors or wires

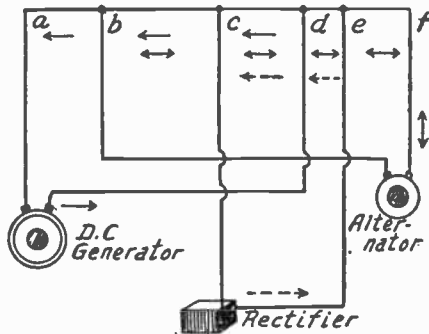

FIG. 2.—Three Electric Circuits with a Common Return.

through which we desire to have them flow and to keep them out of other wires or conductors.

A filter used to separate direct current and alternating current operates because of two facts. First, direct current will not pass through a condenser while alternating current will pass through a condenser. Second, direct current will pass freely through the windings of a coil while the same windings will offer opposition or reactance to the passage of alternating current through them.

Take the case shown in Fig. 3. Here, in the wire at the left, we have both direct current and alternating current coming along through the same wire. Then this wire divides, one part being connected to a condenser, the other to a choke coil. The dielectric which is between the plates of the condenser is an insulator as far as the direct current is concerned and the direct current cannot get through the condenser. But the direct current can pass through the winding of the choke coil with only the ohmic resistance of the

FILTER

wire to hinder its flow. So the direct current takes the path through the choke coil and avoids the path through the condenser.

But when the alternating current starts through the choke coil its alternations set up a strong electromagnetic field around the coil and the counter electromotive force set up in the coil windings so opposes the alternating current that it finds great difficulty in getting through. The condenser, if of large enough capacity, offers little opposition or reactance to the alternating current passing

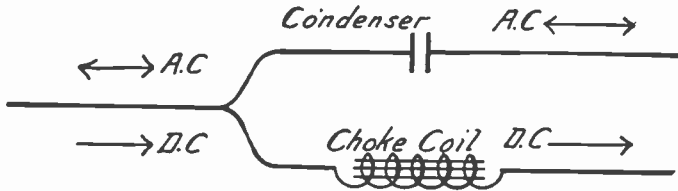

FIG. 3.—Filter Separation of Alternating Current from Direct Current.

right on through it. This is explained under the heading *Condenser, Action of*. So the alternating current takes the path through the condenser and avoids the path through the choke coil. At the right hand side of Fig. 3 the two kinds of current have been separated, each going its own way.

While it is of great advantage to be able to separate direct and alternating currents it is of equal importance to be able to separate

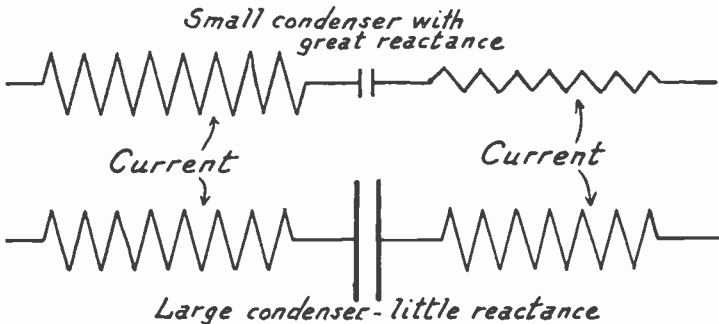

FIG. 4.—Effect of Large and Small Filter Condensers on Alternating Currents.

an alternating current of one frequency from an alternating current of a higher or a lower frequency when both frequencies are originally flowing in the same wire.

For separating different frequencies use is made of several rather peculiar properties of coils and of condensers.

In Fig. 4 an alternating current is shown passing through two condensers, one of small capacity, the other of large capacity. The condenser of small capacity offers a great reactance or opposition to any alternating current.

FILTER

The voltage or amplitude of any alternating current is reduced and the flow of current is reduced by a condenser of small capacity placed in a circuit.

At the bottom of Fig. 4 is shown the effect of a condenser of large capacity on an alternating current. The greater the capacity of a condenser, the less reactance or opposition it offers to any alternating current, consequently but little reduction in current is caused by the large condenser.

In Fig. 5 are two alternating currents passing through the same capacity or same condenser. One current is of high frequency, the other of low frequency. The high frequency current passes through the condenser with little

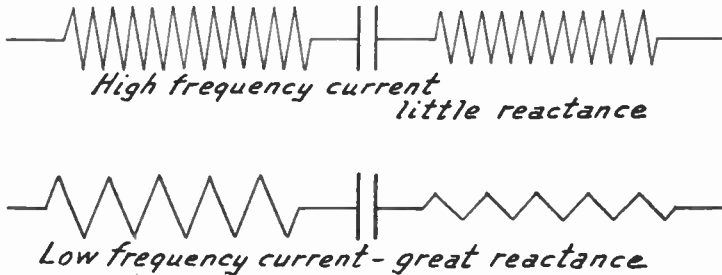

FIG. 5.—Effect of Filter Condensers on High and Low Frequencies.

reduction either in its amplitude or current flow. The condenser has little reactance or opposition to a high frequency current.

At the bottom of Fig. 5 is shown the effect of the low frequency current meeting the same condenser or capacity in its circuit. Now the current is greatly reduced. Any given size or capacity of condenser has greater reactance to low frequencies than to high frequencies. Thus it is possible to choose condensers which offer either large reactance or small reactance to alternating currents.

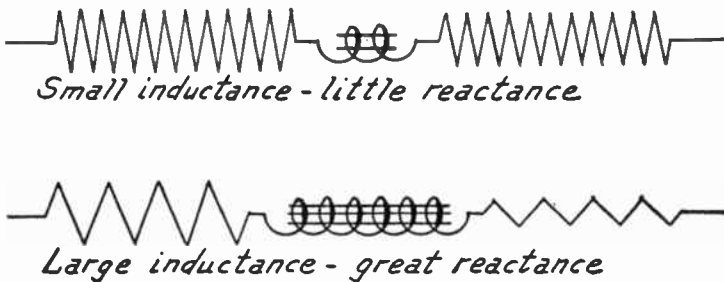

FIG. 6.—Effect of Filter Inductances on Alternating Currents.

Now to consider the effect of inductance as obtained in coils on the flow of alternating currents. At the top of Fig. 6 is shown an alternating current passing through a coil of small inductance. As may be seen, such a coil offers little reactance or opposition to the current, which passes through without much loss of voltage or amperage.

Should the amount of inductance be increased, as at the bottom of Fig. 6, and the same alternating current brought to the coil, there would be a great reduction of voltage and amperage because of the greater reactance of the larger inductance in the coil.

FILTER

Fig. 7 shows the effect of a given inductance on alternating currents of different frequencies. At the top is a current of high frequency trying to pass through the inductance coil. The coil has a large reactance to the high frequency and the flow of current is greatly reduced.

At the bottom of Fig. 7 is shown a low frequency current passing through the same inductance. Here we find but little reactance and the low frequency current passes with but small loss through the same inductance that nearly stopped the current of high frequency. So we may choose inductances or coils which offer either little reactance or great reactance to the flow of alternating currents of various frequencies.

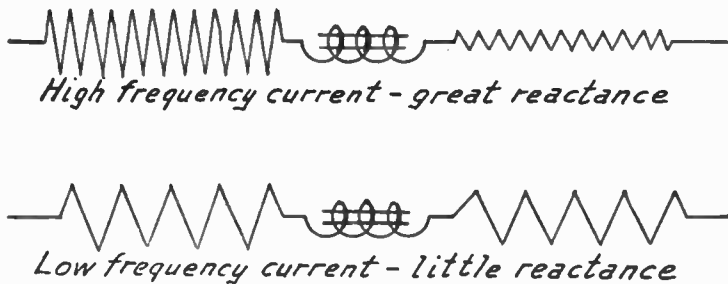

FIG. 7.—Effect of Filter Inductances on High and Low Frequencies.

The facts brought out in the foregoing examination of capacities and inductances in their effects on alternating currents of high and low frequencies are summarized in the following table:

		Amount of Opposition to Alternating Currents	
		At High Frequency	At Low Frequency
Condenser capacity.....	Small	Little	Great
	Large	Very Little	Little
Coil Inductance.....	Small	Little	Very Little
	Large	Great	Moderate

In addition to the effects produced by condensers and coils when used separately from each other, there are other valuable and useful effects to be secured by using capacities and inductances together. In Fig. 8 are shown the effects to be secured by employing series resonance and by employing parallel resonance.

At the left in Fig. 8 the circuit carries an inductance coil and a condenser connected in series. The combination of inductance and capacity will, at some certain frequency, become resonant or "tuned" to that frequency. In the con-

FILTER

dition of series resonance the reactance of the circuit drops to the lowest possible value. In fact, the opposition to current flow which is caused by the reactance of the coil and the condenser is completely balanced out and nothing remains to hold back the current except the ohmic resistance of the conductors.

At the right in Fig. 8 the coil and the condenser, the inductance and the capacity, have been connected in parallel with each other and the combination is placed in series with the rest of the circuit. Just as before, the combination of inductance and capacity will be resonant at some certain frequency. But now, in place of series resonance reducing the reactance we have parallel resonance increasing the reactance to an enormous extent. In fact the reactance in the circuit becomes so high that currents of this particular resonant frequency are practically stopped from passing through at all.

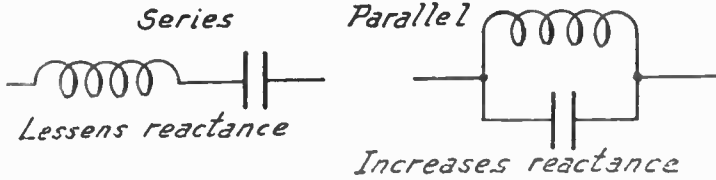

FIG. 8.—Effects of Series Resonance and Parallel Resonance in Filters.

Kinds of Filters.—Filters may be made to do almost anything in the way of passing or rejecting different frequencies of alternating current. Four principal types are in common use. These are; low pass filters, high pass filters, band pass filters and band exclusion filters. The purpose of each is shown in Fig. 9.

At the left of Fig. 9 the shaded square is supposed to represent a great number of different frequencies from low frequencies at the bottom to high frequencies at the top of the square.

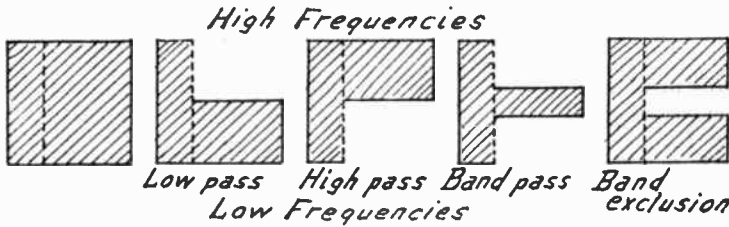

FIG. 9.—Types of Filters.

A low pass filter will allow the low frequencies to pass through the circuit but will oppose high frequencies.

A high pass filter will allow the higher frequencies to pass through the circuit but will oppose the lower frequencies.

A band pass filter will allow certain frequencies to pass through but will oppose frequencies which are either lower or higher than the band that the filter is designed to pass.

A band exclusion filter opposes certain frequencies but allows passage through the circuit of all frequencies which are either higher or lower than the band which the filter is designed to exclude.

FILTER

Low pass and high pass filters are used for the prevention of some kinds of interference and are also used in power units for supplying filament and plate current to receivers. Band pass filters are the basis of tuned radio frequency amplifier circuits and are used in the absorption type of wave traps. Band exclusion filters are used in the impedance type of wave traps.

Action of Filters.—Circuits generally consist of two sides and are composed of two conductors or wires which are called the line. As shown in Fig. 10 the line comes from the source and, after passing through the filter, goes on to the other devices in which the current is to be used.

Filter units are made up of coils, of condensers, or of both coils and condensers working together. A filter unit connected into the line may be called a line unit as in the diagram. The purpose of any unit in the line is to pass or encourage the flow of the desired

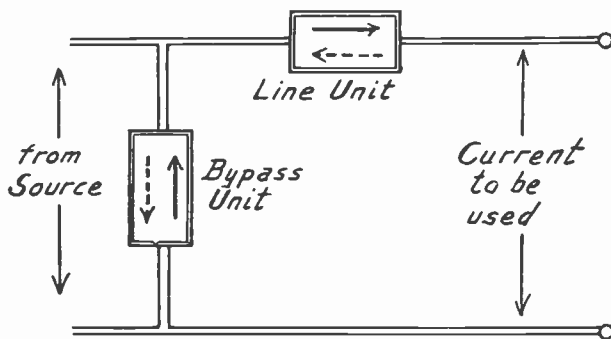

FIG. 10.—Connection of Filter Units in Circuit. Desired Frequencies in Full Line Arrows; Unwanted Frequencies in Broken Line Arrows.

frequencies and it may also resist or hold back the unwanted frequencies as indicated by the full-line and broken-line arrows in Fig. 10.

Many types of filters also employ coils, condensers, or both coils and condensers connected between the two sides of the line. Units so connected may be called bypass units. Their purpose is to bypass or to turn the unwanted frequencies back to the source without letting them go on with the current to be used. Another purpose of bypass units may be to oppose the flow of the desired frequencies so that they are forced on through the line, this also being indicated in Fig. 10.

In the types of filters to be shown it will be sufficient to illustrate the action by showing only one line unit and one bypass unit in most cases. However, it should be understood that the effectiveness of any filter will be improved if duplicates of line units are inserted in both sides of the line as in Fig. 11. Additional bypass units may also be connected as shown. The complete filter may be followed by another set of units exactly like the first set, thus further increasing the effectiveness of the whole device. This is shown at the right hand side of Fig. 11.

FILTER, BAND EXCLUSION TYPE

The capacity of bypass condensers is generally between one-half microfarad and two microfarads, although much larger capacities are often employed in the filters for power supply units and for special filters of various kinds.

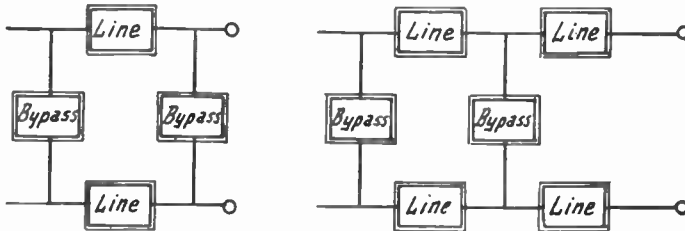

FIG. 11.—Filters Composed of Multiple Line Units and Bypass Units.

In the design of general purpose filters the reactance of the chokes is more than double that of the condensers. The ratio of condenser reactance to choke reactance usually runs between 1/10 and 1/50.

See *Coil, Choke; Condenser, Bypass; Power Unit; and Interference.*

FILTER, BAND EXCLUSION TYPE.—The purpose of a band exclusion filter is to oppose the flow of certain frequencies in a circuit while allowing the flow of frequencies both above and below the excluded band.

To prevent the passage of the unwanted frequency a coil and condenser in parallel with each other are placed in the line as shown at the left of the diagram. The inductance and capacity are of such values that the combination is resonant at the frequency to be excluded and this resonant condition offers great opposition to this frequency. Other frequencies flow through easily.

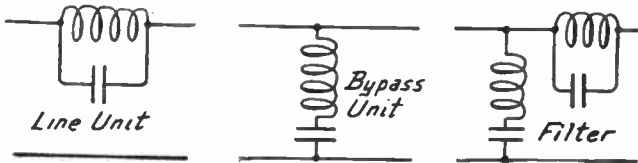

Band Exclusion Filter Units.

In the center of the diagram is shown a bypass unit consisting of a coil and a condenser in series with each other. The inductance of the coil and the capacity of the condenser are so selected that the combination is resonant at the frequency to be excluded from the main circuit. Therefore, at this frequency the bypass offers the lowest possible opposition to current flow and the unwanted frequencies go back through the bypass to the source, being thus prevented from going on through the filtered circuit.

At the right is shown the combination of line unit and bypass unit for the complete band exclusion filter. These units may be used in both sides of the line or may be repeated.

FILTER, BAND PASS TYPE.—The purpose of a band pass filter is to allow the entrance into a circuit of only a certain frequency or a narrow band of frequencies, excluding all frequencies either greater or less than those wanted.

FILTER, HIGH PASS TYPE

The combination of a coil and a condenser in series with each other will be resonant at a certain frequency. The inductance of the coil and the capacity of the condenser are selected so that they are resonant at the frequency to be passed through the circuit. Their reactance will then be least at this frequency and will be high at all other frequencies.

In the center of the diagram is shown the bypass unit for a band pass filter. This unit consists of a coil and condenser in parallel with each other. The

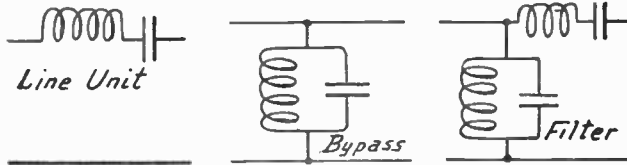

Band Pass Filter Units.

inductance of the coil and the capacity of the condenser are selected so that the combination is resonant at the desired frequency. The combination forms a case of parallel resonance which offers the greatest possible opposition to flow of current at the resonant frequency. Consequently this frequency is rejected by the bypass unit and is forced on through the circuit. All other frequencies, however, go back to the source through the bypass which offers little opposition to frequencies other than the one at which it is resonant.

At the right hand side of the diagram is shown the combination of line unit and bypass unit to form a complete band pass filter. These units may be repeated to increase the effectiveness of the filter.

FILTER, HIGH PASS TYPE.—A high pass filter is designed to allow all frequencies above a certain point to flow in a circuit and to prevent the flow of all frequencies below this point. A condenser will pass currents of high frequency much easier than currents of low frequency. A condenser is inserted in the line as shown at the left in the diagram, the capacity of this condenser being selected of such value as to allow passage of frequencies above the desired cut-off point and to hinder the flow of frequencies below this point.

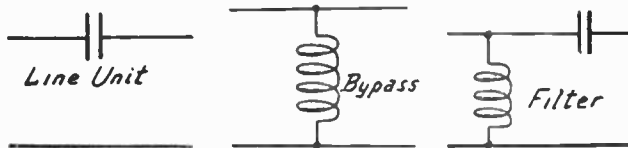

High Pass Filter Units.

In a high pass filter it is desired to return all frequencies lower than the critical point to the source and to accomplish this an inductance coil is used for a bypass as shown at the center of the diagram. An inductance will allow comparatively free flow of low frequencies through it while offering great opposition to higher frequencies. The inductance of this coil is of such value that it carries off the frequencies below the cut-off point, but rejects the higher frequencies which are thus forced to pass on through the circuit.

The combination of a line condenser and a bypass coil to form a high pass filter is shown at the right. As with all other filters, these units may be repeated. Since the cut-off points of coils and condensers with respect to frequency are not sharply defined it is necessary to build a high pass filter of repeated units if it is to be reasonably effective in its work.

FILTER, LOW PASS TYPE

FILTER, LOW PASS TYPE.—A low pass filter is used to allow all frequencies below a certain value to pass into a circuit while rejecting or turning back all higher frequencies. An inductance coil inserted in the line, as at the left hand side of the diagram, will allow low frequencies to pass through it with comparative ease while offering much greater opposition to high frequencies.

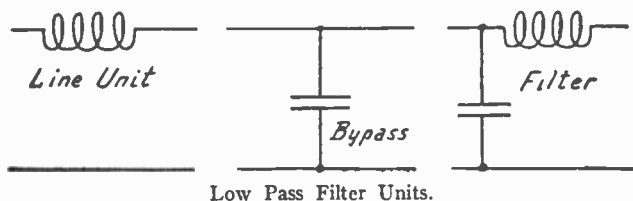

In order to turn the undesired high frequencies back to the source a condenser may be used as a bypass as shown in the center. The capacity of a condenser may be selected of such value that it offers little reactance or opposition to frequencies above a certain value, yet greatly impedes the flow of lower frequencies through it. Such a condenser is used for low pass filters.

At the right hand side of the diagram is shown the combination of a coil line unit and a condenser bypass unit, making a low pass filter. The inductance of the coil holds back the higher frequencies, which are bypassed through the condenser. The condenser rejects the lower frequencies, which are allowed to pass through the coil to the circuit.

The cut-off points of coils and condensers are not at all sharp with reference to passing or rejecting certain frequencies, therefore a low pass filter should be made up of a number of similar units as shown at the right.

FILTER, SCRATCH.—See *Phonograph*.

FILTER, WAVE.—See *Trap, Wave*.

FINDER, DIRECTION.—See *Compass, Radio*.

FIXED CONDENSER.—See *Condenser, Fixed*.

FIXED COUPLER.—See *Coupler, Fixed Type*.

FIXED RHEOSTAT.—See *Resistor, Filament Control*.

FLAT TOP ANTENNA.—See *Antenna, Forms of*.

FLEMING VALVE.—A two-element vacuum tube used as a detector.

FLUX, DENSITY OF.—See *Iron and Steel*.

FLUX, DIELECTRIC.—It is considered that when the plates of a condenser are charged with a certain quantity of electricity an equal quantity of electricity is displaced or moved through the dielectric which is between the plates of the condenser. This electricity that is displaced in the dielectric is called the dielectric flux. See *Current, Displacement*.

FLUX, ELECTROMAGNETIC.—The magnetism which flows in a magnetic circuit and forms the field of the magnet or coil is called the electromagnetic flux. The flux consists of the lines of force. See *Field, Magnetic and Electromagnetic*.

FLUX, LEAKAGE

FLUX, LEAKAGE.—In an electromagnetic circuit a part of the lines of force do not completely encircle all of the turns of the magnet coil. The part of the flux which is not useful in producing linkage is called the leakage flux.

FLUX, SOLDERING.—See *Soldering*.

FM RECEIVER.—See *Receiver, Frequency Modulation*.

FORCED ALTERNATION.—See *Current, Alternating*.

FORCED OSCILLATION.—See *Selectivity*.

FORM, COIL WINDING.—See *Coil, Design*.

FORMICA.—See *Phenol Compounds*.

FOUCAULT CURRENT.—See *Current, Eddy*.

FRAME.—See *Television*.

FRAME ANTENNA.—Another name for a loop. See *Loop*.

FRAME, RECEIVER.—In many of the more modern types of receivers all of the units are carried upon a strong metallic framework which is called the receiver frame.

This framework is generally made up of cast brackets of aluminum or of brass. Provision is made for supporting a sub-panel at some distance above the bottom of the cabinet when a sub-panel is included in the receiver's design. Otherwise the framework is built so that tuning condensers mount solidly in the framework and tuning coils may be supported at convenient points for proper connection into their circuits. The framework always carries the front panel which may be of metal or of some dielectric material. With all of the parts mounted on the frame a complete receiver is formed and this receiver may then be handled as a unit.

FREE ALTERNATIONS.—See *Current, Alternating*.

FREE OSCILLATION.—See *Oscillation*.

FREQUENCY.—The number of complete cycles that occur during one second in an alternating current is called the frequency of the current. A cycle includes the time between the rise of the current from zero to maximum in one polarity, its fall to zero, rise to maximum in the other polarity, and return again to zero.

Various frequencies are used in radio. Audible frequencies lie between 16 and 15,000 cycles per second. Broadcasting transmission frequencies or carrier wave frequencies vary from 550,000 cycles to 1,500,000 cycles. Visible light rays are measured in hundreds of trillions of cycles per second. The frequency of X-rays is far higher than that of the visible light rays.

FREQUENCY, AUDIO.—Audio frequencies include all of the frequencies of vibration of sound waves which can be heard by the human ear. The lowest audible frequency is around 16 cycles per second while the highest audible frequency is somewhat higher than 10,000 cycles per second. The parts of a radio receiver which

FREQUENCY, BEAT

handle and amplify these audible frequencies are called the audio frequency parts of the receiver. Audio frequency is generally abbreviated "A. F." See also *Sound*.

FREQUENCY, BEAT.—See *Beats, Formation of*.

FREQUENCY, CRYSTAL CONTROL OF.—See *Crystal, Frequency Control by*.

FREQUENCY DISTORTION.—See *Distortion*.

FREQUENCY, FUNDAMENTAL.—All radio circuits contain inductance and capacity. An antenna circuit contains the capacity of the antenna and the inductance of the antenna as well as the inductance of any coil connected in this circuit. All coils have inductance but have distributed capacity as well.

Any combination of inductance and capacity forms a resonant circuit at some frequency. No matter how small the inductance nor how small the capacity there will be a frequency, although it may be a high one, at which they form a resonant circuit. The frequency at which the natural inductance and capacity in any circuit or any unit are resonant is called the fundamental frequency. Another name for fundamental frequency is natural frequency. The fundamental or natural frequency is the frequency at which the unit or circuit is resonant without making any adjustments or intentional changes either in the capacity or the inductance and without adding either external inductances or external capacities.

FREQUENCY, FUNDAMENTAL OF ANTENNA.—See *Antenna, Fundamental Frequency of*.

FREQUENCY, GROUP.—The number of sets or groups of waves passing in one second is called the group frequency. The number of groups per second is usually low enough so that the group frequency is an audio frequency or the frequency of an interrupted continuous wave.

FREQUENCY, HIGH.—The terms high frequency and low frequency have a relative value only. Compared with the 60-cycle frequency ordinarily used in house lighting and power circuits a frequency of 500 cycles is considered to be a high frequency. Compared with a broadcasting frequency of perhaps 1,000,000 cycles per second a frequency of 15,000,000 cycles per second used in amateur radio is a high frequency.

FREQUENCY, IMAGE.—See *Receiver, Superheterodyne*.

FREQUENCY, INTERMEDIATE.—In between audio and radio frequencies. See *Receiver, Superheterodyne*.

FREQUENCY, LOW.—See *Frequency, High*.

FREQUENCY, MEASUREMENT OF.—See *Meters, Frequency*,

FREQUENCY, METERS FOR.—See *Meters, Frequency*.

FREQUENCY MODULATION.—See *Receiver, Frequency Modulation*.

FREQUENCY, RADIO.—Radio frequencies include all of the

FREQUENCY, RADIO

frequencies of radio waves which are used for the transmission of radio signals through space. These frequencies range from between 90,000 and 100,000 cycles per second in long wave transmission up to 400,000,000 or more cycles per second used in some kinds of amateur transmission.

The parts of a radio receiver which take these frequencies from the waves coming through space, amplify them and deliver them to a detector tube, are called the radio frequency parts of a receiver. Radio frequency is generally abbreviated "R. F."

FREQUENCY, REACTANCE AFFECTED BY.—See *Reactance*.

FREQUENCY, RESONANT.—Any circuit in which are found inductance and capacity will combine its inductive reactance with its capacitive reactance so that the two balance out at some certain frequency, leaving only the ohmic resistance in the circuit. The frequency at which this balancing of the two reactances takes place is the resonant frequency for that circuit with its particular values of inductance and capacity. See *Resonance*.

A tuned circuit in a radio receiver has either its capacity or its inductance adjusted so that their reactances balance out and make the circuit resonant at the frequency which is to be received and to which the circuit is tuned. See *Resonance, Inductance-Capacity Values for*.

FREQUENCY, SUM.—See *Beats, Formation of*.

FREQUENCY, WAVELENGTH RELATION TO.—See *Wavelength, Frequency Relation to*.

FULL WAVE RECTIFIER.—See *Rectifier, Full Wave*.

FUNDAMENTAL FREQUENCY.—See *Frequency, Fundamental*.

FUNDAMENTAL WAVELENGTH.—See *Antenna, Fundamental Frequency of*.

FUSES AND PROTECTIVE DEVICES.—When using batteries as a source of filament voltage and of plate voltage for the tubes in a receiver there is considerable danger that the voltage of the plate battery will be accidentally applied to the filament circuit. The result will be an instantaneous burning out of the filaments in all tubes connected to circuits receiving this abnormally high voltage. Of course it is not the voltage that causes the filaments to burn out but is the greatly increased flow of current or increase in the number of amperes that pass through the filaments under the effect of the high voltage.

Various forms of fuses have been made for attachment to the filament circuits of vacuum tubes in such a way that any abnormal increase of voltage would immediately cause burning out of the fuse, this resulting in opening the filament circuit and protecting the filaments themselves. It is quite difficult to make a fuse which will be burned out by the increase of amperage which is sufficient to destroy a tube's filament.

G

GAIN.—The ratio of the output power, voltage or current to the input power, voltage or current of an amplifier or an electrical system. See *Amplification, Voltage and Power.*

GAS-FILLED PHOTOTUBE.—See *Cell, Photoemissive.*

GAS-FILLED TUBE.—See *Tube, Gas-filled.*

GENERATOR, SIGNAL.—See *Oscillator, Modulated.*

GLOW DISCHARGE.—See *Ionization.*

GLOW TUBE.—See *Tube, Glow.*

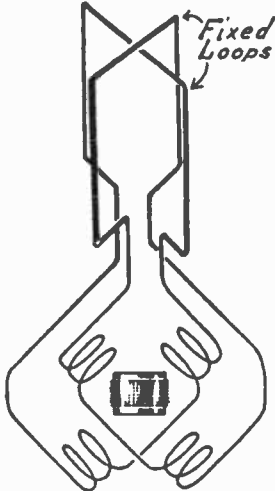

Principle of the Goniometer.

GONIOMETER.—A form of radio compass or direction finder employing two loops mounted in fixed position with their planes at right angles. Each loop is tuned by a condenser, with both condensers operated by a single control. In series with each loop are two coils. The four coils are arranged as shown in the drawing. At the intersection of the axes of the loop coils is a small pickup coil which is connected to the input of a receiver. The pickup coil is rotated until the receiver output becomes of minimum value. With the pickup coil rotates a dial or pointer whose position when the weakest signal is received indicates the direction from which the signal is coming to the loops.

GREEK LETTERS.—See *Symbols.*

GRID BIAS.—See *Bias, Grid.*

GRID-GLOW TUBE.—See *Tube, Grid-glow.*

GRID-POOL TUBE.—See *Tube, Grid-pool.*

GRID RETURN.—See *Return, grid.*

GROUND, RECEIVER.—The ground terminal of a receiver should be connected through insulated copper wire to a cold water pipe or other metal which leads into permanently moist earth. If such a ground is not accessible, the connection may be made to a rod or pipe driven five or six feet into the earth, or to a metal plate one or two feet square which is buried in the earth. Connection to a cold water pipe should be made with a ground clamp designed for the purpose, or made to a buried ground with a soldered joint. A length of copper wire laid in a stream or immersed in a cistern or well makes a satisfactory ground. All joints and connections in the grounding lead should be of low resistance and of permanently tight construction.

H

h.—A symbol for henries of inductance.

H.—A symbol for magnetic field intensity.

HACK SAW.—See *Tools*.

HALF WAVE RECTIFIER.—See *Rectifier, Half Wave*.

HAMMER.—See *Tools*.

HARD RUBBER.—See *Rubber, Hard*.

HARD TUBE.—See *Tube, Hard*.

HARMONIC.—A harmonic is a frequency which is a multiple of another frequency. The first frequency is called the fundamental frequency. A frequency twice as great is called the second harmonic, one three times as great is the third harmonic, one four times as great is called the fourth harmonic, and so on.

Starting with a fundamental frequency of 600,000 cycles or 600 kilocycles, for an example, its second harmonic would be 1,200,000 cycles or 1200 kilocycles. Its third harmonic would be three times the fundamental, or 1800 kilocycles, the fourth harmonic being four times the fundamental of 2400 kilocycles.

In music, harmonics are desired since they make the tone difference between two different instruments sounding the same note. A certain note struck on a piano sounds different from the same note on a violin, yet the fundamental frequency is the same for both. The piano produces one series of harmonics along with the fundamental while the violin produces a different series of harmonics, thus making its note differ from that of the piano. Musical harmonics are called overtones.

In broadcasting it is desired that the transmitter send out a carrier wave of a fundamental frequency only. No harmonics are desired, in fact they are very harmful since they too are transmitted and may be received if sufficiently strong. A loosely coupled and properly controlled transmitter will not emit harmonics.

Taking the series of harmonics of the fundamental frequency of 600 kilocycles mentioned in a foregoing paragraph, it is interesting to trace the frequencies and wavelengths of the several harmonics. The second harmonic of 1200 kilocycles corresponds to 250 meters wavelength while the fundamental frequency of 600 kilocycles corresponds to 500 meters wavelength. The third harmonic of 1800 kilocycles forms a wavelength of 166.6 meters. The fourth harmonic of 2400 kilocycles is at a wavelength of 125 meters while a fifth harmonic of 3000 kilocycles would have a wavelength of 100 meters. In each case the approximate wavelength is found by dividing 300,000,000 by the frequency in cycles or by dividing 300,000, by the frequency in kilocycles. See also *Sound*.

HEADPHONE.—See *Phone, Head*.

HEAT.—See *Temperature, Scales of*.

HEATING, ELECTROSTATIC

HEATING, ELECTROSTATIC.—Electrostatic heating, called also dielectric heating, is a method used in industrial processes for heating materials that are poor conductors or insulators, such as plastics, cements and glues, woods and fabrics. Electrostatic heating employs high-frequency voltages to produce dielectric displacement currents in materials that are non-conductors. Induction heating employs high-frequency voltages to produce induction currents in materials that are good conductors, such as metals of all kinds.

A simplified circuit for an electrostatic heating system is shown by Fig. 1. The material to be heated is placed between two metallic electrodes which are connected across part of the coil winding in the tuned plate circuit, or tank circuit, of an oscillator tube.

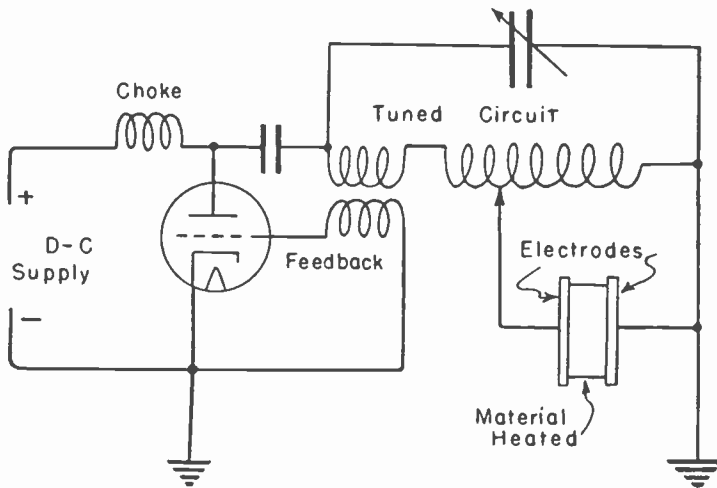

FIG. 1.—Simplified Circuit for Electrostatic Heating.

coil thus are applied to the electrodes, and the material between them is subjected to rapidly alternating electrostatic fields.

In a non-conducting material nearly all of the electrons are tightly bound in the atoms of the material, and there are but few free electrons which might form an electric current flowing all the way through the material from one electrode to the other. It is this characteristic of having tightly bound electrons and very few free ones that marks the chief difference between non-conductors, insulators or dielectrics, and the good conductors in which there are great quantities of free electrons.

While the alternating electrostatic field is acting in one direction through the material to be heated, the bound electrons are subjected to a stress that shifts them a very little way with reference to the centers of their atoms. This shift is toward the electrode that is instantaneously positive. Although the force exerted by the electrostatic field is great enough to move the elec-

HEATING, ELECTROSTATIC

trons, they are not carried completely away from their atoms to form free electrons but still remain as part of their atomic structures. When the field reverses, the electrons are shifted in the opposite direction.

This back and forth motion of the bound electrons is a current in the sense that any electrons in motion form what we call a current. But the current continues in one direction only until the heated material, now acting like the dielectric of a condenser, is charged to the extent permitted by the capacity and by the voltage applied during one cycle. The momentary current that alternates in direction may be called displacement current, charging current, or dielectric flux.

Were the current to be continuous from one electrode to the other there would have to be quantities of free electrons taking part in the movement. To free these electrons from their atoms would require a high voltage, and the tearing apart of the atoms would mean a breakdown and puncture of the material which would char or burn it. In the displacement current there is a total movement of a number of electrons per second through enough back and forth distance to be the equivalent of a large current flowing continuously from side to side of the body of material, or, at least, the displacement current is equivalent in heating effect to a large continuous current. The large displacement current causes heating of the dielectric material just as any current in any substance heats that substance; the reason being relative movement of electrons and their atomic structures, and the resulting electronic friction. But the displacement current does not break down the heated material as would an equivalent continuous current.

An ideal dielectric material would be one with which all of the energy put into it during charge would be returned to the supply circuit during discharge. It would act like a perfectly elastic spring which, on expansion, would give back all the energy that had been used to compress it. But during bending or straining of any actual spring some of the input energy is used to overcome friction between molecules of the metal as they are forced to move with reference to one another.

Materials which are electrostatically heated are far from being ideal dielectrics, and, as with the imperfectly elastic actual spring, require that power be used to overcome the electronic friction as the electrons are shifted one way and the other with reference to their atomic structures. The effect of the electronic friction is called dielectric hysteresis, and it is the watts of power used to overcome it that cause heating of the material.

The electrodes between which the heated material is placed usually are sheets of copper whose edges extend slightly outside the material. The edges and corners of the electrodes are slightly rounded to lessen the chance of a corona or brush discharge into surrounding air. Such discharges occur from sharp edges or points which are at high potential, and they cause a loss of power. Air spaces between electrodes and heated material are eliminated so far as is possible, because to maintain electrostatic fields through extra air spaces would require extra voltage and power. Since the electrodes are good conductors they are not electrostatically heated, and they remain cool except for heat conducted into them from the heated material.

As at *A* and *B* in Fig. 2, the electrodes and the heated material may be arranged so that the outer electrodes, which often are parts of a press, are grounded and remain at ground potential. These arrangements also permit heating several pieces of material at the same time. In some cases power is

HEATING, ELECTROSTATIC

applied through adjustable capacitors as at *C*, or through an adjustable inductive coupling as at *D*.

Operating frequencies are from two million to one hundred million cycles, or from two to one hundred megacycles. Voltages range as high as 15,000 to 20,000. The same heating effect may be had at high frequencies and relatively low voltages, or at lower frequencies and relatively high voltages. The heating effect depends on the product of volts and the square root of frequency in cycles. For example, on a given job it might be possible to use 4,000 volts at 4,000,000 cycles or to use 2,000 volts at 16,000,000 cycles, for here the square roots of the frequencies are respectively 2,000 and 4,000, and products of these square roots and the corresponding voltages are the same in both cases. In both cases the heating power input in watts or kilowatts, and the time for heating, would be the same.

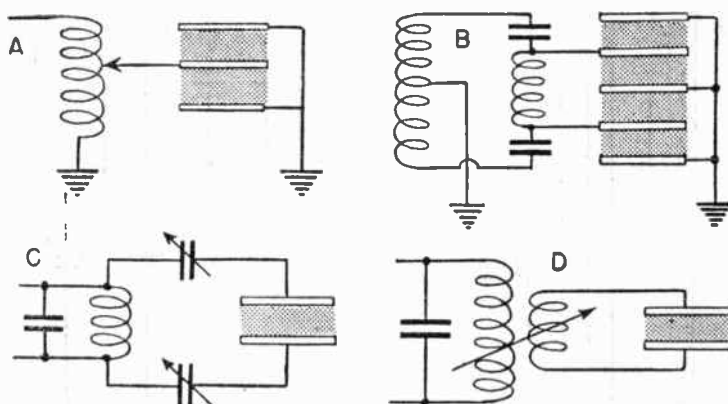

FIG. 2.—Electrode Arrangements for Electrostatic Heating.

The voltage must not be so high as to break down the material, so is limited by the dielectric strength of the material or by the number of volts which a given thickness will withstand without being punctured. This means that higher voltages may be used with thicker materials, and that the voltage must be reduced for thin sections. Also, most materials lose some of their dielectric strength as they become heated, and this characteristic further limits the permissible voltage. The highest permissible voltages are advantageous because heating effect varies as the square of the voltage.

Materials which may be subjected to only rather low voltages may usually be heated at relatively high frequencies to maintain a satisfactory time for heating. The higher the frequency the faster the heating when other conditions remain unchanged. If the frequency is made so high that the corresponding wavelength becomes comparable to the thickness of the material being heated there may be production of standing waves between the electrodes and a non-uniform heating effect in the material. But because the thickness would be nearly 12 feet for a wavelength corresponding to a frequency of 100 megacycles this is not a serious limitation.

HEATING, ELECTROSTATIC

Displacement current or charging current, which is the heating current, varies with the dielectric constant of the material heated. The dielectric constant is a direct measure of the charge which may be put into a condenser, so is a direct measure of the current which may move in a condenser during charge and discharge. For any given combination of voltage and frequency the displacement current will vary almost directly with the dielectric constant of the material. Dielectric constants of most materials which are electrostatically heated run from four to eight, although some woods run as low as 1.5. The dielectric constant of water is about 80, so any material that is moist will have a relatively high dielectric constant.

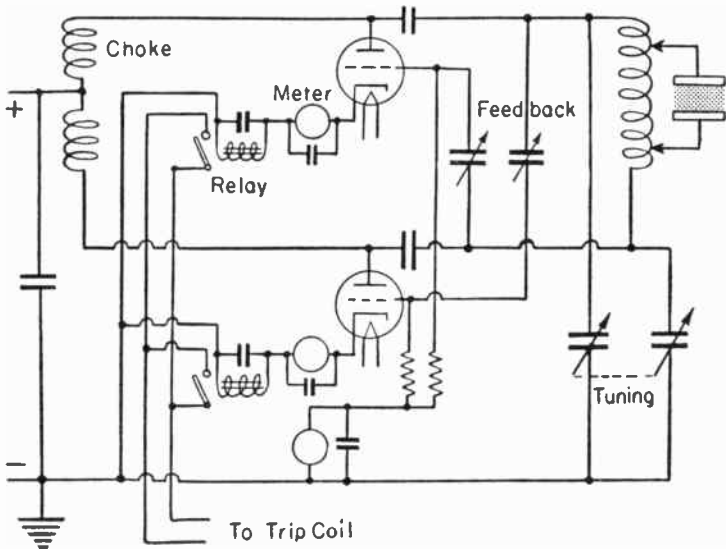

FIG. 3.—Typical Circuit for Electrostatic Heating.

Heating depends also on the dielectric power factor of the material handled. This dielectric power factor is the ratio of the power used to overcome electronic friction or dielectric hysteresis to the total applied power as measured in the product of volts and amperes, or is the ratio of power used up in the material to the total applied power. The difference between applied power and power consumed is the power returned to the supply circuit during discharge of the condenser which is formed by the heated material and the electrodes. The power factor varies with the kind of material. With materials such as glass, which are classed as good dielectrics, the dielectric power factor may be around 0.004, while with poor dielectrics such as fibre it may be about 0.04.

HEATING, ELECTROSTATIC

The heating effect is approximately proportional to the product of dielectric constant and power factor. This product sometimes is called the loss factor. The greater the dielectric constant and the higher the power factor, or the greater the loss factor, the more heating is produced by a given applied power. As a consequence, the poorer the heated material when considered as a dielectric for a condenser, the more efficiently it may be heated electrostatically. Non-conductors of electricity are almost invariably poor conductors of heat, so are ill adapted to ordinary methods of heating by thermal conduction from hot bodies, while being well adapted to electrostatic heating.

The power required for electrostatic heating is approximately proportional to the number of cubic inches of material heated. Heating time for thick sections need be no longer than for thin ones provided there is available sufficient power per cubic inch. Heating will be uniform throughout the material unless there are different loss factors in various portions of it. There is little tendency to damage the surfaces or surface finishes.

Fig. 3 shows a circuit for electrostatic heating in which power is furnished from two oscillator tubes to the oscillatory circuit which is tuned by a two-section ganged condenser. Feedback to the grid of each tube is through an adjustable condenser from the plate circuit of the other tube. The tube plates are supplied with positive potential through high-frequency chokes from the positive side of the rectifier output circuit. The negative supply line is connected to the tube cathodes and to ground. Meters are in the cathode line of each tube and in the common portion of the grid circuit. In the cathode lines are overload relays which operate a circuit breaker in the rectifier power supply.

HEATING, INDUCTION

HEATING, INDUCTION.—Induction heating or inductive heating is an industrial method for heating all kinds of metals. With other methods of heating the heat is conducted from a furnace, oven, or some hot body into the metal whose temperature is to be raised, but with induction heating the high temperature is produced originally and directly in the metal. The metal is placed within an alternating magnetic field which induces in the work itself electric currents whose flow is opposed by resistance of the metal. The electric energy of the currents thus is changed to heat energy just as in any conductor wherein there is flow of current against the opposition of resistance. In magnetic metals, including iron, steel, and some alloys, additional heat is produced by the rapidly alternating magnetization and demagnetization of the work, or by magnetic hysteresis. Induction heating occurs only in electrical conductors, while electrostatic heating occurs only in non-conductors.

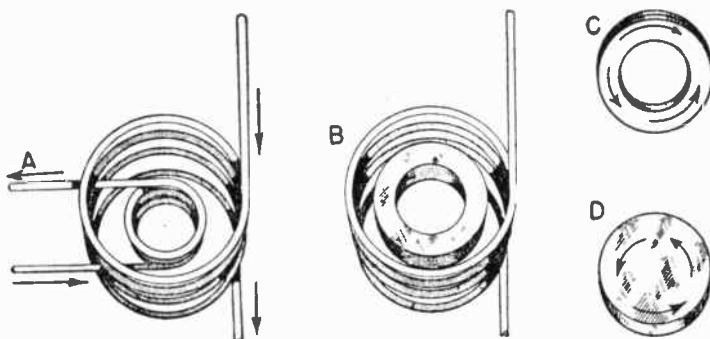

FIG. 1.—Elementary Principle of Induction Heating.

Fig. 1 shows the elementary principle of induction heating. At *A* there is one coil within another. When there is any change of current in either coil there is a change of the magnetic field of that coil. The field expands as current increases, and contracts as current decreases. The expanding and contracting magnetic lines cut through the turns of the other coil. This cutting of the magnetic lines through the conductors of the other coil induces in those conductors an electromotive force which, if the coil is part of a closed circuit, will cause current to flow in it. This is the same action that occurs with the two windings of a transformer.

At *B* in Fig. 1 a ring of metal has been substituted for the inner coil. Such a ring is simply a closed circuit consisting of a single turn of conductor. Currents are induced in the ring, and flow as shown at *C*. If the hole in the ring is eliminated, as at *D*, induced currents will flow around the solid disc. Instead of replacing the inner coil with a ring or disc the outer coil might be replaced with a ring or any piece of metal having a hole large enough to take the inner coil, and currents would be induced in this ring or piece of metal by changes of current in the inner coil. When alternating current flows in the coil there are alternating emf's induced in

HEATING, INDUCTION

whatever metal is in the magnetic field of the coil, and alternating currents will flow in the metal. These alternating currents produce a heating power in watts which is equal to the product of the square of the current in amperes and the resistance of the metal in ohms, or to I^2R . The alternating currents induced in the work may be called eddy currents.

Fig. 2 is a simplified circuit diagram showing one way in which high-frequency alternating currents are supplied to the coil which induces heating currents in the work. Power in the heater coil is adjusted by connecting it to various taps on the plate coil in the oscillatory circuit or tank circuit of an oscillator tube. Direct-current power supply is furnished by high-voltage rectifiers.

Aluminum, brass, copper, and other non-magnetic metals are heated only by the effects of induction currents as just described. Iron, steel, and magnetic alloys are heated by induction currents and also by the effects of magnetic hysteresis. These magnetic

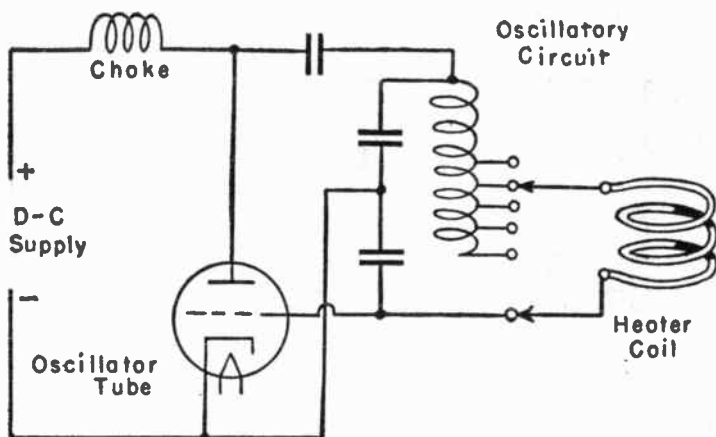

FIG. 2.—Simplified Circuit for Induction Heating.

materials are magnetized first in one direction and then in the opposite direction by the alternating magnetic fields of the heater coil. When there is a reduction of the magnetizing force which has been acting in one direction the magnetization of the work does not drop as fast as the force, and when the magnetizing force has become zero there still is much residual magnetism in the metal. As the magnetizing force reverses its direction it must overcome the residual magnetism before magnetization can occur in the other direction or other polarity. The force or energy used twice in every cycle to overcome the residual magnetism produces heat in magnetic metals. The delay in the rate of magnetization and demagnetization caused by residual magnetism is called magnetic hysteresis.

HEATING, INDUCTION

When induction currents are induced in any metal there are produced at the same time within the metal magnetic fields that tend to force the currents out of these fields. This means that the currents are forced away from the interior of the metal and toward the outer surfaces or the skin. The action is called skin effect. Skin effect becomes more pronounced as the operating frequency is increased. This is illustrated by Fig. 3. Direct current is uniformly distributed throughout the body of a conductor. At a few thousand cycles nearly all the current is in a small outer shell, and at very high frequencies all the current is in a slight depth at the surface. Skin effect is greater in magnetic metals than in those that are non-magnetic.

Induction heating occurs only where induced currents flow in the work. As a consequence, skin effect confines the induction heating to the surface or to a shell near the surface of the work. The higher the frequency the less is the depth of current and of heating, so the degree of penetration may be controlled by regulating the frequency. This allows work to be heated all the

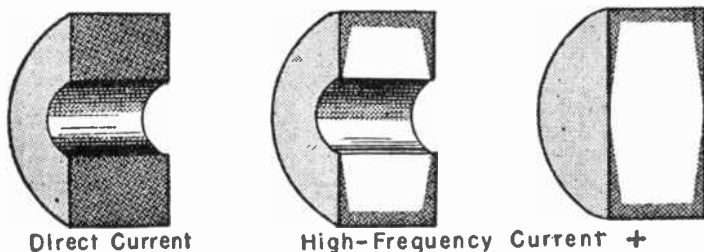

FIG. 3.—High-frequency Currents Are Induced Chiefly in the Skin or Outer Part of Heated Metals.

way through, as when it is to be melted, or to only a little depth as for surface hardening. A surface may be heated red hot in from two to ten seconds.

The depth of induction heating is inversely proportional to the square root of the frequency, or is proportional to the number 1 divided by the square root of the frequency. Increasing the frequency by 100 times will lessen the penetration to $\frac{1}{10}$ of its original depth. Penetration increases directly with resistivity of the work; double the volume resistivity means double the depth of heating. Penetration is inversely as the magnetic permeability of the heated metal. The permeability of non-magnetic materials is 1, and of magnetic materials is higher than 1. The greater the permeability the shallower is the heating. It should be noted that at a certain high temperature, called the Curie point, metals which are magnetic at lower temperatures become non-magnetic or suffer a reduction of permeability, which allows deeper heating. The Curie point for iron is about 1450° F.

Although heating by induction currents may be confined to the surface, heat produced there is conducted very rapidly to the interior of the work. To have high temperature only near the surface the heating power may be applied for only a brief time, and there must be a total depth of metal great enough so that portions below those carrying heating currents do not have time to get hot before the power is cut off.

HEATING, INDUCTION

Some induction heating is done at power frequencies of 50 or 60 cycles where the object is melting, heat treatment throughout, or heating of steam chambers and chemical vats. Frequencies up to 12,000 or 15,000 cycles usually are furnished by motor-driven high-frequency induction alternators connected to the heater coil as in Fig. 4. Such equipment is used for melting, for heat treatment, an-

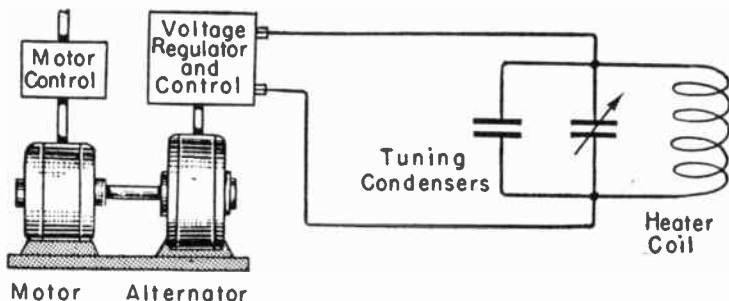

FIG. 4.—Medium Frequencies for Induction Heating Are Produced by Rotating Machines.

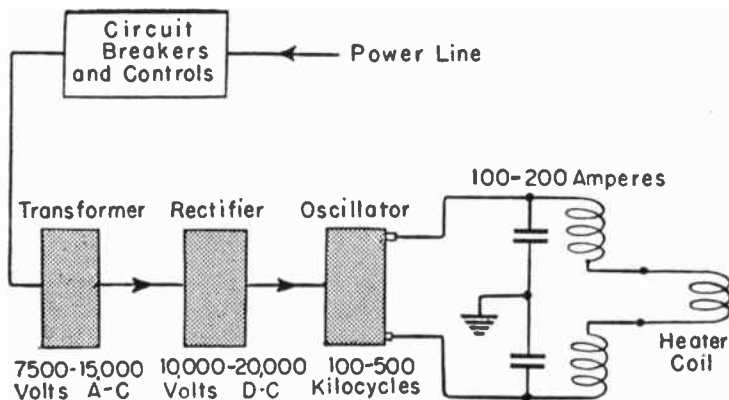

FIG. 5.—Principal Parts of an Induction Heating System.

nealing, and similar purposes. Frequencies higher than may be obtained economically from rotating machines are furnished by various types of power oscillators using electronic tubes. These oscillator frequencies usually range from 15 to about 450 kilocycles, or to just below the broadcast frequencies. The oscillator and power system are generally similar to those used for broadcasting. The frequency required varies with the depth to which the work is

HEATING, INDUCTION

to be heated. The smaller and thinner the work, or the less the depth of heating, the higher must be the frequency.

Because heating currents must result from induction there may be no electrical connection or contact between the work and the heater coil. High-frequency coils often consist of from one to ten turns, and may be formed to fit around the work with a clearance of $\frac{1}{8}$ inch or less. The smaller the clearance the closer is the coupling and the more power is transferred from the coil to the work. The coils usually are of small diameter copper tubing. Water may be circulated through the coil tubing to remove excess heat that results from coil currents that often are 100 amperes or more. Heater coils are connected to the oscillator plate circuit coil through spaced taps on the plate coil. To have maximum power transfer from one circuit to another it is necessary that the impedances be matched as closely as possible, which is the case with all transfers of power.

In Fig. 5 are represented the principal parts of a typical induction heating system. The power line is connected through circuit breakers and automatic controls to a transformer which raises the potential to between 7,500 and 15,000 volts, at which the power goes to phanotron rectifier tubes whose direct-current output is between 10,000 and 20,000 volts. This high voltage is fed to pliotron oscillator tubes operating at 100 to 500 kilocycles frequency and furnishing 100 to 200 amperes of high frequency current to the circuit in which is connected the heater coil. The relations between voltage and currents in the high frequency circuits may be adjusted by air-core transformers. Power may be regulated by tapped auto-transformers and by adjustments in the grid circuits of the oscillator tubes. Heating and cooling times may be controlled with automatic time-delay relays.

HEAVISIDE

HEAVISIDE LAYER.—See *Fading*.

HELIX.—A coil which is wound in the form of a spiral.

HENRY.—A unit of inductance. It is the inductance in which a current changing its rate of flow by one ampere per second induces an electromotive force of one volt. The inductance of air-core coils usually is measured in microhenrys.

HETERODYNE.—When currents of two different frequencies flow in the same circuit they will produce a new frequency which is equal either to the difference between the first two frequencies or is equal to the sum of the first two frequencies. When two different frequencies combine in this way to produce a new frequency they are said to heterodyne and the new frequency is called a heterodyne frequency. This is the principle upon which is based the action of the superheterodyne receiver. See also *Beats, Formation of*.

HIGH FREQUENCY.—See *Frequency, High*.

HIGH FREQUENCY BUZZER.—See *Oscillator, Buzzer Type*.

HIGH FREQUENCY GENERATOR.—See *Oscillator*.

HIGH FREQUENCY RESISTANCE.—See *Resistance, High Frequency*.

HIGH MU TUBE.—See *Tube, Amplification of*.

HIGH PASS FILTER.—See *Filter, High Pass Type*.

HOOK-UP.—The method of connection between the various units which compose a radio receiver is called the hook-up of that receiver. This word is also applied to the diagram of connections used. The principle upon which the receiver action is based is often spoken of as the hook-up of the receiver; for example, a Neutrodyne receiver may be said to use a Neutrodyne hook-up.

HORN.—See *Speaker, Loud*.

HOT WIRE METER.—See *Meters, Ampere and Volt*.

HUM, REMEDIES FOR.—See *Trouble, Receiver and Power Unit*.

HYDROMETER.—See *Battery, Storage Type*.

HYSTERESIS.—When current commences to flow around the winding of an electromagnet the magnetism and the electromagnetic field do not appear in their full strength instantaneously but require a short time to rise from zero to maximum value. When the flow of current in the winding is stopped the magnetism and the electromagnetic field die away to zero but the speed with which this dying away takes place is less than the speed with which the magnetism built up. In other words there is a lag in completely demagnetizing the iron core of a magnet. This lag is called magnetic hysteresis. This lagging is caused by the residual magnetism which remains in the iron and must be destroyed.

I

i.—The symbol for current (instantaneous value) in amperes, etc.

I.—The symbol for electric current or for amperage (effective value). See *Current*.

I. C. W.—An abbreviation for interrupted continuous wave.

IGNITRON.—See *Tube, Ignitron*.

ILLUMINATION.—See *Light*.

IMAGE FREQUENCY.—See *Receiver, Superheterodyne*.

IMPEDANCE.—Impedance (symbol Z) is the total opposition to the flow of alternating or pulsating direct current in a circuit containing resistance and reactance. (See *Reactance*.) The unit of impedance is the ohm. The numerical value of impedance is obtained by taking the algebraic sum of the values of resistance and reactance, i.e., the impedance is equal to the square root of the sum of the squares of reactance and resistance. The reactance

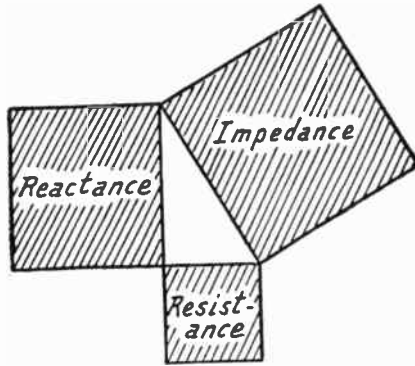

Relation of Impedance to Reactance and Resistance of a Circuit.

used represents the *net* reactance which is the arithmetic difference between the inductive reactance and capacitive reactance if both are present. The above relationship is shown in the diagram.

The total impedance in ohms bears the same relation to ohmic resistance and reactance that is borne by the hypotenuse of a right angle triangle to the two sides of the triangle. The square of the hypotenuse, representing the impedance is equal to the sum of the squares of the other two sides which represent respectively the ohmic resistance and net reactance.

Where only one type of reactance is present in a circuit, substitution is made directly in the formula. If both inductive and capacitive reactance exist the net reactance, which is their difference, must be used.

A capacitance in an A.C. circuit causes the current in the cir-

IMPEDANCE

cuit to lead the voltage, a perfect condenser causing the current to lead by 90 degrees. A perfect condenser could be connected directly across an A.C. circuit and would take no power from the source. This condenser would return to the line on discharge all of the energy required to charge it. Condensers are rated as to their excellence by the amount of energy they fail to return to the line as measured by their failure to throw current and voltage exactly 90 degrees out of step or phase. This value is called the phase angle of the condenser and where the phase angle is small it is substantially equal to the power factor. See Phase.

Likewise a perfect inductance, i.e., one having no resistance, would throw the current and voltage 90 degrees out of phase, but in this case the voltage would lead the current. Thus by the selection of the proper amount of inductance and capacitance for a given frequency, the current and voltage can be thrown exactly in step and the only opposition to the flow of current in such a circuit is the ohmic resistance. This condition is termed resonance. The following formula shows the method of finding the impedance where both inductive and capacitive reactance are present.

$$(1) \quad Z = \sqrt{R^2 + X^2}$$

where Z = Impedance in Ohms
 R = Resistance in Ohms
 X = Net reactance in Ohms

$$(2) \quad Z = \sqrt{R^2 + (X_L - X_C)^2}$$

where X_L = Inductive reactance in Ohms
 X_C = Capacitive reactance in Ohms

Expanding

$$(3) \quad Z = \sqrt{R^2 + \left(2\pi fL - \frac{1}{2\pi fC}\right)^2}$$

where $\pi = 3.1416$

f = Frequency in cycles per second of the impressed voltage

L = Inductance in Henrys

C = Capacitance in Farads.

If the capacitive reactance is greater than the inductive reactance, the portion of equation 3 under the radical sign contained within the parenthesis will be negative. Squaring this negative value as indicated will result in a positive value which will be added to R^2 .

For the special case where $X_L = X_C$ the reactances will cancel and

$$(4) \quad Z = \sqrt{R^2 + 0} = \sqrt{R^2} = R$$

This is the condition met with in a resonant circuit.

IMPEDANCE

Ohms law can be applied to reactive circuits by the substitution of Z for R . Thus

$$(5) \quad I = \frac{E}{Z}$$

where I = Current in Amperes

E = Pressure in Volts

Z = Impedance in Ohms.

The following examples will serve to illustrate the method of finding impedance.

Example I. Given an inductance of 400 microhenrys (.0004H), a frequency of 1000 KC (1,000,000 cycles), a resistance of 10 ohms and a capacitance of 100 micro-microfarads (.0000000001 farad). Find the impedance.

$$X_L = 2\pi fL = 6.2832 \times 1,000,000 \times .0004 = 2513.28 \text{ Ohms}$$

$$X_C = \frac{1}{2\pi fC} = \frac{1}{6.2832 \times 1,000,000 \times .0000000001} = 1591.06 \text{ Ohms}$$

$$Z = \sqrt{(10)^2 + (2513.28 - 1607.46)^2} = \sqrt{(10)^2 + (905.82)^2} \\ = \sqrt{100 + 820,509.87} = \sqrt{820,609.87} = 905.87 \text{ Ohms.}$$

It will be seen that in the foregoing problem, the ten ohm's of resistance is insignificant insofar as opposition to the current flow is concerned because of the large value of reactance. In this case the inductive reactance predominates and the voltage will therefore lead the current.

Example 2. The same constants are given as in the previous problem but the inductance is changed to 255.835 micro-henrys (.000255835H.)

$$X_L = 2\pi fL = 6.2832 \times 1,000,000 \times .000255835 = 1591.06 \\ \text{Ohms}$$

$$X_C = \frac{1}{2\pi fC} \text{ as previously} = 1591.06 \text{ ohms}$$

$$Z = \sqrt{(10)^2 + (1607.46 - 1607.46)^2} = \sqrt{100 + 0} = \\ \sqrt{100} = 10 \text{ ohms}$$

This is an example of resonance. The current and voltage are in phase and the only opposition to the current flow in the circuit is the 10 Ohms of ohmic resistance.

IMPEDANCE, COUPLING BY

IMPEDANCE, COUPLING BY.—See *Amplifier, Audio Frequency, Impedance Coupled*.

IMPEDANCE, MATCHING OF.—An amplifying tube delivers maximum power only when the input impedance or primary impedance of a transformer or coil in the plate circuit is at least as high as the plate impedance of the tube. Tube impedance may be taken as equal to plate resistance for the applied voltages and bias, and remains constant with changes of frequency. Transformer impedance increases at higher frequencies.

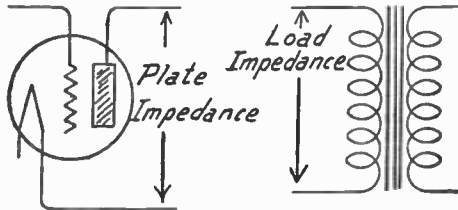

FIG. 1.—Impedances of Plate Circuit and of Load.

A coupling transformer, Fig. 2, is used between an output or power tube and the usual low impedance loud speaker. Transformer primary impedance equals or exceeds the plate resistance, while the secondary impedance matches the input impedance of the speaker.

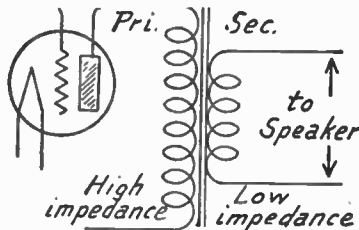

FIG. 2.—Matching Impedances with Special Transformer.

$$\text{Turns ratio} = \sqrt{\frac{\text{plate resistance of preceding tube}}{\text{input impedance of following unit}}}$$

The actual impedance in ohms should be as great as possible on the tube side of the transformer, which means a large number of turns on a core of ample size.

IMPEDANCE, PLATE.—See *Tube, Output Resistance and Impedance of*.

IMPEDANCE, TUBE

IMPEDANCE, TUBE.—See *Tube, Output Resistance and Impedance of.*

IMPULSE.—Any force acting during a short time is called an impulse. For example, a momentary rise of voltage would be called a voltage impulse.

IMPULSE EXCITATION.—See *Selectivity.*

INDICATOR, RESONANCE.—See *Meter, Frequency.*

INDICATOR, VOLUME.—A volume indicator is a device which shows visually the average voltage or power at any point in a circuit, such as at some amplifying apparatus or along a transmission line. Volume indicators or power level indicators are used for observing or monitoring the power in any circuit carrying sound frequencies. The indicator allows an operator to maintain the signal power above the level of interference and below the level at which there is overloading of apparatus and cross talk in lines. These indicators also are used in making measurements for equalizing transmission lines as described under *Public Address System.*

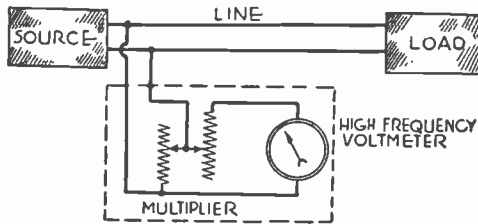

FIG. 1.—Simple Form of Volume Indicator.

A volume indicator is a voltmeter capable of measuring voltages at sound frequencies. Since the voltage is a function of the power when suitable impedance relations are observed these indicators may be called power indicators and may be calibrated to read in units of power such as milliwatts, or in decibels gain or loss from a reference power level. One type of volume indicator is essentially a vacuum tube voltmeter. Other types employ rectifying types of instruments of the copper-oxide or thermocouple variety.

The connections for a simple volume indicator are shown in Fig. 1. The voltmeter is connected to the points at which the volume or power is to be measured, the connection being through an L-section resistor network which maintains a constant impedance on the input side. This network allows application to the meter of a voltage giving positive readings, yet not so high as to run the meter reading off the scale limits. Extra calibrations may be made and the range of the meter extended by using different settings of the resistance network.

The pointer of the meter in any type of volume indicator cannot follow the instantaneous fluctuations of voltage in the measured circuit but swings in accordance with average changes of voltage and power.

Volume indicators are designed so that their readings are correct when the input impedance of the indicator matches the impedance of the part, such as a transmission line, to which connection is made. If the impedance

INDICATOR, VOLUME

of the connected part is not the same as that of the indicator, then the reading will be high or low. If two or more measurements are to be compared all of them must be taken at points of the same impedance.

Power level indicators generally are calibrated to read in decibels of attenuation below a reference level or of gain above the same reference level. The usual reference levels are six milliwatts or ten milliwatts. The meter reading shows the ratio in decibels between the actual power and this reference level of power.

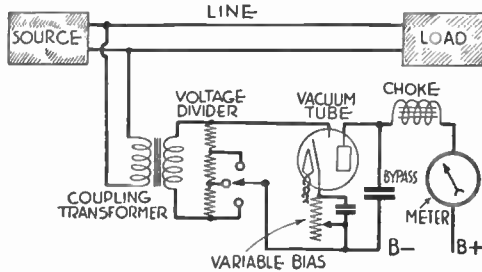

FIG. 2.—Vacuum Tube Type of Volume Indicator.

The circuit and connections of a typical vacuum tube volume indicator are shown in Fig. 2. The indicator is connected to a line or other unit through a transformer of which the primary impedance matches the connected impedance. The transformer secondary is of high impedance and is connected to a tapped voltage divider. The divider is across the grid circuit of a tube negatively biased to the point at which it acts as a rectifier of the sound frequency voltages applied to its grid circuit. The pulsating rectified current in the tube's plate circuit is filtered by the choke and the large capacity bypass condenser so that the direct component of this current passes through the meter and causes its pointer to swing proportionately to the amplitude of the volt-

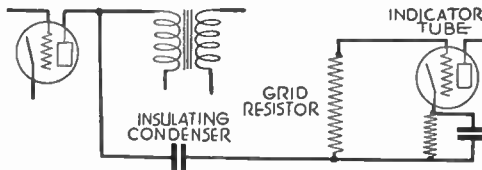

FIG. 3.—Indicator Connection Through Condenser.

ages applied to the tube's grid circuit. It will be recognized that this is a simple form of vacuum tube voltmeter.

The indicating instrument may be a low range milliammeter or it may be a more sensitive type of galvanometer, the latter instrument requiring that a damping resistance be connected as a shunt across the meter terminals. Various means are employed to keep the readings within the scale range of the indicating instrument. In the arrangement of Fig. 2 this may be accomplished by selecting a suitable tap on the voltage divider or by

INDOOR ANTENNA

varying the tube's grid bias to change the maximum value of rectified plate current. It also is possible to use a coupling transformer with a tapped secondary winding.

Other means for coupling the indicator to the measured circuit may be adopted. One method is shown in Fig. 3 where the grid circuit of the indicator tube contains a resistor which is connected to the circuit being measured through an insulating condenser. The chief requirement of any means for connection is that the volume indicator must have the least possible effect on the line or other unit to which it is applied.

INDOOR ANTENNA.—See *Antenna, Indoor Type of*.

INDUCTANCE.—Any change of current, either a rise or fall, in an electric circuit will cause the generation of an electromotive force or voltage in that circuit or in any nearby circuit. The property of a circuit which enables it to exercise this power is called inductance. The greater the ability of the circuit to cause voltages in itself or in neighboring circuits the greater is its inductance.

Inductance is measured in the unit called a henry or in millihenries or microhenries which are respectively the one-thousandth part and the one-millionth part of a henry. See *Coil, Inductance of*, for the factors which affect this property of a circuit and for its calculation.

Forming a conductor into a coil, turning it back upon itself many times, greatly increases the inductance. Because of this faculty of coils they are generally used when it is desired to obtain a maximum of inductance in a minimum of space. A coil used because of its property of inductance is sometimes called an inductance, although it is more properly called an inductor.

If the inductance in a circuit or in a coil causes the rise and fall of current to produce a voltage in the same circuit it is called self-inductance. The voltage produced by self-inductance has a polarity which acts against the polarity which is causing the flow of current in the circuit. That is, the voltage of self-inductance or the self-induced voltage opposes the original voltage in the coil or circuit and thereby opposes the change in flow of current. If the current is increasing, the induced voltage opposes this increase. When the current is decreasing the induced voltage opposes the decrease, that is, tends to keep the current flowing.

When the inductance in a circuit or a coil produces an electromagnetic field around the circuit or coil this electromagnetic field may pass through nearby circuits or other coils and will cause an electromotive force or voltage to appear in these nearby circuits. This is called mutual inductance. It is this property of mutual inductance that is used to obtain coupling between the primary and secondary windings of transformers. See also *Induction*.

The inductance of an oscillatory circuit at resonance may be expressed in terms of the capacity in the circuit and the frequency of resonance. The formula is as follows:

$$\text{Inductance} = \frac{(159.17 \div \text{Frequency})^2}{\text{Capacity}}$$

The inductance is in microhenries, the capacity in microfarads and the frequency in kilocycles.

Should the inductance be measured in henries, the capacity in farads and the frequency in cycles, the formula becomes:

$$\text{Inductance} = \frac{(0.15917 \div \text{Frequency})^2}{\text{Capacity}}$$

INDUCTANCE, ANTENNA

INDUCTANCE, ANTENNA.—See *Antenna, Capacity and Inductance of.*

INDUCTANCE, EFFECTIVE.—See *Coil, Inductance of.*

INDUCTANCE, MEASUREMENT OF. — See *Bridge, Measurements by.*

INDUCTANCE, MUTUAL.—Mutual inductance is the property of a circuit or a coil whereby it is enabled to produce voltage in another nearby circuit or coil whenever there is a change of current, either a rise or fall, in the first circuit. If the neighboring circuit is a closed circuit a flow of current will take place in it because of the voltage set up by mutual inductance.

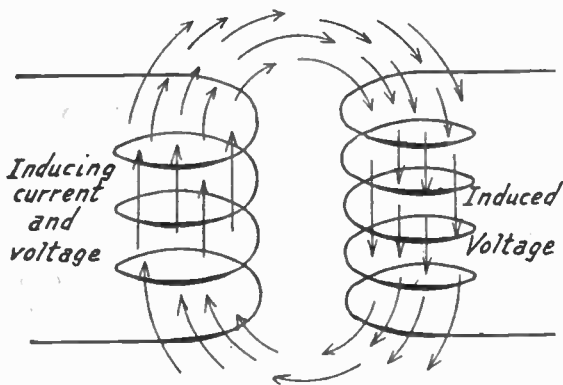

Mutual Inductance between Two Windings.

The induced voltage is produced in the second circuit or coil whenever current in the first one starts to flow, ceases to flow, changes its rate of flow, or changes its direction of flow. It may be said that any change whatsoever in the current of the first coil will, by means of mutual inductance, produce a voltage in the second coil. The intensity of the voltage induced depends on and is proportional to the rate at which current changes take place in the first coil. The greater the frequency the more rapid is the change of current and the greater will be the induced voltage. The greater the amplitude or rise and fall of current in the first coil with a given frequency the greater will be its rate of change and the higher will be the induced voltage.

Two coils may be placed with reference to each other so that a part of the electromagnetic field of one coil passes through or cuts through the conductors forming the other coil. Then as the electromagnetic field rises and falls, there is mutual inductance between the coils and they are said to be coupled. See *Coupling.*

INDUCTANCE, RESONANCE VALUES OF

The value of the mutual inductance is represented by the symbol M . The mutual inductance, or M , depends upon the size of the two coils, their distance apart and the angle which their axes make. The value of M is also affected by the induced voltage. The larger the coils the greater their mutual inductance. The closer they are to each other the greater their mutual inductance. And the more nearly their axes coincide the greater is the mutual inductance.

The calculation of mutual inductance when taking into account all of the foregoing factors is rather complicated, involving the use of logarithms to a considerable extent.

The inductive effect of the two coils on each other is called the coefficient of coupling and is usually represented by K . The value of K changes as the coils are moved with reference to each other, whether this movement changes their distance apart or whether it changes the angle of their axes. The value of K also depends on the sizes of the two coils, on their diameter and on their length.

The percentage changes of mutual inductance or coupling between two coils as they have their axes inclined to each other and also as they are moved lengthwise away from each other are given under the heading, *Coupling, Coefficient of*.

See also *Induction, Electromagnetic*.

INDUCTANCE, RESONANCE VALUES OF.—See *Resonance, Inductance-Capacity, Values for*.

INDUCTANCE, SELF.—The property which is called self-inductance causes the generation of a second electromotive force or voltage in any circuit whose current is changing its rate of flow. The flow of current in the circuit may be starting and then increasing, or it may be decreasing and coming to a stop, or it may be changing its direction of flow. Of course, there is a voltage being

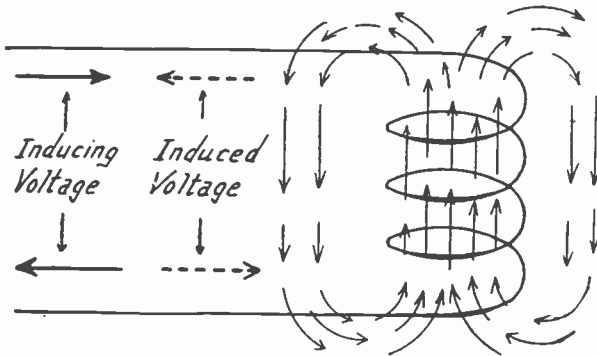

FIG. 1.—Effect of Self-Inductance in a Coil.

applied to the circuit in order to cause the flow of current, but the current itself causes a second and different voltage to appear. The ability of the circuit to generate this second induced current in itself is called the circuit's self-inductance or simply its inductance in most cases. The self-induced voltage is called counter electromotive force.

The induced voltage tries to prevent the current from doing whatever it may be doing at the time. If the current is on the increase.

INDUCTANCE, SELF-

the induced voltage tries to hold it back, tries to prevent its increase. If the current is already decreasing, then the induced voltage tries to keep it going, tries to keep it from decreasing.

Since self-inductance is an effect that a circuit has upon itself, the effect is greatly increased by turning the circuit around and around on itself; in other words winding the circuit into a coil. Whenever self-inductance is desired, coils are used to obtain it in a lumped form.

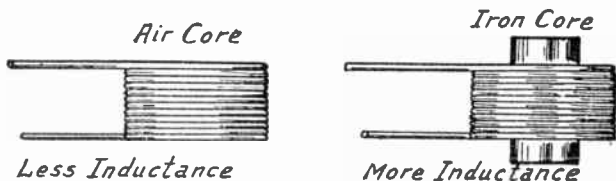

FIG. 2.—Iron Core for Increase of Self-Inductance.

Inductance in electricity is like inertia or momentum in mechanics. Adding inductance to an electric circuit is like adding weight to a pendulum; the weight prolongs the swings of the pendulum and makes them persist, while the inductance keeps the swings of electric current or the oscillations more persistent.

The energy which goes into a coil in the form of voltage and current reappears in the form of a magnetic field around the coil. The lines of force which form this magnetic field travel around through the center of the coil and the space around the outside of the coil. As soon as these magnetic lines of force have risen to their maximum they then start to collapse. If but few of them have been lost in the process and if nearly all collapse back into the coil, most of the original energy or voltage and current reappears in the windings of the coil.

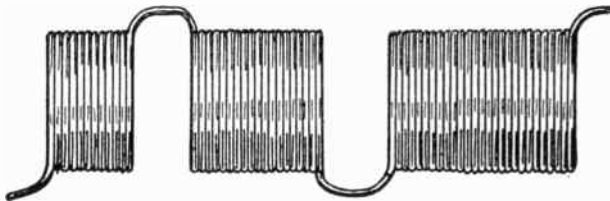

FIG. 3.—Inductance Coils in Series.

If it is easy for the magnetic lines to travel through the field then there is little loss and the coil will have great self-inductance. But if there is a great loss in the magnetic lines while they are in the field of the coil, then the self-inductance will be reduced.

The difficulty with which magnetic lines of force travel through any substance is called the reluctance of that substance. Reluctance is magnetic resistance. Anything that reduces the reluctance of the magnetic field will increase the inductance of the coil and anything that increases the reluctance of the field space will decrease the inductance. Iron has only a small fraction of the reluctance possessed by air, so making the core of the coil from iron as in Fig. 2 increases the inductance by decreasing the reluctance of the magnetic path.

INDUCTANCE, SELF-

Shortening the magnetic path, decreasing the size of the field of the coil, will also reduce the reluctance and give the coil greater self-inductance.

For the calculation of self-inductance in coils, see *Coil, Inductance of*.

Inductances in Series and Parallel.—Coils connected in series as in Fig. 3 simply add their self-inductances together. Three coils, having inductances of 100, 150 and 200 microhenries, would have a combined inductance when connected in series of 100 plus 150 plus 200, or 450 microhenries.

This adding together of the inductances of coils in series applies in the manner just stated when the coils are so far apart in space or are placed at such angles with each other that they have no magnetic coupling. Should there be magnetic coupling the effect of the mutual-inductance will be added to the self-inductances and the total will be greater than the sum of the self-inductances only.

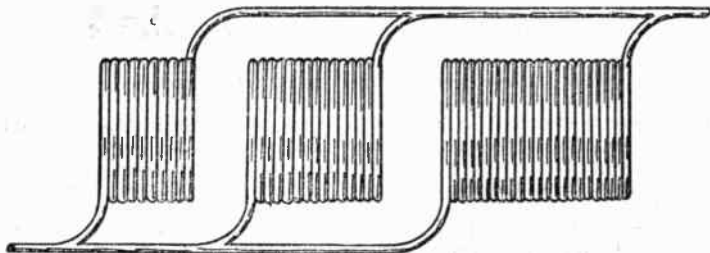

FIG. 4.—Inductance Coils in Parallel.

When coils are connected in parallel with each other as in Fig. 4 their combined inductance cannot be found by simply adding the separate inductances. The sum of the reciprocals of the separate inductances is equal to the reciprocal of the combined inductance. A reciprocal of any number is 1 divided by that number. The formula is as follows:

$$\frac{1}{L_t} = \frac{1}{L_a} + \frac{1}{L_b} + \frac{1}{L_c}, \text{ etc.}$$

When L_t is the total inductance of all coils in parallel, L_a , L_b , L_c , etc., are the separate inductances of the separate coils.

If the separate inductances are in microhenries, the total will be in microhenries, if the separate inductances are in henries the total will likewise be in henries.

Again taking the three coils whose separate self-inductances are 100, 150 and 200 microhenries; their combined self-inductance would be found as follows:

$$\frac{1}{\text{Total Inductance}} = \frac{1}{100} + \frac{1}{150} + \frac{1}{200} = \frac{13}{600}$$

The total inductance is then 600/13 microhenries or approximately 46.15 microhenries. The combined self-inductance of coils in parallel will always be less than the smallest separate self-inductance of any one coil.

See also *Induction, Electromagnetic*.

INDUCTANCE, SWITCH FOR

INDUCTANCE, SWITCH FOR.—See *Switch, Tap*.

INDUCTANCE, UNITS OF.—The standard unit of inductance, whether of self-inductance or mutual-inductance, is the henry. One henry is the inductance of a circuit when one volt electromotive force is produced by a current changing at the rate of one ampere per second.

Except for the larger sizes of iron-core coils, the henry is a larger unit than is convenient to use. Therefore, most radio inductances are measured in millihenries and microhenries. One millihenry is one thousandth of a henry. One microhenry is one millionth of a henry.

INDUCTANCE, VARIOMETER FOR.—See *Variometer, Coupling with*.

INDUCTION.—Induction is the action by means of which an electric force is produced in a conductor by an electric field. The electric force produced may be an electromotive force or voltage in a conductor, it may be a charge on a condenser plate or it may be magnetism in a magnet. The field may be composed of lines of force about a conductor, of electrostatic lines of force about a charged body, or of magnetic lines of force about a magnet.

Induction is the act itself while inductance is the ability or property of a circuit to produce induction.

INDUCTION, ELECTROMAGNETIC.—A voltage and current may be produced in a conductor whenever it is cut by or is itself cutting through lines of force which are coming from a magnet, from a coil acting as a magnet, or from another conductor. The act of producing voltage and current in a conductor by any of these means is called electromagnetic induction.

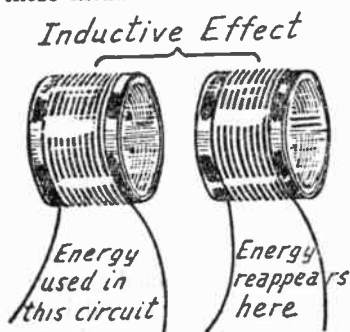

Energy Transfer by Electromagnetic Induction.

If the induction is brought about by the magnetic field around a conductor or coil, the voltage and current which are induced may be set up either in the conductor or coil having the field or in any other nearby conductor or circuit. If the induced voltage is in the same conductor whose field causes the induction, the action is called self-induction. If the voltage is induced in a nearby circuit the action is called mutual-induction.

Whenever there is any change of current in a conductor that change causes lines of force to appear around the conductor. As these lines arise out of the conductor and fall back into it they, of course, move. And in moving thus, either through the conductor itself or through any nearby conductor, they set up an induced voltage either in the same conductor which is carrying the current changes or in a neighboring conductor. Any movement of

INDUCTION, ELECTROSTATIC

lines of force through a conductor induces a voltage in that conductor.

Naturally enough, the same effect may be secured if the lines of force stand still and the conductor is moved through them. This is simply another way of making the lines of force and the conductor cut each other.

The intensity of the induced voltage and current depends on the rate at which the conductor cuts lines of force or on the rate at which lines of force cut through the conductor. The cutting of 100,000,000 lines of force in one second produces an electromotive force of one volt in the conductor.

The direction or polarity of the induced voltage is always such that it tends to retard or oppose the motion which produces it. This motion may be of the lines of force through the conductor or may be of the conductor through the lines of force, but the induced voltage always acts to retard this motion. See *Inductance, Self*.

Electromagnetic induction is one of the most important actions in the whole field of practical electricity, whether it is used to set up voltages in a radio coil or to operate the motors of an electric locomotive.

As utilized in radio receivers, electromagnetic induction may be considered as the action which produces a voltage and current in one conductor or coil when there is any change in the amount of current flowing either in the same circuit or in a nearby circuit.

INDUCTION, ELECTROSTATIC.—If any conductor is given a charge of electricity, of static electricity, and is then brought near another conductor, there will be two equal and opposite charges induced on the other conductor. On the part of the second conductor which is nearest the first one, there will be induced a charge of opposite polarity from the first one. And on the part of the second conductor which is farthest from the first one will be induced a charge of the same polarity as the first charge.

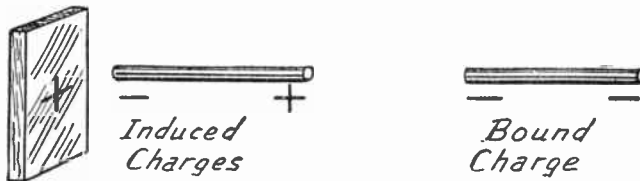

Charges Produced by Electrostatic Induction.

This is shown in the drawing. The plate is assumed to carry a positive charge. A metal rod is brought near the plate, but is not allowed to touch it. Two charges appear on the rod. At the end nearest the plate is found a negative charge and at the end farthest from the plate is found a positive charge. The positive charge on the one end of the rod just equals the negative charge on the other end, although neither will equal the original charge on the plate.

The like charge or positive charge on the far end of the rod may be removed by touching or connecting the rod to earth for a moment. The negative charge which was on the end of the rod nearest the plate will now travel along the rod and distribute itself evenly along the length of the rod.

INDUCTION

The positive charge which first appeared on the far end of the rod is called the repelled charge. The negative charge which remains on the rod after the removal of the positive charge is called a bound charge. The rod may now be taken away from the plate and will keep its bound charge until it is neutralized by an equal positive charge from some other source, this retention of the bound charge being possible provided the rod is properly insulated.

INDUCTION HEATING.—See *Heating, Induction.*

INDUCTION, MAGNETIC.—When a piece of iron or steel is brought into a field composed of lines of force the iron or steel becomes a magnet. If a field or lines of force are caused to pass through a piece of iron or steel here again the metal will become a magnet. This action of producing magnetism in the iron or steel by the action of lines of force or a magnetic field is called magnetic induction.

In a transformer the lines of force in the field set up by the primary winding will magnetize the core by magnetic induction. Soft iron loses its magnetism as soon as removed from the field or as soon as the field dies away. Hardened steel retains its magnetism. See also *Field, Magnetic and Electromagnetic.*

INDUCTIVE COUPLING.—See *Coupling, Inductive.*

INDUCTIVE FEEDBACK.—See *Oscillation.*

INDUCTIVE REACTANCE.—See *Reactance.*

INDUCTOR.—See *Coil.*

INDUCTOR, VARIABLE.—See *Variometer.*

INSULATION.—Electric voltages and currents are kept within their proper circuits and are made to follow the desired paths by the use of insulation around conductors. Any material or substance used for insulation must be a non-conductor having high resistance to voltage. The greater its resistance or the higher the voltage required to break through, the better is the material as an insulator.

The insulating ability of such materials is specified in either of two ways. The insulation resistance is measured by the number of ohms resistance offered by a piece of the material having a certain size. The dielectric strength is measured by the number of volts required to force a current through the insulation by breaking it down.

Many kinds of insulation are described under their respective headings, the following being the principal ones so treated:

<i>Air</i>	<i>Porcelain</i>	<i>Rubber</i>
<i>Fibre</i>	<i>Mica</i>	<i>Waxes, Insulating</i>
<i>Paper</i>	<i>Quartz</i>	<i>Cloth, Insulating</i>
<i>Glass</i>	<i>Wood</i>	<i>Oils, Insulating</i>

Insulation resistance is of two kinds; volume resistance or resistance to passage of voltage through the mass of the substance, and surface resistance or the resistance measured across the surface or across a film of the substance.

The dielectric strength or voltage required for breakdown is affected by heat, becoming less as the temperature increases; by the length of time the impressed voltage continues, becoming less with increase of time; and by the frequency of the applied voltage, becoming less as the frequency increases. As a general

INSULATION, MOULDED AND LAMINATED

rule the insulator will have greater dielectric strength if it is made up of a large number of thin layers or laminations. See also *Strength, Dielectric*.

INSULATION, MOULDED AND LAMINATED.—Very few of the materials used as insulators in radio work are employed in their natural state. Most of them are compounds of different substances treated under heat and pressure and with the aid of chemical reactions while they are moulded into desired shapes or while they are built up in layers or laminations to form sheets. Many kinds of raw materials enter into the composition of insulators. Among the more common are phenol base compounds, resins, shellacs, varnishes, waxes, powdered and sheet mica, clay, wood flour, rubber, vegetable fibres and asphalt.

The principal insulators used in radio receivers include phenol compounds, hard rubber, woods, and to some extent fibre. The characteristics of these materials and of others used for similar purposes are described under their respective headings to which reference may be made.

INSULATION, RESISTANCE OF.—See *Resistance, Insulation*.

INSULATOR.—Any piece of insulating material which is used for its insulating properties and often as a support for other parts at the same time is classed as an insulator in the usual meaning of the word.

Such use of an insulator calls for high resistance, both volume and surface.

The volume resistance is taken care of by selecting materials of high ohmic resistance; glass, porcelain, hard rubber, and the better grades of moulded and laminated compounds being favored. The surface insulation is increased by corrugations and by extending rings or bosses such as seen on antenna insulators and on the insulating spacers of some variable condensers. Any shape which increases the distance measured over the surface between the two ends of the insulator will increase the surface resistance which is a desirable feature.

Since almost all insulators used around receiving equipment must withstand high frequencies it is important that they have a satisfactory dielectric constant and small losses from dielectric absorption and dielectric hysteresis.

Insulators used as supports, such as antenna insulators, must have good mechanical properties. They must not absorb moisture, they should not be too brittle, and they should be strong both in tensile strength and compressive strength. These qualifications are well cared for by porcelain, high grade moulded materials and glass.

INSULATOR, ANTENNA.—See *Antenna, Insulators for*.

INTENSIFIER.—See *Trap, Wave*.

INTERFERENCE.—By interference is meant any kind of an electrical impulse, other than the desired signal, which may be heard from the receiver. The kinds of interference to be considered under this heading are impulses which come through in spite of a receiver's having a satisfactory degree of selectivity. Signals from

INTERFERENCE

a broadcasting station whose frequency or wavelength is nearly the same as the one it is desired to hear are not here treated as interference because a receiver of great enough selectivity might tune out this unwanted station. See *Selectivity*.

All interference must arise from some electrical cause. By strict interpretation this definition of interference would include static disturbances. But static will not be considered here because it is given individual treatment under the heading *Static*.

The bothersome interference may come through the air from the outside, may come through circuits used for power, light or telephone service, may come from faults in electrical wiring and electrical devices within the building where the receiver is located, or may arise within the receiver itself. It is first in order to list the principal causes of all kinds of interference.

Interference coming through the air to the antenna:

Radio telegraph transmitters, either on shipboard or on shore, may emit a wave so broad and so overpowering that no receiver will tune them out. They are heard as the series of rapid dots and dashes that sooner or later becomes familiar to most broadcast listeners.

The receiving antenna may be close to, or may even run parallel with, electric power lines. Loud crackling noises will then be picked up whenever these lines are in use.

Discharges of lightning during any kind of electrical storm.

An oscillating receiver operated by some neighbor.

Interference coming through power, light or telephone circuits from outside:

Sparking commutators of motors, of oil burners, vacuum cleaners, sewing machines, or other household devices.

Sputtering arc lamps.

Sparking trolley wheels or third rail shoes.

Heating pads, curling irons, electric irons, and all other devices using electric heat.

Vibrating battery chargers.

Violet ray and X-ray machines.

Power or lightning circuits in which may be found accidental grounds through trees or guy wires, cracked or dirty insulators, defective switch contacts, grounded transformer neutrals, etc.

Interference from electrical parts within the building:

Sparking may be suspected in any electrical device which contains a motor. Radiation of interference as well as of warmth may be suspected from any device which uses electricity to produce heat.

Practically all medical and physiological appliances for household use are likely to cause interference.

Loose connections or contacts anywhere in the house lighting circuit; this applying to switches, fuses, wall plugs, lamp sockets, and everything else about the wiring or fixtures.

Apparent interference within the receiver:

Faults of this kind will produce noisy operation. All of the causes and remedies for noise are treated under the heading *Noise*.

If interference of the kinds already considered is of considerable strength and comes from a nearby source it may be picked up by any long leads between the receiver and batteries.

INTERFERENCE

If the receiver is operated from any kind of a power supply unit attached to the lighting circuit of the building, disturbances in these circuits may be carried through into the receiver if the power supply unit has a faulty or poorly designed filter system.

Recognizing the Kind of Interference.—It is not sufficient to simply realize that some kind of interference is spoiling reception. It is quite necessary to be able to make an intelligent guess as to the cause of the interference. About the only thing on which such a guess may be based is the kind of sounds that are heard. Some of these will now be described although it is rather difficult to describe some of the sounds that are caused by interference.

A rapid and regular clicking noise which keeps time with the frequency of the power lines may be attributed to vibrating battery chargers or any other electrical device employing a vibrator.

A rapid whirring noise which rises in pitch immediately after it starts and then falls in pitch as it comes to a stop may be blamed to direct current motors using commutators.

An intermittent rasping and scratching noise of varying intensity may be caused by defective insulators, accidental grounds or loose contacts in any circuit.

A loud roar which dies out after a few seconds is usually caused by the charging of lightning arresters.

A more or less steady and continual crackling comes from arc lamps, medical devices or any electrical units in which there is a heating coil.

A rather faint buzzing which lasts for only a few seconds at a time is generally due to vibrating bells, door bells, telephone bells, etc.

A violent squeal which rises and falls in pitch when the receiver's dials or controls are not being touched is caused by a nearby oscillating and radiating receiver. The changes are caused by the operator of the offending receiver because he cannot be satisfied with his lack of success in tuning and is continually trying to do the impossible by changing his controls.

A loud crashing noise which rises in intensity and finally dies away after five or ten seconds is generally caused by trolley cars, elevated trains or subway trains whose contact wheels or shoes are sparking.

Rather musical long and short dashes and dots which rise and fall in pitch are caused by radio telegraph stations. These are especially noticeable when tuning at the highest wavelengths.

A steady, rapid, sharp buzzing may be caused by the small motors used in vacuum cleaners, electric sewing machines, oil burners, etc.

A low pitched, rather soft vibration, continuing as long as the receiver is used is almost always caused by the antenna or ground lead being near power lines or by the use of an improperly filtered power supply unit.

A cracking sound which recurs at regular intervals is generally due to electric sign flashers

INTERFERENCE

Locating the Position of the Source of Interference.—The first step in this part of the work is to decide whether the interference is in the receiver, in electrical parts within the building, in outside power, light or telephone lines, or in the air.

First disconnect the antenna. If the interference continues, disconnect the ground. If it still continues the fault is in the receiver itself, unless a power supply unit is being used. Of course, if the power supply unit were to be disconnected the receiver would no longer detect nor amplify either interference or signals and nothing would be gained. If the power supply unit furnishes current for the filaments only and contains a small storage battery it may be disconnected and the tubes operated from the storage battery for a short time.

If the removal of antenna or ground stops the interference the trouble may have been coming through the air or it may be due to faults in the antenna or ground. Reconnect both of these and then go over them while the receiver is in operation; moving and shaking all joints, insulators and supports. If this procedure has any effect on the interference it indicates that there are ~~poor~~ connections or poor insulators in the antenna or ground circuits.

To determine whether the interference comes from electrical equipment within the building, wait until the offending noises are decidedly noticeable and then open the main supply switch just inside of the building. This of course presumes that the receiver is operated from batteries and not from power supply units. If it is found that the interference may be stopped as the switch is opened the fault is within the building. The test should be made by opening the switch while the interference is bad and noting the result. Noting the effect of closing the switch is not so reliable because the interference may stop while the switch is open and may not start immediately after the switch is closed.

Should it be decided that the interference is in the building, try removing the fuses or opening the circuit breakers for any branch circuits, handling these circuits one at a time. Should the interference stop with any one circuit open, that is the circuit giving the trouble. It is then in order to go over this line of wiring; tightening all terminal screws, loose wire ends, fuse clips, switch contacts, service outlet plugs, lamp sockets, lamp bulbs in their sockets, wall switches, etc.

Interference Coming Through Wiring from Outside.—If none of the foregoing methods have stopped the interference and shown it to be in the receiver or within the building, it may be coming through the air to the antenna. The location of the antenna should be checked and if it runs near to or parallel with any power lines its position must be changed so that it is as nearly as possible at right angles to these lines. Using a shorter antenna or a lower antenna will help to reduce the effect of the interference although it will not eliminate it. The effect of the interference may be reduced by connecting a resistance of 50,000 to 100,000 ohms between the antenna binding post and the ground binding post of the receiver as in Fig. 1. This will bypass most interference of low frequency to ground, but it will also greatly reduce the sensitivity and distance getting ability of the receiver.

INTERFERENCE

If it is finally decided that the interference is coming from outside the building, either over power lines leading into the building or through the air to the antenna, it is advisable to attempt cooperation with other listeners in the neighborhood. Inquire of these neighbors whether they experience the same kind of interference and enlist their help in tracing it to its source.

Power and light companies, also all other companies using electrical apparatus which may be causing the interference, are almost without exception more than glad to help in its removal. This is true because the interference indicates that something is wrong with their equipment and any faults in the equipment generally mean a loss of money to its owners.

The interference may be reported to any of these companies. It is necessary to make an intelligent report if anything is to be gained. In writing to the company or talking with its representatives be prepared to describe as

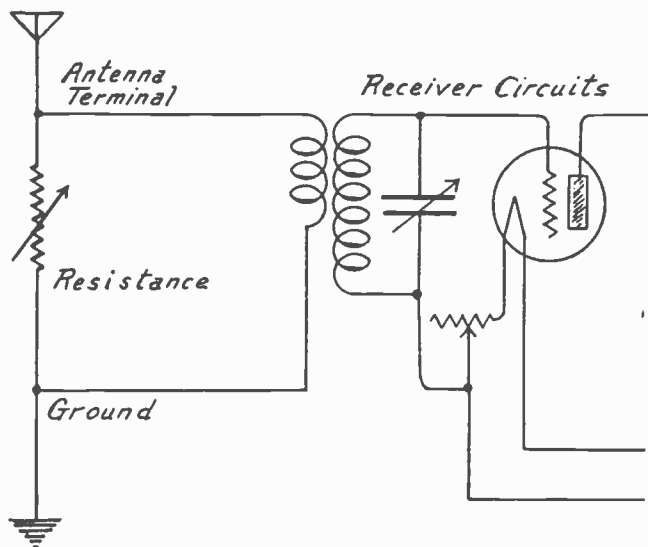

FIG. 1.—Using Resistance to Reduce Effect of Interference.

well as possible the sound of the interference, its tone or pitch and whether it is intermittent or continuous. Make a notation of the exact time down to the minute at which the interference starts and when it stops. Also make a note of weather conditions during the time of interference, whether rain was falling, whether there was a high wind, the temperature and any abnormal conditions. With this information the power company or any other organization interested will be enabled to trace down the interference and remove its cause in most cases.

Tracing Interference.—Should it become necessary to locate the point at which the interference is originating without help from other listeners this may be done with the help of a reasonably sensitive portable receiver equipped with a loop antenna. The receiver must be completely self-contained, batteries and all, within its cabinet. Nothing except the loop may appear outside. The cabinet

INTERFERENCE

must be completely shielded, top, bottom and sides, with no joints or openings at any point.

A receiver for this work may be of the three-tube regenerative type, using a detector regenerating with a tickler coil, followed by two stages of audio frequency amplification. Since headphones will be used in tracing the interference it is advisable to provide jacks for the phones so that they may be used either after the detector, after the first audio stage, or after the second audio stage. This is done because the sound from the interference may be too loud for comfort with two stages of audio amplification when the operator finally comes close to the source of the trouble. It is also possible to use a portable superheterodyne receiver for this work provided it is completely shielded and self-contained.

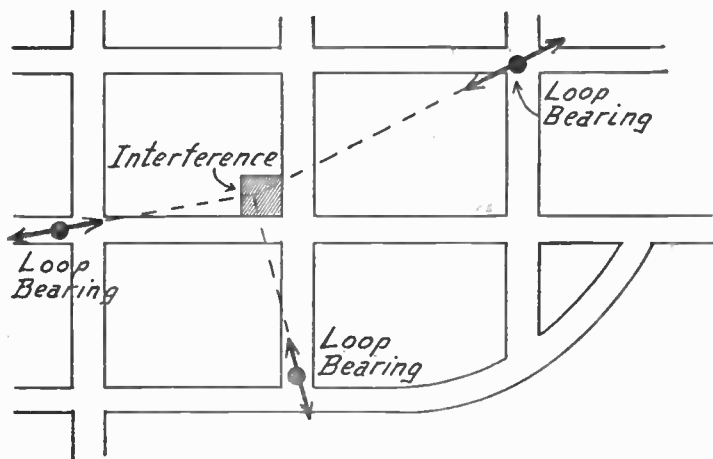

FIG. 2.—Locating Interference with Portable Receiver.

Unless the receiver is light enough to be carried about in the hands it is best to carry it in an automobile. The receiver is placed in operation and the tuning controls or regeneration controls are changed so that the sound of the interference is loudest. The loop is then rotated until the sound of the interference is at its maximum volume. The loop is then pointing toward the interference.

It is almost essential to have some kind of a map of the locality in which the work is being done. This map may be nothing more than a rough pencil sketch showing the principal streets but something of the kind should be used. The position of the portable receiver when the first bearing is made with the loop should be noted on the map and a short straight line laid off on the map in line with the plane of the loop. This line will then point toward the interference as in Fig. 2.

The portable receiver is now moved three or four blocks away from the first position, the loop is again turned until maximum interference is heard, and a second line is laid off on the map to coincide with this new position of the loop. A third and fourth bearing may be taken after moving the receiver into new positions each time. The map will now have three or four

INTERFERENCE

lines on it and if these lines are extended until they meet or until they come almost together at a central point the source of interference is at or very near the place on the map at which all the lines cross.

The receiver should then be taken to this indicated point of trouble and moved around while the loop is rotated. It will finally be possible to move the receiver all the way around one location with the loop being continually changed to point toward the center of this small area around which the receiver is being carried. The cause of the interference is somewhere around this point. It is then in order to go back to the list of causes of interference given at the beginning of this section and check over each one as to the possibility of its being present.

Reducing and Eliminating Interference.—If the interference is found to be in some electrical device such as a motor, a converter, a spark coil, a heater, or similar offending unit, various means may be taken to prevent its further radiation of troublesome waves through the air or surges through its supply lines. For this purpose use is made of choke coils and bypass condensers, most of the principles being described under the heading of *Filter*.

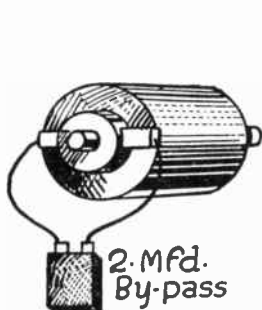

FIG. 3.—Bypass Condensers for Preventing Interference from Sparking Brushes on Motor

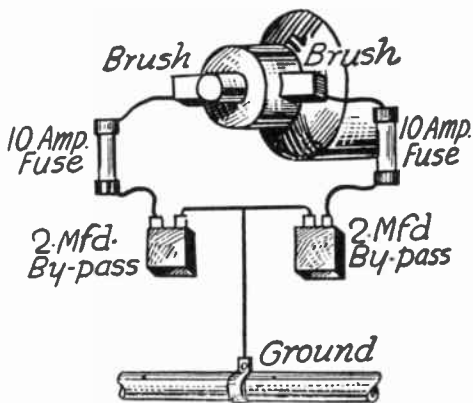

FIG. 4.—Use of Ground and Fuses on Interference Filter.

All bypass condensers which are used in connection with supply lines of from 110 to 220 volts must be able to stand one thousand volts of direct current. Should it be necessary to use bypass condensers in connection with 550-volt lines two of the thousand-volt condensers should be connected in series and inserted wherever a bypass condenser is called for.

Filter circuits used for eliminating interference must contain fuses which protect the power lines to which they are connected. Two fuses should be used, one placed in each side of the power line between the filter and the line. The fuses should not be larger than ten-ampere size unless more than ten amperes of current are used by the device being handled. Filters for any electrical unit which uses more than ten amperes of current require special construction to comply with insurance rules.

INTERFERENCE

Where the interference arises from nothing more serious than a slight sparking between the brushes and commutator of small motors it may be sufficient to connect a two-microfarad bypass condenser between the brushes of the motor as shown in Fig. 3. With larger motors, or if the simple bypass con-

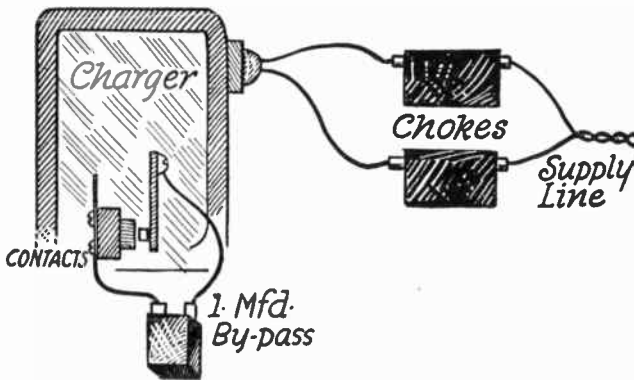

FIG. 5.—Handling Interference of Vibrators and Flashers.

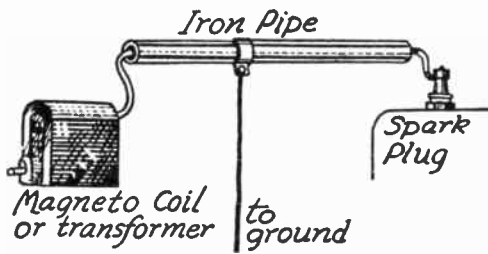

FIG. 6.—Shielding of Ignition Circuits to Prevent Interference.

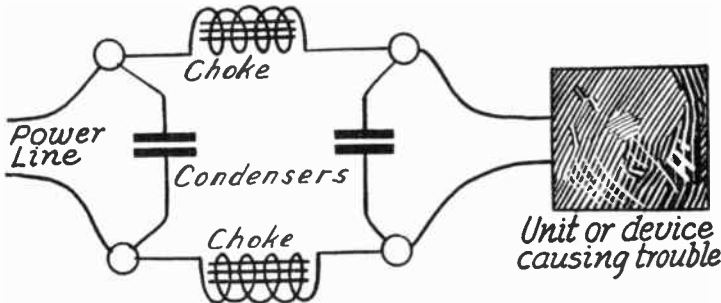

FIG. 7.—Filter Placed between Interfering Device and Power Line.

denser does not eliminate the interference, it may be necessary to use two condensers across the brushes with a connection made to ground from between the condensers. This is shown in Fig. 4. This illustration also shows the installation of protective fuses.

INTERMEDIATE FREQUENCY

Any electrical device using vibrating contacts, such as a vibrating battery charger, may be handled by the method shown in Fig. 5. A bypass condenser of at least one microfarad capacity is connected across the contacts and choke coils are inserted in each side of the supply line. The same method may be used with sign flasher contacts.

An ignition system such as used for farm light engines or for oil burners should have its high tension wiring between the spark plug and the magneto, coil, or transformer shielded by running the wires through an iron pipe which is grounded. This is shown in Fig. 6.

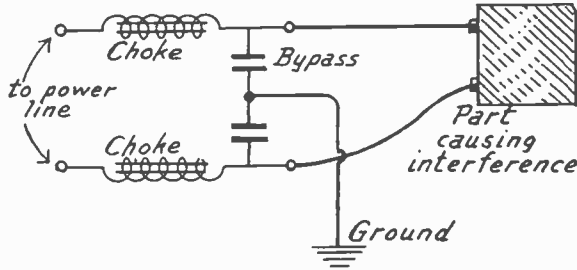

FIG. 8.—Interference Filter with Grounded Center Tap.

A low pass filter as shown in Fig. 7 and constructed according to the principles laid down under the heading *Filter, Low Pass*, may be placed between any electrical device which is causing interference and its power line. In Fig. 8 is shown a form of low pass filter which will often give excellent satisfaction. Here the disturbance is bypassed to ground through two condensers having the ground lead between them. The disturbance is prevented from going into the power line by choke coils in each line.

Any kind of filter system must be connected as close to the source of trouble as possible. The case containing filter chokes and condensers should be placed right alongside of the device which causes the interference, not four or five feet away.

Choke coils suitable for this work are described under the heading *Coil, Choke*.

INTERMEDIATE FREQUENCY.—See *Receiver, Super-heterodyne*.

INTERNAL CAPACITY OF TUBE.—See *Tube, Capacities, Internal*.

INTERSTAGE COUPLING.—See *Coupling, Interstage*.

INTERSTAGE SHIELDING.—See *Shielding*.

INVERSE DUPLEX SYSTEM.—See *Reflexing, Principles of*.

ION.—When a molecule is broken up into two parts the parts are called ions. One of the ions is minus one electron and therefore has a positive charge. The other ion is a negative charge. An ion may consist of one or more atoms of an element. Positive ions are called cations while negative ions are called anions. The cations move toward the cathode and the anions move toward the anode. This action takes place in electrolytes and in gases. See the following: *Anode; Cathode, and Electrons*.

IONIZATION

IONIZATION.—Ionization of a gas is an action by which the gas is made electrically conductive due to the formation of ions from the atoms of which the gas is composed. An ion is a very small particle of an element or a compound which has become either positively or negatively charged, the ion then acting as a carrier of the charge through a space occupied by the gas.

An atom of gas or other substance is the smallest particle of that substance which can exist. An atom cannot be further divided to form other elements. Considered electrically an atom consists of a positive center or nucleus around which rotate one or more negative electrons. In what is called a neutral atom the positive and negative charges are exactly balanced. The nucleus and the associated electrons may be considered as shown in Fig. 1, at the left, which represents an atom of helium gas.

Ionization takes place as a result of heat, light, electrical potential or any other force causing a speeding up of electrons which have been emitted from some substance and which travel through the gas.

During ionization these electrons collide with atoms and in doing so they detach other electrons from the atoms. The atom then has lost a part of its negative charge, therefore must be considered as having a net positive charge and is called a positive ion. The result may be pictured as at the right in Fig. 1.

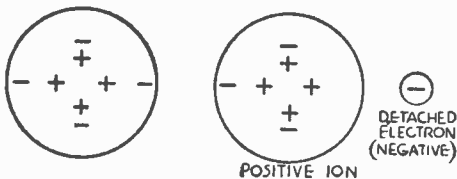

FIG. 1.—Neutral Atom and Positive Ion.

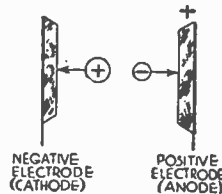

FIG. 2.—Attraction Between Charges.

The positive ion and the negative electron may be considered as placed between two electrodes, a cathode and anode, as in Fig. 2, the anode being positive and the cathode negative. These electrodes might be those of a vacuum tube, a photocell or other electronic device. The positive ion is attracted by and travels to the negative cathode while the negative electron is attracted by and travels to the positive anode. Such a movement of electrons and ions is the equivalent of a flow of electric current just as any electron movement is equivalent to a current.

Before the assumed collision there was one negative electron, the one which collided with the atom, and that electron must have been traveling toward the anode. But with the ionization occurring there still is the original electron traveling toward the anode, and there also is the detached electron and the positive ion. So the current now corresponds to the two negative electrons and to the positive ion, whereas it originally corresponded to only the one electron. Thus the ionization results in an increase of current and the gas has the qualities of an electrical conductor.

Analysis of what has taken place shows that the change in electrification at the anode must be equal and opposite in sign to the change at the cathode. It was previously shown that the anode receives the charge of two negative electrons, while the cathode electrode received the charge of only one positive ion. But the original negative electron must have come first from the cathode, which reduced the cathode's negative charge and

IONIZED LAYER

left it more positive. Thus the cathode has been affected by the loss of one negative charge and the acquirement of one positive charge, the equivalent of losing two negative charges. At the same time the anode has acquired the negative charges of two electrons.

The simple action so far described may be only a part of the total effect. The electron originally considered may have been moving with speed sufficient to make a number of collisions, at each of which an additional electron will be detached from an atom. Also the positive ions may strike the cathode with enough force to detach still more electrons from it in addition to the primary electrons. Thus the flow of current may be multiplied to many times its value before ionization. Of course it also is true that some of the moving electrons may meet and combine with positive ions to again form neutral atoms, thus reducing the amount of current.

The degree of ionization depends on several factors. One of these is the difference of potential between cathode and anode, a higher potential difference increasing the speed of the electrons and enabling them to make more collisions. Another factor is the distance between electrodes, a less distance increasing the ionization.

A third factor is the gas pressure. Greater pressure means more atoms in a given length of path and less pressure means fewer atoms in the same path. Up to a critical density of atoms an increase of gas pressure results in an increase of ionization because there are more atoms with which electrons may collide. But beyond this pressure the density of gas atoms is so great that the speed of the electrons is reduced below that value at which they are able to detach other electrons from the atoms.

The fourth factor is the kind of gas. Different gases have different ionization potentials. The ionization potential is the smallest potential difference through which an electron must pass in order that it may acquire enough energy to detach another electron from an atom with which it comes into collision. This potential varies with the kind of gas. Approximate ionizing potentials for several commonly used gases are as follows: Helium, 25 volts. Neon, 21 volts. Nitrogen, 17 volts. Argon, 15 volts. The lower the ionizing potential the less potential difference is required between electrodes to produce a given degree of ionization.

IONIZED LAYER.—See *Fading*.

IRON AND STEEL.—The performance of iron and steel in magnetic circuits is described in terms of magnetic units, nearly all of which are analogous to terms used in descriptions of actions in electric circuits.

Permeability is a measure of the iron's ability to carry magnetic lines of force and is similar to conductivity in electric circuits. It is measured as the ratio of the permeability of the metal to that of air taken as equal to 1.0, or unit permeability. See *Permeability*.

Reluctance measures opposition to magnetic flow and is similar to electric resistance. See *Reluctance*. Retentivity is a measure of the iron's ability to retain magnetism which has been imparted to the metal.

Hysteresis is a lag in magnetizing or demagnetizing the iron, and represents a power loss. The force which produces magnetic lines of force is called magnetomotive force or magnetizing force and is measured in ampere-turns.

Magnetic flux density is equal to the number of magnetic lines of force passing through a given area of cross section of a field.

Various alloying substances are added to iron or steel which is to be used in magnetic circuits. Carbon decreases the permeability, increases coercive force and hysteresis losses and also increases

IRON CORE

the electrical resistance of the iron. Silicon, which is often used in magnetic iron and steel, increases the permeability and reduces the hysteresis loss. Aluminum has very much the same effect as silicon, increasing the permeability to a slightly greater degree than silicon.

Tungsten and chromium harden the steel, greatly increasing its retentivity and making it suitable for permanent magnets.

The permeability of iron and steel is changed but little by moderate increases of temperature but when a temperature around 1,400 degrees Fahrenheit is reached iron becomes non-magnetic.

Ordinary iron and steel suffer from the effects of aging in increasing their hysteresis losses and decreasing their permeability. Silicon steel is practically non-aging under all ordinary temperatures.

Cast iron is not a satisfactory material for use in radio work when considered from the standpoint of magnetic qualities. Malleable iron is slightly better than cast iron. Cast steel is not suitable when the field strength is changing rapidly. Wrought iron is satisfactory from the standpoint of permeability but has rather high hysteresis losses.

It has been found in laboratory experiments that the desirable magnetic qualities of iron would be greatly increased were it possible to obtain the iron by electrolysis and to then melt it in a vacuum. Under such conditions it has been possible to obtain nearly four times the permeability with but one-third the hysteresis loss of ordinary transformer steel. This is mentioned simply to show what is possible under ideal conditions.

The electrical resistance of iron is of importance in its effect on eddy currents. The higher the resistance of the iron the less will be the loss in eddy currents. Silicon steel has advantages in this respect inasmuch as its resistance is about five times that of ordinary iron.

When iron is used in a field produced by a high frequency current its permeability does not change from the value found with low frequencies. It is fortunate that the great increase of skin effect at high frequencies tends to reduce eddy current losses far below their value at low frequencies.

JACKS AND SWITCHES.—The constructions of a phone jack and plug are shown by Fig. 1. While the plug is withdrawn from the jack, as at the top, connections are complete between prongs 1 to 2 and 3 to 4. With the plug inserted in the jack the plug circuit is cut in between prongs 1 and 4, while 2 and 3 are

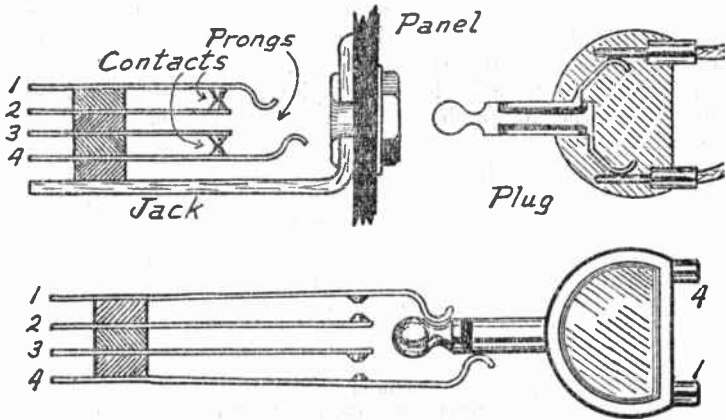

FIG. 1.—Phone Jack and Plug.

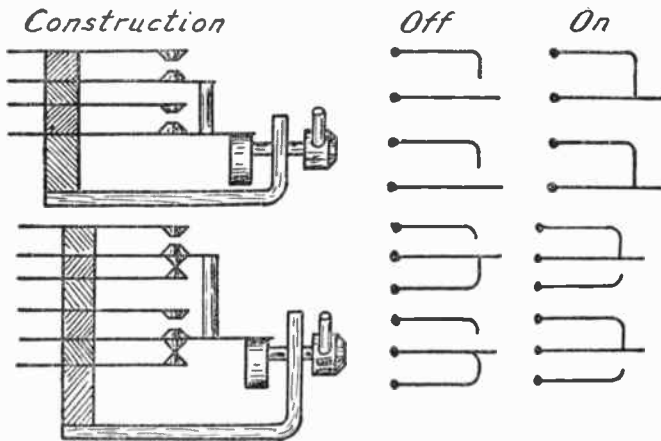

FIG. 2.—Operation of a Jack Switch.

JACKS AND SWITCHES

open circuited. The contacts of a jack switch are operated in a generally similar manner, as shown by Fig. 2.

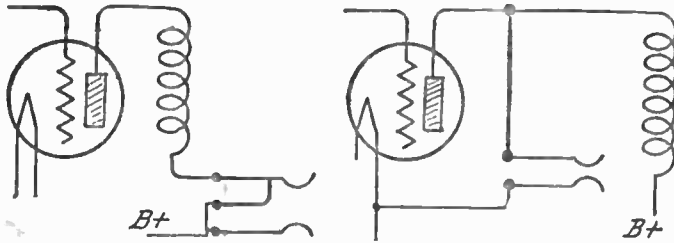

FIG. 3.—Jacks for Plate Current Meter (left) and Voltmeter (right).

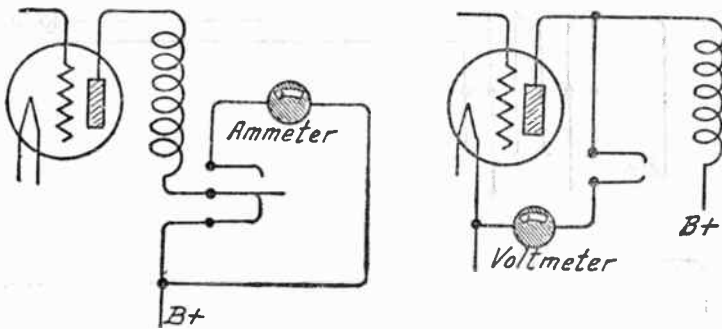

FIG. 4.—Meter Connections Made with Switches.

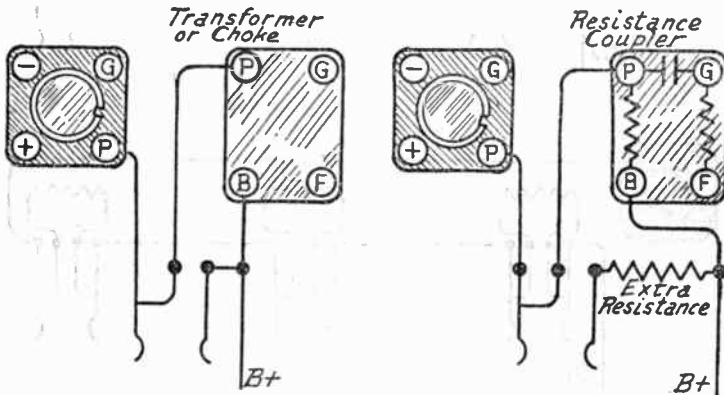

FIG. 5.—Jacks for Headphone or Loud Speaker.

JACKS AND SWITCHES

Fig. 3 shows jack connections for temporary connection of a milliammeter (left) and a voltmeter (right) in the plate circuit of a tube. Fig. 4 shows equivalent connections for the two kinds of meters when a switch is used instead of a jack.

In Fig. 5 are shown connections for jacks that permit temporary insertion of headphones or a loud speaker in the plate circuit of any amplifying tube. With a resistance-coupled amplifier it is necessary to have extra resistance in the jack circuit to compensate for the lower resistance of the phones or speaker in comparison with that of the coupling unit.

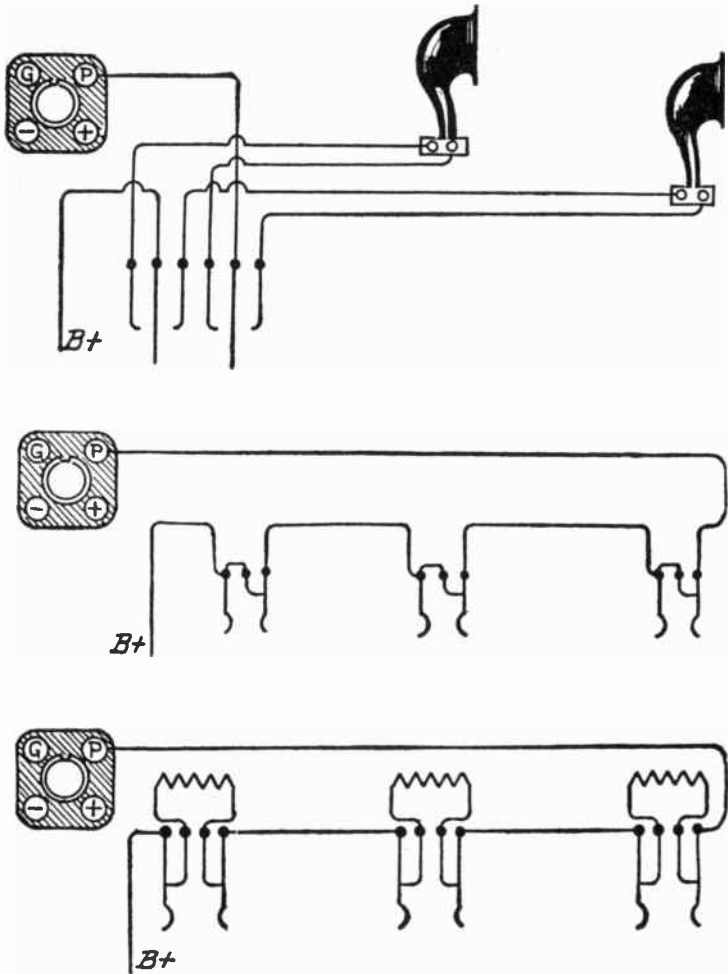

FIG. 6.—Jacks for Connection of Several Speakers.

JACKS AND SWITCHES

The upper diagram of Fig. 6 shows connections for a double-throw switch for connecting either of two loud speakers into the plate circuit of an output tube. The center diagram shows jacks for connecting loud speakers at any of several points in an output plate circuit. When a number of speakers are in use at one time their total impedance may be much different from that required for a good match. The difficulty may be avoided as in the lower diagram, where the jacks carry resistors which are approximately equivalent to the impedance of a speaker to be inserted.

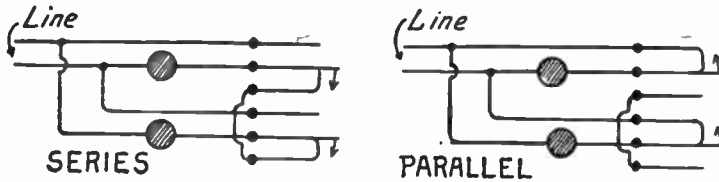

FIG. 7.—Switch for Series or Parallel Connection.

Fig. 7 shows connections for a double-pole double-throw switch that will connect the two loads, represented by shaded circles, either in series or in parallel with the line.

L

l.—The symbol for length.

L.—The symbol for inductance. See *Inductance*.

L-ANTENNA.—See *Antenna, Forms of*.

LAG, ANGLE OF.—See *Phase*.

LAMINATED INSULATION.—See *Insulation, Moulded and Laminated*.

LAMINATION.—Any part constructed of a large number of thin layers is said to be laminated and the layers are called laminations. Transformer cores are made of laminated iron, that is, of a large number of very thin sheets of iron. Insulators are often laminated to increase their resistance.

LAMP, PILOT OR PANEL.—A small incandescent lamp is often connected in parallel with the filament lighting circuit of a

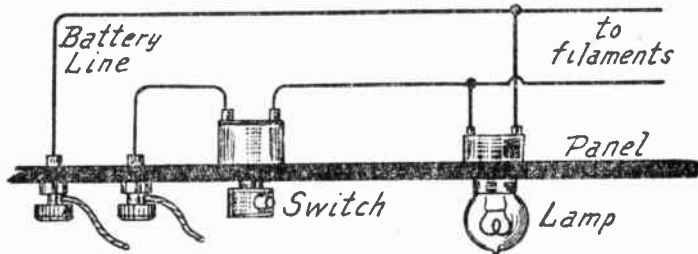

Pilot Lamp Connections.

receiver so that the lamp glows and indicates that the filament switch is closed. The connections for such a lamp are shown in the diagram.

LAMP SOCKET ANTENNA.—See *Antenna, Light and Power Circuit for*.

LAW, OHM'S.—The relation between volts, amperes and ohms, from which any one of the values may be found when the other two are known, is called Ohm's law. The rules based on this law are among the most useful in electricity and it is best to become familiar with their application to practical problems.

In writing Ohm's law, use is made of symbols or letters which stand for volts, amperes and ohms. For volts the letter E is used, standing for Electromotive Force; for amperes the letter I is used, standing for Intensity of current; and for ohms the letter R is used, standing for Resistance.

The number of ohms resistance is equal to the number of volts divided by the number of amperes. Written in the form of a formula this would be:

LAW, OHM'S

$$\text{Ohms} = \frac{\text{Volts}}{\text{Amperes}}$$

Substituting the letters or symbols, the formula is:

$$R = \frac{E}{I}$$

The number of volts pressure is equal to the number of amperes times the number of ohms, and as a formula this would be:

$$\text{Volts} = \text{Amperes} \times \text{Ohms}$$

Then substituting the letters, the formula is:

$$E = I \times R$$

The number of amperes is equal to the number of volts divided by the number of ohms, and as a formula this is:

$$\text{Amperes} = \frac{\text{Volts}}{\text{Ohms}}$$

And substituting the letters:

$$I = \frac{E}{R}$$

If one of these formulas is true, then the others must also be true, as may be easily seen by taking certain values for the letters; for example, 3 amperes, 6 volts, and 2 ohms as the values in a certain circuit. Then, taking the first formula and substituting these numerical values, we have:

$$R = \frac{E}{I} \quad \text{or} \quad 2 \text{ (ohms)} = \frac{6 \text{ (volts)}}{3 \text{ (amperes)}}$$

It is seen that 2 is equal to 6 divided by 3, as the formula shows. Then, taking the second formula and substituting the numbers:

$$E = I \times R \quad \text{or} \quad 6 = 3 \times 2$$

And, taking the third formula with the numerical values:

$$I = \frac{E}{R} \quad \text{or} \quad 3 = \frac{6}{2}$$

Many problems encountered in receiver construction and in the location and remedy of troubles are simplified when considered in their relation to the facts of this law.

LAW, RADIO

A few applications of Ohm's law will be given. In Fig. 1 is shown the determination of the number of ohms resistance in a rheostat where this value is unknown. An ammeter is connected in series between the rheostat and any convenient battery and a voltmeter is connected across the terminals of the rheostat. The other side of the rheostat is then connected to the battery as shown. Supposing that the current is shown to be .2 Amps. and the voltage to be 6. on the voltmeter. Substituting these values in the formula for resistance we would find that the number of ohms resistance in the rheostat is equal to 6 divided by 0.2, giving 30 ohms as the resistance to be found.

In Fig. 2 is shown the determination of the drop in voltage through a resistance of 20 ohms when the resistance is carrying a current of one-quarter ampere. Now substituting the known values in the formula for voltage we have $\frac{1}{4}$ (ampere) times 20 (ohms). One-quarter of 20 is 5, therefore, the voltage drop across the resistance is 5 volts.

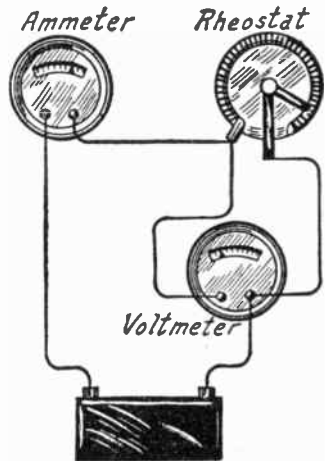

FIG. 1.—Determining Rheostat Resistance with Ohm's Law.

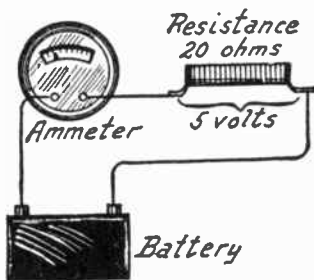

FIG. 2.—Determining Voltage Drop with Ohm's Law.

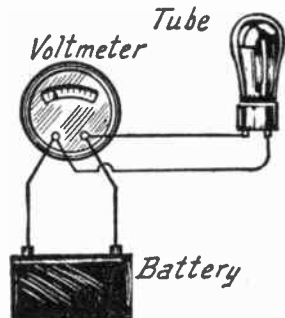

FIG. 3.—Determining Current with Ohm's Law.

Fig. 3 shows the determination of current flow in amperes through a known resistance connected to a known voltage. Assuming the tube to have a resistance of 24 ohms in its filament and to be connected across a battery giving 6 volts. Substituting these values in the formula for current we have the current as equal to 6 (volts) divided by 24 (ohms). Six divided by 24 equals $\frac{1}{4}$, so the tube will take a current flow of one-quarter of an ampere.

LAW, RADIO.—The law governing radio communication in the United States is known as The Radio Act of 1927. It became a law February 23rd, 1927.

Radio communication is defined as an electrically transmitted message, signal, picture, communication, intelligence or energy without the aid of connecting wires.

LAW, SQUARE

LAW, SQUARE.—The average plate current from a detector tube varies as the square of the voltage or amplitude of the signal impressed on the detector's grid. This is called the square law.

L-C VALUES FOR RESONANCE.—See *Resonance, Inductance-Capacity Values for.*

LEAD, ANGLE OF.—See *Phase.*

LEAD-IN, ANTENNA.—See *Antenna, Lead-in for.*

LEAK, GRID.—A grid leak is a resistor of from one-half to 10 megohms used with some detectors as in Figs. 1 and 2. Some leaks have adjustable resistance. The grid leak is connected directly between the grid and the cathode or filament of a detector, as in Fig. 1, or around the grid condenser as in Fig. 2. See *Detector, With Grid Condenser and Leak.*

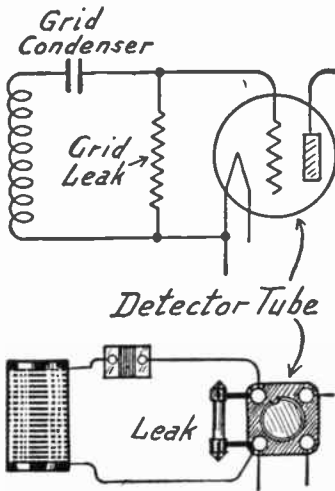

FIG. 1.—Grid Leak Connected to Detector Tube Terminals.

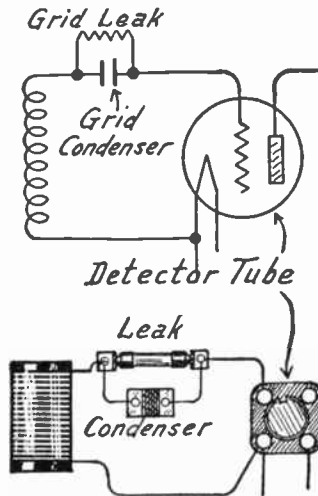

FIG. 2.—Grid Leak Connected Across Grid Condenser.

Grid leaks or grid resistors are used also in resistance-coupled and in impedance or choke-coupled amplifiers. Whenever signal voltages are applied to a grid through a coupling condenser, the grid must be connected to the tube filament or cathode through a high resistance. Otherwise negative charges accumulate on the grid and block plate current through the tube. Also, the grid cannot be biased except through a conductive connection like the resistor. Audio amplifier grid resistors usually run from 50,000 to several hundred thousand ohms. Higher values may increase the amplification, but will make the amplifier likely to oscillate.

LEVEL, STATIC

LEVEL, STATIC.—The static level or the noise level is the combination of all the noises coming into a receiver. These noises are caused by true static, by any kind of interference, by squealing and re-radiating receivers, or by anything that forms electrical impulses which may be picked up and amplified.

The static level determines and limits the distance from which reception may be had with a receiver capable of great amplification. As stations sought for become more and more distant, the strength of their signals which finally reach the receiving antenna is weaker and weaker. A point is reached at which the feeble signal of the far distant station has less strength than the impulses forming the static level. It is then impossible to receive such a station because, as the receiver attempts to amplify its signal into audibility, so will the noises be equally amplified and will continue to be louder than the signal sought for. See *Static*.

LIGHT.—Visible light is a wave motion having such frequency or wavelength as will affect the sense of light. The radiation which is called visible light differs from other forms of radiation such as heat and radio waves only in that light radiation acts upon the human vision. The motion of light waves is transverse or across the direction of propagation, differing thus from sound waves in which the motion is longitudinal or back and forth along the line of propagation.

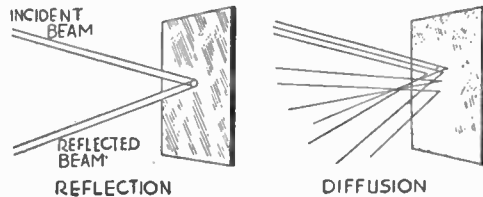

FIG. 1.—Reflection and Diffusion of Light.

The waves constituting visible light are exceedingly short, ranging from 0.000039 to 0.000076 centimeters. A unit more commonly used for such measurements is the micron which is equal to 0.0001 centimeter. The symbol for micron is the Greek letter mu. Another convenient unit in common use is the Angstrom unit, equal to 0.0001 micron or to 0.00000001 centimeter.

Variations in wavelength affect the eye as variations in color. The shortest visible wavelength corresponds to violet and the longest to red. The range of visible colors is called the visible spectrum and includes violet, indigo, blue, green, yellow, orange and red when arranged in order of increasing wavelength. The different colors merge into each other by imperceptible gradations, but the wavelengths in Angstrom units generally associated with the colors are: violet—4100, indigo—4400, blue—4700, green—5200, yellow—5700, orange—6200, red—7000. It is interesting to note that the frequency of green light is about 575 million, million cycles per second. The limits of human vision usually are considered as extending from 3900 to 7600 Angstrom units.

LIGHT

Radiation at wavelengths shorter than the extreme violet is called ultra-violet and extends to the X-ray region. Radiation at wavelengths longer than deepest red is called infra-red and extends to the region of the shortest radio waves. Both ultra-violet and infra-red radiations are outside the limits of visible light.

Light is emitted from its sources in various ways. The most common form of emission is that due to incandescence or to the heating of a body to a degree which makes it luminous. Light which is emitted from gases or vapors because of electrical actions in them is said to result from luminescence. A kind of luminescence in which there is radiation resulting from exposure to light, but continuing after the exciting light has been removed, is called phosphorescence. Certain materials emit light while acted upon by high frequency radiation such as the cathode rays, and this kind of emission is called fluorescence.

Action of Light Waves.—Light waves are subject to numerous effects which alter the direction and sometimes the character of the waves. These effects include reflection, refraction, diffusion, dispersion, diffraction, interference and polarization.



FIG. 2.—Refraction of Light.

Reflection, or the turning back from a surface of the light waves as in Fig. 1, is the most familiar of these phenomena because it occurs not only from specially prepared mirrors but also in some degree from practically all surfaces. If the waves are reflected back at various irregular angles, rather than in beams like those striking the surface, the action is called diffusion of the light.

Refraction, as shown in Fig. 2, is a bending of a beam of light which passes obliquely from one substance into another, or which passes from one region in a substance into another region having a different characteristic such as a difference in density. Refraction occurs where there is a change in the rate of travel of the light waves.

The angle of refraction varies with the wavelength or frequency of the light waves, short wavelengths being bent at greater angles than long waves. If a beam of white light, which contains all the visible wavelengths, be subjected to refraction the light is separated into beams or rays arranged in accordance with wavelength and there is produced the visible spectrum as in Fig. 3. Such a separation of wavelengths is called dispersion of light.

As light waves pass across the edge of an object in their path they are bent and spread apart, the bending being greater as the wavelength becomes longer. This action is called diffraction.

Light beams of different wavelengths may act together to produce interference of light whereby the resulting beam may be weakened or may be separated into bands of different colors.

As has been mentioned, the wave motion constituting light takes place

LIGHT

transversely to the line of propagation of the light. In a beam of ordinary light the vibrations occur in all the directions which are at right angles to the line of propagation. By means of reflection and refraction in certain materials a beam of this ordinary light may be polarized as indicated in Fig. 4 whereupon all the waves except those vibrating in one particular series of parallel planes are stopped and the resulting polarized light has all its wave motion confined to these planes.

Measurement of Light.—The rate of flow of light as it affects the sense is called luminous flux. The amount of light or the flux emitted per unit of area of a source, which is the density of luminous flux from a source, is called the luminous intensity of that source. There are several accepted units of luminous flux, the one in most common use being the candle or international candle. The international candle is defined as the light emitted by the flame of a sperm candle seven-eighths inch in diameter burning at the rate of 120 grains per hour. The candlepower of a light source is its luminous intensity measured in candles. Standards

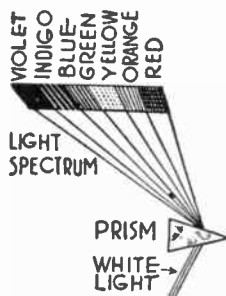

FIG. 3.—The Visible Spectrum.

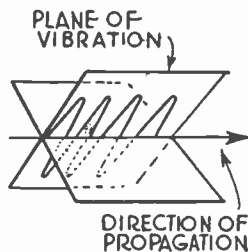

FIG. 4.—Plane Polarized Light.

of candlepower are maintained in the form of carbon filament electric lamps by various government laboratories.

Another unit of luminous intensity is the Hefner lamp which is accepted as being equal to 0.9 candle, although some measurements show it to be more nearly equal to 0.88 candle. The pentane lamp, equal to 10.0 candles is another unit.

The unit of measurement for luminous flux is called the lumen. The lumen is a unit of flow of light just as the ampere is a unit of flow of electric current. A point source of one candle emits a total flux of 4π lumens, or approximately 12.566 lumens. The lumen often is defined as the luminous flux emitted through a solid unit angle by a point source of one candle.

Light Sources.—Electric lamps as sources of light generally are rated either in candlepower or in the number of watts of electrical power consumed. A carbon filament lamp gives about 3.5 lumens per watt. A vacuum lamp with tungsten filament emits about 9.5 lumens per watt. Gas filled lamps are more efficient and their efficiency increases with their size. A 75-watt gas filled

LIGHT

lamp gives about 11.5 lumens per watt while very large lamps, such as those rated at 1000 candlepower, give nearly 20 lumens per watt of power consumed.

Radiation of light or radiant energy from any substance often is compared with the emission of a "black body." A black body is an imaginary ideal material which completely absorbs without reflection any rays which reach it and which is capable of emitting a complete range of wavelengths in any radiation. Such a material does not actually exist but is approximated by a space completely enclosed except for a very minute hole through which rays may pass to or from the interior. As the temperature of a black body is increased the radiation from it increases, but increases at a more rapid rate than the temperature.

Temperatures at which radiation takes place are specified in degrees Kelvin. This is a temperature scale using degrees equal to those of the centigrade scale but having absolute zero for its zero point. Absolute zero is a temperature of 273.1 degrees centigrade or 459.6 degrees Fahrenheit below zero. Sunlight is assumed to be the equivalent of radiation from a black body at 6000 degrees Kelvin. Ordinary tungsten filament electric lamps have radiations equivalent to a black body between 2400 and 2700

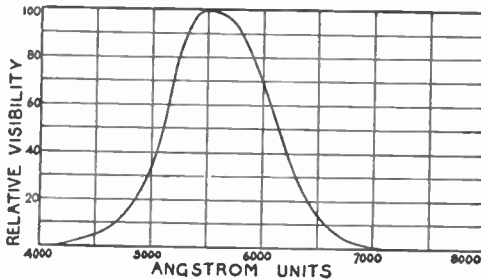

FIG. 5.—Response of the Human Eye to Light.

degrees Kelvin. In calculations of light effects it is customary to use a gas filled lamp from which the light is like that from a black body at 2650 degrees Kelvin.

Illumination.—The amount of luminous flux falling upon a surface of given area is called the illumination of that surface. The illumination is thus the density of luminous flux on a surface which is intercepting light. With a unchanging amount of light at a source the illumination decreases as the surface is taken farther from the source.

The most commonly used unit for measurement of illumination is the foot candle. One foot-candle is the degree of illumination received from a source of one candle at a distance of one foot and it also is equal to the illumination of one lumen of flux falling on one square foot of surface. The illuminatin in foot-candles may be found by dividing the candlepower of the source by the square of the distance in feet from the source.

The illumination produced by one lumen per square meter is called one lux. The illumination resulting from a flux of one lumen per square centimeter is called one phot and one-thousandth part of this unit is the mill phot. One foot-candle is equal to 1.076 milliphots.

LINE, LOAD

LINE, LOAD.—A load line shows the number of volts of potential difference required to force plate current of a given number of milliamperes through a plate circuit load resistance of specified number of ohms. A load line is a straight line drawn on a graph of plate characteristics of a tube. Plate characteristics typical of power pentodes are shown by Fig. 1. They are represented by a "family" of curves, each for a given grid potential, and show the relations between plate current and plate voltage at the various grid potentials.

Since a graph of plate characteristics has a scale for current and another for voltage, load lines are drawn to show currents and corresponding voltages on these same scales. Before a load line can be drawn its "slope" is determined according to the following principles: First, Ohm's law for

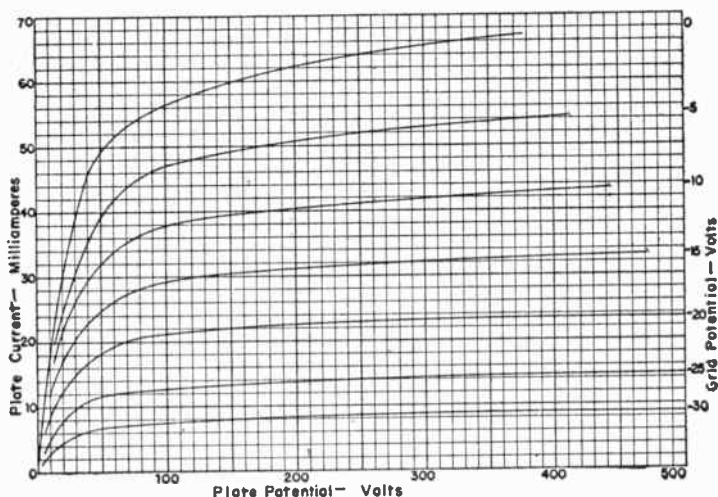

FIG. 1.—Plate Characteristics of a Power Pentode.

resistance ($R = E/I$) shows that resistance in ohms is equal to volts per ampere. When current is measured in milliamperes the formula is changed to $R/1000 = E/I$. This form shows that the number of ohms divided by 1,000 is equal to volts per milliampere. Then, for example, if there is a load of 6,000 ohms in the plate circuit of a tube, the number of ohms, 6,000, is divided by 1,000 and the result is 6 volts per milliampere. All of the lines in Fig. 2 have this slope, for on each of them there is a change of 6 volts for each change of 1 milliampere. This slope is equal also to 60 volts per 10 milliamperes, to 100 volts per 16.7 milliamperes, or to any other ratios having an equivalent value.

In Fig. 3 are shown load lines having slopes that correspond to various other load resistances. For each line the slope, in volts per milliampere, is determined by dividing the number of ohms of load resistance by 1,000. The less is the load resistance the more nearly vertical is its load line and the less is the change of voltage per milliampere change of current.

LINE, LOAD

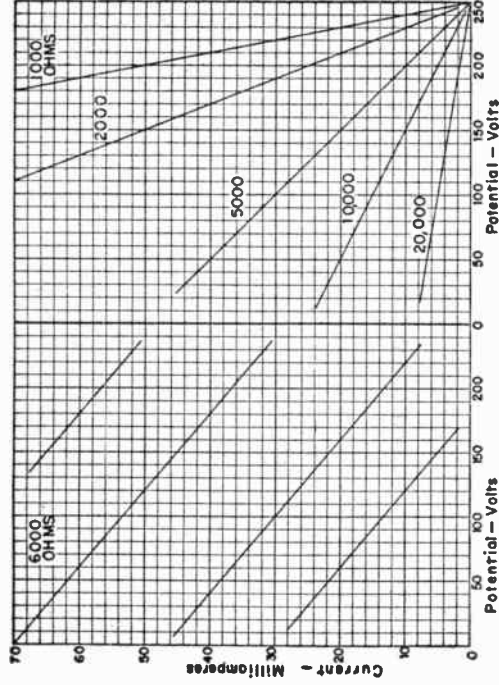

Fig. 2.—Load Lines for 6,000 Ohms Resistance.

When a load line is to be drawn on a graph of plate characteristics, as in Fig. 4, the load line must be placed so that it crosses a combination of voltages, or a combination of voltage and current, at which the tube is to be operated. This operating point may be at

Fig. 3.—Load Lines for Various Resistance Values.

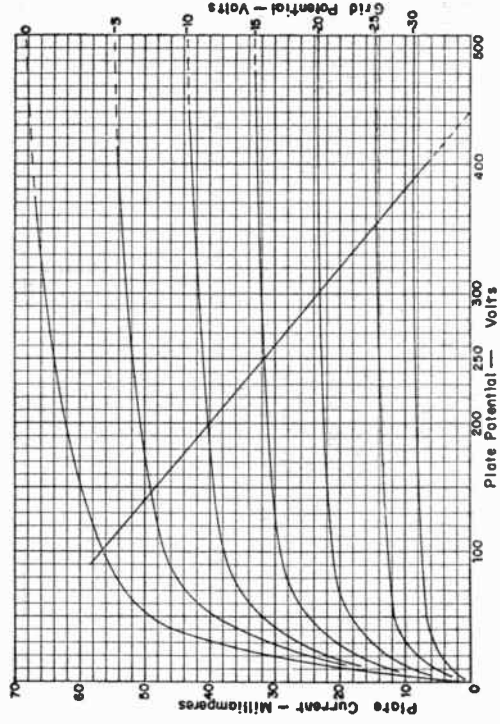

Fig. 4.—A 6,000-ohm Load Line on the Plate Characteristics.

LINE, LOAD

a certain grid (bias) voltage and plate voltage, or at a grid voltage and plate current, or at a plate current and plate voltage.

In Fig. 4 it has been assumed that the tube in whose plate circuit there is a 6,000-ohm load is to be operated at a negative grid bias of 15 volts and at a plate potential of 250 volts when no signal is being applied to the grid. Under these conditions the tube will operate at the intersection of the curve for 15 volts negative grid potential and the vertical line for 250 volts plate potential. The plate current, as read from the graph, will be 31.7 milliamperes. The load line is placed on the graph so that it crosses this intersection, and is drawn to have a slope of 6 volts per milliampere or 60 volts per 10 milliamperes. The load line usually is extended as a straight line in both directions until it crosses all the curves for grid potentials.

Load lines always are sloped upward from right to left, as in Figs. 2 to 4. This direction of slope shows, as in Fig. 4, that more plate current is accompanied by less plate potential at the tube. The reasons for these opposite changes of plate current and potential are as follows.

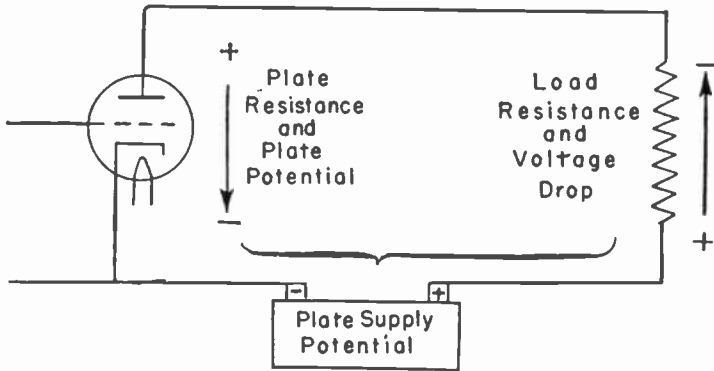

FIG. 5.—Relations of Supply Potential to Potential Drops.

The plate supply potential is applied to the resistance of the load and the plate resistance of the tube in series, as shown by Fig. 5. The total potential of the supply must divide between the load and plate resistances, and because the supply potential is assumed to be constant, the sum of the voltage drops across load and tube must remain constant. The voltage drop in the load resistance is equal to the product of load current and load resistance, as is shown by the form of Ohm's law that reads $E = IR$. But because the load current and plate current are the same thing, we may say that the voltage drop in the load is equal to the product of plate current and load resistance. Then it follows that as plate current increases there must be a greater voltage drop in the load, and, since the sum of the voltage drops in load and tube must remain constant, the increase of drop in the load is accompanied by an exactly equal decrease of voltage drop across the tube. This voltage drop across the tube is the plate potential, and so it appears that more plate current must be accompanied by less plate voltage at the tube.

LINE, LOAD

When an alternating signal voltage is applied to the grid circuit of the tube the grid will become alternately more and less negative than the bias voltage. For every resulting grid potential the accompanying plate current and plate voltage will lie on the load line at the point where this line crosses the new value of grid potential. For example, with the conditions of Fig. 4, there may be a signal that swings the grid from 5 volts to 25 volts negative. When the grid is 5 volts negative the plate current is read on the load line as 49.0 milliamperes and the plate potential (at the tube) as 146 volts. When the grid goes to 25 volts negative the plate current drops to 14.4 milliamperes and the plate potential at the tube increases to 354 volts. The tube is being "worked" along the load line.

If a load line is extended until it crosses the horizontal scale line for zero plate current, as has been done in Fig. 4, the point of intersection will show the plate supply potential required for operation of the tube at the conditions shown by the load line. In Fig. 4 the plate supply potential would have to be 440 volts. This comes about because, with zero plate current and load current, there would be no voltage drop in the load, and the plate potential on the tube would be the full supply potential.

If a tube is to be operated with a given plate supply potential and a specified load resistance, the slope of the load line may be determined in the usual way and the line run from the point on the graph corresponding to zero plate current and a plate potential equal to the supply potential. When it is desired to check the performance of a tube with different load resistances the common practice is to draw load lines for the various resistances, all starting from the supply potential which is to be used. For example, all of the load lines of Fig. 3 might be drawn on the graph of Fig. 4, starting them upward and to the left from any supply potential to be used.

LOOP, ANTENNA ACTION OF

LOOP, ANTENNA ACTION OF.—Any loop consists of vertical wires and horizontal wires. The loop might be circular or the wires placed at various angles, still we would have some wires running up and down or practically so and others running across or horizontally.

As shown in Fig. 1 a loop operates as a coil or an inductance in which the radio waves generate a signal voltage. On the other hand an open antenna, outdoor or indoor, is primarily a condenser on whose plates the radio waves build up electric charges.

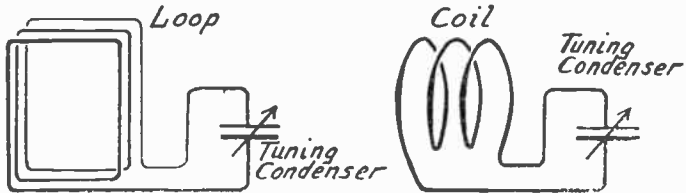

FIG. 1.—The Loop Is, in Effect, an Inductance Coil.

The radio signal may be considered as traveling horizontally away from the transmitting station. Oncoming radio waves will strike first one edge of the loop, then pass across to the other edge. As a wave strikes one side of the loop it causes a voltage to be generated in the vertical wires on that side. The wave then travels across the loop, strikes the other side, and causes an exactly equal voltage to be generated in the vertical wires on the other side of the loop. The two voltages oppose each other as may be seen from Fig. 2. Both voltages tend to force current up or both tend to force it down

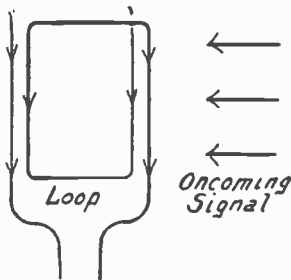

FIG. 2.—Equal Voltages Generated in Both Sides of Loop.

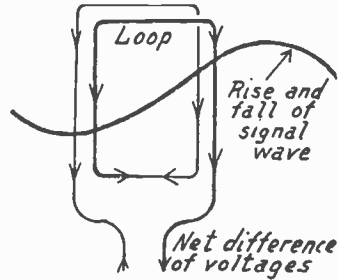

FIG. 3.—The Phase Difference Allows a Net Voltage to Be Delivered by a Loop.

on both sides of the loop. Naturally two currents flowing down on opposite sides of the coil formed by the loop will meet each other, and if they meet at exactly the same time and in equal quantities will balance each other completely. The same thing will happen with two currents both flowing upward on opposite sides of the loop.

LOOP, ANTENNA ACTION OF

The only reason the loop delivers any signal to a receiver is because the two voltages generated on opposite sides of the loop are not generated at exactly the same time. The voltage in the side of the loop toward the transmitting station, in the side the radio wave strikes first, rises to its maximum a little before the maximum voltage in the side of the loop away from the transmitting station. There is a difference in phase or in time between the two voltages.

Because of this difference in phase the voltage peak in one side of the loop will occur when the voltage in the other side is not quite at its peak as in Fig. 3. The difference between the higher voltage on one side of the loop and the lower voltage on the other side of the loop will be the net voltage that is available as signal strength in the receiver.

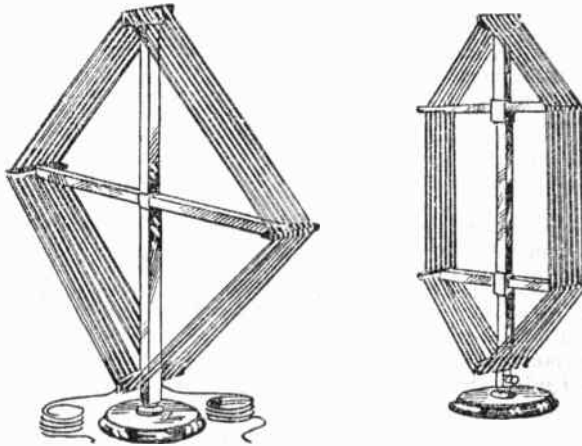

FIG. 4.—Box Type Loops.

Were it possible to build the loop with its sides so far apart that they would be separated by one-half the length of the wave we would have ideal conditions because the rise of the wave to positive voltage would then act on one side of the loop while the increase of the wave in negative voltage acted on the other side of the loop. To build loops as wide as one-half a wavelength would mean they would be of the general proportions of battleships and this is not practical. It is true however that the greater the distance between the sides of the loop the greater will be the power received.

The higher the loop the greater will be the length of the vertical sides. The greater the length of wire exposed to the radio wave the greater will be the voltage generated in such a wire. Therefore, the higher the loop or the longer its vertical sides the greater will be the signal strength received by the loop.

Thus the signal is increased by increasing the width of the loop and it is also increased by increasing the height of the loop. The greater the area of the loop the greater will be the signal strength it delivers.

The signal energy received by a loop increases with increase of the number of turns or with increase of the inductance of the loop. The signal energy increases with decrease of resistance in the loop.

LOOP, DESIGN AND CONSTRUCTION

LOOP, DESIGN AND CONSTRUCTION OF.—In building a loop for a receiver the safest method is to use an excess length of wire to begin with. After the loop is wound, a high wavelength or low frequency broadcasting station should be tuned in. If the dial setting of the loop tuning condenser is much too low, that is, if too little of the condenser is used for this wavelength, wire should be removed from the loop. Take off one-half turn at a time. The loop should be retuned after each alternation and wire should be removed until the dial setting is correct for the station being received.

The inductance of the loop and the maximum capacity of the tuning condenser used with it determine the highest wavelength or lowest frequency to which the combination will be resonant. It would be highly desirable to use a loop with large inductance and a very small tuning condenser because the large loop would collect much more energy than a small one and the voltage changes across it would be greater than those across a small one.

However, it is unfortunate that such ideal combinations cannot be made to handle the entire range of broadcasting frequencies. The small condenser has not sufficient change of capacity between minimum and maximum settings to change the L-C value over the necessary amount for tuning. Furthermore, the distributed capacity of the loop winding forms a much larger proportion of the whole capacity in the circuit when the variable condenser is a small one and this distributed capacity in the loop is not subject to variation for tuning.

It will be found that a tuning condenser of .00025 microfarad capacity is slightly too small for loop work in many cases. With a carefully constructed loop having the wires well spaced a .00035 condenser will generally cover the entire broadcasting range. A condenser of .0005 microfarad capacity will be still easier to tune and the signal power will be only slightly reduced. It should hardly be necessary to use a .001 microfarad condenser to tune a loop.

Condenser Capacities.—Loops with few turns have a greater range of tuning than those with many turns. The big problem in designing and building a loop is to reach the lower wavelengths or higher frequencies when a small condenser is used. It is desirable to use the largest loop and smallest possible condenser because the larger the loop in area and number of turns the greater will be the signal strength collected. With such a combination the minimum capacity of the condenser must be small and the distributed capacity of the loop must likewise be small, otherwise the two capacities combined will prevent tuning to low wavelengths because of the combination of the capacity with the large inductance in a big loop. By using a larger condenser and a smaller loop the change of capacity in the condenser between minimum and maximum settings

LOOP, DESIGN AND CONSTRUCTION

is great enough to avoid trouble in tuning, but the signals will not be as strong.

The wires on the sides of the loop may be run in two banks staggered with reference to each other as at the left in the illustration. They may also be run at angles with one another as at the right in the same drawing. Either of these methods reduces the distributed capacity of the loop but reduces the inductance at the same time.

Length of Wire on Loop.—The length of wire on a loop has no direct bearing on the frequency or wavelength to which the loop will respond. The frequency depends on the inductance of the loop just as the frequency to which a coil will respond depends on its inductance and not directly on the number of feet of wire in the coil.

Loops of average size and construction, when used to receive broadcasting stations, require about eighty-five feet of wire when the loop sides are short, and about one hundred feet with long sides. This wire should be flexible stranded, double silk covered. Loop wire generally consists of thirty to sixty strands of very fine bare copper wire such as number 38. Solid or stranded wire may be of number 14 or number 16 gauge.

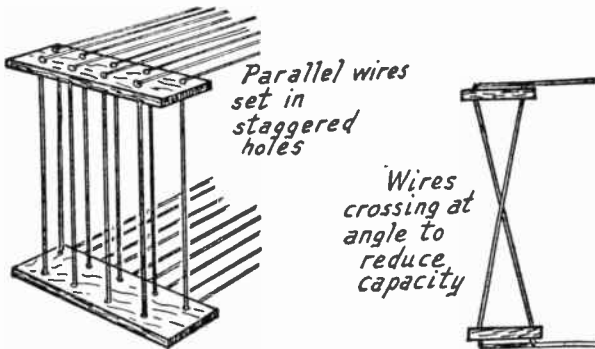

Arrangement of Wire on Loop Framework.

Construction of Frame.—The framework of a loop should have no metal inside of the turns of wire. Any metal within the loop is, in effect, inside the field of a tuning coil and the eddy currents set up in the metal cause a loss of energy. The framework of the loop should contain the least possible material of any kind and whatever material is used should have low dielectric losses. That means that the most suitable materials are the high grade moulded and laminated compounds such as Formica, Bakelite, Celoron, etc., also well prepared woods and glass.

All supporting points for the wire windings should be made of the best of insulating material. It is not sufficient to depend on the insulating covering of the wire alone. If wood is used for supports the wires should not rest directly against the wood but should be carried upon some insulation of greater resistivity.

The two ends or terminals of the loop winding should be kept at the greatest possible distance from each other. They should never

LOOP, DESIGN AND CONSTRUCTION

be connected to a duplex cable, a cable with two conductors, on their way to the receiver but should be kept well separated. This is to avoid the bypassing effect of the capacity between parallel wires and terminals that are close together.

Spacing of Wires.—A loop, like any other coil, has inductance which is desirable, and distributed capacity which is undesirable. Therefore, we do everything possible to increase the inductance for a given length of wire or resistance and do everything possible to decrease the distributed capacity without too greatly affecting the inductance.

Inductance is increased by using more turns, greater length in each turn, and less spacing between turns. Distributed capacity is reduced by using fewer turns and more spacing between turns.

It will be seen that these requirements are opposed to one another. We want more turns to increase the inductance, but fewer turns to reduce the capacity. We want less spacing to increase the inductance and more spacing to decrease the capacity.

There is a more or less critical spacing beyond which additional spacing does not greatly reduce the distributed capacity. For a loop only two feet square the gain with spacing greater than one-eighth of an inch becomes less noticeable. For a loop four feet square this critical spacing is somewhat less than one-quarter of an inch, while for a loop eight feet square the wires should be at least three-eighths of an inch from one another.

As the number of turns on the loop is increased the distributed capacity becomes greater. At first this increase in capacity is quite rapid but as more and more turns are added to the loop, bringing its ends farther apart, the increase of capacity does not keep pace with the number of turns.

Turns Required on Loops.—The following table shows the number of turns required on box loops of various dimensions when used with tuning condensers from .00025 to .001 microfarad capacity. The loops are considered as being square, that is, with four sides of equal length. These sizes run from ten inches square up to thirty-five inches square.

Dimensions are given both for length of the sides of a square loop and for the area in square inches of the side of an oblong rectangular loop. A rectangular loop having the same area as a given square will operate satisfactorily with the number of turns specified for the square loop. The longer dimension of the loop should not be more than twice its shorter dimension.

As an example, a loop having sides of 16 inches and 25 inches has an area of 400 square inches. A loop 20 inches square likewise has an area of 400 inches. The numbers of turns given in the columns for loops 20 inches square are applicable then to loops with sides 16 and 25 inches long or to any other combination of dimensions which yields an area of approximately 400 square inches.

In winding loops which are longer than they are wide and using the following tables in determining the number of turns, it is always advisable to place at least one extra turn in the beginning to care for changes brought about by the difference in shape. The extra wire may then be removed if it is found unnecessary, this being known when the loop is tried out with the tuning condenser which will be regularly used. The added turn or turns may be supported in a temporary manner while testing.

LOOP, DIRECTIONAL EFFECT OF

URNS REQUIRED FOR RECTANGULAR LOOPS

Length of Side in Inches—Square Loop or Area of Rectangular Loop									
Condenser Capacity in Mfds.	Spacing $\frac{1}{4}$ -inch Between Turns								
	10x10 100	12x12 144	14x14 196	16x16 256	18x18 324	20x20 400	25x25 625	30x30 900	35x35 1225
.00025	—	—	—	25	23	21	17	15	13
.00035	—	—	22	20	18	17	14	12	11
.0005	—	21	18	16	15	13	11	10	9
.001	16	13	11	10	9	9	7	6	6
Spacing $\frac{1}{2}$ -inch Between Turns									
Condenser Capacity in Mfds.	Spacing $\frac{1}{2}$ -inch Between Turns								
	10x10 100	12x12 144	14x14 196	16x16 256	18x18 324	20x20 400	25x25 625	30x30 900	35x35 1225
.00025	—	—	—	—	—	—	20	17	15
.00035	—	—	—	—	23	20	16	14	12
.0005	—	—	24	20	18	16	13	11	10
.001	22	17	14	12	11	10	8	7	6
Spacing $\frac{3}{4}$ -inch Between Turns									
Condenser Capacity in Mfds.	Spacing $\frac{3}{4}$ -inch Between Turns								
	10x10 100	12x12 144	14x14 196	16x16 256	18x18 324	20x20 400	25x25 625	30x30 900	35x35 1225
.00025	—	—	—	—	—	—	24	20	17
.00035	—	—	—	—	—	25	19	16	13
.0005	—	—	—	26	22	19	15	12	10
.001	—	21	17	14	12	11	9	8	7

LOOP, DIRECTIONAL EFFECT OF.—If a loop is turned so that it is pointed edgewise toward the transmitting station, radio waves from that station will travel the **greatest distance between the**

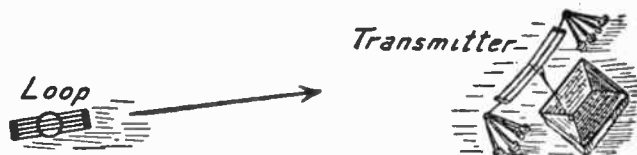

FIG. 1.—Loop Pointed at Most Favorable Direction Toward Transmitter.

LOOP, DIRECTIONAL EFFECT OF

two sides of the loop. This is shown in Fig. 1 with the loop turned at the most favorable position toward the transmitting station.

When the loop is finally turned so that its flat side is toward the transmitting station the signal strength will be least. Under this

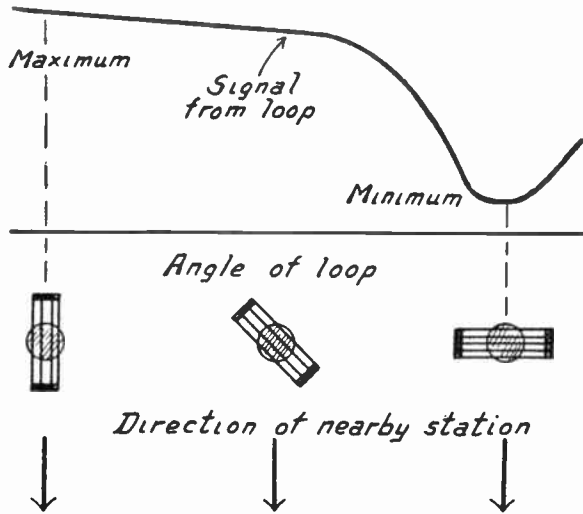

FIG. 2.—Effect on Signal of Turning Directional Loop with Reference to Nearby Transmitting Station.

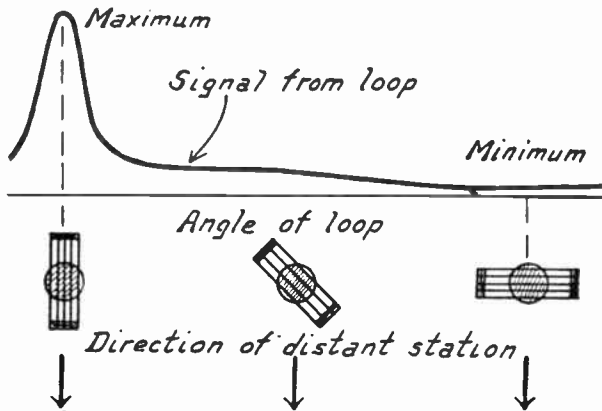

FIG. 3.—Effect of Turning Directional Loop with Reference to Distant Station.

condition the advancing radio wave strikes both sides of the loop at the same instant, generates exactly equal and opposite voltages which balance each other out completely, leaving no signal for the receiver except that due to loop capacity.

LOOP, PRECAUTIONS IN USE OF

It will be seen from the foregoing that the strongest signal will be delivered by a loop which is pointed directly toward the transmitting station, that is, when its edge is toward the station. The least signal strength is received when the loop is broadside toward the station.

Therefore, it is possible to partially or wholly tune out an undesired station by turning the loop broadside toward it. Pointing the loop will greatly increase the signal strength from a distant station. One of the greatest advantages of the loop is in this ability to tune out unwanted signals while receiving the desired signals with maximum strength.

In using a loop it will be found that the signal strength from a nearby station remains approximately the same until the loop is turned almost exactly at right angles to the station. The signal strength will then show a sudden and decided decrease during the last few degrees of loop movement. This is shown in Fig. 2 for various angles of a loop.

On the other hand the signal strength from a distant station will show a very gradual increase as the edges of the loop are brought into line with the direction of the radio waves. But during the final few degrees of loop movement, the movement that brings the loop directly in line with the station, a decided and sudden increase in signal strength will be noticed. This is shown in Fig. 3.

LOOP, PRECAUTIONS IN THE USE OF.—A loop will not receive signals with any satisfaction from stations whose fre-

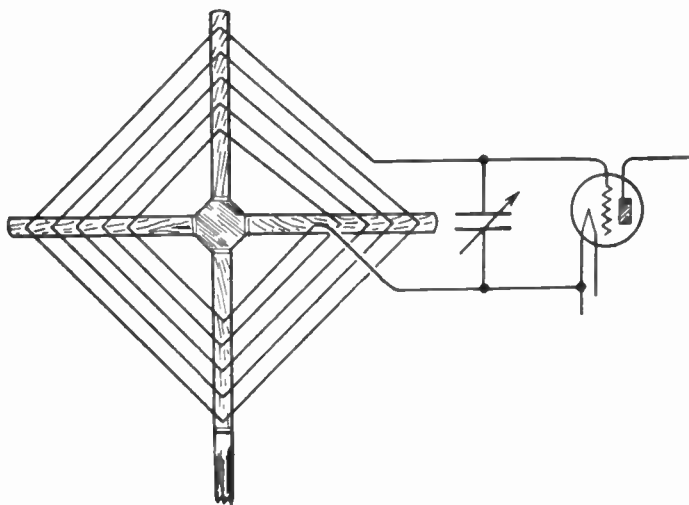

Connections from Spiral Loop to Receiver.

quency is above the fundamental frequency of the loop. This fundamental frequency of the loop is determined by the combination of its inductance and its distributed capacity. Whatever the frequency at which these two produce resonance, that is the limit of

LOOP, REGENERATION WITH

the loop's usefulness on the lower wavelengths. This is the reason for taking every care to reduce distributed capacity.

In making connections between a spiral loop and its receiver the inside of the spiral should always be connected to the filament circuit in the receiver, as in the drawing. The outer end of the spiral will then be connected to the grid of the first tube.

It is necessary that the loop be protected from the field of any radio frequency coil or oscillator coil in the receiver. These coils often have a wide-spread and rather powerful field. A loop placed close to the receiver will pick up energy from such a coil and oscillation will be difficult to control. In a loop receiver it is often necessary to shield the radio frequency or oscillator coils or to shield the entire receiving set.

A loop receiver used in the same room with another receiver connected to an antenna and ground will be broad tuning. Experiments show that an antenna wire ten or twelve feet away from a loop will so strongly affect the loop that a station tuned in on the antenna may be heard regardless of change in loop tuning. In buildings having steel framework it may be found that a short indoor antenna is much better than a large loop.

LOOP, REGENERATION WITH.—Since the amount of energy collected by a loop is very small even under the most favorable conditions, it is of great advantage to employ regeneration. This greatly reduces the effective resistance of the loop circuit at the frequency being received. Regeneration may be obtained in a loop by any of the methods which would allow regeneration in a tuned radio frequency transformer.

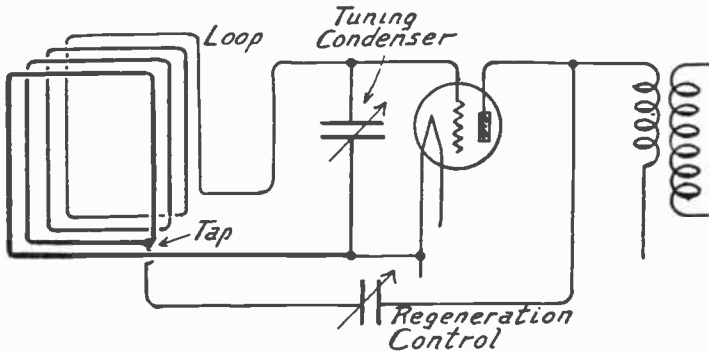

One Method of Regeneration with a Loop.

Energy from the plate circuit of the first tube may be fed back into the loop through a variable condenser of small capacity. The connections are shown in the diagram. One end of the loop is connected to the grid of the first tube. Two or more turns away from the connection to the filament circuit at the other end a tap is used. From the tap, connection is made through the small condenser to the plate circuit.

LOOP, SPIRAL TYPE

With another method a few additional turns are placed on the loop and used as a tickler winding. Current through this tickler may be controlled with a high resistance, a variable condenser or any other means generally adopted for control of tickler effect.

LOOP, SPIRAL TYPE.—A spiral type loop may be mounted to swing either upon its long or short horizontal axis or upon a diagonal axis. Spiral loops are often made of circular or oblong shape.

A spiral loop has less inductance than a box loop for the same outside dimensions and for the same length of wire used. The spiral loop has slightly less distributed capacity than a box loop, spacing and other factors being the same.

LOOP, TAPS IN.—Dead ends are very harmful in a loop. They reduce the power and broaden the tuning. If a loop is built with a dead end and the dead end turns then removed, the wavelength to which the loop responds with a given condenser setting will be lowered, that is, the loop will respond to higher frequencies. Short circuiting the dead end turns will only make matters worse.

LOOP, WAVE TRAP WITH.—Any form of wave trap may be used in connection with a loop. A series or impedance wave trap may be placed in the lead from the loop to the filament connection in the set. An absorption wave trap may be connected in this same lead which goes to the filament connection in the receiver. See *Trap, Wave*.

LOOSE COUPLING.—See *Coupling, Loose*.

LOSSES IN COIL.—See *Coil, Losses In*.

LOSSES IN CONDENSER.—See *Condenser, Losses In*.

LOSSES IN CONDUCTORS.—See *Resistance, High Frequency*; also *Skin Effect*.

LOSSES IN TRANSFORMERS.—See *Transformer*.

LOUD SPEAKER.—See *Speaker, Loud*.

LOW FREQUENCY.—See *Frequency, High*.

LOW-LOSS.—Radio units and parts which are described as low-loss are understood to have low radio frequency resistances and slight absorption of energy. See the following: *Coil, Losses in*; *Condenser, Losses in*; and *Resistance, High Frequency*.

LOW PASS FILTER.—See *Filter, Low Pass*.

LUMEN.—A unit of light or luminous flux. See *Light*.

M

m.—A symbol for mass.

M.—A symbol for mutual inductance.

MAGIC EYE.—See *Tube, Electron-ray.*

MAGNET WIRE.—See *Wire, Magnet.*

MAGNETIC CIRCUIT.—See *Circuit, Magnetic.*

MAGNETIC COUPLING.—See *Coupling, Inductive.*

MAGNETIC FIELD.—See *Field, Magnetic and Electromagnetic.*

MAGNETIC HYSTERESIS.—See *Hysteresis.*

MAGNETISM AND ELECTROMAGNETISM.—Like electricity, magnetism can be described best by telling of its actions and effects. The action most commonly thought of is that by which a magnetic piece of iron or steel attracts another piece of iron or steel to itself.

Magnetism is assumed to flow in magnetic lines of force and these lines of force travel in magnetic circuits through the magnet and through the space immediately surrounding the ends or poles of the magnet.

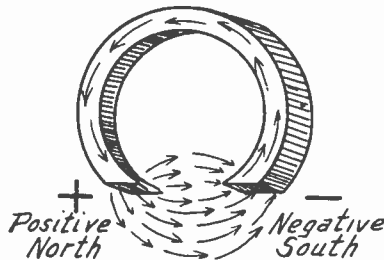

FIG. 1.—The Poles and Field of a Magnet.

These lines of force pass through the metal of the magnet from one end to the other and after issuing from the magnet travel through the surrounding space to re-enter again, thus keeping up a continuous travel or magnetic circuit as shown in Fig. 1. The end of the magnet from which the lines of force leave the magnet is called its positive pole, and the end at which they re-enter is called the negative pole.

A piece of iron or steel may be made a magnet through the influence of another piece that is already magnetic or by being acted upon by the electrical influence from a conductor carrying current. A magnet shows attraction for another magnet or for any piece of iron or steel near it.

The end at which the lines of force enter, the negative pole in other words, may also be called the south pole, while the end from

MAGNETISM AND ELECTROMAGNETISM

which the lines of force leave is called either the positive or north pole. The space in which the lines of force travel outside the magnet is called the magnetic field.

While all metals are conductors of electric current, in practical work only iron and steel can become magnets. However, lines of force easily pass through all other substances, metal or otherwise, almost as if the substances did not exist. Magnetism can be controlled only by providing paths of iron or steel for it to travel through, there being no materials that confine magnetism as insulators confine electric current.

A hard steel magnet retains magnetism until heated, violently jarred, etc., and is called a permanent magnet. Soft iron will not retain magnetism and remains magnetic only while in the field of another magnet or of a current-carrying conductor. Soft iron in contact with a magnet becomes magnetic itself.

Magnets brought near each other with like poles together show repulsion for each other; with unlike poles together, they attract each other. Two positive or two negatives repel, while a positive and a negative attract.

Magnets placed together with like poles together form a compound magnet stronger than a one-piece magnet of the same weight as all the parts together. Magnets placed together with unlike poles (positive and negative) next one another, neutralize each other's strength and there is no useful outside magnetic field.

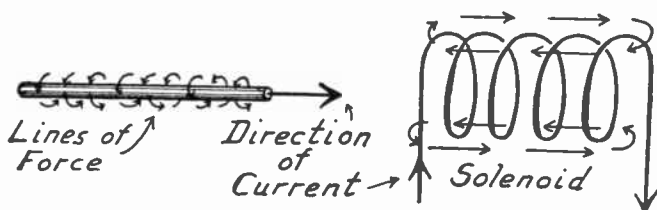

FIG. 2.—Electromagnetic Lines of Force Around a Conductor and a Coil.

Electromagnetism.—A conductor through which is flowing an electric current is surrounded by circular lines of force which whirl around the conductor as a center. These lines of force always travel around the conductor in one direction relative to the direction of current flow through the conductor and as shown in Fig. 2. If the current flow is reversed through the conductor, the direction of the lines of force is also reversed.

Should the conductor be made into a coil as shown at the right in Fig. 2, the lines of force will not make complete circles around the turns of the conductor, but will pass completely through the coil, which is now a solenoid, and will then return in the other direction around the outside of the coil.

If a piece of iron be placed within the solenoid the lines of force that were traveling inside the coil will travel through the iron in the same direction as shown in Fig. 3, making the iron a magnet whose polarity corresponds to the direction in which the current flows through the conductor. This combination of an iron core and a coil is called an electromagnet. The strength of the electromagnet depends on the number of amperes flowing through the

MAGNETOMOTIVE FORCE

coil and on the number of turns of the conductor around the iron core.

To produce a strong magnetic effect in iron or steel, the conductor is wound around the metal. The lines of force then go through the metal, called the core, and their direction through the core depends on the direction of current flow through the conductor and on the direction in which it is wound around the core.

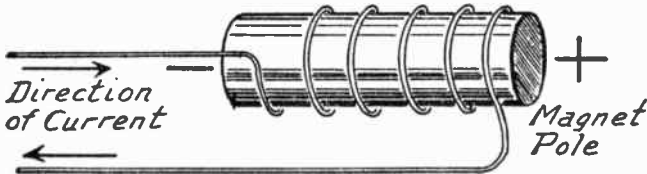

FIG. 3.—Current Flow Around an Electromagnet.

The core of an electromagnet is made from soft iron, usually in thin sheets or lengths of wire in place of in a solid piece. Such a magnet retains its magnetism only as long as current flows through its winding. A small amount of magnetism remains in the core, no matter how soft the iron may be, and this remaining magnetism is called residual magnetism. See also *Induction; Circuit, Magnetic; Field, Magnetic and Electromagnetic; and Iron and Steel.*

MAGNETOMOTIVE FORCE.—See *Iron and Steel.*

MAGNETOSTRICTION.—A property of nickel and some magnetic alloys by which they change dimensions when magnetized. A magnetostriction oscillator operates at the natural vibration frequency of a rod having this property, which is used for regenerative feedback in a vacuum tube circuit.

MAGNETRON.—A two-element high-frequency oscillator tube in which flow of electrons from a central cathode to a surrounding cylindrical plate is controlled by magnetic deflection of the electrons. The magnetic field is generated outside the tube. The electrons are caused to follow curved paths, which may or may not extend as far as the plate.

MATCHING IMPEDANCE.—See *Impedance, Matching of.*

MEAN FREE PATH.—The average distance traveled by electrons between collisions with atoms in a gas, or the distance between collisions of atoms with other atoms.

MEG- or MEGA-—A prefix meaning one million times the unit. Thus, one megohm is 1,000,000 ohms.

MEISSNER OSCILLATOR.—See *Oscillator.*

MERCURY ARC RECTIFIER.—See *Rectifier, Mercury Arc.*

MERCURY VAPOR RECTIFIER.—See *Rectifier, Mercury Vapor.*

MERCURY VAPOR TUBE.—See *Tube, Gas-filled.*

MERSHON CONDENSER

MERSHON CONDENSER.—See *Condenser, Electrolytic*.

METALS.—See names of various metals; also *Resistance, Materials for*.

METER.—A unit of length in the metric system of measurement. One meter is equal to 39.37 inches, 3.281 feet, or 1.094 yards in English units of length. Commonly used fractions of the meter include the centimeter, which is one one-hundredth of a meter, and the millimeter, which is one one-thousandth of a meter. For conversion values of metric and English units of length, area, volume and mass see *Metric System*.

The meter is the unit in which the length of radio waves is measured. See *Wavelength*.

METER-AMPERE.—A measure of the strength of a radio transmitting station. The number of meter-amperes is found by multiplying the number of amperes of maximum current in the antenna by the number of meters of height of the antenna.

METERS.—Any instrument which measures electrical values is called a meter. An ammeter measures the current in amperes, a voltmeter measures the electromotive force in volts, a wattmeter measures electrical power in watts. A milliammeter measures current in milliamperes or thousandths of an ampere. The potentiometer is wrongly named since it does not measure potential but divides potential between different circuits. Frequency meters measure the frequency of alternating fields.

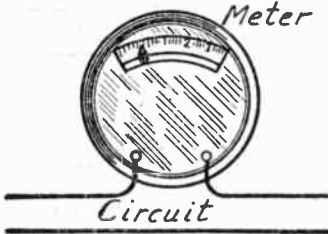

FIG. 1.—Ammeter in Series with Circuit.

METERS, AMPERE AND VOLT.—An ampere meter or ammeter measures electric current flow in amperes, its scale being graduated in amperes and parts of amperes. A voltmeter measures electric pressure, potential or electromotive force in volts with a scale divided into divisions representing volts and parts of volts. The principles upon which ammeters and voltmeters operate are the same. The ammeter allows the

current to flow practically unhindered and indicates the effect of the current passing in a circuit. The voltmeter offers such high resistance to the flow of current that this flow is practically stopped. The voltmeter then measures the effect of the voltage or pressure acting upon its terminals.

Ammeters are connected in series with the circuit in which the current is to be measured. That is, the circuit is opened and the ammeter inserted between the opened ends, as in Fig. 1. Voltmeters are connected in parallel across the two sides of a circuit without opening the circuit when the voltage difference between the two sides is to be measured. Voltmeters are also connected across any two points in a circuit when the voltage drop between these points

METERS, AMPERE AND VOLT

is to be measured. A voltmeter may be connected between any two points whose voltage difference is to be measured, either in an open circuit or a closed circuit. Such connections are shown in Fig. 2.

Ammeters may be used in a receiver to measure the flow of current to the filaments of the tubes, although this is seldom done. Milliammeters are often used to measure the flow of direct current in the plate circuits of the tubes, this being an indication of considerable value in the proper operation of a receiver.

Voltmeters are often used to measure the voltage across the tube filaments and other voltmeters or a double range meter may be used to measure the voltage applied to the plate circuits.

More current flows through the filament of a new tube than flows when the same tube is older. While the current in amperes for best reception decreases with age, the voltage across the filament remains the same for best reception practically regardless of age or at least until the tube is in such condition it should be discarded. For these reasons a reading of the filament voltage is of greater value in a receiver than a reading of filament current. A filament voltmeter is to be recommended in place of a filament ammeter.

Voltmeter connections may be made by using an open circuit jack between positive and negative filament connections at or near the tube, making the connection on the tube side and not on the battery side of any resistor in

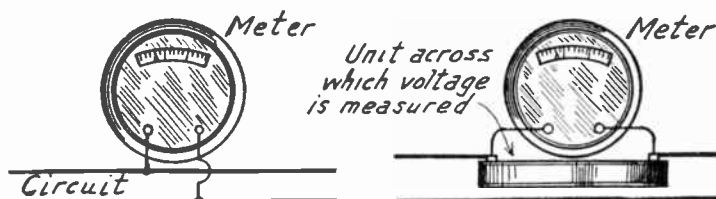

FIG. 2.—Voltmeter Connected Across a Circuit.

the circuit. Ammeter connections may be made by placing a closed circuit jack in series with the line whose current or amperage is to be measured. Methods of inserting voltmeters and ammeters into the various receiver circuits are shown under *Jacks and Switches, Uses of*.

Ranges of Meters.—The range of a meter is the greatest value it will measure, either in amperes or volts. For instance, a voltmeter which reads from zero up to eight volts is said to have a range of eight volts. For measuring filament voltages when using storage batteries the voltmeter should have a range of at least $0-7\frac{1}{2}$ volts and this may well be $0-10$ volts. For measuring plate voltages when using batteries for this work a voltmeter of $0-150$ volts range is generally employed, since voltages greater than 150 are seldom secured from batteries. Voltmeters having two or more ranges combined in the one instrument are often used with a switch-over connection so that either range may be employed. These double range meters generally have the first range of from $0-7\frac{1}{2}$, $0-10$ or $0-15$ volts and the other of $0-150$ volts.

Plate milliammeters for measuring the flow of direct current to plate circuits have ranges depending on the total plate current consumption of the receiver. Some receivers use very little plate cur-

METERS, AMPERE AND VOLT

rent and a meter of 0-30 milliamperes range will be sufficient. But with some of the larger power tubes a meter showing up to 50 milliamperes or even higher may be required.

Voltmeters Used as Ammeters.—It will be found that many voltmeters may be used as plate milliammeters although the voltmeter scale will not read correctly for milliamperes. Because voltmeters have a very high resistance this is not good practice. The high resistance cuts down the plate voltage and may cause resistance coupled feedbacks and howling.

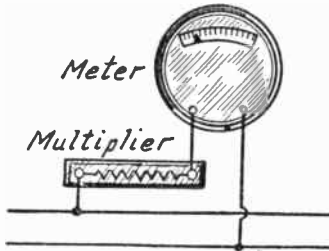

FIG. 3.—Multiplier Used with Voltmeter.

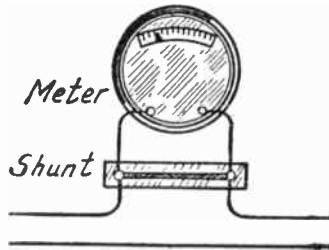

FIG. 4.—Shunt Used with Ammeter.

A voltmeter originally intended to read comparatively low voltages may be used to read higher voltages which are multiples of the lower ones by inserting a resistance unit in series with the voltmeter as in Fig. 3. These resistances are called multipliers. They may be bought ready made of proper value for many high grade meters and serve the purpose of making the instrument one of several ranges.

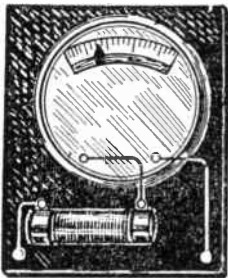

FIG. 5.—Milliammeter Used as Voltmeter.

A voltmeter may be used as an ammeter by placing a rather low resistance unit between its terminals. Of course, the meter scale must then be calibrated for the new purpose. An ammeter made for one range may be used for measuring higher ranges by adding a low resistance element called a shunt between its terminals. These ammeter shunts may be bought for the better grade instruments just as voltmeter multipliers may be bought. Fig. 4 shows a shunt in use. The meter scale readings must then be multiplied by some number, generally 2, 5, 10 or similar numbers, to give correct indications.

Ammeters Used as Voltmeters.—A milliammeter may be used as a voltmeter by connecting a high resistance unit in series with the milliammeter as in Fig. 5. The number of ohms resistance will determine the maximum voltage that may be measured with the remodeled instrument.

Milliammeters generally have a full scale reading of one, five, ten, twenty, thirty or fifty milliamperes. It will be convenient to

METERS, AMPERE AND VOLT

make the meter read a maximum voltage which is some even multiple of the maximum number of milliamperes since it will then be comparatively easy to translate the scale readings into voltages. For example, a milliammeter reading up to ten milliamperes may be changed to a voltmeter reading up to one hundred volts. Each milliamperere on the scale will then indicate ten volts and the entire ten milliamperes will become equal to the entire one hundred volts.

The number of ohms resistance to be placed in series with various milliammeters to change them over into voltmeters is given in the following table. The resistance is shown at the intersection of the lines for the present maximum reading of the milliammeter scale and the desired maximum voltage reading.

The less the range of the milliammeter to begin with the more efficient it will be as a voltmeter. This is because the meter must always carry enough current in milliamperes to cause its pointer to move and it takes more current to get a full scale deflection from a meter originally intended to measure comparatively large currents. To operate a meter with a range of ten milliamperes takes ten times the current required to operate one having a range of one milliamperere.

The resistance used must be capable of carrying the number of milliamperes which the meter is originally designed to indicate with full deflection. As a general rule none of the leak type resistors will carry more than twenty milliamperes without overheating, and the only sizes that will carry this much current are those of lowest resistance. The table of resistance shows only the combinations that may be made within the current carrying ability of high grade resistors of the types sold for resistance couplers.

Any other combination may be figured out by dividing the desired full scale voltage by the decimal indicating the maximum number of amperes handled by the milliammeter. The result will be the required resistance in ohms.

RESISTANCES FOR MILLIAMMETERS USED AS VOLTMETERS

Present Full Scale in Milliamperes	Desired Full Scale Voltage Reading							
	10	20	30	50	100	200	300	500
1	10000	20000	30000	50000	100000	200000	300000	500000
5	2000	4000	6000	10000	20000	40000	60000	—
10	1000	2000	3000	5000	10000	—	—	—
15	667	1333	2000	3333	6667	—	—	—
20	500	1000	1500	2500	—	—	—	—
25	400	800	1200	—	—	—	—	—
30	333	667	—	—	—	—	—	—

The combination of milliammeter and fixed resistance should be tested with several known voltages, such as B-battery voltages, to ascertain the accuracy of the device and to make a record of its error due to the use of resistances not of the exact number of ohms specified.

If the milliammeter has a full scale reading of more than five milliamperes, the arrangement will be of little use for testing the voltages of plate power supply units because the meter combination will then take more current than all the tubes together in many receivers. This current through the meter will drop the voltage far below its actual value when the power unit is working only on the receiver.

METERS, AMPERE AND VOLT

Requirements of Meters.—Cheap meters, either voltmeters or ammeters, are generally unsatisfactory. In a voltmeter high resistance is desired. Only very little current should flow through the meter to operate it and its mechanism must be very delicate and fine. Such construction cannot be put into a cheap meter. In an ammeter we want the least possible resistance and the meter's movement is shunted across a low resistance conductor carrying the current. Again the mechanism must be delicate and costly.

A poor voltmeter of low resistance will allow so much current to flow through itself that this load will reduce the voltage in the measured circuit below its proper value without the voltmeter in use. Small, low-cost voltmeters are worthless for measuring the voltages from plate power supply units because many of these voltmeters take far more current than all the tubes in the receiver combined.

Various types of meters will measure either alternating currents and voltages or direct currents and voltages, but one meter is not always suitable for both direct and alternating. Meters for use in alternating circuits give greatest satisfaction when of the hot-wire or thermo-couple type. Both of these types depend on the heating effect of a current and heating is independent of whether the current is direct or alternating. Hot-wire meters operate because of the expansion of a wire which is heated by the current to be measured. Thermo-couple meters operate from the electricity generated at a joint between two different metals, this electricity operating a small galvanometer which indirectly indicates the conditions in the main circuit.

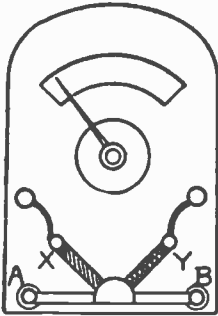

FIG. 6.—Thermo-couple Meter.

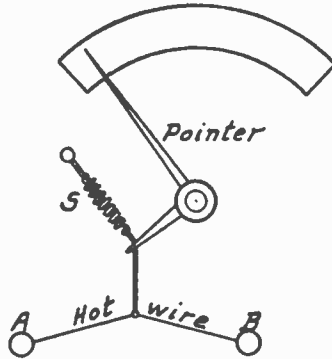

FIG. 7.—Hot Wire Meter Movement.

For high frequency measurements it is customary to use hot wire meters or thermo-couple meters. The principle of a thermo-couple is explained under the heading *Thermo-electricity* and the principle of a thermo-couple ammeter or milliammeter is shown in Fig. 6. Two dissimilar metals, X and Y, are joined as indicated. High frequency current flows between terminals A and B and in doing so flows across the junction between metals X and Y. The current in A-B produces heat which causes a voltage to be generated at the thermo-couple. This voltage sends a small current through the galvanometer, which is a very sensitive moving coil instrument. Move-

METERS, FREQUENCY

ment of the galvanometer pointer indicates the amount of current flowing in *A-B*.

The action of a hot-wire ammeter or milliammeter may be understood from Fig. 7. Current to be measured flows between terminals *A* and *B* through a wire which is heated by the power consumed in causing the current to flow through it. As the wire heats, it expands or lengthens correspondingly. Near the center of the hot wire is a connection to a pointer and a small spring. The spring maintains a steady pull so that lengthening of the hot wire allows the spring to move the pointer over its scale in proportion to the lengthening of the current carrying wire. This lengthening is proportional to the heating, and the heating is proportional to the amount of current so that the meter may be calibrated to indicate amperes or milliamperes.

Both of the meters just described operate because of heating effects. Heat developed in a circuit varies as the square of the current. Increasing currents will then cause a greater and greater proportional movement of their pointer as the current goes through a uniform rate of increase. Since the indications of these instruments vary as the square of the current they are sometimes called "current squared meters." On the scales, divisions for equal changes of current will be farther apart at the high readings than at the low readings.

METERS, FREQUENCY

METERS, FREQUENCY.—A frequency meter is a device for the measurement and visual indication of the frequency at which a circuit or apparatus is operating. Since for every frequency there is a corresponding wavelength, the frequency meter may be calibrated in wavelengths rather than in frequencies and called a wavemeter. The essential feature of a meter for measurement of high frequencies is a tunable oscillatory circuit consisting of an inductance coil and a variable condenser as shown by Figs. 1 and 2.

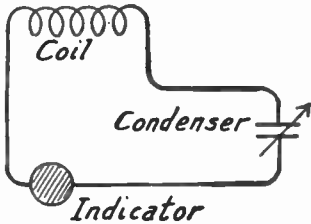

FIG. 1.—The Simplest Frequency Meter Circuit.

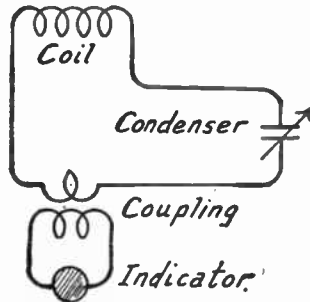

FIG. 2.—Frequency Meter with Coupled Indicator Circuit.

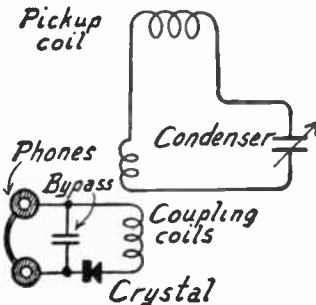

FIG. 3.—Inductively Coupled Indicator Circuit for Frequency Meter.

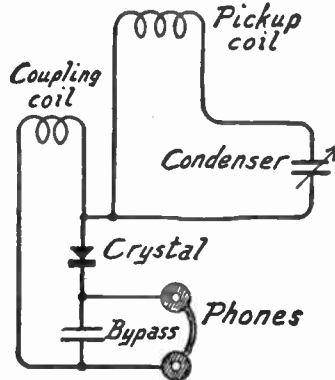

FIG. 4.—Frequency Meter with Special Coupling for Indicator.

Only a small power need be introduced into the coil-condenser circuit to cause strong oscillatory currents and voltages when the power is at the same frequency as that to which the circuit is tuned, or when the condenser capacity is varied to tune the circuit to the frequency of whatever power source is available. The strong current and voltage which are induced at the resonant frequency actuate an indicator. When the indicator shows maxi-

METERS, FREQUENCY

imum current or voltage the frequency to which the meter is then tuned is read from graduations on the condenser dial.

The indicator may be a sensitive thermocouple meter, a small neon lamp, or a flash lamp bulb when considerable power is available, or it may be a detector tube and headphones or a vacuum tube voltmeter when the power is very small. The indicator may be in series with the oscillatory circuit or may be inductively coupled. All of the power for operating the indicator must come from the frequency meter, and the power in the meter must come from the high-frequency currents or fields to which it is tuned. The less the high-frequency resistance, or the smaller the loss introduced into the frequency meter circuit by the indicator, the sharper will be the resonance response and the more accurate the indications. For the same reason, the tuning condenser, the coil, and other parts of the resonant circuit must have the least possible high-frequency losses.

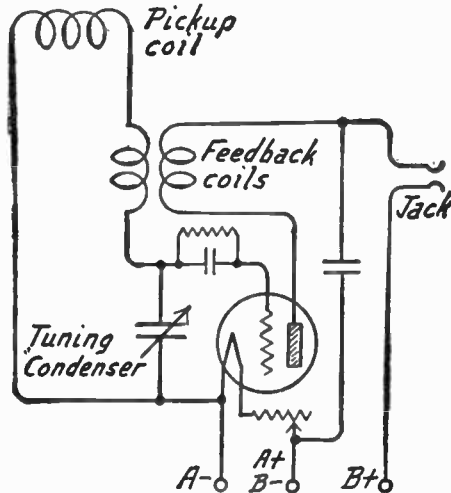

FIG. 5.—Calibrated Oscillator Used as Frequency Meter by Heterodyning with Frequency to Be Measured.

The coil or inductor of the tuned circuit usually is easily detachable, with a plug-in mounting, so that coils with various numbers of turns and various inductances may be used to cover different ranges of frequencies. The tuning condenser is mounted within a shielding metal case with the movable plates grounded to the case. The coil is mounted outside the case so that it may pick up the energy necessary for oscillation. With some meters the total inductance is in two coils, a larger one mounted in the case and a smaller one in series carried on the outside. The smaller external coil is the pickup coil. It may have leads long enough to allow placing the pickup in high-frequency fields which could not easily be reached by the complete meter.

Frequency meters of greater sensitivity and accuracy operate on the heterodyne principle. A heterodyne frequency produced by the meter is caused to beat with the frequency to be measured, with the beat frequency, in the audible range, used to indicate the measured frequency. The heterodyne frequency is produced by an oscillator in the meter. One or more stages of audio-frequency amplification for the beat note make it possible to identify and measure the frequency of very weak fields.

METERS, VACUUM TUBE.—A vacuum tube voltmeter is an instrument capable of measuring alternating or direct voltages while taking very little current or power from the circuit in which the voltages are measured. For measurement of alternating voltages or pulsating voltages the vacuum tube voltmeter may act similarly to a detector, in that it employs the measured voltage to control the grid potential of a tube and thus to vary the average plate current which usually is measured by a direct-current meter. By means of a suitably graduated dial, or with the help of a calibration graph, the meter readings indicate the values of measured voltages. In other types of instrument, the vacuum tube may be used as a rectifier, with the rectified current measured and its value trans-

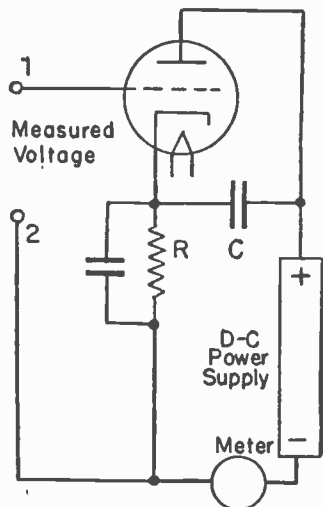

FIG. 1.—Plate Current Detector Used as VT Voltmeter.

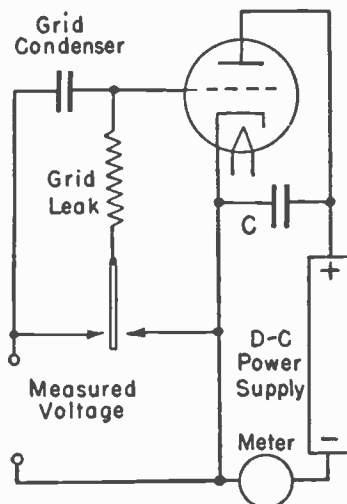

FIG. 2.—Grid Leak Detector Used as VT Voltmeter.

lated into equivalent value of the applied voltage. For measurement of a steady direct voltage the voltage is employed to control the grid potential of a tube and thus to control the plate current. Plate current readings are translated into equivalent values of applied direct potential. Some vacuum tube voltmeters have input resistances as high as one megohm at a frequency of one megacycle, and even higher resistances at lower frequencies.

In Fig. 1 is shown the elementary circuit for a vacuum tube voltmeter operating on the same principle as a plate current detector. Leads or prods from terminals 1 and 2 are connected to points between which voltage is to be measured. Because there must be a grid return path, it is necessary that there be a conductive path between 1 and 2 in the circuit being measured or that a high resistance be connected between these points in the meter

METERS, VACUUM TUBE

itself. Current in the plate circuit of the tube flows downward through biasing resistor R to make the grid return negative with reference to the cathode. A milliammeter or microammeter in the plate circuit measures the plate current. The change of plate current with change of input (grid) voltage will be proportional to the mutual conductance of the tube. Bypass condensers $C-C$ should have capacities great enough so that their capacitive reactances are negligible at the lowest frequencies to be measured. The range and sensitivity of the instrument may be adjusted by varying the resistance of R and the voltage of the power supply, thus changing the grid bias and plate potential for the tube.

Fig. 2 is the circuit for a grid-leak type of vacuum tube voltmeter which utilizes the principle of the grid-leak detector. By means of a double-throw switch the grid leak is connected across the grid condenser when direct voltages are to be measured, and is connected from grid to cathode when al-

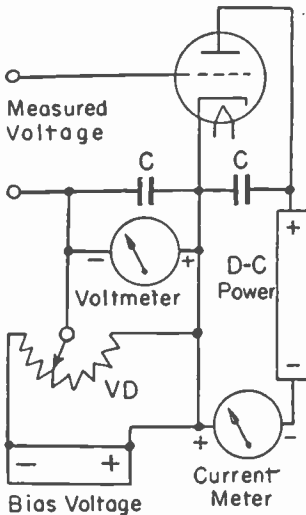

FIG. 3.—Slide Back Instrument Using Two Meters.

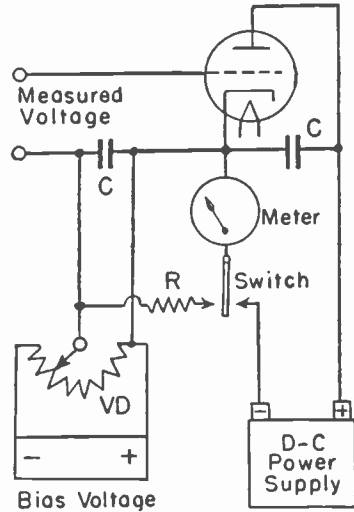

FIG. 4.—Slide Back Instrument Using a Single Meter.

ternating voltages are to be measured. The grid condenser should have negligible capacitive reactance at any frequency measured, and its reactance in ohms should be much less than the resistance of the grid leak. Typical values for broadcast frequencies are 0.01 microfarad for the condenser and five to ten megohms for the leak. Bypass condenser C should be of one microfarad or greater capacity. Just as with a grid-leak detector, alternating voltage between grid and cathode makes the grid more negative and reduces the plate current. Therefore, plate current is maximum with no voltage being measured and decreases as the measured voltage becomes higher. Because of the charging current for the grid condenser and flow through the grid leak this type of instrument takes more power from the measured circuit than does the plate current type, but it will measure lower voltages.

Fig. 3 shows a circuit for one style of slide back voltmeter which operates on the principle of the plate current detector but uses an

METERS, VACUUM TUBE

adjustable grid bias voltage to measure the input voltage. The bias potential is adjusted by voltage divider *VD* which makes the grid return more or less negative with reference to the cathode. This grid bias is measured by the voltmeter. Plate current is measured by a current meter in the plate circuit. Condensers *C-C* are by-passes. To use the slide back instrument the input terminals are short circuited and the bias adjusted so that the plate current meter reads from five to ten per cent of full scale. This reading and the bias voltage are noted. The short is removed from the input and the voltage to be measured is applied. The bias voltage is made more negative by an amount that brings the plate current meter back to its originally adjusted reading, and the difference between

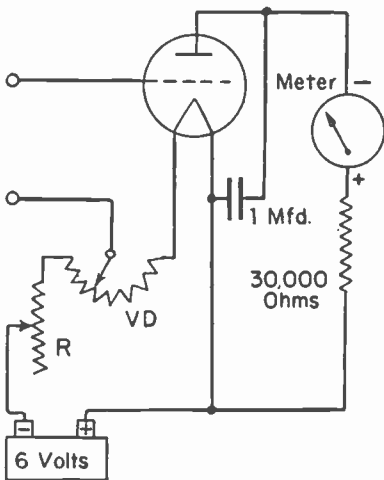

FIG. 5.—Circuit for Moullin Type VT Voltmeter.

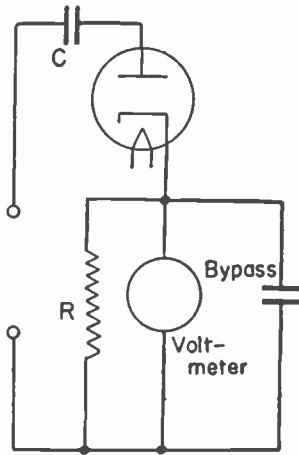

FIG. 6.—Diode Used for a VT Voltmeter.

the present bias voltage and the original bias is noted. This difference is nearly proportional to the measured voltage, but requires calibration in terms of measured voltages for accurate measurements.

The change of bias voltage in the slide back instrument is less than the peak alternating voltage measured, but remains nearly constant over the meter scale. This type of instrument takes very little power from the measured circuit. It is well adapted for measuring potentials between about 3 and 40 volts, but becomes difficult to read for lower voltages. As shown by Fig. 4, the same meter may be used for both plate current and bias voltage. Resistor *R* is a voltmeter multiplier resistance which allows the milliammeter or microammeter unit to be used as a voltmeter for grid biases. The switch is moved to the right for the initial plate current adjustment, then to the left

METERS, VACUUM TUBE

for bias measurement, again to the right while the bias is adjusted, and back to the left for reading the change of bias.

The circuit for a Mullin type vacuum tube voltmeter is shown by Fig. 5. Filament and plate voltages are furnished by the same battery, with grid bias adjusted by a voltage divider VD in the filament circuit. Rheostat R is adjusted to operate the filament at 70 to 85 per cent of its rated voltage. To use this instrument the input terminals are short circuited and the voltage divider adjusted to bring the meter reading to between ten and twenty per cent of full scale. With the short removed the input is connected to the voltage to be measured. The increase of plate current is translated into equivalent input voltages by suitable meter dial scale or with the help of a calibration graph. The point on the meter scale for which current is adjusted is the point from which the instrument originally is calibrated, and when a special dial is used this point is marked zero.

The principle of a diode type vacuum tube meter is shown by Fig. 6. With alternating potential applied to the input terminals there is flow of rectified current through the tube and from top to bottom of resistor R . The voltmeter measures potential drop across this resistor, the drop being propor-

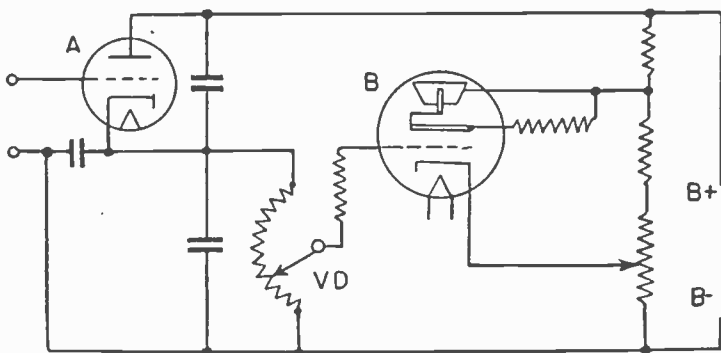

FIG. 7.—Electron-ray Tube Used as the Indicator for VT Voltmeter.

tional to current and to applied alternating potential. For direct voltage measurement the condenser C is omitted from the circuit. A diode instrument of this style takes a considerable current and power from the measured circuit. Other vacuum tube voltmeters employ a diode in a circuit having high input resistance, followed by a direct-current amplifying tube whose output is measured by a meter. A multi-element tube may be used as a diode by connecting together all the elements except the cathode and using them as the plate.

The sensitivity or range of any vacuum tube voltmeter may be increased by amplifying its output with one or more stages of direct-current or alternating-current amplification, with the indicating meter in the plate circuit of the last tube. Alternating-current amplifiers are usually of the degenerative type to make the gain more nearly independent of frequency and allow easier calibration. Power supplies for plate voltage and grid bias should be of some constant voltage type, such as those using voltage regulator tubes, or should be batteries. It is preferable that triode and other

METERS, VACUUM TUBE

multi-element tubes be of types having a top cap for the control grid connection. Vacuum tube voltmeters normally indicate peak values of measured voltages, but they may be calibrated to read effective or r-m-s values, which are equal to 0.707 times the peak values of a sine wave voltage.

An electron-ray tube may be connected to the output of a plate current type of instrument, as shown by Fig. 7, and take the place of a meter. Cathode current from the voltmeter tube *A* flows through the calibrated voltage divider *VD* whose slider is connected to the grid of electron-ray tube *B*. The calibration marks on the voltage divider scale show input voltages with which the target shadow of the electron-ray tube is narrowest. The divider is adjusted until this narrow shadow is obtained, and the measured voltage is read from the dial markings. An electron-ray tube may be used also with a slide back voltmeter to take the place of the plate current meter, a certain width of target shadow then indicating a desired minimum plate current just as such a current would be indicated by a meter.

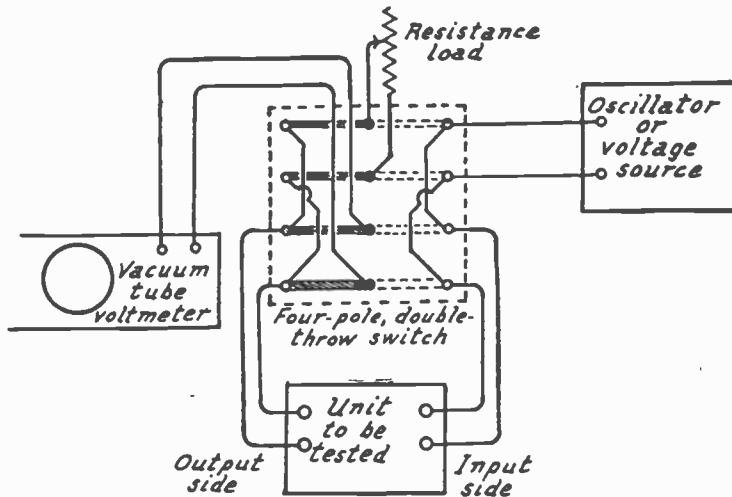

FIG. 8.—Checking Amplifier Unit with VT Voltmeter.

METERS, VOLT.—See *Meters, Ampere and Volt*.

METERS, WAVE.—See *Meters, Frequency*.

METRIC SYSTEM.—The metric system of units and measurements is universally used throughout the world of science. The following tables show the relation between the metric units and English units of length, area, volume and weight.

In the metric system of measurement each unit is equal to ten times the next smaller similar unit and is equal to one-tenth of the next larger similar unit. Thus; one meter is equal to ten centimeters and one centimeter is equal to ten millimeters. The centimeter is then equal to ten millimeters, the next smaller unit, and is equal to one-tenth meter, the next larger unit of length.

MFD.

METRIC UNITS TO ENGLISH UNITS

1 millimeter	=	0.03937 inch	=	0.003281 feet	
1 centimeter	=	0.3937 inch	=	0.032808 feet	
1 meter	=	39.37 inches	=	3.280833 feet	= 1.094 yds.
1 kilometer	=	3281.0 feet	=	0.6214 mile	
1 sq. centimeter	=	0.1549 sq. inches	=	0.001076 sq. feet	
1 sq. meter	=	1549.9969 sq. inches	=	10.76387 sq. feet	
1 cu. centimeter	=	0.0610 cubic in.	=	0.0000353 cu. ft.	
1 liter	=	33.8147 fluid oz.	=	1.05671 liquid qt.	= 0.2642 gals.
1 gram	=	15.43 grains	=	0.03527 avoird. oz.	= 0.0022 lbs.
1 kilogram	=	35.274 avoird. oz.	=	2.20462 pounds	

ENGLISH UNITS TO METRIC UNITS

1 inch	=	25.4 millimeters	=	2.54 centimeters	=	0.0254 meters
1 foot	=	30.48 centimeters	=	0.3048 meters		
1 yard	=	91.44 centimeters	=	0.9144 meters		
1 mile	=	1.609 kilometers	=	1609.347 meters		
1 square inch	=	6.452 square cm.	=	0.00065 sq. meters		
1 square foot	=	929.034 square cm.	=	0.0929 sq. meters		
1 cubic inch	=	16.387 cubic cm.				
1 cubic foot	=	0.0283 cubic meters				
1 liquid qt.	=	0.9463 liters				
1 gallon	=	3.7853 liters				
1 ounce (Av.)	=	28.3495 grams	=	0.02835 kilogram		
1 pound	=	453.592 grams	=	0.45359 kilogram		

MFD.—An abbreviation for microfarad. See *Capacity, Units of*.

MHO.—A unit of measurement for conductivity, the opposite of resistance. A mho is the reciprocal of an ohm. The number of mhos conductivity is equal to 1 divided by the number of ohms resistance. The word mho is formed by spelling the word ohm backward.

MICA.—Mica is one of the most important dielectric materials used in radio and electrical work generally. Mica is a mineral which occurs in laminated crystalline form, it being possible to split sheets of mica along the laminations into layers of about one-fourth of one thousandth of an inch in thickness.

Mica has a dielectric constant of 3.0 to 6.0. It has low radio frequency losses, some grades showing only about 0.05 degree phase angle difference. As a dielectric, built-up mica is not so good, having a phase angle of around one degree. The dielectric strength of mica ranges from 700 to 1200 volts per thousandth of an inch thickness for the grades of lower resistivity. Some mica shows dielectric strength as high as 2000 to 3000 volts per thousandth of an inch. See also *Resistance, Insulation*.

MICA DIAPHRAGM.—See *Speaker, Loud*.

MICARTA.—See *Phenol Compounds*.

MICRO-

MICRO.—A prefix meaning the one-millionth part of. When these letters form the first part of any value, the value is the one-millionth part of the unit forming the last part of the word. Thus a microfarad is the one-millionth part of a farad, a microvolt is the one-millionth part of a volt, and so on. The prefix “micro-micro” means the one-millionth part of a millionth part, one micro-microfarad being the one-millionth part of a microfarad.

MICROPHONE.—A microphone is a device which produces electrical variations in voltage or current which correspond to sound variations in air pressure acting upon the unit. The microphone receives the sounds to be transmitted and translates these sounds into electrical changes which are used to actuate the grid circuit of an amplifying tube. The output of this tube is used, generally after further amplification, to modulate the radiation of the transmitter. See *Modulation*.

Various types of microphones are in use. The most common is the ordinary telephone transmitter. All microphones receive the sound pressures on a thin

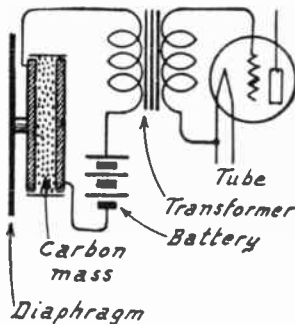

FIG. 1.—Simple Type of Microphone.

diaphragm which is thus set into motion. In the carbon type microphone, motion of the diaphragm alternately compresses and releases pressure on a mass of carbon particles. The changing degree of compression on the particles causes changes of electrical resistance of the mass. The changing resistance causes changes in current through a circuit connected to the vacuum tube. Such a simple arrangement is shown in Fig. 1. The amount of battery current flowing through the transformer primary changes according to the microphone's changing resistance and the current changes in the transformer primary cause corresponding changes in the transformer secondary circuit which is connected to the tube's grid circuit.

To secure a more uniform response with sounds of various frequencies, the “double-button” type of carbon microphone is used in place of the single button type just described. The circuit connections and operating principle of a double-button microphone are shown in Fig. 2. The diaphragm is placed between two units, each of which contains carbon particles. Motion of the diaphragm toward the right compresses the right hand mass and releases the pressure on the left hand mass. This lowers the resistance in the right hand

MICROPHONE

half and raises it in the left hand half. Current from a battery is led to both masses of carbon where it divides and returns through the two halves of a split primary winding of the transformer to the battery.

It will be seen that the steady battery current flows in opposite directions

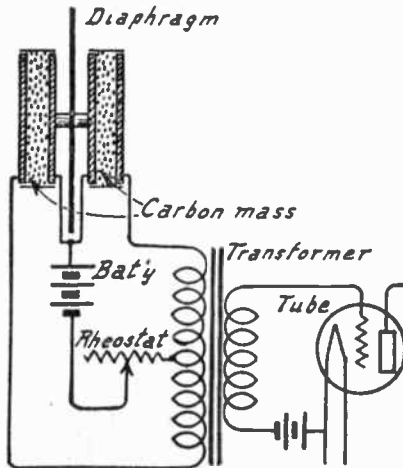

FIG. 2.—Double-button Carbon Microphone.

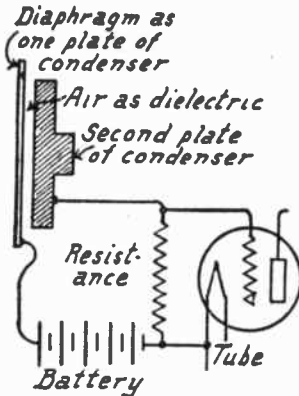

FIG. 3.—Condenser Microphone.

through the two parts of the transformer primary winding so that the magnetizing effect of this current is balanced out. This prevents core saturation in the transformer and prevents changes in battery voltage from affecting the result. The difference in resistance between the two parts of the microphone when in operation causes a change of voltage across the transformer primary which in turn causes a corresponding change to appear in the secondary winding connected to the grid circuit of the tube.

MICROPHONE

The principle of the condenser type microphone is illustrated in Fig. 3. A condenser is formed by the microphone diaphragm as one plate, a solid metal piece as the second plate and the air between them as the dielectric. Sound waves cause motion of the diaphragm toward and away from the fixed plate. The changing distance between the condenser plates causes a changing capacity. The condenser is connected to a battery of high voltage and to a resistor. The battery impresses voltage across the condenser through the resistor and the condenser takes a charge proportional to its capacity. Changing the capacity causes changes in charging current through the resistor and the current flow through the resistor causes voltage differences across it. The ends of the resistor are connected to the tube's grid circuit so that the voltages across the resistor are amplified by the tube.

The action of a moving coil or electrodynamic microphone is shown in Fig. 4. A diaphragm carries a coil of wire in a very strong field produced between the poles of a magnet energized by a battery or other source of current. Sound waves move the diaphragm and the coil. Motion of the

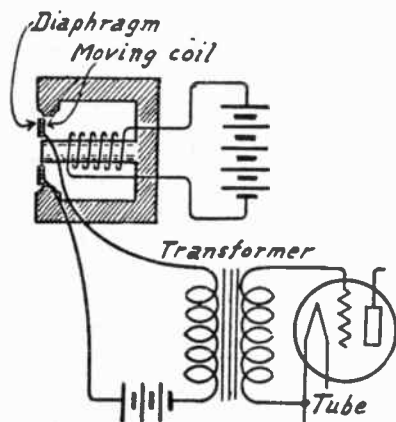

FIG. 4.—Moving Coil Microphone.

coil in the electromagnetic field produces voltages in the coil which is connected through a transformer to the grid circuit of an amplifying tube.

The similarity of the microphone of Fig. 4 to a moving coil or dynamic loud speaker is very apparent. The action in practically all loud speakers is reversible to a greater or less extent so that any of them will form a microphone. The frequency response of loud speakers used as microphones is not well suited for work in which uniformity of response is important.

In a microphone it is desired that the electrical changes be proportional to the sound intensities at all frequencies, that there be no frequencies at which the electrical variations become much too small or much too great in comparison with the sounds applied. To prevent resonance of the diaphragm itself, which would intensify the sound at some frequencies, this part of the microphone is drawn very tightly so its natural frequency of vibration is above audibility. In securing uniformity of response a great deal of the natural sensitivity of a microphone is lost and, therefore, it is always necessary that the microphone output be considerably amplified with tubes before being used for modulation.

As a further precaution against resonance in the diaphragm it is usually placed in an air chamber so that the resistance of the air as it is set in motion will damp the motion of the diaphragm or place a load upon it. This damp-

MICROPHONE, CRYSTAL

ing prevents free vibration of the diaphragm at any particular frequencies. The maximum motion of the diaphragm is but little more than the ten-thousandth part of an inch in usual designs.

In the two-button carbon type microphone it is essential that the currents flowing in the two halves be exactly equal to prevent distortion. The currents are balanced by means of a potentiometer in the transformer and battery circuit. Rough handling or long continued use will cause packing of the carbon particles in these microphones and a consequent loss of sensitivity. Gently shaking the microphone will loosen the carbon. Because of a slight electrical action between the carbon particles as the current flows, there is always a slight hissing sound produced by this type of unit.

The diaphragms of commercial microphones are about one five hundredth of an inch thick and are made from some light material such as duraluminum. The separation of the two plates in a condenser microphone is in the neighborhood of one and one-half thousandths of an inch.

See also, *Modulation*.

MICROPHONE, CRYSTAL.—The crystal microphone possesses several features making it unique among devices designed to convert sound waves into electrical impulses. Its inherent simplicity and low cost are responsible for its increasing popularity. It requires no energizing potential, has a relatively high voltage output and can be worked directly into the grid circuit of an amplifying tube without using cumbersome coupling devices. Its compact construction allows it to be worn on the lapel of a coat. This allows a person to address an audience without being forced to maintain a fixed distance from a stationary microphone. The advantage of such an arrangement is obvious, particularly where an illustrated lecture is being delivered.

Piezo electric activity which is responsible for the functioning of a crystal microphone has been the subject of scientific investigation for over a century. In the period from 1820 to 1833 Becquerel made numerous tests of different substances in studying this effect. The term "piezo electricity" refers to the production of an electrical charge when a substance is subjected to a mechanical stress. In 1880, the Curies, who became famous for their later work with radium, published a report of the results obtained in their experiments with quartz crystals. Quantitative results were tabulated and a comparison made in the electrical output of crystals cut along different axes. The Curies also tested and proved the prediction of Lippman, made in 1881, that if a quartz crystal was subjected to an electrical pressure, a mechanical deformation would result. This established the converse function of piezo electric phenomena. The first practical application of the principle of deformation with electrical stress took the form of an electrostatic voltmeter. Of the many crystal-line substances tested for piezo electric properties, by far the most active was found to be the Rochelle salt crystal.

MICROPHONE, CRYSTAL

In 1890, Roentgen, who is better known for his work with the X-ray, predicted the use of the piezo electric effect in the construction of electro-acoustic transducers. He based his predictions on the results of his experiments with a multiplicity of quartz crystal cylinders subjected to an electrical stress. During the World War increased impetus was given to the development of piezo-electric devices, particularly, as a means of detecting the approach of submarines and aircraft. Supersonic frequencies were used under water with reflection or distortion of the wave taking place upon encountering an undersea craft. Langevin, a French investigator, was the first to combine piezo-electric devices and vacuum tube amplifiers. He demonstrated the possibility of using a piezo-electric device at the input to a vacuum tube amplifier to convert vibrations to electrical impulses and at the output of the amplifier, to reconvert the electrical impulses to mechanical vibrations. He was primarily interested in super-audible frequencies, but demonstrated the practicability of the system in the audible frequency range as well.

The Brush Development Laboratories of Cleveland perfected an assembly called a "sound cell" after an exhaustive investigation of piezo-electric crystal activity. This "sound cell" forms the basis of most crystal microphones, pickups and telephones. The sound cell consists of two plates of Rochelle salt crystal, each approximately $\frac{1}{4} \times \frac{1}{4} \times .01$ inch, so cut and placed together that as one plate expands with the application of a pressure, the other plate contracts, an action similar to that taking place in a

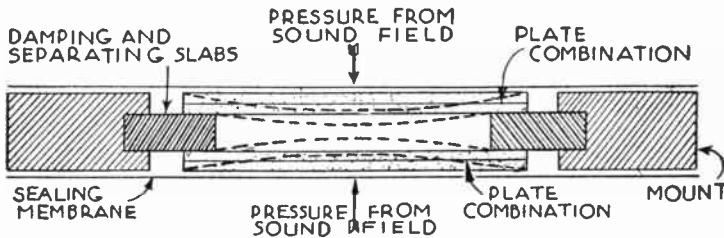

FIG. 1.—Cross Section of Single "Sound Cell."

bi-metallic thermostatic device. The developed electromotive force is taken from the surfaces of the plates by means of attached foil plates. A membrane seals the crystals from the surrounding atmosphere. This is necessary because of the slightly hygroscopic nature of the crystal. Sound pressure exerted against this membrane imparts the pressure to the crystal where the actual generation of e.m.f. takes place. Two sets of plates comprise the "sound cell." These two sets of plates are connected in parallel. The small size of the actuating surfaces serves to resonate

MICROPHONE, CRYSTAL

the microphone considerably above the audible range. Where special impedance conditions are to be matched, a multiplicity of individual cells may be connected in a series-parallel arrangement. The frequency response is excellent as shown by the

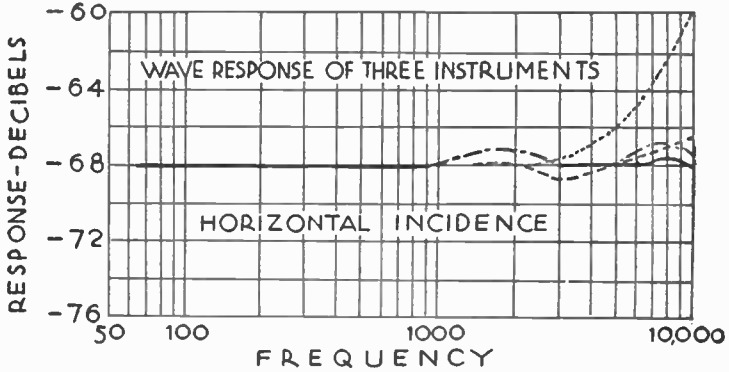

FIG. 2.—Response Curves of Several Multi-cell Crystal Microphones.

fidelity curve and because of its small unit active area even when a multi-unit type is used, the microphone is practically non-directional.

MICROPHONE—VELOCITY.—The velocity microphone

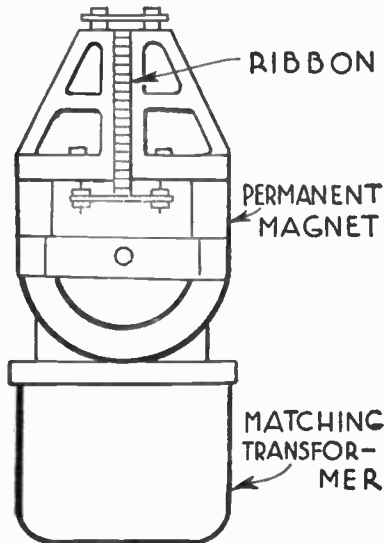

FIG. 1.—Constructional Details of Velocity Microphone.

MICROPHONE, VELOCITY

is a special form of the moving coil or dynamic type in which the moving element is a corrugated or flat piece of aluminum alloy ribbon mounted between the poles of a permanent magnet. The sound disturbance acts directly upon the ribbon which is suspended in such a manner that its resonant frequency is well below the audible range. Constructional details of one make of velocity microphone are shown in Figure 1. The ribbon is approximately two inches long, three-sixteenths of an inch wide and one ten-thousandth of an inch thick.

Air particles impinging upon the ribbon cause it to flutter between the pole pieces of a permanent magnet, thereby setting up, by electromagnetic induction, an e.m.f. which corresponds to the velocity of the ribbon movement and is therefore proportional to the amplitude of the variations of the incident sound wave.

By making the ribbon very light and mounting it so as to have negligible tension, a frictional reaction to the driving force is obtained.

The displacement of the ribbon from its position of equilibrium is accomplished by a pressure difference between the two sides of the relatively wide ribbon. This pressure difference cor-



FIG. 2a.—Constructional Detail of Ribbon Assembly Used in the Static Velocity Microphone.

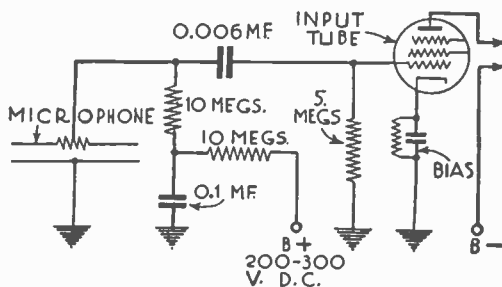

FIG. 2b.—Circuit Connection of Static Velocity Microphone.

responds to that produced by a sound wave between two points in space separated by a distance equal to the thickness of the ribbon.

An alternate method of construction in reality combines the characteristics of a condenser and velocity microphone. This type is termed a "static" velocity microphone. In construction it consists of a flat insulated perforated plate covered with a number of parallel ribbons. The perforated plate contains about 80 holes per inch, each hole being $\frac{1}{8}$ inch in diameter. Insulation is applied to this plate in a series of layers, six in number.

MICROPHONE, VELOCITY

Care is taken in the application of these layers to insure good insulation around each of the perforations where a breakdown would be most liable to occur. Over this plate are laid, side by side, eight duralumin ribbons each being .0002 inch thick, $\frac{1}{4}$ inch wide and approximately 4 inches in length. A second insulated perforated plate is placed over the ribbon structure for mechanical protection.

A polarizing voltage of from 50 to 350 volts is applied between the back plate and ribbon assembly and any displacement of the ribbons results in a greater or lesser charge being drawn from the polarizing circuit. In this respect the action is identical with that of the condenser microphone. A conventional condenser type has a tightly stretched diaphragm which is purposely resonated above the audible range. This necessitates operating the diaphragm under a high stress which materially reduces its electri-

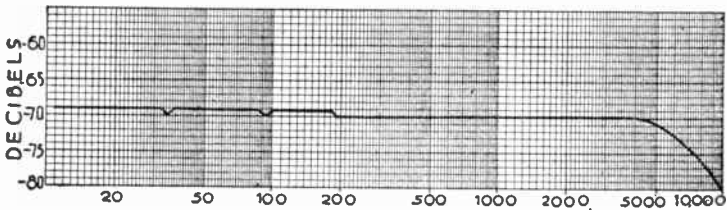

FIG. 3.—Response Curve of Velocity Microphone.

cal output. The ribbon condenser microphone or static velocity type, with its lightly suspended ribbons, has a higher electrical output for this reason.

The impedance of the ribbon of a conventional velocity microphone is very low, necessitating the use of a coupling transformer having a low impedance primary and a secondary which is designed to match either a transmission line or the grid of an amplifier tube.

The pressure difference between the front and back of a velocity microphone is proportional to the impressed frequency. The acoustic impedance is also proportional to the frequency, therefore, the velocity of the ribbon is substantially independent of frequency. This follows from the fact that velocity in a mechanical system is the ratio of the applied pressure to the mechanical inertia (acoustical impedance).

The velocity microphone exhibits several advantages over other types of microphones. The effects of cavity and diaphragm resonance which prove troublesome in the condenser and carbon types are entirely lacking in the velocity microphone, provided the ribbon is suspended in such a manner that it resonates well below the audible range. The electrodynamic type suffers from a pressure doubling effect at the higher audible frequencies which

MICROPHONE, VELOCITY

is not present in the velocity microphone. The structure of the ribbon is such that it is capable of responding to the motion of the air particles even at high frequencies which insures a uniform frequency response curve.

The marked directional characteristics of this type of microphone make it ideally suited to certain installation conditions which would practically preclude the use of any other type. The directional properties are practically independent of the frequency of the impinging sound impulse. This is in direct contrast to the stretched diaphragm types which generally show frequency dis-

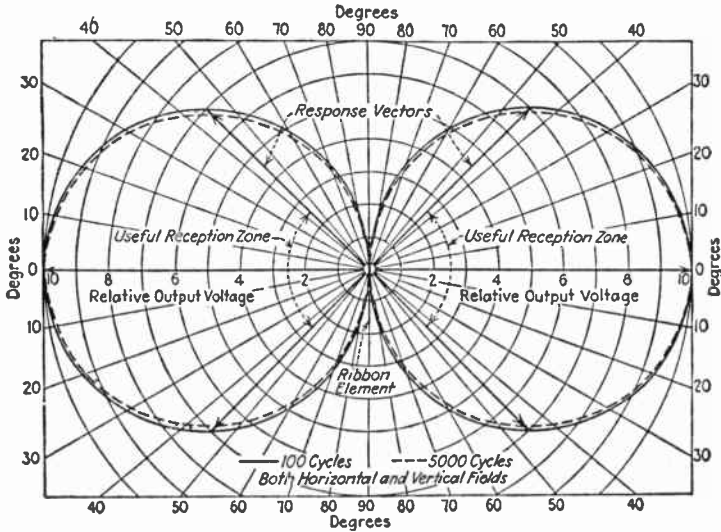

FIG. 4.—Polar Response Curve of Velocity Microphone.

crimination of increasing magnitude as the angle of the incident sound wave is decreased from its right angle normal.

Because of these directional characteristics this type of microphone is capable of discriminating between the desired impulse and undesirable sounds whether emanating from another source or from reverberant sound due to reflection.

MODULATION

MIKE.—Slang for *Microphone*.

MIL, CIRCULAR.—The area of a circle which is one-thousandth of an inch in diameter. The one-thousandth part of an inch is called one mil. The circular mil as a unit of area is used in measuring the cross sectional area or size of conductors.

MILEAGE DISTANCES.—See *Distances, Geographical*.

MILLI.—A prefix meaning the one-thousandth part of. When it precedes a word which indicates a certain value or quantity, that value or quantity is to be divided by one thousand. For example, one milliampere is the one-thousandth part of an ampere.

MILLIAMMETER.—See *Meters, Volt and Ampere*.

MILLIMETER.—See *Metric System*.

MIXER.—See *Volume, Control of*.

MMFD.—Abbreviation for micro-microfarad of capacity.

MODULATION.—Modulation is a process in which either the amplitude or the frequency of a carrier wave is varied in such manner that the wave transmits a signal. The carrier may be a space radio wave or may be an electric current in a wire circuit. The signal may represent voice, music, code or pictures.

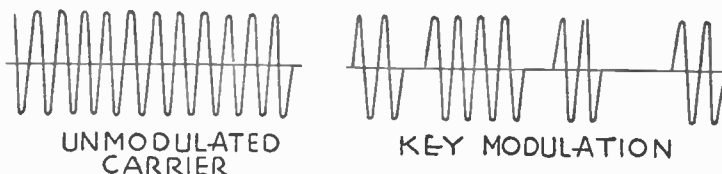

FIG. 1.—Unmodulated Carrier Wave and Key Modulation.

Before the signal modulation is applied to the high frequency carrier currents at the transmitter the carrier may be represented as in Fig. 1, with a continuous wave of unvarying amplitude and unvarying frequency. The frequency of this carrier is above audibility and even though such a wave be received at a distant point it carries no intelligence. If the wave be broken up into the dots, dashes and spaces of a telegraphic code as at

MODULATION

the right hand side of Fig. 1, it has been subjected to key modulation and the interruptions will carry a message.

For the transmission of voice, music and pictures the high frequency currents for the carrier are produced by vacuum tube oscillators and amplifiers. Expenditure of power at a constant rate in these oscillators and amplifiers will result in a carrier of

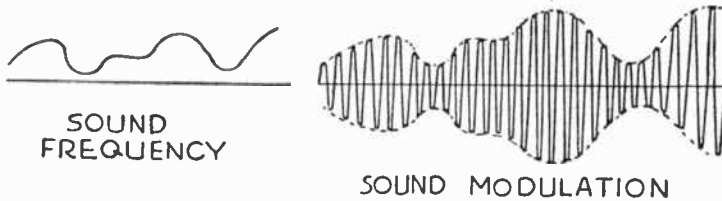

FIG. 2.—Modulation with Sound Frequency.

constant amplitude, but if the output power of the high frequency generators be varied then the amplitude of the carrier wave will vary proportionately. Varying the power at a sound frequency will result in corresponding variations of carrier amplitude. A sound frequency as shown at the left in Fig. 2 may be applied to a carrier to cause amplitude modulation as at the right in this

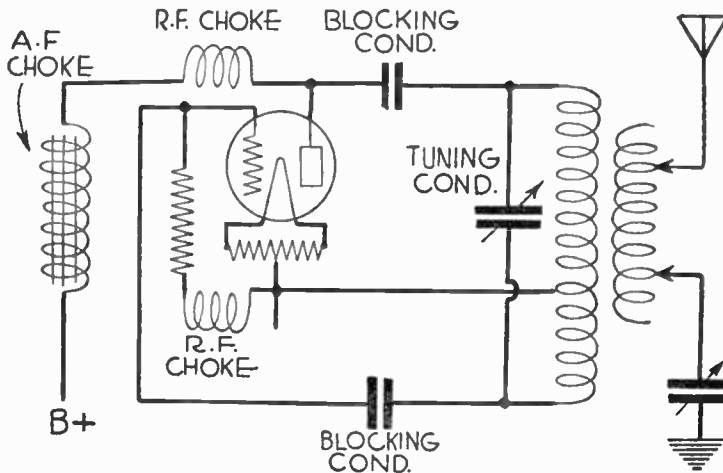

FIG. 3.—Oscillator Coupled to Transmitting Antenna.

diagram. A carrier thus modulated will produce in a receiver currents which may be subjected to the process of detection and which will then yield the original sound frequency as described under *Detector*.

MODULATION

It may be assumed that the modulated high frequency current shown at the right in Fig. 2 is to be produced in the plate circuit of a high frequency or radio frequency oscillator, and that the plate circuit of this oscillator is to be coupled to a transmitting antenna as in Fig. 3. It is apparent that the output power may be varied in either of two principal ways; by changing the grid voltage on the oscillator tube or by changing the plate voltage or current for this tube. Any means for varying the grid voltage would be called grid circuit modulation and any means for varying the plate voltage would be called plate circuit modulation. Practically all modern transmitters employ plate circuit modulation, very few applying the process on the grid side.

In considering grid circuit modulation the voltage of the tube's grid may be thought of as determined by three factors. The average grid voltage is fixed by the bias potential. The high frequency oscillations then cause the instantaneous voltage to vary rapidly above and below this average. If a third voltage, at low frequency or sound frequency, be added to the grid circuit the effective amplitude of the high frequency oscillations will vary above and below the bias point by the amount of low frequency voltage being applied. One method of introducing a sound frequency into the grid circuit is shown in Fig. 4. Oscillations in the tube's plate circuit or output circuit will have the form shown at the right in Fig. 2.

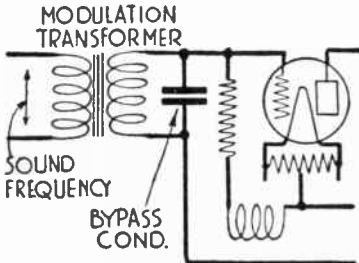

FIG. 4.—Grid Circuit Modulation.

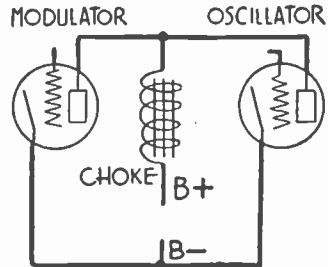

FIG. 5.—Principle of Constant Current Modulation.

Constant Current Modulation.—The type of plate circuit modulation which is used in some form or modification in nearly all transmitters handling sound or picture frequencies is that called constant current modulation or Heising modulation. The simplest form of constant current modulation requires two tubes, one of which is the high frequency oscillator and the other the low frequency modulator. The plates of both tubes are fed from a common source of current according to the principle illustrated in Fig. 5. In the lead furnishing current to the two plates is a choke of high impedance. The reactance of this choke prevents sudden changes of current from passing through it and, so far as audio frequency changes are concerned, the choke maintains a steady total value of current to the two plates, part of the total going to each plate.

Low frequency signal voltages applied to the grid circuit of the modulator tube cause corresponding changes of current in this tube's plate circuit. But, since the total plate current for both tubes remains constant,

MODULATION

these changes in modulator plate current must be accompanied by opposite changes in oscillator plate current. Each decrease in modulator plate current must cause a corresponding increase in oscillator plate current and each increase of modulator current must cause a decrease of oscillator current in order that the sum of the two currents may remain unchanged. Thus low frequency voltage changes applied to the grid circuit of the modulator tube result in low frequency current changes in the plate circuit of the oscillator tube.

Current in the plate circuit of the oscillator always is varying at the carrier frequency because of the oscillatory action, but since the plate current also is varied at the low frequency of the signal the amplitude of the oscillations is changing in accordance with the signal and there is produced a wave of the general form shown at the right in Fig. 2. Constant current modulation is applied to the oscillator of Fig. 3 by making the additions shown in Fig. 6 on the left hand side of the low frequency choke coil. A modulator tube is simply a low frequency or audio frequency power amplifying tube and as such it requires all the precautions against distortion that are required by any other amplifier.

While the simple circuit of Fig. 6 illustrates the operation of constant current modulation, the low frequency is not applied so directly to the

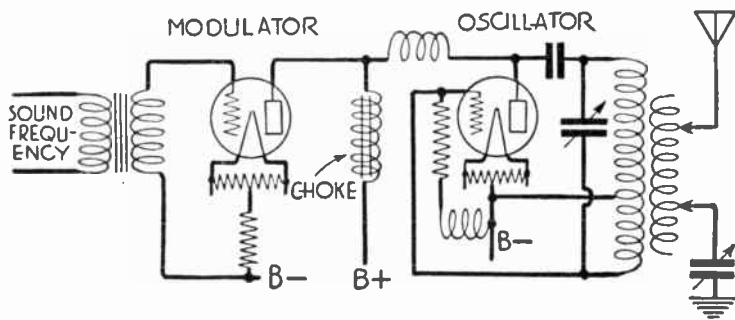

FIG. 6.—Connection of Modulator to Oscillator.

output oscillator in transmitters designed for high quality and fidelity because this direct connection changes not only the amplitude of the oscillations but also their frequency so that the carrier is no longer of constant frequency but changes slightly with the audio frequency or other low frequency.

Side Frequencies.—If a carrier of the general type shown at the top in Fig. 7 be modulated with a constant low frequency such as shown below, then the resulting wave will have the form shown at the bottom where the amplitude of the oscillations rises and falls in time with the low frequency modulation. If this modulated carrier is received with a very selective receiver, is rectified, and the rectified voltages measured with a sensitive vacuum tube voltmeter the resonance curve will appear somewhat like the one in Fig. 8. This curve would indicate the reception of three different waves of three different frequencies. Measurement of these frequencies will show that the lowest one is equal to the carrier frequency minus the modulated frequency, that the

MODULATION

middle one is the carrier frequency, and that the highest one is equal to the carrier frequency plus the modulation frequency.

Were the carrier to have a frequency of 1,000,000 cycles and the modulation a frequency of 1,000 cycles the three received frequencies would be 999,000 cycles, 1,000,000 cycles, and 1,001,000 cycles. The 999,000 cycle frequency is called the lower side frequency and the one at 1,001,000 cycles is called the upper side frequency, the third being the carrier frequency.

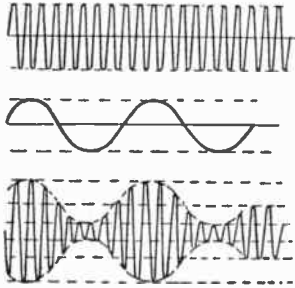

FIG. 7.—Combining the Frequencies in Modulation.

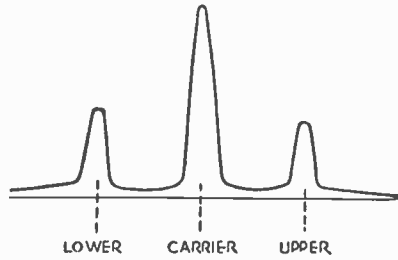

FIG. 8.—Side Frequencies and Carrier Frequency.

The received signal might then be represented as in Fig. 9. If the instantaneous amplitudes of three waves such as those in Fig. 9 are carefully added together the result will be a single wave having amplitude changes like those at the bottom of Fig. 7. Sometimes it is convenient to consider the modulated wave as having one form and again as having the other form, the two forms being different conceptions of the same thing.

Percentage Modulation.—The degree of modulation applied to a carrier generally is specified as a percentage and is called percentage modulation. Modulation is measured as the ratio of

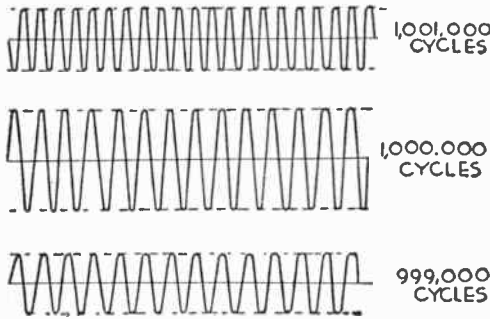

FIG. 9.—The Three Received Frequencies.

half the difference between maximum and minimum amplitudes to the average amplitude of a modulated wave. The average amplitude is the amplitude of the unmodulated carrier. The fraction thus found is multiplied by 100 to change it to a percentage.

In Fig. 10 are indicated arbitrarily the average, the maximum and the minimum amplitudes of a modulated wave. To find the percentage modu-

MODULATION

lation the difference between maximum (30) and minimum (10) is divided by two, giving one-half of 20, or 10. The ratio of this number (10) to the average amplitude (20) is 0.5. Multiplying 0.5 by 100 gives 50 as the percentage modulation and the wave of Fig. 10 is said to have fifty per cent modulation.

With 50 per cent modulation the amplitudes of the side frequencies will be equal to one-fourth the carrier amplitude and with 100 per cent modulation the side frequency amplitudes will be one-half the carrier amplitude. Doubling the percentage modulation doubles the amplitude of the side frequencies. If the side frequency amplitude is to be doubled without changing the modulation percentage it would require that the carrier

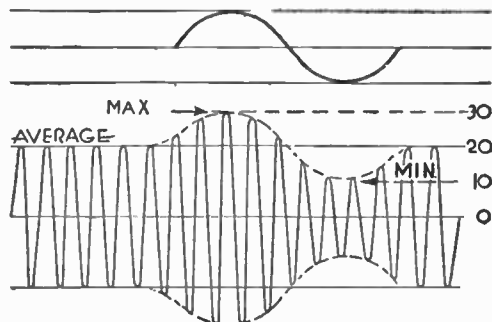

FIG. 10.—Calculating the Percentage Modulation.

amplitude be doubled. To double the carrier amplitude would require that the power in the carrier be multiplied by four. Thus a doubling of percentage modulation is equivalent to using four times the carrier power, and the most effective way of increasing the service range of a transmitter is by increasing its modulation.

When the modulation is increased the carrier power is not increased, so the interference range of the transmitter remains the same as before although the service range is extended. The greatest percentage modulation that may be used is 100 per cent, because with such modulation the carrier amplitude is dropped to zero and is increased to double its original value on the peaks of modulation. Any greater modulation would cut off the carrier completely. Many of the older transmitters are not capable of handling 100 per cent modulation without distortion, some of them being able to care for no more than 50 per cent. Nearly all new transmitters are constructed for 100 per cent modulation. The greatest percentage modulation that may be used without appreciable distortion is called the modulation capability of a transmitter.

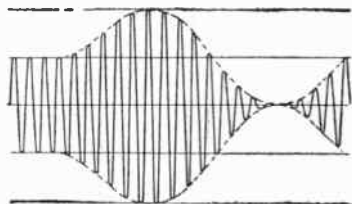

FIG. 11.—One Hundred Per Cent Modulation.

Obtaining One Hundred Per Cent Modulation.—Consideration of the performance of constant current modulation will show that some modifications must be made in the original arrangements in order that 100 per cent modulation may be had.

MODULATION

If the amplitude of the oscillations is to drop to zero, as it must with 100 per cent modulation shown in Fig. 11, then the plate current on the oscillator or other modulated tube must drop to zero during some instants and rise to double its normal value at other times. The same variations would have to take place in the modulator tube.

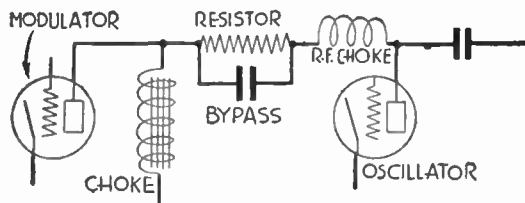

FIG. 12.—Connection of Voltage Dropping Resistor.

The modulator tube is a low frequency amplifier and it is impossible to allow the plate current to drop to zero or the cutoff point without causing distortion in the output when the tube has a plate load which is optimum from the standpoint of fidelity. Since the plate current cannot drop to zero in the modulator tube neither can it do so in the modulated tube and it is impossible to have more than about 60 per cent modulation. Since the modulator plate current must be kept within suitable limits, yet must be equal in its changes to the changes in the modulated tube, the modulator power must be raised until it is much higher than the power in the modulated tube.

Modulation at 100 per cent is allowed in practice by using modulator tubes of greater power than the tubes they modulate and by providing for greater plate voltage on the modulator than on the tube modulated. One method is shown in Fig. 12 where a voltage dropping resistor, bypassed

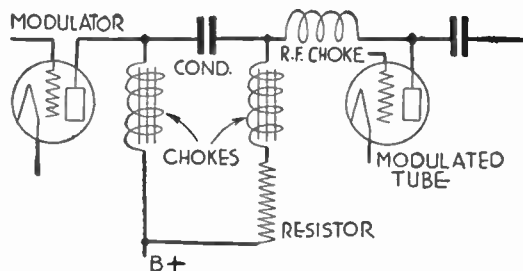

FIG. 13.—Separate Chokes for Modulator and Oscillator.

with a condenser, is placed between the constant current choke and the oscillator tube's plate. The modulator is provided with a correct operating voltage through the choke and the resistor is chosen of such value as to drop this voltage to a value suitable for the oscillator. The bypass provides a low impedance path for the audio frequencies. A second method, one used in many large broadcast transmitters, is shown in Fig. 13. Here the two tubes are fed through two choke coils, audio frequency

MODULATION

potentials passing through the condenser placed between the plates. In series with the choke for the modulated tube is a voltage dropping resistor.

Modulation Measurement.—When a transmitter is designed to operate with 100 per cent modulation it is important that the modulation never exceed this value and thus cause cutoff of the carrier. For this reason such transmitters are worked somewhat below the 100 per cent point and instruments are provided to allow observation of the percentage modulation so that it may be maintained within proper bounds.

Modulation at the transmitter circuits may be measured by means of a meter capable of measuring high frequency current, this meter being connected in the output plate circuit of the modulated tube. The primary winding of a transformer is connected in series with the output and the transformer's secondary is connected to the meter. With increase of modulation there is a definite increase of power and of output current or antenna current. For 100 per cent modulation the current increases about 22.5 per cent. The meter may be calibrated in percentage modulation according to the current flow and the transmitter operated to stay below the maximum allowable increase of current.

Measurement of modulation is conveniently made with a vacuum tube voltmeter. Such a meter is a rectifier in itself and its indications are of peak values of the applied high frequency currents or voltages, thus it will measure the maximum modulation. The meter may be coupled to the output circuit and adjusted with its balancing system so that the indicator reads zero when the output is unmodulated. Modulation then will cause the meter to read proportionately to the percentage and it may be so calibrated.

Very accurate measurements of modulation may be made by the use of a cathode ray oscillograph.

MODULATION, FREQUENCY. — See *Receiver, Frequency Modulation*.

MODULATION, VELOCITY.—See *Tube, Velocity Modulation in*.

MOTORBOATING.—A recurring “putt-putt” sound from the loud speaker, due to low frequency oscillation caused by feedbacks in the audio-frequency amplifier or in the power supply.

MOVING COIL LOUD SPEAKER.—See *Speaker, Loud*.

MU.—The name of a Greek letter which is the symbol for amplification constant of an amplifier tube.

MULTIVIBRATOR.—See *Oscillator, Relaxation*.

MUTUAL CONDUCTANCE.—See *Tube, Mutual Conductance of*.

MUTUAL INDUCTANCE.—See *Inductance, Mutual*.

MYSTERY CONTROL.—See *Tuning, Automatic*.

N

NATURAL FREQUENCY.—See *Frequency, Fundamental*.

NEATSFOOT OIL.—See *Oils, Insulating*.

NEGATIVE.—An electrical pressure less than that of the earth is called negative. The negative parts of a circuit are those toward which the current is assumed to flow, they are the parts having lower electrical pressure than other parts which are said to be positive. Negative is the opposite of positive. A negative current is a current flowing toward the source, a negative conductor is one carrying negative current. Parts which are negative are marked with the negative or minus sign “-”.

NEGATIVE BIAS.—See *Bias, Grid*.

NEGATIVE RESISTANCE.—See *Resistance, Negative*.

NEON LAMP.—See *Television*.

NEUTRAL.—Neither negative nor positive.

NEUTRALIZING.—See *Balancing*.

NEUTRALIZING CONDENSER.—See *Condenser, Balancing*.

NEUTRODYNE RECEIVER.—See *Balancing*.

NODE.—A point in a series of vibrations or waves at which there is no motion in any direction. In the rise and fall of electromagnetic or electrostatic waves, the nodes are the points between

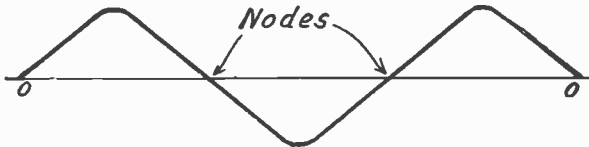

Nodes in a Wave.

risers and falls, the zero points. In an alternating current or voltage the nodes are the points at which there is no flow of current either way or at which there is no voltage.

NODEN VALVE.—One cell of an electrolytic rectifier.

O

OAK WOOD.—See *Wood*.

OHM.—The unit of measurement for electrical resistance to flow of current. One ohm resistance in a circuit will allow a pressure of one volt to send a current of one ampere through the resistance. There is one ohm resistance in 156.6 feet of ordinary number 18 copper bell wire at ordinary temperatures. One thousand feet of number 10 copper wire has a resistance of almost exactly one ohm. The number of ohms resistance in a circuit may be found by dividing the number of volts pressure across the circuit by the number of amperes flowing through it.

One ohm is defined as the resistance of a body of mercury having a weight of **14.4521 grams** when formed into a thread of this metal 106.3 centimeters long and while maintained at the temperature of melting ice. See *Law, Ohm's*; also *Resistance*.

OHMIC RESISTANCE.—See *Resistance, Ohmic*.

OHM'S LAW.—See *Law, Ohm's*.

OILED CLOTH.—See *Cloth, Insulating*.

OILED PAPER.—See *Paper*.

OILS, INSULATING.—Various oils may be used as insulators or as dielectrics. Those commonly employed include castor, neatsfoot, olive, petroleum, and turpentine oils. One advantage in the use of oil either as an insulator or as a dielectric is that the film of oil instantly renews itself between two conductors after a momentary breakdown or puncture by high voltages. The following table gives the average dielectric constants of common oils and also gives their dielectric strengths in volts per thousandth of an inch or volts per mil:

DIELECTRIC CONSTANTS AND STRENGTHS OF OILS

	Dielectric Constant	Dielectric Strength Volts per Mil
Castor Oil.....	4.5 to 4.8	325
Neatsfoot Oil.....	3.0 to 3.2	225
Olive Oil.....	3.0 to 3.3	190
Petroleum Oil.....	2.0 to 2.2	125
Sperm Oil.....	3.0 to 3.2	225
Turpentine Oil.....	2.1 to 2.3	275

OSCILLATION

OSCILLATION.—Oscillation may be defined as an alternating flow of current between the inductance and capacity of a resonant circuit during transfer of energy between the magnetic field formed around the inductance during half of each cycle and the electrostatic field formed in the dielectric of the capacity during the other half of the cycle. Oscillation is sustained if energy is continually added to the circuit at a rate sufficient to make up for energy dissipated in the various losses. Under this condition the oscillatory currents will be of a value dependent on the losses.

A tube is said to oscillate when there are sustained oscillating currents in its plate or anode circuit, and changes of voltage in the grid circuit which maintain the oscillations. Oscillation is self-sustained when energy from the plate circuit is fed back to the control grid circuit in such phase relation as to increase the oscillating currents in the plate circuit. Free oscillation refers to oscillating currents which continue, but with decreasing magnitude, in a resonant circuit after the applied inducing voltage has ceased to act.

Feedbacks which maintain oscillation take place through inductances, capacities, or resistances which are common to both the plate circuit and the control grid circuit. Plate current potential differences in such common impedances are applied to the grid circuit. Self-sustained oscillation may be suppressed, or the tendency to oscillate may be counteracted, by methods explained under the headings of *Balancing* and *Feedback*.

OSCILLATION CONSTANT.— See *Constant, Oscillation and Resonance, Inductance-capacity Values for*.

OSCILLATION, RECEIVER CIRCUIT.— See *Feedback*.

OSCILLATOR

OSCILLATOR.—An oscillator consists of apparatus for producing alternating voltages and currents from direct-current power without the use of moving parts in the apparatus. Types of oscillators to be considered here include those employing electronic tubes and associated circuits in which the values of inductance, capacity and resistance determine the frequency of the alternating voltages and currents produced.

Oscillators of various types are capable of generating frequencies from a few cycles up to hundreds of millions of cycles per second. They may be roughly classified as types especially suited for generation of audio frequencies, radio frequencies, or ultrahigh frequencies. There are also oscillators that produce beat frequencies in the audio or radio ranges by combination of two generated frequencies, and there are modulated oscillators that produce high frequencies modulated with low frequencies or with audio frequencies.

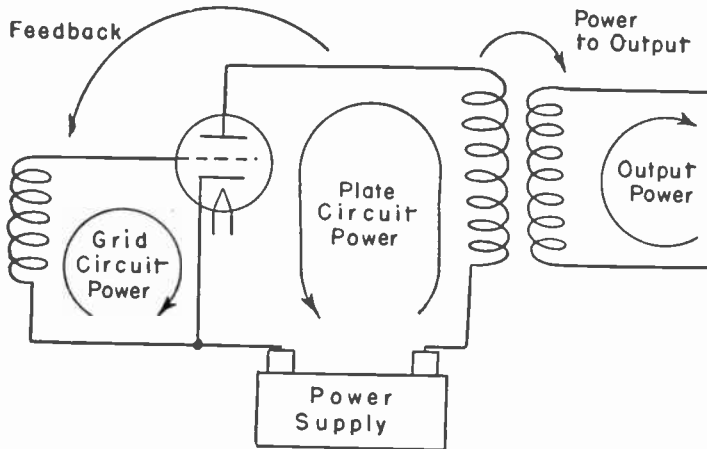

FIG. 1.—Principle of the Feedback Oscillator.

Many oscillators have their operating frequency determined by oscillatory circuits containing capacity and inductance which are tuned to resonance at the desired frequency. For convenience in classification these may be called resonance oscillators. In other types the operating frequency is determined by the time constant of capacity-resistance or inductance-resistance combinations. Units in this latter class may be called time-constant oscillators. They often are called relaxation oscillators, although this name sometimes is applied also to oscillators having tuned resonant circuits.

Feedback Oscillators. — The alternating-current output power of any oscillator is derived primarily from its direct-current power supply. The change from direct- to alternating-current power is made in the plate circuit of the tube. In those resonance oscillators which are classed as feedback oscillators the tube acts as an amplifier for a small amount of power applied to its grid

OSCILLATOR

circuit and amplified in its plate circuit. The principle is illustrated by Fig. 1. The small power required by the grid circuit is fed back from the plate circuit. That is, there is taken from the plate circuit just sufficient power to supply all the losses occurring in the grid circuit. This power acts as the input power for the grid circuit.

Since the tube of a feedback oscillator acts as an amplifier, it is generally true that any tube which is a good amplifier is also a good oscillator. With some types of oscillator apparatus the capacity between plate and grid of the tube is used for feedback of energy, or else as part of the capacity for the resonant circuits. For such cases triodes have advantages because of

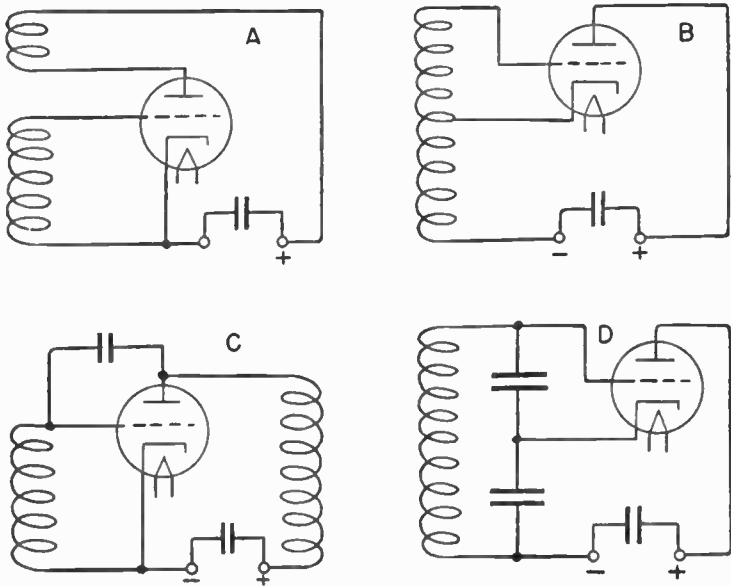

FIG. 2.—Methods of Providing Feedback.

their relatively large grid-plate internal capacity. When it is not desired to use the internal capacity of the tube there are advantages in using tetrodes or pentodes, in which grid-plate capacity is very small. In following circuit diagrams triodes are shown for simplicity in connections, but tetrodes or pentodes may be substituted by adding suitable screen potentials and by connecting the suppressor of a pentode to its cathode if not already so connected inside the tube.

The feedback from plate circuit to grid circuit may be provided in various ways. Some of the methods are shown in principle by Fig. 2. At *A* the feedback coupling is inductive; being provided by the mutual inductance of the two coils which have a common magnetic field. At *B* there is inductive coupling with a tapped

OSCILLATOR

coil whose ends are connected to the plate circuit and the grid circuit. At *C* there is capacity coupling with a condenser between the plate circuit and grid circuit, and here there is capacity coupling also through the plate to grid internal capacity of the tube. At *D* there is capacity coupling with two condensers, one in the plate circuit and the other in the grid circuit, with the same oscillatory current flowing in both of them.

In any case the feedback to the grid circuit must be in such phase relation, or in such polarity and time, as to make grid voltage changes reinforce the alternating currents in the plate circuit. While plate current is increasing, the feedback voltage must be induced in the grid circuit in such direction that the grid is made less negative or more positive, so that the change of grid potential will tend to further increase the plate current. While plate current is decreasing, the induced grid potential must tend to make the plate current decrease further. To have such phase relation with inductive feedback requires that the coupling coils be wound in the correct directions with reference to each other, or that connections to these coils be made in correct polarity. Winding directions or connections are easily changed if necessary to produce feedback in the positive direction. With capacity couplings the opposite polarities of the condenser plates take care of the phase relation provided the circuits have been correctly wired.

The power output of a feedback oscillator usually will be maximum when there is the loosest feedback coupling that will provide enough grid circuit power to maintain oscillating currents in the plate circuit. Coupling which is too close adds effective resistance to the grid circuit. The coupling required will vary with frequency, and must be enough to maintain oscillations at the lowest operating frequencies. The feedback must be enough also to care for any probable decreases in power supply voltage and for changes of tube characteristics with aging.

Oscillation in a Tube.—Oscillating plate currents commence and continue in a tube as shown by Fig. 3. At the left is a curve relating plate voltage and plate current. The plate current can, of course, never decrease to a value less than zero. It will become zero when the grid voltage becomes sufficiently negative. As the grid becomes positive there is increase of plate current, but this current can increase only to the saturation value no matter how positive the grid becomes. Saturation current is that at which electrons emitted from the cathode are drawn to the plate as fast as they are emitted. Plate current cannot exceed electron emission.

When voltage from the power supply is applied to the oscillator there is a sudden building up of plate current, a corresponding feedback of energy to the grid circuit, and the grid becomes more positive. Plate current is thus increased, and becomes as great as possible for the grid voltage. At the instant when plate current stops increasing there is, for just that instant, no change of plate current. With no change of plate current there can be no induction and no feedback of energy to the grid, for induction occurs only while there is a changing current. There is a similar action with capacity feedback.

Now the grid voltage becomes less positive, and there is a corresponding decrease of plate current. This decrease causes the feedback to be in such direction as to make the grid still less positive, or more negative. The grid continues to go negative until plate current drops to zero. Then, for another instant, there is no change of plate current, no feedback, and the grid voltage rises toward its bias value. But this rise of grid voltage causes

OSCILLATOR

plate current to increase, and the plate current again rises to its saturation value. Thus the alternations of plate current and grid voltage continue so long as enough power is supplied to compensate for all losses in the circuits and for alternating-current power withdrawn.

The dips at the tops of the plate current alternations in Fig. 3 are caused by grid current that flows while the grid is positive. This grid current is subtracted from total cathode current, and leaves a deficiency for the plate. The output of a simple oscillator, without compensation, is not a pure sine wave current and voltage, but is near enough to being one to meet most requirements.

Grid Bias Voltage.—It will be noted that in most circuit diagrams for oscillators the control grid of the tube is connected through a high-resistance "grid leak" to the cathode, either directly or else through the grid circuit coil and grid return from

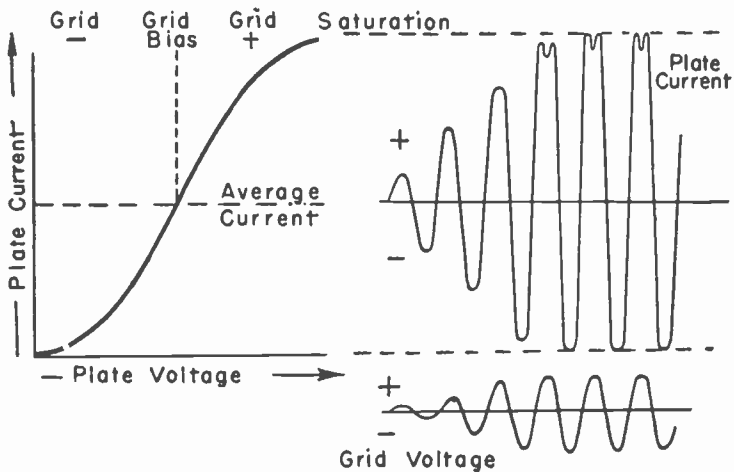

FIG. 3.—The Manner in Which Voltages and Currents Commence and Continue During Oscillation.

the coil. In series with the grid is a condenser. This combination of grid condenser and leak provides a negative bias for the tube, just as for a grid-leak type of detector tube. During the portions of the alternating cycles in which the grid becomes positive, current flows through the grid leak from cathode to grid, and the grid condenser charges. Although some of the charge leaks away during the remainder of the cycle, the leakage rate is small enough to leave some charge on the condenser at all times after the first few cycles. The charge rate and leakage rate quickly equalize, after which there is a steady current and voltage drop in the leak, with the alternating changes going through the condenser. Increasing the resistance of the grid leak makes the bias more negative. When the amplitude of oscillations tends to increase

OSCILLATOR

there is more grid current. This makes the bias more negative, and thus the amplitude of oscillations is automatically limited. The time constant of the capacity and resistance of the grid condenser and leak should be much greater than the period of the operating frequency, and the capacity reactance in ohms of the condenser should be very small in comparison with the resistance of the leak.

Inductive Feedback Oscillators.—Fig. 4 shows the elementary circuits for some of the more generally used oscillators em-

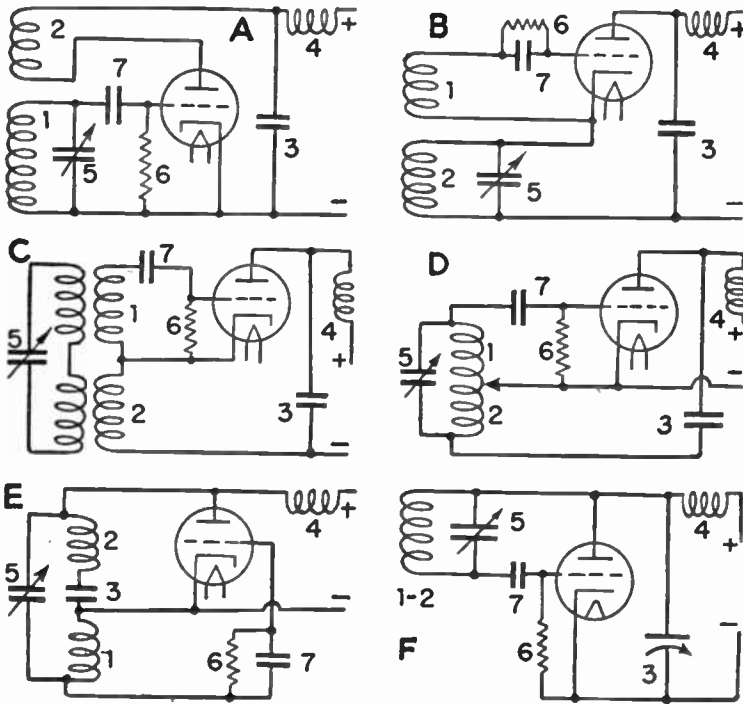

FIG. 4.—Feedback Oscillator Circuits. A and B, tickler feedback. C, Meissner. D and E, Hartley. F, ultraaudion.

ploying inductive feedback. In each diagram 1 is the coil in the grid circuit, 2 is the coil in the plate circuit, 3 is a bypass condenser which completes the plate circuit for oscillating or alternating current while insulating the low voltage portions of the wiring from the high positive voltage of the d-c supply, 4 is a choke coil which prevents oscillating voltages and currents from passing into the d-c supply, 5 is the tuning condenser, 6 is the grid leak for biasing, and 7 is the grid condenser.

OSCILLATOR

At *A* in Fig. 4 is a tuned-grid tickler feedback circuit in which energy from the plate circuit passes to the grid circuit by mutual inductive coupling of coils 1 and 2. At *B* is a tuned-plate tickler feedback circuit that is used less frequently than the type at *A*.

At *C* is the *Meissner oscillator* circuit in which plate circuit energy from coil 2 passes by mutual induction into the lower coil of the tuned coupling circuit containing condenser 5. From oscillating currents induced in the tuned circuit, energy is transferred by mutual inductance from the upper coil to coil 1 in the grid circuit.

At *D* is the *Hartley oscillator* circuit in which a single winding includes a section 1 in the grid circuit and a section 2 in the plate circuit. The amount of feedback depends on the ratio of inductances or inductive reactances between the plate and grid coils. There may or may not be mutual inductive coupling between the two sections.

There are great numbers of possible modifications for any of the basic oscillator circuits. As one example, the Hartley circuit might be rearranged as in diagram *E*. Diagram *F* shows the *ultraudion* circuit in which the single coil 1-2 of the tuned circuit is in both the plate circuit and the grid circuit of the tube.

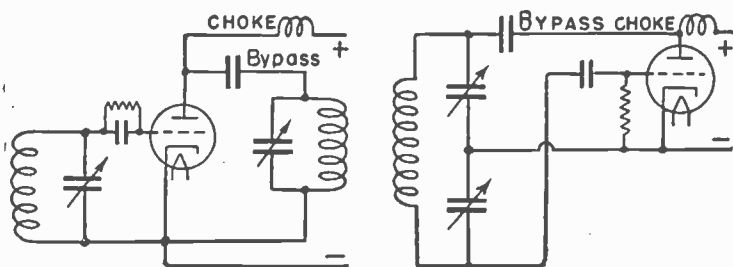

FIG. 5.—Capacity Feedback Oscillator Circuits. Tuned-plate, tuned-grid at left; Colpitts at right.

Capacity Feedback Oscillators.—Fig. 5 shows circuits for types of oscillators having capacity feedback. At the left is a *tuned-plate tuned-grid* oscillator with which feedback is through the plate to grid capacity of the tube. The grid circuit is tuned to the desired resonant frequency. The plate circuit is tuned to a frequency slightly lower in order that this circuit may have the inductive reactance necessary to cause feedback in correct phase relation.

At the right in Fig. 5 is the *Colpitts oscillator* circuit in which the resonant circuit consists of a single coil and two condensers in series. The tube supplies power to this circuit by means of the voltages across the upper condenser, and power is fed to the grid circuit by voltages across the lower condenser. The ratio of the two capacities determines the ratio of oscillating grid voltage to oscillating plate voltage, while their total capacity determines the resonant frequency of operation.

Negative Resistance Oscillators.—In oscillators of the negative resistance class there is no feedback of energy from output

OSCILLATOR

to input circuit. Instead there is utilized the effect called negative resistance. A tube is said to have negative resistance when it is so operated that an increase of voltage at one of its elements is accompanied by a decrease of current through that element, whereas with the usual operation a higher voltage would be accompanied by an increase of current.

Current in any element of a tube flows also through whatever external load is in series with that element. For example, plate current flows through the load in the plate circuit. When there is an increase of current there is a greater voltage drop across the load and, if supply voltage remains fairly constant, there must be a corresponding decrease of voltage at the tube element. With tubes as usually operated this decrease of element voltage tends to decrease the current through the element. Consequently, every increase of current is limited by the accompanying drop in voltage. There is, of course, a rise of element voltage when current decreases, and this limits the decrease. To overcome these limitations on changes of plate current there is fed back into the grid circuit of a feedback oscillator a change of grid voltage that assists the changes of plate current, and that more than overcomes the opposition due to changes of plate voltage.

In a tube operated to have negative resistance the element current will increase when element voltage drops, and will decrease when the voltage rises. Under such conditions the drop of element voltage that naturally accompanies more current acts to cause still more current, and the rise of element voltage that naturally accompanies less current now acts to cause still less current. Thus there is the same tendency to sustain and increase oscillations of element current that is secured with the feedback methods.

Dynatron Oscillator.—One of the simplest and oldest methods of securing a negative resistance characteristic is to operate a tube as a dynatron. A screen grid tube connected as in Fig. 6 will operate as a dynatron oscillator because of the effect of secondary emission. It may be seen that the plate voltage is lower than the screen voltage, and that the control grid is maintained at a small and constant negative voltage. When plate voltage increases, the electron flow from cathode to plate will increase as shown at the bottom of Fig. 6. But, after the first few volts, the increase in the rate at which secondary electrons leave the plate and travel to the more positive screen is greater than the increase in the rate at which electrons arrive at the plate. Consequently, the rate at which the remaining electrons enter the plate to form plate current becomes less and less as plate voltage is raised through a certain limited range, and plate current actually decreases as plate voltage rises. This dynatron action proceeds until the plate voltage becomes high enough to gather electrons into the plate faster than they can leave the plate and go to the screen.

The result may be seen in Fig. 7, where the full-line curve shows plate current, the middle broken-line curve shows screen current, and the top curve shows the sum of plate and screen currents—all as the plate voltage

OSCILLATOR

is increased while screen and control grid voltages remain constant. The downward slope of the plate current curve between 15 and 60 volts is the region of dynatron action for this particular tube. The control grid simply maintains a practically constant rate of electron emission.

With dynatron operation, more plate current means more load current in the oscillatory circuit, more voltage drop across this load, and less plate voltage remaining at the tube. But less plate voltage causes still more plate current, and the extra plate current causes a still further drop in plate voltage. This cumulative effect drops the plate current to the point at which dynatron action or negative resistance ceases. Then plate current commences to rise. This lowers the plate voltage, and because

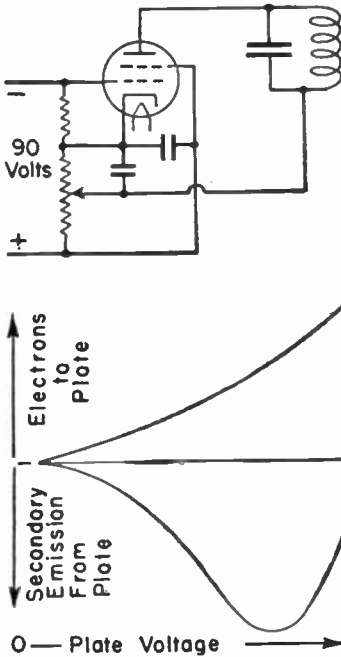

FIG. 6.—Connections and Action of Dynatron Oscillator.

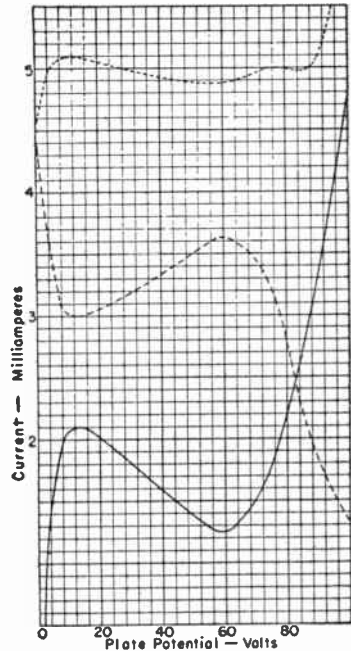

FIG. 7.—Relations of Currents and Potential with Dynatron.

of the dynatron characteristic the plate current is assisted to rise as the voltage goes down. Again the action stops where the dynatron characteristic ends, plate current commences to drop, and the whole performance is repeated over and over again at the frequency determined by the tuned resonant circuit.

Negative Transconductance Oscillator.—Fig. 8 is a schematic circuit diagram for another negative resistance oscillator, called the negative transconductance type, in which the tube is a pentode. The screen is connected to the highest positive voltage through the tuned oscillatory circuit *L-C*. The plate is connected

OSCILLATOR

to a voltage lower than that on the screen. The grid nearest the plate, which is the suppressor in a pentode, now acts as the control element. This grid is coupled through condenser *A* to a point between the screen and the oscillatory circuit, so is affected by changes of oscillating voltage. The element nearest the cathode, which ordinarily is the control grid, is connected directly to the cathode so that its constant potential with reference to the cathode maintains a practically constant rate of electron emission.

The control element becomes alternately more and less negative during the cycles of oscillation. When this element is more negative it more strongly opposes flow of electrons through it to the plate, more of the constant emission current then goes to the screen, and screen current increases. As the control element becomes less negative it permits relatively free flow of electrons to the plate, and screen current is reduced. The plate acts merely as collector for electrons that do not go to the screen.

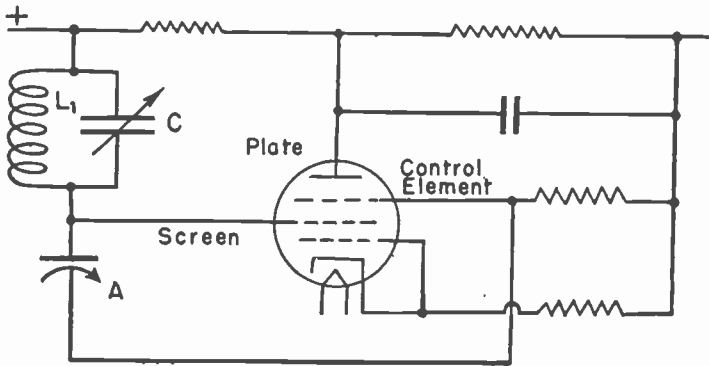

Fig. 8.—Negative Transconductance Oscillator.

When screen current increases, with the control element more negative, the extra current flows in the impedance of the tuned circuit to increase the voltage drop in this load and decrease the voltage at the screen. This decreased voltage affects the control element to make it still more negative, which increases the screen current still further. Thus, when screen current commences to decrease, there is a negative resistance effect between the screen and the control element of the tube that tends to make the screen current decrease even more. During the opposite half-cycle of oscillating voltage the control element is made less negative, and the resulting change of screen current and voltage makes this element still more negative. The screen current is forced to continue changing in whichever direction a change starts, and there is an automatic building up of the strength of oscillating currents.

Fig. 9 is a schematic circuit diagram for an oscillator operating on much the same principle as the negative transconductance type just described, but employing a resistor *R* instead of an inductance coil. The time period of the oscillations increases proportionately to the square root of the product of the time constants

OSCILLATOR

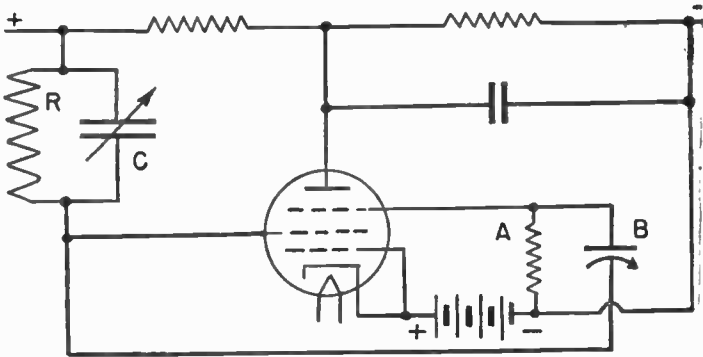

FIG. 9.—Negative Resistance Oscillator Employing Resistance-capacity Circuits.

of R - C and A - B . The effective resistance at A really is the parallel resistance of the resistor and the internal resistance of the tube between its control element and cathode. The operating frequency is increased by using less resistance at R and A , and by using less capacity at C and B .

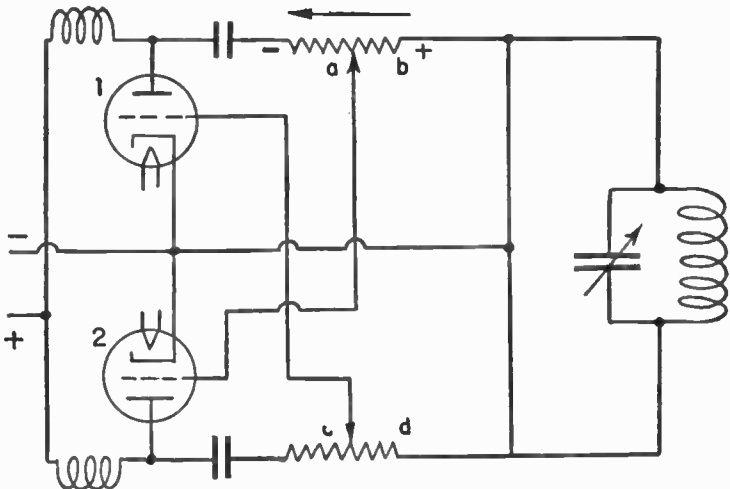

FIG. 10.—Negative Resistance Oscillator with Two Tubes.

OSCILLATOR

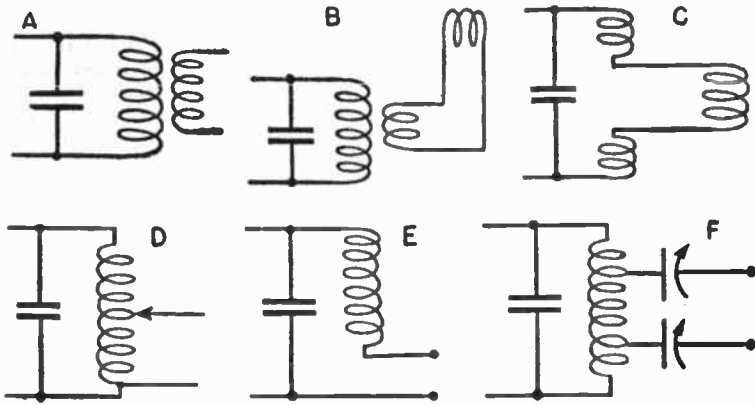

FIG. 11.—Output Connections for Taking Power from the Plate Circuits of Oscillators.

Fig. 10 shows the basic operating principle of a negative resistance oscillator employing two tubes. Changes of plate current in either tube cause such changes of grid potential in the other tube that the two plate currents are caused to change in opposite directions at the same time, one increasing as the other decreases.

While plate current is increasing in tube 1 of Fig. 10 there is an increase of current in its plate circuit resistor. Point *a*, connected to the

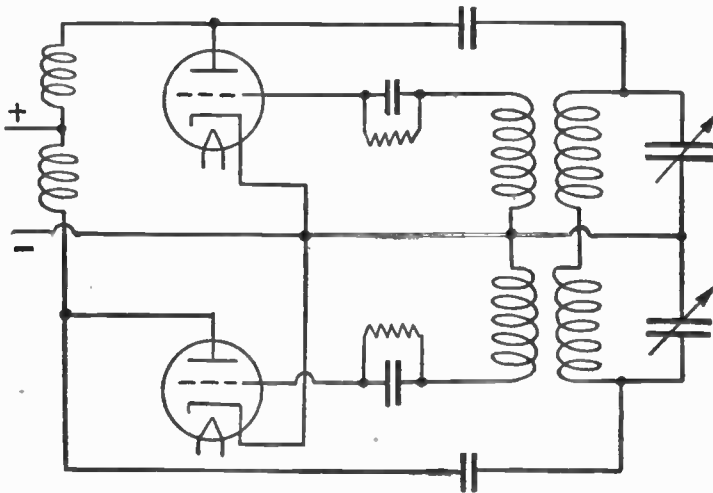

FIG. 12.—Two Oscillator Tubes with Single Resonant Circuit.

OSCILLATOR

grid of tube 2, becomes increasingly negative with reference to the cathode connection. Then there is a decrease of plate current in tube 2 and in its plate circuit resistor. This causes point *c*, connected to the grid of tube 1, to become less negative with reference to point *d* which is connected to the cathode. As a consequence the plate current in tube 1 increases still further. During the other half of an alternating cycle, when there is a decreasing plate current in tube 1, the grid potential of tube 2 is made less negative and the plate current in tube 2 increases. With the circuit operating, the plate currents increase to saturation and decrease to zero at a frequency determined by the connected resonant circuit.

Oscillator Output Connections.—Fig. 11 shows various ways of taking alternating power from the tuned circuits of oscillators. With feedback oscillators the power is taken from the coil in the plate circuit, which often is called the tank circuit. At *A* and *B* there is mutual inductive coupling between oscillator and output. At *C* the output coil is part of the tuned circuit. At *D* the output is connected through taps on the tuned coil, and at *E* is in series with the tuned coil. At *F* the output circuit is connected through condensers which insulate it from high direct voltages in the oscillating circuit.

In order to obtain high power outputs with small oscillator tubes the oscillator output voltage may be fed to the grid circuit of large amplifying tubes which then operate at the oscillator frequency. High-power oscillators often have two tubes connected to a single oscillatory circuit. Fig. 12 shows such an arrangement for two tubes with feedback from a tuned plate circuit.

OSCILLATOR, AUDIO FREQUENCY

OSCILLATOR, AUDIO-FREQUENCY. — The operating frequency of any oscillator depends on the values of inductance and capacity in the tuned resonant circuit, and if these values are made great enough the frequency will be in the audible range. Thus, in theory, any type of oscillator may be designed to produce an audio-frequency output. Feedback oscillators with inductive coupling from plate to grid circuit usually are employed.

Fig. 1 shows the circuit for an audio-frequency oscillator with feedback through an iron-core audio-frequency transformer having more turns in the winding connected to the grid than in the one connected to the plate. A condenser $C-1$ may be used to tune either the plate circuit or the grid circuit, or the distributed capacity in the transformer may be sufficient for tuning. Power output increases as the capacity of $C-2$ is increased. Insulating condenser $C-3$ should have low reactance at audio frequencies.

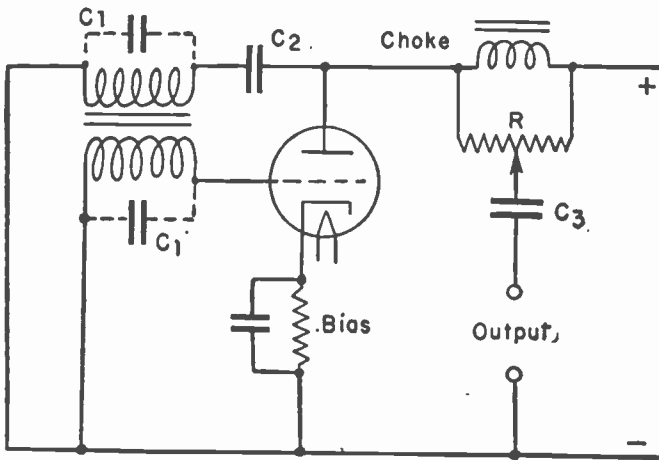

FIG. 1.—Feedback Type of Audio-frequency Oscillator.

Fig. 2 shows the circuit for an oscillator whose frequency is determined by the vibration rate of a tuning fork. The fork is magnetized by a field coil whose current flows also through a microphone button, the metal of the fork, and the input transformer primary. Vibration of the fork is maintained by the armature coil. This vibration alternately compresses and releases the microphone button, whose changes of resistance cause changes of current at tuning fork frequency in the transformers. Such oscillators usually operate at a fixed frequency of either 1,000 or 400 cycles.

Beat frequency oscillators and relaxation oscillators are used to produce outputs at audio frequencies. To obtain maximum transfer of power from an audio oscillator to another circuit the

OSCILLATOR, AUDIO FREQUENCY.

impedances should be matched. Impedance matching transformers may be connected between the oscillator output and the driven circuit.

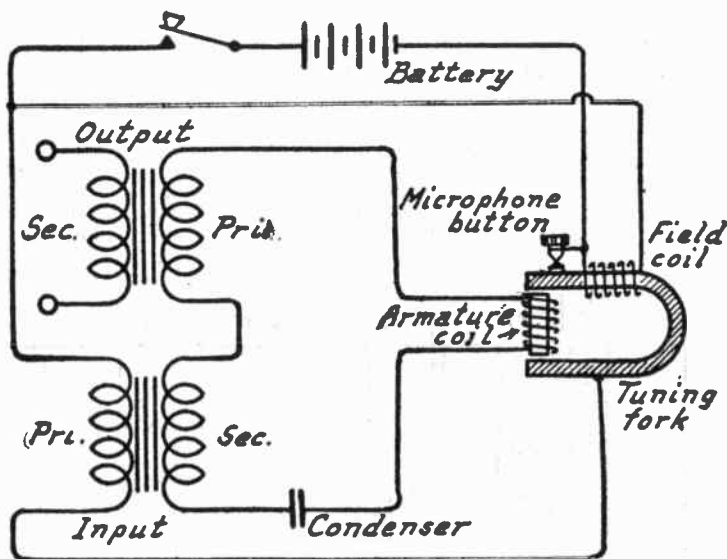

FIG. 2.—Tuning Fork Audio Oscillator.

OSCILLATOR, BEAT FREQUENCY.—A beat frequency oscillator produces audio frequencies or radio frequencies by combining in a single circuit the outputs of two separate oscillators operating at two different frequencies. The combination results in two beat frequencies, one equal to the sum of the combined frequencies and the other equal to their difference. See *Beats, Formation of*.

Fig. 1 shows the circuits for one style of beat frequency oscillator. Here the two separate oscillators are of the same type, with tuned plate circuit coils from which there is feedback to coils in the grid circuits. Coupled to each plate circuit coil is a pickup coil. The two pickup coils are in series and are connected to the grid of a detector tube. One of the oscillators is adjusted to operate at a fixed frequency. The frequency of the other oscillator is varied by adjustment of its tuning condenser. Adjustment of this one tuning condenser controls the frequencies produced by beating, or controls the output frequency of the apparatus. The beat frequency output is of low power and must be amplified for most purposes. The use of degenerative amplifiers makes the final output power fairly independent of changes in the frequency.

As the variable oscillator is tuned, the same beat frequency will be produced with two adjustments of its condenser. For example, if the fixed oscillator operates at 100,000 cycles there will be a beat frequency of

OSCILLATOR, BEAT FREQUENCY

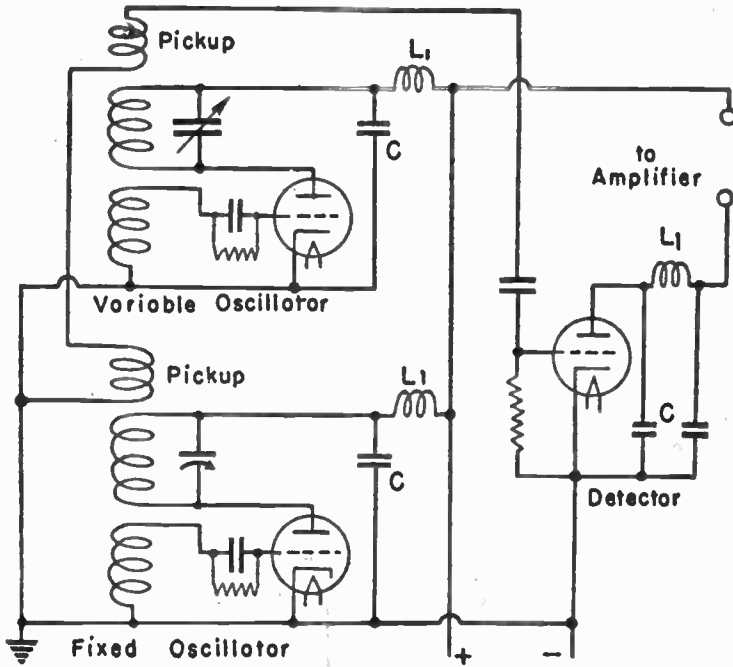

FIG. 1.—Circuits of a Beat Frequency Oscillator.

10,000 cycles when the variable oscillator is tuned to 90,000 cycles and again when the variable oscillator is tuned to 110,000 cycles, for in both cases the difference is 10,000 cycles. There would be produced also the sum frequencies of 190,000 cycles and 210,000 cycles.

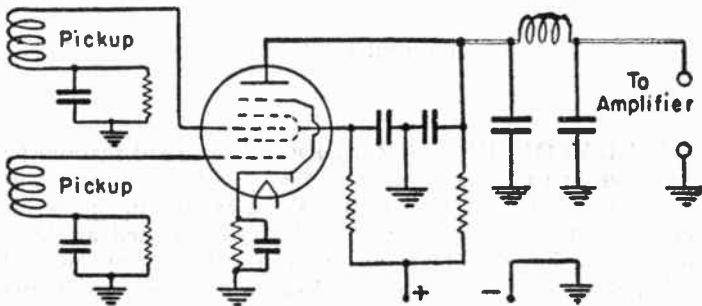
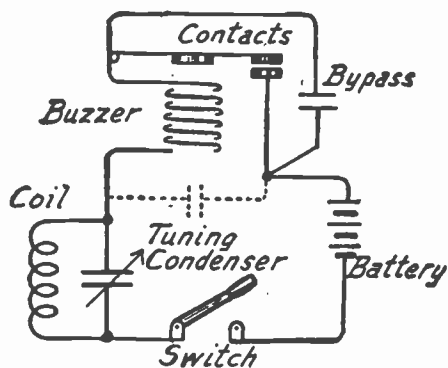

FIG. 2.—Separate Frequencies Combined in Pentagrid Mixer for Output of Beat Frequency Oscillator.

OSCILLATOR, BEAT FREQUENCY

A small percentage change in the frequency of either separate oscillator will cause a relatively great percentage change in the beat frequency when the other oscillator remains at a constant frequency. Such changes may occur with ordinary variations of temperature. If both oscillators "drift" together there is less effect on the beat frequency. When the frequencies of the two oscillators are brought close together there always is a tendency for them to pull into step and operate at the same frequency, whereupon there can be no beat frequency and no output frequency. The two oscillators are built into separate shielded compartments, and all precautions are taken to prevent resistance, capacity or inductive couplings between their circuits other than through the pickup coils.

There is much less tendency to coupling between the oscillators when the pickups are in separate circuits connected to the two grids of a pentagrid mixer tube as in Fig. 2. The electron flow from cathode to plate then is modulated by changes of potential on both grids at the same time, and beat frequencies are produced in the plate circuit just as in the plate circuit of a detector. Beat frequency instruments sometimes have a crystal controlled unit for the fixed frequency oscillator. See *Crystal, Frequency Control by*.



Oscillator Circuit Excited by Buzzer.

OSCILLATOR, BUZZER TYPE.—If a tuned resonant circuit is connected in series with a battery and high-frequency buzzer, as in the diagram, oscillations will be excited in the resonant circuit at its tuned frequency and will be modulated at the frequency of the buzzer. Such an outfit has the advantage of low cost, but it tunes very broadly and does not give a particularly satisfactory output.

OSCILLATOR, CRYSTAL CONTROLLED.— See *Crystal, Frequency Control by*.

OSCILLATOR, MODULATED

OSCILLATOR, MODULATED.—A modulated oscillator is a high-frequency or radio-frequency oscillator whose output is varied at audio frequency or is modulated at audio frequency. The essential parts of such apparatus include a high-frequency oscillator whose operating frequency may be varied by suitable adjustments, a modulating audio-frequency oscillator whose operating frequency may or may not be varied, and an attenuator system by means of which the strength of the output may be adjusted.

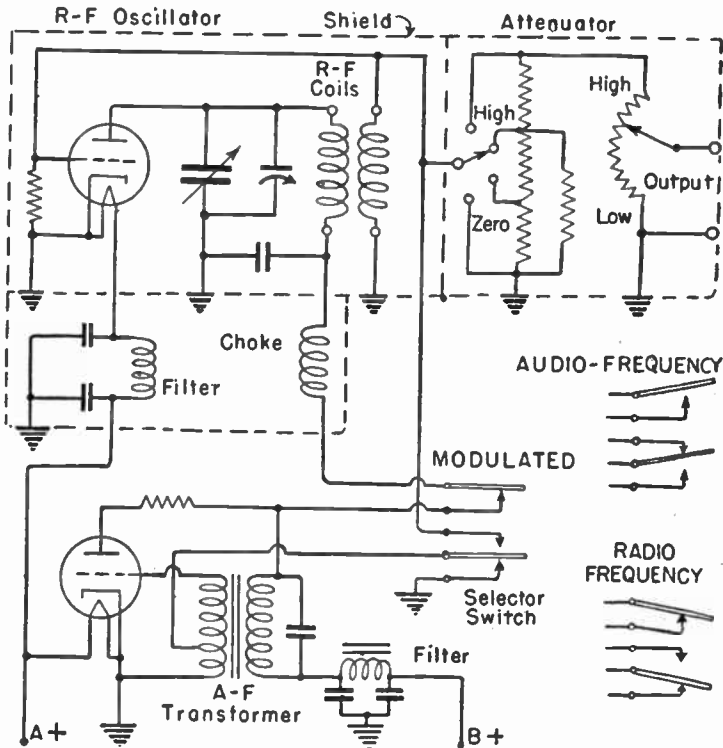

Modulated Oscillator or Signal Generator.

In the circuit shown the radio-frequency oscillator is of the tuned plate type with inductive feedback to the grid circuit. The radio frequency coils are demountable so that units with various numbers of turns may be used to cover different ranges of output frequency. The attenuator is of the voltage divider type adjusted in steps by the left-hand switch and in small increments by the

OSCILLATOR, MODULATED

rheostat at the right. The audio-frequency oscillator is of the feedback type with its plate and grid circuits connected to the windings of an iron-core audio-frequency transformer. Plate current for the radio-frequency oscillator passes through the plate winding of the audio-frequency transformer where it is modulated at the audio frequency.

In the particular design shown there is an output selector switch that may be placed in any of three positions to give three types of output. There may be modulated radio frequency, there may be audio frequency only, or there may be radio frequency only. The switch is shown in its three positions. A filter in the heater circuit of the r-f tube and a choke in the plate supply lead prevent excessive escape of high-frequency fields. Grounded shields completely enclose the radio-frequency oscillator, its filter and choke, and the attenuator. A low-frequency filter is placed in the high-voltage lead to the audio-frequency system.

The three series resistors in the stepped portion of the attenuator may be respectively, from top to bottom, of 990 ohms, 990 ohms, and 110 ohms resistance, with the unit which shunts the two lower resistors of 110 ohms. The right-hand attenuator unit may be a rheostat or potentiometer of 110 ohms resistance.

The r-f oscillator tube is a type 6J5 and the a-f modulating oscillator is a type 76 or equivalent. The resistor in the plate lead of the a-f tube may be of 2,000 ohms resistance. The tuning condenser across the a-f transformer will be of a value depending on the inductance and distributed capacity of the transformer. About 0.5 mfd. capacity usually is required. There is an iron-core filter choke between B+ and the a-f transformer, with filter condensers of 4 mfd. each. Condensers in the filter on the heater of the r-f oscillator are of 0.005 mfd. capacity. The resistor between the grid of the r-f oscillator and ground is of 60,000 ohms resistance. Between the grid of the r-f oscillator and its connection to the r-f coil may be a 0.0015 mfd. condenser, and between the grid connection to the r-f coil and the junction leading to the attenuator may be an 1800-ohm resistor. The bypass condenser from the lower end of the r-f plate coil to ground is of 0.1 mfd. capacity.

OSCILLATOR, RELAXATION

OSCILLATOR, RELAXATION.—Oscillators which are here classed as relaxation types have their operating frequency determined by the rate at which a condenser charges and discharges through a resistance. The frequency is related to the time constant of the capacity-resistance combination rather than to the resonant frequency of a capacity-inductance combination as is the case with other oscillators. See *Constant, Time*.

As a general rule the output current and voltage of relaxation oscillators are not of sine wave form, but may have sudden changes in one polarity with more gradual changes in the opposite direction, or may remain at peak values in either direction, or at zero, for considerable portions of each cycle. It is possible to translate the irregular waveform into one that is approximately sinusoidal by using filter systems to smooth out the sudden changes.

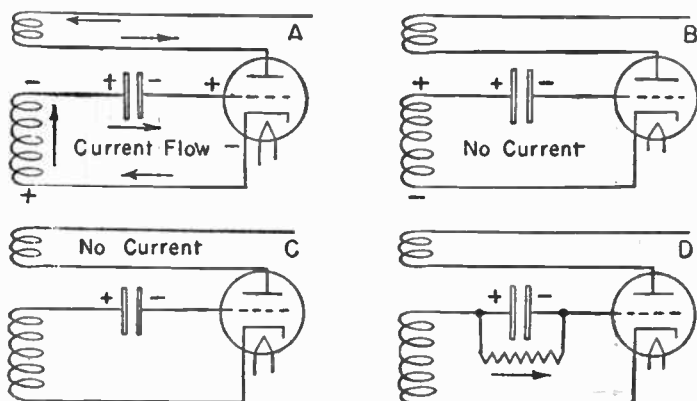

FIG. 1.—Action of Blocking Due to Charge on Grid Condenser.

Blocking Oscillators.—In one general class of relaxation oscillators use is made of the fact that no matter how negative a control grid may be made the plate current can be reduced only to zero. Such action in a tube is called blocking, so units of this type may be called blocking oscillators. The time periods required for plate current to change, or the time during which it remains at maximum or minimum values, is determined by the time constant of a condenser and a resistor in the grid circuit, hence the operating frequency is inversely proportional to the time constant.

Fig. 1 represents a control grid circuit in which a condenser is in series with the grid. At *A* are represented conditions during an alternating half-cycle during which voltage induced in the grid coil by the plate coil is in such polarity as to make the grid positive. There is current flow in the direction of the arrows, which, inside the tube, is from grid to cathode. This current charges the grid condenser in such polarity that its side connected to the grid becomes negative. On the opposite half cycle, as at *B*, the polarity in the grid coil is reversed, but no current can flow because

OSCILLATOR, RELAXATION

current cannot flow from cathode to grid in a tube. Therefore, the grid condenser retains its charge. The charge on the condenser will increase with successive pulses of grid current until the condenser voltage makes the grid so highly negative as to prevent flow of plate current. This condition is represented at *C*, wherein the tube is blocked.

At *D* in Fig. 1 a resistor has been connected across the grid condenser. The charge of the condenser leaks off through this resistor, in the direction of the arrow. This loss of charge lowers the voltage on the condenser and allows the grid to become less negative. When the negative potential of the grid has decreased to a certain value there will be resumption of plate current.

In actual operation, with grid condenser and resistor as at *D* of Fig. 1, there is continual leakage of condenser charge through the resistor, the rate of leakage depending on the value of the resistance and on the voltage which is built up on the condenser. With a high-resistance leak the condenser charge will build up until the grid becomes so negative as to block the plate current,

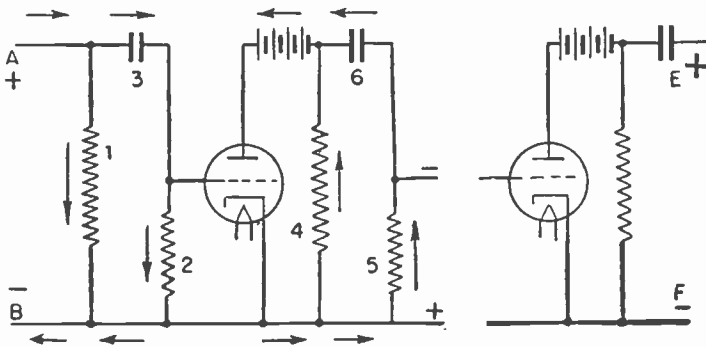

FIG. 2.—Operating Principle of the Multivibrator.

this in spite of the continual small leakage through the resistor. But then, with plate current stopped, there are no voltages induced in the grid circuit, there is no further charging of the condenser, and the existing charge leaks away until grid voltage returns to a value at which the action commences all over again. Plate current then flows and stops flowing at intervals determined by the capacity of the condenser and the resistance of the leak.

Multivibrator.—If an alternating potential is applied to terminals *A* and *B* of Fig. 2, *A* will be positive and *B* negative during one of the half-cycles. During that half-cycle currents will increase in the directions of the arrows through resistors 1 and 2 and on condenser 3. The change of current and potential drop in resistor 2 will make the grid of the left-hand tube increasingly positive. The result will be increase of plate current in this tube, this increase being in the directions of the arrows in resistors 4

OSCILLATOR, RELAXATION

and 5 and in condenser 6. The direction of current in resistor 5, and the increasing potential drop, will make the upper end of this resistor more and more negative with respect to its lower end.

If the top of 5 now is connected to the grid of the following tube, and the bottom to its cathode, the grid potential of this second tube will change in a direction that is opposite to the grid change on the first tube, and, of course, the plate current and plate circuit potentials of the second tube will change oppositely to plate current and potentials of the first tube. Then the change of plate circuit output potential, at *E* and *F*, will be in the same polarity as the change of input potentials at *A* and *B*.

If *E* and *F* of Fig. 2 were connected to *A* and *B*, and were plate current to commence increasing in the left-hand tube, the action of the right-hand tube would force this current to continue its increase. Were plate current in the left-hand tube to commence decreasing, it would be forced to continue its decrease. During the increase of plate current in the left-hand tube there would be a decrease of plate current in the right-hand

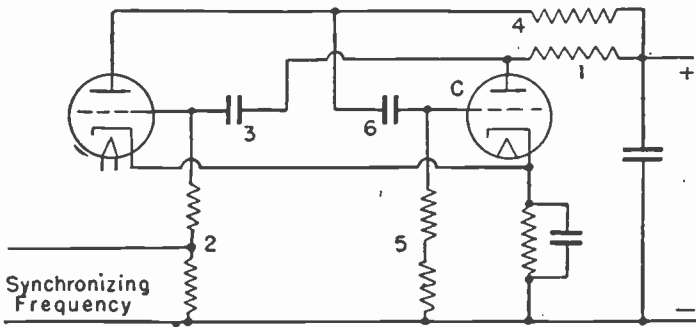

FIG. 3.—Circuit of Multivibrator Oscillator.

tube, and vice versa. When plate current in either tube dropped to zero there no longer would be current in its plate resistor, and there would be no potential difference between grid and cathode of the other tube in whose plate circuit the current had been increasing. Plate current in this other tube then would commence to drop, and this would force a rise of plate current in the first tube. Thus the action would continue.

In Fig. 3 the output of each tube has been connected to the input of the other one. Plate currents change in opposite directions in the two tubes as each tube controls the action of the other one. This arrangement is called a multivibrator because, in its output waveform, there are many frequencies which are harmonics of the fundamental frequency. The fundamental is determined by the time constants of the resistors and condensers. If a synchronizing alternating potential of the fundamental frequency is introduced into one of the grid circuits the operation will be maintained at this frequency and the harmonics may be used for making frequency comparisons with other instruments.

OSCILLATOR, RELAXATION

Gas-filled Tubes for Oscillators.—There are many types of relaxation oscillators in which the maximum voltage to which a condenser may charge is the breakdown voltage of a gas-filled tube connected across the condenser. The simplest of such arrangements uses a small neon lamp as in Fig. 4. The d-c input voltage is higher than the breakdown voltage of the lamp. Condenser C is charged through resistor R . The time required for condenser voltage to rise to the breakdown value for the lamp depends on the time constant of C and R . During this time there is a gradual rise of condenser voltage, which is also the output voltage. When the lamp breaks down its internal resistance suddenly drops to a low value and the condenser discharges through the lamp until the voltage drops to the value at which the lamp deionizes. Then the lamp resistance again becomes very high and the condenser is recharged. See *Tube, Gas-filled*; also *Constant, Time*.

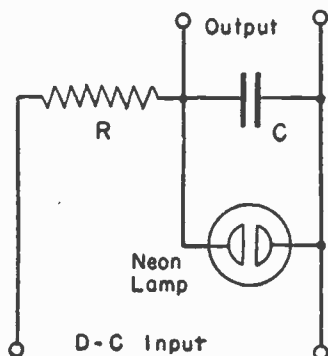

FIG. 4.—Neon Lamp in Relaxation Oscillator.

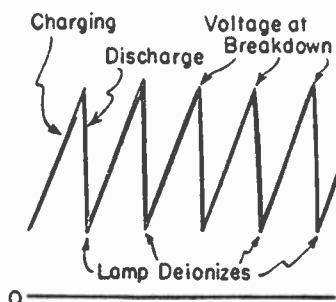

FIG. 5.—Output Wave Form of Neon Oscillator.

The changes of output voltage in all oscillators operating on this general principle are approximately as shown by Fig. 5. The charge of the condenser and the rise of output voltage are gradual, while discharge and drop of voltage are sudden.

Fig. 6 shows connections for a relaxation oscillator employing a thyratron tube. Condenser C is charged from the d-c source through resistor $R-1$. Resistor $R-2$ limits the plate or anode current of the thyratron after breakdown, and resistor $R-3$ limits the grid current. The grid potential of the thyratron is made more or less negative by adjustment of the bias voltage divider through which there is a steady current from the positive of the source and resistor $R-4$. Grid potential adjustment determines the voltage at which the thyratron will break down, and so determines the maximum condenser voltage and output voltage. The frequency of oscillation is inversely proportional to the time constant of $R-1$

OSCILLATOR, RELAXATION

and C . Resistor $R-1$ usually is an adjustable type. Various ranges of frequency may be covered by switching condensers (C) of suitable value into the circuit. This diagram shows the basic principle of some types of sweep circuit oscillators used with cathode-ray tubes. Grid-glow tubes may be used in oscillators of this general type, with the grid connected for positive potential adjustment to a voltage divider in the position of $R-4$ of Fig. 6.

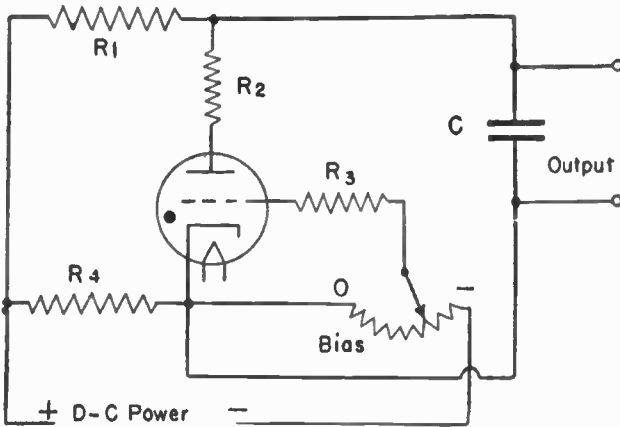

FIG. 6.—Relaxation Oscillator Using Thyratron Tube.

OSCILLATOR TUBE.—Any vacuum tube used for the production of oscillating currents either at radio frequency, at audio frequency or at an intermediate frequency is called an oscillator tube.

OSCILLATORY CIRCUIT.—See *Circuit, Oscillatory*.

OSCILLOSCOPE

OSCILLOSCOPE.—An oscilloscope is a device for producing on a screen visible indications of changes occurring in electric potentials or currents, or both at the same time. The indication usually is a luminous trace or line whose shape represents increases, decreases and, in general, the waveforms of rapidly varying or alternating quantities.

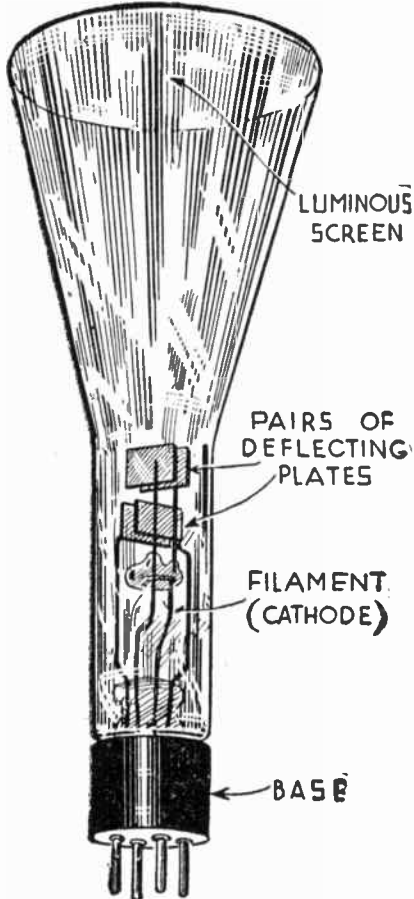

FIG. 1.—A Cathode-ray Tube.

Oscilloscopes used in radio testing and servicing employ a cathode-ray tube whose electron beam is moved by the observed potentials and currents, to produce on the fluorescent screen of the tube a luminous trace corresponding to the changes taking place. An early type of cathode-ray tube is shown by Fig. 1. See *Tube, Cathode-ray*.

OSCILLOSCOPE

Oscilloscopes suitable for observing frequencies to and through the audio range may be of mechanical types. The principle of one such type, called a Duddell oscilloscope or oscillograph, is shown by Fig. 2. Currents from the source under observation are passed through a looped filament which is suspended between the poles of an electromagnet. Reaction between the fields of the

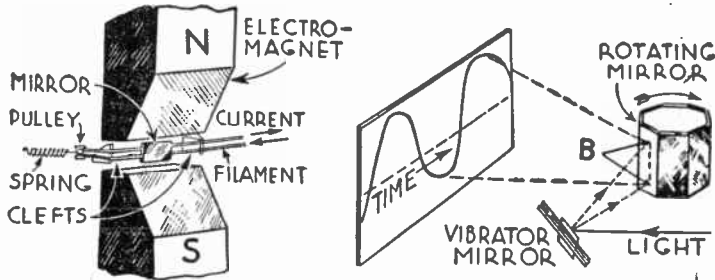

FIG. 2.—Principle of the Duddell Oscillograph.

magnet and of the current in the loop cause the loop to twist proportionately and in time with the current that it carries. Attached to the loop is a small mirror onto which is directed a beam of light that is reflected onto a screen, or which may be made to fall upon a revolving mirror which is rotated in time with frequency of loop current. Reflection from the revolving mirror onto a screen shows the waveform of observed quantities.

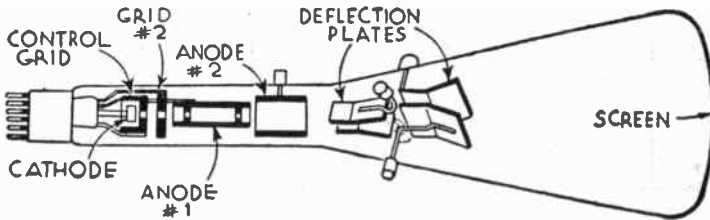

FIG. 3.—Details of a Cathode-ray Tube.

Cathode Ray Oscilloscope Use.—The use of a cathode ray oscilloscope may be divided into two distinct classes: 1. Those investigations requiring a time base which may be linear, sinusoidal or periodic. 2. Those not requiring a time base.

In the first category, periodic as well as transient phenomena may be studied. A partial list would include:

1. Waveform studies of generators of all descriptions.
2. Alignment of resonant circuits.
3. Measurement of modulation percentage.
4. Distortion measurements.
5. Harmonic analysis.
6. Study of electric sparks.
7. Current and voltage surges.

OSCILLOSCOPE, CATHODE RAY

8. Physiological phenomena.

In the second classification the following are a representative group:

1. Vacuum tube characteristics.
2. Comparison of wave shapes.
3. Measurement of voltage and current values.
4. Properties of dielectric and magnetic materials.
5. Hysteresis curves.
6. Radio direction finding.
7. Frequency comparisons.
8. Measurement of modulation percentages.
9. Phase determination.

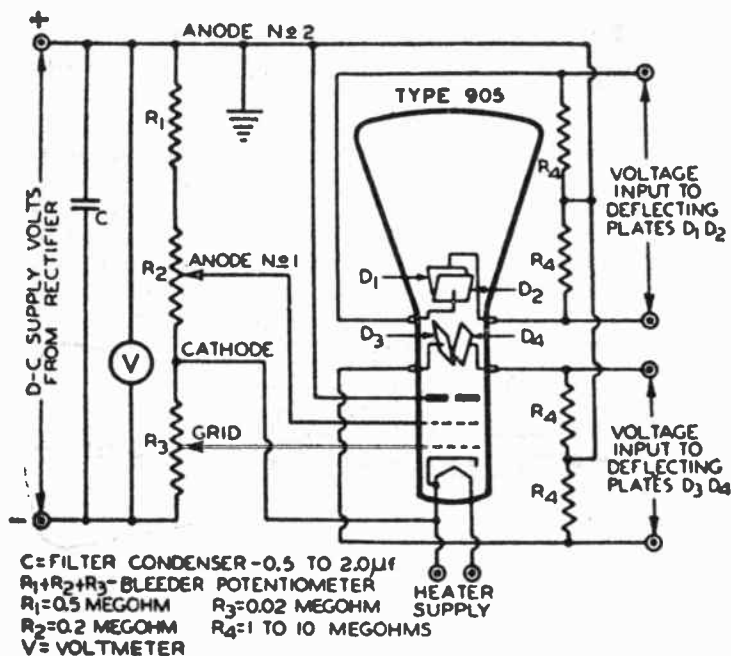

TYPICAL OSCILLOGRAPH CIRCUIT

Fig. 4.—Cathode Ray Tube with Applied Actuating Voltages.

The foregoing lists are far from complete. New applications of the cathode ray oscillograph are being made daily. Automotive engineers are using the device to study reverberant qualities of insulation in an attempt to provide a more quiet operation of vehicles. A cathode ray tube is destined to play a part of utmost importance in television, in fact, the heart of the receiver as well

OSCILLOSCOPE, CATHODE RAY

as the image collector will undoubtedly be some form of a cathode ray tube.

The following diagram shows a cathode ray tube with the proper potentials applied to its elements. The electron gun cathode is emitting electrons due to the heat supplied by the filament. The control element (grid) which is always negative with respect to the cathode, limits the number of electrons proceeding to the gun and thereby controls the intensity of the spot. Grid

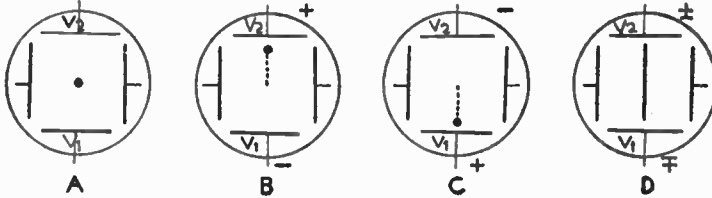

FIG. 5.

number two is an accelerating electrode carrying a fixed positive potential. Anode one and anode two have high positive potentials applied with respect to the cathode, the ratio of A_1 to A_2 bringing the electron stream to focus at the screen. With no voltage applied

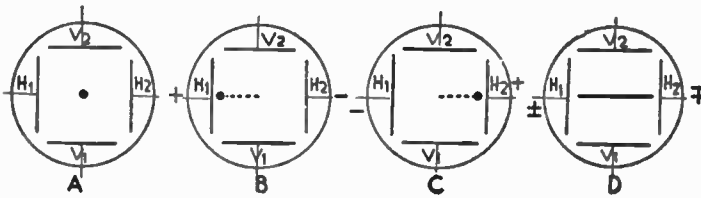

FIG. 6.

to the deflecting plates a small luminous spot will appear at the center of the viewing screen.

Figure 5 shows the positioning of the two sets of deflecting plates. For the purpose of illustration the plates are viewed from the front of the tube as though it were possible to look through the screen and although the plates are fairly close together in actual construction, they are shown removed toward the periphery of the circle in order to show spot displacement.

Consider first the application of a direct potential to the set of plates marked V_1 , V_2 . If V_2 is positive with respect to V_1 , the spot will be drawn toward the plate V_2 . This displacement is shown in figure 5B. The distance of the spot from the center is dependent upon the potential difference between V_1 , V_2 . If the polarity is reversed the spot will be deflected toward V_1 . The application of an alternating voltage to plates V_1 , V_2 will cause the spot to travel between the two terminal positions shown, fol-

OSCILLOSCOPE, CATHODE RAY

lowing instantaneously the rise, fall and reversal of potential. If the frequency of the impressed voltage is below 16 cycles per second, the movement of the spot can be followed in its travel, if the frequency is above this value a line will appear due to the persistence of vision of the eye. The second sequence of figures show the application of a voltage to the horizontal deflecting plates with no potential applied to the vertical plates. Figure 6A shows the spot centered while 6B shows the spot deflected to the left by the application of a positive direct potential to H_1 with respect to H_2 . Figure 6C shows the deflection of the spot to the right due to the reversal of polarity. The last figure in this series shows an apparent line across the tube due to the application of an alternating potential of a frequency greater than 16 cycles per second to plates H_1 and H_2 . Note that the horizontal deflecting plates are mounted vertically in the tube, while the vertical deflecting plates lie in a horizontal plane.

In the simple deflection characteristic just discussed, the cathode ray tube is capable of acting as a voltmeter of many superior qualities. The electron beam acts as a pointer which is substantially weightless and inertia-less, thereby enabling it to follow intricate voltage variations applied to the plates. The sensitivity of the deflection plates is extremely low, consequently amplifiers are used to bring the sensitivity up to a usable value. The amplifiers may be calibrated and a ruled scale placed before the screen, making the tube a voltmeter in fact and enabling quantitative measurements to be made. The gain of the amplifiers is such as to bring the original .1 or .2 millimeter per volt sensitivity of the tube alone up to the point where it may be as high as 3 inches per volt at the input terminals of the amplifiers. The use of resistance-capacitance coupled amplifiers with condenser input makes it impossible to measure direct current potentials with this sensitivity, but in many instances connections are provided which lead directly to the deflection plates and an external direct current amplifier may be used unless the potential being measured is high enough to provide a suitable deflection when applied directly to the plates.

An overload which would be disastrous to a conventional pointer type of meter may safely be applied to the electron beam without causing damage. The spot or line would simply appear to round the end of the tube screen. This is of importance where momentary transients may exceed normal values by a large amount and protection for an ordinary meter would have to be provided.

When using the oscilloscope as a voltmeter, its input impedance is extremely high whether used with or without the associated amplifier, consequently it can be used to make measurements on delicately balanced circuits which would be upset

OSCILLOSCOPE, CATHODE RAY

by the ordinary type of meter. The fact that it is of the high impedance input type makes it necessary to make certain changes when a measurement of current is desired. The electron stream responds to magnetic impulses as well as electrostatic charges, making it possible to lead the current to be measured through coils of wire placed at right angles to the electron stream as shown in the illustration. Calibration can be carried out as with electrostatic deflection and the same general advantages are obtained. The impedance of the deflecting coils must be considered where complete circuit analysis is desired. When using electromagnetic deflection a current amplifier rather than a voltage amplifier is used. Electromagnetic deflection is not provided in the oscilloscopes manufactured for the radio service profession, but finds its most important application in the research laboratory. Useful studies of voltage-current phase relationship are possible by applying the voltage to a pair of electrostatic deflection plates and sending the current through a pair of deflection coils. In all applications of the cathode ray tube as a meter it is important to remember that the tube deflection indicates peak values.

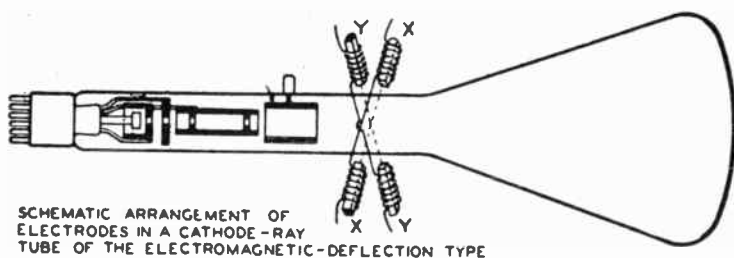

FIG. 7.

In the foregoing discussion the impulse application has been to one set of plates only. If equal potentials (D C) are applied to both sets of plates, the results will be as indicated in the following sequence of figures. Fig. 8A shows the spot deflected to the upper right corner. The angle made with the horizontal will be 45° if the voltage on both sets of plates is such as to compensate for difference in deflection plate sensitivity. Figure 8B shows deflection to the lower left due to a voltage reversal on both sets of plates. Figures 8C and 8D show the application of alternating potentials to the two sets of plates. The slope of the line will depend upon the ratio of voltages applied to the two sets of plates and can vary between a horizontal line and a vertical line by changing this ratio.

The spot on the screen moving back and forth along one axis and accurately following variations in the impulse being studied

OSCILLOSCOPE, CATHODE RAY

is suitable for measurement purposes, but does not yield information on wave shape analysis. The greatest usefulness of the oscilloscope is found in wave pattern analysis wherein the wave being studied is applied as a voltage to one set of deflection plates, generally the vertical plates, and the spot is caused to move horizontally back and forth across the screen according to a predetermined timing impulse. This impulse is referred to as the "sweep" voltage and the circuit in which it is generated is referred to as the "sweep circuit." While it is possible to use any

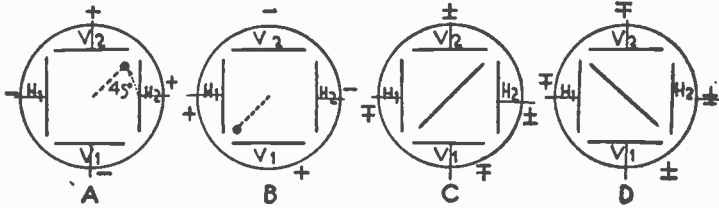

FIG. 8.

type of timing impulse, two distinct types are in general use and find suitable application in the majority of cases. They are the "linear sweep" in which the spot is caused to travel from the extreme left center of the screen across to the right side at a rate which is linear with respect to time and the "harmonic sweep" which is taken from the voltage being measured.

The "linear sweep" requires that the spot move across the screen at a uniform rate and then return to the origin so rapidly that the screen is not activated. This prevents the formation of

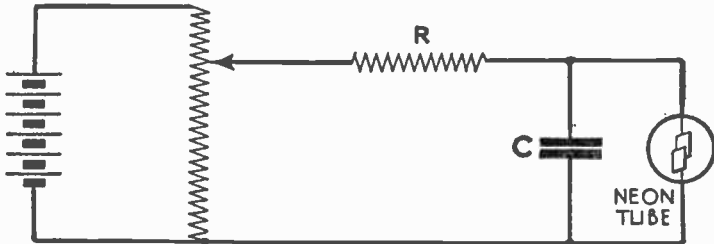

FIG. 9.—Simple Neon Type Saw-tooth Wave Shape Generator.

a return trace which would superimpose an additional wave on the shape being studied and confuse the resulting picture.

A "saw tooth" wave shape is desirable for this purpose and requires the use of a special type of oscillator. The elementary oscillator of this type may consist of a condenser charging from a source of potential through a resistor and discharging through a neon tube. Figure 9 shows this simple oscillator. Condenser *C* is charged through resistor *R* until the potential across its plates

OSCILLOSCOPE, CATHODE RAY

reaches the ionization potential of the neon tube. The tube then discharges the condenser, the voltage across the condenser and consequently the neon tube drops to zero, the tube is extinguished and the action is repeated. The frequency of the cycle is determined by the electrical values of the condenser C and resistor R .

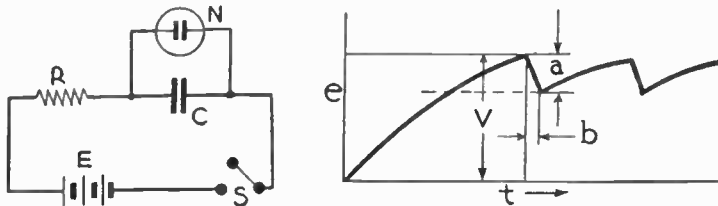

FIG. 10.—Relaxation Oscillator Showing Resulting Saw-tooth Wave Shape.

A wide frequency range is obtainable with this simple system varying from one oscillation in several minutes to well beyond the audible frequency range. The wave shape is not strictly a "saw tooth" type and a higher frequency is desirable so this type is seldom met with in practice.

A new type of tube was developed to produce a "saw tooth" wave shape in conjunction with its associated equipment. It is a

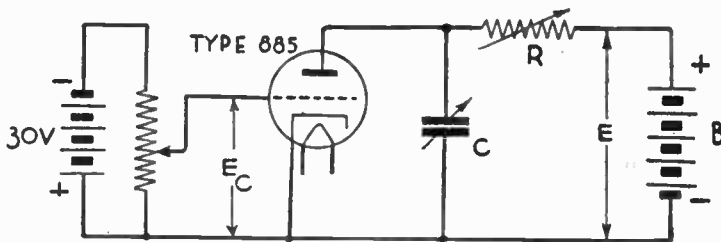

FIG. 11.—Thyatron Sweep Circuit Oscillator.

small grid controlled gaseous rectifier called a "Thyatron" by one manufacturer and carrying the type number 885. Figure 11 shows this tube connected in simplified form to produce saw-tooth oscillations. Condenser C charges until the potential across it rises to the ionization voltage of the thyatron. This voltage is determined by the bias on the grid and is adjustable. The condenser discharges through the tube, which presents a low impedance path for its discharge. Resistor R prevents a surge of current from the B supply from passing through the tube while it is in its ionized condition. As the discharge of the condenser proceeds the voltage difference between the plate and cathode drops to a low value and the tube de-ionizes, restoring its non-conducting status and the condenser again starts to charge. In

OSCILLOSCOPE, CATHODE RAY

practice the limiting resistor is replaced by an emission saturated pentode. A complete sweep circuit is shown in Figure 12 with a frequency range of from 10 to 50,000 cycles, the range being covered by a tapped switch for large changes and a variable resistor for intermediate values. Thus, the frequency range is continuously variable within the range mentioned.

As before stated, the sweep circuit may take any one of several types. For recurrent phenomena the linear type just de-

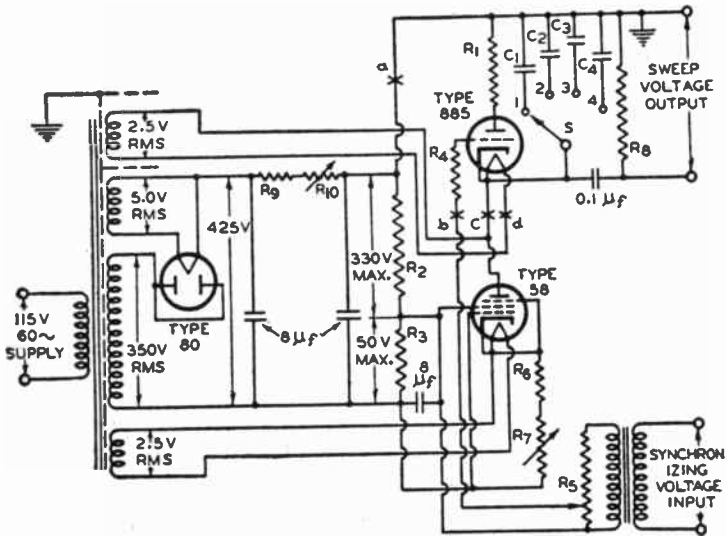

**LINEAR SWEEP-CIRCUIT OSCILLATOR DIAGRAM
WITH CURRENT-LIMITING PENTODE (A-C OPERATED)**

FIG. 12.

scribed is suitable. This circuit may be adjusted to the exact value of the frequency being investigated or it may be operated at an exact sub-multiple of this value where it is desired to investigate radio frequency phenomena. Equal or exact multiple relationship is necessary to obtain a wave shape which appears stationary on the screen.

For transient phenomena, a single sweep of the beam across the screen is suitable, the starting time of the sweep and the transient being synchronized generally by electrical means.

For certain operations it is desirable to use a non-linear sweep which may be logarithmic or sinusoidal. Commercial oscilloscopes generally provide a means of using the operating line frequency to obtain this sinusoidal type of impulse. This is generally marked on the timing control switch as "60 cycles."

The patterns produced by the linear sweep and the harmonic

OSCILLOSCOPE, CATHODE RAY

sweep vary widely in appearance, but they contain the same information when correctly interpreted. When using a harmonic sweep (sinusoidal voltages applied to both sets of plates), a trace is formed which falls in the family of patterns called "Lissajous Figures." Phase displacement can be determined and frequency

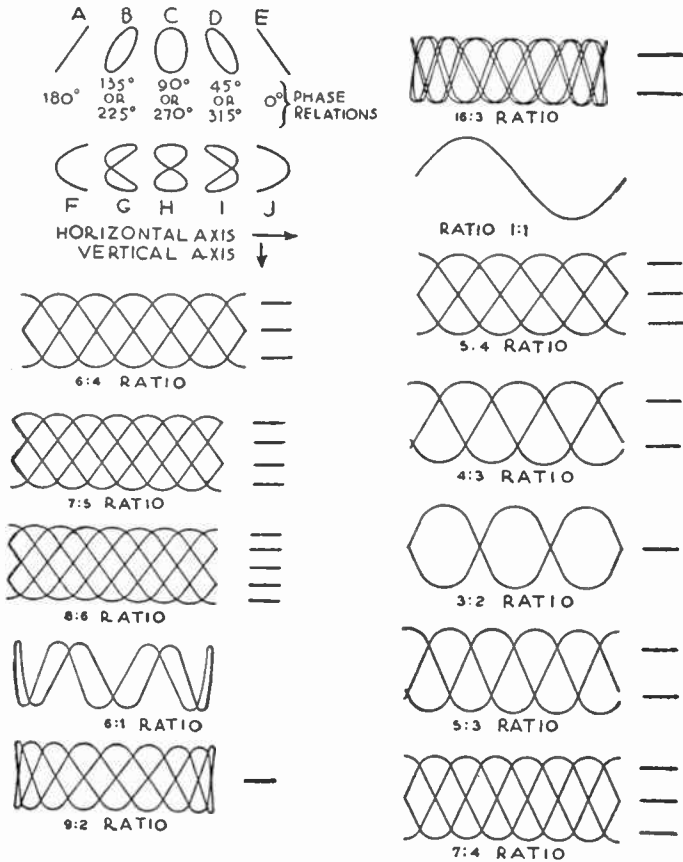

Fig. 13.—Lissajous Figures Caused by a Frequency Difference between Voltages Applied to Vertical and Horizontal Deflecting Plates of Cathode Ray Oscilloscope.

identified providing the sweep frequency is accurately known. Thus, although the cathode ray oscilloscope cannot be used as a frequency meter, it acts as a very accurate frequency comparator. A representative group of Lissajous Figures are provided in the accompanying chart with explanatory descriptions.

By means of harmonic patterns, phase shift with its resulting

OSCILLOSCOPE, CATHODE RAY

distortion may be shown if existing in amplifying systems. Hum level may be shown in AC operated voltage supply systems and the result of corrective measures noted. The oscilloscope may be used with either harmonic or linear sweep to indicate modulation level of radio broadcast transmitters. The transmitter is modulated by a single frequency while this measurement is being made. Hysteresis curves of magnetic materials may be obtained and viewed as an actual hysteresis loop upon the screen.

The oscilloscope can be used to trace a resonance curve of a broadcast receiver and is used effectively to make the proper adjustments of the various circuits to produce the desired curve. In this application a motor driven condenser is used to vary the frequency response of the tuned circuit above and below resonance by a pre-determined amount.

The cathode ray oscilloscope is being called upon for ever increasing applications. A scientific toy of a few years ago is taking its proper place in industry, solving problems which previously seemed impossible of solution. See *Tube, Cathode-ray*.

OUTDOOR ANTENNA.—See *Antenna*.

OUTPUT IMPEDANCE.—See *Tube, Output Resistance and Impedance of*.

OUTPUT TRANSFORMER.—See *Transformer, Output*.

P

p.—The symbol for power (instantaneous value) in watts.

P.—The symbol for electrical power (average value) measured in watts. See *Watt*.

PAD.—A pad is a network or connection of resistors placed between two circuits or two parts of a circuit for the purpose of reducing the amount of energy transferred from one to the other. The pad, also called an attenuation network, generally includes resistors in series with and others in parallel with the two sides of a circuit.

PANEL.—A vertical sheet of metal or insulation carrying controls and other parts of a radio instrument. A sub-panel is a horizontal support for units and wiring.

PAPER.—Used as an insulator, paper has the disadvantage of a liking for moisture, which it retains unless especially dried and treated with oils and waxes. Dry paper is an excellent insulator, withstanding from 100 to 250 volts per thousandth of an inch thickness. Moist paper is a conductor, though a poor one. The dielectric constant of insulating paper before treatment is between 1.6 and 2.5.

Paper that has been treated with oils or paraffin wax has its dielectric strength raised to between 400 and 600 volts per thousandth of an inch thickness and its dielectric constant ranges from 2.0 to 3.2.

PARAFFIN WAX.—See *Waxes, Insulating*.

PARALLEL CAPACITIES.—See *Condenser, Capacity of*.

PARALLEL CIRCUIT.—See *Circuit, Parallel*.

PARALLEL FEED AMPLIFIER.—See *Amplifier, Audio Frequency, Transformer Coupled*.

PARALLEL INDUCTANCES.—See *Inductance, Self-*.

PARALLEL RESONANCE.—See *Resonance, Parallel*.

PARALLEL-SERIES.—A circuit in which two or more parts are connected together in parallel to form parallel circuits and in which these circuits are then connected together in series so that both methods of connection appear.

PARALLEL-SERIES SWITCH.—See *Switch, Series-Parallel*.

PARAMAGNETIC.—Having the ability to become a magnet. Iron and steel are strongly paramagnetic. Nickel and cobalt have this property to a lesser degree.

P. D.—An abbreviation for potential difference. See *Potential, Difference of*.

PEAK VOLTMETER

PEAK VOLTMETER.—See *Meter, Vacuum Tube.*

PEAKED TRANSFORMER.—See *Transformer, Audio Frequency.*

PELTIER EFFECT.—The change of temperature which occurs at a joint between two dissimilar metals when there is a flow of electric current through the joint.

PENTODE TUBE.—See *Tube, Pentode.*

PERIOD.—The time which is required to complete any action. The period of an alternating current is the time required for the current to pass through one complete cycle. Periods are expressed in fractions or multiples of a second. Thus, the period of a current whose frequency is 500 per second, would be $1/500$ second.

PERMALLOY.—An alloy consisting of iron and nickel in various proportions, having a magnetic permeability which is high in comparison with ordinary kinds of iron and steel. The proportion of nickel is between forty per cent and eighty-five per cent, the remainder being iron.

The chief use of permalloy for radio work is in the cores of audio frequency transformers and in coils where high inductance is an advantage. Since inductance increases directly with increase of permeability, the use of permalloy allows more inductance with a given size of core or the same inductance with a smaller core.

The permeability of this alloy with about forty-five per cent nickel is in the neighborhood of 2,500 which is five to six times the permeability of silicon steel in the grades generally used for transformers. Still greater percentages of nickel produce a still greater degree of permeability until a maximum point is reached with slightly less than eighty per cent nickel.

Very careful heat treatment and the addition of small amounts of certain other metals will allow permeabilities as high as 100,000. When the metal has been thus conditioned it must be handled carefully because mechanical shock will destroy the effect of the heat treatment and lower the permeability. These alloys suffer saturation with comparatively small currents and there is little advantage in their use unless the magnetizing forces are small.

The effect of continuous or direct current through windings on permalloy cores is very pronounced. It takes but a small amount of such current to produce saturation with consequent failure to give desired results. To avoid such trouble it is customary to use parallel feed circuits for audio amplifiers which include permalloy core transformers.

PERMEABILITY.—A measure of the ease with which any material, usually iron, carries electromagnetic lines of force or flux. Permeability in magnetism is similar to conductivity in considering electric currents. The permeability of a material is the ratio of the number of lines of force it carries with a certain magnetomotive force or certain number of ampere-turns to the number of lines carried by air with the same magnetomotive force in effect.

The permeability of the iron or steel used in transformers may be 4000 or even higher, that is, this iron will carry four thousand or more times the

PERMITTANCE

number of magnetic lines of force that would be carried by air under the same conditions.

See also *Iron and Steel*.

PERMITTANCE.—The capacity of a condenser is called the condenser's permittance.

PHANOTRON.—See *Tube, Phanotron*.

PHASE.—A fraction representing the portion of a cycle through which an alternating current has progressed since passing through a zero position.

Phase is measured in electrical degrees, of which a full cycle contains 360 and an alternation 180. Phase may be measured in the number of electrical degrees that a wave has progressed from zero. Two waves which start from zero at the same time, rise together and reach maximum at the same time, then fall together to

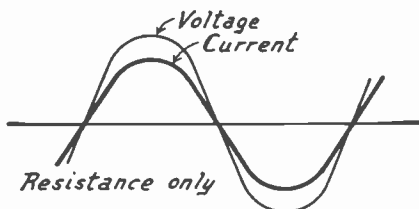

FIG. 1.—Current and Voltage in Phase.

zero are said to be in phase with each other. If the maximum points do not come together in time or electrical degrees, the two waves are said to be out of phase.

Phase relations between voltage and current are generally shown by curves which represent the rise and fall of both values. When one value passes through the maximum point after the other, it is said to lag; and if it passes through maximum first, it is said to lead. If the current passes through

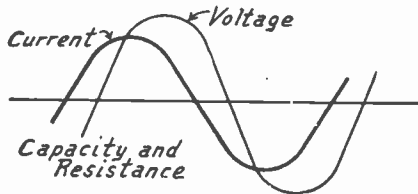

FIG. 2.—Current Leading Voltage.

maximum before the voltage passes through maximum, it is said to be a leading current and if it passes through maximum after the voltage has done so, it is said to be a lagging current.

If a circuit contains resistance only, no inductance and no capacity, the current that is caused to flow will be in phase with the voltage that causes the flow as in Fig. 1.

If the circuit has capacity in series with the resistance, but no inductance, the current leads the voltage impressed on the circuit as in Fig. 2.

PHASE ANGLE, DIFFERENCE OF

If the circuit has inductance in series with its resistance, but no capacity, the current lags behind the voltage as in Fig. 3.

If the circuit has inductance, capacity and resistance, all in series, the current may either lead, lag or be in phase. Which condition actually exists depends on the relative values of inductance and capacity in the circuit. If the inductive reactance is greater than the capacitive reactance, the total re-

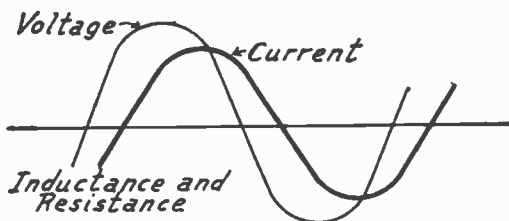

FIG. 3.—Current Lagging Behind Voltage.

actance is said to be positive and the current lags. If the capacitive reactance is the greater of the two, the total reactance is negative and the current leads the voltage. When the two reactances balance each other, only the effect of the resistance remains and the current and voltage are in phase. This last is the condition of resonance.

PHASE, RELATIONS IN TRANSFORMER.—In a transformer having its coils or windings magnetically coupled the phase relations are as follows:

The voltage in the secondary winding is opposite in phase or is 180 degrees out of phase with the voltage in the primary winding. As the primary voltage rises from zero to its positive maximum value the secondary voltage is falling from zero to its negative maximum value. This is true in both iron-core and air-core transformers.

Therefore, when two tubes are coupled through a transformer the grid voltage of the secondary circuit will be opposite in polarity to the plate voltage in the primary circuit. As the primary voltage is becoming more strongly positive, the secondary voltage is becoming more strongly negative, and when the primary or plate voltage has arrived at its maximum positive value, the secondary or grid voltage for the following tube has reached its maximum negative value.

On the page following are shown three curves indicating the phase relations between primary current, primary voltage and secondary voltage in a transformer.

PHASE, RELATIONS IN TUBE.—The relations between rise and fall of grid voltage, plate current and plate voltage in a vacuum tube are as follows:

As the grid voltage rises the plate current rises with it, the grid voltage and plate current being in phase. A fall of grid voltage

PHENOL COMPOUNDS

is accompanied by a corresponding fall of plate current. This is shown in the curves.

The plate circuit voltage and plate current are 180 degrees out of phase with each other. As the plate current rises the voltage in the plate circuit falls proportionately and as the plate current decreases the plate voltage rises.

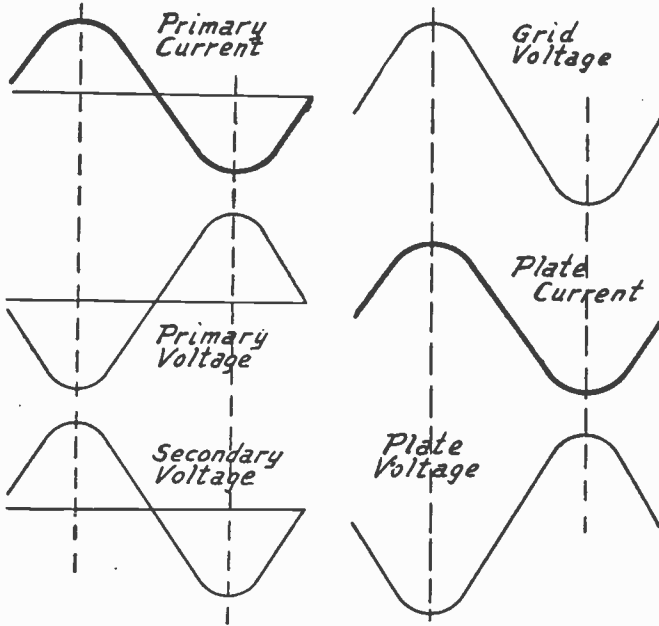

Phase Relations in Transformer.

Phase Relations in a Tube.

From the foregoing it may be seen that the grid voltage and plate voltage are 180 degrees out of phase with each other. The grid voltage and plate current are in phase, but the plate voltage is out of phase with the plate current; therefore, the grid voltage and plate voltage pass through opposite polarities at any one time.

PHASE-SHIFT CONTROL.—See *Tube, Gas-filled, Phase-shift Control.*

PHENOL COMPOUNDS.—Much of the insulation used in radio work is of the phenol compound type. This class includes Bakelite, Formica, Condensite, Celoron, Micarta, Redmanol, Phenolite, etc. All are products of phenol and formaldehyde. Phenol has a characteristic odor like carbolic acid or creosote. It is secured from the distillation of substances such as coal, wood and organic materials of various kinds. Under the action of heat the phenol and formaldehyde form a kind of resin which, at this stage, may be dissolved with acetone or alcohol to form a varnish.

PHENOLITE

The resin may be further treated with heat and pressure in moulds to form moulded insulation parts of almost any desired shape. Metal parts may be inserted into the mould and will be mounted securely in the finished articles. Filling materials such as asbestos, mica and wood flour are added to the resin before moulding and any desired color may be had from dyes. The powder which results from the mixing is placed in the moulds and pressure of about one ton per square inch is used together with about 350 degrees of heat. A few minutes of this treatment causes the final chemical changes with result in a strong, solid piece of insulating material.

Laminated types of insulation are made by applying a phenol binder to sheets of paper, fibre, canvas and asbestos which are built up into panels or slabs of the desired thickness. The binder is the varnish formed by dissolving the resin with alcohol or acetone. After the sheets which form the base are impregnated with the varnish they are subjected to heat and pressure. This drives off the solvents and completes the chemical changes which end with a solid laminated piece of insulation.

Among the principal advantages of the phenol compounds are uniformity of the products, exceedingly high resistivity, good appearance, mechanical strength and durability, and resistance to the effects of heat, moisture and acids to a satisfactory degree. A test on a laminated panel three-eighths inch thick showed no permanent set or distortion under a four hundred pound load applied for twenty-four hours between supports twenty-two inches apart. The panel used was eighteen by twenty-four inches. No such strain is ever imposed in receiver construction.

All of the phenol compounds may be cut, turned, drilled and threaded satisfactorily with ordinary machine tools. These materials dull the tools more quickly than mild steels.

The phase angle difference of phenol compounds ranges between one and one-half and four degrees. This is considerably greater than the phase angle of hard rubber which averages around one-half of one degree. The dielectric constants of moulded phenol compounds run from 5.0 to 7.5 while the constants of the laminated materials run from 4.5 to 6.0. The dielectric strength in volts per thousandth of an inch runs between 650 and 1200 volts for the laminated materials and between 225 and 1000 volts for the moulded types. The electrical losses increase slightly with increase of frequency and the resistivity decreases with increase of frequency.

None of the phenol compounds are readily inflammable and they will withstand continuously a temperature of 300 degrees Fahrenheit. Long continued heating at high temperatures tends to drive off some of the remaining volatile substances and when cooled the material may shrink with danger of splitting.

PHENOLITE.—See *Phenol Compounds*.

PHONE, HEAD.—A headphone is a device which changes rise and fall of current in a circuit into sound waves. The ordinary headphone is very similar in construction to the receiver of a telephone. Each headphone unit consists of an electromagnet near the poles of which a diaphragm of thin and flexible metal is placed. There is a minute air gap between the end of the magnet core and the surface of the diaphragm and the magnetic attraction of the electromagnet acts through this gap to move the diaphragm in pro-

PHONE, HEAD

portion to the strength of currents flowing through the magnet winding. This movement of the diaphragm produces sound waves.

The electromagnet is composed of a permanent magnet with soft iron pole pieces carrying windings of very fine wire, enamelled or silk covered. The magnet is carried in a cylindrical case of metal or of insulating material. The diaphragm is a circular piece of thin metal and it fits over the rim of the case so that its surface is held just the right distance from the pole pieces of the magnet. The diaphragm is locked in place by the rim of the phone which usually screws in place.

Two of these phone units are generally used together, being connected in series to increase their resistance and to force all of the current through both sets of magnets. The sensitivity of the phones is proportional to the number of turns of wire in the windings and the number of amperes flowing through them, the product of the two forming the ampere-turns, a direct measure of magnetic strength.

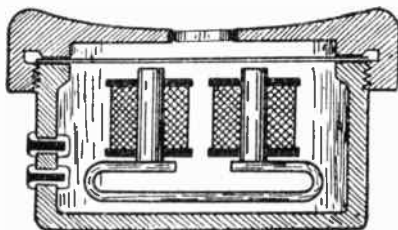

Construction of Headphone Unit.

Granting that the construction of a headphone unit is electrically correct and that a high quality of wire is used, the higher the resistance the greater the sensitivity. High grade units have resistances in excess of 1000 ohms. The sensitivity of such an arrangement may be realized when it is known that it will produce sound with far less than a millionth part of an ampere of current flow.

PHONE, HEAD, CONNECTIONS FOR.—See *Jacks and Switches, Uses of.*

PHONE JACK.—See *Jacks and Jack Switches.*

PHONE PLUG.—See *Jacks and Jack Switches.*

PHONOGRAPH.—The phonograph is a reproducer of sound and consists of a record of sound frequencies formed by undulations in a spiral groove on the surface of a disc of moulded material, also of a device called the pickup which translates the waves of the groove into variations of voltage corresponding to sound frequencies. The thin, flat disc, or record, is supported and revolved under the pickup by a turntable driven from an electric motor or any other motive power.

The pickup head carries a thin, sharply pointed needle with the needle's point resting in the groove of the revolving record as shown in Fig. 1. The head is mounted on the end of a pickup arm which is pivoted to allow movement of the head and needle across the record. Fig. 2 shows an enlarged view of the record groove as it appears when not modulated with sound, also a view of the pointed end of the needle resting in the groove.

PHONOGRAPH

Sound modulation of the needle groove is shown by Fig. 3. The sound frequency is proportional to the length of the undulations of the groove and to the velocity at which the record travels past the needle point. Sound intensity is proportional to the amplitude of the undulations or to the amount by which the groove swings away from the average curvature.

The Record.—Records for home reproduction are standard in 10-inch and 12-inch outside diameters. In the types commonly used these records should be operated at 78 revolutions per minute. The velocity of the groove past the needle averages 157 feet per minute in a 12-inch record, varying from a speed of about 80 feet per minute on the inner groove to about 230 feet per minute on the outside groove. Records for theatre work are of greater diameter and are driven at $33 \frac{1}{3}$ revolutions per minute. On a 16-inch record the velocity varies from 67.5 to 137.3 feet per minute, averaging about 137 feet. Home records are played from the outer to the inner grooves, while theatre records are started at the inner groove and finish on the outer groove. A

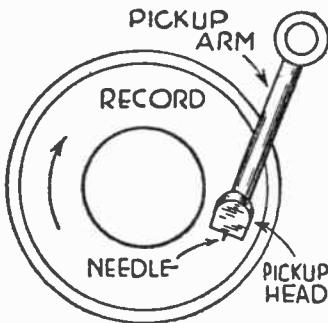

FIG. 1.—Parts of Phonograph.

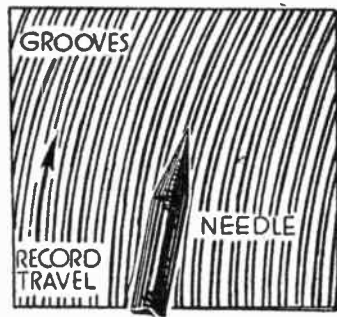

FIG. 2.—Unmodulated Record Grooves.

new needle started on the inner groove or low velocity groove is able to follow the shorter undulations and when worn (toward the outer grooves) the needle is called upon to handle the less difficult longer undulations. Home records of the "long playing" type are made for operation at low speeds.

A cross section through several grooves of a record is shown in Fig. 4. The groove width is 0.006 inch and the spacing between edges of adjacent grooves is 0.004 inch. Thus the maximum amplitude or swing of the groove cannot be more than 0.002 inch in each direction. Any greater modulation would result in one groove cutting over into the one next to it. The depth of the groove is only about 0.0025 inch, and a pressure of four to five ounces is required on the needle to keep it down in the groove and avoid danger of jumping.

Frequency Response of Records.—Sound frequencies from 50 to 5000 cycles are impressed on phonograph records. The maximum possible amplitude of needle swing is 0.002 inch, because of groove spacing, and for frequencies below 250 cycles

PHONOGRAPH

this amplitude is not great enough to allow a power output comparable with that secured at higher frequencies. Consequently, there is a drop of output in direct proportion to frequency below 250 cycles.

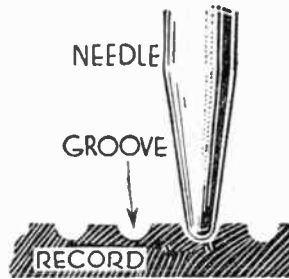
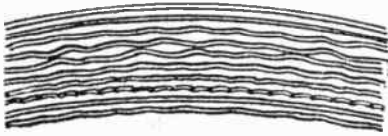

FIG. 3.—Sound Modulated Grooves. FIG. 4.—Cross Section of Record.

From 250 cycles up to nearly 4000 cycles the power output of the record remains practically unchanged. But at still higher frequencies the variations in the groove become so small in proportion to the size of the needle point that the needle cannot follow them. The indentions in the sides of the groove are smaller than the diameter of the needle point and the point cannot sink into them. This causes a rapid falling off in output with increase of frequency above about 4000 cycles. Average record output is represented by the curve in Fig. 5.

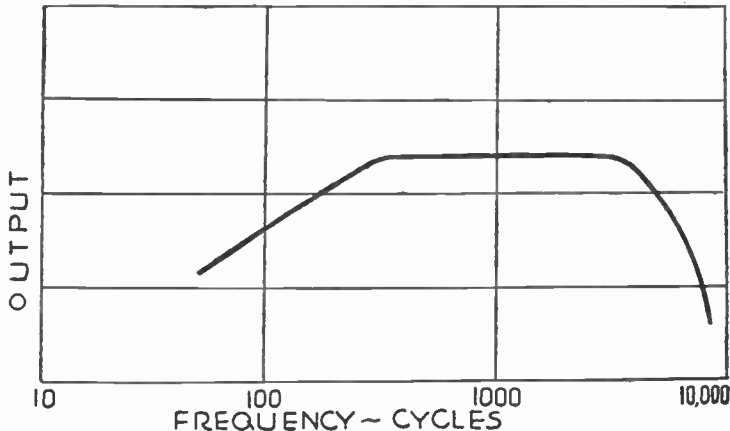

FIG. 5.—Effect of Frequency on Power Output of Record.

The Pickup.—The undulations of the record groove cause the needle to swing from side to side as indicated in Fig. 6. The mass or weight of the head gives it considerable inertia and causes the main body of the head to remain practically stationary while

PHONOGRAPH

the needle and the parts connected to it within the head move in unison with the waves in the groove. This needle movement is translated into corresponding variations of voltage and current.

Innumerable designs of pickup are employed. The operation of one of the most common types may be understood from Fig. 7, this being an electromagnetic pickup of the rocking armature or balanced armature type, sometimes called a four-pole pickup. With movement of the needle toward the left, the lower end of the armature is brought closer to the lower positive pole and the upper end of the armature closer to the upper negative pole of the permanent magnet. Magnetic flux then travels upward through the armature. Movement of the needle to the left brings the armature close to the lower negative pole and to the upper positive pole, flux then traveling downward through the armature. The armature is surrounded by a winding of many turns of fine wire and the changing flux induces corresponding voltages in this winding. The winding is connected to outside circuits in which the pickup voltage is amplified.

One classification of pickups divides them into high impedance types and low impedance types. High impedance pickups have coils with direct cur-

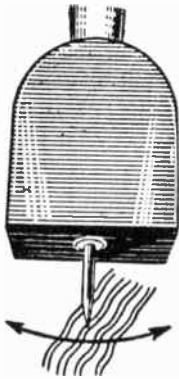

FIG. 6.—Sidewise Motion of Needle Point.

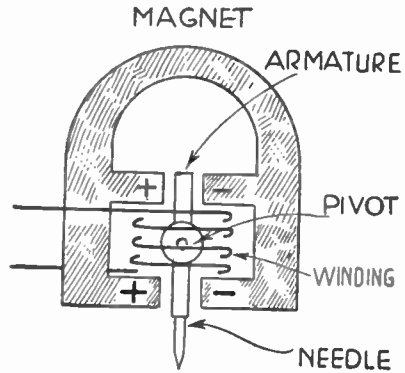

FIG. 7.—Balanced Armature Type of Electromagnetic Pickup.

rent resistances between 1,000 and 2,000 ohms while low impedance units have resistances of 100 to 200 ohms. Since the windings possess inductance they have inductive reactances which increase with increase of frequency. The increase of reactance and of A. C. resistance of a typical high impedance pickup is shown in Fig. 8.

Voltage Output of Pickups.—The voltage output of various types and makes of pickups varies within wide limits. Measurement of several units shows that the average output at 250 cycles is about 0.75 volt, that the output immediately falls to about 0.50 volt with increase of frequency and remains there up to somewhere around 3000 cycles, then falls gradually to about 0.30 volt at 4000 cycles which is the practical upper limit of reproduction for phonograph work. Many pickups have voltage outputs three or four times as great as the values mentioned, while others have outputs little more than one-tenth as great as the average.

PHONOGRAPH

The voltage output determines the amount of amplification which must be used with a pickup. Outputs of 0.50 volt and upward generally give satisfactory performance with ordinary two-stage audio frequency amplifiers.

The voltage output is lessened by the use of half-tone and soft-tone needles. A fibre needle reduces the output at all frequencies above about 1,000 cycles because the needle gives or flexes and does not transmit the full motion from the record groove to the armature. Worn needles will reduce the voltage output at all the higher frequencies.

Low frequency output is improved by giving the pickup head comparatively great weight and inertia so that movement of the needle causes movement of the armature alone rather than of the entire head, but at the lowest frequencies a portion of the needle swing always is transferred to the body of the head. The weight in most heads and arms is greater than that needed for the few ounces of pressure required on the needle

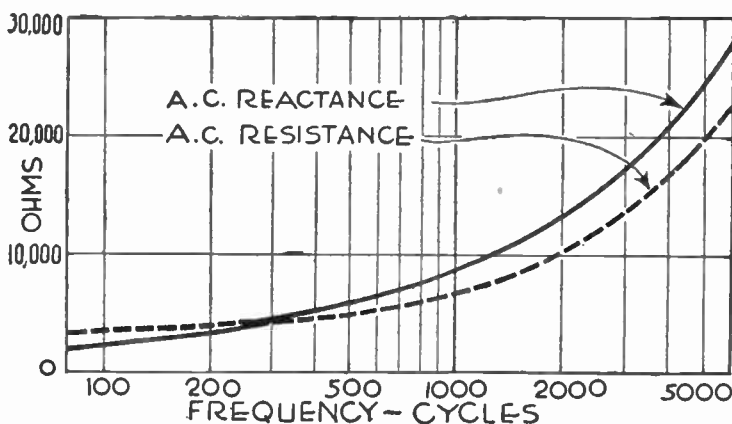

FIG. 8.—Effect of Frequency on Impedance of Pickup.

and the excess weight is counterbalanced to remove its effect from the needle.

Resonance in Pickups.—The graph in Fig. 9 represents the general characteristics of phonograph record and pickup systems in their voltage output at various frequencies. The drops in voltage below 250 cycles and above 4000 cycles are due to the limitations of the record as indicated in Fig. 5. The peak in the upper frequencies is caused by mechanical resonance of the armature structure in the pickup. The exact frequency at which this peak occurs varies with different units, and generally occurs around 3000 to 3500 cycles. Any vibrating mechanical system, such as the needle and armature, is mechanically resonant at some natural frequency depending on the stiffness and on the mass of the parts. Vibration at this frequency is very energetic and is far greater than would otherwise occur with the power applied.

PHONOGRAPH

Movement of the needle and armature at the resonance peak is reduced by means of damping applied to the armature. This damping generally is applied by the use of soft rubber buffers or stops at one end of the armature or around the pivot for the armature. Certain types of pickups employ other forms of damping, such as that furnished by a quantity of oil around some of the moving parts.

All ordinary methods of damping reduce the high frequencies more than the low frequencies, but all methods affect all frequencies to a greater or less extent. It is the damping that causes the fall of voltage output in Fig. 9 at frequencies just below that of resonance. A minimum amount of mechanical damping is applied to the more modern pickups in order to allow improved response at low frequencies. This allows a still higher amplitude at resonance, but this effect may be reduced by suitable filtering between the pickup and the amplifier. Excessive damping damages the record by forcing the whole head to swing, throwing the weight of the head against the sides of the groove and cutting away the record very rapidly.

Needle Scratch.—The roughness which exists on the surface of every record causes a slight movement of the needle and

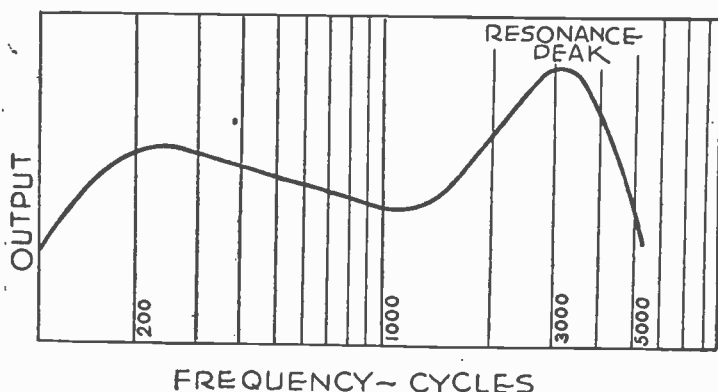

Fig. 9.—Output of Record and Pickup Working Together.

this results in an audible sound commonly called needle scratch. A worn record is very bad in this respect and sometimes the noise is noticeable even during the first playing of a new record. There is some needle scratch noise from all records. This noise occurs between the frequencies of 3500 and 4500 cycles, where various high notes and harmonics of lower ones also are present in the record. Filtering to remove the needle scratch thus inevitably removes some of the desired recorded frequencies as well.

Needle scratch sometimes is reduced by placing a fixed resistor or a fixed bypassing condenser across the output of the pickup, either of these methods reducing the voltage output at high frequencies. The preferred method is that of placing a tuned scratch filter between the pickup terminals as shown in Fig. 10. This filter consists of a choke coil and a condenser in series. The values of inductance and capacity are chosen to produce resonance at the scratch frequency, generally at about 4,000 cycles. The impedance of

PHONOGRAPH

the choke-condenser combination then is minimum at the tuned frequency and the scratch voltages are bypassed and kept out of the amplifier. It may be desirable to broaden the tuning of the filter by adding a resistor in series with the choke and condenser.

Combinations of inductance and capacity tuning at 4,000 cycles may be found by selecting either an available inductance (in henrys) or an available capacity (in microfarads), then dividing the number 0.00158 by either the inductance or the capacity, the quotient being the value of the other unit for the filter. For example, if it is desired to use a condenser of 0.01

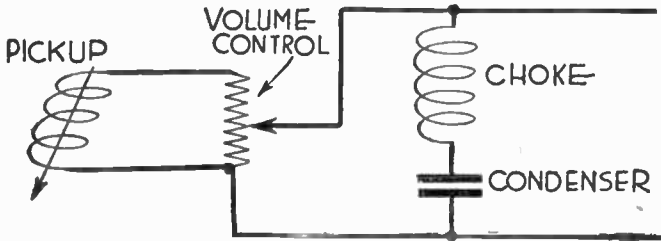

FIG. 10.—Connections for Scratch Filter.

mfd. capacity this number (0.01) is divided into 0.00158 which gives 0.158 henry as the required value of inductance. Since the scratch is not confined to one frequency it is satisfactory to use approximate values of inductance or capacity, in this case an inductance of 0.15 henry being entirely suitable.

Volume Control.—The usual forms of volume control for phonograph pickups are shown in Fig. 11. This consists of a potentiometer having from 100,000 to 250,000 ohms resistance connected either across the pickup or across the output of a coupling transformer used with the pickup. The subject of volume control for pickups is treated in detail under *Volume, Control of*.

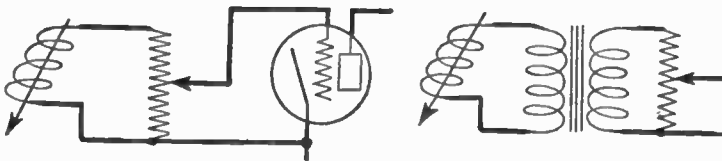

FIG. 11.—Volume Controls for Phonograph Pickups.

If the pickup is used with an audio frequency amplifier in which there is incorporated a volume control, as with some radio receivers, then it becomes possible to use the amplifier volume control for phonograph reproduction. But if the receiver volume control operates only on the radio frequency amplifier, as often is the case, then a separate control must be fitted to the pickup.

PHOTOCELL

PHOTOCELL.—See *Cell, Photoelectric.*

PHOTOCELL, BARRIER LAYER.—See *Cell, Photovoltaic.*

PHOTOCONDUCTIVE CELL.—See *Cell, Photoconductive.*

PHOTOEMISSIVE CELL.—See *Cell, Photoemissive.*

PHOTOTUBE.—See *Cell, Photoemissive.*

PICKUP, ELECTRIC.—See *Phonograph.*

PICTURES, SOUND.—See *Sound Pictures.*

PIGTAIL.—A pigtail is a flexible conductor placed between two parts which are to have relative motion while remaining electrically connected.

The purpose of a pigtail connection is to avoid the rather high and very uncertain resistance of connections made through bearings and sliding contacts. A pigtail formed into a small coil, as is usually done, has practically no inductance perceptible in the action of broadcast tuning units.

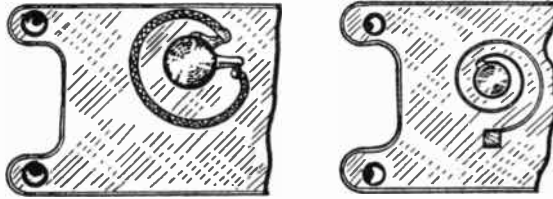

Pigtail Connections for Rotor Shafts.

PITCH.—The frequency of a tone. See *Sound.*

PLATE.—The anode element of a vacuum tube. The element toward which electrons are attracted from the cathode, and into which electric current flows from the outside circuit. See *Tube, Action of.*

PLATE BATTERY.—A battery furnishing plate current. See *Battery, B.*

PLATE CIRCUIT.—See *Circuit, Plate.*

PLATE CIRCUIT MODULATION.—See *Modulation.*

PLATE CURRENT RECTIFICATION.—One method of detection. See *Detector.*

PLATE CURRENT SUPPLY UNIT.—See *Power Unit.*

PLATE-FILAMENT CAPACITY.—See *Tube, Capacities, Internal.*

PLATE-GRID CAPACITY.—See *Tube, Capacities, Internal.*

PLATE IMPEDANCE.—See *Tube, Output Resistance and Impedance of.*

PLATE RESISTANCE.—See *Tube, Output Resistance and Impedance of.*

PLATE VARIOMETER.—A variometer used in a plate circuit. See *Variometer.*

PLIOTRON

PLIOTRON.—See *Tube, Pliotron*.

POLARITY.—Polarity in electric circuits or in electric fields refers to the relative potentials of points in the field or circuit. Of two points in an electric field, the one toward which negative electrons or other negative charges flow is of positive polarity with reference to another point from which they flow, and the point from which the negative charges flow is of negative polarity with reference to the one toward which they flow.

The same relations as to motions of charges holds in an electric circuit, although in speaking of the conventional direction of current flow, which is opposite to actual electron flow, a positive point is one away from which electricity flows, and a negative point is one toward which current flows. The earth is assumed to be of zero potential; points having an electric charge more negative than that of the earth are of negative polarity, and those whose charge is less negative (or more positive) are of positive polarity.

Magnetic polarity refers to the direction of magnetic lines of force between the poles of a magnet or through a magnetic circuit. Magnetic lines of force are assumed to flow from north to south magnetic poles, issuing from the north pole of a magnet and returning to the south pole.

POLYPHASE RECTIFIER.—See *Rectifier, Polyphase*.

POOL TUBE.—See *Tube, Pool*.

POSITIVE.—See *Polarity*.

POTENTIAL.—Potential is a characteristic or a property or positions or points in an electric field which exists between electrostatic charges or near such charges. The potential at a point in a field is a measure of the potential energy or working ability which has been acquired by a charge, such as an electron, which has had work done on it in moving it to that point. Potential is a measure also of the energy remaining in a charge which has done work, such as in overcoming resistance, as it moves to a given point in a field.

Potential is measured in volts. One volt of potential difference exists between two points in a field when one joule of work (0.737 foot-pound of work) has been done in moving one coulomb of electricity from one point to the other. When one coulomb of electricity does one joule of work in moving from one point to another in a field, it has moved through a potential difference of one volt.

Sources of electromotive force may be considered as maintaining electric charges at their terminals, and, consequently, of maintaining differences of potential. When conductors are connected between the terminals, the source maintains a difference of potential through the conductors. Although there is no electric field extending through the conductors, there are differences of potential from point to point throughout their length, and the potential at any given point is a measure of the energy possessed by electrons at that point.

POWER UNIT

POWER UNIT.—A power unit takes alternating current power from a supply line and delivers alternating and direct currents and voltages suitable for filaments, heaters, plates, screens and grids. The power unit is a built-in part of most receivers, but often is separate for large amplifiers.

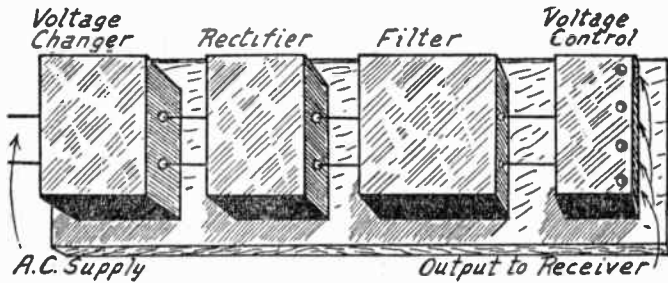

FIG. 1.—Principal Parts of All Power Units.

Divisions of the power unit, Fig. 1, include a voltage changer (transformer), one or more rectifier tubes, a filter which includes condensers and either chokes or resistors, and a voltage divider consisting of resistors and bypass condensers. The transformer

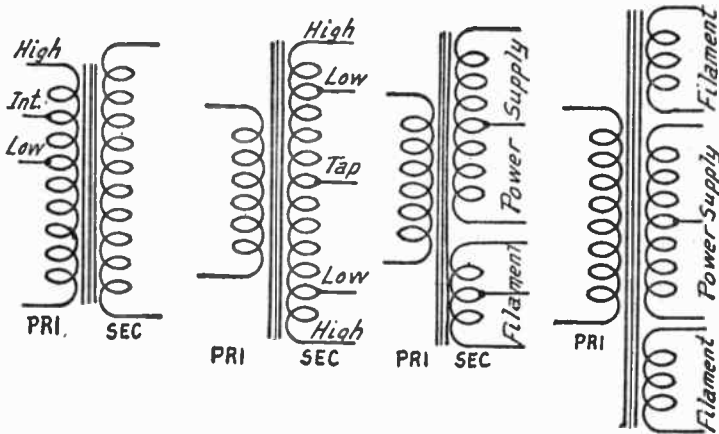

FIG. 2.—Types of Tapped Transformers for Power Units.

primary may be tapped (Fig. 2) to handle various line voltages, and the secondary tapped to furnish suitable output voltages.

Alternating current is changed to direct by one or more full-wave rectifier tubes or by two or more half-wave tubes. See *Tube*,

POWER UNIT

Rectifier Types of. For d-c filament supply two half-wave tubes of the battery charging type may be used as in Fig. 3.

A gaseous full-wave rectifier of the cold-cathode type is connected as in Fig. 4. This tube contains gas which is ionized by the applied voltage, whereupon current flows through the tube

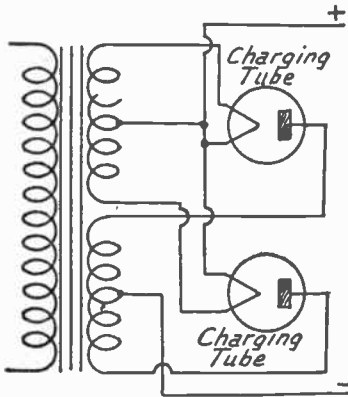

FIG. 3.—Charging Tubes Used as Filament Supply Rectifier.

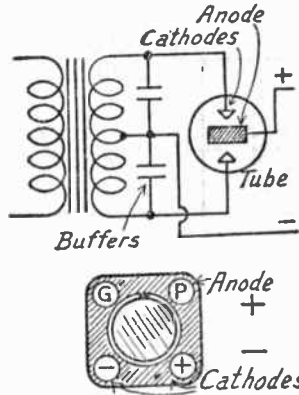

FIG. 4.—Connections for Raytheon Rectifier.

alternately from the two small cathodes to the larger anode, which is the positive terminal for the output.

Pulsating direct current from the rectifier must be filtered to provide smooth direct current for plate, screen and grid circuits. See *Filter*. A filter using two iron-core chokes and three condensers is shown in Fig. 5. The capacity of the first condenser

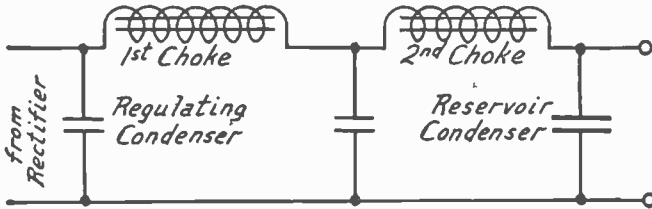

FIG. 5.—Power Unit Filter System with Three Condensers.

largely determines the voltage regulation at the output, while the other condensers act as reservoirs of energy and maintain a fairly steady flow of current through the chokes. The condensers are charged by peak voltages from the rectifier, and discharge through the chokes between alternations of voltage.

Fig. 6 shows a filter using one choke. Full-wave rectifiers re-

POWER UNIT

quire fewer or smaller chokes than do half-wave rectifier systems. Fig. 6 shows also how voltage regulator resistors drop the voltages fed to some output terminals, and how bypass condensers are connected to these terminals. Other arrangements of filter chokes and condensers are shown in Fig. 7.

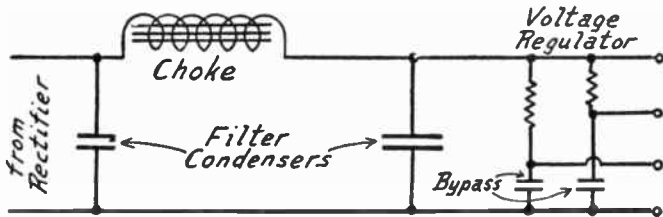

FIG. 6.—Power Unit Filter System with Single Choke.

Fig. 8 shows a choke-input filter in which there is no condenser across the rectifier output. This arrangement reduces the peak voltage on the rectifier, and eliminates a condenser from the position where it must withstand higher voltage than in other positions.

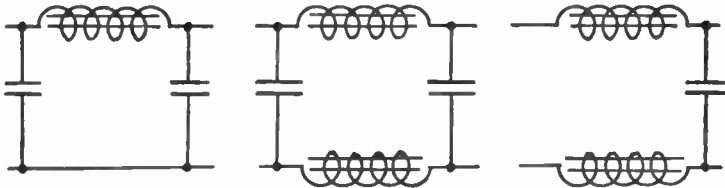

FIG. 7.—Arrangements of Power Unit Filter Condensers and Chokes.

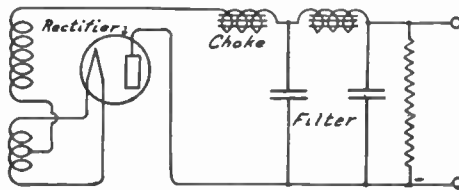

FIG. 8.—Filter with Choke Input.

Fig. 9 shows a filter system used with gaseous cold-cathode rectifier tubes. The choke has two windings on a single core, connected so that magnetic fluxes due to direct current cancel each other. Fig. 10 shows a filter having an input choke tuned to the frequency of the supply current, which retards passage of supply

PRIMARY WINDING

frequency currents as explained under *Filter, Band Exclusion Type*.

Filter condensers in power units furnishing moderately high d-c voltages usually are of the electrolytic type. Paper dielectric condensers may be used for higher voltages. Voltage regulator

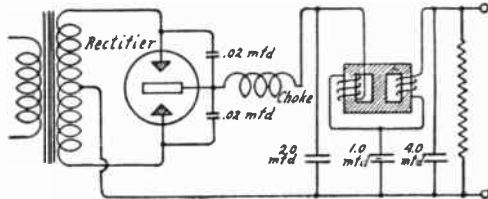

FIG. 9.—Connection of Bucking Coil Filter Choke.

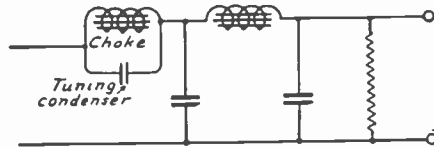

FIG. 10.—Principle of Tuned Filter.

resistors must be large enough to dissipate the power in watts generated by their current and voltage drop. Bypass condensers usually have capacities of one-half to several microfarads, depending on the general design and the need for suppressing the power line frequency.

PRIMARY WINDING.—See *Winding, Primary*.

PROTECTIVE DEVICES.—See *Fuses and Protective Devices*.

PUBLIC ADDRESS SYSTEMS.—A public address system has for its purpose the transmission, amplification and reproduction of speech and music with suitable fidelity and sufficient power to make entertainment or other intelligence available to large numbers of persons at one time. Varied combinations of essential parts go to make up the complete systems, the general idea being illustrated in Fig. 1. The principal sources include microphones for direct pickup of voice and music, phonograph and film systems for recordings of entertainment and other features, and radio receivers for obtaining whatever features may be on the air.

The sources may be used alternately or, as with microphone pickup, the outputs of several similar sources may be combined. Since the power from

PUBLIC ADDRESS SYSTEMS

any of the sources is small it must be amplified at one or more points in the system. The amplified power finally is delivered to loud speakers or reproducers. Between sources, amplifiers, controls and reproducers are transmission lines of various lengths. In the design of such systems it is convenient to commence at the reproducers and determine the requirements as to their number and power in order to furnish suitable volume and distribution of sound. The amplification and power handling ability of the remaining units then are selected to handle the reproducer load.

The power output of a phonograph pickup or of a radio receiver is quite high and requires only a moderate amplification of voltage before it is ready for the power amplifier and loud speakers. But the output from a microphone, especially one of the condenser type, and the output from the photoelectric cell of a film source will require additional amplification before they are brought up to the level of the pickup or radio receiver. This extra amplification is secured either with a small separate voltage amplifier near the microphone or photocell, or by using one or more additional stages in the regular voltage amplifier when these low power sources are in use.

Control Apparatus.—To allow control of power from the several sources in a public address system it is necessary to pro-

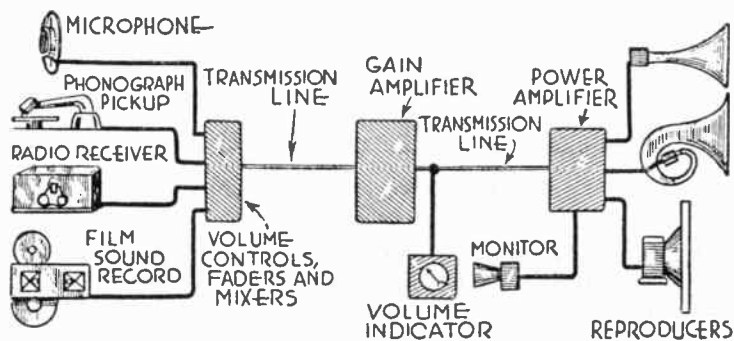

FIG. 1.—Essential Parts of Public Address System.

vide gain controls, faders, mixers, monitors, volume indicators or power level indicators, also such meters as are required for observation of voltages and currents in the different circuits.

The term gain control is simply another name for volume control or for control of signal voltage. A fader allows gradual reduction of the sound energy from one source and gradual increase of energy from another, literally allowing the sound from one source to fade away and be replaced with a different sound. A mixer allows various amounts of energy from several sources to enter one amplifier circuit at a given time, the several sound effects being blended together by the mixer. All of these devices are formed by certain combinations of units which vary the attenuation or power loss between parts of a circuit. Volume controls, faders and mixers are described under *Volume Control of*.

A monitor is a headphone, a loud speaker, or an amplifier with headphone or speaker. This unit is connected to the public address system at some convenient point so that an operator may listen to the performance and judge of its quality. A volume indicator is a vacuum tube voltmeter or any other alternating current voltmeter connected to a public address

PUBLIC ADDRESS SYSTEMS

system so that it indicates the amount of power, voltage or current existing in the circuit to which the indicator is connected. If this device is calibrated to read in watts or fractions of watts or in decibels it may be called a power level indicator. These indicators are described under *Indicator, Volume*.

Impedance Matching.—In order that there may be a minimum loss of power in transferring the signal energy from one part to the following in a public address system it is essential that the internal output impedance of each source be approximately equal to or properly matched to the input impedance of its load. When the source is the plate circuit of a tube it is necessary to consider distortion and to remember that with three-element power tubes the load impedance should be at least double the tube's plate resistance to obtain maximum undistorted power output. With all other units, such as microphones, phonograph pickups, attenuators, transmission lines and loud speakers the impedances of source and load should be matched.

Unlike impedances may be matched by making the interconnection through a transformer of suitable turns ratio or by means of an arrangement of resistances called an impedance matching network or a pad. These

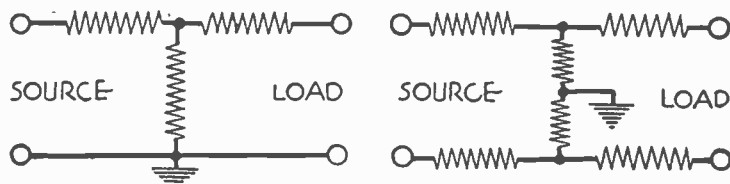

FIG. 2.—Attenuation Networks.

matching networks usually use either the T-section shown at the left in Fig. 2 or else the H-section shown at the right. The values of resistances in the arms are chosen so that the input impedance matches that of the source and the output impedance matches that of the load. Such pads are used only when it is desired to introduce a certain loss or attenuation into the circuit while maintaining correct impedance relations. When loss is to be minimized, an impedance matching transformer is used.

The use of a transformer is illustrated in Fig. 3 where it is assumed that a line of 200 ohms impedance is to be connected to a loud speaker of 2,000 ohms impedance. The required turns ratio for the transformer may be found from the formula:

$$\text{Turns Ratio} = \frac{\text{secondary turns}}{\text{primary turns}} = \sqrt{\frac{\text{impedance connected to secondary}}{\text{impedance connected to primary}}}$$

That is, the turns ratio must be equal to the square root of the ratio of the connected impedances. In the example assumed in Fig. 3 the ratio would be 3.162 to 1.0, secondary to primary. Any impedances may be matched in a similar manner. The number of turns, the inductances and the absolute values of the impedances in the transformer will depend on other factors, the impedance match being secured by selecting the correct ratio

PUBLIC ADDRESS SYSTEMS

of the number of secondary turns to the number of primary turns. Without such impedance matching there will be serious energy losses and also equally serious distortion occurring in the circuits improperly connected together.

Transmission Lines.—A transmission line cannot be considered as only a resistance. All lines, even short ones, have inductance, capacity, leakage between the conductors, and ohmic resistance. A line may be looked upon as made up of the elements indicated in Fig. 4, all of them being distributed more or less

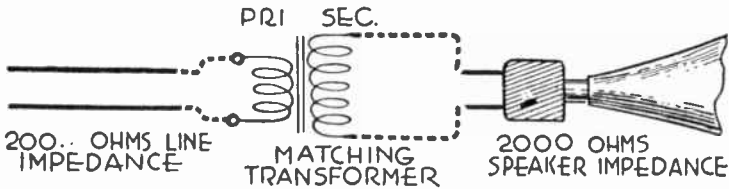

FIG. 3.—Impedance Matching Transformer.

evenly along the length of the line. The ohmic resistance in the wires forming the two sides of the line is in series with the line, as is likewise the inductance. The capacity between the conductors forming the two sides of the line is in parallel with the line. The leakage or conductance through the insulation from one conductor to the other is represented by a resistance in parallel.

Such a structure as shown in Fig. 4 must have impedance to alternating or fluctuating currents such as those in sound signals, and it is just as necessary to match the line impedance with the impedances of connected

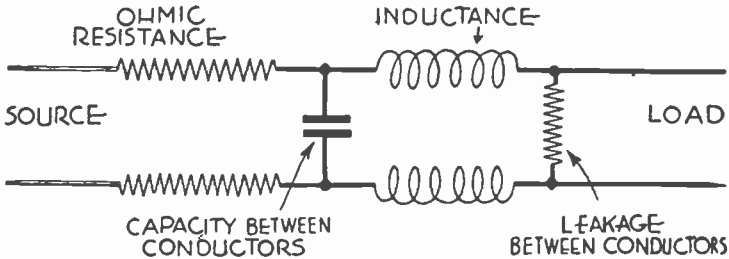

FIG. 4.—Electrical Elements of Transmission Line.

devices as to make such a match between other units in a system. The impedance of a line changes with change of frequency, but so does the impedance of connected apparatus. The impedances of line and of connected apparatus may be matched at some frequency near the middle of the range of frequencies to be handled and the match will remain satisfactory under usual conditions with all frequency changes regularly encountered. The average frequency should be assumed as being between 1,000 and 1,100 cycles, or an average may be used of measurements at 800 cycles and at 1,500 cycles.

PUBLIC ADDRESS SYSTEMS

When making calculations or measurements for matching it is the characteristic impedance or iterative impedance of the line which is considered. This impedance is based on the assumption that the line is of similar construction throughout its length and that any given length of line is similar to any other equal length in electrical qualities. The characteristic or iterative impedance remains the same regardless of line length. That is, such impedance of a line is the same for a hundred feet as for a thousand feet of the same line. This does not mean that the loss or attenuation does not change with line length because the loss factor is proportional to line resistance, and resistance increases with length.

A very close approximation of iterative impedance may be had by measuring the impedance with the far ends of the line open circuited and again with the far ends short circuited, then taking the geometric mean of these impedances. The geometric mean is equal to the square root of the product of two quantities. The impedance of the open circuited line is approximately equal to the capacity reactance of the conductors at the working frequency, so if the capacitance is measured the reactance may be easily calculated. With the far ends of the line short circuited the impedance is practically equal to the resistance of the two sides of the line, and this resistance may be measured quite easily.

As an illustration of this method it may be assumed that a line's capacity is measured as 0.0013 microfarad and its resistance as 1.8 ohms. Then the capacitive reactance at a frequency of 1,000 cycles will be about 122,400 ohms (*see Reactance*). Multiplying this number by the number of ohms (1.8) gives 220,320 and the square root of this latter number is very close to 469 which will be found approximately the value of the iterative impedance in ohms. The length of the line does not enter into this calculation.

Line impedances commonly employed for transmission work are 50, 200, 500 and 600 ohms. The line for which the impedance just was calculated would come in the 500-ohm classification. In a low impedance line the current is large in relation to the voltage, while a high impedance line is one having relatively high voltage and small current. Disturbances and interference of all kinds have less effect in low impedance lines than in those of high impedance, and in the low impedance or low voltage line there is a smaller loss due to leakage.

Public address transmission lines may be run with standard telephone cable of number 19 gauge, lead sheathed, with the sheathing grounded, or they may be of pairs of number 18 stranded wire, insulated and covered with spirally wound soft steel covering which is grounded. Between a local amplifier and the loud speaker or speakers fed by it the wire may be standard "BX" or Greenfield with a spiral metal covering. Wiring for batteries, generators, switchboards and all fixed parts must be installed in strict accordance with the regulations of the National Board of Fire Underwriters as contained in the National Electrical Code. Two to four pairs may be enclosed in a single iron conduit where the runs are not longer than 40 to 50 feet. Greater lengths might be subject to cross talk.

Line Equalizers.—Because a transmission line contains capacitance and inductance it forms a tuned circuit in which there may be resonance at one or more of the frequencies to be transmitted. Some frequencies may be unduly attenuated or weakened while others are over-emphasized. To compensate for line resonance it is customary to add line equalizing circuits and without the process of equalizing even the best of equipment may give most unsatisfactory performance.

The first steps toward equalizing are a determination of the frequencies which are under- or over-emphasized and a measurement of the extent or amplitude of the errors. This work is handled with a circuit of the general

PUBLIC ADDRESS SYSTEMS

type shown in Fig. 5. At the left is any convenient source for voltage at various frequencies. This may be any form of audio oscillator such as one of the beat frequency type, or else it may be a phonograph pickup operating with frequency records. Next comes an amplifier which steps up the output of the source to a value suitable for feeding into the transmission line and the load. The output of the amplifier is measured by any suitable type of high frequency voltmeter such as a vacuum tube voltmeter or a volume indicator. The compensating circuits or equalizer later on will follow the amplifier at any point along the transmission line. At the far end of the line, connected near the normal load, is a second voltmeter.

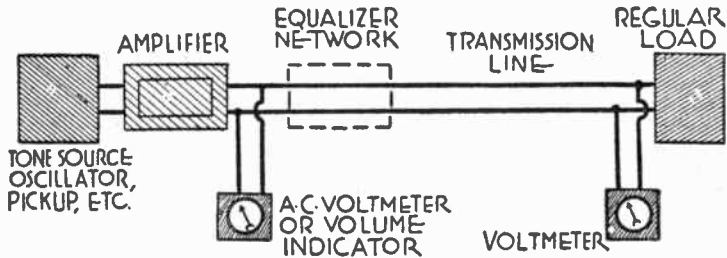

FIG. 5.—Making Measurements for Line Equalizing.

Tone frequencies separated by small steps now are fed into the transmission line and by taking readings of the left hand voltmeter the input is held as nearly constant as is possible, any deviation from a selected level being noted. As each frequency at a known amplitude is fed into the line the voltage at the load is noted by means of the right hand voltmeter. Any excessively high or low voltages at the output indicate points of resonance or of excessive attenuation at certain frequencies. Peaks of voltage usually are reduced by the circuit shown at the left in Fig. 6 in which the inductance and capacity are tuned at the frequency to be corrected and in which the bypassing effect of this resonant circuit is controlled by the adjustable

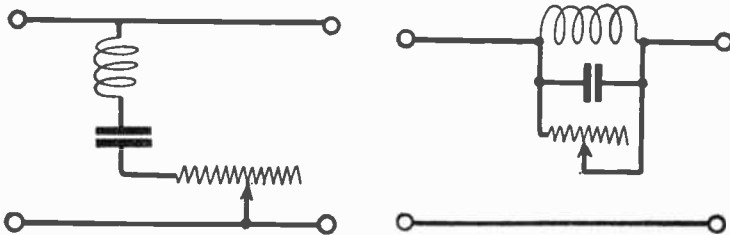

FIG. 6.—Filters for Reduction of Resonance Peaks.

resistance. The circuit at the right hand side of Fig. 6 may be used in a similar manner, the effect here being to offer maximum reactance at the frequency to be corrected.

Points of low voltage may be raised, or certain frequencies may be emphasized to some extent with the equalizer circuits shown in Fig. 7. That at the right places a parallel resonant circuit across the line and that at the left places a series resonant circuit in one line. Either circuit is tuned to the frequency to be accentuated and its effect is controlled by varying the adjustable resistance. The right hand circuit serves to attenuate all

PUBLIC ADDRESS SYSTEMS

other frequencies while increasing the amplitude at the tuned frequency.

If the response is too strong at the entire high frequency end it is possible to reduce it to more nearly match low and intermediate frequencies by the use of a low pass filter as at the left in Fig. 8, which attenuates the highs. Should it be desired to reduce the low frequency response it may be done with a high pass filter as at the right in Fig. 8. These circuits are inherently broad in their tuning.

Loud Speakers or Projectors.—Many factors enter into a determination of the power in watts at the loud speakers which

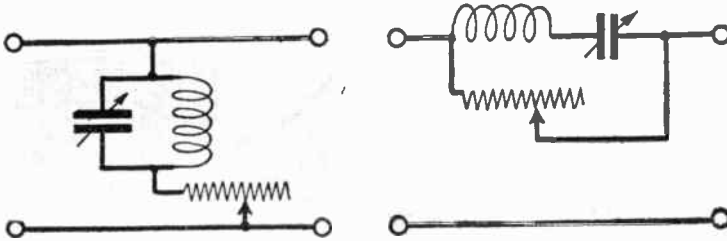

FIG. 7.—Filters for Emphasizing Certain Frequencies.

will produce the desired volume of sound. The power which will be necessary in any particular case depends on the number of listeners to be served, on the size of the room or outdoor area to be covered and especially on the architecture and furnishings with indoor work and on the character of the surroundings in outdoor work. No hard and fast rules can be given for the solution of all problems.

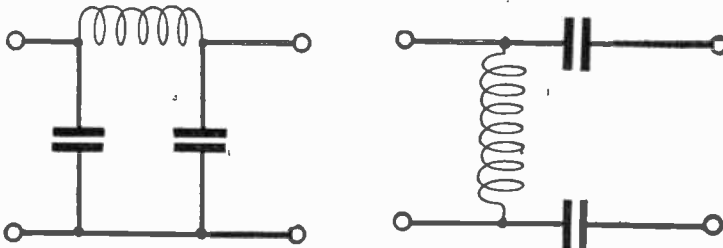

FIG. 8.—High Frequency Reduction (left) and Low Frequency Reduction (right).

Most of the loud speakers used in public address work contain units of the electrodynamic type fitted to projectors or horns of the enclosed air column type similar to those in Fig. 9. The type at the left has a long air column and a large opening, delivering sound for considerable distance in front of the horn and over an arc about forty degrees wide, twenty degrees each side of the center line. The trumpets shown at the center of Fig. 9 have the longest projection and the narrowest distribution, a single trumpet covering an angle of no more than thirty degrees. With sufficient power input this style of horn may have a range of two to three miles. At the right in Fig. 9 is a short projector covering a very wide arc, sixty degrees or more, but on account of this great diffusion there is only a

PUBLIC ADDRESS SYSTEMS

moderate coverage for distance. The form of the area to be covered determines the type or types of projector to be used, also the number of projectors and their location.

For comparatively small rooms and for coverage of small outdoor areas the magnetic type of loud speaker unit sometimes is used. This unit may be used effectively with trumpet projectors and with coiled air columns. Magnetic units of ordinary construction require only about one-fourth



FIG. 9.—Projectors Used for Public Address Work.

watt for full volume but special public address units of the magnetic type may take as high as two watts. The usual small electrodynamic unit, of the style used for home entertainment, may be operated with anywhere from one to three watts of power. Electrodynamic units especially designed for public address use may be operated continuously with from six to ten watts of power in each unit. If headphones are to be used they may be figured at about 0.005 watt per pair or per headset.

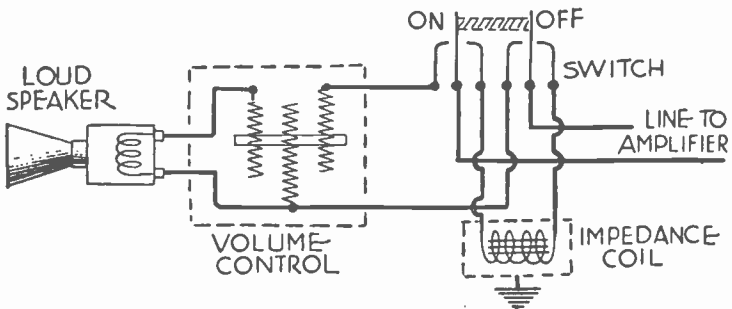

FIG. 10.—Switching and Volume Control at Loud Speaker.

If a microphone is used for the source and if the microphone is in the same room with the loud speakers it is important that the projectors be placed in such positions that there is no acoustic feedback or so that the direct sound waves from a loud speaker cannot strike the diaphragm of a microphone. Were such a thing to happen any slight disturbances in the system would be fed back to the microphone, amplified and fed to the speaker, with a regenerative effect producing singing or howling. With a phonograph

PUBLIC ADDRESS SYSTEMS

pickup or a radio receiver as the source there is no need to observe this precaution. Directional horns of the trumpet or morning glory type avoid much of the difficulty with feedback.

When two or more loud speakers are to be operated from a single amplifier, with some of the speakers out of service for part of the time, it is necessary to take special precautions against upsetting the impedance relations. One satisfactory method is shown in Fig. 10. Each speaker is provided with a volume control of the T-section type in which the impedance remains constant with changes of adjustment. Each speaker is provided also with a double-pole switch so connected that when the speaker is cut off from the amplifier it is replaced with a coil or with a fixed resistor having an impedance equal to that of the speaker movement. Thus the load on the amplifier remains constant regardless of the number of speakers in use.

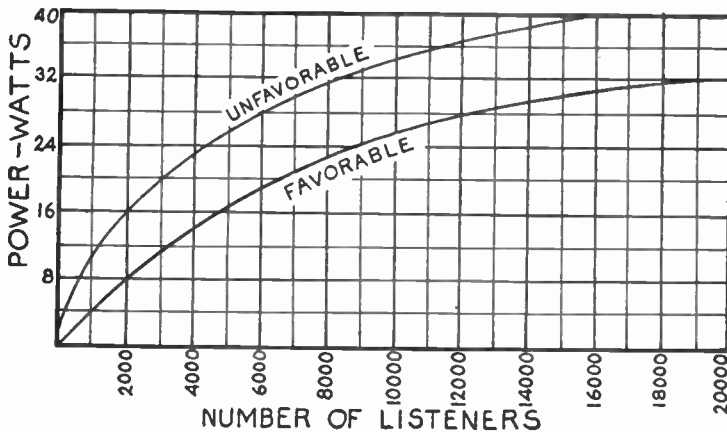

Fig. 11.—Power Requirements According to Number of Listeners.

Power Requirements.—The average amount of loud speaker power required for a given number of listeners is indicated by the curves in Fig. 11. The minimum power in watts is shown by the curve for favorable conditions and the maximum power by the curve for unfavorable conditions. Favorable conditions would be those in which the acoustic properties are good, where there is moderate absorption of sound waves and just the right amount of reverberation to allow a moderate amount of power to give good audibility throughout the area served. Unfavorable conditions would include poor acoustical qualities, excessive absorption, a great deal of extraneous noise, etc. Thus, as an example from Fig. 11, an audience of 5000 persons might be served by anywhere between 16 and 25 watts of power. See *Sound*.

PUBLIC ADDRESS SYSTEMS

The size or the cubic volume of the room affects the amount of power required. Average practice is shown by the curves of Fig. 12 which again are given for favorable and unfavorable conditions. As an example, an auditorium 60 feet wide, 100 feet long and 30 feet high, having a volume of 180,000 cubic feet, might take anywhere between 17 and 25 watts. Such a space would not seat more than 1500 people on one level, and from Fig. 11 it is seen that this number of listeners should require not more than 6 to 12 watts. The power would be determined by compromise between the number of listeners and the room volume.

Amplifiers.—The power which will be available depends on the type of power tubes used in the amplifiers, on the number of tubes and on the number of amplifiers. Power tubes may be used singly, in push-pull pairs, in paralleled pairs, or in parallel push-pull arrangements having four or more tubes in the output stage. Thus it is possible to secure any required amount of power.

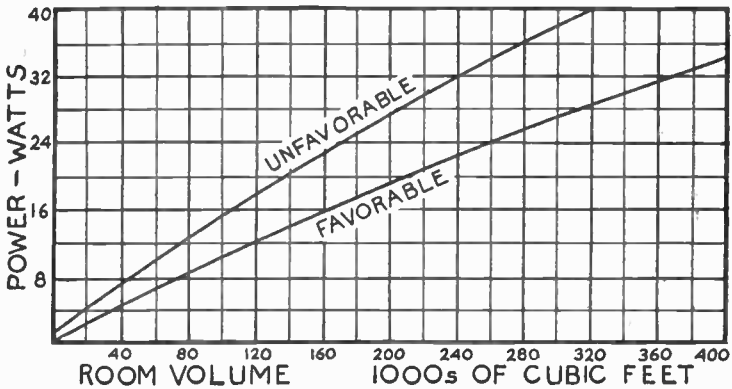

FIG. 12.—Power Requirements According to Room Volume.

Various kinds or types of tubes are used in public address amplifiers, the following being quite common :

Normal Service	Type Numbers	Amplification Factor	Maximum Power Output-Watts	Signal Volts
Receiving	245, 345, etc.	3.5	2.0	35.0
Receiving	210, 310, etc.	8.0	1.6	27.5
Receiving	250, 350, etc.	3.8	4.6	59.0
Transmitting	211, 511, etc.	12.0	10.0	39.0
Transmitting	545, 845, etc.	5.0	20.0	106.0
Transmitting	842, etc.	3.0	3.0	70.5

The maximum power output in watts may be multiplied by the number of power tubes used in the output stage. Theoretically it is possible to obtain slightly more than double the power of one tube when two similar tubes are used in a push-pull circuit, but for calculations it is advisable to figure on no more than a doubling of power.

PUBLIC ADDRESS SYSTEMS

To secure the maximum power output from any tube it is necessary that the signal applied to its grid be of a specified voltage. The foregoing table gives the effective signal voltage which will result in maximum output when all other requirements are satisfied. The voltage gain in the amplifying system must bring the original signal up to this voltage.³

A condenser microphone will deliver little more than 0.0001 volt, a double button carbon microphone not more than 0.05 volt, a phonograph pickup less than 1.0 volt, and a radio detector tube from 0.5 to 5.0 volts according to its type and the preceding radio frequency amplification. Thus it is seen that a very considerable voltage amplification must be provided in bringing the signal up to the power tube grid. As an example, taking the source as a double button microphone delivering 0.03 volt which is to operate a -50 type power tube at 59 volts on the grid, the voltage ratio is 59 to 0.03, or about 1967. This is a gain of 65.88 decibels. Public address amplifiers provide voltage gains of from 50 to 90 decibels, they commonly have from two to four stages, and they are built in a wide variety of styles giving maximum undistorted outputs of anywhere between 4 and 50 watts. The amplifier must be so designed as to operate from the selected sources (microphone, pickups, etc.) and to deliver sufficient power to handle the number and kind of loud speakers which have been found necessary for the installation.

When the source is one of very low output, such as a condenser microphone or a photocell, it is customary to have an additional amplifier of from one to three stages placed near the source. The output of this microphone amplifier or photocell amplifier then is fed into the regular gain amplifier or voltage amplifier which, in turn, feeds the power amplifier. The input to any amplifier generally is handled through a transformer and the output through another transformer. This allows the amplifier to be matched in impedance with the line or other part to which it is connected. The inter-stage coupling in these amplifiers is either of the transformer type or the resistance-capacity type in most units.

With large amplifiers for public address work the power supply often is built as a separate unit to minimize hum pickup and to facilitate service operations. The power supply includes the power transformer, the rectifiers, the filter system and sometimes the voltage dividers. Mercury vapor rectifier tubes are commonly used for amplifiers containing the larger power amplifying tubes, while the thermionic rectifiers such as the -81 type are used in power supplies for amplifiers using receiving types of power tubes. If the line power supply is direct current it becomes necessary to use a rotary converter if standard alternating current amplifying units are to be employed. In the more elaborate public address installations there may be separate power supply units for the gain amplifier and for the power amplifier, and even a third supply for the amplifying tubes in associated apparatus.

Maintenance of amplifying equipment requires periodical checking of some of the circuits. This is especially necessary with tube plate circuits and with microphone circuits. To allow such a check each individual plate lead may be passed through a closed circuit jack and a similar jack may be placed in any other line of which the current is to be measured. One or more milliammeters having suitable ranges then are mounted conveniently on one of the panels and fitted with long, flexible cords terminating in plugs.

PUSH-PULL AMPLIFIER.— See *Amplifier, Audio Frequency, Push-pull Type.*

Q

Q-FACTOR.—The Q of a resonant circuit is the ratio of the reactance to the high-frequency resistance of the circuit. Since most of the high-frequency resistance of such a circuit is in the inductance coil it is the Q of the coil that usually is of most interest. The Q of the coil is the ratio of its inductive reactance to its high-frequency resistance. Most of this resistance is due to skin effect.

During an oscillation there is storage of energy in the magnetic field formed around the coil, and this energy is proportional to the inductive reactance of the coil. The energy that is dissipated during an oscillation is proportional to the high-frequency resistance of the coil. Therefore, the Q of the coil may be said to be the ratio of energy stored to energy dissipated. The Q of any given coil remains practically constant throughout a wide range of operating frequencies, because the reactance is exactly proportional to frequency and the high-frequency resistance is very nearly proportional. The Q of radio coils may have a value as high as several hundred.

In a parallel resonant circuit the oscillating current in either the coil or the condenser is equal to net line current multiplied by Q . In a series resonant circuit the potential across the coil and condenser is equal to Q times the net potential across the complete circuit. Circuits having high values of Q tend to give good selectivity.

QUARTZ.—Quartz is one of the most desirable materials for use as a dielectric and insulator in parts carrying high frequency currents since it has very low losses at radio frequencies. Quartz is a mineral, a variety of silica which is found in crystalline masses. It may be clear and colorless or may be tinted with a variety of colors. The dielectric constant of quartz is between 4.5 and 5.0.

QUARTZ CRYSTAL CONTROL.—See *Crystal, Frequency Control* by.

R

RADAR.—Radar is a Navy code word for *radio detecting and ranging*. The British name for equivalent apparatus is *radio locator*. The purpose of radar is to detect the presence of distant objects, to indicate their distance from the apparatus, also their height or elevation, their position to the right or to the left, and, if moving, their speed in relation to the position of the radar apparatus.

The basic principle of radar is that of the reflection of high-frequency radio waves from any surface or sharply defined region at which there is a decided change from the degree of conductivity or the dielectric constant of the air through which the radio wave is traveling. This means that short wave radiation is reflected

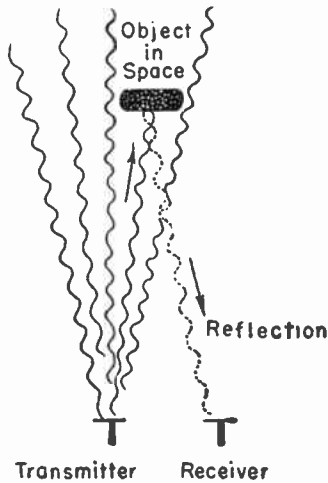

FIG. 1.—Reflection of Radar Waves.

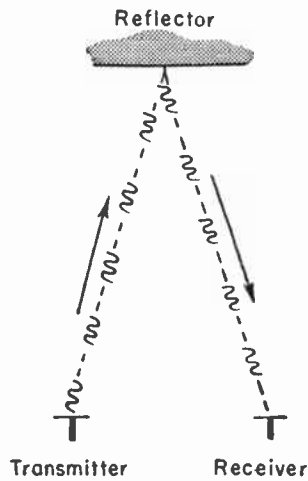

FIG. 2.—Wave Pulses between Transmitter and Receiver.

from buildings, ships, airplanes, land surfaces, trees, even from a human body, and everything whose electrical properties differ materially from those of air. The data conveyed by the received reflected waves is collected and recorded, automatically and quickly correlated, and presented as an easily understood graph or picture.

Short wave radiation passes unaffected through ordinary clouds, but there is reflection at the boundary of any mass of ionized gases in the atmosphere. It is such reflection that permitted radio waves of much the same general type now used for radar to be used twenty years ago in measuring the height of the Heaviside layer, which is a region of ionized gases many miles above the surface of the earth. Even before these measurements it had been noted, during experiments with short wave radio transmission, that a ship

RADAR

passing through the radio waves would distort their pattern as observed at the receiver, and a few years later it was found that similar distortion results when an airplane flies through a short wave transmission beam. It was from these experiments that radar first developed. The effective range of the earliest radar sets was about five miles, but during the following seven or eight years of development the range was increased to between 40 and 50 miles.

Radar operates with frequencies of hundreds of millions of cycles per second, with wavelengths of only a few inches or centimeters. Such waves act similarly to light waves in that they travel in straight lines or in lines of sight from transmitter to reflecting surface and back to the receiver. The effective distance of detection and observation is limited by the fact that such waves cannot pass beyond the curvature of the earth which forms the horizon and still be reflected back to a receiver which is near the transmitter. The size of an object that can be detected depends on wavelength, because the length of the waves must be less than the dimensions of the object. The earliest radar sets were built with short wave tubes such as used for amateur transmission, but at present the tubes are of the klystron type employing velocity modulation for bunching of electrons in the stream flowing through the tube.

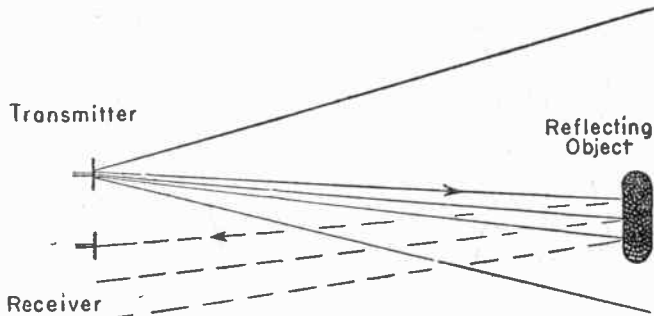

FIG. 3.—The Angle of Reflected Waves Indicates Direction.

Radar waves are not sent continuously by the transmitter, but are emitted in brief pulses with intervening idle periods. The reflected pulses are picked up by the receiver during instants in which the transmitter is idle. This plan of operating transmitter and receiver alternately instead of simultaneously makes it possible to locate these two parts of the apparatus close together or in a single unit without the transmitted waves interfering with reception. The pulses are so close together in time that there is continuous indication of the observed object. A similar method of intermittent transmission is employed in the pulse altimeter for airplanes, with which radio echoes or reflections from the ground give continuous indication of altitude.

The emitted pulses travel through space at a speed of 299,820,000 meters per second, or about 186,340 miles per second. With the speed of the pulses known, measurement of the length of time required for a pulse to go from transmitter to reflecting object and back to the receiver allows determining the distance traveled by the pulse. Half of the total distance traveled is

RADAR

the distance from the radar apparatus to the reflecting object. The total time for a pulse to travel to an object ten miles away and return to the receiver is but little more than one ten-thousandth second.

One method of determining the time difference is by observation of wave pulses on the graduated screen of a cathode-ray tube. The frequency at which pulses are emitted, or the number emitted per second, determines the distance in space between consecutive pulses which are traveling at known speed, and the time difference between emitted and received pulses is proportional to the number of these spaced distances between the radar apparatus and the observed object. The portion of the radar apparatus called the computer automatically and quickly carries out the calculations that translate the received wave pulse data into equivalent distances.

Radiation from the transmitter is emitted in a rather wide sector in the general direction to be scanned by the radar beam. The reflected waves reach the receiver from a direction dependent on the position in space of the reflecting object. It is necessary, therefore, that the radar apparatus determine the angles in both vertical and horizontal directions from which the waves return in order that the exact position of the object may be indicated. The transmitter and receiver may be rotated together to emit and receive waves of the same direction, or to scan a certain area.

The data fed from the receiver to the computer is correlated in the computer and passed to a cathode-ray tube on whose screen the observed object appears as a small illuminated spot having a shape which is recognizable as a ship, airplane, or other object which is in the scanned area. The spot of light moves on the screen as the observed object moves in relation to the position of the radar apparatus.

RADIATION

RADIATION.—The action by which radio waves are sent out from the aerial of a transmitter into space is called radiation. The exact means by which radiation takes place is still a subject for controversy and all explanations of this action are merely theories. Many of these theories are plausible and withstand the tests of close examination and experiment. But still they remain theories because they cannot be proven beyond a reasonable doubt.

Radiation differs from induction. With induction a current through a conductor causes a magnetic field to rise around the conductor. Then the collapse of this field causes a current in the conductor. Thus induction is an exchange of energy between the conductor and its magnetic field. The energy stays in the vicinity of the conductor. With radiation the energy sent into the conductor leaves it and does not return to that conductor.



FIG. 1.—Radiation of Sound Waves from Vibrating Body.

The emission of radio energy from an aerial may be compared with the emission of sound from any object which is set into vibration. Sound is transmitted in a series of compressions and rarefactions in the air very much as shown in Fig. 1. The air itself does not move from place to place in carrying the sound but only a changing condition of the air moves away from the source of sound and to the receiver of the sound. The alternate compression and rarefaction of the air may be represented by a wave form.

Radio energy passes through the ether which is assumed to be all pervading. The radio waves pass almost without loss of strength through all kinds of good dielectric. But when the radio waves try to go through a conductor of any kind their energy changes into electric currents which may be used to good purpose or which may simply be wasted as eddy currents. This explains one reason for the diminished strength of radio signals during daylight. The sunlight partially ionizes the air and any ionized gas is a conductor of a sort. The radio waves are thus dissipated by the conductivity of the ionized air.

RADIATION

The energy of a transmitter in its aerial consists of two parts, one electromagnetic and the other electrostatic. In the circuits of the transmitter, which include the aerial and ground, these two parts are ninety degrees out of phase and therefore oscillate back and forth. As in any oscillatory circuit, either form of energy will change into the other. The energy is first in electrostatic form, then in electromagnetic form as it moves back and forth between the coils and the condensers.

According to one theory these two components of the radio energy leave the aerial out of phase but after traveling for a fraction of a wavelength they are in phase with each other as in Fig. 2. When in phase the two parts of the energy work together and are therefore freed from the need of conductors or condensers to contain or carry them. The radio wave then travels away through the ether, still including both electromagnetic and electrostatic components.

As the wave travels through space the inductive or electromagnetic part of its energy drops rapidly in strength, far more rapidly than the electrostatic part. The drop in the electrostatic part is only in direct proportion to the distance traveled while the electromagnetic part drops in proportion to the square of the distance.

In a certain sense the two parts of the energy support each other and carry each other along. It may be said that the electromagnetic portion of the wave provides the momentum driving the wave along its course while the electrostatic portion provides the needed elasticity between the parts of the wave which correspond to the compressions and rarefactions of a sound wave.

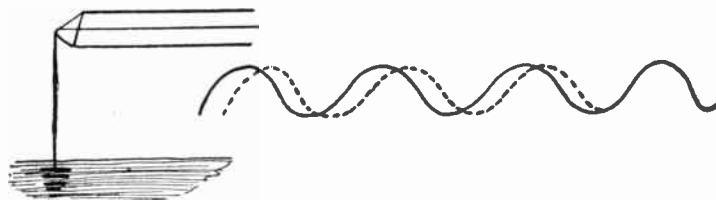

FIG. 2.—Phase Relations of Electromagnetic and Electrostatic Portions of Radiated Wave.

To produce a series of waves some kind of an elastic medium or body is required. For sound waves this body is the air. For water waves it is the water. For radio waves it is the ether. The radio waves are started by the vibrations in an oscillating electric circuit and they displace electricity somewhat in the manner that lines of force are assumed to act.

As already mentioned the strength of the inductive field diminishes rapidly with increasing distance from the antenna. With the usual elevated antenna the strength of the radiation field is greater than the strength of the inductive field at all distances greater than the wavelength in meters divided by 6.28. With the elevated antenna the strength of the radiation field is directly proportional to the frequency, while with a loop antenna the strength is proportional to the square of the frequency. This is the reason why high frequencies or "radio frequencies" are used for the carrier wave. The radiation field from a frequency of fifteen hundred kilocycles is 25,000 times as strong as the radiation field from sixty cycles. This advantage of the higher frequencies is somewhat reduced by

RADIO BEACON

the fact that the absorption of power from high frequency waves is greater than the absorption from low frequencies.

Radio waves act in a manner very similar to light waves. The radio waves appear to pass through some materials as though those materials were transparent. Other materials appear to reflect the radio waves just as light is reflected from a mirror. Still other substances seem to refract the radio waves just as light waves are refracted in passing through thick glass or through liquids. The reflection of radio waves forms one explanation of why these waves travel around the surface of the earth in place of moving away from the transmitter in perfectly straight lines which would soon bring them far above the earth's surface because of the curvature of this surface.

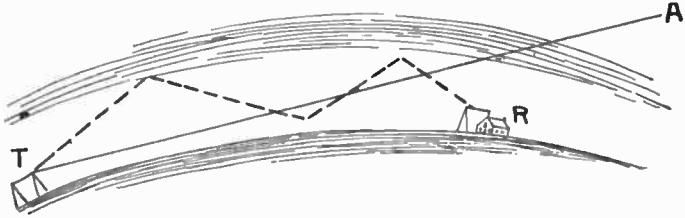

FIG. 3.—Reflection of Radiated Waves.

This idea is shown in Fig. 3. Radio waves leaving the transmitter *T* rise up until they strike the layer of ionized air a few miles above the surface of the earth. The waves are reflected from this layer as shown by the broken lines, coming back to the earth's surface to again be reflected. This continues until the reflected waves reach the distant receiver.

RADIO BEACON.—See *Aviation, Radio in*; also *Beacon, Radio*.

RADIO COMPASS.—See *Compass, Radio*.

RADIO FREQUENCY.—See *Frequency, Radio*.

RADIO FREQUENCY AMPLIFIER.—See *Amplifier, Radio Frequency*.

RADIO FREQUENCY CHOKE.—See *Coil, Choke*.

RADIO FREQUENCY PENTODE.—See *Tube, Pentode*.

RADIO FREQUENCY TRANSFORMER.—See *Transformer, Tuned Radio Frequency*

RADIO TELEGRAPHY

RADIO TELEGRAPHY.—Radio communication by means of the dots and dashes of the telegraphic code is called radio telegraphy. Radio telegraphy may make use of the antiquated spark system or of the more modern continuous wave transmission from vacuum tubes. See also *Code*.

RADIO TELEPHONY.—Radio transmission and reception of the sounds of voice and music as in broadcasting is called radio telephony. By means of radio telephony it is possible to send and receive any sounds that might be handled by wire telephony.

RADIO WAVE.—See *Wave, Radio*; also *Radiation*.

RADIO, WIRED.—Radio waves may be guided by wires between a transmitter and a receiver rather than being allowed to radiate freely through space. This system is called by many names, among them being; wired radio, wired wireless, line radio, carrier current telephony and guided wave telephony. With the output of a transmitter connected to one end of a pair of wires and the receiver connected to the other ends, communication may be maintained often up to distances twenty times as great as without the help of the wires.

The carrier frequency employed in wired radio is generally less than the frequencies employed without wires. The carrier must, of course, be above audibility and is generally somewhere between 20,000 and 500,000 cycles. By proper selection of carrier frequencies so that the side bands do not overlap and so that there is no interference between their harmonics it is possible to use a single set of wires for carrying many different messages at one time, each message using one of the frequency channels. While carrying the wired radio messages the wires may at the same time be in use for ordinary telephony and telegraphy. Power lines, lighting circuits, trolley lines and other electric circuits may all be used for wired radio.

RANDOM WINDING.—See *Winding, Random*.

RANGE, METER.—See *Meters, Ampere and Volt*.

RANGE, RECEIVER.—The range or distance in miles over which a receiver will be responsive to signals from broadcast stations depends on things too numerous to be counted. Were it possible to use two receivers under identical conditions at one time and the same place the relative distance range would depend on the relative sensitivity of the two receivers. The more sensitive one would, of course, have the greatest range of reception. But aside from receiver sensitivity there are dozens of known influences on reception and probably several dozen unknown influences. Atmospheric conditions have a decided effect.

Among the many factors affecting distant reception may be mentioned first of all the weather. There is a difference between results during warm weather and cold, between weather that is undergoing a change and weather that is constant. The location of the receiver is of importance, also its general condition, such as the age of the

RANGE, RECEIVER

tubes, the condition of power supply units or batteries, the antenna and ground connections, etc.

Recent researches seem to show that a weather map may form a rather reliable guide to probable radio reception just as it does to probable weather conditions. At least it seems true that reception will be best when the signals may travel along the lines of equal barometric pressure and will be poorer when the signals must travel from a point of high pressure to one of lower pressure or from a low pressure area to a high pressure area.

This theory may account for the fact that in a given locality the reception may sometimes be best from the South, then again from the West, or the East or the North. It is impossible to be sure of any particular distance range at any particular time because conditions never remain the same for very long even though the set be unchanged and continue in the care of the same operator.

The location of a receiver with reference to the broadcasting station determines to a great extent the reception that may be consistently expected. This is because of the effect of attenuation of the radio waves. Attenuation is the loss of energy due to dielectric losses and eddy current losses taking place in materials and obstacles which the waves must pass through or around on their way to the receiver. For this reason a receiver located way out in the country will generally do much better distance work than a similar receiver operated in a city. The difference is usually measured by a thousand miles or more. A receiver surrounded by steel buildings is decidedly handicapped.

The power of the broadcasting station has a great effect on the distance at which it may be received. Reliable night-time reception under fair conditions with a sensitive receiver may be expected from 100-watt stations up to about 40 miles, from a 1000-watt station this distance will be between 150 and 200 miles, from 2000-watt stations it will run between 250 and 300 miles, from 5000-watt broadcasters the distance will increase to between 350 and 500 miles, while 10,000-watt stations should be heard quite regularly from 500 to 700 miles away. The distance to which a broadcaster reaches out depends not only on the power put into the aerial but also on the general excellence of the station and on the degree of modulation.

Where a station gives fairly consistent reception at night up to 300 to 400 miles its daytime range will be about 100 to 150 miles. A good average receiver will bring in stations up to a distance of 500 miles with some regularity, will occasionally hear stations 1000 to 1200 miles away and very rarely will bring in signals from a distance of 2000 miles. The very distant stations may come through with real volume for a few minutes and may not be heard again for months.

Taking the volume given on a certain receiver from a broadcasting station one hundred miles away as being represented by the number 100, the effect of greater distances on the strength or volume will drop approximately according to the following table, all other things being equal:

RATIO

DISTANCE EFFECT ON VOLUME

Miles	Volume	Miles	Volume
100	100%	600	10%
200	48%	700	7%
300	24%	800	6%
400	16%	900	5%
500	14%	1000	4%

This is sometimes called the inverse distance effect, since the volume of received signal varies inversely with the distance from the transmitting station.

Extended observations under average conditions show that reception is best from distant stations in January. Taking the January reception as represented by 100 per cent, the other months in the average year rate as follows:

EFFECT OF SEASON ON VOLUME

January	100%	March	80%	May	49%
December	96%	October	77%	August	48%
February	94%	April	64%	June	45%
November	92%	September	62%	July	44%

Excellent radio reception may be expected from November to February and poor reception from May to August. Reception during the remaining months should be fair. These figures are for average years, but many years prove to be decided exceptions.

RATIO.—The quotient obtained by dividing one number by another number is called the ratio of the numbers. Thus the ratio of 10 to 5 is 2 because 10 divided by 5 equals 2. The ratio of 5 to 10 is $\frac{1}{2}$ because 5 divided by 10 equals $\frac{1}{2}$. A ratio may be written as a fraction, as the fraction $\frac{1}{2}$ just given, or it may be written with a colon between the numbers, as 5:10, which is read “the ratio of five to ten.”

RATIO, TRANSFORMER.—See *Transformer*.

RATIO, VOLTAGE.—See *Transformer, Audio Frequency and Transformer*.

REACTANCE.—Reactance is the name given to the opposition to flow of alternating current when this opposition is caused by the inductance of a coil or by the capacity of a condenser. Re-

REACTANCE

actance is measured in ohms. The reactance of a circuit with the resistance of that circuit makes up the circuit's impedance. Reactance is called the reactive component of the circuit's impedance.

Reactance caused by a coil's inductance is called inductive reactance. Reactance caused by a condenser's capacity is called capacitive reactance. Any reactance caused by inductance, whether in a coil or in any other conductor is likewise called inductive reactance while any reactance caused by capacity between parts is called capacitive reactance. Either kind of reactance may act to hinder the flow of alternating currents.

Inductive reactance, the reactance of a coil, increases with increase of frequency and is often called positive reactance. Capacitive reactance, the reactance of a condenser, grows less with increase of frequency and is often called negative reactance. Therefore, the value of inductive reactance may be preceded by the positive sign +, while the value of capacitive reactance may be preceded by the negative sign -.

When the frequency is measured in kilocycles and the inductance in millihenries the inductive reactance in ohms is as follows:

$$\text{Inductive Reactance} = 6.2832 \times \text{frequency} \times \text{inductance}$$

The same formula holds true when the frequency is measured in cycles and the inductance in henries.

If the frequency is measured in kilocycles and the inductance in microhenries, the formula becomes:

$$\text{Inductive Reactance} = 0.0062832 \times \text{frequency} \times \text{inductance}$$

The number 6.2832 is the approximate value of two times π , the Greek letter which stands for the ratio of a circle's circumference to its diameter.

When the frequency is measured in cycles and the capacity in microfarads, the capacitive reactance in ohms is as follows:

$$\text{Capacitive Reactance} = \frac{159,155}{\text{Frequency} \times \text{Capacity}}$$

If the frequency is measured in kilocycles and the capacity in microfarads, the formula becomes:

$$\text{Capacitive Reactance} = \frac{159,154,600}{\text{Frequency} \times \text{Capacity}}$$

If the inductive reactance, which is considered as a positive quantity, just equals the capacitive reactance, which is considered a negative quality, the two will balance each other so that there is no effective reactance remaining in the circuit. The only opposition then remaining to the flow of alternating current at the particular frequency being considered is the resistance, and the circuit is resonant at that frequency. See also *Resonance*.

Reactance is one of the components or parts of impedance in an alternating current circuit. The other part is resistance. Resistance opposes the flow of both alternating and direct currents through a circuit. The energy required to overcome resistance causes heat and is beyond recovery.

Reactance opposes the flow of an alternating current through a circuit but the energy required to overcome reactance may be stored in the circuit, is not lost, and may be recovered.

REACTANCE

When only direct current flows through a circuit it is opposed only by the resistance of the conductors, but when alternating current flows it is opposed by both the resistance and the reactance.

We can say that inductive reactance is the effect that a coil of wire has on an alternating current. Every coil of wire has inductance, that is, any change of current in a coil causes a voltage which opposes the change of current. The effect of a coil of wire on alternating current is to hold back the current or to temporarily choke it. This reactance effect which appears in a coil is called inductive reactance because it is caused by inductance. The inductive reactance turns part of the energy of the alternating current into a magnetic field around the coil or causes such a field to be built up. As this magnetic field collapses it returns energy to the circuit and that is why we say that reactance differs from resistance in not losing energy but in storing energy.

A condenser also has reactance to alternating current. To a direct current a condenser has exceedingly high resistance. In fact, to direct currents whose voltage is not great enough to break through the dielectric, the condenser forms an open circuit, or an infinitely high resistance.

A condenser does not offer this infinitely high resistance to alternating current but offers only reactance. Here again the reactance does not cause a loss of energy but stores it on the plates of the condenser in the form of electric charges which will return the energy to the circuit.

To an alternating current of given voltage and amperage a large condenser has less reactance than a small one and the larger the capacity of a condenser the less is its reactance to a given current and voltage.

REACTOR.—A unit which, by its property of reactance, opposes and limits the flow of alternating currents. A reactor usually is a coil possessing inductive reactance, although it may be a condenser possessing capacitive reactance.

REACTOR, SATURABLE.—A saturable reactor is a unit whose inductive reactance to alternating currents may be varied by changing the value of direct current that flows in some of the coil windings. The principle is shown by the diagrams.

At *A* is a three-leg laminated iron core on the outer legs of which are coils for alternating current. During a half-cycle in which current flows as shown by arrows on the wires, the magnetic flux will be in the direction shown by arrows on the core. During the opposite half-cycle the current and flux will reverse. The changing current induces a counter-emf which is the force causing reactance to flow of the alternating current. The counter-emf in the coils results from changes of magnetic flux.

At *B* is shown on the center leg of the core a winding which carries an adjustable flow of direct current. Current and magnetic flux are in the relative directions shown by arrows. As the direct current is increased, the core iron approaches magnetic saturation. The nearer the iron comes to saturation the smaller must be the changes of flux caused by alternating current in its coils, and the smaller the changes of flux the smaller will be the counter-emf and the resulting reactance to flow of alternating current. Very small power in the d-c winding will regulate large power in the a-c circuit or load circuit which is connected in series with the a-c coils.

In diagram *C* all the windings are shown together on the legs of the core. At *D* is a variation which gives somewhat more efficient performance. The directions of the windings in relation to one another is such that current in the a-c coils can induce no emf in the d-c winding. During each half-cycle the a-c flux reinforces the d-c flux in one leg and opposes it in the other leg, so that the effect is

REACTOR, SATURABLE

the same during both half-cycles. With the d-c winding on the center leg of the three-leg core, or around the two inner legs of the four-leg type, the d-c flux passes through all the legs and affects both a-c coils equally. In actual construction of the unit at *D* the d-c winding encloses both of the a-c coils, with all coils wound on the full length of the legs.

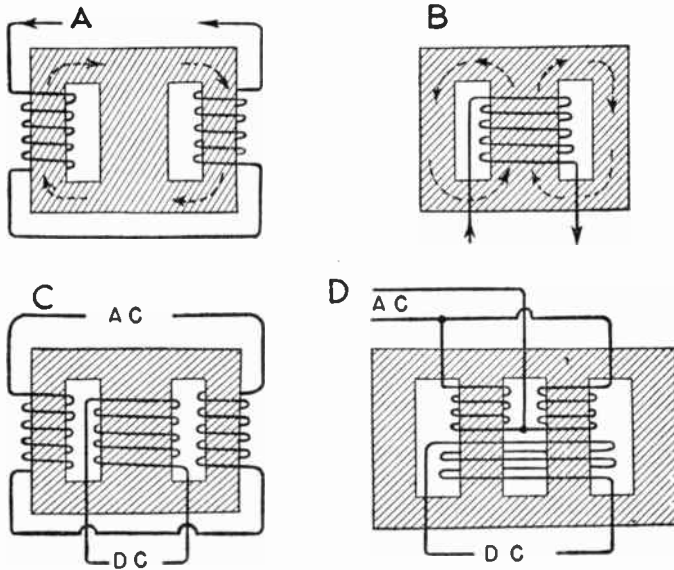

Windings of Saturable Reactors.

Saturable reactors are used for regulation of a-c voltages or currents, for control of lighting in theatres and other large areas, for control of heating currents in furnaces, ovens, heat treating units and similar applications, and for numerous other a-c control functions. The direct current frequently is regulated by thyatron tubes and is taken from the a-c supply through phanotron rectifiers.

RECEIVER, AUTOMOBILE RADIO

RECEIVER, AUTOMOBILE RADIO.—The automobile radio receiver requires certain refinements in design and construction that are not considered essential in the production of a receiver to be used in the home.

Several years prior to the appearance of receivers designed specifically for this purpose isolated attempts were made to adapt home receivers to automotive use. The results obtained were mediocre. Home receivers of the tuned radio frequency type in use at that time were not sufficiently sensitive to give satisfactory broadcast reception over a distance with the rather poor pickup of an antenna mounted on the automobile. The noise pickup from the running motor produced an interference often more intense than the received signal. The tubes available at this time were filament type triodes. These tubes were not satisfactory because of their fragile internal construction. Continued vibration present in a moving vehicle would cause filament breakage or a shifting of the relative positions of the elements resulting in erratic operation.

With the advent of the uni-potential cathode type of tube con-

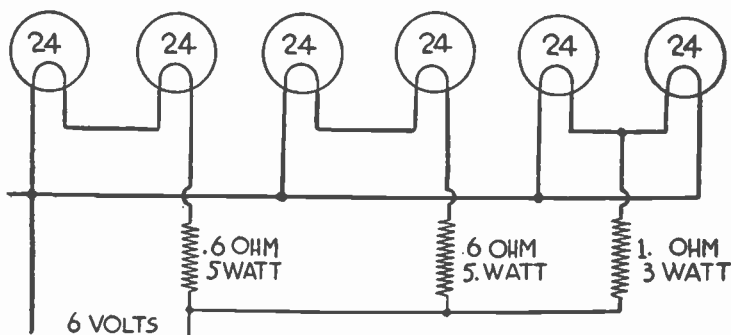

FIG. 1.—Series Parallel Connection of Tube Filaments Used in Early Automobile Receiver Design.

struction, one of the major difficulties was eliminated. However, the first heater types of tubes operated at a heater voltage of 2.5 volts with a heavy current of 1.75 amperes. To design a receiver using several of these tubes to be operated from the automobile 6 volt storage battery required a series-parallel connection of heaters with a relatively heavy drain from the battery. The early automobile receivers of standard manufacture were of the tuned radio frequency type, the superheterodyne circuit not having been released for general use in broadcast receivers at that time. They presented a cumbersome installation consisting of at least five separate units, that is, 1, the receiver proper; 2, the loud speaker; 3, the B and C battery box; 4, control head; 5, antenna.

RECEIVER, AUTOMOBILE RADIO

The B and C batteries were generally mounted in a battery box placed under the floor boards or behind a seat cushion where space permitted. This type of power supply was not entirely satisfactory, due to the extreme temperature changes to which the batteries were exposed, decreasing materially their useful life. The receiver proper and loud speaker were mounted on the engine bulkhead under the dashboard. The control head consisting of the necessary tuning mechanism, volume control and operating switch was mounted on the steering post. The tuning drive connected to the receiver through a flexible shaft or rigid shafts working in universal joints. Antenna installations were made either in the roof of the automobile or under the chassis. Motor noise suppression was accomplished by connecting resistors in series with the spark plugs and distributor and condenser by-passing the generator to ground.

The automobile receiver must be so constructed that all connections are mechanically as well as electrically perfect. Proper ventilation must be provided to allow efficient heat dissipation. Care must be taken to prevent the collection of moisture within the receiver and means must be provided to drain such moisture as may be admitted when the car is washed or when used in rainy weather. A highly efficient AVC circuit must be used to compensate for reduced antenna pickup when driving through viaducts or under overhead structures. A compact unit is required because of lack of mounting space and shielding must be as complete as possible to prevent undesirable noise pickup.

Several tube manufacturers produced heater types of tubes operating at 6.3 volts with a current drain of .3 ampere which allowed a simple parallel connection of heaters simplifying construction considerably and providing greater operating efficiency.

When the superheterodyne type of circuit was made available to the radio manufacturers, the automobile receiver was given a tremendous impetus. Many new circuits were developed and several old principles were brought to the fore. Multi-purpose tubes were used, further effecting a saving of space and means were devised to obtain all necessary operating voltages from the automobile storage battery, thereby doing away with cumbersome B batteries. The loud speaker became an integral part of the chassis, making single unit construction possible, while automobile manufacturers provided built-in antenna systems. With the use of the reflex system and multi-purpose tubes it is possible to obtain the equivalent of an eight tube superheterodyne receiver while actually employing only four tubes.

The present automobile radio receiver generally takes the form of a single unit chassis mounted on the engine compartment with a single through bolt. The control head may be mounted on the steering post or in some cases provision is made for plate mount-

RECEIVER, AUTOMOBILE RADIO

ing the control head directly on the instrument board. Many automobile manufacturers provide a deep receptacle in the instrument board capable of accommodating a special receiver chassis. Design of receivers in some cases again separates the chassis and speaker so that the speaker may be mounted overhead to prevent the muffling of the sound sometimes experienced when the speaker is mounted in the chassis under the dashboard.

Considerable attention is also given the elimination of noise from the car engine. The use of high resistance carbon suppressors is said to reduce engine efficiency and several methods are in use to eliminate this undesirable effect.

The turret dome top automobile construction in vogue makes it impossible to use a top antenna and special types for running board and under chassis mounting have been developed.

All wave construction has not been extended to automobile receivers principally because of the fact that ignition noise increases as the frequency is increased and also because of state laws prohibiting the use of short wave receivers in automobiles.

In general, the auto receiver sound output is pitched slightly higher than an equivalent home receiver to provide a more pleasing sound above normal traffic noises. Many receivers provide a tone control manually operated to allow an adjustment of tone.

Receiver (Automobile Radio) Antenna.—The automobile antenna may be classified as the capacitor type, commonly called a counterpoise system. This type is necessary because of lack of space for the erection of the highly inductive system and also because of the fact that no portion of the automobile is at true ground potential with respect to radio frequency energy.

Any metallic portion insulated from the automobile chassis proper may be used for antenna pickup. Bumpers, spare tire carriers and like metallic objects have been used as antennae where such objects were well insulated from the car frame.

Antenna systems have been fairly well standardized and present day installations differ from one another only because of slight changes in automobile construction.

The best type of installation from the standpoint of efficiency of pickup as well as freedom from motor noise consists of a conducting screen mounted in the top of the automobile. This type of construction should be used wherever possible. It combines good electrical efficiency with mechanical rigidity. It is also weatherproof and will not ground to chassis if installed properly.

The antenna material is generally a close woven copper screen of 8 to 14 mesh, three feet wide and the maximum length of the top. The headliner (inside top lining) is lowered and this wire screen cloth is securely tacked in place, care being taken to prevent grounding to any metal cross bows or diagonal braces encountered. A hole is cut in the screen to accommodate the dome light and the

RECEIVER, AUTOMOBILE RADIO

dome light leads are re-routed to present a minimum of coupling to the antenna screen.

The lead-in is a shielded piece of copper wire connected to the front edge of the screen nearest to the side on which the receiver is to be mounted. It is generally led down a front corner post for concealment. Too long a shielded lead-in serves to by-pass some

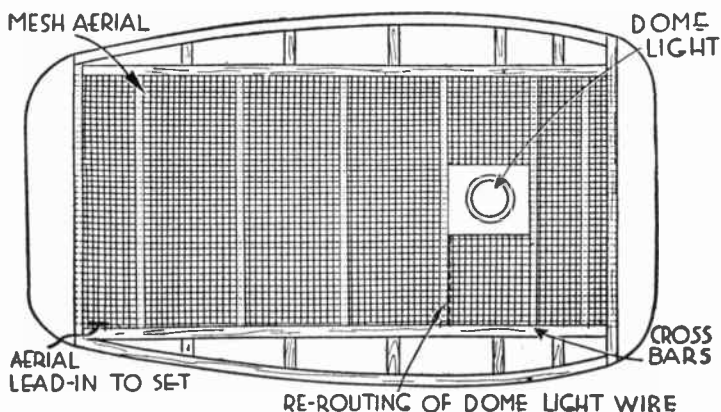

FIG. 2.—Construction of Copper Mesh Roof Type Automobile Antenna.

of the received energy to ground. For this reason the rubber insulation supporting the shield should be as thick as possible. This shield is grounded in several places. In some automobiles, chicken wire is used in the top construction to keep the top padding material in place. If this wire is not grounded or is freed from grounds it may be used for the antenna.

In cars having folding tops a wire screen antenna cannot be used because the screen is not flexible enough to permit folding. In this case a wire antenna about 50 feet in length is stitched to the top pads in lateral rows about four inches apart. An unshielded antenna lead-in is used with this type of construction. Weatherproof wire is recommended for the lead-in.

In general an antenna located underneath the car is only approximately 50% as efficient as a well installed top antenna. In the turret top (all metal) roof automobiles it becomes necessary to mount the antenna under the body or running boards.

A triangular aerial connected between the flywheel housing and each rear spring may be used, but unless special impedance matching transformers are used this type is somewhat less efficient than either the roof or running-board type. Single wire axle to axle systems also possess low efficiency.

Several types of running board aeriels are available. The solid metal type is made to clamp under the running board and is gen-

RECEIVER, AUTOMOBILE RADIO

erally adjustable in length to fit any length of running board.

A recent development in running board aerials is the di-pole or folded doublet type. The antenna lead-in is taken from the mid-section of the di-pole and a special low capacity shielded lead-in

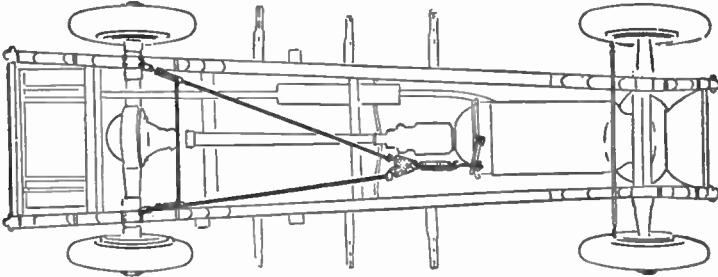

FIG. 3.—Installation of Triangular Under Chassis Automobile Antenna.

is used. This type of antenna construction permits maximum signal pickup with a decrease in ignition noise pickup although its overall efficiency is less than a well installed roof type. In common with other running board types this antenna is treated and insulated to prevent an accumulation of ice, salt spray, dirt or grease from affecting its performance.

Chassis.—The peculiar conditions under which an automobile radio receiver must operate satisfactorily result in several

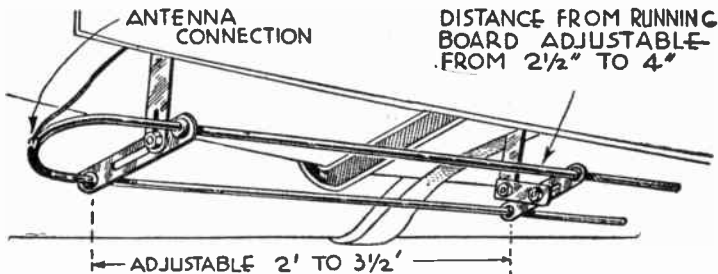

FIG. 4.—Folded Doublet or Di-pole Automobile Antenna Installed under Running Board.

radical departures from home receiver design both electrically and mechanically. These conditions are, reduced and varying antenna signal pickup, ignition interference, rigid mechanical construction and space limitation. The necessity for producing an adequate plate voltage supply from a 6-volt source must be considered, likewise the poor acoustical conditions found in most closed cars make necessary special frequency compensation in the receiver circuits.

The receiver is continually subjected to vibration and shocks

RECEIVER, AUTOMOBILE RADIO

as well as extreme temperature and humidity changes. These factors make it necessary to rigidly secure all integral parts to prevent them from shaking loose and causing erratic operation. The tube sockets must grip the prongs securely in order to retain the tubes. The outer casing covering the chassis and speaker serves several purposes. It allows a convenient means of mounting the receiver to the car bulkhead, it serves as a protection against mechanical injury to the delicate parts comprising the receiver and it also serves as an electrical shield protecting the sensitive circuits from being actuated by undesirable electric and magnetic fields.

In construction the receiver must be compact enough to allow it to be conveniently located in such a place as not to interfere with the comfort of the car occupants or the installation of other accessories such as heaters, fans, etc. It must also be located to allow easy access for necessary servicing and tube replacement.

The average audio output of a receiver designed for automobile use should be between two and three watts. With the reduced auto antenna pickup an input to the receiver of 15 microvolts would produce the required output providing the design of the receiver was such that it had an overall gain of approximately 127 db. This high gain must be obtained with the least possible number of tubes to reduce the drain on the storage battery and to minimize tube noises. The rather high speaker output, that is 2 to 3 watts is necessary to override the attendant motor, wind and traffic noises. Ordinarily in home receivers 2 watts is considered an ample audio output to comfortably supply sound to a medium sized room.

A superheterodyne type of circuit is necessary to produce the requisite gain. Multi-function tubes used as detector oscillator—second detector and delayed AVC—push-pull audio in a single glass envelope—synchronous vibrators and the use of reflexed circuits makes it possible to construct an automobile receiver having the required characteristics with only five tubes. The total current consumption, from the storage battery, of such a set is 5 to 7 amperes.

The automatic volume control used in these receivers must operate over a wider scope than those designed for home receivers. This is because of the shielding effects of large buildings and steel structures encountered in driving in cities. According to motor car receiver manufacturers the AVC system should operate over a ratio of signal change inputs at least as great as 100 to 1 or a 40 db change. Some receivers are provided with an AVC sensitivity delay adjustment, making it possible to only admit signals to the receiver above a certain pre-determined level.

The loud speakers used are generally of the flat baffle, moving coil type. The field may be energized by a current of approxi-

RECEIVER, AUTOMOBILE RADIO

mately one ampere obtained from the storage battery, or a permanent magnet may be used. Either type has certain disadvantages. The directly excited field while more positive in its operation, places an additional drain on the storage battery which is undesirable. The permanent magnet type loses its magnetism by being continually subjected to shocks. Speakers are generally so located that the sound wave is projected directly toward the interior of the car at a level just under the dash board. Some installations face the speaker toward the floor, however. The acoustical properties of the interior of the car are such that the high frequencies are absorbed while the lack of a baffle of sufficient size decreases the low frequency response. The automobile radio receiver audience is not highly critical as to perfect fidelity, however, due to the numerous distractions occurring during a drive.

The receiver must be phased or lined up when installed, therefore small dust caps are used to cover the holes in the outer casing giving access to the adjusting screws.

The tuning controls are generally of the "dental cable" type. A flexible shaft is formed of a number of fine steel wires twisted together to form a shaft which is protected by an outside housing very similar to a speedometer cable. This flexible shaft is used to drive the tuning condenser while a similar shaft actuates the volume control. Still another type of condenser drive makes use of

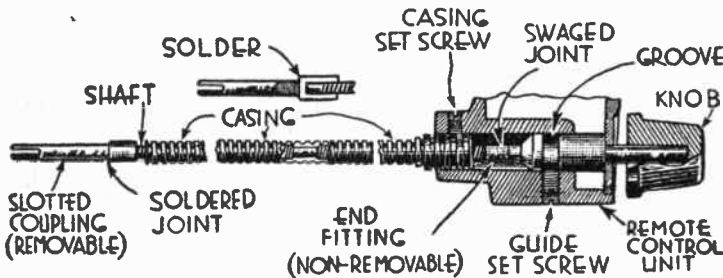

FIG. 5.—Construction at "Dental Cable" Flexible Control Shaft.

a fine steel wire inside of a suitable housing which is wound upon the steering gear tuning drum against a spring tension on the variable condenser shaft. This type is even more flexible than the "Dental cable" type but becomes less positive in action after several months of use.

Power Supply.—The power supply necessary to convert the six volt direct current supply of the automobile storage battery to the 250 volts DC necessary for the tube plate and screen supply may be obtained in any one of three ways: rotary converter or dynamotor, non-synchronous vibrator with transformer and tube rectifier and synchronous vibrator transformer assembly.

RECEIVER, AUTOMOBILE RADIO

The most desirable characteristics of the power supply are dependability and low battery drain.

The dynamotor, while less efficient than the vibrator type of supply, is desirable from the standpoint of dependability. Its disadvantages lie in its higher cost, greater mounting space and difficulty in properly fusing its input. The current drawn on starting the dynamotor rises to a value several times greater than normal operating current making the use of fuses or circuit breakers difficult. Construction of these units has been refined to the point where practically no attention need be given it after proper installation is made. Oilless bearings are used to eliminate the necessity of periodic lubrication. The overall efficiency is rather low, approximately 60% for the driver and 65% for the generator portion, giving an overall efficiency of 35%. The use of a multi-

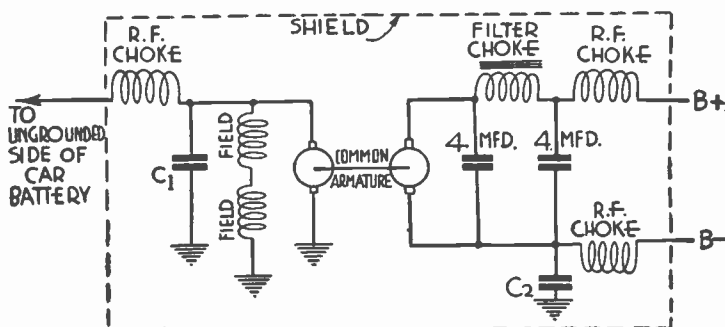

FIG. 6.—Circuit Diagram of Dynamotor Type Automobile "B" Supply. C_1 and C_2 Are .3 mfd.

section armature reduces the filtering necessary which is a distinct advantage.

The difference between the synchronous and non-synchronous type of vibrator assembly is that the synchronous type delivers pulsating direct current of the proper voltage to a filter system while the non-synchronous type must pass its output through a rectifier tube before passing to the filter. Thus the former type is often referred to as a rectifying type of vibrator.

It is customary to consider the associated transformer (required with both types) as a portion of the vibrator system.

In general, the vibrator proper supplies direct current impulses which, when put through a transformer primary, produce AC in the secondary winding.

The problem of the design of a vibrator type of power supply resolves itself into an intensive study of the elimination of the mechanical and electrical disturbance caused by normal vibrator operation. The frequency of vibration is generally from 10 to 30

RECEIVER, AUTOMOBILE RADIO

cycles per second, while the amount of metal moved by the vibrating arm makes careful mechanical construction necessary.

Vibrators are mounted in resilient materials such as sponge rubber to prevent the mechanical vibration from being communicated to the receiver proper. Sound absorption material is placed around the rubber to prevent direct radiation of the sound wave set up by the vibrating reed. Exacting electrical shielding must surround the complete assembly to prevent the interference set up by sparking at the contacts from being picked up by the receiver.

The non-synchronous type of vibrator interrupts the 6V direct current delivering pulsating impulses to the primary of a step-up transformer. The secondary voltage of approximately 300 volts is rectified by a full wave cathode type rectifier tube and the output passed to a suitable filter system. This type of vibrator has an efficiency of approximately 60%. Its chief disadvantage is the rectifier tube required with its cost and attendant storage battery drain. In its favor may be cited the lesser number of contact

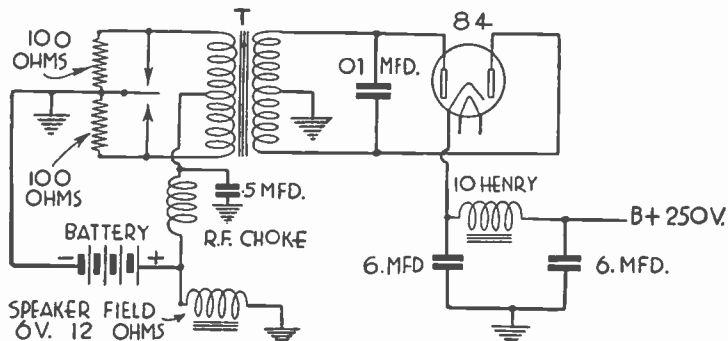

FIG. 7.—Non-synchronous Vibrator Power Supply Showing Filter System and Speaker Field Excitation. The 100 Ohm Resistors Are to Prevent Excessive Contact Arcing.

points to be adjusted and a somewhat reduced interference level. Proper spacing of contacts must be maintained and they must be properly cleaned.

In the early type of vibrator the attempt was made to eliminate the interference caused as well as the deterioration of contacts by using condensers across the points. Lack of intelligent knowledge of the peak voltages encountered resulted in numerous vibrator failures due to breakdown of these condensers.

The vibrator must operate satisfactorily with the car battery voltage as low as 3.5 volts or as high as 8.5 volts under varying conditions of charge and load. This requires careful design to prevent slow starting and sticking of the reed which results in blowing fuses.

RECEIVER, AUTOMOBILE RADIO

The synchronous type carries an additional set of contacts connected to the secondary of the transformer, the purpose being to commutate the AC secondary output. This type of vibrator has the higher efficiency ranging from 65 to 75% per unit. With a greater number of contacts to adjust, clean and synchronize and the greater interference produced, the synchronous type compares unfavorably with the non-synchronous type from a maintenance standpoint. However, its greater efficiency and the saving of rectifier tube, space, cost and drain makes this type ideal from the manufacturers standpoint. A further advantage lies in the fact

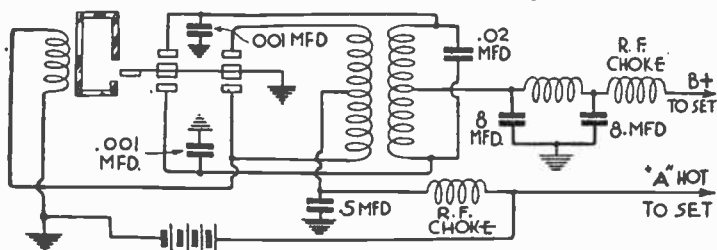

FIG. 8.—Diagram at Synchronous (Rectifying) Type of Vibrator "B" Supply for Automobile Radio Receivers.

that a greater output may be obtained from the synchronous type than can be obtained from the rectifier tube of the 84 type used with the non-synchronous rectifier.

Interference and Its Elimination.—Interference to radio reception due to the operation of a receiver in an automobile may be introduced into the set in either or both of two ways. It may be picked up directly by the antenna or lead-in or it may be due to chassis pickup. Generally it is a simple matter to determine the method of pickup. Grounding the antenna close to the point of entry to the chassis will eliminate interference picked up by the antenna while it will persist if the pickup is to the chassis under this condition.

The ignition system of an automobile is similar to the induction coil type of spark transmitter used in the early days of wireless communication. The wave sent out by this type of transmitter was highly damped causing exceedingly broad tuning at the receiver. Each individual spark plug acting as a transmitter makes the elimination of interference at the auto receiver a difficult matter.

A typical ignition system consists of a storage battery, motor driven circuit breaker, ignition coil, distributor and the spark plugs. In operation the 6 volt DC from the storage battery is interrupted by the circuit breaker and sent in impulses through the primary of the ignition coil. It is stepped up to the proper voltage in the secondary and led to the proper spark plug by the action

RECEIVER, AUTOMOBILE RADIO

of the distributor. Another source of interference is the generator whose operation is always attended by a certain amount of sparking at the commutator. The unshielded wiring necessary to inter-

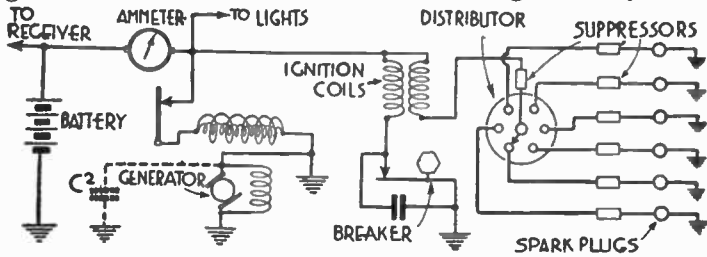

FIG. 9.—Circuit Diagram of Automobile Ignition System Showing "Standard" Suppression.

connect the various electrical devices in the car forms a very excellent radiator for the interference produced.

Interference may come from other sources also. Static charges of considerable intensity accumulate in dry weather wherever two surfaces are in frictional contact. This is particularly true at the brake bands, dry clutches and even the friction of the tires on pavement. This type of interference manifests itself in more or less periodic discharge clicks and each case requires individual treatment for its remedy.

The starting motor is another source of interference, but due to its infrequent and momentary use no attempt is made to suppress the interference it causes.

If the radio receiver is of reputable manufacture and of current design there should be no chassis pickup of interference. Should this type of pickup exist care should be taken to insure all ground cables being clean and tight. All cables leading into the chassis such as control shafts should be firmly seated and grounded and the chassis itself firmly mounted.

When it is established that the interference is being picked up by the antenna alone a systematic process of elimination should be followed.

Standard suppression generally furnished by the manufacturer with the car

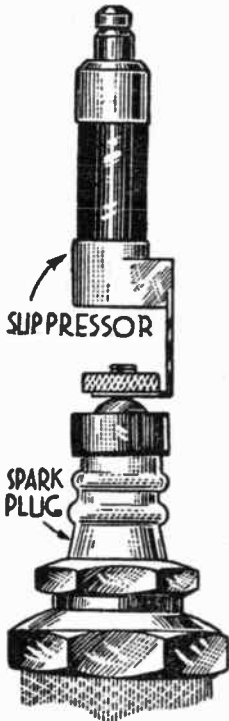

FIG. 10.—Spark Plug Auto Radio Suppressor.

RECEIVER, AUTOMOBILE RADIO

radio consists of a carbon resistor to be placed in series with each spark plug and mounted directly on the plug, a generator condenser to be connected across the generator brushes and a resistor to be placed in series with the distributor lead. The use of these devices successfully eliminates interference in approximately 50% of the installations.

The spark plug resistors are of the carbon type, having a resistance of 10,000 to 20,000 ohms and constructed so that they will not deteriorate under the varying temperature conditions met with on the motor block. The purpose of the resistors is to make the ignition system a poor radiator by damping the spark as quickly as possible. The use of these resistors decreases motor efficiency by reducing the intensity of the spark at the plug. However they serve as an inexpensive method of suppression and their use is universal. The interference caused by the plugs firing increases as the frequency to which the receiver is tuned is increased. Tests show that the interference is most intense between 20 and 40 meters. The use of suppressors increases the broadness of the interference band thereby reducing the total amount received over any

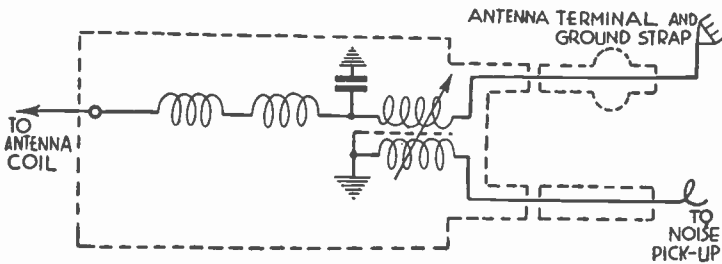

FIG. 11.—“Magic Eliminode” Used on Galvin Motorola Automobile Radio Receivers.

given band width. Suppressors have also been made of the inductive type having a relatively low DC resistance. This type should be more efficient than the high resistance carbon type as far as motor performance is concerned.

The generator condenser, of one-half microfarad capacity, is used to absorb the spark occurring at the generator brushes. It does not affect the efficiency of the circuit in which it is connected. If excessive sparking is noticed at the brushes the condenser will not be capable of removing all of the interference from this source. The commutator should be cleaned and the brushes refitted from a standpoint of generator efficiency as well as for the elimination of interference.

The suppressor used in the distributor lead serves the same purpose as those used on the spark plugs. Occasionally it is necessary to connect a .002 condenser (mica) directly across the primary breaker points to stop interference from this source.

RECEIVER, AUTOMOBILE RADIO

A perfectly grounded, shielded, ignition and lighting circuit would not pick up motor and static charge interference. However, motor car manufacturers do not install such shielding because of the expense involved. Most systems for the elimination of interference could be classed as "losser" systems. They are makeshift at the best and fail to work perfectly in all cases.

Each individual car of an identical model requires different

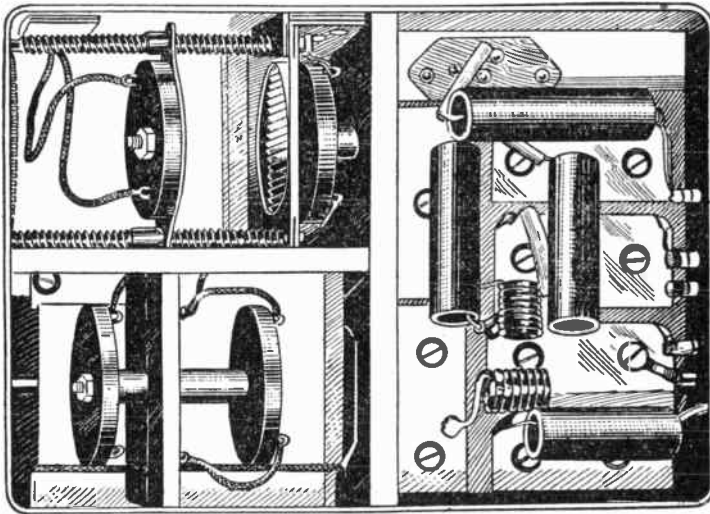

FIG. 12.—Interior View of Compartment Housing Galvin Motorola "Magic Eliminode."

treatment for noise elimination. No specific rules can be formulated which will be satisfactory in every case.

The Galvin Manufacturing Co. producing the "Motorola" receiver, employs a unique circuit to bring about a cancellation of the unwanted interference without resorting to the use of suppressors.

A pickup lead is placed in the interference field and a small amount of this energy is fed to the antenna coil in reversed phase through an inductive medium using variable coupling. This cancels out the interference without affecting the normal efficiency of the circuit. This system seems to be a step in the right direction toward the intelligent elimination of interference.

RECEIVER, FREQUENCY MODULATED

RECEIVER, FREQUENCY MODULATED, OR FM.—

Frequency modulation of a radio carrier wave differs from amplitude modulation as shown, much exaggerated, in Fig. 1. See also *Modulation*. In both cases the carrier wave, while unmodulated, remains at a constant or unvarying frequency. This constant frequency is represented in the diagrams by successive waves all the same distance apart, left to right. Both carriers, while unmodulated, are also of constant amplitude, as represented by the uniform height of the waves.

With amplitude modulation the audio, television or other signal to be transmitted is added to the carrier in such manner as to vary the carrier amplitude, but the carrier frequency remains constant during modulation. With frequency modulation the carrier amplitude remains constant, but the frequency varies in accordance with the frequency of signals being transmitted. The carrier frequency becomes higher and lower (during modulation) than the constant frequency that exists without modulation.

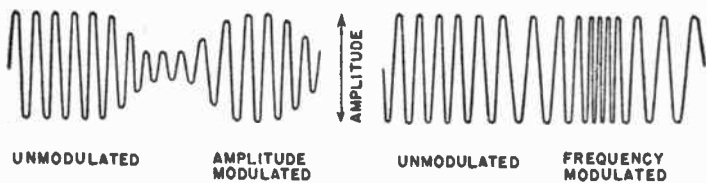

FIG. 1.—The Two Kinds of Modulation.

The range of frequencies provided for a frequency modulated carrier is several times as great as the actual range of audio frequencies or other transmitted signals. Consequently, the carrier-wave band width for frequency modulation is greater than with amplitude modulation. Whereas an amplitude modulated carrier may occupy a band of 10 kilocycles, a frequency modulated band may occupy 150 kilocycles. Frequency modulation transmission is carried on at high frequencies, such as 40 to 50 megacycles.

An FM (frequency modulation) receiver has parts and circuits which perform the same general functions as units in a superheterodyne receiver for amplitude modulation. Because of certain features peculiar to frequency modulation, some of the units operate differently and are given different names.

The principal parts of an FM receiver are shown by Fig. 2. The antenna may be of any kind that will satisfactorily receive short-wave transmission at frequencies being used for the carriers. The radio frequency amplifier must be designed to efficiently handle the incoming short-wave signals. The intermediate frequency amplifier is, in general, similar to the i-f amplifier of a receiver

RECEIVER, FREQUENCY MODULATED

for amplitude modulation, but must be designed to handle the much wider frequency band used with frequency modulation.

The intermediate frequency amplifier must handle frequencies which are as much as 75 kilocycles above and below the average (unmodulated) frequency, or handle a band 150 kilocycles wide. Intermediate frequency amplifiers may operate at average (unmodulated) frequencies of from two to five or more megacycles.

The limiter stage is peculiar to the FM receiver. It is a tube circuit whose purpose is to get rid of any amplitude modulation which accidentally may have gotten onto the carrier, as from various kinds of interference which would produce hum and other noises. The output of the limiter stage is fed to the input of the following discriminator stage, which also may be called the frequency detector.

The discriminator of the FM receiver serves the same purpose as the second detector in a receiver for amplitude modulation. The discriminator changes the frequency modulation into variations of voltage at audio frequency, so that this audio frequency

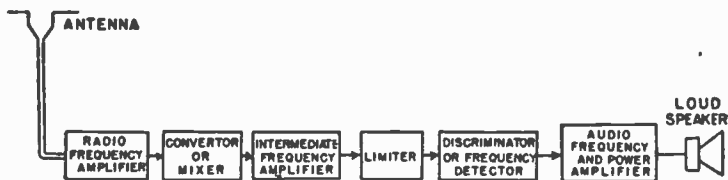

FIG. 2.—Principal Parts of an FM Receiver.

voltage may be fed to the audio frequency amplifier or power amplifier and to the loud speaker. Audio amplification, and the speaker system, are no different from similar parts in other receivers.

Limiter.—Connections such as may be used in a limiter stage are shown in Fig. 3. The tube is a pentode. Around the cathode is a control grid, then the screen, a suppressor or space charge grid, and the plate. Grid voltage comes from the preceding intermediate-frequency transformer whose secondary L_1 is tuned by the adjustable condenser C_1 . Screen voltage is supplied through resistor R_2 , and plate voltage through resistor R_3 . The tuned plate circuit, consisting of coil L_2 and adjustable condenser C_2 , is part of the transformer that couples the output of the limiter to the input of the discriminator. Condensers C_a , C_b and C_c are bypasses for the resistors.

Plate and screen voltages applied to the limiter are so low that it takes only a small negative grid bias to cause almost complete cutoff of plate current. It is by such cutoff of the plate current, when the grid goes slightly negative, that unwanted amplitude

RECEIVER, FREQUENCY MODULATED

modulation is removed from the signal. The process is as follows:

Assume that the intermediate-frequency amplifier delivers a signal having more or less amplitude modulation in addition to the desired frequency modulation. This is shown at *a* in Fig. 4. Negative alternations, shown below the line, will make the limiter grid negative to such an extent that no plate current flows. However, the positive alternations of the signal make the grid positive. The positive voltages on the grid cause grid current to flow (as shown by arrows in Fig. 4) from grid to cathode, to ground, upward through resistor R_1 , through coil L_1 , and back to the grid.

This flow of current through resistor R_1 makes the bottom of the resistor positive and the top negative. Since the top of R_1 is connected to the grid, and the bottom through ground to the cathode, the grid becomes negative with reference to the cathode.

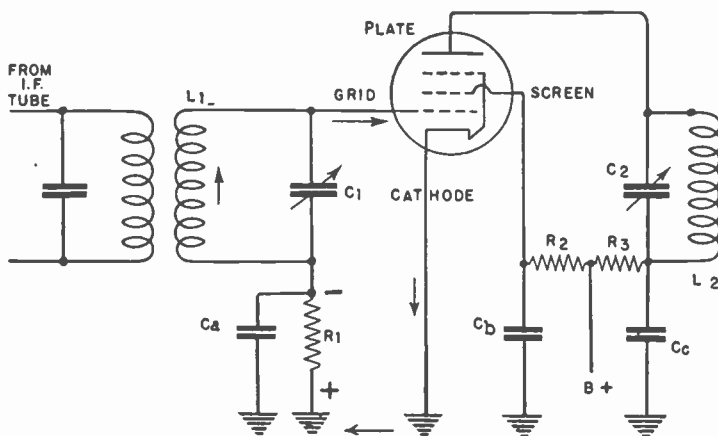

FIG. 3.—Connections for a Typical Limiter.

Grid current flows for only a brief instant before the grid becomes sufficiently negative to cut off plate current.

It is important to note that the time required to secure plate current cutoff is independent of the amplitude (height) of signal modulation, for after the grid becomes sufficiently negative to stop plate current it matters not how much greater is the positive voltage or amplitude applied to the grid—the plate current remains cut off. The result is that the pulses become a series of peaks of practically uniform height or amplitude, as at *b* in Fig. 4.

The positive pulses of grid voltage cause corresponding pulses of plate current, as at *c* in Fig. 4, and while the grid is negative there is no plate current. The plate current pulses are all practically uniform, since they are produced by uniform pulses of grid voltage. The plate current pulses will vary in frequency accord-

RECEIVER, FREQUENCY MODULATED

ing to the modulated frequency of the carrier, but now are of constant amplitude after coming through the limiter.

If some of the signal amplitudes coming to the limiter are too small to produce negative grid voltages great enough to cause cutoff of plate current, the plate current will vary in accordance with the actual grid voltages, and the plate current pulses will not be of constant amplitude. This is shown in Fig. 5. Here the signal amplitudes which are above a certain minimum value produce uniform pulses of grid voltage and plate current, while the amplitudes which are below this level produce smaller or non-uniform pulses of grid voltage and plate current. These non-uniform pulses of plate current mean that amplitude modulation still is present in the output of the limiter.

The amplification in stages preceding the limiter must be great enough so that any carrier signals to be correctly reproduced come

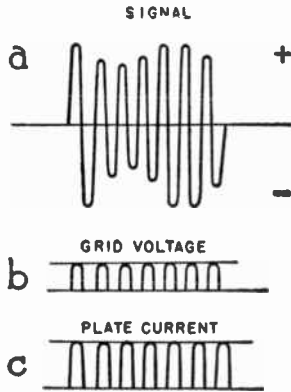

FIG. 4.—How the Limiter Affects a Strong Signal.

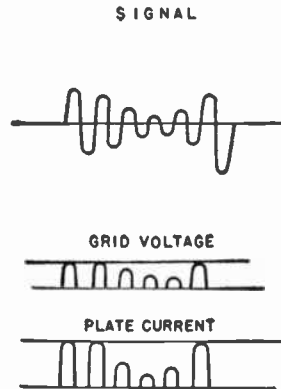

FIG. 5.—Limiter Fails to Make a Weak Signal Uniform.

through to the limiter with enough strength to produce uniform pulses of plate current in the limiter output. If the signal is insufficiently amplified to do this, the noises represented by amplitude modulation will pass through the limiter stage and be reproduced in the loud speaker. If every negative amplitude is not strong enough to produce plate current cutoff the noise-free characteristic of this type of receiver will not be present, for then the limiter acts merely as a voltage amplifier. Some receivers use more than one limiter stage, with the stages in cascade.

Discriminator.—Connections which may be used in a discriminator stage are shown by Fig. 6. Adjustable condenser C_2 , coil L_2 , bypass C_c , and resistor R_3 are the same as similarly numbered parts in Fig. 3, and are parts of the coupling transformer between the limiter and discriminator.

Center-tapped coil L_3 of Fig. 6 is inductively coupled to L_2 ,

RECEIVER, FREQUENCY MODULATED

and there is also a direct coupling between limiter and discriminator through condenser C_3 . Coil L_3 is tuned by adjustable condenser C_4 , and the outer ends of this tuned circuit are connected to the two plates in the double-diode tube.

A diode tube, containing only a plate and a cathode, acts as a rectifier and allows current to flow only from plate to cathode, not in the reverse direction. Therefore, when alternating current is applied to such a tube the alternations in one direction pass through, while those in the opposite direction are stopped. The result is that a pulsating direct current flows in the tube circuit. The double-diode tube of Fig. 6 is merely two pairs of plates and two cathodes in one bulb, the combination acting as two rectifiers or as a full-wave rectifier.

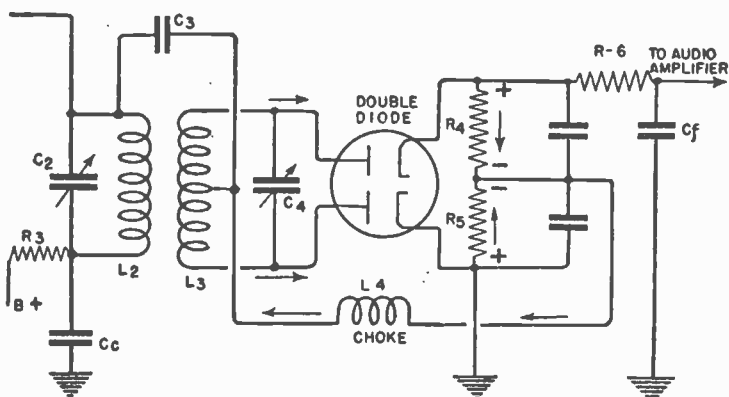

FIG. 6.—The Discriminator Stage of an FM Receiver.

Between the cathodes of the double-diode tube in Fig. 6 are resistors R_4 and R_5 , bypassed by condensers C_d and C_e . The other ends of these two resistors are connected together and through choke coil L_4 to the center tap on coil L_3 and to coupling condenser C_3 . A resistor is sometimes used instead of the choke. The output signal from the discriminator goes to the grid of an audio amplifying tube through resistor R_6 which is bypassed by condenser C_f .

Since coil L_2 is connected to the center of L_3 through condenser C_3 , and since a condenser passes alternating current, the alternating signal voltage across coil L_2 will add to the alternating voltage produced in the upper half of L_3 , and will be applied to the upper diode plate of the tube. The voltage from coil L_2 will similarly add to the voltage produced in the lower half of L_3 , and will be applied to the lower diode plate in the tube.

The positive alternations of these voltages applied to the diode plates cause currents to flow, as shown by arrows, from the upper

RECEIVER, FREQUENCY MODULATED

cathode through resistor R_4 and from the lower cathode through resistor R_5 , then through choke L_4 , the halves of coil L_3 , and back to the diode plates.

When the frequency coming from the limiter is higher than the average frequency of the carrier, to which L_2 and L_3 are tuned, the upper diode receives more voltage than the lower one, and its direct current through R_4 becomes greater than the direct current through R_5 . Since this greater direct current makes the top of R_4 strongly positive, while the top of R_5 is but weakly negative, the effect is to make the upper end of the resistor combination positive. Then the voltage applied to the audio output goes positive.

When the incoming frequency is lower than the frequency to which L_2 and L_3 are tuned, the lower diode receives the greater voltage and passes the greater current through R_5 . Now the strongly negative voltage at the top of R_5 overcomes the weakly positive voltage at the top of R_4 , and the upper end of the resistor combination becomes negative. This negative voltage is applied to the audio frequency output.

Thus, in the output of the discriminator stage we have a rising and falling voltage whose frequency corresponds to changes of frequency in the incoming signal, as the signal frequency goes above and below the average carrier frequency during modulation. This is the audio frequency impressed on the carrier at the transmitter, and now it actuates the audio amplifier in the receiver. The discriminator is in reality a detector stage which changes the modulated intermediate frequency coming through the limiter into audio frequency voltages which will reproduce as sound.

In order to provide as many channels as possible, with their overall band width of 50 to 150 cycles, frequency modulation is necessarily restricted to the very high frequencies, above 40 megacycles. At these high frequencies the carrier waves act much like light waves, traveling in almost straight lines. This limits the area over which the signals may be received. An advantage of operating at these high frequencies is that static makes comparatively little trouble.

When two transmitters are operating on frequencies close to each other, a receiver ordinarily can hear only the stronger of the two stations. Signals from the weaker station are entirely inaudible in the background. As a general rule, and especially in broadcast reception, this blanketing of the weaker signal is an advantage, because it gives the effect of additional selectivity. However, when it is the weaker station that is desired, it is difficult to know whether the signals are or are not present. This may be a disadvantage in communication work when searching for certain signals.

RECEIVER, LONG WAVE

Transmitting apparatus for frequency modulation is quite simple, with almost no power being used in modulating the carrier. The frequency is varied by varying the effective inductance of the oscillator tuned tank circuit. This effective inductance is varied in accordance with the audio frequency input applied between the screen and cathode of the modulator tube. To obtain the necessary wide frequency swing with modulation, the oscillator frequency usually is much lower than the desired carrier frequency, with frequency doublers being used to multiply the original modulated carrier frequency.

RECEIVER, LONG WAVE.—A great deal of the commercial and Government radio telegraph communication is carried on with the so called “long waves,” the wavelengths above 600 meters and extending to 15,000 meters. The circuits of a receiver suited for these long waves or low frequencies are shown in the diagram. Layout, wiring and specifications are also given.

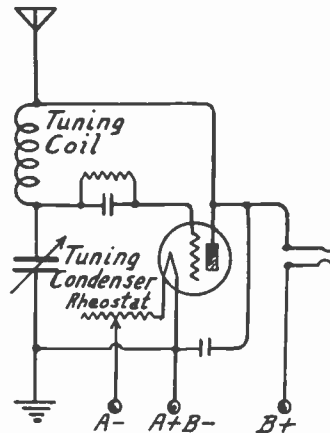

Long Wave Receiver.

The tube may be any of the usual amplifying types. Receiving is done with the tube in an oscillating condition so that a beat note is produced between the tube and the incoming signal. The variable tuning condenser is of .001 microfarad or 1000 micro-microfarad capacity. The tuning coil is made of various sizes according to the wavelength to be received. The mounting for this coil should be such that the coil itself is easily removed and replaced with a different size.

RECEIVER, SHORT WAVE

RECEIVER, SHORT WAVE.—Short wave radio refers to transmission and reception of signals of any character in the frequency range greater than 1,750 kilocycles or at wavelengths shorter than about 160 meters.

With the development of the triode vacuum tube as a generator of radio frequency energy the necessity for long wave transmission ceased to exist. However, the behavior of the short wave regions had not been explored and the general impression that waves below 200 meters were of no value continued until approximately 1922.

Ship code transmitters prior to the advent of regular broadcast programs, operated on three commercial wavelengths by international agreement. These wavelengths were 600, 450 and 300 meters. Maximum efficiency was obtained, by design, on the 600 meter wave which was used as the international calling and distress wave. The other two waves were used for traffic handling in congested areas after original contact had been made on 600 meters.

Today, by mutual agreement between the United States and Canada, the ship transmitters used on the Great Lakes operate on a wavelength of 732 meters rather than 600 meters to minimize interference to broadcast reception.

Early broadcast transmitters were assigned a wavelength of 340 meters and unlimited operating hours. It soon became apparent, however, that interference in the form of a heterodyne whistle would attend reception if two transmitters were operated at nearly the same fundamental frequency. Thereafter each broadcast transmitter was granted a separate wavelength until a more logical system was evolved. A certain frequency band was set aside for the exclusive use of broadcast transmissions and each station was assigned a definite frequency in this band. This standard broadcast band occupies a frequency spread between 540 and 1500 kilocycles. Stations are spaced 10 kilocycles apart within these limits. An additional 100 kilocycles was recently added to the high frequency end of the band and assigned to high fidelity transmissions. Station separation within this high fidelity band is twice as great as in the normal broadcast band, that is, high fidelity transmitters are 20 kilocycles apart.

Intensive development of wavelengths below 200 meters began in 1923. Contributions to the development of the short waves were made by government agencies, commercial communication interests as well as amateurs. Today, by far the greater portion of radio communication takes place below 200 meters. Stations of several hundred kilowatts output operating at frequencies as low as 10 K C (30,000 meters) were necessary to establish reliable communication over great distances prior to 1923. An equivalent dis-

RECEIVER, SHORT WAVE

tance with greater reliability can be covered with 25 K W at frequencies above 3000 K C with modern tube transmitters.

Within the past few years general public interest has been awakened in short waves because of the production of "all wave" receivers for home use designed to receive the many interesting types of telephone communications carried on below 200 meters such as police calls, aviation reports, foreign transmissions and amateur phone work. Television signals will undoubtedly be transmitted in the high frequency spectrum and the modern "all wave" receivers serve to acquaint the public with the intricacies of short wave tuning in preparation for television.

Independent experimenters have successfully transmitted short wave signals of a wavelength as low as 3 centimeters. Behavior of the ultra short waves is a direct contradiction to the results experienced in the medium short wave band and a considerable amount of research is still necessary to formulate rules governing their propagation.

In the medium short wave band covered by "all wave" receivers many factors enter into set design and operation requiring special attention.

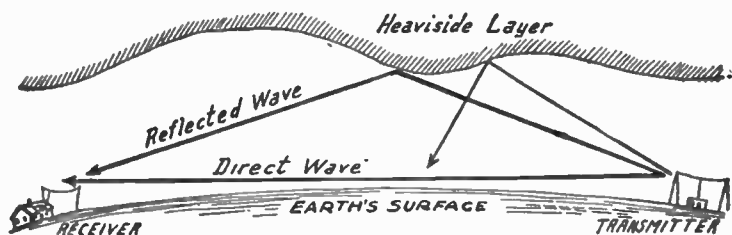
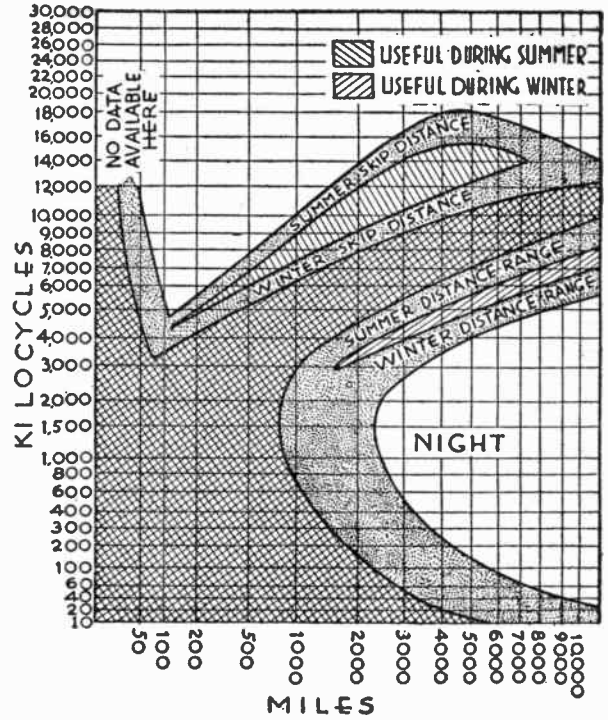
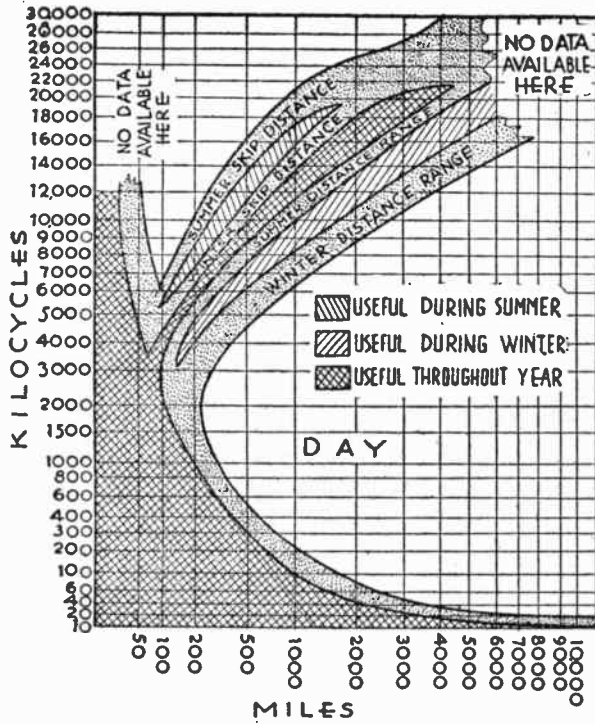

FIG. 1.—Effect of Heaviside Layer on Fading

Undoubtedly the greatest factor affecting short wave reception is the "fading" so prevalent at high frequencies which is only infrequently met with in the broadcast band. Radio transmission takes place by means of the propagation of a "ground wave" following the surface of the earth, a "sky wave" either reflected or refracted from the layer of ionized gases above the earth called the Kennelly-Heaviside layer, or by both waves. Both waves are subject to absorption and reflection in their transmission and further, the sky wave may be subject to multiple reflections, causing the reflected waves to arrive at a receiver in various phase relations. Reception from the ground wave of a transmitter is extremely reliable but can be received over only a comparatively short distance. Sky wave reception can take place over great dis-



RECEIVER, SHORT WAVE

FIG. 2.—

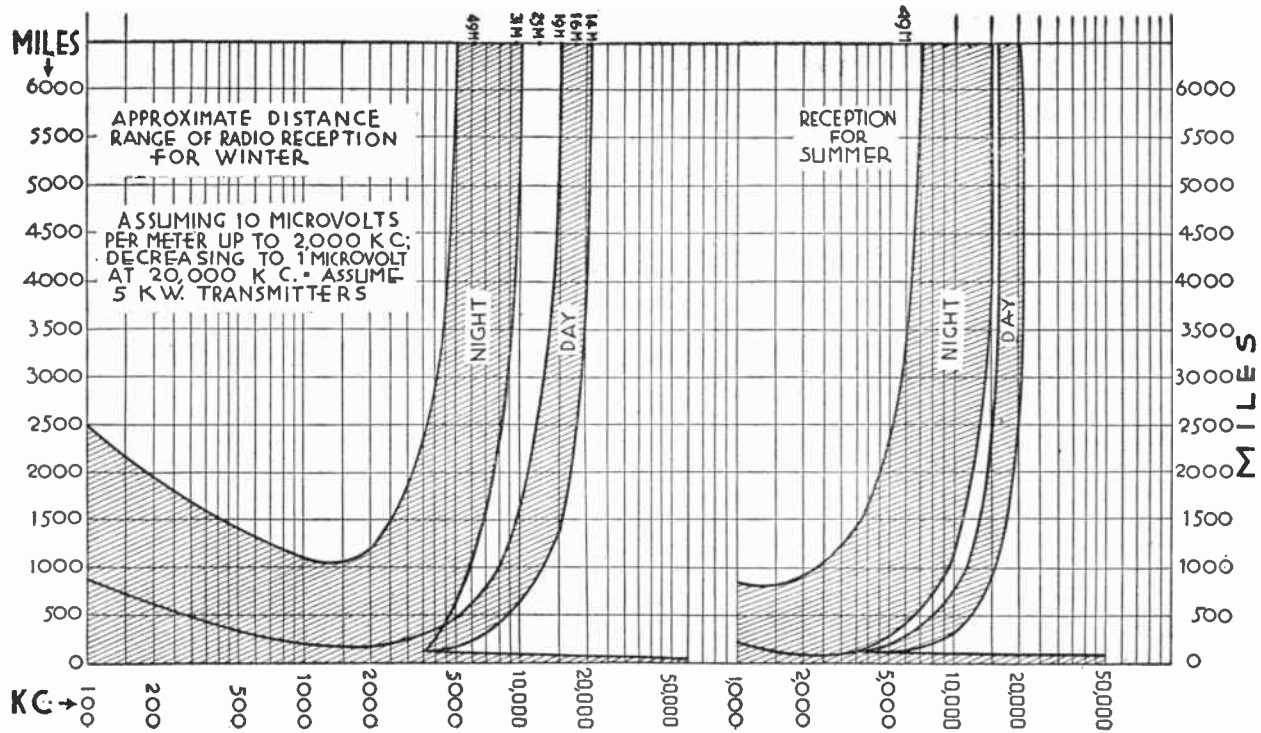

FIG. 3-1

RECEIVER, SHORT WAVE

tances but is affected by sun spots, seasonal changes as well as day and night heights of the Kennelly-Heaviside layer. Certain sections normally within the range of a transmitter will be unable to receive signals due to the phenomena known as "skip distance." Skip distance is defined as those areas beyond the ground wave range where the sky waves cannot be received. These skip distance boundaries are not stable and change greatly from one hour to the next, making reliable communication difficult. The reliable ground wave area for 3000 K C waves is approximately 100 miles and only about 20 miles for a frequency of 15,000 K C.

It is customary to refer to frequencies above 1000 K C in terms of megacycles, a megacycle being 1,000,000 cycles. Thus a 30 meter wave whose frequency is 10,000 K C would be said to have a frequency of 10 megacycles.

For wavelengths below 25 meters reception is generally more reliable during the day than at night while above 50 meters night-time reception is better than day. Tests show that below 20 meters the skywave can be heard with greatest consistency when the entire transmission distance lies in daylight. Between 20 and 35 meters, reception is most reliable when either the transmitter or receiver, but not both, lies in darkness.

The extent of public interest in short wave reception is shown by the fact that at least one popular radio receiver manufacturer has subsidized a foreign broadcast station to allow an increase of power and a more frequent broadcasting schedule to permit more consistent reception of a foreign station in the United States.

Seasonal changes in short wave reception are quite noticeable and again affect different frequencies in a different manner. During the summer months, and the year around in the tropics, reception is more satisfactory on wavelengths below 50 meters, while during the winter months short waves above 50 meters provide better reception. In general, short waves are less adversely affected by atmospheric disturbances than long waves and it is possible to obtain static-free reception even during a severe thunderstorm. Counteracting this beneficial effect is the fact that short waves are seriously interfered with by "man made" static such as auto ignition systems, electrical appliances, etc.

In the ultra short wave region the sky wave phenomena is not apparent and the ground wave alone carries the transmission. These waves seemingly follow the laws governing the transmission of light waves in that definite focusing, reflecting and refracting phenomena are noticeable. Waves below 10 centimeters, however, have a penetrability totally differing from any other type of wave existent.

Trans-oceanic commercial radio telephone systems use short wave transmitters of approximately 15 K W radiated power. It

RECEIVER, SHORT WAVE

is found, however, that at certain hours of the day, generally at sunrise and sunset when the action of the Kennelly-Heaviside layer undergoes its most erratic changes it becomes necessary to use a long wave (60 K C) transmitter of about 50 kilowatts to maintain communication. This long wave transmitter is also called into use when a severe magnetic storm disrupts short wave communication. Stations in the short wave service generally use one of several available frequencies such as 7, 9, 13 and 19 megacycles and change from one frequency to another on advice from a "monitoring bureau," constantly checking reception efficiency on all four frequencies.

The regenerative detector, popular in the early broadcast receiver circuits, was used for short wave reception but was found to be unsuitable for broadcast signals. Figure 4 shows the adoption of a regenerative circuit to short wave reception.

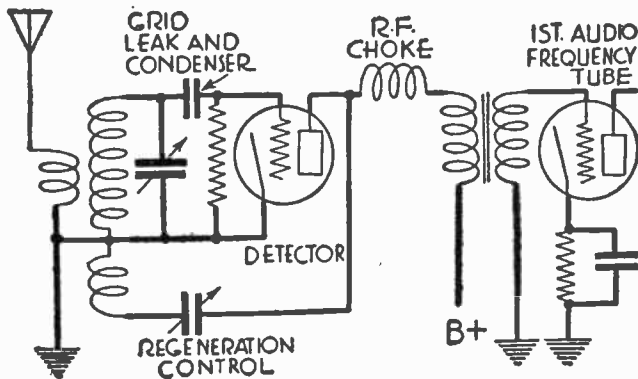

FIG. 4.—Regenerative Detector for Short Wave Reception

Regenerative Detectors.—In receivers employing a regenerative detector it is customary to provide an adjustment which varies the amount of regeneration for control of sensitivity and amplification. The feedback is secured in nearly all cases by coupling a tickler winding to the control grid winding for the detector, the tickler being connected in the tube's plate circuit. The regeneration control then varies the amount of radio frequency current flowing through the tickler.

In order to avoid the detuning effects of hand capacity it is necessary that one side of the control device be at ground potential and that the operating knob be attached to this grounded side. The variable unit may be either a condenser or a resistance, since either one will provide an adjustable opposition to radio frequency currents. Several methods of regeneration control with

RECEIVER, SHORT WAVE

one side of the resistance or condenser grounded are shown in Fig. 5.

The tickler winding is of small wire, something like number 30, is wound in the smallest possible space, preferably in a slot or in a narrow winding of many layers. This tickler is located at the cathode or ground end of the grid winding in order that regeneration control may have the least detuning effect. The small physical size of this type of tickler reduces its capacity coupling with the grid winding, but the inductive coupling is made rather close by placing the tickler near the end of the grid winding.

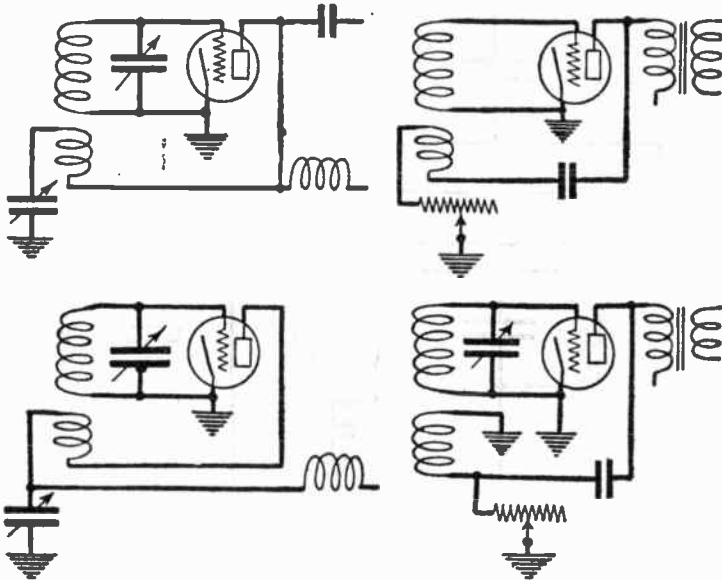

FIG. 5.—Regeneration Control Devices Having One Side Grounded

The number of turns in a tickler winding depends on the constants of other elements in the circuit and generally is determined by trial. The number of turns on a tickler for a given number of turns on the tuned grid winding may be about as follows:

Grid Winding	Tickler Winding	Grid Winding	Tickler Winding	Grid Winding	Tickler Winding
3	4	15	11	30	16
6	6	20	13	40	19
10	8	25	15	50	20

The aerial may be connected to the grid end of the tuned winding as in Fig. 6 or there may be a separate antenna winding coupled to the grid winding. When no separate winding is used it is necessary to place in series with the aerial lead a fixed or variable condenser having a maximum capacity of about 30 micro-

RECEIVER, SHORT WAVE

microfarads so that the capacity of the aerial and ground won't have too much effect on tuning. In a separate antenna coil there should be about the same number of turns as in the grid winding up to about six or eight turns, and from that point on there should be from one-half to one-third as many antenna turns as grid turns.

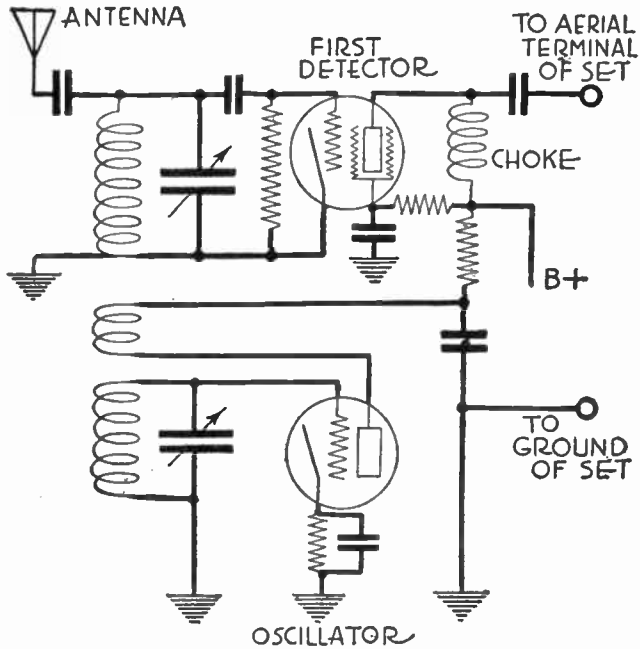

FIG. 6.—Superheterodyne Converter for Short Wave Reception

A broadcast band T.R.F. receiver can be converted into a short wave superheterodyne by the use of a so-called converter circuit. This converter is in fact the first detector and oscillator of a superheterodyne receiver with the proper inductances and capacities for short wave reception. The broadcast receiver is tuned to a portion of its spectrum normally unused and the radio frequency stages are used as the intermediate frequency of the superheterodyne. Figure 6 shows a schematic diagram of a converter.

Figure 7 represents a screen grid tube used as a space charge detector. A similar connection is sometimes encountered in early short wave receivers in which a screen grid tube is used as a space charge audio frequency amplifier. In this case the proper negative bias must be applied to the control element.

Practically all modern home type all-wave receivers are of the superheterodyne type. Fundamentally they are identical with the

RECEIVER, SHORT WAVE

standard broadcast band superheterodyne. Several features must be incorporated in the all-wave receiver structure making it differ considerably in design from the broadcast band type.

Short wave broadcast receivers were originally rated in several graduated steps such as "dual band," skip band and all-wave types. Manufacturers were lax in their descriptive terminology, which resulted in the Radio Manufacturers Association (an association of all important radio receiver manufacturers) formulating designations as follows:

1. A Standard Broadcast Receiver is one which will respond to the entire broadcast frequency range of 540 kilocycles to 1600 kilocycles (555.2 meters to 187 meters).

2. An All-Wave Receiver is one which will respond to all frequencies between 540 kilocycles and 18,000 kilocycles (555 to 16.6 meters).

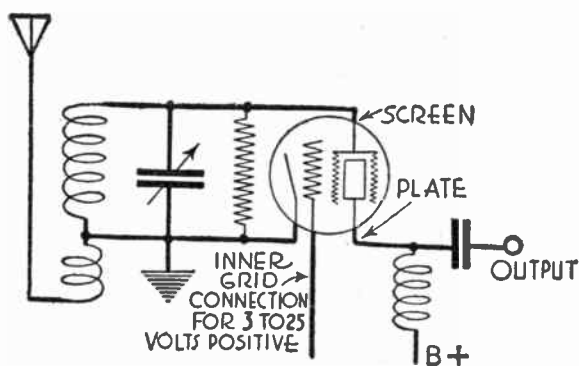

FIG. 7.—Screen Grid Tube as Space Charge Detector

Many receivers are designed to cover the standard broadcast band and an additional short wave band. The R M A does not officially designate such sets and the manufacturers refer to such receivers as "two band" or double range receivers.

It is customary to refer to high frequencies in terms of megacycles as stated before. However, it is convenient to speak of a given short wave band in terms of wavelength where the frequency would be an odd number. Thus manufacturers often mark a short wave dial with inscriptions such as "49 meter band," "31 meter band," etc.

All wave receivers cover the necessary frequency spread in four or five consecutive switching operations. The first position makes the receiver operative over the standard broadcast band 550 to 1600 kilocycles; the second provides tuning over the police, aviation and amateur radio phone band, the frequency range being from 1500 to 3900 kilocycles; the third band encompasses the

RECEIVER, SHORT WAVE

portion of the radio spectrum assigned to international broadcast transmission and covers from 3.9 to 10 megacycles while the fourth band ranging from 8 to 18 megacycles embraces four of the standardized short wave broadcast bands, viz., 16, 19, 25 and 31 meters respectively. A sufficient overlap is provided between bands to provide efficient coverage. Code signals will be heard over the portions of the short wave bands not assigned to broadcast service, but unless a beat frequency oscillator is provided, working into an I F stage or the second detector, the signals from

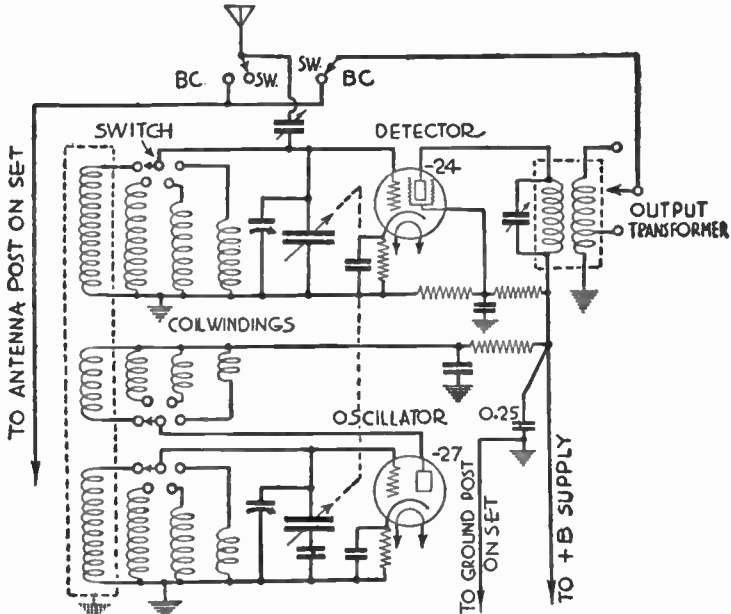

FIG. 8.—Circuit Diagram of Superheterodyne Converter

continuous wave transmitters will be unintelligible. Interrupted continuous wave commercial code signals will be heard in their normal characteristic sounds without the use of a beat frequency oscillator.

The switching system used to change from one band to another must function perfectly in a highly sensitive circuit combination. This requires infinite care in the design and construction of a switch to insure proper electrical contact as well as reliable mechanical operation over a long period of time. Many failures observed in early all wave receivers resulted from assigning too great a mechanical function to the wave-change switch such as moving successive dials into position, which caused warping of the switch shaft and eventual poor electrical contact. The switch

RECEIVER, SHORT WAVE

must provide a change of four or five inductances in each of three and sometimes four separate circuits. The first radio frequency stage, modulator or first detector and the oscillator circuit each require inductance changes, as switching is made from one band to another. Some receivers provide an additional stage of radio frequency amplification as the higher frequency bands are used. This requires that a fourth inductance be provided for on the switching arrangement.

Plug-in coil inductances were used in early short wave receivers, but the inconvenience attendant with band changing and their inefficiency prevented the use of such devices in factory built home receivers.

Several methods of inductance switching are prevalent in modern all wave receivers. Perhaps the simplest method is to provide an inductance large enough to cover the standard broadcast band with taps brought out at the proper points to provide lesser values of inductance for the short wave bands. These taps are brought out to switch points. This method is not highly efficient due to the "dead end" loss in the unused portion of the coil at high frequencies. Another method provides separate inductances connected to a special type of switch which parallels successive inductances. Still another type uses a separate and distinct coil for each band, which is perhaps the most approved method.

The switch proper is a multi-gang arrangement operated from a common shaft, each circuit being carefully insulated and shielded from its adjacent switch circuit. At least one all wave receiver manufacturer uses a method of rotating inductance coils for band changing, in which case the contact points connecting the coils to their associated tuning circuit remain stationary.

In common with other high frequency switching gear, the all wave switches must possess low contact resistance, low capacity between successive contact points and high insulation resistance.

The inductance coils for the high frequency bands must be carefully constructed to have the necessary characteristics. Coil forms must be rigid, non-hygroscopic and of high insulation resistance value. A slight change in coil form due to aging or warpage may detune a circuit several hundred kilocycles at the highest frequency band, causing faulty operation of that band. Windings must be rigidly fixed in position by grooving the coil form or some similar operation. The use of litz wire is of no marked advantage in the high frequency band and may in fact be a distinct disadvantage. The wire turns are generally spaced to reduce distributed capacity effects.

Connecting wires leading to the switch points are usually fixed in position as a slight shift of a lead would change the frequency response of a high frequency circuit.

RECEIVER, SHORT WAVE

The tuning condenser gang drive of an all wave receiver requires different treatment than that accorded a broadcast band set.

A high ratio vernier drive must be provided for tuning the short wave bands. A very slight progression of the mesh of the variable condenser plates on the short wave bands is capable of driving the resonant frequency over several hundred kilocycles—a frequency range capable of accommodating numerous short wave broadcast stations. In fact, the art of tuning a short wave band is not to be acquired in a few minutes of time as is the case in the standard broadcast band. Rather it becomes necessary to spend a certain amount of time in careful, patient search to be able to tune in foreign broadcast programs successfully.

Most tuning dials are equipped with a dual ratio drive, allowing a convenient, rapid tuning of the broadcast band while a high

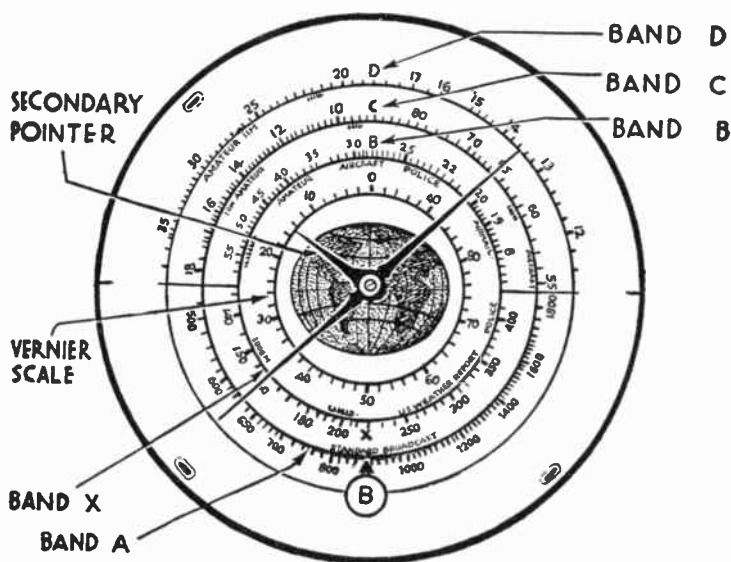

FIG. 9.—All Wave Tuning Dial

reduction ratio is used to explore the short wave bands. Vernier drives may have a ratio as high as 100 to 1. Various methods are used to change from one drive ratio to the other. One manufacturer obtains slow speed by reversing the rotation of the tuning knob, a full turn again engages the high speed tuning. Still another manufacturer uses a vertical displacement of the tuning knob in a friction drive to provide high and low ratios, while a third makes use of a planetary slow speed drive, which comes into action when the tuning knob is pulled out a short distance.

RECEIVER, SHORT WAVE

Dial indicators assume many different forms. The individual band in use may be illuminated while unused bands are dark; a cylindrical form may be rotated by the action of the wave change switch showing only the band in use; the dial may be displaced vertically before an aperture or separate pointers may be used for each band. The "airplane" type of dial with a main pointer and second hand is a popular type of dial in use on many brands of all wave receivers.

A beat frequency oscillator working into an intermediate frequency amplifier stage or second detector may be used to provide a convenient means for locating a distant short wave broadcast

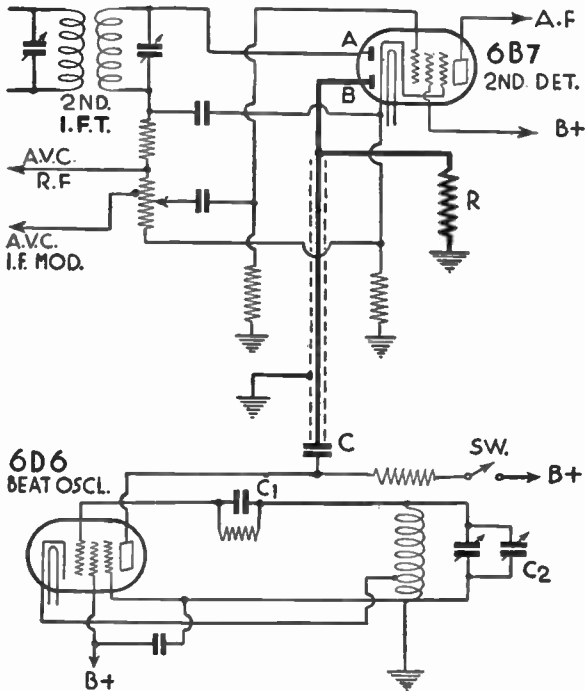

FIG. 10.—Beat Frequency Oscillator Circuit

station on the dial. The combination of the frequencies produced by the incoming carrier, after conversion to the intermediate frequency of the receiver, and the unmodulated signal output of the beat frequency oscillator produces an audible note in the loud speaker. This note is tuned to maximum intensity, the beat frequency oscillator is turned off and the short wave signal is reproduced by the loud speaker. Beat frequency oscillators are operated at a constant frequency in short wave broadcast receivers, the

RECEIVER, SHORT WAVE

audible note being in the neighborhood of 500 cycles, while in amateur and commercial short wave receivers a variation of the note is provided to suit the convenience or desire of the operator. Broadcast short wave receivers incorporating these beat frequency oscillators are referred to as having a "station locator" or a "signal beacon."

The purpose of automatic volume control used in conjunction with short wave receivers is materially different than its function in the standard broadcast band. A V C finds its greatest usefulness at standard broadcast frequencies in preventing overloading of the audio frequency amplifier when powerful nearby stations are being received. Signal fading in the high frequency portion of the spectrum makes it necessary to provide a highly efficient A V C system capable of varying the receiver sensitivity over



FIG. 11.—Reversed Scale Meter Tuning Indicator

wide limits to hold a constant loud speaker output. In this respect the A V C system is comparable to that used in automobile radio receiver design. Variation tolerances of components in the A V C circuit are held to more precise limits and these values must be adhered to if replacement is necessary.

By-pass condensers and cathode bias filter condensers of improved design are used in all wave receiver circuits. A special non-inductive type of condenser is necessary to prevent inductive loading of the high frequency circuits. This condenser construction aids in preventing the occurrence of "dead spots" at certain portions of the dial, which are caused by the high frequency oscillator becoming inoperative. An absorption circuit formed by stray

RECEIVER, SHORT WAVE

inductance and capacity is capable of throwing the high frequency oscillator out of oscillation at resonant frequencies and produces the "dead spot" effect.

Tuning indicators are used to indicate exact resonance with the incoming signal in the higher priced all wave receivers. The indicator is connected in the common plate supply to the A V C controlled stages. It may be a D C milliammeter with reversed scale, an iron vane milliammeter or a miniature cathode ray tube.

The reversed scale D C milliammeter has a full scale deflection of from three to ten milliamperes, depending on the number of A V C controlled stages. As a signal is tuned in the A V C system produces an additional voltage drop to be applied to the grids of the controlled tubes. This results in a decrease of plate current. The meter scale is reversed so that when the meter pointer is indicating a maximum value, actually the minimum current is flowing through the meter circuit. This is done to

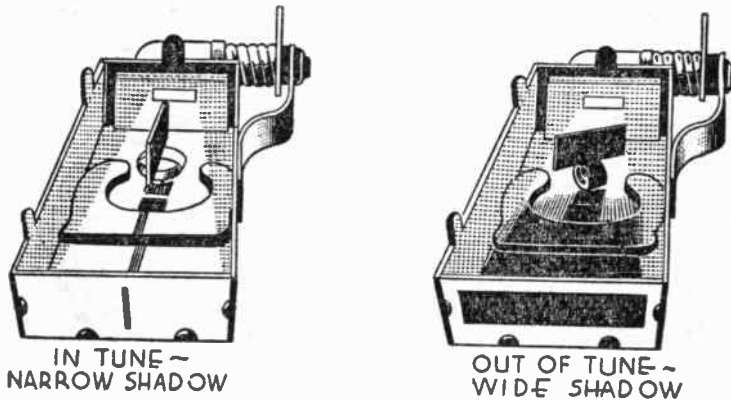

FIG. 12.—Iron Vane Tuning Meter

prevent confusion of the layman in his operation of a tuning meter controlled receiver.

The iron vane type of tuning meter deflects a pivoted circular vane in front of a pilot light. This causes a wide or narrow shadow on a ground glass, depending on the position of the vane. Proper tuning is obtained when the shadow is narrowest on the ground glass for a given carrier intensity. This corresponds to a minimum deflection of the iron vane.

All tuning indicators operate on the radio frequency carrier of a signal, the average amplitude of which is independent of the presence or absence of modulation. As no two stations are apt to put down the same signal level at a given receiver position, the tuning meters give a different indication for each station received.

RECEIVER, SHORT WAVE

The latest type of tuning indicator makes use of an electron stream impinging upon a luminescent screen coated on a target inside of a glass bulb. This type should not be confused with the early gaseous tuning indicators, depending upon ionization of an inert gas, such as neon, for its operation.

The 6 E 5 cathode ray tube used as a visual tuning indicator comprises an amplifier and the cathode ray section built in the same glass envelope. It is comparable in size to the standard glass R F amplifier tubes. The conically shaped luminescent screen upon which the image is formed produces a pattern varying in a shaded angle from 90 degrees to approximately 0 degrees, depending upon the voltage impressed on its control electrode.

When used in a commercial receiver the tube is mounted in a horizontal position with a small portion of its dome shaped top protruding through the front control panel. With no signal tuned in, the fluorescent area covers a ninety degree angle in the form

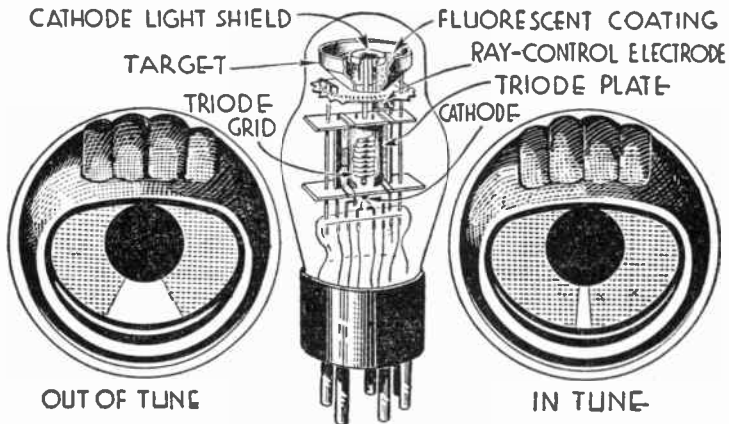

FIG. 13.—Cathode Ray Tuning Meter

of an arc around the target. As a signal is tuned in, the arc becomes narrower, reaching its minimum width as exact resonance is reached.

All Wave Antenna Systems.—Antenna systems required considerable revision in order to obtain good signals from distant stations in the high frequency bands.

With the increased sensitivity of the standard broadcast receivers the necessity for a highly efficient antenna system ceased to exist. Manufacturers suggested in their sales literature that the outside antenna be done away with wherever possible and in most cases a short indoor antenna would operate satisfactorily to bring in all except the very remote or extremely low powered stations.

RECEIVER, SHORT WAVE

The desire on the part of the public to tune in foreign short wave broadcast programs restored the antenna to the position of prime importance it was accorded in the very early days of the broadcast art. Short wave reception not only made a very good antenna system become a necessity, but it also brought about changes in antenna design due to the high level of "man made static" pick-up so noticeable in the short wave regions.

Shielding an antenna lead-in to prevent interference pick-up is entirely proper at the standard broadcast frequencies, but its efficiency decreases rapidly at the higher frequencies. This is due to the desired signal being passed to ground through the capacity effect of the shielding.

An unshielded twisted pair of wires are used as a lead-in to cancel out undesirable interference. This necessitates dividing the antenna into two sections, which produces a "doublet" type

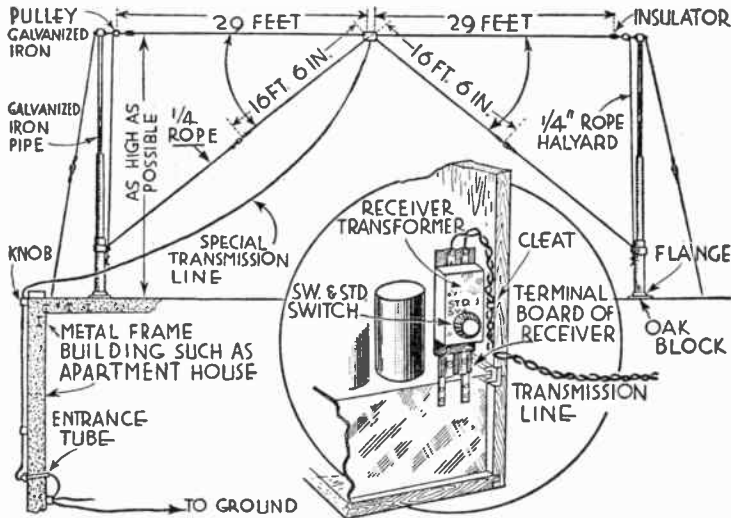

FIG. 14.—All Wave Antenna

and the lead-in becomes the transposed transmission line. It is found that a distinct advantage is obtained in increased signal strength when both halves of the doublet antenna resonate at one-fourth of the wavelength to be received. Also increased efficiency is obtained by matching the impedance of the antenna to the transmission line and the line, in turn, to the receiver. Coupling transformers are used for this purpose. A coupler is placed in the antenna system at the point where the transmission line is attached to the aerial and another is used at the junction of the line and receiver input. The antenna impedance changes from

RECEIVER, SHORT WAVE

one wave band to another, making it difficult, if not actually impossible, to design these coupling transformers to work efficiently on all of the receiver wave bands.

One of the most efficient antenna systems designed for all wave reception makes use of a double doublet. One doublet is tuned to the 16 meter band, the other being tuned to the 49 meter band. The connection of both doublets to the transmission line tends to give fairly high efficiency over all of the short wave bands. A switch is used on the matching transformer located at the receiver to adapt the antenna system to standard broadcast reception. Throwing this switch to "S T D" position eliminates the primary of the receiving transformer and disconnects one side of the twisted pair, thus converting the antenna system into a conventional "flat top" type for standard broadcast reception.

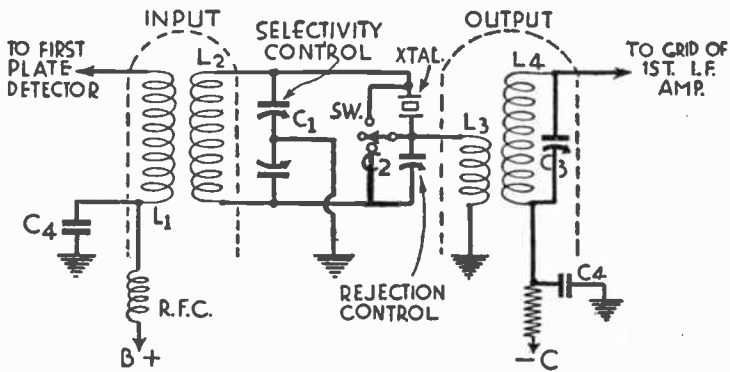

FIG. 15.—Crystal Filter Circuit

In special amateur and commercial communication receivers designed for code work increased selectivity is obtained by providing a quartz crystal filter ahead of the intermediate frequency amplifier. This crystal filter is connected in a bridge arrangement which serves to suppress one side-band from the received signal. Careful design is necessary to prevent the low impedance of the crystal at resonance from loading the following tuned circuit too greatly. The use of a crystal filter changes the characteristic of the received signal to a considerable degree. Quite frequently the advantage gained in selectivity by the elimination of one side-band is offset by the difficulty in copying the peculiar signal produced by the effect of the crystal.

RECEIVER, SUPERHETERODYNE

RECEIVER, SUPERHETERODYNE.—In the superheterodyne receiver signal amplification is carried out at three different frequencies in the three amplifiers of which such a receiver is composed. This principle is illustrated in Fig. 1. The signal which comes to the antenna in the form of a modulated radio frequency carrier wave is first amplified at radio frequencies. The amplified signal then is acted upon by a frequency changer which lowers the carrier frequency to an intermediate frequency at which further amplification takes place. The amplified intermediate frequency is changed to an audio frequency by the process of detection, and the remaining amplification takes place at audio frequencies.

It is in the intermediate frequency amplifier and the frequency changer, and in providing of amplification at an intermediate frequency, that the superheterodyne differs from other types of re-

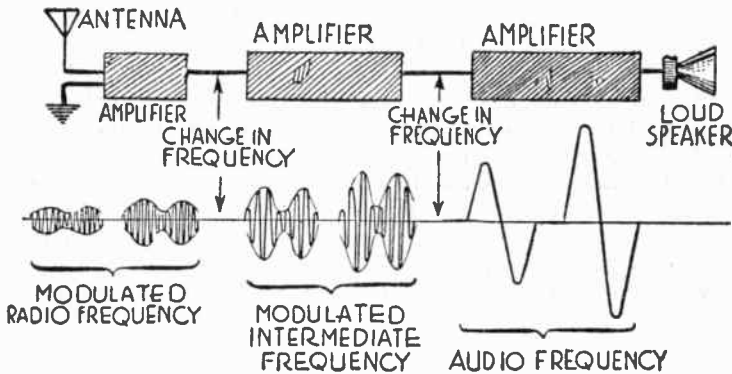

FIG. 1.—The Three Frequencies Used in Superheterodyne Reception.

ceivers. The radio frequency amplifier, the detector which precedes the audio frequency amplifier, and the audio frequency amplifier differ in no important particulars from similar parts in tuned radio frequency apparatus.

Early Types of Superheterodynes.—In the earliest superheterodyne receivers there appeared only the frequency changer, the intermediate amplifier, the detector and the audio amplifier; amplification at radio frequencies not being attempted. The parts of such a receiver are shown by Fig. 2. The chief reason for using the superheterodyne was that it avoided the troubles associated with radio frequency amplification, troubles such as lack of stability and tendency toward oscillation in the amplifying tubes, also low amplification per stage. Intermediate frequencies first were chosen around 30 to 40 kilocycles, just above audibility. At these low intermediate frequencies the three-element tubes then used

RECEIVER, SUPERHETERODYNE

were stable in operation, feedbacks were not troublesome, and it was possible to obtain the maximum amplification of which the tubes were capable. Since all the intermediate stages of a superheterodyne are tuned to the one intermediate frequency it was possible to use three or more such stages without complicating the tuning controls, and thus the overall amplification and the selectivity of the superheterodyne could be made far superior to these qualities in any other contemporary type of receiver. The great

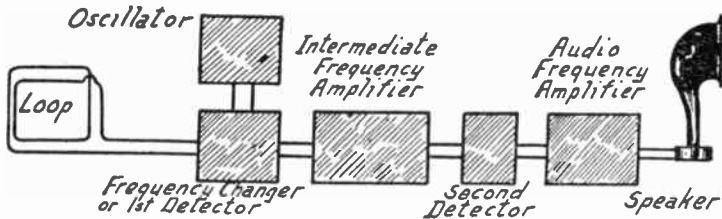

FIG. 2.—Parts Used in Early Superheterodynes.

practical disadvantage of early superheterodynes was in the comparatively large number of tubes required, the cost of these tubes, and the difficulty of supplying sufficient operating power.

Manufacture of the superheterodyne was restricted by patent rights, and tuned radio frequency receivers were developed to high efficiency at low cost during a number of years. Release of these restrictions then allowed production of the superheterodyne by many makers, and while the fundamental principles have been re-

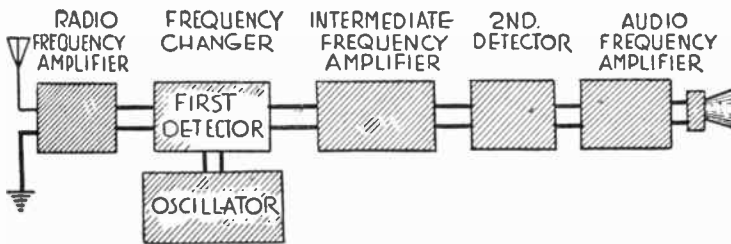

FIG. 3.—Elements of a Modern Superheterodyne.

tained, the new designs contain numerous refinements not present in the early models.

Elements of the Superheterodyne.—The parts entering into the construction of a modern superheterodyne receiver are indicated in Fig. 3. The radio frequency amplifier consists of one stage, or possibly two stages, of tuned radio frequency amplification. The frequency changer includes two tubes, one called the first detector or modulator and the other called the oscillator. This

RECEIVER, SUPERHETERODYNE

portion of the receiver changes the radio frequency signal to a signal at the intermediate frequency which retains the modulation of the carrier.

The intermediate frequency amplifier consists of one or more tuned stages, each having a high degree of amplification, in which the signal strength is greatly increased. The second detector, also called the demodulator, separates the signal modulation from the intermediate frequency and passes the modulation in the form of audio frequency currents to the audio frequency amplifier where the signal power is increased to an amount allowing operation of the loud speaker.

The principle of the first detector or modulator is shown in Fig. 4 where the tube's tuned grid circuit is excited by the modulated radio frequency from the pre-amplifier, thus impressing this radio frequency on the control grid. The grid circuit passes through the oscillator in which there is being generated a frequency higher than that of the signal. The oscillator frequency thus is impressed on the modulator grid along with the radio frequency.

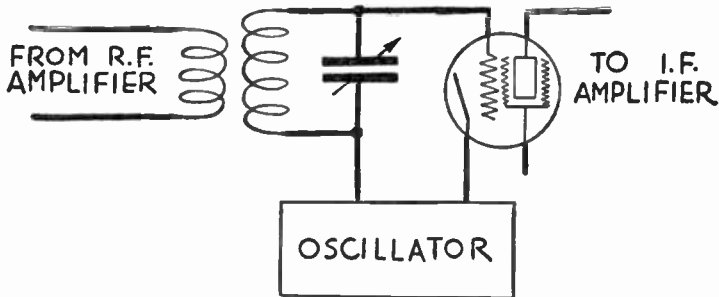

FIG. 4.—How the Oscillator Frequency Is Added to the Carrier.

The two frequencies applied to the modulator tube combine as explained under *Beats, Formation of*, to produce a third frequency called the beat frequency which is equal to the difference between the oscillator frequency and the radio frequency of the incoming signal. This beat frequency is the superheterodyne's intermediate frequency which is delivered by the first detector or modulator to the intermediate frequency amplifier.

Various intermediate frequencies have been used, most of them lying between 30 kilocycles and 350 kilocycles, higher than the highest audio frequency and lower than the lowest carrier frequency in the broadcast band. A very large number of superheterodyne receivers have been built to use an intermediate frequency of 175 kilocycles and this frequency will be used for purposes of illustration in many examples following, although all the principles apply equally well to any other intermediate frequency. Each of the stages in the intermediate amplifier is adjusted once for all to be resonant at the chosen intermediate frequency and no tuning operations are required in this part of the receiver during its use.

Intermediate and Carrier Frequencies.—The intermediate frequency must always be equal to the difference between the oscillator frequency and the carrier frequency. For example, if a 1000-kilocycle carrier is to be changed to a 175-kilocycle inter-

RECEIVER, SUPERHETERODYNE

mediate, then the oscillator frequency is made 1175 kilocycles so that the difference between this 1175 kilocycles and 1000 kilocycles will equal the 175 kilocycles of the intermediate frequency.

The whole intermediate amplifier is tuned permanently to its frequency, consequently the intermediate frequency cannot be changed as different stations are brought in. But the carrier frequencies of these different stations are different from one another. Then inasmuch as the intermediate frequency cannot be changed and the carrier frequency must change, the only way to maintain the constant difference between oscillator and carrier is to change the frequency of the oscillator every time a new carrier is tuned in.

The radio frequency tuning for the carrier and the tuning of the oscillator are always changed together by connecting the tuning controls for both units to the single tuning knob or dial of

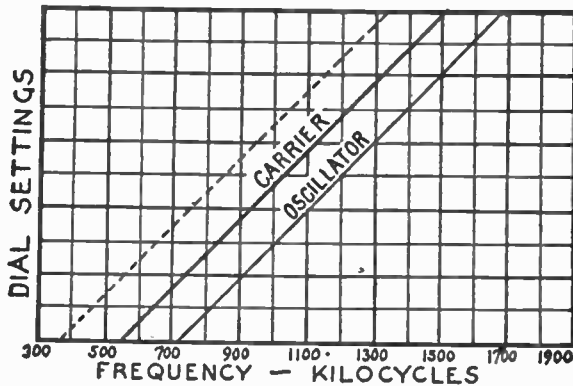

FIG. 5.—Relation of Oscillator and Carrier Frequencies.

the receiver. Thus the proper separation between oscillator and carrier frequencies is maintained throughout the entire tuning range as indicated in Fig. 5 which shows the correct oscillator and carrier frequencies for the broadcast band when a 175-kilocycle intermediate frequency is in use.

Again considering the 1000-kilocycle carrier, it is found also that an oscillator frequency of 825 kilocycles will produce a beat of 175 kilocycles, because the difference between 1000 kilocycles and 825 kilocycles is 175 kilocycles. For any other carrier the oscillator may be set at a frequency 175 kilocycles below that carrier and the intermediate frequency will be produced just as effectively as with the oscillator above the carrier. This is indicated by the broken line in Fig. 5. In the early superheterodynes the loop for the first detector was tuned with one dial and the oscillator with a separate second dial, it being possible to receive any given station either with the oscillator frequency set above the carrier or below the carrier. This two-spot tuning was one objection to those receivers.

Only the upper frequency of the oscillator is used at present because it

RECEIVER, SUPERHETERODYNE

is easier to tune through the upper settings than the lower ones. From Fig. 5 it may be seen that the upper oscillator settings require tuning only from 725 to 1675 kilocycles, a change of about 131 per cent. But with the lower settings the change must be from 375 to 1325 kilocycles, a change of nearly 254 per cent. Another reason for choosing the higher frequencies is that any tube oscillates more easily at high than at low frequencies. Having chosen the higher oscillator frequency, the relation is maintained because both the oscillator and the first detector are tuned by means of a single dial in the new receivers and it is impossible for the user to alter this relation.

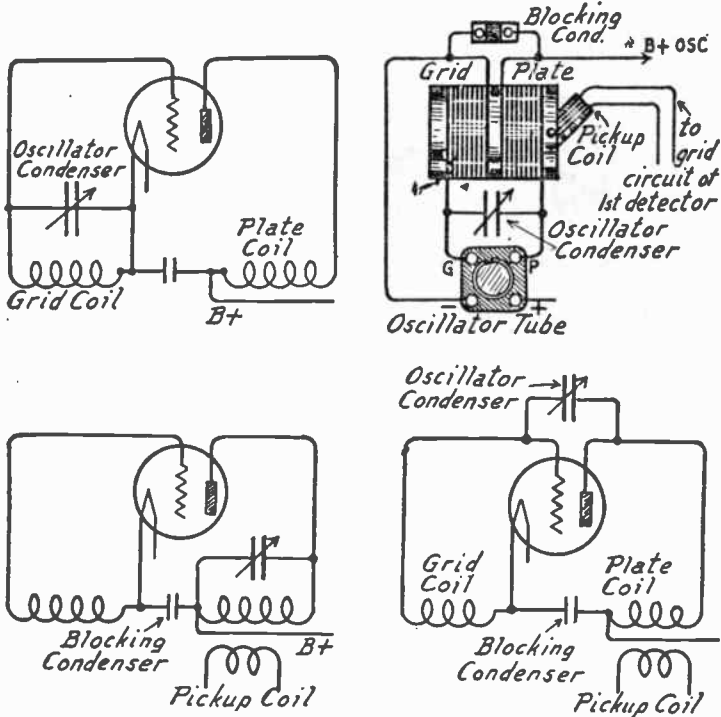

FIG. 6.—Oscillators with Tuned Grid (above) and Tuned Plate (below).

FIG. 7.—Oscillator in Which Grid Coil and Plate Coil Are Tuned Together.

Choice of Intermediate Frequency.—When speaking of high or low intermediate frequencies reference is not being made to any relation between oscillator and carrier frequencies, but rather to the absolute value of the intermediate as compared with other intermediate frequencies which may be used. Thus, a 30-kilocycle intermediate frequency is considered to be a very low one, and a 350-kilocycle intermediate is considered as high. Nearly all superheterodynes of recent design use intermediate frequencies somewhere between 100 kilocycles and 250 kilocycles.

RECEIVER, SUPERHETERODYNE

There are advantages and disadvantages both with high intermediate frequencies and with low ones, so the choice must be a compromise. A low frequency intermediate amplifier has advantages of greater stability or less danger of self-sustained oscillation because of lessened feedbacks between circuit elements. Low frequency thus allows greater amplification per stage. The low frequency amplifier is more selective than the high frequency type because of having less high frequency resistance to broaden the tuning.

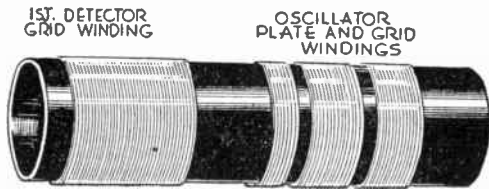

FIG. 8.—Coupling of Oscillator and First Detector Coils.

On the other hand a very low intermediate frequency allows noisy reception because it efficiently amplifies any low frequency interference which enters the circuits. With a low intermediate frequency its second harmonic may be radiated from the second detector circuits and get back into the preceding stages to produce beats with undesired signals. With an inter-

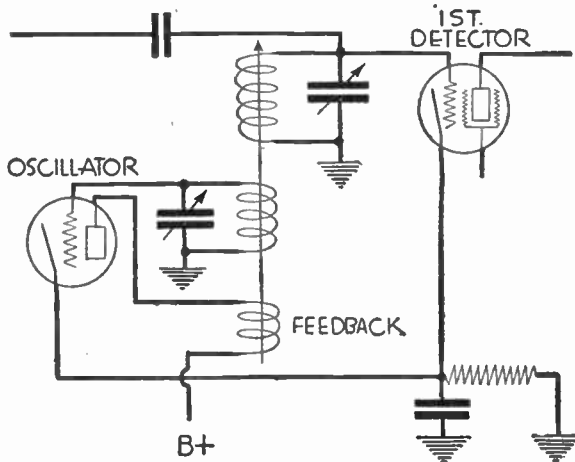

FIG. 9.—Coupling of Grid Windings of Oscillator and Detector.

mediate of 175 kilocycles, the fourth harmonic of 700 kilocycles is the lowest that falls within the broadcast band.

Oscillator Circuit.—It is possible to use any type of oscillator for a superheterodyne and as shown in Figs. 6 and 7, these

RECEIVER, SUPERHETERODYNE

oscillators have been built with tuned grid circuits, with tuned plate circuits, and with the tuning condenser connected across both the grid and plate windings at once. In the newer receivers it is customary to tune only the oscillator grid winding.

The oscillator voltages may be carried into the grid circuit of the first detector in any one of several ways. In many of the older receivers the pickup coil included in the first detector grid circuit was inductively coupled to the oscillator windings as shown in Fig. 7, the angle of the pickup coil being adjustable so that more or less of the oscillator voltage might be applied to the detector and the amplified carrier. Newer receivers seldom provide adjustable coupling between oscillator and first detector but, as shown

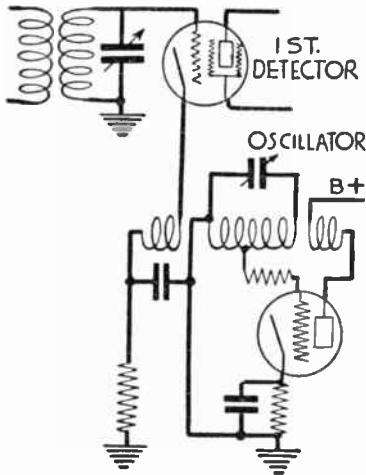

FIG. 10.—Oscillator Coupled to Detector Cathode.

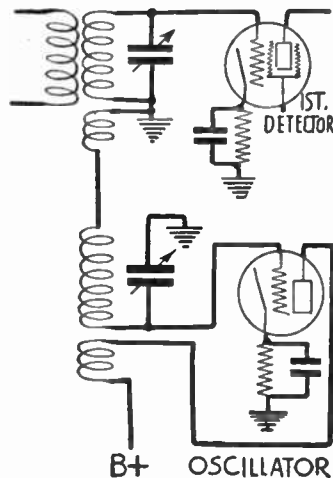

FIG. 11.—Oscillator Coupled to Detector's Tuned Grid Coil.

in Fig. 8, place all of the coils in fixed relation to one another on a single winding form.

In the circuit of Fig. 9, which applies to the windings shown in Fig. 8, the grid circuit winding of the first detector is inductively coupled, though quite loosely coupled, to the windings of the oscillator grid circuit and plate circuit. Feedback to maintain oscillation is provided through coupling a small winding in the oscillator's plate circuit to the grid circuit windings of this tube.

In the circuit of Fig. 10 the cathode lead of the first detector contains a small coil which is inductively coupled to the oscillator's grid and plate windings, the cathode ground being on the other side of this coupling coil. Since the cathode forms a part of the grid circuit for the first detector the coupling coil is included in this grid circuit and oscillator voltages are applied to the detector grid.

In the circuit of Fig. 11 a small coupling coil is connected in series with the oscillator's tuned grid winding and this small coil is inductively coupled to the tuned grid circuit of the first detector.

RECEIVER, SUPERHETERODYNE

Any type of coupling between oscillator and first detector **must** be loose enough so that tuning of the detector during reception won't affect the frequency of the oscillator. The principal means of feedback in all the oscillators shown is through coupling between a winding in the tube's plate circuit and another winding in its grid circuit. Feedback through the interelectrode capacities of the oscillator tube also assists in the action.

Oscillator Power Output.—Within certain limits the strength of signal fed to the intermediate amplifier is proportionate to the sum of the voltage applied to the first detector by the radio frequency amplifier and the voltage applied by the oscillator. Thus, as shown in Fig. 12, a greater oscillator voltage results in a stronger signal for the intermediate amplifier and in greater output from the receiver as a whole. The oscillator voltage is maintained at the highest level which will not overload the first detector at any point in the tuning range.

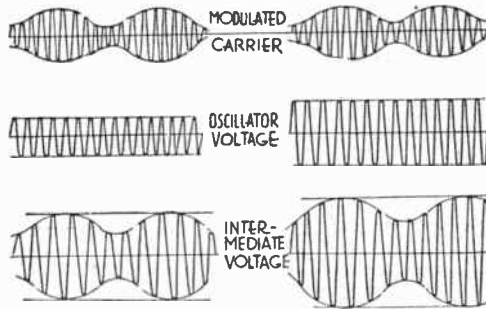

FIG. 12.—How Oscillator Voltage Increases Intermediate Voltage.

It also is important that the oscillator voltage be maintained at a uniform level throughout the tuning range, or at a level as nearly uniform as is possible. If the oscillator voltage is relatively very high either at the low frequency end or at the high frequency end of the tuning, the receiver power output likewise will be high at that end, and will be relatively low at the other end of the dial. To attain a practically constant voltage from the oscillator it is customary to tune the grid circuit rather than the plate circuit of this tube, also to use a comparatively large capacity and small inductance to form the tuned circuit.

Although nearly all commercial superheterodynes introduce the oscillator voltage into the cathode lead or the control grid circuit of the first detector, there are designs in which the oscillator output is coupled to the detector's plate circuit and others with coupling to the screen circuit of the first detector.

Effect of Oscillator Harmonics.—Any oscillating tube tends to produce in its output not only the frequency to which the circuits are tuned but also a series of harmonics of this frequency. Thus, an oscillator working at 800 kilocycles will tend to produce also 1600 kilocycles, 2400 kilocycles, etc. Under some conditions

RECEIVER, SUPERHETERODYNE

this effect may lead to reception of a second station in addition to the one desired.

For an example, assume that a receiver using the 175-kilocycle intermediate frequency is tuned to a carrier of 600 kilocycles. The oscillator frequency then will be 775 kilocycles and its second harmonic will be 1550 kilocycles. If, at the same time, there is another nearby station broadcasting on 1370 kilocycles the difference between the 1550-kilocycle second harmonic and this carrier will be 180 kilocycles, which is within 5 kilocycles of the intermediate frequency. Similarly a third station on 1380 kilocycles will beat with the oscillator harmonic to produce 170 kilocycles, again within 5 kilocycles of the amplified intermediate frequency.

The possibility of such troubles as outlined is practically eliminated by the tuned radio frequency circuits ahead of the first detector, these circuits effectively tuning out the interfering stations. It also is possible to greatly reduce the strength of oscillator harmonics by operating this tube with moderate plate voltages and grid biases.

First Detector.—The first detector tube usually is a screen grid type, often a variable-mu variety, because of the superior amplification possible with such tubes. The detection is obtained by plate rectification or by grid bias rather than with the grid leak and condenser method of grid rectification.

The first detector generally is operated with automatic grid bias, that is, with a biasing resistor in the tube's cathode line. An increase of signal voltage on the control grid results in an increase of average plate current, and this greater plate current makes the bias more negative. The amount of negative bias thus increases somewhat proportionately to the signal voltage and the danger of overloading this tube with strong signals is lessened.

The oscillator's output voltage naturally tends to increase toward the high frequency end of the tuning range, and these higher voltages are applied to the first detector grid. But overloading of the detector is automatically prevented by the grid biasing arrangement just explained, and it is permissible to work the oscillator at outputs higher than could be used under other conditions of detector operation.

Radio Frequency Amplifier.—The chief purpose of the radio frequency amplification used ahead of the first detector is to select only the one carrier frequency to which the receiver is tuned, or to provide sufficient selectivity to rule out stations which may provide interference in various ways, such as because of oscillator harmonics and other difficulties still to be mentioned.

The amplification provided in most radio frequency stages is also of assistance in raising the strength of the carrier before it reaches the first detector, thus improving the ratio of signal voltage to oscillator voltage. Any oscillator produces a certain amount of hiss which passes through the first detector into the intermediate amplifier and unless the signal is of good strength before reaching the first detector this hiss will form a large proportion of the receiver's audio frequency output.

An incidental advantage of radio frequency amplification is that it so isolates the oscillator from the antenna system that there is none of the objectionable radiation which occurred with early superheterodyne receivers not having such pre-amplifiers. The radio frequency amplifier also allows the use of an ordinary open antenna system in place of the loop antenna generally used with early superheterodynes. Loop tuning is troublesome in that it is affected by any movement of the loop with reference to other

RECEIVER, SUPERHETERODYNE

nearly objects. To make loop tuning effective requires a separate tuning condenser and prohibits single control.

A typical pre-amplifier using a band selector circuit for tuning is illustrated in Fig. 13. Any form of radio frequency amplification providing good selectivity without excessive side band cutting is satisfactory ahead of the first detector.

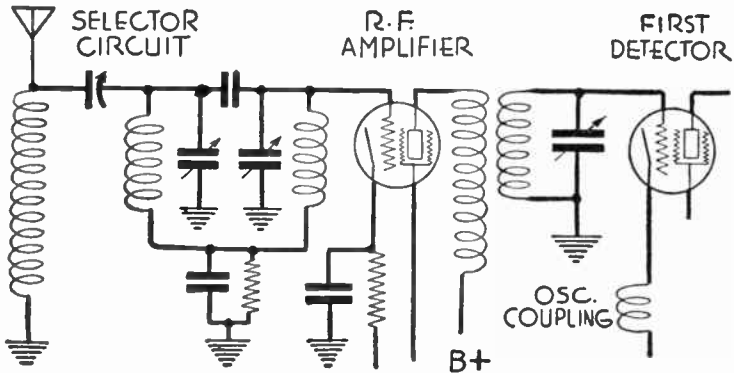

FIG. 13.—Band Selector Type of Pre-amplifier for Superheterodyne.

Intermediate Amplifier.—The majority of intermediate amplifiers for superheterodynes embody variable- μ screen grid tubes with transformer coupling giving band selector characteristics.

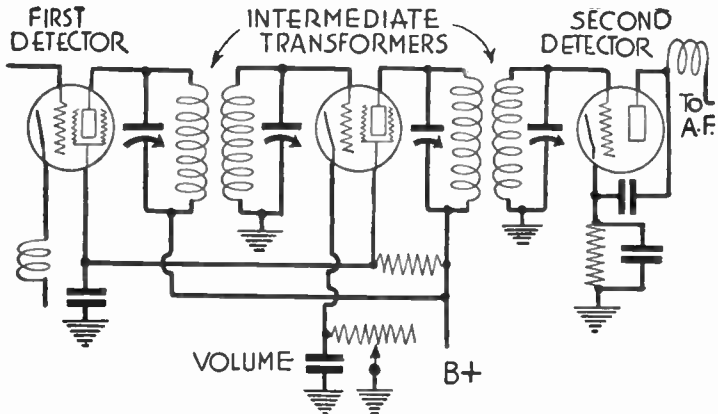

FIG. 14.—Typical Intermediate Frequency Amplifier.

Such an amplifier is shown in Fig. 14. In this design, which represents common practice, both the primary or plate side and the secondary or grid side are tuned in each transformer. In other designs some transformers may have both windings tuned while

RECEIVER, SUPERHETERODYNE

other transformers in the same amplifier tune only the plate side or only the grid side.

The transformer following the first detector may be built with coupling sufficiently loose to produce sharply a peaked resonance curve as shown at the left in Fig. 15, the second transformer and those following it having close coupling which results in broader tuning as shown at the center of

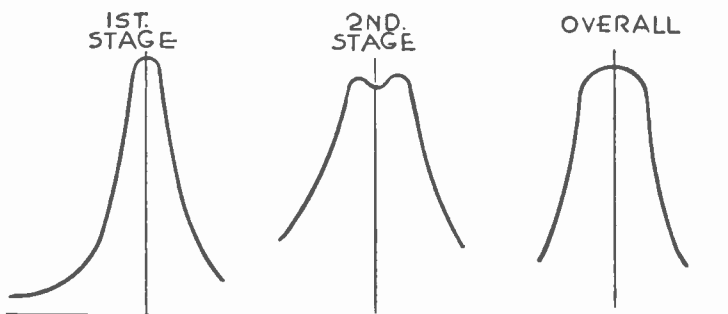

FIG. 15.—Resonance Curves for Intermediate Amplifier.

Fig. 15. The overall response of the intermediate amplifier is then as shown at the right, having a broad top to prevent side band attenuation and having quite sharp sides to provide good selectivity.

The construction of typical intermediate frequency transformers is illustrated in Fig. 16 where the shielding cans have been cut away to show the

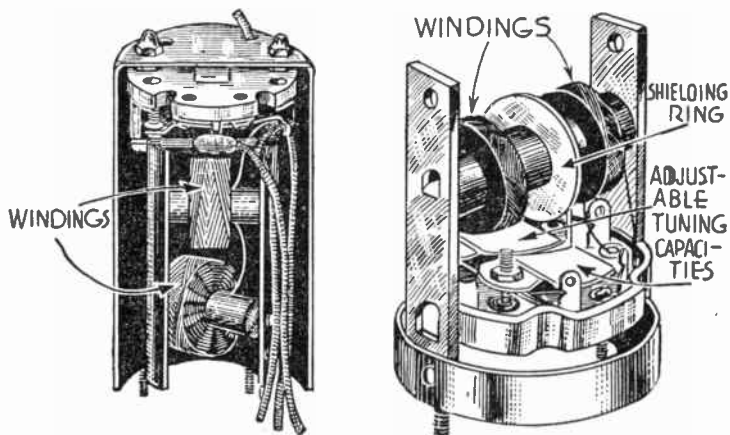

FIG. 16.—Construction of Intermediate Frequency Transformers.

inductances and capacities. The coupling may be varied by changing the angle between windings or by moving the two windings, primary and secondary, farther apart on their support. The transformer shown at the right in Fig. 16 has a copper shielding disc between the two windings, this disc greatly lessening the coupling factor and allowing a sharply peaked

RECEIVER, SUPERHETERODYNE

resonance curve such as employed in some first stages of these amplifiers.

Tuned transformers for intermediate frequency amplification generally have large inductances tuned with small capacities. The greater the ratio of inductance to capacity the greater will be the voltage gain per stage. Although transformer coupling is most popular, intermediate amplifiers also are built with tuned impedance couplings or even with non-tunable resistance couplings in some stages.

Superheterodyne Selectivity.—Selectivity against interfering signals is provided in the radio frequency amplifier, in the tuned grid circuit of the first detector, and in each of the tuned circuits of the intermediate amplifier. Because of the excellent characteristics of a properly designed intermediate amplifier only a moderate degree of selectivity is required in the pre-amplifier.

With a selective pre-amplifier circuit such as the band pass arrangement of Fig. 13 it is permissible to use close coupling for maximum power transfer between the radio frequency tube and the first detector. Otherwise it is possible to attain selectivity by reducing the inductive coupling and the capacity coupling from the radio frequency amplifier to the first detector. All parts of the first detector circuit, especially the grid side, are well shielded to reduce direct pickup of signals.

It is an inherent quality of tuned radio frequency amplifiers to suffer a decrease in selectivity with increase of frequency of the receiver carrier, and the pre-amplifier of a superheterodyne is no exception to this rule. However, since the intermediate amplifier always works at the one frequency its selectivity does not vary with the frequency of the received carrier. Whatever frequency separation exists between a desired carrier and an interfering signal coming through the pre-amplifier, the same frequency separation will appear in the intermediate amplifier regardless of the fact that the frequency has been changed to the intermediate value.

A typical example will show that it requires much less selectivity in the intermediate amplifier than in a radio frequency amplifier to effect separation of interfering stations. A radio frequency amplifier might be tuned to a 1000-kilocycle carrier, the adjacent broadcast channels then being those centered at 990 kilocycles and at 1010 kilocycles. For a tuned radio frequency amplifier to receive the 1000-kilocycle signal without interference from either of the other channels would require 10-kilocycle separation. This 10-kilocycle separation is only 1.0 per cent of the operating frequency (1000 kilocycles) and it would represent extreme selectivity.

Now it may be assumed that a superheterodyne using a 175-kilocycle intermediate frequency is to handle the same signals, and that both the desired 1000-kilocycle carrier and the undesired 1010-kilocycle carrier come through to the first detector and are impressed on the intermediate amplifier. With this receiver tuned to 1000 kilocycles the oscillator frequency will be 1175 kilocycles. The undesired 1010-kilocycle carrier will beat with this 1175-kilocycle frequency and produce a beat of the difference, or of 165 kilocycles. This 165-kilocycle frequency is 10 kilocycles from the 175-kilocycle intermediate frequency, just as the 1010-kilocycle carrier was 10 kilocycles from the 1000-kilocycle tuned frequency of the radio amplifier. But the 10-kilocycle separation now represents a difference of 5.7 per cent of the operating frequency whereas in the radio frequency amplifier it represented only 1.0 per cent. It is comparatively easy to build an intermediate frequency amplifier which will reject frequencies 5.7 per cent off

RECEIVER, SUPERHETERODYNE

resonance, but it is exceedingly difficult to build a radio frequency amplifier which will reject frequencies only 1.0 per cent off resonance without making this latter amplifier do a great deal of side band cutting in the process.

If the resonance characteristic of the intermediate frequency amplifier be made of the general form shown at the right in Fig. 15, with a sharp cutoff at a little more than 5 kilocycles from the band center, there will be provided excellent selectivity for all stations in the broadcast band.

Image Frequencies.—It was shown that superheterodynes with independently tuned oscillators would receive a single station in either of two oscillator dial positions, one position giving an oscillator frequency higher than the signal and the other giving an oscillator frequency below that of the signal. It also is possible to receive two different stations with one setting of the oscillator. When one of these stations is the one desired, the frequency of the other is called an image frequency.

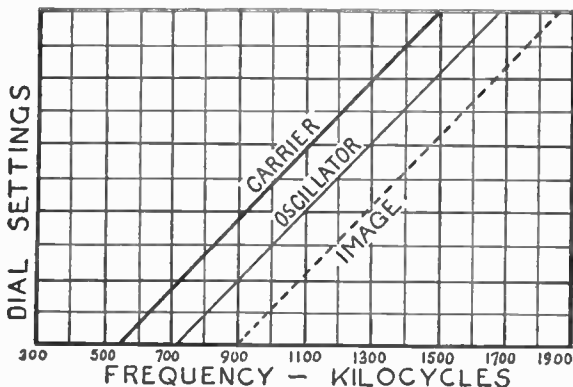

FIG. 17.—Relations Between Image, Oscillator and Carrier Frequencies.

Assuming a receiver tuned to a 1000-kilocycle carrier and using a 175-kilocycle intermediate frequency, the oscillator frequency will be 1175 kilocycles. At the same time there may be a station broadcasting on a carrier of 1350 kilocycles and this frequency will beat with the 1175-kilocycle oscillator to produce a frequency of 175 kilocycles, which is the intermediate frequency amplified by the receiver. Should the modulated carrier of the 1350-kilocycle station reach the first detector, its signal will be amplified at the same time that the 1000-kilocycle signal is amplified and both will be heard from the loud speaker. The relations between frequencies of desired carrier, oscillator and image frequencies for the broadcast band are shown in Fig. 17.

With the 175-kilocycle intermediate frequency the image always is above the desired carrier by exactly 350 kilocycles, or by double the intermediate frequency. Thus it becomes necessary for the pre-amplifier to separate two carriers which differ in frequency by twice the intermediate frequency, this not requiring any unusual degree of selectivity. The lower the intermediate frequency the closer together are the desired carrier and the image, and the greater the selectivity which will be required in the pre-amplifier and first detector tuning.

RECEIVER, SUPERHETERODYNE

Single Control for Superheterodynes.—All modern superheterodyne receivers control the tuning of the radio frequency stages, the first detector and the oscillator with a single knob or dial. No great difficulty is encountered with simultaneous tuning of the radio frequency stages and first detector, this problem being discussed under *Control, Single*. However, the tracking of the oscillator presents some unusual features.

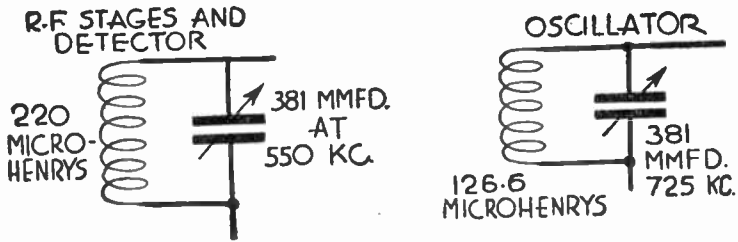

FIG. 18.—Tuning Inductances and Capacities.

The oscillator always is tuned to a frequency higher than that of the radio frequency stages and first detector. If the oscillator is to be tuned with a condenser section like the sections used for these other circuits then the oscillator inductance must be smaller than the other inductances to allow for the constantly higher frequency. A typical radio frequency circuit as indicated in Fig. 18 might use an inductance of 220 microhenrys. To tune this inductance to 550 kilocycles would require a capacity of 381 micro-microfarads. A 175-kilocycle oscillator would be required to tune at

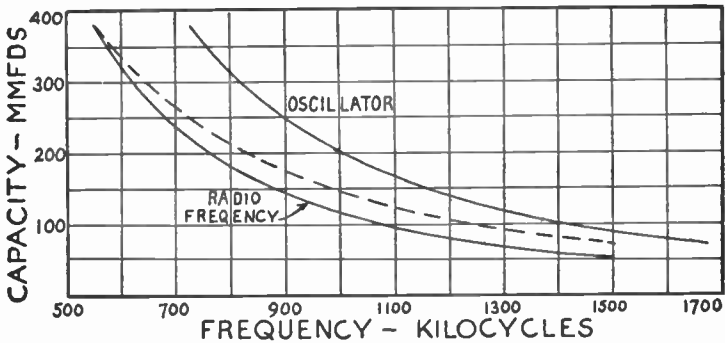

FIG. 19.—Change of Capacity to Maintain Oscillator Frequency.

the same time to a frequency of 725 kilocycles and were the oscillator to use the same capacity of 381 mmfds. the tuning inductance would have to be dropped to 126.6 microhenrys.

Commencing with both the oscillator and the R. F. capacities at 381 mmfds. for their respective frequencies of 725 kilocycles and 550 kilocycles, the capacity variations required to maintain this 175-kilocycle separation throughout the tuning range are shown by the full line curves in Fig. 19.

RECEIVER, SUPERHETERODYNE

The broken line curve is the oscillator curve moved down so that one end coincides with the R. F. curve to more clearly show the difference between the curves, both in form and in slope. The oscillator capacity does not change as rapidly as the capacity for the radio frequency and detector stages.

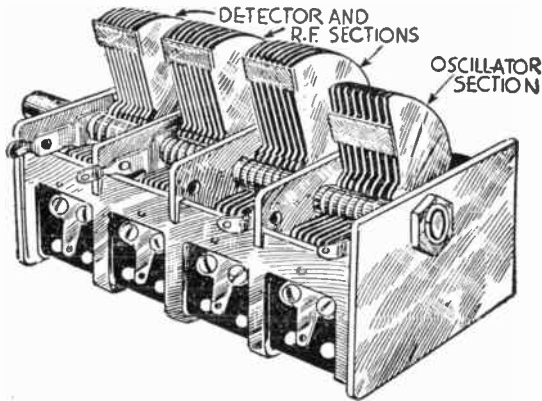

FIG. 20.—Oscillator Tuning Condenser with Special Plates.

One method of overcoming this difficulty is to build the oscillator section of the ganged tuning condenser as in Fig. 20, with plates of special size and shape, these plates being so formed that they provide suitable oscillator capacities throughout the tuning range. The use of such a condenser requires either that the remainder of the oscillator circuit be designed to match it or that

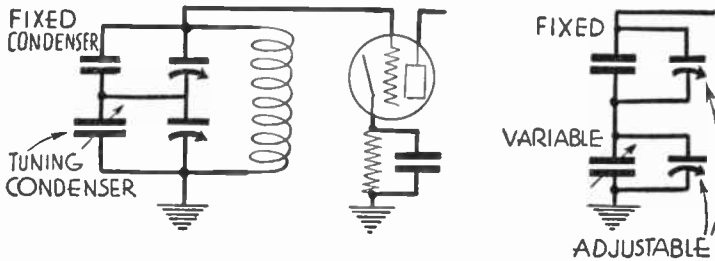

FIG. 21.—Arrangement of Capacities for Oscillator Tuning

the condenser section be designed to match the remainder of the circuit in which it is to be used.

Another method consists of displacing the rotor plates of the oscillator tuning condenser with reference to the plates of the other sections, to make the oscillator tuning capacity always less than the R. F. and detector capacities. This allows the oscillator to tune to the required higher frequency.

A third method commonly employed when all tuning condenser

RECEIVER, SUPERHETERODYNE

sections are alike uses an oscillator tuning circuit usually diagrammed as in Fig. 21 where four capacities are shown. One of these capacities is the variable tuning condenser which is ganged with other tuning units in the receiver. In parallel with the tuning unit is a small adjustable trimmer capacity, the kind usually found incorporated in all tuning condensers. In series with the tuning condenser is a fixed condenser and in parallel with this fixed unit is another adjustable trimmer condenser.

The effective capacity of any two condensers in series is less than the capacity of either one taken alone, therefore the arrangement of Fig. 21 lowers the effective capacity of the tuning unit, which means that the change of capacity with movement of this unit won't be as great as without the series condenser. The larger the series capacity the less it changes the total capacity, and the smaller this series capacity the more it will restrict the capacity change. The curves of Fig. 22 show the capacity change of a typical 400-mmfd. tuning condenser with dial movement, also the way in which the capacity variation is altered by placing in series with the tuning condenser fixed capacities of 1000 mmfd. and of 500 mmfd. It is seen that

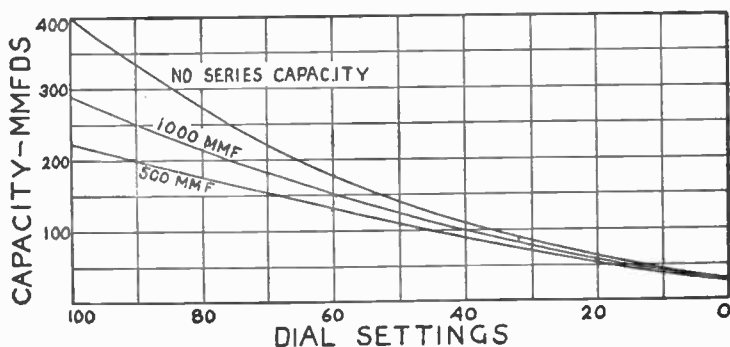

FIG. 22.—How Series Capacities Affect the Tuning.

the capacity curve for the tuning unit may be changed in slope and restricted in any degree by suitable series capacities.

The small trimmer condenser in parallel with the tuning unit allows addition of the trimmer capacity over the entire range of the tuning condenser, thus allowing the tuning condenser's capacity curve to be moved bodily in either direction. Adjustment of the series capacity with its trimmer, and adjustment of the tuning capacity with its separate trimmer allows shifting the two capacity curves into such positions that they maintain the required difference to closely approach the intermediate frequency throughout the receiver's range.

In practice the trimmer for the oscillator tuning condenser is adjusted first, with the receiver tuned to a high frequency, say 1400 kilocycles. The receiver then is tuned to a low frequency, about 600 kilocycles, and the trimmer for the series condenser is adjusted to produce the proper heat frequency. It is customary to work back and forth between these adjustments until they are set at optimum positions.

RECEIVER, SUPERHETERODYNE

Mixer and Oscillator Combined.—One of the greatest faults with the earliest superheterodynes was in the large number of tubes required and almost the first attempts toward reducing the number were in the form of a single tube for both oscillator and mixer.

In the type of oscillator-mixer called a pentagrid converter the grids are arranged as in Fig. 23. Nearest the cathode is the oscillator control grid which, as its name signifies, acts as the control grid for the oscillator portion of the tube. Next comes the oscillator anode grid which serves the purpose of a plate for the oscillator section. This anode grid is an open mesh; stopping enough of the electrons from the cathode to serve its purpose in the oscillator system, but allowing the remainder to go through and serve the mixer section.

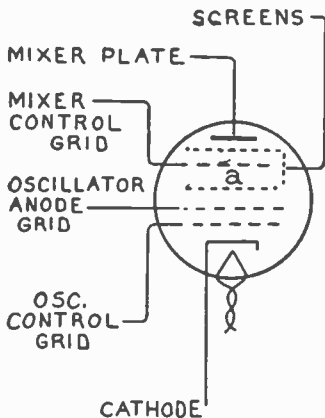

FIG. 23.—The Pentagrid Converter.

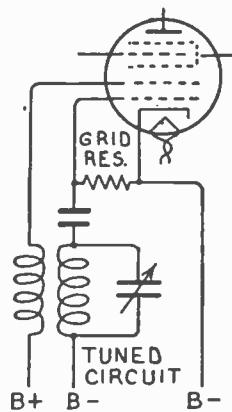

FIG. 24.—Pentagrid Oscillator Circuit.

Next in the order of the grids, moving away from the cathode, comes one part of the screen. Then comes the control grid for the mixer, and just outside of it the second or outer part of the screen. Both parts of the screen are connected to the same prong on the tube base. The final electrode is the regular plate which acts as the plate for the mixer section.

One circuit for the oscillator section of this tube is shown in Fig. 24 where the elements operating only in the mixer circuit are neglected. The feedback and tuning coils fix the oscillator operating frequency and maintain the necessary feedback from the plate (anode grid) to the oscillator control grid. Negative grid bias is applied. The grid return is through the resistor to the cathode.

The action of the mixer section is different from most other tubes in the method of supplying the electron stream. Electrons originally emitted

RECEIVER, SUPERHETERODYNE

from the heated cathode pass right through the oscillator control grid in considerable quantity because of the strong attraction of the positively charged oscillator anode grid and the positively charged screen. These electrons enter the space marked *a* in Fig. 23 and there they encounter the negative control grid. The electrons are thus retarded in their travel and form a cloud between the inner section of the screen and the mixer control grid. This cloud of electrons forms the cathode for the mixer section and is called a virtual cathode.

For the mixer section of the tube there are thus four elements; the virtual cathode, the mixer control grid, the outer section of the screen between the control grid and plate, and the mixer plate. These four electrodes form a screen grid tube or a tetrode, and since the control grid has irregular spacing of its wires we have a super-control or variable- μ mixer. Circuit connections which may be used with the mixer section are shown in Fig. 25 where the oscillator circuit is also included.

The signal input from the preceding radio frequency amplifier enters the control grid and controls the plate current in the usual way. The plate circuit is connected to the intermediate frequency amplifier and feeds the beat frequency or intermediate frequency to that amplifier. The screen acts

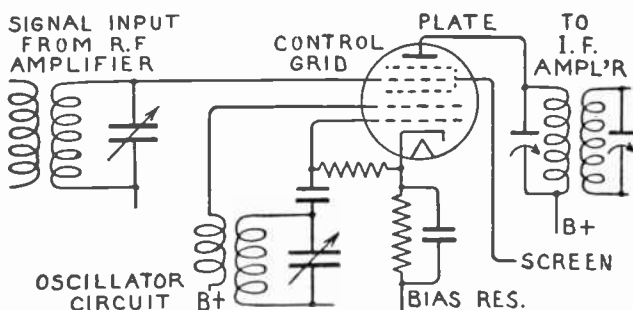

FIG. 25.—Complete Pentagrid Converter Connections.

in its ordinary manner to reduce the internal capacitance of the tube. This mixer section not only handles the production of the new intermediate frequency but is an excellent amplifier as well. The control grid bias is shown as provided by a fixed biasing resistor, but it is possible to use a variable resistor for volume control.

Electron Coupling.—The manner in which both the carrier frequency and the oscillator frequency affect the plate circuit in this pentagrid converter and allow production of the beat frequency is a form of electron coupling. The virtual cathode for the mixer section depends for its supply of electrons on those which come through the oscillator control grid. During the time this oscillator grid is only slightly negative it allows plenty of electrons to pass through it for the mixer section. But as the oscillator grid is made more negative during the cycles of oscillator voltage, the supply of electrons for the mixer is cut off or at least reduced. Thus it appears that the voltage variations on the oscillator grid, which are at the oscillator frequency, really

RECEIVER, SUPERHETERODYNE

control the electron flow to the mixer plate. Since the electron flow to this plate is controlled also by the mixer grid and the carrier frequency, the plate current is determined by the combination of oscillator frequency and carrier frequency.

This combined control with two frequencies produces the beat frequency which is the intermediate frequency for the superheterodyne. The sole coupling between oscillator and mixer results from their both affecting the single electron stream from cathode to plate; an electron coupling.

Pentagrid Mixer.—A pentagrid tube may be used as a mixer in connection with a separate oscillator. The connections are shown by Fig. 26. The advantage of this arrangement over a mixer operating as a grid bias detector is that with the pentagrid tube the oscillator and mixer circuits are isolated. The signal and mixer grids are screened by the two adjacent grids. The fifth grid acts as a suppressor. The bias detector used as a mixer allows feedback from its output to its input circuits, so that tuning of the input affects the oscillation frequency.

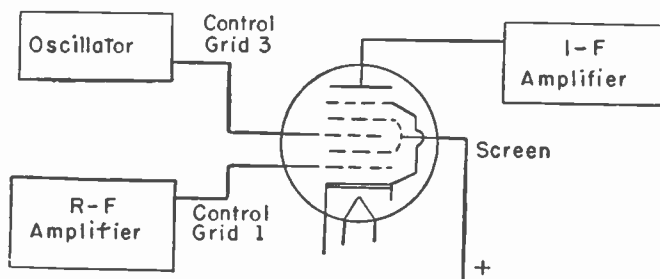

FIG. 26.—Connections for a Pentagrid Mixer.

Crystal Filter.—A quartz crystal used in the intermediate frequency amplifier as shown by Fig. 27 increases the selectivity of this amplifier and permits rejection of an interfering signal whose frequency is very close to that of the desired signal. As the frequency is varied in the voltage applied to the crystal, the crystal acts like a series resonant circuit at one frequency and like a parallel resonant circuit at a frequency which is higher, usually by less than one part on a thousand, than the first frequency.

The crystal acts as a very small resistance at the frequency of series resonance, allowing the output voltage of the crystal circuit to be almost equal to the voltage impressed on coil *A*, or half that across coils *A-B*. At frequencies widely different from the resonant frequency of the crystal it has capacitive reactance because of the capacity formed by the crystal holder with the quartz as a dielectric. Because this capacitive reactance is high in comparison with the load impedance the voltage developed across the load impedance is very small.

RECEIVER, SUPERHETERODYNE

Condenser *C* of Fig. 27 allows rejection of a signal whose frequency separation from the tuned signal is such as to cause an audible beat note. The superheterodyne oscillator is tuned to bring in the interfering i-f signal on the high-frequency side of the tuned i-f signal. At just above the frequency at which the crystal acts as a parallel resonant circuit the crystal has a small net capacitive reactance while still oscillating. This reactance depends on the strength of the signal that excites the crystal.

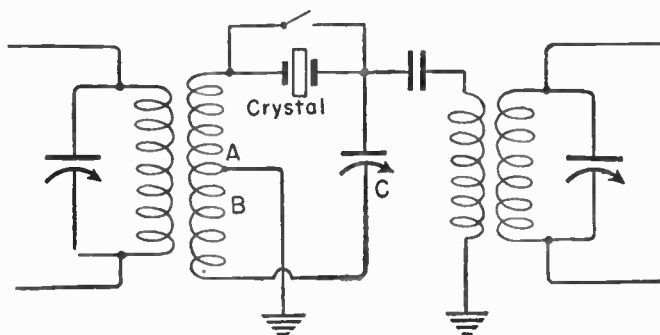

FIG. 27.—Crystal Used in Intermediate-frequency Amplifier.

With the capacity of condenser *C* made equal to that of the crystal at the frequency of the interfering signal, the net output at this frequency will be very small. This is due to the fact that the capacities of the crystal and condenser *C*, together with the inductances of coils *A* and *B*, form the arms of a bridge circuit which is balanced. If the capacity of *C* is made equal to that of the crystal holder, all frequencies at which the crystal does not oscillate will be rejected.

RECEIVER, SUPER-REGENERATIVE

RECEIVER, SUPER-REGENERATIVE.—The super-regenerative receiver is designed to allow maximum regeneration while automatically preventing free oscillation. There are several variations of the principle of super-regeneration, one type being shown in Fig. 1.

Neglecting for the present the coils *A* and *B* and the condensers *M* and *N* at the lower part of the diagram it will be seen that the receiver is of the ordinary regenerative type. Signal energy is collected by the loop, the loop tuning being accomplished by the variable condenser. The grid coil is tuned with the variable condenser *C*. Feedback of energy from plate circuit to grid circuit is secured by coupling the tickler coil to the grid coil.

With the parts of the circuit so far considered it is possible for the tickler coil to couple with the grid coil closely enough to produce regeneration which will almost instantly build up into oscillation. Maximum amplification will be secured just before regeneration changes into oscillation. In actual operation the receiver allows regeneration to start and to build up to a point that

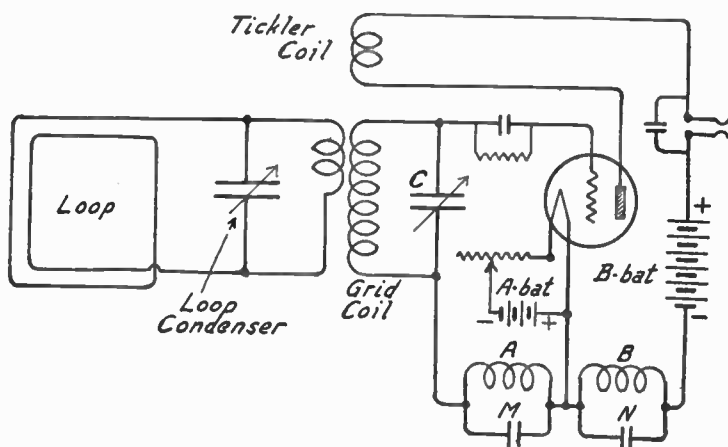

Circuits of Super-Regenerative Single Tube Receiver.

sends great energy into the grid circuit of the tube. While regeneration is continuing to build up, but before it changes into oscillation, the additional circuit in the lower part of the diagram absorbs so much power from the grid circuit that regeneration is completely stopped. The absorption of power is then stopped and regeneration once more starts building up.

Coils *A* and *B* together with their condensers *M* and *N* allow the tube to act as an oscillator. Coil *B* is in the plate circuit and coil *A* is in the grid circuit. The two are coupled together so that continuous oscillations are generated. The frequency of these oscillations is determined by the inductances of the coils and by the capacities of the condensers *M* and *N*. The frequency of the oscillations is made of some value above audibility, fifteen thousand to twenty thousand cycles being suitable values.

The oscillation voltages are impressed on the grid of the tube so that the grid voltage is alternately positive and negative. While the grid voltage is negative the regenerative action in the grid and tickler coils builds up rapidly and applies the signal to the grid of the tube with great power. As soon as the oscillator voltage swings to the positive half of a cycle the grid becomes positive and absorbs power. This absorption of power stops the regeneration

RECEIVER, SUPER-REGENERATIVE

just before it changes to oscillation. This action continues so long as the receiver is in operation.

The super-regenerative receiver is difficult to control, very critical in adjustments, and because of the peculiar action in the grid circuit it lacks selectivity. The great advantage is in the extreme amplification obtainable from a single triode tube. When audio-frequency amplification is added it becomes necessary to place a filter circuit between the super-regenerative tube and the first audio-frequency tube to prevent the oscillations from coming through and being amplified with great volume.

RECEIVER, TUNED RADIO FREQUENCY.—A tuned radio frequency receiver employs one or more stages of radio-frequency amplification between which the coupling is by means of inductances and capacities which are tuned to resonance at the frequency to be received. Coupling ordinarily is with tuned transformers which are alike for all stages. Tuned impedance coupling

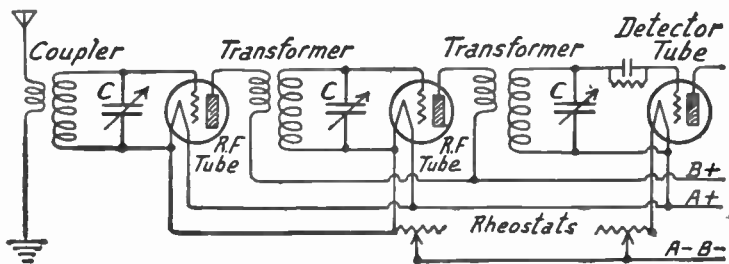

Radio Frequency Circuits of Tuned Radio Frequency Receiver.

sometimes is used. Balancing circuits of one kind or another are used with triode tubes to neutralize excessive feedback. Band selector circuits are employed to improve fidelity while retaining selectivity. Tuned radio frequency amplification is used ahead of the intermediate-frequency amplifier in superheterodyne receivers.

RECEIVER, UNIVERSAL.—A universal receiver is designed to operate when connected to either an alternating-current or a direct-current power supply. Such receivers have no power transformers because, when connected to a d-c supply, no voltages or currents would be induced in the secondary windings of a transformer.

Universal receivers have rectifiers and have filter systems so that when they are connected to an alternating current source the alternating current can be changed to direct current. When such a receiver, with its rectifier tube in circuit, is connected to a direct current line the tube simply allows the direct current to flow from one plate to the cathode all the time.

RECTIFIER

RECTIFIER.—A rectifier is a device in which an alternating voltage produces a flow of direct current. Most of the rectifiers employed in the fields of radio and electronics are of the electronic tube or tank type. Industrial types of hot-cathode vacuum tube rectifiers are called kenotrons; gas-filled and mercury vapor types are called phanotrons. Rectifiers with mercury pool cathodes are called pool tubes, of which an example is the mercury arc rectifier. Although two-element cold-cathode tubes are used as rectifiers, the three-element cold-cathode types are more common.

With rectifier tubes containing only cathodes and anodes or plates the direct-current output depends on applied alternating voltage, on internal resistance of the tube, and on resistance or impedance of the load. The output of a given tube may be substantially altered only by changing the applied voltage or the load. With controlled rectifiers, which contain control elements in addition to cathodes and anodes, it is possible to obtain wide variation of direct-current output without change of applied voltage or load when suitable control circuits are used. Controlled rectifiers include types such as thyratrons, grid-glow tubes, and ignitrons.

Next to electronic tube types the rectifiers most commonly used in radio and electronics are the contact types, of which a well known example is the copper-oxide rectifier. Liquid electrolytic rectifiers are sometimes used. Large direct currents often are obtained from motor-generator sets, from converters, or from dynamotors, all of which use alternating-current power to produce a direct-current output. Vibrating rectifiers sometimes are used for battery charging.

RECTIFIER, BRIDGE.—See *Rectifier, full-wave.*

RECTIFIER, CONTACT.—There are certain pairs of substances which, when in contact with each other, offer very low resistance to flow of current in one direction and very high resistance to flow in the other direction. Such substances are used as contact rectifiers, since an applied alternating potential will cause free flow of current one way, but very little flow in the reverse direction, and the result is a one-way or direct current in the circuit containing the rectifier. There are three principal types of contact rectifiers. One consists of discs or plates of metallic copper on one side of which is formed a layer of copper oxide. Flow of current is from the oxide to the copper. Another type consists of copper coated with copper sulphide, and with a disc or plate of magnesium in contact with the sulphide. Current flows from the copper sulphide to the magnesium. The third type consists of an iron or steel base on which is a very thin layer of selenium, with the selenium covered with a low-resistance metallic alloy that insures uniform current distribution over the selenium surface. Current flows from the iron to the selenium to the front coating.

Current-carrying contact with the oxide of the copper-oxide rectifier is made with a disc of lead held firmly against the oxide, or, in some types, by coating the oxide with thin layers of conductive metal. Similar contact

RECTIFIER, CONTACT

is made with the magnesium of the copper-sulphide magnesium rectifier. When using the lead contact members the elements of the rectifier are assembled on an insulated stud or bolt and the necessary pressure is maintained by using spring steel washers or stiff coiled springs under a nut on the bolt. The current-carrying contact with the front coating of the selenium rectifier element is made with a plate or disc of thin brass. The pressure with this type of rectifier need be only that which insures low resistance between the brass and the coating of the element. At intervals in the assembly of discs or plates of all these contact rectifiers are larger metallic discs whose purpose is to remove excess heat by radiation and convection to surrounding objects and air.

Copper-oxide and copper-sulphide magnesium rectifiers will withstand a reversed potential of three to four volts per disc, while the selenium type will withstand 14 to 18 volts. Higher voltages than allowed by a single element are handled by assembling any required number of elements in series. Standard stacks are made to operate at potentials as high as 400 volts for copper-oxide types, about 500 volts for selenium types, and about 60 volts for copper-sulphide-magnesium types. Any number of complete rectifiers may be used in series to handle higher voltages than allowed by one of them. If full-wave rectifiers are thus connected in series it is necessary to provide a separate transformer secondary winding for each unit.

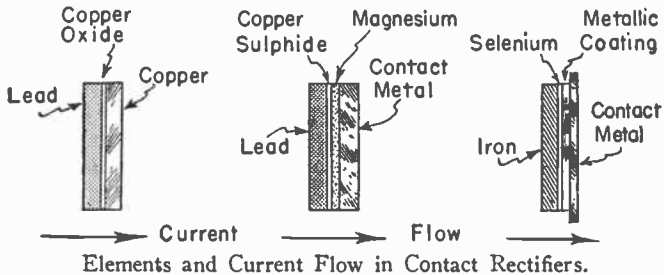

Any number of rectifier units may be connected in parallel to handle larger currents provided all the units so connected have the same voltage rating.

Single stacks of copper-oxide rectifiers usually are made in current capacities up to 5 amperes, selenium types to 10 amperes, and copper-sulphide-magnesium types up to 30 amperes. All types will withstand large short-time overloads provided they are allowed to cool to normal temperature between loads. Rectifier current and voltage ratings usually are based on operation at 35° to 40° C., or 95° to 104° F. Maximum operating temperatures should not exceed 60° C. or 140° F. with copper-oxide types, 75° C. or 167° F. with selenium types, and 85° C. or 185° F. for copper-sulphide-magnesium types, although this latter type may be operated at temperatures as high as 130° C. or 266° F. with some shortening of useful life. Excessive temperatures allow an increase of back current, which is the current flowing in a reverse direction from the desired rectification. In voltage regulation and operating efficiency the copper-oxide rectifier is somewhat better than the copper-sulphide-magnesium type, and the selenium rectifier is better than either of the others in these respects.

RECTIFIER

RECTIFIER, COPPER-OXIDE.—See *Rectifier, Contact*.

RECTIFIER, DRY.—See *Rectifier, Contact*.

RECTIFIER, ELECTROLYTIC.—Electrolytic rectifiers employing metallic electrodes immersed in a liquid electrolyte are used chiefly for low-rate battery charging in signal systems and similar applications.

In a commonly used electrolytic rectifier the active metallic electrode is of tantalum and the electrolyte is a sulphuric acid and water solution having specific gravity of about 1.200. The current flows from the liquid electrolyte into the tantalum through a layer of tantalum oxide that forms on the plate. Current is carried into the electrolyte through an inert electrode of lead. Iron sulphate and copper sulphate in small quantities may be added to the electrolyte to reduce polarization.

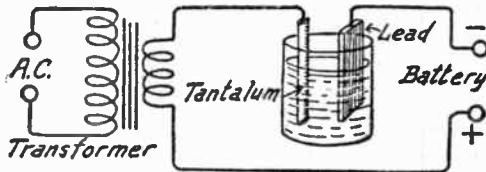

Tantalum Electrolytic Rectifier for Battery Charging.

Another rectifier combination consists of aluminum immersed in a saturated solution of ammonium sulphate or of ammonium phosphate, with lead for the inert electrode. Still another combination consists of magnesium in a solution of sodium fluoride or other alkaline fluoride. In all cases the flow of current is from the external circuit through the inert electrode into the electrolyte and from electrolyte into the active electrode of tantalum, aluminum or magnesium.

RECTIFIER, FULL-WAVE.—A full-wave rectifier is a rectifier in which both half-cycles of the applied alternating voltage produce flows of direct current. The full-wave rectification is due to the type of circuit employed. The rectifier units themselves may be electronic tubes, contact rectifiers, electrolytic rectifiers, or any other device which allows only one-way current flow or only direct current through it when the applied voltage is alternating.

Fig. 1 shows two tubes of the filament-cathode type connected for full-wave rectification with a transformer having a center-tapped high-voltage winding for the plates or anodes and a separate center-tapped low-voltage winding for the filaments. Current can flow through the tubes only from their plates or anodes to their filaments, as shown by arrows. When the upper end of the high-voltage winding is positive, current flows only through the upper tube, for during this half-cycle of alternating voltage the lower end of the high-voltage winding is negative and the plate of the lower tube is thus made negative with reference to its filament. During the opposite half-cycle the lower end of the high-voltage winding becomes positive and the upper end negative, the plate of the lower tube becomes positive and the plate of the upper tube negative, so that only the lower tube conducts current. Current from the tube filaments flows through the filament winding to its center tap, then to and through the load in the direction indicated, back to the center tap of the high-voltage winding, and through the half of this winding leading to the tube plate which is positive.

RECTIFIER, FULL-WAVE

Fig. 2 shows connections for two tubes of the heater-cathode type. Since the heaters are insulated from the cathodes there is no flow of rectified current in the heater circuit. The load is connected between the positive cathodes and the negative center tap of the high-voltage winding. Otherwise the action is the same as in Fig. 1. Fig. 3 shows connections for a single

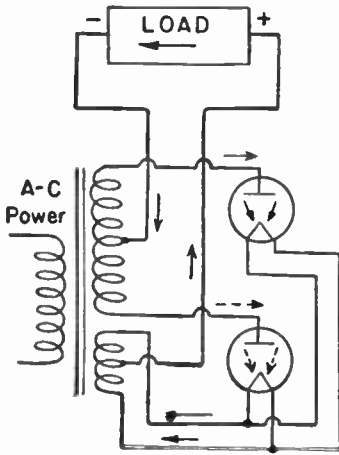

FIG. 1.—Two Filament-cathode Tubes in Full-wave Rectifier.

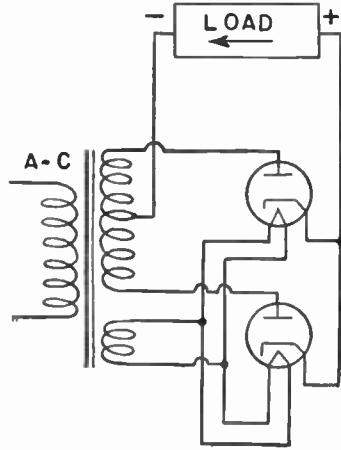

FIG. 2.—Two Heater-cathode Tubes in Full-wave Rectifier.

full-wave rectifier tube of the filament-cathode type. The two plates or anodes carry current alternately during the half-cycles of applied alternating voltage, just as do the two plates of the separate tubes in Fig. 1. Fig. 4 shows connections for a full-wave rectifier tube of the heater-cathode type, wherein the two plates of the one tube act as do the two plates of the separate tubes in Fig. 2.

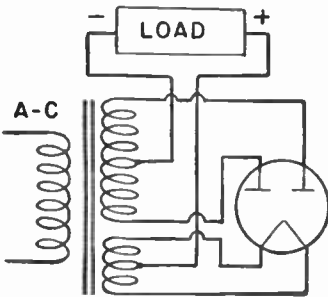

FIG. 3.—Full-wave Filament-cathode Rectifier.

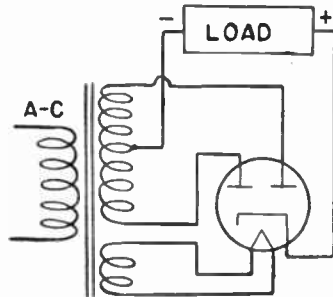

FIG. 4.—Full-wave Heater-cathode Rectifier.

RECTIFIER, FULL-WAVE

Contact rectifiers or electrolytic rectifiers may be indicated as in Fig. 5 at *A* where two rectifier units are connected between the outer ends of a center-tapped transformer secondary and the positive terminal of the load, with the negative of the load connected to the center tap. Current flows alternately through the rectifier units on opposite half-cycles of applied alternating voltage.

At *B* in Fig. 5 is shown a divided primary winding on the transformer, with the two sections connected in series to handle a high line voltage, such as 230 volts. If the line supply is at 115 volts the primary sections are connected in parallel as at *C*. The secondary winding of the transformer has taps at its outer ends, so that a low line voltage may be provided with a greater step-up ratio by using the outer taps as at *D*. Similar voltage taps and sections may be used in the transformers for any type of rectifier.

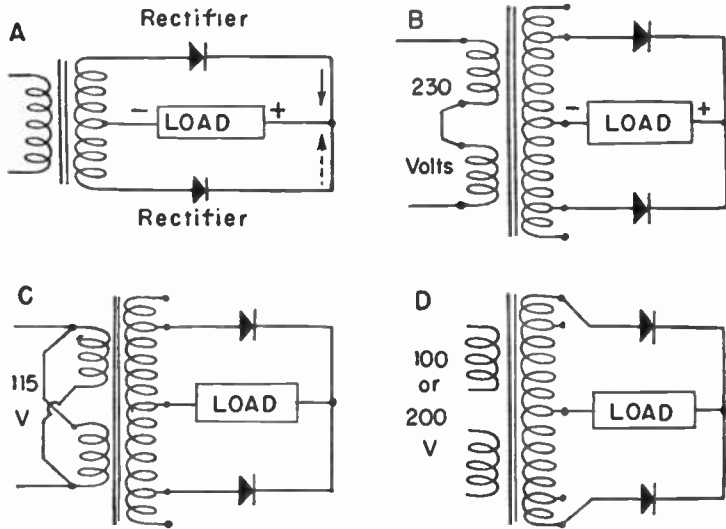

FIG. 5.—Contact Rectifiers in Full-wave Circuits.

Bridge Rectifier Connections.—In Figs. 1 to 5 full-wave rectification is obtained with two rectifier units and a center-tapped secondary winding on the transformer. In Fig. 6 is shown a bridge circuit with which full-wave rectification is obtained by using four rectifier units and no center tap on the transformer secondary. The left-hand diagram shows direction of current flow when the upper end of the transformer secondary is positive, and the right-hand diagram shows direction when the upper end is negative on the opposite half-cycle. Two rectifiers are working and two are idle during each half-cycle. One advantage of the bridge circuit is that the two rectifiers in series during each half-cycle will withstand double the reverse voltage of a single unit. Another advan-

RECTIFIER, FULL-WAVE

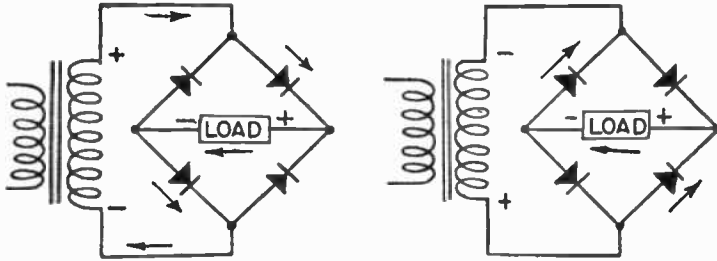

FIG. 6.—Bridge Type Full-wave Rectifier.

tage common to all full-wave rectifiers in comparison with half-wave types is that the ripple voltage in the output is at double the frequency of the supply voltage, thus allowing more economical filtering.

In Fig. 7 at the left are shown connections for four tubes of the heater-cathode type in a bridge circuit for full-wave rectification. When the upper end of the high-voltage transformer secondary winding is positive, current flows to the load through tube 1 and returns from the load through tube 2. On the opposite half-cycle the flow goes to the load through tube 3 and returns through tube 4. At the left in Fig. 7 are shown connections for four tubes of the filament-cathode type. Separate center-tapped filament windings are required for tubes 2 and 4, since the filaments of these tubes must be connected individually to the plates of the other two tubes and to the high-voltage winding.

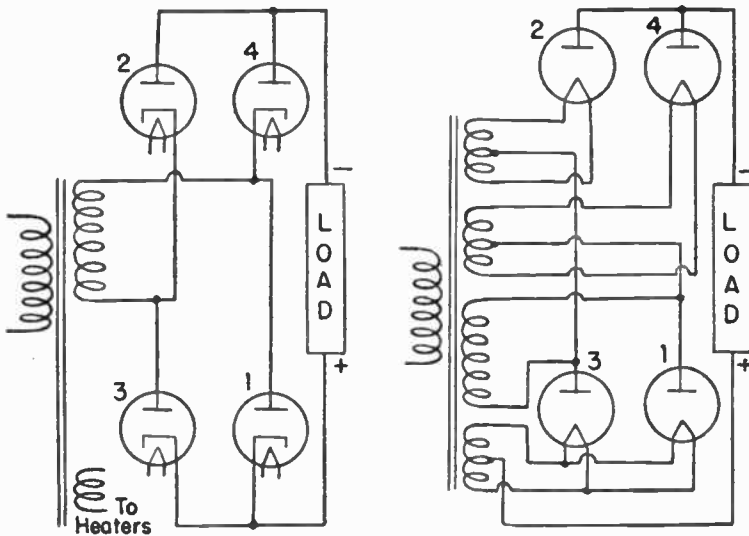

FIG. 7.—Four Tubes in Full-wave Bridge Circuit.

RECTIFIER, FULL-WAVE

Fig. 8 shows connections for four electrolytic rectifiers in a full-wave bridge circuit as used for battery charging. At the left the line voltage is reduced by a transformer and at the right by a lamp bank resistance in series with the line.

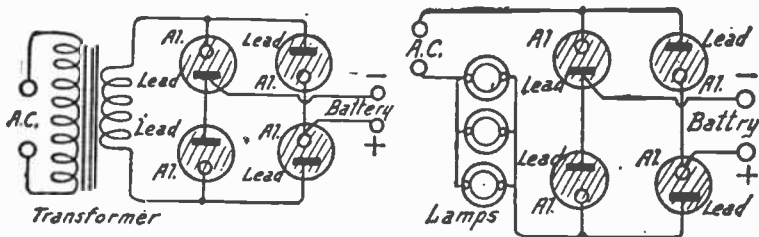

FIG. 8.—Electrolytic Rectifiers in Full-wave Bridge Circuit.

RECTIFIER, GAS-FILLED TUBE.—Gas-filled tubes designed especially for use as rectifiers include some of the phanotrons, also the types known by the trade names of Rectigon and Tungar. See *Tube, gas-filled*; and *Tube, phanotron*.

Rectigon and Tungar Bulbs.—These are tubes designed primarily for such low-voltage applications as battery charging, some types of heater current supplies, motion picture projectors, and telephone installations where the operating potentials range from 7.5 to 250 volts. Commonly used types have average current ratings of 0.5, 2, 5, 6 and 15 amperes. Peak currents may be about three times the rated average currents. Most of these types may be operated at higher than rated voltages provided the current is proportionately reduced to maintain about the same power dissipation in watts.

The envelopes are filled with the inert gas argon at a pressure of about five centimeters, which is much higher than pressures in other styles of gas-filled tubes. The high gas pressure allows operating the tungsten filament at temperatures high enough to cause copious electron emission, but it also limits the inverse breakdown potential to around 300 volts. The filaments need not be preheated before plate voltage is applied. The potential drop in the tube, after ionization takes place, is in the neighborhood of eight volts. These tubes are made in half-wave types having one filament and one anode, also in full-wave types with a single filament and two anodes.

RECTIFIER, HALF-WAVE.—A half-wave rectifier is a rectifier in which flow of direct current occurs during only one of the half-cycles of applied alternating voltage. With an electronic tube half-wave rectifier there is current flow through the tube only during the half-cycle in which the plate or anode is made positive with reference to the cathode. During the opposite half-cycle the anode is negative with reference to the cathode, and, since current can flow only from anode to cathode, there is no conduction during this period.

RECTIFIER, HALF-WAVE

Fig. 1 shows half-wave rectifier circuits for a filament-cathode tube at the left and for a heater-cathode type at the right. Current flows only in the direction of the arrows. The filament or the separate cathode is the positive output terminal of the rectifier. The negative terminal is one end of the high-voltage winding on the transformer. Contact rectifiers or electrolytic rectifiers may be similarly connected in series with the load and the alternating voltage supply to provide half-wave rectification.

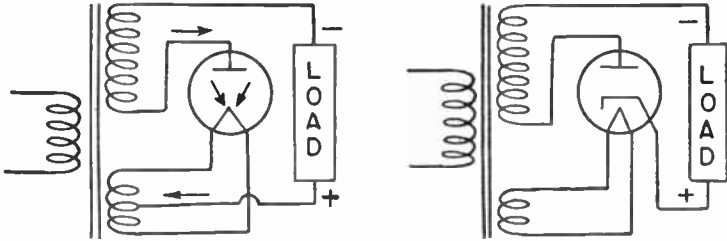

FIG. 1.—Tubes Used as Half-wave Rectifiers.

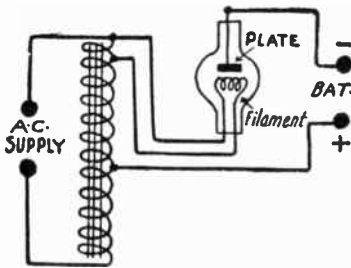

FIG. 2.—Auto-transformer for Rectifier.

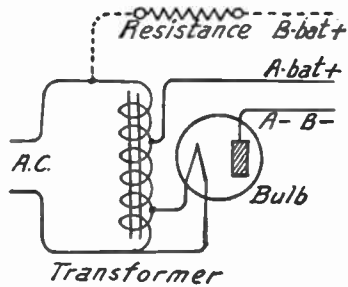

FIG. 3.—Two Voltages with Auto-transformer.

Fig. 2 shows a filament-cathode tube operated as a half-wave rectifier from an auto-transformer arranged to reduce battery charging voltage below that of the a-c supply and to provide filament heating current. Fig. 3 shows connections for an auto-transformer with which a low direct charging voltage is furnished for an A-battery and another direct voltage of line value for simultaneous charging of a B-battery.

RECTIFIER, MERCURY ARC.—This is a rectifier employing a mercury pool cathode which furnishes mercury vapor that is ionized during operation of the tube. In the full-wave type whose connections are shown there are two anodes in extensions on either side of the bulb. Current flows on alternate half-cycles through the vapor to an arc maintained at the surface of the mercury. Action is started by tilting the bulb so that mercury flows from the main cathode into a small auxiliary cathode extension,

RECTIFIER, MERCURY ARC

then tilting it back to break the mercury contact and form the initial arc at the break.

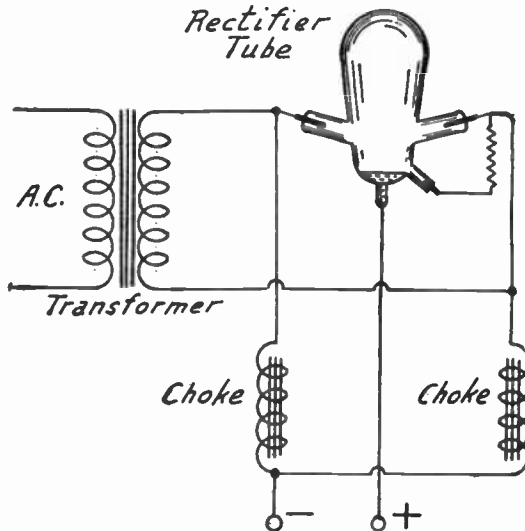

Circuits of Mercury Arc Rectifier.

The two choke coils permit relatively free flow of direct current in the load circuit while impeding flow of alternating current in this circuit but allowing it to flow to the tube. Instead of placing the negative load terminal between two chokes this terminal may be at a center tap on the transformer secondary. Inductance is required somewhere in the circuit in order to prolong the current beyond the end of each half cycle and thus maintain the ionization or the arc in the tube.

RECTIFIER, MERCURY-VAPOR. — A mercury-vapor rectifier tube has a hot cathode of the filament type or else an indirectly heated type. Within the envelope are a few drops of liquid mercury which are vaporized by heat during operation of the tube, thus providing the mercury vapor that is ionized to permit conduction. Mercury vapor tubes may be of either the half-wave or full-wave type. See *Tube, gas-filled*; also *Tube, phanotron*.

In a vacuum rectifier the current rises and falls smoothly with changes of applied current. In the mercury vapor rectifier there is no appreciable current at all until the voltage on the plates has risen to a certain critical value. Then ionization sets in, the internal resistance drops to a low value, and there is a sudden rise of current to practically full value in an instant.

These surges of current in the rectifier circuit generate radio waves which are picked up by the receiver circuits and amplified much like a regular signal; except that the result is a disagreeable noise. It is necessary to enclose the base of these rectifier tubes with a grounded metal shield, or in very sensitive receivers to enclose the whole rectifier tube with a shield. In addition to the shield it is necessary to connect small radio frequency choke

RECTIFIER, MERCURY-VAPOR

coils between each of the plate terminals in the socket and the wires connecting to these plates. These chokes are placed inside the metal shield.

There is danger of damaging the mercury vapor rectifier if the full rectified current is drawn before the cathode has time to reach its working temperature. In most receivers the amplifier tubes take longer than the rectifier to heat up and draw their full plate and screen currents, thus providing just enough delay between the time the rectifier reaches working temperature and the time the amplifiers impose a full load to make for safe operation.

RECTIFIER, PARALLEL CONNECTION OF.—Rectifier tubes may be connected with their plates and cathodes in parallel with each other, and with the paralleled group in series with a single load, to provide a total output d-c current approximately equal to the rated current per tube multiplied by the number of tubes so connected. The impressed voltage or inverse peak voltage may be no greater than permissible for one of the tubes. All paralleled tubes should be of the same class and type. The two plates or anodes of a full-wave rectifier tube may be connected together to make it a half-wave rectifier of double its normal current rating and of the original voltage rating.

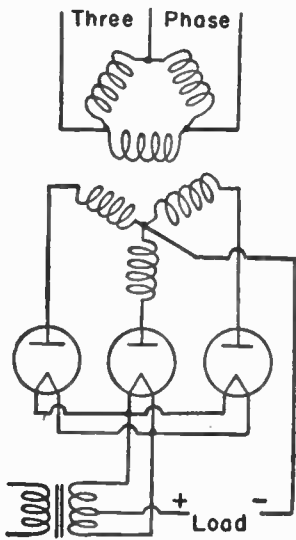

FIG. 1.—Polyphase Half-wave Rectifier.

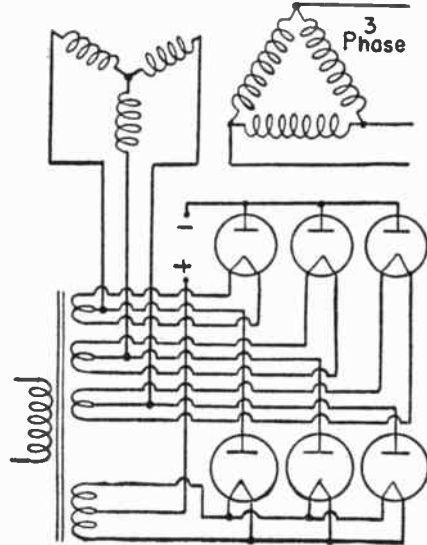

FIG. 2.—Polyphase Full-wave Rectifier.

Parallel operation may save tube cost where the voltage rating of small tubes is sufficient for the requirements, but where the required current is more than may be taken through one tube. With high-vacuum rectifier tubes the connection of their internal resistances in parallel gives a lower total tube resistance and allows a load voltage somewhat greater than with a single tube. To insure that all paralleled tubes carry equal loads it is nec-

RECTIFIER, POLYPHASE

essary to connect in series with each plate or anode a ballast resistor or a choke coil. The resistance or impedance should be such that its voltage drop with normal current flow is greater than the internal voltage drop in the tube. This is especially necessary when using gas-filled or mercury vapor rectifiers. With filament-cathode rectifier tubes in parallel the corresponding filament prongs of each tube should be connected together to insure even distribution of current in the filaments.

RECTIFIER, POLYPHASE. — The connections for a three-phase half-wave rectifier using three tubes are shown by Fig. 1, and those for a three-phase full-wave rectifier using six tubes are shown by Fig. 2. In both cases the power transformers are connected delta on the primary side and star or *Y* on the secondary. There is a somewhat higher current per tube with the full-wave connection. Average load current is equal to the average current per tube multiplied by the number of tubes in the rectifier.

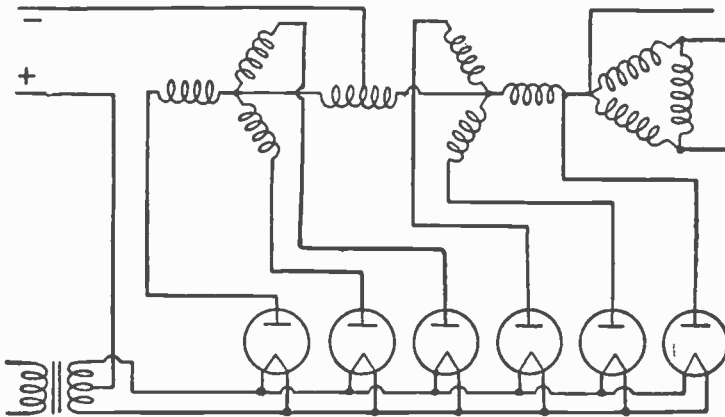

FIG. 3.—Three-phase Double-Y Parallel Rectifier.

Ripple frequency is three times the supply frequency with the half-wave rectifier and is six times supply frequency with the full-wave system. Ripple voltage from the half-wave connection is more than four times that from the full-wave connection. Fig. 3 shows connections for a three-phase double-Y parallel rectifier which has the same relations of ripple frequency and voltage as the full-wave rectifier but a higher current per tube. Contact rectifiers may be used in any of the circuits shown for tubes, the filament heater supply being omitted and the connection for the center tap of the filament transformer being connected to the current output sides of the contact rectifiers. Similarly, tubes may be used in circuits shown for contact rectifiers by adding the necessary connections for filaments when filament-cathode tubes are used.

Fig. 4 shows connections for a three-phase full-wave rectifier system using six rectifier elements and having center-tapped secondaries on the power transformer. Fig. 5 shows a three-phase full-wave rectifier system using a bridge circuit for six rectifier elements. The power transformer is connected in delta on both primary and secondary.

RECTIFIER

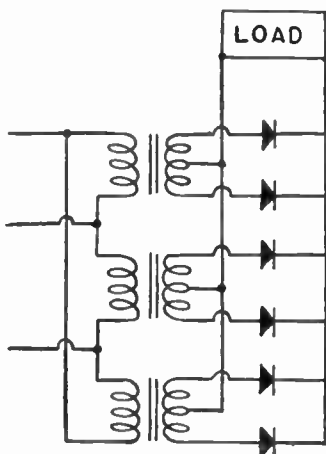

FIG. 4.—Six Elements with Center-tapped Transformer.

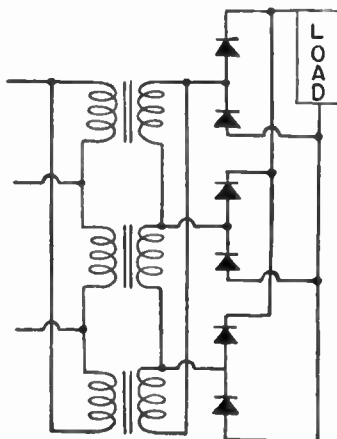

FIG. 5.—Six Elements in a Bridge Circuit.

RECTIFIER, SELENIUM.—See *Rectifier, Contact*.

RECTIFIER, VACUUM TUBE.—High-vacuum rectifier tubes, such as kenotrons, have the ability to withstand far higher inverse peak voltages than gas-filled or vapor-filled types. This is due to the fact that the vacuum is an almost perfect insulator during the half-cycle in which the cathode is positive and the anode negative, whereas in a gas- or vapor-filled tube a high inverse voltage will cause ionization and breakdown in the reverse direction. However, the absence of ionization in the high-vacuum tubes results in high plate or anode resistance within the tube and a relatively great loss of power in the tube itself. For this reason the rectified current is limited to an ampere or less.

RECTIFIER, VIBRATING.—A vibrating rectifier of the full-wave type, such as used for battery charging, is shown by Fig. 1. When alternating current from the transformer secondary flows through the a-c electromagnet in one direction this electromagnet attracts one end of the d-c electromagnet and repels the other end. This closes the pair of contacts that allow current to flow from the transformer to the battery in correct polarity. On the opposite half-cycle of alternating current the other pair of contacts close to carry the reversed transformer current to the battery in the same polarity as before. Instead of the d-c electromagnet energized by the battery circuit some rectifiers have a permanent magnet.

Fig. 2 shows a half-wave vibrating rectifier. The contacts are drawn closed only during the half-cycle of alternating current that acts to charge the battery in correct polarity. During the opposite half-cycle the contacts

RECTIFIER, VIBRATING

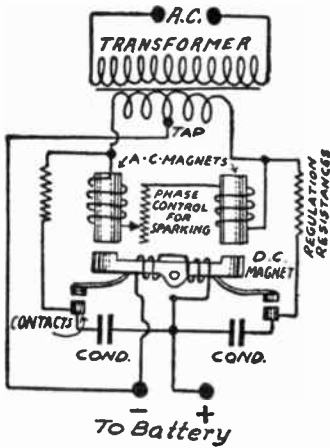

FIG. 1.—Full-wave Vibrating Rectifier.

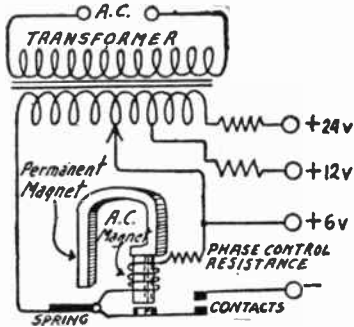

FIG. 2.—Half-wave Vibrating Rectifier.

remain open. Some vibrating rectifiers have one contact carried by a flat spring whose tension is adjusted so that the spring vibrates in synchronism with the power supply frequency.

RECTIFIER, VOLTAGE MULTIPLYING.—A voltage multiplying rectifier permits obtaining a direct voltage higher than the line voltage or supply alternating voltage without the use of a transformer. A voltage doubling rectifier has two plates and two separate cathodes, being equivalent to two independent rectifiers of the half-wave type. Two half-wave rectifier tubes may be similarly connected. The arrangement is shown by Fig. 1.

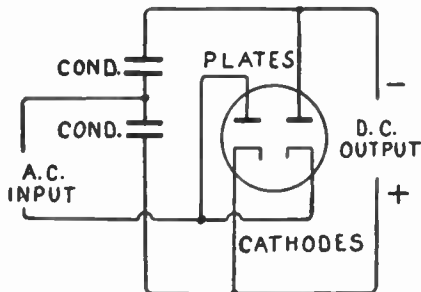

FIG. 1.—Voltage Doubler Connections.

One side of the alternating current supply is connected to one of the plates and to one of the cathodes of the rectifier. The other side of the line connects to a point between two condensers. The direct current output or

RECTIFIER, VOLTAGE MULTIPLYING

load is connected to the other sides of the condensers and to the remaining plate and cathode of the rectifier as shown. If the two sides of the rectifier are represented by arrowheads to indicate the direction in which current may flow, and if the output load (filter and plate circuits) be represented as a simple resistance the circuit is equivalent to that shown in Fig. 2.

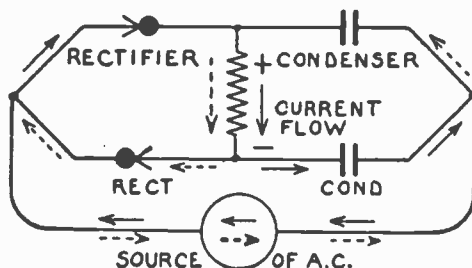

FIG. 2.—Equivalent Circuit for Voltage Doubler.

The flow of current in one direction is indicated by full line arrows and in the opposite direction by broken line arrows. It is necessary to keep in mind that there is a complete circuit established through the source of alternating current, even though the generator be miles away, and also to remember that in any alternating current circuit it is necessary only for the electrons to surge back and forth without any of them traveling completely around the circuit. The two condensers are charged alternately by the current surges. Then the current through the load is affected not only by the voltage applied from the alternating current source, but also by the discharge voltage of a condenser which has been previously charged. The sum of these two voltages will be much greater than the voltage from the source.

RECTIGON.—See *Rectifier, Gas-filled Tube*.

REFLEXING, PRINCIPLES OF.—It is possible to use a single vacuum tube for the amplification of two different frequencies at one time, this being called reflexing. The principle is shown by the diagram in Fig. 1.

The operation of a reflex amplifier is shown in Fig. 2. The two frequencies travel as follows: High frequency or radio frequency,

REFLEXING

is introduced from the winding 1 which is coupled with the winding 2 to form a radio frequency transformer. Voltage changes in winding 2 are impressed on the grid of the tube. The grid circuit is completed to the filament through the bypass condenser *A* which carries the high frequency around the high impedance of the iron-core transformer.

The high frequency output from the plate of the tube passes through the winding 3 which is coupled with winding 4 to make a transformer. The high frequency circuit is completed through the bypass condenser *B* from winding 3 to the filament circuit of the tube. Plate voltage from the B-battery is applied through the winding of the right hand air-core radio frequency transformer. The amplified high frequency appears in the winding 4.

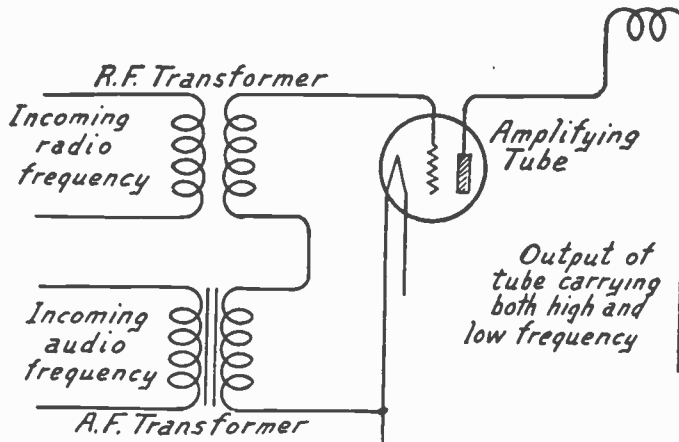

FIG. 1.—Effect of Reflexing on Amplifying Tube.

Still referring to Fig. 2 low frequency or audio frequency is introduced through the left hand audio frequency transformer. The audio frequency voltages pass to the grid of the tube through winding 2, the grid circuit being complete through the winding of the audio frequency iron-core transformer and winding 2 of the air-core radio frequency transformer. Bypass condenser *A* is of small capacity which offers a very high reactance to the low frequency, therefore does not bypass it but forces it through the winding of the audio transformer. Winding 2 of the air-core radio frequency transformer is of comparatively few turns, has no iron core, and is therefore of low reactance to the audio frequency voltages and offers practically no opposition.

The audio frequency output from the plate of the tube passes through winding 3 of the right hand radio frequency transformer. The reactance of this winding is very low to the audio frequency

REFLEXING

and it passes through with practically no opposition until the right hand bypass condenser *B* is reached. This condenser, being of small capacity, offers such great reactance that the audio frequency is forced through the winding of the right hand iron-core audio fre-

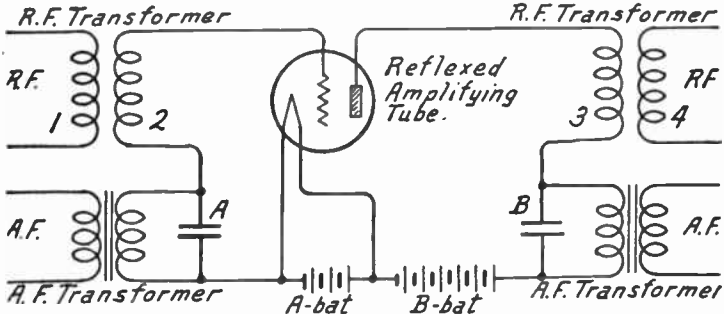

FIG. 2.—Circuits of Reflexed Amplifying Tube.

quency transformer. The audio frequency output then appears in the secondary of this transformer.

Reflex receivers provide two paths for the grid voltages and two paths for the plate currents of all reflexed tubes. One path carries the radio frequency current. This path is of low reactance to the radio frequency and of high reactance to audio frequency. The other part carries audio frequency current

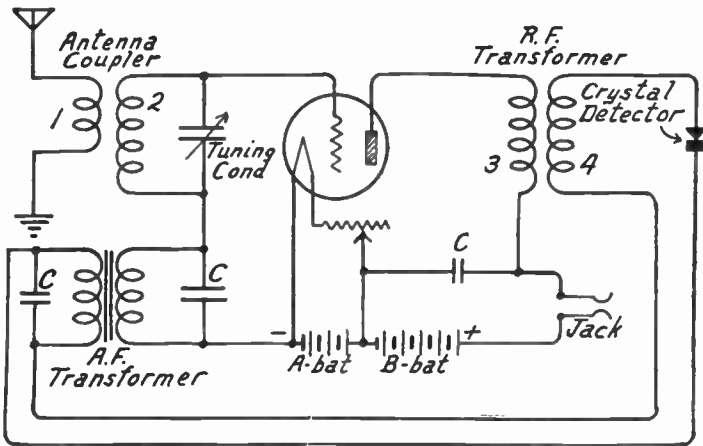

FIG. 3.—Single Tube Reflex Receiver with Crystal Detector.

and is of high reactance to the radio frequency. The two paths meet in the tube and in the batteries. The radio frequency circuit is always carried around the windings of iron-core transformers, speakers, etc. by bypass condensers.

Fig. 3 shows a one-tube receiver (crystal detector) with coils numbered as in Fig. 2. Tube detectors may be used instead of the crystal type shown here. Reflex receivers are generally rather un-

REGENERATION, ACTION AND PRINCIPLE OF

stable and are more inclined to oscillate than receivers using separate tubes for radio frequency and audio frequency amplification. Any of the oscillation controls described under *Oscillation* may be applied to these receivers.

REGENERATION, ACTION AND PRINCIPLE OF.—

Regeneration is the action by which a part of the energy from the plate circuit of a tube is fed back into the grid circuit of the same tube. The plate circuit energy is added to the energy already in the grid circuit.

Fig. 1 shows a tube having one inductance coil in the grid circuit and another inductance coil in the plate circuit. The energy in the plate circuit is several times greater than the energy in the grid circuit. The grid circuit is called the input circuit of the tube and the plate circuit is called the output circuit of the tube. The signal coming to the tube is introduced into the grid circuit and the voltage changes in the signal cause corresponding voltage changes on the grid of the tube. These voltage changes on the grid control the flow of current in the plate circuit.

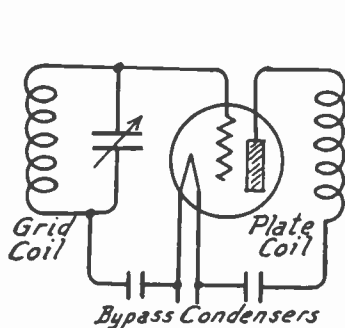

FIG. 1.—Grid and Plate Coils Entering into Regeneration.

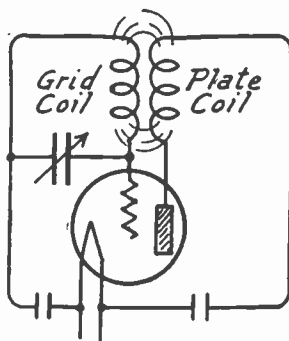

FIG. 2.—Feedback from Plate Circuit to Grid Circuit Causing Regeneration.

The strength of the output from the tube is proportional to the strength of the signal input. If the signal voltage impressed on the grid is made stronger by any means, it will be followed by a greater output in the plate circuit. Signal strength may be increased through many causes outside of the receiver. For example, a stronger signal will be received from a nearby or powerful broadcasting station than from a distant or weak broadcasting station.

By means of regeneration the tube itself is made to increase the input voltage. In Fig. 2 the two coils of Fig. 1 have been rearranged so that they are brought close together. The one magnetic field now includes both coils. They are coupled and energy from the plate coil is fed back into the grid coil.

If the grid circuit of the tube is tuned to resonance with the frequency of the incoming signal, as is the case in radio frequency

REGENERATION, ACTION AND PRINCIPLE OF

amplifiers and in detectors, the inductive reactance and the capacitive reactance in the grid circuit neutralize each other and leave only the resistance of the conductors in the circuit to oppose flow of current. Were it possible to reduce this resistance to zero nothing would remain to oppose the current flow and when oscillating voltages were once introduced into the grid circuit they would continue to flow indefinitely.

It is evident that the same results may be secured by adding just enough energy to that already in the grid circuit so that this additional energy overcomes the loss due to resistance. As an example, supposing the resistance of the grid circuit caused a power loss of five watts and suppose that just enough of the plate circuit energy were fed into the grid circuit to make up for this five-watt loss. Then the signal voltage originally brought into the grid circuit would set up oscillations which would continue on and on without diminishing.

It is possible to feed energy from the plate circuit back to the grid circuit and reinforce the voltages in the grid circuit because the frequency in the plate circuit is exactly the same as the frequency in the grid circuit.

After enough plate circuit energy has been fed back to just overcome the grid circuit resistance still more may be fed back to increase the grid circuit voltages to almost any desired extent. The power fed back from the plate circuit may be made sufficient to maintain oscillations in the grid circuit without the help of any outside voltage, such as an incoming signal voltage. Under such conditions the tube will maintain oscillations in its circuits as long as the filament batteries and plate batteries hold out. The tube is then oscillating.

As long as the grid circuit absorbs power from the incoming signal we have regeneration with a feedback in use. But just as soon as the feedback energy is great enough to sustain oscillation without outside help we have gone beyond regeneration and have oscillation in the tube. The feedback energy is then able to keep the tube's circuits in continuous oscillation.

It is apparent that regeneration allows an exceedingly weak signal to be built up until it is as effective as a powerful signal. Thus regeneration increases the sensitivity of a receiver many times. Regeneration also increases the selectivity of the receiver as may be seen from Fig. 3. The curve at the left side indicates the response of a receiver to various frequencies when the receiver is tuned to a frequency of 750 kilocycles. When tuned to this frequency the circuits have the least possible reactance at 750 kilocycles. At points below and above this frequency the response of the receiver will not be so powerful because the reactance has not been eliminated by the process of tuning to resonance.

The effect of regeneration is shown at the right in Fig. 3. The frequency of 750 kilocycles is being fed back from plate circuit to grid circuit and the signal at this one frequency is built up to great volume. Since the feedback is occurring only at the tuned frequency other frequencies below and above the resonant points are not increased in strength. Therefore the relative strength of the 750 kilocycle signal with regeneration is several times as great as with-

REGENERATION, CONTROL ADJUSTMENT OF

out regeneration. Any signals attempting to enter the receiver at other frequencies are relatively weaker under the conditions shown at the right in Fig. 3.

The feedback of energy from the plate circuit to the grid circuit may be made through inductive coupling, through capacitive coupling or through resistance coupling. Inductive coupling and capacitive coupling are the types generally used because resistance coupling is not effective at radio frequencies. With the more commonly used methods of obtaining regeneration an inductive coupling between two coils or two parts of one coil is employed. Capacitive coupling through the capacity existing between the plate and the grid inside of the tube is used in a few instances.

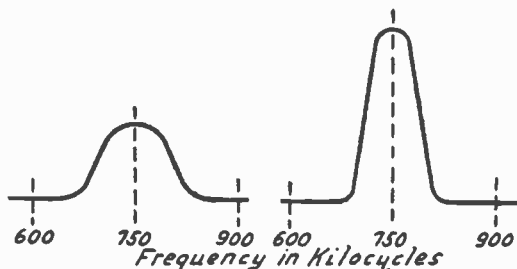

FIG. 3.—Effect of Regeneration on Signal.

There is always a feedback of energy from plate circuit to grid circuit through the capacity between the tube's plate and grid. This capacity feedback is independent of any external means for additional feedback. Since the reactance of any capacity is less at high frequencies than at low frequencies, the capacity feedback at high frequencies will be much greater than at low frequencies because of this change of effective reactance in the tube's internal capacity.

Regeneration and oscillation occur more easily at high frequencies than at low frequencies. Therefore less feedback will always be required to produce regeneration at the high frequencies or low wavelengths. Any control for regeneration provides for increasing the feedback as the frequency is lowered. The lower the frequency or the higher the wavelength the more regeneration will always be needed to produce a given strength of signal in the tube's output.

REGULATOR

REGULATOR TUBE.—See *Tube, Voltage Regulator.*

RELAXATION OSCILLATOR.—See *Oscillator, Relaxation.*

RELUCTANCE.—Reluctance is a measure of the opposition to magnetic lines of force in a magnetic circuit. Reluctance in oersteds is equal to magnetomotive force in gilberts divided by flux in lines or maxwells. Reluctance in a magnetic circuit is similar to resistance in an electric circuit.

RELUCTIVITY.—The reluctance of a centimeter cube of a magnetic substance.

REPEATER.—A telephone repeater is an audio-frequency amplifier placed in a transmission line to maintain or increase the strength of line signals.

RESISTANCE.—Resistance is the opposition to flow of electric current offered by conductors through which the current flows. Resistance affects the flow both of direct currents and of alternating currents. The opposition to the flow of alternating currents caused by inductance and by capacity is called reactance. The combined opposition of the resistance and the reactance to alternating currents is called impedance. See also *Impedance, Reactance* and *Skin Effect.*

Resistance considered as to its effect on high frequency currents is generally assumed to include not only true resistance, but also all losses of energy. These losses affect the circuit in much the same way that it would be affected by a loss due to resistance. These are often called equivalent resistances.

All resistances, reactances and impedances are measured in ohms. The symbol for resistance is "R," for reactance "X" and for impedance "Z."

RESISTANCE, ANTENNA.—The antenna resistance is assumed to include all causes of energy loss in the antenna circuit. This circuit consists of the antenna, lead-in, ground lead and the ground itself.

The antenna resistance includes the resistance of the wires and conductors used in parts of the antenna circuit. It also includes the loss of energy due to leakage through and over the surface of insulators, the loss due to currents set up in nearby conductors and the losses due to nearby dielectrics such as building walls, trees, poles, etc.

RESISTANCE, CALCULATION OF.—See *Law, Ohm's.*

RESISTANCE COUPLED AMPLIFIER.—See *Amplifier, Audio Frequency, Resistance Coupled.*

RESISTANCE COUPLING.—See *Coupling, Resistance.*

RESISTANCE, DIELECTRIC.—A name for dielectric strength. See *Strength, Dielectric.*

RESISTANCE, DIRECT CURRENT.—See *Resistance, Ohmic.*

RESISTANCE, EFFECTIVE.—The effective resistance of a circuit is equal to the power in watts that is used in the circuit

RESISTANCE, EQUIVALENT

divided by the square of the number of amperes flowing in the circuit. This is a true measure of the losses in a circuit whether they are due to resistance, reactance or actual loss of energy through leakages and similar effects.

RESISTANCE, EQUIVALENT.—The equivalent resistance of any circuit is the resistance which would have to be added to another circuit of the same type but composed of electrically perfect units in order to make the losses in the two circuits the same.

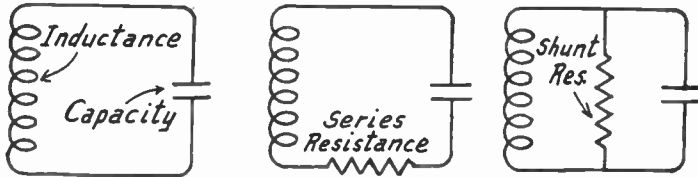

FIG. 1.—Equivalent Series and Shunt Resistances.

Equivalent resistance is usually indicated as being either in series or in parallel with the circuit. In Fig. 1 at the left is shown a circuit including only inductance and capacity and having no resistance. Since it is impossible to obtain such a perfect circuit in practice the resistance of all the parts may be shown as a series resistance or as a shunt resistance, both of these being indicated at the right hand side of Fig. 1. The resistances shown, if considered as equivalent resistances, represent all of the losses in the circuit. These losses are due to actual resistance, to eddy currents, to leakages, and to dielectric losses.

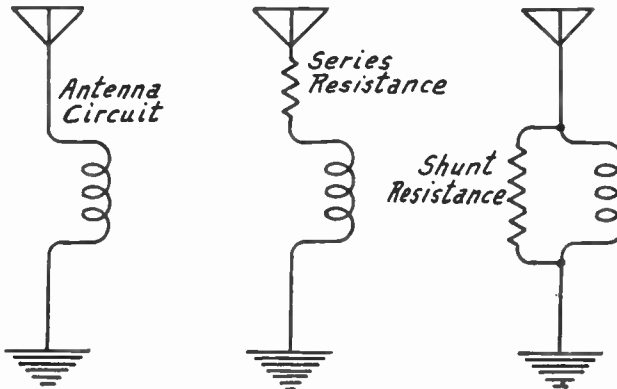

FIG. 2.—Equivalent Resistances in Antenna Circuit.

Fig. 2 represents an antenna circuit. The equivalent resistance of such a circuit may be shown as an actual resistance in series with the antenna or as a parallel resistance across the antenna capacity and the coil inductance. Both representations are shown at the right hand side of Fig. 2. The equivalent series resistance would tend to oppose flow of current. The equivalent parallel resistance would tend to bypass or waste a part of the energy in the antenna circuit.

RESISTANCE, FEEDBACK FROM

A vacuum tube is represented at the left in Fig. 3 while at the right are shown the equivalent resistances for such a tube. The equivalent resistances of the tube are shown as existing between the plate and the filament and

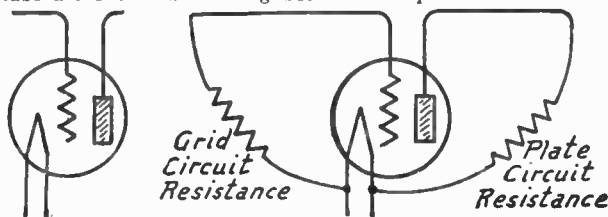

FIG. 3.—Equivalent Resistances of Vacuum Tube Circuits.

between the grid and the filament. The plate-filament resistance is the output resistance while the grid-filament resistance is the input resistance.

See also *Condenser, Losses in.*

RESISTANCE, FEEDBACK FROM.—See *Oscillation.*

RESISTANCE, FIXED.—Any resistance unit in which the amount of resistance is not readily variable is called a fixed resistance. Filament control resistors, grid leaks of the usual type and some power supply resistors are examples of fixed resistances.

RESISTANCE, HIGH FREQUENCY.—The effective resistance to high frequency currents is the total of all resistances and loss effects in the circuit.

HIGH FREQUENCY RESISTANCE OF COPPER WIRE

Ohms per Hundred Feet in Straight Wires

Gauge Number of Wire	Resistance at Direct Current	Resistance at 600 Kilocycles	Resistance at 1500 Kilocycles
12	.159	.94	1.55
14	.253	1.25	1.97
16	.402	1.62	2.51
18	.639	2.10	3.20
20	1.02	2.75	4.01
22	1.61	3.50	5.25
24	2.57	4.50	6.77
26	4.08	6.35	8.78
28	6.49	7.90	11.41
30	10.32	11.35	14.80
32	16.41	17.50	19.92
34	26.09	27.00	28.52
36	41.48	42.20	43.14
38	65.96	66.40	67.00
40	104.90	105.15	105.57

RESISTANCE, INSULATION

The total high frequency resistance depends partly on the actual resistance of the conductor at the frequency being considered, this resistance in turn depending to a great extent on the skin effect. The effective resistance depends also on the resistance in circuits which are coupled, either loosely or closely, to the circuit being considered. The loss due to the production of eddy currents in nearby conductors also enters into the high frequency resistance and this resistance is raised still higher by any loss of energy through the capacities between parts of the circuit or between its parts and those of neighboring circuits. Finally, the high frequency resistance is increased by the losses in condensers and coils used in the circuit. See *Skin Effect*.

High frequency resistance in a tuned circuit reduces the frequency at which the circuit is resonant. The effect is as if capacity or inductance were added to the tuned circuit. Therefore, less of the variable tuning capacity is required to reach a given frequency when the circuit contains high resistance.

RESISTANCE, INSULATION.—The ohmic resistance of an insulating material to voltages tending to break through the material is called the insulation resistance. It is measured in ohms. See also *Strength, Dielectric*. The following table shows volume resistance of dielectric materials as given by the *Bureau of Standards*.

RESISTIVITY OF SOLID DIELECTRIC MATERIALS

Resistivity of a centimeter cube at 22° Cent. or 71.6° Fahr. in billions of ohms (1,000,000,000 or 10^9)

Bakelite	India, slight stains	50,000,000
No. 1	moulded	1,000,000
No. 150	Porcelain, unglazed	300,000
No. 190	Quartz, fused	5,000,000,000
No. L-558	Rosin	50,000,000
micarta	Rubber, hard	1,000,000,000
Celluloid, white	Shellac	10,000,000
Condensite	Sulphur	100,000,000
Fibre, hard	Waxes	
red	beeswax, yellow	2,000,000
Glass, ordinary	beeswax, white	6,000,000
plate	ceresin (over)	5,000,000,000
Lavite	halowax No. 1001	20,000
Marble	halowax No. 5055B	20,000,000
Italian	paraffin	50,000,000
Tennessee	parowax	10,000,000
Vermont	sealing	8,000,000
Mica	Woods, paraffined	
African, spotted black	mahogany	40,000
African, brown clear	maple	30
colorless	poplar	500
India ruby, stained	walnut	10

The surface resistivity of any material is lowered by humidity, by the presence of moisture. For example, the surface resistivity of hard rubber which is 10^{14} ohms at a relative humidity of zero drops only to 10^{13} at a humidity of 60; but it then drops to 10^{12} at humidity of 80 and to 10^9 at a humidity of 90.

RESISTANCE, MATERIALS FOR

RESISTANCE, MATERIALS FOR.—Resistance which is necessary for the control of current flow and voltage is generally obtained from wires, rods or bars of metal or carbon. In the following table the resistances of commonly used materials are given in ohms per mil foot. These values show the resistance in ohms of a piece of the material having a cross-sectional area of one mil or one-thousandth of a square inch, and a length of one foot. To find the resistance per foot of the material having any given cross-sectional area it is only necessary to divide the value given in the table by the number of mils of cross-sectional area in the piece being considered.

For example, a number 30 gauge wire has a cross-section of 101 circular mils. If it is desired to find the resistance per foot of number 30 aluminum wire, the resistance given in the table, 17.02, is divided by 101, the result being 0.169 which is the resistance in ohms of one foot of number 30 aluminum wire. The cross-sectional area of wires of various gauges is given under *Wire, Copper*.

RESISTANCES IN OHMS PER MIL FOOT OF METALS AND CARBON

Aluminum	17.02	Manganin	264.70
Antimony	250.87	Mercury	576.23
Bismuth	721.92	Monel Metal	252.67
Brass	42.11	Nichrome	601.57
Cadmium	45.72	Nickel	46.92
Carbon (coke, lampblack) 22,000.00		Palladium	67.17
Copper (annealed)	10.37	Phosphor Bronze	46.90
Copper (hard drawn)	10.65	Platinum	60.15
German Silver (18%)	198.53	Silver	9.56
German Silver (30%)	294.78	Steel (cast)	114.50
Gold	14.68	Steel (soft carbon)	95.50
Graphite	4,300.00	Steel (transformer)	66.17
Iron (pure, annealed)	60.16	Tantalum	93.25
Iron (Cast)	435.00	Tin	69.17
Lead	132.35	Tungsten (drawn)	33.68
Magnesium	276.74	Zinc	34.85

RESISTANCE, MEASUREMENT OF.—See *Bridge, Measurements by*, also *Law, Ohm's*.

RESISTANCE, NEGATIVE.—The effect of feeding energy from the plate circuit of a tube back into the grid circuit of the same tube so that the resistance of the grid circuit is overcome is called negative resistance. The effect is much as though the resistance of the grid circuit were made less than zero. Then, in place of the grid circuit absorbing power, it delivers power to the tube. Oscillation and regeneration will take place with negative resistance. See also *Regeneration, Action and Principle of*.

RESISTANCE, OHMIC.—The opposition to flow of electric current which is due to the material, temperature and size of the conductor is called ohmic resistance. Ohmic resistance affects both direct and alternating currents. It affects the flow of low frequencies and high frequencies. Resistance is measured in ohms. A circuit through which an electrical pressure of one volt will send a current of one ampere has a resistance of one ohm. See *Law, Ohm's*.

RESISTANCE, PARALLEL CIRCUIT

The resistance of a conductor depends on the material of which it is made, on its length, on its size or cross-sectional area, and to some degree on temperature, high temperatures increasing the resistance of metals.

The resistance of a conductor varies directly with its length, that is, a conductor 200 feet long has twice the resistance of another one which is similar except for being 100 feet long. A conductor similar in all other ways, but only fifty feet long, has half the resistance of the 100-foot length.

The resistance of a conductor varies inversely with its cross-sectional area or its size around. That is to say, a conductor two square inches in area has half the resistance of a similar conductor having one square inch area, and one having one-half square inch area would have twice the resistance of the one square inch size.

RESISTANCE, PARALLEL CIRCUIT.—The calculation of resistance in parallel circuits differs from the calculation for series circuits. The total resistance of two conductors in parallel is less than the resistance of either conductor taken alone. A parallel circuit consists of two or more conductors all connected to a common source of voltage and current as in Fig. 1. A parallel circuit is sometimes called a shunt circuit and the conductors are called shunts.

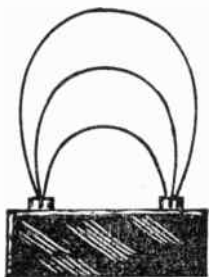

FIG. 1.—Circuits with Resistances in Parallel on Battery.

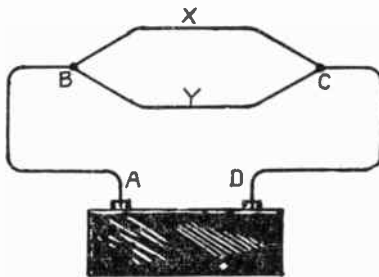

FIG. 2.—Parallel Circuit with Its Resistance as Part of Series Circuit.

For purposes of explanation, the parallel circuit will be treated as if the conductors forming the shunts were each attached to the common source of pressure and current. It will often be found, however, that a parallel circuit will form a part of a series circuit as in Fig. 2. In the illustration the portion of the circuit between A and B would be treated as a series circuit and so would the portion from C to D. In this way it would be possible to determine the amperage flowing through the shunts X and Y from B to C and to find the potential difference between B and C, which would be the voltage acting on the parallel circuit.

If the source of Fig. 2 is considered as having 12 volts pressure, if the lines A-B and C-D have 2 ohms resistance each and if the shunt circuit B-C has 2 ohms, then 2 amperes will flow in each part and 2 amperes will flow from B to C, dividing between X and Y. We know the amperage in B-C and the resistance, each being 2. Then multiplying 2 by 2 gives the potential difference as 4 volts between B and C. This 4 volts pressure acts on X and also on Y.

RESISTANCE, PARALLEL CIRCUIT

It is often desired to find the combined resistance of all the parts forming a parallel circuit, or to find the current flowing in each branch when the resistances of the branches are known.

If all the branches of a parallel circuit have the same resistance, as with the four parts of the circuit *A-B* in Fig. 3, the resistance of the entire circuit is found by dividing the resistance of one branch by the number of branches. Thus, in *A-B* of Fig. 3, dividing 20 (resistance of one branch) by 4 (number of branches) gives the combined resistance as 5 ohms. The resistance of any parallel circuit is always less than the resistance of any of its branches, because providing the current with several paths makes it easier for the electricity to flow than would be the case using only one of the several paths.

If the resistances of the several parts of a parallel circuit differ from one another, their combined resistance is found as follows: All of the resistances are multiplied together and the product forms the upper part or numerator of a fraction which will show the total resistance. Thus in *A-B* of Fig. 4, multiply $2 \times 3 \times 4 = 24$, which will be the numerator. Then multiply each resistance by each one of all the other resistances and add together all the numbers thus found. In *A-B* of Fig. 4, this would be done as follows: (2×3) plus (2×4) plus $(3 \times 4) = 6 + 8 + 12 = 26$, which will be the lower part or denominator of the fraction to be found. It will be seen that in the latter operation each resistance was multiplied by each of the other resistances. The fraction indicating the resistance of the shunt circuit *A-B* will then be $24/26$ or $12/13$ ths of an ohm. The same method can be applied to any number of shunts.

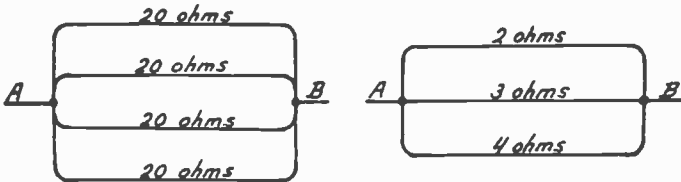

FIG. 3.—Parallel Circuits with Equal Resistances.

FIG. 4.—Parallel Circuits with Unequal Resistances.

If the potential difference or voltage between the ends of any one shunt is known and if the resistance of the shunt is known, the flow through that branch may be found by applying the rule: amperage is equal to voltage divided by resistance. Thus, in *A-B* of Fig. 4, if the potential difference is assumed to be 12 volts, then the flow through the 2-ohm branch will be 12 divided by 2, or 6 amperes; the flow in the 3-ohm branch will be 12 divided by 3, or 4 amperes; and the flow in the 4-ohm branch will be 12 divided by 4, or 3 amperes. The total flow will then be equal to the sum of the flows in the branches, or $6 + 4 + 3 = 13$ amperes.

This conclusion may be proven correct because the total resistance of the circuit *A-B* was previously found to be $12/13$ ths of an ohm and applying the rule, amperage is equal to voltage divided by resistance, dividing 12 (the voltage) by $12/13$ (the resistance) the amperage is found to be 13.

The combined resistance of two resistances in parallel is shown as follows:

$$R = \frac{Ra \times Rb}{Ra + Rb}$$

RESISTANCE, PLATE

when R is the combined resistance and R_a and R_b are the separate resistances.

The combined resistance of any number of resistances in parallel is shown as follows:

$$\frac{1}{R} = \frac{1}{R_a} + \frac{1}{R_b} + \frac{1}{R_c} + \frac{1}{R_d} + , \text{ etc.}$$

when R is the combined resistance and R_a, R_b, R_c, R_d , etc. are the separate resistances. The reciprocal of the total resistance is equal to the sum of the reciprocals of the separate resistances.

RESISTANCE, PLATE.—See *Tube, Output Resistance and Impedance of.*

RESISTANCE, SERIES CIRCUIT.—The diagram illustrates a series circuit made up of five different conductors attached between the terminals of a 6-volt battery and with the assumed resistance of each part marked for reference. Current flowing through any one part must flow through all the others.

The resistance of a series circuit is equal to the sum of the resistances of the parts included in the circuit. Therefore, the resistance of the circuit is as follows:

A to B	1/2 ohm
B to C	1 ohm
C to D	3 ohms
D to E	1 ohm
E to F	1/2 ohm
Total, A to F	6 ohms

Knowing the resistance of a series circuit and the voltage acting on the circuit (in this case 6 volts) the amperage can be found by the rule that the amperes are equal to the volts divided by the ohms. Then, dividing 6 (volts) by 6 (ohms) gives the current flow as 1 ampere. The current flow is the same through all parts of a series circuit regardless of the resistance of the part being considered. Thus, the current through the circuit from C to D against 3 ohms resistance is 1 ampere and the current through the circuit from A to B against 1/2 ohm resistance is likewise 1 ampere.

In the example being considered it is known that there is a pressure of 6 volts between the ends of the circuit A and F, and it is evident that it requires 6 volts to send 1 ampere through this circuit. Yet there will not be 6 volts pressure between C and D, for example, because it is known that it does not require 6 volts to send 1 ampere against 3 ohms resistance. The rule has been given that voltage is equal to the number of amperes times the number of ohms, and, applying this rule between C and D, 1 (ampere) times 3 (ohms) we find that 3 volts pressure is required. This pressure of 3 volts is used between C and D and the potential difference is said to be 3 volts. Similarly the potential difference between any other points may be found; as from B to C, 1 ohm times 1 ampere indicates 1 volt drop from B to C.

RESISTANCE, SHUNT.—See *Resistance, Parallel Circuit.*

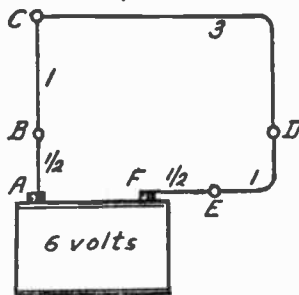

Series Circuit of Five Conductors.

RESISTANCE, UNITS OF

RESISTANCE, UNITS OF.—The practical unit of resistance is the ohm. One ohm is the resistance of a column of pure mercury having a weight of 14.4521 grams, a uniform cross-section of one square millimeter and a length of 106.3 centimeters at a temperature of 0 Centigrade, 32° Fahrenheit. See also *Ohm*.

A microhm is the one-millionth part of an ohm. A megohm is one million ohms.

RESISTANCE, VARIABLE.—A resistance unit in which the value of the resistance is readily changed is called a variable resistance. Rheostats and potentiometers are forms of variable resistances.

RESISTANCE, WIRE FOR.—See *Resistance, Materials for*.
RESISTANCE COUPLED AMPLIFIER.—See *Amplifier, Audio Frequency, Resistance Coupled*.

RESISTANCE COUPLING.—See *Coupling, Resistance*.

RESISTOR.—A resistor is a device of which the purpose is to provide resistance in an electrical circuit. Adjustable resistors may be varied in value of resistance while in use. Fixed resistors cannot readily be changed while in use. Adjustable resistors are used as rheostats, potentiometers, volume controls, etc. Fixed resistors are used in the voltage dividers of power units, for furnishing grid biases and for grid leaks, for resistance couplings, for control of filament current and similar purposes.

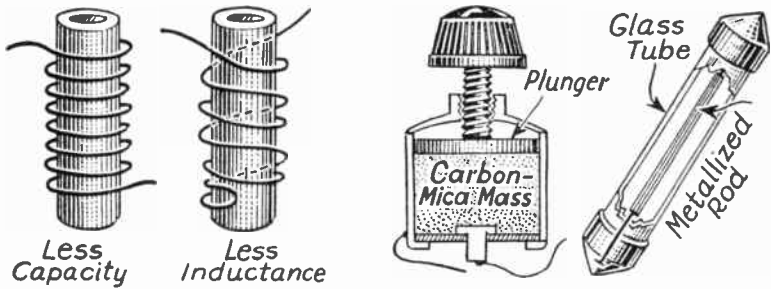

FIG. 1.—Space Winding and Non-inductive Winding of Resistors.

FIG. 2.—Carbon Type and Metallized Type of Resistors.

There are three electrical factors in a radio circuit; resistance, inductance and capacity. A resistor should have the least possible inductance and capacity. Resistors formed of wire windings have a certain amount of capacity distributed between turns, the amount being lessened by spacing the turns as in Fig. 1. An ordinary spiral of wire has more or less inductance because it forms a coil but the inductance may be reduced by winding one half the wire in each direction as shown.

Adjustable resistors are sometimes constructed from a mixed mass of carbon which is a conductor, and flake mica which is an insulator, as the resistance material. The resistance is lessened by compressing this mixture to force

RESISTOR

the carbon particles into closer contact and is raised by releasing the pressure, whereupon the springiness of the mica separates the carbon particles and reduces the area of contact. The construction is shown in Fig. 2. Such a resistor has negligible inductance and but small capacity.

Many fixed resistors are made by depositing carbon or a metal such as tungsten on glass or other insulating material, then subjecting the unit to great heat which unites the elements and makes a permanent job. The conducting deposit may be carried on a thin glass filament placed within a protecting glass tube as in Fig. 2 or it may be deposited on the inner wall of a glass tube. Such units have practically no inductance and are nearly free from capacity.

Vitreous enamelled resistors are used extensively in power units. They are made by space winding the resistance wire on a tube of insulating material, then covering the whole with material which, when subjected to great heat, turns to a glass-like enamel. The supporting tube, the wire and the enamel are selected so that all three have practically the same amount of expansion at given degrees of heat. Mechanical stresses are avoided by the uniform expansion as the unit heats and cools when in use. This type of resistor and those shown in Fig. 2 have the desirable characteristics of being unaffected by moisture.

Most materials change their resistance with change of their temperature. In general, the metals increase their resistance with increase of heat and are said to have a positive temperature coefficient of resistance. Carbon, on the contrary, decreases its resistance as its temperature rises and is said to have a negative temperature coefficient. The relation between the change of temperature and the change of resistance is called the temperature coefficient of the material. The smaller the temperature coefficient or the less the change of resistance, the more satisfactory will be the resistance material.

Special resistance wires have been developed in which the temperature coefficient is very small. While conductors such as copper, aluminum and steel will increase their resistance by about thirty per cent between ordinary room temperature and the temperature of boiling water, special resistor wires show less than the hundredth part of this change. Most of these special wires are alloys of iron and nickel. The actual resistance of any commercial resistor is presumed to be within five to ten per cent above or below its normal rating in ohms.

The chief limitation in the use of any given resistor is its heating. The heat developed is proportional to the product of the resistance in ohms and the square of the current in amperes. This product equals the number of watts of power being dissipated in the resistor and because of this fact resistors which are to handle any appreciable current are generally rated in the number of watts they will safely dissipate as well as in the number of ohms resistance. The heating of a resistor, while due chiefly to the power dissipated, is also increased by its proximity to other hot parts such as tubes and other resistors and to lack of sufficient air circulation. As a matter of safety and to insure long life, resistors are generally operated at about one-half their rating in watts and at something less than three-fourths of their maximum carrying capacity in milliamperes.

The safe current in milliamperes which may be carried by a resistor of given rating in watts is found from the formula:

$$\text{Maximum Milliamperes} = 1000 \times \sqrt{\frac{\text{allowable watts}}{\text{resistance in ohms}}}$$

For example, the allowable current through a 1000-ohm resistor rated at 40 watts is found by dividing 40 by 1000, giving 0.04; extracting the square root of this quantity, which is 0.2; and multiplying by 1000 to give 200 milliamperes as the safe current limit.

RESISTOR, FILAMENT CONTROL

In the selection of a resistor for certain work it is generally known to begin with that there should be a drop of so many volts and a current flow of a given number of milliamperes. Multiplying the voltage by 1000 and dividing the result by the number of milliamperes gives the required number of ohms resistance, thus:

$$\text{Resistance in ohms} = \frac{\text{Volts Drop} \times 1000}{\text{Milliamperes Current}}$$

Knowing the required resistance and the current to be carried, the required wattage is found by squaring the number of amperes and multiplying this result by the number of ohms. If the current is measured in milliamperes, the formula becomes:

$$\text{Required Watts} = \frac{(\text{milliamperes})^2 \times \text{Ohms}}{1,000,000}$$

Resistors of the types described here are used for voltage control, for coupling resistances, for control of filament current, for grid leaks and for all similar work in radio circuits. Resistors are also used to change the characteristics of coupling transformers, to flatten resonance curves in tuned circuits and to control the volume and amplification in all types of receivers.

RESISTOR, FILAMENT CONTROL.—Fixed resistance units are used for the automatic control of filament voltage in radio receiver tubes, these fixed resistors taking the place of rheostats.

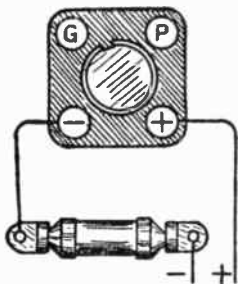

FIG. 1.—Filament Resistor.

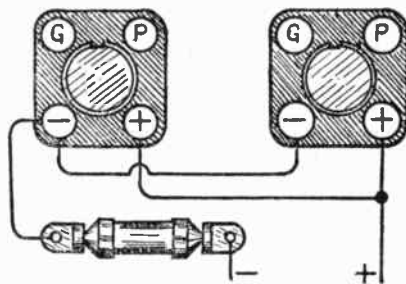

FIG. 2.—Single Filament Resistor for Two Tubes.

These units are made in different current carrying capacities. A unit for handling a one-quarter ampere tube is of course designed to carry one-quarter ampere of current. Its connection in the filament circuit is shown in Fig. 1. These units are also made to carry six hundredths of an ampere, one-eighth ampere, one-half ampere,

RESONANCE

or one ampere. A one-half ampere unit may be used for controlling a single tube requiring one-half ampere of filament current or it may be used to control two one-quarter ampere tubes in parallel as in Fig. 2. The one ampere unit is used for the control of a single tube requiring one ampere of filament current, for the control of two half-ampere tubes in parallel, or for the control of four quarter-ampere tubes in parallel.

The resistance element used in these units is made of iron wire or of iron alloys. Iron has the peculiar property of greatly increasing its resistance at a critical temperature which is just below red heat. This characteristic of iron is illustrated in Fig. 3. With a gradual rise of temperature the resistance of the iron rises slowly but just before the iron becomes red hot the resistance goes up rapidly and limits the flow of current. The size or gauge of the wire is selected so that this increase of resistance will occur when the rated current flow of the resistor has been reached. This action of the wire is independent of the voltage applied, therefore, a resistor of this type tends to maintain a fairly constant flow of current through the tube filament even as the battery becomes discharged.

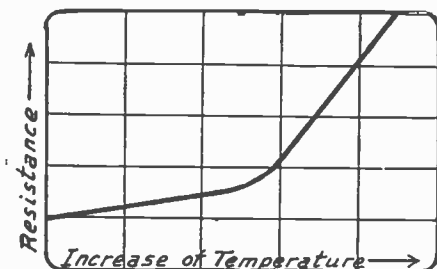

FIG. 3.—Increase of Resistance with Temperature in Iron Used as Filament Resistor.

The various kinds of fixed resistance for controlling filament voltage operate satisfactorily with storage batteries but not with dry cells. With a storage battery the change in current flowing to a quarter-ampere tube between the voltage given by a fully charged battery and the voltage of a discharged battery is only about six thousandths of an ampere. This is because the voltage of a storage battery does not drop to any great extent until it is almost fully discharged.

These fixed resistors are very satisfactory for the control of current through audio frequency and radio frequency amplifying tubes. But because it is often advantageous to change the voltage applied to the detector tube filament in obtaining maximum sensitivity, they are not as well suited as a variable rheostat for use with the detector.

RESONANCE.—Flow of alternating current in a circuit is opposed by three things; the resistance, the inductive reactance and the capacitive reactance. The resistance is due to the resistance of the various conductors in the circuit and to the connections between them. It may be reduced by using conductors of adequate size and of good conductivity, but resistance cannot be completely eliminated from any circuit.

The inductive reactance depends on the inductance in the circuit, the greater the inductance in the coils and other parts the greater

RESONANCE

being the resultant inductive reactance. The capacitive reactance depends on the capacity of the condensers and other parts in the circuit, the greater the capacity the less the capacitive reactance. Further explanations are given under the heading of *Reactance*.

Inductive reactance is often called positive reactance while capacitive reactance is often called negative reactance. This is because they have opposite effects in a circuit, that is, they tend to neutralize each other.

If we have an alternating current circuit containing a certain amount of inductive reactance, we can introduce capacitive reactance into this circuit and by gradually increasing the capacitive reactance can finally reach a point where the two reactances exactly balance each other and leave only the resistance to oppose flow of current through the circuit.

A circuit containing only resistance and inductive reactance offers opposition to the flow of current, this opposition being due to the combined effects of the resistance and the inductive reactance. We may also have a circuit containing only resistance and capacitive reactance in which opposition to flow of current is caused by the

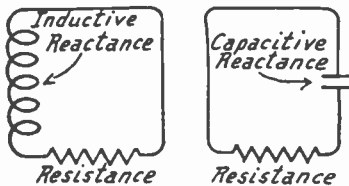

FIG. 1.—Circuits with Inductive and Capacitive Reactances to Produce Resonance.

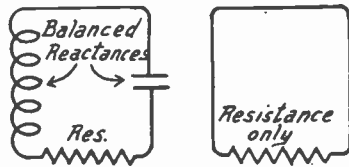

FIG. 2.—Condition of Series Resonance.

combined effects of the resistance and reactance. These circuits are shown in Fig. 1. But if we have an alternating current circuit containing resistance, inductive reactance and capacitive reactance, the two reactances may be made such that they balance out. This condition is called resonance.

When an alternating current circuit, as in Fig. 2, containing resistance and the two kinds of reactance all in series is at its resonant point the effect of the reactances is removed and we have the greatest possible flow of current through the circuit at this time because only resistance remains. Resonance obtained when the resistance, the inductive reactance and the capacitive reactance are all in series with each other is called series resonance.

When we are speaking of adjusting the capacity and inductance to resonance we are always referring to resonance at a certain frequency. At any given frequency there are certain values of capacity and inductance which cause resonance at this frequency but at no other frequency. If the frequency in the alternating current circuit should change, it would be necessary to make a different adjustment of either inductance or capacity, in order that the resonant condition might again be obtained at the new frequency.

RESONANCE

With a given adjustment of capacity and inductance or a given relation between them their reactance will balance out for one certain frequency and current at this frequency will then flow through the circuit in maximum volume although currents at any other frequency still will be opposed by the reactances. The circuit is then said to be in resonance at that frequency.

In practice, resonance is never so sharply defined at any one frequency that the reactance disappears completely for that frequency, yet remains high for all other frequencies. The reactance is least for the resonant frequency, then gradually increases for frequencies farther and farther away from the point of resonance.

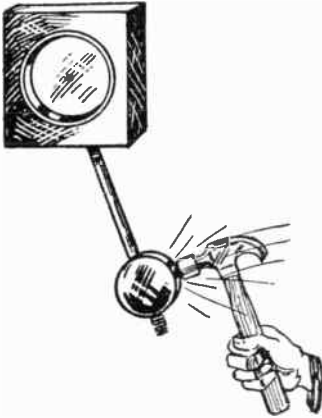

FIG. 3.—Mechanical Resonance
Between Pendulum and
Hammer.

As the frequency is lowered, either the inductance, the capacity of both must be increased to maintain resonance. If the frequency is increased, then the capacity, the inductance, or both must be decreased to maintain resonance. In other words, the greater the frequency the less must be the capacity and inductance and the lower the frequency the greater must be the capacity and inductance.

We may consider a circuit tuned to resonance as being similar to the pendulum of Fig. 3 which swings naturally at a certain speed or frequency. The applied alternating current, which must be of the same frequency, may be considered as similar to a hammer with which the pendulum is being struck. The hammer must be swung at the same speed or frequency with which the pendulum is moving.

Then every blow of the hammer adds to the swing of the pendulum until the pull of gravity and the friction on the pendulum prevent further increase just as in the resonant circuit the resistance finally prevents further increase of current.

The frequency of resonance is given by the following formulas when the inductance and the capacity are known:

$$\text{Frequency} = \frac{159,155,000}{\sqrt{\text{microhenries} \times \text{micro-farads}}}$$

$$\text{Frequency} = \frac{159,155}{\sqrt{\text{microhenries} \times \text{microfarads}}}$$

$$\text{Frequency} = \frac{5,033}{\sqrt{\text{millihenries} \times \text{microfarads}}}$$

$$\text{Frequency} = \frac{159.16}{\sqrt{\text{henries} \times \text{microfarads}}}$$

These values of frequency are in cycles per second. Dividing the result by 1000 will reduce the frequency to kilocycles.

RESONANCE, COUPLING EFFECT ON

The wavelength in meters for resonance is given by the following formulas:

$$\text{Wavelength} = 1.884 \times \sqrt{\text{microhenries} \times \text{micro-microfarads}}$$

$$\text{Wavelength} = 1884 \times \sqrt{\text{microhenries} \times \text{microfarads}}$$

$$\text{Wavelength} = 59,750 \times \sqrt{\text{millihenries} \times \text{microfarads}}$$

$$\text{Wavelength} = 1,884,000 \times \sqrt{\text{henries} \times \text{microfarads}}$$

RESONANCE, COUPLING EFFECT ON.—See *Coupling, Effect on Resonance.*

RESONANCE, INDICATOR FOR.—See *Meter, Frequency.*

RESONANCE, INDUCTANCE-CAPACITY VALUES FOR.—It is the product of the inductance and capacity in a circuit that determines the frequency at which the circuit is resonant. For each frequency there is a certain value of this product which is called the inductance-capacity value or the L-C value for resonance. Knowing this value it is possible to determine the correct inductance for use with any given capacity or the correct capacity for use with any given inductance. The L-C value is divided by the known capacity or the known inductance, the quotient of the division being the required inductance or capacity, thus:

$$\text{Inductance} = \frac{\text{L-C value}}{\text{Capacity}} \qquad \text{Capacity} = \frac{\text{L-C value}}{\text{Inductance}}$$

In the following table are given the inductance-capacity values for resonance at frequencies in the broadcast transmission bands. The inductance is to be measured in microhenries and the capacity in microfarads.

As an example, it might be desired to find the required inductance of a coil to tune to a frequency of 550 kilocycles or 545.1 meters wavelength with a condenser of .0005 microfarad capacity. The L-C value for this frequency is found from the table to be .08428. Substituting in the formula and dividing this value by the capacity (0.0005) gives the result as 168.56 microhenries of inductance or approximately 170 microhenries.

Again, it might be desired to learn the required minimum capacity of the tuning condenser to reach the frequency of 1500 kilocycles or the wavelength of 199.9 meters with the coil of 170 microhenries inductance. The L-C value for this frequency is found to be .01127 in the table. Dividing this by the inductance (170) gives as a result .0000663 (approximate) microfarad of minimum capacity. The required change of capacity is then from about .000066 to .0005 microfarad. Any other coil and condenser combination may be similarly calculated.

RESONANCE, INDUCTANCE-CAPACITY VALUES FOR

Frequency in Kilocycles	Wavelength in Meters	L-C Value	Frequency in Kilocycles	Wavelength in Meters	L-C Value
550	545.1	.08428	1030	291.1	.02389
560	535.4	.08119	1040	288.3	.02343
570	526.0	.07827			
580	516.9	.07551	1050	285.5	.02299
590	508.2	.07288	1060	282.8	.02255
			1070	280.2	.02213
600	499.7	.07040	1080	277.6	.02171
610	491.5	.06808	1090	275.1	.02130
620	483.6	.06593			
630	475.9	.06383	1100	272.6	.02090
640	468.5	.06185	1110	270.1	.02052
			1120	267.7	.02016
650	461.3	.05998	1130	265.3	.01980
660	454.3	.05823	1140	263.0	.01946
670	447.5	.05658			
680	440.9	.05501	1150	260.7	.01914
690	434.5	.05348	1160	258.5	.01882
			1170	256.3	.01852
700	428.3	.05198	1180	254.1	.01821
710	422.3	.05051	1190	252.0	.01789
720	416.4	.04907			
730	410.7	.04767	1200	249.9	.01760
740	405.2	.04630	1210	247.8	.01731
			1220	245.8	.01702
750	399.8	.04495	1230	243.8	.01675
760	394.5	.04380	1240	241.8	.01648
770	389.4	.04268			
780	384.4	.04164	1250	239.9	.01622
790	379.5	.04060	1260	238.0	.01596
			1270	236.1	.01571
800	374.8	.03960	1280	234.2	.01546
810	370.2	.03866	1290	232.4	.01522
820	365.6	.03774			
830	361.2	.03684	1300	230.6	.01499
840	356.9	.03596	1310	228.9	.01476
			1320	227.1	.01452
850	352.7	.03511	1330	225.4	.01432
860	348.6	.03429	1340	223.7	.01411
870	344.6	.03351			
880	340.7	.03275	1350	222.1	.01390
890	336.9	.03201	1360	220.4	.01370
			1370	218.8	.01350
900	333.1	.03129	1380	217.3	.01330
910	329.5	.03059	1390	215.7	.01311
920	325.9	.02991			
930	322.4	.02926	1400	214.2	.01292
940	319.0	.02864	1410	212.6	.01274
			1420	211.1	.01256
950	315.6	.02804	1430	209.7	.01239
960	312.3	.02746	1440	208.2	.01222
970	309.1	.02688			
980	305.9	.02634	1450	206.8	.01205
990	302.8	.02582	1460	205.4	.01189
			1470	204.0	.01173
1000	299.8	.02532	1480	202.6	.01157
1010	296.9	.02483	1490	201.2	.01142
1020	293.9	.02436	1500	199.9	.01127

RESONANCE, PARALLEL

RESONANCE, PARALLEL.—We may have a circuit in which the inductance and capacity are in parallel with each other and are then placed in series with an alternating current circuit as shown in the diagram. It is now possible to adjust the inductance and capacity so that the two together form a resonant circuit. In this resonant circuit, composed of the inductance and capacity with the resistance of their connections, we would then have the conditions which allow the greatest possible flow of oscillating current back and forth between the inductance and the capacity.

With parallel resonance the loop circuit which contains the coil and condenser is itself practically in a condition of series resonance. Under this condition the voltage on the condenser is equal and opposite to the voltage on the coil and there is a flow of current back and forth between condenser and coil. At any instant the current in the coil is opposite to the condenser current. The current in the main circuit is the algebraic sum of these two currents in coil and condenser and with these currents opposite and of practically the

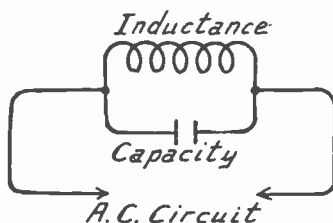

Circuit for Parallel Resonance.

same value they just about balance and the net current in the main circuit approaches zero, being equal only to the difference between the coil current and condenser current.

In adjusting the coil's inductance or the condenser's capacity to obtain parallel resonance we are really adjusting these values to cause the same value of current in both coil and condenser. The nearer the two currents approach equality the less will be the current in the main circuit.

Inductance and capacity thus arranged in parallel with each other and adjusted to resonance are sometimes called anti-resonance when placed in an alternating current circuit because this combination allows the smallest possible flow of current through the alternating circuit whereas series resonance allows the greatest possible flow through the alternating current circuit.

It is possible to change either the capacity or the inductance until they are resonant at the frequency of the alternating current circuit in which these units are connected. A condenser and coil thus tuned to a certain frequency offer an exceedingly high impedance to flow of current at that frequency.

With the capacity and inductance remaining unchanged, the frequency of the outside circuit connected to them may be changed until it reaches the frequency to which the condenser and coil happen to be tuned. We again would have the condition of parallel resonance. The condition of parallel

RESONANCE, SERIES

resonance is always reached when the values of capacity, inductance and frequency are such that the least current will flow through the circuit.

RESONANCE, SERIES.—If a condenser and a coil, that is, a capacity and an inductance are connected in series with each other and placed in series with a circuit carrying alternating current, it is possible to change either the capacity or the inductance until the inductive reactance (alternating current opposition caused by inductance) is just equal to the capacitive reactance (alternating current opposition caused by capacity). When this condition of balance is reached there will be the greatest possible flow of current

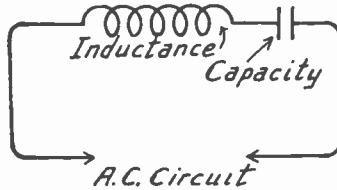

Circuit for Series Resonance.

through the circuit because the inductive reactance and capacitive reactance counteract each other for the frequency existing in the connected circuit. This condition is called series resonance. If the frequency of the circuit is changed, it will be necessary to change either the capacity or inductance to again obtain series resonance.

RESONANT CIRCUIT.—See *Resonance*.

RESONANT FREQUENCY.—See *Frequency, Resonant*.

RESONANT PEAK.—See *Transformer, Audio Frequency*.

RESONATOR, CAVITY.—A cavity resonator is an enclosure within which may be produced electromagnetic waves consisting of electrostatic field lines and of magnetic field lines which are at right angles to each other. At a frequency determined by the shape and dimensions of the cavity there will be exchange of energy between the electric and magnetic fields much as there is an exchange of energy between the electric field of a condenser and the magnetic field of a coil in the usual type of resonant circuit. At this frequency the cavity resonator is an oscillatory circuit. Frequencies possible with cavity resonators are far higher than those for condensers and coils without excessive dissipation of energy in the oscillatory circuit itself.

At *A* in Fig. 1 is represented a resonant circuit consisting of the two plates of a condenser and, connected between them, a short conductor. The short, straight conductor has sufficient inductance to perform its function of supporting magnetic fields when the circuit is operating at very high frequencies. During a resonant cycle there will be alternately the magnetic field lines shown around the straight conductor and the electric field lines shown between the condenser plates. If many conductors are connected in parallel between the condenser plates, as at *B*, there still will be magnetic

RESONATOR, CAVITY

lines around the conductors and electrostatic lines between the plates. If the number of straight conductors is infinitely increased they finally will form a cylinder whose ends are closed by the condenser plates. Then, as in the top view at *C*, there will be magnetic lines traveling in horizontal circular paths, and, as in the side view at *D*, there will be electrostatic lines in vertical paths. Thus the magnetic and electric fields are acting at right angles to each other, and they act as an electromagnetic wave.

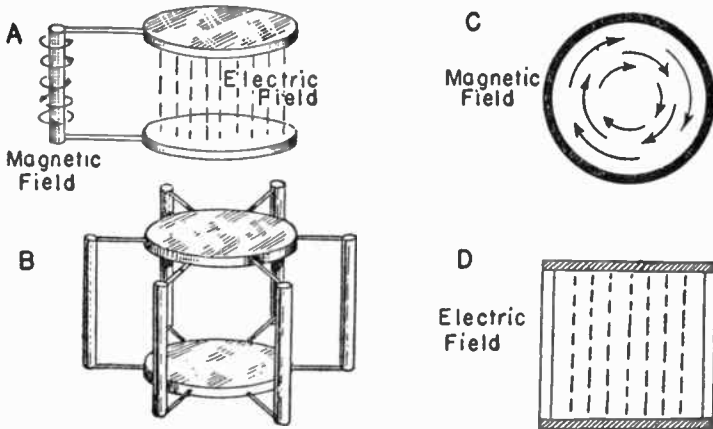

FIG. 1.—Principle of the Cavity Resonator.

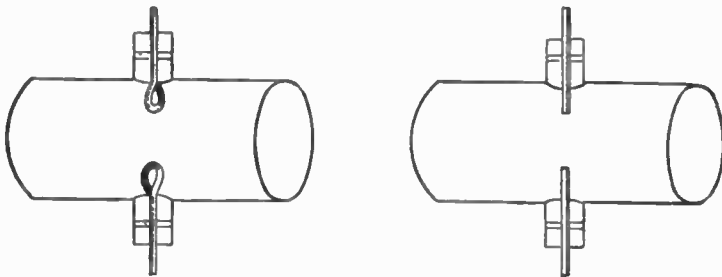

FIG. 2.—Energy Transfer Probes for Cavity Resonator.

Energy may be introduced into and extracted from the cavity resonator by means of probes such as shown in Fig. 2. The loops at the left are affected chiefly by the magnetic component of the electromagnetic waves, much as a loop antenna acts with radio waves. Straight rods, as at the right, are affected chiefly by the electric component of the waves, much as a straight wire antenna is affected by radio waves in space.

RETURN, CATHODE

RETURN, CATHODE.—The cathode return for a tube is the conductive path through which circuits for control grids, screen grids, plates or anodes, and other elements are connected to the cathode. Returns for typical circuits are shown by Fig. 1. Between the elements of the tube and their cathode return points

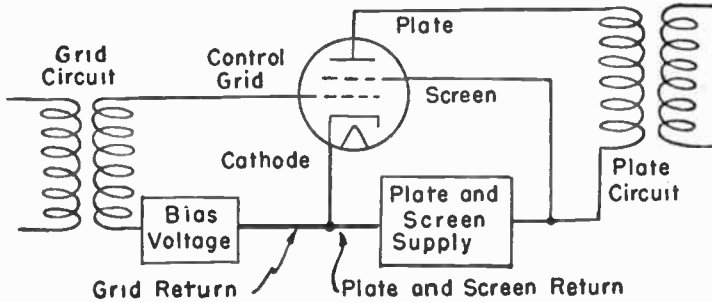

FIG. 1.—Cathode Returns for Various Circuits of a Tube.

are the necessary sources of voltage and current, also the coupling devices.

Fig. 2 shows various returns used with heater-cathode types of tubes. At *A* all returns are made directly to the cathode. At *B* they are made to the end of a biasing resistor which is in the cathode line. When cathode and one side of the heater are internally connected to the same base prong, as at *C*, the return is to this prong, not to the one connected only to the heater. Some tubes have the cathode connected to one side of the heater and to a

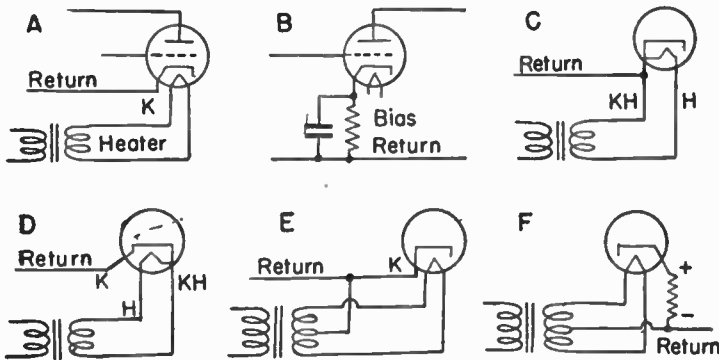

FIG. 2.—Returns for Heater-cathode Type Tubes.

separate prong, as at *D*. Here the return is made to the separate cathode prong. In some circuits the cathode is connected to a center tap on the heater winding of the power transformer, as at *E*. The heater may be maintained at a negative potential with reference to the cathode by means of a resistor between the cathode and the return, with the return connected to the center tap of the heater winding as at *F*.

RETURN, CATHODE

Fig. 3 shows returns for filament-cathode tubes, also for circuits in which there is a grid condenser or stopping condenser. At *A* the return is to a center tap on the filament winding of the power transformer. At *B* the return is to a center-tapped resistor connected across the heater supply. The tap position may or may not be adjustable. When a tube has two filaments with a tap between them, as at *C*, the return is made to the filament tap. Whenever the filament is heated with direct current, as at *D*, the grid re-

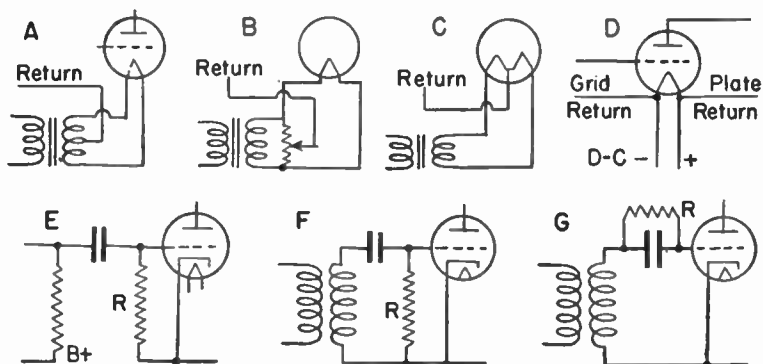

FIG. 3.—Returns for Filament-cathode Type Tubes, Also for Circuits with Grid Condensers.

turn may be to the negative side and the plate and screen returns to the positive side of the filament, or all returns may be to the negative side. With resistance coupling, as at *E*, the return is through grid resistor *R*. With a grid condenser and leak, as at *F* and *G*, the return is through leak resistors *R*. With the three latter connections the resistor provides a complete conductive path where otherwise such a path would not exist because of the condensers.

RHEOSTAT.—A rheostat is a resistor whose value may be easily adjusted while it is a part of a current-carrying circuit in order to provide a variable drop of voltage between the source and the load or between any other parts of the circuit. Most rheostats consist of a winding of resistance wire over which a slider contact is moved to alter the amount of resistance which is effectively in circuit. Other rheostats have carbon blocks or carbon particles which are pressed more tightly together to lessen the resistance, or loosened to increase the resistance.

RUBBER.—In the original state crude rubber is the gum of a tree. The crude gum is washed and thoroughly cleaned after which various fillers are added to give the rubber certain desired characteristics or to adulterate it and lower the cost of the article as finally used. This prepared gum is treated with sulphur and is heated to produce the action called vulcanization. The vulcanized rubber gains elasticity, strength and durability. The rubber generally used for wire insulation contains considerable percentages of adulterants and is often composed largely of old rubber which has been worked over or reclaimed.

RUBBER, HARD

The dielectric constant of pure rubber varies between 2.0 and 3.0, this constant increasing with increase of fillers in the compound. Good grades of insulating rubber have a dielectric strength of 250 to 900 volts per thousandth of an inch thickness.

RUBBER, HARD.—When rubber is vulcanized at high temperature, with great pressure and with the use of comparatively large quantities of sulphur it becomes very hard and strong, being called hard rubber. Hard rubber is generally jet black and takes a high gloss easily. The surface of rubber for use in decorative panels may be colored to represent natural woods or other ornamental designs.

From the standpoint of electrical properties hard rubber is one of the best of all available materials for use in insulators, brackets, supports, bases and panels of radio receivers. Hard rubber has the disadvantage of changing its form under pressure or bending strain. Bolts and other fastenings which pass through hard rubber should be secured with lock washers because in time the rubber will give under the nuts or bolt heads and looseness will result.

Hard rubber may be quite easily formed and bent into any desired shape by immersing it for a minute or two in boiling hot water. The rubber softens sufficiently to bend without cracking or breaking and if held in position until it cools the new shape will be retained. This is a very handy method for making special brackets and supports for receiver parts.

Good grades of hard rubber have a dielectric constant of 2.0 to 3.5. The dielectric strength is high, being from 1000 to over 2000 volts per thousandth of an inch thickness. It has very low dielectric losses when used in and near coils and condensers which are carrying radio frequency currents.

The phase angle difference of hard rubber at radio frequencies is about one-half of one degree. This represents an exceedingly low loss, being about one-sixth that of fibre and one-third to one-eighth that of phenol compounds.

Hard rubber deteriorates slowly with age, but if properly vulcanized in the first place and if then protected from light it is not affected. This material softens to a noticeable extent at 150 degrees Fahrenheit, at the temperature of boiling water it bends easily, at 240 degrees it becomes leathery and may be cut easily with a knife, and at 390 degrees it melts.

When exposed to sunlight hard rubber discolors and deteriorates after a few months. The sulphur in the rubber oxidizes and forms the equivalent of sulphuric acid which may take up ammonia from the air or may attack the fillers used in manufacture. Various sulphates are then formed on the surface of the rubber and its surface resistivity is greatly lowered.

Hard rubber is practically moisture proof. It absorbs only 0.02 per cent of its weight of water when immersed for twenty-four hours. Even when exposed to steam, the rubber is affected only by the heat and not by the moisture. Alcohol attacks this material to a slight degree, ammonia has no effect, benzol softens the rubber and ether dissolves a very small amount of the rubber and any free sulphur from the vulcanizing.

See also *Panel, Materials for.*

RUBBER COVERED WIRE.—See *Wire, Rubber Covered.*

S

SATURABLE REACTOR.—See *Reactor, Saturable*.

SATURATION.—As the number of ampere-turns acting upon a piece of iron is increased, the number of magnetic lines of force in the iron increases very rapidly up to a certain point which is the saturation point of the iron. With still further increase of ampere-turns there will be a further increase of lines of force but this increase of lines will be at a comparatively slow rate and the additional energy to produce the extra ampere-turns is partially wasted.

In a typical piece of transformer iron the first ten ampere-turns produced about 12,000 lines per square centimeter, the next ten ampere-turns wound within the original space of winding produced only about 2300 additional lines, while the third ten ampere-turns added produced an increase of but 1100 lines.

Saturation in the cores of audio frequency transformers produces distortion because the comparatively large currents cannot produce a proportional change in magnetism and a proportional effect on the secondary windings when compared with smaller currents.

SAW, HACK.—See *Tools*.

SCANNING METHODS.—See *Television*.

S. C. C.—An abbreviation for single cotton covered. See *Wire, Cotton Covered*.

S. C. E.—An abbreviation for single cotton enameled wire. See *Wire, Cotton Covered*.

SCRATCH FILTER.—See *Phonograph*.

SCREEN GRID TUBE.—See *Tube, Screen Grid Type*.

SCREEN GRID PENTODE.—See *Tube, Pentode*.

SCREWS AND BOLTS, TYPES OF.—Various types of screws and bolts are used in the construction of radio receivers. The most common forms are shown in the illustration. The machine screws shown at the top of the drawing are used for fastening all kinds of small parts. These screws are specified according to the kind of material; iron, brass or nickel; the type of head; the length and the number of threads per inch. The types of heads are shown. The length of the screw is given in inches or fractions of an inch, the measurement for round heads being made from under the head to the extreme end and for flat heads from the top of the head over the entire length of the screw.

In using these screws it is necessary to drill holes which are then threaded, or to drill holes through which the screws pass freely. Tap and clearance sizes are given under *Drilling*.

The diameter of the screw is specified according to a series of numbers starting with number 2 for the smallest size and ending with number 30 for the largest. Sizes 2, 4, 6, 8 and 10 are generally used in receiver construction. The following table shows the diameter of the body of the screw, the number of threads per inch, and the lengths available.

SEASON OF YEAR, EFFECT ON RECEPTION

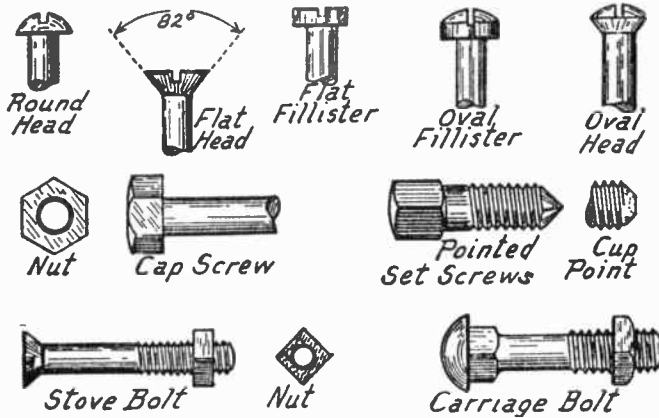

Screws and Bolts Used in Construction Work.

MACHINE SCREW SPECIFICATIONS

Number	Diameter in Inches	Threads per Inch	Lengths in Inches
2	.0842	48-56-64	1/8 to 7/8
3	.0973	48-56	1/8 to 7/8
4	.1105	32-36-40	1/8 to 2
5	.1236	32-36-40	1/8 to 2-1/4
6	.1368	30-32-36	1/8 to 2-1/4
7	.1500	30-32	1/8 to 3
8	.1631	30-32-36	1/8 to 3
9	.1763	24-30-32	3/16 to 3-1/2
10	.1894	24-30-32	3/16 to 3-1/2
12	.2158	20-24	1/4 to 3-1/2

Numbers 6 and 8, both with 32 threads per inch, are most commonly employed.

SECONDARY EMISSION.—See *Tube, Secondary Emission In.*

SELECTIVITY.—Selectivity is the ability of a receiver to respond to the signals from one transmitting station without being affected by or responding to the signals from other stations of nearly the same frequency as the one being received.

Selectivity depends on the design of the receiver, on its antenna and ground, on the quality of the materials used and on the excellence of workmanship. Broadcasting stations are operated with separations of ten kilocycles throughout the broadcasting band of frequencies. The lowest frequency is 550 kilocycles and the highest is 1500 kilocycles. This provides ninety-six broadcasting channels, each occupying a wave band of ten kilocycles. A receiver having

SELECTIVITY

good selectivity should be able to respond satisfactorily to a station at one frequency while completely excluding stations ten kilocycles away on either side provided these stations are a reasonable distance, say fifty miles or more, from the receiver.

Because of the large number of broadcasting stations in operation, selectivity is one of the prime essentials in a good receiver. The degree of selectivity needed depends on the nearness of broadcasters to the receiver and on the separation between the frequencies of the nearby or local broadcasters. A receiver operated one hundred miles from the nearest station needs but moderate selectivity to be satisfactory. But let that moderately selective receiver be brought into a locality crowded with broadcasting stations, such as found in the large cities, and it will prove a more or less complete failure as far as providing entertainment is concerned because there is little pleasure to be had in listening to two or more stations at the same time from the same loud speaker.

A receiver may be said to have sufficient selectivity for almost all purposes when it will receive a distant station operating on a frequency thirty kilocycles from the frequency of a local station which is a mile or more from the receiver. Many receivers will receive a distant station within twenty kilocycles of a local station also in operation, but this is really exceptional performance. If a set will not receive a distant station closer than fifty or sixty kilocycles to an operating local station, it cannot be said to have reasonable selectivity.

The selectivity of a receiver cannot be judged unless the two stations to be separated are both in actual operation. A local station may be tuned in and a note made of the control or dial settings. The dials may then be moved to the settings for another station, possibly a distant one, which is twenty or thirty kilocycles from the local broadcaster. If this distant station is not operating when the test is made, in all probability the local station will still be heard at the different setting. Yet if the different station were in operation, it might be tuned in to the almost complete exclusion of the local station.

In discussing the question of selectivity it is assumed that the operator of the receiver is sufficiently skilled and experienced to get the best possible performance. If the receiver has several tuning dials, all of them must be turned to the exact point of resonance with the frequency to be received. If one dial is properly tuned and others are slightly detuned, the receiver cannot show its real selectivity and only the operator is to be blamed. It will often be found that a local station is heard on both sides of the settings for a distant station, yet when the distant station is once being received with its settings properly made the local station will no longer be heard. See also *Tuning*.

Shock Excitation.—There is a condition under which a receiver having all the inherent selectivity that might reasonably be desired will fail to exclude a nearby local broadcaster. When a receiver is tuned or adjusted to receive signals at a certain frequency or wavelength, it will receive and amplify broadcast or other signals at this frequency better than at any other frequency. But when all the circuits are tuned to resonance at any frequency, they will oscillate at this frequency when any sufficiently powerful signal strikes the antenna. This powerful signal may be at the frequency to which the circuits are tuned, but it may just as well be at any other frequency. If it is strong enough, then the tuned circuits will be set into oscillation at their resonant frequency.

SELECTIVITY

Everyone who has tuned a receiver located close to a powerful broadcasting station has found that the instant the set is allowed to oscillate at any frequency or wavelength the nearby station will be heard regardless of its frequency.

A tuning fork having a certain pitch will vibrate when this pitch is sounded by a piano or other musical instrument near the tuning fork. Any other piano note may be sounded without causing the tuning fork to respond but if the fork is struck a direct blow with a hammer it will vibrate at its pitch or frequency even though the blow itself had no frequency or pitch.

When a radio circuit is tuned to a certain frequency it is like the tuning fork. It will respond to a radio signal of the same frequency but should any impulse of sufficient strength reach this tuned circuit it will respond at the frequency to which it is tuned regardless of the frequency of the powerful impulse which causes the action. Such a response of a radio frequency circuit is called shock excitation or impact excitation. This explains why the sharpest possible tuning and the most selective possible circuits have no effect whatever in excluding static or other atmospheric interference.

Selectivity in a receiver will not exclude the sounds caused by interference from power lines, from electric machinery, or from disturbances arising in the faulty operation of neighborhood electrical devices. The problem of getting rid of these troubles is treated under *Interference*.

The effect of shock excitation from nearby broadcasters whose signals tend to blanket all other reception may be greatly reduced by the use of proper shielding (see *Shielding*) or by tuning the antenna circuit. See *Antenna, Tuned*.

Causes for Lack of Selectivity.—There are three main classifications of the causes for lack of selectivity in a receiver. First comes the class containing all the faults that produce excessive resistance in the circuits. Reducing this resistance to the lowest possible value will not only greatly increase the selectivity but at the same time will multiply the sensitivity or distance-getting ability and the volume of the receiver. This makes an all around improvement in receiver performance.

The second class of faults includes mistakes in coupling between the various circuits. As a general rule, loosening the coupling between any two of the radio frequency circuits will increase the selectivity. At the same time, too loose a coupling will reduce the sensitivity of the receiver.

The third class includes the faults of poor proportion between inductance and capacity in the tuned circuits and in the antenna circuit. Many non-selective receivers are found to have too little inductance in their circuits. Increasing the ratio of inductance to capacity will improve the selectivity and the sensitivity at one and the same time.

It is often said that the qualities of selectivity and of power or sensitivity are opposed to each other in receiver design. To a limited extent this may be true. If there need be no regard whatever for selectivity, it is possible to build a comparatively simple receiver with great distance-getting ability. But it will also be found that a well designed and well built receiver which is selective will also have ample power or sensitivity for all demands.

SELECTIVITY

Resistance and Losses.—Any point of high resistance or any point at which there is excessive loss of radio frequency energy introduces excessive “damping” into the circuit containing the fault. This damping does two things. It acts as a resistance to flow of current, reducing the power, the sensitivity, and the volume from that circuit and at the same time broadens the resonance peak so that the circuit admits many frequencies each side of the one to which it is tuned. These effects of damping increase with increase of frequency. Therefore, the performance of the receiver will be especially poor at the high frequencies or low wavelengths.

There are literally dozens of places in which to look for radio frequency resistance and losses. Any one of these, or many of them together, may be causing the lack of selectivity. Among the most common errors in receiver layout and wiring are lack of sufficient spacing between coils, condensers and other parts. Trouble also arises from long grid and plate wires running close together and parallel to other wires. In home made receivers poor connections and loose joints are always to be suspected. Loose and corroded terminals and attachments of wires to terminals are very common when the receiver has been in use for some time. Soldered joints may appear good yet really be making almost no electrical contact at all. Even such items as dirty contacts in tube sockets should be looked for.

Losses that occur in the tuning coils are often responsible for lack of selectivity. Anything that is treated under the heading *Coil, Losses in*, may be doing harm and these things should be looked after. The same advice applies to the tuning condensers; any of the things treated under the heading *Condenser, Losses in*, may be broadening the tuning and if possible they should be remedied. Among the most frequent troubles are poor connections between condenser rotors and their terminals.

Under the heading of *Oscillation* are described methods of preventing free oscillation by introducing resistances or losses into the tuned circuits. Every one of these schemes for preventing uncontrollable squealing and whistling will go a long ways in destroying selectivity. True selectivity is almost a synonym for efficiency in radio receivers.

Having gone over the receiver itself with the aim of discovering high resistances and losses it is in order to examine the antenna circuit. The antenna may have joints that are not properly soldered but are simply twisted together or the antenna may be supported by broken or leaky insulators or even found to have no insulators at all. Antennas are still found supported with nails and rope. The antenna may run so close to guy wires, power wires, trees or building walls that its collected energy is largely wasted.

Every joint in the lead-in and in the ground connection should be examined for looseness and corrosion, not forgetting the ground clamp or other attachment of the ground wire to whatever ground is used. The ground may be a poor one, this being certain to destroy selectivity. Grounds should not be made to piping that leads through water or gas meters and it is best to avoid grounds to hot water or gas pipes altogether. See *Ground, Receiver*. Many installations are found in which the lead-in and the ground wire run close together for long distances, this serving to bypass much of the energy from the antenna to ground.

Incorrect Coupling.—There is a certain best coupling between the primary and secondary windings of radio frequency trans-

SELECTIVITY

formers. Too close a coupling will actually reduce the power of the receiver and will broaden the tuning to an almost unbelievable extent by producing two different frequencies at which the circuit is resonant. As the coupling is loosened the power will increase and so will the selectivity. At a certain coupling the power will be maximum and the selectivity good. A still looser coupling will increase the selectivity but will reduce the power. See *Coupling, Optimum*.

Loosening the antenna coupling is one of the easiest and most effective ways to increase selectivity. Here again will be found a certain optimum coupling for power. Loosening the coupling beyond this point will reduce the power and still further increase the selectivity. See *Antenna, Coupling of*. Should it be difficult to increase the spacing between the antenna coil and the circuit to which it is coupled, the same effect may be obtained by inserting a fixed condenser of from .0005 to .0001 microfarad capacity between the antenna lead-in and the antenna terminal on the receiver. This will increase selectivity at the sacrifice of power.

Inductance and Capacity Ratio.—Tuned circuits containing coils of comparatively large inductance and condensers of small capacity will prove more selective than small inductances and large capacities. This is because greater voltages are secured across the large inductances and it is possible to use looser couplings while still obtaining the same response to a signal of given strength.

A long and high antenna is naturally opposed to selectivity. Such an antenna has greater resistance than a shorter and lower one and the antenna of great capacity tunes itself much more easily to any powerful signal regardless of the receiver tuning. There is a best size of antenna for any given receiver. Antennas longer than this will greatly reduce selectivity without adding much to the distance range. Shorter antennas will improve the selectivity but will also reduce the sensitivity to distant signals. It is better to use a short and low antenna together with the coupling giving greatest power in the receiver rather than to use a very long antenna and try to obtain selectivity by using extremely loose couplings in the receiver circuits. An indoor antenna is more selective than any outdoor antenna of ordinary size and a loop is many times more selective than either an indoor or outdoor antenna.

The greatest single aid to selectivity is regeneration. Regeneration tremendously magnifies signals of the frequency to which the receiver is tuned, yet adds nothing at all to the strength of other frequencies. A receiver operated in a non-regenerative condition may receive two or three stations at one time, yet will be highly selective when regeneration is added.

RULES FOR SELECTIVITY

The following series of rules may be followed to obtain maximum selectivity in any receiver:

- Allow ample spacing between tuning coils and all other parts.
- Avoid long plate and grid wires.
- Keep grid and plate wires well separated from other parts.
- Keep terminal connections clean and tight.
- Examine and test all soldered joints for looseness and poor contact.

SELECTOR CIRCUIT

Clean all tube contacts.

Avoid all constructions and materials causing losses in coils.

Avoid all constructions and materials causing losses in condensers.

Do not control oscillation or regeneration with methods that introduce losses into the tuned circuits.

Make all antenna connections through soldered joints.

Use perfect and unbroken insulators at both ends of antenna.

Allow good separation between antenna and all other objects.

Solder all joints in lead-in and in ground wire.

Make solid connection of good conductivity to ground.

Use a good ground, preferably a cold water pipe or a deeply buried metal plate surrounded with permanently moist earth.

Use the optimum coupling in radio frequency transformers or use a coupling still looser than this.

Use loose coupling between the antenna and the receiver circuit.

Make tuning circuits with large inductances and small capacities.

Use a short, comparatively low antenna, use an indoor antenna, or use a loop.

Use regeneration properly controlled.

SELECTOR CIRCUIT.—See *Circuit, Band Selector*.

SELECTOR, WAVE.—See *Trap, Wave*.

SELENIUM.—Selenium is an element somewhat similar to sulphur. Selenium has a rather high electrical resistance as long as it is kept in darkness, but when exposed to light of any kind its resistance is reduced to between one-tenth and one two-hundredth of the value in the dark. This makes selenium suitable for use in some forms of photo-electric cells. See *Cell, Photoconductive*.

SELENIUM RECTIFIER.—See *Rectifier, Contact*.

SELF-INDUCTANCE.—See *Inductance, Self*.

SELF-OSCILLATION.—See *Oscillation*.

SELF-SHIELDED COIL.—See *Coil, Closed Field Type*.

SENSITIVITY.—Sensitivity is a measure of the ability of a receiver to receive, detect and amplify radio signals.

In a sensitive receiver everything possible has been done to amplify or magnify the received signals without distortion, but more especially everything has been done to conserve every bit of energy all the way through the receiver from the antenna to the loud speaker.

The first aid to sensitivity is a good antenna in a good location. This means the entire antenna circuit, ground and all. A large antenna is more sensitive than a small one but the receiver must be adapted for use with a large antenna. A good ground is absolutely essential if real sensitivity is to be attained.

In the receiver it is possible to increase the distance-getting ability or the sensitivity by using large tuning inductances and by using the coupling between radio frequency circuits that will result in the greatest possible transfer of power from one to another. This is not the closest possible coupling, nor is it the loosest coupling, but is somewhere between. See *Coupling, Optimum*.

The more stages of radio frequency amplification the receiver contains the greater will be its sensitivity provided that these stages

SENSITIVITY

really amplify. Many radio frequency amplifier stages are so poorly designed and constructed that two, or even three of them are barely equal to one good radio stage.

Tubes which are specially adapted to the work they are called upon to do are among the greatest aids to sensitivity. Some tubes make especially good radio frequency amplifiers, giving a good voltage gain from stage to stage. Other tubes are built only for the work of detection and they do this exceedingly well. Some of the newer detector tubes will make it possible to listen to stations on a loud speaker which are audible only in headphones with other detectors.

Power tubes in the last audio frequency stage have the effect of increasing sensitivity because they allow really satisfactory reception of weak and distant stations without forcing the amplification in preceding stages to the point of distortion.

If a receiver is to be made sensitive to weak signals, every point of design, every item of workmanship and every choice between materials must be watched. Every possible loss of energy must be eliminated from tuning coils and condensers. All wiring must be placed with proper regard to the capacity and inductive effects between it and other parts of the receiver. The position of every part, and especially the inductance coils, must be studied so that there will be no excessive energy loss because of undesired couplings.

The final point in obtaining sensitivity is in the receiver's operation. Very few receivers are operated to obtain the maximum possible distance and power. It is only when an operator has learned all the tricks and peculiarities of his receiver that he is able to reach out to the farthest broadcasting station and bring it through with loud speaker volume.

There is a limit to the useful sensitivity of a receiver. There are certain electrical disturbances always in the air. These may be very slight at times, but they are always present to some extent at least. No matter how weak these disturbances or interferences they are more powerful than the signals from broadcasting stations at extreme distances from the receiver. A receiver may be made so sensitive that it will amplify the weakest atmospheric disturbances to loud speaker volume. Any signals from distant stations that are weaker than these disturbances cannot possibly be heard above the interference. Then the useful sensitivity of the receiver has been reached because it has gone down to the "static level."

Distance reception is often made impossible by one bad joint somewhere in the antenna circuit or inside the receiver. The same result will come from a short circuited or wet lightning arrester.

It is often possible to greatly increase the volume on very distant and weak signals by using a high resistance grid leak on the detector circuit. This leak may be from five to ten megohms with good results. Sometimes removing the leak entirely will result in an increase of sensitivity.

It should be mentioned that the ability of a receiver to bring in local and nearby stations without either the antenna or ground connected to their proper terminals does not prove any excellence of the receiver. It only proves that the wiring, the coils, and most of the other connections in the receiver are acting as antennas. This proves that the receiver will be far from selective when in normal operation.

See also *Range, Receiver*.

SERIES CAPACITIES

SERIES CAPACITIES.—See *Condenser, Capacity of.*

SERIES CIRCUIT.—See *Circuit, Series.*

SERIES CONDENSER.—See *Condenser, Antenna.*

SERIES INDUCTANCES.—See *Inductance, Self.*

SERIES-PARALLEL SWITCH.—See *Switch, Series-Parallel.*

SERIES RESISTANCE.—See *Resistance, Series Circuit.*

SERIES RESONANCE.—See *Resonance, Series.*

SET, RADIO.—See *Receiver.*

SHARP TUNING.—See *Tuning; also Selectivity.*

SHELL TYPE TRANSFORMER.—See *Transformer.*

SHELLAC.—See *Binders.*

SHIELD GRID OR SHIELDED PLATE TUBE.—See *Tube, Screen Grid Type.*

SHIELDING.—The practice of surrounding parts producing or carrying electrostatic or electromagnetic fields is called shielding. The purpose is to prevent radiation and coupling. Since every conductor carrying alternating current has an electromagnetic field around it, and since every conductor having an electric charge has an electrostatic field around it, these fields will produce electric currents or charges on any other conductors in the neighborhood.

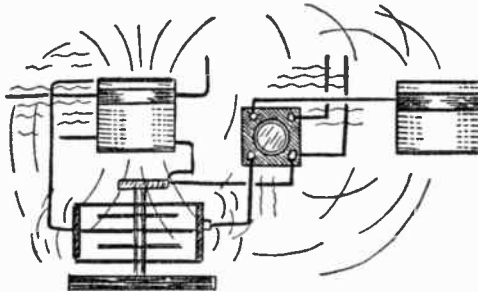

FIG. 1.—Some of the Stray Fields to be Shielded in Radio Frequency Circuits.

The higher the frequency of the alternating currents the more widespread will be the fields surrounding their conductors. In the radio frequency part of a receiver every coil, every condenser and almost every wire will be surrounded by an extensive field because they all carry high frequency currents. The field of every single part is doing its best to produce extra currents in every other part of the receiver. In dozens of places the extra currents are harmful; they may reinforce other currents and produce oscillation or they may oppose other currents and cause decided losses of signal strength. This free-for-all struggle between the fields as barely suggested by Fig. 1 is something to be avoided if possible.

SHIELDING

The lines of force of which both electromagnetic and electrostatic fields are composed will pass through insulators practically as if the insulators were not in existence. In fact, the better the dielectric properties of the insulating material the less success it will have in hindering the passage of field lines of force.

Direct current itself may be confined within conductors by covering these conductors with insulation or by leaving them exposed in air, which is one of the best insulators. But high frequency electric fields behave in a manner the exact opposite of the behavior of the direct current.

An electric field, such as exists around a coil, a condenser, or any conductor carrying high frequency alternating currents, travels freely and almost without hindrance through air or any other good dielectric. The electric field, which moves to great distances through dielectrics, may sooner or later meet a barrier in the form of a material that is a good electrical conductor. The lines of force forming the field enter the conductor but all of them do not pass through it because their energy is used to produce electric currents in the conductor as in Fig. 2. These are eddy currents and they simply dissipate or destroy the energy of the field so that practically no lines go on through the conductor.

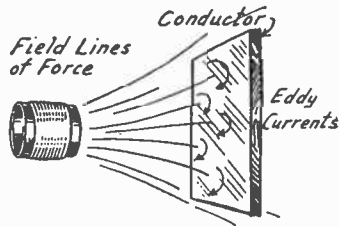

FIG. 2.—Dissipation of Energy in a Conductor Such as a Shield.

Thus it is seen that the effects of electric currents travel freely in conductors and are confined by insulators, while the effects of electric fields travel freely in insulators but are confined by conductors. Conductors used to confine electromagnetic and electrostatic fields are called shields and their proper application in radio receivers is called shielding.

Were it possible to separate the various parts carrying high frequency currents by great distances from one another their respective fields would not come together and would not need to be confined. The lines of force forming any such field become fewer and fewer as the distance from their source increases. Therefore, were the separation between sources great enough the fields would not join.

The field of a good active coil will spread to a distance of a foot or two from the coil before losing the strength required to generate undesired currents in other coils or conductors. The field around a wire carrying a good healthy plate current will be full of activity at a distance of several inches. So when a receiver having a total length of thirty inches contains three or more radio frequency coils, three or more tuning condensers, a collection of iron-core transformers together with miscellaneous tubes and wires the condition of Fig. 1 is multiplied.

Applications of Shielding.—Properly applied shielding accomplishes two objects. It prevents harmful feedback of energy from the parts in one amplifying stage to parts in the preceding amplify-

SHIELDING

ing stage. This reduces the receiver's tendency toward oscillation, makes it more stable. The shielding also prevents pickup of energy radiated from parts of amplifying stages or radiated from the antenna system. This increases the receiver's selectivity because it forces the signals from the antenna to proceed through the successive stages of amplification in an orderly manner and it prevents stray energy from powerful and nearby broadcasting stations from being picked up by the coils and wiring in the receiver. It gives the tuned stages of radio amplification a chance to get in their full filtering effect.



FIG. 3.—Shielding Applied to a Wire.

The action of any kind of a shield is to catch the wandering lines of force, turn their energy into eddy currents in the shield and thus prevent the lines from passing on through the shield. The shield itself is usually grounded so that whatever forces appear in its body will be neutralized or destroyed by carrying them to ground.

Shielding may be applied to individual wires as in Fig. 3. The conductor is first covered with insulation to confine the electric currents. Then the insulation is surrounded with a sleeve or a tube of the shielding metal, generally copper. This confines the lines of force that would otherwise radiate from the conductor.

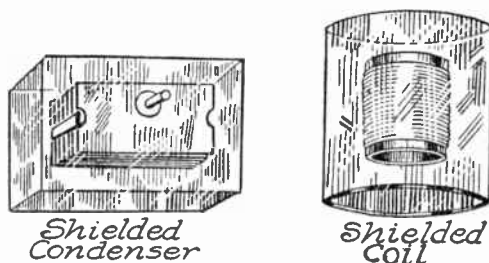

FIG. 4.—Tuning Condenser and Coil Enclosed in Shields.

Shielding may be applied to coils by placing the coil within a completely closed box or can. The field of the coil will travel out as far as the metal of the shield, but there it will be stopped. Neither can other fields get in to influence the coil. Tuning condensers are similarly enclosed in copper or aluminum boxes which form shields and prevent the exit of the condenser's own electrostatic field and prevent the entrance of other fields. This is shown in Fig. 4.

Shielding as in Fig. 5 may be applied to each complete stage of radio frequency amplification in a receiver. A metal box or shield completely encloses the radio frequency transformer, its tuning condenser and the tube to whose grid the transformer and condenser are connected. This leaves only the output plate wire from the tube to pass out through the shield to the following stage.

SHIELDING

In a superheterodyne or similar receiver the oscillator may be enclosed in one shield, the first detector stage in another shield, the intermediate amplifiers in a third shield, and the second detector in a fourth.

Finally the complete receiver may be shielded. The top, the bottom, and all four sides of the receiver cabinet are completely lined with thin metal which acts as a shield for the receiver against all outside influences and interference.

Effect of Shielding.—Unquestionably there are many advantages to be gained by shielding. But these gains cannot be had without some penalties in the form of lost energy. For shielding to be effective the energy of the lines of force which are to be confined must be changed into eddy current losses. That much energy is thrown away. The shielding metal must be a good conductor so that eddy currents may be formed easily. If no eddy currents are formed, there will be no shielding effect. Were the resistance of the shield high enough to lessen the formation of eddy currents, the shield would have to be a partial insulator and it would act like a dielectric in passing some of the lines of force right on through.

If shielding is used it is going to cause a loss of power and to make up for this loss more power must be added. With only two

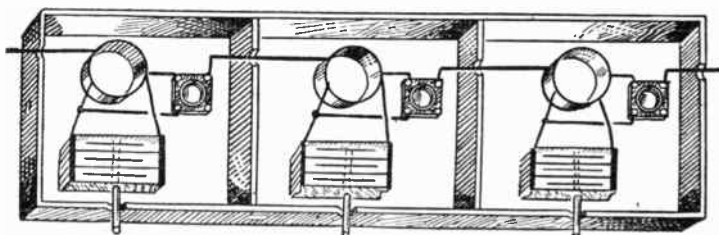

FIG. 5.—Amplifying Stages Enclosed in Individual Shields.

stages of radio frequency amplification the loss may be great enough to more than overcome the savings from prevention of intercoupling, and the net result will be a reduction of the receiver's power. But with three or more stages of radio frequency amplification there is a net gain with shielding when it is properly applied. Three radio stages without shielding must have such low amplification per stage in the prevention of oscillation that they are little better than two stages. With shielding applied, the amplification per stage may be greatly increased without danger of uncontrollable oscillation. There is no real advantage in shielding with only one radio frequency stage except when working at very high frequencies.

The effect of enclosing a tuning condenser in an individual shield whose sides come rather closely around the condenser plates is to greatly increase the apparent or effective resistance of the condenser. The larger the capacity of the condenser the less serious will be the effect of close shielding. Condensers of .0005 microfarad capacity and larger may show an increase of as much as twenty-five per cent in resistance. Smaller condensers show increasing losses. A

SHIELDING

tuning unit of .00025 microfarad capacity may show from thirty to forty per cent increase of loss when shielded. This is not as serious as it sounds because the loss caused by a good condenser in its circuit is seldom more than three or four per cent of the total circuit loss and increasing this small original loss even by as much as one-third would not greatly raise the total circuit resistance.

The effect of a shield around a coil is to increase the effective resistance of the coil and to reduce the coil's apparent inductance. In other words, a larger coil must be used in order to tune to a given frequency. If the shield is insulated from all circuits to which the coil is connected as at the left in Fig. 6, the resistance increase is much less than when the shield connects to one of the coil circuits, such as the A-battery negative circuit or negative filament circuit of the tube in the stage being shielded.

When a coil is enclosed in an individual shield for the coil alone it is necessary to keep the shield well separated from the coil if the loss is to be kept within reasonable limits. A large part of the total loss from coil shielding is due to the capacity effect between the body of the coil and the metal of the shield. The greater the space between the two, the less will be the capacity

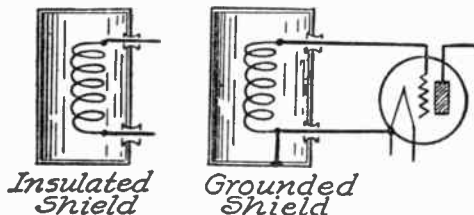

FIG. 6.—Insulated and Grounded Shields.

and the less the loss. Of course, the principal loss is due to eddy currents formed in the shielding metal by the field of the coil. This effect too is lessened by increasing the distance between coil and shield.

If the shield is brought within three-eighths of an inch of even a very small and compact coil, the loss will be very high. Conditions improve quite rapidly as the shield is moved away until the separation reaches an inch. To obtain only reasonable losses the separation between a compact form of coil and its shield must be at least one and one-half inches and two inches will be a still safer minimum separation. Separations greater than two inches offer little additional saving of resistance and, because of the great space required, are hardly worth while.

As may be judged from the foregoing paragraphs the form of the coil has much to do with the success of the shielding and in determining whether there is to be an overall gain or loss.

For a given inductance the multi-layer honeycomb type of coil has the advantage because it is of the smallest possible size and has the smallest field of any form of coil with open ends. It is only surpassed in this respect (extent of field) by the coil forms having closed or partially closed fields. A single layer solenoid coil having the same inductance as a honeycomb generally shows three to four times the loss of the honeycomb when shielded. This may be completely offset because the losses in a single layer solenoid without shielding are much lower than the losses in a honeycomb without shielding. A flat spiderweb coil shows greater losses by about fifty per cent than the single layer solenoid of equal inductance. All things considered, single layer solenoids

SHIELDING

wound on forms having a diameter greater than their length and wound with small sizes of wire, number 26 and smaller, are best suited for shielding. However, a well designed honeycomb is almost as good from the standpoint of overall efficiency.

Partial Shielding.—Shielding by placing sheets of metal between parts is generally ineffective. As a rule it is better to shield completely by fully enclosing the parts than to attempt the use of partial shields.

As indicated in Fig. 7 a partition form of shield allows passage of the lines of force around it. The smaller the shield and the farther it is from the part to be shielded the greater will be the escape of the lines and the less effective the shielding.

If a receiver is built with coils at angles such that there is minimum coupling between them when no shielding is used, it will often be found that the introduction of a shielding partition between two coils will actually cause them to couple where no coupling to speak of exists without the shield. The shield will so displace the field of one or both coils that the new paths of the lines of force will cut through the other coil of a pair.

Materials for Shielding.—Copper, aluminum and brass are the metals best suited for use as shields. Their relative values are in

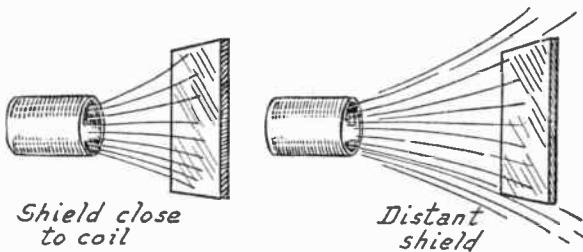

FIG. 7.—Effect of Distance Between Partial Shield and a Coil.

the order named, copper being best. A shield must be of good conducting material so that eddy currents may be formed within its mass. Lead foil and tin foil have resistances too high to allow them to be used in satisfactory and effective shields. Here again it must be remembered that the idea of shielding is to produce a loss, not to prevent one.

Iron or steel must never be used for shielding high frequency currents or circuits. Iron and steel have relatively high resistance when compared with copper and therefore do not so readily absorb the energy from field lines of force. Furthermore, iron and steel introduce magnetic effects and then have fields of their own which may make matters worse than ever.

The lower the frequency the less effective a shield of given size and thickness will become. If audio frequencies were to be shielded the shields would need be much thicker than those effective at radio frequencies. But the radiation of lines of force is less at these low frequencies so that the problem is not made any more difficult in reality. A thin shield is effective at high frequencies because these frequencies, short wavelengths, do not go through any shields as readily as lower frequencies or higher wavelengths. The same thin

SHIELDING

shield is also effective at low frequencies because the radiation is less than the radiation at the higher frequencies. Any thickness of metal from number 6 down to number 30 may be used satisfactorily for shielding. The following table gives the thicknesses and weights of commonly used sizes:

THICKNESS AND WEIGHT OF METAL FOR SHIELDING

Gauge Number	Thickness in Inches	Weight in Pounds per Sq. Ft.		
		<i>Copper</i>	<i>Brass</i>	<i>Aluminum</i>
10	0.102	4.72	4.51	1.43
11	.091	4.20	4.02	1.27
12	.081	3.74	3.58	1.10
13	.072	3.33	3.19	1.01
14	.064	2.97	2.84	.90
15	.057	2.64	2.53	.80
16	.051	2.35	2.25	.71
17	.045	2.10	2.00	.64
18	.040	1.87	1.79	.57
19	.036	1.66	1.59	.50
20	.032	1.48	1.42	.45
21	.028	1.32	1.26	.40
22	.025	1.17	1.12	.35
23	.023	1.05	1.00	.32
24	.020	.93	.89	.28
25	.018	.83	.79	.25
26	.016	.74	.71	.22
27	.014	.66	.63	.20
28	.013	.59	.56	.18
29	.011	.52	.50	.16
30	.010	.46	.44	.14

Construction of Shielding.—It is impossible to build a perfect shield because all metals used for this work have some resistance and therefore cannot absorb all of the radiated lines of force. The fewer openings and the smaller the openings through the shield the more effective it will be. Joints in the shield should be crimped or soldered for their entire length.

Where a cabinet is completely shielded there will be an opening formed at any hinged cover. If this joint is staggered as shown in Fig. 8, or as a refrigerator door is staggered, the shielding at the joint will be practically perfect. Wires passing through a shield should be run through the smallest possible opening which will allow for insulation. To prevent the passage of any lines of force into a shield the wires may enter and leave through bent copper tubes as in Fig. 8.

SHOCK EXCITATION

While these precautions may seem rather elaborate their necessity may be realized from the results of a simple experiment. A radio frequency receiver may be completely shielded and a signal from a nearby powerful station tuned in. Disconnecting antenna and ground will cause the signal to disappear. Opening a crack sixteenth of an inch wide in the shield will allow the signal to be brought back again without either antenna or ground when the receiver is slightly re-tuned.

The extent of capacity effects between the shield and all coils, condensers, tubes and wiring within the shield is increased the closer any or all of these parts come to any point on the shield. So far as space limitations will allow the shield should be kept at least two inches from all of the shielded parts.

The capacity effect depends also on the difference in voltage of the shield and the parts it encloses. It is customary to ground the shield to the negative side of the tube filament circuit, to the negative A-battery line when a battery is used or to whatever line connects through to the receiver ground. This method causes the greatest voltage difference to exist between the shield and the enclosed parts because the shield is then at zero voltage.

The best results in the prevention of feedbacks will be secured if shields enclosing separate stages of a radio frequency amplifier are allowed to remain insulated from all circuits in the receiver. That

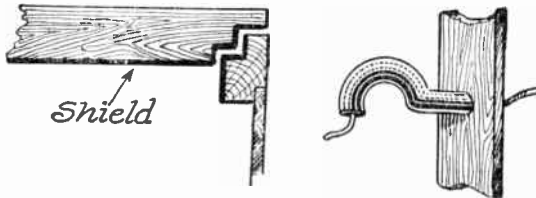

FIG. 8.—Protection of Joints in Shielding.

is, interstage shielding may remain insulated. On the other hand, the best protection against pickup of outside interferences will be had by using a grounded shield. If the receiver is fitted with both interstage shielding and with complete cabinet shielding, the interstage shields may remain insulated and the cabinet shield may be grounded. This will provide almost perfect protection from feedbacks and from energy pickup.

The effect of a rather close shield around a coil will be to more than double the effective resistance of the coil if the shield is not grounded. That is, the resistance will be somewhat more than twice the resistance of the coil unshielded. If the shield be grounded the effective resistance is still further increased and is one-fourth to one-third greater than with the shield ungrounded. This is because of the added capacity effect.

When the shielding is connected to the negative filament line it is customary and advisable to connect all negative filament leads to the shield. In this way much of the negative filament circuit wiring is done away with, the shield taking its place.

SHOCK EXCITATION.—See *Selectivity*.

SHORT CIRCUIT.—See *Circuit, Short*.

SHORT WAVE RECEIVER.—See *Receiver, Short Wave*.

SHUNT

SHUNT.—One of the current paths or one of the branches in a parallel circuit is called a shunt. See *Circuit, Parallel*.

SHUNT FEED AMPLIFIER.—See *Amplifier, Audio Frequency, Transformer Coupled*.

SHUNTING CONDENSER.—See *Condenser, Antenna*.

SIDE BAND.—One-half of a wave band. In broadcasting with wave bands each ten kilocycles wide, the side bands are each five kilocycles wide. See *Band, Wave*.

SIGNAL.—Properly speaking the various messages sent out from a radio telegraph station by using the code are called signals. By common consent anything sent out from a radio station, whether radio-telephone or radio-telegraph, is called a signal. Thus any radio waves that are received from stations of any kind are generally called signals.

SIGNAL GENERATOR.—See *Oscillator, Modulated*.

SILK.—See *Cloth, Insulating*.

SILK COVERED WIRE.—See *Wire, Silk Covered*.

SILVER.—Silver is the best conductor of all the metals. The resistance of silver is 9.56 ohms per mil foot. This is about 92.2 per cent of the resistance of copper; the resistance of copper is about 108.5 per cent that of silver. This advantage of lower resistance is hardly worth while in view of the much greater cost of silver. Like copper, silver oxidizes quite readily when exposed to the air. Coin silver has slightly more resistance than pure silver because coin silver contains only about ninety per cent pure silver, the remainder being copper.

SILVER, NICKEL.—Nickel silver is a resistance alloy containing copper, nickel and zinc; but no silver. The metal is made up of from fifty to sixty per cent copper, with from ten to thirty per cent of each of the other metals. The greater the nickel content the higher the resistance. The alloy is generally specified by mentioning the percentage of nickel in its composition. It may have anywhere from fifteen to thirty times the resistance of copper. This alloy is sometimes called German Silver. See *Resistance, Materials for*.

SINE WAVE.—See *Wave, Sine*.

SINGLE ANTENNA.—See *Antenna, Multiple Receiver Connections to*.

SINGLE CONTROL.—See *Control, Single*.

SKIN EFFECT.—When direct current flows through a wire it is evenly distributed throughout the body of the wire, that is, there is as much current flowing near the center of the wire as near the outside of the wire. With alternating current this is not true.

SKIN EFFECT

Alternating current of high frequency tends to flow principally on the surface of a wire and through the part of the wire nearest the surface. Alternating current tries to avoid flowing through the center of the wire.

The resistance of a wire to direct current is a definite quantity depending on the material, the length, the cross section or diameter, and the temperature of the wire. Resistance to alternating current depends on all of the things which affect direct current but the resistance to alternating current depends also on the frequency. The higher the frequency the greater the resistance because when the alternating current leaves the center of the wire and flows near the surface, the surface portions of the wire are carrying more than their share of the current.

This action of alternating current is called "Skin Effect." It increases with increase of frequency. Skin effect acts not only in wires but in all conductors, such as the plates of condensers. At rather high frequencies for a given weight of conductor we would get better conductivity from a tube with thin walls than from a

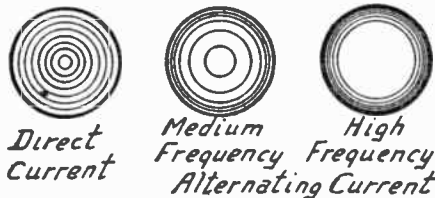

Skin Effect on Current Distribution in Wires.

solid wire because the center of the wire only adds to the weight and cost of the conductor without serving much of any purpose in carrying current. The added resistance due to skin effect is greater in large wires than in small ones because in the large wire less of its total bulk is represented by the skin or surface so the less we use of the whole bulk of the wire to carry current.

At a frequency of 1000 kilocycles (a wavelength of 300 meters) if we represent the skin effect as equal to 1 for number 28 wire, for number 26 it is equal to $1\frac{1}{2}$, for number 24 it is equal to 2.2, for number 22 it is equal to 2.7, for number 20 it is equal to 3.4, for number 18 it is equal to 4.2, and for number 14 it is equal to 6.4.

At higher frequencies the skin effect is even more pronounced while at lower frequencies it is less pronounced. For example, taking a number 20 wire at a frequency of 600 kilocycles (a wavelength of 500 meters) the skin effect may be represented by 2.7. At 800 kilocycles the skin effect would be represented by 3; at 1000 kilocycles by 3.4; at 1200 kilocycles by 3.7; and at 1400 kilocycles by 3.9. This shows that there are disadvantages in the use of too much conductor when handling high frequency currents.

The values which have just been used to represent the relative resistances are the ratios of the high frequency resistance of a wire to the direct current resistance of the same wire. When we say that the resistance is represented

SLIDE BACK VOLTMETER

by 2.5 we mean that it is two and a half times as great as the resistance to direct current.

It should be remembered that the direct current resistance of a wire decreases as the wire size is increased so that the total resistance of the wire is affected both by skin effect and ohmic resistance. See *Resistance, High Frequency*.

When wire is formed into a coil the strength of the magnetic field inside the coil is greater than its strength outside the coil. This makes the distribution of current in the wire even less uniform than when the wire is straight and the result is that a given length of wire formed into a coil shows from two to two and one-half times as great a skin effect as the same wire when straight.

The resistance due to skin effect may be reduced by using a conductor composed of a large number of very small wires each thoroughly insulated from all the others and formed into a cable. This cable is known as Litzendraht wire. Each of the small wires is enamel covered. They are then woven in such a manner that each small wire comes to the surface of the cable and remains on the surface for exactly the same proportion of the whole length as every other small wire. There is little advantage in simply using a number of small wires laid parallel. See *Wire, Stranded*.

The great skin effect in a coil is due to the crowding of magnetic lines of force inside of the coil winding. The greatest part of the current flowing through the wire forming a coil winding is on the sides of the wire toward the inside of the coil. A non-inductive coil shows none of this effect. The losses due to skin effect form one of the best reasons for using small size wire in winding radio frequency coils.

SLIDE-BACK VOLTMETER.—See *Meter, Vacuum Tube*.

SLIDE WIRE BRIDGE.—See *Bridge, Measurements by*.

SOLDERING.—Soldering is the most effective way of making permanent electrical connections.

Material and Tools.—The first essential is a good soldering iron. The best to be had is an electric iron with a good large heating element and a copper tip about three-eighths to one-half inch in diameter extending out to a distance of two or three inches from the heater. This is the best size tip for all around work. Electric soldering irons with small heating elements will usually fail to heat the tip sufficiently to do good work on large conductors which carry heat away from the iron quite rapidly.

If an electric iron cannot be used, a plain soldering copper of the half-pound or three-quarter pound size is about right. This copper should have a rather long tip well tapered. In heating this kind of an iron, keep its tip in the blue part of a gas flame. The yellow part of the flame will deposit so much soot on the iron that soldering will be very difficult.

Wire solder will be much easier to use than bar solder. Plain wire solder may be used but the work will be made easier by selecting good resin-core wire solder. Never use acid-core solder because the joint will surely corrode and cause high resistance.

SOLDERING

Even though resin-core solder is used it will be advisable to have some good non-acid soldering paste handy or to have some pure resin in a small tin container such as the cover of a small can. The advantage of using only resin is that it does not contain any acid to cause corrosion.

The purpose of the resin-core of the solder or of the soldering paste is to clean the oxide from the work and leave the surfaces clean enough so that the hot solder can unite with them. The resin and the pastes are called soldering fluxes.

Aside from the soldering iron, the solder, and the flux it will be necessary to provide a fine cut file, a piece of emery cloth and a piece of plain heavy cotton or wool cloth for cleaning. An old knife will also come in handy.

Tinning the Iron.—The tip of the iron must first be prepared for its work. Coating the tip of the iron with a thin layer of solder is called tinning. First clean the tip for half to three-quarters of an inch back from the end by using the file. Then polish this surface with the emery cloth. Heat the iron as if for soldering and dip the hot tip into the flux or else spread some flux on the tip. Immediately touch the end of the wire solder to the fluxed iron or rub the tip of the iron on a piece of solder. The solder will stick to the copper tip and form a bright coating wherever the tip was thoroughly cleaned. The iron is now ready for work.

If the iron becomes overheated or stays very hot for a long time, the coating will burn off and the tinning process must be gone through with again. When doing considerable soldering, occasionally wipe the tip of the iron with the padded cloth. This will remove any dirt and scale and leave the brightly tinned surface clean again.

Preparing the Joint.—To make really good soldering joints the joint must first be made mechanically strong independently of the solder. That is, the joint between the two parts must be made so that they will hold together indefinitely even were no solder to be applied. Never depend on solder to hold two parts together. The solder has practically no mechanical strength and it is not the purpose of soldering to provide mechanical strength.

If the ends of two wires are to be joined, cross the ends, then twist them one about the other as shown in Fig. 1. Don't simply loop them together and don't lay them along side each other and expect to have a permanent joint. When a wire end is to be joined to another wire running straight on through the joint, wrap the end around the through wire as in Fig. 2. Don't simply butt the end against the through wire and look to the solder to do the mechanical work. When attaching a lug to a wire end, loop the wire through the lug or around the lug when this is possible. Bending the wire end over at a right angle and sticking the projection through the lug will make a solid joint. Don't just lay the wire on top of the lug. The purpose of the solder is to make an electrical joint. The mechanical joint must be made without solder.

Before the parts are fastened together and again after they are fastened, they should be scraped thoroughly clean with the file, a knife blade, or the emery cloth. The grease from a person's hands is enough to prevent making a good soldered joint when conditions are at all difficult.

Heating the Iron.—The iron, whether electric or gas, should be heated just hot enough to blacken a piece of soft pine wood. This does not mean the iron should be hot enough to actually char

SOLDERLESS CONNECTIONS

the wood. An iron at the proper degree of heat will cause solder to flow like water when the tip end of a piece of wire solder is touched to the hot tip. The iron must be hot enough to flow the solder into place, not simply to spread the solder over the outside of the joint.

Soldering the Joint.—Apply a very little soldering paste to the joint. Do not use more paste than can be picked up on the small end of a toothpick. Then touch the solder to the tip of the hot iron and let a drop of solder leave the wire and hang to the surface of the iron's tip. Now touch the tip, with the solder hanging on, to the joint. Hold the tip firmly on top of the joint until the parts to be joined become hot enough from the iron to let the solder run down all through the joint. Even though the solder runs onto the joint the very first thing, keep the iron there until it runs through the joint. There's a big difference.

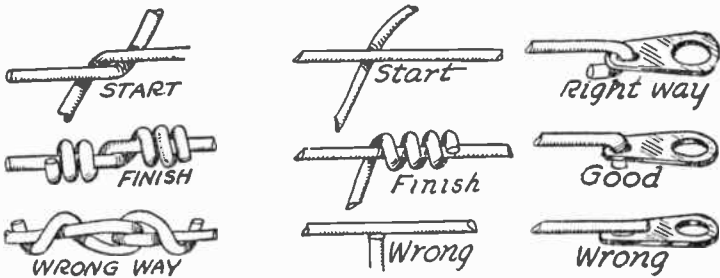

FIG. 1.—Making Joint Between Two Wire Ends in Soldering.

FIG. 2.—Preparing to Solder Wire Ends to Other Wires or Lugs.

Another way is to apply a little flux to the joint, then hold the hot iron underneath the joint until the parts become hot. Then touch the tip end of the wire solder to the top of the joint and let some of the solder run down through the joint until it reaches the iron below. This is a surer way to make a good joint than the first method.

In all this work use the least possible flux and the least possible solder. The flux is an insulator and it must not remain between the surfaces being soldered. As soon as the joint has been soldered and while the solder is still hot, wipe away the excess solder and all the flux with the cloth which has been folded to make a pad. A soldered joint made according to these rules will still be a good joint after the rest of the receiver has fallen apart.

SOUND.—Any motion of the air which is distinguishable by the sense of hearing is called a sound. Sound is carried through air and other materials by sound waves which consist of alternating compressions and rarefactions of the material carrying the waves.

The speed with which sound travels through various materials differs greatly. In air sound waves move 1087 feet per second. They move through

SOUND

water nearly five times as fast as through air and through hard, dense materials such as steel and glass the sound waves travel from fifteen to twenty times as fast as through air.

Sound is a form of energy whose strength or intensity may be measured and whose amplitude or force may likewise be measured. The strength of a sound diminishes as the square of the distance from the source of the sound. The strength varies according to the square of the amplitude of the sound waves. The amplitude of the sound waves is a measure of their extent or their swing back and forth, just as the amplitude of a pendulum's swing is measured by the distance it moves each way from a center position.

If the sound waves are regular in occurrence, they are musical or pleasant to the ear. If they are irregular, they are classed as noises. The lowest vibrations which can be heard are those having a frequency between sixteen and twenty per second. The highest audible sounds have frequencies from 10,000 up to 30,000 or more per second. The highest audibility depends on the hearing of the listener.

The frequency of sound waves determines their pitch in the musical scale. In the octave above middle C, starting with middle C the frequencies per second of the notes are as follows:

<i>C</i>261.0	<i>G</i>391.5
<i>D</i>293.6	<i>A</i>435.0
<i>E</i>326.2	<i>B</i>489.4
<i>F</i>348.0	<i>C</i>522.0

The foregoing frequencies are those of the international pitch. For convenience in making calculations the philosophical pitch is sometimes used. With this pitch middle C has a frequency of 256.0 in place of 261.0. This frequency, 256.0, is the eighth power of 2, or two multiplied by itself eight times. It therefore allows of easy division and multiplication.

In the philosophical pitch the octave above middle C would have the following frequencies:

<i>C</i>256	<i>G</i>384
<i>D</i>288	<i>A</i>426.6
<i>E</i>320	<i>B</i>480
<i>F</i>341.3	<i>C</i>512

A pure tone or simple tone has but a single frequency, at a definite pitch. Few pure tones sound pleasant or musical until they are combined with one or more higher frequencies called overtones. When these overtones have frequencies which are multiples of the fundamental frequency or tone they are called harmonics. Notes produced by most of the musical instruments are composed of fundamentals and of harmonics of the fundamentals. It is the harmonics and overtones produced with the fundamental that distinguish a certain note on one instrument from the same note on another instrument.

The frequencies of the notes in any one octave have the following ratios to one another:

<i>C</i> to <i>D</i> 8/9	<i>G</i> to <i>A</i>9/10
<i>D</i> to <i>E</i>9/10	<i>A</i> to <i>B</i> 8/9
<i>E</i> to <i>F</i>15/16	<i>B</i> to <i>C</i>15/16
<i>F</i> to <i>G</i>8/9	

SOUND

It is this relation between frequencies of notes which follow each other in the octave that gives the human ear the familiar impression of gradually rising sound. In actual musical instruments the frequencies are slightly different from those of either the international scale or the philosophical scale. These changes make what is called the tempered pitch. The following frequencies of tempered pitch may be compared with those given for the international pitch:

<i>C</i>258.7 <i>D</i>290.3 <i>E</i>325.9 <i>F</i>345.3	<i>G</i>387.5 <i>A</i>435.0 <i>B</i>488.3 <i>C</i>517.3
--	--

Sound waves may be reflected back from a surface which they strike just as light waves are reflected from a mirror. Sound is also refracted or bent out of a straight path as it passes through various materials just as the view of an object through a thick layer of glass or through water appears to be bent by refraction. Sound striking an irregular surface is also subject to a scattering or dispersion effect by which the waves are sent in various different directions from the surface. Sound waves of one frequency may be subject to interference from and to combination with waves of other frequencies so that the resultant sound is affected by both frequencies.

The octaves in the philosophical pitch start with the following frequencies: 16, 32, 64, 128, 256, 512, 1024, 2048, 4096. An octave would start with the harmonics of 4096; the octave for the second harmonic starting with a frequency of 8192.

The following table shows the frequencies of the various keys on a piano:

FUNDAMENTAL FREQUENCIES OF PIANO KEYBOARD

White Keys	Black Keys	White Keys	Black Keys	White Keys	Black Keys	White Keys	Black Keys
27	—	97	—	326	—	—	1096
—	28	—	103	345	—	1161	—
30	—	109	—	—	366	—	1230
32	—	—	115	388	—	1304	—
—	34	122	—	—	411	1381	—
36	—	129	—	435	—	—	1463
—	38	—	137	—	461	1550	—
40	—	145	—	488	—	—	1642
43	—	—	154	517	—	1740	—
—	45	162	—	—	548	—	1843
48	—	173	—	581	—	1953	—
—	51	—	183	—	615	2069	—
55	—	194	—	652	—	—	2192
—	58	—	205	691	—	2323	—
61	—	217	—	—	732	—	2461
65	—	—	230	775	—	2607	—
—	69	244	—	—	821	2762	—
73	—	259	—	870	—	—	2926
—	77	—	274	—	922	3100	—
81	—	290	—	977	—	—	3285
86	—	—	308	1035	—	3480	—
—	91	—	—	—	—	—	—

SOUND

The average ranges of frequencies covered by various musical instruments and by singers' voices are shown by the chart.

It is generally more difficult for a radio amplifying and speaker system to reproduce speech clearly than for it to handle instrumental music. Clarity of speech and differentiation between various

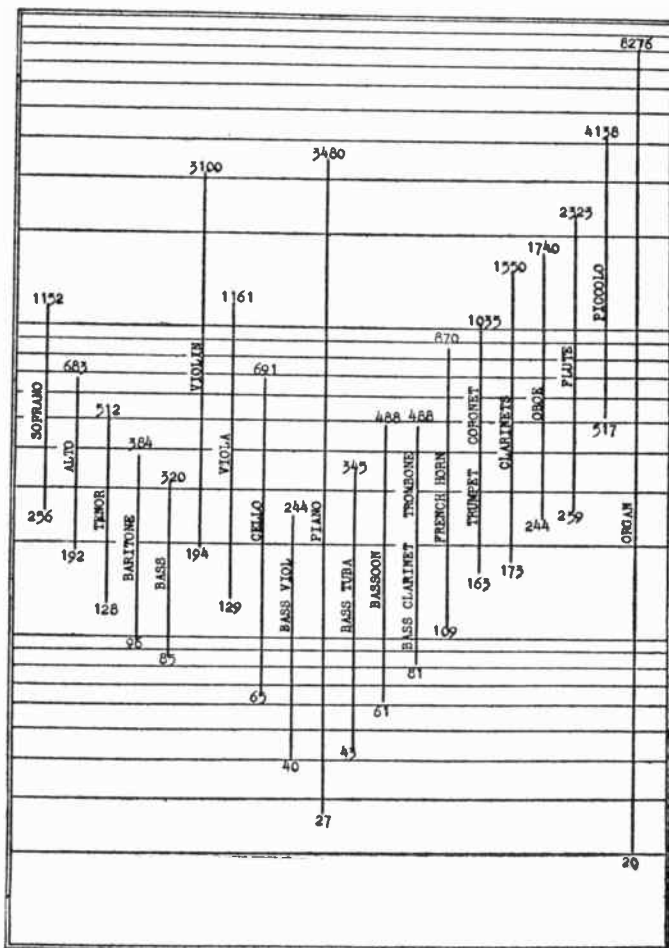

spoken sounds requires good response to the frequencies above seven hundred per second. Should all frequencies below this point be absent, the speech would still be easily understood. Removing the higher frequencies will seriously affect the reproduction of speech and will leave many sounds to be supplied by the imagination.

SOUND

Frequencies between 500 and 3000 are most valuable for a speech amplifier.

The sensitivity of the human ear varies with change of sound frequency. The curve in Fig. 1 shows the sound intensity in dynes required to just affect the sense of hearing at frequencies within the audible range.

Reflection of sound waves from surfaces against which they strike causes three kinds of acoustical trouble in theatres and auditoriums. These troubles are echoes, dead spots and excessive reverberation. Echo is a more or less exact repetition of a complete sound. A dead spot results when compressions in waves traveling one direction coincide with rarefactions in waves travel-

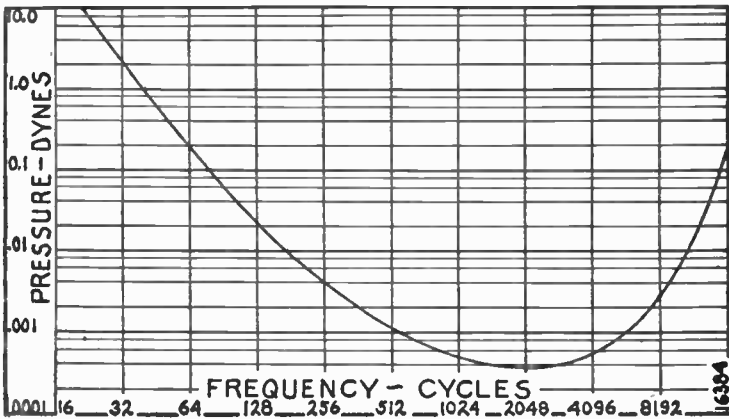

FIG. 1.—Threshold of Audibility.

ing the opposite direction, the result being a weakening of sound at the point where the two effects coincide

Reverberation is the continuation of a sound within an enclosure because of repeated reflections of the sound waves back and forth until they finally die away. A certain amount of reverberation is desirable because it gives liveness and naturalness to speech and music. Too much reverberation results in such confusion of sounds that they become unintelligible.

The number of seconds required for a sound to drop to one-millionth of its original intensity, or to drop 60 decibels, after the sound source has ceased to act is called the reverberation period. For maximum intelligibility of speech the reverberation period should be shorter than for the best effect with music. The optimum period for best average results with both speech and music depends on total room volume, becoming greater as the volume increases. Suitable reverberation periods for rooms of various volumes are shown by the curve in Fig. 2.

A formula developed by Professor Sabine states that the reverberation period in seconds is equal to one-twentieth of the room volume in cubic feet divided by the total number of absorption units for sound which are present within the enclosure.

One absorption unit for sound is the amount of dissipation for sound energy provided by a clear opening, such as a window, one foot square. Sound passing through such an area is assumed to be completely dissipated. The fraction of sound energy which is absorbed by a material reached by the sound waves is called the absorption coefficient of that material. Thus, if a material absorbs one-fourth of the sound energy reaching it, it is said to have an absorption coefficient of 0.25.

Sound absorption varies with frequency in all materials. In Fig. 3 the full line curve shows the absorption coefficients for average rooms which contain neither people nor furniture and which have not been treated to improve their acoustic qualities.

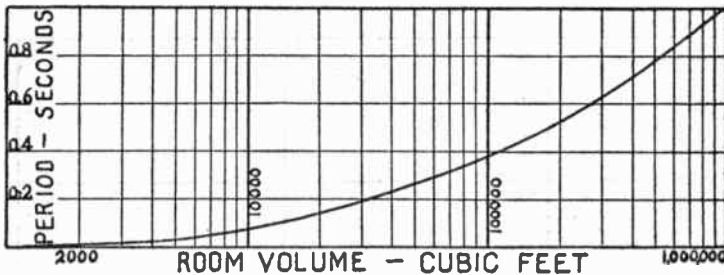

FIG. 2.—Optimum Reverberation Periods.

Many materials are marketed for acoustic treatment of rooms by shortening the reverberation period, preventing echoes and avoiding formation of dead spots. The average absorption coefficients for several of these materials are shown by the broken line curve in Fig. 3.

The number of absorption units presented by any material is equal to the surface area of the material in square feet multiplied by the material's absorption coefficient. The following table gives, for a frequency of 512 cycles per second, the absorption coefficients for various materials according to Professors Sabine and Watson:

Brick, in cement.....	0.025
Carpets30 to 0.15
Concrete015
Cork tile03
Cotton cloth13 to 0.11
Cotton cloth, heavily draped.....	.50 to 0.40
Glass, window027
Hairfelt, one inch thick60 to 0.55
Hairfelt, one inch, painted45 to 0.25
Hairfelt, one-half inch thick.....	.31
Linoleum03
Marble01

SOUND

Plaster, rough finish.....	.06 to 0.04
Plaster, smooth finish.....	.032 to 0.03
Velour45 to 0.35
Window, open	1.00
Wood, sheathing06
Wood, varnished03

The number of absorption units for objects in a room is found by multiplying the number of absorption units per object by the number of objects. The following list gives usual values:

Each person in audience.....	4.7 units.
Each chair or seat, unupholstered.....	0.2 to 0.1 unit.
Each chair or seat, upholstered.....	3.0 to 1.5 units.
Church pews, unupholstered (per seat).....	0.2 to 0.18 unit.
Church pews, cushioned (per seat).....	2.0 to 1.5.

The total number of absorption units in an enclosure is the sum of the number of units for surface materials plus the number of units for persons and other objects.

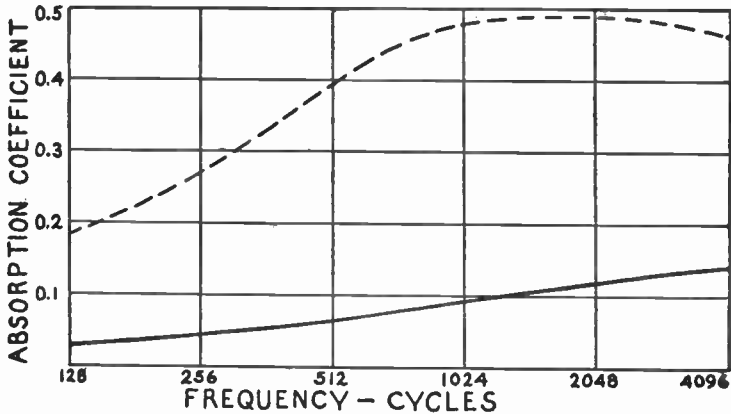

FIG. 3.—Effect of Frequency on Absorption of Sound.

Having determined the optimum reverberation period and calculated the room volume in cubic feet, the required number of sound absorption units will be equal to one-twentieth the volume divided by the period in seconds. From this required number may be deducted the present units in walls, ceilings, floors, furniture and persons. The remaining quantity is the number of units which must be added by treatment with draperies, upholstering and special sound absorbing materials to obtain the optimum reverberation period for best acoustic qualities.

SOUND PICTURES

SOUND PICTURES.—A motion picture which is accompanied by a simultaneous reproduction of the sounds normally associated with the action is called a sound picture. Although some development toward this end had been taking place for the greater part of forty years it was only in the last few years that commercially successful methods were evolved.

Sound may be added to the showing of a motion picture in either of two principal ways. One method utilizes a phonograph record while the other method records the sound on a small portion of the film used for the picture. Several variations of the film system are in use.

All sound recordings, either film or disc, commence with a microphone which changes the air vibrations into corresponding variations of electric current and voltage as described under the heading of *Microphone*. Carbon microphones, condenser microphones and dynamic microphones are in use, but the majority of recording systems employ either the condenser or electrodynamic types.

In the same housing with the microphone, or at least located very close to the microphone, is an amplifier of one or two stages which steps up the

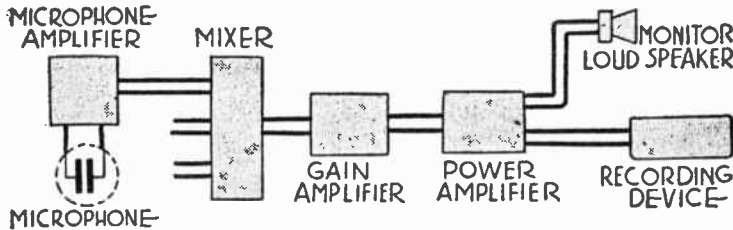

FIG. 1.—Parts Used for Sound Picture Recording.

microphone output to a value which allows its transmission through suitable lines to a mixing panel. The schematic arrangement is shown in Fig. 1. To the mixing panel come the signals from all of the microphones in use, and from the mixer the combined signals are delivered to a gain amplifier which increases the signal voltage before it is passed to the power amplifier. Most of the power amplifier's output goes to operate the recording device either for the phonograph disc system or the film system but some of the output from this amplifier is diverted to a monitor loud speaker which allows these in charge of the work to judge of the results being attained.

With the disc method the recording device is an instrument called a cutter which operates an accurately ground sapphire stylus to engrave the sound groove on the surface of a disc of prepared wax. The wax recording is electroplated to form a metal shell which is a negative of the wax or which is exactly the reverse in surface contour. This negative is electroplated to form a positive impression exactly like the wax and then another negative is made, this latter being called a stamper. The stamper is used to press or mould the finished records used for reproduction. Infor-

SOUND PICTURES

mation on this type of recording is given under the heading of *Phonograph*.

Film Recording.—In all of the film systems of recording, a portion of one edge of the film is taken away from the picture area and is used to carry the sound record. This narrow sound track is of varying degrees of transparency so that more or less light may pass through it. Film recordings may be classified by the formation of the light and dark portions of the sound track.

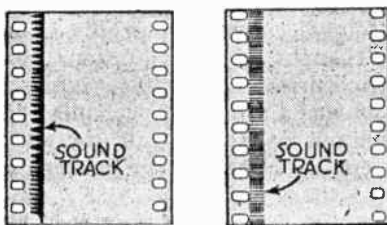

FIG. 2.—Sound Tracks with Variable Area (left) and Variable Density (right).

The form shown at the left hand side of Fig. 2 is called a variable area method and that at the right is called a variable density method.

The fundamental principle of sound reproduction from the film is illustrated in Fig. 3. At the left is a lamp from which a beam of light is focused onto the sound track of the film which is being moved through the projecting machine. The amount of light which passes through the film varies with the variations in sound track transparency and this varying light flux is directed onto the cathode of a photoelectric cell. The voltage output of the photoelectric cell varies in accordance with the changing light and

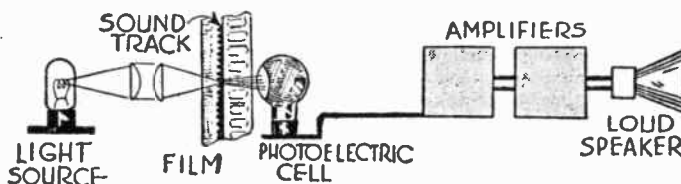

FIG. 3.—Reproduction of Sound from Film.

this output is stepped up in a system of amplifiers until it is of sufficient power to operate the loud speakers. Details of the sound reproducing systems will be taken up later.

Variable Area Recording.—The variable area method, which is the R. C. A. Photophone method, darkens one side of the sound track, the dark portion varying in width with variation of sound intensity and of sound frequency. When there is no sound or no modulation on the film the track is divided equally between the light and dark portions as at the left hand end of the strip in Fig. 4. Sounds are represented by waves in the track. Low fre-

SOUND PICTURES

quencies cause gradual changes in light and dark areas while high frequencies cause rapid fluctuations as shown in Fig. 4. As also shown in Fig. 4, toward the right, the intensity or volume of sound is represented by the depth of the swings in the sound track dividing line.

The recording device for the variable area film system consists of three essential parts; first an optical system including a light source and a series of lenses, second a modification of a vibrating mirror galvanometer, and third the mechanism for pulling the unexposed film past the light beam.



FIG. 4.—Changes in Variable Area Sound Track.

Variable Area Vibrator.—The operation of the vibrator and the lens system may be seen in the diagram of Fig. 5. From the lamp forming the light source the beam passes through a double convex condensing lens and a light stop, then striking the small mirror of the vibrator. From the mirror the light beam passes through the galvanometer lens, which forms the window of a chamber containing the damping oil in which the mirror system is immersed. This window lens is tilted to prevent its reflect-

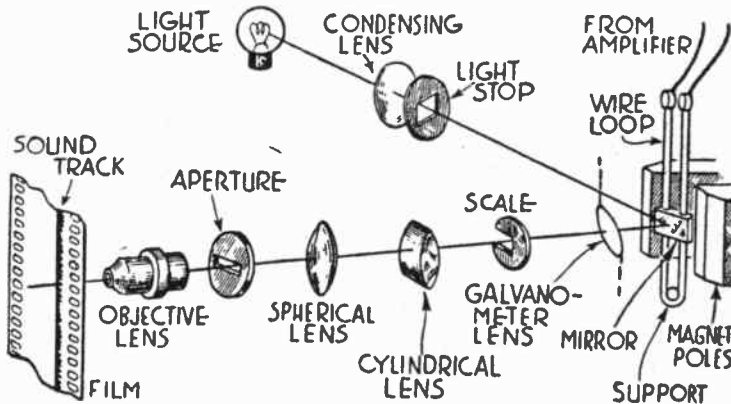

FIG. 5.—Variable Area System of Recording.

ing light to other parts. The light then travels through the scale opening and through a cylindrical lens which condenses the beam in one direction. After passing another spherical condensing lens the light goes through the aperture opening, which is 0.003 inch

SOUND PICTURES

wide, and to the objective lens which focuses the narrow strip onto the sound track, at which point the beam is 0.00075 inch wide and 0.07 inch long.

The portion of the vibrator carrying the wire loop and the mirror is adjusted to such a position that one end of the light beam is at the center of the sound track. Were the film now drawn through the projector one-half of the sound track would be exposed with the result shown at the left hand side of Fig. 4.

The wire loop of the vibrator is mounted between the poles of a powerful magnet. When current flows through the wire there are magnetic fields set up around it and these react with the field of the magnet to move one side of the loop outward and the other inward. Reversal of current flow in the loop reverses the forces and the direction in which the sides of the loop are moved.

An alternating current such as produced by sound frequencies comes from the microphone and amplifiers, passes through the wire loop and causes the loop and the attached mirror to rock first one direction and then the other. This action moves the edge of the light beam from one side to the other on the film sound track and the variations of width of the exposed area correspond to the sound frequencies to be recorded.

Variable Density Recording.—With the variable density film shown at the right in Fig. 2 and again in Fig. 6 the unmodu-

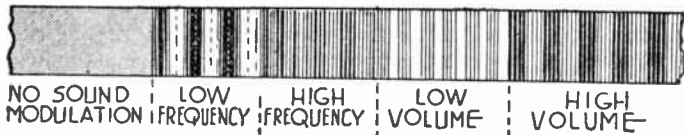

FIG. 6.—Changes in Variable Density Sound Track.

lated sound track which carries no sound record appears as uniformly gray in shading. The intensity or flux of the light which reaches the film with no modulation is such that this degree of shading is maintained. If the light is reduced the finished film is made darker and if the light is increased the film is made lighter. Thus the degree of transparency or opacity of the film, or the contrast between light and dark, is proportional to the intensity or the volume of the sounds recorded. With low sound frequencies the changes from light to dark take longer than when the frequencies are high, therefore the light and dark bands will be wide for low frequencies and narrow for high frequencies. It is apparent that the variable density method is more dependent on the film, and on its exposure and development, than is the variable area system.

Light Valve System.—One of the variable density systems changes the amount of light flux by means of the Western Electric light valve, the principle of which is shown by Figs. 7 and 8. The operating portion of the valve, shown in Fig. 7, consists of a looped ribbon of the non-magnetic metal duralumin, this ribbon

SOUND PICTURES

passing over an insulating pulley and having the two ends wound onto windlasses by means of which the ribbon may be placed under tension. Insulating pincers hold the two sides of the central part of the loop so that they are parallel for a distance of 0.256 inch and are separated by an opening of one mil or 0.001 inch, this being the opening of the valve through which light is allowed to pass.

The ribbon loop is supported in the field of an electromagnet, the plane of the loop being at right angles to the direction of the magnetic flux as indicated in Fig. 8. Signal currents from the microphone and amplifiers

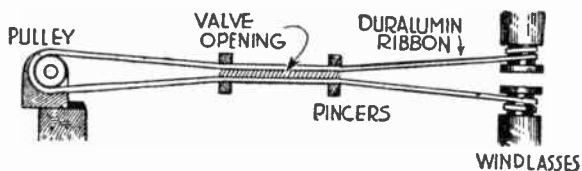

FIG. 7.—Principle of Western Electric Light Valve.

pass through the loop, the windlasses being connected to the output of the power amplifier. Since these signal currents are alternating, the current through the loop at any one instant may be in the direction indicated in Fig. 8 and then will reverse to flow the other way around. The direction of magnetic flux remains unchanged. Fleming's rule for direction of motion of a conductor in a magnetic field indicates that with the current flowing as in Fig. 8 the sides of the loop are forced apart, and with the current reversed the sides of the loop will be forced closer together. The amount of movement given to the sides of the loop is proportional to the amount of current. Therefore, with varying signal currents in the loop it will become alternately wider and narrower, opening and closing the light valve

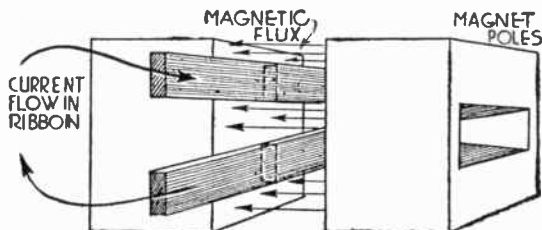

FIG. 8.—Magnetic Action in Light Valve.

at a frequency determined by the sound signal frequency and to an extent determined by the strength or intensity of the signal.

A beam of light from a lamp is focused by a condensing lens system into the light valve which, with no signal currents in the loop is 0.001 inch wide and 0.256 inch long. The strip of light which goes through the valve passes through an objective lens which reduces the dimensions of the light strip to one-half their first size and focuses the light onto the sound track of the film as an image 0.0005 inch wide and 0.128 inch long. These are the dimensions with no signal affecting the light valve.

SOUND PICTURES

With sound signal currents flowing in the light valve it opens and closes while the film with its sound track moves through the recording apparatus. The varying light flux in the image focused on the film results in the variable density pattern of recording.

Glow Lamp Recording.—Whereas the variable density system just described operates with a light source of constant intensity and a controlled beam, another generally used method, the Fox Movietone, uses a source of varying intensity to produce the variable density type of sound track. The light source is a glow lamp shown in Fig. 9 as containing an anode and a cathode and having within the bulb some gas which allows ionization and a glow discharge upon application of sufficient voltage across the anode and cathode. The voltage varies in accordance with a sound signal, and the intensity of the glow varies with the voltage.

A type of glow lamp often used is called the Aeolight. Its cathode is a coated filament and the anode is of nickel. Cold cathode glow discharge tubes also are used, but they require a higher voltage to produce a glow. The voltage applied to the glow tube is secured from the amplifiers which have stepped up the voltage from the microphones. Increase of voltage causes increases both of the intensity and of the size of glow in the lamp,

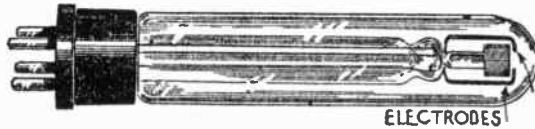

FIG. 9.—Glow Lamp for Sound Recording on Film.

while a reduced voltage decreases the glow. The glow is maintained only as long as the voltage remains above a certain critical value, called the extinction voltage. If the potential falls below this point the glow ceases, and to cause it to reappear a voltage higher than that of extinction must be applied, this higher potential being called the striking voltage. The glow lamp must be operated with a voltage which always remains above the extinction point.

Three-element glow lamps sometimes are used to prevent the glow from ceasing altogether with low voltages. These lamps have an additional anode to which is applied a voltage sufficiently high to cause a faint glow to be maintained between it and the cathode, even with no voltage applied between the regular anode and the cathode. With this method the extinction voltage and striking voltage are equal for the regular anode-cathode circuit.

So far as is possible the glow discharge is confined to a small space in the end of the lamp. This is accomplished by making the cathode compact in form or by surrounding the cathode with an insulating cup. Were the glow to be unconfined the changing voltage would alter the size of the glow more than its density.

Light from the glow lamp may be passed through a slit about 0.0008 inch wide cut into a coating of silver which has been applied on a piece of quartz. The slit is covered with a thin window, is supported in a contact shoe illustrated in Fig. 10 and held

SOUND PICTURES

against the moving film. This particular construction is called a contact slit and there is no opportunity for the narrow light beam to spread because the slit is so close to the film. Other constructions use a larger slit and remove it from the vicinity of the film. The light beam coming through this larger slit is reduced in size to the correct film dimension and is focused onto the sound track by a system of lenses. This latter method is called an optical slit.

With the glow lamp method of film recording the intensity of light, with no signal, is maintained at a value which exposes the film to a uniform gray as at the left hand end of Fig. 6. This value of light is produced by applying a constant polarizing voltage to the lamp. The voltage changes which represent the sounds then are added to and subtracted from this polarizing voltage. The voltage on the glow lamp thus fluctuates above and below the average value, or polarizing value, and the film is exposed by the varying light to form the usual variable density pattern.

Film Speed.—The film is moved past the light beam at a velocity of 90 feet per minute with all systems of recording. Elaborate precautions are taken to maintain the speed at exactly

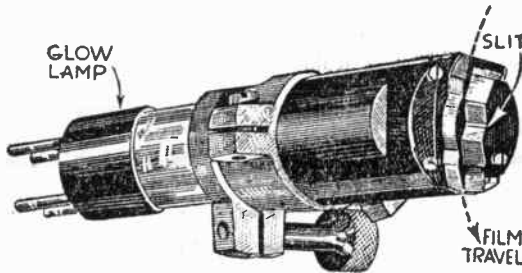

FIG. 10.—Glow Lamp Holder with Slit.

this point, also to prevent the slightest fluctuations in speed. The picture and the sound record are made originally on separate films and after the necessary processes of editing are applied to each, the two are printed together on the film which is actually used for reproduction. In order that the picture film and the sound film may be brought into perfect synchronism for the final printing the recording equipment includes two marker lights connected in series and arranged so that one light exposes part of the edge of the picture film at the same instant the other light exposes part of the edge of the sound film, the two marks identifying corresponding points of the two records.

Noiseless Recording.—One of the chief difficulties encountered with all systems of recording is that of background noises. This is the effect which results in a more or less constant hiss in the loud speaker output, being especially noticeable and objectionable when the volume or intensity of the desired sound is at a low level. Background noise with disc recordings is discussed under

SOUND PICTURES

the heading *Phonograph*. With film recording this noise is due to several things. It actually may be recorded on the film because of extraneous noises getting to the microphone or it may come from faults in the amplifiers and lines. Ground noise may result from dirt on the sound track, which should be clean. A cause of noise for which remedies have been devised rather recently is that consisting of scratches and imperfections in that portion of the sound track which should have maximum transparency.

During the periods when there is no sound or but a small volume of sound the full ability of the sound track to carry modulation is not needed. That is, a much narrower track would suffice when the modulation is low. Several systems have been worked out which effectually reduce the sound track proportionately to the modulation, these going by the general name of noiseless recording systems. Most of these methods depend on the diversion of a part of the amplified power into a separate circuit which controls the width of sound track. The diverted sound currents are rectified so that the average current is proportional to the amplitude of modulation just as with radio detectors. This average current then is used in various ways.

The first method used with variable area recording applies the controlling power to the vibrator mirror so that the end of the light beam is held close to the edge of the sound track when there is no modulation, producing a pattern like that at the left hand side of Fig. 11. With another



FIG. 11.—Methods of Noiseless Sound Recording.

method the controlling power operates an additional shutter to darken the greater part of the sound track and produce the pattern at the center of Fig. 11.

With the light valve method of variable density recording, ground noise reduction is secured by allowing the controlling power to hold the sides of the loop or valve closer together for weak modulation and allow them to move apart their full normal distance, 0.001 inch, only for peak amplitudes. Another method applied to variable density recording uses mats during the printing process to reduce the width of the sound track as shown at the right in Fig. 11.

The reduction of ground noise allows the whole recording to be carried out at a lower level, since the noise is not present to interfere with the weaker sounds. This lower average level allows sounds requiring great intensity to be handled more effectively since there is now available a greater portion of the ability of the sound track, the portion which has been taken out of the ground noise region.

Sound Reproduction.—The elementary layout for a sound head used with any system of film recording is shown in Fig. 12. The sound mechanism is located below the regular motion picture projector and the portion of the sound track being reproduced at any instant is $14\frac{1}{2}$ inches, or 19 picture frames, below the picture which is then being projected. Thus the sound track on the film always is $14\frac{1}{2}$ inches ahead of the picture to which it applies.

This separation of sound and picture avoids the mechanical difficulties

SOUND PICTURES

which would be encountered with the two alongside each other. Separation is a necessity inasmuch as the pictures must have an intermittent motion while the sound track must have a perfectly uniform and steady rate of travel. The film velocity in the sound head must be exactly the same as the speed used in recording, which is 90 feet per minute. If the rate of film travel varies by as much as one per cent the effect is noticeable to the average listener as a change of pitch. To maintain an unvarying speed use is made of mechanical filters, oil damping, heavy flywheels and other precautions quite similar to those employed in recording.

Light from the lamp in the sound head is collected by a condenser lens and focused on an optical slit the dimensions of which fix the size of the beam finally reaching the sound track. The remainder of the lens system serves to focus the light as a beam 0.001 inch high on the sound track of the film. The sound recording varies the light flux through the film and this changing flux passes into a photoelectric cell. The output of the cell then carries the sound signals in the form of voltage and current changes.

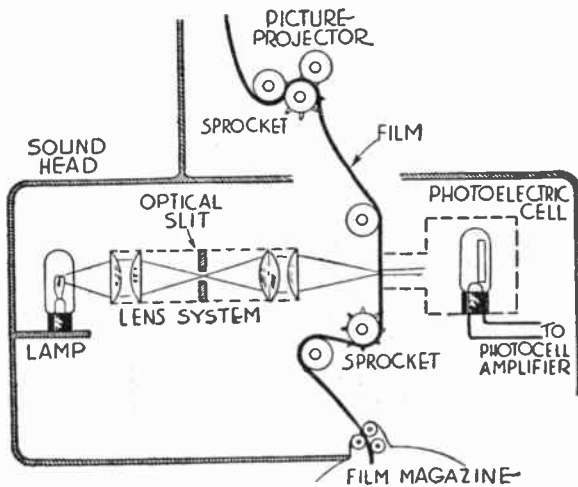

FIG. 12.—Principal Parts of a Sound Head.

The small area of the light image reaching the sound track results in an exceedingly small illumination of the photocell and a great amount of amplification is required to bring the photocell output up to a point where loud speakers may be operated. A wider beam will allow more illumination in the cell but there will be a loss in high frequency amplification at the same time.

The high frequency loss comes about as follows: The length of sound track occupied by one cycle or wave of sound depends on the frequency and on the speed of film travel. The film travel is fixed at 90 feet per minute, which is 18 inches per second. If the sound frequency is 4000 cycles, for an example, the wavelength on the film will be 18 inches divided by 4000, or will be 0.0045 inch. Now it is apparent that if there is to be appreciable change of light during this length of film then the height of the light beam must be much less than the wavelength. The beam 0.001 inch high has been found to give the best average between fidelity and output of the system.

SOUND PICTURES

A light beam more than 0.001 inch high allows more light to reach the photocell and allows a greater total variation between minimum and maximum light, therefore producing greater photocell voltages and greater output from the amplifiers and loud speakers. A narrower beam is affected to a greater degree by high frequency changes in the sound track recording, therefore allows greater fidelity in the reproduction of high sound frequencies.

Amplifiers.—If the photoelectric cell is of the photoemissive type it has high impedance and its output circuit is a high impedance circuit. Long wiring connections in such a circuit will easily pick up various kinds of disturbances and interference. To avoid long high impedance circuits the first one or two stages of amplification may be placed close to the cell. This photocell amplifier will raise the power output to the same level as that secured from a phonograph pickup. Then the remainder of the amplifying system may be used interchangeably with either the film or disc types of recording. The entire subject of photoelectric cells and of amplifying their output is treated under *Cell, Photoemissive*; *Cell, Photoconductive*; and *Cell, Photovoltaic*.

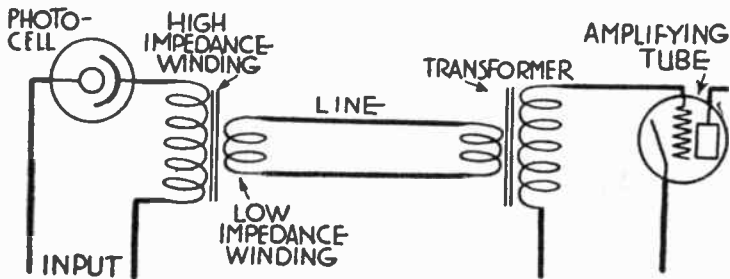

FIG. 13.—Use of Low Impedance Line in Photocell Amplifier.

If the amplifier is placed at some distance from the photocell it is customary to use the arrangement of Fig. 13. The output of the photocell is connected to a transformer having a high impedance primary, to match the cell, and a low impedance secondary connected to the line. At the amplifier there is a step-up transformer providing high impedance in the grid circuit of the first amplifying tube. The line itself then is operating at low voltages and relatively high current and does not pick up ordinary disturbances.

Following either the photocell amplifier or the phonograph pickup is the gain amplifier which increases the voltage of the sound signal. Then comes the power amplifier or amplifiers connected to the loud speakers. The amplifiers, lines and loud speakers are similar to those used in any type of public address installation.

For additional information see *Microphone; Volume, Control of; Phonograph*; and *Public Address Systems*.

SOUND PICTURES

The circuit for one type of vacuum tube amplifier used in sound picture work is given in Fig. 14. Resistance-capacity coupling is used between the photocell and the first amplifying tube, with transformer coupling between the two vacuum tubes. In an amplifier of this type the higher the resistance of the resistor in the cell circuit the greater will be the voltage drop available for operating the grid of the first amplifying tube. The value of resistance at this point is limited by the fact that the time constant of this unit and the condenser may be too low for the frequencies to be handled, also by the fact that a very high coupling resistance will approach the value of the insulation resistance of the photocell mountings and too great a portion of the total current may be forced to flow through and across the insulation.

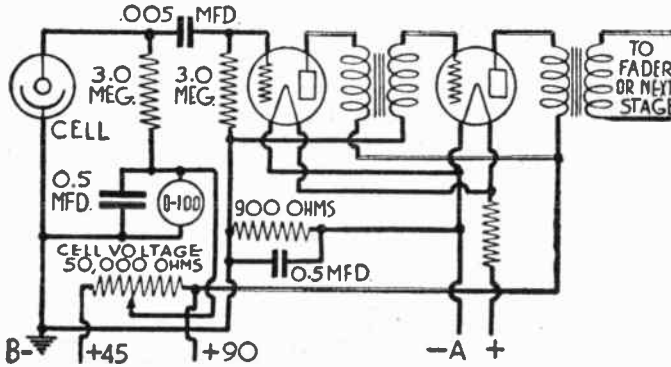

FIG. 14.—Sound Picture Amplifier with Phototube.

With a resistor in the grid circuit of the amplifying tube, as in Fig. 14, it is of the greatest importance that there be a minimum amount of grid current in the tube at all times. Grid current flows through this resistor and the resulting voltage drop may be large enough to completely mask the effect of the small voltages developed by the photo current in the coupling resistor.

SOUND TRACK

SOUND TRACK.—See *Sound Pictures*.

SOUND WAVE.—See *Sound*.

SPACE CHARGE.—See *Charge, Space*.

SPACE CHARGE PENTODE.—See *Tube, Pentode, Screen Grid Type*.

SPACE RADIO.—Transmission of signals through space by radiation, without the aid of metallic conductors to carry the signals. Compare *Radio, Wired*.

SPACE WINDING.—See *Coil, Space Wound*.

SPAGHETTI.—See *Tubing, Insulating*.

SPARK TELEGRAPHY.—See *Radio Telegraphy*.

SPEAKER, LOUD.—The principle of an electromagnetic loud speaker is shown in Fig. 1. The thin diaphragm is of steel, or of non-magnetic material to which is attached a piece of iron. The attraction of the permanent magnet for the diaphragm is varied by audio frequency currents in the magnet windings, whose electromagnetic effect either assists or opposes the permanent magnet. Thus the diaphragm is vibrated at the audio fre-

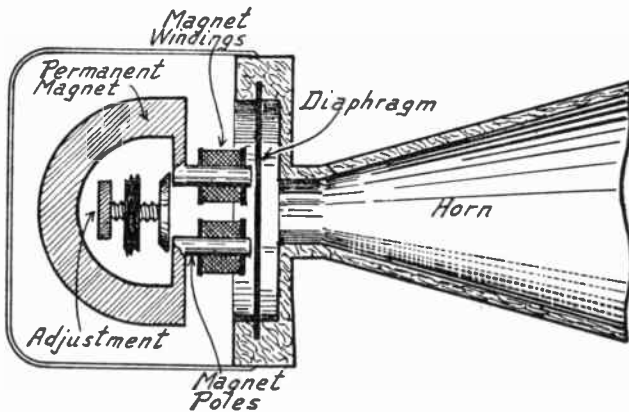

FIG. 1.—Electromagnetic Type of Loud Speaker.

quency to be reproduced as sound. The adjustment moves the magnet toward or away from the diaphragm, and varies the speaker sensitivity.

The balanced armature loud speaker, Fig. 2, has a permanent magnet with two south and two north poles, between which is a pivoted armature surrounded by a coil carrying audio frequency currents. Coil currents make the ends of the armature alternately north and south in polarity, and the ends are attracted to permanent magnet poles of opposite polarity. The armature vibrates

SPEAKER, LOUD

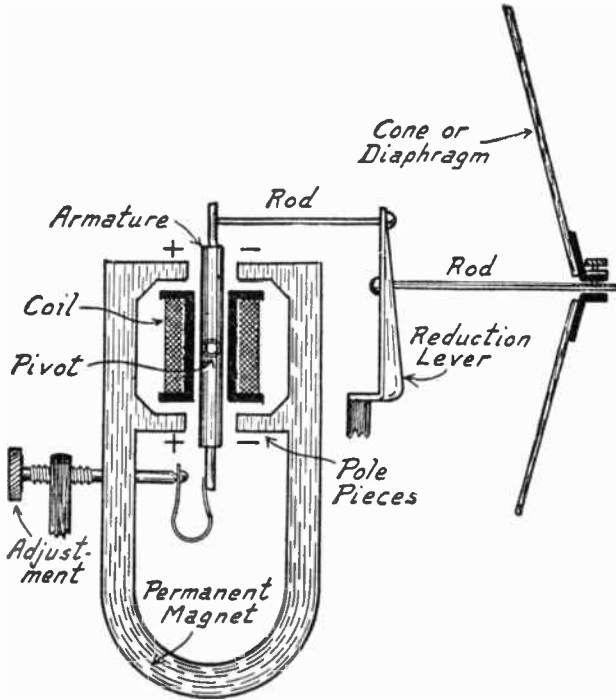

FIG. 2.—Balanced Armature Type of Loud Speaker.

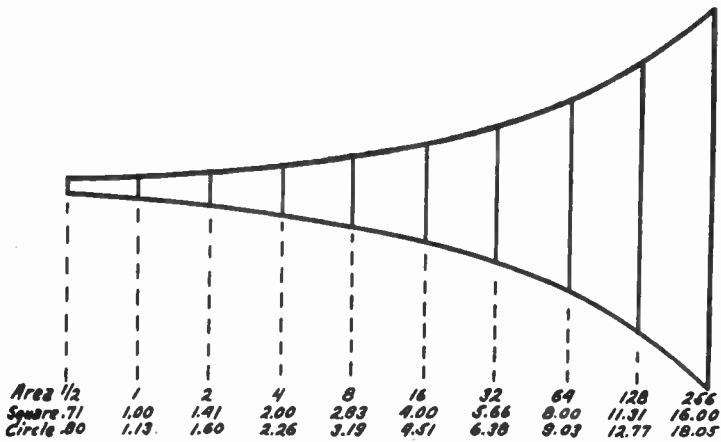

FIG. 3.—Design of Exponential Horn.

SPEAKER, LOUD

at audio frequencies and moves the connected diaphragm or cone to produce sounds.

Some large speakers are fitted with an exponential horn, Fig. 3, in which the cross sectional area doubles for each unit of increase in length. The diagram shows the equivalent sides of squares and diameters of circles. Such a projector has good response at low and medium frequencies.

Moving Coil or Electrodynamic Speaker.—Fig. 4 shows the principle of the moving coil or electrodynamic loud speaker. The soft iron field magnet is continuously magnetized by direct cur-

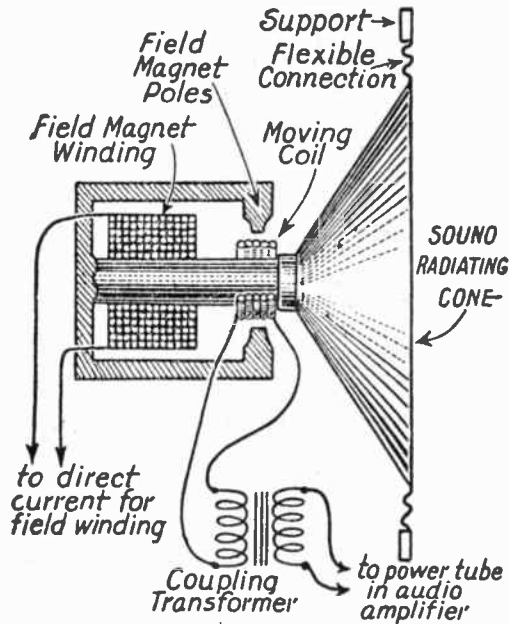

FIG. 4.—Parts of a Moving Coil or Dynamic Speaker.

rent through the field winding. Attached to the sound-radiating cone and surrounding the end of the magnet core is the moving coil consisting of only a few turns. This moving coil is coupled to the audio frequency output through an impedance matching transformer. Audio frequency currents produce around the moving coil a magnetic field that reacts with the steady field of the field magnet to produce motion of the coil and the attached cone.

Fig. 5 shows one type of connection to the audio output. The filter is tuned to reject those frequencies which produce scratching noises. On the end of the magnet core is a small winding whose

SPEAKER, LOUD, CONNECTIONS TO RECEIVER

allows direct current to flow through the field winding. Direct current for the speaker field may be secured also from a dry rectifier connected as in Fig. 7.

An electrostatic type of loud speaker consists of a large fixed plate and a second plate free to vibrate, both made of thin metal

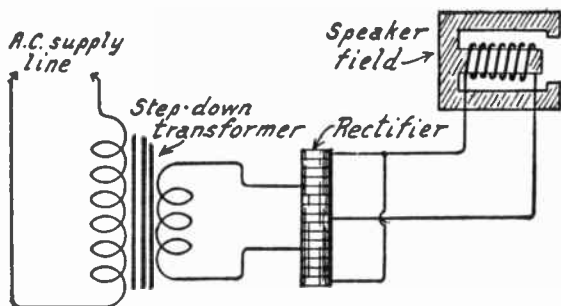

FIG. 7.—Rectifier Field Current Supply.

or foil, and separated by dielectric material. A high applied voltage maintains an electrostatic field between the plates. This field is varied in strength by audio frequency voltages to be reproduced as sound by vibration of one plate.

SPEAKER, LOUD, CONNECTIONS TO RECEIVER.—With small receivers using electromagnetic or balanced armature types of loud speaker, audio frequency currents from the output tube flow through the speaker winding. A bypass condenser between tube plate and cathode keeps high frequency currents out of the speaker winding.

Most loud speakers are connected to the audio amplifier through a transformer that matches the impedances. See *Impedance, Matching of*. In some cases an iron-core choke is connected from the plate of the output tube to the $B+$ line, and a condenser is connected from the plate to one side of the speaker. The other side of the speaker winding is connected to the cathode of the tube or to ground. The condenser is of capacity large enough to carry audio frequency currents to the speaker winding.

SPEAKER, LOUD, REQUIREMENTS FOR.—Any loud speaker must be used with due regard to the sound volume it is capable of producing without distortion and overloading. For example, a balanced armature type of speaker will generally handle considerably more power and will deliver greater volume without distortion than may be secured from an electromagnetic type. On the other hand, the electromagnetic type will often be found more sensitive to weak signals than the balanced armature type.

In a moderately large room the cone type speaker will deliver

SPECIFIC INDUCTIVE CAPACITY

more sound volume than the horn speaker except within a space directly in line with the opening from the bell of a horn.

The larger the horn, the longer and the wider at the mouth, the better it will deliver low notes and the less likely it will be to have points at which it is resonant to certain moderately high frequencies. Since a cone has a comparatively large vibrating surface it sets a greater amount of air into motion and inherently amplifies low notes better than they are amplified by a horn of any reasonable size.

Cabinet speakers are either of the horn type or the cone type, the cabinet acting simply as an enclosure for the horn or the cone.

In order for a good speaker to do good work it must be connected to a good audio frequency amplifier. A large cone speaker will rattle badly when connected to an amplifier having only a dry cell tube of the smaller size as an output tube, yet this is no fault of the speaker and is entirely the fault of the amplifier which is totally inadequate to meet the power requirements of the speaker. Storage battery tubes of the small amplifier type when operated with plate voltage below one hundred will be little better. Power tubes should be used to operate large speakers, especially if the speakers are of the cone type. If ordinary amplifier tubes are used for output, a horn speaker will generally be more satisfactory than a cone.

Speakers should be so placed in a room that there are no objectionable echoes produced by the walls of the room. A speaker of good quality placed in front of heavy draperies will sound better than when it is placed in front of a bare wall because the draperies absorb the sound that would be reflected by a wall. The tone quality of a powerful speaker will often be better when heard from an adjoining room than in the room occupied by the speaker.

SPECIFIC INDUCTIVE CAPACITY.—Another name for dielectric constant. See *Constant, Dielectric*.

SPERM OIL.—See *Oils, Insulating*.

SPIRAL LOOP.—See *Loop, Spiral Type*.

SPLIT VARIOMETER.—See *Variometer, Split Type*.

SQUEALING.—The noise caused by heterodyne whistles or by free oscillation in a receiver.

S. S. C.—An abbreviation for single silk covered wire. See *Wire, Silk Covered*.

S. S. E.—An abbreviation for single silk enameled wire. See *Wire, Enameled*.

STABILITY.—Freedom from oscillation in the tuned circuits or other circuits of a receiver is called stability. See *Oscillation*.

STABILIZING.—The prevention of free oscillation in a receiver. See *Oscillation*.

STAGES OF AMPLIFIER.—See *Amplification, Cascade*.

STAND BY.—A phrase meaning to wait for further signals to come later on, keeping the receiver in operation and tuned to the same frequency in the meanwhile.

STATIC.—Static is a form of radio interference caused by electrical disturbances in the atmosphere. These disturbances may be comparatively violent, such as flashes of lightning, or they may be

STATIC

weak such as the gradual discharge between a cloud and the earth. But of whatever kind, they produce radio waves which travel to great distances and which are picked up by the antenna of a receiver just as any other radio wave would be picked up.

A static impulse has no particular frequency, therefore cannot be prevented from entering the receiver by any tuning means. The effect is that of shock excitation so that the receiver responds to static impulses when tuned to resonance at any frequency. See *Selectivity* for an explanation of shock excitation.

These static impulses are several thousand times as powerful as the impulses or waves coming from a distant station. Their average duration is about one five-hundredth part of a second.

Occasional loud crashes and intermittent rattling noises are caused by discharges of lightning, either near at hand or at great distances. When a storm is close enough to allow the lightning to make distinct impressions on the receiver and for the thunder to be heard, the distance of the flash from the receiver may be easily calculated. The speed of the radio waves from the flash is practically instantaneous while the sound of the thunder travels at only 1087 feet per second. By noting the number of seconds and fractions of a second between the sound of the static in the receiver and the sound of the thunder coming through the air, then multiplying 1087 by this number of seconds, the result will be the approximate distance in feet of the flash from the receiver.

Static is generally much worse during warm weather than in cool and it is worse around sunset than at other times of the day. Static that is characteristic of warm weather and changing weather consists of an almost continual series of crashing and grinding sounds, some being quite loud and others relatively weak.

Impending weather changes always cause considerable static. This is true when the weather is changing from warm to cold or when it is changing from cold to warm. When the weather is constant and undergoing no change there is comparatively little static, this being true whether the weather is exceedingly cold, exceedingly warm or anywhere in between.

When an electrical storm is gathering, the receiver will often give forth a continuous hissing sound caused by the steady electrical discharge passing through the antenna circuit to ground. Static may be quite bad during a snow storm as the minute electrical charges on the snow flakes are discharged through the antenna.

There have been many attempts to devise means for eliminating static impulses from the receiver circuits. So far none of them have been wholly successful. Those which have attained moderate success have been very complicated and add greatly to the cost and complication of the receiver.

Reducing the amplification or slightly detuning the receiver will generally lessen the ratio of static strength to signal strength and will give the effect of reducing the static. During periods of heavy static more enjoyment will be had if the loud speaker is placed in a room adjoining that in which the listeners are sitting.

STATIC LEVEL

A high resistance, one of 100,000 ohms or more, connected between the antenna and ground terminals of the receiver will bypass a greater proportion of static than signal because the signal frequency is the frequency at which the receiver circuits are resonant. This scheme gives the effect of reducing the static although it reduces the signal strength at the same time.

The most logical method of reducing the effect of static is increase of power used in broadcasting. If the signal strength can be made considerably greater than the static strength, then the amplification may be reduced while still giving a satisfactory signal.

STATIC LEVEL.—See *Level, Static*.

STATIONS, BROADCASTING.—See *Broadcasting*.

STATOR.—The stationary part of a variable condenser or variable inductance is called the stator of the device. The stator plates of a condenser are those which do not move as the condenser capacity is adjusted. The stationary winding of a coupler or variometer is called the stator winding. The stator of any unit is always connected to the high voltage side of the circuit containing the unit since the stator is not in contact with the control knob or dial touched by the operator's hand and is not directly affected by body capacity.

STEEL.—See *Iron and Steel*.

STEP-UP AND STEP-DOWN TRANSFORMER.—See *Transformer*.

STORAGE BATTERY.—See *Battery, Storage Type*.

STRAIN.—The change of shape, size or form that is caused to take place in a substance by forces that are applied.

STRANDED WIRE.—See *Wire, Stranded*.

STRAY FIELD.—See *Field, Stray and Confined*.

STRAYS.—Another name for atmospheric disturbances or static. See *Static*.

STRENGTH, DIELECTRIC.—The ability of an insulating material or a dielectric to resist the passage of voltage through it is called the material's dielectric strength. It is measured by the number of volts required to break down the material and force a current to pass through. The general expression is in the number of volts required to break through a thickness of one mil or one-thousandth of an inch. The dielectric strength may also be expressed in the number of volts required to break through a thickness of one millimeter.

The conditions under which tests are made affect the results to such a great extent that values given for dielectric strength are always approximate only. The dielectric strength of insulators decreases very rapidly as the frequency increases. At audio frequencies the strength may drop to one-quarter or less of the value with direct currents.

STRENGTH, SIGNAL.—See *Range, Receiver; Sensitivity; also Volume*.

STRESS

STRESS.—The force which is applied to a substance and which tends to produce a strain in it.

SUB-PANEL.—A shelf-like support inside of a receiver's cabinet upon which and from which are supported various units such as tube sockets, resistors, coils, transformers and wiring. The sub-panel is horizontal or approximately so.

SULPHUR.—Ordinary yellow roll sulphur or melted and cooled flowers of sulphur make a rather useful insulator and supporting material for experimental work in radio. Sulphur melts at about 250° Fahrenheit and may then be poured into moulds of any required shape. Metal or other inserts may be placed in the moulds.

Sulphur has a dielectric constant of 2.5 to 4.0. It has low losses at radio frequencies and has high resistance, both volume and surface leakage being slight.

SUPER-CONTROL TUBE.—See *Tube, Variable- μ* .

SUPERHETERODYNE RECEIVER.—See *Receiver, Superheterodyne*.

SUPER-POWER.—Comparatively large power used by a broadcasting station in its aerial. There are no definite limits between which a station's power is designated as super-power. However, super-power is generally accepted as being something in excess of 10,000 watts or ten kilowatts.

SUPER-REGENERATIVE RECEIVER.—See *Receiver, Super-regenerative*.

SURFACE LEAKAGE.—A leakage of current or voltage that takes place over the surface of insulation is called surface leakage as distinct from leakage that takes place through the body of the insulation which is called volume leakage.

SURGES, POWER LINE.—Sudden increases of current and voltage in a power line which give rise to electrical interference in receivers are called power line surges. See *Interference*.

SUSCEPTANCE.—A part of the admittance in a circuit, the remainder being conductance.

SWINGING.—A change in transmitted frequency.

SWITCH.—A device which will open or close a circuit or which will alter the connections between different parts and different circuits is called a switch. There are a number of different principles employed in the construction of switches and there are innumerable manufacturing variations introduced by makers of these units. The principal types are described in the following sections.

SWITCH, ANTENNA.—An antenna switch is a single-pole, double-throw switch connected to the antenna terminal of a receiver, to the antenna itself and to the ground as shown. The switch should be mounted vertically, with the antenna connected to the center, the antenna terminal of the receiver connected to the upper terminal and the ground and ground terminal connected to the lower end of the switch.

SWITCH, ANTI-CAPACITY TYPE

With the switch blade thrown to the upper position, the antenna connects through the switch blade to the receiver. With the switch thrown down, as is done during an electrical storm, the receiver is disconnected from the antenna and both antenna and receiver are grounded.

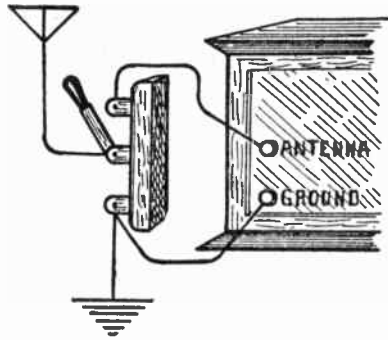

Antenna Grounding Switch.

SWITCH, ANTI-CAPACITY TYPE.—Any form of switch made with its metal poles and terminals well separated and with these metal parts made of small size is called an anti-capacity switch because the separation and the small size tend to reduce the capacity between the metal parts.

SWITCH, BATTERY OR FILAMENT.—The switch which connects the battery or other source of filament current to the filament circuit of a receiver, and which disconnects these parts from each other when the receiver is to be inoperative, is called a battery switch or a filament switch.

SWITCH, CAM TYPE.—A switch in which contacts are brought together or are allowed to separate by the action of a cam is called a cam switch. With the small lever pushed down, the cam turns on its pivot and closes the upper contacts while the lower ones are allowed to open.

Cam switches are made with one or several sets of contacts which are operated simultaneously.

SWITCH, DEAD-END.—A switch which connects more or less of an inductance coil into a circuit and which completely disconnects the unused portion of the coil is called a dead-end switch. Such a switch is shown in the diagram.

The coil is divided into several sections, wound together but with both ends of each section connected to the switch rather than to each other. The switch has one contact point attached to one end of the circuit and has a number of contact points, each one of which rests on two of the contacts at once, thus connecting the two together. All of the points move together but are insulated from one another.

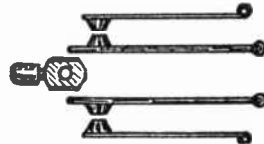

A Cam Type Switch.

SWITCH, DOUBLE-POLE

In the position shown the two sections of the coil toward its left hand end are connected in circuit while all of the remainder is disconnected. Were the switch to be moved one more notch to the right it would cut in one more

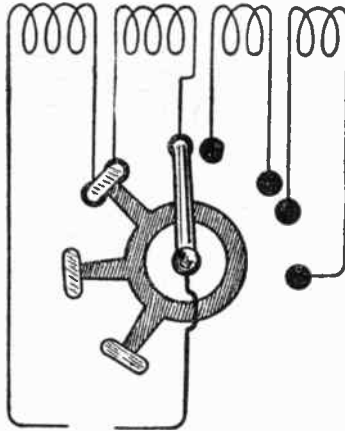

A Dead-End Switch.

coil section and would complete the necessary connections between all the coil sections then in use. Such a switch is advantageous when it is necessary to use a tapped coil winding.

SWITCH, DOUBLE-POLE.—Any switch that opens or closes two lines or both sides of a circuit at the same time is called a double-pole switch. The switch shown is a double-pole switch

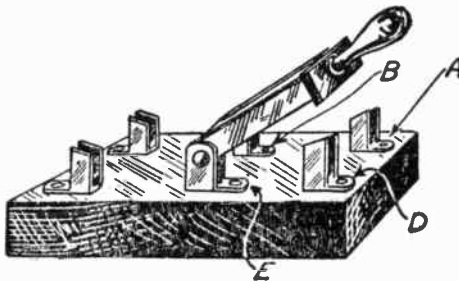

Double-Pole Switch.

since it connects or disconnects *A* with *B* and *D* with *E* with one motion of the switch blades which are mechanically fastened together but electrically insulated from each other. The abbreviation for double-pole is "D-P."

SWITCH, DOUBLE THROW.—A switch that may be thrown to either of two terminals.

SWITCH, FOUR-POLE.—A four-pole switch is a switch to which four lines may be connected as in the drawing. The switch has two positions. In the position shown by full line connections

SWITCH, GROUNDING

A is connected to *B* and *C* is connected to *D*. In the alternative position, shown by the broken lines, *A* would be connected to *C* and *B* would be connected to *D*.

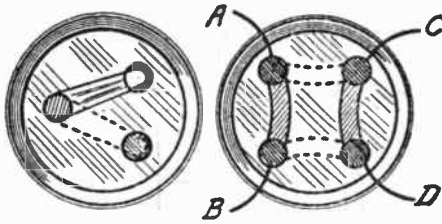

Double Throw Switch and Four-Pole Switch.

SWITCH, GROUNDING.—A switch used to connect an antenna or other circuit to ground is called a grounding switch. A lightning switch is one form of grounding switch.

SWITCH, INDUCTANCE.—An inductance switch is a switch used for cutting more or less of an inductance coil into a circuit. See *Switch, Dead-end*; and *Switch, Tap*.

SWITCH, JACK TYPE.—A switch whose general construction is similar to that of a jack. See *Jacks and Jack Switches*.

SWITCH, KNIFE.—A switch with long thin metal blades somewhat like the blades of a knife is called a knife switch.

SWITCH, LIGHTNING.—A switch used during lightning storms or electrical storms to ground the antenna so that electrical discharges coming through the antenna will be led to ground is called a lightning switch.

SWITCH, LOCKING.—A battery switch or filament switch that incorporates a lock which must be operated with a key to open or close the switch is called a locking switch.

SWITCH, POLE CHANGING.—A switch that connects one two-wire circuit to either of two other two-wire circuits is called

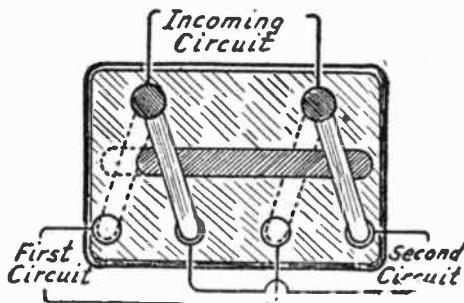

Pole Changing Sw.

a pole changing switch. The connections of one such switch are shown. It is a form of double-pole, double-throw switch.

SWITCH, SERIES-PARALLEL

SWITCH, SERIES-PARALLEL.—A switch that will connect two separate units either in series with a line or in parallel with the same line is called a series-parallel switch. One type is shown in Fig. 1.

The two units, which may be resistances, inductances, capacities or any combination of these, are shown as number 1 and number 2. The line enters the switch at the top and leaves from the bottom.

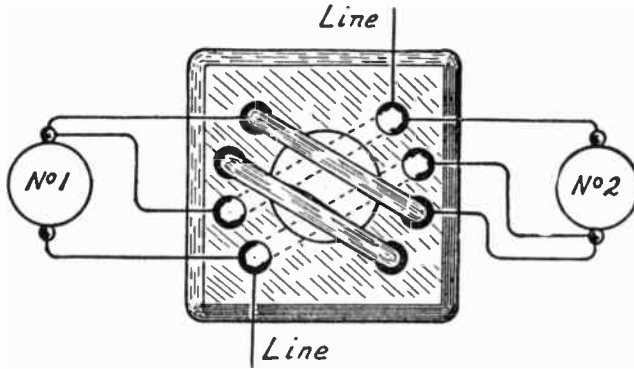

FIG. 1.—Special Form of Series-Parallel Switch.

In the position shown by the full line connections of the switch blades, the two units are in series with each other. The switch blades are fastened together mechanically but electrically insulated and they may be moved to the position shown by broken lines. In this broken line position the two units are in parallel with each other.

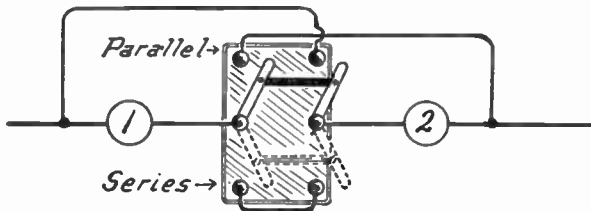

FIG. 2.—Double-Pole, Double Throw Switch with Series-Parallel Connections.

An ordinary double-pole, double-throw switch may be used as a series-parallel switch with the connections made as in Fig. 2. With the switch thrown to the top the units numbered 1 and 2 are in parallel and with the switch thrown to the bottom they are in series. Connections for a jack type switch used for series-parallel work are shown under *Jacks and Switches, Uses of*.

SWITCH, SINGLE-POLE.—A switch which opens or closes but a single line is called a single-pole switch. The abbreviation for this type is "S-P."

SWITCH, SNAP

SWITCH, SNAP.—A snap switch is a switch so constructed that upon moving its control knob or button a spring is first placed under tension while the contacts remain in their original position, either open or closed. When the spring has been given considerable tension the contacts are snapped by the spring into their other position. The object of this construction is to make a quick break of the circuit and thus avoid drawing an arc between the contacts as they separate.

SWITCH, TAP.—Any form of switch that connects more or less of an inductance coil, a resistance or a series of capacities into a circuit is called a tap switch. A tap switch used with a tapped inductance coil is shown. One side of the circuit is connected directly to one end of the coil while the other side of the circuit is connected to the switch arm. As the arm makes contact with successive tap points, a greater or less number of coil turns are included in the circuit. The unused portion of the coil forms an undesirable dead-end.

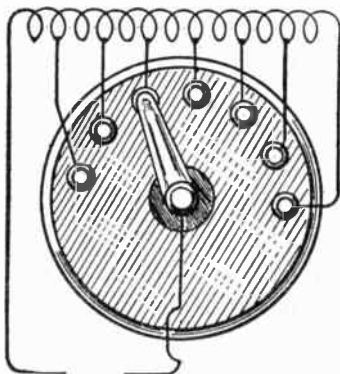

A Tap Switch.

SWITCH, THREE-POLE.—A switch having three sets of contacts so that it may be used to open or close three different lines simultaneously is called a three-pole switch.

SWITCH, THREE-WAY.—A switch that will connect one line to either one of two other lines is called a three-way switch.

SWITCH, TOGGLE.—A switch operated by a small lever or arm which springs the switch contacts into one position or the other is called a toggle switch.

SYMBOLS, RADIO AND ELECTRICAL.—A symbol as used in wiring diagrams is a sign or mark which in itself is simple and easily made, yet which represents a part or device which may be rather complicated in actual construction and which may be subject to wide variations in actual appearance and details of construction. The symbol stands for the idea or represents the principle which it is desired to illustrate.

The use of symbols greatly simplifies all kinds of radio diagrams, making it possible to easily trace the circuits all the way through the different parts. Such tracing would be absolutely impossible with actual pictures of the parts since only their outside terminals would be shown.

The use of symbols also makes the radio worker or constructor completely independent of any particular make or model of apparatus. A diagram or layout drawn with pictures or accurate representations of certain forms of the units can be used only with difficulty and uncertainty when other makes of units have to be substituted for those shown.

SYMBOLS

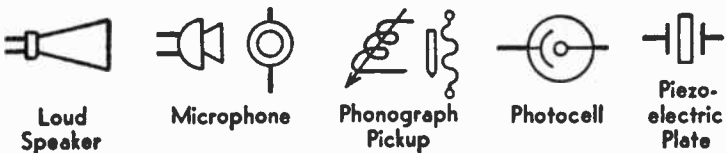
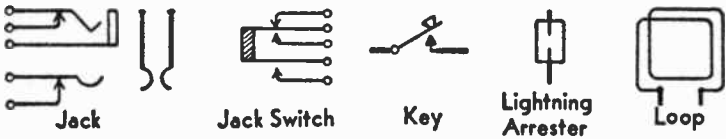
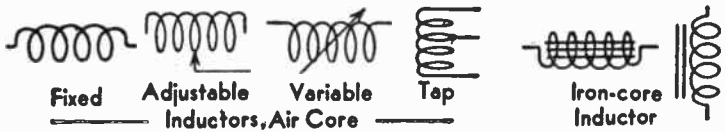
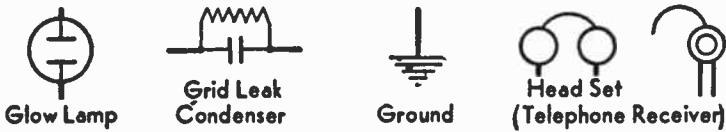
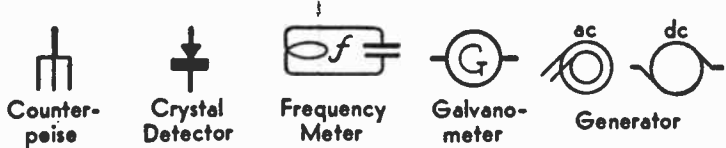
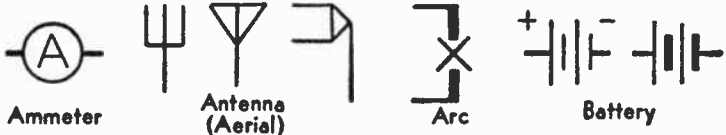

SYMBOLS

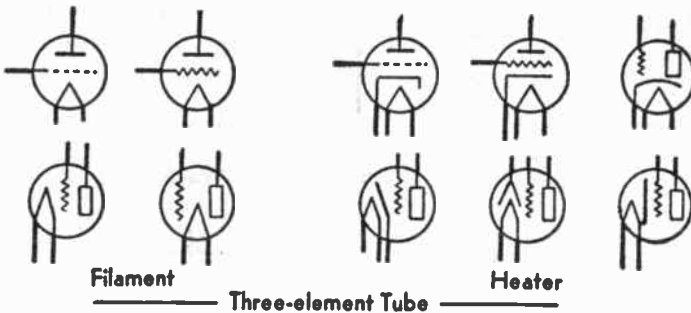
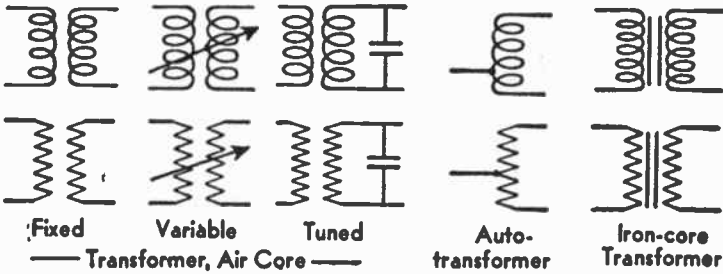
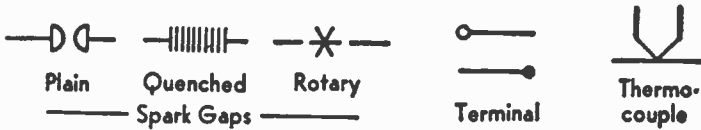
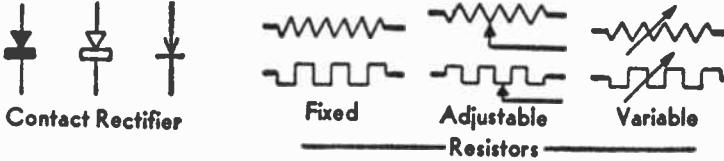
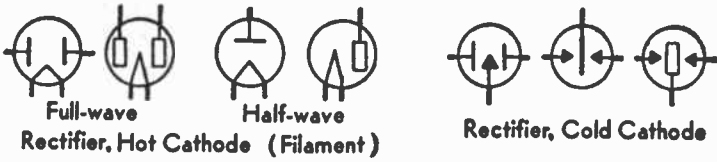

SYMBOLS

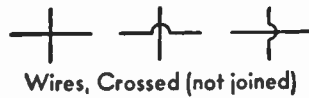
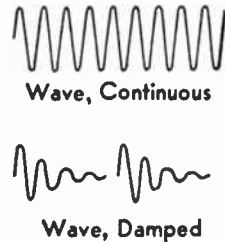
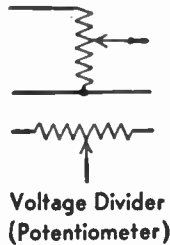
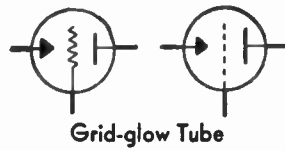
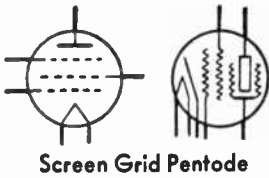
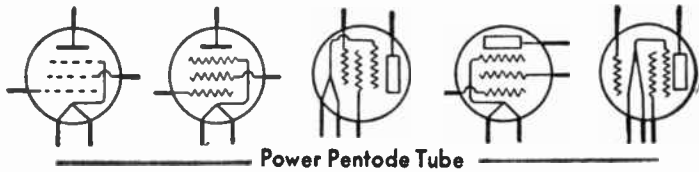
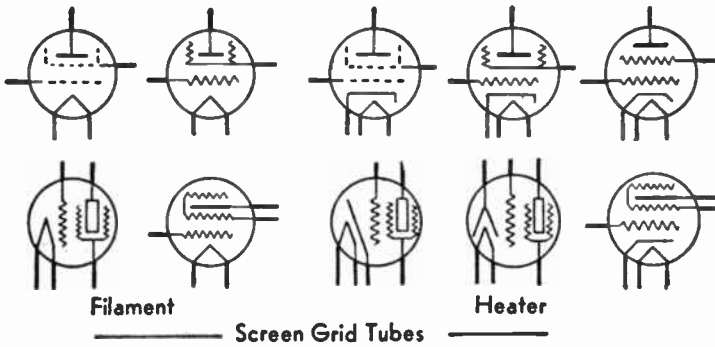

SYNCHRONOUS BROADCASTING

GREEK LETTER SYMBOLS			
δ (delta)	logarithmic decrement	alpha	A α
e (epsilon)	base of Naperian logarithms=2.71828	beta	B β
θ (theta)	phase angle, phase displacement	gamma	Γ γ
κ (kappa)	constants	delta	Δ δ
λ (lambda)	wavelength	epsilon	E ϵ
μ (mu)	permeability; amplification factor	zeta	Z ζ
μf (mu)	micro as a prefix; = microfarad	eta	H η
ν (nu)	reluctivity	theta	Θ θ
π (pi)	circumference \div diameter = 3.14159	iota	I ι
ρ (rho)	volume resistivity	kappa	K κ
τ (tau)	time-phase displacement, time constant	lambda	Λ λ
ϕ (phi)	magnetic flux	mu	M μ
ψ (psi)	phase difference, angular velocity	nu	N ν
ω (omega)	$2 \times \pi \times$ frequency	xi	Ξ ξ
		omicron	O o
		pi	Π π
		rho	P ρ
		sigma	Σ σ
		tau	T τ
		upsilon	Υ υ
		phi	Φ ϕ
		chi	X χ
		psi	Ψ ψ
		omega	Ω ω

SYNCHRONOUS BROADCASTING.—See *Broadcasting*.

T

TALKING MOTION PICTURES.—See *Sound Pictures*.

T-ANTENNA.—See *Antenna, Forms of*.

TAP, DRILL HOLES FOR.—See *Drilling*.

TAP SWITCH.—See *Switch, Tap*.

TAPE, INSULATING.—Several different kinds of insulating tapes are used in electrical work. The most common is friction tape made of a fabric filled with rubber compounds in the better grades and with pitch and tar compounds in cheap grades. This tape makes fair insulation for low voltage conductors.

Tape is also made from varnished cloth cut into strips. This material has high insulating value but the spaces left between layers of the tape prevent the covering from being proof against moisture.

Rubber tape consists of a thin layer of soft rubber gum compound laid on a strip of varnished or oiled cloth. The rubber may be removed and used alone to make a close, weatherproof and moisture-proof insulating covering. A layer of this rubber tape covered with a layer of friction tape, the whole being then varnished, makes an excellent and permanent insulating covering for exposed wires and wire joints such as those in the antenna circuit.

TAPS AND DIES, THREAD CUTTING.—See *Tools*.

TELAUTOGRAPH.—A communication system in which characters impressed by a stylus or pencil on the transmitter are sent to the receiver by levers, electromagnets, and connecting circuits, where the characters are reproduced by a moving pen.

TELEGRAPH MODULATED WIRE.—A continuous wave varied in frequency or amplitude by a telegraph key.

TELEGRAPHPHONE.—A sound recording and reproducing device in which a moving wire, tape, or disc of steel is unevenly magnetized at different points on its length or surface by means of signal currents. This unevenly distributed magnetism then is used to produce inductive effects which cause sounds in a reproducer or loud speaker. A wire recorder.

TELEMETER.—A device which furnishes visible or audible indications of the operation or functioning of apparatus which is located at a distance.

TELEPHONE REPEATER.—An audio-frequency amplifier placed in a long transmission line, with suitable input and output impedance matching transformers, for the purpose of increasing signal strength to compensate for line losses or attenuation.

TELEVISION

TELEVISION.—A picture or scene which is to be transmitted and reproduced by television first is viewed by a television camera. The essential parts in one type of camera are shown by Fig. 1. The lens system is similar to those found in cameras for still and motion pictures. However, instead of focusing the image on a photographic film, as in an ordinary camera, it is focused on a photo-sensitive surface called the mosaic. This mosaic is mounted inside a special form of cathode-ray tube called the camera tube. Basic principles of such tubes are explained under *Tube, Cathode-ray*.

When the mosaic is illuminated by the focused image, and at the same time is traversed by an electron beam originating in the

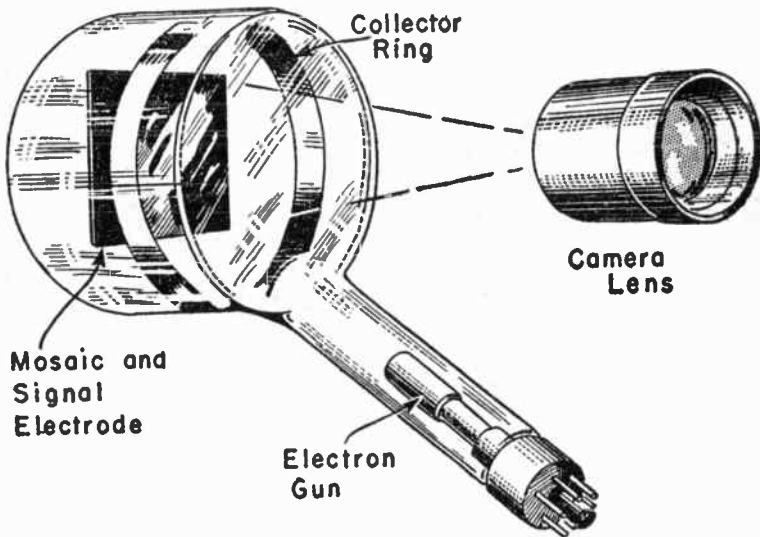

FIG. 1.—An Iconoscope Used in a Television Camera.

electron gun of the tube, changes of light and color in the image are translated into changes of electron flow and voltage. The voltage changes are amplified and applied as amplitude modulation to a carrier wave for transmission. At the television receiver this signal modulation acts in another type of cathode-ray tube to reproduce the original image with all the movements of objects in the scene being viewed by the camera.

Two types of camera tubes are in general use, the Iconoscope and the Image Orthicon. Fig. 1 illustrates the Iconoscope. The Image Orthicon contains an electron multiplier system which gives light sensitivity far greater than obtained in the Iconoscope.

Instantaneous transmission and reproduction of televised images

TELEVISION

with all their motion is made possible by separating the images during each $\frac{1}{30}$ second into as many as 250,000 minute parts or elements. These parts are so small that each consists of only a single tone of gray or color shading. Signal voltages corresponding to these shadings are transmitted and reproduced as variations of light and shadow or color at the receiver picture tube within the same $\frac{1}{30}$ second. The shading or color of each small part of the reproduced picture persists in our vision for a period of $\frac{1}{15}$ to $\frac{1}{20}$ second. Consequently, one impression remains in the eye until followed by another in the same position, and the series of picture elements reproduced every $\frac{1}{30}$ second blends into a continuing image, with objects appearing to move just as they are moving in the original televised scene.



FIG. 2.—The Image Is Divided Into Horizontal Lines.

Before discussing the electrical action in the camera tube it will be well to examine the process by which the image is subdivided for transmission. This process of separation at the camera tube and reconstruction at the picture tube is called *scanning*. The camera tube mosaic, on which the picture is focused, reacts to changes of light not over the entire image at one time, but only where the mosaic is momentarily struck by the moving electron beam. The beam is made to travel from left to right along successive horizontal lines on the image, thus dividing the image somewhat as shown by Fig. 2. Actually the beam travels on

TELEVISION

about 490 successive horizontal lines in going from top to bottom of the image, thus separating the picture into this number of lines every $\frac{1}{30}$ second.

Travel of the electron beam horizontally and vertically is brought about by electrostatic or magnetic deflection systems just as in other cathode-ray tubes. Iconoscopes employ either electrostatic or magnetic deflection, with electrostatic focusing of the beam. Image Orthicons employ magnetic deflection and magnetic focusing of the beam.

Fig. 3 shows how the electron beam travels over the mosaic. Only a few lines are shown here, but action is the same for the

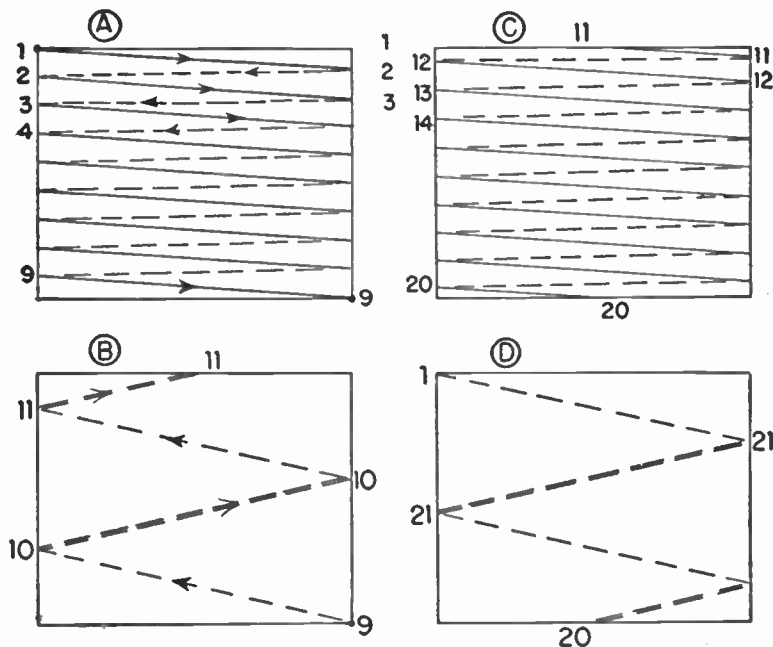

FIG. 3.—Travel of Electron Beam for Interlaced Scanning.

several hundred lines actually formed. Commencing at the upper left in diagram *A* the beam traces line 1 to the right. Then the beam is stopped or blanked while deflection currents or voltages return to values which cause the beam to start line 2. Had the beam continued, it would have followed the broken line back to the beginning of active line 2 at the left. The change of deflection current or voltage represented by this broken line is called a *horizontal retrace*. Remaining lines are traced and retraced in the same manner until the beam reaches the lower right-hand

TELEVISION

corner of the image area, on line ρ of diagram *A*. Travel of the beam as shown by this diagram forms one *field*.

Now the beam is cut off or blanked while deflection currents or voltages go through the changes represented in diagram *B*. These changes would have moved the beam from the lower left through line 10 and half of line 11 . Here the beam is re-established, starts from the top center of diagram *C*, and traces the remaining half of line 11 . Then, with successive traces from left to right, and blanked retraces from right to left, the beam follows the horizontal lines of this second field as shown.

Because the top line of diagram *C* starts half way across the image area, this line and all those following in this second field fall midway between lines traced for the first field in diagram *A*. This is *interlaced scanning*, with half the total number of lines traced during each of the two fields. Two fields make up one picture *frame*.

The second field ends with the beam half way through line 20 of diagram *C*. The beam again is blanked while deflection currents or voltages go through the changes represented by diagram *D*. Had the beam continued it would have been deflected from bottom to top of diagram *D*. Had the beam continued during the period of diagram *B* it would have been deflected from bottom to top. The periods represented by diagrams *B* and *D* are called *vertical retraces*. Upon completion of the vertical retrace in diagram *D* the deflection currents or voltages are of such values as to bring the beam to the upper left-hand corner of the image area when it is re-established for the next field. This is at the start of line 1 in diagram *A*. Thus the scanning continues.

One line period is the time required for one horizontal trace and accompanying retrace. One complete frame consists of 525 line periods. About $17\frac{1}{2}$ line periods are required during each vertical retrace, or 35 line periods for the two vertical retraces in each frame. This leaves about 490 active lines per frame, about 245 lines for each field.

The time for each field and accompanying retrace is $\frac{1}{60}$ second, and for each complete frame is $\frac{1}{30}$ second. Since there are 525 line periods per frame and 30 frames per second, the time for one line period is $\frac{1}{15750}$ second. Frame frequency is 30 cycles per second, field frequency is 60 cycles per second, and line frequency is 15,750 cycles per second.

Examination of any one horizontal line in Fig. 2 shows it to be made up of a series of changes between black, white, and intermediate tones of gray. These variations of illumination exist on the mosaic which, at the same time, is being traversed by the electron beam. The mosaic consists of a coating of very small globules which emit electrons at a rate inversely proportional to the degree of illumination when acted upon by the electron beam.

When the electron beam strikes a globule, electrons are released from the globule. Losing electrons leaves the globule less negative, or more positive. After the beam passes, the globule receives electrons thrown off by other globules and from parts within the camera tube, thus gaining negative electricity and becoming less positive or more negative.

When light in the image acts on the globule it emits electrons and becomes less negative. Consequently, the next time the beam strikes this globule it will reach its maximum positive condition after emitting fewer electrons than had it not been affected by light in the meanwhile. This means that there is less emission and less current from a lighted globule than from an unlighted one.

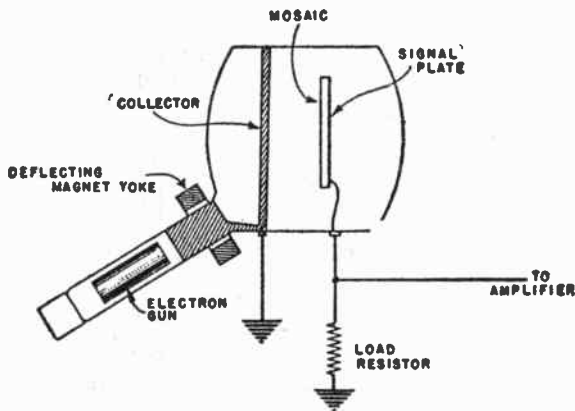

FIG. 4.—Circuit for Signal Current in the Iconoscope.

The mosaic is formed on one side of a thin sheet of insulation. On the other side is a conductive coating called the signal plate or signal electrode. The mosaic, the insulation, and the signal electrode form a condenser. These parts are shown by Fig. 4. Electrons emitted at the mosaic are drawn to the collector ring, which is a conductive coating around the inside of the tube. The varying electron flow due to variations of illumination on the mosaic passes through the load resistor, and changes of potential difference across this resistor correspond to changes of light and shade along lines being scanned by the beam. This varying voltage is the *video signal*. After amplification it is used to modulate the television carrier.

TELEVISION

Image Reproduction.—Fig. 5 shows a typical picture tube such as used in television receivers. It is a cathode-ray tube having a phosphor which produces white traces for black and white picture reproduction, or, in some systems of color television a phosphor producing blue, green, or red traces. The tube illustrated operates with magnetic deflection and magnetic focusing. Other picture tubes operate with electrostatic deflection and electrostatic focusing. A few have magnetic deflection and electrostatic focusing.

The electron beam in the picture tube is deflected horizontally and vertically in precisely the same manner illustrated for the camera tube by Fig. 3. At every instant of time the electron beams in all picture tubes affected by a given signal are at exactly the same relative position on their screens as is the camera tube beam on its mosaic. If the electron beam is of constant strength

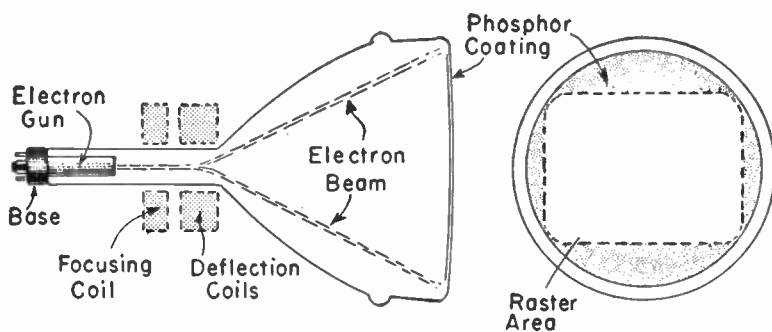

FIG. 5.—Television Picture Tube for Magnetic Deflection.

or intensity it traces a closely spaced series of horizontal luminous lines to form the *raster*. In order to form a picture the intensity of the electron beam is varied by the video signal. Then on each horizontal trace there are variations of light which correspond to and reproduce the variations in the original televised image.

In the video signal produced at the camera tube the higher voltages result from relatively dark areas in the image, while brighter areas cause a decrease of signal voltage. Such a signal is spoken of as *negative transmission*. Before this signal may be applied to the control grid of the picture tube the polarity must be inverted. The control grid must be made less negative to increase beam current and reproduce a bright area in the picture, and must be made more negative to reduce beam current for dark areas.

Television Signal.—The video signal or picture signal is applied as amplitude modulation to the carrier wave. After being demodulated by the video detector in the receiver the picture sig-

TELEVISION

nals for three horizontal lines might appear about as shown by Fig. 6. Between successive horizontal lines of the picture are blanking intervals in which occur the horizontal retraces.

The lowest signal voltage indicated in Fig. 6 is called the *white level*. This is a potential equal to 15% of the maximum signal potential, or one which is 15% above zero signal voltage. At this potential would be produced the brightest or whitest possible trace on the screen of the picture tube. The blackest areas in the reproduced picture result from zero current in the electron beam. The picture tube is operated in such manner that beam current is reduced to zero, or is blanked, when signal voltage rises to 75% of its maximum possible value. This signal potential is called the *black level*, as marked in Fig. 6. Intermediate grays are repro-

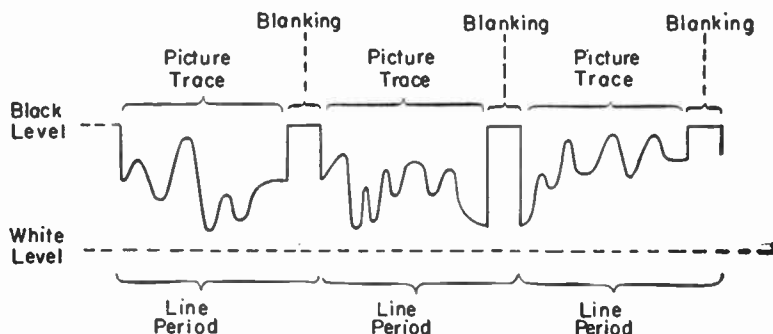

FIG. 6.—Horizontal Blanking Intervals Between Picture Signals.

duced as the signal potential varies between the white and black levels or potentials. During blanking intervals for horizontal retraces the signal potential reaches the black level and cuts off the beam so that no visible line is produced during the retrace.

Voltages or currents which deflect the electron beam are produced by sweep oscillators or deflection oscillators. These oscillators must be kept precisely in time with or precisely synchronized with the received signal. Otherwise the electron beam would not sweep across the screen during the period in which a picture line is being traced, and would not start the following line at the correct instant. There is one oscillator which controls the horizontal trace and retrace, and another oscillator which controls the vertical downward travel and upward retrace.

To time or synchronize the horizontal sweep oscillator, horizontal synchronizing pulses of voltage are added to the signal during each horizontal blanking interval. These horizontal "sync" pulses are shown by Fig. 7. The sync potential rises from the black

TELEVISION

level to maximum signal potential, or rises from 75% to 100% of signal potential. Since the electron beam remains cut off with any signal potential greater than 75% of maximum, these sync pulses do not show in the reproduced picture.

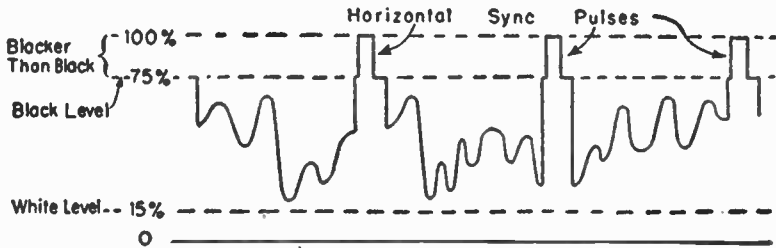

FIG. 7.—Horizontal Sync Pulses During Blanking Intervals.

It is necessary also to time or synchronize the vertical sweep oscillator. This is done by means of vertical sync pulses added to the signal during the vertical blanking intervals. At the top of Fig. 8 is shown how a vertical sync pulse might be added to the signal. At the left are shown signals for the last three horizontal lines and horizontal sync pulses in a field. Then comes the vertical blanking interval with the vertical sync pulse. This pulse, like

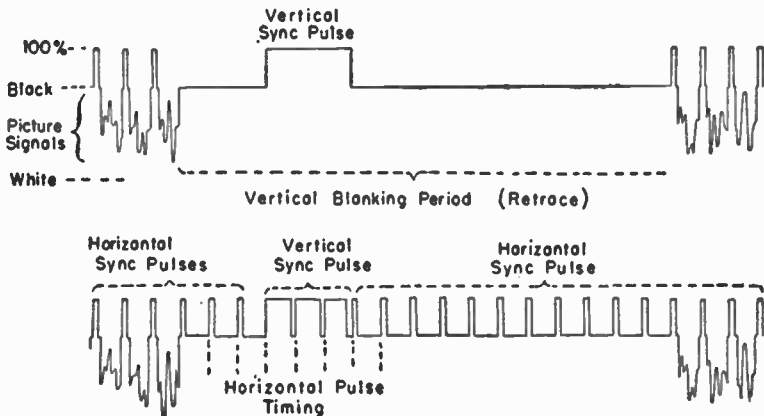

FIG. 8.—Vertical Sync Pulse During Vertical Blanking Period.

those for horizontal synchronization, is an increase of potential from the black level to maximum signal potential.

The horizontal sweep oscillator might get out of time with the picture lines during the rather long vertical blanking interval. To prevent this, the entire vertical blanking interval is filled with horizontal sync pulses as shown at the bottom of Fig. 8. The

TELEVISION

horizontal sweep oscillator is caused to go through one cycle of oscillation, and to deflect the electron beam horizontally, each time there is a rise of signal voltage through the sync range of potentials. To carry the horizontal sync through the long vertical sync pulse, this long pulse is broken up into three parts with a rise of voltage at the beginning of each line period.

This breaking up of the vertical sync pulse, and insertion of horizontal sync pulses throughout the vertical blanking interval, have no effect on the vertical sweep oscillator. The complete signal is applied to two filters, one leading to the horizontal sweep oscillator and the other to the vertical sweep oscillator. The filter for the vertical sweep oscillator passes only the long pulses which make up the three-line vertical sync pulse, and bypasses the much shorter horizontal pulses. The filter for the horizontal oscillator

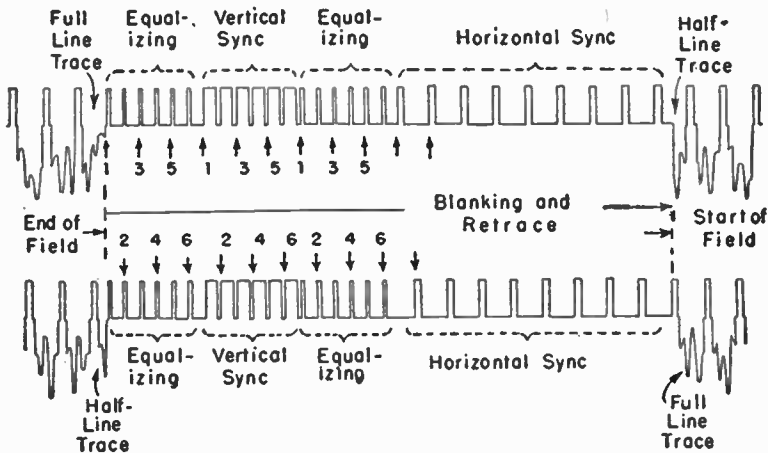

FIG. 9.—Principal Parts of a Television Receiver.

contains a condenser which is charged by each horizontal pulse, but which discharges so quickly that it is not affected by a pulse which continues as long as do the parts of the vertical pulse. Thus the horizontal oscillator is operated only by rising potential at the beginning or at the leading edge of a pulse, while the vertical oscillator is operated only by pulses which hold a high potential during a relatively long time.

The television signal still is not quite complete, because provision must be made to handle interlaced scanning. With this method of scanning, alternate fields commence with full-line traces while intervening fields commence with half-line traces. It must be possible for the vertical sweep oscillator to act on a full-line interval to start one field, and on a half-line interval to start the next field. This is accomplished by using equalizing pulses before

TELEVISION

and after the vertical sync pulse, as shown by Fig. 9, and by further breaking up the vertical pulse so that it consists of six parts.

In the upper portion of Fig. 9 the preceding field ends with a full line. The horizontal sweep oscillator continues to be timed by leading edges of equalizing pulses numbered 1, 3 and 5, then by leading edges 1, 3 and 5 in the "serrated" vertical pulse, and finally by leading edges 1, 3 and 5 of equalizing pulses which follow the vertical sync pulse. At the beginning of the next vertical blanking interval, as shown down below, the horizontal oscillator is timed by leading edges numbered 2, 4 and 6 after the preceding field ends on a half line.

The complete or composite television signal shown by Fig. 9 carries all the picture signals for successive lines, all the horizontal

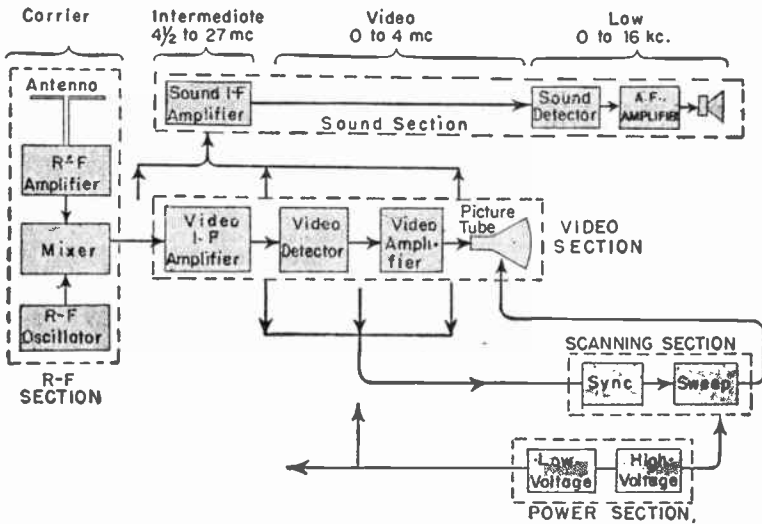

FIG. 10.—Signal Paths and Operating Frequencies in a Receiver.

sync pulses which keep the horizontal sweep oscillator timed, and the vertical sync pulses for timing the vertical oscillator. This graph represents the modulation applied to the carrier at the television transmitter, and recovered from the carrier in the receiver.

The television signal for pictures and synchronization is transmitted as amplitude modulation. The accompanying speech, music, and other sound is transmitted and received as an entirely separate frequency-modulated signal. Principles of frequency modulation are explained under *Receiver, Frequency Modulated*.

Television Receiver.—The television receiver is a superheterodyne type whose fundamental principles are explained under *Receiver, Superheterodyne*. The principal parts as used for television are shown as a block diagram in Fig. 10. Carrier signals

TELEVISION

from the antenna are applied to the r-f amplifier which may provide some amplification or gain, but whose chief purpose is prevention of image interference and of radiation from the r-f oscillator. From the r-f amplifier the signal goes to the mixer. To the mixer are applied also such frequencies from the r-f oscillator as produce beats at the desired intermediate frequency. Television carrier frequencies in the very-high frequency band (channels 2 to 6 and 7 to 13) extend from 54 to 216 megacycles. In the ultra-high frequency band the range is from about 500 to 900 megacycles.

Intermediate frequencies in television receivers most often are between 20 and 27 megacycles, although some are in the range above 30 megacycles, and for one style of sound reproduction (intercarrier beat) the intermediate is 4.5 megacycles. After the video intermediate frequency is demodulated by the video detector the remaining video frequency applied to the grid-cathode circuit of the picture tube usually has a maximum value of about 4 megacycles. In the scanning section we have the field frequency of 60 cycles per second and the line frequency of 15,750 cycles per second.

The r-f oscillator for television usually is a separate tube, or is one section of a twin tube, rather than being combined with the mixer to form a converter tube as used for superheterodyne sound receivers. The r-f oscillator frequency is higher than the carrier frequency, with the intermediate frequency as the difference.

The r-f oscillator frequency beats with the video carrier frequency of the television signal to produce an amplitude-modulated intermediate frequency which carries the picture signals and all the sync pulses. The same oscillator frequency beats with the television sound carrier frequency to produce a sound intermediate which is frequency-modulated with the sound signal. The sound carrier frequency in any one channel always is exactly 4.5 megacycles higher than the video carrier frequency in the same channel.

The sound section of the receiver begins with a sound i-f amplifier of one or more stages taking the sound intermediate frequency either from the mixer output, or from some point along the video i-f amplifier, or from the output of the video amplifier. The takeoff point for sound varies in different receivers. The sound detector or demodulator may be either a discriminator or else a ratio detector. The audio-frequency amplifier and loud speaker are like those used in sound receivers of any type.

The video i-f amplifier takes the amplitude-modulated video and sync signal from the mixer, amplifies this signal, and applies it to the video detector. The video detector is a diode type, sometimes a tube and again a crystal, as used in nearly all types of amplitude-modulation sound receivers. The video amplifier, of one or more stages, is a high-frequency broad-band type. It must provide gain at frequencies all the way from 60 cycles to 4 or more

TELEVISION

megacycles per second in the larger receivers, and up to about 3 megacycles in small ones.

The scanning section is the portion of the television receiver in which are produced the currents or voltages that cause horizontal and vertical deflection of the electron beam in the picture tube. In the first part of this section, marked *Sync* in Fig. 10, the various sync pulses of the composite signal are used to produce voltages of suitable form for timing the sweep oscillators. The sync pulses applied to this section may be taken from just ahead of the video detector, or at the input to the video amplifier, or at the output of the video amplifier.

In the sweep portion of the scanning section are the vertical and horizontal sweep oscillators, also amplifiers which follow the oscillators in most receivers, and sometimes special automatic frequency control circuits which help keep the horizontal oscillator correctly synchronized with the received signal.

In the low-voltage portion of the power section are produced filament or heater currents for all tubes, also voltages and currents for plates, screens, and biasing of all amplifier tubes and tubes working under generally similar conditions, and for some electrodes of the picture tube. In the high-voltage section are produced potentials ranging from about 5,000 to 15,000 volts for anodes and deflection plates of picture tubes.

Principles employed in television receivers are the same as in sound receivers from the r-f section through the entire sound section to the loud speaker, and through the video i-f amplifier and video detector. Sections beyond the video detector have no counterparts in sound receivers. These sections and the travel of television signals through them are shown by Fig. 11.

At the output of the video detector, *A*, we have the composite television signal shown earlier by Fig. 9. This signal goes through the video amplifier where, in a single stage, the signal polarity is inverted and comes out as at *B*. Any signal voltage applied to the control grid of a tube having a grid and plate appears in the plate circuit with inverted polarity; positive changes become negative changes and negative changes become positive changes. The control grid of the picture tube is so biased that the negative sync pulses are cut off and only the picture and blanking potentials act to vary the beam current. The sync pulses drive the grid so far negative as not to affect the beam or the picture.

With the particular arrangement of circuits shown by Fig. 11 the detector output signal goes through the sync takeoff circuit and becomes the input for the sync amplifier at *C*. This amplifier inverts the signal, as shown at *D*. This inverted signal is the input for the sync separator which is operated with grid, plate, and screen voltages which cause cutoff of all picture signals. In the output of the sync separator, at *E*, we have then only the horizontal and vertical sync pulses.

TELEVISION

The two kinds of pulses are fed to the filters mentioned earlier, at whose outputs we have voltages corresponding to the long vertical pulses, *F*, and the short horizontal pulses and all the leading edges as represented at *G*. The voltages occurring at vertical intervals are applied to the vertical sweep oscillator, and those occurring at horizontal intervals are applied to the horizontal sweep oscillator. The vertical oscillator and associated circuits produce the relatively long sawtooth voltage waves *H* which are the input for the vertical sweep amplifier. In the output of this amplifier are similarly shaped sawtooth currents or voltages which deflect

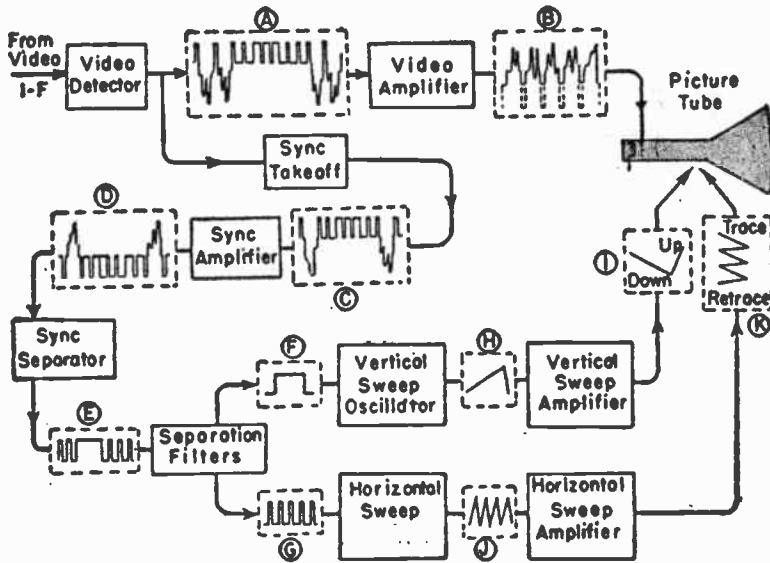

FIG. 11.—Signal Waveforms Between Video Detector and Picture Tube.

the picture tube beam downward during the fields and provide the vertical retraces.

The horizontal sweep oscillator is timed by pulses at *G* and produces in its output the closely spaced sawtooth voltages at *J*, which are the input for the horizontal sweep amplifier. The output of this amplifier consists of sawtooth currents or voltages, *K*, which deflect the picture tube beam for horizontal line traces and provide the horizontal retraces.

Television Channels.—The fact that picture signals or video signals require frequencies as high as 4 megacycles makes it necessary to use wide frequency channels for television transmission. With the method of amplitude modulation used for standard sound broadcasting, the range of frequencies extends above and below

TELEVISION

the carrier by an amount equal to the maximum modulating frequency. For modulation up to 4 megacycles this would require a band 8 megacycles wide. To this would have to be added enough range for f-m sound transmission and still more for prevention of interference with adjoining channels, making a total channel width of about 9.5 megacycles.

Television transmission, including the accompanying sound, is carried out in channels only 6 megacycles wide by employing *vestigial sideband* transmission as illustrated at the top of Fig. 12. The video carrier frequency is not at the center of the channel, but is 1.25 megacycles above the lowest frequency limit. The up-

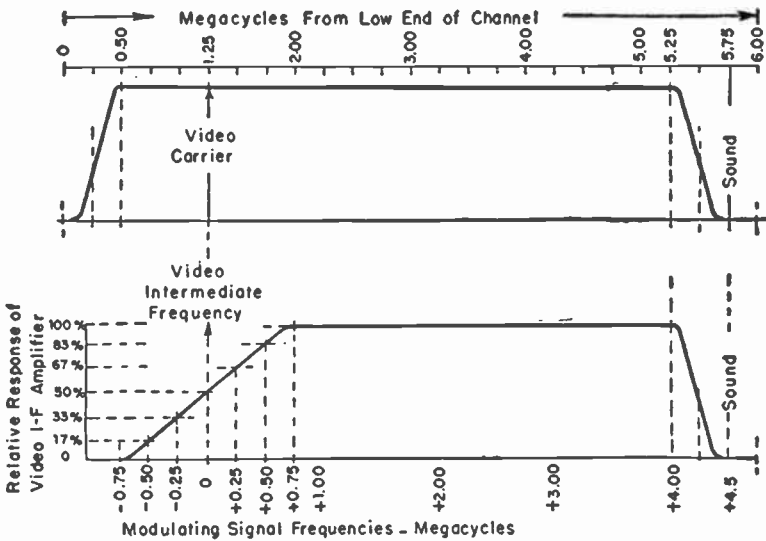

FIG. 12.—Distribution of Transmitted Frequencies and Frequency Response of the Video I-f Amplifier.

per sideband of modulation extends to 4.0 megacycles above the video carrier, or to 5.25 megacycles above the low end of the channel. But only part of the lower sideband is transmitted, only the portion extending from the video carrier frequency down to 0.50 megacycle above the low end.

The carrier frequency for accompanying sound is 4.5 megacycles higher than the video carrier, which brings the sound carrier to 5.75 megacycles above the low end of the channel, and 0.25 megacycle below the high end. Deviation corresponding to 100% modulation with television sound is only 25 kilocycles each way from the sound carrier frequency, which is a total deviation

TELEVISION

of only 50 kilocycles or 0.05 megacycle. Consequently, with the sound carrier 0.25 megacycle below the high end of the channel and 0.50 megacycle above the highest video modulation there is ample protection against interference from sound signals.

With vestigial sideband transmission some modulation frequencies are transmitted in both upper and lower sidebands, while others are transmitted in only the upper sideband. All modulation frequencies extending 0.75 megacycle from the video carrier are transmitted in both bands, or are transmitted with double strength. All modulation frequencies extending between 0.75 and 4.00 megacycles from the video carrier frequency are transmitted only in the upper sideband or with only single strength.

The double strength of the doubly transmitted frequencies is reduced to single strength in the television receiver. This is accomplished by making the gain or amplification of the video i-f amplifier, with respect to frequency, as shown at the bottom of Fig. 12. The video intermediate frequency for this amplifier is derived from the video carrier frequency. Gain at the video intermediate frequency is made 50% of maximum, is down to zero at 0.75 megacycle on one side of this intermediate frequency, and rises to 100% at 0.75 megacycle on the other side.

The sum of the gains for the same modulation frequency on both sides of the video intermediate always is 100%. For example, at 0.25 megacycle below the video intermediate the gain is 33%, at 0.25 megacycle above the intermediate the gain is 67%, so the total gain at this frequency is 100%. Every other modulation frequency as far as 0.75 megacycle from the video intermediate receives total amplification of 100%. All higher modulation frequencies are transmitted and received in only single strength, and in the video i-f amplifier of the receiver the gain for all these higher frequencies is 100%. This method of equalizing the strength of the received signal is called *receiver attenuation*.

The sound carrier always is at a frequency 4.5 megacycles higher than that of the video carrier. But when the r-f oscillator frequency beats with these carrier frequencies to produce the video and sound intermediate frequencies there is reversal of the frequency relation. The sound intermediate frequency is 4.5 megacycles lower than the video intermediate frequency.

Fig. 13 is a typical curve showing the relation between gain and frequency of a video i-f amplifier. For illustration in this example the video intermediate frequency has been chosen as 26.4 mc (megacycles). Note that the gain at this frequency is about 50% of maximum. The sound intermediate frequency for the same channel is 21.9 mc, which is exactly 4.5 mc lower than the video intermediate frequency. Gain at the sound intermediate is reduced nearly to zero, because sound signals should not go through the video i-f amplifier to the picture tube, but should be taken off earlier and applied to the sound section.

TELEVISION

The adjacent sound frequency of 27.9 mc is the beat frequency of the sound carrier frequency in an adjoining channel. This adjacent sound frequency is exactly 6.0 mc above the 21.9 mc accompanying sound frequency, because the width of a television channel is 6.0 mc and similar frequencies in adjoining channels must differ by 6.0 mc.

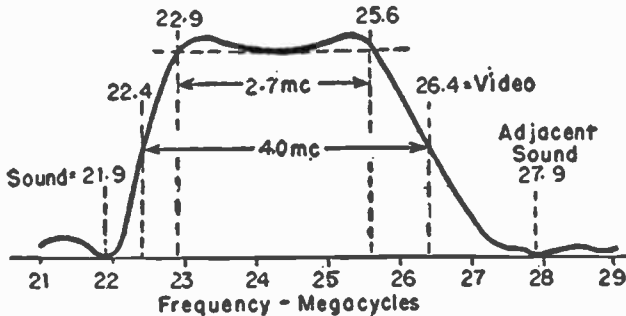

FIG. 13.—Frequency Response of Video I-f Amplifier.

The accompanying table lists frequency limits, also video carrier and sound carrier frequencies for the very-high frequency channels numbered 1 to 13. Although frequencies are listed for channel 1, this channel no longer is used for television transmission, but may be tunable in some of the older receivers.

TELEVISION CHANNEL AND CARRIER FREQUENCIES

Channel Number	Channel Limits, megacycles	Video Carrier, megacycles	Sound Carrier, megacycles
1	44 to 50	45.25	49.75
2	54 to 60	55.25	59.75
3	60 to 66	61.25	65.75
4	66 to 72	67.25	71.75
5	76 to 82	77.25	81.75
6	82 to 88	83.25	87.75
7	174 to 180	175.25	179.75
8	180 to 186	181.25	185.75
9	186 to 192	187.25	191.75
10	192 to 198	193.25	197.75
11	198 to 204	199.25	203.75
12	204 to 210	205.25	209.75
13	210 to 216	211.25	215.75

TELEVISION

Television Antennas.—Within a few miles of a transmitter, and where conditions are generally favorable for reception, it is possible to pick up television signals with an indoor antenna or with an antenna built into the receiver. At greater distances and where unfavorable conditions must be overcome, better reception is had with an outdoor antenna erected as high as practicable and as far from surrounding objects as possible. Television carrier waves are of such high frequency that they behave in much the same manner as light waves, and the more nearly there is an unobstructed line of sight between transmitter and receiver antennas, the stronger and clearer will be the received signals.

The simplest television antenna is the half-wave dipole illustrated by Fig. 14. The dipole consists of two straight metallic

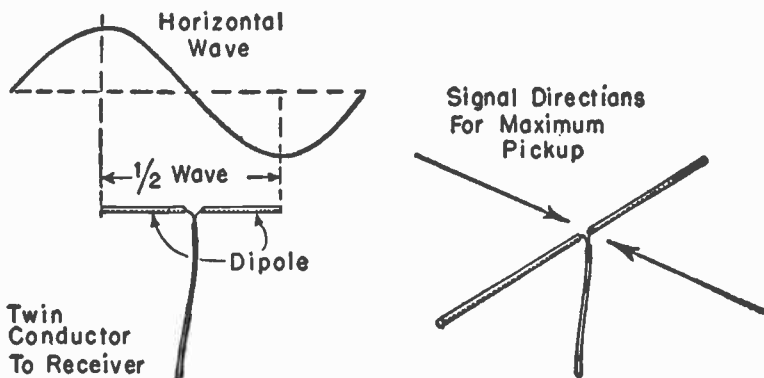

FIG. 14.—Half-wave Dipole Antenna.

conductors, usually tubular, supported in line with each other. The overall length of the dipole is approximately one-half wavelength of the carrier to be received in maximum strength. With such a length, one end of the dipole is affected by maximum positive polarity of the horizontal electrostatic wave, while the other end is affected by maximum negative polarity. Maximum current is induced in the antenna and the line going to the receiver. Because of capacity effects the actual length of the dipole is made about 5% less than that of a half-wavelength at the frequency for which the antenna is tuned.

A dipole antenna has maximum pickup for signal waves approaching it at right angles to the length of the dipole, as shown at the right in Fig. 14, and has minimum pickup for signals traveling in line with the antenna conductors. The impedance of a plain half-wave dipole at the center gap, the takeoff point, is 72 to 75 ohms at the frequency for which the antenna is cut. For

TELEVISION

maximum transfer of signal power to the receiver it is necessary to use a transmission line having a characteristic impedance of 75 ohms, or to use some special matching device when the line impedance is other than 75 ohms.

Fig. 15 shows a reflector used with a half-wave dipole antenna. The reflector is a continuous straight conductor, usually tubing, supported $\frac{1}{4}$ wavelength or slightly less than this from the active dipole. The reflector is not connected electrically to the active dipole, the transmission line, or anything else. The reflector greatly reduces pickup of signals approaching from its side of the antenna, and at the same time causes a decided increase of pickup from the opposite direction.

Fig. 16 shows a half-wave folded dipole antenna. This type consists of a loop of metallic tubing or other conductor supported

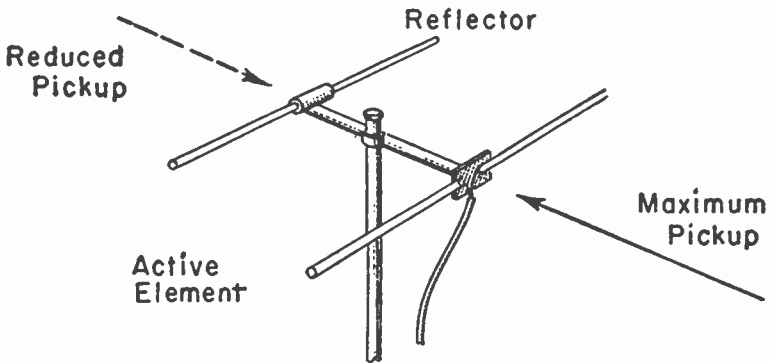

FIG. 15.—Half-wave Dipole with Reflector.

with its sides in a vertical plane. There is a gap midway of one side, and to the ends of the tubing are connected the ends of the transmission line going to the receiver. The impedance of the folded dipole is 300 ohms at the wavelength or frequency for which the antenna is cut, and for maximum signal transfer it is necessary to use a line having a characteristic impedance of 300 ohms or to use some matching device.

The response of a plain dipole falls off quite rapidly at frequencies or wavelengths both greater and less than those for which its length is chosen. The response of the folded dipole is much broader, and it will receive with fair uniformity all signals in either the band including channels 2 to 6 or the band including channels 7 through 13.

At the right in Fig. 16 is an array consisting of one folded dipole cut for the middle frequency in the low-band channels and a second folded dipole cut for the middle frequency in the high-

TELEVISION

band channels. Here the relatively long low-band element acts as a reflector for the high-band element, while the straight reflector back of the array serves for the low-band element.

There are a great many other types and modifications in design

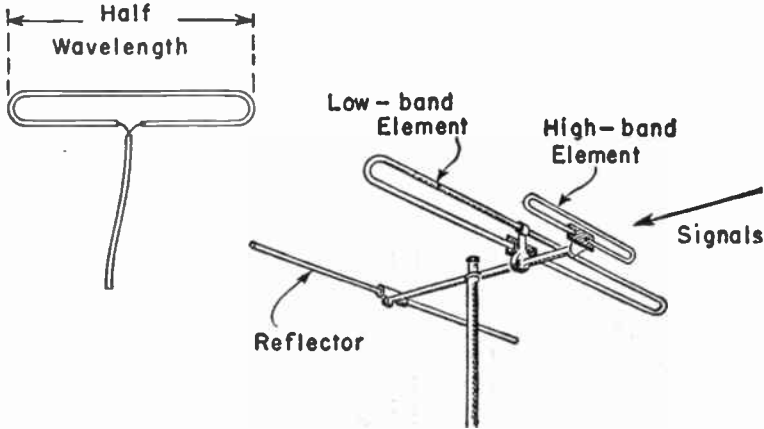

FIG. 16.—Folded Dipole Antenna.

of television antennas. The objects of the variations include obtaining greater signal strength for desired signals, reduction of signal strength from high-frequency transmissions other than television, and reduction of interference due to electrical machines and apparatus of all kinds. In localities far from transmitters

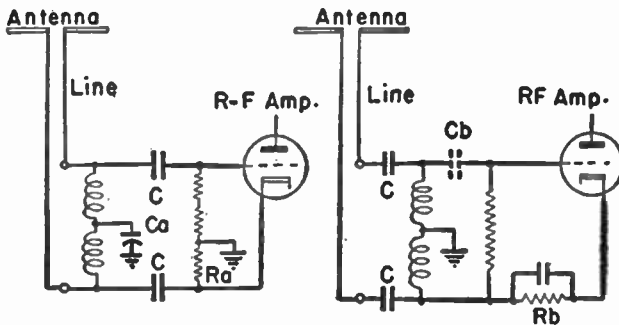

FIG. 17.—Untuned Input Circuits for 300-ohm Lines.

it is necessary to use elaborate antenna arrays for satisfactory reception.

Television R-f Sections.—Fig. 17 shows typical untuned input circuits for coupling a 300-ohm transmission line to the r-f

TELEVISION

amplifier tube. The line is connected across coils or inductors whose average impedance at received frequencies is around 300 ohms, with a center connection to ground. Isolating condensers are shown at *C* and *Cb*. One side of the line and impedance coils connects to the amplifier control grid, while the other side connects to the cathode. Resistors *Ra* and *Rb* provide cathode bias for the tube. In other input circuits the coupling between antenna and amplifier is individually tuned for each channel to be received.

The coupling between r-f amplifier plate and mixer control grid always is tuned for the channel to be received, and the r-f oscillator always is tuned for each channel in order to provide the same video and sound intermediate frequencies on all channels.

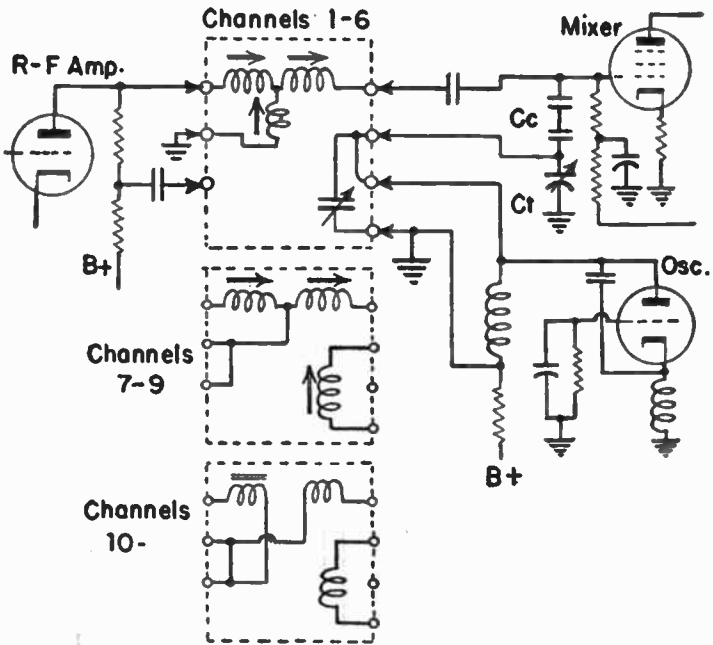

FIG. 18.—Channel Tuning with Rotary Switch or Rotary Turret.

Fig. 18 shows one method of channel tuning. The arrowheads represent fixed contacts in the tube circuits. Within the broken-line squares are shown coil assemblies moved into the tube circuits for various channels by mounting these assemblies on a drum or turret rotated by the channel selector knob or pointer. There would be an individual assembly for each channel, with inductances and capacitances for resonance at the channel frequency

TELEVISION

band. The three assemblies shown by the diagram illustrate differences in design required for the various ranges of frequency.

In other types of tuners the coil assemblies may be stationary, quite often being mounted on or close to the channel selector switch. Then the switch contacts are rotated to complete connections with the tube circuits for each channel.

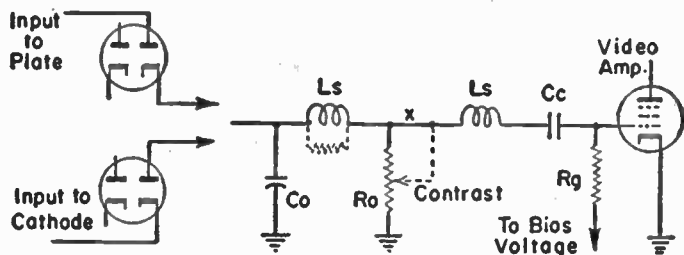

FIG. 19.—Typical Connections for Video Detectors.

In tuned high-frequency circuits of television receivers there always are coils or inductors, but seldom any tuning condensers. Capacity required for tuning to resonance is in the internal capacity of the tubes and in distributed or stray capacity of coils, wiring, and other circuit parts.

Video Detector and Amplifier.—The video detector which follows the video i-f amplifier nearly always is a diode, and usually is one section of a twin-diode tube whose other section is employed for automatic gain control or some other purpose in the receiver.

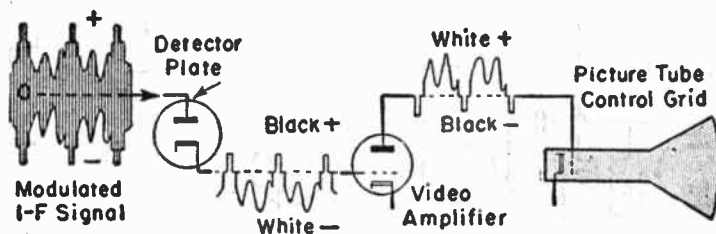

FIG. 20.—Signal Polarities with a Single Video Amplifier.

As shown by Fig. 19 the input from the video i-f amplifier may be to either the plate or the cathode of the detector. At L_s are series peaking coils whose purpose is to improve the gain at the higher video frequencies. Shunt peaking coils, for the same purpose, may be in series with the detector load resistor R_o .

When signal input is to the detector plate, and when there is

TELEVISION

but one video amplifier tube between detector and picture tube grid, the signal polarities are as shown by Fig. 20. The detector retains the positive modulation of the i-f signal, in which the white level is negative. The amplifier inverts the signal polarity so that white is positive and black is negative at the picture tube grid. This is necessary for correct reproduction of picture shadings.

Fig. 21 shows signal polarities when input is to the detector grid and there are two video amplifiers. Here the negative side of the

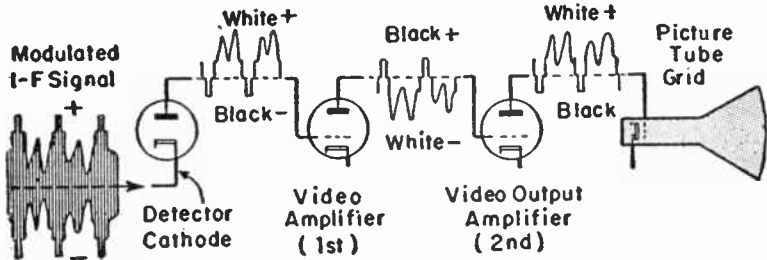

FIG. 21.—Signal Polarities with Two Video Amplifiers.

i-f modulation is retained, in which the white level is positive. There are inversions in each amplifier, and a positive white signal at the picture tube grid. If the video signal is applied to the picture tube cathode the white level must be negative and the black level positive. With any number of video amplifiers, and with the signal applied to either the control grid or the cathode of the pic-

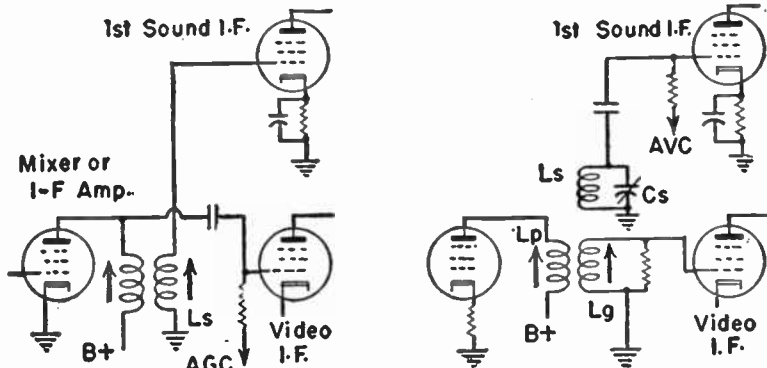

FIG. 22.—Sound Takeoff Couplings.

ture tube, i-f input to the detector may be such as causes correct polarity of the signal at the picture tube.

Sound Systems.—In some television receivers the sound intermediate frequency is taken from the output of the mixer or from one of the i-f amplifiers with couplings such as shown by

TELEVISION

Fig. 22, or by some equivalent arrangement. This sound intermediate frequency, which results from beating of the carrier and r-f oscillator frequencies, then is carried through the sound i-f amplifier to the demodulator or detector.

Other receivers make use of what is called the *intercarrier sound* system in which the path of sound signals is as shown by Fig. 23. Both the video and sound intermediate frequencies pass all the way through the video i-f amplifier to the video detector. This detector acts as a mixer for the two intermediate frequencies, and in the detector output is a beat frequency of 4.5 mc—the difference between video and sound intermediates. This 4.5-mc beat frequency is frequency-modulated with the sound signal. It passes through the sound i-f amplifier, working at 4.5 mc center frequency, and to the demodulator.

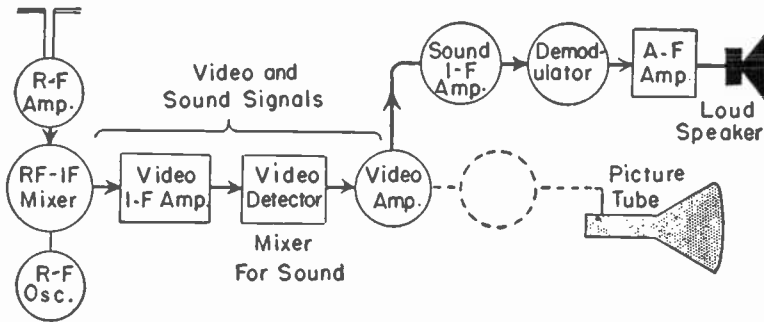

FIG. 23.—Path of Signal in Intercarrier Sound System.

Picture Tube Input.—In order that lights and shadows in the reproduced picture may have the same relations as in the original scene, the electron beam must be cut off at the black level of the signal. In the d-c signal output of the video detector this black level remains at a constant potential. But when the video signal passes through a coupling capacitor anywhere between detector and picture tube the d-c component disappears and the signal becomes an alternating voltage. In this a-c signal the black level varies in potential between pictures which are of generally light tone and those of generally dark tone. To restore the d-c component the control grid bias of the picture tube must be automatically varied to suit the picture.

D-c restoration or reinsertion may be accomplished with grid leak-condenser biasing of the video amplifier preceding the picture tube, and direct conductive connection from amplifier plate to picture tube grid. A more usual method of d-c restoration is by means of a diode connected into the picture tube grid-cathode

TELEVISION

circuit as shown by Fig. 24, or some equivalent arrangement. The diode is connected to the amplifier load resistor R_o through condenser C_m and resistor R_m , and also across resistor R_b which, with resistor R_a , provides biasing potential for the picture tube. The bias is made less negative by light toned pictures and more negative by those of dark tone.

Picture tube bias is varied also by the *brightness control*. This is an adjustable potentiometer in the picture tube grid-cathode circuit. It is adjusted by the operator of the receiver. *Contrast controls* in television receivers really are controls for gain or amplification in the video i-f amplifier, the video amplifier stages, or both. Contrast controls for pictures act like volume controls for sound, and operate on the same principles used for volume control. Contrast is varied by the operator of the receiver, always

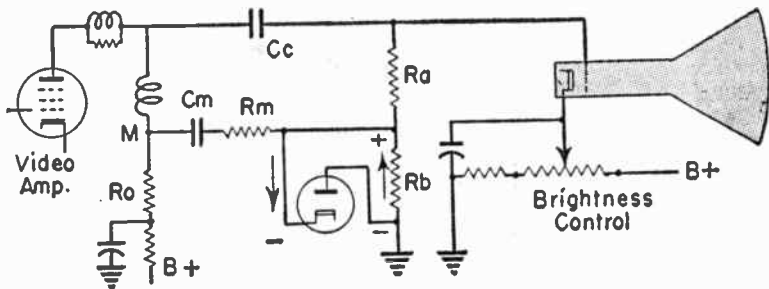

FIG. 24.—A Diode Used for Restoration of the D-c Component.

in connection with the brightness control, to allow a satisfactory combination of shading and overall brightness in the reproduced picture.

Sweep Section.—As explained earlier the sync pulses are separated from the composite signal and put through the sync section of the receiver for amplification and shaping. These separated sync pulses are shown at the top of Fig. 25, as they are applied to the horizontal and vertical filters. In the output of the horizontal filter are sharply peaked voltage pulses. The pulses indicated by arrows act on the horizontal oscillator to cause cycles of oscillation. In the output of the vertical filter there is a rising voltage for each vertical sync pulse in the signal. When this voltage rises to the value indicated by the broken line it causes the vertical oscillator to go through one cycle of oscillation.

The two types of sweep oscillators in general use are the blocking oscillator and the multivibrator. Elementary principles of both types are explained under *Oscillator, Relaxation*. Circuit constants are such as to make the natural periods of these oscillators

TELEVISION

approximately 60 cycles per second in the vertical system and approximately 15,750 cycles per second in the horizontal system. Precise adjustment of oscillation frequency is provided by vertical and horizontal *hold controls*. In most circuits these controls are adjustable grid leaks or grid resistors on the oscillators.

Hold controls are adjusted to make the periods of oscillation just a little longer than the periods between horizontal and vertical sync pulses. Then, when voltages resulting from the sync pulses are applied to the oscillators, each cycle of oscillation is

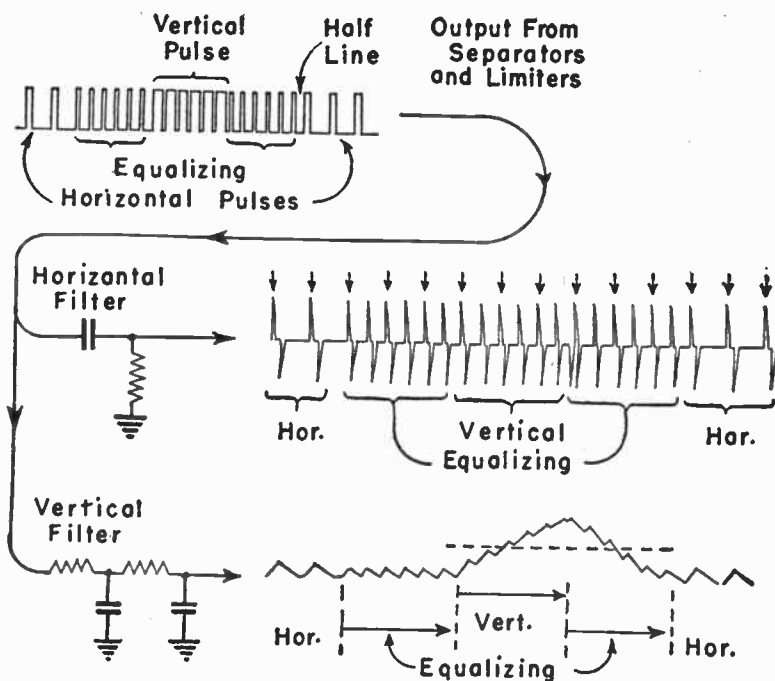

FIG. 25.—Sync Pulses Are Separated by Vertical and Horizontal Filters.

forced to begin at the instant of the leading edge of the pulse voltage. Thus the sweep oscillators are synchronized with the pulses in the received signal.

Fig. 26 shows a typical circuit for a blocking oscillator with a hold control. During the non-conductive interval of the oscillator there is charging of condenser C_s from the B-supply, through resistor R_s , the height or width control, resistor R_t , and the ground return. When the oscillator becomes conductive, with its grid positive, condenser C_s discharges very rapidly through the tube. Thus the charge and discharge of condenser C_s becomes a saw-

TELEVISION

tooth voltage wave which eventually causes tracing and retracing of the electron beam in the picture tube.

The maximum voltage to which the sawtooth condenser is charged depends on the setting of the height or width control resistor. The greater the charge voltage the farther the electron beam will be deflected horizontally or vertically in the picture

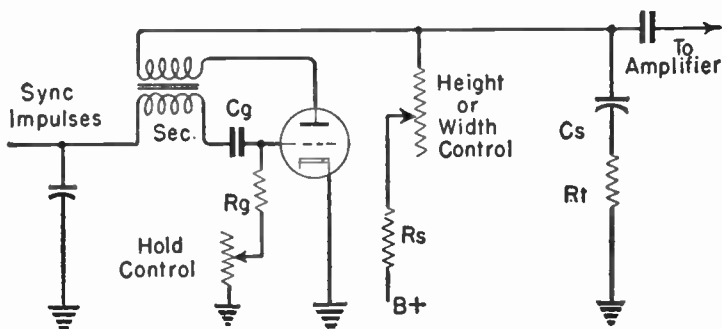

FIG. 26.—Blocking Oscillator Used in Sweep Circuits.

tube. Thus the control acts to vary the picture height if it is in the vertical deflection system, or to vary the width if the control is in the horizontal system.

Fig. 27 shows a typical multivibrator oscillator circuit as used in television receivers. This modification of the elementary multivibrator is called the Potter sweep circuit.

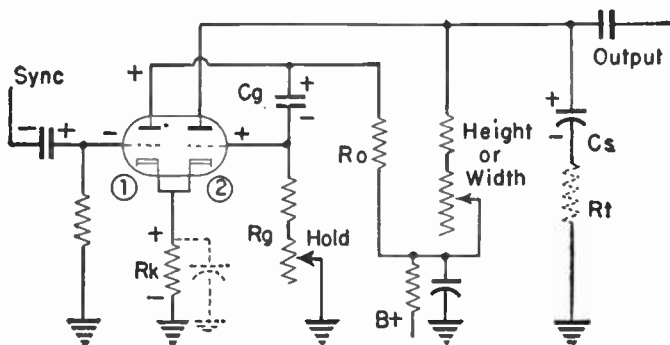

FIG. 27.—Multivibrator Oscillator for Television Sweep Circuits.

Because the rather high horizontal sweep frequency may be disturbed by electrical interference, many television receivers employ automatic frequency control for the horizontal sweep oscillator.

TELEVISION

All such controls operate by combining a voltage obtained from the oscillator or from some following part of the sweep circuit with another voltage obtained from the sync pulses of the received signal. This combination results in a correction voltage which is applied to the oscillator to either reduce or increase the oscillation frequency and bring it back into synchronization when there is any tendency to vary.

Fig. 28 is a complete sweep system from horizontal oscillator to deflection coils in the yoke on a magnetic deflection tube. The *dampner tube* provides a load which prevents oscillation at the natural frequency of inductances and capacities in the yoke circuit. The *linearity control* is used to insure correct distribution of picture elements or to insure that there is a constant and uniform rate of deflection all the way across the picture tube screen. Addi-

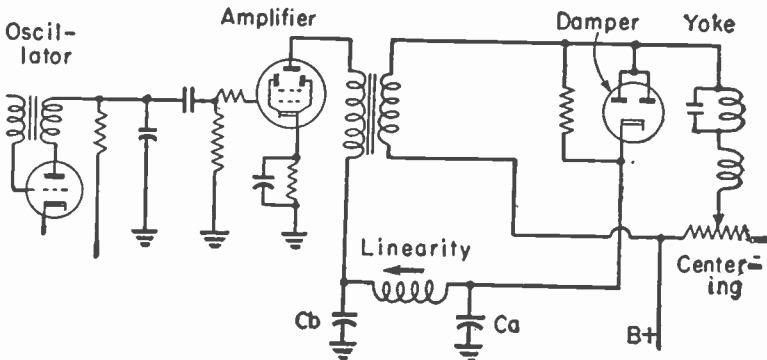

FIG. 28.—Sweep Circuits for Magnetic Deflection.

tional linearity control may be provided on the sweep amplifier cathode bias circuit. The purpose of the *centering control* is to permit flow of a steady direct current in the deflection coils as may be required to center the deflection and the picture on the screen.

Vertical deflection systems do not include the damper tube nor the linearity control of Fig. 28, but may have a linearity control on the sweep amplifier. Ordinarily there is no automatic frequency control for the vertical oscillator. The relatively low 60-cycle vertical frequency allows deflection systems which are simpler than those employed for horizontal deflection.

Television Receiver Controls.—Controls for use by the operator of a television receiver include those for brightness and for contrast, as previously mentioned, and often include controls for both horizontal and vertical hold. Incorrect adjustment of the vertical hold control causes the picture or test pattern to move up and down on the screen more or less rapidly, or causes the picture

TELEVISION

to be divided horizontally, with the bottom portion above the top portion. Wrong adjustment of the horizontal hold control causes complete breakup of the picture or test pattern, with effects such as pictured by Fig. 29.

Another control for the operator is the channel selector for tuning the receiver to frequencies of the various channels. The selector most often is a rotary switch or a rotary turret for connecting into the circuits of r-f amplifier, mixer, and r-f oscillator the inductances and capacitances which resonate at the carrier frequencies to be received. In some receivers there is continuous tuning through all the carrier frequencies from lowest to highest, and in still others there is continuous tuning through each of the

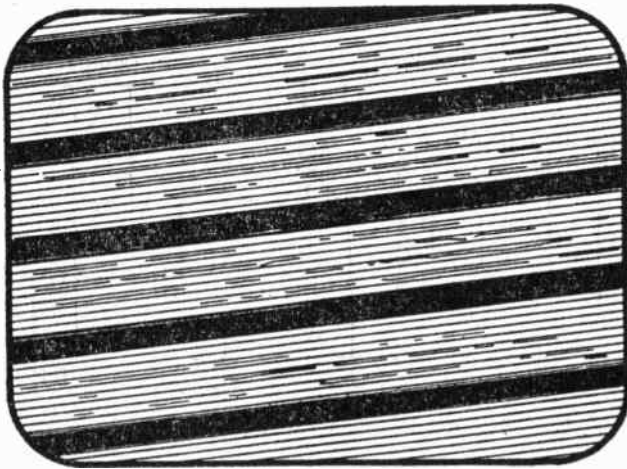

FIG. 29.—Effect of Wrong Adjustment of Horizontal Hold Control.

frequency bands, with a switchover when going from one band to the other.

There is a tendency for the frequency of r-f oscillators to undergo slight variation or to drift as the tubes and other circuit elements warm up each time the receiver is turned on, and there is gradual drift also as tubes, resistors, capacitors, and inductors undergo changes due to aging and long use. This oscillator drift may be compensated for by an operators' adjustment usually called a *fine tuning control*. This control commonly is an adjustable condenser which will make small changes of r-f oscillator frequency.

A height control may be called a vertical size control, and a width control a horizontal size control. These always are service adjustments for regulating the voltage to which the sawtooth

TELEVISION

condenser may charge. The condenser voltage changes are applied to the control grid of the sweep amplifier, and they determine the extent of plate current changes which produce sawtooth currents for magnetic deflection or sawtooth voltages for electrostatic deflection.

Fig. 30 shows how sawtooth voltages deflect the electron beam when applied to the plates in a tube designed for electrostatic deflection.

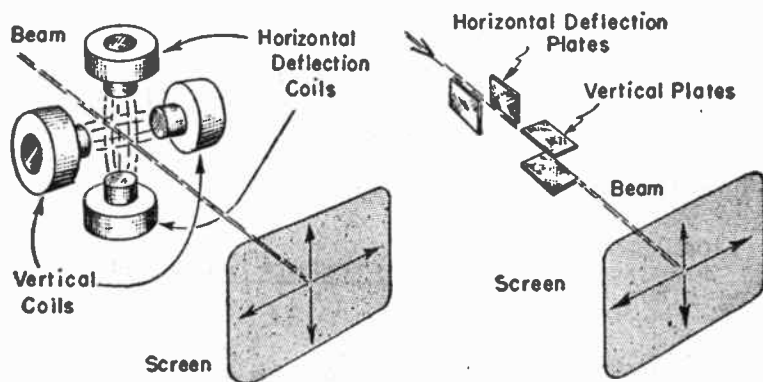

FIG. 30.—Principles of Electrostatic Deflection (left) and of Magnetic Deflection (right).

deflection, and how sawtooth currents cause their magnetic fields to deflect the beam in a picture tube designed for magnetic deflection.

Height and width controls are independent of each other. Either or both may be incorrectly set. Fig 31 shows at the left the effect

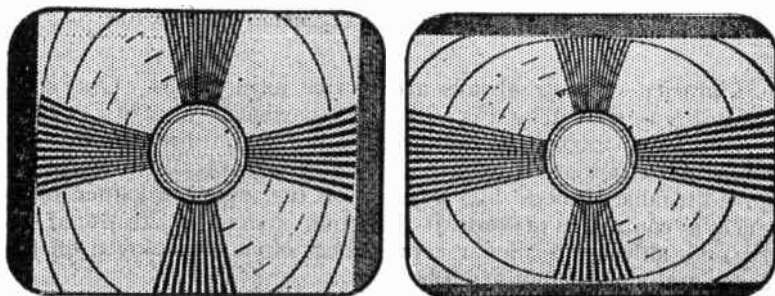

FIG. 31.—Effects of Wrong Adjustment of Height and Width Controls.

on a test pattern of excessive height and insufficient width, and at the right shows the effect of too little height and excessive width.

In many receivers there are *drive controls* which regulate the amplitude of sawtooth voltage applied to the control grid of the

TELEVISION

sweep amplifier, either independently of, or else in addition to, the effect of charge voltage on the sawtooth condenser. One type of drive control is shown by Fig. 32. Condenser C_g and the adjustable drive control condenser are in series with each other and in parallel with the sawtooth condenser C_s . The amplifier grid is connected to a point between C_g and the drive control unit.

The fraction of the sawtooth voltage applied to the amplifier grid is the ratio of capacitive reactance in the adjustable condenser to reactance of condenser C_g . These two units act as a capacitive voltage divider. Lessening the capacitance of the control condenser increases its reactance and applies a greater sawtooth voltage to the amplifier. Since a drive control varies grid voltage and plate current of the sweep amplifier, this control affects height or width of the picture. Drive controls and size controls must be adjusted at the same time; each affects the other.

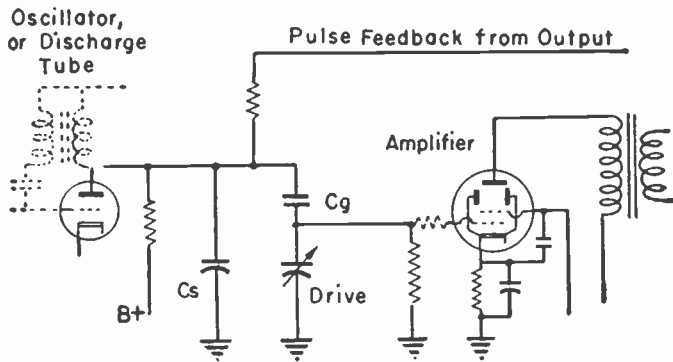

FIG. 32.—A Drive Control in the Amplifier Grid Circuit.

Linearity controls always are service adjustments. One such control was shown by Fig. 28. That particular linearity control stretches or contracts the picture in a horizontal direction, having maximum effect at the center. Linearity controls often consist of an adjustable cathode bias resistor on the sweep amplifier tube. Such a control in a vertical deflection system is illustrated by Fig. 33, although a similar arrangement often is employed on the horizontal sweep amplifier tube.

This type of linearity control causes the amplifier to operate on different portions of its grid-voltage plate-current curve, moving the operating range to where there is either more or less curvature. This variation of the amplifier operation compensates for non-uniform charging of the sawtooth condenser and resulting curvature in a graph of charging voltage. The purpose of the adjustment is to work the amplifier on a curve which is opposite to the

TELEVISION

charging curve of the condenser, and thus to overcome the effects of the non-uniform charging rate. This grid bias control for linearity affects chiefly the left-hand side of the picture or pattern when the control is on a horizontal amplifier, and the top of the picture or pattern when the control is on the vertical amplifier.

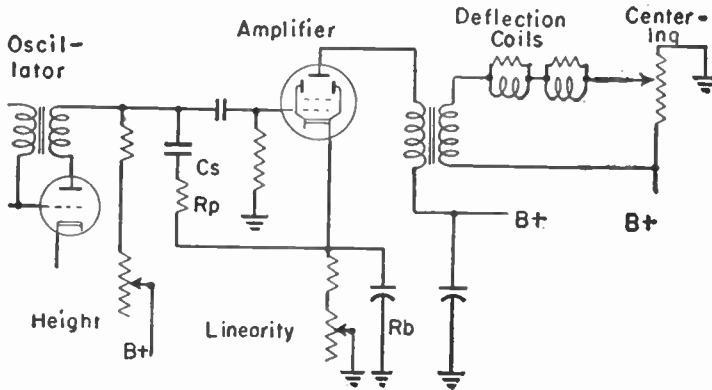

FIG. 33.—Linearity Control in Cathode Circuit of Sweep Amplifier.

There are still other controls for linearity. Some are in the circuits of damper tubes, others are in feedback connections from sweep output to sweep amplifier grid circuits, and still others are in the amplifier grid circuit. The effects of adjustments for linearity, centering, and size may be so similar on the distribution

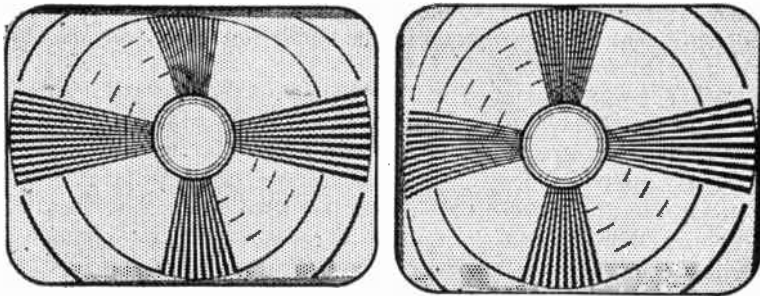

FIG. 34.—Effects of Wrong Adjustment of Linearity Controls.

of picture elements that all three controls usually must be readjusted when one is altered. Non-linear deflection results in distorted circles and displacement of the centers of test patterns, as illustrated by Fig. 34.

TELEVISION

It is necessary that electrons in the picture tube beam be focused to a very small spot or point where they strike the screen surface. With *electrostatic focusing* the beam is brought to a small spot by varying the voltage on a focusing anode which is part of the electron gun. For *magnetic focusing* there is an adjustment for the amount of direct current flowing in a focusing coil placed around the neck of the picture tube. Electrostatic focusing usually is used with tubes having electrostatic deflection, and magnetic focusing with tubes having magnetic deflection, although some picture tubes have magnetic deflection and electrostatic focusing.

Centering of the picture with electrostatic deflection tubes is accomplished by applying steady direct voltages to opposite plates of the pairs for vertical and horizontal deflection. This and many other features relating to electrostatic deflection systems are explained under *Oscilloscope, Cathode-ray*. Except for the kind of phosphor, oscilloscope tubes are much like electrostatic picture tubes used in television.

Centering with magnetic deflection may be accomplished by passing a direct current, in addition to the deflecting currents, through the deflection coils. The centering current is adjustable as to polarity and amount. It serves to bring the center of deflection to the center of the screen, even though the deflection may extend to unequal distances either way from the point at which the beam would strike with no deflection currents in the coils.

When picture tubes are provided with a focusing coil, this coil may be tilted with reference to the axis through the tube neck to center the picture. The focusing coil acts much as though the electron beam were aimed along the axis of the coil. When this axis is shifted with reference to the neck of the picture tube there is shifting of the picture on the screen. Some receivers have no other centering control, while again there may be provision for centering with direct current in the deflection coils and also by tilting of the focusing coil.

Earlier it was mentioned that frequency of the horizontal sweep oscillator often is automatically synchronized with the received signal. There is great variety in methods used for such automatic frequency control, but always there are one or more service adjustments in addition to the hold control used by the operator.

Fig. 35 shows circuits for one kind of *horizontal a-f-c control*. Oscillator frequency is fed back through a transformer to a discriminator tube. To the discriminator, by way of the center tap on the transformer secondary, are fed also the horizontal sync pulse voltages. If the two voltages are out of time with each other the discriminator develops a positive or negative direct voltage which is applied in the control grid circuit of the reactance tube. The reactance tube feeds into the tuned circuit of the oscillator an out-of-phase voltage which corrects the frequency error.

TELEVISION

The oscillator in this system is an electron coupled Hartley type. The hold control on the oscillator grid varies the intervals between leading edges of voltage pulses in the plate circuit. The fre-

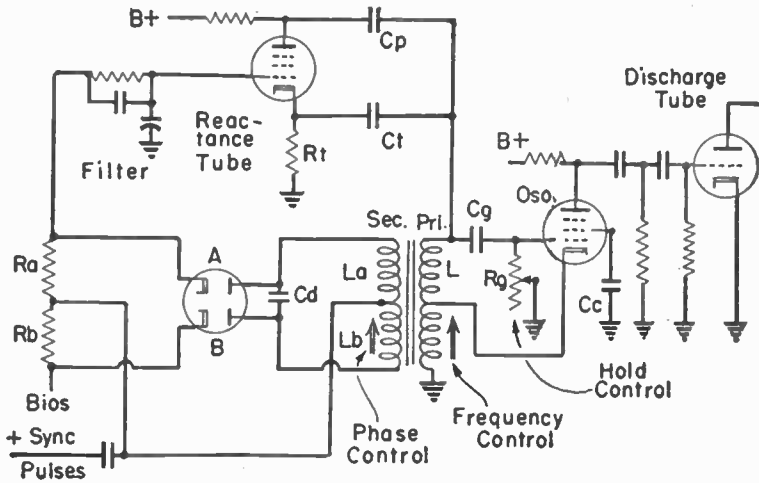

FIG. 35.—Horizontal A-f-c Control Employing a Discriminator.

quency control is an adjustable core for the transformer primary, by means of which the natural frequency of the oscillator may be varied to bring it into synchronization. The phase control is a

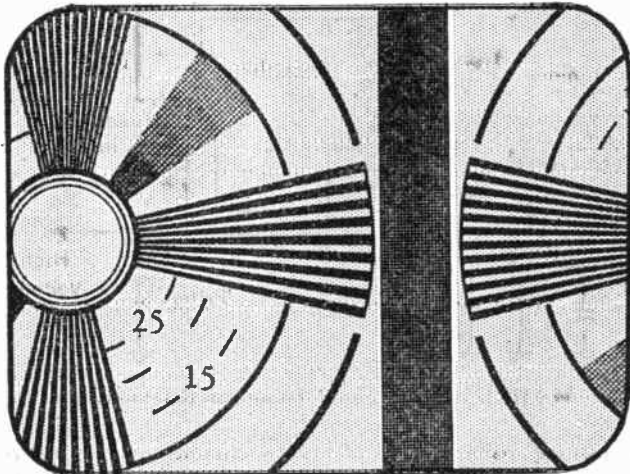

FIG. 36.—Effect of Wrong Adjustment of Phase Control.

TELEVISION

second adjustable core for the transformer secondary. This control brings transformer voltages into correct phase relationship for keeping the picture in horizontal position on the screen. Misadjustment of the phase control may allow the picture to divide vertically, as illustrated by Fig. 36.

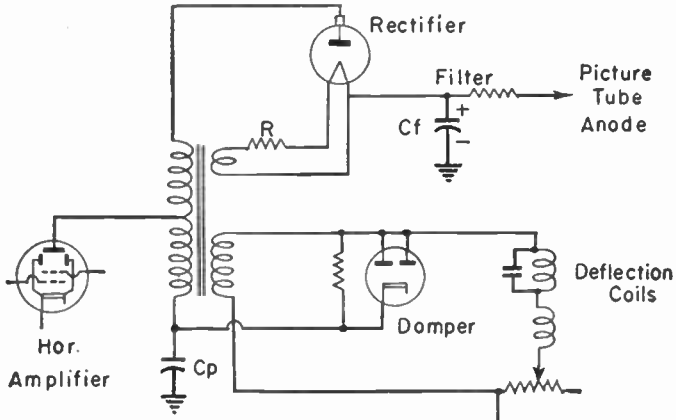

FIG. 37.—Flyback Type of High-voltage Supply.

High-voltage Power Supplies.—Fig. 37 is a “flyback” circuit for obtaining potentials up to about 10,000 volts for the high-voltage anode of magnetic deflection picture tubes. When the

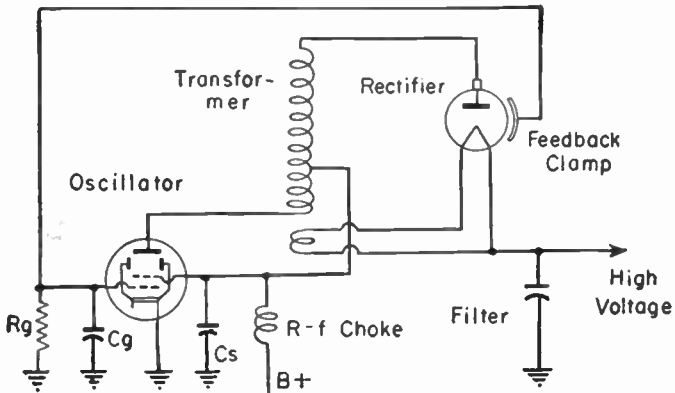

FIG. 38.—High-voltage Supply Using an R-f Oscillator.

negative retrace voltage cuts off plate current in the horizontal amplifier there is sudden collapse of magnetic fields in the transformer secondary and deflection coil circuit. The sudden and

TELEVISION

large change of magnetism induces a potential of 4,000 to 6,000 volts in the transformer primary. The two parts of the primary act as an auto-transformer to step up this potential, which then is applied to the high-voltage rectifier. The pulsating output of the rectifier is filtered and applied to the picture tube anode. This entire system, including the rectifier filament, operates at the horizontal line frequency of 15,750 cycles per second.

Fig. 38 is a circuit for one type of r-f high-voltage supply. The oscillator operates at some frequency in the neighborhood of 200 kilocycles. The oscillator plate coil is the primary of a transformer having a step-up ratio of about 35 to 1. The high-voltage rectifier is connected to the transformer secondary. The rectifier output is applied to picture tube circuits and may be used also for high voltages required by other tubes. In some r-f power supplies the oscillator plate circuit is adjustably tuned for varying the output voltage. This general type of power supply is found with both electrostatic and magnetic deflection picture tubes.

NOTE: Many circuit diagrams and illustrations in this section have been taken from the more complete explanations in the book, *Television Servicing for Radiomen*.

TELEVISION, ELECTRO-MECHANICAL

TELEVISION, ELECTRO-MECHANICAL. — The earlier experimental methods of television employed various combinations of electrical, mechanical and electronic devices instead of the purely electronic systems now used. Many of the mechanical systems divided or scanned the image at the televisior, and repro-

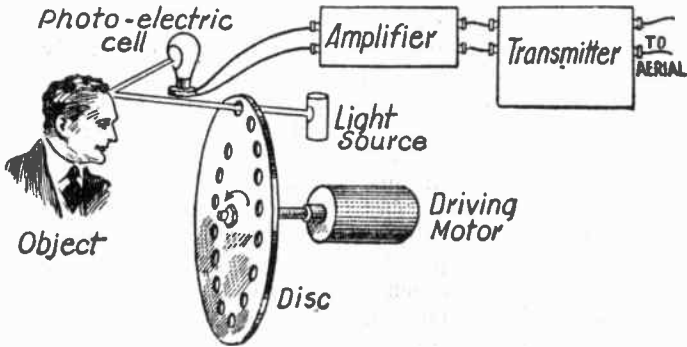

FIG. 1.—Nipkow Disc Scanning at Televisor or Transmitter.

duced it at the receiver, by means of a Nipkow disc whose action is shown by Figs. 1 and 2. The disc contains a series of openings laid out on a spiral so that, as the disc is rotated, beams of light passing through the openings are caused to travel across the object scanned. Because of the spiral arrangement of the openings, the

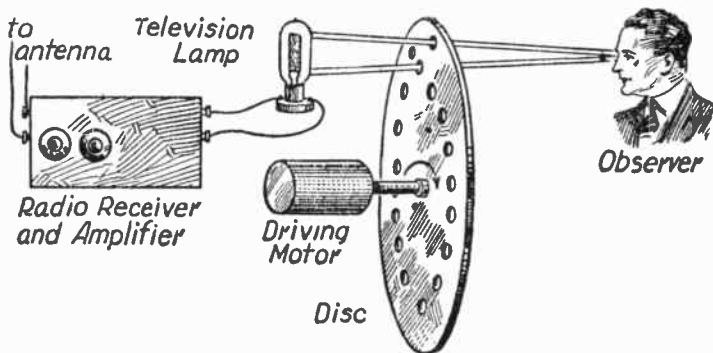

FIG. 2.—Nipkow Disc Reproduction at Television Receiver.

spot of light from each opening crosses the object on a horizontal line slightly below the travel of the spot from the preceding opening. Thus the entire object is scanned at each revolution of the disc. The variations of reflected light affect a photocell whose output is amplified and used to modulate a transmitted wave.

TELEVISION, ELECTRO-MECHANICAL

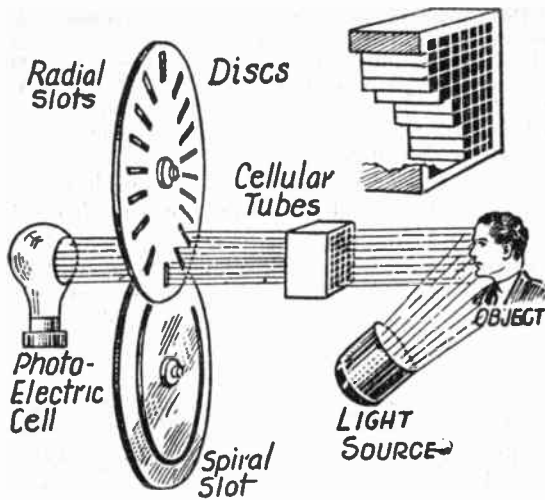

FIG. 3.—Action of Baird Discs in Television.

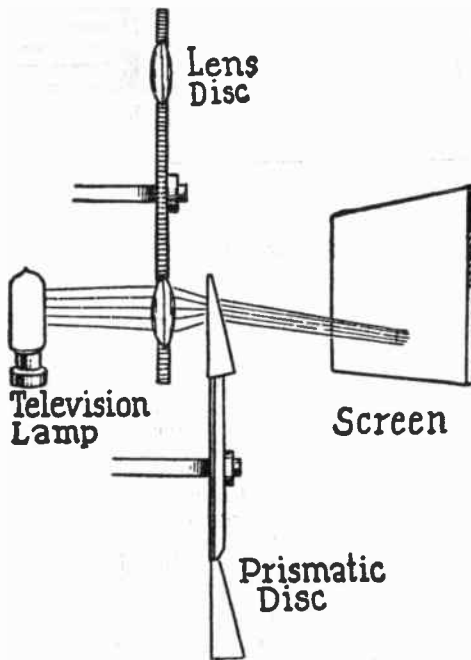

FIG. 4.—Jenkins Discs Employing Lenses and Prisms.

TELEVISION, ELECTRO-MECHANICAL

A disc at the receiver (Fig. 2) rotates in synchronism with the disc at the televisor and transmitter. Through the successive openings of the receiver disc is viewed the illuminated plate of a glow lamp. The brilliancy of the glow is varied by the received signal, with the result that the area of the lighted plate being viewed at any one instant has a degree of brightness proportional to the brightness of the corresponding area of the object being scanned at the same instant.

Fig. 3 shows the operation of two discs, one having radial slots and the other a single spiral slot. Light passing from the strongly illuminated object being scanned to the superimposed slot openings goes through a structure of parallel tubes which insure that all light beams remain parallel. At the receiving end the varying brilliancy of a glow lamp is viewed through a similar pair of discs.

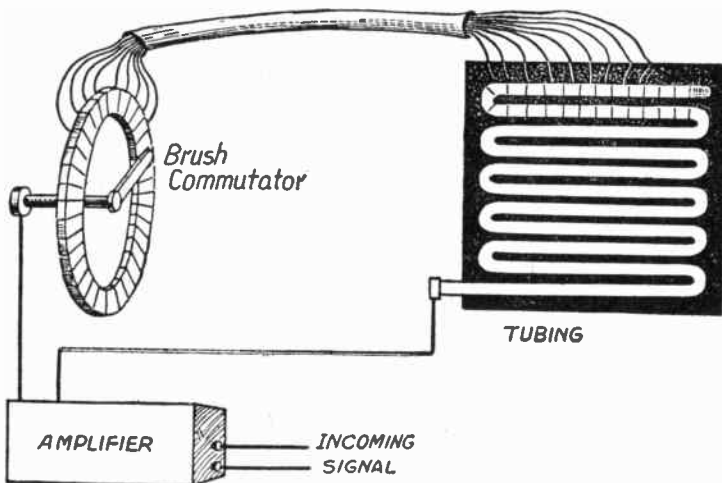

FIG. 5.—Reproduction by Varying Brilliancy in Tubing.

In Fig. 4, which illustrates a receiving or viewing apparatus, lenses in one revolving disc concentrate the varying light from a glow lamp into beams which are swept horizontally across the viewing screen by motion of the lens disc while being moved from top to bottom of the screen by prisms mounted on another revolving disc. Fig. 5 illustrates the basic principle of a system in which small sections of a glow tube are connected through a commutator and revolving brush to the receiving amplifier. The brilliancy to which the tubing sections are lighted corresponds to the strength of incoming signal, so that the entire area appears lighted in the varying shades which form the reproduction of the image being scanned at the transmitter.

The modulating frequency for the carrier wave is proportional to the square of the number of lines per frame and directly proportional to the number of frames per second. Such modulation requires a band width of at least 20,000 cycles for even moderately

TELEVISION, ELECTRO-MECHANICAL

good definition in the received picture. Synchronizing of the mechanisms at transmitter and receiver was one of the major problems with the early methods. Various methods were tried in obtaining identical speeds and in scanning and viewing identical

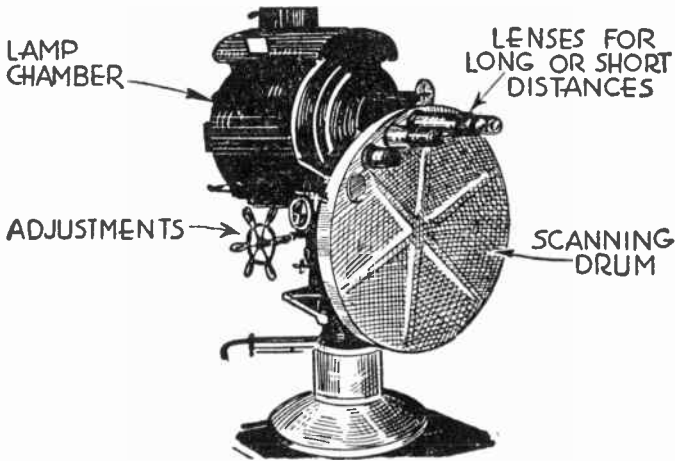

FIG. 6.—Television Scanner Employing an Arc Lamp.

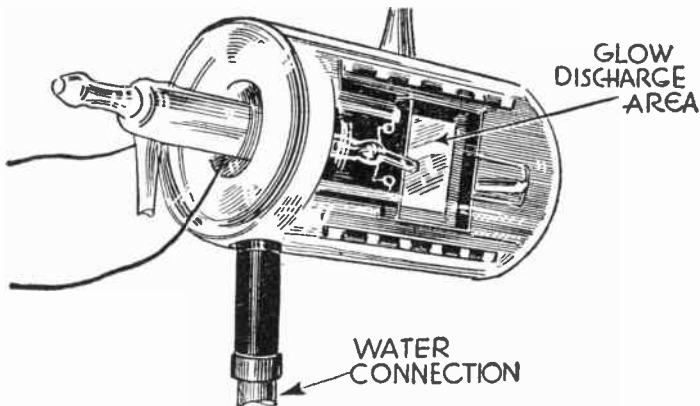

FIG. 7.—High Power Glow Lamp for Television.

areas at the same instant. One method employed a synchronous motor with its operating frequency controlled by a signal transmitted simultaneously with the picture modulation. Other frequency controls made use of tuning forks and of quartz crystals.

TEMPERATURE

TEMPERATURE, SCALES OF.—In scientific and technical work temperatures are measured according to the Centigrade scale.

The values of degrees Centigrade in degrees Fahrenheit are as follows for one to ten degrees Centigrade, these values being for interpolation in the next table:

<i>Centigrade...</i>	1	2	3	4	5	6	7	8	9	
<i>Fahrenheit...</i>	1.8	3.6	5.4	7.2	9.0	10.8	12.6	14.4	16.2	18.0

DEGREES CENTIGRADE TO DEGREES FAHRENHEIT

Cent.	Fahr.	Cent.	Fahr.	Cent.	Fahr.	Cent.	Fahr.
-40	-40	45	113	160	320	330	626
-35	-31	50	122	170	338	340	644
-30	-22	55	131	180	356	350	662
-25	-13	60	140	190	374	360	680
-20	-4	65	149	200	392	370	698
-15	+ 5	70	158	210	410	380	716
-10	+14	75	167	220	428	390	734
- 5	+23	80	176	230	446	400	752
0	+32	85	185	240	464	410	770
+ 5	+41	90	194	250	482	420	788
10	50	95	203	260	500	430	806
15	59	100	212	270	518	440	824
20	68	110	230	280	536	450	842
25	77	120	248	290	554	460	860
30	86	130	266	300	572	470	878
35	95	140	284	310	590	480	896
40	104	150	302	320	608	500	932

The two following formulas may be used to convert readings in one temperature scale into readings in the other scale:

$$\text{Degrees Centigrade} = \frac{5}{9} (\text{degrees Fahrenheit} - 32)$$

$$\text{Degrees Fahrenheit} = \frac{9}{5} \times \text{degrees Centigrade} + 32$$

TESTERS, APPLIANCE

TESTERS, APPLIANCE.—Such common faults as open and shorted circuits may be located with a simple circuit tester. It is, however, necessary to make additional measurements and tests when all kinds of troubles are to be accurately diagnosed. Especially helpful are measurements of alternating-current (a-c) voltages. This requires an a-c voltmeter with a range up to 150 when working with 110-120 volt lines, and to 250 or 300 volts for 220-230 volt lines.

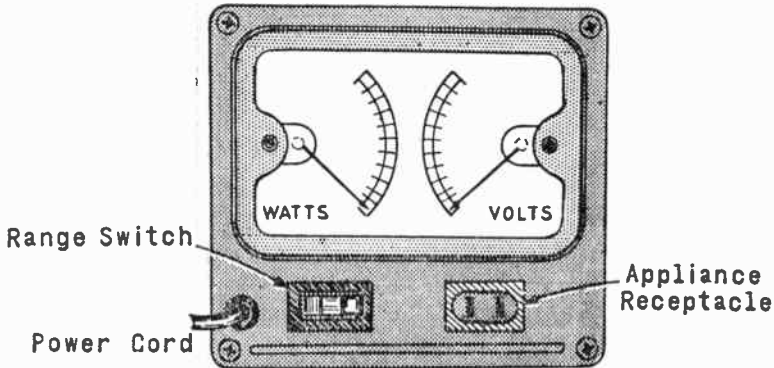

Fig. 1—Appliance tester with wattmeter and voltmeter

It is desirable also to measure actual power consumption in watts, or, at least, to measure alternating current flowing in a tested appliance. Furthermore, various circuit tests may be made better with an ohmmeter than with a lamp-type circuit tester, since the ohmmeter indicates actual resistances in ohms. Finally, many obscure faults may be located with a leakage test which shows up short circuits or grounds whose resistance is in excess of about 1,000 ohms but which still allow continual flow of small currents with consequent overheating.

Appliance testers of moderate cost provide various combinations of measurements and tests in a single instrument. The particular tests depend on the make and model of instrument. There may be a single or multi-range a-c voltmeter and a multi-range wattmeter as in Fig. 1. Other testers may measure current, voltage, resistance and leakage. Such an instrument is shown by Fig. 2.

The tester is provided with a cord and plug for connection to the building power and lighting lines. Either on the panel of the tester or else on a separate cord is a receptacle or socket into which may be inserted the regular power cord

TESTERS, APPLIANCE

plug of the appliance being checked. With the tester connected to the line and the appliance to the tester, and with selector switches properly positioned, the meter or meters of the tester are properly connected.

Some testers are provided with panel jacks into which may be plugged flexible leads terminating at their free ends with spring clips. These clips may be connected to terminals or

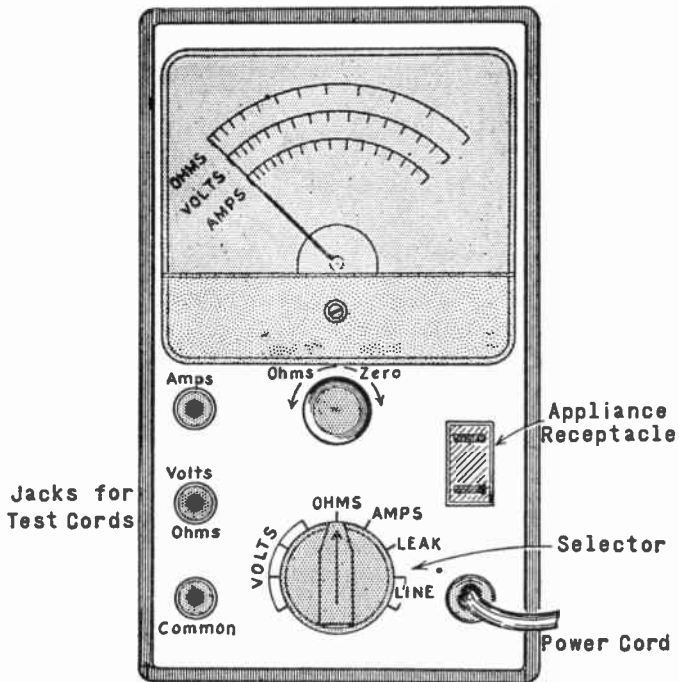

Fig. 2—A tester for voltage, current and resistance.

other parts of appliances in which it is desired to measure voltage, current, resistance or leakage. The kind of test is determined by placing one or more selector switches at suitable positions.

Precautions During Tests.—Allowing any parts of your body to come in contact simultaneously with both sides or wires of a building power line will cause a painful shock, much worse on 220-230 volt lines than on 110-120 volts.

If contacts are to your two hands, to one hand and your feet, or any way which allows line voltage and current to

TESTERS, APPLIANCE

pass through vital organs the shock may be dangerous or possibly fatal when firm contact is made or when your body members are wet. Therefore, make it a rule never to grasp any two metal test clips or terminals, or either of these and a metal housing. Handle test clips only by their insulating sleeves or covers. Safest of all is to disconnect the appliance and tester from the building power line while making connections, then reconnect to the power line only while taking readings.

If the tester is provided with flexible test leads and clips be sure to remove these leads while making tests which do not require them. This will make it impossible to get a shock from the jack plugs or the spring clips, and will prevent short-circuiting them, with possible damage to the test instrument.

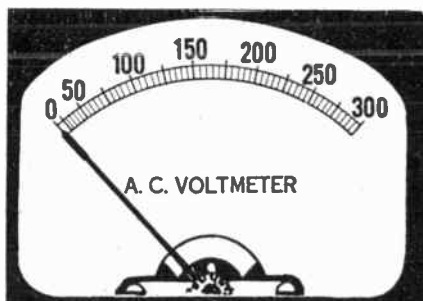

Fig. 3—Readings are crowded at the low end of an a-c meter dial.

One side of all properly installed building power lines will be grounded. This means that one side of the line is conductively connected to all building water piping, gas piping, possibly to metal trim on appliances and room fixtures, possibly to metal cabinets of any electrically operated device such as a radio, a television set, a refrigerator or an air conditioner, and quite likely there is an effective ground connection to wet cement floors.

Meter Readings.—Meters of appliance testers are designed to measure a-c values. The dial scales of all such meters have markings close together at the low end. This is illustrated by Fig. 3. Reading of voltage, current or power in values less than about $1/10$ to $1/5$ of full-scale or highest dial values are unreliable if they can be made at all.

When powers or currents less than $1/10$ to $1/5$ of full-scale value must be measured it is advisable to first connect to

TESTERS, APPLIANCE

the tester some power or current consuming device which will bring the meter pointer up on the dial scale, then, in addition, connect the appliance to be measured. The increase of meter reading shows power or current taken by the appliance.

As an example, to measure less than 100 to 200 watts of power on a 1,000-watt scale, first connect several lamps or possibly a large soldering iron to the tester. This will bring the pointer to a position where readings are easily made. Then make an additional connection of the appliance whose power is to be measured and note how much higher the pointer indicates. This difference is a measure of power consumed by the appliance last connected. A similar procedure may be followed for measuring currents. This method cannot so readily be employed for voltage measurements.

Voltage Measurements.—When working from building lines supplying 110-120 volts set the tester to a range of 130 to 150 volts. For 220-230 volt lines use a range from 250 to 300 volts. If the applied voltage is unknown, begin with the highest voltage range on the tester, then drop to a lower range if indicated voltage is within that lower range.

Alternating-current meters used in appliance testers may themselves have such small internal resistance as to require considerable current merely to move the meter pointer. This current for the meter must come from the building line. If meter current flows through any considerable resistance in the line connections, not in the appliance or the tester, there will be a drop of voltage in that resistance. Then the meter will indicate a voltage somewhat less than exists without the tester connected.

Building power lines in good condition will furnish enough additional current for any tester meter without appreciable drop of voltage, so tests of appliances are unaffected. But the appliance tester with its high-current or low-resistance voltmeter is not suitable for measurements in radio or television receivers, or in other apparatus in which power supply circuits contain large resistances.

Low Line Voltage.—The first check during most trouble shooting procedures is measurement of voltage from the building power line. Plug the tester cord into the same line receptacle as used for the appliance being checked, or into a receptacle on the same branch of the building line. Read the line voltage with the appliance turned off, then with it turned on. Leave the appliance turned on while turning on any other appliances, also lamps and any electrically operated devices on the same building line.

TESTERS, APPLIANCE

Should indicated voltage go much if any below 100 to 105 on a 110-120 volt line, or below about 200 on a 220-230 volt line, the appliance probably will operate unsatisfactorily because of one or more of the following reasons: Voltage from outside power lines to the building is low, which is a matter to be taken up with the public utility furnishing electric power. Building internal wiring may be too small for the currents carried, or the wiring may be badly overloaded. There may be poor contacts at terminals, connectors, fuses, circuit breakers or switches on the building line to the appliance outlet. The appliance being tested, or others on the same line, may have defects causing them to draw excessive current and power.

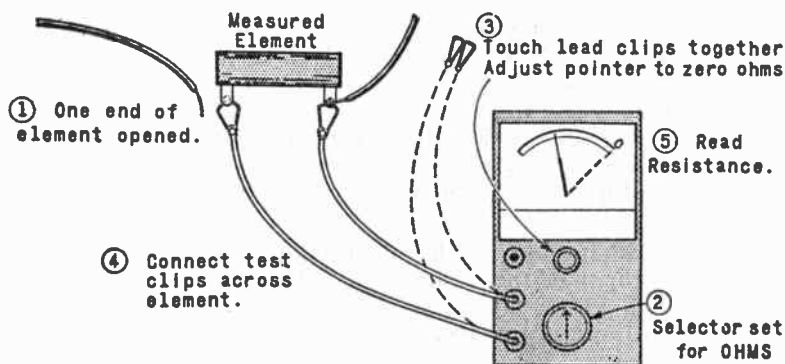

Fig. 4—Steps in measuring resistance of a single element.

Resistance Measurements.—A tester having an ohmmeter function or provision for measuring resistances in ohms will be used with its test leads connected to panel jacks or terminals marked for ohms.

First disconnect the appliance from the building power line. If resistance is to be measured in only one part or one circuit of the appliance, disconnect one end of that part or circuit from everything else in the appliance. Set the selector of the tester for measuring ohms. Connect together the clips at the free ends of the two test leads and operate the “zero adjuster” on the panel to bring the meter pointer exactly to zero on the ohms scale. Immediately disconnect the test clips. The procedure is illustrated by Fig. 4.

Now connect the test clips across the part or circuit to be measured, so that current from the tester can pass only

TESTERS, APPLIANCE

through that part or circuit, and read the resistance value from the meter dial scale for ohms.

Leakage Tests.—Quite often there may be leakage of small current through some path having high resistance. Heat will be generated because heat is proportional to the product of amperes squared and ohms of resistance. Even with small current the high resistance may cause appreciable heating.

Leakage should be checked first with the ohmmeter function of the tester. Even though such a test indicates infinitely great resistance, there still may be slight leakage through resistance greater than the ohmmeter can measure. On some testers is a small neon lamp which will glow when test leads are connected across parts between which resistance is as great as one or two million ohms (megohms).

Such leakages may be caused by defective insulation or by dirt or moisture. Check especially from the metal case or housing of the appliance to all its resistance elements and their connections. If there is a motor, test from the metal frame and housing to windings, brushes, their terminals and connecting leads. Leakage usually may be prevented by thorough cleaning or by replacement of defective or doubtful insulation.

During leakage tests with a neon lamp be sure not to touch both test clips at the same time. The resistance through your fingers and body is small enough to make the lamp glow, even though you feel only a slight tingling or nothing at all.

Current Measurement.—On the nameplates of most appliances will be shown the current which should be taken during normal operation. Current 10 to 15 per cent more or less than this rating for appliances having only heating elements often means internal trouble—assuming that line voltage is normal with the appliance operating. Nameplates on appliance motors usually show maximum current at full load. Most motors operate at less than full load. For example, a $\frac{1}{2}$ -horsepower motor usually runs at less than $\frac{1}{2}$ -horsepower output, and will take somewhat less than maximum current.

If current is to be measured in only one part or in one circuit of an appliance it will be necessary to use the flexible test leads and clips. To begin with, do not have the tester cord plugged into a building power line, also disconnect the appliance from the power line. Then open the appliance circuit to be tested at any convenient point and to the two open ends connect the clips of the two test leads. Adjust the tester selector for measuring current.

TESTERS, APPLIANCE

Now connect the appliance to the power line, with its regular power cord plug, turn on the appliance and read the current. Turn off the appliance and pull the appliance cord plug out of the power line receptacle before disconnecting the test leads.

Should actual motor current exceed the maximum as given on the nameplate or rating plate, and if applied voltage is not abnormally high, either the motor is being overloaded or else there is internal trouble of some kind allowing the excessive current.

Power Measurements.—Power consumed by any appliance is measured in watts. If the appliance operates entirely with resistance elements, power in watts is equal to the product of multiplying applied volts by amperes of current. If the appliance operates on alternating current and contains a motor or any other parts having coils, or if it contains one or more capacitors, the power consumption as measured in watts will be less than the product of volts and amperes.

The lesser power is due to the fact that part of the current taken from the building power line by the appliance is returned to the line without having done any useful work in the appliance. The fraction or percentage of "volts times amperes" which does useful work is called the power factor.

Single-phase a-c induction motors rated between $\frac{1}{4}$ and $\frac{3}{4}$ horsepower may have power factors of 50 to 60 per cent. This means that power in watts will be only 50 to 60 per cent of the product of volts and amperes, called volt-amperes. Induction motors of $\frac{1}{10}$ to $\frac{1}{6}$ horsepower may have power factors of 45 to 50 per cent.

Indications of a wattmeter are caused by combined effects of voltage, current and power factor. Such meters are rated not only as to number of watts they will measure, but also for maximum voltage and maximum current. For instance, a 750-watt meter might be rated for 150 maximum volts and $7\frac{1}{2}$ maximum amperes. If either the voltage or the current is exceeded, the meter may be damaged even though the wattage is less than maximum. This can happen when power factor is very small.

Connect an appliance tester containing a wattmeter to the power line and the appliance in exact accordance with instructions for the instrument. If the tester is to be plugged into the power line, and the appliance into the tester receptacle, meter connections always will be correct.

TESTERS, APPLIANCE

Appliances operating only with heating elements often are rated in watts of power instead of amperes of current. If your tester measures volts and amperes, but not watts, measure the voltage with the appliance turned on. Then divide the rated number of watts by the number of volts, which gives proper operating current in amperes. Compare this with actual current as measured by the tester; it should be within about 20 per cent of the computed value.

Circuit Tests.—An appliance tester measuring resistance or ohms may be used for all tests which may be made with a circuit tester. Wherever those explanations call for connecting the spring clip and the bared end of wire, connect instead the clips on the flexible leads of the tester which are used for measuring resistance in ohms. Any movement of the meter pointer away from the infinite resistance position and toward lower resistance is equivalent to lighting of the lamp on the circuit tester.

The ohms function of the appliance tester may be used for locating an open circuit, an accidental ground or short circuit, and abnormally high resistance — remembering always that movement of the meter pointer on the appliance tester is equivalent to lighting of the test lamp.

A neon lamp test for leakage may be employed also for checking open circuits, accidental grounds and short circuits in the same manner as the lamp of the circuit tester. Glow in the neon lamp is equivalent to lighting of the circuit tester lamp.

Test Procedure.—If an appliance overheats, blows a fuse or opens a circuit breaker in building wiring, check first for excessive current or power. If there is no mechanical overload on an appliance motor the overheating usually results from short circuits, accidental grounds, abnormally high resistance, or leakages within the appliance.

If there is no overheating, but the appliance does not operate satisfactorily, make the following tests.

1. In accordance with instructions in this section, measure voltage at the outlet or receptacle of the building wiring into which the appliance is plugged when operating.

2. Measure voltage at the appliance end of the power cord or at the terminals of the appliance itself. If a switch of any type is on the cord or appliance make sure this switch is closed or in its *on* position.

TESTERS, APPLIANCE

3. If voltage at the appliance end of the cord is different than at the building wiring outlet, use the ohms function of the tester to check the cord. From each blade of the wall plug to one of the cord terminals at the appliance end should be zero resistance. From either plug blade to the other and from each blade to any metal parts on the cord should be infinite resistance. Make sure that the plug blades fit snugly in the wall outlet and that the socket at the appliance end fits snugly onto the appliance connector.

4. Use the ohms function of the appliance tester with test lead clips on the appliance terminals. Check for short circuit (zero resistance), for open circuit (infinite resistance), and for accidental grounds to the metal housing. Use a neon lamp test, if available, to check the leakage between any current-carrying conductors and the metal housing or case of the appliance.

5. Check any or all switches with the ohms function of the tester. With a switch turned on or closed, resistance through the switch should be zero. With the switch turned off or open the resistance should be infinite.

6. If an appliance operating with heating elements has a control allowing two or more heat ranges, check each range. Use the ohmmeter function of the tester. Resistance of the appliance should be greatest with the control set for lowest heat, and should be least with the control set for highest heat.

Motor Capacitor Test. — Many induction motors used on appliances start with the help of a capacitor. Some motors use the capacitor also during running periods. Should the capacitor be open circuited internally or should any of its connections be open the motor will not start. An internally leaky or short circuited capacitor will cause overheating in some types of motors.

For testing, one side or the other of the capacitor must be disconnected from motor wiring. A starting relay or switch may be temporarily held open to thus disconnect the capacitor.

Using the ohms function of the appliance tester, connect one of the test leads to one side or terminal of the capacitor. Watch the tester meter while touching the second test lead to the other side or terminal of the capacitor. The meter pointer should deflect momentarily away from the position for infinite resistance, then return to that position. This indicates that the capacitor is not open, is not shorted, is taking a charge, and probably is good.

TESTERS, APPLIANCE

No deflection of the meter pointer indicates an internally open capacitor. Deflection which continues, without the pointer returning to infinite resistance, indicates an internally leaky or short circuited capacitor. Do not use a neon lamp test for checking motor capacitors; the neon lamp will indicate leakage even though the capacitor is good.

Each capacitor is rated for some certain capacitance measured in microfarads, which may be abbreviated *mf* or *mfd*, and most capacitors are marked in this manner. To check capacitance, first make certain that the capacitor is not internally shorted or leaky. Then connect one side of the capacitor to a 60-cycle a-c power line, the other side to one terminal of an a-c ammeter, and the remaining ammeter terminal to the a-c line. Note the current, and disconnect from the power line. Next, measure line voltage applied to the capacitor and meter.

Multiply the number of amperes current by 2,650. Divide the result by the number of applied volts. The answer is capacitance in microfarads. This capacitance should be at least as great as the rating, and if the capacitor is good may be much greater.

TETRODE

TETRODE.—See *Tube, Screen Grid*; also *Tube, Thyatron, Four-element*.

THERMAL.—Related to heat or temperature, and their properties and effects.

THERMIONIC EMISSION.—Electron emission for which energy is furnished by heating of a cathode.

THERMIONIC TUBE.—See *Tube, Thermionic*.

THERMOCOUPLE.—A junction of two dissimilar materials which, when heated, produces an electromotive force across the contact surfaces. When the opposite ends of the materials are connected, and maintained at a lower temperature, there is flow of current in the circuit.

THERMOCOUPLE METER.—See *Meter, Ampere and Volt*.

THERMO-ELECTRICITY.—Electricity produced by the direct action of heat is called thermo-electricity.

When two different metals are placed in contact and electric current is sent through the joint, heat is produced at the junction between the metals. The reverse of this action will also take place.

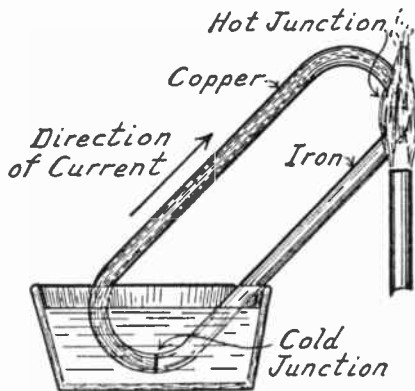

FIG. 1.—Principle of the Thermocouple.

If the joint between the two metals is heated, a voltage will be set up and current will flow in a circuit of which the metals and their junction form a part.

The amount of voltage produced depends on the heat applied and on the metals used, different metals giving different voltages. Practical combinations are made from antimony and bismuth, from German silver and copper sulphide, from copper and constantan and from iron and constantan. The voltage from any one junction is so small as to be measured in microvolts or millivolts.

THERMO-ELECTRICITY

One such junction is called a thermo-couple and a collection of thermo-couples is called a thermopile. In the thermopile, alternate junctions are heated and cooled, this giving rise to a continuous difference of potential through the circuit. The energy required to maintain the heating and cooling is changed into electrical energy.

When any two of the metals in the following list are joined to form a thermo-couple and the joint heated, current will flow from the metal higher in the list to the one lower:

Bismuth
Platinum
Copper
Lead
Silver
Antimony

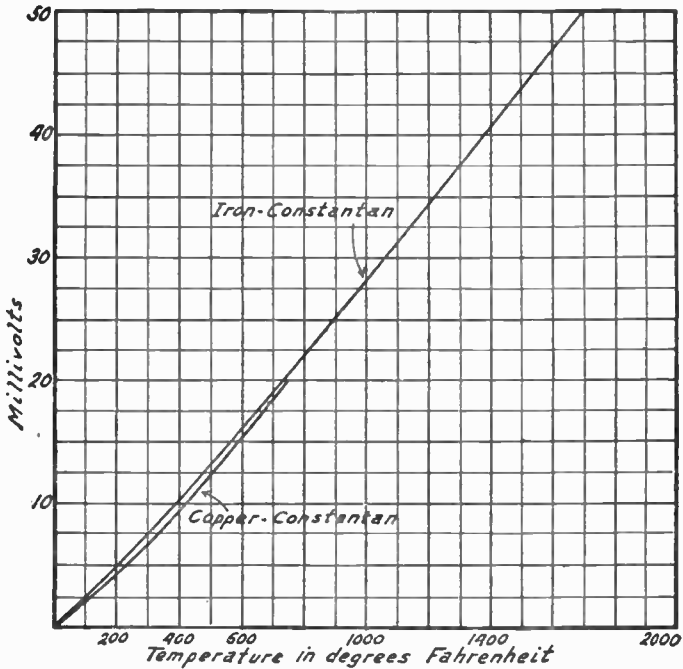

FIG. 2.—Voltage Developed by Thermocouples.

The joint may be made in any convenient way which will hold the metals in place while heated. It may be bolted, clamped or even soldered. The greatest voltage will be developed between metals farthest apart in the list. For instance, the greatest voltage will be between bismuth and antimony while comparatively little voltage would be developed between bismuth and platinum or between copper and lead.

Various alloys are commonly used for one or both metals of a couple. Whether using an elementary metal or an alloy, the purity and physical condition of the parts are of importance in securing uniform results.

Thermoelectric voltages and currents are often found to be generated at the junctions of metals where no such effect is desired. A generally used re-

THERMOMETER SCALES

sistance wire made by alloying copper and nickel develops a large thermo-electric voltage against brass or copper when the joint becomes heated as it might in a resistance element.

The principle of the thermocouple is illustrated in Fig. 1. The circuit is composed of copper and iron in this particular case. One of the junctions between the two metals is kept heated with a flame while the other junction is cooled. As long as the heat is applied there will be a flow of current from the copper into the iron at the hot junction and from the iron into the copper at the cold junction.

The greater the difference in temperature between the two junctions the greater will be the voltage developed. For greatest efficiency one of the junctions is artificially cooled while the other is heated. In practical applications it is generally sufficient to cool the one junction simply by allowing air to circulate around it.

An idea of the electric force generated in thermocouples may be had from Fig. 2. This shows the electromotive force in millivolts (thousandths of volts) generated in one circuit consisting of copper and constantan and of another with iron and constantan. One of the junctions is heated to the degree shown along the bottom of the graph while the other one is kept at the temperature of melting ice. It will be seen that the generated voltages are very small. With a temperature of 1000 degrees the iron-constantan couple produces less than thirty millivolts. Other combinations will produce greater voltages, a couple formed of antimony and bismuth being one of the strongest.

THERMOMETER SCALES.—See *Temperature, Scales of*.

THERMOPILE.—See *Thermo-electricity*.

THORIATED FILAMENT. — A filament type cathode made of tungsten alloyed with thorium to permit copious emission of electrons at lower temperatures than with pure tungsten.

THREE-ELEMENT TUBE.—See *Tube, Triode*.

THYRATRON.—See *Tube, Thyatron*.

TICKLER.—A coil in the plate circuit of an amplifier or oscillator tube, inductively coupled to a coil in the control grid circuit to permit feedback.

TIME CONSTANT.—See *Constant, Time*.

TONE, QUALITY OF.—The ability of a receiver to evenly and faithfully amplify and reproduce in sounds the music, voice or other material received by the antenna system is the tone quality of the receiver.

Good tone quality assumes that there is no distortion either in the radio frequency amplifier, the detector or the audio frequency amplifier. See *Distortion*. It also assumes that all frequencies, from lowest to highest, are amplified to the same extent without exaggeration of some frequencies and suppression of others.

To secure good tone quality the radio frequency amplifier or the tuner must not tune so sharply as to cut off part of the side bands. The detector should not be allowed to come too close to oscillation

TOOLS

when using regeneration. The audio frequency amplifier tubes must be capable of handling the power without distortion and the audio frequency coupling devices; transformer, chokes or resistances; must have sufficient iron and copper to operate without overloading either their magnetic or electric circuits.

Finally, the loud speaker must be able to handle the power delivered to it, must not have pronounced resonant points of its own, and must be suited to the audio amplifier which feeds it.

Good quality can be secured only when no part of the receiver is overloaded or forced beyond its normal ability. This requires that the signal from the antenna be of moderately high power and it generally precludes the possibility of getting good tone quality from stations at great distances from the receiver.

TOOLS.—The more tools and the better their quality, the more easily and quickly can radio work be done and the more workmanlike will be the results. It hardly pays to buy a four dollar panel and ruin it with ten cent tools. Tools may be divided into three general classes; those used for laying out the work, those used for cutting and drilling, and those used for mounting and fastening. Of course there are some other tools that are difficult to classify but these three general classes make a convenient division for purposes of description.

Tools for Laying Out.—The tools that will be found of real help in laying out the work, in preparing the panels, the subpanels, the brackets, etc., are as follows:

Dividers with legs four to six inches long and with both points sharp. It will be better to use instruments provided with a screw adjustment than those depending only on friction.

Prick punch for making the preliminary dent in which the point of the center punch is placed later on. The prick punch should be kept well pointed.

Center punch for making depression deep enough for a drill point to enter and start the hole without danger of running to one side or the other.

Scriber about six inches long with one point straight and the other bent over.

Adjustable square whose blade may be set at any required angle and clamped in position as shown in Fig. 1. This square is set at right angles while laying off square lines with the scriber. It may be set at any angle when transferring the angle for slanting panels to brackets and other parts.

Adjustable template as shown in Fig. 1. This device consists of a clamping knurled nut having a quarter-inch hole and provided with a bushing for handling three-sixteenth inch shafts. The three adjustable arms each carry a hard steel center punch tip. The hole in the nut is slipped over the shaft of any instrument (condenser, tickler, coupler, etc.), the center points placed exactly in the screw or bolt holes for mounting and the nut tightened. The template may then be removed from the instrument and laid on the panel or other part with the center of the large hole over the center that has been marked for the instrument shaft. A light blow with a small hammer on top of each center point will then mark off the places for drilling with great accuracy.

Tools for Cutting and Drilling.—The following will be found convenient and many of them are really indispensable in preparing the parts for the mounting of instruments such as condensers, transformers, rheostats, etc:

Round shank twist drills of the following diameters in fractions of an inch:

TOOLS

1/16, 1/8, 5/64, 3/16, 13/64, 1/4, 17/64, 5/16, 21/64, 3/8, 25/64, 7/16, 1/2, and 33/64. The sizes in sixty-fourths are for drilling a hole originally of the next smaller size slightly larger to make an easy fit.

Round shank numbered twist drills of the following sizes are needed for drilling holes to be tapped or threaded and for drilling holes allowing clearance for the standard sizes of screws and bolts: Numbers 1, 3, 9, 11, 13, 15, 18, 19, 20, 22, 23, 24, 27, 28, 29, 30, 31, 33, 36, 37, 41, 42, 44, 48. If, as should be the case, all mountings are made with screws of number 4, 5, 6, 8 and 10 size and with 1/8, 3/16 and 1/4 inch diameter bolts; the sizes of numbered drills may be reduced to the following: Number 9, 11, 12, 18, 20, 23, 27, 28, 30, 31, 33, and 41.

Geared hand drill having three-jaw chuck taking up to 1/4-inch diameter drills.

Ratchet brace taking up to one-half inch or larger drills.

Countersink such as shown in Fig. 2. This is used in the hand drill or brace for tapering holes which are to receive flat head screws.

Files as follows: One six-inch single-cut mill file; one ten-inch double cut mill file; one ten-inch double-cut bastard file; one eight-inch single-cut

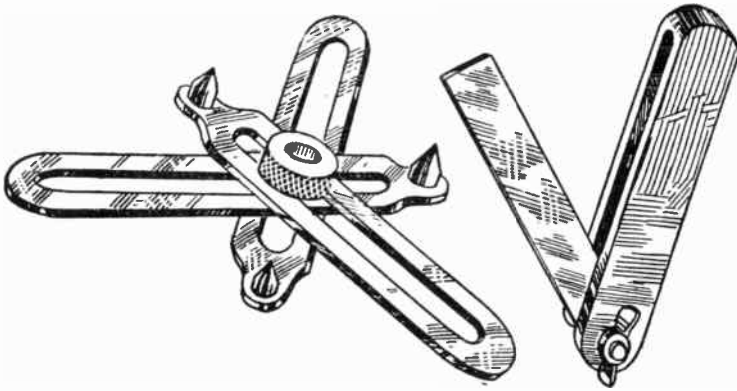

FIG. 1.—Adjustable Template and Adjustable Square.

half-round file; one eight-inch single-cut three-square or three cornered file; one four-inch rat-tail file; and one eight-inch rat-tail file.

Adjustable hack saw frame taking blades up to twelve inches long.

Hack saw blades one-half inch wide and ten inches long. Some blades should have 22 teeth per inch for cutting steel and iron; others should have 28 teeth per inch for cutting brass, copper and panel materials; while a few may have 32 teeth per inch for cutting tubing.

Electricians' knife for general handy work.

Square reamer for enlarging drilled holes which are found to be slightly too small or slightly out of line with the position counted on.

Electrician's scissors as shown in Fig. 2. These are strongly made with heavy, thick blades. They will cut fibre, thin sheet metal, small wires, cardboard templates, etc.

Panel hole cutter as shown in Fig. 2. When placed in a brace this tool will cut clean holes through panel material. It is made in sizes which cut holes having three-quarter inch, one inch, or one and one-half inch inside diameter.

Taps for cutting threads on the inside of holes, and dies for threading the outside of rods of the following sizes. The first part of each number indicates

TOOLS

the gauge number of the rod or the diameter, while the second part indicates the number of threads per inch. Taps are made with three styles of entering ends; taper, for starting the threads in difficult material; plug, for carrying the threads nearly to the bottom of a hole; and bottoming, for following one of the other types and carrying the threads clear to the bottom of a hole. These sizes are regularly used in radio work: 4-36, 6-32, 8-32, 10-32, 10-24, 3/16-24, 1/4-20. See *Screws and Bolts, Types of*.

Tap wrench for holding the taps while working.

Die stock for holding the dies while working.

Tools for Mounting and Fastening.—After the work has been laid out and the brackets, panels, etc., prepared for mounting the various parts of the receiver, a new class of tools will be needed for fastening things in place.

Ball peen hammer of one-half to three-quarter pound weight. The face is used for regular work and the ball shaped peen is used for riveting.

Soldering iron, electric or gas heated. See *Soldering*.

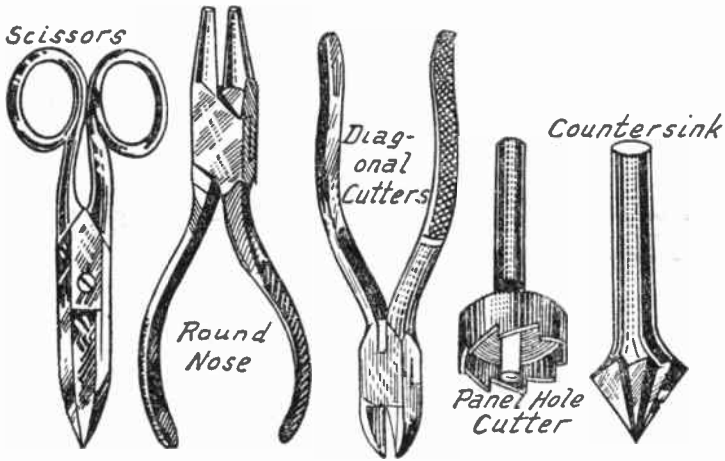

FIG. 2.—Pliers and Cutting Tools.

Pliers of the following types. Pliers having a total length over all of five to six inches will be found most convenient for all around use. There is no place where a little additional investment in first cost will produce more lasting results in satisfaction than in the purchase of pliers.

One pair of substantial flat-nose pliers which may be of the side-cutter type for cutting fairly large wires. One pair of double round nose pliers as shown in Fig. 2. These are for forming terminal loops at the ends of wires. One pair of diagonal cutting pliers as shown in Fig. 2. One pair of round long-nose pliers. One pair of flat long-nose pliers. It is also convenient, but not necessary, to have end cutting pliers of heavy construction for cutting off the extra length of machine screws.

Socket wrenches with handles as shown in Fig. 3. These are made in two types, one type fitting hexagon nuts and the other fitting round knurled nuts. Both types come in different sizes to fit the different sizes of nuts.

Screw driver with four-inch blade and tip five-sixteenth inch wide for heavy work.

Screw driver with six or seven-inch blade and tip three-sixteenth or one-quarter inch wide for reaching inaccessible places.

TOROIDAL COIL

Swivel base bench vise with jaws three inches wide.

Miscellaneous Tools.—There are endless varieties of special tools on the market, all of them claimed to allow the radio worker to accomplish better results in less time. Many of these special tools live up to all the claims made for them, but it is impossible to begin to describe each one here.

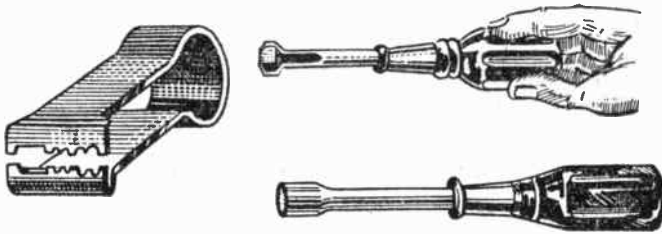

FIG. 3.—Wire Skinner and Socket Wrenches.

It will be found a real convenience to secure a wire skinner somewhat like the one shown in Fig. 3. This tool has openings of different sizes which fit wires of different gauges. With the jaws clamped down on the wire a pull will completely and cleanly strip the insulation. The type shown has additional knife edges for cleaning wire ends ready for the solder.

It may be desirable to have a wire gauge which is a piece of steel with slots or tapering grooves along which are marked the gauge number of wires which just slide into the slots or which just fill the groove at the point marked.

TOROIDAL COIL.—See *Coil, Closed Field, Toroid.*

TRAIN, WAVE.—A series of radio waves is called a wave train. If the waves start with maximum amplitude and then diminish in amplitude, it is called a damped wave train. If the amplitude does not diminish, it is called an undamped wave train or the waves are called continuous waves.

TRANSFORMER.—A transformer is a device for transferring energy from one alternating current circuit into another alternating current circuit by means of induction. As shown in Fig. 1 the trans-

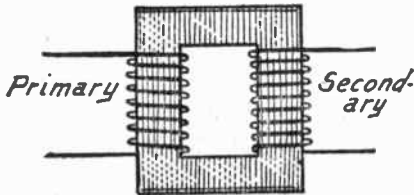

FIG. 1.—Core Type of Transformer.

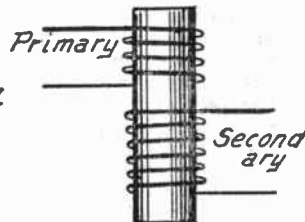

FIG. 2.—Open Core Type or Coil Type Transformer.

former consists of two windings placed on a common magnetic core.

The winding by means of which energy or power is supplied to the transformer is called the primary winding and the winding from

TRANSFORMER

which power or energy is taken from the transformer is called the secondary winding.

Current flowing around the turns of the primary winding causes a flow of magnetic lines of force in the core, which is of silicon steel or other suitable steels. This sets up a magnetic field about the core and the movement of this magnetic field causes a voltage to appear in the secondary winding by electromagnetic induction. See *Induction, Electromagnetic*.

In order for an electromagnetic field to induce a voltage in a conductor, such as the transformer's secondary winding, it is necessary that the field move with reference to the conductor or that the conductor move with reference to the field. It is evident that the secondary winding cannot be moved with reference to the field of the core, therefore the field must be kept moving by rising and falling in magnetic strength in order that voltage may be induced in the secondary.

While a direct current through the primary would cause the core to become magnetized and thus produce a magnetic field, this field would be stationary because the direct current would be steady. But an alternating current is constantly changing in value, first rising, then falling and reversing its direc-

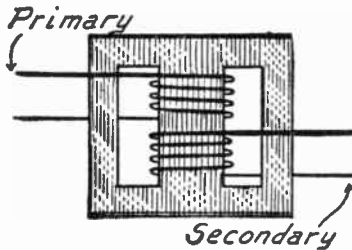

FIG. 3.—Shell Type Transformer.

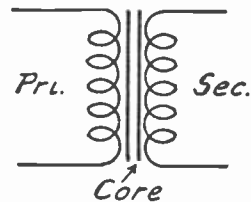

FIG. 4.—Symbol for Iron Core Transformer.

tion to once more rise. This fulfils the requirement of a moving field and voltage is induced in the secondary winding, but is induced only with an alternating or changing current in the primary.

It is not necessary that the current reverse its direction as does an alternating current, only that its value change to induce a secondary voltage. Such a change is caused by a pulsating direct current, one which is continually rising and falling in value although continuing to flow in the same direction.

If the secondary winding forms part of a closed circuit, the induced voltage will cause a current to flow in that circuit. The rise and fall of voltage and current in the secondary circuit will be at the same frequency as the rise and fall in the primary.

Transformers used in power circuits and in audio frequency circuits of radio receivers have cores as indicated in Fig. 1 for the core type, as in Fig. 2 for the open core type, and as in Fig. 3 for the shell type. The symbol for the steel core or iron-core transformer as shown in Fig. 4 is made up of two inductances with several lines between them, this indicating the two windings and their common core.

TRANSFORMER

For very high frequencies, such as radio frequencies, the change in magnetism of the core would be altogether too slow to get any real action. Transformers for radio frequency work are built with a very small iron core, or without any core except the air inside the coils as shown by Fig. 5. The magnetic field of one winding passes through the other windings and energy is transferred. Symbols for air-core transformers are shown in Fig. 6.

Transformer Ratios.—The sole purpose of a transformer is to get energy from one circuit into another and, if desired, to change the voltage and current of the secondary circuit to something different from these values in the primary. A transformer cannot produce power in itself and it should not consume any more power than absolutely necessary.

Electrical power is measured in watts and the number of watts in a direct current circuit is equal to the number of volts multiplied by the number of amperes in that circuit. A power of 100 watts may be secured from 2 amperes at 50 volts, from 10 amperes at 10 volts, from 50 amperes at 2 volts, or from any other combination of amperes and volts whose product is 100. The same general principles hold true for alternating current circuits.

In a transformer having no loss of energy within itself, 100 watts put through the primary winding would give up all its power and this power would reappear as 100 watts in the secondary. Of course such a perfect



FIG. 5.—Air Core Radio Frequency Transformer.

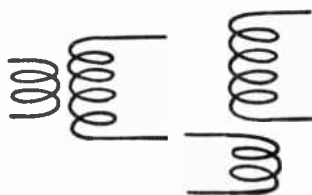

FIG. 6.—Symbols for Air Core Transformer.

transformer is not commercially or even experimentally possible. But for purposes of explaining the relations between voltages and amperages this condition of perfection will be assumed.

The change between the voltage and amperage in the primary circuit and the voltage and amperage in the secondary circuit depends on the turn ratio of the windings, that is, on the ratio of the number of turns in the secondary winding to the number of turns in the primary winding.

The ratio of secondary turns to primary turns is the same as the ratio of secondary volts to primary volts. That is to say, if we have ten times as many turns in the secondary winding as in the primary, we will have ten times as many volts in the secondary as in the primary. If we have one-half the number of turns in the secondary as in the primary, then the secondary voltage will be half of the primary voltage.

Since the power must be the same in both windings, an increase of secondary voltage means a decrease in secondary amperage while a decrease of secondary voltage will mean an increase of secondary amperage.

TRANSFORMER

Starting again with 100 watts of power and assuming the primary circuit to carry this 100 watts at 20 volts and 5 amperes, let us see what will appear in the secondary with different turn ratios. The transformer of Fig. 7, has twice as many turns on its secondary as on its primary. Since the turn ratio is 2/1 and the primary voltage is 20 the secondary voltage at the ratio of 2/1 will be 40. The secondary power must be the same as the primary power, therefore, the number of amperes in the secondary will be 100 (watts) divided by 40 (volts) or $2\frac{1}{2}$ amperes.

In the transformer of Fig. 8 there are 6 primary turns and 3 secondary turns so that the ratio of primary to secondary is $\frac{1}{2}$. Since the primary voltage is still 20 and the ratio is $\frac{1}{2}$ the secondary voltage must be 10. The number of watts in the secondary will be the same as in the primary, 100. Therefore, the secondary current will be 10 amperes, since 100 divided by 10 equals 10.

The transformer of Fig. 7 increases the voltage and is called a step-up transformer. The transformer of Fig. 8 reduces the voltage and is called a step-down transformer.

The relation between turns and voltage may be expressed by the following proportion:

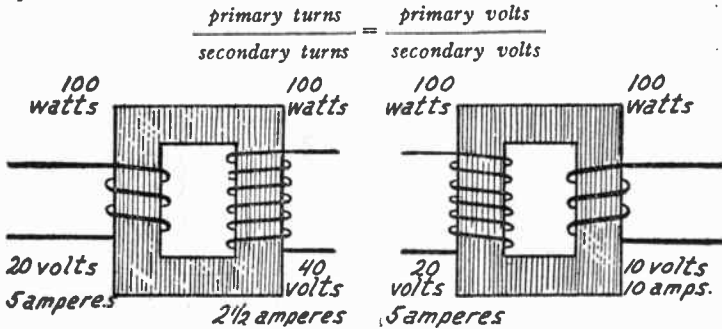

FIG. 7.—A Step-Up Transformer.

FIG. 8.—A Step-Down Transformer.

Inasmuch as the power in watts in the secondary is the same as the power in watts of the primary, the ratio between the currents in the two circuits will be in inverse proportion to the ratio of the number of turns in the two circuits. The proportion is as follows for current:

$$\frac{\text{primary turns}}{\text{secondary turns}} = \frac{\text{secondary amperes}}{\text{primary amperes}}$$

It will be noticed that the first parts of the two foregoing proportions are the same. Therefore, the second parts must be equal to each other and we can get a new proportion showing the relations between voltages and currents in the two circuits. This proportion is as follows:

$$\frac{\text{primary volts}}{\text{secondary volts}} = \frac{\text{secondary amperes}}{\text{primary amperes}}$$

These relations would be exactly true only for an ideal transformer with no losses. Even though they are not exactly true in practice they serve as a convenient basis upon which different transformers may be compared.

Transformer Losses.—There are a number of causes for loss of power in transformers. Power is consumed by the eddy currents

TRANSFORMER

set up in the metal of the core, also because of the hysteresis of the core iron. There is a copper loss represented by the power that is used in heating the windings of the transformers. Heat is also produced in the iron by the eddy currents and the hysteresis, this heat representing an iron loss.

In the theoretical transformers shown by the core type and the shell type of Figs. 1 and 3 all of the magnetic lines of force are shown as passing through the iron core. Consequently, all of the magnetic lines that pass through one winding pass also through the other. This condition is not realized in practice because some of the lines escape and do not flow through their proper path. This leakage of lines of force or "leakage flux" causes a loss of the energy in the lines of force which do not pass through all the turns of both windings, that pass through only part of each winding or through only one of the windings. The larger the core, the fewer turns in the coils and the closer together the coils are placed the less will be the leakage. The coils are often wound one over the other for this reason. In the construction of high grade transformers all of these losses are reduced as much as is commercially possible.

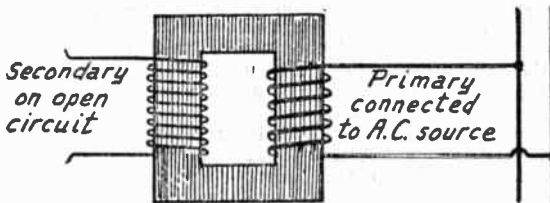

FIG. 9.—Transformer at No Load.

The copper loss due to resistance in the windings is reduced by using wire of large cross-section and by adequate allowance for radiation of the heat. The iron loss due to eddy currents in the core and to hysteresis is reduced by using iron having a low hysteresis, an iron which is easily demagnetized. These losses are also reduced by using iron of high permeability, iron which is easily magnetized. The leakage reactance or loss is reduced by using a large core and comparatively small windings. See *Current, Eddy; Hysteresis; and Permeability*.

Transformer Regulation.—If, as in Fig. 9, a transformer is connected to a supply line and allowed to remain with its secondary open-circuited the following action will take place. Current will flow from the supply line through the primary winding and will cause magnetic flux or lines of force in the core. This flux, which is rising and falling, will produce a voltage in the secondary. But it also reacts upon the primary and produces another and a new voltage in the primary. This new voltage in the primary is in addition to the voltage coming from the supply line. Its polarity is

TRANSFORMER, AUDIO FREQUENCY

opposite to that of the supply line voltage and it therefore tends to stop the flow of current.

This additional voltage increases in value until it stops all current from the supply line except just enough to produce a flux sufficient to maintain the opposing voltage. Therefore, a transformer connected to a supply line and having its secondary open-circuited will draw an exceedingly small current from the supply line. This exciting current is usually so small as to be negligible.

The condition illustrated in Fig. 9 is called the no-load condition. When the secondary of the transformer is connected to some form of current consuming or power consuming device, it is said to be loaded. When the transformer is putting forth the maximum power the condition is called full-load.

The change in the secondary voltage between no-load and full-load when expressed as a fraction is called the transformer regulation or the voltage regulation. As an example, if the voltage at the no-load were 100 and the voltage at full-load 90, we would have a drop of voltage of 10. The fraction representing the transformer regulation is written by placing the voltage drop over the remaining voltage. In the case just mentioned this fraction would be $10/90$ or $1/9$ or 11.1%. The regulation of this transformer would then be about eleven per cent.

Anything over ten per cent is generally considered as being poor regulation. In certain forms of power transformers poor regulation is undesirable. But in some other types of transformers poor regulation is an advantage. For instance, should the secondary become short-circuited a very heavy instantaneous load would be put upon it. The heavy current which would flow would tend to burn out the secondary winding. But if the transformer has poor regulation it will drop its secondary voltage to a low value, thus reducing the flow of current and preventing the burn-out.

Regulation depends upon the losses in the transformer, especially upon the copper loss and the leakage. A transformer with a high copper loss, due to the use of small wire, and with high magnetic leakage, will have poor regulation.

TRANSFORMER, AUDIO FREQUENCY.—The purpose of an audio frequency transformer used as a coupling device between two amplifying tubes is to receive the current changes from the preceding tube and to deliver to the following tube the greatest possible variations of voltage. The connections are shown in Fig. 1. An audio frequency transformer is often called an amplifying transformer because it is expected to amplify uniformly all of the frequencies which come to it.

Primary Winding.—If the primary of a transformer is small, has few turns and low impedance, the lower frequencies which should be amplified pass through this low impedance without having any great effect on the secondary. The low impedance does not allow the current changes to magnetize the core or to transfer their energy to the secondary, therefore the low frequencies are practically bypassed through the low impedance primary and are not amplified.

Theoretically the impedance of the primary winding should be about equal to the output impedance or plate resistance of the tube in its circuit. It is found that the primary impedance has to be about two and one-half times as great as the tube output resistance in order to fully amplify the lowest notes.

TRANSFORMER, AUDIO FREQUENCY

The primary impedance should be measured only under operating conditions, that is, with the secondary winding connected to a tube such as it will be called upon to operate when in actual service. The impedance of the primary may be increased by increasing the number of primary turns or by increasing the cross-section of the core.

Transformer Core.—To obtain the desired high impedance in the transformer primary it is generally better to use a core of large cross-section rather than to greatly increase the number of primary turns. If a small core is used it means that many primary turns are required and in order to obtain a step-up voltage ratio in the transformer the number of secondary turns will be still larger. When a great many secondary turns are used the distributed capacity of the secondary winding is increased and the higher frequencies are bypassed through this capacity and are not properly amplified.

In general the larger the core of a transformer the more uniformly it will amplify both low and high frequencies. Transformers having very small cores amplify well over a rather narrow range of frequencies.

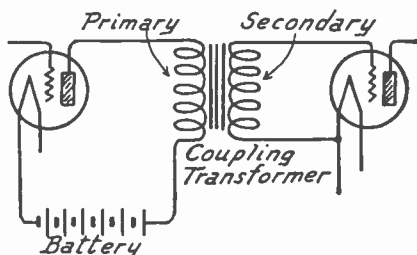

FIG. 1.—Connection of Audio Frequency Transformer Between Tubes.

High permeability is very desirable regardless of the size of the core. High permeability is found in silicon steel and aluminum steel which are used for transformer cores. If it were commercially possible to use perfectly pure iron such as electrolytic iron, or to use pure iron which has been remelted in a vacuum, the permeability might be increased to between three and four times its usual value. At the same time the coercive force would be reduced to about one-half its usual value. The cost of such iron prohibits its use.

In an amplifying transformer there are two currents flowing, one is the alternating current at audio frequencies, the other is the direct current from the B-batteries or power supply. The direct current is larger than the alternating current. If the transformer has a small core these two currents together may be great enough to saturate the iron of the core. This saturation causes the production of harmonics or frequencies which never existed in the signal as it was broadcast from the transmitting station. These harmonics are caused by changes in the flux density in the core when it is saturated and when it is not saturated. The effect is somewhat like the operation of a tube on the curved parts of its curve rather than on the straight part. See also *Iron and Steel*.

Distributed Capacity.—Distributed capacity between the turns of a transformer winding acts as a bypass for the high frequencies, thus reducing amplification. A large number of turns in a transformer winding gives a large distributed capacity which bypasses

TRANSFORMER, AUDIO FREQUENCY

and loses the higher frequencies. Thus a transformer of many turns which amplifies well at low frequencies is often poor at high frequencies. If the number of turns is reduced to reduce the distributed capacity the inductance is then lowered to such a point that it does not amplify low frequencies properly, therefore, it is a problem of obtaining the best balance between high frequency and low frequency amplification.

The distributed capacity in a secondary winding of many turns may be reduced by increasing the thickness of insulation on the wire. This increases the space between adjacent turns and reduces the capacity.

Resonant Peaks.—The combination of inductance and distributed capacity in the winding of a transformer forms a circuit which is resonant at a certain frequency, generally a rather high audio frequency. If a curve is drawn which represents the amplification of a transformer at different frequencies this curve will be found to have a more or less pronounced peak at one point. This

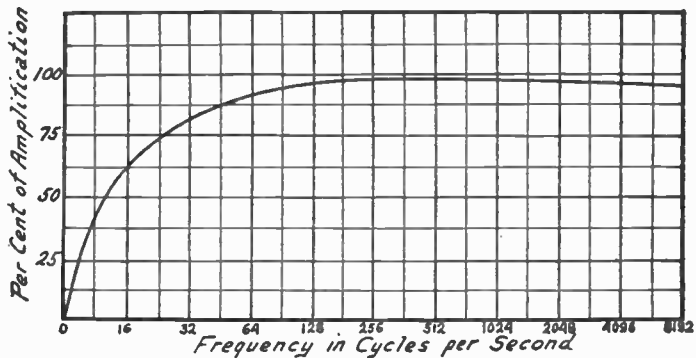

FIG. 2.—Amplification Curve for a Good Audio Transformer.

indicates the frequency at which resonance occurs. The impedance of the secondary is greatly reduced at this frequency, larger currents flow and the amplification is increased. See *Distortion*.

Placing a fixed condenser in parallel with transformer windings does not change the form of the amplification curve but moves the entire curve, also its resonant peak, to a lower frequency.

Amplification of Transformer.—Uniformity of amplification in a transformer is one of the greatest virtues this part of a radio receiver may have. Amplification is the ratio of the voltage delivered by the secondary circuit to the voltage delivered to the primary circuit at various frequencies.

The lowest audible frequencies are of the order of twenty per second. The highest frequencies of pure tones are around five thousand per second. The harmonics and overtones reach frequencies higher than ten thousand per second. An audio frequency transformer is expected to give perfectly even amplification to all of these frequencies. In practice it cannot be done but some

TRANSFORMER, AUDIO FREQUENCY

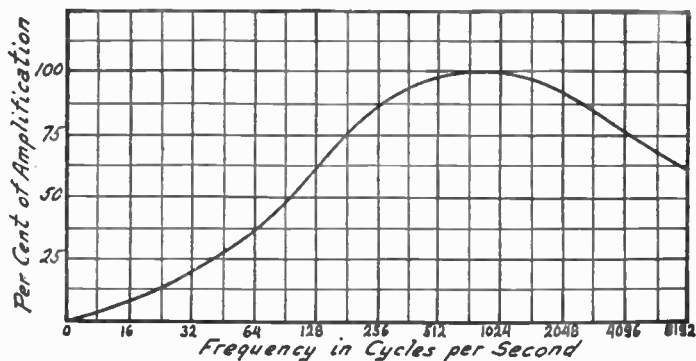

FIG. 3.—Amplification Curve of a Poor Audio Transformer.

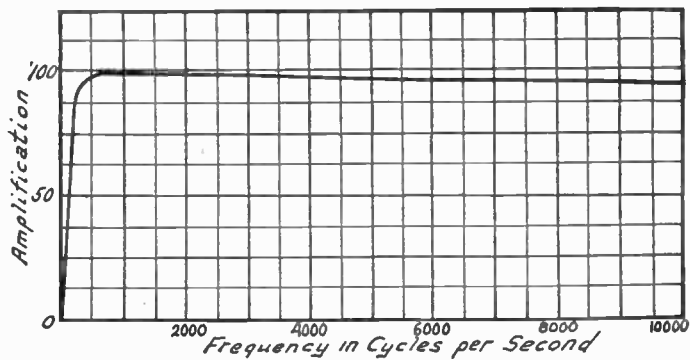

FIG. 4.—Curve for Good Audio Transformer Drawn on Arithmetical Scale

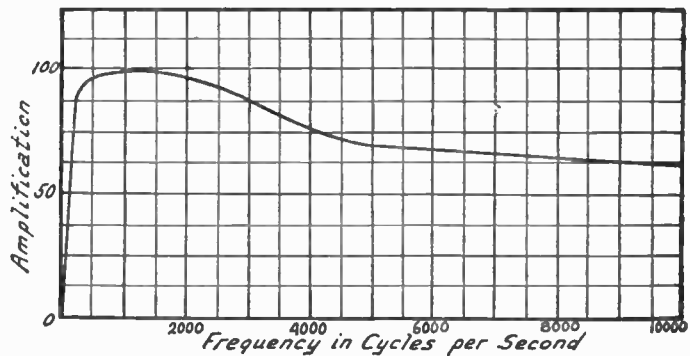

FIG. 5.—Curve for Poor Audio Transformer Drawn on Arithmetical Scale.

TRANSFORMER, AUDIO FREQUENCY

of the high grade transformers come remarkably close to the ideal. An amplification curve for one of the best audio frequency units is shown in Fig. 2. The amplification curve for a poor transformer is shown in Fig. 3. It will be seen that uneven amplification will cause notes of certain frequencies to sound almost twice as loud as notes of low frequency and to sound much louder than notes of higher frequencies.

An amplification curve for a transformer drawn with the vertical lines of the curve marked off evenly according to hundreds or thousands does not give a correct idea of the transformer's uniformity or lack of uniformity in amplifying different frequencies.

If the first key is struck in the various octaves of a piano, starting at the lowest notes and working toward the high notes, the same note in the second octave sounds twice as high pitched as that note in the first octave. It is actually true that the frequency is doubled for each succeeding octave. The lowest note on the piano vibrates at a frequency of 27 times per second. The frequencies of successive octaves in one kind of musical scale start with the

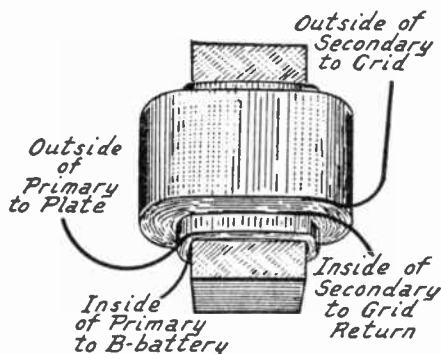

FIG. 6.—Windings and Connections of Audio Frequency Transformer.

following number of cycles per second; 32, 64, 128, 256 (middle C), 512, 1024 and 2048, etc. It is this type of scale that should be used in drawing curves of amplification. The amplification curves for a good transformer and for a poor one are shown in Figs. 2 and 3. They are drawn to this scale of frequencies. In Figs. 4 and 5, the same transformers are shown drawn to a scale which increases by hundreds—400, 800, 1200, 1600 and 2000. It will be seen that the second method makes the poor transformer appear almost as good as the better one.

It has already been explained that proper amplification of the low frequencies is secured by increasing the number of primary turns, by increasing the size of the core, and by using core iron of high permeability. The high frequencies are properly amplified in transformers having small distributed capacity.

Transformer Construction.—In the construction of transformers the secondary winding is on the outside and the primary winding is between the core and the secondary. Terminal connections of these windings are made as shown in Fig. 6. The out-

TRANSFORMER, AUDIO FREQUENCY

side of the secondary winding is connected to the grid of the following tube. The inside of the secondary winding is connected to the grid return, a C-battery or the filament circuit. The outside of the primary is connected to the plate of the preceding tube. The inside of the primary is connected to the B-battery or other voltage supply unit.

The cores in practically all iron-core transformers are made up of a large number of thin sheets of transformer iron or steel. These thin sheets are called laminations and the core is called a laminated core. The purpose of the laminations is to reduce the eddy currents. These eddy currents can flow only in the single laminations and cannot grow large by flowing through the entire mass of iron in the core. The laminations are electrically insulated from one another by the coating of scale upon their surfaces or by insulating varnish.

The arrows in Fig. 7 show the path taken by the magnetic lines of force and it is seen that the laminations are continuous so far as the magnetic path

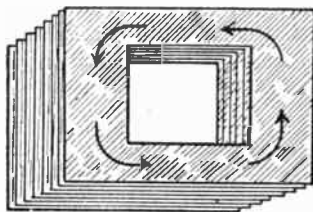

FIG. 7.—Laminated Core Construction for Audio Frequency Transformer.

is concerned. There is little reduction in the permeability of the core but the eddy current loss is reduced because any given eddy current is confined to the one thin lamination in which it arises.

Some audio frequency transformers are completely enclosed within a sheet iron housing. This housing forms a shield for the transformer and may be grounded. In the shell type of transformer the iron of the core forms a partial shield. The secondary winding is outside of the primary winding as in Fig. 6 and if the secondary carries no current there will be so little field around the transformer that shielding is almost uncalculated for. There will be no secondary current as long as the grid bias remains sufficiently negative.

Turn Ratio and Voltage Ratio.—It is desirable to obtain a step-up of voltage in a transformer provided this step-up may be had without sacrificing other desirable qualities, principal among which is uniform amplification at all frequencies.

In the explanation of the effect of turn ratio under the heading of *Transformer* ideal conditions were assumed. It is unfortunate that in practice the actual voltage ratio is not the same as the turn ratio but is considerably less. A transformer having a turn ratio of three to one will not deliver three times the voltage from its secondary circuit that is applied to its primary.

The voltage ratio is affected by the frequency being handled. The step-up of voltage is lower at low frequencies than at high fre-

TRANSFORMER, AUTO-

quencies. It is especially low when the windings are both of small impedance.

A transformer having a high turn ratio generally has a primary of small size and small impedance because the high ratio calls for a large secondary which takes up most of the winding space. When using such a transformer, with a small primary winding and a very large secondary winding, it is sometimes found that there is no step-up whatever or that there is an actual loss in voltage as well as in current.

The actual voltage ratio of a transformer is equal to the square root of the ratio of secondary impedance to primary impedance. Since impedance depends on frequency, on reactance and on resistance, it is apparent that the voltage ratio of a transformer may be something quite different from its turn ratio.

It has been shown that a large primary is desirable to amplify low frequencies while a small secondary is desirable to reduce distributed capacity and amplify high frequencies. A large primary and small secondary would prevent building the transformer with a step-up turn ratio to increase the voltage. The one factor which may be changed to improve both low frequency and high frequency amplification is the core. A large core built of iron having high permeability makes a better transformer from every standpoint.

The amplification of high ratio transformers is good at the middle frequencies but is generally very poor at low frequencies and quite poor at the higher frequencies. In Fig. 3 is shown the amplification curve for high ratio transformer (6 to 1) and in Fig. 2 for a low ratio (2 to 1) transformer. It will be seen that the high ratio instrument gives its best amplification between 500 and 2,000 cycles but gives much less amplification either below or above these frequencies. A high ratio transformer will deliver a great deal of volume but generally gives poor quality. This applies to ordinary transformers of low cost. Of course if a transformer is built large enough, which means costly enough, a transformer of moderately high ratio may be made to give practically uniform amplification at all frequencies.

TRANSFORMER, AUTO.—The auto-transformer has its primary and secondary windings conductively connected to each

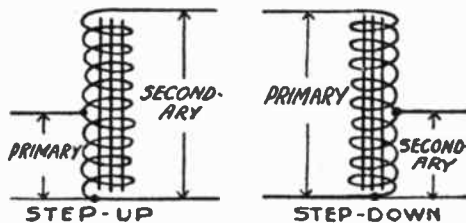

FIG. 1.—Principle of the Auto-Transformer.

other as shown in Fig. 1. In the step-up auto-transformer the entire length of winding is included in the secondary and only a part of it is in the primary circuit. In the step-down auto-transformer the entire length of winding is in the primary and only a part in the secondary circuit.

TRANSFORMER, AUTO-

The voltage ratio of an auto-transformer is the ratio of the number of secondary turns to the number of primary turns just as in any other type of transformer. This is shown in Fig. 2. The transformation or transfer of energy from primary to secondary is somewhat greater in an iron-core auto-transformer than in an ordinary iron-core transformer having two separate windings. This is because a part of the energy is transformed while part flows through

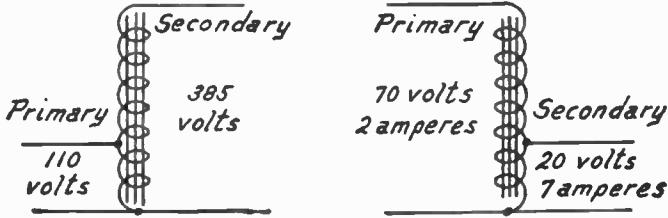

FIG. 2.—Voltage Ratios of Auto-Transformers.

the windings conductively. One form of auto-transformer is found in the type of impedance coupled amplifier which uses a tapped winding to obtain a step-up ratio of voltage.

Iron-core auto-transformers are used for power work such as battery charging transformers, also for audio frequency amplifier couplings in some forms of impedance or modified choke coupling. Air-core auto-transformers are fre-

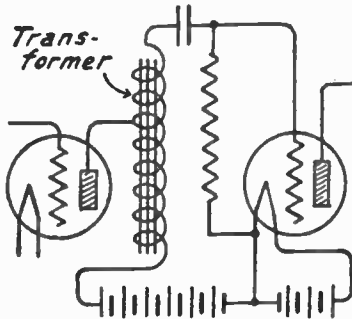

FIG. 3.—Auto-Transformer Interstage Coupling.

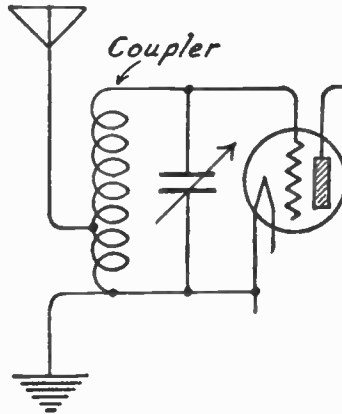

FIG. 4.—Auto-Transformer Antenna Coupling.

quently used as couplings for the antenna circuit and first tuned circuit in a radio receiver and are sometimes used as interstage couplings between radio frequency amplifying tubes. The general principle of auto-transformer interstage coupling is shown in Fig. 3 and the use of the auto-transformer as an antenna coupler is shown in Fig. 4.

TRANSFORMER COUPLED AMPLIFIER

TRANSFORMER COUPLED AMPLIFIER.—See *Amplifier, Audio Frequency, Transformer Coupled*; also *Amplifier, Radio Frequency, Tuned Transformer Coupled*.

TRANSFORMER COUPLING.—See *Coupling, Transformer*.

TRANSFORMER, MICROPHONE.—The transformer through which a microphone is coupled to the circuits of a radio transmitter. See *Modulation*.

TRANSFORMER, OSCILLATION.—A transformer used for coupling the output of an oscillating vacuum tube to another circuit or for coupling the output circuit to the input circuit so that the necessary feedback of energy may be provided for maintaining oscillation. See *Oscillator*.

TRANSFORMER, OUTPUT.—In radio receiving circuits, the transformer which couples the plate circuit of a vacuum tube to the loud speaker circuit. See *Speaker, Loud, Connections to Receiver and Impedance, Matching of*.

TRANSFORMER, PEAKED.—An audio frequency transformer having a resonant peak at a certain frequency which is to be received, thus allowing great amplification of this frequency. The peaked transformer is used in the reception of radio telegraph signals transmitted by continuous waves, the peak generally being between 900 and 1,200 cycles. Any audio frequency transformer may be peaked by the use of a fixed condenser across its secondary winding. See *Resonant Peaks* under the heading of *Transformer, Audio Frequency*.

TRANSFORMER, PHASE RELATIONS IN.—See *Phase Relations in Transformer*.

TRANSFORMER, POWER.—A transformer used for handling considerable power as distinguished from audio frequency and radio frequency transformers which handle extremely small powers as measured in watts. Small sizes of power transformers are used in battery chargers and power supply devices. Power transformers are of the iron-core type.

TRANSFORMER, PUSH-PULL.—A special form of audio frequency transformer provided with a center tap either in the secondary or in the primary winding. See *Amplifier, Audio Frequency, Push-Pull Type*.

TRANSFORMER, TUNED RADIO FREQUENCY.—A tuned radio frequency transformer is an air-core transformer designed for the transfer of energy between circuits operating at very high frequencies, at radio frequencies. This type of transformer consists of two or more air-core coils, as in Fig. 1. The factors entering into its design, its action, its construction and its losses of power are those of the coils of which the transformer is constructed. All such details are covered under the heading of *Coil* which should be referred to for further information.

TRANSFORMER, TUNED RADIO FREQUENCY

Amplification of Tuned Transformer.—The voltage amplification of an air-core radio frequency transformer depends only in part on the turn ratio. The leakage of lines of force between primary and secondary of a radio frequency transformer is so great and the coupling is necessarily so small that little or no voltage gain is actually realized when using the usual constructions.

With a tuned transformer the required inductance, or number of turns, in the secondary depends on the frequencies to be handled and on the maximum capacity of the tuning condenser used with the transformer. The number of turns in the secondary winding may therefore be regarded as a fixed quantity. Any increase in the number of primary turns will increase the transfer of power and with usual design will increase the voltage in the secondary up to the point at which the primary inductance is equal to the secondary inductance. In other words, the greatest gain is obtained in an air-core radio frequency transformer when the primary and secondary are alike in inductance.

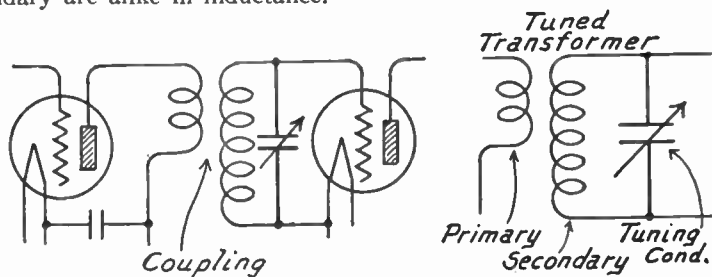

FIG. 1.—Tuned Radio Frequency Transformer Used as Coupler.

We may start with an air-core transformer having a turn ratio such that its secondary voltage is equal to its primary voltage. Then, leaving the secondary unchanged and increasing the number of primary turns, at first it will be found that doubling the original number of primary turns will nearly double the amplification and tripling the number will nearly triple the amplification. This gain of voltage amplification with multiplication of the number of primary turns does not continue indefinitely but grows gradually less until, when the primary inductance is greater than the secondary inductance, there is a loss of voltage because of the step-down effect.

It would seem possible to get extremely high voltage amplification and high transfer of power by increasing the primary turns until we had a transformer with a turn ratio of one to one. But the practical limit in gain is reached when it becomes impossible to control oscillation due to the feedback through the plate-grid capacity of the tube. With two or more stages of radio frequency amplification this limit is reached with an overall voltage amplification of about three to one in each stage.

The voltage amplification in air-core radio frequency transformers depends to a great extent on the degree of coupling between primary and secondary windings. Were the coupling in such a transformer gradually changed from very close coupling to very loose, and were the voltage amplification to be measured as the coupling changes, the conditions would be found as follows:

TRANSFORMER, TUNED RADIO FREQUENCY

The voltage amplification would be fairly high with the closest possible coupling, but the tuning would be broad. As the coupling was loosened, the voltage amplification would increase and would become maximum with only a moderately close coupling between the windings. Still looser coupling would decrease the voltage amplification until it would finally become minimum with very loose coupling. This is indicated in Fig. 2. See also *Coupling, Optimum*.

Maximum possible voltage gain in a radio frequency transformer is secured by using the largest primary that will allow control of oscillation and by experimenting to find the coupling that gives the greatest power gain or voltage gain in the amplifying stage of which the transformer is a part.

Effects of Tuning Condensers.—In a tuned radio frequency transformer the secondary is usually much larger than the primary, the turn ratio being somewhere in the neighborhood of three to one down to eight to one. Since the two windings are rather closely coupled, tuning the secondary circuit to a certain frequency has

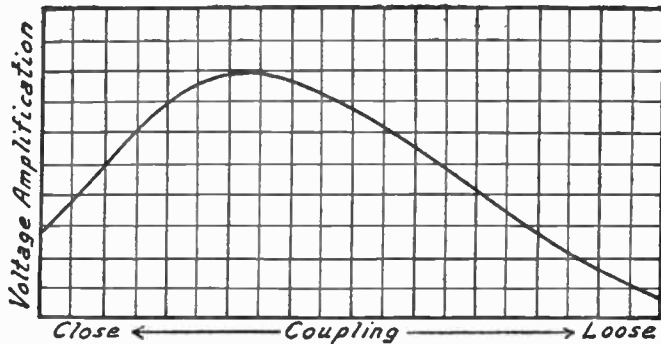

FIG. 2.—Effect of Coupling in Tuned Radio Frequency Transformers.

the effect of tuning the primary circuit to the same frequency because the two windings have a fairly high mutual inductance.

Therefore, it is not necessary to tune the primary circuit with a separate condenser, although this is sometimes done as in Fig. 3. With the primary separately tuned to the frequency being received and with the secondary also tuned with its own condenser to the same frequency, it is possible to get a very great transfer of power from primary circuit into secondary circuit. The impedance is reduced to a minimum in both circuits and the received frequency causes maximum current to flow in both. With this scheme, feedback of energy is very difficult to control since the primary winding in the output circuit of a tube is tuned to the same frequency as the input or grid circuit not only of the following tube, but also of the same tube. The feedback through the capacity between plate and grid is large enough to cause oscillation unless there is great damping or a large load of some kind on the tube's grid circuit.

TRANSFORMER, TUNED RADIO FREQUENCY

As a general rule the tuning condenser in the secondary circuit of a radio frequency transformer should have the smallest capacity that will allow tuning over the entire range of broadcasting frequencies or other frequency band to be handled. This allows the largest possible inductance in the secondary winding, the largest possible coil as indicated in Fig. 4. The greater the coil's inductance the greater will be the voltage changes across its ends when

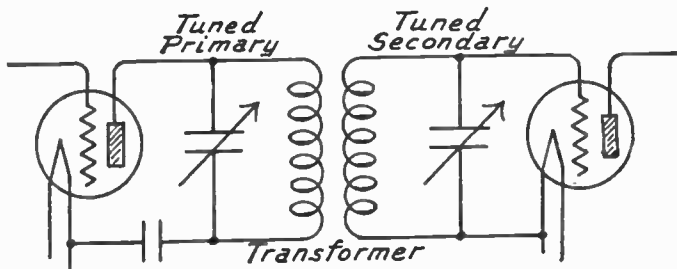

FIG. 3.—Radio Frequency Transformer with Tuned Primary and Tuned Secondary.

power is applied to it. These greater changes in voltage are applied to the grid of the following tube, resulting in considerably greater overall amplification than is secured with a small coil and a large condenser in the tuned circuit of the transformer.

The limit of coil size or inductance in a tuned radio frequency transformer is reached when the secondary circuit has a natural frequency within the band

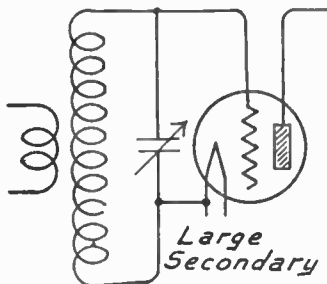

FIG. 4.—Large Secondary Giving Increased Power or Voltage.

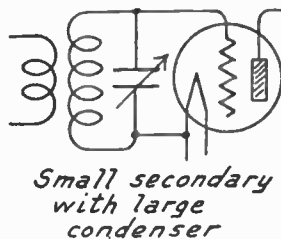

FIG. 5.—Small Secondary Reducing Voltage and Increasing Stability.

of frequencies to be handled by the receiver. If the coil has large inductance it may be found that the combination of the coil's distributed capacity and the tuning condenser's minimum capacity will form a circuit which is resonant to some high frequency. That is, the inductance of the coil together with the capacities of coil and condenser will tune naturally to some high frequency or low wavelength.

If the frequency is within the broadcasting band, for a broadcast receiver, it will be impossible to tune to any higher frequency or any lower wavelength because the minimum of capacity is not low enough. Then the coil con-

TRANSFORMER, UNTUNED RADIO FREQUENCY

struction must be changed to reduce its distributed capacity, the condenser must be changed for one having a lower minimum capacity, or a smaller coil and larger condenser must be used as in Fig. 5.

A condenser placed across the secondary winding of a transformer not only acts as a capacity across this winding but also has an effect on the primary winding that is much the same as though a condenser were connected across the primary. This effect of the capacity across the secondary reacts on the primary inversely as the square of the turn ratio. This is strictly true only with the closest possible coupling, a condition which never exists in radio frequency transformers. But with actual couplings the effect still exists to a considerable degree.

As an example of this effect on the primary assume a transformer with ten primary turns and fifty secondary turns, a turn ratio of 10/50. The square of this ratio is 100/2500, or 1/25. Then, with a condenser of .0005 microfarad capacity across the secondary, there would be the effect of 1/25th this capacity, or .00002 microfarad, across the primary winding.

Matching of Transformers.—When a radio frequency amplifier includes two or more radio frequency transformers these transformers should be like one another in every respect.

While it is not necessary to wind the primary turns in the same direction as the secondary turns, clockwise or anti-clockwise, the primary windings in all transformers should be wound the same way and the secondaries in all the transformers should likewise be wound the same way.

TRANSIT TIME

TRANSIT TIME.—See *Tube, Transit Time in.*

TRANSMISSION.—See *Broadcasting*; also *Radiation.*

TRANSMISSION, BEAM.—Transmission or radiation of radio waves in only one principal direction from a transmitter rather than in all or random directions. The principle of wave reflection is used. The reflector may be composed of a number of vertical wires placed around the transmitting aerial in the form of a parabola, with the aerial at its focus. Reflectors may also be of sheet metal, shaped in general like reflectors used for visible light.

TRANSMISSION LEVEL.—The signal power or radio field intensity at some point in a communication system, either in relation to some reference value or in absolute units.

TRANSMISSION LINE.—An audio frequency circuit in which distortion due to distributed capacity and inductance have been reduced. See *Public Address Systems.*

TRANSMISSION UNIT.—See *Unit, Transmission.*

TRANSMITTER.—Apparatus for production and signal modulation of radio waves. Includes the oscillating, amplifying and modulating circuits. See *Broadcasting.*

TRAP, WAVE.—A circuit for attenuating or absorbing interfering signals of an undesired frequency. The most common trap consists of a parallel resonant circuit in series with the receiver antenna lead-in. The trap circuit is tuned to the undesired frequency, whereupon it forms a very high impedance to that frequency. Another form of trap consists of a series resonant circuit with its inductance coil loosely coupled to another coil connected in series with the antenna lead-in. When tuned to the unwanted frequency there is absorption of power at that frequency.

TRIODE.—See *Tube, Triode.*

TROUBLE, CIRCUIT, OPEN, LOCATION OF.—An open circuit is a conducting path which is not complete from the source of current to the current consuming device and back again to the source. No current will flow in any part of a circuit that is open. Opens may occur in any of the circuits of a radio receiver. These circuits are described and shown under the following headings: *Antenna, Circuit of*; *Circuit, Filament*; *Circuit, Grid*; and *Circuit, Plate.*

Open circuits are located by bridging around the open point with some device which will indicate voltage or a flow of current. In radio work circuit testing of all kinds is easily done with a pair of headphones or with a voltmeter to which are attached rather long flexible wires ending in test points.

The principle of testing for open circuit is shown in Fig. 1. The battery is connected to the circuit *A-B-C-D*. The circuit is assumed to be complete

TROUBLE, CIRCUIT, OPEN

from the left hand terminal of the battery to point *A*, on through to point *B* and on to point *C*. But the resistor between *C* and *D* is assumed to be open circuited. Consequently no current will flow from the battery into any part of the circuit.

If a voltmeter is connected temporarily between points *A* and *B* no voltage will be indicated because there is no current flow and no voltage drop between these points. But when the voltmeter is connected across the resistor *C-D*, battery voltage will be indicated by the voltmeter because the circuit is complete from the battery around to point *C* and also from point *D* back to the battery.

The voltmeter is bridged across each part or section of the suspected circuit and when it indicates battery voltage the open circuited connection or units exists between the points to which the voltmeter is then connected. The voltmeter's range should be at least as great as the maximum voltage of any battery or power supply unit in the circuit.

Headphones may be used in place of the voltmeter and the test may be made exactly as shown in Fig. 1. When the headphone cord tips are touched to the circuit at points such as *A* and *B* there will be no sound. But when

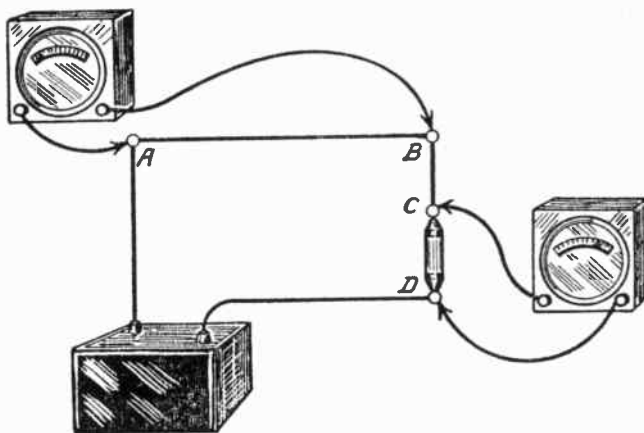

FIG. 1.—Principle of Testing for Open Circuits.

the phone tips are touched to points such as *C* and *D* between which exists an open circuit there will be a sharp click as the phone connection is made and another click as the connection is broken. But while the connection of the phones is complete there is little or no sound.

Because the phones give no sound while they are completing a circuit around an open place they are not as satisfactory for testing as the voltmeter because the voltmeter gives a continuous reading or indication as long as it remains connected to the circuit.

In Fig. 2 is shown a filament circuit from A-battery to tube and back to battery. This circuit includes the battery, the filament switch, the filament rheostat, the tube itself and the wiring between these units.

One side of the voltmeter is connected to one side of the battery and allowed to remain there during the test. Starting from the battery the other side of the voltmeter is temporarily connected to each point in the circuit as shown by the broken lines.

TROUBLE, CIRCUIT, SHORT

As long as complete parts of the circuit are being thus bridged there will be no reading of the meter. But when the meter does show voltage it indicates that the open point is between the place then being touched and the last one touched at which there was no reading.

Thus, in Fig. 2, the meter might be connected to both sides of the switch, then to both sides of the rheostat; and with the connection made to the side of the rheostat farthest from the battery a voltage reading might be secured. This shows an open circuit between the point then being touched and the last one touched. These two points are the two terminals of the rheostat, consequently the rheostat is open circuited, possibly burned out.

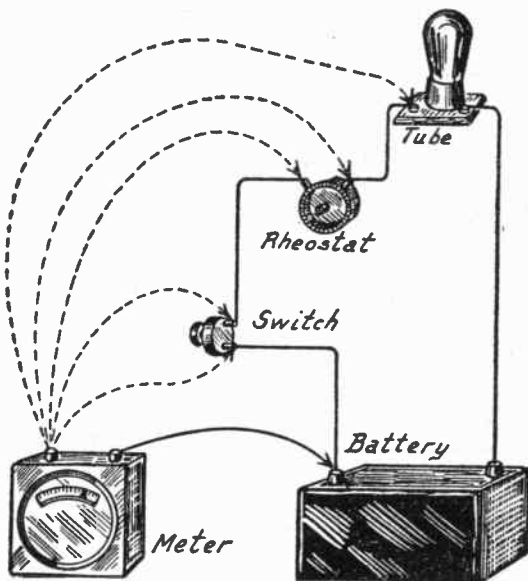

FIG. 2.—Testing Filament Circuit for Opens.

No voltage may be found at one end of a wire while at the other end of this wire the meter may give an indication, thus showing that the open circuit exists in the wire or its connections. The same principle may be applied to the location of open circuits in any part of the receiver.

TROUBLE, CIRCUIT, SHORT, LOCATION OF.—A short circuit is formed by a connection between two conductors carrying different voltages, this connection allowing current from a source, such as a battery, to pass back to the source without having gone through the parts which are to be operated by the current under normal conditions.

TROUBLE, CIRCUIT, SHORT

If the filament circuit of Fig. 1 has the two wires touching at *A*, this point forms a short circuit because battery current flows through this short and back to the battery rather than flowing through the tube's filament. A short circuit generally draws a current heavier than normal from the source although in the case of plate circuits and grid circuits this may not be the case.

The most certain way of locating a short circuit is by connecting the voltmeter in series with the battery at one of the battery ter-

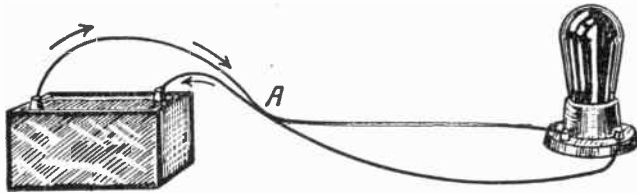

FIG. 1.—Short Circuit in Filament Lines.

minals as in Fig. 2 and then proceeding as follows: The short circuit will cause the meter to read full battery voltage while at the same time the damaging effects of the short are stopped by the meter's high resistance.

The circuit leading away from the meter is now to be opened, one point at a time, until the opening of some one point does not stop the indication of voltage on the meter. As an example, supposing the short to be at the point indicated in Fig. 2. Opening the circuit at the switch will cause the meter indication to drop to zero. The next point is the rheostat and opening

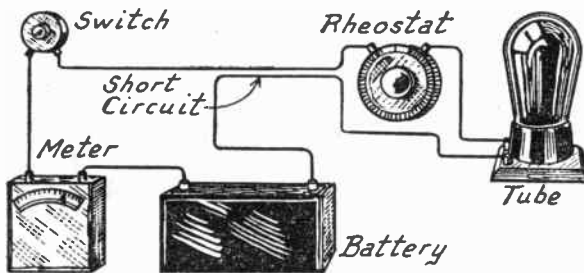

FIG. 2.—Testing for Short Circuit with Voltmeter.

the circuit at the rheostat will not cause the meter indication to drop to zero because the circuit is still complete through the short somewhere between the rheostat, now opened, and the battery.

Therefore, as each point is opened observe the meter. If it drops to zero, continue along the circuit, opening the various points. When opening some one point does not cause the meter to drop to zero it indicates that the short circuit lies between this point and the last one opened. Every portion of any circuit may thus be tested, even though it may sometimes be necessary to disconnect wire ends from their terminal connections. The same principle may be applied to the location of short circuits in any circuit of a receiver.

TROUBLE, RECEIVER

TROUBLE, RECEIVER AND POWER UNIT.—In the following pages are outlined some of the principles employed in the testing of complete receivers or amplifiers, and of certain of their parts. The tests are chiefly for circuit continuity, shorts, opens and high resistance, rather than for amplification, tone, distortion, and selectivity. These latter performance characteristics are treated under their respective headings. The test circuits are shown with triode tubes, although the same general principles would apply with tetrodes and pentodes.

Troubles in operation result from old or defective tubes more often than from any other single cause. Substitution in one socket after another of tubes known to be in good condition and of suitable type is the simplest and surest way of locating such troubles. The most common faults of tubes are burned out heaters or filaments, and insufficient cathode emission due to long use or to misuse. These two faults may be detected by means of a simple tube tester that checks nothing more than the rate of emission. Such testers sometimes are arranged to detect short circuits between elements in a tube. To make an effective check of mutual conductance or other tube characteristics requires more elaborate equipment.

Analyzers are constructed along the same general lines as the simple receiver testers shown in following pages, although the analyzers have enough different types of sockets to handle all the common tubes and have switching arrangements that permit tests to be made accurately and quickly.

Testing Operation of Each Stage.—Broadcast receivers include one or more stages of radio frequency amplification, intermediate-frequency amplification, a detector and one or more stages of audio frequency amplification. By simple tests it is possible to determine which of the stages contains a defect which makes the receiver inoperative or which makes its operation unsatisfactory.

The circuits of a typical stage of radio frequency amplification are shown in Fig. 1. If this is the first stage, the antenna and ground will be connected substantially as shown by the broken lines, otherwise the primary of the first transformer is connected in the plate circuit of the preceding tube just as the primary of the second transformer is connected in the diagram.

Now, if the first radio frequency amplifying tube be removed from its socket and the antenna connected to the plate terminal or the plate prong hole in this socket, the first stage will be effectively cut out and the second stage of the receiver will operate as an antenna stage. From the diagram it will be seen that an antenna connection made to the plate of the tube will cause the primary of the second transformer to become a part of the antenna circuit. The ground connection need not be changed since, from the *B* end of the primary winding there is always a connection through the plate power unit to the B-minus side of the circuit and from this point a connection is made to ground.

With this temporary antenna connection the receiver may be operated in the usual manner. Even with all parts following the temporary antenna connec-

TROUBLE, RECEIVER

tion in good working order, the signal volume will be somewhat less than normal because of using one less stage of amplification. However, satisfactory operation at the reduced volume indicates that all parts beyond this first stage are in working order and that the fault lies between the primary winding of the second radio frequency transformer and the antenna and ground connections marked *A* and *G*. The parts to be suspected include the primary and secondary windings of the first transformer, also their terminal connections;

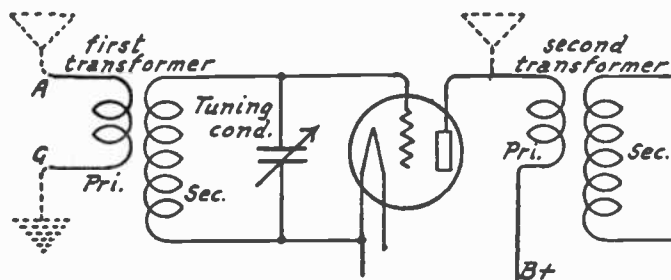

FIG. 1.—Antenna Connections for Testing Radio Stages.

the tuning condenser and its connections; the tube and its socket with their connections; also the primary of the second transformer only in its connection to the plate voltage supply.

In any of these tests, but one tube at a time should be removed from its socket. Tubes for the sockets of which the tests have been completed should be replaced before the following tube is removed so that there will not be an excessive filament voltage applied to the tubes remaining in place. Filament transformers and filament resistors handling more than one tube are designed to carry a certain current at their rated voltage and when the current is reduced by removal of tubes the voltage will rise.

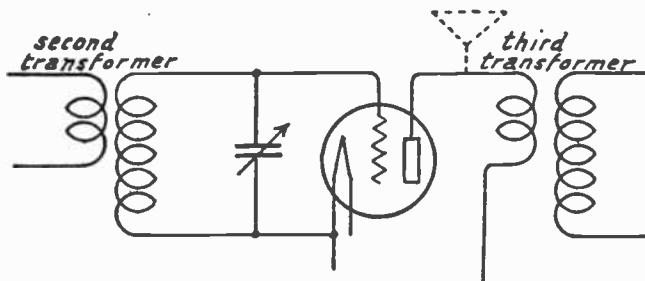

FIG. 2.—Testing the Second Stage.

If operation is still completely unsatisfactory the second radio frequency tube is removed. The temporary antenna connection is then made to the plate connection of the second tube as in Fig. 2. This will test the parts of the second stage, including everything from the second transformer, through the tuning condenser and tube to the primary of the third transformer. Should there be a third radio frequency tube a similar test may be made at its socket and so on for all the tubes up to, but not including, the detector.

TROUBLE, RECEIVER

Having tested all the radio frequency amplifying stages it is next in order to make tests on the audio frequency amplifying stages, working from the loud speaker connections back toward the detector tube. The first test is shown in Fig. 3. The two speaker leads are disconnected from the receiver or amplifier. One of the leads from a separate speaker of the high impedance type (not a dynamic) is touched to the plate connection of the power tube socket and the other is touched to the high voltage connection of the plate power supply unit as shown. Should the speaker then operate it indicates that the fault lies between the plate of the power tube and the speaker connections and that the power tube and all of the amplifier back of the tube are in good order. In this test the power tube is allowed to remain in its socket. Care must be exercised in making the temporary connections to the speaker since high voltages are present. It is best to make temporary connections with the amplifier turned off and to turn it on after the hands are removed. The

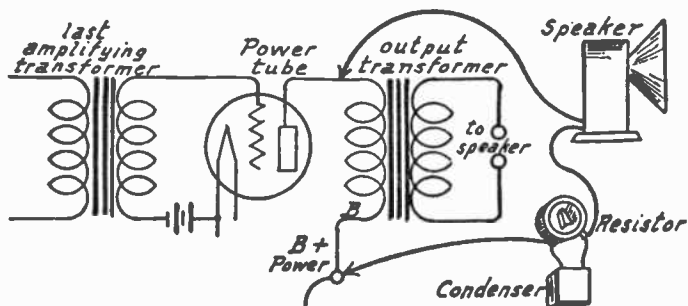

FIG. 3.—First Test on Audio Amplifier with Transformer Speaker Coupling.

moving coil of a dynamic speaker will not respond if connected directly to the plate of a tube, consequently it is necessary to test with a magnetic speaker or with a moving coil type fitted with a self-contained coupling transformer.

Examination of the diagram in Fig. 3 will show that the speaker is connected in parallel with the primary winding of an output transformer or speaker coupling transformer. This will reduce the volume from the speaker but will still allow its operation. Should the primary circuit of the output transformer be open, all of the plate current for the power tube would flow through the speaker windings and if this tube is one of the larger types the amount of current may easily cause damage. To prevent such danger it is advisable to place an adjustable high resistance and a bypass condenser in parallel with each other and in series between the speaker and the amplifier as shown in Fig. 3. The resistor should have a maximum resistance of 10,000 ohms and should be able to carry the full current of the power tube used. See *Resistor*. The condenser should have a capacity of one microfarad or more. In commencing the test, the full amount of resistance should be in circuit, and it may then be reduced until the speaker will make some sound as the tube plate connection is made and broken. If the speaker connection

TROUBLE, RECEIVER

is made through a choke and condenser as shown in Fig. 4, the test is made in essentially the same way.

Having tested the speaker coupling, the next step is to test the final audio frequency amplifying stage as indicated in Fig. 5. With all tubes in place and turned on, one of the speaker leads is touched to the plate connection of the audio amplifying tube which precedes the power tube and the other speaker lead is touched to the connection for the amplifier plate voltage supply.

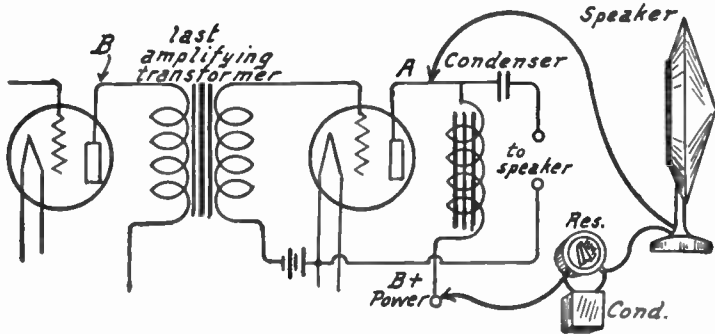

FIG. 4.—First Test of Audio Amplifier with Choke Speaker Coupling.

The speaker is then connected directly between the plate of this amplifying tube and the plate current supply with the primary winding of the last coupling transformer in parallel with the speaker. The speaker should operate provided the audio frequency tube and all parts preceding it are in working order. Operation of the speaker in this test indicates that the trouble lies between the audio amplifying tube and the speaker coupling devices, the parts including those shown between A and B in Fig. 4; the last coupling transformer, the power tube and their connections.

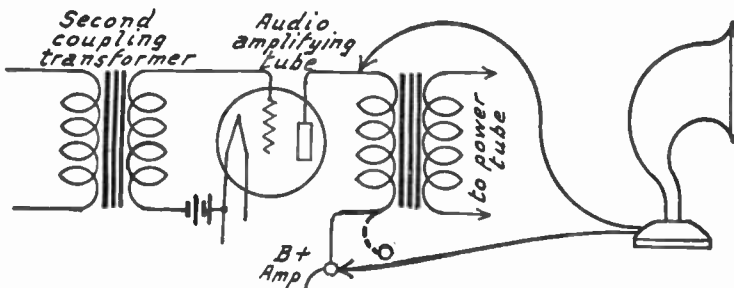

FIG. 5.—Second Test on Audio Amplifier.

In the test described, the primary winding of the last coupling transformer is in parallel with the speaker. A more satisfactory test may be made by removing this primary winding from the circuit so that only the speaker is in the tube's plate circuit. The removal is accomplished by first disconnecting from the power unit the wire running from it to the connection for the audio amplifier plate voltage. This connection is generally marked "B + Amp," "B + 90" or something similar. One line from the speaker is then touched to

TROUBLE, RECEIVER

the power supply terminal while the receiver connection is removed as indicated by the broken line in Fig. 5.

The next test is similar to that of Fig. 5, except that connection is made to the plate connection of the detector tube and to the plate voltage connection for the detector tube. The volume available in this test will be too small for operation of a loud speaker, therefore it will be necessary to make the connections from a pair of headphones. Satisfactory reproduction of sound from the headphones indicates that the detector tube and all parts between it and the antenna are working and that the trouble lies in the following coupling transformer, the following audio tube or their connections.

Testing Circuits While in Operation:—In most modern receivers it is quite difficult to reach directly the coupling transformers and wiring connections in order to make tests. In all receivers the easiest parts to reach are the tubes and fortunately almost all circuits come more or less directly to the tube socket connections which are easily reached for test work.

The general scheme of connections for any type of amplifying stage is shown between the broken lines in Fig. 6. The input is

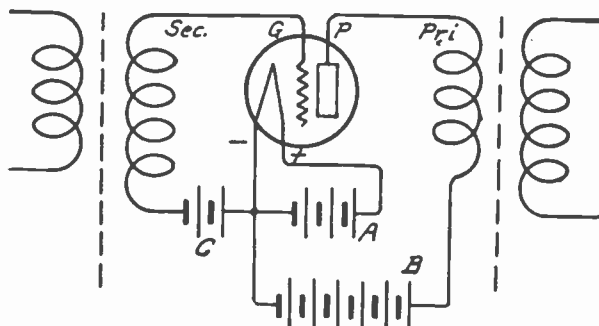

FIG. 6.—Circuits of Amplifying Stage.

from the secondary of a transformer and the output is to the primary of a transformer. The filament supply, either a transformer, a rectifying unit or a battery, is indicated at *A*. The plate supply, either a power unit or a battery, is indicated at *B*. The biasing voltage is indicated at *C*. The four terminals of an ordinary tube are indicated by *G* for the grid, by *P* for the plate and by + and — for the two filament connections. The tube fits into a socket having corresponding terminals.

Test connections are made as shown in Fig. 7, extra connections being brought out from the socket in the receiver to an extra socket in which is placed the tube found in the receiver socket. Connection to the receiver socket is made by means of the base taken from a broken or burned out tube. The base is prepared by first breaking away as much of the glass as possible, then immersing the base in boiling water to soften the cement so that, with remaining particles of glass, it may be scraped away by using a knife blade. Inside the base will be seen wire leads running down into the prongs. The prongs are hollow, the wires being soldered in place. To remove these wire leads, catch the base in a vise, pull with pliers on the wire and

TROUBLE, RECEIVER

while pulling touch the outer end of the corresponding prong with a hot soldering iron, whereupon the wire will come out. The iron should be very hot so that the work is completed before the entire prong becomes heated. Heating the whole prong will loosen it in the base which is made of phenol material. Should a prong become loosened it may be tightened by holding its exposed portion in a vise while spreading the inner end with a blunt punch tapped with a hammer.

New leads of stranded rubber covered wire are now to be inserted. The opening through a prong is large enough to take only five or six strands of the new wire, so the remainder should be trimmed away and the strands to be used twisted together. With the base held in a vise the bared end of the new lead is started into the prong from inside the base. The hot soldering iron is then touched to the end of the prong to soften the remaining solder while the new lead is pushed through. The extra length of wire now exposed outside the prong's tip is clipped off and a drop of solder applied. The job is finished by dressing off any excess solder with a fine file. In this manner a new wire is soldered into each prong, being left long enough to reach the

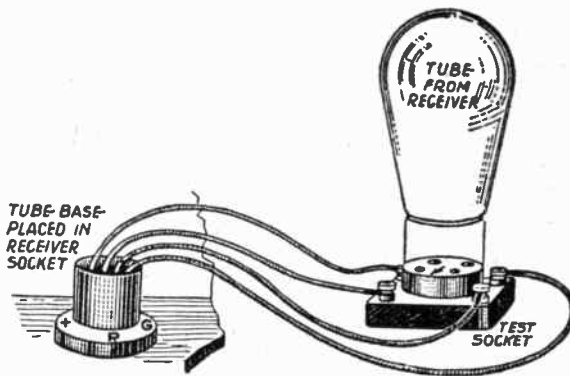

FIG. 7.—Tester Connection To Receiver.

test socket placed two feet or more away. The interior of the base is filled with sealing wax to support the wires and give a finished appearance.

Testers of varying degrees of completeness may be constructed around the test socket. If the available outlay allows, it is convenient to permanently attach meters suitable for testing plate current, plate voltage, filament current, filament voltage and grid bias. If meters cannot be spared for this work alone it is satisfactory to provide the necessary terminals to which meters may be attached when the tester is to be used. Suitable connections for the former plan are shown in Fig 8, all the meters being permanently connected with the test socket.

To operate the tester, a tube is removed from the receiver and the base with its attached wires is inserted in the socket left vacant. The tube is then put into the test socket and the receiver placed in operation as usual. The filament ammeter will show the amount of current flowing to the filament, the filament voltmeter will show the voltage across the filament and the plate milliammeter will show the number of milliamperes in the plate circuit.

TROUBLE, RECEIVER

Closing the plate switch will show on the plate voltmeter the voltage actually applied between the plate and the B-minus line. Closing the grid switch will show on the grid voltmeter the negative biasing voltage acting on the grid. Closing either of these switches will prevent the amplification of signals, this being the reason for providing disconnecting switches for the two meters.

The filament meters will be of D.C. types if a direct current filament tube is to be tested and will be of A.C. types if the filament or heater supply is alternating current. The filament ammeter for D.C. tubes must measure from one-eighth ampere to one and one-quarter amperes; for A.C. tubes it must measure from one-third ampere to two and one-half amperes. The filament voltmeter for D.C. tubes must measure up to six volts and for A.C. tubes should measure up to fifteen volts. The plate milliammeter is always of the D.C. type and should measure up to 100 milliamperes. The plate voltmeter is required to measure all voltages from the twenty or more applied to detector

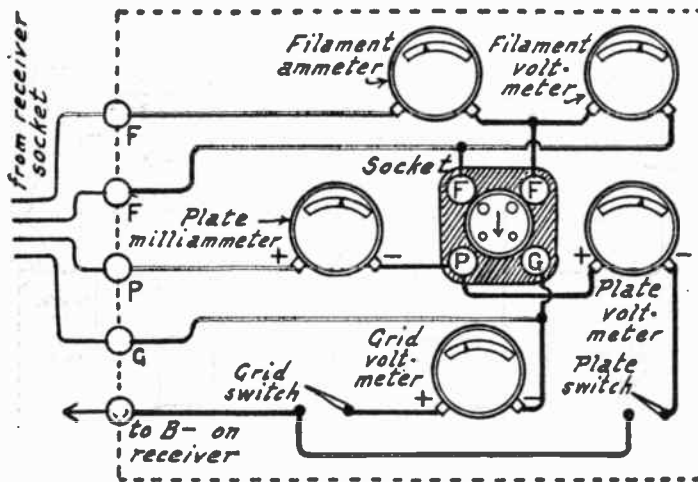

FIG. 8.—Receiver Tester with Attached Meters.

tubes up to more than four hundred volts applied to large power tubes. A double range meter, something like 0-100 volts and 0-500 volts is most satisfactory. The plate voltmeter must be of the high resistance type, 800 to 1000 ohms resistance per volt. The grid voltmeter, also of the high resistance type, will be required to measure biasing voltages as high as eighty to ninety when handling large power tubes, yet must accurately measure biases as low as one or two volts. This makes it advisable to use a double range meter in this position, something with ranges of 0.10 and 0.100 being satisfactory.

The connections of test sockets for use with separate meters are shown in Fig. 9. Both a four-prong A.C. or D.C. filament socket and a five-prong A.C. heater type socket are shown since either or both types may be required in testing a single receiver. The five meters are connected as required between the terminals indicated with due regard to correct polarities, positive and negative. The meters should be of the same types specified for the tester of Fig. 8. If a filament ammeter is not used, the terminals to which it would be attached are connected together, otherwise the tube would not light. The plate milliammeter terminals must be connected together when this meter is not used or there will be no plate supply for the tube. The voltmeters may or may not be used, their use or omission having no effect on the operation of the tube except that

TROUBLE, RECEIVER

signals will not be amplified while the plate voltmeter or the grid voltmeter are connected to the sockets.

A tester which will locate most troubles may be made without all of the meters shown. The plate milliammeter and plate voltmeter are most necessary, the filament voltmeter comes next, then the grid voltmeter and finally the filament ammeter in the order of their usefulness.

The type of tester here described allows all important voltages and current to be measured while the receiver is operating under normal conditions. From the tables given under *Tube, Characteristics of* may be learned the correct combinations of filament voltage, filament current, grid bias, plate voltage and plate current for any generally used tube. A radical departure from any of the values in a given combination indicates trouble, the value actually found giving a direct check on the troubles which are probably present.

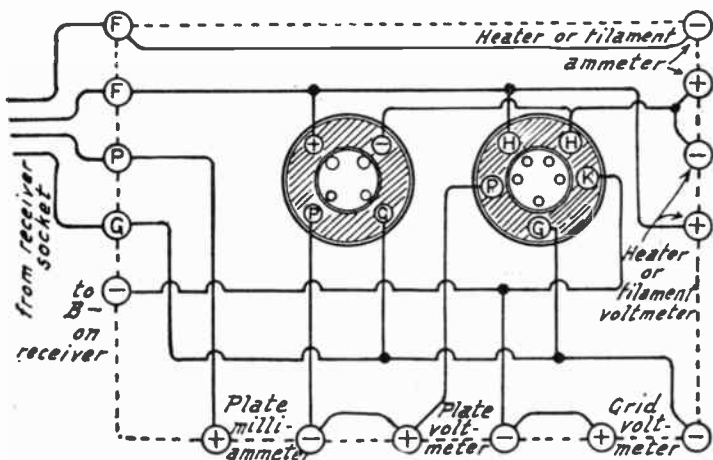

FIG. 9.—Test Board with Sockets.

In the following table are listed most of the probable causes of various incorrect meter readings:

Plate Voltage and Plate Current Both Too Low or Zero:

Open circuit, ground or short circuit in plate wiring of receiver.

Poor connections or loose joints in plate wiring of receiver.

Poor contact on plate prong in socket.

Short across bypass condenser between end of plate winding and B-minus line.

When testing detector tube, shorted plate bypass condenser.

Short circuit between coil in plate circuit and coil in following grid circuit or between windings of transformer in plate circuit.

With resistance coupling, plate resistor burned out, disconnected or of too high value.

With resistance or impedance coupling, plate circuit coupling condenser short circuited.

Old and worn out B-battery.

Shorts or grounds in high voltage lines of power unit.

TROUBLE, RECEIVER

- Open circuit in power unit wiring.
- Incorrect connections to power unit terminals.
- Wrong adjustment of power unit voltage divider resistors.
- Open circuited resistor in power unit voltage divider.
- Shorted bypass condenser on power unit voltage divider.
- Short circuited voltage regulator tube in power unit.
- A.C. supply line voltage too low.
- Short circuited or leaky condenser in power unit filter or voltage divider.
- Disconnected or open circuited first filter condenser in power unit.
- Open circuited filter choke in power unit.
- Defective rectifier in power unit.
- Burned out or disconnected transformer in power unit.

Plate Voltage and Plate Current Both Too High:

- Wrong connections to power unit.
- A.C. supply line voltage too high.
- Open circuited or short circuited resistor in power unit voltage divider.
- Short circuited filter choke in power unit.
- Defective voltage regulator tube in power unit.
- With resistance coupling, short circuited plate resistor.

Plate Voltage Too Low and Plate Current Too High:

- Tube oscillating.
- With resistance or impedance coupling or when testing detector with grid leak, disconnected or open circuited grid leak.

Plate Voltage Too Low and Grid Bias Polarity Reversed:

- Windings of preceding transformer short circuited on each other.
- Grid and plate short circuited in tube.

Plate Voltage Too Low and Filament Voltage High:

- Plate and filament short circuited in tube.

Plate Voltage Fluctuates:

- Loose connections in plate circuit wiring of receiver.
- Defective volume control resistor or condenser.
- Defective resistor in power unit voltage divider.
- Defective rectifier in power unit.

Plate Current Too High:

- Open circuit in grid wiring of receiver.
- Grid bias voltage too little.
- Poor contact on grid prong in tube socket.
- Reversed connections to A-power unit or A-battery.
- Reversed connections to biasing resistor or to C-battery.
- Bypass condenser for biasing resistor or C-battery short circuited.
- With resistance or impedance coupling, grid circuit coupling condenser short circuited.

Plate Current Too Low:

- Grid bias voltage too great.
- Tube old or damaged by abuse.

Grid Bias Voltage Too Little or Zero:

- Poor connection, open circuit or ground in grid circuit wiring of receiver.
- Voltage of C-battery or biasing resistor value too low.
- Short circuited bypass condenser across biasing resistor or C-battery.
- Poor contact on grid prong in tube socket.
- Grid in tube short circuited on filament or cathode.
- If test is on detector or radio frequency amplifying tube, low bias may not indicate trouble.

TROUBLE, RECEIVER

Grid Bias Voltage Too Great:

Resistance of biasing resistor too high or C-battery voltage too high.

Grid Bias Reversed in Polarity:

Connections reversed to biasing resistor or to C-battery.

Windings of transformer in grid circuit short circuited on each other.

Grid and plate in tube shorted together.

With resistance or impedance coupling, shorted coupling condenser in grid circuit.

Filament Voltage and Filament Current Both Too Low or Zero:

Short circuit, open circuit or poor connection in filament or heater wiring.

Poor socket connection for filament or heater prongs.

A-battery discharged, defective or has corroded terminals.

Defective operation of A-power supply unit.

Broken or dirty filament or heater circuit switch.

Broken or burned out filament rheostat or resistor.

A.C. supply line voltage too low.

Wiring for filaments or heaters too small or laid out so one tube is farther from transformer than others.

Filament Voltage and Filament Current Both Too High:

A.C. supply line voltage too high.

Burned out or disconnected tube in socket other than one on test.

A-battery used too soon after being on charge with trickle charger.

Filament Voltage Too High and Filament Current Zero:

Filament or heater burned out or broken in tube or poor connections in wiring or at socket prongs.

Filament Voltage Reversed in Polarity:

Reversed connections to A-power unit or to A-battery.

Filament Voltage Fluctuates:

Defective A-power unit or discharged A-battery.

Loose connections in filament or heater wiring circuit.

Reference to Fig. 6 will show that tests may be made with this outfit on the filament, plate and grid circuits of the tube being checked. In Fig. 10 is illustrated a test for the grid circuit. The circuit tester consists here of a voltmeter and 22 1/2 volt B-battery in series. With the test points touched to the ends of a complete circuit the dry cell is connected to the voltmeter and the meter indicates voltage. If the circuit is open, no voltage is indicated. If the circuit is of high resistance the meter will indicate less than the full battery voltage.

For a receiver with power unit plate supply the plate circuit is tested with the receiver and plate supply turned off and with the tester points connected between the plate terminal *P* and the negative terminal or B-minus terminal. In this test the meter will show less than full battery voltage because of the voltage divider resistors in the power unit. If B-battery plate supply is used the plate circuit is tested by connecting between the plate terminal *P* and the minus terminal a voltmeter capable of measuring the full voltage of the B-battery. No testing battery such as that in Fig. 10 is used for this test. With the receiver turned on an unbroken circuit will allow the voltmeter to show full or partial battery voltage depending on the resistance of the coupling devices. An open circuit shows no voltage.

TROUBLE, RECEIVER

The filament circuit is tested by connecting between the two filament terminals a voltmeter capable of measuring the full normal filament voltage and turning on the filament supply, either power unit or A-battery. A complete circuit will allow the test meter to show something more than normal filament voltage while an open circuit will allow no voltage to be shown.

Hum In A. C. Operated Parts.—The most generally experienced trouble in receivers and power units operated with alternating current is the hum present in greater or less degree. With the tuning controls of a receiver placed at a point midway between two stations, so that no outside signal is received, there is always an audible hum from the loud speaker. With such a normal hum it will not be noticeable when either music or speech is being received. Should the hum be sufficient to make it noticeable when signals are being received with any volume, measures should be taken to reduce the effect.

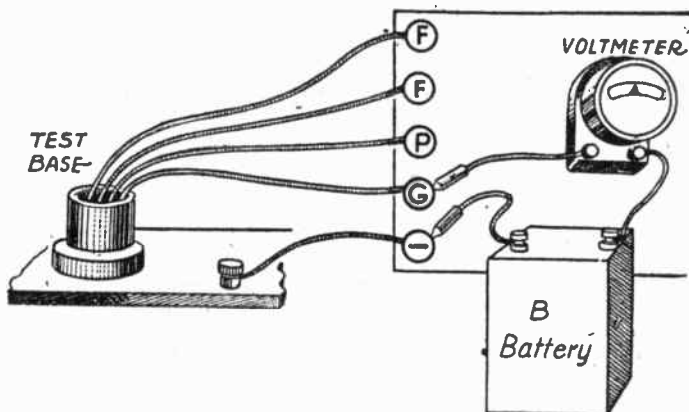

FIG. 10.—Circuit Tests on Receiver.

Hum from the radio frequency stages and the detector is due to incorrectly placed wiring with A.C. and D.C. lines too close together or else to operation of the amplifying tubes in an oscillating condition.

In combined power units and amplifiers the location of the parts with reference to each other is important. Audio frequency transformers or coupling chokes should be kept as far as possible from all power transformers, filament transformers and rectifier tubes. Filter chokes should be kept well separated from power transformers. When such a power amplifier is being constructed, it is advisable to alter the positions of coupling transformers and chokes with reference to each other and to the power transformers until the positions for least inductive coupling are found. Considering any two transformers or chokes the position of least coupling is that in which the center lines or axes of the two windings are at right angles to each other. The position of the first audio frequency coupling transformer or choke is the most critical and that of the last transformer is generally least critical. To still further reduce the effect of inductive coupling between units, the cases of all transformers, all chokes and all condensers should be connected to the B-minus line and to ground.

TROUBLE, RECEIVER

Maintenance of correct filament voltages, plate voltages and grid biasing voltages is important in the reduction of hum. Grid bias voltages which are much greater or less than normal for the applied plate voltage will cause hum. Bypass condensers of one microfarad capacity should be connected across each grid biasing resistor. In case of any doubt, all grid bias voltages should be measured and the bypass condensers should be tested, usually by the substitution of another one or by trying a condenser of greater capacity. It is important that the filament voltage on the detector tube be that which is normal for the tube in use. The plate voltage applied to the detector tube should be high enough to cause a plate current of at least one milliampere through this tube. Increasing the detector plate voltage may reduce the amount of hum.

Hum often is reduced by installing bypass condensers of one microfarad or greater capacity in the plate circuits as shown under the heading, *Condenser, Bypass*.

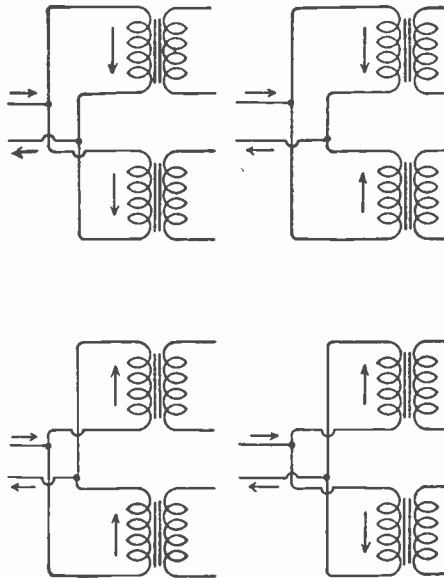

FIG. 11.—Connections of Transformers to Supply Line.

In all parts of the power unit and the amplifier the two wires carrying alternating current for any circuit should be twisted together. All these A.C. lines should be kept well separated from wires carrying plate circuits and grid circuits.

If two or more separate transformers are used for plate power supply and for filament supply a considerable reduction in hum often may be made by trying different connections of the primary sides of these transformers to the supply line. With two primaries to be connected to a single power line there are four possible connections as shown in Fig. 11. For a given alternation in the supply line it will be seen from the arrows that four relationships are secured between current direction through the two primaries.

In severe cases of hum the trouble may be reduced in some cases by bridging the supply line with two one microfarad 500-volt condensers in series

TROUBLE, RECEIVER

and connecting the B-minus or ground line of the amplifier and power unit between these condensers as in Fig. 12.

Filter condensers which are open circuited, have high resistance leaks or which are too small in capacity will cause hum. They may be checked by disconnecting them, one at a time, and noting the increase of hum as each is disconnected. If any one condenser allows little or no increase when taken out of the filter circuit it may be tested for the troubles mentioned.

The center taps of filament supply transformers are not always electrically centered and this defect may result in considerable hum when such transformers are used with A. C. filament type tubes. The correctness of centering may be tested by disconnecting the wire from the tap terminal and connecting it to the slider of a potentiometer connected across the outer terminals of the winding as in Fig. 13. The potentiometer may have from thirty to fifty ohms resistance and must be capable of carrying a number of amperes equal to the voltage across the outside terminals divided by the resistance in ohms. The slider of the potentiometer is then moved to the position of least hum. The center tap wire may now be changed back and forth between the potentiometer and the transformer terminal and if there is a considerable improvement with the potentiometer it may be permanently connected.

With incorrectly designed filter systems or with power units which are overloaded the filter chokes may be carrying so much direct current that their

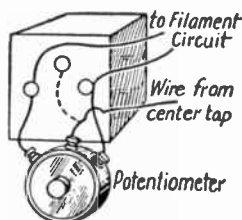
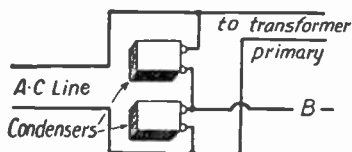

FIG. 12.—Filtering the Supply Line. FIG. 13.—Checking Center Tap.

inductance is materially lowered. This reduces the choking effect and allows hum to develop. If the direct current in milliamperes can be measured and compared with a rating for the choke a check may be made upon conditions of operation. It is possible that a filter choke may be short circuited. A rough test may be made by temporarily connecting the two terminals of the choke to a 500-ohm resistance whereupon there should be a decided increase of hum if the choke is in good condition. Little or no change in amount of hum may indicate a damaged choke.

Old rectifier tubes or tubes which have been badly overloaded at times are likely to cause hum. The most satisfactory test is to substitute a new or good tube and note any improvement in operation.

Tests on Power Unit Transformers and Chokes.—Power transformer and choke windings may be open circuited, shorted on each other, shorted across their own ends or grounded to the transformer case. Loose laminations or cores completely loose within the case will also cause trouble.

Transformer or choke coil windings are tested as shown in Fig. 14, using a dry cell and voltmeter or any other convenient form of circuit tester. The tester is first checked by touching the two points together whereupon the meter will read full battery voltage. The points are then touched to the two terminals of the winding to be tested and the meter reading noted. Zero

TROUBLE, RECEIVER

reading indicates an open circuited or burned out winding. The normal reading for filament transformers in good order will be practically full battery voltage because of the low resistance of such windings. If there is a center tap, the test should also be made between this tap and each of the outside terminals. The normal reading for filter chokes in good order will be much below full battery voltage; using a single dry cell the reading is usually in the neighborhood of one volt instead of one and one-half volts. If the reading on a choke is zero an open circuit is indicated while if the reading is full battery voltage the choke is short circuited.

The test for short circuit of a filament transformer winding is made as in Fig. 15. One wire from a single dry cell is connected to one terminal of the winding to be tested. The second lead is lightly brushed across the terminal to which the first one is attached and a rather faint spark will be observed. This second lead should then be brushed quickly across the other terminal of the winding and if this winding is not shorted and is in good working order there will be a much heavier spark due to the inductive action of the winding.

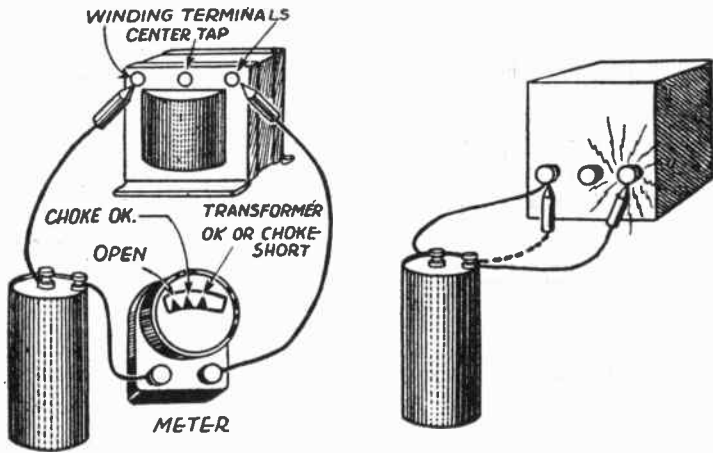

FIG. 14.—Test for Open Circuit or Short in Transformer or Choke. FIG. 15.—Test for Short Circuited Transformer Winding.

If the spark is no larger than when the two battery leads were touched it indicates a short circuited winding.

A transformer is tested for short circuit between primary and secondary windings by touching one point of a circuit tester to a terminal of the primary winding and the other test point to a terminal of the secondary winding. There should be no indication of a connection, no voltage on a meter, unless the unit is an auto-transformer. An auto-transformer is seldom if ever used for this work.

Transformers and chokes are tested for grounds of the windings on their cases by touching one test point of a circuit tester to the case or housing and the other test point to a terminal of each winding. There should be no indication of connection because any connection would be a ground. In some types of filament transformers the center tap is grounded intentionally.

Condenser Tests.—Filter or bypass condensers are tested as shown in Fig. 16. A B-battery or power unit of the highest available voltage up to 180 volts is used for charging the condenser on

TROUBLE, RECEIVER

test. One battery or power unit terminal is connected to the common terminal of the condenser block being checked or to either of the terminals of a single condenser. The line from the remaining condenser terminal is first touched to the other terminal of the battery or power unit, is then removed and touched to the common terminal of the condenser as shown by the broken line in the illustration. If the condenser takes and holds a charge there will be a small bright spark just as this second contact is made. If the condenser is short circuited or open circuited there will be no spark. The size of the spark depends on the condenser capacity and the voltage applied, twenty-two and one-half volts being about the smallest pressure which will give a satisfactory check.

A condenser is tested for grounds to its case by touching one point of a circuit tester to one terminal of the condenser and touching the other test point to the case as in Fig. 17. Any voltage reading indicates a ground, zero reading indicating proper insulation. The test for shorts between condenser

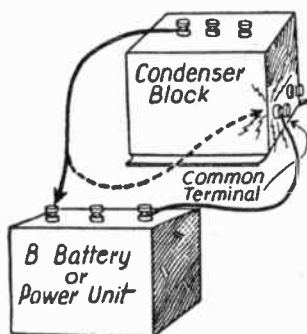

Fig. 16.—Test for Capacity, Short or Open Circuit on Condenser.

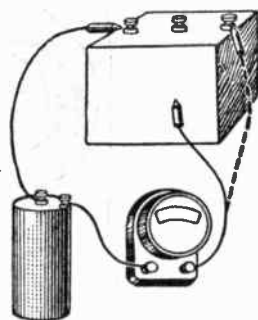

Fig. 17.—Test for Ground and Short Between Condenser Sections.

sections is made with one circuit tester point on the terminal of one condenser section while the second test point is touched to one of the terminals of other sections as shown in Fig. 17 by the broken line. There should be no circuit.

Resistor Tests.—The resistance in ohms of a voltage divider resistor may be measured approximately as shown in Fig. 18. The instruments required include a B-battery, a voltmeter having a maximum scale reading at least equal to the battery's voltage and a milliammeter reading up to ten mils or more. The voltmeter need not be of the high resistance type, a B-battery testing meter being satisfactory.

The battery, the voltmeter, the ammeter and the resistor are connected as shown. Connection *A* is left off the resistor to start with and a note is made of the current shown by the milliammeter. This is the current required to operate the voltmeter. The connection is then made to the resistor at *B* and readings noted on both the milliammeter and the voltmeter. The re-

TROUBLE, RECEIVER

sistance is calculated by multiplying the number of volts by 1000, then dividing this result by the difference between the second and first milliampere readings. For example, suppose with the *B* connection in place that the voltmeter read 15, that the milliammeter read 10 mils without the resistor and 13 mils with the resistor connected. Multiplying 15 (volts) by 1000 gives 15000. Subtracting 10 mils from 13 mils gives 3 and dividing 15000 by 3 gives 5000 ohms as the value of the resistor. Many voltmeters require so much current to operate them that the correction is necessary if any accuracy in results is to be obtained. Expressed as a formula the calculation is:

$$\text{Resistance in Ohms} = \frac{\text{Volts} \times 1000}{\text{mils with resistor} - \text{mils without resistor}}$$

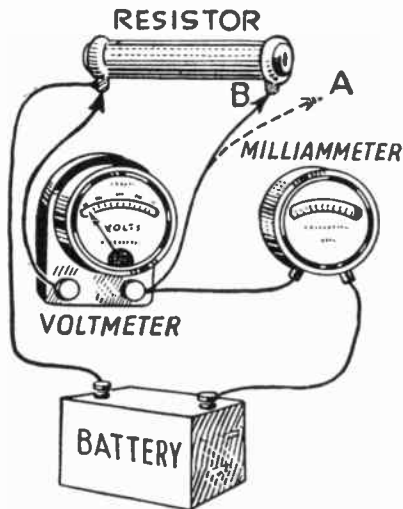

FIG. 18.—Measuring the Resistance of a Resistor.

A resistor that shows only a fraction of its rated value is partially short circuited or is not correctly rated. If the milliammeter reading is exactly the same whether the resistor is disconnected as at *A* or connected as at *B*, the resistor is open circuited.

An old and worn out rectifier tube will result in low voltage. The most practical check is substitution of a rectifier known to be good. Rectifier tubes will burn out when old and are often burned out before that time by accidental shorts and grounds in filter chokes, condensers or voltage dividers which impose an excessive load. An overloaded rectifier tube indicates the fact by a blue haze within the tube or by the plate becoming red hot. Before condemning the rectifier tube the socket contacts on its prongs should be cleaned and all wiring leading to this socket should be checked carefully.

TUBE, ACTION OF

TUBE, ACTION OF.—An electronic tube comprises an envelope or bulb made of glass, metal, or a combination of the two. Within the envelope is either a nearly complete vacuum or

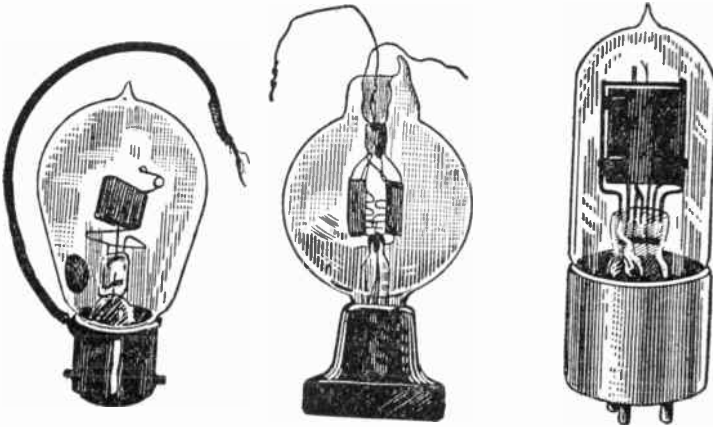

FIG. 1.—Early Experimental Types of Vacuum Tubes

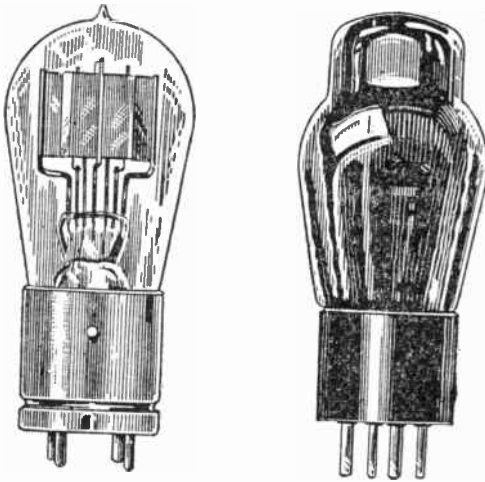

FIG. 2.—Short Prong UV201 of Early Manufacture and Latest Dome Shaped Long Prong UX201A

else a small quantity of some inert gas or of mercury vapor, also the various elements or electrodes whose form and function depend on the purpose for which the tube is designed.

TUBE, ACTION OF

In all tubes there are one or more cathodes, which are metallic elements made of or coated with substances which readily emit large quantities of electrons when heated or when subjected to strong electric charges or potentials. In all tubes there are also one or more anodes or plates to which travel the electrons emitted from the cathode provided the anode or plate is maintained at a potential which is positive with reference to the potential of the cathode. Tubes used as rectifiers, and some used for voltage regulation, have cathodes and anodes as their only elements.

In tubes used as amplifiers, oscillators, current control units, and as rectifiers whose current may be regulated, there are additional elements in the space between cathode and anode. These added elements, usually called grids, are operated at various potentials with reference to the cathode. The control of electric fields within the tube which thus is afforded permits

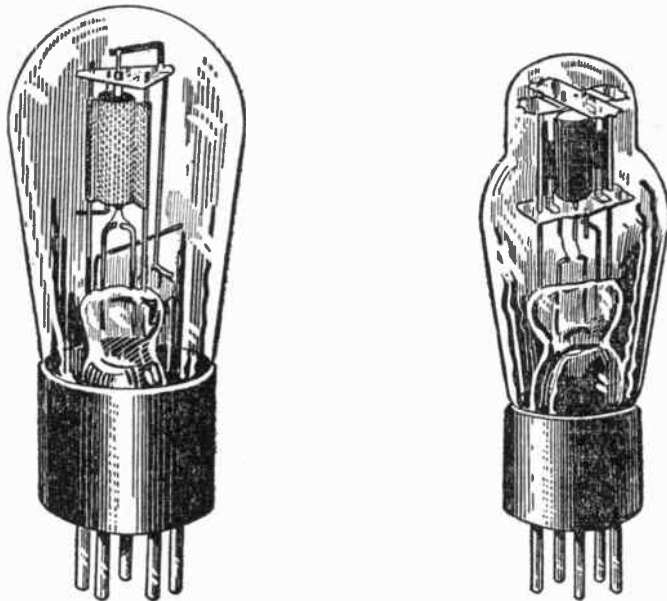

FIG. 3.—Original Slow Heater Type 227 Tube and Latest Dome Shaped Type Showing Reduction in Size Without Change of Electrical Characteristics

starting, stopping and varying the rate of electron flow between cathode and anode. Types of electronic tubes in general use are described in sections which follow.

Tubes may be named in accordance with their total number of cathodes, anodes and grids. Such names and the numbers of active elements are: Diode — 2; triode — 3; tetrode — 4; pentode — 5; hexode — 6; heptode — 7; octode — 8; and so on. Names otherwise may indicate the function of the tube, or they may be derived from Greek or Latin words related to the functions or to the number of elements.

Some of the earliest types of tubes are illustrated in Fig. 1. An early type of triode for broadcast reception is shown at the right. A little later appeared the metal-based triode at the left-hand side

TUBE, ACTION OF

of Fig. 2, which evolved into the style at the right. The tubes of Figs. 1 and 2 have filament-cathodes. At the left in Fig. 3 is one of the earliest triodes in which the cathode is heated from a separate heater element supplied with alternating current. This tube developed later into the form illustrated at the right.

During the early part of 1935 appeared the first receiving tubes having an all-metal envelope instead of the glass envelopes used up to that time. Fig. 4 shows a glass tube together with a metal type having generally equivalent performance.

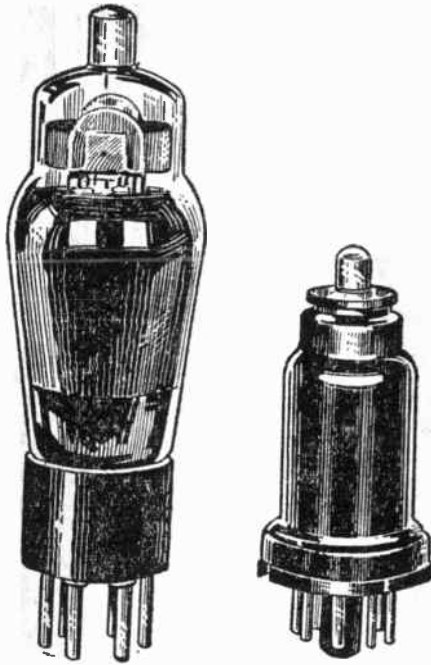

FIG. 4.—Glass Envelope Tube and Metal Type Having Generally Similar Performance.

At the left-hand side of Fig. 5 is illustrated a heavy-duty glass tube in which the inside of the envelope is graphite coated to assist in heat dissipation and at the same time to carry away electrostatic charges which tend to collect on the glass surface. At the right in Fig. 5 is a high-power triode originally developed for use as an amplifier, modulator or oscillator in transmitters, and now used also as an oscillator in high-frequency industrial electronic apparatus. The lower extension of this tube is its anode, which, in use, is surrounded by a jacket through which water is circulated to remove excess heat.

TUBE, ACTION OF

Multi-purpose and Multi-unit Tubes.—With one class of tubes in common use it is possible to change the tube from one purpose to another by making different connections between outside wiring and the elements within the tube. Thus, a tube may be used either as a radio frequency pentode or, by changing connections, used as an amplifier with control of selectivity.

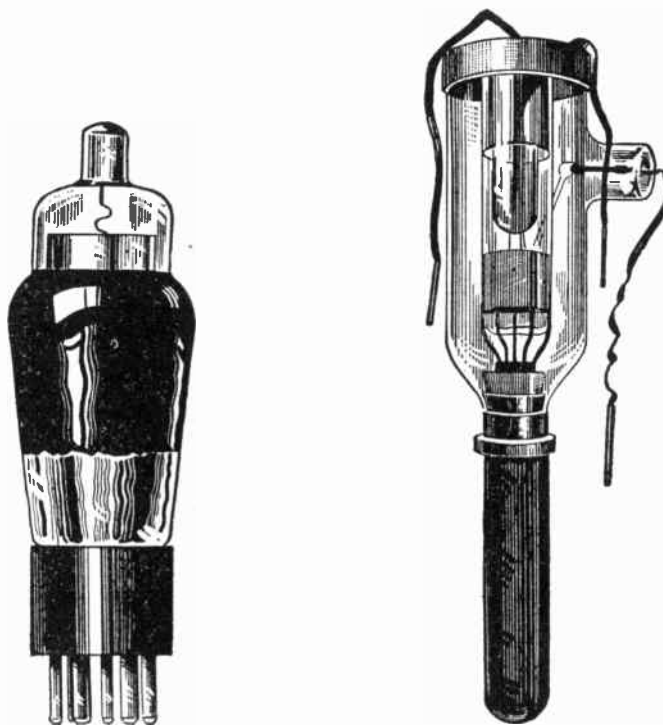

FIG. 5.—Heavy Duty Glass Envelope Tube (left) and High Power Water Cooled Type (right).

Another class of tubes includes those performing two or more functions at the same time and within the bulbs of which there actually are two or more complete sets of elements. Building a tube with numerous elements of one type and another and bringing a connection from each element to the base prongs opens up almost limitless combinations. The same basic principles applying to the simpler tubes apply to these more complex types, and an understanding of control grids, screen grids, suppressors and similar elements makes it easy to understand what takes place.

TUBE, ACTION OF

Functions of Receiving Tubes.—The construction of a tube does not necessarily determine nor limit the kind of work the tube may be called upon to do. So far as construction is concerned, we find diodes, triodes, tetrodes, pentodes and other more complex types such as duplex-diode-triodes, pentagrid converters, variable-mu tubes, rectifier doublers and so on. The work which may be handled by these various tubes may be classified as follows:

Radio-frequency Voltage Amplifier.—A tube used for this purpose follows the aerial, taking the weak currents and voltages from the aerial circuit and delivering a strengthened voltage of the same frequency to following circuits. A receiver may contain one or more radio-frequency voltage amplifier tubes.

Mixer, Frequency Changer, Converter or First Detector.—These are different names for the same thing. A tube used for this purpose is found only in superheterodynes. It follows the r-f voltage amplifiers and receives amplified or strengthened r-f voltages from them. In addition to the r-f voltages this mixer tube receives from an oscillator tube, or else produces within itself, another voltage having a frequency higher than that received from the preceding r-f amplifiers. The two voltages at different frequencies combine in the mixer and produce a third voltage at a frequency equal to the difference between the r-f and oscillator frequency. This third frequency is called the intermediate frequency. There is only one mixer in an ordinary receiver.

Oscillator.—This is another tube found only in superheterodynes. It furnishes the frequency which is higher than the aerial frequencies or radio frequencies, and which goes to the mixer tube. There is only one oscillator in an ordinary receiver.

Converter or Combined Mixer-Oscillator.—This is a single tube that performs the work of both mixer and oscillator; furnishing its own higher frequency to be combined with the frequency from the r-f amplifier and thus replacing the separate mixer and oscillator with one tube for the two functions.

Intermediate-frequency Amplifier.—A tube used for this purpose is a voltage amplifier which receives the intermediate-frequency voltages from the mixer tube and increases their strength. There may be one or more i-f amplifiers in a receiver. Intermediate frequency amplifiers are found only in superheterodynes.

Second Detector.—A tube used in this position takes the i-f voltages after they have been strengthened by the i-f amplifier and changes them into an audio frequency. When a tube handling this work is used following the i-f amplifier in a superheterodyne it is called the second detector because the mixer is often called the first detector. In a receiver not of the superheterodyne type the detector immediately follows the r-f amplifiers and changes the r-f voltages into audio frequency voltages, then

TUBE, ACTION OF

being called simply the detector instead of the second detector.

Automatic Volume Control or AVC Tube.—All receivers have a hand operated or manual volume control, and in the earlier designs this was the only volume control. In later designs there are arrangements which prevent the loud speaker sound intensity from exceeding a limit determined by the manual volume control setting, no matter how strong or weak the aerial signal becomes within certain limits. In many designs an extra tube is required to provide this automatic control and is called an automatic volume control tube or an AVC tube.

Audio-frequency Voltage Amplifier.—A tube handling this class of work follows the detector or second detector, taking the a-f voltages from the detector and increasing their strength. Some receivers have no a-f voltage amplifier, others have one such tube, but practically no sets of today have more than one.

Power Amplifier.—A power amplifier tube takes the a-f voltages from the a-f voltage amplifier if used, or directly from the detector, and uses these voltages to release sufficient power to operate the loud speaker. There may be one or more power amplifiers in a receiver.

Rectifier.—This tube takes alternating current such as comes from an ordinary light and power line, and changes it into direct current which is required in many of the receiver circuits. Most receivers designed for light socket power supply have one rectifier although a few sets use two such tubes. Receivers operated from direct current lines and those operated from batteries require no rectifier tubes.

All of the tubes which have been mentioned, as well as many other special purpose types, are described in detail in following sections whose titles indicate the construction or the function for which the various types are designed. In many instances the same tube may be used for many different purposes. For example, a given tube might be used for amplification, for detection, or for oscillation.

TUBE, AMPLIFICATION OF.—The amplification factor, constant or coefficient of a tube is the ratio of the alternating voltage appearing in the plate circuit to the alternating voltage applied to the control grid when the plate load is an infinite impedance.

If we wish to change the amount of current flowing in the plate circuit of a tube it may be done in either of two ways. First, we may increase or decrease the plate voltage or the B-battery voltage. Second, we may increase or decrease the voltage applied to the grid. Either of these will cause a change in the plate current which is usually measured in milliamperes.

A change of five volts in plate voltage or B-battery voltage will cause only a slight change in plate current. A change of five volts

TUBE, AMPLIFICATION OF

applied to the grid of the tube will cause a very great change in plate current. Say, as in Fig. 1, that the five-volt change in grid voltage causes a change of ten milliamperes in plate current. Were we to increase the plate voltage sufficiently to bring about this same ten milliamperere change in plate current we might find that it required a forty-volt increase of plate voltage to obtain the same plate current change obtained by only a five-volt change of grid voltage. Thus it would require eight times the change of plate voltage as of grid voltage to obtain the same result in plate current change. The amplification factor of this tube would then be eight.

To find the amplification factor of a tube we divide the number of volts change of B-battery current required to produce a certain increase in plate current by the number of volts change on the grid to produce the same increase of plate current. The quotient is the amplification factor of the tube. Another way of stating this is to say that the amplification factor is the

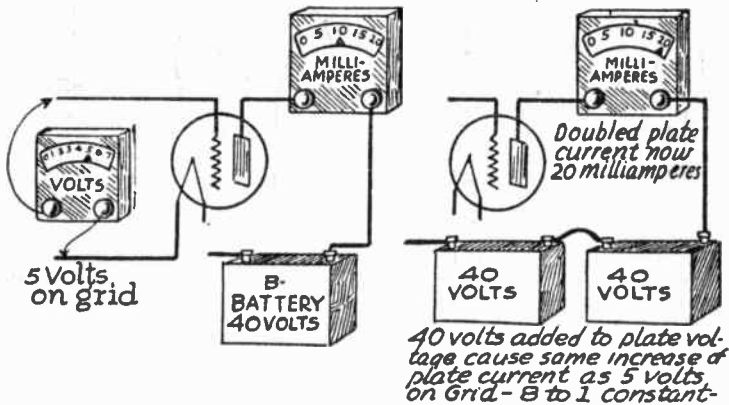

FIG. 1.—The Voltage Amplification of a Vacuum Tube.

number of times the effect of a certain grid voltage is greater than the effect of the same plate voltage on the plate current from the tube.

The general subject of amplification in radio receivers is discussed under the heading of *Amplification*. The explanations given under *Amplification, Voltage and Power* should be referred to in considering the amplification of tubes.

Voltage Amplification.—The actual voltage amplification or increase of voltage realized depends not only on the amplification factor of the tube, but also on the resistance, the inductance and the capacity in the plate circuit of the tube. The resistance in the plate circuit includes the resistance of any coils between the tube plate and the battery, the resistance of the battery itself and the resistance of the connections. Of these the resistance of the coil or of an amplifying resistor is the only thing of great importance from the standpoint of amplification. The resistance in the plate circuit also includes the internal resistance of the tube between its plate and filament. See *Tube, Output Resistance and Impedance of*.

TUBE, AMPLIFICATION OF

The value of the voltage amplification for various values of amplification factor, plate resistance and external circuit impedance is shown by the following formula:

$$\text{Voltage Amplification} = \frac{\text{Amplification Factor} \times \text{External Impedance}}{\text{Plate Resistance} + \text{External Impedance}}$$

From this formula it is evident that the voltage amplification is increased by increasing the amplification factor and by increasing the external impedance. It is decreased by increasing the plate resistance.

The tube may work into a pure resistance as at the left in Fig. 2 or it may work into a reactance as at the right. A pure reactance cannot be obtained in practice because with the reactance of any coil must be combined the resistance of the coil so that the combination forms an impedance.

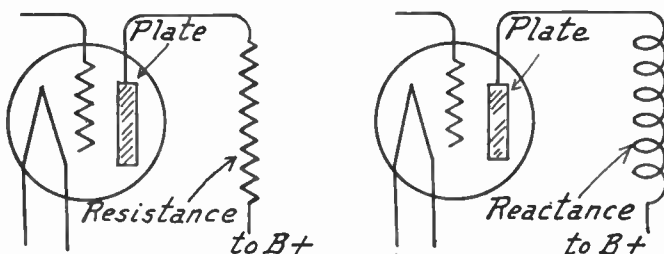

FIG. 2.—Tubes Working into Resistance and Into Reactance for Amplification.

The voltage amplification is higher when working into a reactance than when working into a resistance only. The value of the tube's amplification factor is the maximum possible voltage amplification that might be obtained. In practice it is possible to gain from fifty to ninety-five per cent of the total amplification factor as voltage amplification. The following table shows the percentages obtained with various amounts of external impedance when the impedance is composed of pure resistance and when it is composed of pure reactance:

PERCENTAGE OF TOTAL AMPLIFICATION FACTOR OBTAINABLE

Number of Times External Impedance is Greater Than Plate Resistance	Per Cent of Mu When Working into a Pure Reactance	Per Cent of Mu When Working into a Pure Resistance
6 times plate resistance	99%	84%
4 times plate resistance	97%	80%
3 times plate resistance	95%	75%
2 times plate resistance	88%	67%
Equal to plate resistance	72%	50%

This shows the necessity of having a high impedance in the plate circuit if a real gain is to be obtained. It also shows that the number of ohms in a pure resistance must be several times as great as the number of ohms in a reactance to obtain a given amplification. When using transformers as intertube couplings the maximum voltage will be applied to a following tube from the secondary of the transformer when the external impedance in the plate

TUBE, AMPLIFICATION OF

circuit of the first tube at least equals the internal impedance of the first tube.

The voltage amplification from a tube decreases as the frequency increases, this effect being partly due to the internal capacities in the tube. The drop of amplification with a typical tube giving an amplification of about seven and one-quarter at 500 kilocycles is down to an amplification of about four and one-half at 1500 kilocycles. This is shown in Fig. 3.

Amplifying tubes in common use have amplification factors varying between three and ten, the exact value depending on the type of tube and on the internal construction of the tube. A factor of eight is a fair average value for making rough calculations.

High Mu Tubes.—Tubes having a very high amplification factor are called high mu tubes. It is difficult to make a high mu tube that will not also have a high plate resistance. Consideration of the preceding formula for voltage amplification will show that the gain

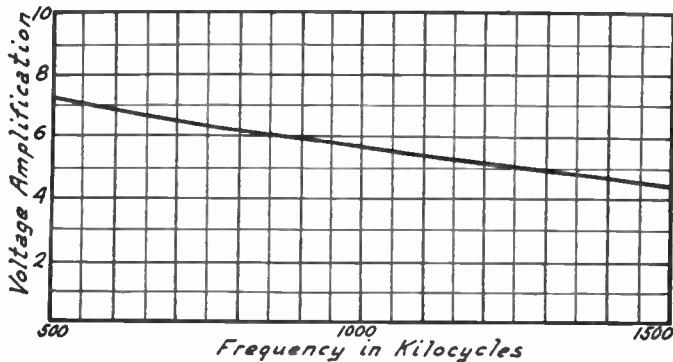

FIG. 3.—Decrease of Amplification with Increase of Frequency.

from increased amplification factor may be offset by a corresponding increase of plate resistance.

High mu tubes have amplification factors of from fifteen to forty as compared with an average of about eight for ordinary amplifiers. These high mu tubes are used as audio amplifiers and sometimes as detectors. They are not satisfactory as radio frequency amplifiers but they will greatly increase the amplification of a resistance coupled audio amplifier and will often prove very satisfactory with choke coupling.

In experimental work the use of tubes having an amplification factor of twenty in place of the usual amplifying tubes increased the voltage amplification of a three-stage resistance coupled amplifier to four times its former value. Using the same high mu tubes in a three-stage choke coil coupled amplifier increased its overall voltage amplification in about the same ratio, four to one. The use of high mu tubes will allow a three-stage resistance coupled or choke coupled amplifier to exceed the voltage amplification of a two-stage transformer coupled amplifier. Otherwise the overall amplification of the two-stage transformer coupled amplifier is greater than the overall amplification of the three-stage resistance or choke amplifier.

TUBE, AMPLIFICATION OF

Power Amplification.—The power output of a tube is measured in watts whereas the voltage output is, of course, measured only in volts. The voltage might be very high but if the current or amperage were extremely small the power output of the tube in watts (volts times amperes) would still be small.

The current change (or alternating current) in the plate circuit will be equal to the amplified voltage divided by the total resistance and impedance in the plate circuit, thus:

$$A. C. \text{ in Plate Circuit} = \frac{\text{Amplification Factor} \times \text{Grid Voltage}}{\text{Plate Resistance} + \text{External Impedance}}$$

The plate voltage is really taken into consideration in this formula because the plate resistance is affected by the plate voltage, being lowered by higher plate voltages.

The voltage acting across the primary of a transformer in the plate circuit depends on the impedance of the primary winding and on the current forced to flow through it. Since the preceding formula gives the current forced to flow in the plate circuit, multiplying the expression for this current by the impedance of the external circuit will give the following for the value of impressed voltage:

$$\frac{\text{Voltage Across}}{\text{External Impedance}} = \frac{\text{External Impedance} \times \text{Amplification Factor} \times \text{Grid Voltage}}{\text{Plate Resistance} + \text{External Impedance}}$$

The power in watts expended in the external circuit is the useful power put forth by the tube. The power in the external circuit is a product of the voltage and the amperage. It is represented by the following formula:

$$\text{Power Output in Watts} = \frac{\text{External Impedance} \times (\text{Amplification Factor} \times \text{Grid Voltage})^2}{2 \times (\text{Plate Resistance} + \text{External Impedance})^2}$$

The grid voltage is the maximum voltage change applied to the grid of the tube. This voltage will be something less than the grid biasing voltage or C-battery voltage as long as there is no distortion caused by making the grid positive at the voltage peaks.

If the number of ohms in the external impedance is just equal to the number of ohms plate resistance in the tube, a somewhat simpler formula will give the value of the power output in watts. Since these two values are seldom balanced in practice, the following formula is not as dependable as the preceding one:

$$\text{Watts Output} = \frac{(\text{Amplification Factor} \times \text{Grid Voltage})^2}{8 \times \text{External Impedance}}$$

In all amplifying tubes except the last one in the audio amplifier the object desired is an amplification or increase of signal voltage.

TUBE, AMPLIFICATION OF

The voltages act upon the grids of following tubes to control the plate currents. But in the last audio amplifying tube, the tube that operates the loud speaker, it is power that is desired since power is required for proper working of the speaker. The formulas for power output are therefore of interest principally in considering the action of the last audio amplifier.

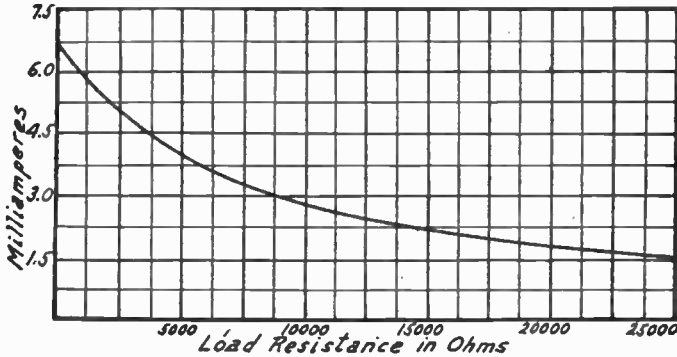

FIG. 4.—Drop of Output Current from Tube with Increase of Load When Maintaining Constant Voltage at Plate Supply Unit.

The effect of the external resistance or impedance on the power output of a tube may be seen in Figs. 4 and 5 which show the change in plate current caused by changes in the external load. Fig. 4 shows the drop of output current caused by increase of load when the voltage of the B-battery or power

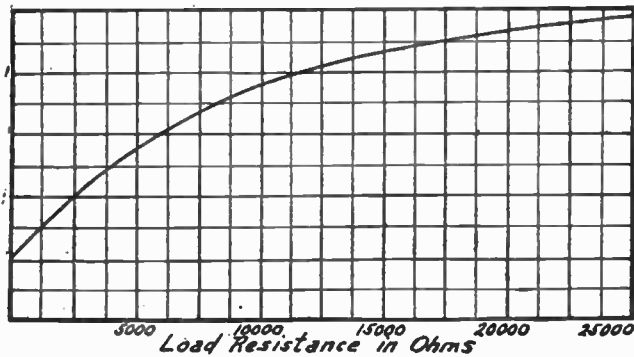

FIG. 5.—Increase of Power from Tube with Increase of Load When Maintaining Constant Voltage at the Plate Itself.

unit remains unchanged. Under this condition the actual voltage applied to the plate of the tube is lowered by the increase of load resistance. In Fig. 5 is shown the effect of maintaining a steady voltage on the plate while the load is increased. This requires a continual increase of B-battery or power unit voltage to make up for the continual increase of voltage drop through the increasing load. With a steady voltage on the plate, as in Fig. 5, the power output actually increases with increasing load.

TUBE, BALLAST

TUBE, BALLAST.—A ballast tube is designed to maintain a nearly constant current in a circuit or a device which is subjected to variations of voltage. The tube consists of one or more filaments in a gas-filled bulb. Small changes of current cause relatively large changes of filament temperature and resistance. The increase of resistance opposes and limits the change of current.

These tubes may be connected in series with the filaments of other tubes to maintain practically constant current in the other filaments when the supply voltage changes, as it does during discharge of a battery. They are employed in universal a-c and d-c receivers, and in battery operated portable receivers. Many of the receiver-type ballast tubes contain sections of filament across which the voltage drop remains fairly steady, and across which are connected pilot lamps.

TUBE, BEAM POWER.—In the beam power tube, which is a development of the power pentode, secondary emission from the plate is controlled not by the use of a suppressor grid as in the pentode, but by a negative space charge consisting of a cloud of negative electrons which are caused to collect in the space between plate and screen of the beam tube, or in the space which would be occupied by the suppressor in a pentode. This negative space charge, which acts like the suppressor of the pentode, comes

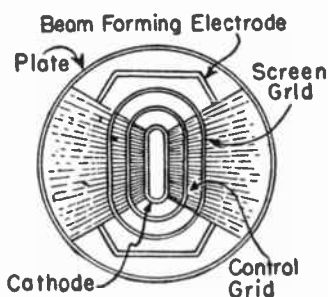

FIG. 1.—Element Arrangement in Beam Power Tube.

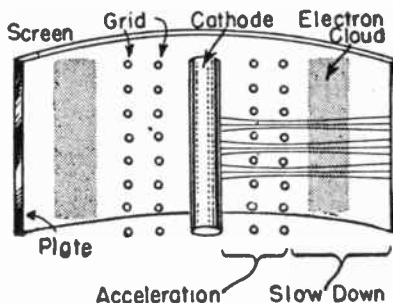

FIG. 2.—Electron Streams in the Beam Power Tube.

into being only when the plate voltage becomes less than the screen voltage. This is the only time when suppressor action is needed. Furthermore, the intensity of the space charge increases with difference of voltage between plate and screen, and thus exerts a suppressor action proportional to the need for such action.

Looking into the top of a beam power tube the elements would be arranged as in Fig. 1. Around the cathode is the control grid, and around the control grid is the screen grid. Partially enclosing these elements are two beam-forming electrodes which confine the stream of electrons from cathode to plate into two rather wide beams. The plate or anode is around the outside of the beam-forming electrodes.

Were the beam power tube cut vertically in two, the cathode, control grid, screen and plate would be seen arranged as in Fig. 2. The control grid and

TUBE, BEAM POWER

screen grid have the same number of wire turns and the spacings between turns are alike. As a result there is a control grid wire directly between each screen grid wire and the cathode surface, and since electrons from the cathode must pass through the spaces of the control grid they are formed into narrow beams that pass between turns of the screen grid rather than striking the wires of the screen grid. This protection of the screen grid from the electron streams keeps the screen current at a very low value.

The potential of the screen grid is very high in relation to that of the cathode. Therefore, electrons emitted from the cathode are accelerated to high velocity in the space between cathode and screen. But if the plate potential is less than that of the screen there is no tendency to further accelerate the electrons between screen and plate. On the other hand, there is an actual slowing down of the electrons in this region, and as a result the electrons collect in greater density in this space than elsewhere within

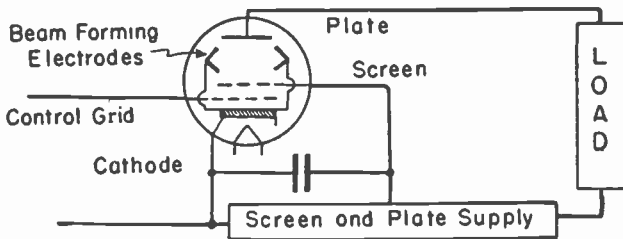

FIG. 3.—Circuit Connections to a Beam Power Tube.

the tube. The lower the plate voltage with reference to screen voltage the greater will be the slow-down, and the greater will be the negative space charge between the screen and the plate. This negative space charge acts just as does the suppressor grid of a pentode in preventing secondary electrons knocked off the plate from reaching the screen.

As shown by Fig. 3, the beam forming electrodes of the beam tube are internally connected to the cathode, so are at cathode potential, are highly negative with reference to the plate and the screen, and have the ability to prevent passage of stray secondary electrons from plate to screen. In all except the smallest battery-operated beam tubes the maximum screen voltage is lower than the maximum permissible plate voltage. Plate characteristics of the beam power tube have practically the same general form as those for the power pentodes.

TUBE, CAPACITIES, INTERNAL.—The conductive elements of tubes act as plates, and the spaces between as dielectrics, to form capacities which are equivalent to externally connected condensers. There are additional capacities between the prongs and external leads. All these capacities may permit undesirable couplings and energy feedbacks.

TUBE, CATHODE-RAY

TUBE, CATHODE-RAY.—The cathode-ray tube consists of a rather long glass bulb in one end of which is a cathode and heater. Fig. 1. The cathode, when heated, is capable of emitting electrons. See *Electrons*. The inner surface of the opposite end of the bulb is coated with a fluorescent material, called a phosphor, which glows brilliantly when it is struck by electrons. This coating is called the screen of the tube.

Surrounding the end of the cathode which is toward the screen is an electrode called the control grid. The voltage difference between cathode and control grid determines the rate at which electrons may leave the cathode. This voltage difference is the grid bias. The more negative the grid with reference to the cathode, the fewer electrons may leave the cathode.

Just beyond the control grid is the first anode, which is maintained at a high positive voltage. This positive voltage, or charge, pulls a stream of electrons from the cathode through the grid and through an opening in this first anode. At the outer end of the

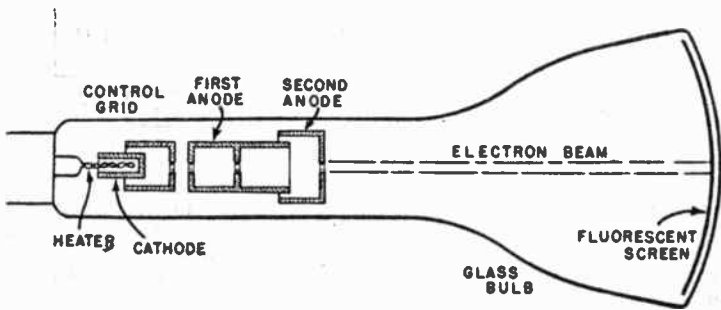

FIG. 1.—Principal Parts of a Cathode-ray Tube.

first anode is the second anode, maintained at a much higher voltage. This high voltage imparts great speed to the electrons, which shoot through the opening in the second anode to form a small diameter beam that strikes the screen. The tube is highly evacuated so that the electrons may pass easily through the spaces inside. The cathode, control grid, and first and second anodes compose what is called the electron gun, since these parts shoot the electron beam against the screen. In some tubes the second anode consists of a conductive coating, such as graphite, on the inside of part of the bulb.

With only the parts shown in Fig. 1 the electron beam would remain focused at one place on the screen. To make practical use of the tube it is necessary that the beam be moved up and down, also crosswise, on the screen to form tracings or patterns as the luminous spot travels over the screen. There are two methods of deflecting or moving the electron beam.

TUBE, CATHODE-RAY

Fig. 2 illustrates the principle of deflecting the electron beam by means of magnetic fields produced between the poles of opposite pairs of electromagnets. Electrons are negative electricity, hence will be deflected or pushed one way or the other when the beam is in a magnetic field. The field lines push the beam of electricity out of the space they occupy, just as they would push a wire conductor through which is flowing an electric current.

One magnetic field, passing vertically through the tube just ahead of the second anode, is formed between electromagnets *A* and *B*, whose cores are vertical. A second magnetic field, at right angles to the first one, is formed between the poles of magnets *C* and *D*, which are in a horizontal line.

When current flows through magnet coils *A* and *B*, their field causes the electron beam to move horizontally one way or the other, depending on the direction of current flow and the direction of the resulting magnetic field. Alternating current in the coils, or a current which reverses its direction, causes the beam

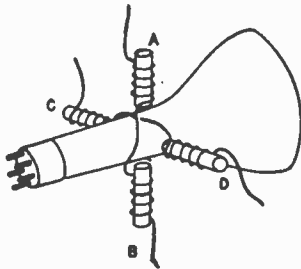

FIG. 2.—Electromagnetic Deflection of the Electron Beam.

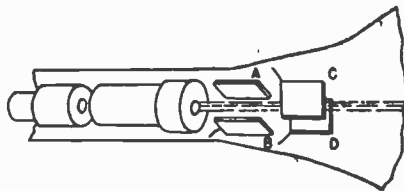

FIG. 3.—Electrostatic Deflection of the Beam.

to vibrate back and forth horizontally across the screen. In similar manner, magnets *C* and *D* are used to move the electron beam vertically up and down on the screen.

The beam will move simultaneously in vertical and horizontal directions, depending on the direction and strength of currents in the magnet coils. Thus the path traced by the luminous spot on the screen will show, when correctly interpreted, the direction, strength and frequency of currents in the magnet coils. The magnet coils are supported by a deflecting yoke placed around the neck of the bulb close to where the bulb commences to flare out.

Instead of using magnet coils outside the tube to deflect the electron beam there may be four metal plates inside the tube just where it commences to flare, as in Fig. 3. The opposite plates forming one pair are positively and negatively charged, like the plates of a condenser, by connecting them to the positive and negative sides of a source of d-c voltage. Then there is an electro-

TUBE, CATHODE-RAY

static field between the plates of each pair. This field will move the electron beam in a direction depending on the polarity of the plates, and a distance depending on the voltage on the plates.

Plates *A* and *B* will move the beam vertically, or parallel to the lines in the field, while plates *C* and *D* will move the beam from side to side. If alternating voltage is applied to the plates, the beam will vibrate in a vertical or horizontal line across the screen, and at a frequency corresponding to the frequency of the alternating voltage on the plates. The beam may be affected by both pairs of plates simultaneously so that the luminous spot on the screen traces a pattern which indicates the strength, polarity, and frequency of the applied voltages.

The elements inside the cathode-ray tube are connected to pins on the base, which fits into a socket. In some tubes the cathode is connected to one side of the heater, so that only two base pins are needed for both heater and cathode connections. The cathode side of the circuit usually is at or near ground potential, although in some circuits the high voltage side is grounded.

Phosphors used in television picture tubes glow white when struck by the electron beam. Tubes in measuring instruments may have yellow or green phosphors. Any phosphor continues to glow for a few hundredths of a second after the beam passes. Different phosphors have different degrees of this light persistence.

Typical connections to a cathode-ray tube are shown in Fig. 4. Resistors R_1 , R_2 and R_3 are in series across a filtered d-c power supply. From the positive side of the power supply a connection is made (through the socket) to the second anode, which here is shown as a coating inside the tube. The four deflecting plates are connected to this high-voltage line through four resistors which may be of one to ten megohms each. Instead of connecting these resistors directly to the power supply terminal, they may connect to sliders on voltage dividers, which allows varying the voltage applied to the deflector plates.

The slider on resistor R_2 in Fig. 4 provides an adjustable positive voltage for the first anode. Resistor R_3 , on the negative side of the cathode connection, provides an adjustable negative voltage (bias) on the control grid.

Referring to Fig. 4, a voltage which is to deflect the beam vertically is applied to one pair of plates at V_1 and V_2 . A voltage which is to deflect the beam horizontally is applied to the other pair of plates at H_1 and H_2 . If the control grid is to be used only for controlling the current in the electron beam and the intensity of the spot on the screen, as in a cathode ray oscilloscope, no connections are made to points G and K . If a television picture signal, or video voltage, is to be used on the control grid to vary the spot intensity and provide areas of varying brightness

TUBE, CATHODE-RAY

in the picture, this video input voltage is applied between points *G* and *K*, or between the grid and cathode of the tube.

When cathode-ray tubes are used near electrical apparatus that produces strong fields, the bulb of the tube may be enclosed in an iron or steel case. The iron or steel of the case must be completely demagnetized, and should be connected to ground.

Adjustments.—If the spot does not remain in the center of the screen with no voltages being applied to deflect the beam, either the beam current is too great, and must be reduced by a more negative grid bias or less anode voltage, or else the resistance is too high in the connections from the plates to the high voltage.

The more negative the grid is made the less current flows in the beam, and the less brilliant and smaller is the spot on the

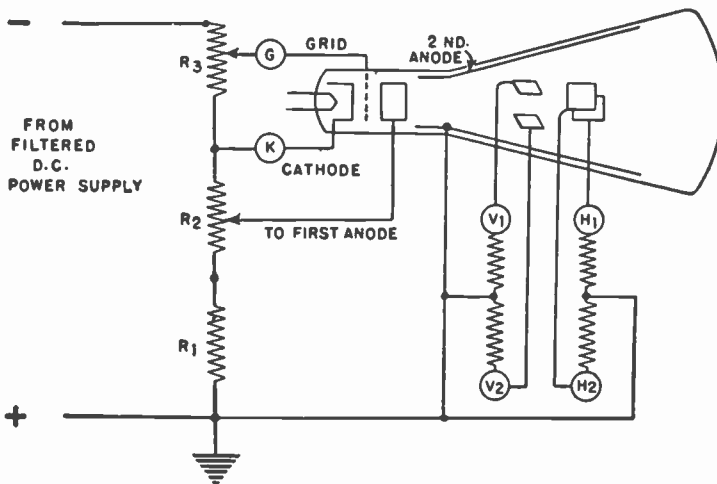

FIG. 4.—Control Circuits for Cathode-ray Tube.

screen. A less negative grid allows a brighter spot. Raising the voltage on the second anode will make the spot more intense, but of smaller size. The spot is focused, or adjusted to the desired size, by varying the voltage on the first anode by means of adjustment R_2 . This changes the ratio of the voltages on the first and second anodes. The spot control is the same when using magnetic deflectors.

The amount that the beam may be deflected by external voltages applied on the pairs of plates is almost directly proportional to these voltages, which makes the tube satisfactory for measuring and indicating instruments. However, the higher the voltage on the second anode the less will be the deflection for any given external voltages applied to the plates. The deflection sensitivity

TUBE, CATHODE RAY

may be made greater for given deflecting voltages by lessening the voltage on the second anode, but this generally is an undesirable method.

The resistors in series with each deflector plate usually have resistance of not more than three to five megohms. Higher resistance may allow the picture to change position on the screen in television reception when there is any decided change in brightness of the picture.

Care When Using Cathode-ray Tubes.—Tubes of medium and large size may collapse if roughly handled. Scratching the glass of the bulb may greatly weaken the bulb, so always use a soft padding where the tube rests on a table or bench. Be especially careful not to strike or press hard on the portion of the bulb surrounding the screen.

When a tube is supported by one or more clamps around the neck of the bulb the clamp jaws must be padded, and they should not be drawn too tightly together. Don't subject a cathode-ray tube to sudden and great changes of temperature. While tubes are out of their sockets keep them in their original cartons.

While being used in television receivers and other instruments, the screen end of the tube is covered with a sheet of clear shatter-proof glass for protection against flying particles of the bulb in case it collapses. This cover should be kept closed except while removing or replacing the tube. Some tubes are fitted with a close-fitting sleeve around the sides of the bulb. Large tubes should be handled only while wearing gloves and shatter-proof goggles.

In case it becomes necessary to examine the spot on the screen while the beam is stationary, the brightness must be reduced to a very low level by adjusting the grid bias or anode voltages. The same is true if motion of the spot is made so slow that it appears as a spot rather than as a luminous line on the screen. A stationary or slowly moving spot will temporarily lessen the sensitivity of the screen, and often will cause permanent damage.

Anode potentials run to several thousands of volts, which is dangerous for some persons even though the current is limited. Never touch any part of a circuit for cathode-ray tubes until the power supply has been cut off from the line, and until all condensers have been discharged by connecting both terminals to ground. High-voltage terminals and connections should be enclosed in such manner that opening an access door or panel operates an interlocked switch that opens the power supply. High-voltage terminals should have insulating caps. In many cathode-ray devices the high-voltage side, rather than the negative or cathode, is grounded. See also, *Oscilloscope*.

TUBE, CHARACTERISTICS OF

TUBE, CHARACTERISTICS OF.—The principal operating characteristics of tubes used as amplifiers, modulators and oscillators include (1) amplification or amplification factor, (2) mutual conductance, and (3) output resistance or impedance, which usually is called plate resistance. All of these are discussed under their respective headings. Plate characteristics or anode characteristics are graphs or sets of curves showing the relations between plate current, plate voltage, and control grid voltage.

TUBE, COLD-CATHODE.—A cold-cathode tube is a gas-filled tube in which the initial electron emission that starts the process of ionization is caused by subjecting the surface of a cold cathode to a strong positive potential or a strong positive field. Tubes of this general type include two-element cold-cathode rectifiers and three-element grid-glow tubes in which the electron flow assumes the character of an arc discharge, also pool tubes, grid-pool tubes, and ignitrons, which have a mercury pool cathode and in which there is an arc discharge. Other cold-cathode tubes are glow tubes and voltage regulator tubes in which electron flow occurs only as a glow discharge rather than as an arc. Although phototubes have unheated cathodes they are not classed as cold-cathode tubes.

The cold cathode may have a larger surface area than the anode or plate, or the cathode may be coated with substances which permit relatively free electron emission, or both methods may be used. If this were not done, alternating potential applied across cathode and anode would cause electron and current flow in both directions, depending only on the relative polarity of the elements. When ionization commences there is a concentration of positive ions close to the surface of the cathode when it is negative. These ions form a concentrated positive charge so that almost the whole anode-to-cathode voltage drop is at the cathode surface. This highly positive potential pulls free electrons from the cathode through its surface and into the tube space.

If anode-cathode potential difference is on the order of 100 volts or less, as in a glow tube, the tube operates and carries current with a uniform visible glow at and near the cathode surface. The internal resistance of the tube and its voltage drop change but little even though there are relatively large changes of current. If current is allowed to increase above a certain value there is enough increase of ionization to cause positive ion bombardment of the cathode surface, which heats some portion of this surface to incandescence. This ionic heating permits greatly increased electron emission from the cathode. This is the action which occurs in cold-cathode rectifiers.

The current and electron flow through a cold-cathode tube always must remain at least great enough to maintain ionization, so these tubes have a minimum as well as a maximum current rating. To start the ionization and current flow in a cold-cathode tube it is necessary to apply an anode-cathode potential difference greater than that required to maintain ionization and current flow after the process is under way. Consequently, these tubes have voltage ratings for starting, for normal operation, and for stopping the ionization or for drop-out. The voltage drop in cold-cathode tubes is con-

TUBE, COLD-CATHODE

siderably greater than in hot-cathode gas-filled types of otherwise similar function.

The chief advantages of cold-cathode tubes are that they require no power for cathode heating, they may carry current without any delay for cathode preheating, and they do not deteriorate while not carrying current. Their disadvantage is a limited current and power handling ability in comparison with hot-cathode gas-filled types.

TUBE, DOUBLE-DIODE.—A double-diode tube consists of a triode or pentode, and in the same envelope two additional small plates or anodes which act with the cathode as two diodes. Fig. 1 is a symbol for a double-diode triode tube. Some tubes have only the two diode units, with no other elements in the envelope.

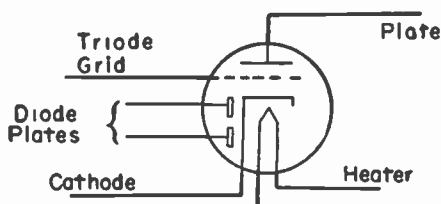

FIG. 1.—Elements of Double-diode Triode.

A circuit using this tube as a detector and also as an amplifier is shown in Fig. 2. The diode (two-element) units are indicated by the two small diode plates placed near the cathode; one of these plates and the cathode forming one diode, the other plate and the cathode forming the second diode. The triode amplifier consists of the cathode, the control grid and the amplifier plate.

Signal voltages produced in the coil by the preceding radio-frequency or intermediate-frequency amplifier (not shown) first make the upper end of the coil positive and then the lower end positive. With the upper end of this coil positive, current flows as shown by the arrows from the coil to the upper diode plate, to the cathode, through the coupling resistor and back into the center tap of the coil. On the following half of the signal voltage cycle the lower end of the coil becomes positive; current flows as shown by the arrows through the lower diode plate, the cathode, and the coupling resistor back to the center tap of the coil. Thus there is current through the coupling resistor during both halves of the signal cycle, and this current always flows in the same direction through the resistor. This direction of current flow makes one end of this resistor positive and the other end negative.

TUBE, DOUBLE-DIODE

The tube's cathode is connected to the positive end and its control grid to the negative end. Consequently, the continuous current portion of this flow through the resistor maintains the amplifier control grid at a negative potential with reference to the cathode, or places a negative bias on the control grid. This is called diode biasing of the triode.

The modulation or the audio frequency portion of the radio frequency signal consists of increasing and decreasing signal voltages. During the time when the voltages of the modulated carrier are becoming stronger there is more and more current sent through the coupling resistor, and the amplifier control grid is made more negative. As the signal voltages decrease, the current becomes less and the amplifier control grid becomes less negative. In this manner the voltage of the amplifier control grid is changed proportionately to the modulation. The amplifier plate current rises and falls with these changes in control grid voltage, and

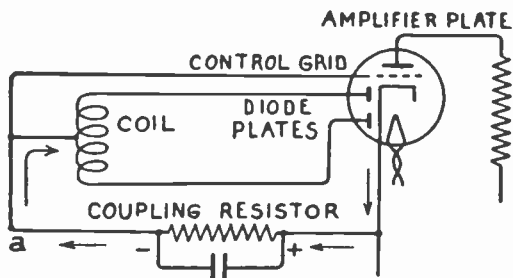

FIG. 2.—Double-diode Triode as Detector and Amplifier.

these plate current changes represent the signal modulation. Thus the diodes have provided detection. In the circuit of Fig. 2 the two diodes act as a full-wave detector because both halves of the signal voltage are rectified. The triode acts as an ordinary voltage amplifier for the audio frequency coming from the detector.

Automatic Volume Control With the Double-diode.—While acting as a detector and as an amplifier this tube may also furnish an automatic volume control biasing voltage for radio-frequency or intermediate-frequency amplifier tubes preceding it. The connections are shown in Fig. 3 where the added parts are drawn in heavy lines. The point *a* in this diagram is the same as point *a* in the one preceding. The resistance of the filter resistor is made higher than that of the coupling resistor to confine the high frequency and audio frequency action to the tube circuit. The capacity of the condenser used with the filter resistor is large enough to bypass any voltage fluctuations that get through the resistor. The connection for automatic volume control then is

TUBE, DOUBLE-DIODE

affected only by the average potential at point *a*. When a powerful signal is being received, the correspondingly large current through the coupling resistor makes point *a* become more negative. This increased negative voltage provides an increased negative grid bias for the preceding amplifier tubes, reduces their amplification, and thus provides automatic volume control.

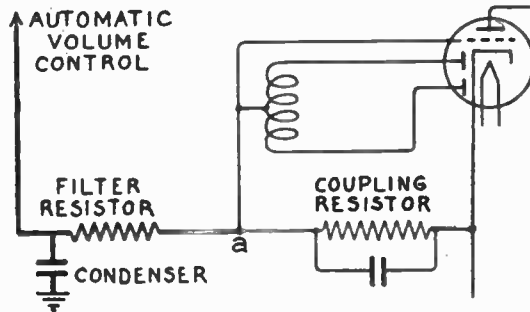

FIG. 3.—Double-diode in Automatic Volume Control.

Half-wave Detection.—Another method of using this double-diode tube is shown in Fig. 4 where the two diode plates are connected together and act as a single plate. Current from the coil now flows through these plates, the cathode, the resistor and back to the coil, but flows only when the upper end of the coil is

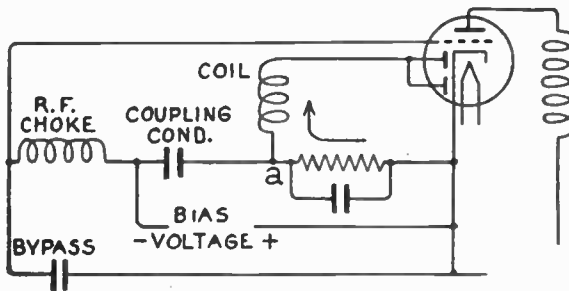

FIG. 4.—Double-diode Half-wave Detector.

positive, the other half of the signal being cut off. The action is essentially the same as before, producing the rising and falling voltages across the coupling resistor to reproduce the modulation.

In Fig. 4 the amplifier control grid is not biased by the steady voltage drop through the resistor. Any separate source of grid bias voltage may be used and connected to the circuit as shown.

TUBE, DOUBLE-DIODE

The amplifier control grid is not connected directly to the resistor, but through a coupling condenser. The audio frequency signal for the amplifier control grid is alternating and therefore will pass through the condenser. In the lead running to the control grid there is a small radio frequency choke coil to retard the passage of radio frequency or intermediate frequency voltages attempting to reach the control grid. These high frequencies which escape the choke go harmlessly to the cathode through the bypass condenser. Biasing voltage for automatic volume control may be had from this circuit by connecting through a filter resistor and condenser to the point marked *a*.

Sensitivity Control.—The connections of Fig. 5 show how a fourth function may be added to the duties of this one tube. Here only the upper diode plate is used as a detector. Otherwise the

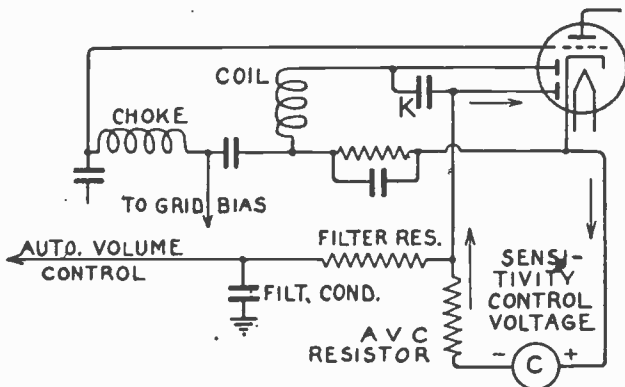

FIG. 5.—Sensitivity Control with Double-diode.

detector action is the same as in Fig. 4. The lower diode plate is used exclusively for volume control. This lower plate is connected to the signal coil through a small condenser *K*. The alternating voltages acting through this condenser cause a one-way current to flow from the lower diode plate to the cathode, then to follow the path indicated by arrows through the automatic volume control resistor and back to the diode plate. The continuous current portion of this flow passing through the AVC resistor in the direction shown makes passing the upper end of this resistor more negative than the lower end. The stronger the signals being received, the more current will flow and the more negative will this end become. Connection of the automatic volume control lead at the point indicated thus gives the volume control voltage for preceding amplifier tubes.

TUBE, DOUBLE-DIODE

In the lower part of the diagram at the position marked *C* it is possible to open the line between the cathode lead and the AVC resistor and to insert some means for providing a variable voltage. As shown by the positive and negative signs on this voltage, the lower diode plate may be made more or less negative with reference to the cathode. This variation of potential changes the amount of current flowing in the AVC circuit and resistor, and provides a control over the automatic biasing voltage such that the entire receiver may be made more or less sensitive.

Double-diode Pentode.—The triode portion of a double-diode triode tube may be satisfactorily used for audio frequency amplification, but an attempt to use it as a radio frequency or intermediate frequency amplifier leads to trouble because of grid-plate capacities. In order to use the amplifier portion of this tube for high frequency work the triode is replaced with a screen grid pentode and the tube becomes a double-diode pentode. The added screen is connected to an additional prong on the base, but the suppressor is connected to the cathode inside the tube and requires no extra outside terminal.

The operation of the diodes in the double-diode pentode is no different from their action in the type having a triode section. The pentode section may be used in the same manner as any other pentode; either as a high frequency amplifier ahead of the diode detector or as an audio frequency amplifier following the diode detector.

TUBE, ELECTRON-RAY

TUBE, ELECTRON-RAY.—An electron-ray tube is a vacuum tube with a visible circular cone-shaped target coated with fluorescent material which glows brightly when it receives electrons flowing to it from a centrally located cathode. The construction of one such tube is shown in Fig. 1. Between the central cathode and the target, on opposite sides of the cathode, are two ray-control electrodes whose potential and resulting electric field may be varied to alter the portions of the target that receive electrons from the cathode, and thus to alter the portions of the target which glow.

When the control electrodes are positive with reference to the cathode there is free flow of electrons and the glow appears over nearly the whole target. But when the control electrodes are made negative, the negative electric fields produced around them hold

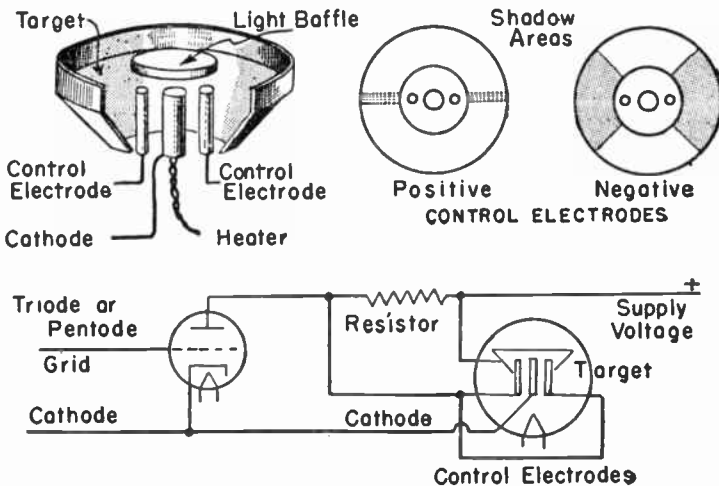

FIG. 1.—Two Ray Control Electrodes and Tube Circuit.

back the electron stream from those portions of the target protected by these fields, and there appear wide wedges of darkened shadow, each covering about one-fourth of the target area. Electron-ray tubes are used chiefly as indicators of correct tuning in radio receivers. The shadow area of the target becomes narrowest when the receiver is tuned to resonance.

Fig. 1 shows connections for an electron-ray tube operated from a triode, or from a pentode with its plate, suppressor and screen connected together to act as a triode plate. The positive of the supply voltage is connected to the target, and through a resistor of one-half to one megohm is connected to the control electrodes of the electron-ray tube and the plate of the triode. Triode plate current through this resistor causes a drop of voltage across the resistor. This drop forms the voltage difference between target and control electrodes of the electron-ray tube, and its variation

TUBE, ELECTRON-RAY

changes the potential of the control electrodes with reference to the target and also with reference to the cathode.

As the grid of the triode is made more negative with reference to its cathode there is less plate current, less voltage drop across the resistor, and the potential of the control electrodes in the electron-ray tube becomes more nearly equal to that of the supply voltage and the target. Then there are narrow shadows or none at all on the target. When the triode grid is made less negative there is more plate current, more voltage drop across the resistor, a lowering of control electrode potential, and a widening of the shadows on the target of the electron-ray tube. The control voltage for the triode grid circuit may be taken from some point in the automatic volume control circuit.

Other electron-ray tubes are made, as shown by Fig. 2, with a single ray-control electrode and with the plate and grid of a triode in the same envelope. The cathode furnishes electrons for both the target and the triode plate. The ray-control electrode is at-

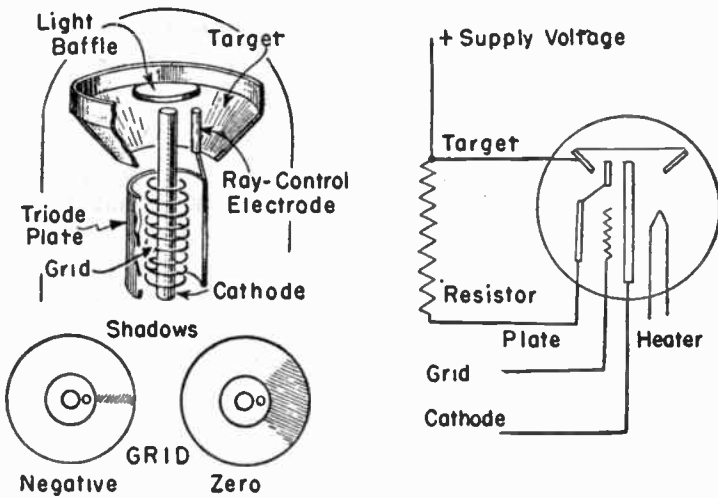

FIG. 2.—Tube and Circuit for Single Control Electrode.

tached to the triode plate, so has the same potential as the plate. When the grid of the triode is made highly negative with reference to its cathode there is the narrowest shadow on the target, and when the control grid potential is made zero there is the widest shadow.

In Fig. 2 the positive of the supply voltage is connected directly to the target, and through a resistor of one-quarter to one megohm to the triode plate. This connection is equivalent to that of Fig. 1, since in both diagrams the supply voltage is connected to the target, the triode plate and the ray-control electrode are connected directly together, and there is a voltage dropping resistor between the supply voltage and the connection to the plate and control electrodes. The action is the same with both arrangements.

TUBE, GAS-FILLED

TUBE, GAS-FILLED.—A gas-filled tube or a gaseous tube is one whose envelope has been evacuated to a high degree, and to which then has been admitted a small quantity of some inert gas such as argon, helium, neon or xenon. An inert gas is one which will not enter into chemical combination with other substances, which undergoes no chemical changes, and which has no effect on other materials in the tube. Other tubes in this general class have in their envelopes a small quantity of mercury vapor which, during operation of the tube, is evaporated either from a few drops of mercury contained in the envelope or else from a pool of liquid mercury which forms the cathode of the tube. Gas-filled and vapor-filled tubes include two-element glow tubes, phanotrons, and other rectifiers, also three- and four-element thyratrons, grid-glow tubes, and ignitrons.

During normal operation of all of these gas- or vapor-filled tubes there is ionization, which releases electrons from the atoms or molecules of the

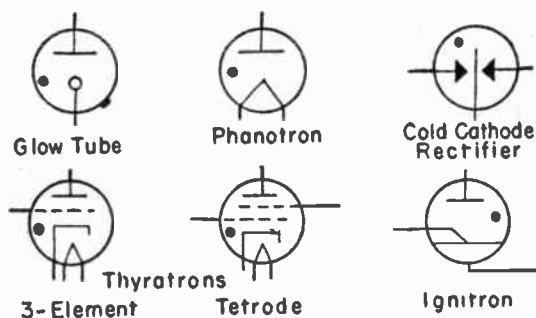

FIG. 1.—Symbols for Gas-filled Tubes.

gas or vapor. These released electrons join those which are flowing from cathode to anode. The atoms or molecules which have lost electrons are then positively charged, and are called positive ions. These ions move toward a negative cathode where they re-combine with electrons. This reduces the negative space charge and permits greatly increased electron emission. As a result of ionization the gas- or vapor-filled tubes conduct large currents with relatively small voltage drops in the tube. The fact that a tube is gas- or vapor-filled is indicated on its symbol by placing a dot, as in Fig. 1, anywhere within the circle which represents the envelope or bulb.

The cathodes or filaments of most of these tubes are of the oxide coated type, although some are of tungsten or of thoriated tungsten, and the ignitron has a mercury pool cathode. With all except the small sizes of hot-cathode phanotrons and thyratrons it is necessary to preheat the cathode before applying plate or anode voltage and before drawing current through the cathode. If this is not done, the cathode will not have had time to emit enough negative electrons to combine with the positive ions, and the ions will so violently bombard the cathode surface as to

TUBE, GAS-FILLED

knock off particles of the electron-emitting material. Then there may follow arcing and sputtering, and a rapid disintegration of the whole surface.

Required preheating time usually is less than a minute for gas-filled tubes, but is two or three minutes for mercury-vapor types. Times are specified in published tube ratings. When a mercury-vapor tube is newly installed, or when it has been moved, particles of liquid mercury which have been thrown about will adhere to the anode and other elements. Preheating then must continue until the tube temperature reaches a point at which the particles distill to vapor and condense in the bottom of the tube. This may take from 15 to 45 minutes, depending on the size of the tube. When plate current is required only intermittently the cathode is kept heated during idle periods. Preheating often is controlled by time-delay relays which commence their timing period when the heating power is first turned on.

When tubes are operating normally the average voltage drop in the tube itself is from 12 to 25 volts with gas-filled types, from 6 to 20 volts with hot-cathode mercury vapor types, and from 50 to 200 in cold-cathode types. The voltage drops vary with the age of the tube, and with the operating temperature of mercury-vapor types. The voltage at which ionization will commence, called breakdown or pickup voltage, may be 25 to 50 per cent higher for mercury-vapor tubes and may be several hundred per cent higher for gas-filled types.

The small voltage drops in all of these tubes show that the internal resistance is very low, and is quite incapable of limiting the current to values which would not overheat and destroy the tube. Consequently, the external plate circuit or anode circuit must include enough resistance or impedance to limit the tube current to a safe value. Except in very low-voltage circuits the tube resistance is neglected and the external impedance is made such as permits only the maximum allowable tube current with the voltage which is applied to the plate or anode circuit.

Pressures and Temperatures.—Pressures of inert gases may be anywhere from about 1/5000 pound per square inch to one pound per square inch, the latter value being found only in some low-voltage gaseous rectifiers. Mercury vapor pressures normally range between 50 and 250 millionths of a pound per square inch. The pressures which remain in high vacuum types of tubes are in the neighborhood of one ten-millionth of a pound per square inch. Relatively high pressures raise the temperature at which a hot cathode may be operated, but they decrease the voltage which the tube will withstand in a reverse direction (anode negative and cathode positive) without arcing through the tube.

The internal pressure in gas-filled tubes undergoes very little change with variations of operating temperature, but with mercury-vapor types there are wide changes of pressure with temperature. Rated operating temperatures usually are listed as ambient temperatures, which means the temperature in the space around the tube. Gas-filled tubes usually operate satisfactorily at temperatures between a few degrees below zero and 150° F. above zero, while temperatures of mercury-vapor tubes should be maintained within a range from about 65° to 130° F. for best results. Gas-filled tubes are used where there will be great changes in ambient temperature.

In a mercury-vapor tube there is continual evaporation of mercury by the heat, and a continual condensation on the cooler parts of the envelope. The

TUBE, GAS-FILLED

internal vapor pressure thus maintained depends on the temperature of condensation, which is the temperature of the coolest part of the envelope or of the part nearest the base. Fig. 2 shows how rise of temperature in a mercury-vapor tube causes an increase of internal pressure and an accompanying drop of inverse or reversed voltage that the tube will withstand be-

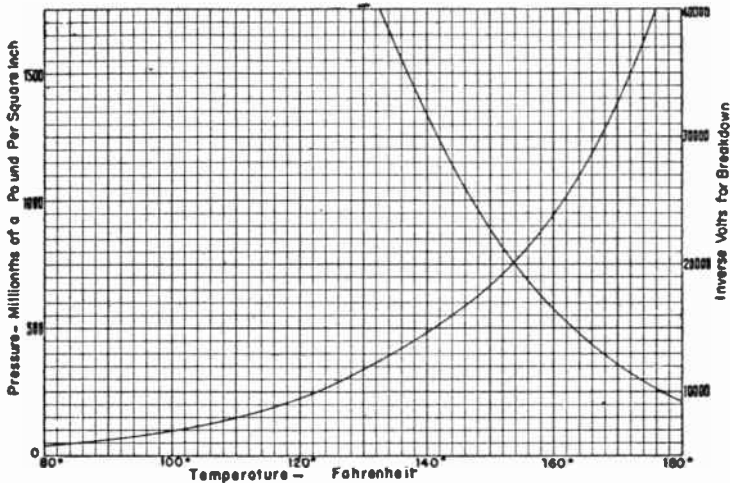

FIG. 2.—Relations between Operating Temperature of a Mercury-vapor Tube and Internal Vapor Pressure (curve starting from left), Also between Temperature and Inverse Voltage for Breakdown.

fore permitting a reversed current. Operating temperature usually is maintained within desirable limits by water cooling or by forced air circulation. Mercury-vapor tubes must be mounted vertically, or nearly so, with the cathode or filament end downward so that condensed mercury may return to this end. Gas-filled tubes may be mounted in any position that does not cause overheating.

TUBE, GAS-FILLED, GRID CONTROL

TUBE, GAS-FILLED, GRID CONTROL OF.—Gas-filled or vapor-filled tubes in which a grid or other element controls current flow by changes of grid potential include thyratrons, grid-glow tubes, and ignitrons, also some other types which operate in a generally similar manner. During the operation of all such tubes the gas or vapor is ionized. The instant at which ionization commences is determined by the relative potentials of the anode and control grid, and it is at this instant that appreciable flow of current begins. Current flow cannot be stopped by any change of grid potential which is practically possible, but ionization and current flow are stopped only when the anode potential is reduced to or near zero.

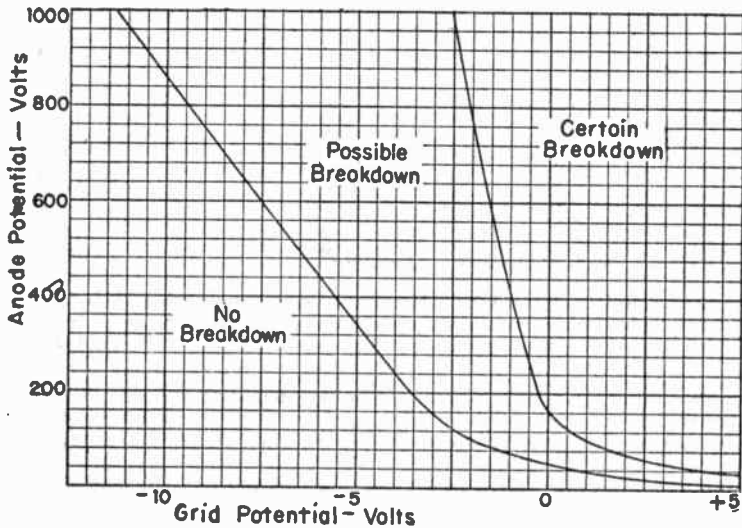

Fig. 1.—Range of Breakdown Potentials for Mercury-vapor Thyatron of Three-element Type.

Fig. 1 shows, for a typical three-element mercury-vapor thyatron the relations between anode potential and control grid potential at which ionization and current flow commence, or the potentials at which the tube is said to break down, to fire, or to pick up. The two curves represent minimum and maximum limits for average tubes. The range between them allows for differences between individual tubes, for variation of operating characteristics that occur during the life of a tube, and for unavoidable differences in such factors as heater or filament voltage. There will be no breakdown with any combination of voltages at the left of and below the left-hand curve, and there always will be breakdown with any combination of voltages at the right of and above the right-hand curve.

As an example, with 600 volts anode potential there will be no chance of breakdown when the grid is more than 7.5 volts negative, as shown by the

TUBE, GAS-FILLED, GRID CONTROL

left-hand curve, and there always will be breakdown when the grid is less negative than 1.5 volts and when the grid is positive, as shown by the right-hand curve. With the grid potential between 7.5 and 1.5 volts negative there may or may not be breakdown, depending on the tube and the operating conditions. Again, considering that the control grid is 2.0 volts negative, there will be no breakdown unless the anode potential is at least 100 volts, and there always will be breakdown with an anode potential of 780 volts or more, and between these limits of anode voltage there may or may not be breakdown. It must not be inferred that any one tube will have such wide variation of operating characteristics as shown by Fig. 1. A particular tube operating with well controlled conditions would have little variation in breakdown potentials.

When the grid is more negative than the breakdown voltage for the anode potential being used, the negative charge of the grid in combination with the negative space charge prevents flow through the tube of enough electrons to start ionization. But at the instant when the grid is made less negative, or when the anode potential is increased, ionization will take place and there will be a flow of current limited only by the supply potential in relation to the external impedance and the very small impedance of the tube itself. The time for ionization to reach its full value usually is around 10 millionths of a second, and in some cases may be much less.

While there is ionization in the tube the envelope is filled with positive ions. These are attracted to the negative grid in sufficient quantity to neutralize its negative charge. No matter how much more negative the grid is made, within any reasonable limits, the result is merely to attract more positive ions. Thus the grid loses all of its former ability to oppose emission and electron flow, and it can neither limit nor stop the current.

To stop the flow of current it is necessary to decrease the anode potential to a value below that which imparts enough velocity to the electrons to maintain ionization, and the anode potential must remain there until the existing positive ions have re-combined with negative electrons to form neutral atoms or molecules of gas. This is the process of deionization. Deionization usually takes about 1/1000 second, but the time may be much shorter. Deionization time is shortened by small plate currents, by highly negative grid voltage, by lower anode potentials, and by lower operating temperature. The time required for ionization and deionization limits the frequency at which the tube may operate, because were an alternating potential to reverse while ionization continued there would be a flow of current in the reverse direction through the tube. In practice the anode potential is reduced to zero, or is made negative, when stopping current flow.

When ionization has ceased, the anode potential may again rise to its former value, and, if the grid is sufficiently negative, there will be no further ionization and current flow until breakdown potentials exist. Breakdown conditions are practically unaffected by temperature of a gas-filled tube, but vary with temperature of a mercury-vapor filled tube.

Since current will flow in the grid circuit during ionization, and because this current might become large with the grid potential positive, it is necessary to have in series with the grid circuit enough resistance or impedance to prevent excessive grid current. Unless there is enough other circuit im-

TUBE, GAS-FILLED, GRID CONTROL

pedance it is customary to insert a series resistor of 10,000 to 50,000 ohms. This and other features of the tube circuits are shown by Fig. 2.

When the control grid has a steady bias potential only slightly more negative than required to prevent breakdown, any small pulse of control potential that makes the grid less negative will allow current to flow. Such a control circuit usually is run with shielded conductors and the shields are grounded. The tube itself may be in a grounded shield. The effects of momentary voltage surges often are absorbed by a capacitor connected between grid and cathode, as in Fig. 2.

Control of Grid Voltage.—In Fig. 3 the anode circuit is supplied with direct current, the grid is maintained normally negative by a d-c grid bias voltage, and control of grid potential for breakdown is from a d-c source. Grid potential is equal to the differ-

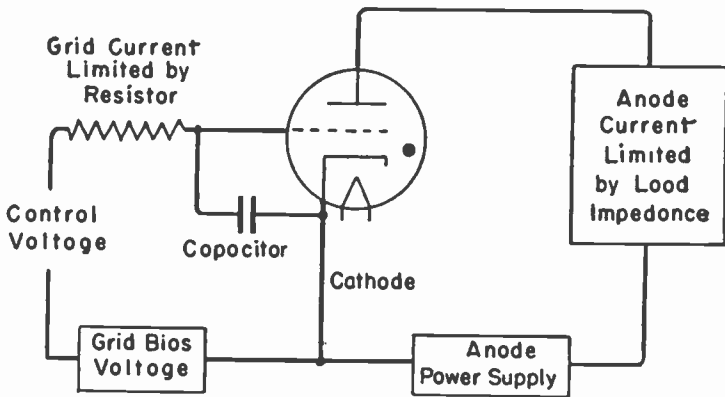

Fig. 2.—Grid and Plate Circuits of Gas-filled or Vapor-filled Triode.

ence between control voltage and bias voltage, and when the control voltage is enough higher than the bias voltage the tube will break down and current will flow in the load. The load may be a relay or any device operated by anode current. Current is stopped by opening the switch in the anode circuit.

Fig. 4 shows a circuit somewhat similar with the difference that the control voltage is alternating. When the peak value of this control voltage in a positive direction exceeds the negative biasing voltage by an amount required for breakdown, the tube will fire and current will flow in the load. Since the anode circuit is supplied with d-c power it will be necessary to open this circuit to stop the load current. If it is desired that there be only a momentary pulse of current in the load circuit, the load circuit may include a relay on which is an extra set of contacts that open the anode circuit immediately after the main contacts close the load circuit. D-c grid bias usually may be secured from a voltage divider across the d-c power circuit, with control of breakdown adjusted by the setting of the voltage divider.

TUBE, GAS-FILLED, GRID CONTROL

In the majority of applications both the power supply and the anode potential are alternating rather than direct. Then, as shown by Fig. 5, current can flow in the anode circuit only during the half-cycles in which the anode is made positive with reference to

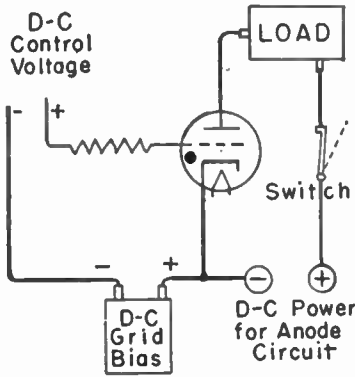

FIG. 3.—D-c Control of D-c Power for Load.

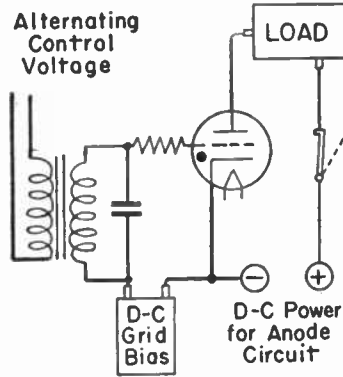

FIG. 4.—A-c Control of D-c Power for Load.

the cathode. Current will stop every time that the anode potential drops back to zero, which will be at the end of each positive half-cycle. With a-c supply for the anode circuit it is not necessary to provide a switch for opening the anode circuit when current is to

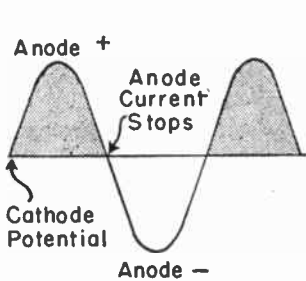

FIG. 5.—Anode Current Flows Only During Positive Half-cycles.

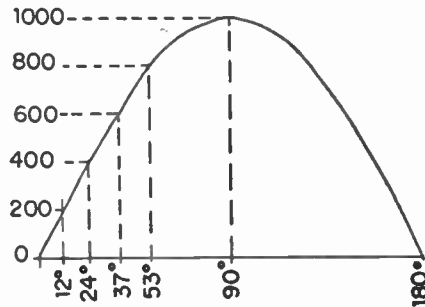

FIG. 6.—Potentials at Certain Times in a Sine-wave Half-cycle.

be stopped, because current is automatically stopped once in every alternating cycle, and will not resume unless the relation between the potentials of anode and grid are such as to allow breakdown when the anode again becomes positive.

TUBE, GAS-FILLED, GRID CONTROL

Fig. 6 shows, for a sine-wave alternating potential, the instants in approximate degrees during a positive half-cycle at which the anode potential will have increased to various voltages.

Fig. 7 shows a curve for grid and anode potentials at which breakdown will occur, the values on this curve being averages taken between the two curves of Fig. 1. For each 200 volts change of anode potential in Fig. 2 there are shown the corresponding negative grid potentials which permit breakdown, also the corresponding degrees of the positive half-cycle as taken from Fig. 6. Here it may be seen that with the grid 6.9 volts negative, breakdown will be delayed until 90 degrees, or until one-quarter cycle has elapsed. With the grid 5.7 volts negative there will be breakdown at 53 degrees, with 4.5 volts negative there will be breakdown at 37 degrees, and so on.

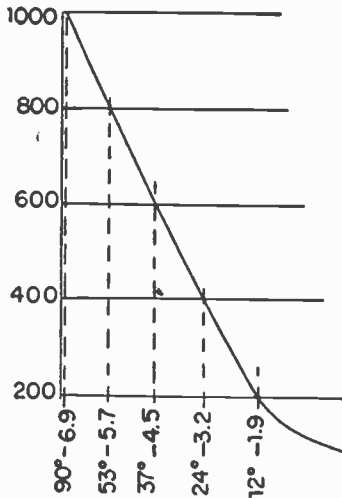

FIG. 7.—Average Grid and Anode Potentials for Breakdown.

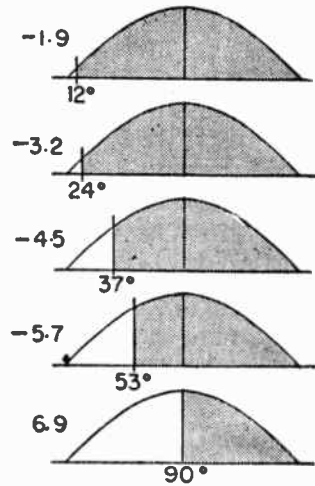

FIG. 8.—Control of Anode Current by Instants of Breakdown.

When breakdown has once occurred, ionization and current flow will continue until approximately the end of the half-cycle, or until the instant at which drop of anode potential allows deionization. Fig. 8 shows the portions of the positive half-cycle during which there will be flow of current for the various grid voltages shown by Fig. 7. Now it becomes apparent that, by making the grid more or less negative, the flow of current in the anode circuit may be regulated to anything between a complete half-cycle and one half of the half-cycle. However, with this method of varying the potential of the grid, it is impossible to have current flow during less than one half of the positive half-cycle. It is impossible because, with the grid made more negative than 6.9 volts, the anode potential never will become high enough to cause breakdown and there will be no current flow at all. The effect of this method of control is to vary the average anode current from a maximum value corresponding to flow during the entire positive half-cycle to half of this maximum.

TUBE, GAS-FILLED, PHASE SHIFT

TUBE, GAS FILLED, PHASE SHIFT CONTROL.—

Current in the anode circuit of a gas-filled tube having a control grid may be varied from zero to maximum value by using alternating potentials for both the anode circuit and the grid circuit, and by varying the phase relation or the time relation between these two potentials. This is the method of control most commonly employed for thyratrons, grid-glow tubes, ignitrons, and other tubes of generally similar characteristics.

Fig. 1 shows average relations between anode and grid potentials for breakdown in a typical gas-filled grid-controlled tube. The same relations may be shown as in Fig. 2. Here the upper curve represents the changes of anode potential during a positive half-cycle of a sine-wave alternating voltage. The lower curve represents grid potentials. On any one of the verti-

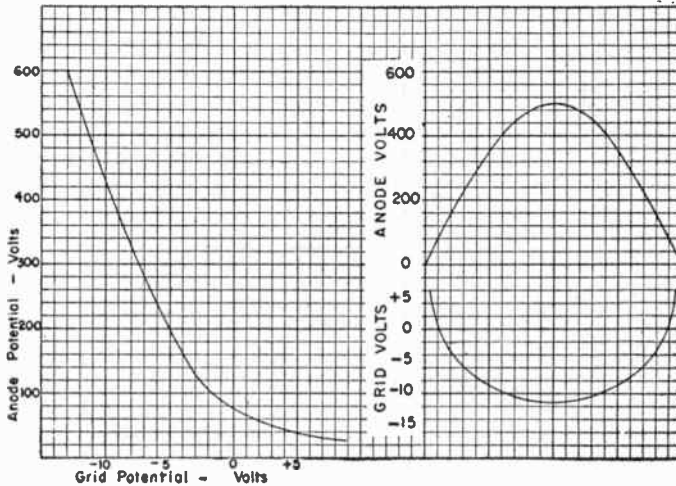

FIG. 1.—Average Breakdown Potentials for a Gas-filled Tube.

FIG. 2.—Relations of Grid and Anode Volts for Breakdown.

cal lines are found the positive anode potential and the negative grid potential which, in combination, permit breakdown. The advantage of the representation in Fig. 2 is that it shows the instants during the positive half cycle of anode potential at which breakdown will occur with various grid voltages.

In Fig. 3 there have been added to the curves of Fig. 2 two additional broken-line curves which represent a half-cycle of alternating grid potential which is in opposite phase to the anode potential, which means that the grid potential becomes negative while the anode potential becomes positive. Curve *A* represents a grid potential of low voltage or small amplitude. This curve first crosses the curve of breakdown voltage at point *r*. Consequently, with this small negative grid potential, the tube will break down at the point in the half-cycle which is at *r*, and anode current will continue during the remainder of the half cycle. Curve *B* of Fig. 3 shows greater negative potential or amplitude than does curve *A*. When the negative grid potential

TUBE, GAS-FILLED, PHASE SHIFT

is as shown by curve *B* it never crosses the curve of breakdown voltage, and so the grid always will be too greatly negative to permit breakdown at any point in the cycle. As the alternating grid voltage is increased from the value at *A* toward the value at *B* breakdown will occur later in the cycle.

Grid potential curves *A* and *B* of Fig. 3 are of so nearly the same form as the curve of breakdown voltage that the intersections, as at *1*, always are at very small angles. This means that a very small change of grid potential will cause a large change in the instant of breakdown and a large change of anode current. This control, with anode and grid potentials in opposite phase, is too critical to be of much practical use. The opposite phase relation may be secured by connecting the grid circuit to the secondary of a transformer whose primary is connected to the a-c anode circuit supply, as in Fig. 4.

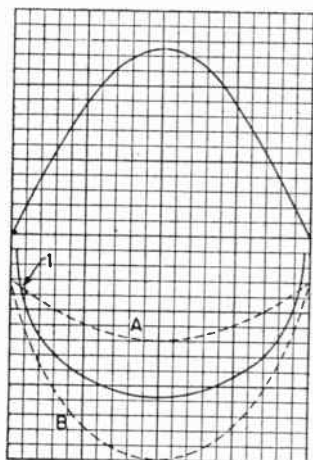

FIG. 3.—Relations of Control Potentials Applied to Grid, and Breakdown Potentials.

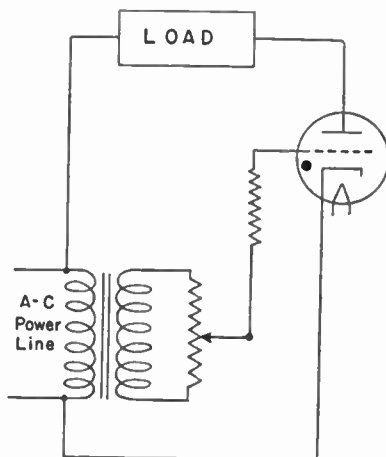

FIG. 4.—Method of Varying the Amplitude of Control Voltage Applied to the Grid.

To improve the control characteristics the alternating potential applied to the grid may be shifted in its time relation or phase relation to the alternating potential on the anode, as shown by Fig. 5. Now, with a grid voltage of small amplitude, the curve of alternating grid potential cuts the curve of breakdown voltage at *1*, which is early in the positive half-cycle of anode potential. With a greater grid voltage the cutting, and breakdown, will be at *2*, and with still greater grid voltage they will be at *3*. Thus, by changing the value of alternating potential on the grid, it is possible to cause breakdown in a satisfactory manner at any instant during the first portion of the anode half-cycle.

During the half-cycle of grid potential in which this potential is positive there are either of two conditions. Either the anode current flow is con-

TUBE, GAS-FILLED, PHASE SHIFT

tinuing during the latter part of its positive half-cycle, or else the anode has become negative. In neither case can the positive potential of the grid have any effect on ionization or current flow.

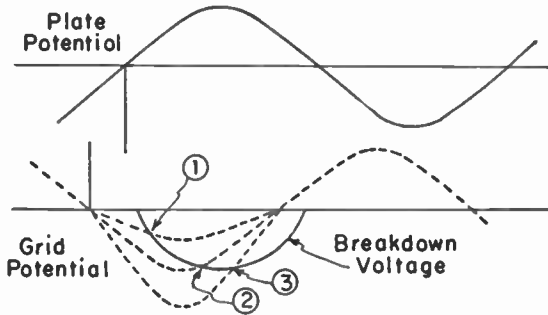

FIG. 5.—Breakdown Control by Variation of Grid Potential Amplitude, with Phase Shift of Grid Potential.

A still different method of control is had by maintaining the alternating potential on the grid at a high constant value or amplitude, and by varying the amount of phase shaft, or by varying the time difference between grid and anode potentials. This is shown by Fig. 6. When the alternating grid potential has a very great

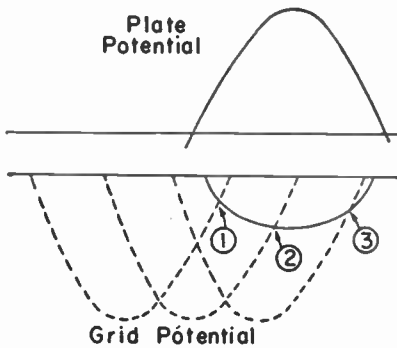

FIG. 6.—Control by Variation of Phase Shift of Grid Potential, with Constant Amplitude.

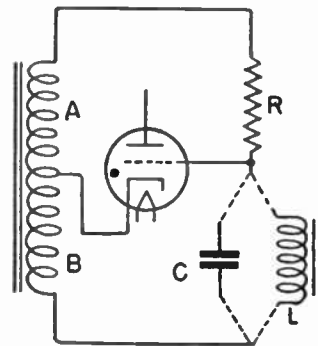

FIG. 7.—Principle of Phase-shift Control Employing Resistance and Capacity or Inductance.

lead in relation to the alternating anode potential breakdown will occur at point 1, very early in the positive half-cycle of anode potential. Less lead of grid potential will cause breakdown at 2, about half way through the half-cycle. A small lead will delay

TUBE, GAS-FILLED, PHASE SHIFT

breakdown until point 3, almost at the end of the half-cycle. Thus, with variable phase shift and constant amplitude of grid potential, it becomes possible to have breakdown anywhere in the positive half-cycle of anode potential, and to vary the average anode current to any value between zero and the maximum represented by flow throughout the entire positive half-cycle. This is the method of control generally referred to when using the term phase-shift, and it is the most stable and flexible of all the controls which have been examined.

The basic arrangement of many of the most generally used phase shifting circuits is shown by Fig. 7. An alternating emf is induced in the center-tapped coil *A-B*. The center of this coil remains at a potential midway between potentials at its ends, or at zero potential, and with this center point connected to the tube cathode the cathode remains at zero potential. Across the ends of the coil are connected, in series, a resistor *R* and either a condenser *C* or else an inductor *L*. The grid of the tube is connected to a point between *R* and *C* or *L*. The potential at this point, and on the

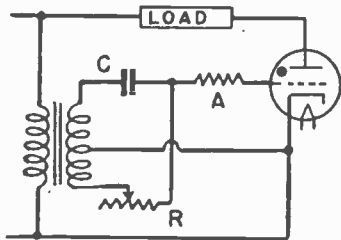

FIG. 8.—Phase Shift with Adjustable Resistor and Fixed Condenser.

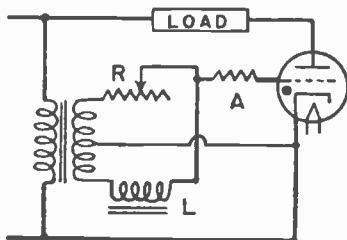

FIG. 9.—Phase Shift with Adjustable Resistor and Fixed Inductor.

grid, will be higher or lower or will be ahead of or behind the potential on the cathode when there is a difference between the reactance of *C* or *L* and the resistance of *R*. The time relation of the potential on the grid to the potential on the cathode may be varied by changing the resistance of *R*, the capacitive reactance of *C*, or the inductive reactance of *L*. Since potentials on the grid and anode of the tube always are opposite, any of the adjustments mentioned will effectively shift the phase relation between grid potential and anode potential.

Fig. 8 shows a phase-shift circuit including an adjustable resistor *R*. The center-tapped winding is the secondary winding of a transformer whose primary is connected to the line that furnishes power for the load and the anode circuit of the tube. Resistor *A* limits current in the grid circuit. In Fig. 9 the phase-shifting circuit includes an adjustable resistor *R* and an inductor *L*, which replaces the condenser of Fig. 8. Some circuits include a saturable reactor which provides a variable inductance. The effective reactance of the saturable reactor may be varied by connecting the direct-current circuit of the reactor into the plate circuit of a vacuum triode, whose grid voltage then regulates its plate current, regulates the reactance of the reactor, thereby varying the phase-shift and anode current of the gas-filled tube.

TUBE, GAS-FILLED, PHASE SHIFT

Fig. 10 shows one circuit arrangement in which adjustable resistance in the phase-shift circuit consists of the plate resistance of a vacuum triode. The effective plate resistance of the triode is varied by changing its grid voltage. In Fig. 11 the variable resistance for the phase-shift circuit is the resistance of a phototube. This circuit is adjusted by means of a variable condenser.

When the alternating grid potential which is shifted as a means of control is of sine wave form, or approximately so, the relations of grid and anode voltages in a cycle of anode potential are as at the left-hand side of Fig. 12. The grid is positive during a portion of the time in which the anode is negative, which means that the grid is positive with reference to both cathode and anode. There will be electron flow to the grid from both of these other elements, and this will cause some ionization to persist in the tube space because of the fact that there is grid current. It has been

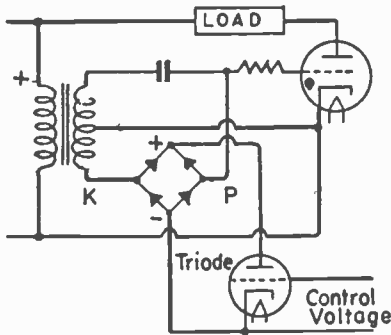

FIG. 10.—Phase-shift Control by Means of a Vacuum Triode Connected to a Bridge Rectifier.

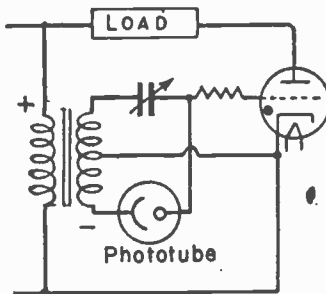

FIG. 11.—Phase-shift Control by Means of Varying Resistance of a Phototube.

mentioned that a resistor is connected in series with the grid to limit this grid current and the ionization that accompanies it. But the varying flow of current in the grid resistor varies the voltage drop across this resistor, varies the actual potential of the grid, and may result in unreliable control.

It is possible to have more precise control of the instant of breakdown by obtaining the alternating grid potential from a peaking transformer which furnishes very brief peaks or pulses of potential rather than a long drawn out rise and fall as in a sine wave. As shown at the right-hand side of Fig. 12, the potential from the peaking transformer is combined with a permanently negative bias of the control grid. Then the grid remains negative throughout the entire anode cycle, and there is no appreciable grid current at any time. The pulse of potential in the positive direction from the peaking transformer opposes and reduces the negative bias sufficiently to cause breakdown, and then the grid potential immediately returns to its full negative value. The potential from the peaking transformer is shifted in phase relation to the anode potential just as is the sine wave grid poten-

TUBE, GAS-FILLED, PHASE SHIFT

tial from any other source. The peaked wave intersects the curve of break-down potentials at a very sharp angle, so that there may be very exact control of the instant of breakdown regardless of such things as tube temperature and changes in supply voltage.

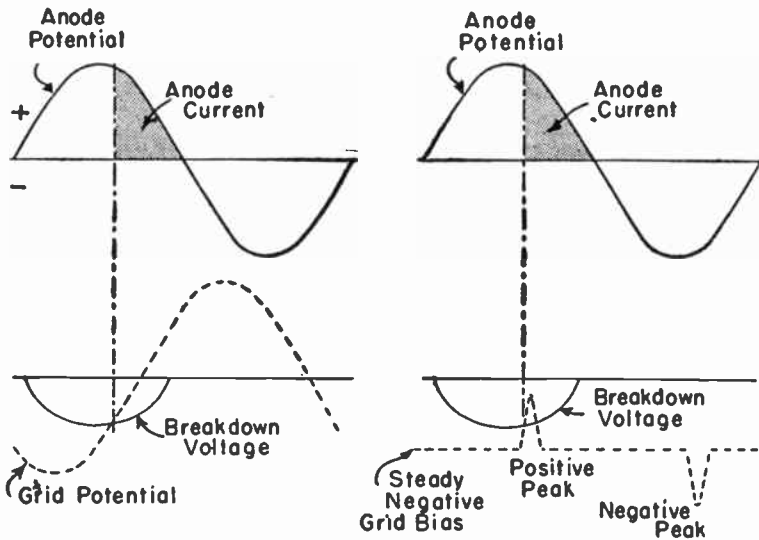

FIG. 12.—Left: Sine-wave Control Potential Used on Grid.
Right: Potential from Peaking Transformer Applied to Grid.

TUBE, GLOW.—A glow tube is a gas-filled tube with a cold cathode and an anode. Gas between these electrodes becomes ionized when the potential difference is made great enough to produce the initial electron flow which detaches electrons from some of the gas atoms or molecules. Thereafter there may be large variations of current through the tube with but small accompanying changes of voltage drop.

See *Tube, Gas-filled*; *Tube, Cold-cathode*; and *Tube, Voltage Regulator*.

TUBE, GRID-GLOW

TUBE, GRID-GLOW.—A grid-glow tube is a cold-cathode gas-filled tube in which are a cathode, an anode or plate, and one or more control elements called grids, starter-anodes or other names descriptive of their function. Grid-glow tubes are used for electronic control of a great variety of electrical devices and for controlled rectification, somewhat similarly to thyratrons but with smaller currents and powers.

The construction of one style of grid-glow tube is shown by Fig. 1. The cathode is a large open-ended metallic cylinder. The anode is the

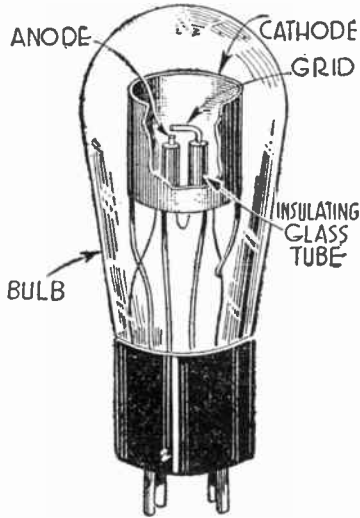

FIG. 1.—Construction of One Style of Grid-glow Tube.

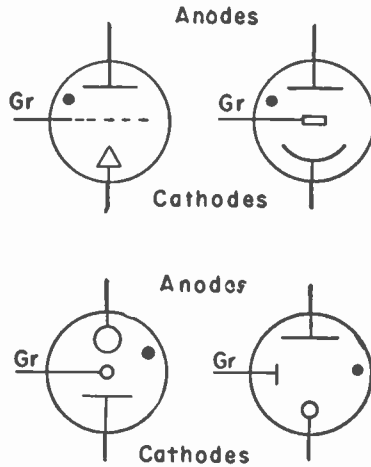

FIG. 2.—Some of the Symbols Used for Grid-glow Tubes.

exposed end of a centrally located insulated wire or rod, and the grid or control electrode is the bent-over end of a small wire that comes close to the anode. There are various other designs. In one of them the grid is a wire loop around the end of the anode. In some the cathode is a large circular disc with the control electrode a wire loop. Some of the many different symbols used for grid-glow tubes are shown by Fig. 2.

For descriptions of fundamental action of grid-glow tubes see *Tube, Gas-filled*; *Tube, Gas-filled, Grid Control of*; and *Tube, Cold-cathode*.

TUBE, GRID-GLOW

The potential difference applied between anode and cathode is great enough to maintain ionization after the process is started, but is lower than needed to start ionization. Because the grid is closer to both the cathode and anode than they are to each other, ionization between the grid and either of the other elements will start when there is a relatively small potential difference between the grid and either the cathode or anode. When the control grid is brought to this potential the gas will be ionized in the tube space. Then, because there is a greater potential difference between anode and cathode than between either of these elements and the grid, flow of current will transfer to the anode-cathode path. Thereupon the grid loses control. Current flow will stop only when the anode-cathode potential difference is dropped below the voltage necessary to maintain ionization.

As usually operated, the initial ionization in the grid-glow tube takes place between cathode and grid. The grid is operated at positive potentials with reference to the cathode, whereas with thyratrons the grid may be negative. With the grid of the grid-glow tube positive, there will be current in the grid circuit. When this grid current rises to a certain value, depending on the type of tube, there will be enough ionization so that the main current flow transfers to the anode-cathode path. The requirements for this transfer may be stated either as the grid current or as the grid potential. The more positive the grid, or the greater the grid current, the lower will be the anode-cathode potential at which current flow will transfer to the anode-cathode path, or at which the tube will break down. There must be maintained a minimum current with which ionization continues; otherwise the tube will stop conducting.

The principles of controls used with grid-glow tubes are the same as explained under *Tube, Gas-filled, Grid Control of*; and *Tube, Gas-filled, Phase-shift Control*. Phase-shift control with a phototube often is used.

TUBE, GRID-POOL.—A grid-pool tube is a tube, or tank, having a mercury pool cathode and one or more control elements or grids which control starting of ionization and current flow by variations of potential or charge on these grids. Mercury arc rectifiers are examples of a grid-pool tube.

TUBE, IGNITRON

TUBE, IGNITRON.—The ignitron is a heavy-duty steel jacketed water-cooled tube having a mercury pool cathode. Ionization and current flow are started by a momentary flow of current from an electrode called the ignitor into the mercury cathode. This establishes an electron-emitting spot on the mercury surface

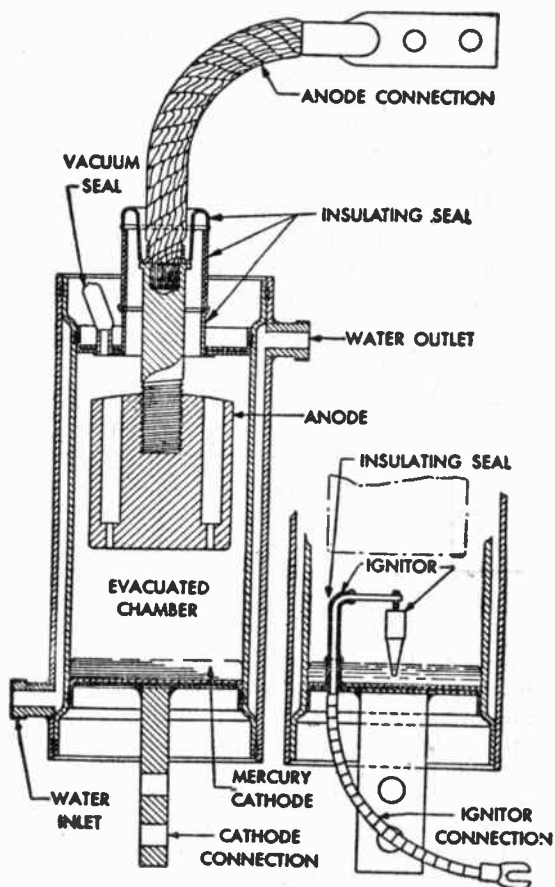

FIG. 1.—Construction of One Type of Westinghouse Sealed Ignitron.

where pierced by the ignitor, whereupon there is breakdown or ionization and a flow of current from the anode to the cathode.

The construction of a sealed type ignitron is shown by Fig. 1. Much larger units are constructed as tanks which are continually evacuated by connection of the interior of the tank to a vacuum pump. Referring to Fig. 1, the mercury pool cathode is in the bottom of a steel cylinder around which is a jacket that carries circulated water for removing excess heat.

TUBE, IGNITRON

The anode is of graphite, carried on the lower end of a rod supported in the jacket by an insulating glass seal. The ignitor is a pencil-like element made of some high-resistance crystalline material such as silicon carbide. The tip of the ignitor dips below the surface of the mercury cathode. The external connection of the ignitor is through a wire with an insulating glass bushing passing through the bottom of the tube.

The support for the tube of Fig. 1 is a lug attached to the jacket and conductively connected to the cathode through the jacket metal. The lug is bolted or clamped to a bus bar or other solid part of the apparatus. The entire outside surface of the jacket is at cathode potential which, in some circuits, may be so high as to make it dangerous to touch the jacket while the apparatus is in operation. Because of the liquid cathode, ignitrons must be mounted vertically with their cathode end down. Generally used types have shells from two to six inches in diameter, six to fourteen inches long. They will handle average currents from 20 up to several hundred amperes, and for a fraction of a second will carry several thousand amperes. Potential drops in the tube vary from 10 to 30 volts, depending on operating conditions, especially temperature and the age of the tube.

Ignitor potential for starting is made 100 to 250 volts positive, and the current must be as great as 15 to 40 amperes. However,

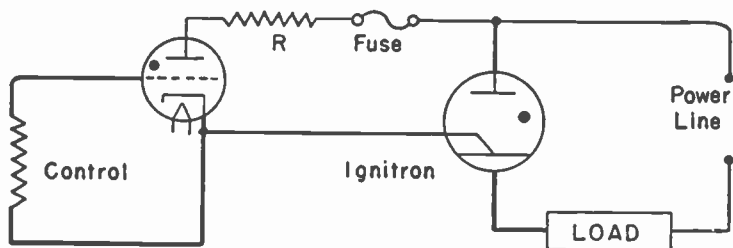

FIG. 2.—Thyratron Used for Control of an Ignitron.

this current need continue for only a few millionths of a second, so very little energy is used. The arc formed at the ignitor causes instant starting of anode-cathode current if the anode is sufficiently positive. Continued current in the ignitor will overheat this element, so starting circuits include provision for removing ignitor potential after the tube breaks down or fires. As soon as anode-cathode current commences, the ignitor loses control just as in any other grid controlled gas-filled tube. Current is stopped when anode-cathode potential falls low enough to stop ionization, and continues so for long enough to permit deionization. Then the ignitor regains its control. Because of the cold cathode it is permissible to apply potential to anode and ignitor at the same time.

Phase-shift control may be used for regulation of current in ignitrons, the cathode spot being formed at the required instant during each positive half-cycle of anode potential. Ignitrons often are controlled from a thyatron connected as in Fig. 2. The thyatron may be controlled by any method suitable for grid control of gas-filled tubes, including phase-shift control. As soon as the

TUBE, IGNITRON

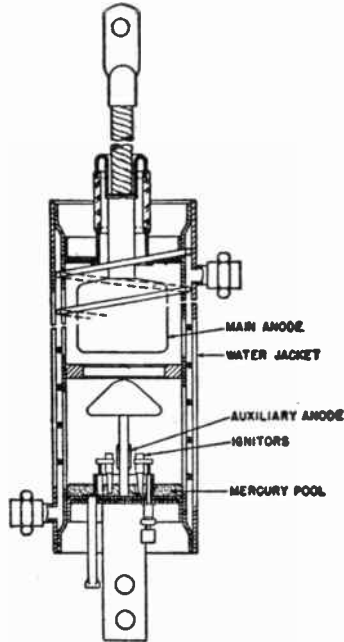

FIG. 3.—A General Electric Sealed Ignitron Having Two Ignitors and an Auxiliary Anode.

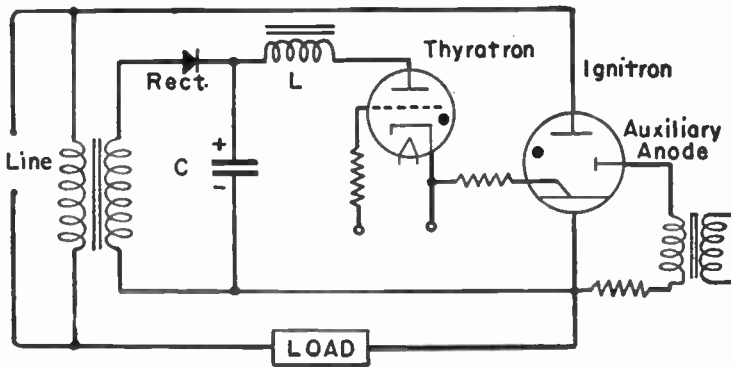

FIG. 4.—Ignitron Control Circuit with Auxiliary Anode Connections.

TUBE, IGNITRON

ignitron breaks down, the voltage drop between its anode and cathode decreases to a very low value. The thyatron anode and cathode are connected across the ignitron anode and cathode (through the ignitor), so the thyatron no longer receives enough voltage to continue its operation, and the ignitron ignitor is effectively open circuited.

An ignitron may have two ignitors, of which only one is used at a time, with the other in reserve. Such a type is shown by Fig. 3. This ignitron has also an auxiliary anode or holding anode which is energized from an auxiliary circuit and which maintains a cathode emission spot in applications where current is not continuous through the main anode, or where main anode current is not always great enough to maintain ionization. The holding anode makes it unnecessary to keep the ignitor active after ionization has been established.

Fig. 4 shows a control circuit including an ignitron with auxiliary anode. Capacitor *C* is charged through a dry rectifier or copper-oxide rectifier. When the capacitor potential is high enough to break down the thyatron, the capacitor discharges through inductor *L*, the thyatron, and the ignitor of the ignitron. The inductor limits the rate at which ignitor current may increase. The auxiliary anode of the ignitron, energized from a transformer, maintains the cathode spot during the remainder of the positive half-cycle.

TUBE, KENOTRON.—A kenotron is a two-element tube with a hot cathode and a plate or anode, and with a highly evacuated envelope. The kenotron is used as a rectifier for currents which ordinarily do not exceed one ampere, but is made in designs which may operate at peak anode voltages of 100,000 and more.

TUBE, KLYSTRON

TUBE, KLYSTRON.—The klystron is a velocity modulated tube which may be used at ultrahigh and hyper frequencies as an oscillator, amplifier, detector or modulator. The klystron employs the drift space method of converting velocity modulation to intensity modulation. It has a hot cathode and a highly evacu-

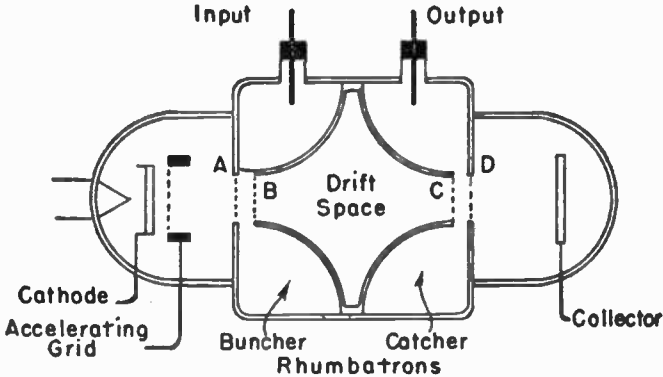

FIG. 1.—Arrangement of Elements in a Klystron.

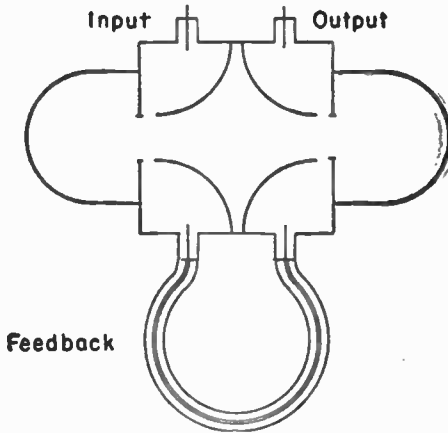

FIG. 2.—Feedback for Klystron Used as an Oscillator.

ated envelope. The arrangement of elements is essentially as shown by Fig. 1. See also *Tube, Velocity Modulation in*.

The electron stream from the cathode in Fig. 1 passes through the accelerating grid, through velocity modulating grids *A* and *B*, through the drift space where velocity modulation is changed to intensity modulation, through output grids *C* and *D*, and to the collector. These are the elements required

TUBE, KLYSTRON

for a velocity modulated tube using the drift space method of obtaining intensity modulation. The klystron has in addition, as part of its structure, two cavity resonators. In one, called the buncher rhumbatron, are the velocity modulating grids *A* and *B*. In the other, called the catcher rhumbatron, are the intensity modulated output grids *C* and *D*. These two rhumbatron resonators are made of such dimensions that both are resonant at the frequency to be handled by the tube. See *Resonator, Cavity*.

Electric waves at the resonant frequency, induced in the buncher rhumbatron by input energy, produce between grids *A* and *B* the differences of potential or charge that vary or modulate the velocity of electrons passing from *B* into the drift space. The intensity modulated electrons at the output end of the drift space pass through grids *C* and *D*, where they induce varying charges and waves at the resonant frequency in the catcher rhumbatron. Output energy at this frequency is taken from the catcher rhumbatron.

Because of the time taken by the electrons in going through the drift space, any given variation of charge at the output occurs appreciably later than the input variation that causes it. The delay may amount to the time of several cycles, although, of course, the output frequency is the same as the input frequency. There is also a time delay or phase difference of 90 degrees due to maximum density at the output grids occurring at the instant of zero field strength at the input.

When the klystron is used as an oscillator, part of the output energy from the catcher rhumbatron may be fed back through a loop of coaxial cable to the buncher rhumbatron, as in Fig. 2. The klystron with its tuned rhumbatrons will oscillate strongly at certain voltages, but not at intermediate voltages.

TUBE, MERCURY-VAPOR.—See *Tube, Gas-filled*.

TUBE, MUTUAL CONDUCTANCE OF.—In a tube used as an amplifier it is desirable to have a high amplification factor and a low plate resistance. The high amplification factor allows a large voltage gain while the low plate resistance allows a large power output. These two measures of a tube's action may be combined into a third which is called mutual conductance. Since mutual conductance takes into account both the amplification factor and the plate resistance of the tube, it forms an excellent guide to the all-around ability of a tube, as an amplifier.

The mutual conductance of a tube may be found by dividing the amplification factor by the plate resistance in ohms thus:

$$\text{Mutual Conductance} = \frac{\text{Amplification Factor}}{\text{Plate Resistance}}$$

From this formula it may be seen that the mutual conductance is increased by an increase of amplification factor but is decreased by an increase of plate resistance. It is always desired to have the mutual conductance as large as possible. Consequently a tube having a large factor of amplification, but also having a high plate resistance will show no gain in mutual conductance since the one offsets the other.

The foregoing formula for mutual conductance gives the result in mhos. The mutual conductance is usually expressed in micromhos or in millionths of a mho. Taking a tube with an amplification factor of 6.4 and with a plate resistance of 8000 ohms, the mutual conductance as given by the equation would be .0008 mho, 8/10000 of a mho, or 800 micromhos. Receiving tubes may have mutual conductances, measured in micromhos, of from 500 to 2000.

TUBE, MUTUAL CONDUCTANCE OF

The mutual conductance of a tube indicates the control over the plate current that is given by changes of grid voltage. It indicates the curvature and the slope of the grid voltage-plate current curve of the tube. The steeper the slope of this curve the greater is the effect of grid voltage change on plate current and the greater is the mutual conductance.

The mutual conductance may be found also from the grid voltage-plate current curve. Part of such a curve is shown. This is the part of the curve used when the grid is kept at zero voltage, it is the part of the curve to the left of the zero line. Ordinarily only a straight part of a curve is used in measuring

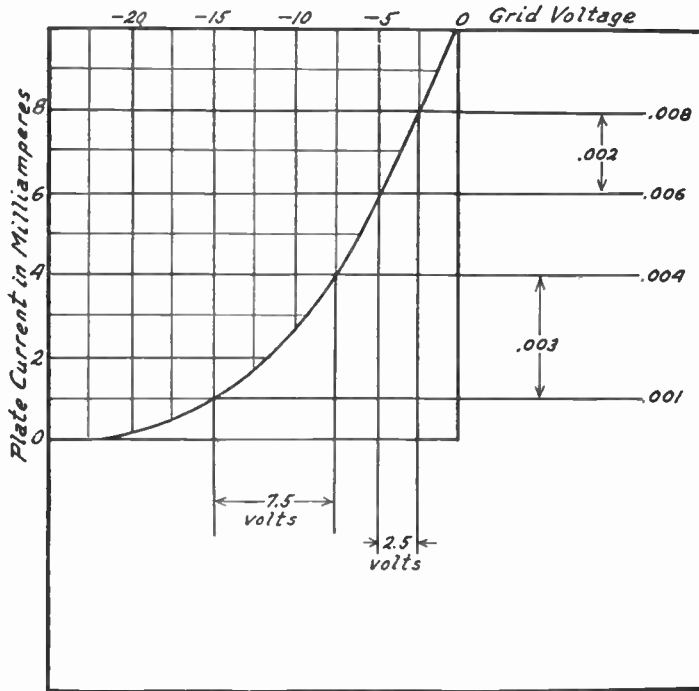

Measurement of Mutual Conductance from Grid-Voltage, Plate-Current Curve.

mutual conductance but to show the difference made by the degree of slope measurements will be made at two points on this curve having a bend.

An examination of the curve will show that a change of grid voltage from -7.5 to -15.0 , which is a 7.5 volt change, will decrease the plate current from four milliampères to one milliamperè, a change of three milliampères or $.003$ ampère.

Dividing the change in plate current in ampercs by the required change in grid voltage will give the mutual conductance of the tube. The formula is:

$$\text{Mutual Conductance} = \frac{\text{Change in Plate Current}}{\text{Change in Grid Voltage}}$$

TUBE, OPERATION OF

Placing the above values taken from the curve in this formula, we divide .003 ampere by 7.5 and obtain .0004 mho or 400 micromhos as the mutual conductance.

That the steepness of the curve is indicated by the mutual conductance may be proven by taking readings from the curve at points higher up and on a steeper part than the first ones considered. A change of 2.5 volts on the grid, from — 2.5 volts to — 5.0 volts, causes a plate current decrease from eight milliamperes to six milliamperes, a change of .002 ampere. Dividing this plate current change, .002, by the grid voltage change, 2.5, gives the mutual conductances as .0008 mhos or 800 micromhos compared with only 400 micromhos where the curve is less steep.

TUBE, OSCILLATION IN.—See *Oscillation*; also *Regeneration, Action and Principles of*.

TUBE, OSCILLATOR TYPE.—Any amplifier tube may be used as an oscillator, there being no special construction required when the tube is used as a generator of oscillating currents. For uses of tubes as oscillation generators see *Oscillator* and also *Receiver, Superheterodyne*.

TUBE, OUTPUT RESISTANCE AND IMPEDANCE OF.—The opposition to flow of current between the plate and filament in the tube is the plate resistance or plate impedance. This opposition is caused chiefly by the space charge effect which opposes the electron flow.

The higher the voltage applied to the plate of a tube the greater will be the positive charge placed upon the plate. This increased positive charge overcomes to a greater extent the space charge effect so that it becomes easier for the electron flow to pass between plate and filament. Thus, increasing the plate voltage reduces the plate resistance or the internal resistance of the tube.

Plate Resistance.—The direct current resistance of the plate circuit in the tube is found by dividing the plate voltage by the plate current. The alternating current plate resistance is found from the following formula:

$$\text{Plate Resistance} = \frac{\text{Plate Volts} + (\text{Amplification Factor} \times \text{Grid Volts})}{2 \times \text{Plate Current}}$$

The numerator in the second term of the foregoing formula is the effective plate voltage which is found by adding to the voltage which is applied to the plate itself the grid voltage multiplied by the amplification factor. Since the plate resistance is generally figured with the grid at zero voltage the formula for plate resistance then becomes:

$$\text{Plate Resistance} = \frac{\text{Plate Volts}}{2 \times \text{Plate Current}}$$

TUBE, OUTPUT RESISTANCE AND IMPEDANCE

Plate Impedance.—A curve showing the relation between plate current and plate voltage will show the effect that a certain change in plate voltage will have in increasing or decreasing the plate current, other things remaining the same. A curve is shown.

The plate impedance indicates the curvature and degree of slope in the plate-current, plate-voltage curve. The plate impedance is found by selecting a certain change of plate voltage on the curve and noting the corresponding change in plate current. The following formula is then used:

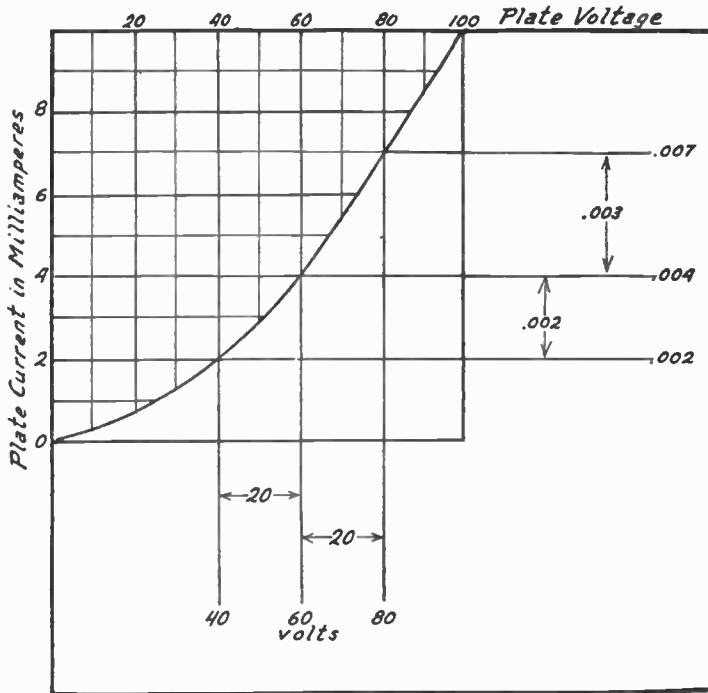

Measurement of Output Impedance from Plate-Voltage, Plate-Current Curve.

$$\text{Plate Impedance} = \frac{\text{Change in Plate Voltage}}{\text{Change in Plate Current}}$$

Looking at the curve it will be seen that changing the plate voltage from 40 to 60 increases the plate current from two to four milliampères or from .002 to .004 ampere. Dividing the change in voltage, 20 volts, by the change in amperage, .002 ampere, gives the plate impedance at this point on the curve as 10,000 ohms.

Again looking at the curve and changing the plate voltage from 60 to 80 it is found to increase the plate current from four to seven milliampères

TUBE, PARALLEL OPERATION OF

or from .004 to .007 ampere. Here we again have a voltage change of 20 but have a current change of .003 ampere. Again dividing the voltage change by the current change, the result is 6,666 ohms plate impedance. Thus it is seen that the plate impedance becomes less with increase of plate voltage.

The impedance under given conditions of plate voltage and plate current is greater than the resistance measured under the same conditions.

See also *Impedance, Matching of.*

TUBE, PARALLEL OPERATION OF.—Any two amplifying tubes may be operated in parallel and their combined output of plate current will be almost twice as great as the plate current output from either of the tubes alone. The connections are shown in the diagram. The two grids are connected together, the two plates are likewise connected together, and these combined grid terminal connections and plate terminal connections are treated the same as similar terminals for a single tube.

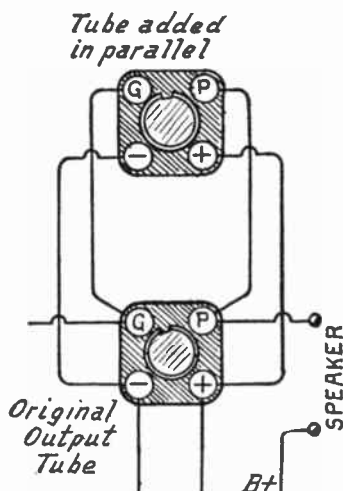

Parallel Operation of Tubes.

Two tubes used in this way must be of identical type and preferably of the same make. With two tubes in parallel a given input voltage on the grids will produce double the power of one tube in the plate circuit. The voltage gain is high with parallel operation. The combined plate impedance or resistance of the two tubes is equal to one half that of one similar tube. The amplification of two tubes in parallel is not as great as from two tubes in a push-pull amplifier properly operated. However, the parallel arrangement requires no special transformers and good results may be expected from equipment of ordinary quality whereas push-pull parts must be of the very best and the circuits must be properly laid out.

TUBE, PENTODE

TUBE, PENTODE.—The pentode is a five-element tube in which there are, in order, a cathode, a control grid, a screen grid, a suppressor grid, and a plate or anode. The purpose of the screen grid is the same as in the screen grid tube or tetrode which has four elements; namely, to reduce the effective capacity between plate and control grid, and thereby to reduce or prevent feedback

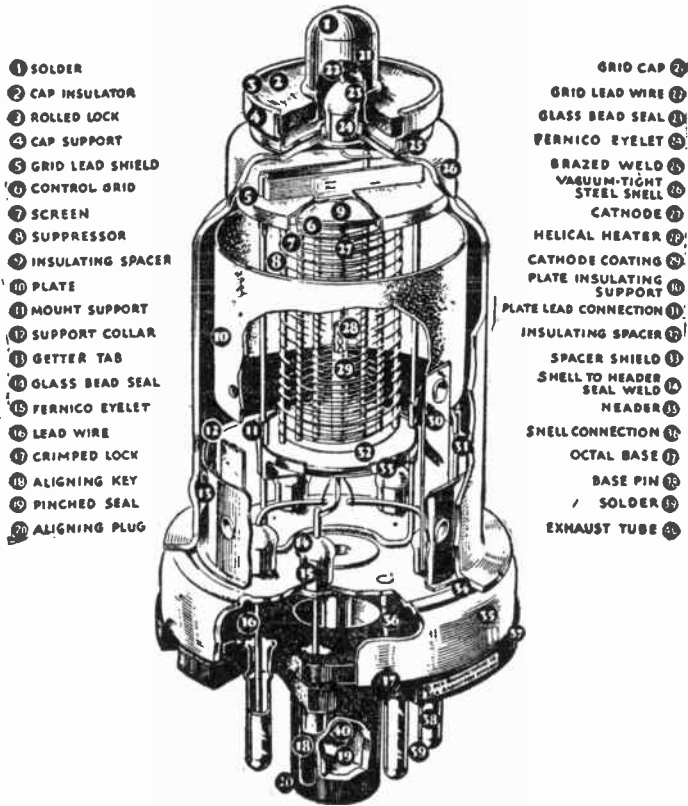

FIG. 1.—Construction of One RCA Type of Voltage-amplifier Pentode.

of energy from plate circuit to grid circuit and to prevent self-sustained oscillation. The purpose of the added suppressor grid is to prevent the ill effects of secondary emission that limit the signal-handling and power-handling ability of the screen grid tetrode. The construction of one style of RCA voltage-amplifier pentode is shown by Fig. 1.

TUBE, PENTODE

Pentodes designed for voltage amplification most often are connected as in Fig. 2, with control grid, screen grid and plate connected as they would be for a screen grid tetrode. Maximum plate potentials range around 250 to 300 volts, and maximum screen potentials from 100 to 150 volts. The suppressor grid, which is located between the screen grid and the plate, nearly always is connected to the cathode so that it is maintained at cathode potential. The connection may be external to the tube, as shown, or, in some types the suppressor-to-cathode connection is internal with no separate terminal or pin for the suppressor.

Voltage amplifier pentodes may be of the remote cutoff type which is described in connection with variable- μ tubes, or they may be of the sharp cutoff type. The remote cutoff or variable- μ types are used where there is a great variation of signal or input voltage applied to the control grid, as occurs with automatic volume control systems.

Power amplifier pentodes most often have the suppressor connected internally to the cathode, as in Fig. 3. Screen supply voltage usually is equal to plate supply voltage, although in some power pentodes the maximum screen voltage is somewhat lower than the maximum permissible plate voltage.

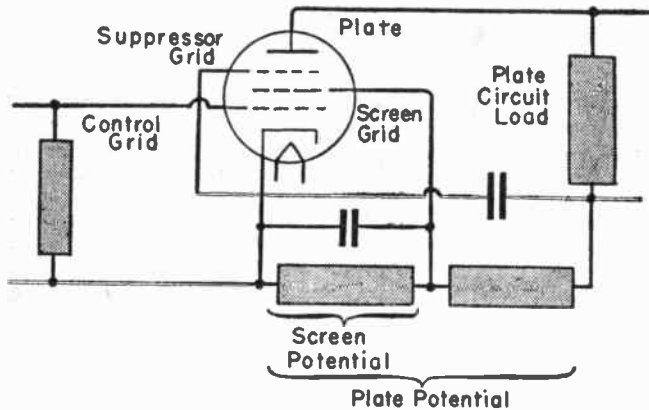

Fig. 2.—Typical Connections for Pentode Voltage Amplification.

Suppressor Action.—In any tube operated at even moderately high plate voltages or screen voltages the electrons coming from the cathode are given such high velocity that they strike the plate with enough force to detach other electrons from the plate. Electrons thus detached by bombardment are called secondary electrons and the action is called secondary emission. When, during operation of a tetrode or screen grid tube, the plate voltage becomes lower than the screen voltage, the secondary electrons are attracted to the more positive screen and there is a serious diversion of electrons from the plate and from the plate current.

To understand why the plate voltage sometimes may become lower than the screen voltage, even with the same supply voltage furnished to both of them, it is necessary to keep in mind that the total voltage of the supply is applied to the entire plate circuit, which includes not only the impedance of the space between plate and cathode in the tube, but also the impedance

TUBE, PENTODE

of whatever load is in the plate circuit. The total voltage of the supply then divides between the tube and the load. For example, were the supply potential 300 volts, and were current through the load to be such as to cause a drop of 100 volts in the load, the voltage remaining at the tube plate would be only the difference of 200 volts. The greater the plate

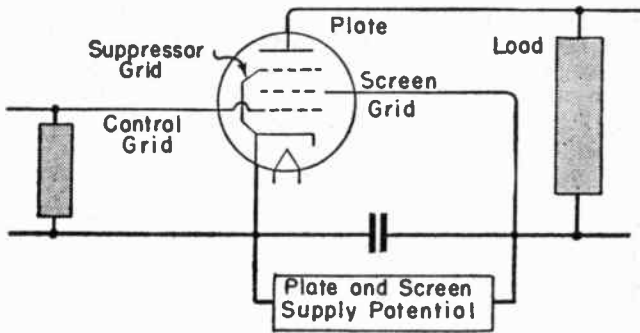

FIG. 3.—Typical Connections for Pentode Power Amplifier.

current at any instant the greater is the current and the voltage drop in the load, and the less is the voltage remaining at the plate of the tube.

Plate voltage will become lower than screen voltage when strong signal voltages are applied to the control grid. During the positive alternations of the strong signals there will be large current in the plate circuit, which

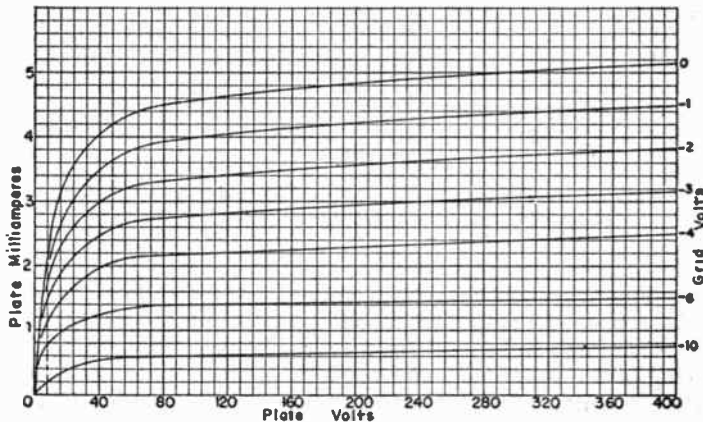

FIG. 4.—Plate Characteristics of a Voltage-amplifier Pentode.

includes the impedance of the load. At the instants when there are large currents in the load there must be correspondingly large differences of voltage across the load, and these voltage differences are being taken from the plate supply. Then there remains but a relatively small portion of the supply voltage for the plate of the tube.

TUBE, PENTODE

Although it is impossible to prevent emission of secondary electrons, these electrons may be kept from the screen and driven back to the plate. This is the function of the suppressor grid in the pentode. With the suppressor connected to the cathode it is at the same potential as the cathode, so is at a negative potential with reference to the plate and the screen. When negative electrons are knocked off the plate they encounter the negative potential or charge of the suppressor, and, since two negative charges repel each other, the electrons cannot get through the space occupied by the suppressor to reach the screen grid, but rather are driven back to the plate. The negative suppressor has, of course,

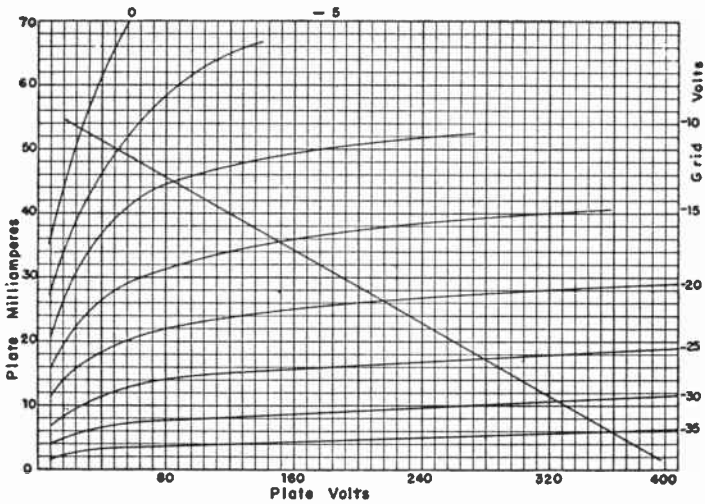

FIG. 5.—Plate Characteristics of a Power-amplifier Pentode.
The Load Line Is for 7,000 Ohms Load Resistance.

a repelling action on electrons coming from the cathode as well as on those from the plate, but the electrons coming from the cathode have such high velocity that they easily pass through the wide spacing of the suppressor and reach the plate.

Performance of the Pentode.—The plate characteristics of one type of voltage-amplifying pentode are shown by Fig. 4. Comparing these with the characteristics for a screen grid tetrode shows that the unstable operation of the tetrode at low plate voltages has been replaced with a smooth increase and then a leveling off of plate current with increase of plate voltage from zero. This is due to the prevention of secondary emission effects in the pentode.

TUBE, PENTODE

Fig. 5 shows the plate characteristics for one type of power pentode, also a load line for a plate circuit load of 7,000 ohms. Here it may be seen that the tube is capable of handling large changes of control grid voltage and large changes of plate current and plate voltage without any of the unstable action which would result were secondary emission not controlled by the suppressor action.

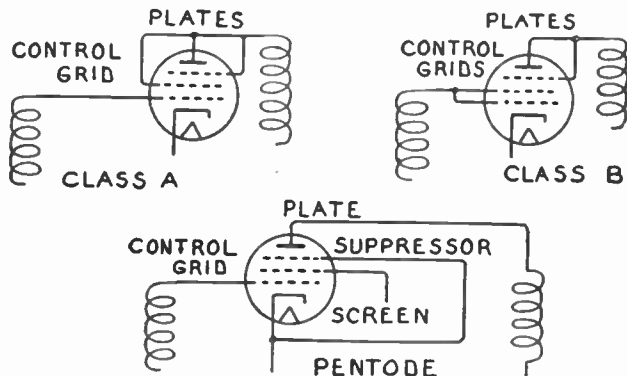

Fig. 6.—Connections for Voltage-amplifier Pentodes.

Fig. 6 shows various connections for the five-element tube. With plate, suppressor and screen tied together it may be used as a class A triode amplifier; with the suppressor tied to the plate, and the screen and control grid tied together the tube may be used as a class B triode amplifier. The regular pentode connections are shown by the lower diagram.

TUBE, PHANOTRON.—A phanotron is a two-element hot-cathode tube used as a rectifier. The cathode may be of the filament type or of the indirectly heated type with a separate heater element. The envelope or bulb may be gas-filled, with some inert gas, or may be of the mercury-vapor type with the vapor produced by evaporation from a few drops of mercury in the envelope.

Phanotrons, like all gas- or vapor-filled tubes, have very small voltage drops after breakdown or ionization. They will withstand maximum peak inverse voltages of from 150 to somewhat more than 20,000, depending on the type of tube. They are designed to handle average currents of one-quarter to 30 amperes, again depending on the type. Maximum peak currents may be four to six times the average value. See *Tube, Gas-filled*.

TUBE, PHOTO.—See *Cell, Photoemissive*.

TUBE, PLIOTRON.—A pliotron is a vacuum type triode, tetrode or pentode having a hot cathode and designed for use in industrial electronic work, transmission, and other heavy-duty applications. High-power pliotrons may operate with plate potentials as high as 20,000 volts, and with power dissipations up to 100,000 watts. Some are air-cooled, others are water-cooled.

TUBE, POOL.—A pool tube is any tube having for its cathode a pool of liquid mercury and having no grids, starters

TUBE, PROTECTIVE

or other elements for controlling the start of ionization and of current flow in the tube.

TUBE, PROTECTIVE.—A protective tube is a glow tube of the inert gas-filled type having two or more electrodes which may act as either cathode or anode depending on the polarity of the circuit connections. When circuit voltage exceeds a certain value the tube breaks down or ionizes, whereupon there may be a high rate of current flow to a ground connection or other point which will relieve overload current in the protected circuit. See *Tube, Glow*.

TUBE, RECTIFIER.—See names of various types of tubes under the general headings of *Rectifier*.

TUBE, RECTIGON.—See *Rectifier, Gas-filled Tube*.

TUBE, SCREEN GRID.—The screen grid tube, or tetrode, is a tube containing four active elements; the cathode, the control grid, a screen grid, and an anode or plate. The purpose of the screen grid is to reduce the capacity between plate and grid which is quite large in a triode, and thereby to reduce or prevent feed-backs of energy from the plate circuit to the grid circuit which often cause self-sustained oscillation.

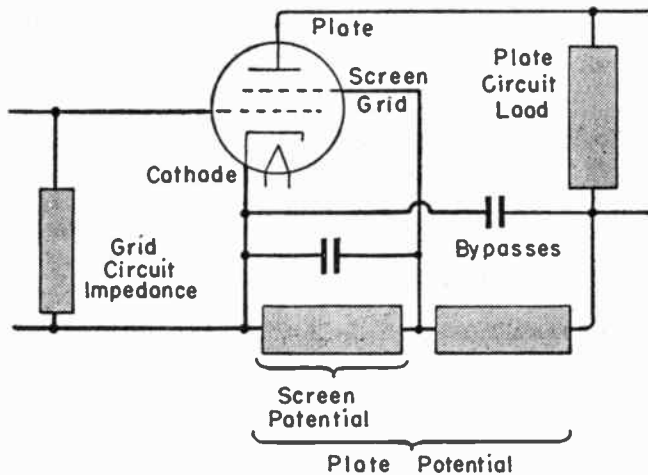

FIG. 1.—Typical Connections for a Screen Grid Tube.

As shown by Fig. 1, the screen grid is placed between the control grid and the plate, and is connected to the power supply at a point which gives the screen a potential less than that of the plate. The screen is connected to the cathode through a bypass condenser providing a low-impedance return for high-frequency impulses. Since there is no load impedance in the screen grid circuit this grid remains at a practically constant potential. As a consequence, changes of potential or of charge on the plate cannot reach

TUBE, SCREEN GRID

through the constant-potential screen grid to affect the potential of the control grid. Whereas the effective grid-plate capacity of a triode is on the order of eight micro-microfarads, this capacity in the screen grid tube is something like 0.01 to 0.02 micro-microfarads. Because excessive feedback and the danger of oscillation are prevented in the screen grid tube its amplification factor may be made as high as 700 or 800.

Fig. 2 shows the relations between plate current (solid line curves) plate voltage, and various control grid voltages for a screen grid tube in which the screen is maintained at a potential of 90 volts. The broken-line curve shows current in the screen grid. When the plate voltage is less than or only slightly more than the screen grid voltage, the relations between plate current and control grid voltage are erratic and somewhat unstable. It may be noted also that in the region of normal operation, with plate voltage higher than screen grid voltage, the plate current is

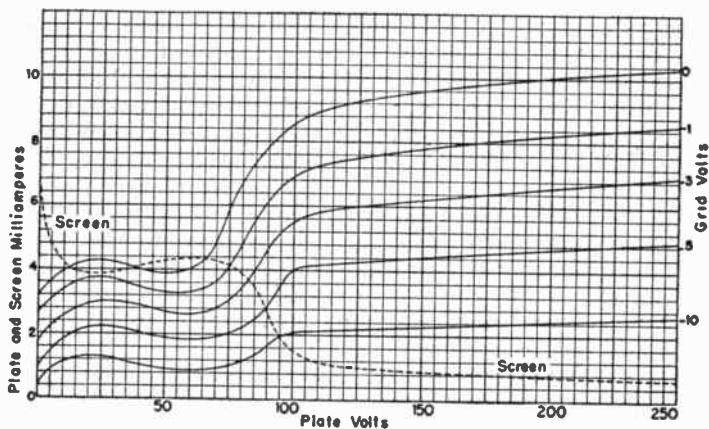

FIG. 2.—Plate Currents and Screen Current in a Screen Grid Tube.

almost constant when the plate voltage is changed within wide limits, although the plate current is changed over a wide range by variations of control grid voltage.

The unstable performance at low plate voltages is due chiefly to the effects of secondary emission. Secondary electrons released from the plate by bombardment of high-velocity electrons from the cathode are attracted to the screen when its voltage is higher than the plate voltage. These electrons then form part of the screen grid current, which is large in this region, rather than helping to form plate current. This condition exists also when, during amplification, large plate currents flowing through the impedance of the plate circuit load cause in that load a voltage drop so great that the remaining voltage on the plate is lower than the voltage on the screen. For this reason the screen grid tube can handle only small signal voltages which cause only small changes of plate current. The amplification factor may be very great, but the power handling ability of the screen grid tube is very small. The effects of secondary emission and the

TUBE, SCREEN GRID

limitation on variation of plate current are overcome in the pentode and in the beam power types of tubes.

The reason why changes of plate voltage have little effect in changing the plate current may be explained as follows. The combination of a fairly high potential on the screen, the nearness of the screen to the cathode, and the fact that the screen grid is made of thin wires widely spaced, allows the screen potential to draw electrons from the cathode and to accelerate them to high velocities. Thereupon the fast moving electrons pass through the spaces of the screen and go to the plate. The rate of cathode emission and the rate at which electrons may leave the space charge near the cathode is controlled by control grid potential, while the rate at which these released electrons are drawn to the plate is controlled by the potential and acceleration action of the screen. This leaves the plate to act as little more than a collector of the electrons whose rate of flow is controlled by the control grid and the screen grid. The constant screen voltage prevents changes of plate voltage from having much effect in the space charge region near the cathode.

Screen grid tubes are made either with the remote cutoff type of control grid action described in connection with variable-mu tubes, or with a sharp cutoff. With remote cutoff types the control grid voltage may become highly negative and still allow some plate current to flow, while with the sharp cutoff types a moderately negative control grid prevents flow of plate current.

TUBE, SECONDARY EMISSION IN.—Whenever any element of a tube is struck or bombarded by electrons attracted to it by its positive potential, or driven against it by accelerating potentials in other parts of the tube, electrons are forcibly knocked out of this bombarded element. The action is called secondary emission, and the electrons thus released are called secondary electrons. Secondary emission occurs most often from plates or anodes, but also from control grids.

The energy with which an electron strikes an element to cause secondary emission depends on the mass and the velocity of the electron. Although the mass (weight) of an electron is exceedingly small, its velocity is very high. The energy depends on the total change of potential through which the electron has traveled since starting from rest, not on any variations of potential which have occurred in the path followed. The velocity becomes equal approximately, in miles per hour, to 1,343,000 times the square root of the potential difference, or, in feet per second, to about 1,968,500 times the square root of the potential difference in volts.

When secondary emission takes place from the plate of a triode the secondary electrons immediately go back to the plate, which is the only highly positive element. In a tetrode they may go to the screen. In a pentode and in a beam power tube this emission is returned to the plate by suppressor action. See *Tube, Pentode*, also *Tube, Beam Power*.

TUBE, SUPER-CONTROL.—See *Tube, Variable-mu*.

TUBE, TETRODE.—A tube having four active elements; a cathode, a control grid, an anode or plate, and a screen grid or shield grid. See *Tube, Screen Grid*; also *Tube, Thyatron, Four-element Type*.

TUBE, THERMIONIC.—A tube in which electron emission from the cathode is caused by thermal energy applied to the cathode, or by heating of the cathode. A hot-cathode tube.

TUBE, THYRATRON

TUBE, THYRATRON.—A thyatron is a gas-filled tube with a hot cathode, an anode, and one or more grids whose potentials and charges control the instant at which ionization and current flow commence in the tube. The envelopes of thyratrons may contain inert gases, they may contain a few drops of mercury which vaporizes during operation, or they may contain both inert gas and mercury vapor. The hot cathode may be either of the filament type or else of the indirectly heated type with separate heater element. The general principles of thyatron action are explained under *Tube, Gas-filled; Tube, Gas-filled, Grid Control of;* and *Tube, Gas-filled, Phase-shift Control.*

Thyratrons are used for the control of a great variety of electrical devices, including speed and torque control of d-c motors, voltage regulation of generators and power lines, complete timing

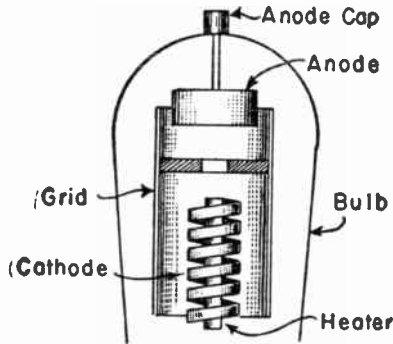

FIG. 1.—Arrangement of Elements in One Style of Thyatron.

control for resistance welding, control of theatre and other large scale lighting effects, and many other purposes. Thyratrons are used as relaxation oscillators in which blocking action of the grid produces frequencies up to 1,000 cycles from a d-c supply. They are used also as sweep circuit oscillators for oscilloscopes.

Fig. 1 shows the arrangement of elements in one style of three-element thyatron. Anodes are made of metal or of graphite. Cathodes have large surfaces, such as that of the spiral ribbon type shown in the illustration, and in tubes that handle large currents the cathodes usually are indirectly heated. The grid of the tube shown by Fig. 1 almost completely surrounds both the cathode and anode, and in it is a single small opening for the electron stream. Such a grid allows control with negative grid potentials. Other styles of grids are of perforated metal, of wire mesh or screen, or of other forms suitable for various operating characteristics.

Fig. 2 shows average grid and anode potentials for breakdown in two different thyratrons. The left-hand curve shows control with the grid negative throughout nearly the whole range of anode po-

TUBE, THYRATRON

tentials, which is characteristic of a negative control type of tube. With the tube represented by the right-hand curve the grid potential must be positive to cause breakdown throughout most of the anode potential range, so this is a positive control type of tube, or, it might be called an intermediate type because some of the control range is negative and the remainder is positive.

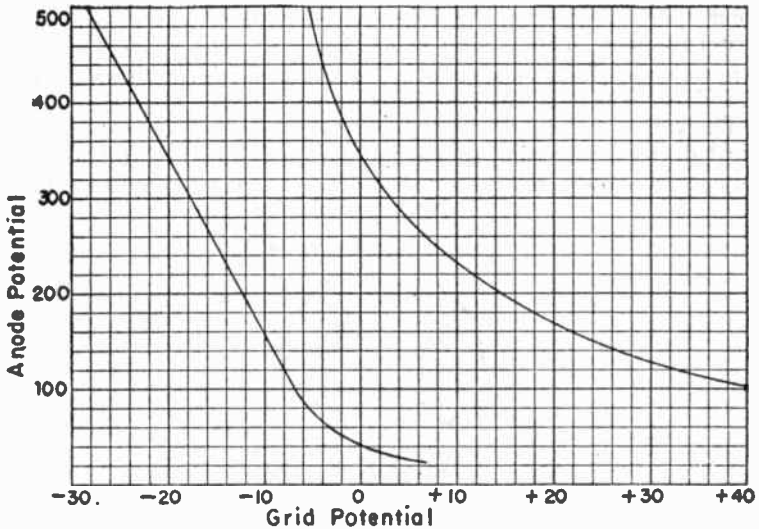

FIG. 2.—Breakdown Potentials for Negative Control Thyratron (left-hand curve) and for Positive Control Type (right-hand curve).

Tubes designed for negative control are suited for use with grid circuits of high impedance, since there is relatively little current or power in the grid circuit. Negative control tubes are operated so that the grid never becomes more than 10 or 12 volts positive. Greater positive potential may cause ionization between grid and cathode, and allow reversed current at fairly low alternating potentials on the anode.

With positive control tubes there is considerable flow of grid current at the instant of breakdown. Deionization ordinarily takes less time in a positive control tube than in a negative control type. Positive control tubes may have a grid with many openings, or the cathode and anode may be completely exposed, with a small grid between them.

TUBE, THYRATRON, FOUR-ELEMENT

TUBE, THYRATRON, FOUR-ELEMENT TYPE.—A four-element thyatron is a thyatron which contains, in addition to its control grid, an additional screen grid or shield grid. The tube may be of the inert gas or mercury vapor type. Other names are gas tetrode, shield-grid thyatron, and screen-grid thyatron. The structural arrangement of a heavy-duty tube of this type is shown by Fig. 1, and that of a smaller type by Fig. 2.

The control grid may be a short open cylinder, a metal ring, or of some other form having a passage through which electron flow travels from cathode to anode and which is adapted to the production of an electric field which controls the start of ionization and current flow. Either wholly or completely surrounding the cathode, anode and control grid is a cylindrical

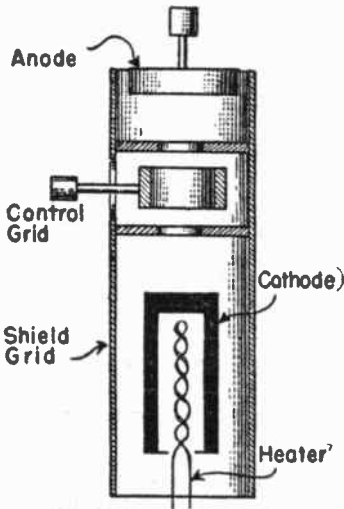

FIG. 1.—Element Arrangement in Heavy-duty Four-element Thyatron.

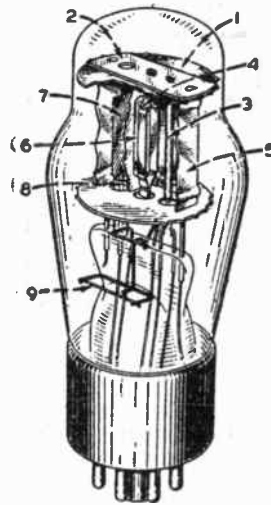

FIG. 2.—Construction of One Type of RCA Gas Tetrode.

or box-shaped metallic enclosure which is the shield grid. With this construction the cathode and anode are shielded by the added grid instead of by extensions of the control grid as in most three-element thyatrons.

The shield grid reduces the capacity effect between anode and control grid, thus lessening the effect of anode potentials on the potential of the control grid, and preventing the erratic control which otherwise may result from momentary changes of power supply voltage. The condenser used between control grid and cathode of the three-element tube for absorbing these voltage surges usually may be omitted with the four-element tube. The small physical size of the control grid helps reduce the capacity effect and also lessens the grid current which flows while the tube is ion-

TUBE, THYRATRON, FOUR-ELEMENT

ized. Possibility of electron emission from the control grid is lessened because the shield grid protects the control grid from heat radiated by the cathode and anode, and helps prevent deposit of active material from the cathode onto the control grid surface.

Varying the potential of the shield grid with reference to the cathode changes the relation between anode and control grid potentials at which breakdown occurs. Fig. 3 shows average characteristics for one style of tube with the shield grid potential at +10, at 0, at -5, -12 and -30 volts. With the shield grid at positive or zero potential the tube acts as a negative control thyatron, while with the shield grid negative the tube acts as

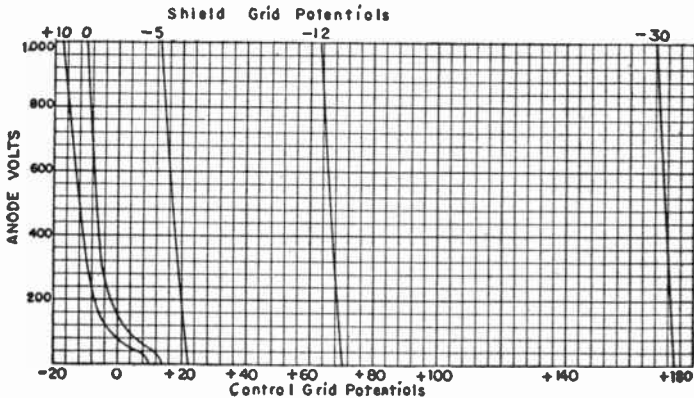

FIG. 3.—Control Grid Breakdown Potentials of Four-element Thyatron.

a positive control type. The shield grid most often is operated at zero potential, by connecting it directly to the cathode, or is operated at only a few volts either positive or negative.

It is apparent from Fig. 3 that making either of the grids negative will prevent breakdown, and that making either one less negative will permit breakdown. In some circuits a negative potential applied to one of the grids acts as a holding potential which prevents operation even though potential is shifted by a considerable amount on the other grid. Removal or reduction of the negative holding potential then allows the regular control potential (on the other grid) to break down the tube during some certain interval.

TUBE, TRANSCONDUCTANCE

TUBE, TRANSCONDUCTANCE OF.—Conductance in mhos, which is the reciprocal of resistance in ohms, is the ratio of amperes of current to volts of potential difference in a circuit or portion of a circuit, or is equal to amperes divided by volts. Transconductance in mhos is the ratio of the change of current produced in one element of a tube to the change of voltage in another element that causes the change of current, when potentials of all remaining elements are constant. Transconductances are small fractions of mhos, so usually are specified in micromhos. Transconductance between control grid voltage and anode current is called *mutual conductance*, which see.

TUBE, TRANSIT TIME IN.—Transit time is the time required for an electron to travel from one element or electrode to another, as from cathode to plate or anode. Although transit times are so brief as to be measured in fractions of microseconds, they are long enough to have a decided effect at ultrahigh frequencies and hyper frequencies in tubes such as magnetrons, positive-grid oscillators, velocity modulated tubes, and cathode-ray tubes.

For an electron starting from rest at one electrode and traveling to another electrode the transit time in microseconds increases with distance between electrodes and decreases as the potential difference is raised.

$$\text{Microseconds} = \frac{0.0847 \times \text{distance in inches}}{\sqrt{\text{applied volts}}}$$

In a tube having a separation of 0.1 inch between cathode and anode, operated at an anode potential of 225 volts, the transit time is found to be 0.000565 microsecond. This is about the same as the time for a half-cycle during which potential remains in one direction at a frequency of 1,000 megacycles.

The effects of transit time in a triode operated with a negative grid are complicated by the fact that the grid potential is continually changing, and by the fact that there are continual changes of anode-cathode potential brought about by varying voltage drops across the anode load with changes of anode current through the load, as this current is controlled by action of the grid. Although an electron traveling from cathode to anode is subjected to a positive accelerating potential throughout the entire distance, this potential is undergoing continual change.

At low frequencies and at radio frequencies the changes of potential in the tube space are very slow in relation to transit times. Consequently, electrons have ample time to reach the anode in considerable numbers while the accelerating potential undergoes its slow change, and the changes of current at the anode occur almost exactly in time with, or in phase with, the changes of potential on the control grid. But at ultrahigh frequencies and hyper frequencies the grid and anode potentials are varying so rapidly that electrons do not have time to complete their travel from cathode to anode before there have been decided changes in the accelerating potential, this because the periods corresponding to these frequencies are not greatly different from the electron transit times. The result of all this is that only a fraction of the electrons arrive at the anode in correct time or phase relation to the changes of grid potential. All the others arrive at times so unrelated to grid potential changes that their energy is wasted so far as power output of the tube is concerned.

TUBE, TRANSIT TIME

Transit time is lessened by using higher anode voltages and smaller spacings with smaller elements. But this leads to insulation difficulties, and a limit on power output because of inability to dissipate heat. Tubes which have more or less conventional construction and are operated with negative grids, even when of small size, cannot be operated satisfactorily at frequencies in excess of 600 to 700 megacycles. Special constructions, such as velocity modulated tubes, are required for higher frequencies.

TUBE, TRIODE.—A triode is a tube containing three active elements; a cathode, a plate or anode, and a control grid. The cathode may be of either the filament type or the indirectly heated type. The principal parts of a triode with filament-cathode are illustrated by Fig. 1. The filament, grid and plate, with their base connections, are shown by Fig. 2. A triode of the vacuum type may be used as an amplifier, a modulator, or an oscillator. Gas-filled triodes, which are thyratrons or grid-glow tubes, are used as controlled rectifiers.

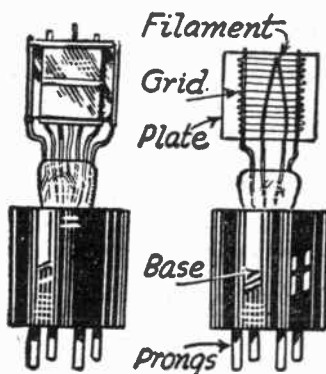

FIG. 1.—Principal Parts of a Triode Having a Filament-cathode.

The control grid of the vacuum triode is located in the space charge region between cathode and plate. When the grid, through its grid return, is connected to a point more negative than the cathode the negative charge of the grid assists the negative space charge in limiting the electron emission and the flow of electrons from cathode to plate. As the control grid is made less negative the emission and the plate current increase, and if the grid is made positive with reference to the cathode there will be relatively great emission and plate current. However, the positive grid attracts negative electrons to itself just as they are attracted to the positive plate, and part of the cathode current goes through the grid and its circuit instead of through the plate circuit. Small changes of grid potential cause large changes of plate current, so that the tube acts as an amplifier, modulator, or oscillator, depending on the kind of circuit in which it is used. The effect is shown by Fig. 3.

There is a rather large internal capacity between the plate and grid of a triode. This capacity provides a coupling between the plate circuit and the

TUBE, TRIODE

grid circuit of the tube, and through this capacity coupling it is possible for energy to feed back from the plate circuit to the grid circuit and to cause self-sustained oscillation of the tube circuits. The grid circuit consists, of course, of impedances; as does also the plate circuit. The connection between these impedances which is formed by the grid-plate capacity pro-

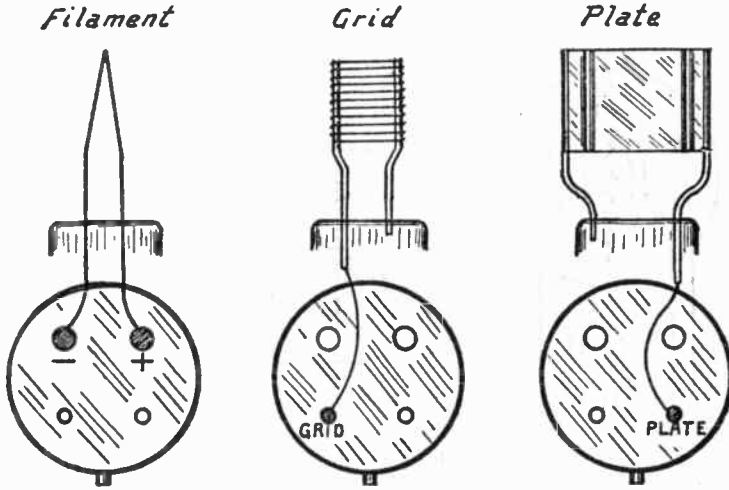

FIG. 2.—Connections Between Tube Elements and Base Prongs Looking at Bottom of Tube.

vides a coupling similar to that provided by a coupling condenser in a resistance amplifier. The metallic grid acts as one plate, the conductive anode as a second plate, and the vacuum-filled space between them acts as the dielectric of a condenser. The screen grid type of tube has an additional element, the screen grid, which greatly reduces or eliminates the capacitive coupling that exists in the triode.

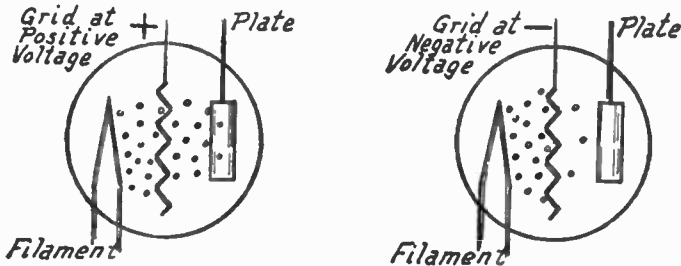

FIG. 3.—Effect of Positive and Negative Grid on Electron Flow.

TUBE, TUNGAR.—See *Tube, Rectifier, Gas-filled.*

TUBE, VACUUM.—A vacuum tube is an electronic tube from whose envelope or bulb have been removed nearly all air and

TUBE, VACUUM

other gases to leave a very high vacuum. The pressure of the gases remaining in the common types of vacuum receiving tubes is about one four-hundred-thousandth of an ounce per square inch. The principal reasons for this high evacuation are to permit free travel of electrons through the tube space, to prevent ionization in the tube, and to remove substances which might chemically combine with materials of the tube structure.

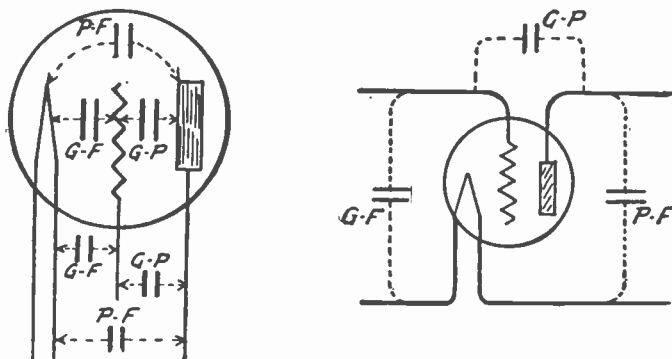

FIG. 4.—Internal Capacities between the Elements of a Triode, the Capacities between the Leads and Pins, and the Relations of These Capacities to the External Circuits.

Vacuum tubes have hot cathodes from which electron emission results from heat energy, or, in phototubes, have a cold cathode from which emission occurs because of radiant energy. The hot cathode-tubes ordinarily are operated with a negative space charge near the cathode. In two-element tubes the rate of electron flow to the anode is maintained low enough that all of the space charge is not drawn away from the cathode. In tubes having a control grid the charge on this grid acts in conjunction with the space charge to control the rate of electron flow from cathode to anode. In a gas-filled tube the negative space charge is neutralized by positive ions produced during ionization, and a grid has no control over electron flow after ionization commences.

Vacuum tubes include diodes, triodes, tetrodes, pentodes, and tubes with six or more elements, also the beam power and variable- μ types. Other vacuum types include plotrons, kenotrons, cathode-ray, electron-ray, magnetron, and phototubes. Various types are used as rectifiers, amplifiers, modulators, and oscillators.

TUBE, VARIABLE-MU

TUBE, VARIABLE-MU.—A variable-mu tube, called also a super-control tube, is a hot-cathode vacuum tetrode or pentode whose amplification factor or “mu” may be varied over a wide range by changes of control grid bias. Such a tube permits volume control by adjustment of its grid bias. Used in automatic volume control circuits, the bias of the variable-mu tube is automatically

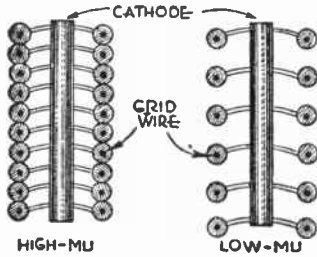

FIG. 1.—Control Grid Spacing and Extent of Fields.

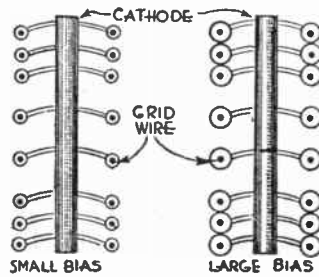

FIG. 2.—Control Grid Spacing in Variable-mu Tube.

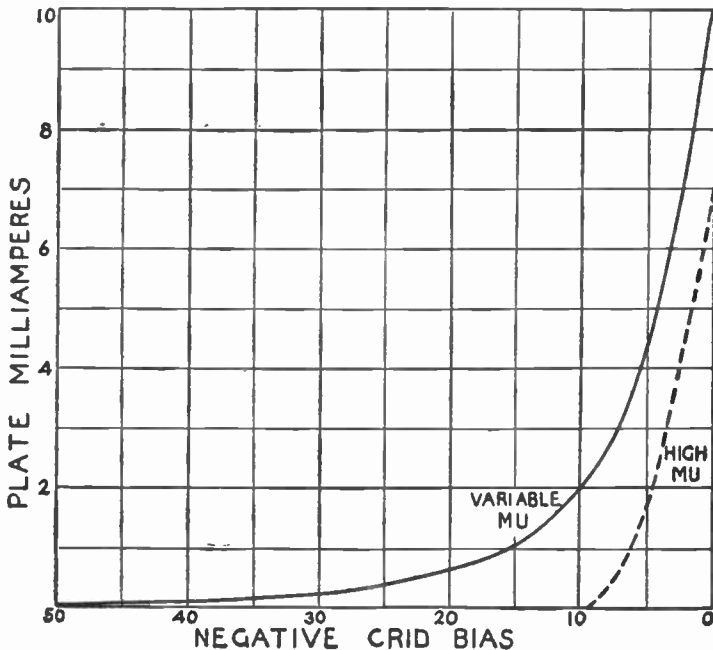

FIG. 3.—Effect of Grid Bias on Average Plate Current in Variable-mu and in High-mu Tubes.

TUBE, VARIABLE-MU

varied by voltage drop in a resistor through which flows amplified radio-frequency current which has been rectified by a double-diode tube. The use of the variable-mu tube as a first r-f amplifier lessens the effects of cross modulation, which is modulation of the desired carrier wave by the carrier of an interfering station. When used in the final intermediate frequency stage this type of tube lessens modulation distortion which affects the audio frequency when the grid bias of an r-f amplifier has been made excessively negative to lower the output or volume.

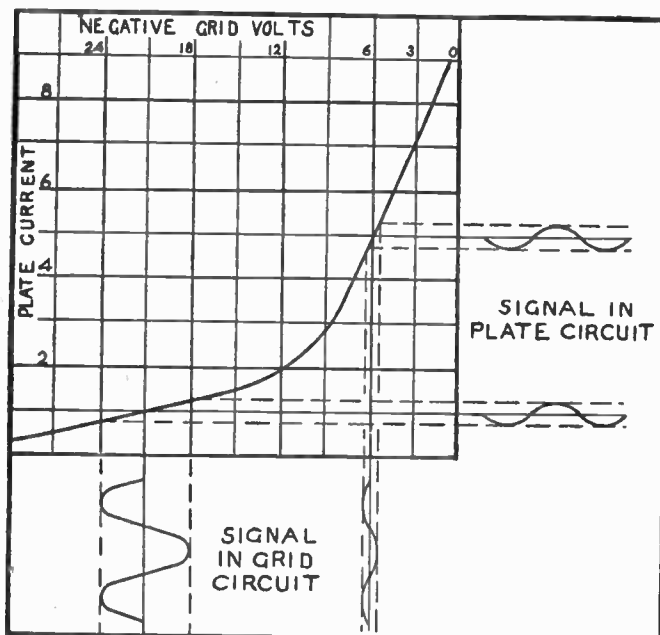

Fig. 4.—Effect of Grid Bias on Amplification of a Variable-mu Tube.

The amplification factor of any tube is raised when, as at the left in Fig. 1, control grid wires are so close together that their negative field (shown shaded around the wires) extends almost all the way from one turn to the next. This permits a moderately negative grid potential to almost completely stop the plate current. With wide grid spacing, as at the right, the negative field does not fill the space between turns, the grid has less control over plate current, and there is a lower amplification factor.

In the variable-mu tube the grid wires are spaced farther apart at the center than near the ends of the winding, as in Fig. 2. With the grid only slightly negative, as at the left, the field does not fill

TUBE, VARIABLE-MU

the spaces between wires and there is a low amplification factor. Making the grid more negative, as at the right, causes the negative field to fill the spaces between end turns, but not between the center turns. Then the grid potential has more effect in reducing plate current, and there is relatively high amplification factor. The result of this construction is shown by Fig. 3, where the full-line curve shows the effect of grid bias on plate current in a variable-mu tube, and the broken-line curve shows this relation for a tube having uniform spacing of grid wires.

Pentodes and tetrodes having the characteristic shown by the broken-line curve of Fig. 3 are said to have a sharp cutoff (of plate current), while those types having the variable-mu or super control characteristic are said to have remote cutoff. Fig. 4 shows how a large and a small grid signal voltage may be caused to produce equal plate current signals from a variable-mu tube by making the grid bias more negative for the strong input signal and less negative for the weaker signal.

TUBE, VELOCITY MODULATION

TUBE, VELOCITY MODULATION IN.—Velocity modulation is a method for operating a tube at ultrahigh and hyper frequencies by causing the input voltages to vary the velocity of electrons in part of a constant-current beam flowing through the tube, rather than by causing the input voltages to vary the current rate in a constant velocity electron flow as in conventional tubes. Velocity modulation overcomes most of the limitation imposed by transit time effects on the frequencies at which conventionally designed tubes may operate. Velocity modulated tubes maintain satisfactory power outputs and efficiencies at frequencies in excess of 5,000 megacycles. See also, *Tube, Transit Time in.*

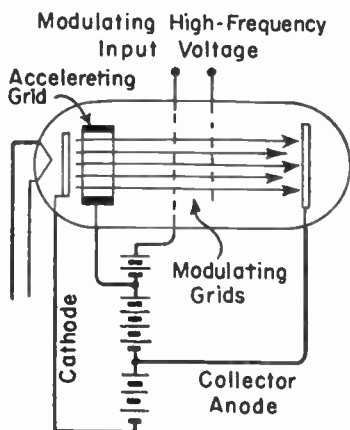

FIG. 1.—The Elements Employed for Velocity Modulation.

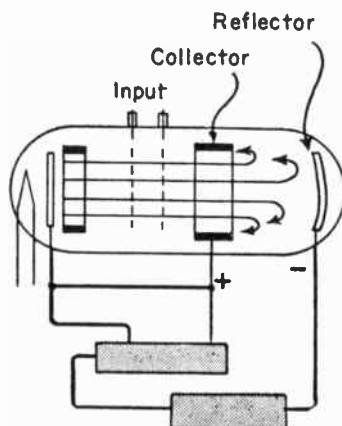

FIG. 2.—Method of Changing Velocity to Intensity Modulation.

The elementary principle of velocity modulation is shown in Fig. 1. Electrons emitted from the hot cathode are accelerated to high velocity by a positive potential applied to an accelerating grid which has the form of a ring or cylinder, and they are drawn onward to modulating grid *A*. The electrons pass through the openings of the modulating grids *A* and *B*, thence to the collector anode, which is at a low positive potential, and from there back to the cathode.

To the modulating grids is applied a high-frequency input voltage which is of low value compared with the voltage between the cathode and the first modulating grid. The potential of the second grid becomes alternately higher and lower than that of the first one. For example, were the potential 100 volts at the first grid, and were the high-frequency alternating input 10 volts, the potential at the second grid would become alternately 110 volts and 90 volts. While the potential is 110 volts the electrons are given additional acceleration as they pass between the grids, and when the potential is 90 volts the electrons are decelerated. Thus the electrons leaving the second modulating grid travel at velocities which vary with the alternations of potential applied to the grids.

TUBE, VELOCITY MODULATION

The rate of electron emission and current flow at the cathode remains practically constant, because it is fixed by the constant potential of the accelerating grid. That is, the total number of electrons per unit of time remains constant, or practically so. The electrons pass through the entire space from cathode to collector anode at practically this same constant number of total electrons per second; the variation or modulation being only of speed or velocity, and not of total flow rate or current.

The distance between modulating grids is very small, and because of their initial high velocity the electrons pass through the grids in a very brief transit time, a time which is much less than that of a half cycle of input voltage, even at very high frequencies. The velocities of electrons leaving the second grid depend on the instant during the alternating input cycle at which they went through the space between the modulating grids.

Although velocity modulation has been brought about with the arrangement of Fig. 1, the total rate per second of electrons (or the current) reaching the collector anode still is constant. It is as though men were arriving at a destination at varying speeds in miles per hour, but arriving at a practically unvarying rate in the number of men per minute or per hour. Because of this condition the alternating input voltage is having no effect on anode current, because current means the number of electrons per second. Thus it appears that velocity modulation, considered alone, is not useful in producing output current that varies in accordance with the input voltage. Before velocity modulation can accomplish anything useful it must cause variation or modulation of output current. Such current modulation may be called intensity modulation, because current is considered to be intensity of electron flow. The usual symbol for current is I , which stands for intensity.

There are various possible methods of producing intensity modulation from velocity modulation. One of the older methods might be used with the arrangement of Fig. 2. Here velocity modulated electrons travel toward a reflector plate which is sufficiently negative that electrons are slowed down and stopped before reaching it. How close the electrons come to the reflector depends on their velocity. The electrons then are drawn to a positively charged collector anode. The electric charge induced on the reflector varies as more and then fewer electrons come close to it, the variation being in accordance with electron velocity which, in turn, varies with the alternating input voltage.

With another method the velocity modulated electron stream is subjected to either an electric or a magnetic deflecting field which acts somewhat like the deflecting fields for a cathode-ray tube. The higher velocity electrons will be deflected or turned from a straight path in smaller degree than the slower electrons. One anode is placed to receive the slightly deflected high-velocity electrons and another anode is placed where it receives the more greatly deflected low-velocity electrons. Then there are variations in the number of electrons with respect to time at these anodes, and there is intensity modulation.

The most generally employed method of changing velocity modulation to intensity modulation is shown by Fig. 3, where there is a drift space following the modulating grids of the tube. While the electrons are traveling through this drift

TUBE, VELOCITY MODULATION

space, those of higher velocity overtake the ones of lower velocity which left the modulating grids somewhat earlier. The result is that both fast and slow electrons arrive at a certain point in the drift space at the same time. At this point in the space there will be alternating instants of maximum and minimum electron density, which are equivalent to alternating instants of intensity or of negative charge, and which constitute intensity modulation.

With the drift space method shown by Fig. 3, a group of electrons is represented at various positions in their travel through the space. As they leave the input grids the electrons are about equally spaced, although moving at different velocities. Farther along the faster traveling electrons are overtaking the slower ones, and are forming groups of greater density. At the point where the groups become of maximum density are placed two closely spaced output grids. As the high density groups pass through these

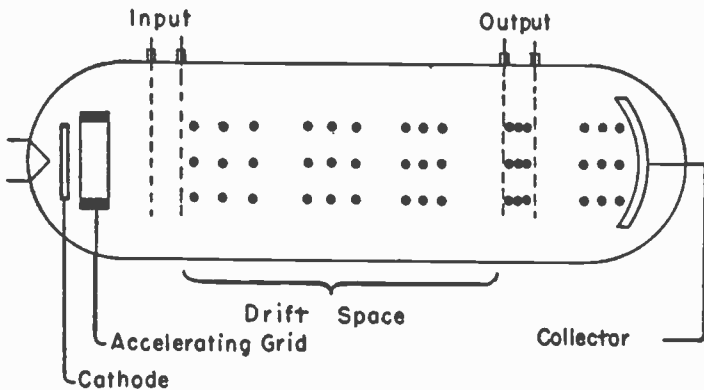

FIG. 3.—The Drift Space Method of Changing Velocity Modulation to Intensity Modulation.

output grids they induce strong charges in the grid space, and at the intermediate intervals of low density there are relatively weak charges. Thus, at the output grids, there are induced electric charges which alternate in strength according to variations of velocity imparted to the electrons by the input grids.

The distance from the input grids at which there are maximum changes of electron density at alternating instants depends on the difference between the velocities of fastest and slowest electrons, or on the time for the fastest ones to catch the slowest ones, and on the relation of this time to the average velocity at which the electrons are traveling. It is at this distance from the input grids that the output grids are located.

The drift space is maintained free from all electric fields except those of the electrons passing through it. After passing the output grids the electrons again spread out, because of their varying velocities. They are slowed down in the space between output grids and collector because of the relatively low potential of the collector. Consequently, the energy which remains in the electrons as they strike the collector is low enough so that there is not excessive production of heat at this point.

TUBE, VOLTAGE REGULATOR

TUBE, VOLTAGE REGULATOR.—A voltage regulator tube is an inert gas-filled tube having, in the most common types, a centrally located wire anode and around it a cylindrical cold cathode as shown by Fig. 1. In the base of the tube, between two of the prongs, is a wire jumper which completes the power supply circuit of the apparatus in which the tube is used. These tubes are used to maintain practically constant potentials for plate, screen and grid circuits when there are rather large variations of load current, or for any similar purpose. See *Tube, Cold-cathode*.

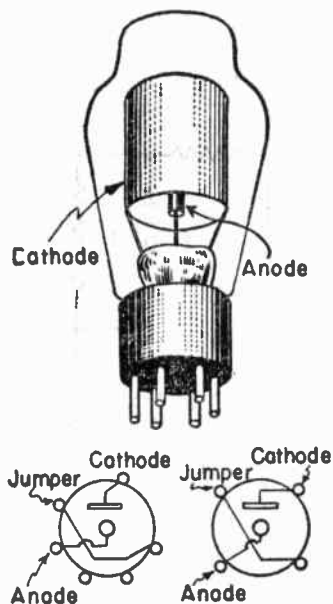

FIG. 1.—Construction and Connections of One Type of Voltage Regulator.

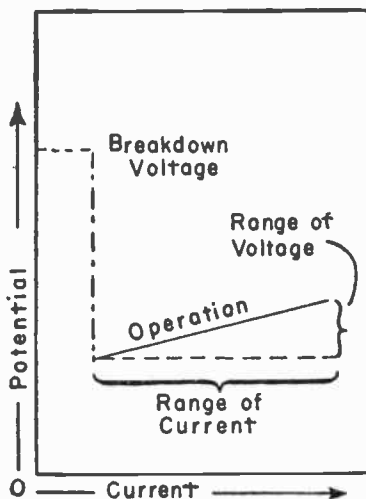

FIG. 2.—Relations between Voltage and Current During Operation of Voltage Regulator.

When the potential difference applied between anode and cathode is high enough to cause breakdown and ionization of gas within the tube, the voltage drop across the tube decreases, as shown by Fig. 2, and current commences to flow. Thereafter the current may vary over a considerable range with but small change of voltage across the tube. In typical tubes the current may vary between 5 and 50 milliamperes with only one to seven volts change in tube drop; the voltage change depending on the type of tube. The reason is that a small change of applied voltage causes a relatively large change of ionization and of resulting current.

Connections for a voltage regulator tube are shown by Fig. 3. The anode and cathode are connected across the d-c power supply

TUBE, VOLTAGE REGULATOR

and the load in which voltage is to be regulated. When conditions in the load are such as to allow a change of load current there is an accompanying drop of voltage across both load and regulator tube. Then, as shown by Fig. 2, there is a decrease of current in the regulator tube. The regulator tube acts to maintain a nearly constant total current through itself and the load, and to maintain a nearly constant voltage across itself and the load because, with constant total current being taken from the power supply there would be no change of voltage at the output terminals of the power supply.

The jumper of the regulator tube of Fig. 3 is shown connected in series with the line for the power supply. If the regulator tube is taken out of its socket the power supply is cut off. Otherwise, with the regulator tube removed, there might be excessive voltage applied to the load. Fig. 4 shows two regulator tubes connected to maintain two regulated voltages in a load represented by a voltage divider. Potential difference between the negative load terminal and the center positive terminal will be maintained near the

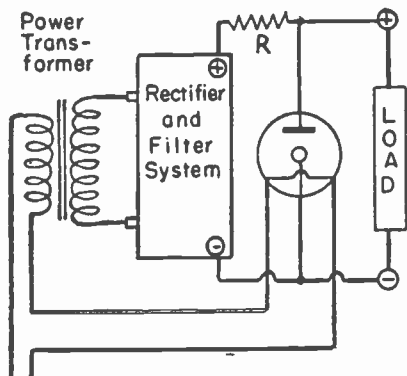

FIG. 3.—Connections Used with Single Regulator Tube.

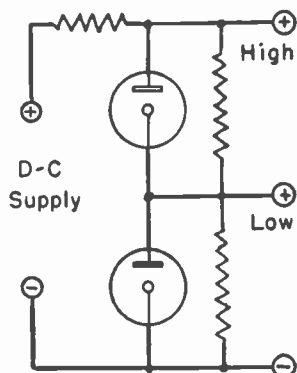

FIG. 4.—Two Tubes Regulating Two Voltages.

rated operating voltage drop for the lower tube. The potential from negative to the top positive terminal will be maintained near the sum of the operating voltages of the two regulator tubes. For example, with a 90-volt regulator below and a 150-volt unit above, the potential at the low positive terminal will be regulated at 90 volts, and that at the high positive terminal at 240 volts.

It is necessary that a minimum current flow through the regulator tube to maintain ionization and regulating action. This current usually is 5 or 10 milliamperes. The d-c supply potential must be enough higher than the rated breakdown potential of the regulating tube to insure starting as the tube ages. The excess runs from 15 to 30 volts, depending on the type of tube used. Between the regulator tube and the power supply there always must be a resistor R which will limit the operating current of the tube to its rated maximum value. The value of the resistance at this point will depend on the load current plus tube current, and on the operating voltage. Regulator tubes safely withstand up to two and one-half times their maximum rated current during the few seconds in which the tube is warming up to normal operating temperature.

TUBING, INSULATING

TUBING, INSULATING.—Small diameter tubing which is slipped over bare conductors or over conductors whose insulation is to be increased. Most such tubing is made of fabric heavily impregnated with varnish or other material of high dielectric strength. It is commonly called “spaghetti” tubing. Flexible rubber tubing sometimes is used in similar manner.

TUNED ANTENNA.—See *Antenna, Tuned*.

TUNED AUDIO FREQUENCY AMPLIFIER. — An audio frequency coupling system in which certain frequencies or certain frequency ranges are amplified more than others by using in these circuits values of inductance and capacity which produce series resonance at the frequencies to be emphasized.

TUNED CIRCUIT.—An oscillatory circuit containing capacity and inductance of such values as to produce resonance. Usually either the capacity or the inductance is adjustable in order that the resonant frequency may be changed.

TUNED FILTER.—A band exclusion filter consisting of one or more parallel resonant circuits tuned to a frequency which is to be attenuated. The band exclusion circuit may be incorporated as part of a low pass filter in a power supply.

TUNED-GRID TUNED-PLATE OSCILLATOR. — See *Oscillator*.

TUNED IMPEDANCE AMPLIFICATION.—A high-frequency amplifying system in which the tube plate circuit includes a parallel resonant circuit tuned to a frequency which is to be amplified.

TUNED RADIO FREQUENCY TRANSFORMER.—See *Transformer, Tuned Radio Frequency*.

TUNED TRANSFORMER.—A radio-, audio-, or intermediate-frequency transformer whose secondary, primary, or both, are tuned to resonance at the frequency applied to the primary.

TUNER.—That portion of a radio frequency amplifier in which are located the circuits tuned to resonance at the frequency to be received or transmitted.

TUNGAR RECTIFIER.—See *Rectifier, Gas-filled Tube*.

TUNING.—Variation of the capacity or inductance in an alternating-current circuit to cause resonance at a certain frequency called the tuned frequency, thus securing maximum power in reception or transmission at this frequency.

TUNING, AUTOMATIC.—The difficulty in tuning a highly selective modern radio receiver exactly to resonance with an incoming signal has indicated the desirability of a tuning system capable of simple manipulation. The almost universal use of all-wave receivers made necessary the reduction gear type of tuning control in order to provide accurate tuning of high frequency stations. This means that it is necessary to rotate the main tuning knob from ten to twenty-five times or more in order to drive the indicating pointer across the dial a single time. Several ingenious

TUNING, AUTOMATIC

devices and mechanisms are employed to reduce this drive ratio to allow a more rapid change from one end of the dial to the other. Various clutch arrangements and inertia spinner systems are employed but the difficulty in educating the public to the proper use of such devices often results in poor tone quality because of inaccuracies in tuning. Thus an otherwise excellent receiver might be condemned while the actual fault would be found to be in the carelessness or lack of skill on the part of the person manipulating the controls.

Push button and remote control systems have been available in higher priced receivers in the past, but they were never entirely satisfactory over a protracted period due to both electrical and mechanical failures.

The development of automatic frequency control circuits in which slight imperfections in the setting of the tuning control

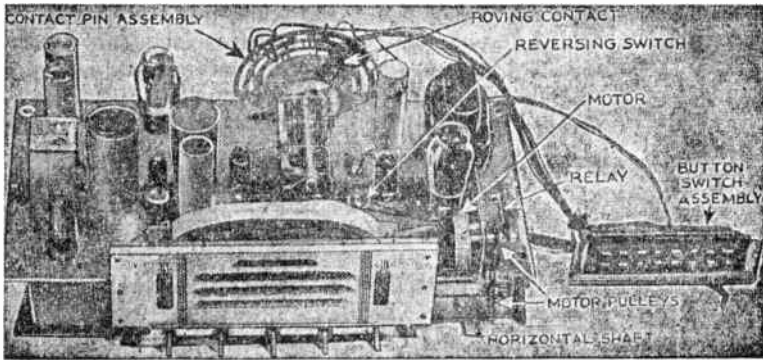

FIG. 1.—General Electric Touch Tuning Chassis.

mechanism is automatically corrected, makes possible a system of push button tuning which was generally considered impractical a few years ago.

There are three general types of automatic tuning systems: motor driven, pre-calibrated trimmer (inductance or capacitance variants), and the telephone dial type. Numerous variations of each type are used but they will be found to fall into one of the three main classifications.

The motor driven automatic tuning system requires a fractional horsepower reversible motor which is used to drive the main tuning condenser through the use of a driving gear train. The electric motor is driven by a special secondary winding on the power transformer. This type of tuning system resembles the remote control receiver of earlier days but with two notable exceptions: (1) In the older systems it was necessary to keep the

TUNING, AUTOMATIC

tuning button depressed until the motor had driven the gang condenser rotor to the position of the desired station, while in the present method the tuning button need only be momentarily touched. (2) In the older systems the final tuning operation was frequently done by hand while with the use of automatic frequency control circuits the modern receiver is pulled exactly into line with the incoming signal electrically, if the tuning mechanism should be slightly inaccurate in its action.

Motor driven automatic tuners are available to tune from six to sixteen different stations, depending upon the manufacturer's

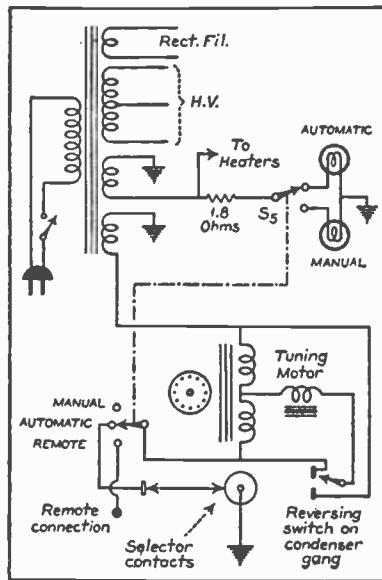

FIG. 2.—Electric Tuning Circuit.

idea as to what is desirable. The various stations to be tuned automatically are selected according to their popularity, excellence of program or personal desires of the owner of the receiver, and will generally be in the immediate vicinity in which the receiver is operated. A switch or push button is provided to disconnect the automatic mechanism when it is desired to use the receiver as a standard manually tuned set, in which case, station selection is accomplished by rotating the conventional condenser tuning knob. Some models provide for automatic tuning in the short wave bands, but the push button is generally used to seek the middle of a particular band in which it is desired to receive signals, manual operation takes over at this point for the actual

TUNING, AUTOMATIC

tuning-in of individual stations. It is usually necessary to turn the band switch by hand before going through the foregoing operation. A "scanning" button may also be provided which drives the pointer slowly over the dial from one end to the other. When the desired program is heard, the button is released, thus permitting a search of the band without the necessity of turning the tuning knob by hand. When using the "scanning" arrangement, several circuits which would be inoperative while the motor is in rotation for ordinary push button tuning, remain energized.

Several types of motor driven automatic tuners are arranged for remote control. A set of push buttons similar to those at-

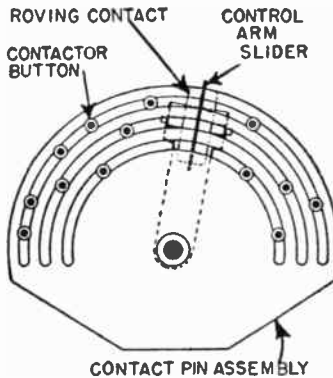

FIG. 3.—Roving Contact Pin Assembly.

tached to the receiver are mounted in a convenient box and connected to the receiver by a multi-wire cable. The push buttons in the box simply parallel those in the receiver and function in the same manner. Twenty to thirty feet of cable are provided, allowing control of the receiver within that radius.

The motor used is usually a 6-volt reversing type using a split phase winding. The shaft of the motor is coupled to the condenser rotor by means of a reduction gear arrangement having a high ratio, possibly 100 to 1. The station indicating pointer is also operated by this means and a reversing switch operated from the variable condenser shaft reverses the motor at either end of the run. Provision is made for disengaging the motor shaft drive when manual operation is desired.

Coupled to the tuning condenser shaft is a roving contactor which passes over the contact pins arranged in a semi-circular row and mounted back of the gang condenser assembly. Connections are carried from the contact pins to the push buttons mounted on the front of the cabinet.

TUNING, AUTOMATIC

Pressing one of the buttons starts the motor and puts into operation the variable condenser rotor, station indicating pointer and the roving contactor. The receiver is made inoperative during the motor action (except when "scanning") by biasing to cut off one or more tubes in the audio section of the receiver.

When the roving contactor strikes the contact pin which is connected to the depressed button, a relay mounted on the end of the motor shaft is energized causing the motor circuit to open. This relay also releases the blocked audio system and connects the automatic frequency control system into the circuit. The motor pulley is blocked which stops the tuning condenser instantly. A friction drive clutch is used on the motor drive to

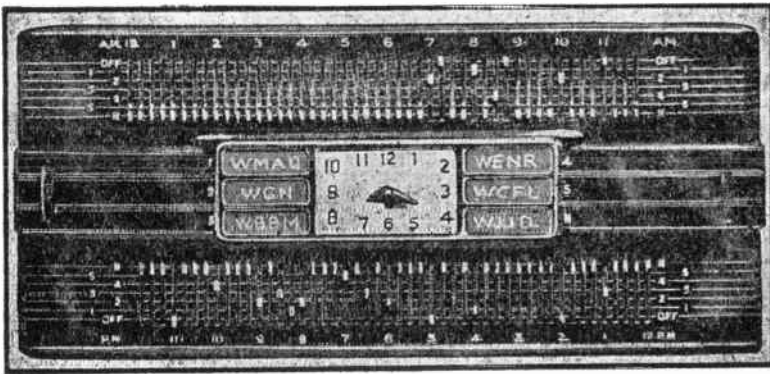

FIG. 4.—Time Tuning Selector.

prevent undue stress on the condenser shaft due to rapid stopping.

Interlocking push button assemblies are used, i.e., pushing any button releases any other button which may have been depressed. Volume and tone control operations are performed in the customary way by manual rotation of the control knobs.

One manufacturer provides a time tuning feature, making it possible to preselect any one of five stations for any 15-minute period over a full 24 hours. Once the stations are set up, over all or any portion of the time period, the action is completely automatic, stations being tuned in and the receiver being turned on or off as required. An electric clock is an integral part of the pre-selector mechanism.

The tuned trimmer type of automatic tuner makes use of a number of adjustable trimmer condensers of the type in common use for the alignment of the intermediate frequency stages of superheterodyne receivers. A push button control is provided to disconnect the main variable tuning condenser gang when using push button tuning.

TUNING, AUTOMATIC

In a conventional superheterodyne receiver there are three circuits which require tuning, the R.F. stage and detector or mixer stage, both of which must be tuned to the frequency of the desired signal and the oscillator circuit which is tuned to the incoming frequency, plus the intermediate frequency. In most instances where push button tuning of the tuned trimmer type is provided, the R.F. stage is disconnected while using push button operation. This reduces the number of trimmers necessary and simplifies the construction. The disconnecting of the R.F. stage is accomplished by pushing a button or turning a switch which converts the receiver from manual operation to automatic.

There are of course exceptions to the foregoing statements, receivers are available which provide the necessary trimmers to

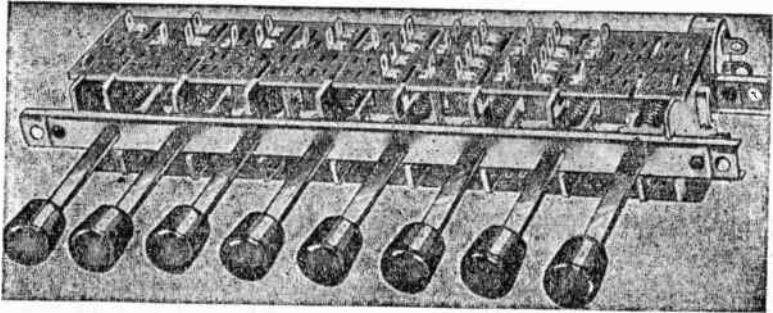

FIG. 5.—Multiple Circuit Push Button Switch.

push button tune the R.F. stage. This is an advantage where the receiver is to be used in a location some distance from broadcast transmitters and the additional gain of the R.F. stage is necessary.

After actuating the control which disconnects the variable tuning condenser, the push button which has been preset to a given station is depressed. Pushing this button connects a trimmer condenser to *each* of the circuits formerly tuned by the variable gang condenser.

Where six push buttons are provided, each button is capable of being set to a station within a definite band of frequencies. Thus the first button may be capable of adjustment to any frequency between the limits of 1600 KC to 1240 KC, the second 1400 KC to 990 KC and so on across the broadcast band. A sufficient overlap is provided to allow the tuning of two stations separated by only a few channels.

Push button sets come equipped with sheets upon which practically all of the call letters of broadcast stations in the United States are printed. The desired station tabs are cut out and fastened to the buttons as they are set up.

TUNING, AUTOMATIC

In construction, the trimmers are mounted close to the push button latch switch assembly to avoid long leads and the leads from the antenna and oscillator are encased in low capacity shields.

In the lower price range receivers of the T.R.F. type are available having this type of push button tuning. These receivers are intended principally for use in localities where numerous high power transmitters are operating.

At least one manufacturer has provided push button tuning

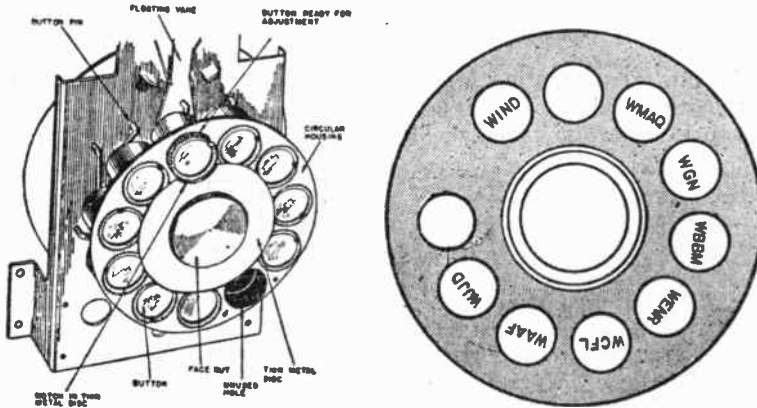

FIG. 6.—Telephone Type Tuning Dial.

using variable inductances instead of trimmer condensers for setting up the stations. The inductance value is adjustable by changing the degree to which a powdered iron core is inserted into the coil. This system is called "permeability tuned" and claims the advantage of having a minimum number of adjustments in setting up a given frequency.

The telephone dial type of tuning control works directly on the tuning condenser rotor or may use a cam and lever principle. In operation, the desired station button mounted on the telephone dial is depressed and held in this position while the dial mechanism is rotated to a fixed stop position. The button is then released and the station is heard without further adjustment.

During the rotation of the dial the audio circuit is suppressed so that the set is silent until this button is released. Rotation of the dial causes a rotation of the main tuning condenser through a belt and pulley system. The physical size of the tuning dial varies from approximately the size of a telephone dial to several times that value. As many as sixteen different stations may be set up, depending on the number of button positions supplied with the dial. Considerable care must be taken in the construc-

TUNING, AUTOMATIC

tion of this type of automatic tuner to prevent backlash in the gear or pulley system.

A combination of push button actuation and dial tuning is also available. Pushing a button moves a cam and latch mechanism which directly rotates the gang condenser rotor. This type requires that the push button be firmly pushed to its terminal position to insure that the condenser rotor is driven to its proper position.

The latter system is also applied to automobile receivers, a total of four or five stations being selectable by push button tuning.

Tuning, Automatic, Mystery Control.—A novel type of automatic tuning device brought out by the Philco Radio & Television Corporation called the "Mystery Control," allows the tun-



FIG. 7.—Philco Mystery Control Box.

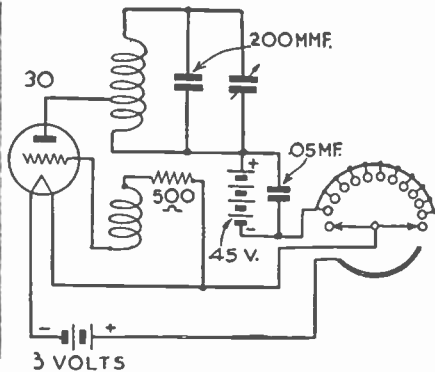

FIG. 8.—Mystery Control Circuit.

ing of the radio receiver to any one of a number of pre-selected stations by the manipulation of a control box which has no physical connection with the receiver proper. Any one of eight stations may be tuned in by the use of the remote control, the volume may be increased or decreased by any desired amount and the receiver may be turned off, but not on, by means of the same control. Complete control may be exercised at a distance as great as eighty feet from the receiver if no highly reflective surface intervenes. An adjustment is provided on the receiver which controls the sensitivity of pickup of the controlling impulse.

The receiver is a standard eight tube all-wave superheterodyne employing conventional circuits of approved design. It may be used without the remote control in which case station selection is provided by the use of a variable condenser gang rotated by a manual control. Three wave bands are provided covering all of the important local and foreign short wave broadcast bands.

The remote system consists of a control box measuring $9\frac{3}{8}$ " x

TUNING, AUTOMATIC

supply to the 30 tube is disconnected. The dial returns to its home position due to the action of a circular spring which is wound during the clockwise rotation of the dial. It is prevented from returning to its original position too rapidly by the use of a mechanical dampener in the form of a vane on the end of the shaft.

To increase volume the dial position at the extreme right is dialed and the end stop held down until the volume reaches the desired level. Two pulses are set up in the oscillator coil as the dial returns to its home position. Holding down the end stop keeps the oscillator in operation and produces a continuous radiation from the oscillator. To decrease volume the second position from the right is dialed. Holding down the end stop for the required time after dialing the second position will turn the receiver off.

A loop is provided in the receiver cabinet to pick up the energy radiated by the oscillator. This loop circuit is tuned to the oscillator frequency. Any one of five different frequencies between 355 KC and 395 KC can be used. This is necessary to prevent interaction between two receivers which may be used in adjoining apartments. The loop circuit, which is tuned by a trimmer condenser, receives the pulsating energy radiated by the control box and applies this energy to the first control amplifier, which is a 78 type of tube. A 6J7G serves as the second control amplifier, the output of which is fed to a 6ZY5G acting as an AVC tube to maintain constant output. This is necessary because of the varying distances at which the mystery control box may be used. One diode plate has a time delay circuit adjusted to the frequency of the pulser to prevent actuation of the circuit by random electrical impulses and static which may be picked up by the loop. The output of the 6ZY5G is fed to a 2A4G thyatron having a stepping relay and holding relay in its output circuit. Grid and plate voltages for the thyatron are obtained from an A.C. source. When the thyatron fires, the holding relay closes and the stepping relay pushes a ratchet as many times as the pulses sent out by the pulser in the control unit. Operation of the stepping relay mutes the receiver during the station selection operation.

The stepper assembly operates three groups of contacts. One group changes the oscillator coils, the second group changes the antenna condensers, while the third group lights the pilot lights indicating the station being tuned. As the stepper switch moves up to the desired station the pilot light of each prior station is momentarily flashed on in sequence.

A sensitivity control is provided on the type 78 control amplifier to allow for greater pickup distance between the control box and receiver. Normally the sensitivity should be reduced to the minimum value required to effectively operate the control circuits.

U

UMBRELLA ANTENNA.—See *Antenna, Forms of.*

UNDAMPED WAVE.—See *Wave, Undamped.*

UNDERGROUND ANTENNA.—See *Antenna, Underground.*

UNIT, POWER SUPPLY.—See *Power Unit.*

UNIT, TRANSMISSION.—The transmission unit is a measure of the gain or loss in either power, voltage or current of an electrical system, the measure being based on the ratio of the power, voltage or current at one point to the power, voltage or current at another point in the system.

The ratio of gain in power is equal to the greater power (in watts) divided by the lesser power (in watts). The ratio of loss in power would be equal to the lesser number of watts divided by the greater number. Similarly, ratios of gain or loss in voltage or current are found by dividing one voltage or current by the other. If the input power to an amplifier is 10 milliwatts and the output is 100 milliwatts, the gain ratio is equal to 100 divided by 10, or is 10. If the power at the beginning of a circuit is represented by 30 watts and the power at the end of the circuit is represented by 15 watts, the loss ratio is equal to 15 divided by 30 or $\frac{1}{2}$. Voltages or current are similarly treated in determining the ratio.

CURRENT RATIOS AND CORRESPONDING NUMBERS OF TRANSMISSION UNITS

Current Ratio	Transmission Units	Current Ratio	Transmission Units	Current Ratio	Transmission Units
0.001	loss 60.00	0.5	loss 6.02	20	gain 26.02
0.005	loss 46.02	1.0	0.00	50	gain 33.98
0.01	loss 40.00	1.5	gain 3.52	100	gain 40.00
0.05	loss 26.02	2.0	gain 6.02	500	gain 53.98
0.1	loss 20.00	5.0	gain 13.98	1000	gain 60.00
0.2	loss 13.98	10.0	gain 20.00	10000	gain 80.00

To change the power ratio into the equivalent number of transmission units the ratio is multiplied by ten times the common logarithm of the ratio. For example, if the input power is 10 and the output power is 100, the ratio is 10. The common logarithm of 10 is 1 and 1 multiplied by 10 equals 10, therefore there is a gain of ten transmission units. If the input power to a circuit is 30 watts and the output power is 15 watts, the ratio is $\frac{1}{2}$. The common logarithm of $\frac{1}{2}$ is 0.301 which, multiplied by 10 becomes 3.01, the number of transmission units loss in the circuit.

To change voltage ratios or current ratios into transmission units the ratio is multiplied by twenty times the common logarithm of the ratio. If an

UNIT, TRANSMISSION

amplifier increases the signal voltage to eight times its original value the ratio of gain is 8. The common logarithm of 8 is 0.9031 which, multiplied by 20 becomes 18.062, the voltage gain in transmission units.

The National Electrical Manufacturers Association has adopted the following definition as a standard: "A unit of power ratio used for expressing transmission loss or transmission gain (amplification). Two amounts of power differ by one transmission unit when they are in the ratio of $10^{0.1}$. Two amounts of power differ by N transmission units when they are in the ratio of $10^{(0.1)N}$. The number of transmission units is ten times the common logarithm of the power ratio to be expressed."

The accompanying tables show the power ratios of gain or of loss which correspond to certain fractions or numbers of transmission units.

POWER RATIOS AND TRANSMISSION UNITS

Ratio of Gain	Number of T. U.	Ratio of Gain	Number of T. U.	Ratio of Gain	Number of T. U.
1.0	0.000	4.12	6.232	12.0	10.792
1.1	0.414	4.3	6.335	13.0	11.139
1.2	0.792	4.4	6.435	14.0	11.461
1.26	1.000	4.5	6.532	15.0	11.761
1.3	1.139	4.6	6.628	16.0	12.041
1.4	1.461	4.7	6.721	17.0	12.304
1.5	1.761	4.8	6.812	18.0	12.553
1.59	2.000	4.9	6.902	19.0	12.788
1.6	2.041	5.0	6.990	20.0	13.010
1.7	2.304	5.01	7.000	25.0	13.979
1.8	2.553	5.2	7.160	30.0	14.771
1.9	2.788	5.4	7.324	35.0	15.441
1.99	3.000	5.6	7.482	40.0	16.021
2.0	3.010	5.8	7.634	45.0	16.532
2.1	3.222	6.0	7.782	50.0	16.990
2.2	3.424	6.2	7.924	55.0	17.404
2.3	3.617	6.31	8.000	60.0	17.782
2.4	3.802	6.4	8.062	65.0	18.129
2.5	3.979	6.6	8.195	70.0	18.451
2.51	4.000	6.8	8.325	75.0	18.751
2.6	4.150	7.0	8.451	80.0	19.031
2.7	4.314	7.2	8.573	85.0	19.294
2.8	4.472	7.4	8.692	90.0	19.542
2.9	4.624	7.6	8.808	95.0	19.777
3.0	4.771	7.8	8.921	100.0	20.000
3.1	4.914	7.94	9.000	200.0	23.010
3.16	5.000	8.0	9.031	400.0	26.021
3.2	5.051	8.2	9.138	600.0	27.782
3.3	5.185	8.4	9.243	800.0	29.031
3.4	5.315	8.6	9.345	1000.0	30.000
3.5	5.441	8.8	9.445	2000.0	33.010
3.6	5.563	9.0	9.542	4000.0	36.021
3.7	5.682	9.2	9.638	6000.0	37.782
3.8	5.798	9.4	9.731	8000.0	39.031
3.9	5.911	9.6	9.823	10000	40.000
3.98	6.000	9.8	9.912	20000	43.010
4.0	6.021	10.0	10.000	100000	50.000
4.1	6.128	11.0	10.414	1000000	60.000

UNTUNED RADIO FREQUENCY AMPLIFIER

Ratio of Loss	Number of T. U.	Ratio of Loss	Number of T. U.	Ratio of Loss	Number of T. U.
0.95	0.223	.34	4.685	.158	8.000
.90	0.458	.32	4.949	.150	8.239
.85	0.706	.316	5.000	.145	8.386
.80	0.969	.30	5.229	.140	8.539
.79	1.000	.29	5.376	.135	8.697
.75	1.249	.28	5.528	.130	8.861
.70	1.549	.27	5.686	.126	9.000
.65	1.871	.26	5.850	.125	9.031
.63	2.000	.251	6.000	.120	9.208
.60	2.218	.25	6.021	.115	9.393
.55	2.596	.24	6.198	.110	9.586
.50	3.000	.23	6.383	.105	9.788
.48	3.188	.22	6.576	.100	10.000
.46	3.372	.21	6.778	.01	20.000
.44	3.565	.20	6.990	.001	30.000
.42	3.768	.19	7.212	.001	40.000
.40	3.978	.18	7.447	.00001	50.000
.38	4.202	.17	7.696	.000001	60.000
.36	4.437	.16	7.959		

V

VACUUM PHOTOCELL.—See *Cell, Photoemissive*.

VACUUM TUBE.—See *Tube*.

VACUUM TUBE VOLTMETER.—See *Meter, Vacuum Tube*.

VALUE, AVERAGE AND EFFECTIVE.—The effective value of an alternating current is equal to a direct current which would produce the same heating effect as the alternating current in a circuit. The average value of a rising and falling current or voltage is the difference, if any, between the values of one polarity and those of opposite polarity. In an alternating cycle the value of the positive alternation is equal to the value of the negative alternation; therefore the two balance each other and the average value is zero. The average value of a pulsating current may be anywhere between zero and the maximum value of the pulsations.

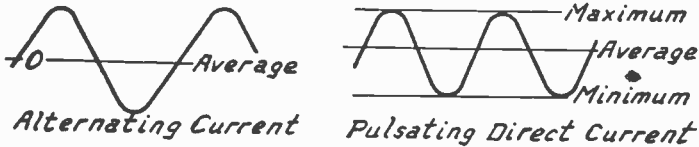

Average Values of Alternating and Pulsating Currents.

A direct current voltmeter or ammeter indicates average values. When such meters are inserted in alternating current circuits their pointers stand at zero since the tendency is to deflect them just as much one way as the other. Alternating current voltmeters and ammeters indicate effective values and will move their pointers in the same direction regardless of the direction of the current flowing through them. The position of the pointer is proportional to the average of the squares of all the values of current during the cycle. See *Wave, Sine*.

The effective value of an alternating current is equal to the maximum value multiplied by 0.707. The maximum value is equal to the effective value multiplied by 1.414. This relation holds true for sine wave currents.

VALVE.—This is another name for a vacuum tube. See *Tube*.

VARIABLE AREA RECORDING.—See *Sound Pictures*.

VARIABLE DENSITY RECORDING.—See *Sound Pictures*.

VARIABLE GRID LEAK.—See *Leak, Grid*.

VARIABLE-MU TUBE.—See *Tube, Variable-mu*.

VARIOMETER, ACTION OF.—A variometer is a continuously variable inductance. It is a device by means of which inductance may be increased or decreased in much the same way that capacity is changed by a variable tuning condenser. Variometers

VARIOMETER, ACTION OF

are used in tuned circuits with which change of resonant frequency is made by changing the inductance while using a fixed capacity rather than by the more common method of changing the capacity while using a fixed inductance or coil.

A variometer is made up of two coils of approximately equal inductance. One coil is wound on the outside of its form and the

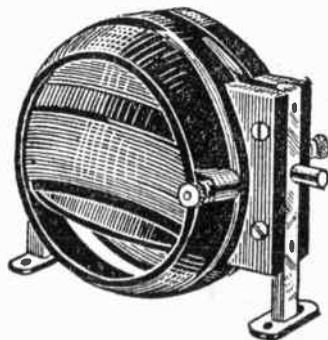

FIG. 1.—Variometer with Spherical Windings.

other coil is carried on the inside of its form. The two are placed together as in Fig. 1 or Fig. 2 so that the coil on the outside of its form may be rotated within the other one.

The two inductances may be made to assist each other or to oppose each other. With the two coils working together the inductance of the whole variometer is at its maximum. With the two coils op-

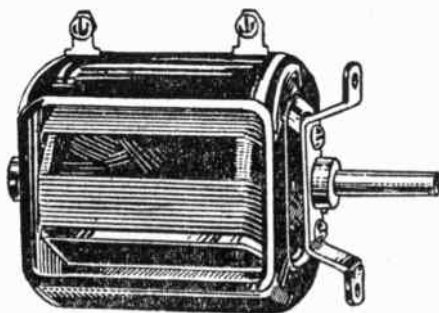

FIG. 2.—Variometer with Rectangular Windings.

posing each other the total inductance is at its minimum. Variometers used for receiving work generally have a minimum inductance of 50 to 75 microhenries and a maximum inductance of from 500 to 700 microhenries.

The principle of the variometer may be understood from Figs. 3 and 4. In Fig. 3 the winding of the two coils passes around both in the same direction. Therefore, their self-inductances and their mutual inductance are added.

VARIOMETER, ACTION OF

If one is slipped inside the other as below, the combined inductances will be more than double that of either coil alone.

In Fig. 4 one of the coils has been turned upside down while the other one remains in its original position. Their fields and inductive strengths now oppose each other. If one coil be now slipped inside the other the two fields will oppose each other and the inductance of one coil will destroy that of the other so that the combination has little remaining inductive effect.

In actual practice the one winding, called the stator, is supported securely in position by the mounting device. The other winding, called the rotor, is carried by a shaft so that it may be rotated inside the stationary winding. By turning the rotor through one half a revolution the combined inductance is changed gradually and

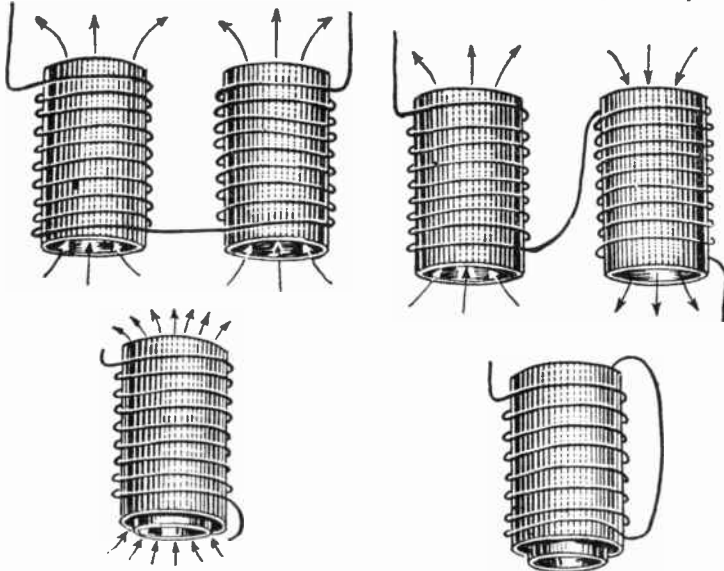

FIG. 3.—Coils Working Together to Add Their Inductances as in a Variometer.

FIG. 4.—Coils Opposing Each Other to Destroy Inductance as in a Variometer.

smoothly from its maximum value to its minimum. If rotation is continued the inductance will again increase until it reaches a maximum value again as the coils come into their former relation or position with reference to each other.

Variometers are wound with wire between number 20 and number 26 gauge sizes. Double silk covered wire is suitable because of its small thickness of insulation and because it is well protected from mechanical injury. The wire is laid into the forms and is held in place by clamping and by small amounts of binder. Some types of variometers are built with basket weave windings, then requiring but little solid dielectric in their construction. The losses in variometers are the same as found in coils.

VARIOMETER, COUPLING WITH

The change of inductance as a variometer is turned from minimum to maximum is shown by the curve in Fig. 5. The change is gradual at first, then quite rapid as the coils are passing the position

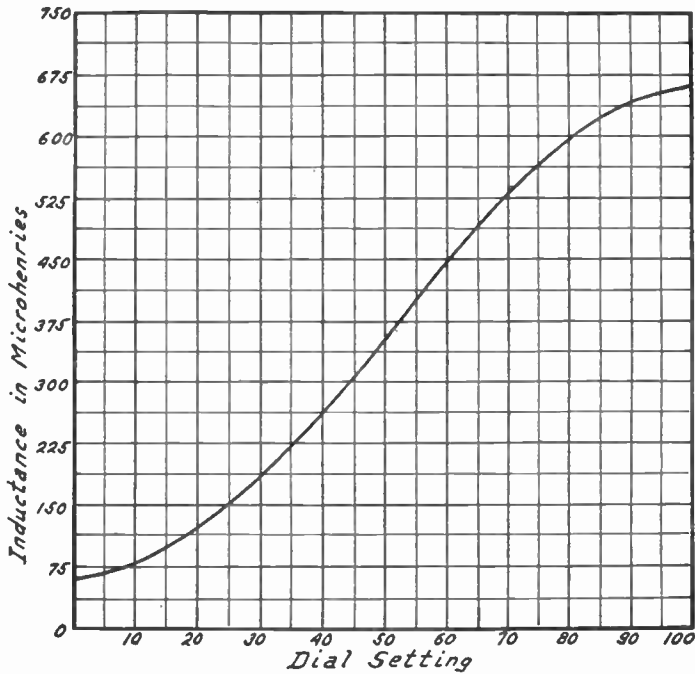

FIG. 5.—Change of Inductance with Rotation of Variometer Rotor.

of right angles or ninety degrees to each other. As the coil axes again come to the parallel position the inductance change is less rapid.

VARIOMETER, COUPLING WITH.—A variometer may be used as a tuned impedance coupling between radio frequency amplifying tubes or as a form of tuned transformer coupling with a variable secondary. Tuned impedance coupling with a variometer is shown in Fig. 1. The plate of one tube is connected to the grid of the following tube through a coupling condenser. The second tube is provided with a grid leak to prevent blocking. The variometer is connected between the plate of the first tube and the B-battery or plate voltage supply unit. See also *Amplifier, Radio Frequency, Tuned Impedance Coupled*.

Fig. 2 shows the use of a variometer as the secondary of a tuned radio frequency transformer. The terminals of the variometer are bridged with a fixed condenser, thus forming a combination of vari-

VARIOMETER, COUPLING WITH

able inductance and fixed capacity that is equivalent in action to the more familiar fixed inductance and variable tuning condenser. The primary of the transformer is formed by three to twenty turns of wire around the variometer or supported along side the stationary winding of the variometer. These primary turns are connected between the plate of the preceding tube and the B-battery or voltage supply unit in the usual way. The arrangement of the primary winding, the variometer and the fixed condenser is shown by Fig. 3.

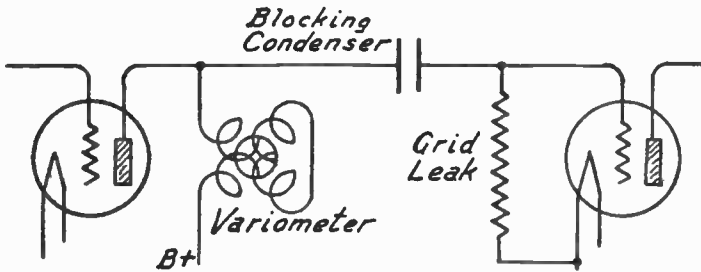

FIG. 1.—Tuned Impedance Coupling with Variometer.

The required capacity of the fixed condenser across the variometer windings will depend upon the maximum inductance of the variometer. The ratio between maximum and minimum inductance in well built variometers is ten to one or better, this being a range sufficient to cover the broadcasting band of frequencies when used with a fixed condenser for tuning. The following table gives the approximate minimum and maximum inductances required in the variometer when tuned with fixed condensers of various capacities. The variometer should have a range somewhat greater than the required minimum to maximum.

CONDENSERS FOR TUNING VARIOMETERS

Capacity of Fixed Condenser in Microfarads	Microhenries of Inductance Required in Variometer	
	Minimum	Maximum
.001	12	86
.00075	15	114
.0006	19	142
.0005	23	171
.0004	28	213
.00035	32	244
.0003	38	284
.00025	45	341
.0002	57	426
.00015	75	568
.000125	90	682
.0001	113	852
.000075	150	1133
.00005	225	1704

VARIOMETER, COUPLING WITH

The increase of inductance in a variometer as the frequency decreases or as the wavelength increases is more favorable to uniform amplification of all frequencies than is the increase of capacity for

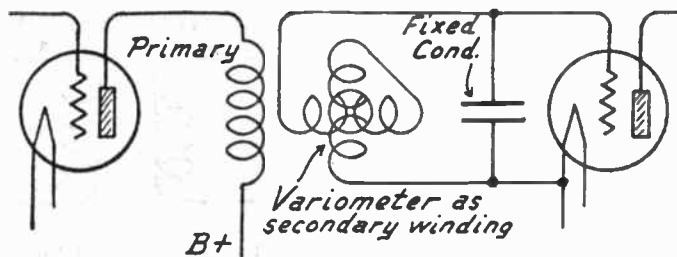

FIG. 2.—Variometer Used as Secondary of Tuned Transformer for Coupling.

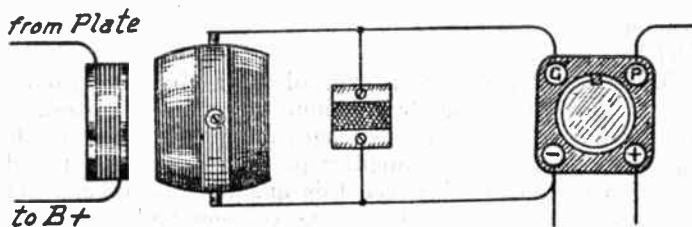

FIG. 3.—Layout of Variometer Used in Tuned Transformer for Coupling.

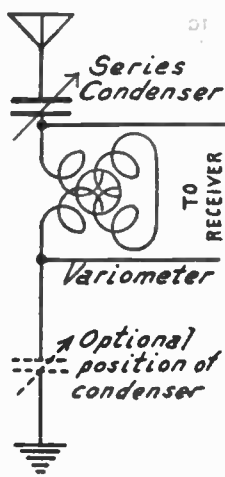

FIG. 4.—Variometer and Series Condenser for Antenna.

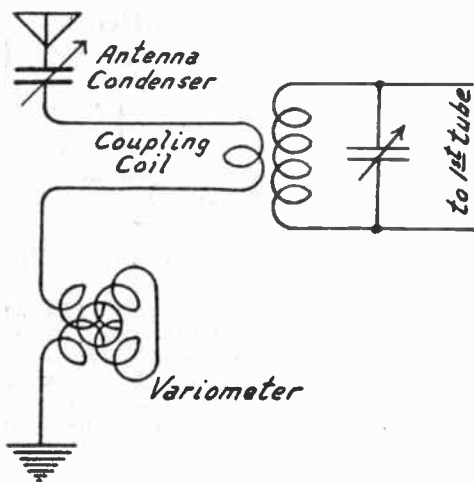

FIG. 5.—Variometer Tuned Antenna with Loose Coupling.

VECTOR

VARIOMETER, SPLIT TYPE.—The two windings of a variometer may be disconnected from each other at the center connection and the two coils used as the primary and secondary wind-

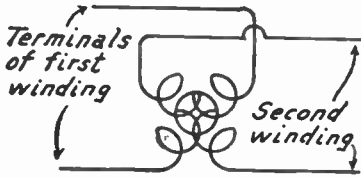

FIG. 1.—Split Variometer Circuit.

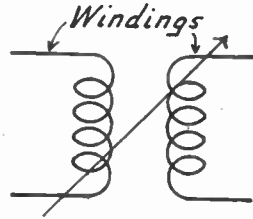
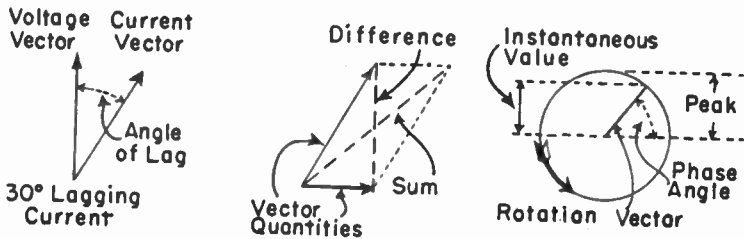

FIG. 2.—Equivalent Circuit.

ings of an adjustable coupler employing mutual inductance. The resulting arrangement of the two coils is shown by Fig. 1, and the equivalent coupler by Fig. 2.

VARNISH.—See *Binders*.

VECTOR.—A vector is a symbol for a changing quantity which, at a given instant, has definite direction and magnitude. A straight line represents by its length the magnitude of an alternating quantity and by its angular position in relation to other lines the phase relation between this quantity and others. Thus it is possible to represent alternating voltages and currents and to graphically show their phase relations.



Representation of Quantities by Means of Vectors.

A vector sum or difference is the result of adding or subtracting quantities vectorially. Two vectors form the two sides of a parallelogram, which is completed. Then the longer diagonal represents the sum and the shorter one the difference of the two quantities, both in magnitude and in phase relation.

A rotating vector is a vector considered as rotating anticlockwise about one of its ends, the rate of rotation being equal to the cycles per second of an alternating frequency, and each cycle being represented by one full turn or a 360° travel of the vector. When the angle of the rotating vector with a horizontal line is equal to the phase angle, a projection of the vector on a vertical line represents the instantaneous value of the alternating quantity.

VELOCITY MICROPHONE

VELOCITY MICROPHONE.—See *Microphone, Velocity*.

VELOCITY MODULATION.—See *Tube, Velocity Modulation in*.

VIBRATING RECTIFIER.—See *Rectifier, Vibrating*.

VIBRATOR POWER SUPPLY.—See *Receiver, Automobile Radio* under subheading of *Power Supply*.

VOLT.—The practical unit of electromotive force or potential difference. The steady emf that causes a current of one ampere to flow in a resistance of one ohm.

VOLTAGE DIVIDER.—A resistance unit provided with one or more sliding contacts and having across its ends a potential difference. Various values of voltage may be had between a slider and either end of the resistance, or between sliders. Also, that portion of a power supply consisting of resistors through which flows all or part of the rectified current and from various points on which are taken potentials suitable for the various elements of tubes operated from the power supply.

VOLTAGE DROP.—See *Law, Ohm's*.

VOLTAGE MULTIPLYING RECTIFIER.— See *Rectifier, Voltage Multiplying*.

VOLTAGE REGULATION. — The change in voltage brought about by change of load on a generator, rectifier, transformer, or other unit acting as a power source. The ratio of the drop in output voltage between no load and full load to the voltage at full load or rated load.

VOLTAGE REGULATOR TUBE. — See *Tube, Voltage Regulator*.

VOLT-AMPERE.—A unit of measurement for the apparent power in an alternating-current circuit as distinguished from the actual or real power which is measured in watts. Volt-amperes of power are equal to the product of applied alternating volts and amperes. If a circuit contains only resistance the volt-amperes are equal to the watts of power, but if there is reactance due to inductance or capacity a portion of the applied power is returned to the source and only the remainder is used in the circuit. The ratio of the power used (in watts) to power applied (in volt-amperes) is the power factor of the circuit.

VOLTMETER.—See *Meters, Ampere and Volt*.

VOLTMETER, VACUUM TUBE. — See *Meter, Vacuum Tube*.

VOLUME, CONTROL OF

VOLUME, CONTROL OF.—Volume is a measure of the intensity of sound from a loud speaker, or of the loudness of sound. Volume is increased by increase of power or voltage which is the input for amplifying apparatus, and it is increased by providing greater amplification for any given input. When the input power or voltage is a fixed quantity, control of volume may be had by varying the amplification of the gain in any part of the amplifying apparatus. Volume may be controlled also by varying the loss of power or the attenuation of voltage at any point in the amplifying and reproducing apparatus.

Volume controls may be inserted in almost any of the amplifying circuits of a radio receiver, and often are used simultaneously in two or more circuits. A common method of volume control is by variation of control grid bias on variable- μ tubes. Automatic volume control may be had by taking the control grid bias for one or more variable- μ tubes from a rectified part of the output voltage, whereupon the output itself increases or decreases the gain to provide a fairly uniform sound intensity when there are moderate variations of input voltage or power. Volume control devices allow increasing or decreasing either loss or gain in voltage, current or power in a circuit carrying any form of signal. Attenuation of the signal requires a reduction of power at the source or else a dissipation or loss of power somewhere between the source and the load. Gain calls for an increase in power at the source or else a lessening of the dissipation of power after it leaves the source.

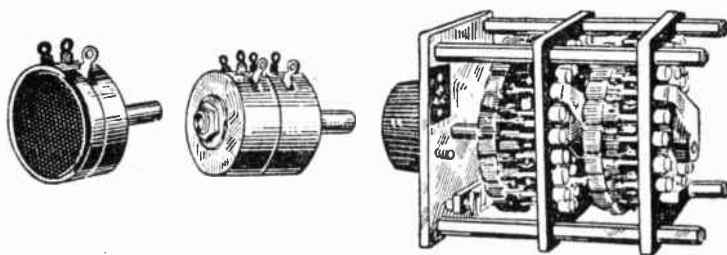

FIG. 1.—Volume Control Devices.

Transmission Circuit Controls.—Volume controls used between sources or amplifiers and their loads, or between such devices and transmission lines, operate to increase or decrease the attenuation or dissipation of energy. The volume or output is maximum when there is least dissipation and is minimum when there is the greatest possible dissipation of which the control is capable.

One of the requirements in most applications of volume control devices is that the impedance relations between source and load be changed as

VOLUME, CONTROL OF

little as possible. Any great change of impedance offered to a source will introduce unwanted losses and distortion. In the following typical examples of volume control practice it is assumed that a phonograph pickup is to be connected to the primary winding of a transformer with the control unit between the two. The pickup represents the source of signal energy

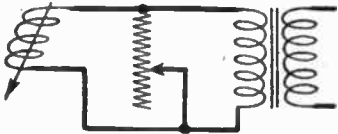

FIG. 2.—Rheostat for Volume Control.

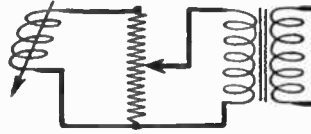

FIG. 3.—Voltage Divider or Potentiometer Control.

and the transformer represents the load. Any other source such as a microphone, and any other load such as a loud speaker, might be used with no change in the principles involved. Volume control devices may be quite simple or rather complex in physical construction, as illustrated by the types in Fig. 1.

The most elementary volume control uses a variable resistance as a rheostat with the connections of Fig. 2. Since the impedance varies greatly in both directions this does not make a satisfactory method. In Fig. 3 the resistance is used as a voltage divider or potentiometer. The particular application shown would be unsatisfactory, but were the transformer replaced with a negatively biased vacuum tube drawing no grid current and having very high input impedance, then the potentiometer would form an acceptable control as shown in Fig. 4.

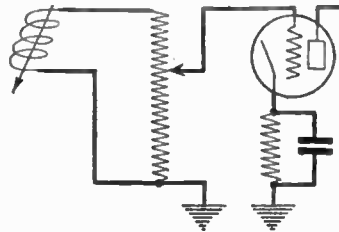

FIG. 4.—Voltage Divider for Vacuum Tube Input.

The simplest type of attenuator which may be made to give satisfactory results is the L-section shown at the left in Fig. 5. Two resistors, both variable, are connected in the form of the capital letter *L*. As used in a practical circuit the connections of



FIG. 5.—L-section Attenuators.

the L-section might be shown as at the right hand side of Fig. 5 where the resistors are numbered to correspond with those at the left. Both resistors are adjusted simultaneously by the sliding arm which makes contact with both elements, one resistance in-

VOLUME, CONTROL OF

creasing as the other decreases in value. The result is that the resistance or impedance presented to the source (the pickup) remains of constant value and it may be matched to the internal output impedance of the source.

A type of attenuator which will maintain constant impedance in both directions is the T-section shown schematically at the left in Fig. 6. Here there are three resistors, all of them adjustable, arranged in the form of the capital letter T. As arranged in the pickup-transformer circuit the T-section might be shown as at the right hand side of Fig. 6 where the elements are numbered as at the left. As the sliding contact arm is moved,



FIG. 6.—T-section Attenuators.

the resistance of elements $R1$ and $R3$ increases as that of element $R2$ decreases. The total resistance or impedance presented both to the source and to the load remains constant as the attenuation is varied.

Faders.—Two volume controls or attenuators may be used together with a single contact arm to form a fader with which the volume from one source is lowered before that from the other is increased. A commonly employed voltage divider system is shown in Fig. 7. With the contact arm on the upper resistor the tube is fed from the upper pickup. Moving the arm downward

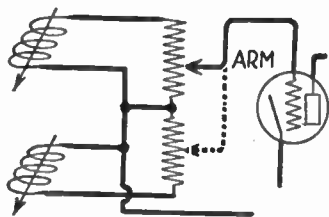

FIG. 7.—Double Voltage Divider as Fader.

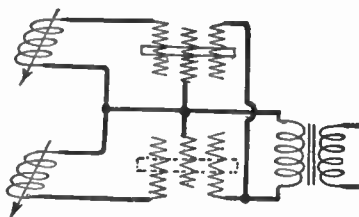

FIG. 8.—T-section Type of Fader.

lessens the input voltage to the tube until it is of minimum value. Continued movement of the arm picks up and increases the signal from the lower pickup.

The use of two T-sections in a fader is shown in Fig. 8. With the single slider or contact member in the upper (full line) position the upper pickup is used as the source and the upper attenuation unit controls the volume. As the slider is moved downward the signal from the upper pickup fades out as that from the lower pickup is brought into the load circuit. A simplification of Fig. 8 which still remains a T-type attenuator, is shown in

VOLUME, CONTROL OF

Fig. 9 where the impedance on the source remains constant although there is some variation of the impedance on the load side.

Mixers.—Attenuators of any type may be connected to each of a number of sources and to a single output or load circuit to form a mixer by means of which any desired strength of signal may be had from each of the sources. With such an arrangement

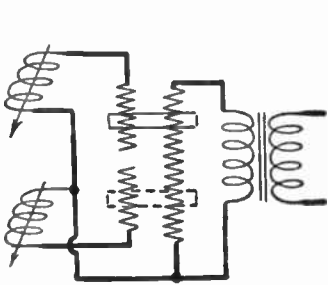

FIG. 9.—Simplified T-section Fader.

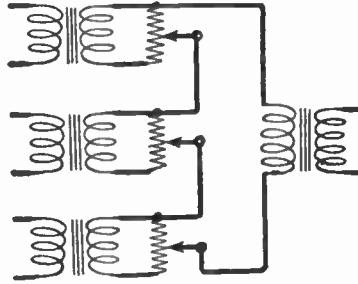

FIG. 10.—Voltage Dividers Used in Mixer.

the voice of a speaker from one source might be accompanied with musical background from a second source, or several microphones might be used for pickup of a single orchestra whereupon the mixer would allow emphasis to be put upon certain instruments or groups of instruments. The mixer allows almost any desired effect to be secured.

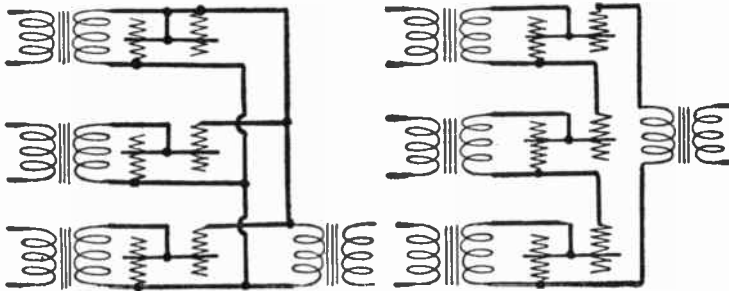

FIG. 11.—L-sections Used in Mixer.

Three voltage dividers used as a three-element mixer are shown in Fig. 10. The three sources might be any of the kinds previously considered. Each element of this or any other mixer is provided with an individual operating control, usually a knob or dial. Voltage dividers used as mixers are not very satisfactory because there is too great a variation in the impedance on both sides.

Mixers employing L-section attenuators are shown in Fig. 11. At the left the units are connected in parallel with the load or output transformer

VOLUME, CONTROL OF

primary while at the right they are connected in series with the transformer primary. The series arrangement allows the impedance on the output side to remain more uniform than with the parallel connection. In these circuit diagrams but three sources and three attenuator elements are shown, but it is possible to add any additional number of sections.

T-section attenuators used in a mixer system are shown in Fig. 12, a parallel connection being used at the left and a series connection at the

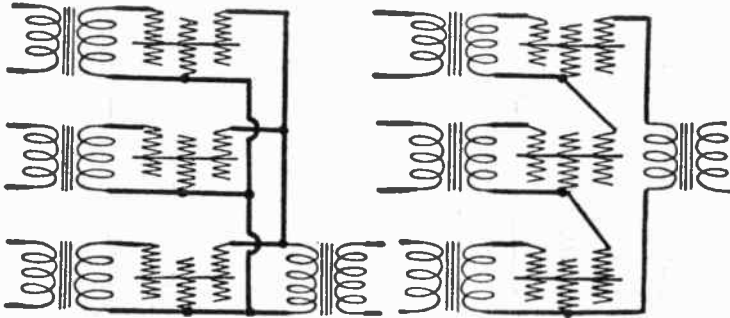

FIG. 12.—T-sections Used in Mixer.

right. Here the impedance remains constant in both directions with changes of adjustment.

Radio Receiver Volume Control.—In order that the sound intensity from a loud speaker may be maintained at the level desired, and in order that amplifying tubes may not be overloaded, it is necessary to provide manual control of signal intensity and of amplification. Such control may be applied to the antenna cir-

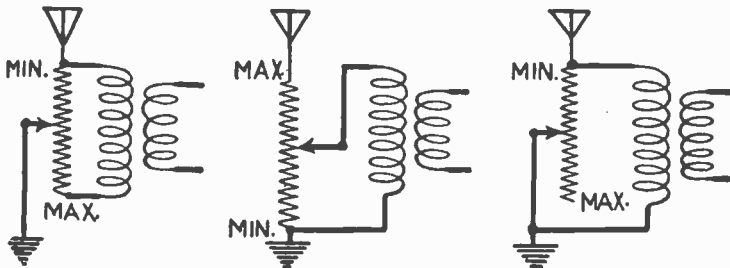

FIG. 13.—Antenna Circuit Volume Controls for Transformers.

cuit for reduction of input voltage, or it may be applied to limit the amplification in radio frequency stages, intermediate frequency stages or audio frequency stages. The volume control also may be applied at the same time in any two or more of these places.

Antenna volume controls employed when transformer coupling is used between antenna and first radio frequency stage are shown in Fig. 13. The controls at the left and at the center employ potentiometers of about

VOLUME, CONTROL OF

10,000 ohms resistance and the one at the right uses a rheostat of 50,000 ohms or more. Positions of the slider are indicated for maximum and for minimum volume. Minimum volume is secured with the aerial or the high voltage side of the transformer primary connected most directly to ground.

At the left hand side of Fig. 14 is shown the use of a potentiometer with about 2,000 to 3,000 ohms resistance in an untuned antenna circuit with the slider connected to the grid of the first amplifying tube. At the

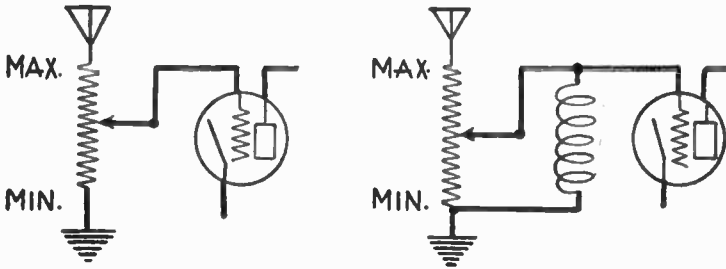

FIG. 14.—Volume Controls for Untuned Antenna Circuits.

right in Fig. 14 a potentiometer of about 10,000 ohms resistance is connected across a high impedance winding in the untuned grid circuit of the first amplifying tube.

Control of radio frequency or intermediate frequency amplification by variation of control grid bias is shown in Fig. 15 for two tubes, although any additional tubes may be connected to the

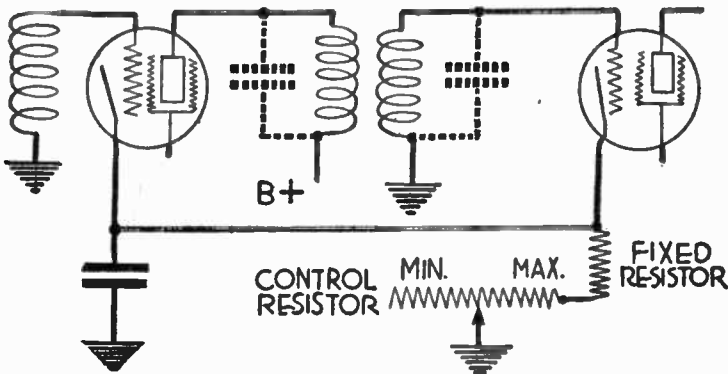

FIG. 15.—Volume Control by Variation of Cathode Resistor.

same circuit. Plate and screen current passing into the tubes returns to the negative side of the B-supply through the cathodes and the resistors placed between these cathodes and ground. In these resistors there is a voltage drop equal to the product of amperes of current and of ohms of resistance, the cathode thus

VOLUME, CONTROL OF

being placed at a potential higher than that of ground or B-minus. The grid returns are connected to ground, making their potential lower than that of the cathodes, and negative grid bias is provided. The value of this bias in volts may be varied by adjustment of the control resistor of Fig. 15. The tubes' amplification will decrease as the bias is made more negative by increase of control resistance.

The fixed resistor in series with the control unit is made of such value that the grid bias never can too closely approach zero. This fixed resistor is of such value as to provide the minimum allowable negative bias with all resistance cut out of the control unit. The number of ohms in the fixed resistor must be equal to the minimum bias in volts divided by the total plate and screen current in amperes, this current to be measured with this amount of bias applied to the tubes. The number of ohms in the variable control resistor is made equal to the maximum additional required bias in volts divided by the combined plate and screen current in amperes. This latter current must be that which will flow with the maximum negative bias applied to the tubes.

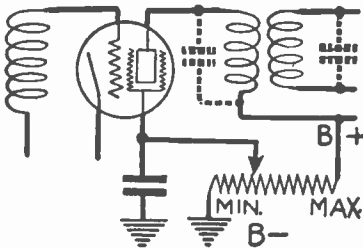

FIG. 16.—Screen Voltage Control of Volume.

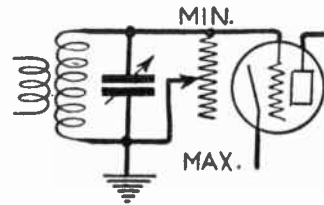

FIG. 17.—Volume Control in Grid Circuit.

Control of radio frequency amplification by variation of screen voltage is shown in Fig. 16. A potentiometer is connected between a point of high positive voltage and B-minus or ground. The slider is connected to the screen or screens of the tubes to be controlled. Moving the slider to a point of maximum voltage increases the amplification and moving it toward ground decreases the amplification.

The voltage drop across the potentiometer must be at least equal to the maximum screen voltage to be used, which means that the potentiometer must be connected between ground and a point having at least this positive voltage. The current through this potentiometer may be small because there is no need for good voltage regulation. Resistance of 25,000 to 50,000 ohms will be satisfactory, but the rating of the potentiometer in watts must be high enough to insure that the sum of screen current and constant current through the resistance won't cause overheating.

A control sometimes used for radio frequency amplification is shown in Fig. 17 where a variable resistor of 500,000 ohms is connected across a tuned grid circuit. Such a control causes a great reduction in selectivity, but may be employed preceding a detector tube.

A volume control often applied to audio frequency amplifying

VOLUME, CONTROL OF

stages is illustrated at the left hand side of Fig. 18 for transformer coupling and at the right for resistance-capacity coupling. A potentiometer of about 500,000 ohms resistance is connected across the input circuit for the grid of the audio frequency tube or power tube, with the slider connected to the control grid of this tube. This method may be used in conjunction with other controls in

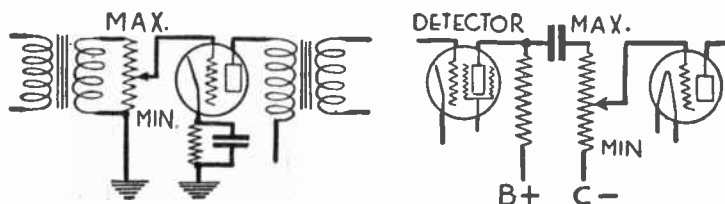

Fig. 18.—Volume Control in Audio Frequency Stages.

the radio frequency or intermediate frequency amplifier, and is commonly employed where automatic volume control is applied to the high frequency amplifiers.

Dual Volume Controls.—Before the advent of variable- μ tubes for radio frequency and intermediate frequency amplification it often was necessary to provide control both of antenna input and of tube amplification. Ordinary screen grid tubes op-

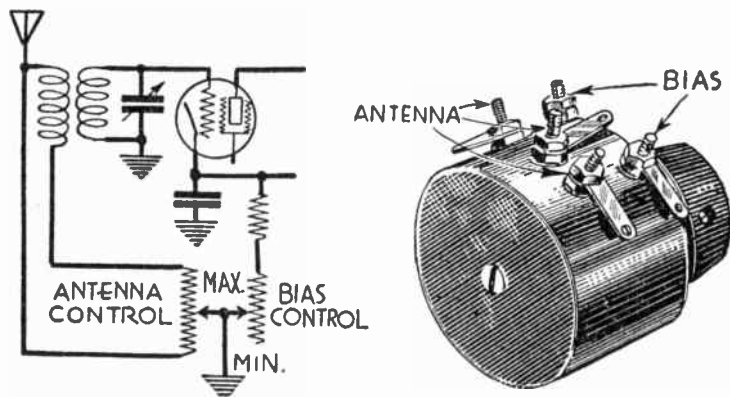

Fig. 19.—Twin Volume Control for Antenna and Grid Bias.

erated with high input voltages and highly negative biases for volume control give rise to various kinds of interference due chiefly to the tube's acting as a rectifier. Any form of antenna input control may be combined with any form of amplification control to allow simultaneous reduction of signal input and of amplification.

VOLUME, CONTROL OF

Fig. 19 shows a combination of the antenna control from the left hand side of Fig. 13 with the grid bias control of Fig. 15, the twin control unit having both the antenna potentiometer and the biasing resistor on the one shaft. A similar effect sometimes is secured with a single potentiometer used as in Fig. 20 to control both antenna input and grid bias through the one resistance, the slider being connected to ground and B-minus. Control of several stages with this system may require a bias resistor of such low value that it applies little attenuation to antenna input.

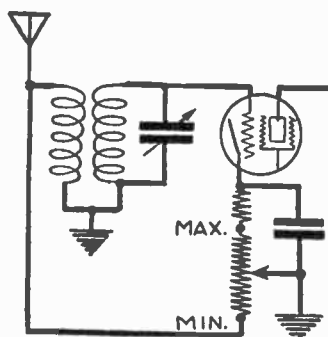

FIG. 20.—Dual Control with One Potentiometer.

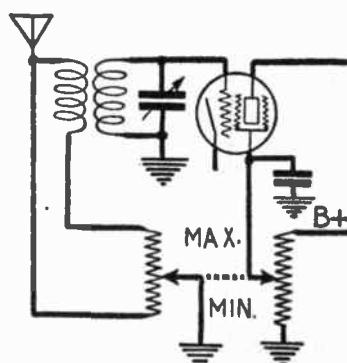

FIG. 21.—Twin Control for Antenna and Screen Voltage.

Simultaneous control of antenna input and of screen voltage is shown by the diagram in Fig. 21, this circuit combining the methods of Figs. 13 and 16. By the use of two control units operated together by one knob it also is possible to combine adjustment of control bias (Fig. 15) with adjustment of screen voltage (Fig. 16), or to combine any of the high frequency controls with the audio frequency control of Fig. 17.

Automatic Volume Control.—Automatic control of volume allows a receiver to vary its own amplification in accordance with the strength of a received signal, the amplification automatically increasing for weak signals and decreasing for strong ones. The maximum volume limit is adjustable by manual means, and with this adjustment set for a certain output that output will be maintained for all signals of which the field strength is high enough to properly operate the receiver.

The majority of automatic volume control systems operate on the same general principle, although there are many variations in the exact manner of obtaining the desired result. A portion of the amplified radio frequency signal or intermediate frequency signal is rectified to produce a direct current which varies in amount according to the amplitude of the received carrier wave. This direct current then is used to produce an increase of negative control grid bias on one or more amplifying tubes. A greater carrier amplitude thus makes the grid bias more negative and this reduces the amplification in the tubes so controlled.

Variations of this method utilize the rectified current to lower the voltage on the screens of the amplifying tubes, thus reducing the amplification. Other systems take a portion of the receiver's audio frequency output,

VOLUME, CONTROL OF

rectify it and use the resulting current to affect either control grid bias or screen potential.

The rectification generally takes place in an ordinary three-element or four-element tube which is negatively biased to a point that causes plate current cutoff on grid voltage peaks and produces a plate current with a direct component. Sometimes the plate is connected directly to either the control grid or the screen to make the two electrodes act as one. A two-element effect may thus be produced and the tube will perform as a diode rectifier.

Although a separate tube generally is used as the rectifier, it is possible to employ the voltage drop across a resistor in the plate circuit of the regular detector tube since this tube rectifies the voltages applied to its grid circuit and has a direct component in its plate circuit.

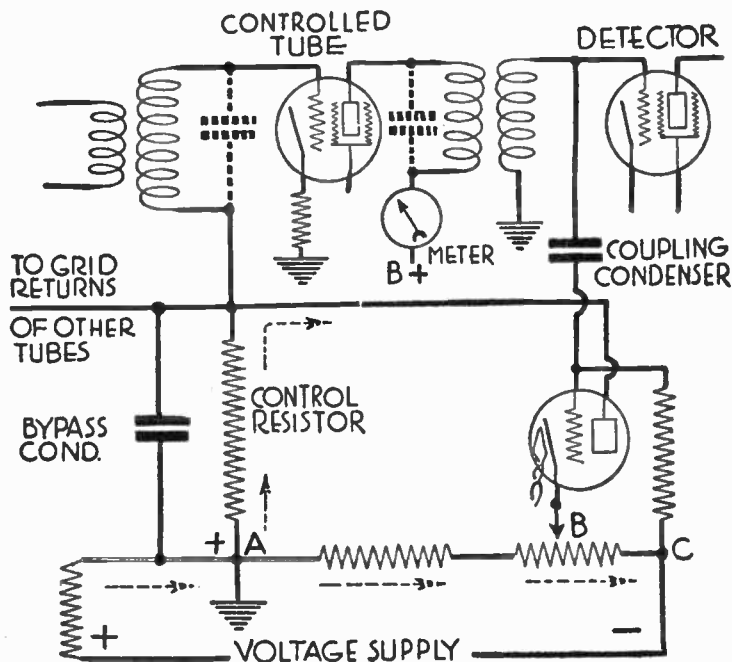

FIG. 22.—Automatic Volume Control by Grid Bias Variation.

The principles of automatic volume control by variation of control grid bias are illustrated by the circuit of Fig. 22. Although only one amplifying tube is shown as being automatically controlled, the grid returns from any additional number of such tubes may be brought together and handled in the same manner. The voltage supply is a part of the voltage divider system which regularly furnishes plate currents and grid biasing voltages to the remaining tubes in the receiver.

The direction of current flow through the several resistors comprising this control is shown by the arrows, and it should be borne in mind that the

VOLUME, CONTROL OF

voltage is higher at a point from which current is flowing than at another point toward which the current flows. The highest potential in this system is at point *A* and this point is connected through the control resistor to the plate of the volume control tube. A lower voltage appears at point *B*, connected to the cathode of the volume control tube, and there is a still lower voltage at *C*, connected to this tube's grid. Therefore the control grid of the volume control tube may be given a negative bias sufficiently great to cause rectification or plate current cutoff.

Plate current for the volume control tube flows upward through the control resistor, making the upper end of this resistor lower in voltage than the bottom. The grid return of the controlled tube is connected to the top of this resistor and the cathode of the controlled tube is connected through ground to the bottom of the resistor. Therefore, any increase of current through the control resistor will increase the voltage drop across it, and this increased drop will make the grid of the controlled tube more negative with reference to that tube's cathode. The controlled tube is provided with a minimum negative bias by the fixed resistor between its cathode and ground, the plate and screen currents for the controlled tube flowing through this resistor and causing a voltage drop.

A portion of the amplified carrier voltage in the grid circuit of the detector tube is taken through the coupling condenser to the grid of the volume control tube. This voltage causes flow of rectified plate current in the volume control tube; the greater the voltage applied to the grid the greater this rectified plate current. Thus an increase in amplitude of the carrier voltage results in an increase of plate current in the volume control tube and this increased current flowing through the control resistor makes the bias for the controlled tube become more negative. The greater negative bias reduces the controlled tube's amplification proportionately to the strength of the carrier and automatic volume control is attained.

With the system shown in Fig. 22 the grid bias of the volume control tube may be varied by moving the slider to which its cathode is connected. Altering the bias alters the amount of plate current for any given voltage applied to the grid. Adjustment of this bias thus varies the effect of the automatic control and provides a manual control for maximum volume from the receiver. It also is possible to operate the volume control tube with a fixed grid bias and provide manual control in the audio frequency amplifier. The fixed bias of the volume control then is adjusted to apply optimum signal voltage to the detector.

Those who are not used to automatic volume control often find difficulty in tuning a receiver fitted with such a device. Since the volume remains almost constant it is difficult to determine by ear when the exact point of resonance is reached because the signal is equally loud either side of resonance. This difficulty sometimes is overcome by the use of a tuning meter such as shown in the plate supply lead of the controlled tube in Fig. 22. This is a milliammeter which indicates the plate current.

When the receiver is tuned to exact resonance with a carrier it is tuned to a point at which the carrier amplitude is of maximum value. This maximum value of carrier results in maximum effect of the automatic volume control system and in the greatest negative grid bias on the controlled tube. Under this condition the plate current in the control tube is at a minimum value, and tuning to resonance is indicated by the meter's showing minimum current. The scale of this meter may be reversed, whereupon tuning is handled to produce the highest possible meter reading although this really indicates minimum current. The tuning meter sometimes is placed in the plate circuit of the volume control tube and in this position the tuning is handled to produce maximum current through the

VOLUME INDICATOR

meter, since this maximum current indicates maximum carrier amplitude, as the signal field strength falls off. This results in the reduction of signal

With automatic volume control the sensitivity of the receiver is increased strength being accompanied by a rise in background noise. Receivers not fitted with some form of tuning indicator, such as a meter, are tuned by ear for minimum background noise on weak signals, this condition indicating the resonance point or point of maximum carrier strength. On strong signals the receiver is tuned for greatest clarity of sound.

When tuning between stations no carrier is received and the sensitivity automatically increases to maximum value, the result being considerable noise during such tuning. Some receivers are fitted with a switch to be manually operated for reduction of sensitivity during the tuning operation. This switch may operate to partially short circuit either the antenna, the grid circuits of amplifying tubes, or the output to the loud speaker. The switch also may operate on the control grid bias of amplifying tubes. In any case the sensitivity is reduced only to a point which prevents excessive noise, but not low enough to prevent from knowing when a station is received.

Automatic volume control of the type described operates to make all carriers of the same effective amplitude as they appear in the amplifying circuits. With the carriers thus equalized the sound output from the loud speaker will be proportionate to the depth of modulation or to the modulation percentage. Consequently the absolute volume level at the loud speaker will be made equal only for all stations having equal percentage modulation and those having greater or less modulation will produce greater or less loud speaker output.

It is necessary that the automatic control operate quickly enough to overcome rapid variations which sometimes occur in field strength, yet not so quickly as to affect low audio frequency variations in the carrier. Too rapid action would tend to reduce the amplification of low notes.

The period required for operation of the automatic control is determined by the time constant of the control resistor and its bypass condenser. This time constant should be about equal to the time required for one alternation of the lowest frequency to be amplified. If this frequency is to be 50 cycles, for which the period is $1/50$ second, then the time constant should be not less than $1/100$ second. The time constant is equal to the product of the capacity in farads and the resistance in ohms.

For additional information on automatic volume control see *Tube, Double-diode*.

VOLUME INDICATOR.—See *Indicator, Volume*.

W

W.—The symbol for energy in watt-hours, joules, etc.

WATT.—The watt is the practical unit of electrical power. A power of one watt is produced by a current of one ampere at a pressure of one volt. The number of watts of power is found by multiplying the number of amperes flowing in a circuit by the number of volts drop in the circuit or by the voltage measured across the ends of a circuit.

WATT-HOUR.—A unit of electrical work. One watt-hour is the work done by a power of one watt in one hour.

WAVE.—A wave is a disturbance in some elastic substance, the disturbance having a regular period or frequency both as to time between repetitions and as to extent or strength. A sound wave is a disturbance in the elastic medium air. An electric wave is a disturbance in the ether. The ether is assumed to pervade all things.

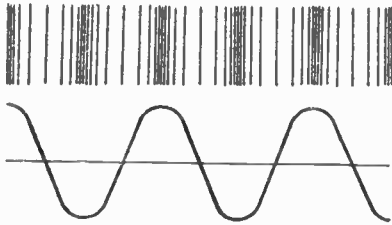

A Wave Disturbance and Its Symbol.

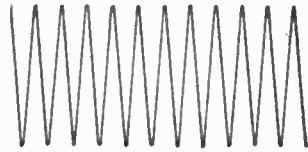

A Continuous Wave.

WAVE BAND.—See *Band, Wave*.

WAVE, CARRIER.—The high frequency wave sent out from a transmitting station. See *Band, Wave; Radiation; also Modulation*.

WAVE, CONTINUOUS.—A radio frequency wave which does not vary in frequency nor in amplitude but which continues with uniformity as long as transmitted. Abbreviated C. W.

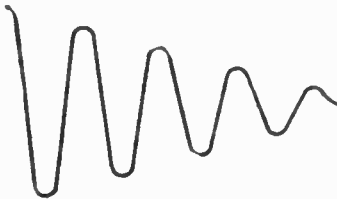

A Damped Wave.



An Interrupted Continuous Wave.

WAVE, DAMPED.—A wave whose amplitude or strength decreases from maximum to minimum because of damping or resist-

WAVE FILTER

ance in the circuit from which the wave is emitted. See also *Damping*.

WAVE FILTER.—See *Trap, Wave*.

WAVE, INTERRUPTED CONTINUOUS.—Continuous waves which are interrupted or stopped at intervals to form the dots and dashes of the telegraphic code. Abbreviated I. C. W.

WAVELENGTH.—The distance, usually measured in meters, which is covered by one complete radio wave in space from the peak of one positive alternation to the peak of the next positive alternation. The more rapidly the waves follow one another the shorter will be the wavelength and the greater will be the frequency. Thus there is a very definite relation between wavelength and frequency. See *Wavelength, Frequency Relation to*.

WAVELENGTH, ANTENNA FUNDAMENTAL.—See *Antenna, Fundamental Frequency of*.

WAVELENGTH, FREQUENCY RELATION TO.—Wavelength is the distance from the positive alternation of one wave to the positive alternation of the following wave as indicated in Fig. 1. If the waves are being sent out from the transmitter at

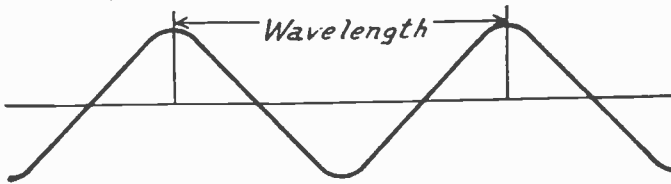

FIG. 1.—Wavelength.

such intervals that the crest of one has traveled 300 meters away from the transmitter before the crest of the second one starts, we have a separation of 300 meters between the two waves and we say transmission is on a 300 meter wavelength. If the frequency is lowered so that the first wave has had time to get 500 meters away from the transmitter before the second one starts, then we are transmitting on a wavelength of 500 meters.

It is easy to see that the more frequently the waves are sent out the less distance there will be between two successive waves. In other words, the faster the waves are sent out or the greater the frequency at which they are transmitted, the shorter will be the wavelength or the distance between successive waves. The less the frequency the greater will be the distance between the two successive waves and the longer will be the wavelength. This is shown in Fig. 2.

In the earlier days of radio it was customary to say that transmitters were operating at certain wavelengths and the receivers were tuned to a certain wavelength. Unfortunately this use of the length of a radio wave measured in meters is misleading, since it does not

WAVELENGTH, FREQUENCY RELATION TO

give a correct idea of the electrical separation between stations as they are tuned in by a receiver. For instance, there is twice the separation in frequency between two stations operating at 303 meters and at 309 meters as there is between two stations operating at 536 meters and 546 meters. The separation in wavelength between the latter two stations is ten meters while between the first two it is only six meters, yet the stations at 536 and 546 meters are only ten kilocycles apart while those at 303 and 309 meters are twenty kilocycles apart.

Radio waves travel away from the transmitter with the speed of light which is about 186,333 miles a second or 299,820,000 meters a second. The first wave will have traveled this distance, 299,820,000 meters at the end of the first second. If the waves are being sent out at a frequency of 600,000 per second there will be 600,000 complete waves between the station and the first wave sent out, that is, there will be 600,000 waves in a space of 299,820,000 meters. Therefore, each wave of the lot must be equal in length

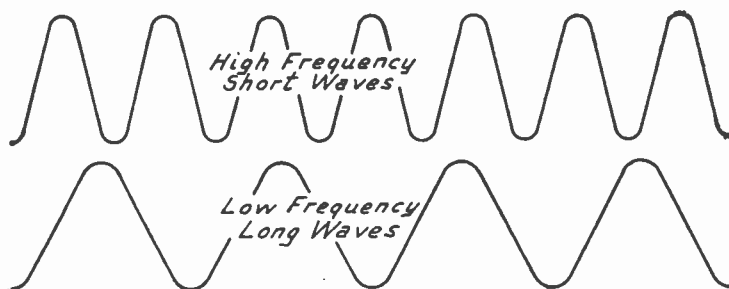

FIG. 2.—Frequency Relation to Wavelength.

to the distance divided by the number of waves or the frequency. In this particular case each wave would be 499.7 meters long and this station would be using a wavelength of 499.7 meters or approximately 500 meters.

In order to translate wavelength in meters into kilocycles of frequency divide 300,000 by the number of meters of wavelength. In order to change frequency in kilocycles to meters of wavelength divide 300,000 by the number of kilocycles. For more accurate results we would use the number 299,820 in place of the number 300,000 but the division would be more difficult and the result from using 300,000 is usually accurate enough.

There is a great advantage in thinking of kilocycles rather than of wavelength because the broadcasters and all other transmitters are assigned to certain frequencies in kilocycles rather than to certain wavelengths. As a general rule broadcasters and others operate at frequencies which are multiples of 5 or 10, that is, the number designating the frequency ends in a 5 or a 0. Wavelengths derived

WAVELENGTH, FREQUENCY RELATION TO

from these frequencies follow no such rule and generally end in a decimal fraction, something very inconvenient to work with.

The following table shows the relation between frequencies in kilocycles and meters of wavelength for the broadcasting band:

FREQUENCY IN KILOCYCLES TO METERS OF WAVELENGTH

Frequency in Kilocycles	Wavelength in Meters	Frequency in Kilocycles	Wavelength in Meters	Frequency in Kilocycles	Wavelength in Meters
550	545.1	900	333.1	1250	239.9
560	535.4	910	329.5	1260	238.0
570	526.0	920	325.9	1270	236.1
580	516.9	930	322.4	1280	234.2
590	508.2	940	319.0	1290	232.4
600	499.7	950	315.6	1300	230.6
610	491.5	960	312.3	1310	228.9
620	483.6	970	309.1	1320	227.1
630	475.9	980	305.9	1330	225.4
640	468.5	990	302.8	1340	223.7
650	461.3	1000	299.8	1350	222.1
660	454.3	1010	296.9	1360	220.4
670	447.5	1020	293.9	1370	218.8
680	440.9	1030	291.1	1380	217.3
690	434.5	1040	288.3	1390	215.7
700	428.3	1050	285.5	1400	214.2
710	422.3	1060	282.8	1410	212.6
720	416.4	1070	280.2	1420	211.1
730	410.7	1080	277.6	1430	209.7
740	405.2	1090	275.1	1440	208.2
750	399.8	1100	272.6	1450	206.8
760	394.5	1110	270.1	1460	205.4
770	389.4	1120	267.7	1470	204.0
780	384.4	1130	265.3	1480	202.6
790	379.5	1140	263.0	1490	201.2
800	374.8	1150	260.7	1500	199.9
810	370.2	1160	258.5		
820	365.6	1170	256.3		
830	361.2	1180	254.1		
840	356.9	1190	252.0		
850	352.7	1200	249.9		
860	348.6	1210	247.8		
870	344.6	1220	245.8		
880	340.7	1230	243.8		
890	336.9	1240	241.8		

WAVELENGTH, RESONANCE FOR.—See *Resonance, Inductance-Capacity Values for.*

WAVELENGTH

WAVE METERS.—See *Meters, Frequency.*

WAVE, PROPAGATION OF.—See *Radiation.*

WAVE, RADIO.—An electric wave or series of waves sent out from the aerial of a transmitting station and passing through space. Radio waves are waves of a frequency high enough to cause their travel through space. Radio waves may be caused also by many kinds of electrical disturbances, such as sparks or the rapid change of voltage and current in electric circuits. These latter radio waves are classed as interference. Radio waves will travel through conductors, wires or otherwise, being guided by the conductors.

WAVE, SINE.—A sine wave current is an alternating current that rises and falls in the form of a sine curve. Such a wave is shown by the curve. Were it possible to place an ammeter in an alternating circuit carrying a frequency low enough so that the meter's pointer might slowly follow the rise and fall, the values at any instant might be read directly. The values for a current which

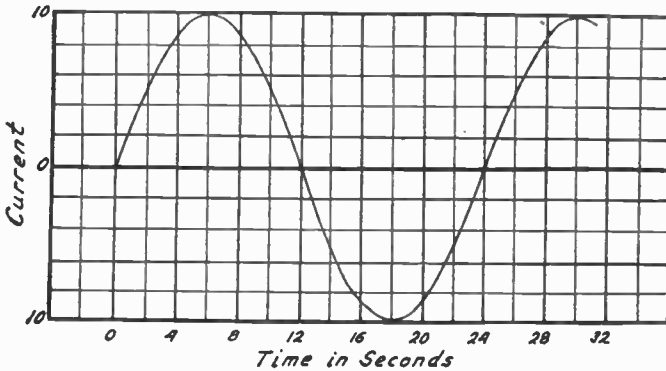

VALUES OF SINE WAVE CURRENT

Time in Seconds	Current Amps.	Time in Seconds	Current Amps.	Time in Seconds	Current Amps.
0	0.00	8	8.66	17	9.66
1	2.59	9	7.07	18	10.00
2	5.00	10	5.00	19	9.66
3	7.07	11	2.59	20	8.66
4	8.66	12	0.00	21	7.07
5	9.66	13	2.59	22	5.00
6	10.00	14	5.00	23	2.59
7	9.66	15	7.07	24	0.00
		16	8.66		

WAVE, SOUND

takes twenty-four seconds to complete one cycle are shown in the table and may be seen in the curve.

A sine wave current would be produced by a coil rotated in a uniform magnetic field. If the field is not uniform, as is usually the case, the current will not follow the true sine wave form.

WAVE, SOUND.—See *Sound*.

WAVE TRAIN.—See *Train, Wave*.

WAVE TRAP.—See *Trap, Wave*.

WAVE, UNDAMPED.—Another name for continuous wave. See *Wave, Continuous*.

WAXES, INSULATING.—Beeswax. Beeswax is an animal wax, acid free, of a dull yellow color. It melts at about 145 degrees Fahrenheit. Beeswax makes a good insulator, having a dielectric strength of about 250 volts per thousandth of an inch thickness. Its dielectric constant is 3.0 to 3.2. It has a phase angle difference or loss coefficient far higher than that of the other dielectric waxes, ceresin and paraffine.

Ceresin.—Ceresin is a prepared mineral wax having much greater dielectric strength and resistivity than either beeswax or paraffine, also having a very low loss at radio frequencies. Its dielectric constant is 2.5.

Paraffine.—Paraffine is a vegetable wax which is affected but little by any acids or other materials that attack and break down other insulating materials. Paraffine melts between 115 and 175 degrees Fahrenheit, depending on its composition. Paraffine has the lowest radio frequency loss of any of the common insulating waxes. Its dielectric strength is about 300 volts per thousandth of an inch and its dielectric constant is from 2.0 to 2.5.

See also *Resistance, Insulation*.

WEAK SIGNALS.—See *Fading; Distortion*;

WEATHER, EFFECT ON RECEPTION.—See *Range, Receiver*; also *Static*.

WHEATSTONE BRIDGE.—See *Bridge, Measurements by*.

WINDER, COIL.—A device which carries a form or support for a coil upon a rotating spindle or shaft so that the form may be turned while wire is fed onto it in forming a coil winding. Coil winders are of many types and kinds. Some are simple and others very elaborate, having many automatic features for spacing turns, maintaining even tension, etc. Different types of coil winders are made to handle plain cylindrical single layer coils, to handle basket weaves, honeycomb, spiderwebs and all other shapes of coils.

WINDING, BANK.—See *Coil, Bank Wound*.

WINDING, BASKET.—See *Coil, Basket Wound*.

WINDING, COIL, METHODS OF.—Forms for winding various special types of air-core coils are shown under their respec-

WINDING, COIL, METHODS OF

tive headings in the section on coils. It is quite difficult to hand wind any type of coil so that its construction and workmanship in general will be a match for the commercial articles made by special machinery. Great difficulty is found in making two or more coils by hand so that they have the same inductance, the same distributed capacity, the same resistance and the same characteristics when in operation.

In winding any coil it is important to see that the spacing between turns, if spaced turns are used, remains the same throughout the entire coil as in Fig. 1. If the turns are close wound they should be really close wound as in Fig. 2, not pressed tightly together for part of the turns and then left loose for the remainder.

The wire must be straight as it is wound onto the form. Kinks and bends will prevent proper spacing of turns. Between the spool from which the wire is taken and the form on which it is being wound the wire should run through a piece of cloth held in the hand or better still run between two pieces of soft fibre or heavy canvas

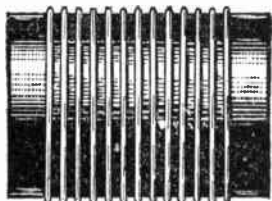

FIG. 1.—Space Wound Coil.

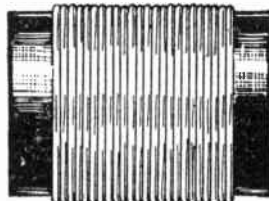

FIG. 2.—Close Wound Coil.

pressed together with spring tension. Wire that is badly twisted to begin with may be made straight and true in this manner.

Novices in coil winding generally are troubled with the turns being loose on the form after the work is completed. This makes a coil whose action will be changeable and uncertain when used for tuning. Such trouble may be avoided by winding the wire while it is hot. In cooling, the wire will then contract tightly around the form and will remain permanently tight.

There is little use in paying so much attention to the reduction of electrical losses that the finished coil is mechanically weak. Such a coil may give excellent results when new and when first installed, but it will give trouble later on when it begins to shake apart and when its joints start to corrode. It is far more satisfactory in the long run to build a strong and rugged coil, even though it may have slightly greater loss than the ideal form. There is generally a real advantage in fastening the end turns or all the turns with some good binder or cement for the sake of moisture-proofness and permanence.

Methods of winding are described for the various types of coils under their names following the general heading *Coil*. See also *Coil, Design* for the effect of winding methods.

WINDING, GRID

WINDING, GRID.—Any winding connected to the grid terminal of a vacuum tube may be called a grid winding.

WINDING, LAYER.—A coil winding made by forming each layer evenly with the turns lying side by side and then placing all the layers evenly over each other, usually separating them with a wrapping of paper or cloth over each layer to form a foundation for the following one.

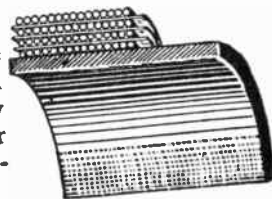

A Layer Winding.

WINDING, PLATE.—The winding of any coil which is connected to the plate terminal of a tube and which forms a part of the plate circuit is called a plate winding. The primary of a transformer is the plate winding when considered in this way.

WINDING, PRIMARY.—The input winding of a transformer is called the primary winding. See *Transformer*.

WINDING, RANDOM.—A winding made with no regard to the position of the turns or layers with reference to each other. The turns in one layer may cross other turns in the same layer and no separation is provided between successive layers.

WINDING, SECONDARY.—The output winding of a transformer. See *Transformer*.

WINDING, SPACED.—See *Coil, Space Wound*.

WINDING, TAPPED.—See *Coil, Tapped*.

WINDING, TRANSFORMER.—See *Transformer*.

WIRE, ALUMINUM.—Aluminum wire is very seldom used in the construction of radio receivers because of the difficulty in making good soldered joints with this metal. The resistance of aluminum wire of a given gauge size is 1.6 times that of copper wire. The weight of aluminum wire of given gauge size is approximately three-tenths that of copper wire. Aluminum makes satisfactory antenna wire.

WIRE, ANNUNCIATOR.—See *Wire, Bell*.

WIRE, ANTENNA.—See *Antenna, Wire for*.

WIRE, BARE.—Bare copper wire is sometimes used in the wiring of radio receivers and in making the windings of radio frequency coils. Bare wire used for wiring connections should be covered with fabric or rubber tubing, called spaghetti, wherever there is the slightest danger of its coming in contact with other metal parts or other wires.

Bare copper wire for connections is usually tinned to prevent corrosion. Untinned bare copper will corrode badly from the effects

WIRE, BELL

of gases in the atmosphere and will greatly increase its resistance at radio frequencies due to this surface corrosion.

WIRE, BELL.—Bell wire or annunciator wire is generally of number 18 gauge, although 16 gauge may also be had. The wire is double cotton covered and the covering is heavily impregnated with paraffine. The covering comes in white and also in various colors and color combinations. Only the white covered wire should be used in radio work.

This wire makes excellent windings for radio frequency coils. The cotton and paraffine covering has a low electrical loss, the paraffine prevents corrosion of the copper surface, and the thickness of the covering provides a desirable spacing between turns. The gauge size, number 18, is satisfactory for use at all broadcasting frequencies.

WIRE, BUS.—Bus wire or bus bar wire is tinned copper wire, either round or square in section. The tinning prevents corrosion and makes for easy soldering. The square bus wire is about 0.062 inch on a side and is the equivalent of number 14 round copper wire. Bus wire is sold in two-foot lengths and in rolls.

WIRE, CABLE TYPES.—A conductor made up of two or more separate conductors insulated from each other but bound together in a single wrapping is called a cable. The separate conductors are called leads. Conductor made of a number of uninsulated wires twisted or woven together is called stranded or braided wire.

WIRE, COPPER.—Wire made from annealed copper or soft copper is used in all radio construction for making connections and for winding all types of coils.

The table on the following page shows the gauge number, the cross sectional area in circular mils and in square inches, the ohms per foot and the number of feet per pound. These sizes are for the copper conductor alone, without insulation. The number of turns per inch of winding is given under *Wire, Turns per Inch*.

See also *Copper*. High frequency resistances are given under *Resistance, High Frequency*.

WIRE, COTTON COVERED.—Copper wire insulated with layers of cotton wound on over the metal conductor. With a single layer of cotton covering the wire is called single cotton covered, abbreviated S. C. C. With two layers it is called double cotton covered, abbreviated D. C. C.

The copper is sometimes covered first with a layer of enamel over which is laid a layer of cotton. This is called single cotton enamelled wire and is specified by the abbreviation S. C. E.

Cotton insulation has good dielectric properties and low electrical losses. The untreated cotton covering attracts moisture but quickly

dries out in dry air. Air-core radio frequency coil windings are made with double cotton covered wire rather than with single covered because the double covering gives a better spacing between turns and lowers the distributed capacity.

The thickness of each layer of cotton covering varies between .002 and .0025 inch so that a wire with single cotton covering will have a diameter between .004 and .005 inch greater than the bare wire. With double cotton covering the diameter will be from .008 to .012 inch greater than for bare wire.

RESISTANCE, SIZE AND WEIGHT OF COPPER WIRE

Gauge Number	Diameter in 1000ths of an Inch	Cross Section		Resistance in Ohms per Foot	Weight Feet per Pound
		<i>Circular mils</i>	<i>Square inches</i>		
10	101.9	10380.0	0.008155	.000999	31.8
11	90.74	8234.0	.006467	.001260	40.1
12	80.81	6530.0	.005129	.001588	50.6
13	71.96	5178.0	.004067	.002003	63.8
14	64.08	4107.0	.003225	.002525	80.4
15	57.07	3257.0	.002558	.003184	101.4
16	50.82	2583.0	.002028	.004016	127.9
17	45.26	2048.0	.001609	.005064	161.3
18	40.30	1624.0	.001276	.006385	203.4
19	35.89	1288.0	.001012	.008051	256.5
20	31.96	1022.0	.0008023	.01015	323
21	28.46	810.1	.0006363	.01280	408
22	25.35	642.4	.0005046	.01614	514
23	22.57	509.5	.0004002	.02036	648
24	20.10	404.0	.0003173	.02567	818
25	17.90	320.4	.0002517	.03237	1031
26	15.94	254.1	.0001996	.04081	1300
27	14.20	201.5	.0001583	.05147	1639
28	12.64	159.8	.0001255	.06490	2067
29	11.26	126.7	.0000995	.08183	2607
30	10.03	100.5	.0000789	.103	3287
31	8.93	79.7	.0000626	.130	4145
32	7.95	63.2	.0000496	.164	5227
33	7.08	50.1	.0000394	.207	6591
34	6.31	39.7	.0000312	.261	8310
35	5.62	31.5	.0000248	.329	10480
36	5.00	25.0	.0000196	.415	13210
37	4.45	19.8	.0000156	.523	16660
38	3.97	15.7	.0000124	.660	21010
39	3.53	12.5	.00000979	.832	26500
40	3.15	9.9	.00000777	1.049	33410

WIRE, CURRENT CARRYING ABILITY

WIRE, CURRENT CARRYING ABILITY.—Copper wire in transformers and chokes will safely carry a maximum number of milliamperes equal to the number of circular mils of cross section.

WIRE, ENAMELLED.—Enamel covered copper wire is generally used in all types of radio parts. The enamel is applied soft and then baked. The finished wire will stand high temperatures, a safe continuous working temperature being in the neighborhood of the boiling point of water. Enamel insulation will fail around 500 degrees Fahrenheit. Enamel has the advantage of being moisture-proof. It is quite tough and an enamelled wire may be bent around its own diameter without cracking the covering.

Enamelled wire should not be used for radio frequency coils because the enamel is a poor dielectric and alone does not provide sufficient space between turns to avoid high distributed capacity.

The enamel covering varies in thickness with the gauge of wire on which it is applied. The thickness on the very small sizes is about .0006 inch and on the large sizes runs up to about .002 inch.

WIRE, GAUGE SIZE OF.—See *Wire, Copper*.

WIRE, LITZENDRAHT.—See *Wire, Stranded*.

WIRE, MAGNET.—Copper wire used for winding various kinds of coils, both air-core and iron-core, is called magnet wire. It is insulated with various combinations of cotton, silk and enamel.

WIRE, RESISTANCE OF, OHMIC.—See *Wire, Copper*.

WIRE, RESISTANCE OF, HIGH FREQUENCY.—See *Resistance, High Frequency*.

WIRE, RESISTANCE TYPES OF.—See *Resistance, Materials for*.

WIRE, RUBBER COVERED.—Rubber covered wire is often used for making connections between the various parts of radio receivers. The rubber covering resists acids and the action of atmospheric gases and is an excellent insulator. No wire except that which is rubber covered should be used around storage batteries.

The sulphur used in vulcanizing the rubber will cause excessive oxidation of the copper in a wire that is rubber covered, thus increasing the wire's resistance at radio frequencies. The strands of copper wire should first be tinned before the rubber is applied and tinned rubber covered wire should be specified for radio work.

WIRE, SILK COVERED.—Copper wire insulated with one or more layers of silk wound over the conductor is called silk covered wire. With one layer of silk it is called single silk covered, abbreviated S. S. C., and with two layers it is called double silk covered and abbreviated D. S. C. The insulation is sometimes made from a layer of enamel with a layer of silk over it, this being called single silk enamelled wire and abbreviated S. S. E.

As an insulator silk is better than cotton and it is less affected by moisture in the air. The silk insulation should always be of double thickness for use in radio frequency coils because single silk covering lets the turns come too close together.

WIRE, SIZES AND GAUGES OF

The thickness of silk covering is only about half that of cotton covering. Each layer of silk is about .001 inch thick so that single silk covered wire has a diameter about .002 inch greater than that of the bare wire and double silk covering makes the diameter from .004 to .005 inch more than that for bare wire.

WIRE, SIZES AND GAUGES OF.—See *Wire, Copper*.

WIRE, SOLID.—Any wire made of only a single piece of conductor, without being stranded or braided from several smaller pieces, is called a solid wire.

WIRE, STRANDED.—A group of small wires used together as a single conductor is called a stranded wire. Stranded wire is flexible and will stand a great deal of bending without breakage of the conductor. In ordinary stranded wire the separate small wires are bare and are twisted or woven together. Such wire may have a greater resistance at high frequencies than a solid wire of the same

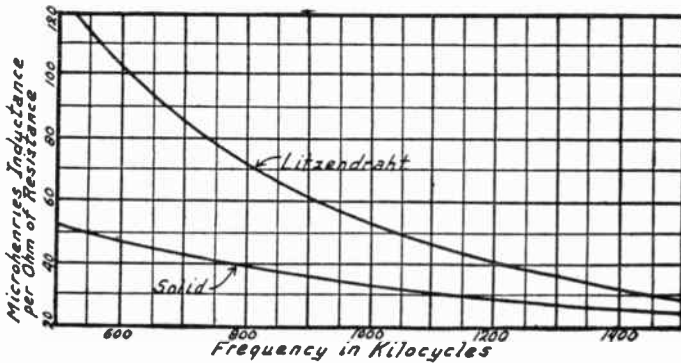

Comparative Inductance and Resistance of Stranded Litz Wire and Solid Wire

effective gauge size. Woven wire is more efficient in this way than twisted wire. It might be thought that the greater total surface area of all the small wires would lower the skin effect and lower the high frequency resistance. This is not true because there are small currents continually flowing through the points of contact between the small wires and this contact resistance may be quite high.

Litzendraht Wire.—This is a special stranded wire made up of a large number of small wires each of which is enamel covered so that they are insulated from one another. The strands are woven in such a way that each separate strand is on the surface of the wire for the same proportion of the total length as each other strand. This wire is specified according to the number of strands and the gauge size of one strand. Thus number 32-38 Litzendraht wire is made of thirty-two strands of number thirty-eight enamelled wire. The entire conductor is covered with silk or cotton.

WIRE, TURNS PER CENTIMETER

Litzendraht wire, or Litz wire as it is usually called, reduces the skin effect and the effective resistance compared with solid wire. Litz wire is most effective around the lower frequencies or higher wavelengths in the broadcasting band. Litz wire is often used for winding loop antennas. When used for windings of radio frequency coils the distributed capacity of the coil increases more rapidly than when solid wire is used for the winding.

When using Litz wire care should be taken at joints to solder to each of the small strands. The enamel may be removed by carefully heating the wire ends and dipping them in alcohol which will remove the hot enamel. It is customary to make careful tests of each strand to see that it is not broken and to see that it is not short circuited on other strands. The effect of various numbers of broken strands on a Litz wire composed of thirty-two strands of number 38 wire is shown by the following table. The tests were made at a frequency of 750 kilocycles.

RESISTANCE OF LITZ WIRE WITH BROKEN STRANDS

Broken Strands	Resistance ohms	Broken Strands	Resistance ohms	Broken Strands	Resistance ohms
none	3.1	12	4.4	24	9.5
2	3.2	14	4.5	26	13.5
4	3.3	16	5.4	28	16.5
6	3.4	18	6.1	29	21.7
8	3.6	20	7.4	30	42.4
10	3.8	22	7.8	31	51.6

The curve shows the relation between the inductance and effective resistance in a coil wound with Litzendraht wire when used at various frequencies in the broadcasting band. The improvement at the lower frequencies is very marked when considered in comparison with the ratio for solid wire which is shown on the same graph.

This may be contrasted with the condition brought about with bare or poorly insulated wires stranded together which are found experimentally to have the same resistance as a solid conductor whose cross sectional area is equal to the sum of the cross sections of all the strands together. At the higher frequencies such stranded bare wire shows additional loss because of the passage of current from strand to strand as has been mentioned. Spiraling or twisting the strands has the effect of still further increasing the resistance in comparison with parallel straight strands. A moderate thickness of insulation around each of the separate strands materially reduces the resistance regardless of the method of stranding or the arrangement. Increase of insulation thickness beyond a moderate amount does not have a proportionate effect.

WIRE, TURNS PER CENTIMETER.—See *Coil, Inductance of.*

WIRE, TURNS PER INCH

WIRE, TURNS PER INCH.—The following tables show the number of turns of wire per inch of length and per square inch in coil windings having the turns close together.

TURNS PER INCH OF LENGTH IN SINGLE LAYER COIL WINDINGS

Gauge Size of Wire	Cotton Covered			Silk Covered			Enamel Covered
	<i>Double D. C. C.</i>	<i>Single S. C. C.</i>	<i>Enamel S. C. E.</i>	<i>Double D. S. C.</i>	<i>Single S. S. C.</i>	<i>Enamel S. S. E.</i>	
16	16.4	17.2	17.6	16.8	18.0	18.2	19.2
17	18.1	18.8	19.4	18.5	20.2	20.5	21.3
18	20.0	21.0	21.5	20.8	22.5	22.9	23.8
19	21.8	23.6	24.0	23.2	25.5	26.0	27.0
20	24.0	26.4	27.0	25.5	28.0	28.6	30.0
21	26.2	29.7	29.5	28.7	31.3	31.8	34.2
22	28.6	32.1	32.5	31.0	34.8	35.2	38.4
23	31.2	36.4	36.1	34.3	38.2	38.7	41.8
24	33.6	39.0	39.5	38.0	43.0	43.5	47.7
25	36.2	43.1	43.3	41.5	47.7	48.1	52.6
26	40.0	47.0	47.5	45.8	52.4	53.0	59.0
27	42.6	51.2	52.0	50.0	58.0	58.8	66.6
28	45.5	56.5	57.5	53.5	64.7	65.0	77.0
29	48.0	61.4	62.3	58.5	71.3	71.4	83.3
30	51.0	67.6	67.2	66.5	80.2	80.5	91.0
31	56.8	72.3	72.5	71.7	87.9	88.0	100.0
32	60.0	79.0	79.0	76.2	95.0	94.3	116.5
33	64.4	85.0	85.4	83.0	105.1	106.0	129.8
34	68.6	91.8	91.7	88.7	110.0	110.0	142.8
35	73.0	98.6	97.8	104.3	130.9	129.0	160.6
36	78.6	106.0	103.5	110.4	140.0	136.0	178.6
37	84.0	114.0	111.0	115.0	150.0	143.0	200.0
38	89.0	123.0	118.0	120.0	160.5	154.0	222.0
39	95.0	131.0	130.0	131.0	182.0	175.0	245.0
40	102.0	139.0	139.0	140.0	200.0	195.0	270.0

The effect of various insulations on the spacing of wires in coils is clearly shown by the above table. For example, number 22 bare copper wire winds approximately 39.5 turns per inch.

While the values given in these tables are approximately correct for wire in general use it should be understood that the exact number of turns per inch will vary slightly according to the manufacturer and according to the grade and thickness of insulation used to cover the wire. This is the reason for variations between tables such as those presented here.

WIRED RADIO

TURNS PER SQUARE INCH OF SOLID LAYER WINDINGS

Wire Gauge	Wire Insulation						
	<i>Enamel</i>	<i>Single Cotton</i>	<i>Double Cotton</i>	<i>Cotton Enamel</i>	<i>Single Silk</i>	<i>Double Silk</i>	<i>Silk Enamel</i>
20	882	742	565	683	857	770	790
21	1110	910	675	835	1065	945	978
22	1380	1142	875	1040	1322	1155	1200
23	1725	1390	1040	1260	1635	1410	1475
24	2160	1690	1230	1525	2030	1720	1820
25	2715	2060	1445	1800	2495	2085	2235
26	3425	2465	1700	2230	3050	2550	2755
27	4300	2975	1975	2680	3745	3050	3375
28	5410	3565	2300	3200	4650	3660	4125
29	6730	4200	2610	3785	5585	4290	4980
30	8475	5000	3000	4475	6880	5125	5945
31	10425	5845	3370	5225	8335	6050	7235
32	13000	6825	3810	6130	9930	7000	8730
33	16550	7950	4250	7160	11950	8200	10525
34	20500	9210	4650	8215	14375	9520	12400
35	25500	10575	5200	9400	17000	10950	14700
36	31800	12000	5670	10700	20125	12520	17250
37	39800	13450	6150	12200	23500	14200	20300
38	49200	15100	6600	13550	27550	16000	23650
39	62500	16750	7050	15300	31900	18000	27900
40	77000	18500	7500	16850	36850	20000	32000

See also *Coil, Choke*.

WIRED RADIO OR WIRED WIRELESS.—See *Radio, Wired*.

WIRELESS.—A name applied to radio telegraphy and formerly to the whole field of radio communication.

WOOD.—Hard wood is a fairly good electrical insulator, having a resistance of about 10,000 volts per inch of thickness when well dried. Impregnation with paraffin wax greatly increases the resistance. The grain of wood should run at right angles to the path of current.

The dielectric constants of bass, cypress and fir are between 2.0 and 3.0, maple has a constant as high as 4.5 and that of white oak may reach 6.0.

Basswood shows the least high frequency loss. Cypress, fir, maple and white oak have about equal losses.

WOOFER

WOOFER.—Woofers is a term used in the audio field to indicate a loudspeaker which is designed and operated with a special network to reproduce only the low notes, while additional loudspeakers are used for the remaining range of sound.

WORK FUNCTION.—In any conductor its thermionic work function is the definite amount of work which must be applied to release one electron. At the point when the electron breaks out through the conductor surface it must have sufficient kinetic energy to match the work function of the conductor.

WOUND POLE.—A section of any electro-magnetic device which uses a metallic pole piece wound with wire to produce magnamotive force, as in the conventional motor, is called a wound pole. An unwound pole might be expressed as a metallic pole to produce the same effect, but using a permanent magnet; such as is used in certain small motors or in the field poles of a magnetron oscillator. The conventional loudspeaker has one unwound pole piece in its structure.

WOUND ROTOR.—A wound rotor is a combination of wound poles which are incorporated in the conventional motor used on direct current, or the universal type of motor for small appliances used on both alternating and direct current.

WOUND STATOR.—This can be defined as the field element of any type of motor both for alternating and direct current. In some new types of motors used on high grade equipment the wound stator is rotated in place of the conventional rotor. It is sometimes called an inside-out motor.

WOW.—This name is given the sound which occurs in the recorded or played back signal of any type of recording equipment. It is produced by a variety of mechanical and electrical factors, the chief among these is one form or another of eccentric drive wheels or elements. This WOW is usually due to those variations in speed which occur at a steady rate below 25 times a second. The effect on the final output signal is a slight but noticeable frequency variation which is measured in percentage at rms. (root-mean-square).

WUNDERLICH TUBE.—A special type of vacuum tube which has two co-planer input grids which operate in direct phase opposition. This tube when used in diode type of rectified detection gives the desirable characteristics of a two tube class A amplifier with their grids in parallel, at increased output voltage.

WWV.—The United States Government through the National Bureau of Standards transmits continuous time and audible frequency standards over a station called WWV in Washington, D.C. The audible tones are A at 440 cycles (with middle C as a starting point), and 600 cycles. The time

WYE CONNECTION

signals are given through the accurately controlled 600 cycles. A tenth subharmonic of 600 cycles is our basic 60 cycle AC line frequency which operates our standard clocks. Power stations and laboratories use special receivers to delineate this tone into split second accuracy. These signals can be received on standard shortwave receivers on the following wavelengths: 2.5, 5, and 10 megacycles.

WYE CONNECTION.—The wye or “Y” type of three phase power system is a four wire system used for a more efficient, larger power capacity, and more easily handled current distribution. The fourth wire of this system is a neutral connection at ground potential. The usual system voltage is 2400/4160 volt A.C. at three phase.

X

X BAND.—One of the range of frequencies commonly used for radar detection. The X band has a wavelength of 3 centimeters. Other bands are the P(2 meters), L(30 centimeters), S(10 centimeters), X(3 centimeters), K(1 centimeters) and experimental bands above this wavelength into the infrared frequencies. K band radar operates at a frequency starting at 30,000,000,000 cycles per second.

XEROGRAPHY.—Xerography is literally “dry-photography,” but actually one of many special processes of electrostatic or thermal dye-deposition used widely in the storage of computer data and in the dry duplication of printed information on plastic or paper film. It is used in the recording type of oscillographs where a permanent record is desired. The electro- or thermal-sensitive paper rolls out of the recording oscillograph much like the paper from a roll of paper towels. The trace has been imprinted permanently on the paper.

X-RAYS.—An x-ray is an electromagnetic wave motion which has a wavelength measured in Angstrom Units as are all frequencies (listed here in sequence) starting after infrared light at 0.4 cm. to .00007 cm, visible light from 7000 A° to 4000A°, ultra violet light from 4000A° to 120A°, X-Rays from 120A° to .06A° and gamma rays from 1.4A° to .01A°.

X-Rays are produced in a vacuum tube in which a target has been placed so that it can be struck by a fast moving or high velocity electron stream (at least equivalent to 10,000 electron volts). This stream hits the target, usually a metallic substance, which is placed at an angle so that the fluorescent type of emission is forced off at a sharp angle to the beam. It has the ability to easily penetrate most metals and solids of non-metallic character. Its applications range from complex medical devices to aid in the detection of disease as well as its cure. The harmful effects of x-rays can be mitigated

X-RAYS

by the skilled operation of the device, allowing no operator to be long exposed. The x-rays have an accumulative effect on the animal tissues.

There is a long list of commercial applications of x-rays which start with the examination of enormous steel objects previously impervious to any type of exact inspection. Most important in industrial applications of x-rays is the fact that the amount of x-ray absorbed by any material is governed by the density of that material, its atomic weight and the wavelength of the x-ray radiation. All of these are controllable factors giving industry and science a valuable tool. Investigation techniques involve the use of film or fluoroscope "shadows" which are governed by the intensity and duration of the x-ray to the viewing medium.

X-RAYS (hard).—These are x-rays which are produced by acceleration voltages from 15,000 volts up to several million volts. The hard x-ray wavelengths are in the short end of the continuous spectrum delivered by the x-ray tube. Larger industrial and scientific x-rays are of this type, where rapid examination of relatively large objects must be accomplished.

X-RAYS (soft).—These x-rays are produced by low acceleration voltages for the electron stream. Soft x-rays are produced by relatively low voltages of 5000 to 15,000 volts. The wavelength of the x-rays at these voltages are longer than those used for more dense materials.

X-Ray Applications.—

Defraction Identification.—A certain portion of the x-rays that strike any surface, no matter how thin, will bounce off in a characteristic pattern depending upon the atomic structure of the element or material. The defracted x-rays are not distributed evenly in an angular pattern, but they are bunched in lines of maximum intensity according to the defracting object, much like the prismatic effect of glass on light. Industry and science has begun to use x-ray spectrography more and more in defining and handling difficult elements and materials.

Industrial radiography.—Industrial radiography refers to the inspection of the interiors or bulk of visually and mechanically opaque objects by the means of photographic exposure of film with penetrating x-rays. In some cases a fluoroscope is employed as the display medium. Those objects thus inspected are solid baseballs, golf balls, fresh fruits and vegetables, canned foods, smoked meats. Larger units inspected in this manner include castings of all metals, important structural welds, rifle and cannon barrels, and other objects.

Thickness Gauges.—Since x-rays can be controlled to a very accurate degree, they can be used in industry and science as thickness gauges where a geiger tube or ionization counter

X-RAY TROUBLE CHART

is on the opposite side to count the amount of penetration over any given period. This type of inspection is used in sheet steel rolling mills where the thickness must be controlled to one-thousandth of an inch. It can be used to gauge the deterioration of metals due to rust, on ships or other immovable objects.

X-RAY TROUBLE CHART.—

(Ma = milliamperes)	<i>Contributing Causes by Numbers as listed on following chart (Check in order given)</i>
<i>Symptoms</i>	
No reading on rectifier meter.....	1, 2, 3, 4, 5, 6, 7, 8
No current through variac transformer	5, 4, 6
Rectifier filaments out.....	11, 12, 4, 5, 6, 7
Rectifier anodes too hot.....	11, 17
Excessive x-ray tube filament reading.	3, 9
No x-ray tube filament reading.....	2, 4, 5, 6, 7, 9
High voltage primary reading low....	15, 16, 19, 9
High voltage primary reading varies..	10
Ma or Ma-time meter varies erratically	8, 15, 10, 14, 16
Ma or Ma-time meter reads low.....	23, 16, 11, 12, 9
Ma or Ma-time meter off-scale reading	15, 23, 16, 9, 19
No high voltage at all.....	20, 22, 19, 18, 4, 5, 6, 7
No reading on Ma or Ma-time meter..	20, 2, 3, 4, 5, 6, 7, 8, 9, 11, 12, 18, 19, 21
No reading on High voltage primary meter	18, 5, 6, 4, 7, 9
Erratic film or fluoroscope display....	8, 10, 13, 11, 14, 15, 16
Overload thermal safety switch opens.	15, 16, 24, 17, 19, 21
X-ray tube filament meter varies.....	8, 10
X-ray tube filament not lighted.....	1, 2, 3, 4, 5, 6, 7, 8

Contributing Causes (as given in right-hand column of preceding chart of troubles).

- 1.—High voltage switch to wrong tube by operator.
- 2.—X-ray tube filament burned out or open due to natural use.
- 3.—Short in the filament circuit of x-ray tube.
- 4.—Power line supply off due to wrong fusing or open safety switch.
- 5.—Power line switch open or faulty open.
- 6.—Line fuses defective or removed or line broken in conduit or pullbox.
- 7.—Open control circuit in unit or control box or connecting leads.

X-RAY TUBES

Contributing Causes (*Continued*)

- 8.—Intermittent open in x-ray tube filament or its circuit.
- 9.—Defective meter due to overload or burnout.
- 10.—Non-stable line voltage.
- 11.—Rectifier tube filaments burned out.
- 12.—Open or defective rectifier filament circuits.
- 13.—Timer mechanism defective or poorly adjusted.
- 14.—Insufficient rectifier filament current.
- 15.—Gaseous x-ray tube.
- 16.—Partial high voltage insulation breakdown.
- 17.—Overloaded x-ray tube and circuit.
- 18.—Variac or autotransformer in off position.
- 19.—Complete high voltage breakdown, shorted out.
- 20.—Main exposure turn-on switch open or faulty.
- 21.—High voltage rectifier capacitor or capacitor breakdown.
- 22.—Control solenoid contactor switch not closing.
- 23.—Incorrect meter scale selection.
- 24.—Corona or arc-over in high voltage circuit.

Caution: Amateur repair men should not attempt to repair a commercial or medical x-ray unit. The unseen rays and their intensity can cause blindness, loss of body parts and life, due to exposure. The voltages of the ordinary x-ray unit can cause instant death upon momentary contact.

X-RAY TUBES.—An x-ray tube is a vacuum type glass tube enclosure in which is placed a filament element of tungsten with a focusing element for the hot electron stream, and a tungsten anode target placed at such an angle so as to direct the x-rays toward the object to be viewed. The vacuum in x-ray tubes must be to a very exact degree due to the elevated voltages that are used. Flash over or arcs could cause serious damage to humans close by and more than likely destroy the equipment.

Y

YOKES.—A television and oscillograph beam deflection yoke is a specially wound coil of wire which is placed around the neck of the cathode ray tube in close enough proximity to effect the electron path toward the screen. The yoke is designed so as to effect a given width, height, and influencing field length. These, of course, are governed by the length of the tube and the size of the viewing screen. Special yokes are used in color television, radar, and computer devices to effect special cathode ray screen displays.

“Y” SIGNAL.—This signal is the luminance portion for monochrome pictures in the compatible color signal. The video signal of the NTSC color television system is divided into two signals for chrominance lettered *I* and *Q*, and one

Z

luminance signal which is lettered the Y signal. There is a numerical ratio of the Y signal to other signals which produce chromance. Expressed in percentage of the various primary television colors it is 59% of the green signal, 30 percent of the red signal, and 11 percent of the blue signal from the camera.

Z

Z.—This is the standard symbol for impedance.

ZENOTOS.—The positive charged condition of the various printed elements in a printed, or etched equivalent of a vacuum tube. All computers, flat wall television tubes operate in this so called Zenotos condition.

ZERO BIAS.—Zero bias defines the point where the voltage that exists between the control grid and the cathode element of the same tube is equal to zero. Thus these two elements of the same tube have the same potential.

ZERO FREQUENCY BEAT.—Where two frequencies mixing or beating have the same precise frequency.

ZERO LEVEL.—A reference level of expressing a ratio between two values such as voltage, current, power or sound energy is called zero level. Zero level or ZERO db is accepted as meaning: 0 db power level or 1.7321^{1/2} volts in a 500 ohm line, or .006 watts of power.