

NEW

Skill-building Transistor Projects and Experiments

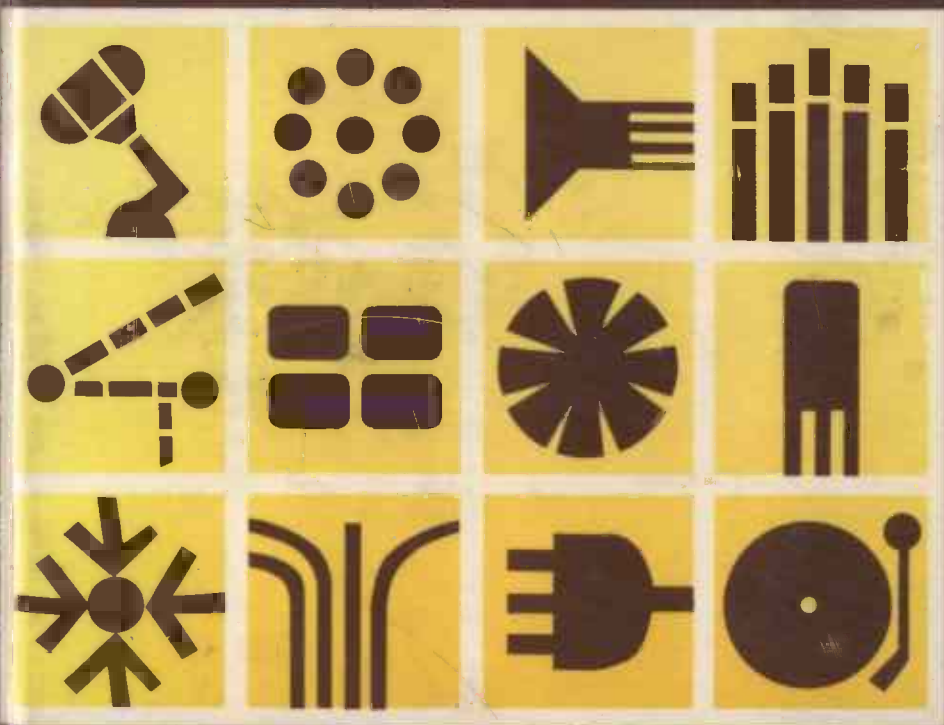

Louis E. Garner

New Skill - Building
Transistor Projects
and Experiments

New Skill - Building Transistor Projects and Experiments

Louis E. Garner Jr.

*With a specially written chapter for
the guidance of the English reader
by W. Oliver*



FOULSHAM-TAB LIMITED
Slough Bucks England

Foulsham-Tab Limited
Yeovil Road Slough Bucks England

New Skill - Building Transistor Projects and Experiments

Copyright © 1966 and 1974 by
G/L Tab Books and Foulsham-Tab Limited

Reproduction or publication of the content in any manner, without the express permission of the publisher, is prohibited. No liability is assumed with respect to the use of the information herein.

Library of Congress Number 66-18412
Cat. Code No. 129

ISBN 0-7042-0111-9

Introduction Printed and Made in Great Britain by
A. Wheaton & Co., Exeter
Balance printed in U.S.A.

It is essential the English reader should read this chapter.

In the ever-changing electronic scene, new devices, new circuits and new applications for existing equipment are constantly appearing. But much that is basic holds good over quite a long period of time, and if you are well versed in the basic principles of transistor theory and practice you are prepared to cope with new developments as they come along.

One of the easiest ways to get acquainted with the fundamentals of transistor theory is the practical way, which involves actually building and experimenting with basic circuits and everyday solid-state equipment. By this means you can learn a surprising amount about the principles of design with semiconductor devices, the best methods of construction for home-built projects, the ways in which they work, and the most efficient troubleshooting techniques for fault-tracing in solid-state circuits.

In this field the present book will be a great help. Being of American origin it looks at the subject from the trans-Atlantic viewpoint; but solid-state technology tends to be more internationally standardized than valve technology ever was, so there is less to re-orientate where transistor circuits etc. are concerned than there was in books that dealt with valve equipment from the American angle.

The book starts off with a list of transistor substitutions. As the American author says, "new types are constantly being released; older types disappear." The types listed, in the "2N" series, are American ones, and many have become officially obsolete since the list was compiled. Obsolescence is a rather peculiar factor where solid-state devices are concerned, however, because types that are classed as obsolete for commercial, industrial, military, and scientific research purposes are often still in general use for amateur projects.

The author points out that "the transistors used in the projects in this book are not critical and throughout we have mentioned substitutions you can make." The substitutes listed are generally other American types; and to find British comparables you will need to refer to some other list. A good many publications giving long tabulated lists of transistor substitutions are readily available, so this should not be difficult.

For your guidance, the following suggestions will help you to find British substitutions for the American types listed; and in some cases, the substitutions indicated will help you to "kill two birds with one stone" by selecting alternatives which are not only in the British ranges but also are of more recent type. Reference to trade lists and manufacturers' data booklets will help you to check the availability of different types and also to ascertain which are classed as obsolescent and which are still in the current category.

In the British ranges, such as Mullard, the AC127 can be tried as an alternative to the 2N170 and 2N229, with the older OC140 as second choice. The AC128 could be tried instead of the 2N132, 2N188A, 2N192, 2N222 and 2N241A. The ACY20 is another possibility. An AD149 and ASZ16 are possibilities to replace the 2N301. In older types, the OC45 has been suggested as suitable for alternative use where the 2N107, 2N135, 2N136 and 2N139 are mentioned. The OC26 might replace the 2N255; the OC29 the 2N173; the OC71 the 2N133; the OC72 the 2N109; the OC139 the 2N169 and 2N293; and the OC140 the 2N168A. The 2N2493 seems a difficult one and may prove really awkward if you cannot find a source of supply or a suitable substitution.

Even in non-critical circuits, such as the selection in this book, you may need to make some adjustments to bias-resistors etc. in order to get optimum results with any individual transistor, either of the type originally specified or of an alternative type-number in British or American ranges. A large variety of American transistors and other solid-state devices are available in this country, nowadays, from leading mail-order and retail suppliers catering for the amateur and hobbyist.

Some of these firms specialize in transistors, diodes, etc., while others also carry a vast range of radio and television spares, components, accessories and constructional hardware materials. Comprehensive catalogues can be bought at a reasonable price from some of the leading concerns, listing thousands of different components etc. by many manufacturers here and abroad.

While most of the projects in this book make use of low-voltage batteries as the source of power for the transistors etc., there are occasional references to mains supplies and where these occur they are based on the American domestic mains standards falling within the voltage range of 110–120 VAC and

with the current alternating at 60 Hz. Both standards are of course different from ours, for British mains run at 240 VAC and 50 Hz. You must allow for these differences where necessary when reading the text or examining the diagrams. But above all you must bear in mind that the much higher voltage of our mains inevitably means that they carry a greater risk of shock. So all safety precautions must be taken accordingly.

For example, in the project shown in Figs. 105 and 106, pp. 16–17, T1 would have to be a British type with 240-VAC primary winding to suit our mains, and the connections to the primary from the mains *must* be made in a safe and shockproof manner with no exposed metal. Some approved type of safety connector is necessary, completely covered and fully insulated so that it is impossible to get a shock from it.

In Chapter 4 there is a project which the author describes as a Home Broadcaster. This is in effect a very low-powered type of transmitter. Apparently it conforms to the regulations laid down by the FCC (Federal Communications Commission), an official body in the United States which deals with such things as transmitting licences, frequency allocations, etc. in American radio and TV.

The regulations in this country differ in some respects from those in force in America, and you should bear this in mind when dealing with anything in the nature of a transmitter. In general, it is a punishable offence to operate a transmitter (even on low power) without an appropriate kind of transmitting licence issued by the authorities which deal with these matters. Amateur transmitting stations are strictly confined to wavebands allotted to them under the terms of their licences; and no one except the BBC and other broadcasting organizations can lawfully transmit on the broadcast wavebands.

As the Home Broadcaster project is designed to work on the broadcast wavebands it should be regarded as of academic interest only and you would be well advised not to build it for use in this country. Despite its very low power it could at least cause interference to radio reception in neighbouring premises.

The "Detectaphone" (Fig. 221) is another project that is open to possible misuse in one of its several applications, namely eavesdropping on other people's conversations. Its other uses, however, are obviously harmless and useful enough.

Regarding the preparation of printed circuit boards: various

methods of achieving the desired results are now available, and some of these avoid the need for chemicals and etching processes. "Veroboard" is one product which is widely used as a ready-made alternative to specially-etched PCB's, but it entails some revision of layout etc. to suit the parallel strips of ready-drilled copper.

If you *do* decide on actual etching of PCB's, this can be greatly facilitated by modern aids such as special pens designed to deposit a coating of resist fluid precisely where required on the copper surface before etching.

Among the many firms now catering for the needs of home constructors, a few typical examples include Arrow Electronics of Brentwood, Electrovalue of Egham; Home Radio of Mitcham; Laskys of London; and Marshall & Sons of London. Full names and addresses of these and numerous other firms in the electronic trade will be found in the various technical journals that cover radio, television and electronics; you can also get latest prices of catalogues etc. from the firms' advertisements in those journals.

Finally, a word on colour codes (see Chapter 7). The fixed-resistor colour code seems to be pretty well standardized throughout the world; but where other components, mains leads etc. are concerned, there is not yet total international standardization, and you must be prepared for variations between the systems in different countries. So watch out for these both in studying technical literature originating outside Britain and, especially, in using any imported electrical or electronic goods. A mistake over identifying colour-coding of leads in mains equipment can be dangerous; so always make sure in any case of doubt.

contents

chapter

page

- | | | |
|----------|--|-----------|
| 1 | How to Get Acquainted or Simple Experiments Prove Theory | 7 |
| | The transistor as a dc amplifier. Experimental circuit board. The transistor as an ac amplifier. Using the vom to check voltages and currents. The transistor as an oscillator. The transistor as a detector. How detection takes place. Transistor power supplies. Primary and secondary cells. Line-operated supplies. | |
| 2 | How to Build Audio Amplifiers or If You Can Hear Them, They Work | 33 |
| | A headphone amplifier. Building the headphone amplifier. Construction hints. Substituting components. Hi Fi preamplifier. Building the compact pre-amp. The etched circuit board. Circuit description. Installation and use of the Hi Fi preamplifier. A power megaphone. Constructing and using the power megaphone. Two-station intercom. Master and slave substations. The intercom master. Installation and operation of the intercom. An audio booster. Testing the booster on a breadboard. Building and using the booster. A "detectaphone." Using a perforated wiring board. Construction and applications of the detectaphone. | |
| 3 | How to Build Radio Receivers or Entertainment in Small Packages | 62 |
| | A light-powered receiver. The self-generating photocell. Construction and experiments with the light-powered receiver. A regenerative receiver. The "pocket pal" regenerative receiver. Building and using the "pocket pal." A complementary receiver. Modifications of the complementary receiver. The cigar box portable. Building and operating the cigar box portable. The pocket superhet. How the superhet works. Construction and alignment of the superhet. Etched circuit board layout. | |
| 4 | How to Build Gadgets and Gimmicks or Other Uses for Transistors | 88 |
| | A sensitive relay. How the sensitive relay works. Assembly and operation of the sensitive relay. Adjusting the sensitive relay. Applications. The sensitive relay as a burglar alarm; as a liquid level indicator; as a moisture indicator. The rain alarm. Combination fire/burglar alarm circuit. An electric eye. The light-controlled relay. Installation and adjustment of the electric eye. Testing the electric eye. An electric timer. Assembly and operation of the electric timer. A light flasher. Breadboard version of the light flasher. A simple code-practice oscillator. Construction and operation of the code-practice oscillator. Multi-purpose code practice oscillator. An electronic metronome. A toy electronic organ. A home broadcaster. | |

5

How to Tackle Advanced Circuits or the Bigger They Are . . . the Better 125

A basic audio amplifier. Layout of the basic audio amplifier. A utility amplifier. A portable phonograph. A radio phonograph. A basic superhet receiver. Construction of the basic superhet. Superhet alignment. A portable receiver. A picture frame receiver. A table model receiver. Novelty receivers. A power inverter.

6

How to Find Trouble or if it Doesn't Work . . . Shoot it! 157

Basic troubleshooting. Wiring. Soldering. Components. Adequate power. Checking batteries. Circuit voltage tests. Using an ohmmeter. Basic transistor tests. Advanced troubleshooting. Signal tracing. Signal tracing probes. Signal injection. Signal tracing techniques. Alignment.

7

How to Save Time or If You Don't Know . . . Look it Up! 177

Semiconductors. Semiconductor symbols. Color code for resistors and capacitors. Transformer color codes. Mathematical formulae. Conversion factors. Etched circuit preparation. Soldering to a circuit board.

Introduction

WHEN you learn to march you have to know your left foot from your right. To eat, you must not only know the difference between a knife, fork and spoon, but you must also know how and when to use them. As a process becomes more complex it becomes less common. One result of this is that it becomes harder to find someone to teach the basic fundamentals.

Electronics is a tremendous field of endeavor. To learn any part of its applications you must first learn about the components. The application is the flower or fruit. A successful gardener must first learn about soil, seed, cultivating and pruning, and how to use the various tools needed.

Electronic components are much more numerous and complex. There are basic categories like transistors, tubes, capacitors, resistors and inductors. But each of the categories is composed of many variations of the basic device. There are power, general-purpose, high-frequency, switching, silicon and germanium transistors. All are transistors. All are made by a certain basic process. All obey certain basic electronic laws. But they are not interchangeable with one another because of their special abilities.

Learning how components work and how they are used is learning electronics. The components are the building blocks of electronic circuits. Many are passive units. Tubes and transistors are active components; they can amplify.

Transistors are ideal building blocks for beginners and experimenters. With the exception of some power transistors, they do not get hot. They shouldn't even get warm. The voltages and currents are small and can be supplied, experimentally, by a small battery or dry cell. Instead of bulky, expensive power supplies needed for vacuum tubes, there is no need for any connection to a potentially dangerous ac power line.

Here's your chance to start at the bottom.

LOUIS E. GARNER, JR.

Silver Spring, Md.

TRANSISTOR SUBSTITUTIONS

One of the problems in working with transistor projects is not that there is a shortage of transistors, but rather that there is such an abundance. New types are constantly being released; older types disappear. The transistors used in the projects in this book are not critical and throughout we have mentioned substitutions you can make. Use the table shown below as a ready-reference guide.

Transistor Substitutes

2N107	2N104; 2N218; 2N402; AT10N
2N109	2N117; AT30H; 2N403; 2N464
2N132	2N112; 2N113; 2N114; 2N130; 2N131; 2N138; 2N138A; AT20H; 2N403; 2N466
2N133	AT20M; 2N186; 2N217; 2N1414
2N135	2N139; 2N394; 2N409; 2N614; HF6M
2N136	2N394; 2N482; 2N520; 2N615; HF12M
2N139	2N218; HF12H; 2N135; 2N394; 2N409; 2N614; HF6M
2N168A	2N169; 2N292; 2N293; 2N449; 2N1121; NR5
2N169	2N168A; 2N292; 2N293; 2N449; 2N1121; NR10
2N170	NR5; 2N377
2N173	2N443; 2N2490; PT501
2N188A	2N186A; 2N187A; 2N241A; AT30H; 2N408; 2N466
2N192	2N189; 2N190; 2N191; AT30H
2N222	AT20M; 2N464
2N229	NA30; 2N377
2N241A	2N186A; 2N187A; 2N188A; AT30H
2N255	PT12; 2N256; 2N235A; 2N253; 2N301A; 2N307; 2N2869
2N293	NR10; 2N168A; 2N189; 2N292; 2N449; 2N1121
2N301	2N255; 2N256; 2N235A; 2N253; 2N301A; 2N307; 2N2869; PT40
2N2493	PT501

CHAPTER 1

How to get acquainted or Simple Experiments prove theory

A hobbyist friend of mine told me this story.

It seems he had just finished assembling and testing a transistorized high voltage power supply when a neighbor dropped by. The neighbor, Bill, had a highly developed curiosity but virtually no technical knowledge . . . at least about electronics.

"What's that?" asked Bill, pointing to the unit on the workbench.

"A high voltage supply," replied my friend.

"A what?"

"A high voltage supply," repeated my friend, then continued, "it's a gadget for converting six volts supplied by those four flashlight cells to several thousand volts dc. I plan to use it in either a Geiger Counter or an oscilloscope."

"Aw, you're kidding," laughed Bill, "change flashlight voltages to thousands of volts—baloney!" With this, he reached towards the unit.

"**CAREFUL, IT'S HOT!**" yelled my friend, trying to avoid a mishap.

But he was too late. Bill touched the exposed terminals, jumped back as if jet-propelled, sat flat on the floor and assumed a slightly dazed expression tinged with overtones of shocked disbelief.

My friend, a gentleman in the truest sense, managed—but only by exerting tremendous self-control—to hold back a laugh and a sneering "I told you so." Instead, he helped Bill to his feet, dusted off his clothing, and inquired as to the state of his health with just the right amount of sympathy. There was no real danger, of course, for the power supply, a high impedance source, could not furnish a lethal current—but it could, *and did*, cause a surprising shock, flooring, to say the least.

This short tale graphically illustrates the two basic types of knowledge—theoretical and practical. Both are important and both have advantages as well as limitations.

Theoretical knowledge may be acquired in several ways, by reading books (such as this one), by deductive reasoning or mathematical analysis and by listening to lectures. It is, in a sense, *second-hand* knowledge. It is accepted as fact because the student (reader or listener) has faith in his source, whether it is a book, magazine article, lecturer or teacher. In a Court of Law, such knowledge would be classified either as opinion or hearsay, and probably would be ruled out as proper evidence. In the story, Bill was given *theoretical* knowledge when he was told that the unit was a high voltage supply. Had he accepted this as fact, he would have avoided an unpleasant surprise and a fast trip to a seat on the floor.

Practical knowledge, on the other hand, is acquired through first-person experience. The student actually conducts an experiment or test, either to acquire new facts or to prove an assumption (or theory). In touching the hot high voltage supply, for example, Bill acquired practical knowledge of the device and, in so doing, *proved* the theoretical information he had received from his neighbor. Practical knowledge is quite valuable and, perhaps, is easier to learn and to retain than theoretical knowledge, for it involves a direct physical experience. Unfortunately, the experience, as Bill discovered, may be an unpleasant one.

Man's progress as an individual as well as his advancement as a species has depended on his ability to accept and to use *both* theoretical and practical knowledge. A research scientist doesn't have to repeat every experiment of every scientist who preceded him in his field, rather, he uses the data gained by others and goes on to carry out *new* experiments of his own, adding to the ever-growing store of knowledge. An individual doesn't have to personally demonstrate that a particular substance is poisonous and will cause death if taken. Instead, he can rely on the theoretical data given on the label.

Either type of knowledge—theoretical or practical—taken alone is incomplete. A medical student, for example, may read dozens of books and listen to scores of lectures on how to perform an appendectomy, but it is in actually seeing such an operation and assisting in its performance that he acquires the skill and confidence which he needs to be a competent surgeon. By the same

token, practical knowledge has limitations. To move forward, we must accept some things as true without personal verification. If Science had been forced to abide by the strict *Rules of Evidence* as practiced in a Court of Law, discounting all opinions and hearsay evidence, mankind would still be in the Early Stone Age instead of the Space Age.

If you are beginning to wonder what this discussion of various types of knowledge has to do with transistors—set your mind at ease. The point is a simple one: *the only type of knowledge that can be conveyed by a book, no matter how skilled the author, is theoretical knowledge.* The book may be basic, even elementary, and may be completely devoid of the hard-to-understand mathematics usually associated with theory, but, nonetheless, it can convey only theoretical knowledge. The present volume is no exception.

In theory books, you've learned something of the history of transistors, studied the different types, learned what they are and how they are made, how they work, and to some extent, how they are used. But to round out this theoretical knowledge and to become *personally* familiar with transistor operation, you'll have to gain practical experience with actual circuits. In this, the present volume can serve only as a guide. *You'll* have to assemble *your* own circuits, make *your* own tests, and draw *your* own conclusions based on the knowledge you've acquired. Afterwards, with practical experience added to your theoretical knowledge, you can go on to assemble a variety of exciting projects, amplifiers, receivers, controls and all types of gadgets.

Let's get started.

THE TRANSISTOR AS A DC AMPLIFIER

A test set-up for studying the operation of a transistor as a direct-current (dc) amplifier is shown *breadboarded** in Fig. 101. The schematic diagram of the circuit is given in Fig. 102. Here, a small p-n-p transistor such as a type 2N107 or 2N109 is connected in the common-emitter configuration. A 0-1 milliammeter (ma) M1 is connected in series with the base lead to measure the base-bias current, I_b . A 0-10 ma. meter (M2) is used to indicate collector current, I_c . A single 9-volt battery, B1, or, if preferred, six penlight cells connected in series, serves as a power source for both base and collector circuits. An adjustable resistor, R_b , such as

* *Breadboard*—An experimental circuit, as opposed to a finished circuit in a piece of equipment. The expression is derived from the early days of radio, when it was customary to assemble circuits on wooden breadboards.

a Resistance-Substitution Box (or you can use individual 1/2 watt resistors), is used in series with M1 as a control over base current. The higher the series resistance used, the lower the base current (and vice-versa). Clip leads are used for circuit interconnections.

A number of important tests and experiments may be performed using this basic set-up. For example, you can determine the



Fig. 101. Clip leads can be used to save time in an experimental setup. Test results can be erratic with this sort of arrangement.

transistor's emitter-collector leakage (I_{ceo}) by opening the base circuit and measuring collector current. For an accurate measurement, you may wish to use the 0-1 ma meter in the collector circuit. In an ideal transistor, this current should be close to 0. A good transistor will have a leakage of under 100 microamperes (μa).

The transistor's dc gain or *beta* (β), may be determined by using the test arrangement exactly as shown in Fig. 102. Adjust the base resistor, R_b , for a nominal value of base current as indicated on M1, $50 \mu a$, for example. Note the collector current on M2. Dividing the base current into the collector current will give an approximation of dc gain. If the base current is $50 \mu a$, and the collector current is 6 ma, the transistor's gain is:

(note that *microamperes* were converted to *milliamperes*).

$$\frac{6.0}{.050} = 120$$

A gain measurement made in this way is only a rough approximation, for it fails to take into account the transistor's inherent leakage. For a more accurate measurement, *two sets* of measure-

ments are made, and the gain is determined by dividing the *difference* in base currents into the corresponding difference in collector currents. As an example, suppose R_b were adjusted for a base current (M1) of $50 \mu a$ and the resulting collector current

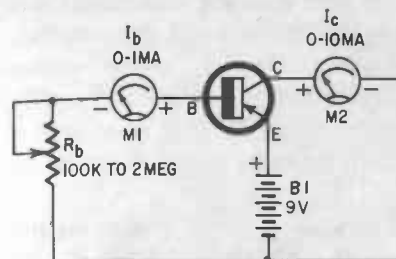

Resistor: R_b —100,000-ohm to 2-meg potentiometer.
Meters: I_b —0 to 1 ma dc; I_c —0 to 10 ma dc.

Battery: B1—9 volts or 6—1½-volt dry cells wired in series.
Transistor: 2N107, 2N109 or other types, as required.

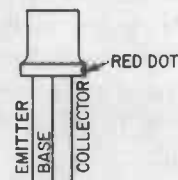

LEAD CONNECTIONS

Fig. 102. Schematic diagram of the circuit shown in Fig. 101.

was 4 ma. Next, we adjust R_b for a base current of $100 \mu a$ and find that the collector current is 9 milliamperes. Here, the difference in base current values is $100 - 50$ or $50 \mu a$ (.050 ma). The corresponding difference in collector current is $9 - 4$ or 5 ma. The gain, then, is:

$$\frac{\text{Collector-current difference (5)}}{\text{Base current difference (0.050)}} = \frac{5}{.050} = 100$$

The transistor's gain is not a fixed value, of course. It varies with applied voltages and bias currents. You can prove this experimentally by using the technique outlined above and making a series of measurements, calculating the gain for *changes* of $5 \mu a$ in base current at starting values of 5, 10, 20, 30, 40 and $50 \mu a$.

Characteristic curves (similar to those discussed in Chapter 3 of the theory volume of this set) are prepared by taking a series of measurements and plotting the results on cross-section paper and drawing a smooth curve through the resulting points. A typical curve might show variations in collector current corresponding to changes in base current, with the collector voltage held constant. Here, the first measurement is made with zero base current (base open). Afterwards, base current could be increased in steps of $5 \mu a$ by adjusting R_b . The corresponding increase in col-

lector current would be recorded for each step. Finally, the results would be plotted on graph paper, with the base-current values shown on the vertical axis and the collector-current values on the horizontal axis. A family of curves might be prepared by changing the constant value (collector voltage) and making additional sets of measurements, again plotting the results to yield new curves. Typically, a set of curves might show collector current versus base current for collector voltages of $1\frac{1}{2}$ volts (one flashlight cell), 3 volts (two cells in series), $4\frac{1}{2}$ volts, 6 volts, $7\frac{1}{2}$ volts and 9 volts, with the base current adjusted in steps from 0 to 50 or 100 μa in each case.

Temperature effects may be demonstrated quite easily. Again, use the test circuit shown in Figs. 101 and 102. Adjust R_b for a nominal base current between 20 and 50 μa . Note the collector current indicated on M2. Next, heat the transistor to body temperature by cupping your hand tightly around its case and holding it for a minute or two, taking care not to disturb circuit connections. Note any variations in base and collector currents. Remove your hand and allow the transistor to cool to room temperature, again noting changes in meter readings. Finally, chill the transistor by holding an ice cube against its case, again recording changes in base and collector currents.

For maximum educational value, the basic measurements and tests outlined above should be repeated for other transistors of the same type number, if available, as well as for other types of transistors. If desired, n-p-n types such as the 2N169, 2N170 and 2N229 may be checked by reversing the meter and battery polarities. Similar techniques may be used for determining transistor dc-amplifier characteristics in the common-base and common-collector configurations. You'll find that these simple measurements prove much of the basic theory discussed in books on theory. If you should check several transistors of the same type number, you'll find that there is considerable variation between units. These differences are the result of normal manufacturing tolerances and, unless excessive, do not indicate that one or another transistor is defective.

AN EXPERIMENTAL CIRCUIT BOARD

Although the use of unmounted components and clip-lead interconnections (as in Fig. 101) is an inexpensive and acceptable breadboarding technique for many types of circuits, it has several disadvantages. The clip connectors may make a high-resistance contact, particularly if attached to dirty or corroded terminals or

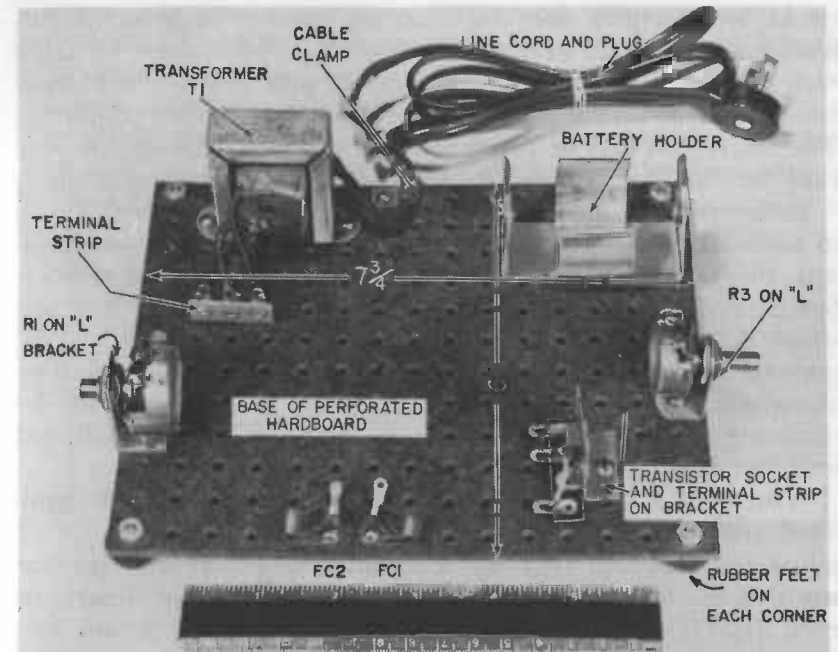

Resistors: R1—50,000-ohm potentiometer (linear taper); R2—10,000 ohms, $\frac{1}{2}$ watt; R3—2-meg potentiometer (linear taper).
 Capacitors: C1—.25 μf , 200-volt paper; C2—.5 μf , 200-volt paper; C3—.05 μf , 200-volt paper; C4—.005 μf , 200-volt paper; C5—365- μf (pf) variable (tuning).
 Coil: L1—Transistor ferrite antenna coil (Superex VLT-950 or equivalent).
 Transformer: T1—6.3 volts, filament type.
 Battery: B1—6 volt (Burgess Z4 or equivalent) or 4—1 $\frac{1}{2}$ -volt dry cells in series.
 Transistors: V1—small signal p-n-p or n-p-n (see text).
 p-n-p type 2N107

2N185, 2N1370, 2N405, etc.
 n-p-n types: 2N229, 2N306, 2N170, etc.
 Phones: 1,000 ohms (or higher) magnetic type.
 Miscellaneous and hardware: FC1, FC2—Fahnestock clips; perforated hardboard chassis (6 x $7\frac{3}{4}$ x $\frac{1}{8}$ inch); rubber feet; line cord and plug; cable clamp; 3-solder-lug terminal strips; L-brackets (see text); transistor socket; battery or dry-cell holders; machine screws and hex nuts; solder lugs; hook-up wire; rosin core solder; spaghetti tubing, etc.
 Accessories: Multi-range volt-ohm-milliammeter; antenna (long wire) with lead-in and clip; knobs.

Fig. 103. Basic construction of an experimental circuit board (and parts list) which you can use to assemble a variety of test circuits. Any perforated material may be used as long as it is an insulator. Some of the many names are Bakelite, phenolic, Masonite, hardboard, pressed board, etc.

leads, changing circuit resistances and leading to erroneous measurements. The clips themselves may jump or pull loose as adjustments or circuit changes are made, causing temporary opens and, occasionally, accidental shorts. Opens or shorts in an active circuit, in turn, may cause voltage breakdowns and overloads which may damage components. In addition, if the breadboarded

circuit is a complex one, the resulting maze of components and leads may spread all over the workbench, resembling a veritable *rat's nest*. This may lead to a variety of problems where critical circuits are involved, such as receivers and high-gain amplifiers. The test circuit may be prone to noise and hum pick-up and may even oscillate due to excessive feedback or interstage coupling.

Before tackling more complex circuits, then, you'll find it wise to assemble a semi-permanent *breadboard chassis*. For most projects, this need only be a small metal chassis or a piece of fiberboard or *Masonite* on which components can be mounted and wired. A suitable circuit board is illustrated in Fig. 103. The components needed for the assembly of the basic board and for later experiments are itemized in the parts lists given later. All the items are standard and readily available through most local and mail order parts suppliers.

With such a board, major components are mounted in semi-fixed positions and interconnections are made using soldered joints and standard hook-up wire. An experimental circuit assembled on the board may be left undisturbed for hours, or even days, if a particular project must be interrupted, and may be easily moved from place to place. For most purposes, a circuit wired on the board is a finished piece of equipment, but parts values may be changed easily and quickly, circuit modifications may be made without difficulty and all terminals and test points are readily accessible.

Referring to Fig. 103, the basic board is a piece of perforated pressed hardboard approximately 6 inches by $7\frac{3}{4}$ inches. The exact size is not critical, however, and larger (or smaller) boards may be used. Rubber feet are mounted in each corner to protect the surfaces of desks, table tops or workbenches. The rubber feet may be cemented in place or, if preferred, may be attached with small machine screws and nuts. Major components such as transformers, battery holders and relays as well as hardware items such as brackets, clips and terminal strips are mounted using small machine screws and nuts. Fahnestock clips are provided where needed for external connections to such accessories as headphones, handkeys or electromechanical devices. Volume controls, switches, and similar parts are supported by small "L" brackets, made up from scrap pieces of sheet metal. Resistors, capacitors and small components are wired in place as needed between terminal strips and fixed components such as switches and controls.

Transistors may be connected in any of several ways, depend-

ing on individual preferences. Since most small transistors are equipped with moderately long leads, they may be wired directly into experimental circuits. If this method is used, care must be taken to avoid heat damage when soldering shortened leads. An alternative method is to affix miniature alligator clips to each transistor lead, clipping the unit in place after all other wiring is finished. The technique preferred by the author, however, is to

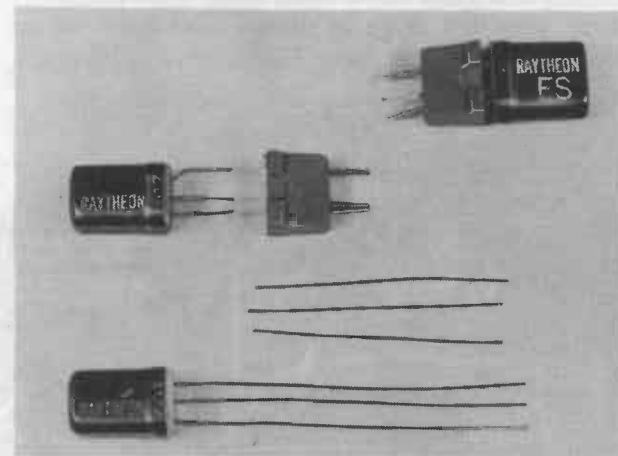

Fig. 104. Transistor leads must be cut short and, often, shaped to fit standard sockets.

provide small experimental socket assemblies, cutting and shaping the transistor leads to fit, as shown in Fig. 104.

A typical experimental-socket assembly is shown mounted in position on the circuit board in Fig. 103. This was made by mounting a 3-terminal strip and a standard miniature-transistor socket on a small "L" bracket formed from a piece of scrap aluminum. Short wire leads were connected between the socket pins and corresponding points on the terminal strip; afterwards, all circuit connections are made to the terminal strip. The complete assembly is mounted at an appropriate point on the circuit board using a machine screw and hex nut. If you decide to use similar socket assemblies for your experiments, you'll find it worthwhile to make three or four assemblies at one time to provide for future projects.

THE TRANSISTOR AS AN AC AMPLIFIER

The general method outlined earlier in this Chapter for studying the practical operation of a transistor as a dc amplifier may be

used, with a few modifications, in examining a single-stage ac amplifier. That is, a basic circuit is assembled and bias currents and other circuit values are measured. Afterwards, changes are made in the transistor's basic operating conditions and the effects of these changes on circuit performance are noted. The actual measurements obtained, while applying *only* to the *specific* circuit and transistor tested, give a general indication of overall transistor operation, thus confirming basic theory.

A practical amplifier stage is shown assembled on an experimental circuit board in Fig. 105. The schematic diagram is given

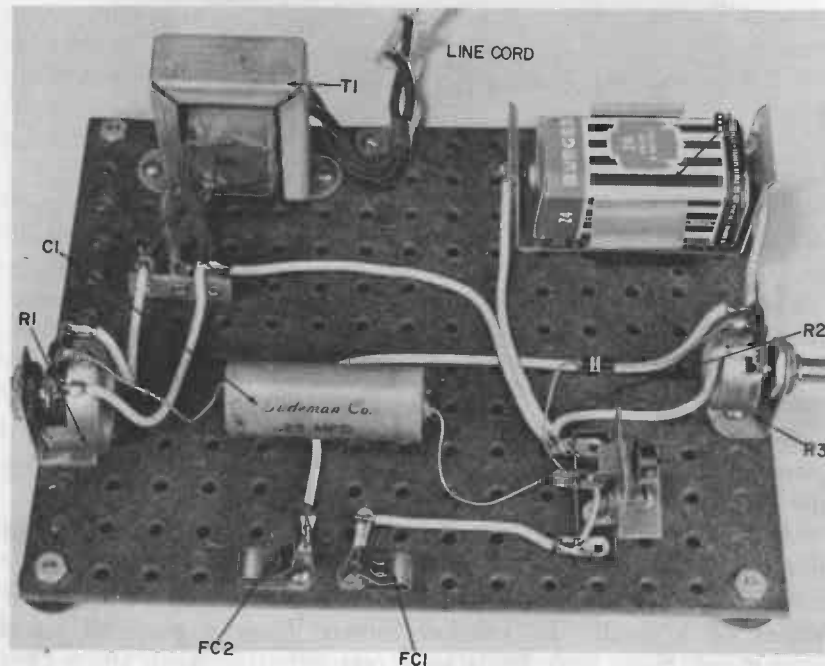
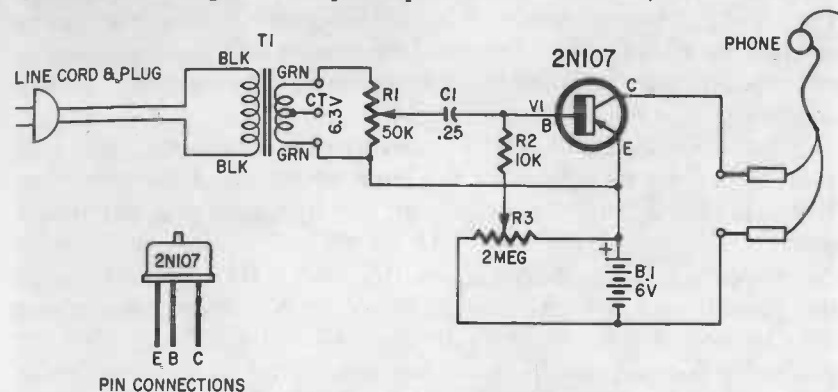

Fig. 105. An experimental audio (ac) amplifier assembled on the circuit board.

in Fig. 106. A p-n-p transistor, V1, is used in the common-emitter configuration. Base bias and collector currents are supplied by a single, small 6-volt battery, (B1). A standard magnetic headphone is used both as V1's collector load and as an output device. The test signal is obtained from an ac-power line through a step-down filament transformer, T1. Potentiometer R1, across T1's secondary winding, permits an adjustment of the input signal level, while

R3, wired across B1, permits V1's base-bias current to be varied from near zero to moderately high values. Thus, performance tests may be made under a variety of circuit conditions.

In operation, then, the 60 cycle sine-wave signal obtained from R1 is coupled through blocking capacitor C1 to V1's base-emitter circuit. This signal is superimposed on the steady base-bias cur-



Resistors: R1—50,000-ohm potentiometer; R2—10,000 ohms, ½ watt; R3—2-meg potentiometer.
Capacitor: C1—.25 μ f.
Transistor: 2N107, etc.

Transformer: T1—6.3 volts
Battery: B1—6 volts or 4—1½ volt dry cells wired in series.
Miscellaneous: Perforated chassis; earphone; line cord and plug; mounting hardware.

Fig. 106. Schematic of the circuit shown wired in Fig. 105. Only major components are detailed in the parts list.

rent obtained from R3 and furnished through current-limiting resistor R2, thus changing V1's *instantaneous* base bias in accordance with the input signal. On negative half-cycles, V1's base-bias current is increased, causing a corresponding, but amplified, increase in collector current. On positive half-cycles, however, the input signal tends to oppose the fixed bias, reducing V1's effective base bias and causing a corresponding, but amplified, *decrease* in collector current. These variations in collector current develop an ac signal across the headphone serving as a collector load which, under optimum conditions, duplicates the waveform of the input signal, but which is of greater amplitude. The ratio between the output and input ac signal levels is proportional to the gain of the stage. The amount of gain obtained, in turn, depends upon the inherent gain of the transistor, upon the fixed base bias, and upon the nature and value of the collector load.

Several important measurements may be made to demonstrate amplifier operation. A standard Volt-Ohm-Milliammeter (or VOM, see Fig. 107) is quite satisfactory for these tests. The basic test points are illustrated in Fig. 108 and include checks of ac-input voltage (A), base-bias current (B), collector-bias current (C), and base and collector dc voltages with respect to the emitter (D). Voltage measurements A and D are made by connecting the instrument's leads directly across the proper test points. Current measurements B and C are made by opening the proper circuit and connecting the meter leads in series.

Before taking actual circuit measurements, however, you will want to become familiar with the basic operation of the amplifier. With the headphone connected and the line cord plugged into a suitable wall receptacle, adjust R3 for minimum bias, that is, with the wiper arm rotated to the emitter and +B1 terminal lug of the potentiometer. Next, gradually adjust R1 until you are just able to hear a 60-cycle hum in the headphone. Adjust R3 for gradually increasing bias (moving the center arm towards the -B1 terminal of the potentiometer). Note changes in the amplitude (volume) and tone quality of the signal heard in the ear-phone.

Under normal conditions, the hum level should gradually increase as the bias increases with, perhaps, a small change in tone quality. As the bias is increased still further, the hum level should reach a maximum and may actually decrease with, in most cases, another change in tone quality. Whether or not this precise pattern will be obtained depends greatly on the individual characteristics of the transistor. Due to manufacturing tolerances, several transistors of the same type number may give varying results.

The results are easy to understand if we analyze the action on the basis of our theoretical knowledge. With zero bias, the transistor is operating as a non linear (half-wave) Class-B amplifier. During positive half-cycles of applied signal the transistor is held at *cut-off* (near zero collector current). On negative half-cycles, the transistor operates as an amplifier and collector current flows, developing a signal in the headphones. However, this is a *distorted output signal* due to the non-linear operation of the transistor. In essence, the positive half-cycles of the input signal are *clipped* off. As the base-bias current is increased (with R3's adjustment), the transistor approaches Class AB and, finally, Class A operation. The stage gain increases and the volume of the signal

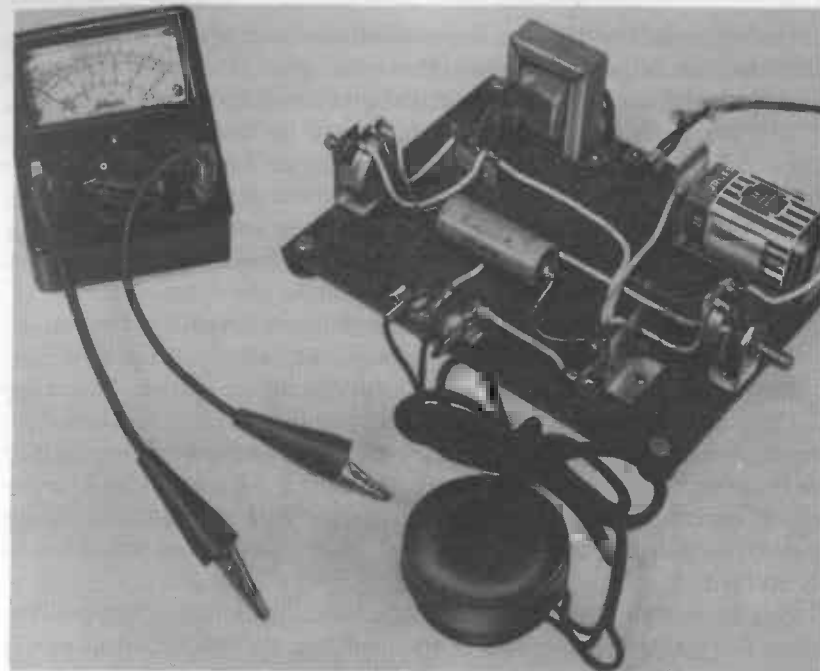

Fig. 107. A multi-range Volt-Ohm-Milliammeter (vom or Multitester) is useful for experimental tests . . . or you can use individual meters.

heard in the headphone goes up. At the same time, the shift from non-linear Class B operation towards linear Class A operation reduces distortion and causes a corresponding change in the quality of the tone. With linear (Class A) operation, a reasonably *pure* tone is heard. When the base bias is increased past the point of the optimum gain and best linearity, the transistor is driven towards *saturation*. That is, the collector current increases with increasing base bias, causing an increased dc voltage drop across the collector load. Eventually, the available dc voltage (from B1) is dropped across the collector load, reducing collector-emitter voltage practically to zero. Under these conditions, there can be no further increase in collector current during negative half cycles of the applied signal and these are clipped. On positive half-cycles, however, the collector current can be *reduced*, developing a signal across the load (headphone). Again, the transistor is operating in a non-linear fashion and the amplified signal is distorted. Thus, as the base bias is increased past the optimum point, the output signal as heard in the headphone may drop in volume and change in tone quality.

Under some conditions, the results outlined above may not be obtained in a practical test. For example, if the transistor is slightly leaky, some base bias will be present even with R3 at its minimum position. This small bias may be enough to establish Class AB or Class A operation. At the other end of the range, it may be impossible to reach collector-current saturation even with maximum bias (R3 full "up"). This may be caused by a low gain transistor or by a low dc resistance in the collector load (headphone), regardless of its rated impedance.

Having observed the effect of base bias on amplifier operation, you'll want to see how input signal-level affects amplifier performance. To do this, repeat the experiment as before, adjusting R3 for optimum gain and best tone quality. Next, increase the input signal level by adjusting R1. This will cause a corresponding increase in headphone volume up to a point. As a larger and larger input signal is applied, the tone quality will change, indicating distortion. With a still larger signal, there may be an actual drop in volume.

Again, our theoretical knowledge indicates what is happening. Since the transistor operates as an amplifier, a stronger input signal develops a louder output signal. However, an extremely strong input signal will *overload* the stage. The transistor is driven to cut-off on positive peaks and to saturation on negative peaks. Thus, both the positive *and* negative peaks of the applied signal are clipped (or flattened) and the output signal is distorted, changing the quality of the tone heard in the headphone. In addition, an extremely strong input signal will cause a change in the *average* base bias, shifting the point of operation and causing a corresponding change in stage gain. As before, of course, these exact results may not be obtained with *all* transistors.

A practical indication of the stage gain achieved may be obtained quite easily. Readjust R1 and R3 for optimum gain, good tone quality and a moderate output signal (as heard in the headphones). Next, disconnect the headphones and reconnect them to the *input circuit*, connecting one lead to R1's center arm and the other lead to the transistor's emitter terminal. Note the relative change in volume.

The effect of a stage's input (and output) impedances on circuit performance is very important when coupling an amplifier to a signal source or load, or when connecting several stages in cascade. For maximum power transfer and highest efficiency, the output impedance of a driving device (whether an amplifier or

generator) should be matched to the input impedance of its load (whether another stage or an output device). In addition, the coupling element should have a very low impedance to prevent a loss in amplitude as the signal is transferred.

In the test amplifier, the blocking capacitor (C1), used to prevent a change in base bias as R1 is adjusted, has a definite impedance at the frequency of the test signal. A *smaller* capacitor has a *higher* impedance and a *larger* capacitor a *lower* impedance. To demonstrate the effect of the impedance of the coupling element (C1) on stage operation, it is only necessary to substitute larger and smaller capacitors for the value specified in Fig. 106.

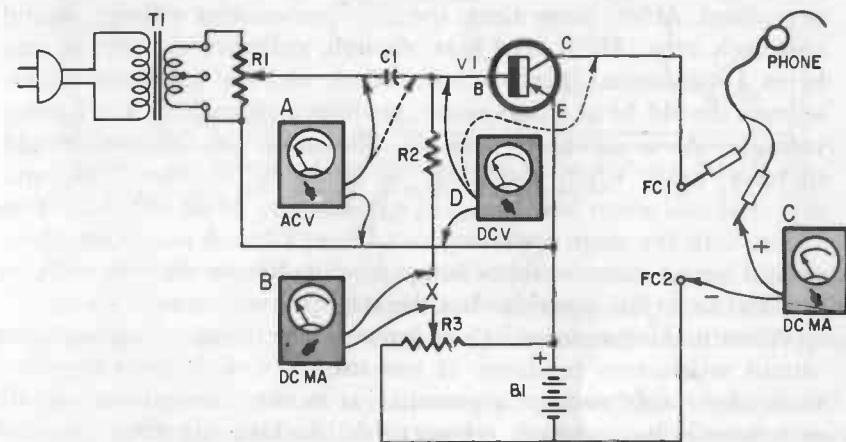

Fig. 108. How to use the vom to check voltages and currents in the basic amplifier circuit. See text for details.

First, readjust R1 and R3 for optimum gain, good tone and a usable output signal (as heard in the headphone). Next, *without changing any adjustments*, shunt a 0.5 μf capacitor (dc voltage rating is not critical) across C1, noting the effect on output volume. This step *increases* C1's effective capacity and hence reduces its impedance at the test frequency. The output volume should increase. Afterwards, remove the shunt capacitor and C1 and substitute 0.05 and .005 μf capacitors for C1, while listening for a change in output volume in each case. You'll find that the output volume drops appreciably each time, and is at a minimum with a .005 μf coupling capacitor. In some cases, the output tone may disappear entirely. The smaller capacitors, having a much higher impedance than the 0.25 μf unit used earlier, cause a larger drop in the signal applied to V1's base-emitter circuit.

Having become familiar with the general operation of the amplifier stage, you may now wish to carry out the test measurements suggested earlier. (See Fig. 108.) These measurements should be made using zero bias, optimum bias and maximum bias with input-signal levels from zero to maximum. In general, your test-results should show that collector current and base-emitter voltage both increase as the bias level is increased, but that the collector-emitter voltage drops. At some point you may find that the collector current reaches a maximum value and levels off, with little or no increase as base bias is increased still further. Leveling off will occur when (and if) collector current saturation is reached. At the same time, the collector-emitter voltage should approach zero. With zero bias, though, collector current should be at a minimum (perhaps even zero), and the collector-emitter voltage should be at a maximum, perhaps approaching the battery voltage. As a signal is applied, the collector current should increase some when the stage is operated at zero bias, and may decrease when base bias is at a maximum. At an optimum bias value, with the stage operating as a linear Class A amplifier, there should be no measurable change in dc-collector current *with or without an input signal*, unless the stage is overloaded.

When making tests, switch to lower meter ranges as necessary to obtain satisfactory readings. If you use an ac voltmeter to make tests where a dc voltage is present (as in the base-emitter circuit or across the headphone), connect a dc blocking capacitor in series with one of the voltmeter leads to prevent erroneous results. Use a 0.5 to 1.0 μf unit; working voltage is not critical. Some meters have a built-in capacitor and it is connected into the circuit when the VOM is set to output. You may wish to make ac voltage tests to determine the signal voltage drop across C1 as different capacitors are used here. You can do this by checking the ac voltage on each side of C1, as shown by the dotted line at A, Fig. 108. Again, you may wish to compare the base-emitter input (signal) voltage (ac) with the output voltage developed across the headphone (measure between FC1 and FC2, Fig. 108) to determine if *voltage gain* is obtained. The voltage gain may be calculated by dividing the ac output voltage by the ac base-emitter voltage.

The tests and experiments outlined above may be carried out with a single multi-range VOM. Of necessity, the results obtained do not permit a rigorous study, nor is the subject covered as well as might be desired by some experimenters. If suitable test equipment is available, however, quite a number of additional experi-

ments may be carried out. For example, an *Audio Signal Generator* and *AC VTVM* would permit frequency response tests. Here, the 60 cps source (T1 and R1) would be replaced by the Signal Generator. The VTVM could be used to check input and output signal levels and gain tests could be performed over a wide range

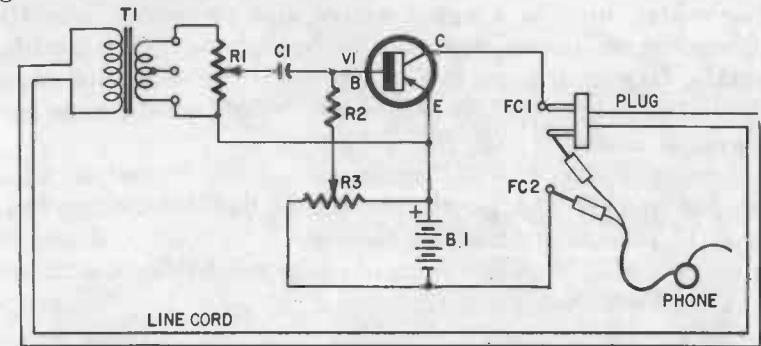

Fig. 109. Schematic of an inductive feedback audio oscillator. Here a filament transformer (T1) is used to couple the amplifier's "input" and "output" circuits.

of frequencies. An Oscilloscope would permit the experimenter to observe input and output signal waveforms and to see how the distortion caused by non-linear operation affects the output signal wave shape.

Most of the transistor amplifiers encountered in practical electronic equipment are basically similar to the experimental circuit just examined. Modifications will be encountered, of course. Common-collector or common-base configurations are used where their special characteristics are needed. The output load may be a resistor, transformer primary, or, in the case of rf amplifiers, a coil or tuned circuit, instead of a headphone. Generally, the base bias is fixed but, in receivers or special purpose audio amplifiers, may be made variable to permit an adjustment of stage gain. Amplifier stages employing multi-watt power transistors operate in a similar fashion. However, as discussed in earlier chapters, the circuit currents are much higher and circuit impedances lower.

THE TRANSISTOR AS AN OSCILLATOR

As defined in *electronics*, an oscillator is essentially an amplifier with its output circuit coupled back to its input in such a way that any signal reinforces itself. The experimental amplifier we've just examined may be changed into an oscillator if we: (a) provide a feedback path between the input and output circuits, (b) make

sure that the proper phase relationship is maintained so that reinforcement (rather than cancellation) is obtained and (c) have sufficient gain to overcome circuit losses, including any power required by the output load (headphone). All of these requirements may be met, rather simply, if T1's line plug is removed from the ac outlet, used as a signal source and connected into V1's collector circuit in series with the headphone. The modified schematic diagram is given in Fig. 109, while the assembled circuit is illustrated in Fig. 110. All component values are the same as in the original amplifier (see Fig. 106).

Referring to Fig. 109, T1 serves to couple the output signal developed in V1's collector circuit back to the base-emitter input circuit. T1's secondary winding becomes a feedback coil and the resulting circuit a modified form of *inductive feedback oscillator*. For oscillation to occur, the feedback signal must have the proper phase relationship. In the experimental circuit, the phase may be reversed by reversing the connections to the line plug. With one arrangement, the circuit *will not* oscillate. When the connections are reversed, the circuit will oscillate, provided that sufficient feedback signal is supplied and the base bias is at an optimum value. In operation then, R1 is used to adjust the level of the feedback signal and, as in the amplifier, R3 serves to adjust V1's base bias.

With a circuit wired as shown in Fig. 109, adjust R3 for a nominal base bias. The exact value is not too critical. Adjust R1 gradually for increased feedback, listening to the headphone for a signal. If you are unable to obtain oscillation and to hear an audio tone in the headphone, reverse the line plug (T1's primary) connections and try again. Once oscillation is obtained, readjust both R1 and R3 for the best compromise between a pleasing tone and maximum headphone volume.

Essentially the same tests may be performed on the oscillator as were made earlier in studying the basic amplifier circuit, while using the same instrument. Base and collector dc currents may be measured, base-emitter and collector-emitter dc voltages checked and ac (signal) voltages determined. As before, these tests should be made under various operating conditions. The effect of different feedback levels may be determined by adjusting R1, while the effect of base bias on circuit performance may be examined by adjusting R3. Under some conditions, it may be possible to obtain *blocking oscillator* action. This will occur at high feedback levels if a high-gain transistor is used and may be identified by a sudden and decided change in the pitch (frequency) of the signal heard.

As a general rule, the oscillator's frequency will be determined by circuit distributed capacitances, the phone's characteristics, and by T1's characteristics, with T1 playing a dominant role. You can

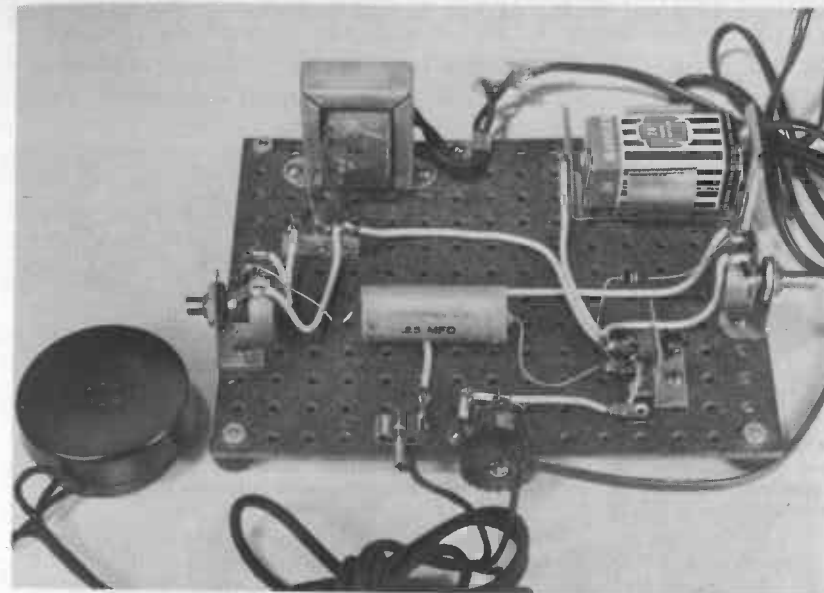

Fig. 110. Breadboard version of the oscillator circuit in Fig. 109.

change the basic frequency experimentally by shunting various value capacitors across T1's primary and secondary windings. If you are able to obtain blocking, then the circuit's frequency will be determined primarily by the R-C time constant of the input circuit. In this case, the frequency or *blocking rate* can be changed by changing C1's value or by adjusting R3. Your tests should indicate that the *larger* the R-C time constant, the *lower* the blocking rate. Hence, a larger value for C1 should reduce frequency and vice versa.

The tickler-feedback oscillator, of course, is only one of a large variety of practical oscillator circuits. All types operate on the same basic principles, and the chief differences are found in the methods used for obtaining an in-phase feedback signal and for controlling frequency. An rf oscillator, for example, could be assembled using a circuit almost identical to that shown in Fig. 109 (without the headphone, of course) if an air-core rf transformer were substituted for T1 and if a transistor which had good high-frequency characteristics were selected for V1.

THE TRANSISTOR AS A DETECTOR

When two different signals are passed through a *linear* device, neither is changed and both are available in the output circuit in their original form, except for amplitude. If the same two

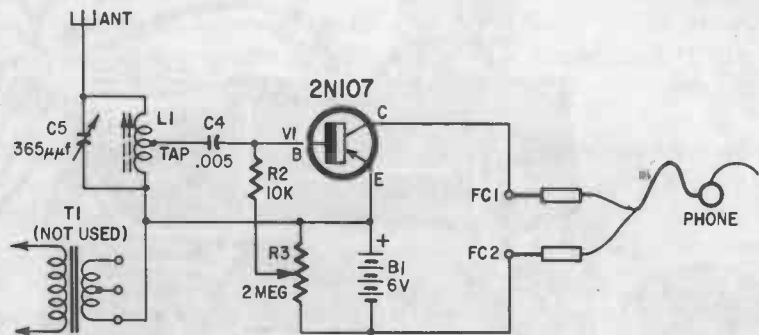

Resistors: R2—10,000 ohms, ½ watt; R3—2-meg potentiometer.
Capacitors: C4—.005 μ f; C5—365 μ f (pf) variable.
Coil: L1—Transistor ferrite loop antenna coil.
Transistor: 2N107, etc.
Miscellaneous: Perforated chassis; earphone; battery; hardware.

Fig. 111. A simple AM broadcast-band receiver circuit. The transistor, V1, is used as a combination rf detector and audio amplifier.

signals are passed through a *non-linear* device, however, one is superimposed on the other and the output signals become quite complex, containing not only both original signals but new signals at their sum and difference frequencies. This process is called *modulation* and a non-linear device used in this fashion is termed a *modulator*. Modulators are used extensively in radio transmitters to combine high frequency rf signals with audio signals such as voice and music.

A non-linear device may also *de-modulate* a signal, separating it into its original components, when used with suitable additional circuits. Used in this fashion, the device is called a *detector*. The old *cats-whisker* and *crystal* is a typical detector, as is the more modern crystal or *semiconductor diode*. Both devices may be used to demodulate a radio signal and, hence, can be used in simple radio receivers.

As we found in earlier experiments, a transistor amplifier may be operated as a non-linear device if a suitable base bias is chosen. It follows, then, that the transistor can be used as a detector. A typical circuit, representing a simple modification of the basic

amplifier examined earlier, is shown schematically in Fig. 111. The same circuit wired on an experimental circuit board is illustrated in Fig. 112.

Referring to Fig. 111, you'll see that the basic amplifier circuit is virtually unchanged, but that the 60 cps signal source, T1-R1, has been replaced by an rf signal source—a tuned circuit and antenna. Since high frequencies are handled, the coupling capacitor

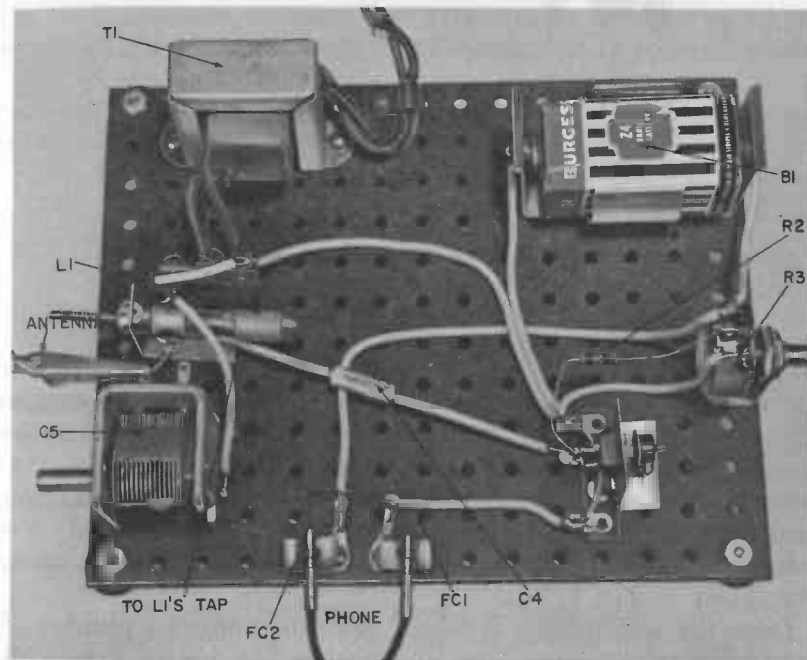

Fig. 112. The receiver circuit assembled on the experimental circuit board.

(C4) has been changed to a smaller value. The resulting circuit, then, is basically a simple radio receiver. As before, V1's base bias is determined by R3's adjustment and is furnished through current limiting resistor R2.

In operation, modulated rf signals are picked up by the antenna and selected by tuned circuit C5-L1. Stations within the AM broadcast band (525 to 1605 kc) are chosen by adjusting C5. A tap on L1 matches the high impedance of the tuned circuit to V1's relatively low input impedance, thus preventing excessive loading of the tuned circuit, with resulting loss of "Q" and selectivity. The selected rf signal has a waveform similar to the

pattern shown in Fig. 113-a, with the instantaneous amplitude of the rf carrier varying in accordance with the modulating audio signal. This signal is coupled through dc blocking capacitor C4 to V1's base-emitter circuit. C4 prevents a short of V1's base-bias

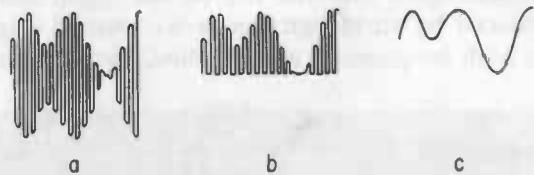

Fig. 113. How detection takes place. The modulated rf signal (a) is passed through a non-linear device, such as a diode or properly biased transistor; one half of the rf cycles are "stripped" away, as shown at (b). Finally, the rf component is filtered out by circuit action, giving an audio signal (c) superimposed on a dc component proportional to the original rf signal.

current through L1's low dc resistance. V1, operated as a non-linear amplifier, detects the selected rf signal, stripping away a portion of the signal and developing a waveform similar to that shown in Fig. 113-b. The detected signal is essentially a series of rf pulses with an average amplitude varying in accordance with the original audio (voice or music) signal. The headphone used as a collector load cannot follow the high frequency (rf) pulsations and, as a result, these are smoothed out to form an audio signal similar to that shown in Fig. 113-c.

Once the basic circuit is wired, you can conduct a number of interesting experiments. Since the receiver has limited sensitivity, however, you'll need a fairly long (50 to 100 feet) external antenna unless you are reasonably close to a powerful AM broadcast station. With the antenna and headphone connected, adjust R3 for a small amount of bias. Next, tune through the broadcast band by adjusting C5 until you can hear voice or music in the headphone. Finally, readjust R3 for maximum output volume and minimum distortion.

Having checked the basic operation of the circuit, tune to the strongest local station you can receive in your area. Now, gradually adjust R3 over its entire range, listening for changes in output volume and signal quality. Although the transistor will operate as a detector with zero bias (it is a non-linear Class B amplifier), better results are generally obtained when some base bias

is used. Under these conditions, the transistor is still operating as a non-linear device (a detector) but, in addition, can provide a moderate amount of amplification. Some detection will take place in the base-emitter circuit and the transistor then amplifies the resulting audio signal.

The effect on the selectivity by loading a tuned circuit may be demonstrated by transferring C4's connection from L1's tap to the antenna (hot) terminal of the coil. With this change, there may be an increase in output volume since a stronger signal is applied to V1. However, tuning is broader due to reduced selec-

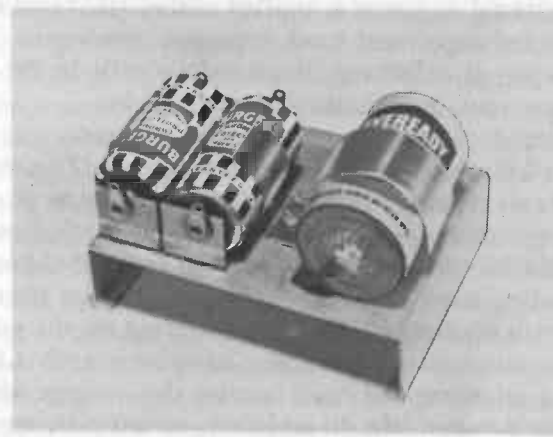

Fig. 114. Standard dry cells are popular as transistor power supplies.

tivity. If there are two fairly strong stations reasonably close together frequency-wise in your area, you may find that both can be heard at the same time, even though they could be separated easily when the rf signal was taken from L1's tap. As in the preceding experiment, tune in different stations and try adjusting R3 over its entire range while listening for changes in signal volume and quality.

In addition to its use as a detector, the transistor will also serve as a modulator when operated as a non-linear device. Transistor-modulator circuits are used extensively in small transmitters and as mixers in superheterodyne receivers.

TRANSISTOR POWER SUPPLIES

Transistor circuits generally are operated from direct current (dc) power sources. Without question, the most popular type of power supply is a battery of chemical cells, but other sources, such

as power-line operated dc supplies and *sun batteries*, *thermo-electric devices*, *atomic batteries* and *fuel cells*, are used for special applications.

Chemical batteries may be grouped into two broad classes—those using *primary* and those using *secondary cells*. Primary cells are those which develop electrical power by an irreversible chemical action. Once fully discharged, the unit is discarded. The familiar zinc-carbon flashlight cell (Fig. 114) is a typical example of a primary cell. Secondary cells, on the other hand, develop electrical power through a *two-way* chemical action which may be reversed if external dc power is applied to the cell. Thus, secondary cells may be recharged and used over and over again. The best known example of a battery of secondary cells is the lead-acid storage battery used in automobiles and trucks.

Three types of primary batteries are in common use: (1) zinc-carbon, (2) alkaline cell, and (3) mercury types. The zinc-carbon and alkaline cell types are somewhat similar as far as physical size, output voltage, and operating life are concerned. Both deliver approximately 1.5 volts per cell when fresh and cost about the same in corresponding sizes. In both, the output voltage starts to drop as the battery is discharged. Mercury batteries, on the other hand, have a lower initial voltage per cell . . . approximately 1.3 volts . . . but offer the advantage of maintaining this voltage virtually to the end of their useful life. In addition, mercury batteries have a very long *shelf life* and may be stored for years without appreciable loss of power. In use, too, a mercury battery may last several times as long as a zinc-carbon battery of corresponding size. As might be expected, however, mercury batteries are more costly than zinc-carbon types.

Two types of secondary-cell batteries are used extensively in transistor equipment . . . (1) lead-acid and (2) nickel-cadmium. Other types, such as iron-nickel and the Silver-Cel, are used in military and industrial applications but are not encountered very often in commercial equipment. Of the two popular types, the lead-acid storage battery is a *wet* cell and requires water occasionally. For this reason, it cannot be sealed permanently. Nickel-cadmium batteries, on the other hand, can be sealed and, as a result, are used in many types of portable equipment, including transistorized TV sets, personal portable receivers, and various types of portable appliances. A lead-acid storage battery delivers approximately 2.1 volts per cell, while a nickel-cadmium battery delivers 1.25 volts per cell. The output voltage of a nickel-cad-

mium type, then, roughly approximates that of a mercury cell, and the former is often used as a rechargeable replacement for the latter.

The number of individual cells in a battery determines its output voltage while, in most cases, the physical size of each cell determines the amount of current it can deliver under load and, to some extent, its operating life. You can determine the number of cells in a typical battery by dividing its rated voltage by the nominal voltage per cell. Thus, a typical 9-volt zinc-carbon transistor battery has 6 cells (9 divided by 1.5). Similarly, a 12-volt automobile battery has 6 cells. When selecting a particular type of battery for a project, a good rule of thumb to remember is *the larger the battery, the longer its life*. This applies only to batteries of the same chemical type and with identical output voltages. A high-voltage battery may be larger, physically, than a low-voltage battery, but because the individual cells are smaller, may have a much shorter life under similar loads.

Unfortunately, it is virtually impossible to determine the exact life of a battery except under closely controlled conditions. Most batteries have a nominal *shelf-life*, that is, a length of time they can be kept in storage in unused condition without losing their effectiveness. This varies considerably with the storage conditions, however, for high temperatures and excessive humidity may cut the nominal shelf-life considerably. Batteries with an extremely long shelf-life, such as mercury cells and some types of storage batteries, are frequently rated in terms of current capacity and time. Thus, a lead-acid storage battery may be rated in *ampere-hours* (ah), and a transistor battery for a portable receiver may be rated in *milliamperes-hours* (mah). Typically, this means that the battery can supply a specified current for a stated number of hours. For example, if a battery is rated as having a capacity of 100 mah, it can supply 5 milliamperes for 20 hours ($5 \times 20 = 100$). This rating applies only for specified discharge rates. If heavy currents are drawn, the battery may have a much shorter life than would be indicated by dividing the current drain into the rated capacity. On the other hand, if very small currents are drawn, the battery's life might be much longer than would be shown by calculation.

For maximum battery life, it is best to stay within the manufacturer's recommended discharge rate. In addition, most batteries will have a longer operating life if used at a moderate rate for short periods than if discharged continuously. In the case of

rechargeable secondary batteries, the *charging rate* as well as the discharge rate may affect life. As a general rule, the charging rate is well under the discharge rate. For example, a nickel-cadmium battery used in a portable receiver may have to be recharged for three hours for every hour of use.

Transistor circuits with low power requirements are often powered by self-generating photocells or *sun batteries*. Used alone or in combination with secondary chemical cells, sun batteries are semiconductor devices capable of changing light into electrical power. Efficiencies range from 4% up to as high as 12%, depending on the type. As in the case of chemical cells, the output voltage of a given sun battery, under a stated load, is fixed and is determined by its basic construction. The amount of current which can be delivered is proportional to its physical size or active area. Where higher voltages are needed, several cells may be connected in series, as are chemical cells. Where larger current capacities are needed, larger cells may be used or several sun batteries may be connected in parallel. Currently available sun batteries are made using either *silicon* or *selenium* as the basic semiconductor material. Of the two, silicon batteries are somewhat more efficient but are more costly.

Line-operated power supplies are used in some types of transistorized equipment, either as the sole source of power or in connection with a rechargeable secondary battery. Except for the voltages delivered, these supplies are roughly similar to those employed in tube-operated equipment and may consist of a step-down transformer, a rectifier and a filter network. In some cases, elaborate circuits are employed for voltage or current regulation.

Adjustable line-operated power supplies are used extensively for laboratory design work, bench tests and servicing. They deliver a continuously adjustable output voltage and are equipped with meters to provide a constant check of both output voltage and load current. Depending on intended application, individual instruments may be designed to deliver maximum currents of under 100 ma or; where designed for use with high-power transistor amplifiers and control circuits, up to 10 or 20 amperes or more.

CHAPTER 2

How to build audio amplifiers or if you can hear them, they work!

Sound is sometimes defined as . . . *mechanical vibrations in the atmosphere or some other medium within the audible frequency range*. At other times, sound may be defined as . . . *the physiological reaction of certain sensory organs to specified mechanical vibrations*. Which of the definitions you accept, if either, depends on your viewpoint.

Differing viewpoints lead to many interesting things—horse and dog races, neighborhood spats, varying tastes in food and clothing, different opinions about types of music and sometimes, rather violent wars. The two definitions of sound given above, for example, often lead to a debate that is almost a perennial favorite with students of First Year Physics—to wit:

RESOLVED: *If a tree falls in a forest miles from any living creature, no sound is produced.*

FIRST STUDENT—“This is not a matter for serious debate, of course, for the statement is obviously false. If a tree falls, the mechanical vibrations in the atmosphere which we call sound are produced. Whether or not a living creature is present to hear the sound is irrelevant and immaterial.”

SECOND STUDENT—“The statement is true, no matter how my opponent belabors the point. If there is no animal with sensory organs such as ears within hearing distance, the mechanical vibrations which may or may not be produced are not converted

into sound. On the other hand, if a living creature, such as a man, were present, I would agree that sound is produced."

FIRST STUDENT—"Even a deaf man?"

SECOND STUDENT—"If he has a hearing aid."

FIRST STUDENT—"With a dead battery?"

SECOND STUDENT—"Provided he's carrying a portable tape recorder."

FIRST STUDENT—"Even if the recorder has a defective microphone?"

... and on and on, ad infinitum.

* * * * *

Let's leave the forest and our debating students. Obviously, the debate is well on its way towards becoming a fist fight.

Derived from a Latin expression meaning "I hear," the word *audio* refers to things concerned with frequencies which can be heard or which can be made *audible*. Generally, it is applied to electronic equipment handling signal frequencies within the range 20 cps to 20 kc. An audio amplifier, then, amplifies signals falling within this range.

The balance of this Chapter is devoted to the description of a number of interesting transistor audio amplifier projects. These all share several basic characteristics . . . they are easy to build, requiring no more than two or three evenings at the most, only familiar hand tools are required for assembly, the components needed are standard and readily available through both local and mail-order parts distributors, and above all, the signals they handle, at some point, can be made audible. Thus, if you can *hear* acceptable results when each project is finished and in use, you know the unit *works*.

A HEADPHONE AMPLIFIER

In many cases, the important difference between expensive headphones costing from \$10 to \$15 and inexpensive units selling for under \$3 is in their relative sensitivity. The inexpensive types may reproduce signals with about the same quality as the more expensive 'phones, but require stronger input signals for comparable output levels. This difference can be minimized by using a simple amplifier with less expensive headsets.

A compact, inexpensive and easy-to-build headphone amplifier can be built to operate on a self-contained power supply. The instrument is designed to plug into the *Phone Jack* of popular types of electronic equipment, such as receivers, signal tracers and test

analyzers. The plug of the headset with which the unit is used is inserted into an output jack near the rear of the case.

As designed, the instrument has an input impedance ranging from 2,000 to 5,000 ohms, and will provide a good match to the *phone* output of most standard equipment. The unit's output impedance varies somewhat, but in general, will match common magnetic headphones with from 600 to 5,000 ohms impedance. It is not suitable for use with crystal headphones. Overall gain

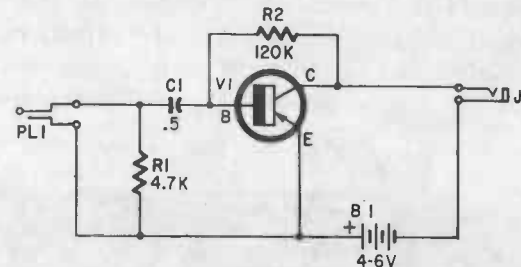

Resistors: R1—4,700 ohms; R2—120,000 ohms (both ½ watt).
Capacitor: C1—.5 μ f, 200 volts tubular.
Transistor: V1—2N107, 2N109, 2N241A, etc. (see Fig. 106).
Jack: J1—open circuit phone jack (to fit earphone).
Battery: B1—4 to 6 volts.
Miscellaneous: small plastic box; transistor socket; wire; solder, terminals, phone plug (PL1) etc.

Fig. 201. Schematic of the Headphone Amplifier.

varies, too, depending on the impedance of the phones and upon the individual characteristics of the transistor, but is usually between 9 and 12 db, or a voltage gain ranging upwards from 3 or 4. Under normal operating conditions, the self-contained battery has a working life of several hundred hours. A separate on-off power switch has been omitted in the interests of circuit simplicity and economy. However, no current is drawn from the battery until a headphone plug is inserted in the amplifier's output jack.

Circuit description

Referring to the schematic in Fig. 201, a single p-n-p transistor, V1, is used in the common-emitter configuration. The simple circuit, then, is a modified form of the basic ac amplifier examined in Chapter 1 (Fig. 106). The external headphones connected to output jack, J1, serve as V1's collector load. A compensated base-bias current is obtained from the collector circuit and furnished to V1's base through R2. Fixed resistor R1 provides a closed dc path for the input circuit, preventing accidental *opens* in the equipment with which the amplifier is used. This is an important

feature for some applications, but is not needed in all cases. Since high dc voltages may be present in the *phone* circuit of some types of equipment, possible transistor damage is avoided by the use of a dc blocking capacitor, (C1), in series with VI's base electrode. Operating power is supplied by a 4 to 6 volt battery, (B1—Fig. 201). Due to the unique self-compensating circuit used; the exact supply voltage is not critical.

The base-bias arrangement used reduces thermal runaway somewhat and minimizes the effects of differences in the characteristics of individual transistors, automatically adjusts circuit performance for headphones of different impedances, and, finally, serves to stabilize circuit operation. These self-compensating fea-

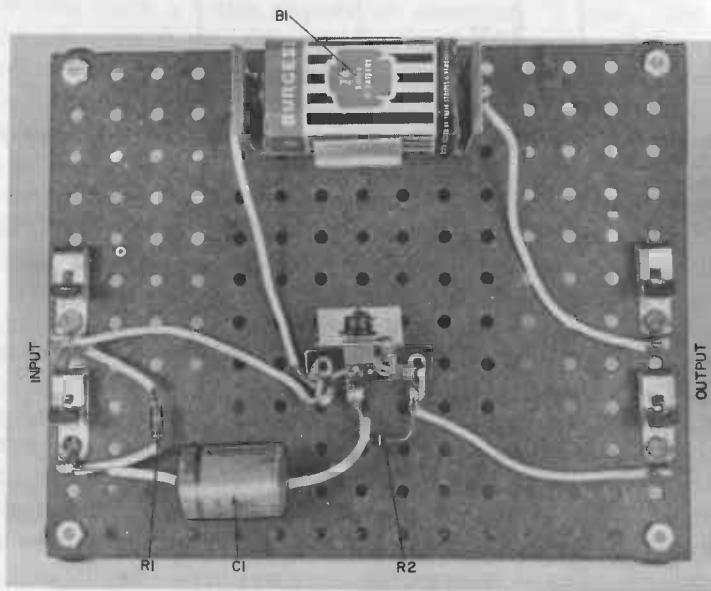

Fig. 202. The Headphone Amplifier wired breadboard fashion.

tures result from the ac and dc feedback between collector and base circuits. Since bias resistor R2 is connected directly between the collector and base electrodes, a portion of the amplified output signal appearing in the collector circuit is fed back to the base circuit. This signal is out-of-phase with the original input signal and thus serves as degenerative feedback, stabilizing gain and minimizing distortion. As far as the dc bias is concerned, this is

directly proportional to the collector-emitter dc voltage which, in turn, varies with the dc voltage-drop across the collector load (headphones). Anything which tends to increase collector current, such as a tendency towards thermal runaway or high leakage, in-

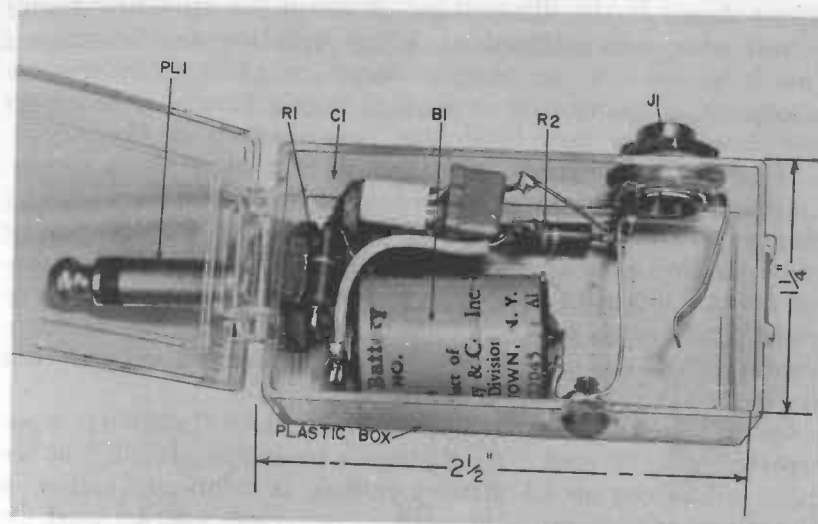

Fig. 203. For permanence, the amplifier can be assembled in a small plastic (or metal) box as a self-contained unit.

increases the dc drop. This reduces the collector-emitter voltage, thus reducing the base bias current and compensating for the increase in collector current.

In operation, the input signal applied to plug PL1 is coupled through dc blocking capacitor C1 to VI's base-emitter circuit. This signal, superimposed upon the base bias furnished through R2, varies the transistor's instantaneous base bias, causing corresponding but amplified variations in collector current, and developing an amplified-output signal in the collector load.

Construction hints

Depending on individual preferences, the Headphone Amplifier may be assembled either breadboard fashion or as a compact self-contained accessory for other equipment. The circuit is shown wired on an experimental circuit board in Fig. 202, while an interior view is given in Fig. 203. The circuit (Fig. 201) is the same in both versions, although standard (full-sized) components were used in the breadboard version while miniature components were used in the compact model. Some builders may prefer to bread-

board the circuit first for performance tests, assembling a finished version later.

Regardless of the method of construction, neither parts layout nor lead dress are especially critical. You can follow the general layout shown in the illustrations, or can make up a new layout to suit your own inclinations. When building a self-contained model, however, some thought should be given to component placement to insure ease of wiring, simple battery replacement and clearance for the phone plug later inserted in J1.

Since the circuit is self-compensating to a large extent, as outlined above, almost any small p-n-p transistor may be used without changes in component values. If preferred, n-p-n types may be employed, but the battery polarity must be reversed. The transistor may be mounted on a small socket, as in the photographs or wired permanently in place. If the leads are soldered in position, however, the usual precautions should be observed to avoid heat damage.

Other substitutions are possible. A larger (or smaller) input capacitor may be used. Values ranging from 0.25 μf to 2.0 μf are quite satisfactory for C1. Battery voltage, as mentioned earlier, is not critical. Other input or output connectors may be used for PL1 and J1. For example, Fahnestock clips were used in the bread-board version. Some builders may prefer to use phone tips and tip jacks or banana plugs and jacks.

To use the completed instrument, connect it to the *Phone* output terminal(s) of the equipment with which the unit is to be used. If a plug-type input connector is employed (PL1), this is simply plugged into the phone jack. Standard magnetic headphones are then connected to the output terminals (or plugged into output jack J1) and are used in conventional fashion. The headphones should be disconnected when not in use to avoid exhausting the battery.

HI FI PREAMPLIFIER

Once upon a time the meaning of *high fidelity* was known only to a small group of enthusiasts and hi-fi was not yet a household synonym for a record player. In those days most phonographs, including expensive as well as low cost models, were equipped with high output crystal pick-ups. Only a moderate amount of amplifier gain was needed to boost the signal obtained from the piezoelectric crystal cartridge to a level sufficient to drive a speaker to full volume.

Then came the evolution! Interest in high quality audio systems, sparked by the hard core of enthusiasts and fanned into roaring flames by equipment manufacturers, spread across the nation. New types of phonograph pick-ups were developed—units with low distortion, low noise and exceptional frequency response. The new units bordered on perfection, except for one small fault; their output voltage was but a small fraction of that of crystal pick-ups and hence they could not be used with the standard amplifiers of the day.

The solution was to provide additional electronic amplification *ahead* of that provided by the regular phonograph amplifier. A

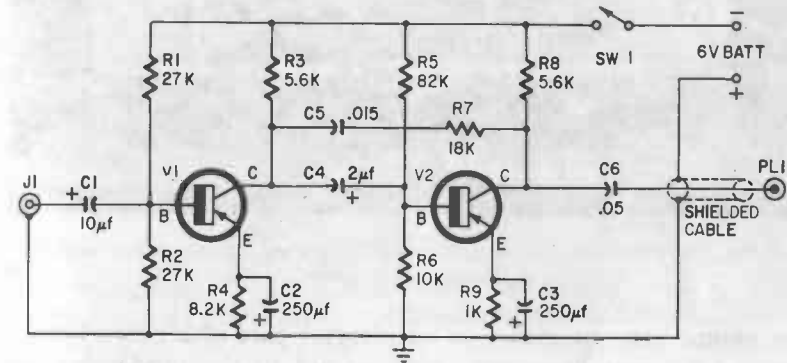

Resistors: R1, R2—27,000 ohms; R3, R8—5,600 ohms; R4—8,200 ohms; R5—82,000 ohms; R6—10,000 ohms; R7—18,000 ohms; R8—5,600 ohms; R9—1,000 ohms; (all 1/2 watt).
Capacitors: C1—10 μf ; C2, C3—250 μf ; C4—2 μf ; (all 6-volt electrolytics) C5—.015 μf , paper or ceramic; C6—.05 μf paper or ceramic.

Transistors: V1—2N133; V2—2N132.
Switch: SW1—spst slide or toggle.
Phono jack: J1—(Switchcraft 3501FP).
Phono plug: PL1—(to match J1).
Miscellaneous: Etched-circuit board (see text); small L-bracket; shielded cable; wire, solder, machine screws, hex nuts, etc.
Battery: 6 volts.

Fig. 204. Schematic diagram of the compact preamplifier.

1- or 2-stage circuit was used in most cases, with its output level (amplitude) roughly comparable to that obtained from a high output crystal pick-up. Thus was born the *pre-amplifier*, or as it is often called today, the *preamp*. Over the years, the meaning of the original term has broadened somewhat and today, a preamp may be anything from a single 1- or 2-stage unit to a complex piece of gear with 3 or 4 stages and numerous controls, switches and adjustments.

The circuit shown in Fig. 204 is for a hi-fi preamp in the origi-

nal sense. It is designed for use with magnetic phonograph cartridges of one of the variable-reluctance types, and features low noise, virtually zero inherent hum, ample gain and a frequency response which compensates for the cartridge characteristics. It may be used in both single channel monaural and multi-channel

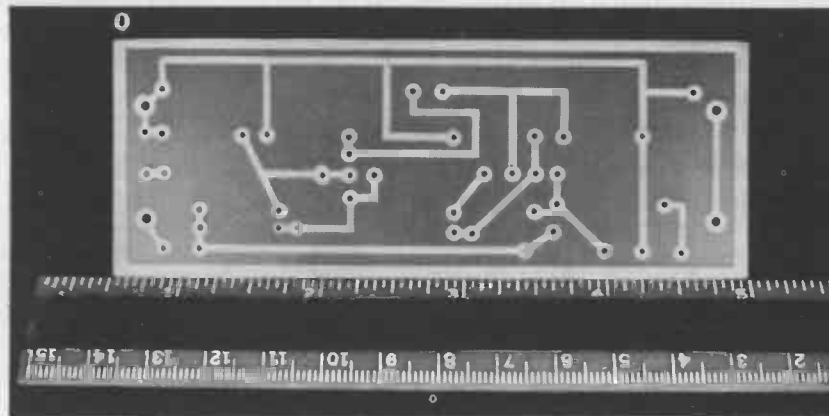

Fig. 205. Preamp circuit board layout—for details on making etched circuit boards, see Chapter 7.

stereophonic systems, either as an integral part of a new installation, as a separate accessory, or as an aid in the modernization and updating of an older system.

Circuit description

Referring to the schematic diagram, a pair of p-n-p transistors, V1 and V2, are used in a two-stage capacity-coupled circuit. The common-emitter configuration is used in both stages. A standard phono jack, J1, is used as an input-connecting device, while the amplifier's output is furnished through a shielded cable and phono plug, PL1. Operating power is obtained from a 6-volt battery and controlled by a SPST switch, SW1, both of which are external to the amplifier proper.

In operation, the signal obtained from the phonograph cartridge is coupled through J1 and coupling capacitor C1 to V1's base-emitter circuit. A stabilized base-bias current is furnished for V1 by voltage-divider R1-R2 operating in conjunction with emitter resistor R4, bypassed by C2. R3 serves as V1's collector load; the amplified signal developed across this component is coupled through dc blocking capacitor C4 to the second stage, V2.

Continuing, V2's base bias is furnished by voltage-divider R5-

R6 in conjunction with emitter resistor R9, bypassed by C3. R8 serves as V2's collector load. The amplified signal obtained from the first stage, then, is amplified further by V2, with its output developed across R8 and coupled through dc blocking capacitor C6 to the output cable and plug. C5 and R7 form a feedback network which adjusts the amplifier's frequency response to complement that of the phonograph cartridge with which it is used.

Relatively large coupling capacitors are used for input (C1) and interstage (C4) coupling to avoid a loss of low frequency signals. Very large bypass capacitors (C2 and C3) are used across the

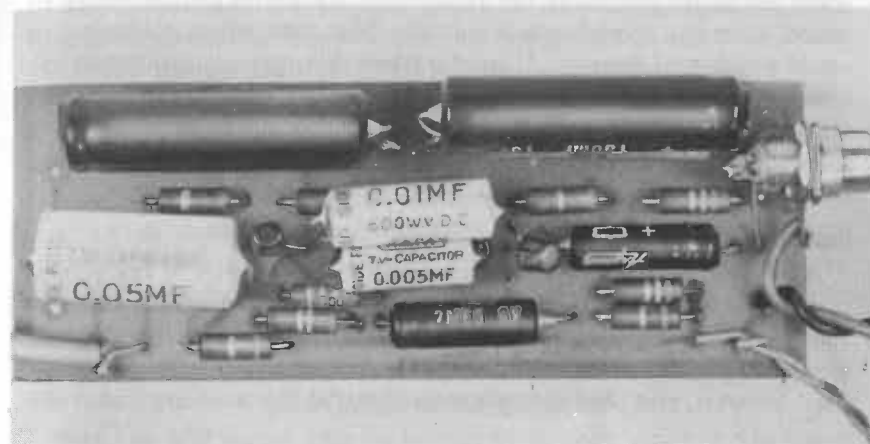

Fig. 206. Top view of wired hi-fi preamp. Although two capacitors are used in parallel for C5, a single unit of the right value is preferred.

two emitter resistors for the same reason. However, since the hi-fi Preamplifier normally is coupled to an amplifier having a high input impedance, a relatively small output coupling capacitor (C6) is satisfactory.

Construction hints

The components needed for the assembly of the hi-fi Preamplifier are specified in the parts list. The author's test model was assembled on an etched circuit board. You can follow a similar technique or, if preferred, can employ a conventional metal chassis and point-to-point wiring. The etched wiring layout used on the author's circuit board is shown in Fig. 205, while a top view of the completed amplifier, showing component placement, is given in Fig. 206. Detailed steps for the preparation and processing of etched circuit boards are outlined in Chapter 7.

Although layout and lead dress are not overly critical, good wiring practice should be followed, particularly if the circuit is assembled on a conventional chassis. The input and output circuits should be well separated and all signal-carrying leads should be kept as short and direct as possible. Minor substitutions are permissible, but not in essential values. For example, different input and output connectors may be employed, the capacitors may have a working voltage somewhat higher than specified and 1 watt or 2 watt resistors may be used in place of $\frac{1}{2}$ watt units.

Regardless of the construction method chosen, be sure to observe all dc polarities. If the transistors are wired permanently in place, as in the model, use a suitable heat sink when soldering to avoid accidental damage. If used, rather than new, components are employed, check their condition *before* installation. Finally, when all wiring is completed, double-check for possible errors, poorly soldered joints and accidental shorts or opens before connecting the power source (battery).

Installation and use

As a general rule, the hi-fi Preamplifier is mounted in the record player (or changer) base, as illustrated in block diagram form in Fig. 207. The shielded output lead is connected to the (external) amplifier which drives the loudspeaker. A shielded lead should be used between the phonograph cartridge (in the tone arm) and the

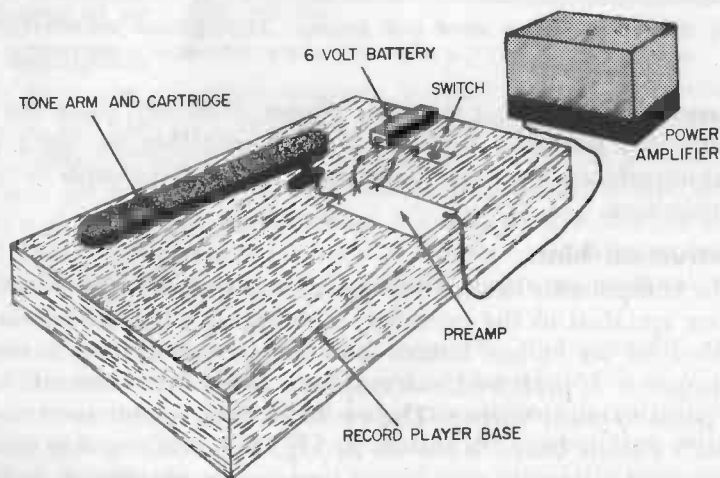

Fig. 207. How the hi-fi preamp is used. For a stereo installation, a pair of preamps is required . . . one for each channel.

preamp, but twisted pairs of ordinary hook-up wire are satisfactory for the battery and switch connections. A *Burgess* type Z4 6-volt battery or four penlight or flashlight cells connected in series are satisfactory power sources.

External hum pick up may be minimized by mounting the preamp chassis as far away from the phonograph motor and ac leads as is practicable. In extreme cases, it may be necessary to mount the preamp assembly in a small metal box to provide additional shielding. Such a box, if used, should be connected to system ground.

The installation shown is for a single-channel monaural system. If a stereophonic set-up is used, *two* preamps are assembled and installed, one for each channel. A common power supply may be used for both in most cases, but better channel isolation is achieved if separate batteries are provided. In such an installation, the SPST switch (SW1) shown in Fig. 204 may be replaced with a DPST unit, with one set of contacts used for each preamp.

Once an installation is completed, no adjustments are needed. System operation is controlled by the regular *Gain* and *Tone* controls on the external amplifier. Since transistors do not burn out as do vacuum tubes, the only maintenance needed under normal conditions is the occasional replacement of the battery.

A POWER MEGAPHONE

You can add a real note of authority to your voice if you use a transistor power megaphone. Such an instrument is handy for

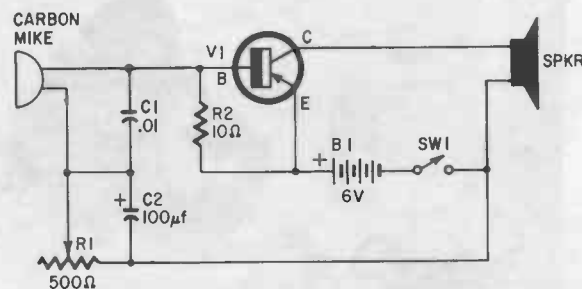

Resistors: R1—500-ohm potentiometer; R2—10 ohms, 1 watt.
Capacitors: C1—.01 μf, 200 volt tubular; C2—100 μf, 6-volt electrolytic.
Transistor: V1—2N255, p-n-p power type.
Switch: SW1—spst, normally open spst push-button.
Microphone: Carbon Mike—carbon cartridge

(Shure type R10).
Speaker: Spkr—8-ohm trumpet type, paging, (University MIL-8).
Battery: B1—6 volts (4—1.5 volt cells in series).
Miscellaneous: Coffee or tobacco can; phenolic chassis; machine screws and hex nuts; wire; solder; etc.

Fig. 208. Power Megaphone schematic diagram.

calling members of the family to dinner, for coaching athletic teams, for supervising picnics and other outdoor events sponsored by church, school and civic groups, and when afloat, for hailing other boats. It is also useful for directing traffic, supervising outdoor work and managing auctions. With so many potential applications, then, the list of individuals who can use a power megaphone to advantage is virtually endless—to name but a few—coaches, lifeguards, rescue squads, volunteer or professional firefighters, construction foremen, auctioneers, masters of ceremony, scoutmasters, yachtsmen, policemen, outdoor-theater ushers, carnival barkers, outdoor lecturers, cheerleaders and race or game announcers.

The schematic of an easily assembled, but effective, power megaphone is given in Fig. 208. Construction and wiring details are illustrated in Figs. 209, 210 and 211. The components needed for construction are specified in the parts list.

Circuit description

By referring to Fig. 208, you can see a relatively simple circuit is employed. A single p-n-p power transistor, V1, is used as a direct-coupled common-emitter amplifier between the carbon microphone serving as a signal source and the voice coil winding of the trumpet type loudspeaker (SPKR) used as a collector load. A 6-volt battery (B1) controlled by a SPST push-button power switch, S1, furnishes both base bias and collector currents.

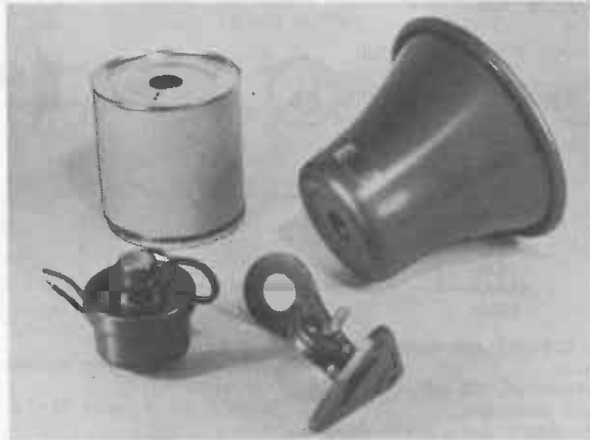

Fig. 209. The paging trumpet is partially disassembled for mounting the coffee can which houses the amplifier and batteries.

In operation, base-bias current is supplied through a series bias adjustment resistor, R1, and the carbon microphone to V1's base electrode. Shunt resistor R2 is connected between base and emitter to stabilize circuit operation and to reduce any tendency towards thermal runaway. Sound vibrations striking the microphone's diaphragm change its instantaneous resistance, causing corresponding changes in the bias current. These current changes are amplified by the transistor, appearing as changes in the collector current through the loudspeaker coil, which, in turn, are converted into amplified sound vibrations by speaker action. Electrolytic capacitor C2, across R1, serves as an audio bypass and thus prevents attenuation of the audio signal developed by the microphone. C1, on the other hand, serves as a high frequency shunt, reducing hiss

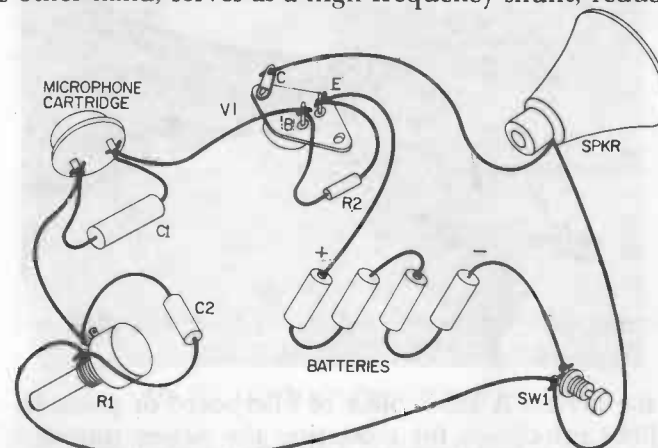

Fig. 210. Power Megaphone pictorial diagram.

and other noise inherent in carbon microphones, thus insuring a reasonably clean input signal.

Construction and use

As long as the schematic given in Fig. 208 or the pictorial wiring diagram shown in Fig. 210 is followed, neither parts arrangement nor wiring dress are especially critical. Therefore, any of several construction methods may be followed. The amplifier and power supply batteries may be assembled in a small metal or plastic case and connected to the microphone cartridge and loudspeaker through flexible leads or, if preferred, the entire circuit may be wired as a single compact instrument. The latter technique was used in assembling the model shown in Fig. 212.

A large coffee or tobacco can makes an excellent cabinet for housing the amplifier circuit and batteries. This may be mounted on the trumpet loudspeaker by punching a hole in one end to fit the threaded coupling on the speaker driver element and assembling the driver, can and trumpet together as a single unit. The loudspeaker's standard mounting bracket is removed, as shown in Fig. 209. A second hole is punched at the rear of the can for the microphone cartridge. Finally, the batteries, control switch and other circuit components are fitted and wired in the can

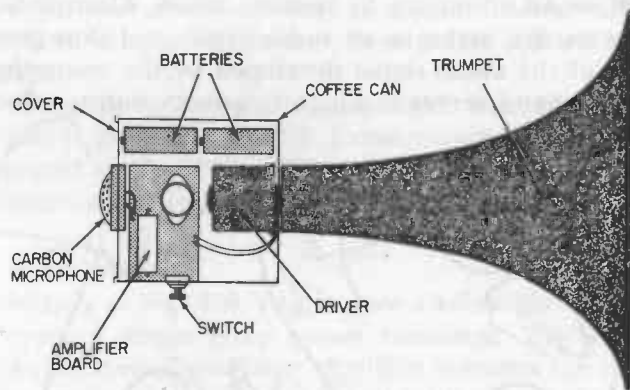

Fig. 211. Cross-section view of the Power Megaphone. Several layouts are possible.

around the driver. A small piece of fiberboard or phenolic makes an excellent sub-chassis for mounting the power transistor (V1), bias control (R1), and other components. Care must be taken, during assembly, that no leads short against the can or speaker driver. Small metal brackets may be cut from scrap sheet metal and shaped to hold the batteries, sub-chassis and other parts securely in place. These are attached to the cabinet with standard machine screws, lockwashers and hex nuts. A typical assembly is shown in cross-section view in Fig. 211.

Once the wiring is completed, double-check all connections for possible errors and accidental shorts *before* installing the batteries. Pay particular attention to the polarity of the electrolytic capacitor (C2) and battery connections. An insulating filler such as sponge rubber may be stuffed into the completed assembly to prevent unwanted vibrations, acoustic feedback and microphonics.

Final adjustment is relatively easy. Take the unit *outdoors* (the power megaphone is not suitable for indoor use, except in large

areas, such as gymnasiums). Holding the microphone close to your mouth, just as you would a conventional megaphone, close SW1 and speak in a loud voice. Keep the switch depressed and continue to talk, adjusting R1 for *maximum* volume and *minimum* distortion. If *squealing* occurs, adjust R1 for slightly less volume. Afterwards, the instrument is used simply by holding the microphone to the mouth, depressing the push-button switch and speak-



Fig. 212. Using the Power Megaphone.

ing. Power is used only while SW1 is closed, that is, only while the instrument is in *actual* use. Thus, battery life is quite long, and a single set of flashlight batteries should last a full summer season under typical operating conditions.

TWO-STATION INTERCOM

Providing instant, private, two-way communication between two or more points, an *intercommunication* system can be a valuable addition to the home or business. In the home, for example, such a system might be installed between the kitchen and the front door, allowing the housewife to answer the doorbell and to question callers without leaving her work. Such a system might also be installed between the kitchen and a basement or garage workshop. In a business office, a suitable system could provide direct communication between an executive and his assistant or between a professional man, such as a doctor or lawyer and his receptionist.

Popularly called an *intercom*, a typical system generally is made up of two basic types of equipment . . . a *Master* unit and one or more *Remote* or *Slave* sub-stations. The Master, as the name implies, is the control center of the system and is equipped with an amplifier and the necessary switches and controls to originate and to receive calls from any of the sub-stations. A typical Remote, on the other hand, is usually nothing more than a combination speaker/microphone mounted in a suitable cabinet. Depending on the intended application it may, or may not, be equipped with controls for originating calls.

A battery-powered transistor intercom offers several advantages over line-powered units. First, the Master and Remote stations may be installed wherever convenient, whether or not a power outlet is nearby. Second, there is no danger of shock if the stations are installed in damp or otherwise hazardous locations, such as kitchens and basements. Third, with no tubes to burn out, maintenance is reduced to the simple operation of replacing a battery at infrequent intervals. Fourth, since the system is not tied to a power line, it can be used in remote locations such as beaches, hunting camps and ski lodges. The schematic diagram of an inexpensive two-station intercom is shown in Fig. 213, while the parts needed for its assembly and operation are specified in the parts list. This particular system can be assembled in two or three evenings by the average worker and installed in a single evening in most locations.

Circuit description

Using p-n-p power transistors in the common-emitter configuration, the instrument is basically a two-stage, resistance-capacity coupled audio amplifier. Two pm speakers are used, one in the Master and a second in the Remote station. Both are used interchangeably as microphones and output devices, with their connections to the amplifier circuit made through a four-pole, two-position spring return switch, SW2. Operating power is furnished by a six volt battery (B1), controlled by a SPST switch, SW1.

With the *Talk-Listen* switch, SW2, in the *Talk* position, as shown in Fig. 213, the pm speaker (SPKR) in the Master is connected in series between V1's base electrode and its source of base-bias current, voltage divider R1-R2. The lower resistor, R2, is bypassed by C1 to prevent attenuation of the signal developed by the speaker which, in this case, serves as a microphone. R3 serves as V1's collector load, and the amplified signal developed across this resistor is coupled through dc blocking capacitor C2 to the

second stage, V2. The Remote pm speaker serves as V2's collector load and V2 is connected between the collector electrode and the negative terminal of the 6-volt battery (B1) through contacts on SW2. V2's base-bias current is furnished by voltage divider R4-R5.

In operation, then, the audio signal developed by the Master's speaker, used as a microphone, is applied to V1's base-emitter circuit, amplified, coupled to V2 through C2, amplified further and applied to the remote speaker serving as V2's load. Thus, the person operating the Master unit can talk to a party stationed at the Remote unit's location. When SW2 is transferred to the *Listen*

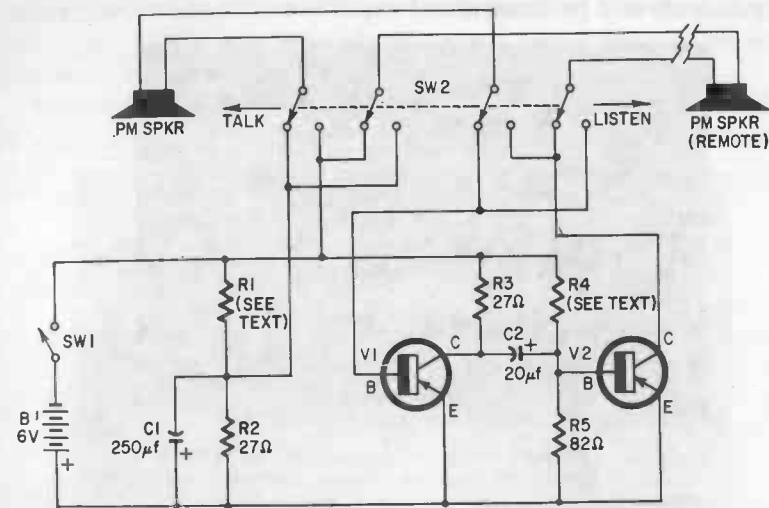

Resistors: R1, R4—1,000-ohm potentiometers; R2, R3—27 ohms, 1 watt; R5—82 ohms, 1 watt.
Capacitors: C1—250 μ f; C2—20 μ f (both 6-volt electrolytics).
Switches: SW1—spst toggle; SW2—4 pdt, spring return, lever type.
Transistors: V1, V2—2N301, p-n-p power type.

Battery: B1—6 volts (4—1.5 volt cells in series).
Speakers: PM-Spkr—4 ohms, 4 inch (Utah SP4D) (2 required).
Miscellaneous: Wooden or metal boxes; perforated board; transistor sockets; rubber feet; wood screws, machine screws and hex nuts; wire; solder; terminals; lugs; etc.

Fig. 213. Schematic diagram of a two-station Intercom.

position, the connections of the two speakers are interchanged, and the individual at the Remote can talk back to the operator at the Master. In this case, the Remote's speaker serves as a microphone and the Master's speaker as an output device.

Construction hints

The transistor amplifier used in the Master unit may be assem-

bled on a conventional metal chassis or on a pressed hard-board or phenolic-circuit board, as preferred. Parts layout and wiring arrangement are not overly critical, but good wiring practice should be followed. All signal leads should be kept short and direct, and electrolytic capacitor polarities should be observed. Take special pains, too, when wiring the *Talk-Listen* switch SW2 to avoid errors.

Resistor values R1 and R4 are not specified in the schematic diagram, Fig. 213. These two resistors establish the base-bias currents for transistors V1 and V2, respectively; for best performance, their values should be determined experimentally after the circuit



Fig. 214. The intercom Master, containing the amplifier, should be assembled in a wooden or metal cabinet of adequate size to hold the batteries as well as the electronic circuitry.

is wired and ready for test. In practice, this is accomplished by installing a pair of small 1,000 ohm carbon controls in place of R1 and R4 on a temporary basis. Later, when the basic assembly is completed and the system ready for a trial run, the controls are adjusted for the best compromise between gain, power output and distortion. The resistance values can be checked afterwards with an ohmmeter and fixed resistors of the proper values installed. One watt resistors may be used here. In the future, if V1 and V2 are ever replaced with other transistors, even of the same type number, it may be necessary to readjust the values of these two components (R1 and R4).

For maximum utility, the two units of the intercom system should be mounted in wooden, metal or plastic cabinets. The Master unit should be assembled in a cabinet large enough to hold

the amplifier chassis, the batteries, control switches SW1 and SW2, and the pm loudspeaker. A smaller cabinet may be used for the Remote unit, since only the pm loudspeaker need be housed. However, some builders may prefer to use identical cabinets for both stations.

Cabinets salvaged from discarded table-model receivers are excellent, but home-made cabinets are quite satisfactory. The model shown in Figs. 214 and 215 was assembled in wooden cabinets obtained by dismantling a cigar box. The Master was housed in the lower portion of the cigar box, the Remote (or Slave) unit in the top or lid. Perforated hard-board was used for the speaker grills, with the central holes enlarged with a hand reamer to insure maximum efficiency.

A variety of power supplies may be used, basically, any battery or combination of cells which will provide 6 volts at moderate

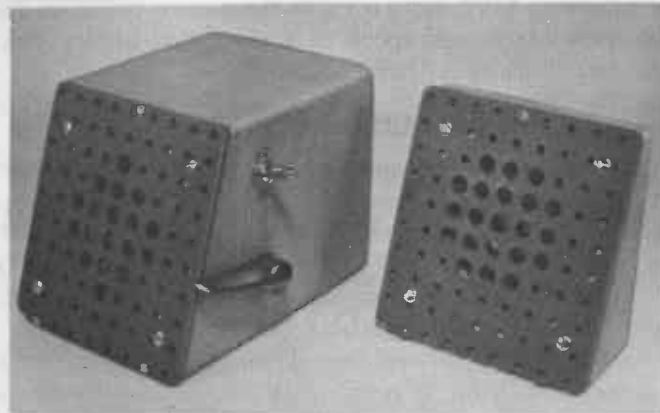

Fig. 215. The completed Intercom system . . . the Remote is the smaller cabinet to the right.

currents. If space is at a premium, use a small 6 volt battery. Where the intercom is to be used frequently, better results and longer battery life will be obtained if a heavy-duty lantern battery is employed; actually any four 1½ volt cells may be wired in series as a 6-volt supply.

Installation and operation

In the usual installation, the Master unit is placed at the *prime* location, that is, near the individual originating calls. The Remote unit is placed in the secondary location, near the person receiving calls and who may originate return messages. In a business office,

for example, the Master might be placed on an executive's desk and the Remote on his secretary's desk.

The Master and Remote units are connected together with a pair of leads. Twisted hook-up wire, telephone wire, two-conductor cable or Zip type lamp cord may be used for interconnection. In a semi-permanent installation, the color of the line's insulation or outer covering should be chosen to match the room's decor. The line itself should be run neatly above baseboards and along door frames and secured in place with wiring tacks or insulated staples. If it is necessary to run the line outdoors, weatherproof cable should be employed.

System operation is relatively simple. The power switch (SW1) is closed to turn the system *on*. No warm-up time is needed. Afterwards, the Remote is called by depressing the *Talk-Listen* lever (SW2), shifting to the *Talk* position. The reply, if any, can be heard by releasing SW2, returning to the *Listen* position. In both cases, the operators should speak in a somewhat louder than normal voice, but there is no need to shout.

AN AUDIO BOOSTER

Requiring relatively few components, an instrument based on the circuit given in Fig. 216 can be used in a variety of applications. Basically a self-contained power amplifier equipped with a moderate-sized pm loudspeaker, the unit has an input impedance approximating that of common magnetic headphones. Typically, it can be used in conjunction with receivers, simple signal tracers, or other instruments to provide speaker output as a substitute for headphones. In addition, it is valuable for improving the general performance of pocket-sized transistor receivers by providing greater power output and better quality sound reproduction. The components needed for assembly are listed in the parts list.

Circuit description

Referring to the schematic diagram, a p-n-p power transistor, V1, is used in the common-emitter configuration as a single-stage power amplifier. Stabilized base bias is furnished from the collector circuit through R1. V1's collector load is the voice coil winding of a medium-sized pm loudspeaker. Input signals applied to jack J1 are coupled to the transistor's base-emitter circuit through impedance matching transformer T1. With a step-down turns ratio, T1 maintains a circuit-input impedance of 500 ohms while matching the comparatively low input impedance of the power

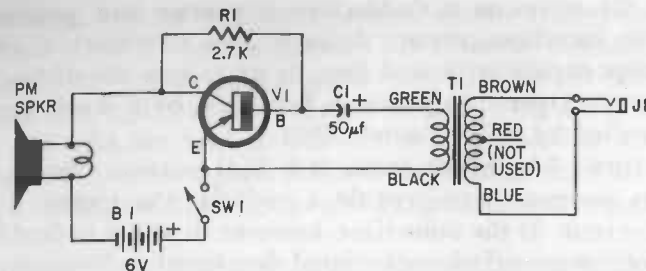

Resistor: R1—2,700 ohms, ½ watt.
 Capacitor: C1—50 µf, 6-volt electrolytic.
 Switch: SW1—spst slide.
 Jack: J1—open circuit phone.
 Transformer: T1—500 ohms CT to 8 ohms (Argonne AR-164).
 Transistor: V1—2N301, p-n-p power type.
 Battery: B1—6 volts (4—1.5 volt cells in series).

Speaker: Spkr—4 ohms, 4-inch pm type (Utah SP4D).
 Miscellaneous: Power transistor socket; perforated circuit board; cigar box; perforated aluminum (or wire screening); terminals; wire solder; machine screws and hex nuts; phone plug; etc.

Fig. 216. Schematic diagram for the Audio Booster.

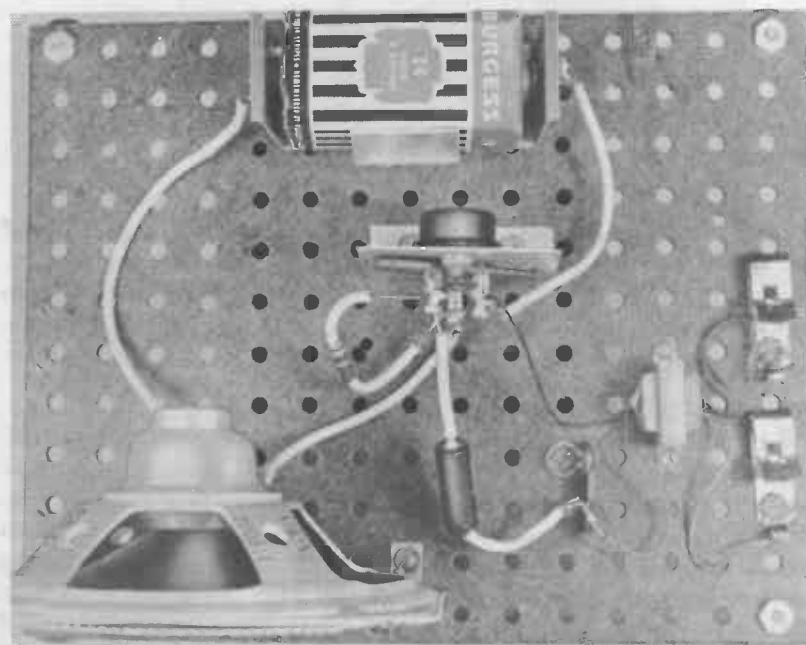

Fig. 217. The Audio Booster assembled breadboard fashion for tests.

transistor. C1 serves as a dc-blocking capacitor and prevents a short of the base-bias current through T1's secondary winding. A fairly large capacitor is used here to prevent a loss of low frequency signals. Operating power is furnished by a 6-volt battery (B1), controlled by a SPST switch, SW1.

In operation, R1, in one sense, is a dual purpose component. Its primary purpose is to provide a path for the transistor's dc base-bias current. At the same time, however, it serves to feed back a portion of the amplified audio signal developed in V1's collector

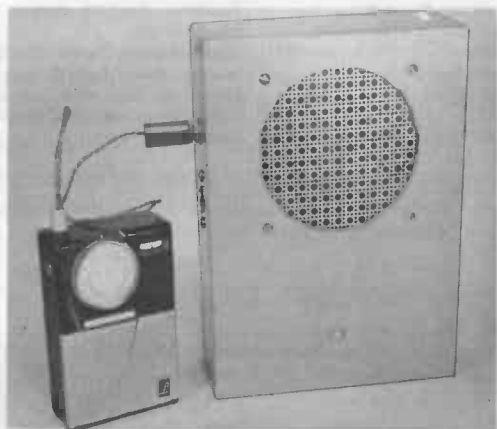

Fig. 218. Assembled in a painted cigar box, the Audio Booster is a useful accessory for personal-sized transistor radios.

circuit. This signal is out-of-phase with the original input signal and thus is a form of degenerative (or inverse) feedback. As explained in Chapter 3, degenerative feedback reduces stage gain slightly but, at the same time, improves circuit stability and reduces distortion.

Construction and use

A breadboard version of the Audio Booster on an experimental circuit board is illustrated in Fig. 217, while a finished model of the device connected to a small-pocket receiver is shown in Fig. 218. With neither layout nor lead dress critical, either or both version(s) may be assembled, depending on individual needs. An interior view of the model shown in Fig. 218 is given in Fig. 219, and a corresponding pictorial wiring diagram is illustrated in Fig. 220.

In the second model, the amplifier circuit is assembled on a small chassis of perforated pressed hard-board. The wired chassis, loudspeaker, battery power pack, ON-OFF switch (SW1) and INPUT jack (J1) are all mounted in an old cigar box. The four flashlight cells are held in place by a long machine screw, wing nut and a flat retainer plate of fiberboard. Other parts are mounted using standard machine screws and hex nuts. A professionally built

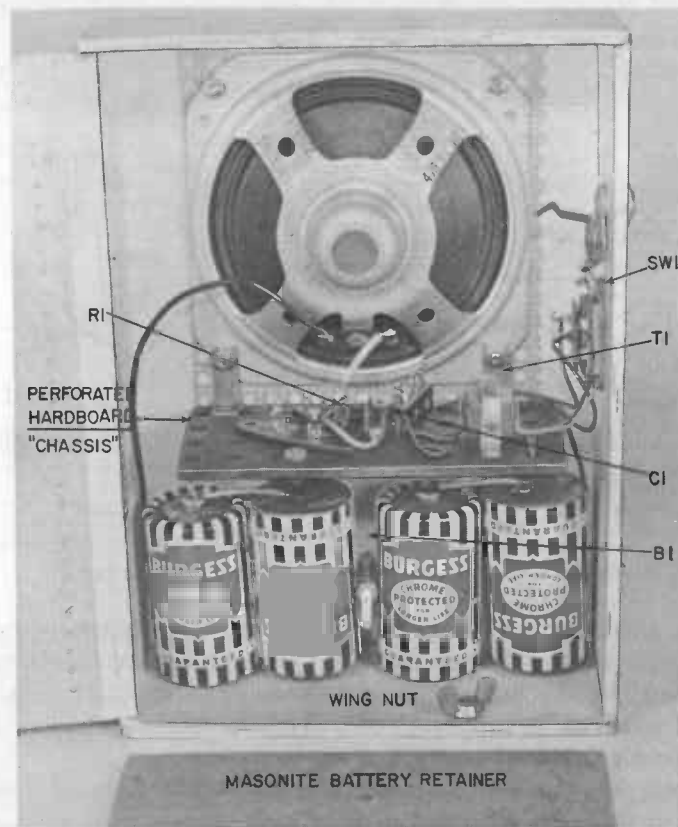

Fig. 219. Interior view of the unit shown in Fig. 218 . . . a perforated pressed-board chassis is used. Power is supplied by four flashlight cells connected in series.

appearance was achieved by painting the exterior of the cigar box and by providing an aluminum grill for the loudspeaker. The latter was cut from a piece of perforated aluminum sheet obtained from a local hardware store.

Several component substitutions are possible. A larger (or smaller) diameter speaker may be used in place of the unit specified. As a general rule, however, the larger the loudspeaker, the better the quality of reproduction and the greater the efficiency of the system. Toggle or rotary switches may be used in place of the slide switch (SW1) used in the model. Other types of jacks (J1) may be used; some builders, for example, may wish to install three or four types of input jacks in parallel, permitting a match to

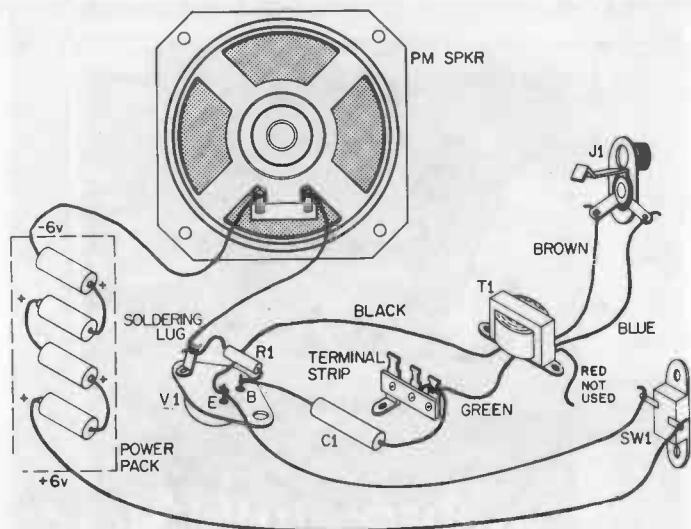

Fig. 220. Pictorial diagram for wiring the Audio Booster.

almost any standard plug. Finally, a variety of batteries may be employed. In the breadboard version, a compact 6-volt battery was used. In the finished model, four flashlight cells were connected in series to supply 6 volts. Another builder may prefer to use a 6-volt lantern battery.

In practice, the Audio Booster is connected to the *earphone* jack of the equipment with which it is used. Output volume is controlled by adjusting the *Volume* or *Gain* control of the other equipment. A pre-assembled connection cable is a useful accessory.

A "DETECTAPHONE"

Most of the projects described in the preceding pages are as much fun to assemble as they are to use, at least as far as the average hobbyist is concerned. Certainly, the real enthusiast derives genuine pleasure from mounting parts, wiring components and

completing a new project—particularly if it works! The *Detectaphone* is an exception to this general rule, however. Although easy and interesting to assemble, the device is *even more* fun to use than to build.

Essentially a high gain multi-stage audio amplifier, the instrument has more potential applications than most dogs have fleas. Depending on the accessories used with it, the Detectaphone may serve as a *hearing aid*, as an *eavesdropping amplifier* for listening

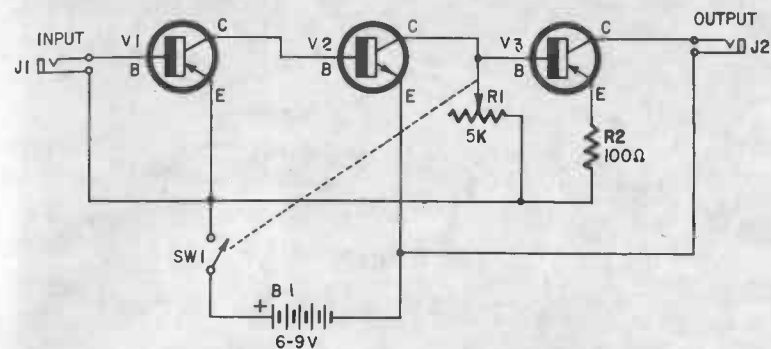

Resistors: R1—5,000 ohms (potentiometer with spst switch) R2—100 ohms, ½ watt.
Switch: SW1—spst (on R1).
Transistors: V1, V3—2N107, p-n-p; V2—2N170, n-p-n.
Jacks: J1, J2—phone jacks, subminiature to match earphones.

Battery: B1—6 to 9 volts.
Miscellaneous: Small plastic box; small knob; perforated phenolic chassis; transistor sockets, hearing aid type earphones (2) with plugs to match J1 and J2; machine screws and hex nuts; wire; solder; spaghetti tubing; etc.

Fig. 221. Schematic diagram of the high gain detectaphone.

to friends' conversation, as a *signal tracer*, as a high-gain audio section for a simple receiver or as a general purpose amplifier for a variety of jobs. In truth, its applications are limited only by the imagination of the individual user. The components needed for the assembly of this versatile instrument are given in the parts list.

Circuit description

As you can see by referring to the schematic diagram given in Fig. 221, the unit is relatively simple, requiring very few components. This simplicity is achieved by the use of a direct-coupled *complementary*-amplifier circuit employing both n-p-n (V2) and p-n-p (V1, V3) transistors.

The first stage, V1, is operated without an external source of base-bias current. Audio signals are applied through *input* jack J1 directly to the base-emitter circuit. V1's emitter-collector circuit,

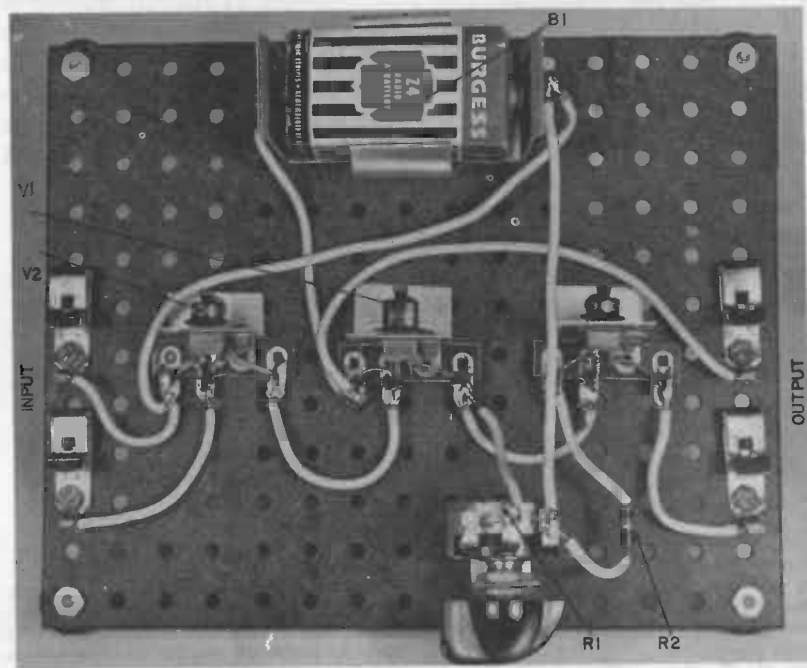

Fig. 222. The Detectaphone circuit assembled on a perforated wiring board.

however, serves as a source of base bias for the second stage, V2, while V2's base-emitter circuit becomes V1's collector load. Thus, the input signal is amplified by V1 and applied directly to V2. The signal is amplified further by the second stage and applied to the third and last stage, V3. Since dc bias as well as signal currents are amplified by the first two stages, an excessive bias might be applied to the third stage, driving it to saturation. This is avoided, however, by the use of an adjustable shunt resistor, R1, in parallel with V3's base-emitter circuit. V2's collector load, then, is made up of R1 and V3's base-emitter circuit in parallel. Since R1's value affects V2's collector load as well as V3's base current, this resistor has a decided effect on overall circuit gain. In practice, it is adjusted for the best compromise between gain and signal distortion. R2, in V3's emitter circuit, introduces a small amount of degenerative feedback and helps stabilize the operation of the last stage. V3's collector load, generally a moderate impedance (2,000 to

6,000 ohms) earphone, is connected to *output* jack J2. Dc-operating power, obtained from a 6- to 9-volt battery, B1, is controlled by a SPST switch, SW1, ganged to R1.

Construction and application

A breadboard version of the Detectaphone assembled on the experimental circuit board described earlier is shown in Fig. 222, while two interior views of a compact model assembled in a small plastic box are given in Figs. 223 and 224. An exterior view of the compact model, together with two miniature earphones (Fig. 225) shows one of the earphones used as a pick-up device or microphone connected to the instrument's *input* jack.

The completed instrument has quite high gain and hence special care must be exercised in choosing a layout if feedback and oscillation are to be avoided. Signal leads must be kept short and

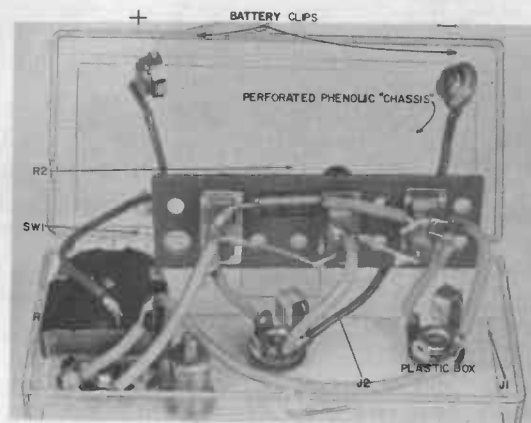

Fig. 223. Interior below chassis view of the Detectaphone wired as a miniature self-contained unit.

direct, and the input and output circuits must be well separated. No difficulty was experienced by the author with either of the models shown, and the average builder should have no trouble assembling a duplicate version of either if he uses the illustrations as a guide.

A small piece of perforated phenolic served as a miniature chassis in the compact model. Standard in-line transistor sockets were mounted on this chassis using tiny spring clips. After wiring, the chassis was mounted in the plastic box used as a case with a

small machine screw, spacer and pair of hex nuts. The two jacks (J1 and J2) and the gain control/switch (R1 and SW1) were mounted directly on the case. The jacks and controls were identified by typing appropriate labels which were placed against the *inside front* of the plastic box and held in place by the control and jacks, as shown in Fig. 225.

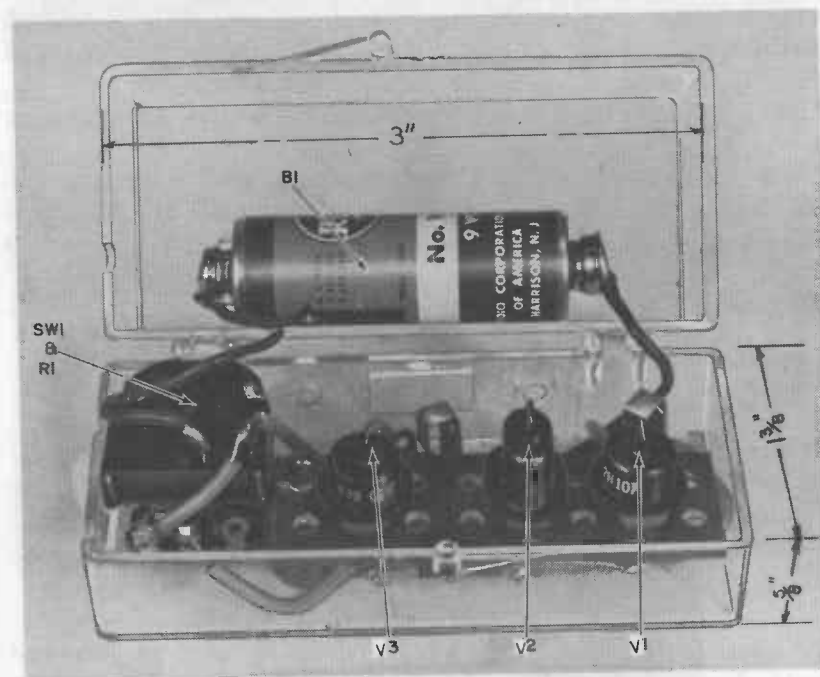

Fig. 224. Above chassis view of the Detectaphone with battery installed.

Regardless of the method of construction, the author suggests that transistor sockets be used. In a few instances, it may be necessary to try different transistors (or to interchange the transistors used in the first and third stages) to obtain optimum performance. This is more easily accomplished if sockets are used than if the transistors are soldered permanently in place.

When the wiring is completed, double-check for possible errors *before* installing the transistors or connecting the battery. If all is well, install the transistors and battery and connect moderate impedance (2,000 to 6,000 ohm) magnetic earphones to the input and output jacks (or terminals). One of the earphones is used as

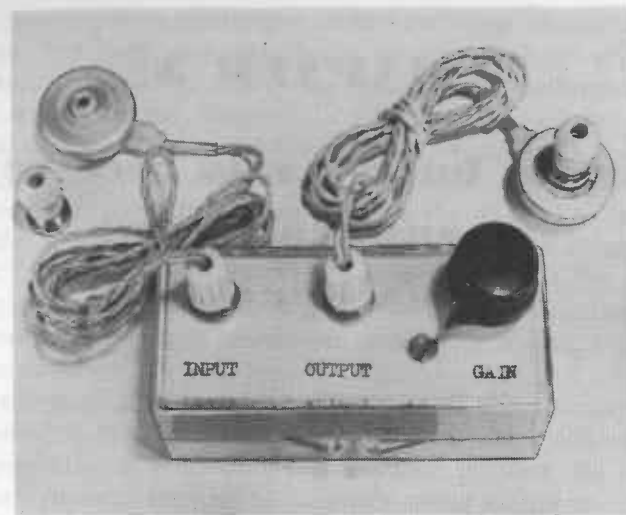

Fig. 225. The completed Detectaphone. The instrument is used with a standard high impedance dynamic earphones . . . one earphone serves as a microphone, the other as an output device.

a microphone. Turn the unit *on* and adjust R1, listening to the *output* earphone. Have someone talk in the room or, if you are working alone, turn on a radio. The circuit should be *live* and pick up the sounds clearly. You'll find that there is an optimum point of adjustment for R1 where good gain and minimum distortion is obtained. Turning *past* this point will reduce gain and increase distortion. R1, then, is *not* adjusted like a conventional volume control. If you are unable to obtain acceptable results, recheck all connections. Make sure the battery polarity is correct, and try interchanging the transistors used in the first and last stages (V1 and V3).

As mentioned earlier, the Detectaphone's possible applications vary with the type of accessories used with it. With an earphone *microphone* as shown in Fig. 225 (note that the earplug is removed on the unit used as a microphone), the device may be used as a low-cost hearing aid or (if the microphone is *planted* in another room) as a secret listening device. With a suitable probe, the instrument may be used as a compact signal tracer. Such an application, as well as construction details for a probe, is described in Chapter 6 (see Fig. 609). As to other applications—use your imagination!

CHAPTER 3

How to build radio receivers or entertainment in small packages

A few days ago, I overheard a conversation between my ten and six year old sons. The ten year old has just finished assembling a small crystal receiver, one of a series of electronic projects in a new Science Kit he had received as a gift. He had attached the antenna lead and earphones and was listening to a local radio station. The six year old had watched the entire procedure with studied interest. In fact, he was almost hypnotized by the proceedings, for he had refrained from asking a question or touching a single one of the components while the work continued. Finally, he could contain himself no longer . . .

"What's that?" he asked.

"A radio," replied the older boy.

"A *what?*?" questioned the younger.

"A radio," repeated the ten year old. Then he paused, frowning his brow in thought as he tried to word an explanation acceptable to his young brother. Finally his face brightened.

"It's just like television," he explained, "only you don't have to watch a picture."

* * * * *

The relentless March of Science often tends to make the unusual commonplace and the familiar a rarity. At the turn of the century, for example, every household had several antimacassars.*

* *Antimacassar*—a small cloth covering used to protect the back or arms of chairs, sofas, and similar upholstered furniture against the stains of *Macassar* hair oil, hence the name. Today, the term is obsolete.

Today, you would be hard put to find someone who could define the term. Similarly, the term *radio* was a household word just a generation ago, while *television* was almost unknown except among science-fiction fans and a few forward-looking scientists and engineers. Today, youngsters are growing up on a diet of daily television programs, but may not learn what *radio* means until they approach their teens. Indeed, the day is not far distant when the word itself will mean only one of two things to the average layman: a personally carried device about the size of a package of cigarettes or an automobile receiver for listening to late news and weather broadcasts and other Public Service announcements.

Regardless of its relative popularity with the younger generation, however, the AM broadcast band receiver is still one of the most rewarding of electronic construction projects. As a general rule, such projects are easy to assemble using inexpensive, readily available components and offer immediate entertainment in the form of news and music without an extra investment in such accessories as phonograph records, prerecorded tapes, or film. Several low-cost transistor receivers are described on the following pages. Any of these may be assembled in one or two evenings by the average hobbyist using familiar hand tools. All are designed to receive the AM broadcast band (540 to 1600 kc).

A LIGHT-POWERED RECEIVER

An old proverb advises one to "make hay while the sun shines." Substitute the word "music" for "hay" and you'll have a good motto for the person owning a receiver based on the circuit given in Fig. 301, for such a receiver derives its operating power from sunlight (or from *any* source of strong light, for that matter). The receiver's power supply is a battery made up of four self-generating selenium photocells.

The self-generating photocell, you may recall, was described briefly in chapter 1. Often called sun batteries or solar cells, these units are semiconductor devices which convert light energy into electrical energy. This is accomplished within the atomic-molecular structure of the semiconductor material used in the cell. In essence, the light energy passes through a transparent metallic layer and is absorbed by electrons normally held tight by valence bonds. These electrons acquire sufficient excess energy to break free of their atomic bonds and to migrate through the material. A certain percentage of these travel across a diode junction or

barrier layer within the cell. Since the diode junction, as we learned earlier, permits a ready flow of electrons in one direction but discourages reverse electron flow, these free electrons gradually accumulate on one side of the barrier layer, building up an electrical potential (or voltage) which can be used in the operation of external equipment.

Historically speaking, the self-generating photocell is not a new device. Commercial units were produced and used extensively during the thirties. In most cases, however, the units were used either as sensing devices or as low power sources for photographer's Light Meters. In the latter application, the photocell served as a power source for an extremely sensitive meter movement. Thus, the meter's reading was proportional to the amount of light falling on the photocell. When properly calibrated, the instrument was (and is) quite valuable in determining proper camera settings for correct photographic film exposure.

For many years, then, this type of photocell found its primary use in test instruments. It became important as a primary power source only *after* the invention of the transistor, which, of course, is closely related to this type of photocell—a cousin if you wish—for both are semiconductor devices. Currently available photocells generally are made using either selenium or silicon as the basic material, although other types of semiconductors, including germanium, are used for special purpose units.

Today, self-generating photocells are still used extensively in light meters and as sensing elements in test instruments and *automatic* cameras. In addition, they are being used in ever increasing quantities as power sources in all types of transistor equipment, in telephone line amplifiers, remote transmitters and instrumentation receivers, artificial satellites and space vehicles to power measuring instruments, receivers and radio transmitters. Assembling and working with the Light-Powered Receiver shown in the illustrations, then, offers an excellent means for becoming acquainted with these wonderful devices.

Circuit description

Referring to the schematic diagram, Fig. 301, a single p-n-p transistor, V1, serves as a combination detector/amplifier. The common-emitter configuration is employed, with a diode, D1, connected in series with V1's base electrode to improve detector action. In operation, then, rf signals picked up by the antenna system are coupled through isolating capacitor C1 to the tuned

circuit, C2-L1. Here, the desired station signal is selected and applied to the detector/amplifier stage, D1-V1. A tap is provided on the inductance (coil L1) to insure, by auto-transformer action, a good electrical match between the high impedance of the tuned circuit and the moderate input impedance of the detector/amplifier stage. This prevents excessive loading of the tuned circuit,

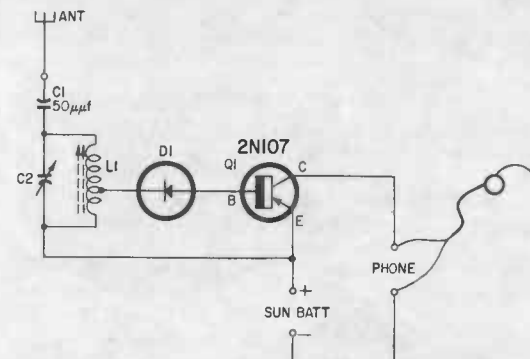

Copacitors: C1—50 μf (pf); mica or ceramic; C2—365 μf , variable (J. W. Miller 2111).

Coil: L1—ferrite antenna coil (Superech VTL-240).

Diode: D1—1N34A.

Transistor: V1—2N107, p-n-p.

Sun battery: Sun Batt—4—B2M solar cells in series-parallel (International Rectifier Corp.).

Miscellaneous: perforated circuit board; knob; Fahnestock clips; transistor socket; rubber feet; machine screws and hex nuts; terminal strips; wire; solder; headphone; etc.

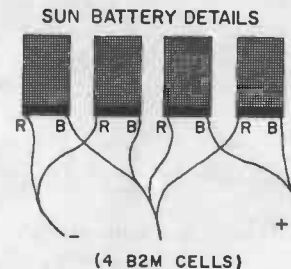

Fig. 301. Schematic of a simple Light-Powered Receiver.

with resulting loss of "Q" and selectivity. The detected audio signal is amplified by V1 and applied to its collector load, a magnetic headphone. Operating power, of course, is furnished by the battery of four selenium photocells connected in series-parallel.

Construction and experiments

The components needed for assembling a Light-Powered Receiver are specified in the parts list. All are readily available through local parts distributors and the larger mail order supply houses.

Depending on individual preferences, the receiver may be assembled either as a self-contained unit in a small cabinet or wired

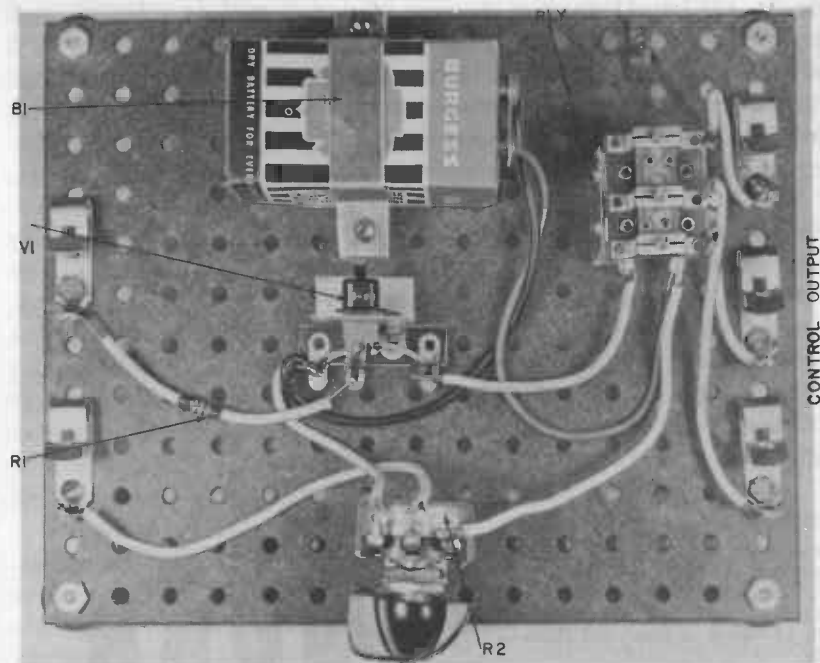

Fig. 302. The Light-Powered Receiver wired on a perforated board.

breadboard fashion on an experimental circuit board. The latter type of construction was used for assembling the model shown in Figs. 302 and 303. Neither layout nor lead dress are critical. However, if the receiver is assembled in a portable case, the photocell battery should be mounted in such a way that light can fall on the sensitive surfaces of the cells. If desired, the battery assembly may be mounted behind a transparent plastic window.

Referring to Figs. 301 and 302, the sun battery assembly used in the model was made by mounting four cells on a long terminal strip, using small machine screws and hex nuts and the "L" brackets preattached to the individual cells by the manufacturer. These brackets are connected, internally, to one of each cells' electrodes and, therefore, must be insulated from each other unless all four cells are to be connected in parallel. In the model, two of the cells were connected in parallel. The two remaining cells were connected in parallel and, finally, the two sets of parallel cells were connected in series to form the complete battery, as shown in the inset of Fig. 301. The electrical polarity of each cell

is indicated by its color-coded leads; red is positive, black negative.

Once the wiring is complete, an antenna and headphone should be connected to the receiver. Use a moderately long (50 to 100 foot) external antenna for best results. Magnetic headphones of 400 to 2,000 ohm impedance can be used. If you prefer to use a crystal phone, connect a 4.7K, half-watt resistor between V1's collector and the negative terminal of the sun battery. The crystal headphone leads are connected directly across this resistor. In use, the sun battery is exposed to normal sunlight and individual stations are tuned by adjusting C2.

A number of interesting experiments may be conducted with the receiver. For example, the effect of light intensity on circuit operation may be shown by casting a shadow across the sun battery. The sun battery itself may be modified by connecting all four

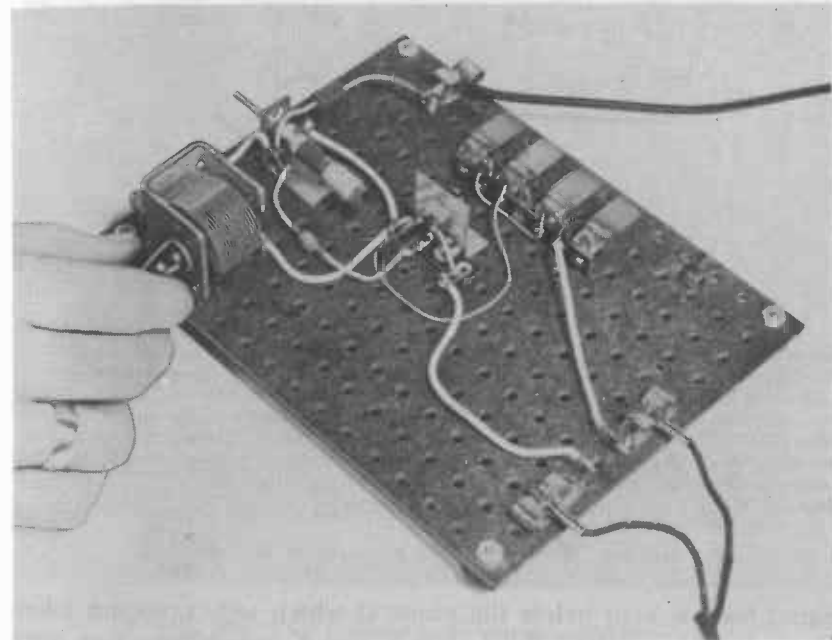
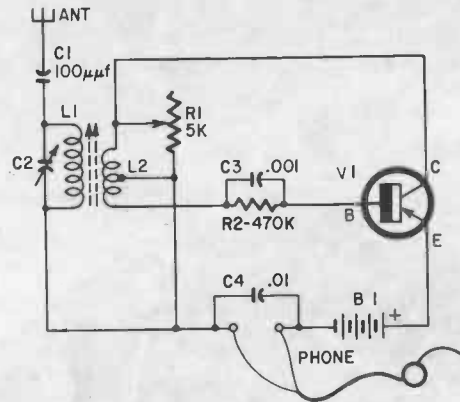

Fig. 303. Using the Light-Powered Receiver. Best results are obtained in full sunlight, but fair reception is obtained on overcast days. Use a moderate, to long, external antenna.

cells in series or in parallel instead of using the series-parallel circuit shown. Finally, the importance of impedance matching may be demonstrated by transferring the signal take-off point from L1's tap to the junction of C1, C2 and L1.

A REGENERATIVE RECEIVER

Except for its power source, the Light-Powered Receiver is quite similar to the basic receiver in chapter 1 (Fig. 111). Where greater receiver sensitivity is needed than can be obtained from the basic circuit, several techniques are available to the circuit designer and builder. A higher gain transistor may be employed, a longer antenna used, additional amplifier stages may be added, or a *regenerative* circuit may be used. In the latter case, a portion of the amplified signal is coupled back to the input circuit in such a way that it reinforces the original signal. The technique, then, is similar to that used in an oscillator, except that the feedback



Resistors: R1—5,000-ohm potentiometer; R2—470,000 ohms, ½ watt.
Capacitors: C1—100 μf (pf), mica or ceramic; C2—365 μf (pf), variable (J. W. Miller 2111); C3—.001 μf , paper or ceramic; C4—.01 μf , paper or ceramic.
Coils: L1, L2—modified ferrite antenna coil (Superec VL).

Transistor: V1—2N2493 rf type p-n-p.
Battery: B1—6 volts (Burgess type Z4).
Miscellaneous: perforated circuit board; knobs (2); Fahnestock clips; small brackets; transistor socket; battery holder; rubber feet; terminals; machine screws and hex nuts.

Fig. 304. Schematic of the Regenerative Receiver.

signal level is kept below the point at which self-excitation takes place. In other words, the feedback signal strengthens, but does not act as a substitute for, the original signal.

The schematic (wiring diagram) of a simple Regenerative Receiver is given in Fig. 304, a breadboard version of the circuit, is shown in Fig. 305. Another version of the same circuit assembled in a pocket-sized plastic case is in Fig. 306. The latter version is an excellent project for the builder desiring a simple, low-cost and efficient pocket receiver.

Circuit description

A single p-n-p transistor, V1, is used in the common-emitter configuration as a combination detector/amplifier. Operating power is supplied by a 6-volt battery (B1). The base bias current of V1 is furnished through the headphone, bypassed by C4, through part of L2 and through current limiting resistor R2, bypassed for rf by C3. The transistor's collector load consists of part of L2, shunted by *Regeneration* control R1, and the headphone. L1 and C2 form a tuned circuit to select the desired station signal while coil L2, coupled to L1, has two important functions.

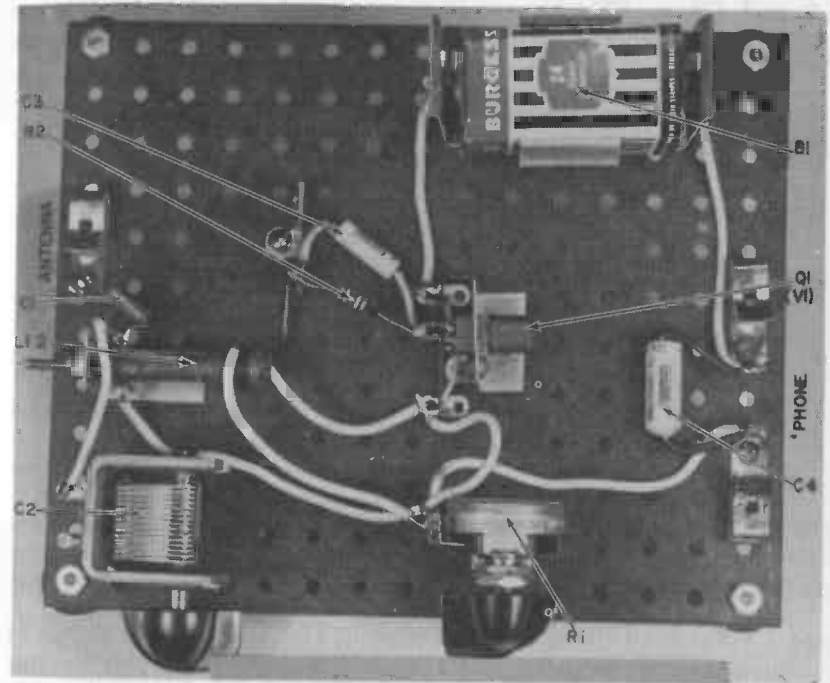

Fig. 305. The completed Regenerative Receiver, wired breadboard fashion.

First, L2 serves as a step-down secondary winding to match the tuned circuit's high impedance to the moderate input impedance of the transistor stage, thus assuring an efficient transfer of signal energy and preventing excessive loading of the tuned circuit. Second, this coil (L2), by virtue of its center-tap, permits a feedback of energy between V1's output (collector) and input (base)

circuits, establishing the basic condition needed for regenerative operation. The feedback signal, as in an oscillator, is *in-phase* with the original signal and thus serves to reinforce it. R1, shunted across a portion of L2, serves to bypass a portion of the feedback signal. As R1's value is reduced, the amount of feedback is reduced, and vice-versa. Thus, R1 permits the amount of regeneration to be changed at the will of the operator for optimum circuit performance.

In operation, then, rf signals picked up by the antenna system are coupled through isolating capacitor C1 to tuned circuit L1-C2. Here, the desired station signal is selected and coupled through L2 and C3 to V1's base-emitter circuit. Some detection takes place and V1 serves to amplify *both* the detected audio signal



Fig. 306. The "Pocket Pal"—essentially the Regenerative Receiver circuit assembled in a pocket-sized plastic case. Miniature, rather than standard-sized, parts are used.

and a portion of the original rf signal. The amplified rf signal is coupled back through L2 to V1's base-emitter circuit, reinforcing the original signal. The detected audio signal is applied directly to the headphone serving as a part of V1's collector load. C4, of course, serves to bypass undetected rf signals across the headphone.

Construction and operation

The schematic diagram given in Fig. 304 is used as a guide when assembling either the breadboard (Fig. 305) or *pocket* (Fig. 306) version of the Regenerative Receiver. The components needed are specified in the parts list and all are available through regular suppliers. Although neither lead nor parts ar-

rangements are especially critical, some care must be exercised in planning the layout of the pocket version to insure that all components will fit within the available space.

A special two-winding rf transformer, L1-L2, (Fig. 307) is required. This is made up by adding an additional winding (L2) to a standard *ferrite* antenna coil (Fig. 307). Use No. 24 to 26 enameled or plastic insulated wire. Small holes are punched in the open end of L1's form to secure the ends of the new coil. Approximately 8 or 9 turns are scramble-wound directly on top of L1. Afterwards, an inch or two of the wire is twisted tightly to form the center-tap and an additional 8 or 9 turns wound *in the same*

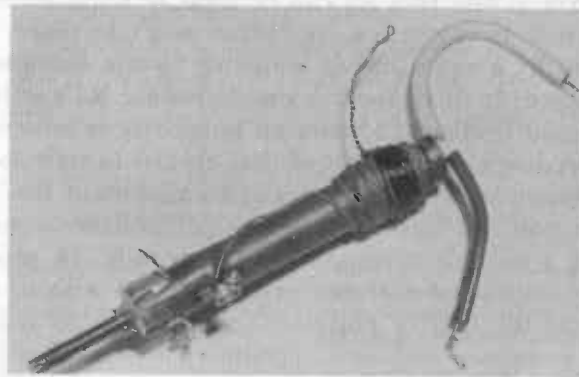

Fig. 307. Coil details. L2 consists of 15 to 20 turns, center-tapped, scramble-wound on top of L1.

direction as the original. The two free ends of the new coil are secured through the holes in the coil form and identified with short lengths of spaghetti tubing. The center-tap is identified by its twisted appearance. A completed coil is shown in Fig. 307.

If you assemble a breadboard version of the receiver, you can use a standard size potentiometer for R1 and a regular variable capacitor for C2. The power supply (B1) may be either four flashlight (or penlight) cells connected in series or a single 6-volt battery. On the other hand, if you prefer to assemble a compact pocket-size version, perhaps similar to the *Pocket-Pal* shown in Fig. 306, you should replace R1 with a miniature control and C2 with a subminiature variable capacitor. In addition, a smaller battery should be used. Although a 6-volt battery is specified, a small 9-volt battery will give acceptable performance and is easier to fit within the limited space of a pocket-sized case.

Once the wiring is completed and checked for errors, connect phones (400 to 2,000 ohms impedance) to the output terminals. Again, a crystal headphone may be used if a small resistor (2K to 4.7K, 1/2 watt) is connected in parallel with the phone leads. An external 50 to 100 foot antenna should be used, although it may be possible to receive local stations with an improvised antenna made, for example, by clipping the receiver's antenna lead to a water faucet, radiator, or window screen.

To operate the receiver, set R1 to its maximum resistance position and tune carefully with C2. Listen for a station in the headphone. When a station is received, readjust R1 and C2 for best reception. You'll find that R1 can be used, to some extent, like a volume control. In some cases, oscillation may take place. This can be identified by a squealing or whistling in the headphone as a station is tuned. If this happens, simply reduce R1's setting, thus reducing signal feedback. Maximum sensitivity is achieved when the signal feedback is just short of that needed to start oscillation.

Don't hesitate to try other types of transistors in the basic circuit. Often, you can improve receiver performance considerably by selecting a suitable transistor experimentally. In general, use a p-n-p type with good rf characteristics. If you wish to try n-p-n types, reverse the battery polarity; no other circuit changes are needed.

A COMPLEMENTARY RECEIVER

During the thirties, a general feeling of "the bigger the better" seemed to suffuse the nation. Automobiles were manufactured with four, six, eight, twelve, and, finally, sixteen cylinder engines. Not to be outdone, radio receiver manufacturers introduced sets with four, six, eight, ten, twelve, fourteen, eighteen, twenty, in fact, as high as *thirty* tubes. Some of those twenty to thirty tube sets were quite impressive. Their chassis lit up like a Christmas tree and they put out enough heat to warm a small home. Unfortunately, not all set manufacturers were conscientious in their designs. Often, a number of tubes were included simply to add sales appeal and had no real function in the operation of the receiver. Yours truly encountered one of these sets in the storeroom of a technical school not too long ago. The set still worked seemingly as good as new! But there was something amiss—although the receiver had never been *cannibalized* for parts and, except for age, was in factory-fresh condition, there seemed to be relatively few components for the number of tubes used—some twenty-three all told. After

a brief study, it was decided to try an experiment. Selected tubes were removed one by one. The set continued to operate normally. More tubes were removed. No deterioration in performance—if anything, a slight improvement in sensitivity! Finally, some *fourteen* of the twenty-three tubes had been removed with no apparent change in receiver performance! When the fifteenth tube was pulled, the set's sensitivity dropped slightly and the experiment was stopped.

The experiment described above is another of those exceptions which help prove a rule: in general, *the greater the number of stages in a receiver, the better its sensitivity, all other things equal.*

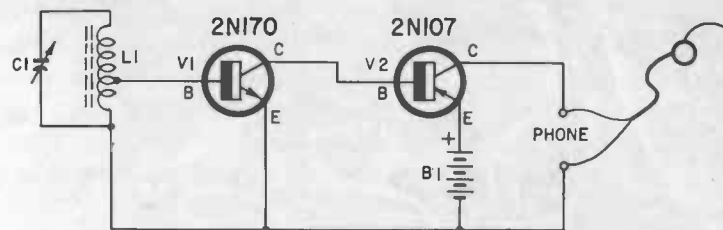

Capacitor: C1—365 μf (pf), variable (J. W. Miller 2111).
Coil: L1—ferrite antenna coil, (J. W. Miller 2000).
Transistors: V1—2N170, n-p-n; V2—2N107, p-n-p.

Battery: B1—6 volts (Burgess type Z4).
Miscellaneous: perforated circuit board; knob; transistor sockets (2); Fahnestock clips; machine screws and hex nuts; wire; solder; headphone; battery holder; terminal strips; rubber feet; etc.

Fig. 308. Schematic of the Complementary Receiver.

The key word, of course, is *in*, for not all the tubes found on the twenty-three tube chassis were actually *in* the receiver circuit—most were simply window dressing.

Having explored, however briefly, the possibilities offered by simple and regenerative single-stage receivers, you might well be in the mood to try your hand at assembling a two-stage design. Such a circuit is given in Fig. 308 and is shown assembled on an experimental circuit board in Fig. 309. Relatively few parts are needed to assemble a duplicate model and these are specified in the parts list.

Circuit description

A glance at the schematic diagram reveals that no fixed capacitors, resistors, potentiometers or similar components are used in the circuit. This economical design was achieved by utilizing the similar but opposite, or *complementary* . . . characteristics of

n-p-n and p-n-p transistors in a direct-coupled arrangement. If the basic circuit seems familiar, don't be surprised. A similar circuit is discussed in Chapter 4 (see Fig. 415). Note the similarities—yet one is an amplifier, the other is an oscillator.

Returning to Fig. 308, the common-emitter configuration is used in both the n-p-n (V1) and p-n-p (V2) stages. Operating

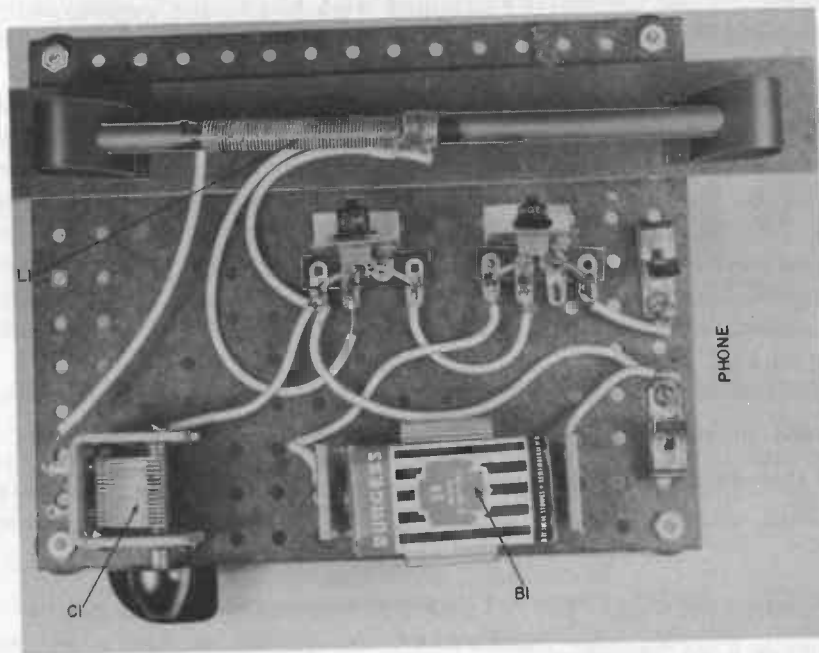

Fig. 309. The Complementary Receiver, wired and ready for use.

power is supplied by a single 6-volt battery (B1). In operation, rf signals are picked up and selected by tuned circuit L1-C1 and applied to V1's base-emitter circuit. A tap on L1 is provided to match the high impedance of the tuned circuit to V1's low input impedance. Operated without an external source of base bias, V1 serves as a detector and amplifier. It delivers an amplified audio signal directly to V2's base-emitter circuit. V1 also serves as V2's source of base bias current. The audio signal is amplified further by V2 and applied to the magnetic headphone serving as V2's collector load.

Construction and modification

As in previous projects, the Complementary Receiver may be

assembled either breadboard fashion, as in Fig. 309, or as a self-contained unit in a small case, depending on individual preferences. The circuit layout is not especially critical. A high gain antenna coil (L1) is specified and this, coupled with the gain of a two stage circuit, should permit the reception of strong local stations in most areas without an external antenna. Moderate impedance (400 to 2,000 ohm) magnetic headphone(s) should be used.

A number of substitutions may be made. Almost any small signal n-p-n transistor may be substituted for V1, and similarly, a number of different p-n-p types may be used for V2. Higher (or lower) battery voltages may be used as long as the transistors' maximum specifications are observed. If desired, a group of flashlight or penlight cells connected in series may substitute for the single battery. Crystal earphones may be substituted for magnetic types if a 4.7K, 1/2 watt resistor is connected across the phone terminals.

Once the basic circuit has been wired and tested, a number of experiments may be performed. For example, a diode may be connected in series with V1's base lead, as in the Light-Powered Receiver covered earlier (types 1N34A, 1N48, 1N95, and so on are quite suitable). An external antenna may be added; use a 100 μ mf mica or ceramic capacitor in series with the antenna lead. V1 and V2 may be interchanged if battery polarity is reversed. As each experiment is tried, note changes in receiver sensitivity, selectivity, and output volume.

A CIGAR BOX PORTABLE

In most cases, complex circuits are evolved simply by combining a number of individual stages. Just as small, individual bricks may be used to erect giant buildings, each stage, then, becomes simply a building block in the overall design. An electronic computer, for example, is made up of a few relatively simple circuits, each of which is repeated hundreds, or even thousands, of times. A similar technique was used in the two-stage Complementary Receiver design we have just examined. It was combined with the Audio Booster circuit of Chapter 2. The resulting schematic is in Fig. 310. The parts needed for assembly are specified in the parts list.

Circuit description

A brief review of the Cigar Box Portable's operation is all that is needed at this time, since we've examined the individual cir-

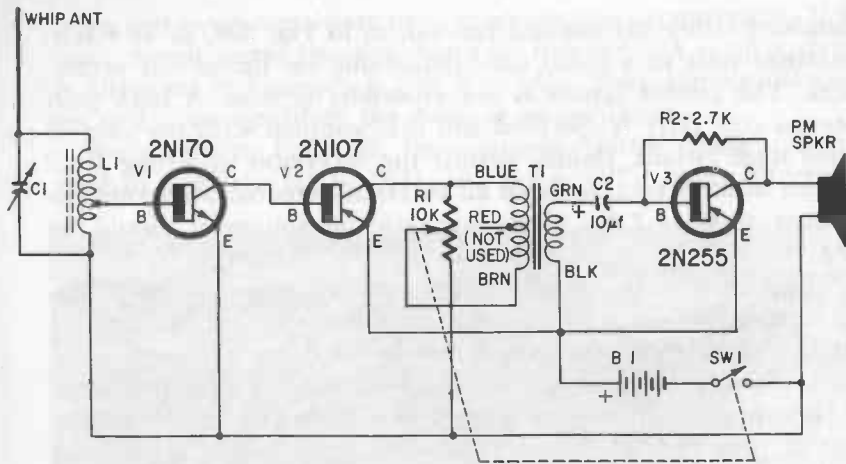

Resistors: R1—10,000-ohm potentiometer with spst switch; R2—2,700 ohms, ½ watt.
Capacitors: C1—365 μf (pf), variable (J. W. Miller 2111); C2—10 μf , 6-volt electrolytic.
Coil: L1—ferrite antenna coil (J. W. Miller 2000).
Transformer: T1—500-ohm CT pri, 8-ohm sec (Argonne AR-164).
Switch: SW1—(on R1).
Transistors: V1—2N170, n-p-n; V2—2N107, p-n-p; V3—2N255, p-n-p, power.

Speaker—4" speaker, 4-ohm voice coil (Utah type SP4D).
Battery: B1—6 volts (Burgess type Z4).
Miscellaneous: perforated circuit board, (4-½ x 2 inches); cigar box; adhesive-backed decorative plastic (Con-Tact); knobs (2); battery holder; power transistor socket; miniature whip antenna; handle; perforated metal or flocked screening (to protect speaker); L-brackets; terminals, machine screws and hex nuts; wire; solder; etc.

Fig. 310. Schematic of the Cigar Box Portable.

cuits in some detail on previous pages. Referring, then, to the schematic, we see that the common-emitter configuration is used in all three stages. Incoming rf signals are picked up by the whip antenna and selected with tuned circuit L1-C1. The selected signal is applied to a two-stage complementary amplifier, V1-V2. Detection takes place in V1, which is operated without base bias. The amplified audio signal delivered by V2, is coupled to the power amplifier, V3, through an interstage matching transformer, T1, and capacitor C2. A variable resistor, R1, is shunted across T1's primary winding and serves as a gain or volume control. As R1 is adjusted, more (or less) of the audio signal is applied to T1's primary. Finally, V3 amplifies the audio signal still further to drive its collector load, the voice coil winding of a PM loudspeaker. Operating power is supplied by a single 6-volt battery (B1) controlled by SPST switch, SW1, ganged to R1.

Construction and operation

Construction details are shown in Figs. 311 and 312. An old cigar box covered with colorful adhesive backed plastic is used as a cabinet for the receiver. The decorative speaker grill is a piece of perforated aluminum, while a drawer pull salvaged from a kitchen cabinet serves as a handle.

A major portion of the circuit, including the complementary amplifier, V1-V2, the interstage transformer, T1, blocking capacitor C2, V3's base bias resistor, R2, and V3 itself are assembled on

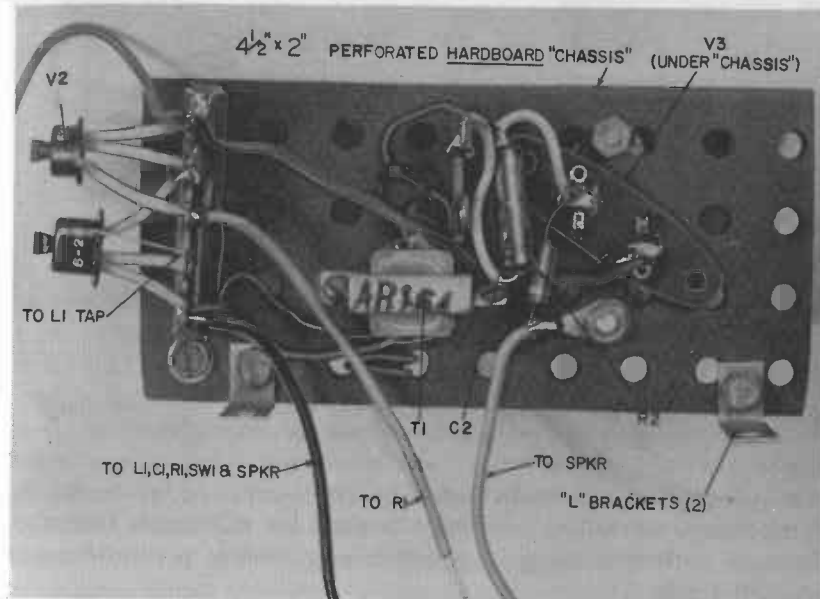

Fig. 311. The basic "chassis" used in the Cigar Box Portable—note that V1 and V2 are soldered in position . . . sockets can be used if preferred, of course. Masonite, hardboard and pressed board are all name variations of the same material.

a small sub-chassis of perforated pressed board, as shown in Fig. 311. In the author's model V1 and V2 were soldered permanently in place on a five-position terminal strip, while a socket was provided for V3. Sockets may be used for all three transistors. Neither circuit layout nor lead dress are especially critical.

The assembled sub-chassis, the pm speaker, the tuning capacitor, (C1), the antenna coil, (L1), the gain control and On-Off switch (R1, SW1), the small whip antenna, and the battery and holder, are all assembled in and on the cigar box, as in Fig. 312.

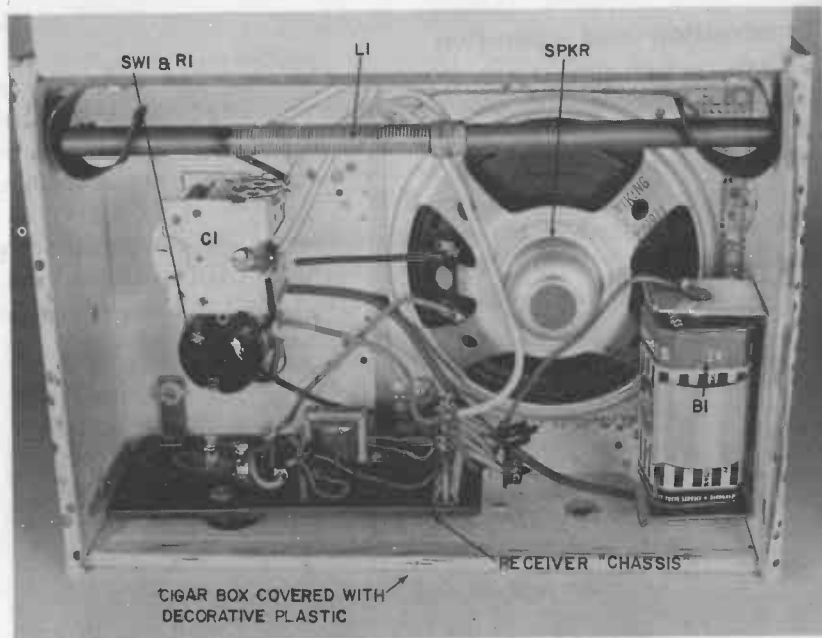

Fig. 312. Interior of the completed Cigar Box Portable. The basic chassis is attached to the cigar box case by means of small "L" brackets.

Machine screws, lock washers, and hex nuts are used for mounting these components. Hook-up wire is used for all circuit interconnections, with insulating spaghetti tubing used to protect bare or exposed leads.

Once the wiring is completed, all connections should be double-checked for errors, poorly soldered joints, and accidental shorts *before* the battery is installed. A dab of red fingernail polish or model airplane dope on the battery holder next to the positive terminal will help insure correct polarity when installing replacement batteries. Knobs should be mounted on the two control shafts.

To use the completed receiver, first extend the whip antenna. Turn the set *on* and adjust for full volume. Tune C1 over its entire range, adjusting this control slowly so as not to miss weak stations. Once a station is tuned in, rotate the receiver. The high gain loop antenna coil has a decided directional characteristic; thus, better pick-up is obtained when this coil is properly oriented with respect to the broadcasting station's antenna. Under good

conditions, the Cigar Box Portable should provide adequate speaker volume on strong local stations. For more distant reception, however, or in poor signal areas, it may be necessary to use a somewhat longer external antenna to supplement the built-in whip antenna.

THE POCKET SUPERHET

In the early days of radio broadcasting, most receivers were simple detectors coupled to tuned circuits and long outside antennas and driving magnetic headphones. Average receiver sensitivity was somewhat less than that of the basic receiver in Fig. 111 or of the Light-Powered Receiver described earlier in this Chapter. A variety of techniques were used to obtain the last bit of performance—high impedance, sensitive headphones, large, high "Q" tuning coils, and exceptionally long antennas.

Later, with the introduction of the triode vacuum tube, it became possible to amplify both the rf and detected audio signals. Regenerative and reflex* circuits became popular, and sets were designed with several stages of tuned radio frequency amplification (abbreviated trf.). It wasn't too long, however, before practical difficulties were experienced. Each time an additional rf stage was added, tuning became more difficult, for all the stages had to be tuned to the *same frequency* to receive a single station and the tuning elements had to stay matched as different stations were tuned. Other problems were encountered . . . mechanical problems in coupling several variable tuning elements to insure matched operation or correct *tracking*, circuit problems in the form of overall instability and generally poor individual stage performance. From a strictly technical viewpoint, it is much easier to design and assemble a tuned amplifier that operates efficiently at a *single frequency* than one that can be tuned to a number of different frequencies.

Many of these problems were solved with the invention of the *superheterodyne* (abbreviated superhet) receiver in the 1920s by Edwin H. Armstrong. In this type of set, all incoming signals, after preselection by suitable tuned circuits, are converted into a fixed frequency signal by a mixing or *heterodyning* action (hence the name). This is accomplished by combining the incoming signal with a locally generated rf carrier signal in a non-linear device

* *Reflex*—A circuit in which a single stage is used to amplify two different types (frequencies) of signals at the same time, such as rf and audio signals, and in which the second signal is a modified (or detected) version of the first.

(often, a modified amplifier stage). The output of the *mixer* contains both original signals as well as their sum and difference frequency signals. One of these, usually the difference frequency signal, is selected and amplified by one or more *fixed tuned* amplifier stages. Since the newly developed signal is intermediate between the original rf signal and the finally detected audio signal, it is called the *intermediate frequency* (abbreviated if). Appropriately enough, the fixed tuned amplifiers are called *if amplifiers*. After if amplification, the signal is detected and amplified using the same techniques employed in the earlier trf receivers. The preselector and local oscillator tuning elements are coupled mechanically in such a way that the difference frequency between the two is always the same, assuring that a proper signal is delivered to the if stages.

Today, the superhet circuit is the accepted standard. Superhet designs are used in radar and television receivers, communications sets, and remote control and telemetering systems as well as in broadcast band receivers. The schematic diagram of a low-cost, easily duplicated 3-transistor superhet receiver is given in Fig. 313. The components needed for assembly are listed in the parts list. This design is especially suitable for the assembly of a home-built, high gain pocket receiver.

Circuit description

Referring to the schematic diagram, we see that p-n-p transistors in the common-emitter configuration are used in all three stages. V1 and V2 are rf transistors, V3 an audio type, while a semiconductor diode, D1 is used as a detector. In a superhet circuit, the audio demodulator is often called a *second detector*, with the mixer stage (where the if signal is developed) considered the *first detector*, due to the fact that *both* the demodulator and the mixer are operated as non-linear devices.

In operation, incoming rf signals are picked up and selected by tuned circuit C1-a-L1. A step-down secondary winding on L1 couples the high impedance tuned circuit to the moderate impedance base-emitter circuit of mixer V1, with the signal delivered through L2's secondary winding and dc blocking capacitor C3. V1's base bias is supplied through R1, in conjunction with stabilizing emitter resistor R2, bypassed by C4. The first stage, V1, serves as a local oscillator in addition to its role as a mixer, with oscillator coil L2, tuned by C1-b, serving to provide the feedback between collector and base circuits needed to start and maintain oscillation. Used in this fashion, that is, as a combination mixer-

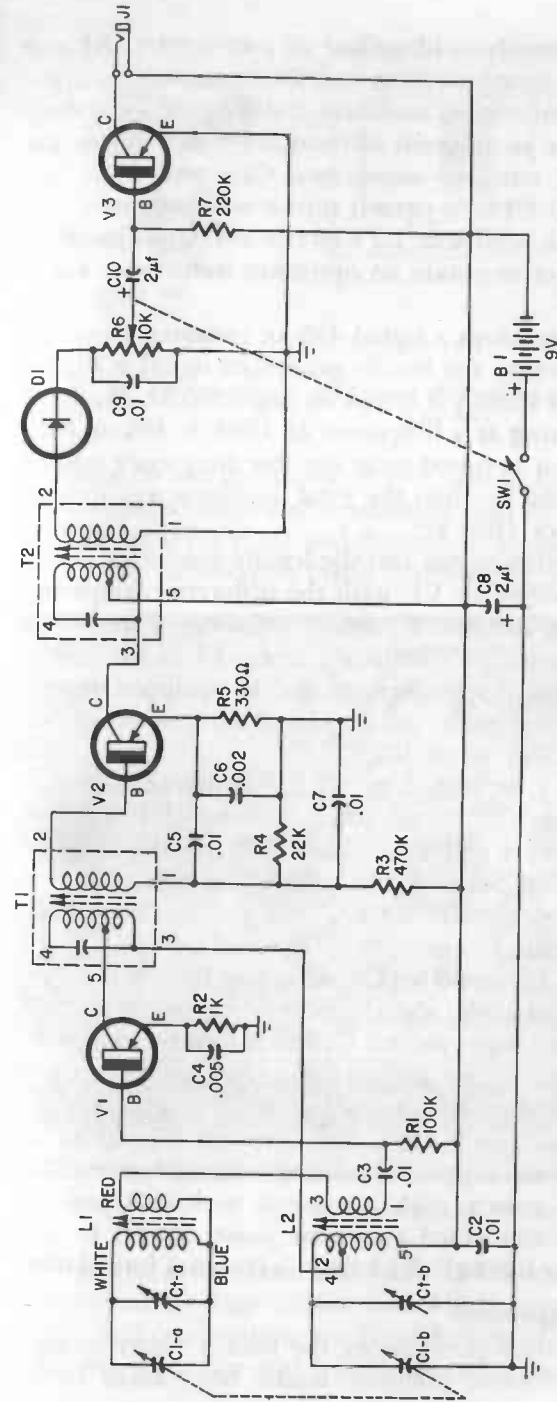

Resistors: R1—100,000 ohms; R2—1,000 ohms; R3—470,000 ohms; R4—22,000 ohms; R5—330 ohms; R6—10,000-ohm potentiometer (audio taper) with spst switch; R7—220,000 ohms; R8—10,000-ohm potentiometer (audio taper) with spst switch.

Capacitors: C1—2-gang variable (to match L1 and L2) (Argonne AR-93); C2, C3, C5, C7, C9—.01 μf; C4—.005 μf; C6—.002 μf; C8, C10—2 μf, 15 volts, electrolytic.

Coils: L1—antenna coil to match C1-a (Argonne AR-69); L2—oscillator coil to match C1-b (Argonne AR-98).

Transformers: T1—455 kc input if (Argonne AR-60); T2—455 kc output if (Argonne AR-71).

Transistors: V1—2N136, rf type p-n-p; V2—2N135, rf type p-n-p; V3—2N107 p-n-p.

Diode: D1—1N48.

Switch: SW1—spst (on R6).

Jack: J1—miniature earphone jack to match earphone plug.

Battery: B1—9 volts (RCA VS309).

Miscellaneous: Etched circuit board; knobs; transistor sockets (3); fuse clip (to fit battery) or battery holder; case; battery connector; machine screws and hex nuts; wire; solder; etc. (C1-a, -b, L1, L2, T1 and T2 are available as a matched set—Lafayette MS-828).

Fig. 313. Schematic diagram of the Pocket Superhet . . . a 3-transistor receiver with good selectivity and gain.

oscillator, the stage generally is identified as a *converter*. Rf and local oscillator tuning capacitors C1-a and C1-b, respectively, are ganged together mechanically to maintain a difference frequency at the if value of 455 kc as different stations are tuned across the broadcast band. Small trimmer capacitors, Ct-a and Ct-b, are shunted across C1-a and C1-b to permit minor adjustments to insure correct tracking. In addition, L2's ferrite core is adjustable, thus allowing the builder to obtain an optimum inductance value for circuit operation.

The local oscillator develops a signal 455 kc removed from the incoming signal. In practice, the locally generated signal is *higher* in frequency. Thus, if a station is tuned at, say, 1360 kc, the local oscillator will be operating at a frequency of $1360 + 455$ or 1815 kc. Similarly, if a station is tuned near the low frequency end of the broadcast band at 600 kc, then the local oscillator will deliver a signal at $600 + 455$ or 1055 kc.

Next, the selected station signal and the locally generated signal are combined and amplified by V1, with the difference frequency (or if) signal selected by the tuned primary winding of interstage transformer T1 serving as V1's collector load. T1 is identified, appropriately, as the first if transformer, and is equipped with a step-down secondary winding to match the moderate input impedance of the if amplifier stage, V2.

The 455 kc if signal is amplified by V2 and delivered through the second if transformer, T2, to the diode detector, D1. T2, like T1, is tuned to the if value and serves both to select the if signal and to match interstage impedances. Stabilized base bias current is supplied to V2 by voltage divider R3-R4, bypassed by C5 and C7, in conjunction with emitter resistor R5, bypassed by C6.

Volume control R6, bypassed by C9, serves as D1's load, with a portion of the detected audio signal (depending on its setting) coupled through dc blocking capacitor C10 to the audio amplifier, V3. The audio amplifier, in turn, delivers its output signal through jack J1 to the external magnetic earphone which serves as V3's collector load. V3's base bias is furnished through R7, while all operating bias currents are supplied by a single 9-volt battery, B1, controlled by a SPST switch (SW1) ganged to R6. Bypass capacitors C2 and C8 are connected across the power supply to prevent interstage coupling through the battery's internal impedance.

Construction and alignment

Depending on individual preferences, the Pocket Superhet may be assembled on a perforated phenolic board, on a small metal

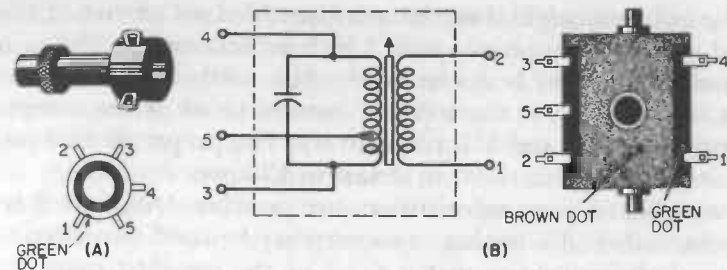

Fig. 314. Oscillator coil (a) and if transformer (b) terminals are identified here.

chassis, or on an etched circuit board. Layout and lead dress are somewhat critical and reasonable care should be exercised to keep all signal leads short and direct and to insure adequate separation between each stage's input and output circuits. Lead connections

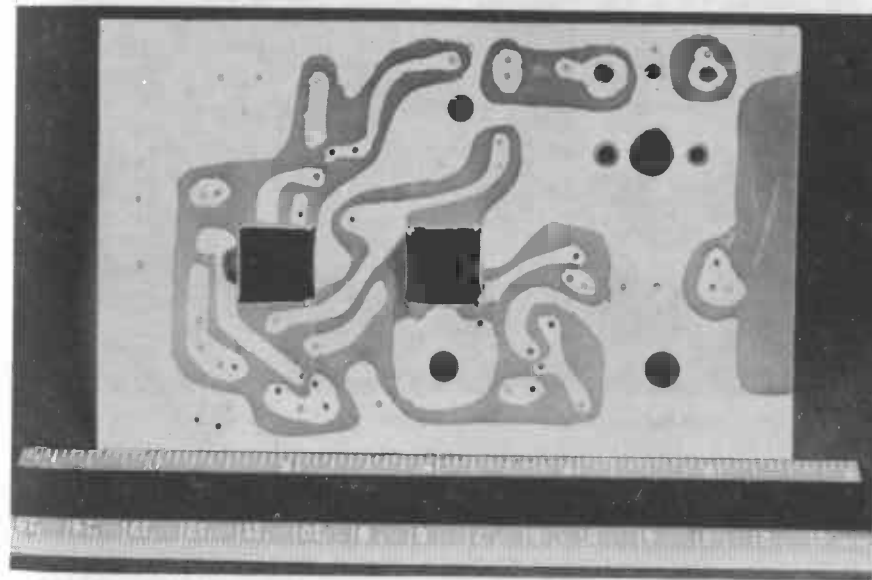

Fig. 315. Etched circuit board layout.

for the local oscillator coil (L2) and if transformers (T1, T2) are identified in Figs. 314-a and 314-b, respectively. The antenna coil (L1) connections are identified by color-coded leads. All electrolytic capacitor and battery dc polarities must be observed.

The author's original model was assembled on an etched circuit board measuring approximately 3 by 5 inches overall. The printed (etched) board used is shown in Fig. 315, while the parts arrangement is illustrated in the top and bottom views of the completed receiver, Figs. 316 and 317, respectively. The preparation of etched circuit boards is described in detail in Chapter 7.

A number of parts substitutions are possible. Different if transformers, coils and a tuning capacitor may be used, provided their electrical characteristics match those of the specified parts. Paper or mica capacitors may be substituted for the ceramic units. A larger battery may be employed (with corresponding increase in battery life). Electrolytic capacitors with values as high as 10 or 12 μf may be used for C8 and C10. Another type of output con-

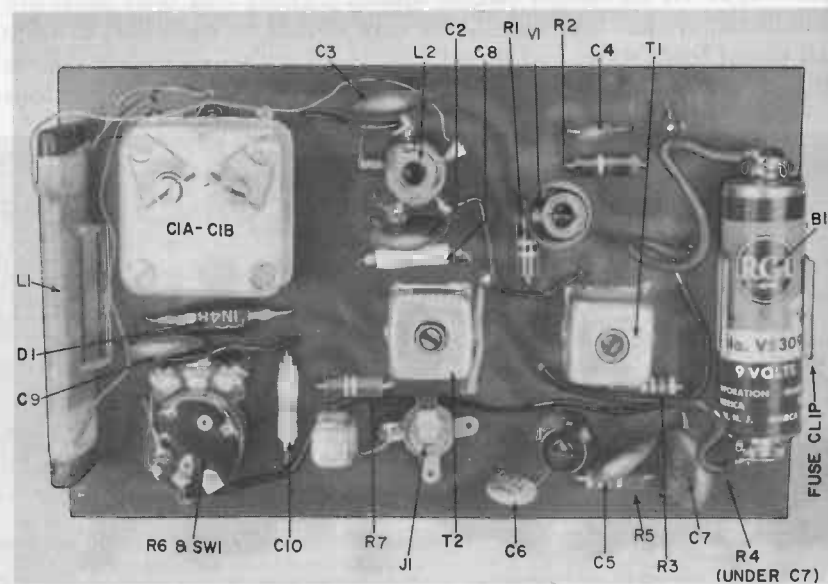

Fig. 316. Top view of the wired Pocket Superhet.

ductor may be used (J1). Other types of transistors may be employed. For V1, suitable replacements are types 2N394, 2N482, 2N520 and 2N615; for V2, suitable substitutes are types 2N139, 2N394, 2N409, and 2N614; finally, for V3, types 2N104, 2N107, 2N218, and 2N402 may be used. Where a substitute transistor is employed, it may be necessary to change the value of its base bias resistor to obtain optimum performance—R1 for V1, R3 for V2,

and R7 for V3. The final value is determined by experiment after trying both larger and smaller values.

Once the wiring is completed and checked for accuracy, the pocket superhet, in common with all superhet receivers, must be *aligned* for best performance. In this process, the fixed tuned circuits (if transformers) are peaked to the if frequency and the variable tuned circuits are adjusted for proper tracking over the band. For this job, a *signal generator* and suitable insulated alignment tool are required.

Before starting alignment, however, the wired receiver should be given a cursory operational test. The battery is installed and a

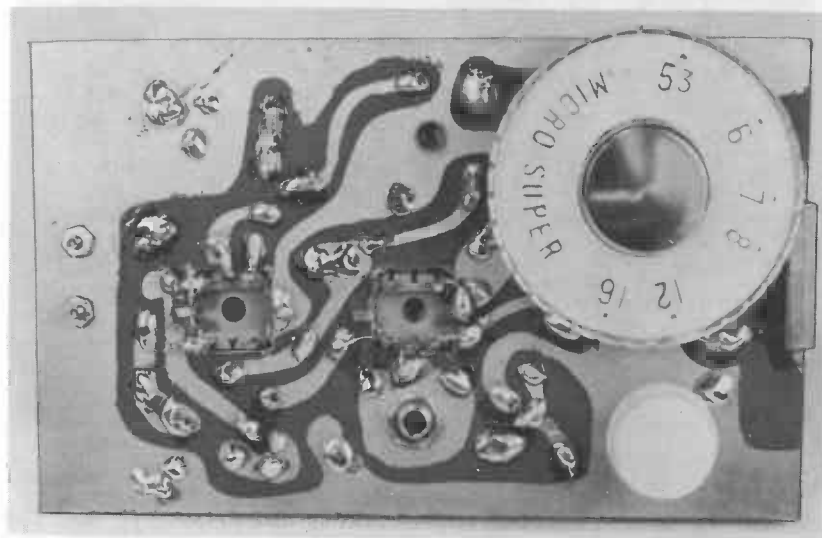

Fig. 317. Bottom view of the Pocket Superhet . . . compare this with the top view (Fig. 316) and with the basic etched board.

1,000 to 6,000 ohms impedance magnetic earphone connected to output jack J1. The set is turned on and adjusted for maximum volume. The tuning control is turned gradually throughout its entire range. It may be possible, at this point, to tune in one or two local stations. If the receiver is completely *dead* (no signal or sound of any kind), or if squealing and oscillation occurs, it indicates trouble, either a defective part, a poor connection, or a wiring error. Any defects should be found and corrected *before* alignment.

Proper alignment technique is illustrated in Fig. 318, and may be carried out using a simple step-by-step procedure, as follows:

(a) With the signal generator warmed up, set for a modulated rf signal at the if (455 kc). Couple the signal generator to the receiver's antenna coil by clipping the output lead to one end of



Fig. 318. Aligning the Pocket Superhet.

the coil (a direct electrical connection is *not* necessary) and the ground lead to circuit ground. As an alternative technique, the signal generator's output cable may be connected to a small coupling coil made up of ten to twelve turns of hook-up wire in a coil about three inches in diameter. This coil is placed near the receiver's antenna coil (L1).

(b) The receiver is turned on and tuned towards the low frequency end of its band. With the volume control at a maximum and listening to the earphone, adjust the if transformer (T1 and T2) cores with an alignment tool for maximum output. Use a *minimum* input signal, readjusting the signal generator's output attenuator as necessary to permit a barely audible tone in the earphone. Repeat the adjustments as necessary to correct for interaction.

(c) Shift the signal generator's output frequency to 1600 kc and, using the receiver's calibrated dial as a guide, tune the set to the same frequency. Next, adjust the oscillator trimmer capacitor, Ct-b, (Fig. 313), for maximum output.

(d) Shift the signal generator's output frequency to 550 kc and, *rocking* the receiver's tuning control about this frequency, adjust L2's core for maximum output.

(e) Shift the signal generator's output frequency to 1400 kc and tune in the signal on the receiver. Adjust the antenna trimmer capacitor, Ct-a, (Fig. 313), for maximum output.

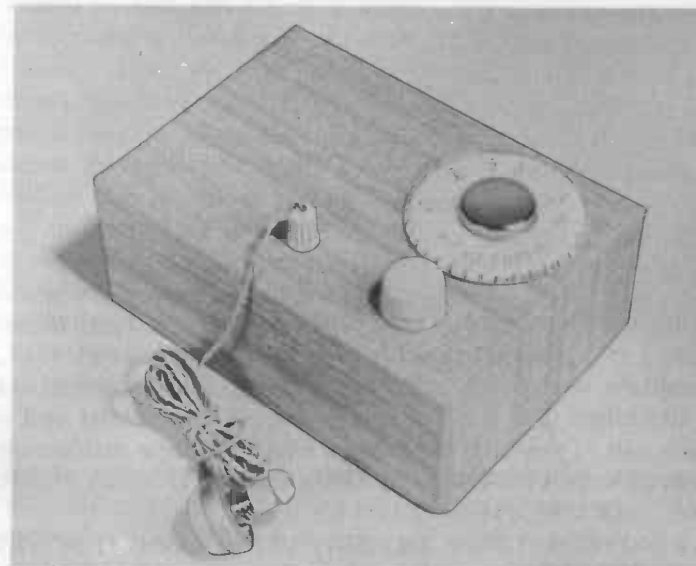

Fig. 319. The Pocket Superhet mounted in a small wooden box . . . if preferred, a plastic case may be used.

(f) Repeat steps (c), (d) and (e), above, at least twice, using a modulated rf signal in each case, and adjusting the signal generator for the least output level that gives an audible tone in the earphones. With this, the set's alignment is completed.

Under normal conditions, an external antenna is not required for the reception of strong local stations, and the tested and aligned receiver may be mounted in a small plastic or wooden case as a self-contained pocket set. The receiver is shown in a wooden case in Fig. 319. A metal case is *not* acceptable as this will detune the receiver and shield the antenna coil.

CHAPTER 4

How to build gadgets & gimmicks or other uses for transistors

During the Depression Years, when money was in short supply and nearly everyone limited his cash purchases to food, rent, and the essentials, writers for many popular magazines favored articles which described new ways of using items that normally end up in the trash can. Typically, magazines would feature articles on . . .

TWENTY WAYS TO USE OLD CLOTHES HANGERS

HOW TO USE OLD BOTTLE CAPS

MAKE YOUR OWN GLASSWARE FROM DISCARDED BOTTLES

SALVAGING TIN CANS FOR SHOP PROJECTS

8 - COUNT 'EM - 8 WAYS TO USE OLD TOOTHPASTE TUBES

Most of the projects described in such articles were quite worthwhile but, occasionally, authors would go to extremes in their efforts to discover new applications for used and second-hand material. In an article on using old thread spools, for example, one writer suggested:

"Gather about seventy spools and cement end to end with waterproof glue. Use large spools at one end, tapering to smaller spools at the other end. Once the cement has set hard, reinforce the assembly by passing a steel rod through the center holes, securing in place with countersunk nuts at each end covered with Plastic

Wood. File or sand the rims off the spools to form a smooth, tapering surface. At the large end, wrap on two layers of overlapping one inch cloth tape, starting about two inches from the end and continuing for a length of about eight inches. Finally, cover the entire assembly with two or three coats of a good quality outdoor varnish."

The result of so much time, toil, and effort?

A fair-to-middling fishing pole—almost as good as one that could be obtained by cutting a limb from a nearby tree!!

* * * * *

Transistors, too, can be used in unusual applications. For example, the author has a pair of cuff-links, a gold-plated lapel pin, and a handy plastic-encased paper weight—all made with defective transistors. Chances are that you would have no difficulty in developing a number of similar uses—small transistors might be used as buttons, for example, while heavy power transistors should be suitable for use as sinkers for fishing lines.

On a more serious note, however, transistors can be used advantageously in a variety of interesting projects other than audio amplifiers and radio receivers. Typical assemblies include controls, instruments and all types of special-purpose electronic devices. A number of inexpensive, easy-to-build, and quite useful projects are described on the following pages.

A SENSITIVE RELAY

A simple *on-off* switch is the basic control element in most electrical and electro-mechanical equipment. The control may be an electrical switch in the conventional sense or, instead, a solid-state device or electromagnetic relay. Of these, the electrical switch is the simplest and least costly, but requires the application of external mechanical force for operation. Someone or something must flip a lever, push a button, or turn a knob. A solid-state switch, such as a *controlled rectifier*, may be operated with a small electrical signal rather than mechanical force, but is likely to be expensive where the load requires moderate to large amounts of power. An electromagnetic relay, on the other hand, is not overly expensive and, with suitable contacts, can handle fairly large currents. Unfortunately, most relays require moderately strong signals for operation. Some types, for example, may require control powers of many milliwatts, or even watts. Sensitive relays are available, of course, with some units operating on a fraction of a milliwatt, but these are likely to be quite expensive and to have limited power handling capabilities.

The small control-signal requirements of solid-state devices and the power-handling capabilities of electromagnetic relays may be obtained in a single instrument by combining a direct-coupled transistor amplifier with a standard relay. The result is a reliable, inexpensive device capable of handling reasonably large currents, but with a sensitivity ten to twenty times greater than that of the relay used alone, depending on the gain (beta) of the transistor. A

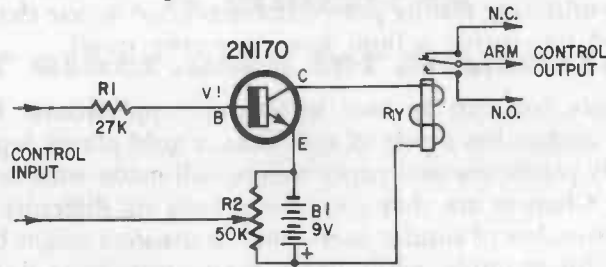

Resistors: R1—27,000 ohms, ½ watt; R2—50,000-ohm potentiometer.
 Transistor: V1—2N170, n-p-n.
 Battery: B1—9 volts (Burgess type 2N6).
 Relay: RY—4,000-ohm coil, contact rating 1.5 amps, 28 vdc (Advance SO/1C/4,000D).
 Miscellaneous: perforated circuit board; rubber feet; transistor socket; brackets; knob; Fahnestock clips; battery connectors; machine screws and nuts; wire; solder; etc.

Fig. 401. Schematic of the Sensitive Relay amplifier that has dozens of applications.

suitable circuit for such an instrument is shown in Fig. 401, while the components needed for assembling a duplicate unit are specified in the parts list. A Sensitive Relay of this type may be used in an almost unlimited number of applications, as we shall see later, depending on the skill and imagination of the individual user.

Circuit description

Referring to Fig. 401, a n-p-n transistor, V1, is used in the common-emitter configuration as a single-stage amplifier. V1's collector load is the coil of an electromagnetic relay, RY. An adjustable base bias is obtained from potentiometer R2 and furnished to V1 through the external control circuit and series limiting resistor R1. Operating power is supplied by a single 9-volt battery (B1). The relay's contacts are used as a simple switch to actuate an external device, such as a motor, solenoid, lamp, bell or buzzer.

In operation, the Sensitive Relay may be used either as an *open-circuit* or *closed-circuit* control, depending on the requirements of the intended application. With the open-circuit mode of opera-

tion, the *control input* terminals are normally open, and both base and collector currents are essentially zero. Under these conditions, the relay is open and its armature (ARM) contact bears against its normally closed (NC) contact. A control signal is applied by closing the *control input* terminals through an external device, such as a microswitch, photocell, or similar *sensor*. This permits a flow of base current and a corresponding, but amplified, flow of collector current, closing the relay and transferring the armature to the normally open (NO) contact. The external output device and its power source are connected through the relay's armature and either the NC or NO contacts, depending on the type of action needed.

As you might expect, the closed-circuit mode of operation is exactly the reverse. Here, the *control input* terminals are normally closed by the external sensor and both base and collector currents flow, closing the relay and holding the armature against the NO contact. Circuit operation is initiated by an open (or considerable increase in resistance) in the control circuit, reducing base and collector currents and allowing the relay to drop out. The armature transfers to the NC contacts. A closed-circuit control is often called a *fail safe* system, for a *failure*, or open, in the control circuit initiates equipment operation. It is the preferred method of operation for many applications even though battery power is used continuously. Typically, closed-circuit systems are used to control power machinery and in burglar alarm installations. In the latter case, for example, an intruder cutting a control line to *disable* the system actually sets off the alarm.

In either mode of operation, the instrument's sensitivity depends on the inherent sensitivity of the relay and the gain of the transistor. For example, if the relay requires a coil current of, say, 2.0 milliamperes for operation, and V1 has an effective beta of 10, then the control circuit need handle only 200 microamperes. Similarly, if V1 has a beta of 20, the control current would be only 100 microamperes. V1's base bias current and the control current, of course, are one and the same. Since full battery voltage is available for biasing, depending on R2's adjustment, the control circuit can have considerable resistance: a direct *short* is not needed for operation. This permits the use of a variety of sensing devices on the input side.

Assembly and operation

The Sensitive Relay circuit is shown assembled on an experimental board in Fig. 402. This type of construction may be used

for general tests or, if preferred, the entire circuit may be assembled in a small metal case or box. Neither layout nor wiring arrangement are critical. If assembled as a finished instrument, however, a SPST switch should be connected in series with one of the battery leads to permit the unit to be turned *off* when not in use.

A number of parts substitutions are possible. R1 may have values from 16K to 33K and R2 can be a 25K or 100K unit in-

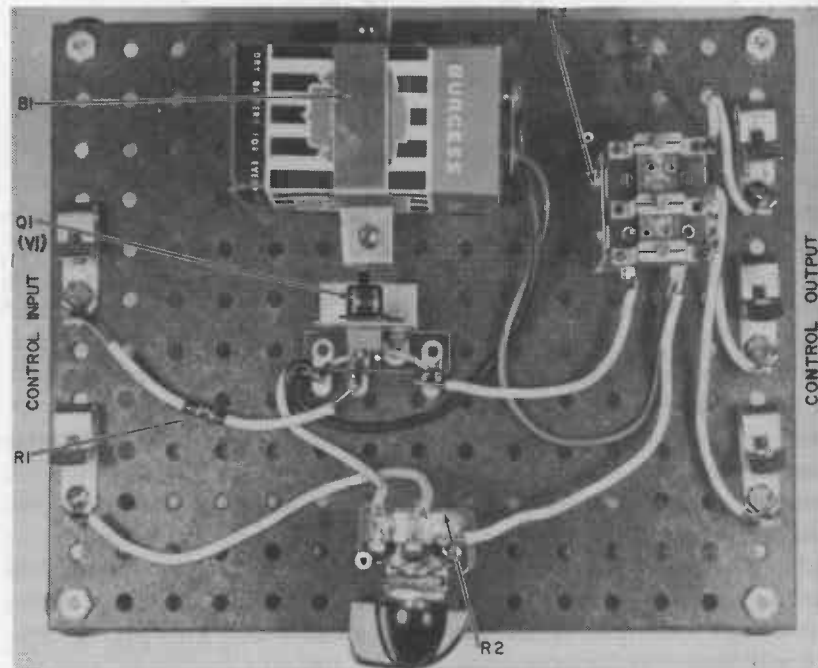

Fig. 402. The Sensitive Relay wired on a perforated board.

stead of the 50K specified. The battery may be replaced with six penlight or flashlight cells connected in series or with a heavy-duty lantern battery. The latter type of power supply is preferred for permanent installations to insure long battery life. Other transistors may be used for V1. Almost any low power type may be used without changing component values, but if a p-n-p unit is employed, the battery polarity must be reversed.

As outlined above, the relay contacts are used as a simple switch to operate an external circuit. The armature (ARM) and either the NC or NO contacts are used, depending on the type of operation needed. Two basic arrangements are illustrated in Fig. 403. Here, the controlled device is an electric bell powered by a standard bell transformer. With the circuit arrangement shown in Fig. 403-a, the bell operates when the relay is open, that is, when

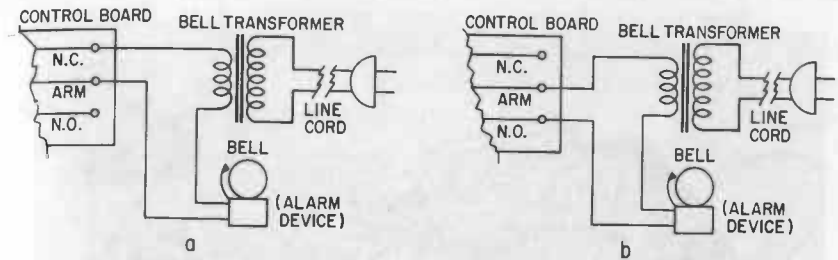

Fig. 403. Connections for using the Sensitive Relay to operate an alarm or signal bell . . . (a) when the relay is "open," or de-energized and (b) when the relay is "closed."

the relay's armature closes against the NC contact. This type of connection generally is used with closed-circuit installations, for an *open* in the control circuit causes the relay to drop out, actuating the alarm device (bell). The arrangement shown in Fig. 403-b generally is used with open-circuit installations. In this case, the bell is actuated when the control circuit is closed and the armature pulls against the relay's NO contact. If necessary for a special installation, both contacts may be used. For example, a single power source may be used to supply either of two output devices. One is turned *on* when the instrument's control circuit is open, the other when the control circuit is closed.

With the wiring completed and checked for errors, the instrument's operation may be tested by connecting a suitable output device (and power source) to the relay's terminals. An electric bell and transformer may be used, as shown in Fig. 404. If preferred, relay operation may be checked by using an ohmmeter or continuity tester connected to the ARM and either NC or NO contacts. The *control input* terminals are shorted together with a piece of hook-up wire. Finally, the bias control adjustment, R2, is turned until the relay closes. This will cause the output device to operate if the ARM and NO contacts were used or to stop operation if the ARM and NC contacts were used. Afterwards, open the input circuit. The relay should drop out.

In a few instances, the relay may close but may not drop out when the input circuit is opened. This will occur if the transistor is excessively leaky. Such a condition may be corrected by using a transistor with less internal leakage, or, in extreme cases, by reducing the relay's sensitivity.

As a general rule, relay adjustments should be made only by a trained technician having access to suitable gauges and special

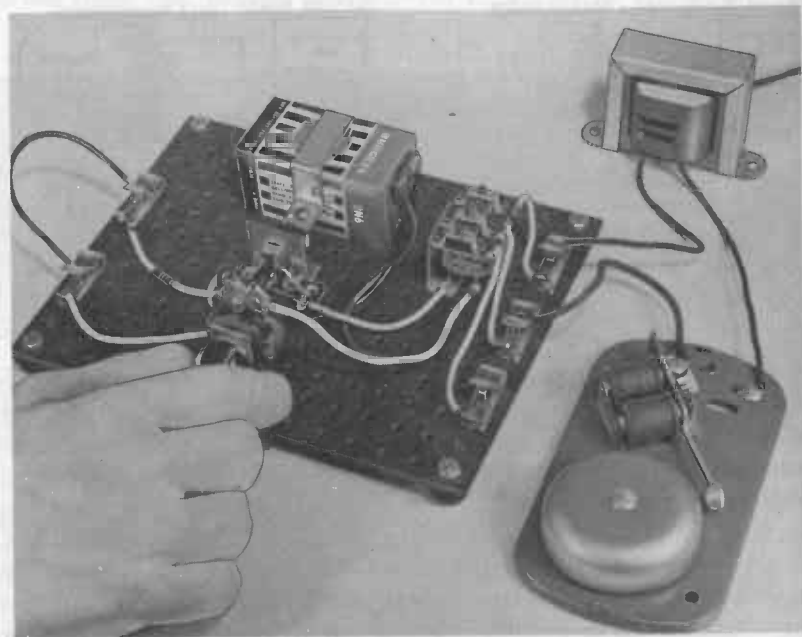

Fig. 404. Adjusting the Sensitive Relay circuit to operate a bell.

purpose tools. In an emergency, however, a relay's sensitivity may be decreased (or increased) by careful readjustment of the NC and NO contact positions and the armature's spring tension. The greater the distance between the armature and the relay's pole (or core) or the stronger the spring tension, the lower the relay's sensitivity, and vice versa.

Applications

Since it is a general purpose control element, the Sensitive Relay's potential applications are virtually unlimited. In general, the only limiting factor is the availability of suitable output and input devices. Any of a number of output devices may be used as long

as the relay's contact ratings are observed (see parts list). Where extremely large load currents or high voltages are to be handled, the Sensitive Relay may be used to operate an external heavy-duty relay. Typical output devices are illustrated in Fig. 405, including a bell, buzzer, lamp, and small motor. Various types of input devices, or *sensors**, are shown in Figs. 406 and 407, including foil tape, simple electrodes, a microswitch, a thermostatic element, a photocell, and a moisture sensitive etched circuit grid.

A typical installation includes a sensor connected to the *control input* terminals (Fig. 401) through a two-conductor cable. The Sensitive Relay and a suitable output device and power source



Fig. 405. Output devices that may be used with the Sensitive Relay . . . electric bell, buzzer, small motor, lamp. In each case, an external source of power (this can be either a heavy duty battery or step-down transformer) must be used to power the device.

are connected to the instrument's *control output* (relay terminals) through a second cable. Either the sensor or output device, or both, may be placed near the Sensitive Relay or in a remote location, depending on operational requirements.

With a suitable choice of sensor and output device, the Sensitive Relay may be used, variously, as a *Burglar Alarm*, *Fire Alarm*, *Liquid Level Indicator* (or control), *Moisture Detector*, *Rain Alarm*, or *Automatic Control*. In a *Burglar Alarm* installation, for example, the closed-circuit mode of operation would be employed,

* *Sensor*—A device which senses an electrical or physical condition, hence the name. Also called transducer.

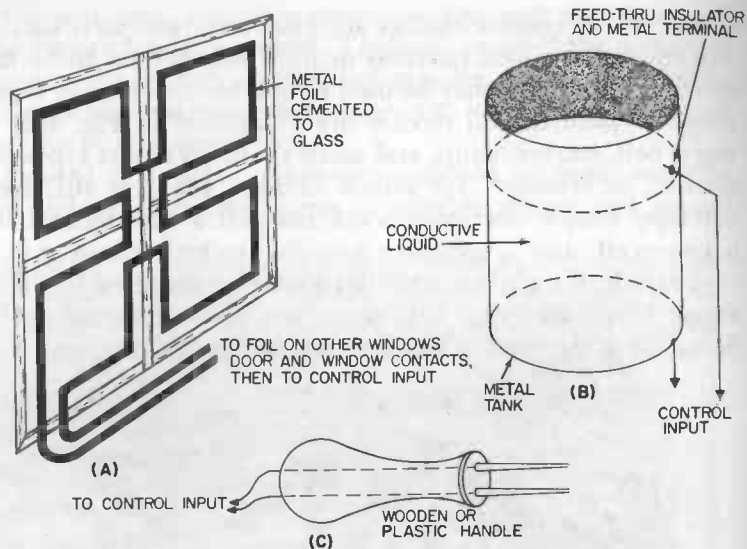

Fig. 406. Sensitive Relay applications . . . (a) as a burglar alarm, (b) as a liquid level indicator, (c) for checking moisture content in bulk products.

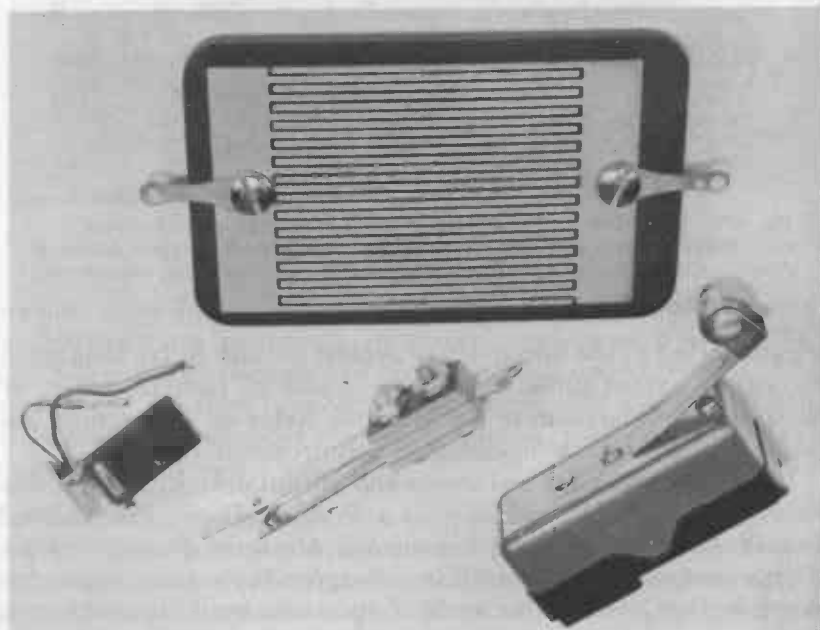

Fig. 407. Input devices for the Sensitive Relay . . . microswitch, thermostatic contact points, photocell, and etched circuit "Rain Alarm."

with the sensor consisting of a closed series circuit of door and window contacts and thin foil tape cemented in a continuous pattern around large glass areas (see Fig. 406-a). In this case, the output device would be an alarm bell, buzzer, or light. A break in the circuit at any point, as may be caused by someone opening a door or breaking a window, causes the relay to open, sounding the alarm. A similar technique would be used in making up *Fire* or *Rain Alarm* circuits, except for the type of sensor used and the mode of operation. In a *Fire Alarm* installation, a closed-circuit system would be employed, with the sensor consisting of

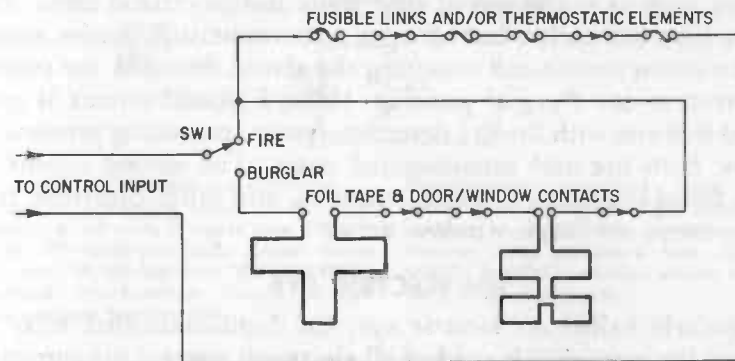

Fig. 408. Schematic of a combination Fire/Burglar Alarm circuit that can be used with the Sensitive Relay. With the SPDT switch SW1 in the Fire position, only the heat-sensitive elements are in the circuit; in the Burglar position, the circuit responds to both an intrusion or fire.

fusible metal links and/or normally closed thermostatic elements. In a *Rain Alarm* system, open-circuit operation would be used, with the sensor a moisture sensitive grid (Fig. 407). In this case, a drop of rain water serves to *bridge* or complete the circuit between alternate conductors, activating the control circuit and operating the alarm.

Other applications are shown in Figs. 406-b, -c. In the first case, the Sensitive Relay is used in conjunction with an insulated electrode mounted on the side of a metal tank to indicate when the liquid contained therein reaches a predetermined level. Either open- or closed-circuit operation may be used, depending on whether the Sensitive Relay serves to operate a signaling device (light or buzzer) or to control a pump. In the second example, a two-electrode probe is used as a sensing device. Connected to the Sensitive Relay, this probe may be used to determine when the moisture content of bulk materials, such as earth, grain, sawdust,

and so on, has reached a predetermined level. The circuit's sensitivity, and hence the moisture level at which the relay operates, can be preset by adjusting R2. The length and separation of the metal spikes are determined experimentally, and will vary with the type of material to be tested and its normal moisture content.

The sensor circuit of a combination *Fire and Burglar Alarm* suitable for a home, office, or small building is illustrated in Fig. 408. During daylight hours, SPDT switch SW1 is turned to the *Fire* position. In this case, the sensor consists of a series circuit of fusible links and/or thermostatic elements placed in strategic locations, such as at the top of stair wells and in critical areas. Excessive heat will melt a link or open a thermostatic element, opening the sensor circuit and actuating the alarm. At night, the switch is thrown to the *Burglar* position. Here, a second circuit is connected in series with the fire detection system, providing protection against *both* fire and unauthorized entry. The second circuit is made up of contacts on doors, windows, and other openings and foil patterns on large window areas.

AN ELECTRIC EYE

Popularly called an *electric eye*, the light-controlled relay is perhaps the most widely used of all electronic control instruments. These units are used in industry for counting, for the automatic control of processing and manufacturing equipment, for product evaluation and inspection, and for protecting workers operating dangerous machinery. A punch press, for example, might be controlled by a light beam aimed across its feed table. If the operator's arms or hands interrupt the beam, the relay automatically stops the press. In homes, offices, and stores, light-controlled relays are used to operate annunciators, control automatic doors, count customers, and to protect the premises against burglars and vandals.

The Sensitive Relay just discussed will serve as an Electric Eye if a self-generating photocell is used as its input sensor. With this arrangement, the series current limiting resistor (R1, Fig. 401) is not needed and may be omitted. The modified circuit is shown in Fig. 409. The photocell (PC) is a selenium Sun Battery similar to the ones used in the Light-Powered Receiver described in Chapter 3. The other components are identical to those used in the Sensitive Relay.

Circuit description

Since the circuit is derived from the one used for the Sensitive

Relay, its operation is quite similar. An n-p-n transistor, V1, is used as a direct-coupled common-emitter amplifier between the photocell sensor, PC, and the electromagnetic relay, RY. An adjustable base bias current is obtained from potentiometer R1 and applied to V1 through the photocell. A single 9-volt battery supplies all operating currents. As before, the relay contacts are used

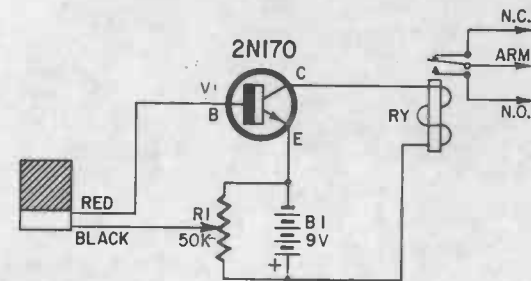

Resistor: R1—50,000-ohm potentiometer.
 Transistor: V1—2N170, n-p-n.
 Battery: B1—9 volts (Burgess type 2N6).
 Relay: RY—4,000-ohm coil, contact rating 1.5 amps, 28 vdc (Advance SO/1C/4,000D).
 Photocell: PC—Selenium photovoltaic cell (International Rectifier B2M).

Miscellaneous: perforated circuit board; rubber feet; Fahnestock clips; battery connectors; brackets; knob; transistor socket; terminal strip; cardboard tube (for light shield); flashlight; machine screws and hex nuts; wire; solder; etc.

Fig. 409. Schematic for an Electric Eye or light-controlled relay.

as a simple switch to control an external electrical or electro-mechanical device.

With R1 properly adjusted and the photocell dark; the base-bias current is relatively small and the corresponding collector current is not sufficient to operate the relay. The armature is held against the NC contact by spring tension. When a strong light falls on PC's sensitive surface, however, its internal resistance drops, permitting an increase in base bias. At the same time, a small voltage is developed by PC which helps to increase the bias current still more. This increase in base bias, amplified by the transistor, results in a large increase in collector current, closing the relay and pulling its armature against the NO contact. If the light is removed (or interrupted), the base bias and collector current drops back to its former value and the relay opens.

Construction

Since neither layout nor lead dress are critical, the Electric Eye may be assembled either on an experimental circuit board, as shown in Fig. 410, or as a self-contained instrument in a metal,

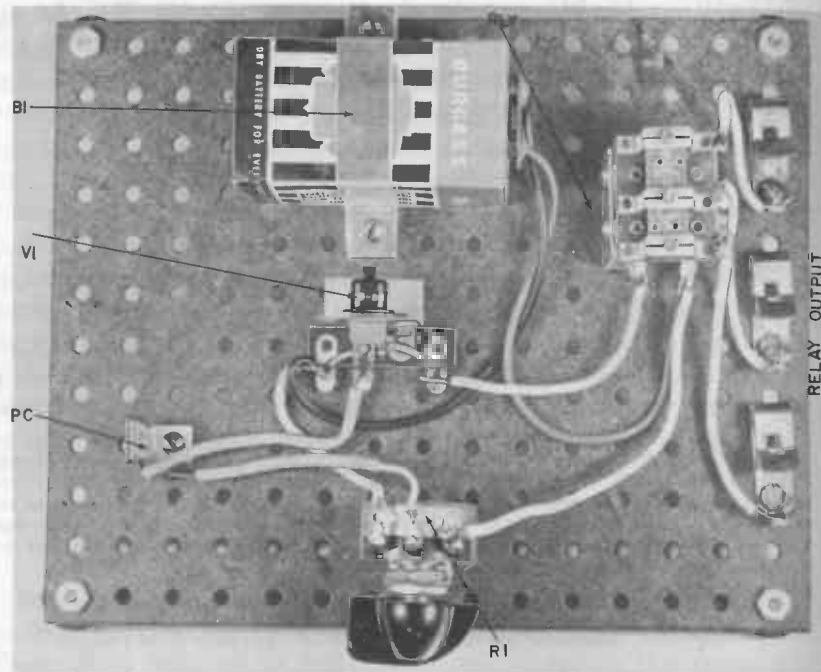

Fig. 410. The Electric Eye wired breadboard fashion.

plastic, or wooden cabinet, as shown in Fig. 411. If only experimental tests are contemplated, breadboard wiring is preferred. On the other hand, if the completed unit is to be used in a permanent or semi-permanent installation, a protective case or cabinet is almost mandatory; in addition, a SPST switch should be connected in series with one of the battery leads to permit the instrument to be turned *off* when not needed. A toggle, slide, or key switch is satisfactory, or, if preferred, a rotary switch may be ganged to the *Sensitivity* control, R1.

As in the Sensitive Relay project described earlier, a number of parts substitutions are possible. R1's value is not critical, and potentiometers with resistances of from 10K to 100K may be used here. Other n-p-n transistors may be used for V1, and p-n-p types may be employed if *both* the battery and photocell (PC) polarities are reversed. Note that PC's polarity is identified by color-coded leads, black for negative, red for positive. Series connected

flashlight or penlight cells may be used in place of the small 9-volt battery. A heavy-duty power supply is preferred, of course, if the instrument is used in a permanent installation.

After the wiring is completed and checked, an opaque plastic or cardboard tube (Fig. 412) should be fitted over the photocell

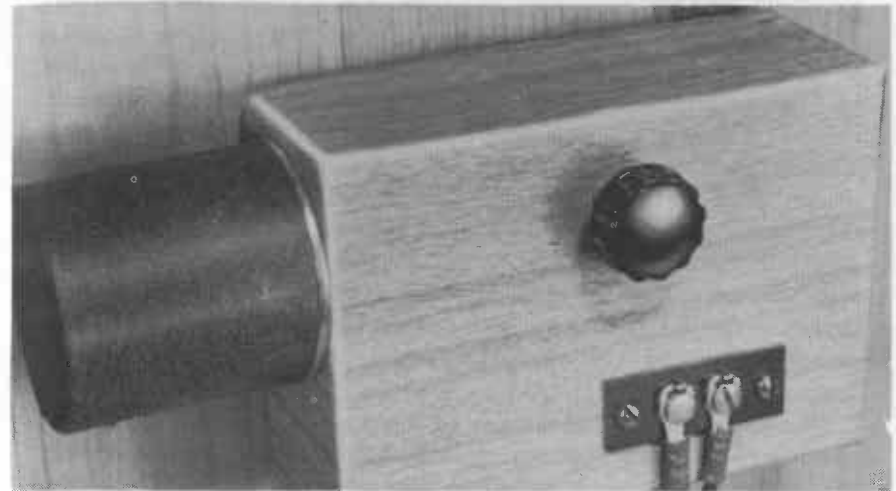

Fig. 411 The Electric Eye circuit assembled in a small wooden box and mounted on a wall. The device may be used as a doorway annunciator or burglar alarm.

to block out extraneous light. One end of this tube should be closed, with the other end left open so that light can fall on the photocell's sensitive surface.

The instrument's operation can be checked by shining a light on the photocell and adjusting R1 until the relay closes. A standard flashlight is an excellent light source. When the light is removed, the relay should open. If the relay remains closed, the transistor may be leaky, the photocell defective, R1 set for too high a fixed bias, or the relay itself may require readjustment. Refer back to the earlier section describing the *Assembly and Operation* of the Sensitive Relay.

Installation and adjustment

The Electric Eye is used with a separate *Light Source*. A small focusing flashlight, since it is equipped with a suitable lens and reflector, is excellent for this application. For permanent installations, the flashlight batteries may be replaced by a small filament transformer.

In a typical installation, the Light Source and Electric Eye are mounted in such a way that the light beam between the two is interrupted whenever circuit operation is desired. Both units are carefully adjusted until the light beam falls squarely on the photocell's sensitive surface. Then, with both units *on*, the Electric Eye's sensitivity control, R1, is adjusted until the relay just closes. Afterwards, an interruption in the light beam will cause the relay to drop out, closing the ARM and NC contacts (Fig. 409), which, in turn, are used as a simple switch to control such electrical devices as a buzzer, bell, signal light, or electromagnetic counter. The output device (buzzer, etc.) is operated on a separate power supply, such as a step-down transformer. If the lamp bulb used in the Light Source and the output device require the same type of power, both may be operated on the same supply. Standard zip-type two-conductor lamp cord may be used for interconnections between the Electric Eye, the output device, and the external power supply, as well as between the power supply and Light Source.

Of course, the actual details of an installation will vary from one job to another, depending on individual needs. For example, the system might be installed to monitor the entrance to a professional man's office, with the relay connected to operate a single-stroke bell or gong. Anyone entering the office would break the light beam, sounding a signal to announce his arrival. A similar system could be used in one-man shops or stores to call the owner. In another case, the system might be used to count the number of people using a given entrance in a department store. Here, the installation would be similar to that of a simple annunciator, except that the relay would be used to control an electromagnetic counter instead of a bell. In still another installation, the system might be used as a Burglar Alarm to protect a critical entrance.

The maximum range at which the Electric Eye will operate effectively depends on such factors as ambient light conditions, R1's setting, the intensity of the Light Source, the relay's adjustment, and the transistor's gain. If a sharply focused, fairly bright Light Source is used, and special pains are taken to adjust R1 for best operation, a range of 12 to 20 feet is typical. However, if a second lens is used to concentrate light on the photocell itself and a very strong Light Source is used, such as a sealed beam spotlight, the maximum range may be extended to 50 or 100 feet, or more.

As a general rule, R1 is adjusted so that the relay closes when-

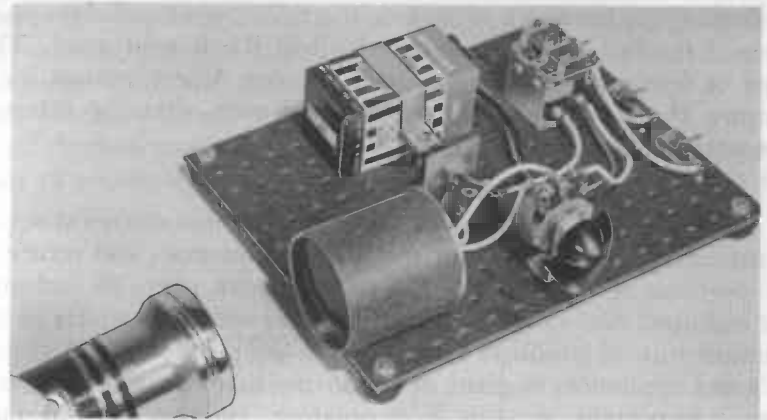

Fig. 412. Testing the Electric Eye with a flashlight. A cardboard tube has been added to shield the photocell (PC) from side light.

ever the light beam falls on the photocell and open whenever the light beam is interrupted. However, under some conditions R1 can be adjusted for a type of self-locking action. Here, the relay remains closed until the light beam is broken. The relay then opens *and remains open* even after the light beam is restored. With a different adjustment, a slightly different self-locking action may be obtained. In the second case, the relay is open *until* light falls on the photocell. Afterwards, the relay closes and *stays closed* even if the light is removed.

Self-locking operation is desirable for some types of installations, as in machinery control and Burglar Alarms, and is made possible by an interesting characteristic of electromagnetic relays. The typical relay requires a *larger* coil current to close the armature than is needed to hold it closed. Referring to Fig. 409, if R1 is adjusted so that the fixed bias (PC dark) is enough to hold the relay closed, but not enough to close it, the relay will remain open until light strikes the photocell. Once light strikes the photocell, however, the relay will close and stay closed, even if the light source is removed (or broken), until R1 is readjusted or until the power supply is opened momentarily. On the other hand, if R1 is adjusted until the relay closes (PC lighted), then backed off to reduce bias so that the light source alone is not enough to close the relay but is enough to hold it closed, the reverse action is ob-

tained. In this case, the relay stays closed until the light beam is broken. Once the beam is broken, the relay opens and stays open, even if the light beam is restored, until R1 is readjusted. This type of operation is desirable in a Burglar Alarm system, for it permits the alarm to continue to sound even after the intruder has passed through the light beam.

AN ELECTRIC TIMER

There are many applications which require that electrical equipment be turned *on* or *off* for specific time intervals and return to its previous condition after the intervals are over. In industry, for example, time-controlled equipment is used extensively in the manufacture of products ranging from simple household chemicals and appliances to giant earth-moving machinery. Proper timing is important, too, in electroplating, etching, and in most chemical processes. At a more personal level, the medical profession uses timed electrical equipment in making x-ray photographs and in radiation, ultrasonic, micro-wave, and electro-shock therapy. But perhaps the prime example of time-controlled equipment is the familiar photographic enlarger used by hundreds of thousands of amateur and professional photographers. Here, accurate timing is essential for proper exposure of the light-sensitive photographic paper.

Generally speaking, mechanical or electro-mechanical clock-like timers are used where relatively long intervals are involved, from several minutes to several hours, for example. On the other hand, where short control periods are needed, from a fraction of a second up to a minute or so, electronic timers are preferred. An effective, but simple and inexpensive, Electronic Timer circuit is given in Fig. 413; the components needed for assembly are listed in the parts list.

Circuit description

The Electronic Timer is basically a special adaptation of the Sensitive Relay circuit described earlier. Referring to the schematic diagram, a n-p-n transistor, V1, is used as a direct-coupled common-emitter amplifier to drive the coil of an electromagnetic relay, RY. Circuit power is supplied by a 9-volt battery. The Electronic Timer differs from the Sensitive Relay in that the sensor used as an input device in the latter has been replaced by a simple R-C network, R1-C1, and that an unbypassed emitter resistor, R2, has been added to increase V1's effective base-emitter impedance and to stabilize circuit performance.

In operation, then C1 is charged by B1 when the SPDT switch, SW1, is depressed. When SW1 is released, C1 is connected to V1's base through control R1, as shown in Fig. 413 and serves as a source of base bias for the transistor, permitting an amplified collector current to flow, closing the relay. The relay then remains closed, with its armature against the NO contact, until the base bias supplied by C1 is no longer sufficient to maintain an adequate collector current. The period during which RY

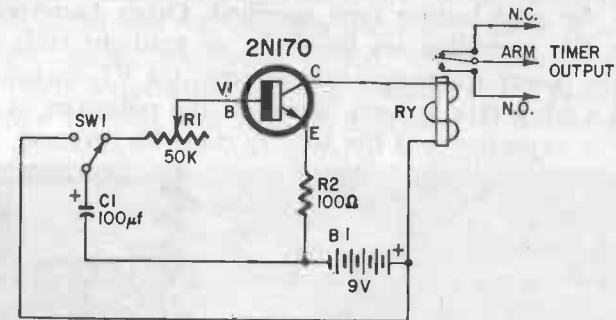

Resistors: R1—50,000-ohm potentiometer; R2—100 ohms, 1/2 watt.
Capacitor: C1—100 μ f, 15 volts, electrolytic.
Switch: SW1—spdt, pushbutton (Switchcraft 103).
Transistor: V1—2N170, n-p-n.
Battery: B1—9 volts (Burgess type 2N6).

Relay: RY—4,000-ohm coil, contact rating 1.5 amps, 28 vdc (Advance SO/1C/4,000D).
Miscellaneous: perforated circuit board; knob; rubber feet; brackets; transistor socket; terminal strips; battery connectors; Fahnestock clips; machine screws and hex nuts; wire; solder; etc.

Fig. 413. Schematic diagram of a simple Electronic Timer.

remains closed is proportional to the R-C time constant of the network made up of C1, R1 and V1's base-emitter impedance. Once C1 has discharged sufficiently, the relay opens and remains open until circuit action is initiated again by depressing SW1 to recharge the capacitor.

The time period during which the relay is closed can be changed by changing any of the component values in the R-C network. In practice, this is accomplished by using a variable resistor for R1. As a rule, the smaller the R-C time constant (and hence the smaller the value of R or C, or both), the shorter the time period, and vice versa. A very large series resistance can not be used for R1, however, since the resulting base bias current will be too small to initiate circuit operation.

Assembly and operation

A breadboard version of the circuit is shown in Fig. 414. This

ta
b
e
t
p
h

r
i
f
r
c

type of construction is best where experimental tests are planned. However, since neither component nor wiring arrangement are critical, the entire circuit can be assembled in a small metal or plastic box if preferred. If the latter type of construction is used, a SPST toggle or slide switch should be connected in series with one of the battery leads as a power ON-OFF switch.

Since the circuit is non-critical, a number of parts substitution may be made. A slide or rotary switch may be used for SW1 in place of the push-button type specified. Other batteries may be used for B1, including six flashlight or penlight cells in series. Other low power transistors may be used for V1, including p-n-p types. If a p-n-p type is used, however, the polarities of *both* the electrolytic capacitor *and* the battery must be reversed.

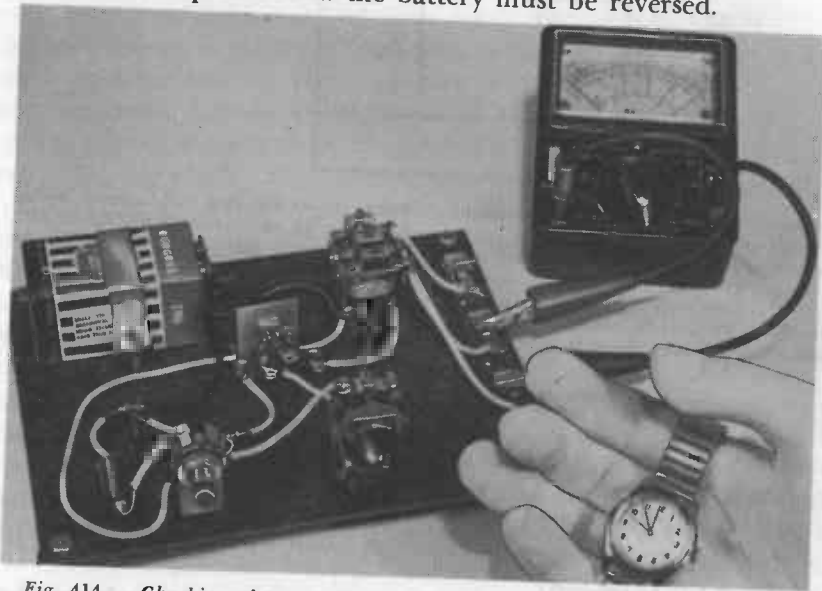

Fig. 414. Checking the operation of the Electronic Timer. The meter is used to indicate when the relay is open or closed.

If desired, the basic circuit may be modified for special applications. The timing range may be changed, for example, by using other values for C1. The larger the capacitor, the longer the time period. In some applications, it may be desirable to provide for several fixed time intervals instead of a continuously adjustable range. Where this is the case, R1 can be replaced with a fixed resistor (or resistors) with different capacitor (C1) or resistor values selected by means of a multi-position switch. In any case,

the timing interval can be checked by connecting an ohmmeter to the relay contacts and using a watch with a sweep-second hand (or stopwatch, if available) to measure the interval during which the contacts are closed (or open), as shown in Fig. 414. A similar technique may be used for calibrating the variable control (R1).

In a practical application, the relay contacts are used as a simple switch to control external equipment. The ARM and NC contacts are used if the equipment is to remain ON *except* during the timed period, the ARM and NO contacts if the equipment is to remain OFF *except* during the timed period. With either connection, the instrument's operation is quite simple. R1 is preset to the desired time interval and SW1 is depressed momentarily, then released. Afterwards, the timing cycle is automatic.

A LIGHT FLASHER

There is no question that a moving object attracts more attention than a stationary one. A trained cobra, for example, is deaf and can't hear music, but it can, and does, follow the movements of the Snake Charmer's body and flute. By the same token, a flashing light is easier to spot than a steady glow, hence the popularity of the former for signaling and alarm displays.

Thermo-electric and electromagnetic light flashers have been available for years and are still used extensively on buses, trucks, and autos and in caution and signal devices. Unfortunately, both types require excessive current for operation. As a case in point, the next time you ride in a car, watch the ammeter needle flick when the directional turn indicators are used. An electronic flasher, on the other hand, may require *less* current for operation than is needed by the lamp bulb alone if used continuously. The schematic of a simple, low-cost transistorized Light Flasher is given in Fig. 415, while the parts needed for constructing a similar unit are specified in the parts list. A self-contained version of this circuit, assembled for use as an auto accessory, can be quite valuable as a caution indicator when a car is stopped for roadside repairs or tire replacement.

Circuit description

Referring to Fig. 415, you should recognize the two-stage complementary amplifier using n-p-n and p-n-p transistors in cascade. The common-emitter configuration is used in both stages. The circuit differs from the amplifiers examined earlier, however, in that the output signal appearing at V2's collector is coupled back

to V1's base through feedback capacitor C1. This simple modification changes the circuit from an amplifier into a type of relaxation oscillator. A 6-volt lamp bulb serves as V2's collector load. R1 provides an adjustable base bias for V1, while all circuit currents are supplied by a single 6-volt battery.

As is common in most relaxation oscillators, circuit operation depends on the charge and discharge of a capacitor—C1 in this

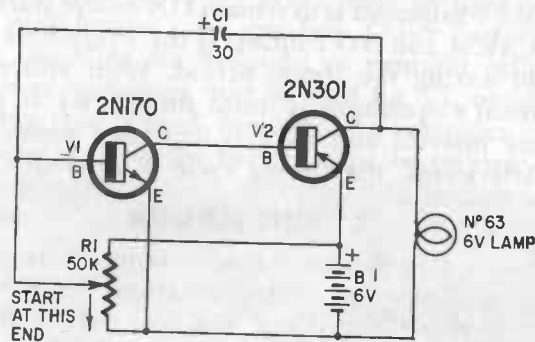

Resistor: R1—50,000-ohm potentiometer.

Capacitor: C1—30 μ f, 6 volts, electrolytic.

Transistors: V1—2N170, n-p-n; V2—2N301, p-n-p power.

Battery: B1—6 volts, heavy duty (Burgess TW1).

Lamp—6 volts (type No. 63).

Miscellaneous: perforated circuit board; transistor sockets; brackets; knob; rubber feet; clearance lamp assembly (with lens and bracket); terminal strips; Fahnestock clips; machine screws and hex nuts; wire; solder; etc.

Fig. 415. Schematic of the transistor Light Flasher.

case. Assuming that neither V1 or V2 is conducting and that C1 is discharged when power is first applied to the circuit, the capacitor starts to charge through the lamp and through R1, applying a reverse bias to V1. This holds V1 in a non-conducting state and, since V1's emitter-collector circuit serves as a source of base bias for V2, holds the second stage (V2) in a high impedance condition. This situation holds until C1 is fully charged. The lamp is dark during this period since C1's charging current is not enough to heat the filament to incandescence.

Once C1 is fully charged, there is no longer a reverse bias developed across R1 and a positive bias can be applied to V1's base-emitter circuit. This shifts V1 to a conducting state which, in turn, applies an operating bias to V2, permitting the second transistor to conduct heavily, lighting the lamp and discharging C1 through V2's emitter-collector and V1's base-emitter circuits. This

condition continues until C1 is discharged, at which time the lamp goes dark and the initial action repeats itself.

The periodic charge and discharge of C1, with corresponding flashing of the lamp, continues as long as power is supplied to the circuit at a rate determined by the R-C time constants of the charge and discharge circuit paths. This, in turn, depends on C1's value, on the transistor impedances, and on R1's setting. In practice, R1 is made adjustable to control the flashing rate.

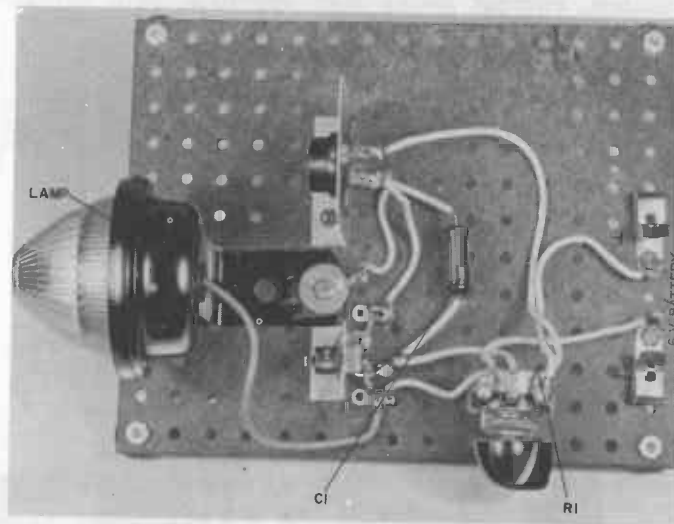

Fig. 416. Breadboard version of the Light Flasher.

Construction

The Light Flasher is shown wired on an experimental circuit board in Fig. 416 and assembled as a self-contained unit in a small plastic box in Fig. 417. In both cases, the construction is simplified by using a commercially available *Clearance Lamp* assembly which includes the 6-volt lamp bulb, a socket, a mounting bracket, and a colored plastic lens. Either type of construction may be used, depending on the needs of the individual worker, although the breadboard version is preferred where circuit tests are planned.

If the self-contained version is assembled, however, a few minor changes should be made in the circuit. First, a SPST switch should be added in series with one of the battery leads to permit the

device to be turned off when not in use; this may be ganged to control R1 if desired. Second, an 8.2K, 1/2-watt resistor should be connected in series with R1's positive lead to prevent the accidental application of excessive bias to V1's base. In the author's version shown in Fig. 417, the plastic box used as a case was drilled to permit mounting directly on the terminals of a lantern battery.

Although the Light Flasher's average current requirements are quite modest, current peaks may approach 500 milliamperes



Fig. 417. The Light Flasher assembled in a small metal box and mounted on a heavy duty lantern battery.

(.5 amp), hence a heavy-duty power source is recommended for optimum performance and maximum battery life. Four standard size flashlight cells connected in series are satisfactory for experimental tests. Before the batteries are connected, however, R1 should be adjusted until the slider arm is against the negative terminal of the potentiometer, as indicated by the arrow in Fig. 415. Afterwards, R1 is readjusted until the lamp starts to flash periodically and is then set for the desired flashing rate.

The basic circuit is relatively fool-proof. If trouble is encountered in obtaining proper operation, however, it may indicate that either V1, V2, or C1 is excessively leaky.

A SIMPLE CODE PRACTICE OSCILLATOR

While most electronics hobbyists prefer to tackle an audio amplifier or a simple receiver as their first construction project, the code practice oscillator is an odds-on favorite with prospective amateur radio operators—or Hams. Supplying an audio tone roughly comparable to the signals heard when a Communications

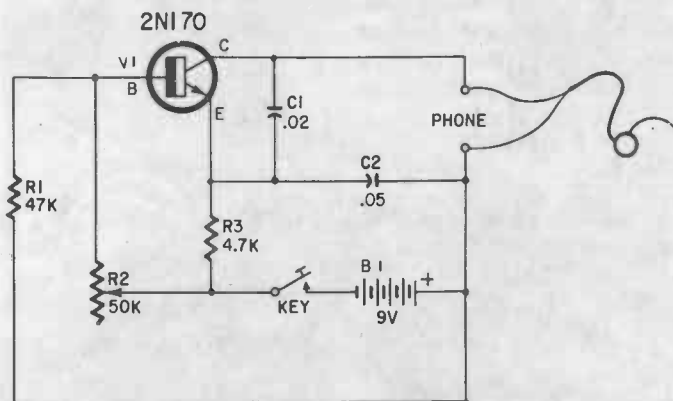

Resistors: R1—47,000 ohms; R3—4,700 ohms (both 1/2 watt); R2—50,000-ohm potentiometer.
Capacitors: C1—.02 μ f; C2—.05 μ f (both paper tubular).
Transistor: V1—2N170, n-p-n.

Battery: B1—9 volts.
Miscellaneous: perforated circuit board; rubber feet; brackets; battery clips; headphones; handkey; transistor socket; terminal strips; Fahnestock clips; machine screws and hex nuts; wire; solder; etc.

Fig. 418. Schematic diagram of an easily assembled Code Practice Oscillator.

Receiver is tuned to a CW (code) station, the oscillator is used for practice in sending and receiving the radiotelegraph code. A working knowledge of the code is needed to qualify for an Amateur Radio Operator's license.

The schematic diagram of an inexpensive unit is given in Fig. 418. Relatively few components are needed, as specified in the parts list. The entire circuit can be assembled in less than an hour by the average worker.

Circuit description

A single n-p-n transistor, V1, is used in the common-emitter configuration as a modified Colpitts oscillator. The stage's operating frequency is determined by a tuned circuit made up of the headphone's inductance and series capacitors C1 and C2. An ad-

justable base bias is supplied by voltage divider R1-R2, while all operating currents are furnished by a 9-volt battery controlled by a standard handkey. R3 has a dual function. First, it operates in conjunction with R1 and R2 to establish a stabilized base bias. Second, it serves to isolate V1's emitter electrode with respect to

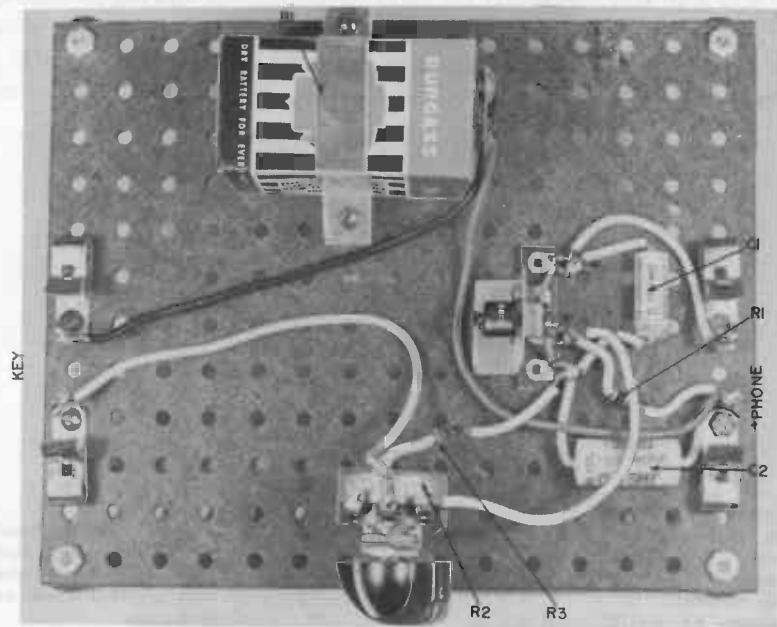

Fig. 419. The Code Practice Oscillator wired on perforated hardboard chassis.

the tuned circuit while, at the same time, providing a dc path for emitter current. For practical purposes, V1's collector and base electrodes are connected to opposite sides of a tuned circuit made up of C1, C2 and the headphone, while the emitter is connected to a capacitive tap at the junction of C1 and C2. This arrangement, then, is roughly analogous to one using a tapped inductance coil and establishes the feedback condition necessary to start and maintain oscillation. Different values are used for C1 and C2 to match the relative impedances of the collector-emitter and base-emitter circuits.

Construction and operation

A breadboard version of the Code Practice Oscillator is illus-

trated in Fig. 419. Circuit layout is not at all critical, nor need special pains be taken to duplicate exactly the wiring arrangement shown. The instrument must be used with a moderate impedance (1,000 to 2,000 ohm) magnetic headphone(s). Since the headphone's inductance is used as an integral part of the oscillator's electrical circuit, the unit will not operate with the headphone removed, nor will it work with a crystal headset.

Once the wiring is completed and checked for errors, the battery can be installed and the headphone and handkey connected,

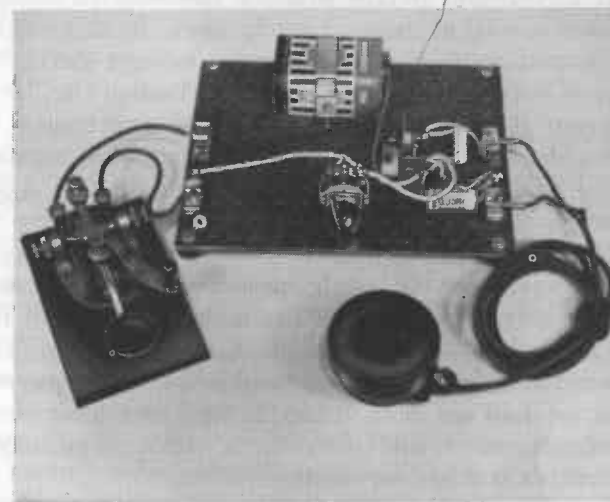

Fig. 420. With key and headphone connected, the Code Practice Oscillator is ready for use.

as shown in Fig. 420. With the handkey closed, R2 is adjusted for best operation. Afterwards, the handkey is used in a conventional fashion to tap out code signals. If a different audio tone (frequency) is desired, other values may be used for C1 and C2 as long as the approximate ratio between the two units is not changed appreciably. Small changes in tone may be made by shunting small capacitors across C1 or C2, or both. Typically, value of 0.001 to 0.01 μf , may be used; working voltages are not critical and either paper or ceramic capacitors are satisfactory.

MULTI-PURPOSE CODE PRACTICE OSCILLATOR

At one time, a pair of headphones was considered the trademark of both amateur and professional radio operators. Short and Long-

wave Communications Receivers were designed for headphone operation only, with the loudspeaker considered a luxury accessory. Many old-timers are openly disdainful of what they often called the *squawk box*. But the situation is changing. Modern Communications Receivers often are factory-equipped with built-in speakers, and, even where the speaker is still considered an optional item, its status has changed from that of a *luxury* to that of a common accessory.

It follows, then, that a prospective radio operator or SWL (Short-Wave Listener) should obtain practice listening to code signals over a speaker as well as through headphones. In this way, he can learn to concentrate on the desired code message through a possible welter of background noises. A Code Practice Oscillator with speaker output is desirable for this type of experience. Such a unit is valuable, too, for group or class practice in sending and receiving the Radiotelegraph code. Here, a single skilled operator can train a fair-sized group.

Fortunately, a single multi-watt power transistor, used as an audio oscillator, can supply ample speaker volume for most applications. A suitable circuit is shown in schematic form in Fig. 421—the parts needed for assembly are listed in the parts list. This particular schematic might well be considered a *multi-purpose* circuit, for, as we shall see later, it can be used as a basic circuit for a number of other electronic instruments with only minor changes in component values and/or wiring.

Circuit description

Referring to the schematic diagram, a p-n-p power transistor, V1, is used in the common-emitter configuration as a modified *tickler-feedback* audio oscillator. An adjustable base bias is furnished V1 through control R2 and current limiting resistor R1. All operating currents are obtained from a single 6-volt battery, B1, controlled by a standard handkey. The collector-base feedback needed to start and sustain oscillation is supplied by means of a small iron-core transformer, T1, through dc blocking capacitor C1. V1's collector load is a parallel circuit made up of T1's *secondary* winding and the voice coil winding of a small PM speaker.

In practice, the feedback signal furnished by T1 is of much greater amplitude than is needed to maintain oscillation. As a result, the circuit operates as a *blocking oscillator* and its repetition rate (frequency) is determined by the R-C time constant of its base-emitter circuit, that is, by the values of C1, R1 and R2.

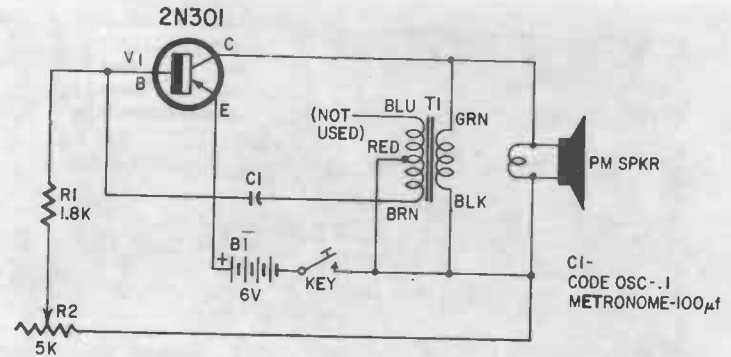

- Resistors: R1—1,800 ohms, ½ watt; R2—5,000-ohm potentiometer.
 Capacitors: C1—.1 μ f, tubular (for Code Practice Oscillator) or 100 μ f (for Metronome), 6 volts, electrolytic (see text).
 Transformer: T1—500 ohms, CT pri, 8 ohms, sec (Argonne AR-164).
 Transistor: V1—2N301, p-n-p power.
 Battery: B1—6 volts (Burgess type Z4).
 Speaker: spkr—4-ohm voice coil, 4-inch PM (Utah SP4D).
 Miscellaneous: perforated circuit board; rubber feet; brackets; battery holder; transistor socket; telegraph key; perforated metal or screening (for speaker protection); machine screws and hex nuts; Fahnestock clips; wire; solder; knob; etc.

Fig. 421. Schematic of a multi-purpose circuit. With speaker output, this can be used as a Code Practice Oscillator or as an Electronic Metronome.

A change in the values of any of these three components will cause a corresponding change in output tone (or pitch). In general, the *larger* the values used, the *lower* the operating frequency, and vice versa. Bias control R2, then, can be used as a *tone* control, permitting the operator to select whatever pitch he finds most pleasing to his ear.

Construction and operation

With neither layout nor lead dress critical, the instrument may be assembled as a self-contained unit in a small plastic, wooden, or metal cabinet or, if preferred, may be wired breadboard fashion on an experimental circuit board, as in Fig. 422. If the latter type of construction is used, the speaker may be secured to the circuit board with small "L" brackets and standard machine screws and nuts. For safety's sake, the speaker's voice cone should be protected against accidental punctures or tears with a stiff cover. A small piece of perforated aluminum or wire screening may be used for this job. The transformer connections are identified by color-coded leads. Since its working voltage is not critical, C1 may be either a low-voltage ceramic unit or a familiar paper capacitor.

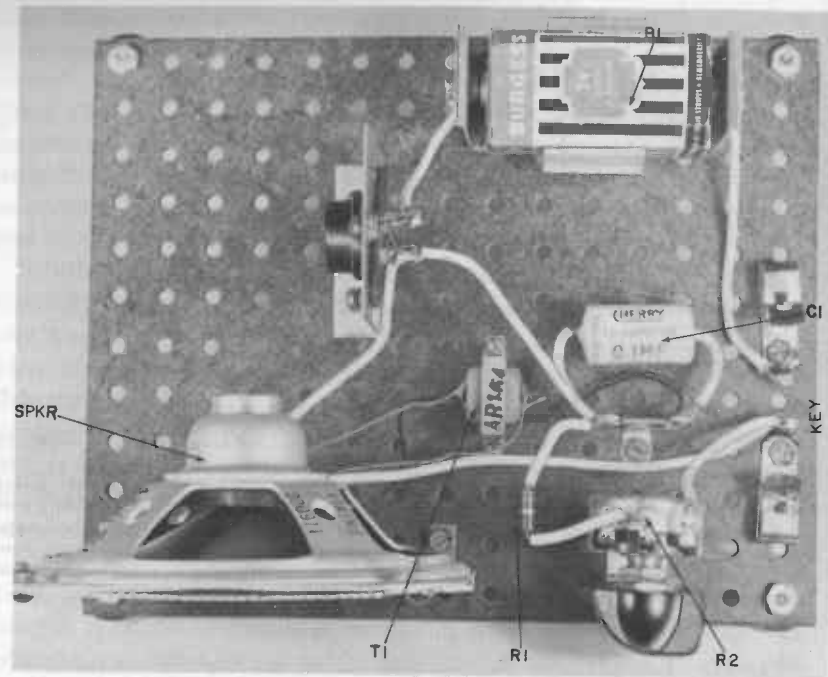

Fig. 422. The multi-purpose circuit given in Fig. 421 assembled breadboard fashion on a perforated board.

Several parts substitutions are possible. Larger (or smaller) PM speakers may be used; in general, the larger the loudspeaker diameter, the lower the tone will be. Almost any standard p-n-p power transistor may be used for V1 . . . typically, types 2N255, 2N256, 2N235A, 2N257, 2N301A and 2N307. Finally, many 6-volt batteries may be used, including lantern batteries or four flashlight cells connected in series.

Once the wiring is completed and double-checked for errors, the battery should be installed and the handkey connected, as in Fig. 423. The key switch is closed (or key depressed) and R2 is adjusted for the most pleasing tone. If the desired tone can not be obtained by adjusting R2 through its entire range, C1 may be replaced with a different capacitor; values of from .05 to .25 μf should be tried. Afterwards, the handkey is used in conventional fashion.

AN ELECTRONIC METRONOME

In its most familiar form, the metronome is a spring-motor-

driven clock-work mechanism with a vertical pendulum. The pendulum is equipped with a movable weight so that its operating

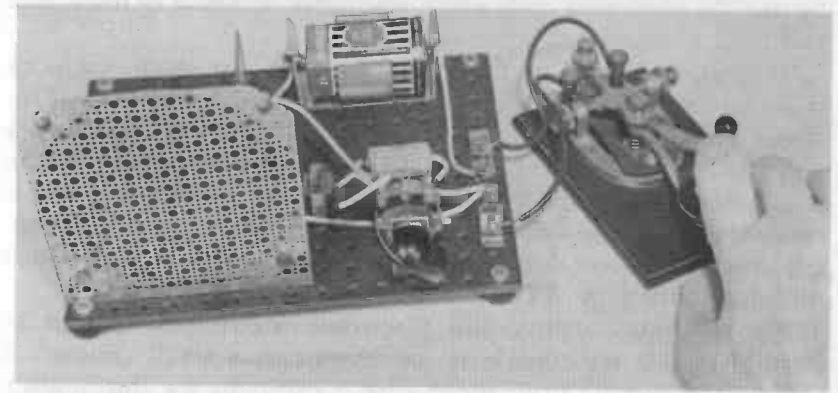

Fig. 423. Using the multi-purpose circuit as a Code Practice Oscillator.



Fig. 424. Here, the circuit given in Fig. 421 has been assembled in a meter case, with a 3-inch speaker, for use as an Electronic Metronome. The SPST toggle switch on the side of the case is wired in series with the battery as an ON-OFF switch.

period (or rate) can be adjusted. In operation, the instrument emits a steady ticking (or tocking, if you prefer) sound that can be used by musicians, composers, and music students to mark time and thus to insure an accurate beat.

As mentioned earlier, the circuit we have just examined is extremely versatile. For example, it may be used for a useful Electronic Metronome merely by changing the value of a single component. Referring to Fig. 421, C1 is simply replaced by a 100 μ f 6 volt electrolytic capacitor. In practice, C1's positive lead would connect to V1's base to insure proper dc polarity. With this change, the unit will deliver a series of short pulses or pops at a repetition rate determined by R2's setting.

For maximum utility, the Electronic Metronome should be assembled as a self-contained instrument in a small cabinet. A commercial sloping front meter case is excellent for this application and permits the construction of an attractive, professional instrument, as shown in Fig. 424. Here, the 4-inch speaker used in the circuit has been replaced by a 2 $\frac{1}{2}$ -inch unit. The completed instrument may be calibrated using a mechanical metronome as a standard or by using an accurate stopwatch.

A TOY ELECTRONIC ORGAN

Electronic musical instruments are among the most fascinating of construction projects. Fun to build as well as to use, these instruments attract the interest of amateur and professional musicians as well as that of the lay public. As might be expected, there is virtually no limit to the variety of types that can be designed and built. On the one hand, a simple unit suitable for playing basic melodies can be assembled for just a few dollars. At the other extreme, it is possible to design complex instruments capable of producing almost any imaginable sound if cost and size are unimportant.

The circuit in Fig. 421 may be used as a simple musical instrument if its tone control, R2, is preset for the frequency (pitch) of different musical notes before the key is depressed. A series of notes, hence a simple tune, is played by readjusting R2 for each note in succession, holding the key depressed long enough each time to sound eighth, quarter, half, or full notes. Unfortunately, this is a rather awkward technique, especially for a novice. Even a skilled musician might have difficulty in determining exactly where to set R2 for a particular note. A better technique is to dispense with the handkey and variable control and, instead, to

provide a series of fixed resistors and individual keys, push-buttons or levers, each of which sounds a single note. A modified circuit, based on this approach, is given in Fig. 425.

Referring to the schematic, we see that the circuit is essentially the same as that in Fig. 421, except that the potentiometer (R2) has been replaced by a series of fixed value resistors, R2 to R10, controlled by SPST switches SW2 to SW10, respectively. The handkey has been replaced with a SPST power switch, SW1. This

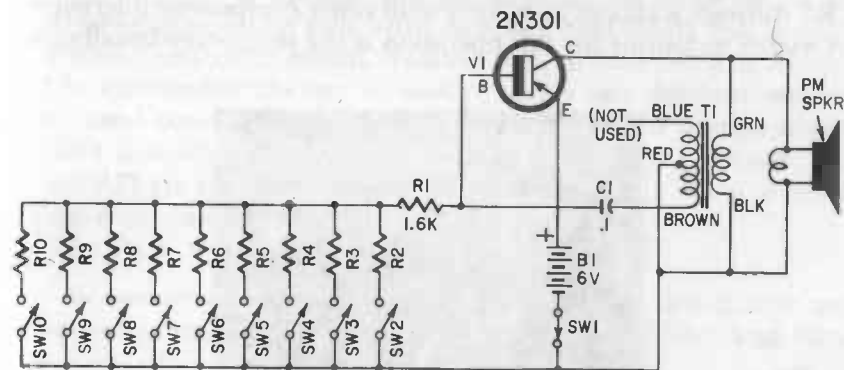

Resistors: R1—1,600 ohms; R2-to-R10—values determined experimentally (see text); (all $\frac{1}{2}$ watt).
Capacitors: C1—.1 μ f tubular.
Transformer: T1—500 ohms CT pri to 8 ohms (Argonne AR-164).
Switches: SW1—spst toggle or slide; SW2 to SW10—spst spring return "key" type.
Transistor: V1—2N301, p-n-p, power.
Battery: B1—6 volts (Burgess F4P1 or 4—

1.5 volt D-cells in series).
Speaker: SPKR—4-ohm voice coil, 4 x 6 inch PM speaker (Utah SP46D).
Miscellaneous: aluminum chassis, 5 x 10 x 3 inches; aluminum chassis, 2 x 9 $\frac{1}{2}$ x 3 inches; rubber feet; grill cloth; terminal strips; transistor socket; battery plug; machine screws and hex nuts; lugs; wire; solder; etc.

Fig. 425. Wiring diagram of a Toy Electronic Organ. This circuit is adapted from the multi-purpose circuit given in Fig. 422.

circuit was used in assembling the Toy Electronic Organ shown in Fig. 426.

The project is a relatively easy one to duplicate. Referring to the photograph, the instrument's case was made up using two metal chassis, with the larger bolted at right angles to the smaller. The case may be painted or enameled to suit individual tastes; this should be done *after* all metal work, drilling, punching, etc., is finished, but *before* the circuit is wired. A 4 x 6-inch oval PM speaker was used in place of the 4-inch type employed in Fig. 423. A toggle switch, mounted on the back of the larger chassis, was used for SW1, while key type push-button switches, obtained from

a local hardware store, were used for SW2 through SW10. These were mounted side-by-side to obtain the overall appearance of a standard keyboard. Finally, a lantern type 6-volt battery was used for B1 to obtain maximum operating life.

Any number of notes may be provided. In the model, for example, 14 key switches were used. In each case, however, the resistance value needed to sound a specific musical note must be determined experimentally, for the exact value of each resistor (R2 through R10, etc.) will vary with other component tolerances. A useful technique for this operation is the temporary installation

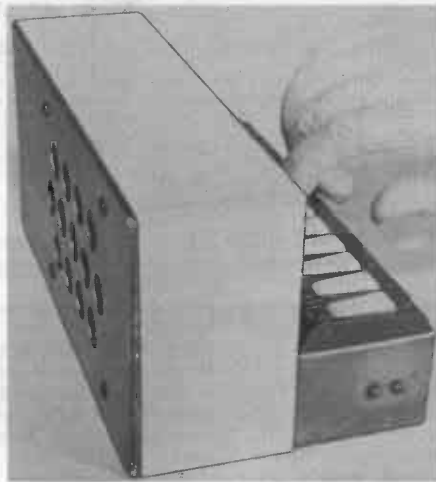

Fig. 426. A completed version of the Toy Electronic Organ.

of a 100K rheostat for one of the fixed resistors (R2, for example). With the corresponding key switch depressed (SW2), the rheostat is adjusted until the desired note is obtained. A musically trained friend is a great help at this point, particularly if, like the author, you have trouble distinguishing between closely adjacent notes and sharps and flats. Afterwards, the rheostat's value is checked with an ohmmeter and a fixed resistor installed in its place. This procedure is repeated for each note. If the resistance needed is a non-standard value, as is likely to be the case, series and series-parallel combinations of 1/2 watt fixed resistors may be used. If cost is no object, or if the builder has access to a good stock of potentiometers, individual rheostats may be used for R2 through

R10 (and so on), with each pre-adjusted for the desired musical note. The entire range of the instrument may be shifted by using other values for C1; larger capacitors are used for lower frequencies, smaller for treble ranges.

With a little practice, almost anyone, from child to senior citizen, can play simple tunes on the completed instrument. The technique is simple. The unit is turned on by closing SW1. No warm-up time is needed. Individual notes are sounded by depressing appropriate keys, with each key held down long enough to sound sixteenth, eighth, quarter, half, or full notes, as needed. *The instrument can not be used to sound two different notes at the same time, however.* If two keys are depressed simultaneously (SW3 and SW7, for example), their corresponding resistors (R3 and R7) are connected in parallel, and the result is a completely new note, usually off-key.

A HOME BROADCASTER

In essence a low-power transmitter, the Home Broadcaster may be used to transmit messages through nearby AM Broadcast Band

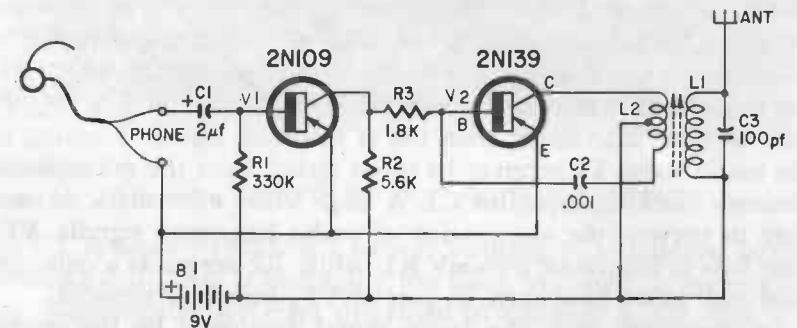

Resistors: R1—330,000 ohms; R2—5,600 ohms; R3—1,800 ohms; (all 1/2 watt).
Capacitors: C1—2 µf, 12 volts, electrolytic; C2—.001 µf ceramic or paper; C3—100 pf (µµf) mica or ceramic.
Coil: L1-L2—modified ferrite antenna coil (Superex VL) see text.
Transistors: V1—2N109, p-n-p; V2—2N139, p-n-p, rf type.

Battery: B1—9 volts (Burgess type 2N6).
Microphone: Phone—1,000 to 2,000 ohms, headphone.
Miscellaneous: perforated circuit board; rubber feet; brackets; battery connectors; transistor sockets; terminal strips; Fahnestock clips; machine screws and hex nuts; wire; solder; etc.

Fig. 427. Schematic of a Home Broadcaster. A similar circuit may be used for assembling a Wireless Microphone.

receivers. The instrument's range is limited, in keeping with FCC regulations governing the use of unlicensed transmitters, but it is suitable for room-to-room broadcasts in the home with receivers

of average sensitivity. Most children, including teen-agers, find the unit especially fascinating and, quite literally, can spend many happy hours using it. Grown-ups, too, can have a good deal of fun using the instrument to broadcast *news*, vocal renditions, and bits of gossip at adult parties. The unit's schematic is in Fig. 427, while the components needed for assembly are specified in the parts list.

Circuit description

At first glance, the Home Broadcaster seems to be a two-stage device. Actually, it is made up of two semi-independent circuits—a combination audio amplifier/modulator, V1, and a rf oscillator, V2. P-n-p transistors are used in both circuits, with an audio type used for V1 and a rf type for V2. Both are used in the common-emitter configuration. A magnetic headphone is used as a microphone, while all circuit operating currents are supplied by a single 9-volt battery (B1).

In Fig. 427, V2 is used as a modified *inductive feedback* rf oscillator, with L2 providing the feedback signal needed to start and maintain oscillation. The operating frequency is determined by tuned circuit L1-C3. V2's base bias is furnished through V1's collector load resistor R2 and through isolating resistor R3. Blocking capacitor C2 prevents the application of collector bias to V2's base without interfering with the rf feedback signal. Turning to the audio stage, V1 receives its input signal from the microphone through blocking capacitor C1. A large value electrolytic is used here to prevent the attenuation of audio frequency signals. V1's base bias is furnished through R1, while R2 serves as a collector load and, as we have seen, as part of V2's base bias network.

In operation, then, the audio signal developed by the microphone is coupled through C1 to V1's base-emitter circuit. The signal is amplified by this stage and superimposed on the steady dc bias furnished through R2 to the rf oscillator, thus amplitude-modulating the rf signal developed by V2. Finally, the modulated rf signal is radiated by the antenna connected to the tuned circuit, L1-C3.

Construction and use

The Home Broadcaster circuit is shown assembled on an experimental circuit board in Fig. 428. Although layout is not too critical, good wiring practice should be observed, with all signal leads kept reasonably short and direct, and with adequate spacing maintained between the input and output circuits. The rf coil,

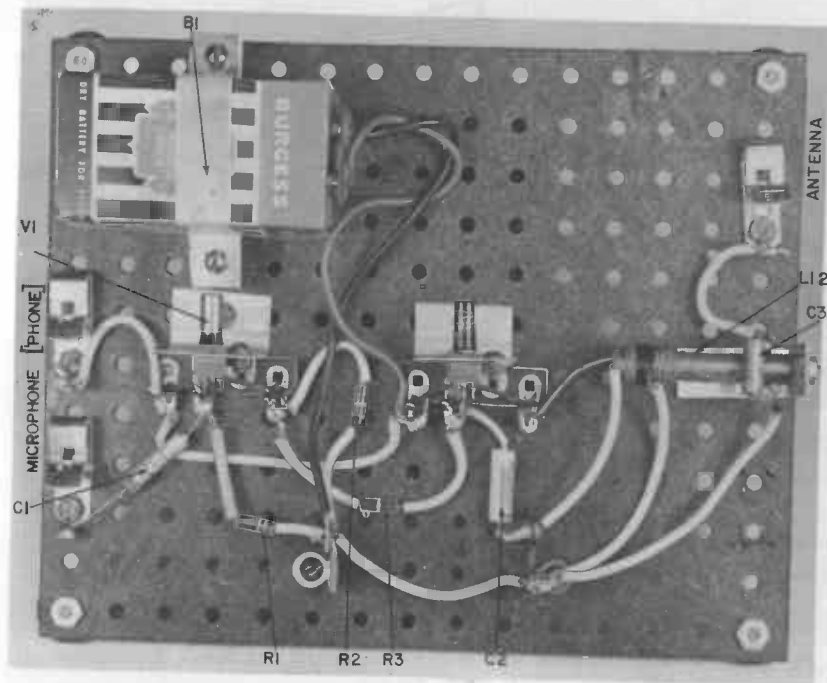

Fig. 428. Breadboard version of the Home Broadcaster.

L1-L2, is made by adding a second winding to a standard ferrite antenna coil. This is essentially the same coil used in assembling the Regenerative Receiver described in Chapter 3, Fig. 304.

After the wiring has been completed and checked for errors, the battery may be installed and the microphone (headphone) and antenna connected, as shown in Fig. 429. A moderate impedance (500-1,000 ohm) magnetic headphone should be used. An elaborate antenna is neither necessary nor desirable. For most work, a short (4 to 8 foot) length of ordinary hook-up wire should be ample. To check circuit operation, first adjust L1's ferrite core to its mid-position. Place an operating AM Broadcast Band receiver near the instrument (about 2 to 6 feet away). Next, tune the receiver *slowly* through its entire range while tapping on the headphone (mike) with one finger. Stop tuning when you pick up the clicking sound and readjust the receiver for best reception. If the Home Broadcaster is operating at a frequency near that of

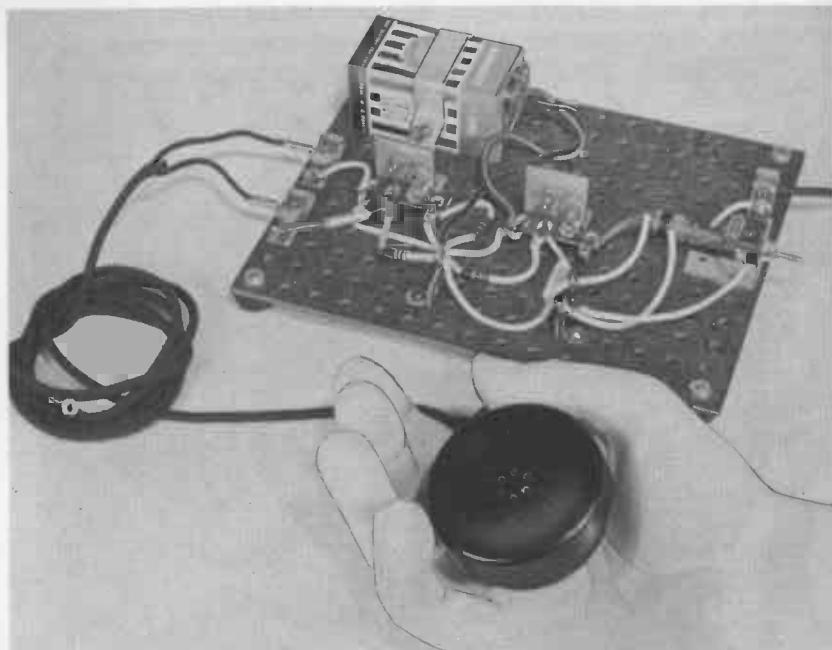

Fig. 429. With microphone and antenna connected, the Home Broadcaster is ready for use.

a local broadcast station, squeals will be heard through the receiver as the signal is picked up. In this case, readjust L1's core until the Home Broadcaster can be tuned in on a dead portion of the receiver's dial, that is, at a point where no stations are received. Afterwards, the instrument is used simply by speaking into the headphone, holding it reasonably close to the mouth and using a normal to moderately loud voice.

If desired, the circuit may be assembled in a small plastic case or box as a self-contained *Wireless Microphone* or broadcaster. In this version components identical to those used in the breadboard version may be employed, with the exception of the battery. Here, a smaller unit should be used. In addition, a SPST toggle, slide or push-button switch should be connected in series with one of the battery leads to permit the instrument to be turned off when not in use. Finally, reasonable care should be exercised in choosing a layout and in wiring a self-contained version, both to make sure that there is ample room for the components without crowding and to avoid accidental shorts.

CHAPTER 5

How to tackle advanced circuits or the bigger they are . . . the better

"Work, work, work," complained the new employee, "only an hour and a half for lunch and three twenty-minute coffee breaks in a seven-hour day. The Boss must think we're machines."

"What are you griping about?" challenged the senior worker, remembering the days of the ten-hour, six-day week, with a half-hour for lunch and *no* coffee breaks.

"You asked for work when you applied for a job, didn't you?"

"Yeh," replied the new employee, "but that doesn't mean I want to drown if I ask for a glass of water."

* * * * *

To many, a steady job is a godsend. Work, even hard labor, is welcomed rather than despised, as long as it means money in the bank and a chance for advancement. But *too* much of a good thing can be boring, if not downright distasteful, as many a youngster has discovered after a spending spree at a soda fountain. This is as true of the pleasures and recreations of life as it is of its duties and obligations.

In the past few chapters, we've discussed a number of easy-to-build electronic equipment projects suitable for home assembly and wiring. Most of these required relatively few components, used only one or two transistors, and, on the average, cost but a few dollars to duplicate. Most could be completed in a single evening. The few multi-stage circuits discussed, such as the *Detectaphone* (Chapter 2, Fig. 221) were based on fairly simple designs. At this point, then, lest you become bored with simple circuits, you might well be interested in tackling something a little more advanced.

Contrary to some opinions, an advanced circuit design needn't involve a large number of stages. For example, a two-stage amplifier might be much more complex than a three-stage unit, if the latter is based on a simple direct-coupled arrangement, while the former incorporates such refinements as inverse feedback, push-pull operation, decoupling networks, and bias stabilization. This isn't to say, of course, that *all* advanced circuits use only a few stages. As a general (but not absolute) rule, in fact, the greater the number of stages, the more complex and advanced the design. Powerful radar systems, giant electronic computers, and communication networks employ hundreds, or even thousands, of stages and are quite complex.

The successful completion of an advanced project can be a richly rewarding experience, generating a warm feeling of accomplishment. In addition, the skills and knowledge gained can open whole new vistas for the hobbyist or student. Surprisingly enough, such projects may not be overly difficult, and, therefore, often can be tackled without apprehension or a nagging fear of failure. In general, advanced projects may be completed using essentially the same techniques as are employed in assembling simpler circuits. All that is needed, basically, is a little more care in layout and wiring and a little more time, plus the willingness to double-check the wiring as the work progresses, for an error might prove much harder to spot in a complex circuit, once completed, than in a simpler design.

With these thoughts in mind, even the most complex of circuits needn't be an impossible challenge. Simply remember that most designs are based on the multiple use of a few relatively simple circuits or stages, and, in a pinch, can be tackled a stage at a time. A giant computer using tens of thousands of transistors, in the final analysis, may employ only a dozen or so basic circuits, just as the largest building may be erected with just a few basic sizes of bricks. Let's take a look, then, at a few advanced projects . . . not as complex as computers, of course, but more advanced than those discussed in earlier Chapters.

A BASIC AUDIO AMPLIFIER

If we turn our attention to multi-stage circuits which are inherently self-contained, that is, which are capable of performing some useful function within themselves, the audio amplifier is perhaps the most widely used of all. In a broad sense, the audio amplifier is the electronic *heart* of such equipment and devices

as Public Address systems, Hi Fi installations, Paging systems, Intercom installations, Tape and Wire Recorders, Power Megaphones, and Record Players. In addition, audio amplifiers are used in conjunction with other electronic circuits in test instruments, such as signal tracers, and in radio receivers, radiotelephone transmitters, and transceivers, as well as in other electronic instruments and special purpose equipment.

The schematic of a basic multi-stage audio amplifier is illustrated in Fig. 501. Designed for operation from a 9-volt battery,

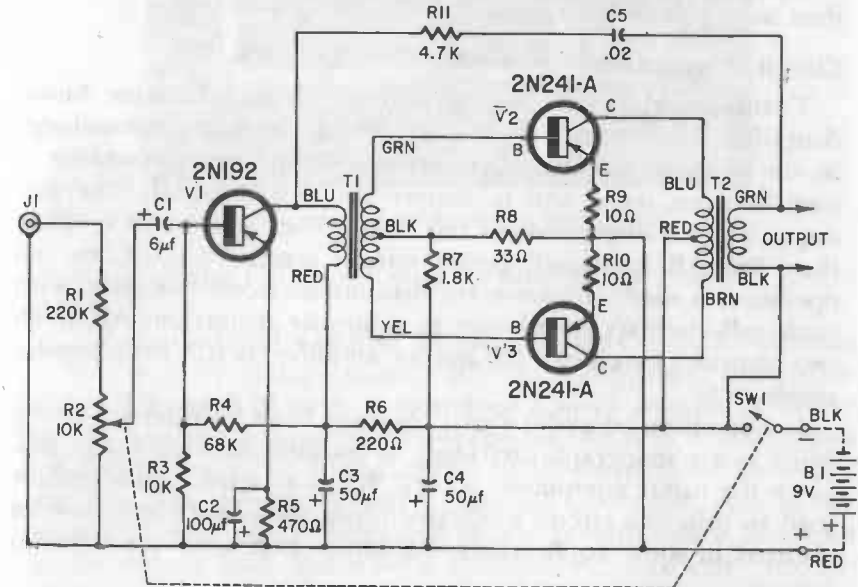

Resistors: R1—220,000 ohms; R3—10,000 ohms; R4—68,000 ohms; R5—470 ohms; R6—220 ohms; R7—1,800 ohms; R8—33 ohms; R9, R10—10 ohms; R11—4,700 ohms (all ½ watt); R2—10,000-ohm potentiometer, audio taper, with spst switch.
Capacitors: C1—6 µf, 15 volts, electrolytic; C2—100 µf, 6 volts, electrolytic; C3, C4—50 µf, 15 volts, electrolytic; C5—.02 µf, paper or ceramic.

Transformers: T1—5,000 ohms, pri to 3,000 ohms CT sec (Argonne AR-173); T2—500 ohms CT to 3.2 ohms (Argonne AR-119).
Input jack: J1—phono jack (Switchcraft 3501FP).
Switch: SW1—spst on R2.
Transistors: V1—2N192, p-n-p; V2, V3—2N241-A, p-n-p.
Battery: B1—9 volts.
Miscellaneous: Etched-circuit board; machine screws and hex nuts; wire; solder; knob; etc.

Fig. 501. Schematic for the Basic Audio Amplifier.

this unit can be used in a wide variety of applications, either as the essential element of self-contained instruments or, coupled to other circuits, as the *audio section* of more complex equipment.

With a frequency response adequate for most general purpose requirements, the amplifier can deliver a maximum output of 350 milliwatts or one-quarter of a watt (250 milliwatts with only 10% distortion). This is quite ample for good speaker volume in most home and office applications. Its basic sensitivity is 0.2 volt for an output of 50 milliwatts, but sensitivity can be increased to 5 millivolts (.005 volt) at the cost of a reduction in effective input impedance. Again, this is ample gain for use in many types of equipment. Standard components are used throughout, as specified in the parts list.

Circuit description

Turning to the schematic diagram, we see that the Basic Audio Amplifier is essentially a two-stage device using p-n-p transistors in the common-emitter configuration. Transformer coupling is used between stages and to deliver the output signal. The first stage, V1, is a single-ended Class A amplifier and serves to drive the Class AB, push-pull power output stage, V2-V3. Class AB operation is used, of course, for maximum circuit efficiency, with push-pull circuitry mandatory to minimize distortion. Although two transistors are used, the output amplifier is still considered a *single stage*.

In operation, an audio signal obtained from an external source (such as a phonograph cartridge) is coupled through *input* jack J1 to the input attenuator, R1-R2. R1 is a simple series resistor used to raise the circuit's effective input impedance and may be omitted in some applications. R2 serves as a *gain* (or volume) control.

A portion of the input signal, depending on R2's setting, is coupled through dc blocking capacitor C1 to V1's base-emitter circuit. V1's stabilized base bias current is furnished by voltage divider R3-R4 in conjunction with emitter resistor R5, bypassed by C2. A large electrolytic capacitor (C2) is used here to minimize low frequency losses. The amplified output signal developed across V1's collector load, T1's primary winding, is coupled through the transformer to the output stage, V2-V3. The interstage transformer (T1), then, has three functions. First, its primary winding serves as V1's collector load. Second, it serves to match interstage impedances. Finally, it serves, by means of its center-tapped secondary, to provide the two out-of-phase signals needed to drive a push-pull circuit. R6 and bypass capacitors C3 and C4 form a simple *Pi* (π) type decoupling network for V1's dc supply,

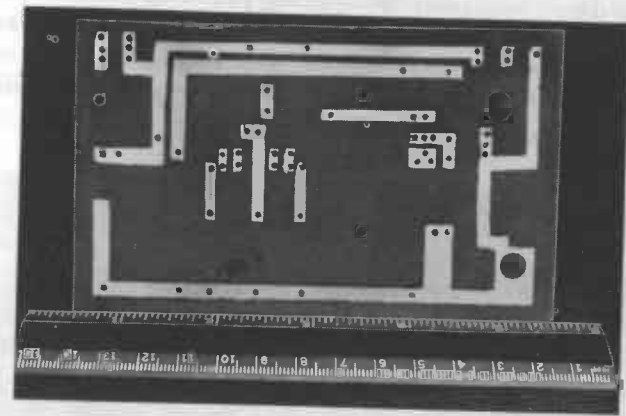

Fig. 502. Basic Amplifier circuit-board layout.

thus preventing interstage coupling through the common power source, B1.

The small base bias needed for output stage Class AB operation is furnished by voltage divider R7-R8. Unbypassed emitter resistors R9 and R10 serve to introduce a small amount of degenerative feedback in their respective circuits and thus to compensate for differences in the characteristics of the output transistors, V2 and V3, thus assuring balanced push-pull operation. Finally, the amplified audio signal developed by the power stage is delivered to the *output* load (generally a loudspeaker voice coil) through impedance matching transformer T2. At the same time, however, a small portion of the output signal is coupled back to V1's collector circuit through an R-C network, R11-C5. This is a degenerative (inverse) feedback signal and serves to improve the amplifier's frequency response, reduce output stage distortion, and to stabilize circuit operation. Circuit power is controlled by a SPST rotary ON-OFF switch, SW1, coupled to the gain control, R2.

Construction and use

Any of several construction techniques may be used for assembling the Basic Audio Amplifier, depending on individual preferences. The unit may be assembled in a small plastic or metal box, for example, or on a conventional chassis. Regardless of the construction method chosen, however, some thought should be given to layout and lead dress. While these factors are not overly critical,

good wiring practice should be followed, with all signal leads kept short and direct and adequate spacing provided between the unit's *input* and *output* circuits. All dc polarities and transformer color codes should be observed.

Since the completed unit is intended for general applications, the author chose to assemble his original model on a 3 x 5-inch

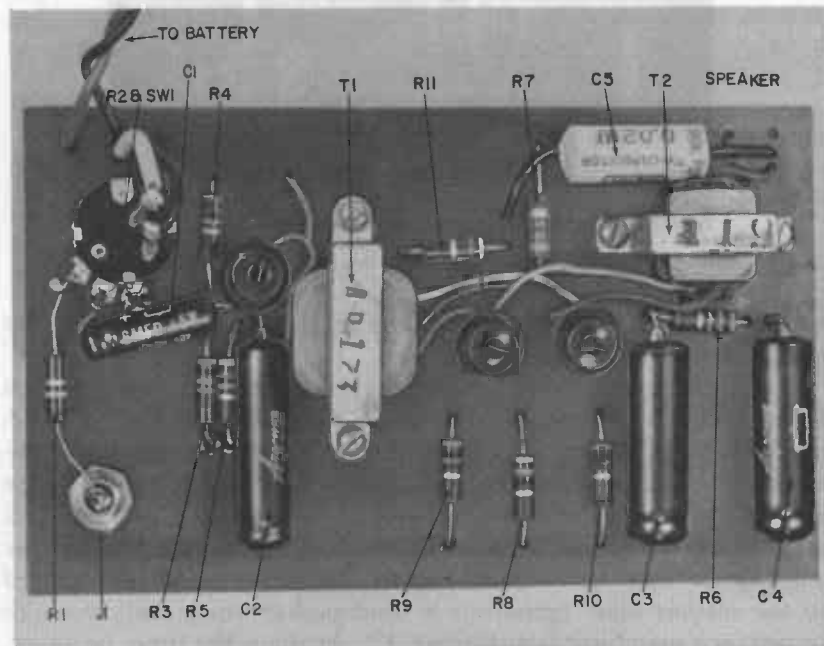

Fig. 503. Top view of the wired Basic Amplifier.

etched circuit board. The wiring layout used is illustrated in Fig. 502, while parts placement and layout is shown in Fig. 503. A below chassis view of the wired amplifier is given in Fig. 504. If this type of construction is used, the unit may be assembled in two evenings without strain (or on a weekend); one evening is devoted to layout, etching and machining (drilling) the board, the second to parts assembly, soldering and test. Small components are mounted by fitting their leads through pre-drilled holes in the board, crimping, cutting off excess, and soldering. The input jack (J1) and gain control are mounted directly on the board using their regular mounting nuts; if preferred, these two components may be mounted with a different orientation by providing

small "L" brackets attached to the board with rivets or machine screws and nuts. The two transformers are secured to the board using machine screws and nuts.

In use, the completed amplifier is connected to an external loudspeaker, power supply, and signal source. Almost any PM

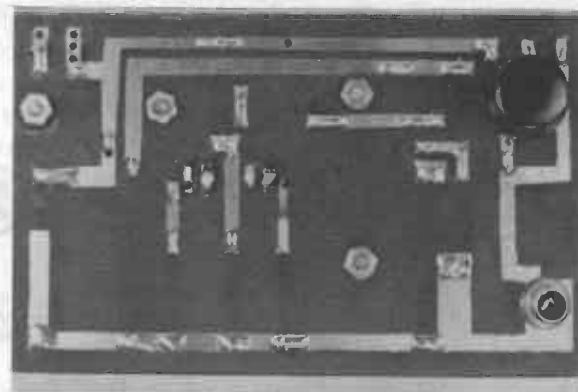

Fig. 504. Bottom view of the Basic Amplifier—compare with Figs. 502 and 503.

speaker with a suitable voice coil impedance (3-4 ohms) may be used. As a general rule, of course, the larger the speaker, the more efficient the circuit and the better the quality of sound reproduction. In many cases, however, speaker size will be dictated by the intended application. The power supply may be a single 9-volt battery or six penlight or flashlight cells connected in series; maximum battery life is obtained if full-sized flashlight cells are used. Any high output, high impedance signal source may be used, typically, a high output crystal microphone, crystal phonograph cartridge, or (musical) instrument microphone. If a low impedance source is preferred, such as a magnetic cartridge, R1 should be omitted, with a direct connection made between J1 and R2. With this change, the amplifier's gain is boosted considerably, and a 5 millivolt input signal will produce approximately 50 milliwatts output.

As might be expected, there is virtually no limit on the number of applications in which the Basic Audio Amplifier may be used, depending on the skill and imagination of the individual builder and his choice of input and output devices. As an example, the amplifier may be combined with the 3-transistor *Pocket Superhet*

described in Chapter 3 (Fig. 313) and a suitable speaker or assemble a high-gain portable receiver. The circuit modifications needed for this application are illustrated in Fig. 505. Referring to the diagram, a 4.7K, 1/2 watt resistor is connected across the receiver's output jack as a substitute load in place of the earphone used normally. This jack may be removed if desired. The amplifier's series input resistor, R1, is replaced with a 10 μ f, 12 volt electrolytic capacitor. Finally, a direct connection is made be-

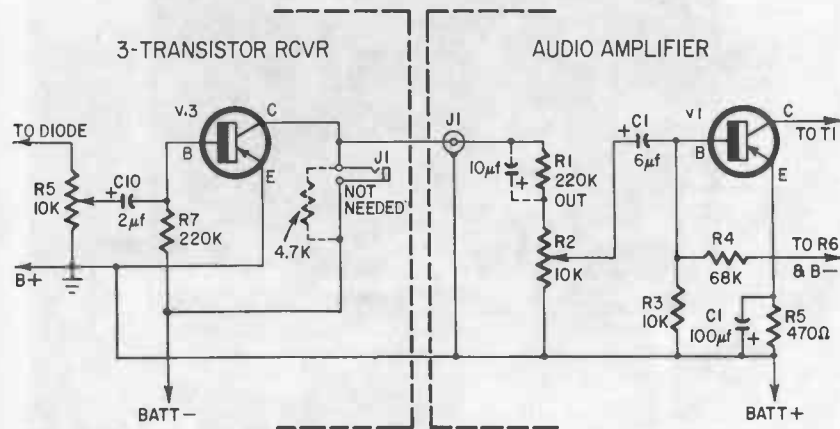

Fig. 505. Schematic showing the Basic Amplifier connected to the Pocket Superhet (described in Chapter 3).

tween V3's collector (in the receiver) and the amplifier's input terminal, and the common ground circuits (BATT+) are connected together. Since both circuits are designed for operation on 9-volt sources, a single battery may be used, if desired. The completed assembly may be mounted in a small cabinet or portable carrying case.

A UTILITY AMPLIFIER

A self-contained audio amplifier having a built-in speaker and its own power supply can be a valuable asset in the home electronics workshop. Depending on the accessories used, the instrument may serve, variously, as a low-power PA System, Guitar Amplifier, Audio Signal Tracer, or as a Test Amplifier for bench-checking microphones, phonograph cartridges, and similar pick-up devices. In a pinch, the unit can even be used as a substitute amplifier for a record player or for the audio section of a radio re-

ceiver while repairs are made to the original. With so many potential applications, an instrument of this type well deserves the title of *Utility Amplifier*. As a further example of its versatility, the Basic Audio Amplifier we have just examined may be used in assembling such an instrument. Exterior and interior views of a model using an etched circuit are given in Figs. 506 and 507.

Referring to the photographs, a commercially available sloping front speaker wall baffle is used as a cabinet. Rubber feet are mounted on the wide end of the baffle to prevent scratches to desks and table tops, with portability assured by the addition of a small handle to the narrow end. A suitable PM speaker is mounted inside the baffle. As shown in Fig. 507, the Basic Audio Amplifier and its battery are mounted on a piece of perforated

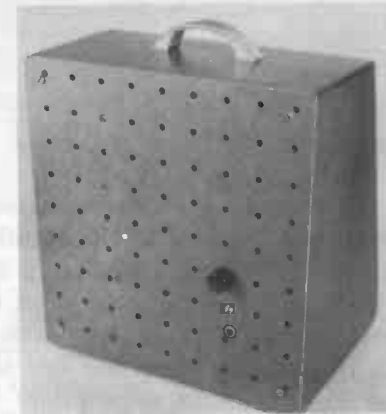

Fig. 506. A self-contained Utility Amplifier . . . a useful addition to the workshop or home electronics laboratory.

board pre-cut to fit the back of the baffle. A small metal bracket is used to secure the battery. Flexible leads are provided for the battery and loudspeaker connections. Finally, the pressed board back is secured to the baffle with standard wood screws, as shown in Fig. 506.

Several modifications may be made in the basic wiring to suit special needs. For example, a SPST switch (toggle, slide, or rotary) may be connected across R1 (Fig. 501) to permit a choice of *Hi* or *Lo* input impedances. As an alternative, a second jack may

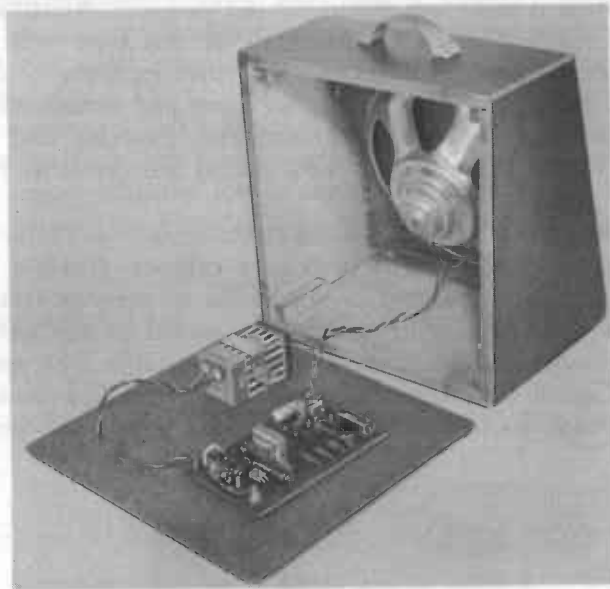

Fig. 507. Rear view of the Utility Amplifier.

be provided for *Lo* impedance; this would be connected directly to the Gain control (R2), bypassing R1. In another case, it may be desirable to attach the loudspeaker leads to a 2-position screw-type terminal strip on the back panel instead of to the amplifier chassis. The amplifier's output leads could be attached to a similar terminal strip. With this arrangement, the two sets of terminals would be connected together with appropriate jumpers, if the built-in loudspeaker were to be used, but the amplifier's output would be readily available for driving external speakers or, if desired, the built-in speaker could be used alone as a Test Speaker. In the latter case, the amplifier would be turned off.

In use, the external signal source is connected to the Input jack and the amplifier is switched on and adjusted for the desired volume level. If the Utility Amplifier is used as a PA System, the signal source might be a high output crystal, ceramic, or dynamic microphone. If used as a Guitar Amplifier, the source might be a suitable contact microphone. For use as an Audio Signal Tracer, it will need a *Test Probe* made of a short length of shielded cable, a plug (to match J1), and a $0.5 \mu\text{f}$, 400 volt capacitor in series with the signal lead. For maximum utility, the capacitor should be mounted in a small tubular housing. As experience is gained in

using the instrument, the worker will have no difficulty in developing other applications.

A PORTABLE PHONOGRAPH

In the early days of the phonograph—known popularly as *Victrolas*—a truly portable record player was no novelty. True, many of the units were built in massive, heavy, Victorian-styled cabinets, but compact models were available. With a clock-work,



Fig. 508. A Portable Phonograph . . . another application for the Basic Amplifier!

spring-powered motor and an acoustic pick-up, these units could be used anywhere, provided a little elbow grease was applied periodically to rewind the spring. Later, with the widespread adoption of vacuum tube amplifiers, electromechanical pick-ups and electric motor-driven turntables, the word *portable* lost its original meaning. A record player was considered *portable* if equipped with a handle. The fact that a near-by source of line power was needed for operation seemed incidental, for the superior performance of amplifier instruments and the convenience of an electric motor far outweighed the loss of portability. Oddly enough, spring-driven acoustic record players were still produced in fair quantity up to and after World War II to fill the needs of those individuals who needed or wanted a really portable instrument.

Today, with the advent of the transistor and the commercial production of efficient, governor-controlled, battery-operated turntables, it is once again possible to have a *really* Portable Phono-

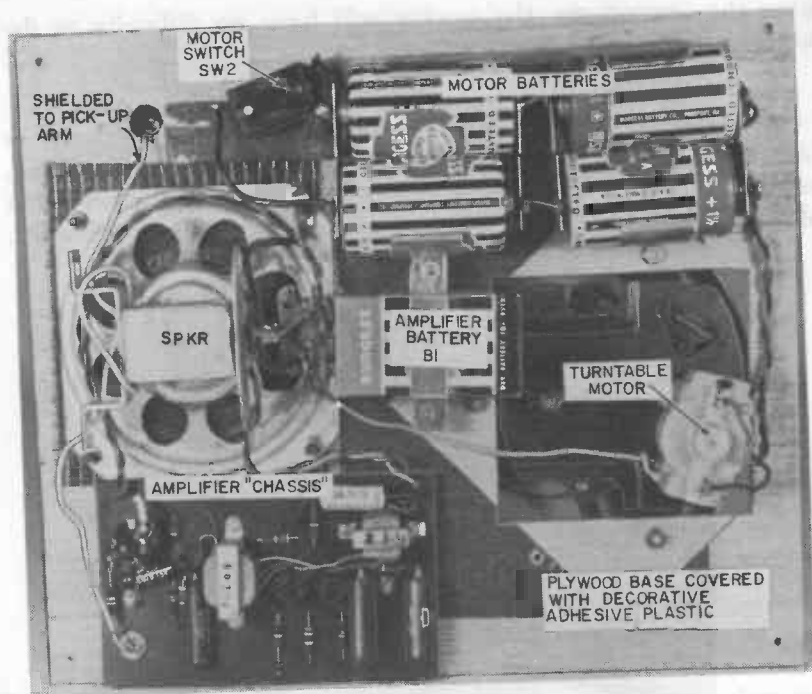

Fig. 509. Bottom view of the Portable Phonograph.

graph, one with all the advantages of an electric instrument to boot. The Basic Audio Amplifier, coupled with a suitable pick-up and loudspeaker, is ideal for this application.

An external view of an assembled instrument is shown in Fig. 508. The amplifier chassis, speaker, turntable (and motor), pick-up arm, and batteries are all assembled on a piece of $\frac{1}{4}$ inch plywood cut to fit a small portable carrying case. The layout used in the model is shown in the "below board" view given in Fig. 509, while circuit connections are shown in semi-pictorial form in Fig. 510. Separate power supplies are provided for the turntable motor and the amplifier in order to minimize noise, to insure optimum performance, and to obtain maximum battery life. The motor supply consists of four standard flashlight cells secured in position in spring-type battery holders and wired in series to supply six volts. A small 9-volt battery is used for the amplifier, and is held in place with a hand-made metal bracket screwed to

the wooden board. A separate push-button SPST switch (SW2) is used for the motor.

Standard components are used, as specified in the parts list. Substitutions are possible, of course, if reasonable care is used in making a choice. A larger (or smaller) PM speaker may be used, provided it has a 3-4 ohm voice coil winding. Other batteries may be used, but, for maximum life, smaller batteries *should not be used for the motor supply*. However, a heavy-duty 6-volt lantern battery is quite satisfactory. Either a crystal or a ceramic pick-up will give satisfactory results, provided a light-weight arm is used to avoid excessive *drag* on the record and the cartridge furnishes a moderate to high output.

The completed Portable Phonograph is used like any standard instrument, but with a slight change in operating procedure. The

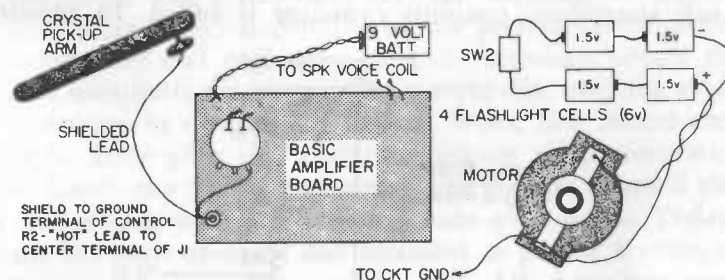

Fig. 510. Portable Phonograph wiring details—compare with Fig. 509.

turntable "Speed Selector" arm has a *neutral* position. This arm should be placed in neutral whenever the unit is not in use and each time *before* the motor is turned on. The last step is to avoid starting the motor under load, which, in turn, might lead to excessive brush wear and shortened operating life. Since a transistor amplifier is used, no warm-up time is necessary. Finally, whenever the instrument is closed for transport the pick-up arm should be attached securely to its spring mounting clip.

Applications? Your imagination can be your guide. The Portable Phonograph may be used at beach parties, on picnics, when camping, or even in your own backyard!

A RADIO PHONOGRAPH

Some hobbyists may prefer to assemble a combination instrument, adding a radio receiver to the basic phonograph to permit

a wider choice of program material, and for listening to news, weather, and similar informative broadcasts. Up-to-the-minute weather news can be quite helpful when boating or at the beach, for example. The modification of the instrument for use as a Radio-Phonograph, to borrow a familiar expression, is a lead-pipe cinch. All that is needed is the addition of a basic radio tuner, since the audio amplifier can serve for both the phonograph and the receiver. The Pocket Superhet described in Chapter 3 is excellent for this application.

In practice, the receiver chassis is mounted wherever convenient in the cabinet. If a carrying case slightly larger than the one shown in Fig. 509 is used, for example, the receiver could be mounted alongside the Basic Audio Amplifier chassis. Assuming that the Pocket Superhet is used, a 4.7K, $\frac{1}{2}$ watt resistor is connected across the set's output jack, as described earlier, and a $10\ \mu\text{f}$, 12 volt electrolytic coupling capacitor is added. In addition, a

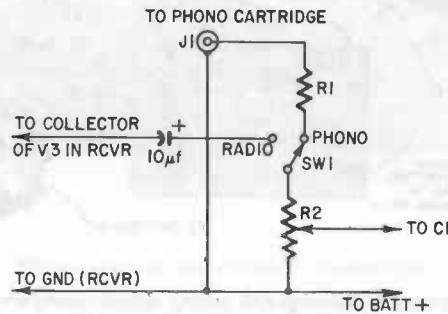

Fig. 511. Circuit modifications for converting the Portable Phonograph into a radiophonograph . . . using the Pocket Superhet receiver. A spdt switch (SW1) is needed.

SPDT switch should be provided to permit a selection of either *Radio* or *Phono*. The basic circuit modifications are shown schematically in Fig. 511. Here, the $10\ \mu\text{f}$ capacitor is connected to the receiver and J1 to the phono cartridge in the pick-up arm. The *Radio-Phono* switch, SW1, may be a rotary, slide, or toggle type, as preferred. If the receiver and amplifier chassis are more than two or three inches apart, a shielded lead should be used for circuit interconnections to minimize noise pick up and interference.

If the completed Radio-Phonograph is to be used in a remote area, as may often be the case, receiver sensitivity may be improved

by adding a short (4 to 8 foot) external antenna. Referring to Fig. 313, the antenna lead would be connected to the "hot" side of the antenna coil, L1; this may be identified as the *white* color-coded lead. With the antenna connected, it may be necessary to touch up the setting of the antenna trimmer capacitor, C_{ta} , for best performance—refer to the section on Alignment.

A BASIC SUPERHET RECEIVER

Somewhat prior to, and for several years following, World War II, one general type of AM Broadcast Band radio receiver circuit was used so extensively that it became known popularly as the *All American* design. Based on the use of five vacuum tubes, the superhet circuit, in general, included a pentagrid converter, a remote cut-off if amplifier, a dual-purpose tube used as a combination second detector and first audio amplifier, an audio power output stage, and a half-wave rectifier. Although a number of variations developed, depending on the preferences of individual manufacturers and engineers, the All American circuit has remained essentially the same to the present day, evolving gradually with changes in component designs. When first introduced, for example, large glass and all-metal vacuum tubes were standard types. Later, the circuit was adopted to the use of small glass or GT tubes and, still later, to miniature glass tubes. Today, the circuit has been up-dated and modified to permit the use of the multi-purpose *compactron* tubes. The All American superhet design has been used in the production of tens of millions of receivers, ranging from low-cost table model sets to moderately expensive consoles and radio-phonographs.

Unfortunately, or perhaps fortunately, depending on your viewpoint, there has been no such standardization of transistor AM receiver circuits. If any one design can be considered *standard*, however, it is the six-transistor Broadcast Band superhet, for this has been the most popular and widely used of all circuits. Variations are encountered, of course, but, as a rule, the circuit includes a converter, two if amplifiers, a diode second detector, and a two-stage audio amplifier section, with the power output stage using two transistors in push-pull. Operating supply voltages vary, but battery operation is well nigh universal, although some sets are equipped with rechargeable cells and built-in, line-powered chargers. Individual set sizes vary, too, and commercially available 6-transistor sets may range from shirt-pocket size to moderately large portables and table models.

Although the 6-transistor superhet design is almost (but not quite) an industry standard, small circuit variations are used occasionally which change the total complement from as few as five to as many as seven transistors. Often, these variations are so minor that the basic circuit is virtually unchanged. For example, a single-ended rather than a push-pull output stage may be used. Here, only five transistors are needed, but the set has the same number of functional stages and, perhaps, approximately the same sensitivity and selectivity as 6-transistor circuits. In another case, the diode detector may be replaced with a transistor detector, raising the total complement to seven transistors, but again, without a really significant change in basic circuitry or overall performance.

The schematic of a 6-transistor AM Broadcast Band receiver suitable for home construction is given in Fig. 512. Typical of many commercial designs, this circuit, as we shall see later, may be used for assembling a variety of radio receivers. Designed for operation on a nine to twelve volt dc power source, the set uses a built-in antenna and has ample sensitivity for the reception of local broadcast stations, delivering as much as several hundred milliwatts to a properly matched PM speaker.

Circuit description

Referring to the schematic, we see that the receiver has six functional stages—a converter (V1), two tuned if amplifiers (V2, V3), a diode-type second detector (D1), an audio amplifier (V4), and a push-pull power output stage (V5, V6). N-p-n transistors are used in the rf and if stages, p-n-p types in the audio section. The common-emitter configuration is used throughout.

In operation, incoming rf signals are picked up and selected by tuned circuit L1-C1A. The antenna coil, L1, is tapped to provide an impedance match, through auto-transformer action, to V1's base-emitter circuit; this minimizes tuned circuit loading and insures high "Q" and good selectivity. The selected rf signal is coupled to the first stage through dc blocking capacitor C1. A stabilized base bias is furnished V1 by means of voltage divider R1-R2 in conjunction with emitter resistor R3.

V1 is used as a converter, that is, as both a mixer and local oscillator. The local oscillator frequency is determined by tuned circuit L2-C1B. A feedback (tickler) coil, coupled to L2, provides the feedback between V1's collector and emitter circuits necessary to start and maintain oscillation. The emitter is isolated from circuit ground by R3 and coupled to L2 through dc blocking ca-

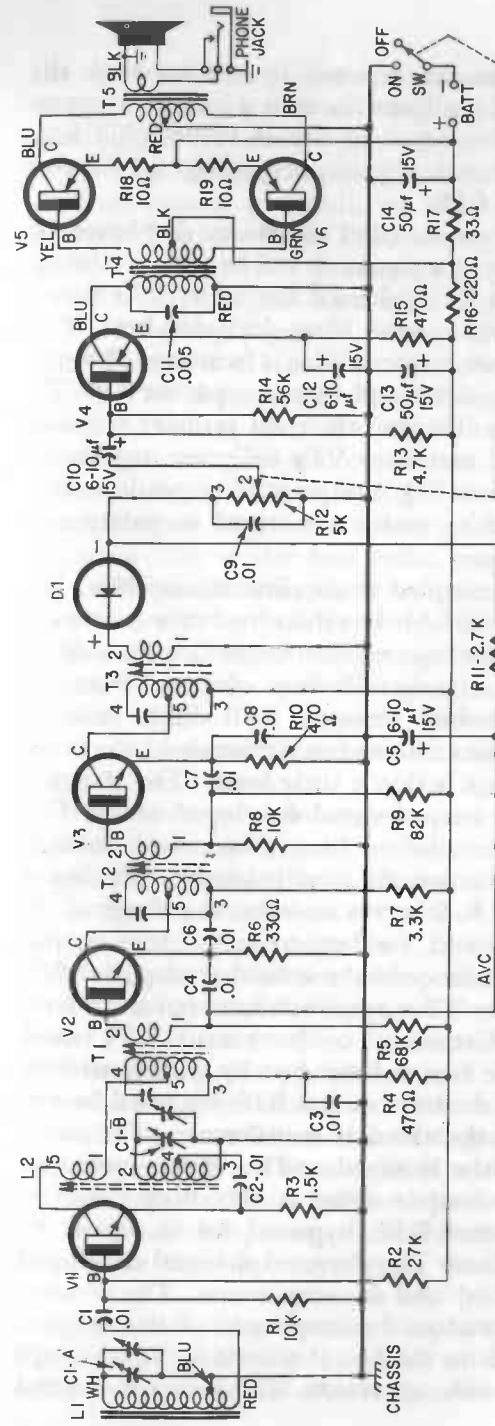

Resistors: R1, R8—10,000 ohms; R2—27,000 ohms; R3—1,500 ohms; R4, R10, R15—470 ohms; R5—68,000 ohms; R6—330 ohms; R7—3,300 ohms; R9—82,000 ohms; R11—2,700 ohms; R13—4,700 ohms; R14—56,000 ohms; R16—220 ohms; R17—33 ohms; R18, R19—10 ohms (all 1/2 watt); R12—5,000-ohm potentiometer (audio taper), with spst switch (SW).
 Capacitors: C1A, C1B—Miniature 2-gang tuning (Argonne AR-93); C2, C3, C4, C6, C7, C8, C9—0.1 μ f ceramic; C5, C10, C12—

6 to 10 μ f, 15 volts, electrolytic; C11—.005 μ f, ceramic; C13, C14—50 μ f, 15 volts, electrolytic.
 Coils: L1—Ferrite antenna coil (Argonne AR-66); L2—Oscillator coil (Argonne AR-223).
 Transformers: T1, T2—455 kc if (Lafayette MS-268A); T3—455 kc if (Lafayette MS-269A); T4—10,000 to 2,000 ohms, CT driver (Argonne AR-109); T5—400 ohms, CT to 11 ohms, output (Argonne AR-120).
 Transistors: V1—n-p-n rf type, 2N168A or

equivalent; V2—n-p-n rf type, 2N293 or equivalent; V3—n-p-n rf type, 2N169 or equivalent; V4—p-n-p audio type, 2N192 or equivalent; V5, V6—p-n-p audio type, 2N188A or equivalent.
 Diode: D1—1N48 or equivalent.
 Miscellaneous: Aluminum chassis (3-1/4 x 6 inches, approx.); transistor sockets; tuning dial; knob; terminal strips; machine screws and hex nuts; ground lugs; insulating tubing; rubber grommet; wire; solder; etc.

Fig. 512. Schematic diagram of a Basic Superhetrodyne Receiver . . . using six transistors. This set tunes the AM broadcast band.

capacitor C2. Different stations are selected by tuning *both* the antenna circuit and the local oscillator in such a way as to maintain a constant difference frequency at the if value (455 kc.). This is accomplished by mechanically coupling (*ganging*) the two tuning capacitors, C1A and C1B.

The incoming and locally generated rf signals are combined by V1 and their difference frequency signal of 455 kc used as the receiver's if. This is selected in V1's collector circuit by T1's tuned primary winding. V1's collector load, then, includes both T1's primary and L2's feedback coil; collector bias is furnished through a decoupling filter made up of R4 and bypass capacitor C3. T1, of course, is the receiver's 1st if transformer; its primary winding is tapped to provide a good match to V1's collector impedance while maintaining tuned circuit "Q" and selectivity, while a step-down secondary is provided to match the input impedance of the next stage.

From T1, the if signal is coupled to the first if amplifier, V2. This stage is provided with a variable base-bias to obtain *automatic gain control* (agc or *automatic volume control*, avc), with a fixed bias furnished through R5 and a variable bias, obtained from the second detector (D1), furnished through R11. Both resistors are bypassed (C4 and C5). Bias stabilization is provided by emitter resistor R6. We'll examine agc action a little later. The if signal is amplified by V2, with its output signal developed across T2's tuned primary winding. V2's collector bias is furnished through decoupling filter R7-C6. The second if transformer, T2, has a function similar to that of L3. It serves to select the if signal, by virtue of its tuned primary, and, further, to match V2's output impedance to the input impedance of the second if amplifier, V3.

The if signal obtained from T2 is amplified further by V3, with the output signal developed across its collector load, T2's tuned primary. V3's stabilized base bias is furnished by voltage divider R8-R9, bypassed by C7 and emitter resistor R10, bypassed by C8.

Like the previous units, the third if transformer, T3, serves both as a tuned circuit for the if signal and to match interstage impedances, delivering V3's output signal to the diode detector, D1. *Gain* (or volume) control R12, bypassed for if signals by C9, serves as the detector's load. The detected if signal developed across R12 has both ac (audio) and dc components. The dc component is directly proportional to the amplitude of the original rf signal and is coupled back to the first if amplifier, V2, through R11, bypassed by C5, to provide agc action. This serves to control

the receiver's effective gain, automatically adjusting for differences in signal strength and reducing any tendency towards *fading* (or *blasting*) as stations of varying strength are tuned.

The agc action can be followed quite easily. Examining the detector circuit in detail, we note that a *negative* dc signal is developed across R12. This is coupled back through R11 and partially cancels the *positive* base bias supplied to V2 through R5. If a strong signal is tuned, a larger dc bias is developed across R12, cancelling a greater portion of the positive bias and reducing V2's effective bias. This, in turn, reduces V2's gain and compensates for the stronger signal. Conversely, a weaker input signal produces less agc bias, allowing V2's positive bias to increase, thus boosting stage gain and compensating for the weaker signal.

Returning to R12, a portion of the audio signal appearing here, depending on the control's setting, is coupled through dc blocking capacitor C10 to the first audio amplifier, V4. A stabilized base bias is furnished this stage by voltage divider R13-R14 in conjunction with emitter resistor R15, bypassed by C12. V4's amplified output signal is developed across its collector load, T1's primary winding. A small capacitor, C11, is shunted across this load to bypass high frequency signals and thus to minimize the effects of harmonic distortion. V4, of course, is operated as a single-ended Class A stage.

The interstage audio transformer, T4, has two important functions. First, it serves to match V4's output impedance to the input impedance of the Class AB push-pull power amplifier, V5-V6, thus assuring an efficient transfer of the signal. Second, by virtue of its center-tapped secondary, it provides the two out-of-phase drive signals needed for push-pull operation.

A Class AB amplifier stage, of course, requires a very small base bias. This is obtained at the junction of power supply resistors R16 and R17. Unbypassed emitter resistors R18 and R19 serve to reduce distortion and to insure balanced push-pull operation, introducing a small amount of degenerative feedback in V5 and V6, respectively. The amplified audio signal developed by the power stage, V5-V6, is delivered to the loudspeaker load by an impedance matching output transformer, T5. A closed circuit jack (shown in the diagram) may be used to provide earphone operation.

In addition to providing output stage bias, resistors R16 and R17, bypassed by C13 and C14, act as a decoupling filter in the power supply circuit. Power is controlled, of course, by a SPST

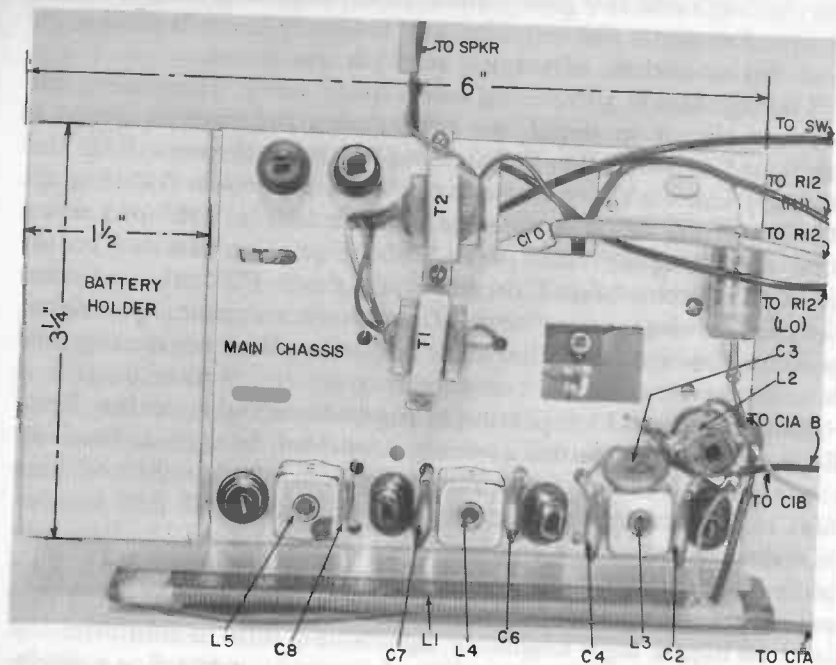

Fig. 513. Top of chassis view—Basic Superhet Receiver.

switch ganged to the gain control, R12. Rotation of R12 should give smooth control of sound, from minimum to maximum volume.

Construction

The Basic Superhet Receiver circuit was adapted from a design used in a commercial construction kit. Any such kit may be used for assembling a similar (but not necessarily identical) receiver offered by manufacturers and distributors. The use of a prepackaged kit is not mandatory, of course, and the receiver can be assembled from individually purchased components by *experienced* builders without too much difficulty. However, *the receiver is not recommended as a suitable first project for a beginner unless a commercial kit is used.* The components needed for assembly are specified in the parts list.

A top-chassis view of the completed receiver, showing major parts layout, is given in Fig. 513. The circuit is assembled on an aluminum chassis measuring approximately 6 x 3 1/4 inches, with a 1 1/2 inch wide rectangular step provided at one end; this serves

as a battery holder in some applications. The oscillator coil, L2, is mounted in a small rubber grommet placed in the chassis, with a friction fit used. The antenna coil, L1, is held in place by a long plastic clip. Transformers T4 and T5 and the terminal strips are mounted using small machine screws and nuts. Sockets are provided for the transistors, secured to the chassis with tiny spring clips. The if transformers (T1, T2 and T3) are mounted in suitable rectangular holes and locked in place by means of their mounting tabs.

Point-to-point wiring is used, with insulated terminals provided where needed, as shown in the below chassis view given in Fig. 514. Layout and lead dress are reasonably critical and care should be taken to follow the arrangement shown in the photographs.*

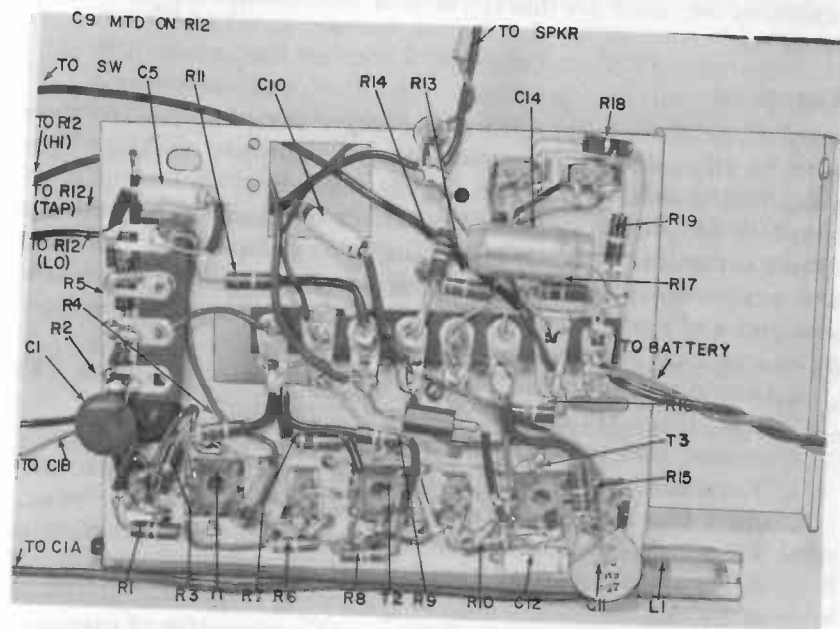

Fig. 514. Below chassis view—Basic Superhet Receiver.

Note, particularly, that small components generally are placed close to the transistor stages in which they are used. All dc polarities and lead color codes should be observed, with insulating spaghetti tubing used on bare leads to prevent accidental shorts.

* If a commercial kit is used, however, the step-by-step layout and wiring instructions outlined in the kit's construction manual should be followed.

The latter precaution is especially important where components are mounted above chassis, with their leads fed through small holes, as, for example, C2, C3, C4, C6 and so on. A heat sink should be used when wiring the diode (D1) in position to avoid heat damage. As in any moderately complex assembly project, wiring steps should be double-checked against the schematic as work progresses to avoid errors.

Referring once again to Figs. 513 and 514, note that external leads are provided for the gain control (R12), power switch (SW), tuning capacitors (C1A/B), speaker and battery, but that these components are not shown. There is ample mounting space on the main chassis for these items if miniature parts are used, of course, but whether they are mounted on, or external to, the chassis depends, as we shall see later, on *how* the completed unit is to be used.

Alignment

In common with other superhet designs, the completed receiver must be aligned for peak performance and proper tracking. This procedure should be carried out *after* the final mounting is selected (see *Variations On A Theme*, later in this chapter), with the tuning capacitor, speaker, battery and other components connected and permanently mounted in position. An insulated alignment tool and a rf signal generator are needed for this job. The basic technique is as follows:

- a. Connect a 100 μmf ceramic or mica capacitor between V1's base (Fig. 512) and the signal generator's hot lead; the ground lead to the set's chassis.
- b. Turn the tuning control until C1A/C1B's plates are fully open, that is, set the dial to about 1600 kc.
- c. Turn the signal generator ON, and allow a few minutes warm-up, setting the controls to deliver a modulated rf signal at 455 kc.
- d. Turn the receiver ON, and rotate gain control R12 for *maximum* volume.
- e. With the signal generator's output attenuator set for the weakest signal that will produce a tone in the receiver's loudspeaker, adjust if transformers T1, T2, and T3 for maximum output, using the alignment tool. Repeat the adjustments at least once to correct for interaction, reducing the signal generator's output as necessary to maintain a barely audible tone from the speaker.

- f. Disconnect the signal generator and remove the 100 μmf capacitor used in Step (a).
- g. Make up a coupling loop of twelve to fifteen turns of hook-up wire wound in a coil three to four inches in diameter. Connect to the signal generator's output cable and place the coil within a few inches of the receiver's antenna (L1).
- h. Readjust the signal generator controls to deliver a modulated rf signal at 1600 kc and set the receiver dial to the same frequency.
- i. Again using the weakest signal that will produce an audible tone from the receiver's loudspeaker, adjust the oscillator trimmer capacitor (on C1B) for maximum output.
- j. Shift the signal generator to 1400 kc and tune the receiver to pick up the signal. Adjust the antenna trimmer capacitor (on C1A) for maximum output.
- k. Shift the signal generator frequency to 550 kc and tune the receiver to this frequency. Rocking the tuning capacitor control back and forth slightly, adjust the oscillator coil slug (L2, Fig. 512) for maximum output.
- l. Repeat Steps (h) through (k), above, to correct for interaction, using the weakest signal generator signal that will produce an audible tone each time, and making all adjustments with the insulated alignment tool.

With the completion of Step (l), the receiver's alignment is finished. Future realignment should not be necessary *unless* one of the rf or if transistors (V1, V2, V3) is replaced, or unless the wired chassis is installed in a different cabinet and the leads to the tuning capacitor (C1A/B) are changed.

VARIATIONS ON A THEME

As mentioned near the beginning of this section, the basic superhet receiver chassis may be used for assembling a variety of practical radio sets, depending on the needs and imagination of the individual builder. The same basic chassis and circuit can be employed in each case with various models being made by using different cabinets, speakers and batteries as well as by shifting the positions of the tuning and gain controls (C1A/B and R12, respectively).

A portable receiver

Historically, the transistor's first widespread use as a component in radio receivers was in portable sets, for it was here that its

unique characteristics could be utilized to its fullest advantages. Because of their very nature, portable receivers should be compact, light-weight, and efficient. Later, of course, the transistor found applications in all types of receivers, including all-band communications types, marine radios, table model receivers, and automobile sets.

The basic superhet may be used as a portable receiver if installed in a suitable plastic or leather carrying case and equipped with a miniature speaker and small 9-volt battery. A rear view is shown in Fig. 515; the case's back flap has been opened to expose the chassis. Here, the tuning capacitor (CIA/B), gain control and switch (R12/SW), and miniature speaker are mounted

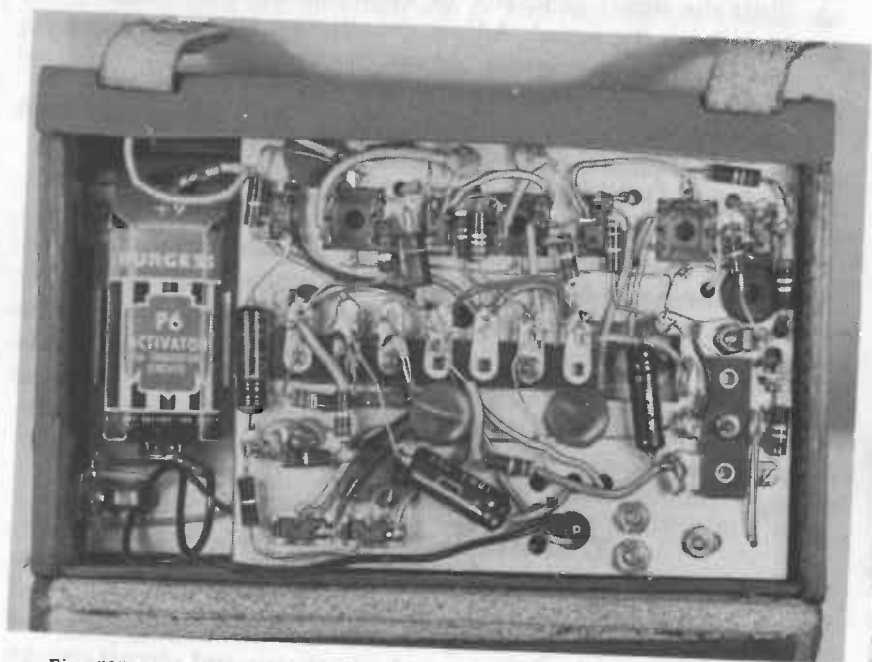

Fig. 515. A Portable Receiver . . . the Basic Superhet Receiver chassis mounted in a leather case. An interior view of the receiver is given here.

directly on the receiver's main chassis. Small metal brackets are used to support the tuning capacitor and gain control and these, together with the speaker, are mounted using small machine screws and nuts. An earphone jack has been added, connected as shown in the original schematic diagram. This unit has been mounted on a small "L" bracket installed just above the battery.

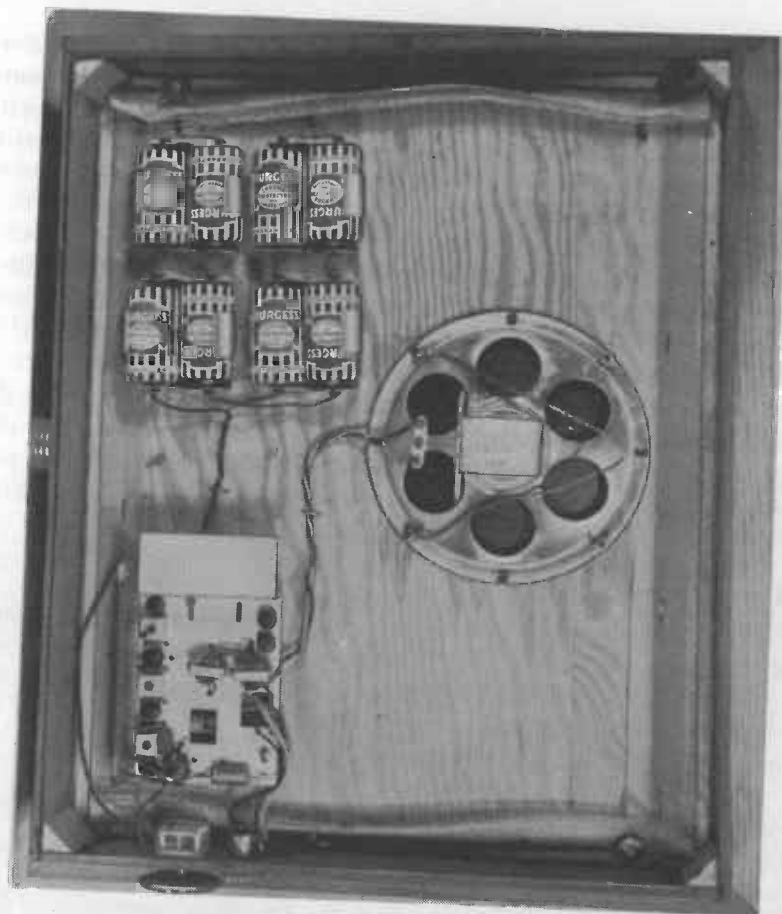

Fig. 516. Rear view of the Picture Frame Receiver—again, the Basic Superhet Receiver chassis is used.

A picture frame receiver

With no dangling power cord to betray its real function, the Picture Frame Receiver is ideal for a business office or, in the home, for the living or recreation rooms. Sure to win the admiration and envy of friends and neighbors, such a set makes a superb gift for the close friend who *has everything*. In addition, since similar designs are not offered too widely on the commercial market, a really clever individual might be able to pick up a little spare-time cash by custom-assembling such sets for sale to local customers.

Construction details are shown in rear view in Fig. 516. Again,

the Basic Superhet Receiver chassis was used. A standard picture frame was used in assembling the model, with the back rim built up using strips of one-quarter inch pressed board reinforced with triangular wooden blocks glued in the corners. Good quality sound reproduction and efficient operation were assured by using an 8-inch PM speaker. A long-life power supply was made by connecting eight standard flashlight cells in series to supply 12 volts. The speaker, receiver chassis, and battery holders are all mounted on a piece of half-inch plywood cut to fit within the frame. Wood-screws were used for mounting. The tuning capacitor (C1A/B) and gain control (R12) were mounted on the built-up rim. A hole was cut in the plywood for the speaker, of course, while the picture itself was made on loosely woven fabric so as not to muffle the sound. In practice, the solid plywood board and built-up picture frame made an excellent baffle for the loudspeaker, improving bass response and overall performance.

A table model receiver

There has always been a limited, but steady, market for battery-operated table model receivers, even during the hey-day of the low-cost ac-dc vacuum tube set. Battery operation is essential on many farms, at hunting camps, beach houses and in other locations where there is no source of line power. Interestingly enough, a battery-powered set offers many advantages even in the home where power receptacles are readily available. First, this type of receiver may be used in a damp basement, bathroom, or in the home laundry without fear of shock. Second, there are no dangling line cords to trip up unwary pedestrians or guests. Finally, such receivers can be placed wherever desired and may be moved about the room, or transferred from one room to another, with a minimum of inconvenience.

Interior details of an attractive, easily and quickly assembled Table Model Receiver are illustrated in the photograph. Fig. 517. A commercial wooden cabinet was used for assembling the model, with an oval PM loudspeaker installed to obtain maximum speaker size in minimum space. Although the Basic Superhet Receiver chassis was used, the battery holder "step" was sliced off with a hacksaw to reduce overall length. The tuning (C1A/B) and gain controls (R12) were mounted on the side of the cabinet. The receiver chassis itself and the metal bracket used to support the four dual-cell battery holders were mounted on a piece of perforated board cut to fit the back of the cabinet and secured in

place with wood screws. Flexible leads were used for chassis connections to the controls and loudspeaker. As in the Picture Frame Receiver, the power pack was made of eight flashlight cells connected in series to supply 12 volts.

Novelty receivers

Broadly speaking, a novelty set can be defined as a receiver mounted in an unusual cabinet. In one sense, then, the Picture Frame Receiver is a novelty radio. On the other hand, some individuals prefer to reserve the term for receivers which are *really* unusual. Such sets make ideal conversation pieces, are excellent for dens or recreation rooms and make superb gifts.

The Basic Superhet Receiver chassis is well-suited for the assembly of unusual radio sets. Basically, all that is needed is a

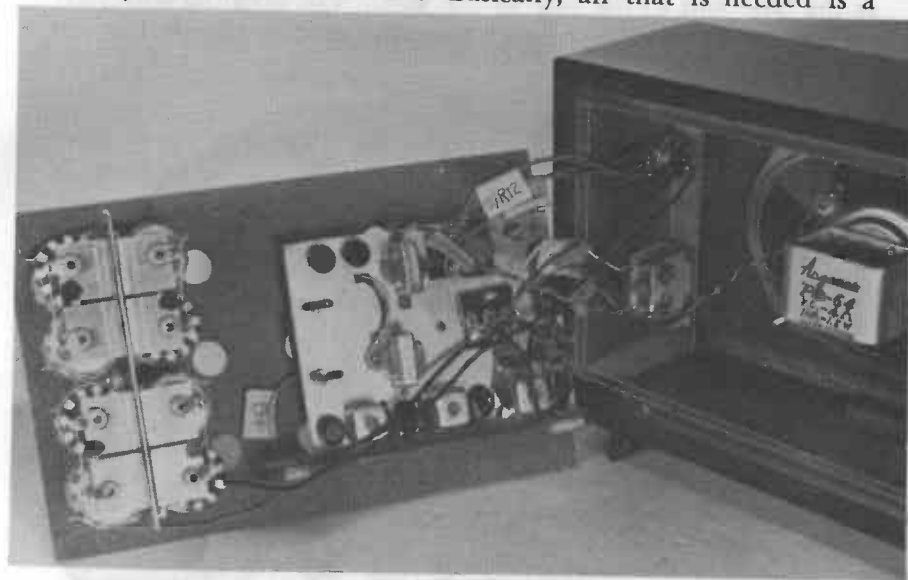

Fig. 517. Mounted in a plastic or wooden cabinet, the Basic Superhet chassis becomes a useful Table Model Receiver.

wide-ranging imagination, plus a dash of skill and a fair sprinkling of ingenuity in fitting the chassis, speaker and power supply into odd-shaped areas. Typically, the receiver might be mounted in the base of a table lamp, in an old camera case, in a lunch box, in the hollow base of a small aquarium, in a statue or other decoration, in a jewel box, a flower vase, an old wall telephone, a hollow World Globe, a variety of toys or even in a book if the pages are glued together and hollowed out with a sharp knife. A slightly

grim, but nonetheless interesting, novelty receiver is the *Skull Radio*. The skull is not a real one, of course, but is a commercially made full-sized plastic model obtained from a local Hobby Store.

Several modifications were made in the basic chassis to fit it within the limited space available. A top view of the receiver, with skull cap removed, is given in Fig. 518. Here, the battery holder step was sliced off with a hack saw, shortening the overall length of the chassis. In addition, the four corners were clipped diagonally to round them off. The gain control (R12/SW) and tuning (CIA/B) capacitor were mounted on small brackets on the main chassis. A subminiature speaker was used (essentially the same type as used in the Portable Receiver) and this was mounted at the base and to the rear of the skull. The antenna coil (L1) was removed and replaced with a smaller unit, as specified in the

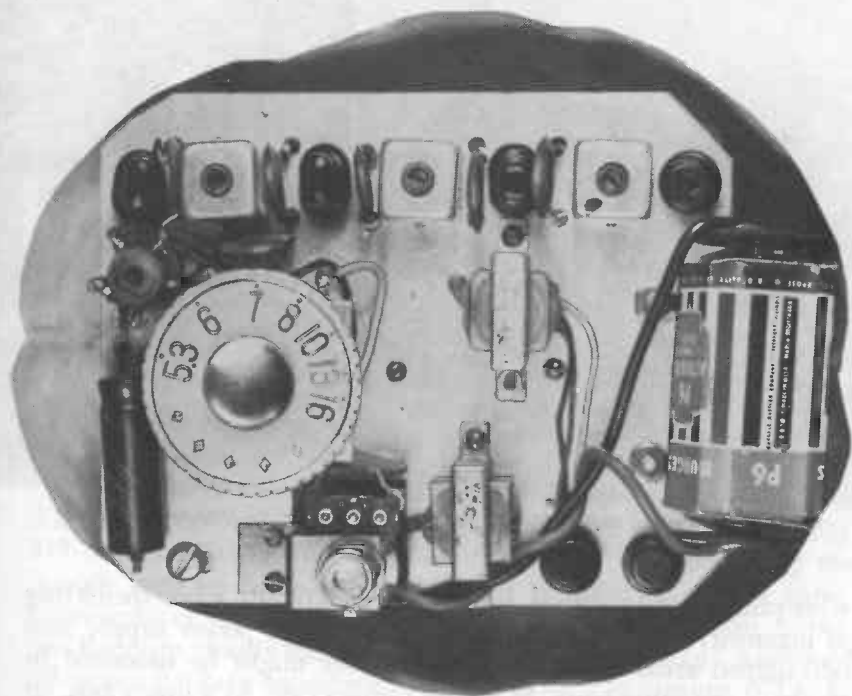

Fig. 518. Here, the Basic Superhet Receiver chassis is cut down and fitted into a plastic skull, thus becoming a unique Novelty Receiver. Many other variations are possible, depending on type of cabinet used and style of mounting.

parts list. The new coil was secured to an "L" bracket mounted below the chassis. Since the rounded skull cap prevented the use of a standard volume control knob, a knurled thumb nut was used as a substitute. The speaker and other components were mounted by drilling and tapping holes in the skull's interior and using small machine screws. Where needed, support brackets made up of scrap plastic were cemented in place. Finally, a small 9-volt battery was used as a power source. In use, the receiver's controls are accessible only when the skull cap is removed, and hence are not generally visible. In operation, then, the effect is quite eerie, for the loudspeaker tends to project the sound through the skull's mouth and there are no tell-tale control knobs.

A POWER INVERTER

Most small electrical appliances are designed for power line operation. This poses a real problem for the individual who may wish to use his electric shaver in his car, or who may need to use a small appliance in a remote location where storage batteries, but not line power, are available. There are solutions, of course. Special appliances may be purchased which are designed for operation on a low-voltage dc source. One manufacturer, for example, offers an electric shaver which will operate on *either* line power or 12 volts dc (as may be obtained from a car battery). As an alternative, an ac generator might be installed in the car as a permanent accessory and driven by a belt coupled to the motor. In a remote area, a motor-generator might be used as a power source.

On the other hand, if the amount of power required is not excessive, an *inverter* can be used. The inverter is basically a device for changing dc, as might be supplied by a battery, first to pulsating dc then to ac by a transformer at a specific repetition rate (or frequency). Pulsating dc, of course, contains a strong ac component which can be stepped-up (or down) by means of a suitable transformer to the desired voltage level. Transistors are ideal for this application. The schematic of a practical, inexpensive, and reliable Inverter is illustrated in Fig. 519. The components needed are specified in the parts list. Designed to supply 115 volts ac at 60 cps when powered from a 12 volt dc source (such as an automotive storage battery), this unit, when used within its power rating of 50 watts, is capable of operating most (but not all) line-powered appliances.

Circuit description

Referring to Fig. 519, a pair of p-n-p power transistors, V1 and V2, are used in a modified push-pull oscillator circuit. Both units are connected in the common-collector configuration to insure maximum heat dissipation and, thus, efficient, cool operation. V1's base bias is furnished by voltage divider R1-R3, V2's by R2-R4. A multi-winding iron-core transformer, T1, serves both to provide the feedback necessary to start and maintain oscillation and to step-up the resulting ac signal to the desired voltage level. The output power, obtained from T1's secondary winding, is furnished to the external load through a standard power line re-

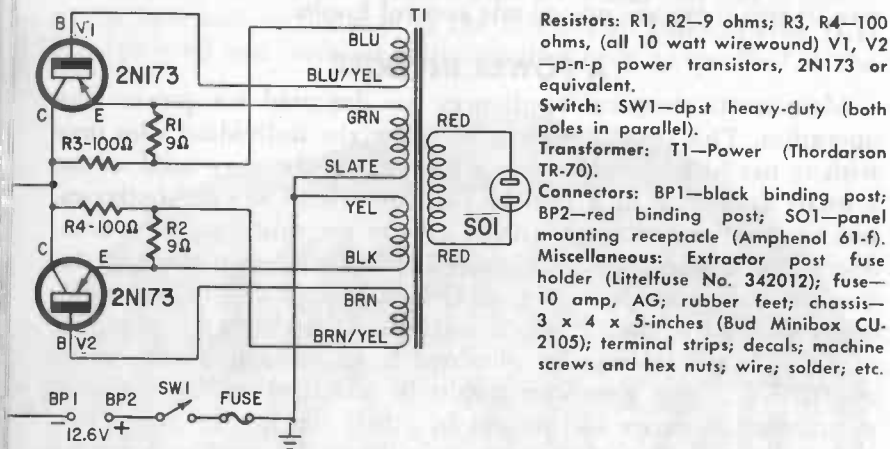

Fig. 519. Schematic of a useful auto accessory—a Power Inverter.

ceptacle, SO1. Circuit operating power is obtained from an external 12 (or 12.6) volt dc source, such as a storage battery, connected to binding posts BP1 and BP2. The unit's operation is controlled by a heavy-duty SPST switch, SW1, while the power source is protected by a standard line fuse.

In operation, the polarity and amplitude of the feedback signals is such as to drive the transistors first to saturation and then to cut-off on alternate half-cycles. If V1 were conducting, for example, it would act as virtually a short-circuit, connecting the *green* lead of the primary winding to circuit ground. The feedback signal obtained from the *blue-blue/yellow* winding and applied to its base would be negative-going, maintaining heavy conduction through the full half-cycle. At the same time, however, the feed-

back signal obtained from the *brown-brown/yellow* winding and applied to V2's base would be positive-going, maintaining this transistor in a high impedance state, so that it acts as an open circuit. On the following half-cycle, the roles would be reversed, with V2 conducting heavily and V1 held in a high impedance state. Thus, the primary current flows alternately in rectangular pulses through first one, then the other, half of the dual primary winding (*green-slate/yellow-black* leads). In a sense, the transistors operate more as electronic *switches* than as conventional oscillators, and the result is a square, rather than sine, wave output signal. The cir-



Fig. 520. Overall view of the completed Power Inverter.

cuit's operating frequency (60 cps) is determined primarily by the transformer's characteristics and will change slightly under no-load conditions.

Construction and use

Exterior and interior views of the author's model are shown in Figs. 520 and 521, respectively. The instrument was assembled in an enameled 3 x 4 x 5 aluminum box, with decals used to identify controls and terminals. The decals were applied *after* all machine work (drilling, etc.) was finished but *before* parts were mounted. The decals are protected, after application, with two coats of clear lacquer. Neither layout nor lead dress are critical, but, for best heat dissipation, the transistors should be mounted firmly against the metal case, with ample separation provided between the transistors and the power resistors (R1, R2, R3 and R4)

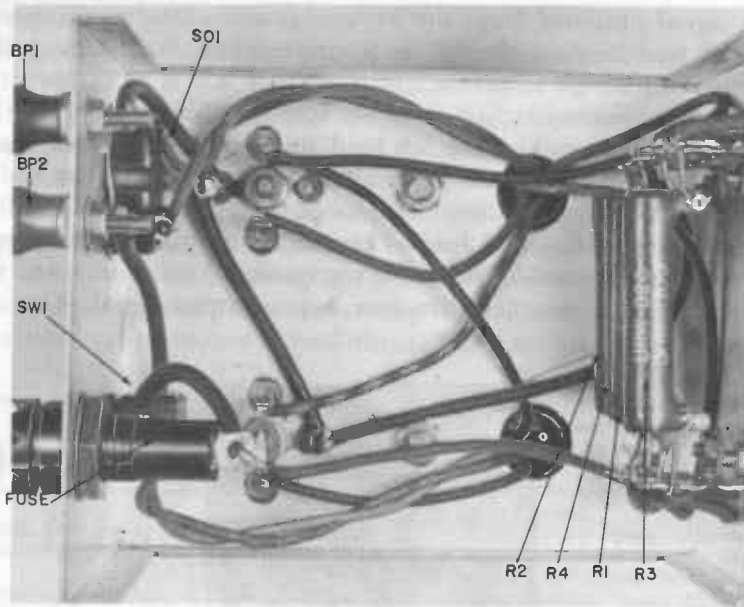

Fig. 521. Interior view of the Power Inverter. Resistors R1, R2, R3 and R4 are attached to terminal strips mounted on the rear apron.

used for biasing. The four resistors were mounted on insulated terminal strips attached to the back apron (Fig. 521). Machine screws, lock-washers and hex nuts were used for mounting all major components. Rubber feet were mounted on the base to prevent scratches to surfaces on which the unit might be placed.

Although the transistors' collector electrodes are connected internally to their metal cases, it is best not to rely on a mechanical connection as a conductor. Instead, heavy soldering lugs were secured to the transistor mounting studs and these, in turn, were connected together and to circuit ground. The power switch, SW1, is a DPST unit, with the corresponding poles connected in parallel to boost current handling capacity. Transformer-lead color-coding must be observed. Use 12 or 14 gauge wire for other circuit wiring. The fuse should not be installed until after the wiring is completed and checked for errors.

CHAPTER 6

How to find trouble or if it doesn't work . . . shoot it!

There's a lot to be said for knowing where and what to do, especially when something goes wrong with a newly finished project. Too often, however, a hobbyist, student or experimenter becomes discouraged if an amplifier, receiver or gadget doesn't work after he has invested money in components and lavished care on its construction. But occasional, or even frequent, failures are to be expected, and, in a sense, welcomed, for the individual who finds it necessary to *debug* or to troubleshoot projects from time to time acquires a much better knowledge of his field as well as technical skills which can be of real value in future work.

Failures occur in the best regulated of families and, generally, are no reflection on the individual. A good friend of mine, one of the nation's top-rated electronic engineers, once told me that, on the average, he allotted six weeks to the design of new projects, two weeks to the construction and test of an experimental model, and *ten weeks to finding and eliminating the bugs that crept in during design and construction*. Your author's personal experiences confirm these figures, but there are many engineers who would dispute the ratios. I know of several, for example, who claim that my friend stretches the truth a little in order to brag, for they find that it takes two or three times longer to debug a project than is required for original design and construction. In any case, my friend has a framed motto hanging above his desk. It reads—

IF ANYTHING CAN GO WRONG —
IT WILL!!!!

BASIC TROUBLESHOOTING

Troubleshooting and debugging are simply other names for servicing. Of these, troubleshooting generally is used in a broad sense and may be applied to many fields of endeavor. A Junior Executive may be called a *troubleshooter*, for example, when he sets out to eliminate inefficient operation in an organization. On the other hand, *debugging* is more often applied to the repair and service of newly designed or assembled equipment, and does not refer to the elimination of insects. A *bug* may be a minor error in design, a component of improper value, poor layout, sloppy lead dress, a mistake in wiring, or an actual defect.

Except in rare instances, virtually any piece of equipment, whether home-built or factory assembled, and whether an electronic instrument, a mechanical appliance, or a giant processing machine, can be serviced in three basic steps:

- (a) Find the defect causing improper operation.
- (b) Correct the defects by parts replacement or adjustment.
- (c) Check out equipment operation.

As applied by the professional service technician, these three steps become part of a general servicing philosophy. He starts by assuming that the equipment worked properly at one time. He assumes, too, that the immediate complaint was caused by only one or two defects. Finally, he tackles the job for the express purpose of correcting the complaint. Thus, his approach is more like that of a rifleman drawing a bead on a target than that of a shotgunner who scatters shot over a wide area, and he concentrates primarily on those possible defects that are *likely* to cause the specific complaint. This type of direct approach is excellent and can save considerable time.

Unfortunately, there are important differences between newly assembled equipment and units that have been in use and these differences, in turn, affect the servicing techniques. In the latter case, we assume that the equipment *did work* and that the complaint is due to the failure of a specific part (or parts). Such an assumption is not valid where newly built equipment is concerned. Generally, we must first make sure that the equipment can work, in other words, that it has been assembled according to specifications, with proper components used, and with no errors in construction. In the great majority of cases, a thorough check-out will reveal the source of the trouble.

Incorrect wiring is perhaps, the major cause of difficulty in all newly assembled projects. If trouble is encountered, the first step

should be a careful double-check of circuit wiring, with particular attention to lead color codes and dc polarities. A preliminary check may be made against pictorial diagram, if available, but the

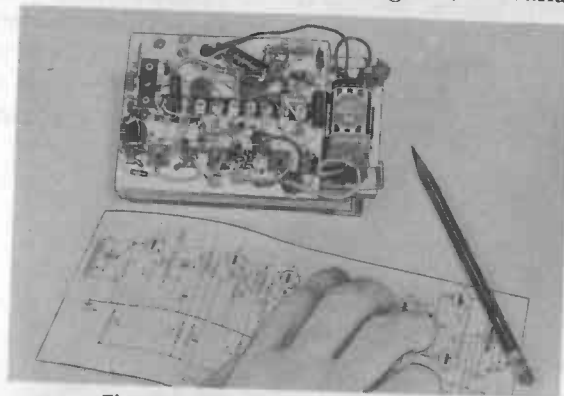

Fig. 601. Double-check your wiring!

final check should always be against the schematic circuit, as in Fig. 601. In the case of kit-built projects, a cross-check between schematic and pictorial diagrams is often revealing.

Most shorts and opens may be ranked alongside actual wiring errors as common causes of trouble. An accidental short may occur when a bare component lead touches a metal chassis or some other part; these may be minimized by the use of insulating tubing (spaghetti) over component leads. Opens develop if a terminal is left unsoldered or if excessive strain is placed on a component lead. Opens may be caused, too, by excessive flexing of leads as components are moved or lead dress rearranged during construction. In some cases, a conductor may break without damage to external insulation. Thus, a particular conductor may pass a quick visual inspection when, in reality, it is open. Be suspicious of leads that have been moved back and forth frequently or which are stretched taut.

Poor soldering, due to carelessness or improper technique, is another common source of trouble. All work should be done with a clean, hot, well-tinned soldering tool. *Rosin-core* solder should be used. Most kit manufacturers, for example, void all guarantees if the builder uses acid-core solder during construction. An adequate, but not excessive, amount of solder should be used for each joint, with the solder flowed smoothly over the terminal and connecting wires; see Fig. 602. If the solder is lumpy and looks pasted on, the leads may be held by solidified flux (rosin); typi-

cally, a *rosin joint* has extremely high resistance and may even act as an open circuit. A frosty appearance may indicate a cold soldered joint, that is, a connection that was disturbed before the solder had cooled properly. In such a case, the connection may open intermittently. Finally, if excessive quantities of solder are used, small drops may hang down, shorting a terminal to chassis, or a large globule may build up, forming an electrical *bridge*

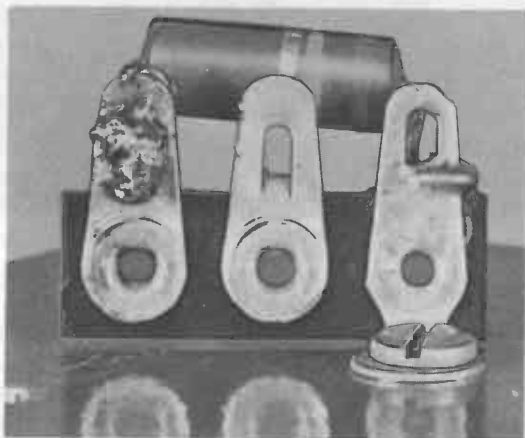

Fig. 602. Poorly (left) and properly (right) soldered joints. Poor soldering is a frequent cause of trouble.

(short) to other terminals. Most of these conditions may be corrected by proper resoldering; excessive solder build-up may be corrected by holding a hot soldering tip against the affected joint and draining the excess away.

Proper components should be used for project assembly, of course. If at all possible, the exact components specified in the original parts list should be employed during construction. This is not to say that substitutions can't be made in most cases; however, where a substitute is used, its electrical characteristics should duplicate those of the specified components as closely as possible, and the fact that a substitute part has been used should be kept firmly in mind. If trouble is encountered, it may indicate that the choice of a substitute was a poor one, or that a readjustment of other circuit component values may be needed for optimum equipment performance. For example, a different type of transistor may be a perfectly acceptable substitute for a specified unit, *if the base bias current is changed*. In this case, a new value may be chosen



Fig. 603. Using a Battery Tester. Some internal load is placed across the battery when voltage measurements are being made.

for the bias resistor by trying other values experimentally. A similar technique (an experimental readjustment of component values) may be used to correct for off-tolerance parts. Always remember that commercial circuit components are seldom manufactured to exact values.

Most of us, being human, will try to save on component costs. A common technique is to make substitutions using parts that are already on hand or salvaged parts taken from the junk-box. Again, such substitutions may be permissible *if* the replacement is in good condition and has the proper electrical characteristics. If in doubt, it is better to invest in new parts.

Adequate power must be available for circuit operation. Since most transistor projects are battery-powered, the batteries used should be checked carefully, using adequate techniques. Don't assume that a battery is in good condition because it works in another piece of equipment or because it has never been used. Current requirements vary from one circuit to another and a weak battery may permit nearly normal operation in one device but may fail dismally in another. A battery can lose effectiveness, too, if stored for too long a period. Most units have a limited *shelf life*. If batteries must be stored for long periods, they should be kept in a dry, cool location.

The best check is one made with a commercial Battery Tester,

as shown in Fig. 603. This type of instrument checks the battery voltage under load and indicates whether the unit should be replaced or whether it can be considered as in weak or good condition. If a professional instrument is not available, a check may be made by measuring the battery's voltage under load, using a standard VOM, as illustrated in Fig. 604. In this case, the battery is installed in the equipment with which it is to be used. A voltage check is made with the equipment turned **OFF**. A second check is made with the equipment turned **ON**. If there is no significant difference in the two voltage readings, the battery is probably in good condition. On the other hand, if the battery voltage is low

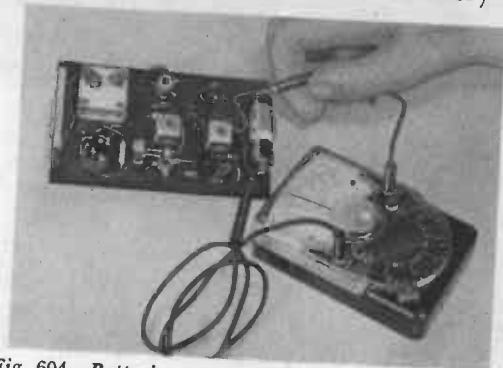

Fig. 604 Batteries can be checked with a voltmeter if a standard Battery Tester is not available . . . but the tests should be made under load—power on.

or drops appreciably, from 10% to 20%, or more, or if the voltage starts to drop gradually and continues to drop, it is a pretty good indication that the battery is weak and should be replaced. This test assumes, of course, that *the equipment itself is in good operating condition*. If there is a partial short in the equipment's circuit, poor results may be obtained even if a new battery is used. In such a case, the battery will be exhausted in short order if kept in the circuit.

Proper voltages (and currents) must be available within the equipment as well as at the power source. Thus, checks of individual stage voltages often are valuable in tracking down wiring errors or defective components. These tests may be made with a standard VOM, as shown in Fig. 605. In general, measurements are made of individual transistor electrode voltages with respect to circuit ground (often, the metal chassis) or the emitter electrode. Care must be taken to avoid misleading results. Remember



Fig. 605. Circuit-voltage tests help spot trouble.

that n-p-n and p-n-p transistors have opposite dc polarities. Remember, too, that some circuit voltages are normally very low. As an example, base-to-emitter voltages seldom exceed a few tenths of a volt, regardless of supply voltage.

Unexpected voltage readings should be investigated. If there is an excessive drop in the voltages measured on each side of a decoupling resistor, for example, it may indicate a possible short in the accompanying bypass capacitor. In another case, if proper voltage is measured on, say, the dc supply lead of an if transformer primary winding, but not on the if amplifier's collector, one might suspect an open winding.

If proper components have been used during project assembly, there are no errors in layout or wiring, no accidental opens or shorts, and adequate soldering techniques have been used, chances are that any difficulty in obtaining proper circuit operation is the result of one or more *defective components*. The fact that a part is new does not *always* mean that it is in good condition. Although a somewhat rare occurrence, new parts have been known to be defective. A resistor may be open or shorted, or may have changed value. A capacitor may be leaky, shorted or open. A coil or transformer may have open or shorted windings.

Where component defects are suspected, any of several test methods may be employed. An ohmmeter may be used to check for electrical shorts or opens (except an open in a small capacitor) and to check the dc resistances of potentiometers, resistors, switches, or the windings of coils, transformers and loudspeakers. An R-C Tester (or an Impedance Bridge) is useful for checking

both resistors and capacitors. If such test equipment is not available, the *substitution technique* may be used. Here, the suspected



Fig. 606. Using an ohmmeter to check transistors.

component is replaced with a duplicate known to be in good condition. If proper operation is obtained, it can be presumed that the replaced component was defective. In some cases, it may not be necessary to remove the old component to make a test. For example, a bypass capacitor can be checked for an *open* simply by connecting a duplicate unit in parallel, that is, by shunting the test capacitor across the suspected unit.

Defective transistors may cause a variety of operational complaints, depending on the nature of the defects and the types of circuits in which they are used. Transistors may change characteristics or may become open, leaky or shorted. Typical equipment complaints may range from *noisy* or *squealing* (oscillation) to *weak* or *dead*.

As far as factory-assembled equipment is concerned, a defective transistor is a relatively rare occurrence, *unless* the component has been subjected to excessive temperatures, overload, or other forms of physical or electrical abuse (see Chapter 7). Unfortunately, this generalization may not hold true for home-assembled projects. An experimenter's transistors are likely to be used under widely varying conditions and, quite often, may be pushed past their maximum ratings or inadvertently subjected to overloads or current or voltage transients. A change in characteristics, unless severe, may go unnoticed for months, or until the unit is installed in a reasonably critical circuit.

Good shop practice, then, dictates that an experimenter's stock of transistors should be checked from time to time and whenever

the units are to be installed in a newly finished project. A Transistor Checker is preferred for these tests, if available. The in-

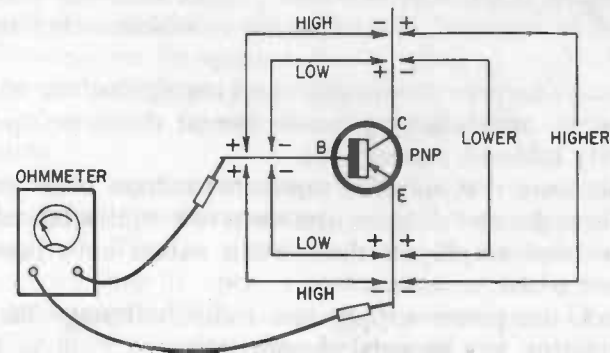

Fig. 607. Basic transistor tests with an ohmmeter.

strument chosen should permit a reasonable test of both gain and leakage characteristics.

If a tester is not available, a suspected transistor may be given a cursory check by using the substitution technique described earlier or by using a series-type ohmmeter (Fig. 606) to check and compare the *forward* and *reverse* resistances of the two diode junctions making up the component.

Referring to the diagram (Fig. 607), the ohmmeter's leads are connected to two of the transistor's electrodes. Assuming that a p-n-p type is being tested, as shown, and that the ohmmeter's battery applies a positive bias to the base electrode, a fairly high resistance should be measured between the base and emitter or between the base and collector. This may be as high as several megohms with some transistors. If the instrument's leads are reversed, applying a negative bias to the base, a moderately low resistance should be measured between the base and emitter or between the base and collector electrodes. Typically, this may run from a few thousand to less than a hundred ohms. In any case, the *ratio* between the *high* and *low* resistance measurements should be from ten to twenty to one, or more. A smaller ratio, perhaps as low as two to one, will be obtained when checking the resistances between the emitter and collector electrodes; in some cases, identical resistance values may be measured here, even where the transistor is in good condition. A similar technique is used for checking n-p-n types, except that dc polarities are reversed. When multi-

watt power transistors are checked, actual resistances are much lower, but the ratios may be about the same.

In summary, if a home-assembled project does not perform as anticipated or expected, the following troubleshooting steps are suggested:

- (a) Visually inspect the wiring, checking against the schematic diagram, and watching for accidental shorts or opens and poorly soldered connections.
- (b) Make sure that specified components have been used and color codes and dc polarities observed or, if substitute parts have been employed, that circuit values have been readjusted where necessary.
- (c) Check the power supply and individual stage biases, investigating any unusual measurements.
- (d) Check and/or replace suspected components or transistors.

ADVANCED TROUBLESHOOTING

If trouble is encountered with a project based on a *proven* circuit, such as might be featured in a magazine article or book, the techniques we have just discussed, properly applied, should be effective in 80% to 90% of the cases. These troubleshooting techniques are also quite effective even when applied to new, previously untested projects, provided the circuits are basically sound and are derived using acceptable design methods and good engineering practice. Occasionally, an obscure defect will develop which cannot be tracked down using these basic techniques. As far as the worker can determine, everything checks properly. There are no wiring errors, specified components have been used, and proper supply voltages are furnished, but the circuit still does not operate as expected. This type of trouble is encountered most often with multi-stage designs and requires the application of more powerful troubleshooting techniques.

For purposes of discussion and analysis, most electronic equipment operational complaints can be grouped into three broad classes. In the first class we can group all complaints that the equipment *simply does not work*. A receiver or amplifier may be dead. A control circuit may not operate. A transmitter may not radiate a signal. In the second class are grouped complaints that the *equipment works, but not quite properly*. A receiver may be weak. An amplifier may deliver a distorted signal. A photoelectric relay may lack sensitivity. Finally, in the third class are grouped complaints that the *equipment works, but that something inter-*

feres with normal operation. A receiver may lack selectivity, so that several stations are received at the same time. An amplifier may have excessive hum or noise. The relay in a control circuit may tend to *chatter* or to trip on extraneous signals. These general classifications can be applied whether the equipment is a home-wired project or a factory-assembled unit, and whether the trouble seems inherent or is one that develops after years of normal operation.

First, if the equipment simply does not work, we can conclude that the defect (or wiring error) is akin to an *open* in the signal carrying path. That is, a transistor may be shorted or open, a resistor or coil may be open, a transformer winding may be open or shorted to ground, a coupling capacitor may be open, or a bypass or filter capacitor may be shorted.

On the other hand, if the equipment works, but not quite properly, we can assume that all stages are functioning, but that the defect has caused a change in operating characteristics. Typically, a resistor may change value, reducing the bias on an amplifier stage and shifting it from Class A to Class B operation, thus distorting signals handled by the stage. Complaints in this general class may be caused by such defects as a leaky transistor, a leaky or partially open capacitor, a changed value resistor, or a partial short in a coil or transformer winding.

Finally, if something seems to interfere with expected operation, we suspect a failure in a selective or protective circuit or component. For example, if a receiver lacks selectivity, we would look for trouble in the tuned circuits, such as misalignment or a loss of "Q." The presence of hum or noise may indicate defective or improper shielding or an open bypass or filter capacitor. Oscillation or squealing (in an amplifier) may indicate poor lead dress or layout, defective or inadequate shielding, or an open bypass or filter unit.

In all three classes, the essential key to discovering and eliminating the defect is found in one word: *isolation*. That is, the defect (or defects) causing the complaint must be isolated before corrective steps can be taken. If the defect turns out to be an error in lead dress or a poor choice of layout, a new circuit arrangement must be chosen; this is not an uncommon source of trouble in newly built equipment, but is relatively rare in equipment that has been in use and has operated normally in the past. On the other hand, if the complaint is caused by a defective or improper value component, a replacement is installed.

Where the circuit is a relatively simple one, such as a one-stage amplifier, the isolation technique may involve nothing more than basic voltage measurements or, in an extreme case, an item-by-item check of *all* the components and wiring. While this technique is an excellent one, it is much too time-consuming for application to complex, multi-stage circuits which may use scores, or even hundreds, of components. Instead, we must look to methods which permit checks of *blocks* of components, such as individual stages. With this approach, the trouble first would be tracked to a section of the equipment, then to an individual stage, and, finally, isolated as a defect in a particular component by item-by-item tests. The two most effective general troubleshooting techniques are *signal tracing* and *signal injection*. Let's take a closer look at these.

Signal tracing

Basically a simple method, the signal tracing technique may be applied to virtually any type of electronic equipment. As the name implies, the signal path through the tested circuit is *traced* electronically, starting at the equipment's input and following through to the output device. Unexpected changes in the signal's form or amplitude at any point are indicative of trouble in the preceding stage. The signal itself may be a change in dc level in the case of an instrument or control device, a low frequency ac voltage (or current) in an audio amplifier, or an rf signal in a radio receiver or transmitter. In some circuits, such as superhet receivers, all three types of signals may be encountered—rf in the *front-end* and if stages, low frequency ac in the audio amplifier section, and dc in the agc circuit as well as in the power supply.

Naturally, the test equipment used for signal tracing will depend on the type of signal followed and the equipment that is to be checked. If signal amplitude is the only critical factor, a suitable voltmeter might be used. A cathode ray oscilloscope (scope) is particularly valuable for signal tracing, for it permits a direct observation of both signal waveform and amplitude. Most commercial *signal tracers*, however, are basically high-gain audio amplifiers coupled to earphones or speakers and, generally, with a device for indicating relative signal amplitude, such as a meter or *tuning eye*. In practice, such an instrument is used with a simple probe for checking audio circuits and with a *rf* or *detector* probe for tracing through rf and if stages.

The basic technique may be followed quite easily by referring to the block diagram of a typical multi-stage audio amplifier given

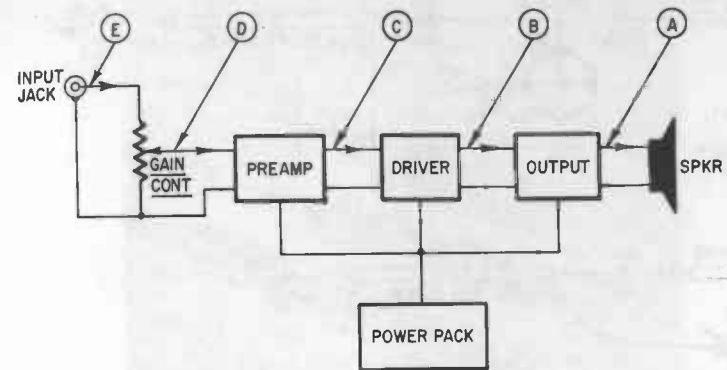

Fig. 608. Block diagram of a typical audio amplifier, showing points at which signal tracing tests may be made.

in Fig. 608. Here, we will assume that there is some obscure defect in the equipment and that a normal signal has been applied to the unit's input jack. The test signal may be obtained from an *audio signal generator* or some similar source. We will assume, further, that supply voltages have been checked and are normal, and it is logical to conclude that the trouble is in one of the signal handling stages.

Using a signal tracer and a suitable probe, we first check the signal at point E, noting its amplitude and quality. Since this is the original signal, it will be normal and establishes a basic point of reference. Afterwards, the operation of the gain control is checked by transferring the test probe to point D, noting the signal obtained at the point. If control operation is normal, we should be able to vary the amplitude of the signal by adjusting the control. Next, we follow the signal through the equipment stage-by-stage by transferring the test probe to points C, B, and A, noting relative signal amplitude and quality at each point. The last test position, of course, checks the signal applied to the output device (speaker).

If the equipment is operating normally, there should be no change in the signal, except as far as amplitude is concerned. We would expect an increase in amplitude with each gain stage, of course. If there is a change in signal quality or a decided adverse change in signal amplitude at any point, we look for trouble in the preceding stage. For example, let us assume that the signal checks *normal* at point C, but is badly distorted and weak (low

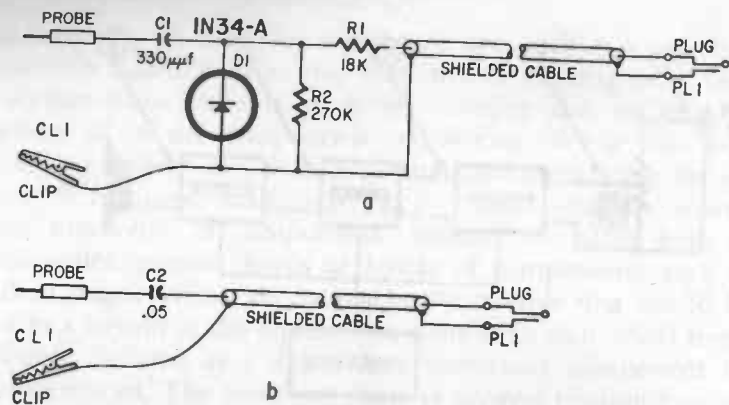

Fig. 609. Schematic diagrams of easy to assemble rf (a) and audio (b) signal tracing probes.

amplitude) at point B. In this case, we have isolated the trouble to the driver stage. We can then make voltage and item-by-item checks in that stage to further isolate the trouble to a specific defect. In another case, the signal might check normal throughout the equipment, but the sound heard from the speaker is badly distorted. Here, we would suspect a defective speaker. As one final example, if we found that the signal checked normal up to point B, but was missing entirely at point A, we would have isolated the trouble to a dead output stage. Again, voltage and item-by-item tests in this stage would be used to find the defective component.

As we have seen, a high-gain audio amplifier, used with adequate test probes, will serve as a signal tracer for checking audio and rf circuits. Thus, the Detectaphone described in Chapter 2 may be used as a handy pocket-sized signal tracer if equipped with an earphone and suitable probes. The schematics for easily assembled rf and audio test probes are given in Fig. 609. Assembled probes are shown alongside the Detectaphone in Fig. 610.

The *rf Probe* in Fig. 609-a consists of a small coupling capacitor, C1, a diode detector, D1, a detector load, R2, and a series isolating resistor, R1. C1 may be a small mica or ceramic capacitor, while R1 and R2 are half-watt resistors. The *Audio Probe* is simply a series dc blocking capacitor—a .05 μf, 400 volt, tubular unit (C2) is used. Both probes are equipped with pin tips and are assembled in short lengths of tubing which, in use, serve as

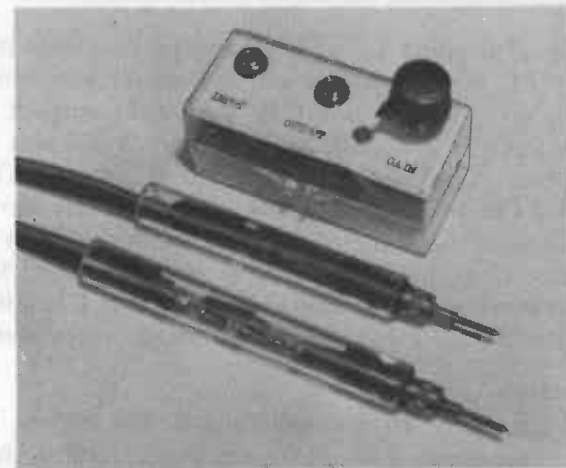

Fig. 610. The signal tracing probes shown in Fig. 609 may be used with any high gain audio amplifier . . . here, the pair of assembled probes are shown with the Detectaphone (described in Chapter 2).

handles. Clear plastic tubing was used in assembling the models to permit the internal construction to be shown, but metal tubing is preferred as a shield against stray noise pick-up. Naturally, the metal housing would be insulated with respect to the signal circuit, but would be connected to the cable shield and ground clip (CL1). Small alligator clips are used for CL1, connected to the shield with short lengths of flexible insulated wire. The probes are coupled to the amplifier through 18" to 24" lengths of shielded single-conductor cable fitted with plugs (PL1) to match the Detectaphone's input jack.

In practice, the Audio Probe is used for checking audio amplifiers and the audio sections of radio receivers, while the RF Probe is used for signal tracing through rf and if stages. With either probe, the ground clip (CL1) is connected to the circuit ground (generally, the chassis) of the equipment to be tested, while the probe tip itself is applied at selected check points. The test signals are heard in the Detectaphone's earphone (connected to the output jack), with the volume adjusted to a comfortable level by means of the instrument's gain control.

Although used primarily for stage isolation, the Signal Tracing technique often is valuable for identifying defective components. Referring to Fig. 611, for example, tests might be made at points D, C, B, and A. If a normal signal was obtained at point

D, but no signal at point C, we would suspect an open or shorted transformer, T1. Similarly, if a normal signal was obtained at point C, but no signal at point B, we would suspect an open coupling capacitor, C1. Finally, if a normal signal was obtained at point B, but a distorted signal at point A, we would look for a defect in V2's stage. Typically, the stage bias may have shifted due to a change in the value of the bias resistor, R1. In this two-stage amplifier, then, points A and B would be used for checking V2's operation, points B and C for checking C1, and, finally, points C and D for checking the interstage transformer.

Signal injection

Preferred by many service technicians, the *Signal Injection* technique, in one sense, is similar to signal tracing but, in another, is just the opposite of the latter method. It is just as effective as signal tracing in most cases and is similar in that it involves a stage-by-stage operational check of the defective equipment. The basic test instrument used is a signal generator rather than a signal tracer, however, and the starting point for tests is generally at the output rather than input. As in signal tracing, the exact instrument needed depends on the type of signal handled and the characteristics of the equipment tested. In general, an *rf Signal Generator* is used for tests in the rf and if sections of radio receivers, and an *Audio Generator* for checking audio amplifiers.

Referring back to Fig. 608, the basic technique is the application, or *injection* (hence the name), of external test signals of the proper frequency and amplitude at various check points in the equipment, starting at the output and working back, stage-by-stage to the input circuit. For example, a test audio signal might be applied at point A to check speaker operation. If a normal signal was obtained, as heard through the speaker, a signal would be applied at point B to check the performance of the output amplifier. This procedure would be repeated at check points C, D, and E in order. In each case, the amplitude of the test signal would be reduced by adjusting the signal generator's *attenuator* (gain control) to prevent overload as the gain of additional stages was added.

As in the signal tracing technique, an unexpected change in output amplitude or quality would indicate that the defective stage had been isolated. If a normal output was obtained when the test signal was injected at point C, for example, but a distorted output was obtained with the signal injected at point D

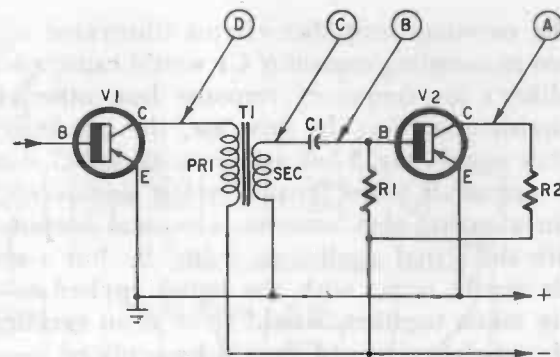

Fig. 611. Signal tracing techniques may be used to isolate component troubles. Tests at A and B check V2, tests at B and C check C1 and, finally, tests at C and D check T1.

we would look for trouble in the *preamp* stage. Similarly, if normal output was obtained with the signal injected at point B, but no output was obtained with the signal applied at point C, we could conclude that the *driver* stage is dead and would look for a defect in this circuit. As before, voltage tests and item-by-item component checks could be used to isolate the defective component or connection.

Where rf or if stages are to be checked, as when troubleshooting a receiver, standard practice is to use a *modulated* rf signal at the proper frequency, at the receiver's if value when checking the if stages, and at a suitable rf value when checking the front-end (antenna and mixer stages). This technique is also useful where special problems are encountered. For example, if the local oscillator used in a superhet receiver was dead, the signal generator could be used to inject an *unmodulated* rf signal at the proper frequency to substitute for that normally supplied by the local oscillator, thus permitting temporary operation, and simplifying the application of other troubleshooting techniques. Here, the correct signal frequency is chosen by adding the receiver's if value to the frequency at which the set is tuned. For example, if the receiver were tuned to receive a station at 1360 kc, and its if were 455 kc, the local oscillator (and signal generator) frequency would be $1360 + 455$ or 1815 kc.

If a variable output frequency is available from the signal generator, as is usually the case, the signal injection technique may be used for qualitative checks of many circuit components. Re-

ferring to the two-stage amplifier circuit illustrated in Fig. 611, a *partial* open in coupling capacitor C1 would cause a severe drop in the amplifier's low-frequency response but, otherwise, might not affect circuit operation. In this case, the test injection of a high frequency signal (say, 2 kc) at points B and C would result in a normal output. If a low frequency test signal (say, 100 cps) were used for a second test, however, a normal output would be obtained with the signal applied to point B, but a severe drop in amplitude would occur with the signal applied to point C. These results, taken together, would serve as an excellent indication that C1 was defective and should be replaced.

In practice, signal tracing and signal injection are both excellent techniques for isolating defects in electronic equipment. Neither is a *universal* troubleshooting method, however, in the sense that it is applicable to all problems. In most cases, one or the other of the two methods is best-suited to the specific problem encountered and to the type of equipment to be checked, and the final choice of technique must be made by the individual worker, based on his experience and upon available test instruments.

Alignment

Although not a troubleshooting technique from the viewpoint that it is used primarily to isolate circuit defects, receiver *alignment* is a valuable service method and, often, is necessary when working with superhet designs. Misalignment may cause a variety of operational complaints and some of these may be similar to, or may mask, complaints caused by defective components. Typically, misalignment may result in complaints ranging from *weak operation* to *poor selectivity*, *interference*, *squealing* or *dead*. Thus, a service technician may find it necessary to check alignment before he can effectively apply such techniques as signal tracing or signal injection in an effort to isolate obscure defects.

In some instances, the alignment procedure itself will reveal the defective stage causing a specific complaint. If a set is dead, for example, but the worker has no difficulty in aligning the if stages or in feeding an if signal through the receiver from the antenna, he would be quite justified in concluding that a defect in the local oscillator stage is the source of his trouble. Further tests could then be made in this stage to isolate the defective part.

Basic AM superhet alignment techniques were discussed in some detail in earlier chapters with respect to specific construction projects. Hence, a brief review should suffice at this point.

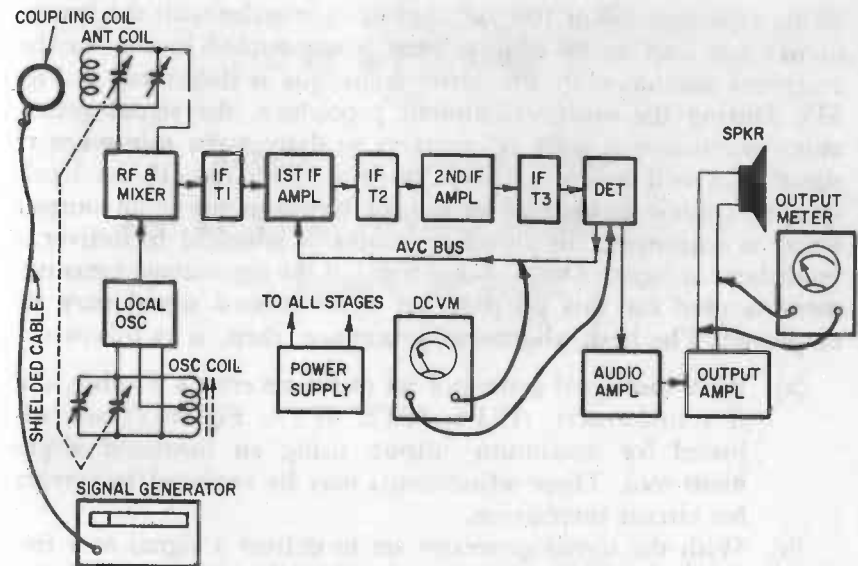

Fig. 612. Block diagram of typical superhet receiver, showing equipment connections for if and rf alignment.

The block diagram of a typical AM superhet receiver is given in Fig. 612. Here, seven functional stages are provided: a separate local oscillator, a combination rf amplifier/mixer, two tuned if amplifier stages, a second detector, an audio amplifier, and a power output stage to drive the speaker. The basic instrument needed for alignment is an *rf Signal Generator*. In addition, an insulated alignment tool must be available, together with some means to identify differences in output signal levels, and thus to indicate when maximum performance has been achieved. Often, this latter job is accomplished simply by listening for changes in the volume of the audio signal delivered by the speaker (or earphones, where used). Alternative techniques are the use of an ac voltmeter connected across the speaker voice coil terminals as an *output meter* or the use of a high impedance dc voltmeter to check agc voltage levels (both of these latter methods are illustrated in Fig. 612).

For best results, the signal generator should be coupled to the receiver in such a way as to minimize its effect on circuit operation. In practice, this may be accomplished by connecting a small iso-

lating capacitor (50 or 100 μf , typically) in series with the instrument's hot lead or by using a small coil coupled loosely to the receiver's antenna coil. The latter technique is illustrated in Fig. 612. During the entire alignment procedure, the signal generator's *attenuator* is reset as necessary to deliver the *minimum* rf signal that will insure a usable output indication. If the loud-speaker volume is used as an output indicator, or if an output meter is employed, the signal generator is adjusted to deliver a *modulated* rf signal. On the other hand, if the agc voltage measurement is used for this purpose, an *unmodulated* signal may be employed. The basic alignment procedure, then, is as follows:

- (a). With the signal generator set at the receiver's if value, the if transformers (IFT1, IFT2, IFT3, Fig. 612) are adjusted for maximum output, using an insulated alignment tool. These adjustments may be repeated to correct for circuit interaction.
- (b). With the signal generator set to deliver a signal at a frequency close to the upper (high frequency) end of the band, the receiver's tuning dial is turned to the same frequency and the oscillator trimmer capacitor is adjusted for maximum output.
- (c). With the signal generator set at a mid-band frequency slightly below that used in Step (b), the receiver is tuned to the same frequency and the antenna trimmer capacitor is adjusted for maximum output.
- (d). With the signal generator set to deliver a signal near the low frequency end of the band, the receiver is tuned to the same frequency and the oscillator coil slug (or padder capacitor, if used) is adjusted for maximum output. Often, better results are obtained if the receiver's tuning control is rocked back and forth slightly during this adjustment.
- (e). Finally, Steps (b), (c) and (d) above, may be repeated to correct for interaction. The insulated alignment tool is used for adjustments in each case.

As outlined above, the alignment procedure can be applied to virtually any AM receiver. The exact signal generator and receiver frequencies will vary with the if value of the circuit, and with its tuning range. In the case of multi-band receivers, the if stages are aligned first, while Steps (b), (c), (d) and (e) are repeated for each separate band, using different frequencies.

CHAPTER 7

How to save time or if you don't know . . . look it up!



Often, a man's technical knowledge is not measured so much by the number of facts he carries in his head and can recite like a parrot as it is by his familiarity with, and ability to use, standard reference sources. With this thought as a guide, then, the balance of this chapter is devoted to a collection of various bits of technical data which should prove useful to the student, hobbyist, or experimenter, including symbols, definitions, names and addresses, color code identification, mathematical formulae, and so on. For convenience in reference and identification, the material is grouped into six sub-sections, as follows:

SEMICONDUCTORS—wherein is given useful data on basic semiconductor devices, definitions, etc.

COLOR CODES—wherein common color codes are defined and their use explained.

MATHEMATICAL FORMULAE—wherein is listed various equations and conversion data.

ETCHED CIRCUIT PREPARATION—wherein is given step-by-step instructions for the preparation of etched circuit boards.

SEMICONDUCTORS

Today, semiconductor devices are manufactured in a tremendous variety of styles, types and sizes. While the most popular devices are diodes and transistors, there are many special purpose units. In addition, diodes and transistors are produced with many

special features and one may encounter, for example, Tunnel diodes, Zener diodes, Backward diodes, and tetrode transistors as well as the more familiar types. Quite often, special schematic symbols are used to identify different, but related, types of devices. The more common symbols are shown and identified in Fig. 701; variations of these may be encountered, of course, depending on individual manufacturer preferences. When in doubt about a unit shown on a schematic diagram, it is always best to refer to the accompanying parts list or, where available, to manufacturer's specification sheets.

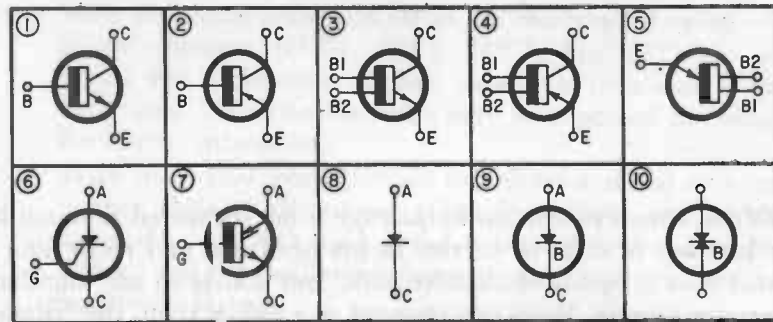

- | | |
|---|---|
| (1) NPN transistor | B = base electrode |
| (2) PNP transistor | B = breakdown device in (9) and (10) |
| (3) NPN tetrode transistor | B1 = base-one electrode |
| (4) PNP tetrode transistor | B2 = base-two electrode |
| (5) PN unijunction transistor | E = emitter electrode |
| (6) (7) silicon controlled rectifier
(NPNP transistor) | C = collector electrode
(symbols 1-4 only) |
| (8) rectifier or diode | C = cathode electrode
(symbols 6-9 only) |
| (9) zener or breakdown diode | A = anode electrode |
| (10) symmetrical zener diode | G = gate electrode |

Fig. 701. The basic schematic symbols used for various semiconductor devices.

A number of transistor types have been specified in earlier chapters in connection with individual construction projects. All of these are listed in Table 7-1. Included here are the type numbers (in order), the electrical type (n-p-n or p-n-p), the manufacturer, the general application for which the type is intended, and a reference to the lead connection diagrams. Detailed specification sheets for any of these transistor types may be obtained by writing directly to the respective manufacturers.

Table 7-1. Transistor types used in construction projects.

TYPE NUMBER	ELECTRICAL TYPE	MANUFACTURER
2N107	p-n-p	GE
2N109	p-n-p	RCA
2N132	p-n-p	Ray
2N132	p-n-p	Ray
2N135	p-n-p	GE
2N136	p-n-p	GE
2N139	p-n-p	RCA
2N168A	n-p-n	GE
2N169	n-p-n	GE
2N170	n-p-n	GE
2N173	p-n-p	Delco
2N188A	p-n-p	GE
2N192	p-n-p	GE
2N222	p-n-p	GT
2N241A	p-n-p	GE
2N255	p-n-p	CBS
2N293	n-p-n	GE
2N301	p-n-p	RCA

Manufacturers:

- CBS — CBS-Hytron (CBS Electronics)
- Delco — Delco Radio Division, General Motors
- GE — General Electric Co.
- GT — General Transistor Corp.
- Ray — Raytheon Semiconductor Division
- RCA — Radio Corporation of America

Where substitutions are necessary, due either to the discontinuance of a particular type or poor availability, follow the general suggestions given under the various project headings. Where no substitutes are suggested, substitution books may be used as guides.

COLOR CODES

A famous nonsensical verse makes reference to a purple cow. While the sight of such a creature would probably bring a smile to most anyone's lips, chances are that a professional electronic technician who saw such an animal would quickly redub it Mrs. Seven, for purple (or violet, if you prefer) is the color representing the numeral "7" in the standard color code for small components.

With limited space available on the bodies of the components, resistor and small capacitor values generally are given by means of a series of vari-colored dots, bands or stripes. Each color represents a specific number or multiplying factor, depending on its location and position. The accepted component color code and is given in Table 7-2.

Table 7-2. Color code for resistors and capacitors.

INSULATED UNINSULATED	FIRST RING BODY COLOR	SECOND RING END COLOR	THIRD RING DOT COLOR	FOURTH RING END COLOR
Color	First Figure	Second Figure	Multiplier	Tolerance
BLACK	0	0	1	
BROWN	1	1	10	
RED	2	2	100	
ORANGE	3	3	1,000	
YELLOW	4	4	10,000	
GREEN	5	5	100,000	
BLUE	6	6	1,000,000	
VIOLET	7	7	10,000,000	
GRAY	8	8	100,000,000	
WHITE	9	9	1,000,000,000	
GOLD				5%
SILVER				10%
NO COLOR				20%

AXIAL LEAD RESISTOR

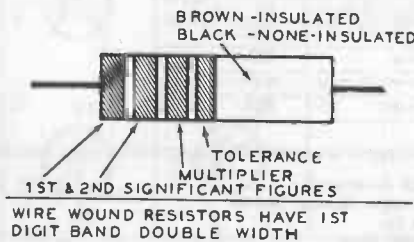

MICA

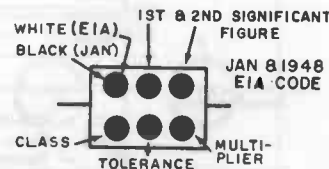

<p>5 DOT RADIAL LEAD CERAMIC CAPACITOR</p>	<p>EXTENDED RANGE TC CERAMIC HICAP</p>	<p>DISC CERAMIC</p> <p>5 DOT</p>
<p>BYPASS COUPLING CERAMIC CAPACITOR</p>	<p>AXIAL LEAD CERAMIC CAPACITOR</p>	<p>3 DOT</p>

As an example of how the code is used, suppose you encounter an axial lead resistor with three bands of color, red, violet and yellow. The band nearest the end represents the first significant

figure which, according to our table, is the numeral 2. The next band represents the second significant figure or, in this case, 7. Finally, the third band represents the multiplying factor, which turns out to be 10,000. Thus, the resistor would have a *nominal* value of

$$27 \times 10,000 \text{ or } 270,000 \text{ ohms.}$$

Since there is no fourth band, the unit would have a tolerance of 20% and might have an *actual* value of from

$$216,000 \text{ ohms (270,000 less 20\%)}$$

to

$$324,00 \text{ ohms (270,000 plus 20\%).}$$

If there had been a fourth band, with the color silver, the resistor would have a tolerance of 10%. The nominal value would still be the same, of course, (270,000 ohms), but the resistor's actual value might be from

$$243,000 \text{ ohms (270,000 less 10\%)}$$

to

$$297,000 \text{ ohms (270,000 plus 10\%).}$$

The component color code specifies resistor values in *ohms* and capacitor values in micro-microfarads ($\mu\mu\text{f}$).

Audio, rf and if transformer connections may be identified by numbered terminals or by color-coded leads. The color code used here differs from that applied to small components in that the colors do not refer to numerical values but, rather, to the conventional use of the windings. The basic system used is illustrated in Fig. 702. Referring to this diagram, the following conventions apply . . .

- A *blue* lead connects to one side of the primary winding and, in a practical circuit, is generally connected to a signal *source*, such as the collector terminal of a transistor (or plate of a vacuum tube).
- A *brown* lead connects to one side of a center-tapped primary winding, and, like the blue lead, is generally connected to a signal *source* in a practical circuit. Again, the collector of a transistor is a typical example.
- A *red* lead connects to one side or to the center-tap of a primary winding. With transistors, this lead returns to the dc supply or to circuit-ground. In a tube circuit, for example, the red lead returns to B+.
- A *green* lead connects to one side of a secondary winding and, in a practical circuit, is connected to the *load*, such as the base electrode of a following stage, the grid of a

- vacuum tube, or the voice coil winding of a loudspeaker.
- (e). A *yellow* lead connects to one side of a center-tapped secondary winding, and, like the green lead, is generally connected to a load in typical circuits, as for example, the base of a transistor.
- (f). A *black* lead connects to one side or to the center-tap of a secondary winding and, in practice, is returned either to a bias source or to circuit ground.

Three basic types of signal-handling transformers are shown in Fig. 702. Other types are possible, of course. For example, the single-ended primary (PRI.) winding shown in Fig. 702-a may

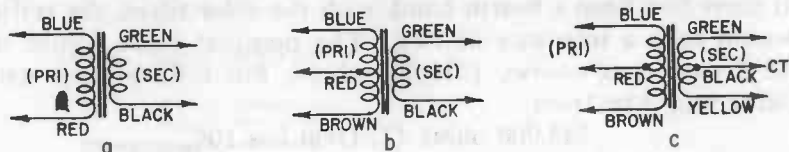

Fig. 702. Transformer color codes. Essentially the same code is used for input, interstage and output transformers. Other combinations are possible . . . for example, single-ended primary as at (a) and push-pull (center-tapped) secondary as at (c). As a general rule, the red primary lead returns to power source, the blue or brown lead to an active element (such as a collector). In the secondary, the black lead is generally the "ground" side.

be combined with a center-tapped secondary (SEC.) winding as in Fig. 702-c in a push-pull driver transformer. However, the same basic color code would still apply.

A somewhat different color code is used to identify the leads of multi-winding *power transformers*, as follows:

- BLACK (or Black-Red)—primary winding—two leads.
- BLACK-YELLOW—primary winding tap (if used).
- RED—high voltage secondary winding—two leads.
- RED-YELLOW—high voltage center-tap.
- YELLOW—low voltage filament winding, generally for a rectifier tube—two leads.
- YELLOW-BLUE—low voltage filament winding center-tap of Yellow leads.
- GREEN—low voltage filament winding, generally for amplifier tubes—two leads.
- GREEN-YELLOW—low voltage filament winding center-tap of Green leads.
- BROWN—low voltage filament winding—two leads.
- BROWN-YELLOW—center-tap for Brown leads.
- SLATE (Gray)—low voltage filament winding—two leads.

SLATE-YELLOW—center-tap for Slate leads.

Where two colors are shown hyphenated, the first color is the basic color of the insulation, the second the contrasting color of a *tracer*. If only two filament windings are provided, only the first two color combinations are used (YELLOW and GREEN). If a center-tap is *not* furnished, the corresponding color-coded lead will be missing.

MATHEMATICAL FORMULAE

In its original meaning, a *formula* is a set method (or form) for accomplishing a specific job. A recipe for a cake or a prescription for medicine are typical examples. As used in electronics technology, however, a formula is a simple expression showing the

Fig. 703. The three basic equations of Ohm's law are represented by this triangle. These mathematical expressions may be used for calculating circuit currents and for estimating component values.

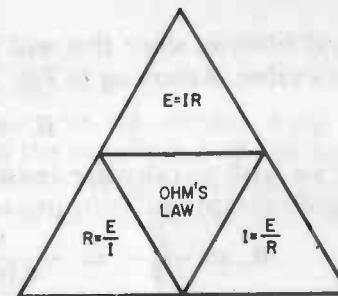

mathematical relationships between various physical quantities. Mathematical formulae (or *formulas*, if you prefer) are quite valuable for they enable a worker to pre-determine electrical quantities or circuit values on the basis of known facts. In practice, a specific value may be calculated simply by substituting the known quantities in the formula and carrying out the indicated mathematical operations of multiplication, division, and so on.

In most experimental work, the most valuable elementary formulae are those associated with *Ohm's law* and electrical *power*. The three formulae making up each of these two groups are diagrammed in triangular form in Figs. 703 and 704, respectively. Referring, first, to Fig. 703, R represents resistance in ohms, E voltage in volts, and I current in amperes. In Fig. 704, R again represents resistance in ohms, E voltage in volts, and I current in amperes, while P represents electrical power in watts. Given any *two* of the circuit values, it is a simple matter to select the applicable formula and to calculate the third value.

As a practical example, suppose we wished to determine the value of a series base bias resistor for a common-emitter amplifier,

where we need a base current of 100 microamperes (or 0.0001 amperes) and have a source of 9 volts. In this case, we can ignore the transistor's internal base-emitter resistance for purposes of

Fig. 704. The power triangle. These equations are used for determining input or output power and power dissipation.

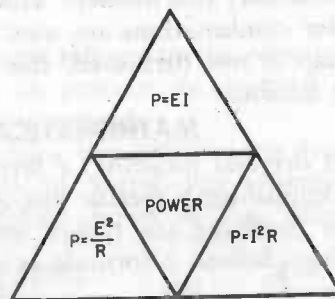

our calculation, since this will be but a small fraction of the resistor's value. Referring to Fig. 703, we would choose the formula.

$$R = \frac{E}{I}$$

since we wish to calculate resistance and know the values of voltage and current. Substituting in the formula, then, we find

$$R = \frac{E}{I} = \frac{9}{0.0001} = 90,000 \text{ ohms.}$$

In another case, we might wish to determine collector current, where we have a collector resistor of 10,000 ohms and a voltage drop, across it, of 5 volts. Here, we would use the formula

$I = \frac{E}{R}$, and, substituting, we would find that

$$I = \frac{5}{10,000} = 0.0005 \text{ ampere, or 0.5 milliampere.}$$

The various power formulae may be used for determining the power dissipated in a device or the power delivered to a load. In the first case, we might wish to determine the size resistor to use in a circuit to avoid excessive heating. In the second we might wish to determine how much audio power is delivered by an audio amplifier.

Referring to our base bias resistor example, let's determine what size resistor is needed. In Fig. 704, we find that we have a choice of formulae, and can use any of the three. Selecting

$$P = EI,$$

we find,

$$P = 9 \text{ (volts)} \times 0.0001 \text{ (ampere)} = 0.0009 \text{ watt or}$$

0.9 milliwatt. Allowing a safety factor of even three or four to one, a standard half-watt (0.5 watt) resistor is more than ample for the application.

Other useful formulae are given below:

1. Reactance

$$X_c = \frac{1}{2\pi fC} \quad \text{or} \quad X_L = 2\pi fL$$

Where X_c is capacitive reactance in ohms, X_L inductive reactance in ohms, π is approximately 3.1416, f is frequency in cycles per second, C is capacitance in farads, and L is inductance in Henrys.

2. Resonance—the resonant frequency of a tuned circuit is that in which the capacitive reactance (X_c) equals the inductive reactance (X_L), or

$$f = \frac{1}{2\pi\sqrt{LC}}$$

where the frequency, f , is in cycles per second (cps), the inductance (L) in Henrys, and the capacitance (C) in farads. If L and C are given in microhenrys and microfarads, respectively, and the frequency in kilocycles, this reduces to

$$f = \frac{159.2}{\sqrt{LC}}$$

3. Figure of Merit—The Figure of Merit, or Q of a coil relates the coil's inductive reactance to its ac resistance and is an arbitrary unit. In general, the higher the Q of a coil, the better, and the greater the selectivity of a tuned circuit in which the coil is used.

$$Q = \frac{X_L}{R}$$

where the inductive reactance, X_L , and the coil's ac resistance are both given in ohms.

4. Transformer relationships

$$\frac{N_p}{N_s} = \frac{E_p}{E_s} = \sqrt{\frac{Z_p}{Z_s}}$$

where N_p is the number of turns on the primary winding, N_s the number of turns on the secondary, E_p primary voltage, E_s secondary voltage, Z_p primary impedance, and Z_s secondary impedance.

5. *Decibel*—Actually a tenth of a *bel*, the decibel is a logarithmic unit used to express power relationships. Where the impedances are qual.

$$\text{db} = 10 \log \frac{P_1}{P_2} = 20 \log \frac{E_1}{E_2} = 20 \log \frac{I_1}{I_2}$$

where the ratio is given in decibels (db), P_1 and P_2 are the two power levels in watts, E_1 and E_2 voltage levels in volts, I_1 and I_2 current levels in amperes, or other identical units, and all logarithms (log) are to the base 10.

6. Efficiency

$$\text{Eff (\%)} = \frac{\text{Output}}{\text{Input}} \times 100,$$

where the efficiency of the device is given as a percentage, and the **Output** and **Input** are identical units.

7. Transistor gain

$$\beta = \frac{\alpha}{(1 - \alpha)}, \quad \text{or } \alpha = \frac{\beta}{(1 + \beta)},$$

where alpha (α) is the transistor's current gain in the common-base configuration and beta (β) is the current gain in the common-emitter configuration.

8. *Time duration*—the time required for one complete cycle of ac signals at various frequencies is given below.

1 cps	— 1	second
10 cps	— 0.1	second
100 cps	— 0.01	second
1 kc	— .001	second, or 1.0 millisecond
10 kc	— 0.1	millisecond
100 kc	— .01	millisecond, or 10 microseconds
1 mc	— 1	microsecond
10 mc	— 0.1	microsecond
100 mc	— .01	microsecond
1,000 mc	— .001	microsecond, or 1 millimicrosecond

Conversion factors

When mathematical formulae are used to calculate component values, the results are generally in terms of the three basic units, *ohms* (resistance), *henrys* (inductance) and *farads* (capacitance). Frequencies are generally determined in cycles per second (cps) or pulses per second (pps), and time values in seconds. In prac-

tical work, however, these values may prove to be too large or too small and other expressions are used. Typically, these new expressions are formed by adding a prefix to the basic term, with *meg-* used for million, *kilo-* for thousand, *milli-* for thousandths, *micro-* for millionths, *millimicro-* for thousandth of a millionth, and *micromicro-* for millionth of a millionth. Occasionally, the prefix *nano-* will be used for *millimicro-* and *pico-* for *micromicro-*. These relationships must be kept in mind when making calculations so that proper conversions can be made to avoid errors. The more common terms and their symbols are given and defined below.

1. *Megohm* (meg) is a million ohms, or 1,000,000 ohms.
2. *Microfarad* (μf) is a millionth of a farad, or 0.000001 farads.
3. *Micromicrofarad* ($\mu\mu\text{f}$) is a millionth of a microfarad.
4. *Picofarad* (pf) is used by some firms in place of microfarad.
5. *Millihenry* (mh) is a thousandth of a henry, or 0.001 henry.
6. *Microhenry* is a millionth of a henry.
7. *Kilocycle* (kc) is a thousand cycles per second, or 1,000 cps.
8. *Megacycle* (mc) is a million cycles per second, or 1,000 kc.
9. *Millisecond* is a thousandth of a second, or 0.001 second.
10. *Microsecond* is a millionth of a second.
11. *Millimicrosecond* is a thousandth of a microsecond.
12. *Nanosecond* is another expression for millimicrosecond.

ETCHED CIRCUIT PREPARATION

The author's original models for several of the projects described in earlier chapters were assembled on *etched circuit* boards. With this technique, circuit interconnections are made through patterns of copper foil bonded on an insulating board instead of with conventional hook-up wire. Component parts are mounted directly on the board, eliminating the need for a metal chassis and such mounting hardware as terminal strips and soldering lugs. The completed assemblies frequently are called *printed circuits*, although the term is not technically correct for this type of construction.

Used industrially in the assembly of precision instruments, computers, and military equipment as well as in consumer products, etched wiring has become increasingly popular with commercial manufacturers in the past years, for it permits accurate wiring

with a minimum of errors and, in addition, is easily adapted to mass production by automated machinery.

Etched circuit boards can be prepared quite easily by the average hobbyist or experimenter, for no special skills, tools, or hard-to-obtain supplies are needed. Cost and time-wise, this method of wiring compares favorably with other techniques. In fact, as skill is acquired, a worker often can prepare and assemble an etched circuit project in half the time that is required to assemble a similar project using conventional chassis construction.

Except for three items, most of the tools and materials used are readily available in the average household or home workshop. The three special items needed are (1) *copper-clad boards*, (2) a supply of suitable *resist* material, and (3) a moderate quantity of *etchant*. Pre-packaged kits of these basic materials are available through most local and mail-order electronics parts distributors, but the items may be purchased individually by those who prefer to roll their own. Copper-clad boards are available in several



Fig. 705. Cleaning a copper-clad phenolic board.

sizes in either single or double-clad types, and with various grades of insulating base materials, ranging from paper-based phenolics to fiberglass-based epoxies. As far as the projects described in this book are concerned, excellent results can be obtained with 1/16 inch thick Grade XXXP, single-clad, paper-based phenolic boards. The *resist* is simply a material that will adhere tightly to the copper foil, that is easily applied in a pattern and easily removed, and yet which will resist the chemical action of the etchant. Any of a variety of materials are suitable, including fingernail polish, acid-resistant inks, paraffin wax, or even strips of cellophane or plastic tapes. The *etchant* is a commercially prepared ferric chloride solution in water; a pint bottle should be an ample supply for several projects.

There are six basic steps in the home-assembly of an etched circuit board project. These are illustrated in Figs. 705 through 707, and include (I) *board preparation*, (II) *resist application*, (III) *etching*, (IV) *cleaning*, (V) *machining*, and (VI) *final assembly*. The procedure is outlined below step-by-step.

(I) **BOARD PREPARATION**—A small board of desired size is cut from the stock copper-clad material. An accurate size and shape may be assured by scribing layout lines on the copper surface, using a sharp-pointed tool and a combination square, then cutting with a fine-toothed hack or coping saw. The rough edges should be dressed smooth with a few passes of a small file. The copper-side of the board is cleaned thoroughly, using a slightly dampened cloth and an abrasive household cleanser. In severe cases, fine steel wool may be used, as shown in Fig. 705. Cleanser residue is removed by rinsing the board thoroughly in clear running water.

(II) **RESIST APPLICATION**—As mentioned above, any of several types of resist material may be used. A special acid-resistant ink is supplied in a collapsible tube type ball-point pen. The method of application will vary with the type of resist chosen. Thick

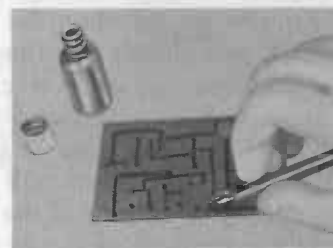

Fig. 706. Applying the resist to a cleaned board.

inks and fingernail polish may be applied using a *Speed-Ball* pen (as in Fig. 706) or a small brush. Paraffin wax may be applied by melting in a small metal cup over a hot plate and using a *pre-warmed* brush; here, the copper-clad board should be warmed slightly to insure good adhesion. A ball-point applicator is used much like any pen, except that the unit is held upright rather than at a slight angle. Finally, cellophane or plastic adhesive tapes are applied in thin strips by laying on the board and burnishing with a hard, smooth tool, such as a rounded half-inch dowel peg. In any case, *good adhesion to the board's surface is essential*.

Regardless of the type of resist used, it is applied to the *copper-*

side of the board in the desired wiring pattern. The pattern may be one abstracted from a project in a book or magazine, such as Figs. 205, 315, 502 or an original one developed by the individual worker. If an original wiring layout is developed, this should be double-checked carefully *before* it is applied to the board as a resist pattern. An easy way of doing this is to draw the layout full-size on a piece of *graph* (cross-section) paper, using the actual components to check dimensions. Several layout patterns may be developed in this way before the best arrangement is selected. Afterwards, this can be transferred to the board by using a piece of *pencil carbon* (carbon paper).

(III) ETCHING—A shallow tray or dish large enough to hold the circuit board is needed for this step. This may be of hard rubber, plastic, glass, porcelain or enameled metal. *A bare metal pan is not satisfactory.* A Pyrex baking dish or a photographic tray are excellent. The *etchant* solution is poured into the selected utensil to a depth of a half-inch or more to insure covering the circuit board, and the prepared board (with resist pattern) is slipped in, copper-side up, as shown in Fig. 707. Afterwards, the solution is agitated slightly, either by moving the board back and forth or by rocking the tray. A plastic or glass stirring rod or plastic photographic tongs should be used for handling the board while in the etchant. Although the ferric chloride solution is not highly corrosive, it can stain the skin and may cause severe allergy reactions in some individuals, hence *bodily contact with the solution should be avoided*, and the work should be done in a ventilated area.

As a general rule, the etching procedure will require from eight to twenty minutes, depending on the size of the board, the amount of exposed copper, and the strength of the etchant. A fresh, unused solution will etch much more rapidly than one approaching the end of its useful life. The board should be lifted from the solution every few minutes and carefully inspected, so that the etching process is carried on only as long as is necessary to remove all exposed copper. Over-etching may undercut the resist pattern and damage the desired pattern.

If desired, the etching process can be speeded considerably by using a *hot* solution. Here, a Pyrex dish or enameled pan is necessary. The tray is placed over a hot plate or low burner and kept reasonably hot, but *below the boiling point*. A small amount of water may be added from time to time to compensate for evaporation. With this technique, the average board can be etched in three to five minutes.

(IV) CLEANING—After all exposed copper is removed by the etching process, the board should be rinsed thoroughly in clear running water and inspected by holding at an angle with respect to a strong light. If a thin film of copper remains, the board is returned to the etchant for another minute or two. Once the etching is completed to the point where the board passes inspection, the etchant may be returned to its original container and the circuit board and all utensils washed thoroughly in clear water. Finally, the resist is removed, exposing a shiny etched wiring pattern. A tape resist is simply peeled off. Wax resist may be removed by scraping. Fingernail polish or acid-resistant ink is removed by rubbing with a soft cloth moistened with a suitable solvent or by rubbing briskly with very fine steel wool.

(V) MACHINING—The etched and cleaned board may be machined with standard shop tools if reasonable care is used to avoid excessive pressure which may crack the base material. For example, mounting holes may be drilled using a drill press, hand electric drill, or manually-operated "egg-beater" type drill. Hole sizes should be kept as small as possible in keeping with the components to be mounted. As a rule, all drilling is done from the etched side of the board, with a piece of scrap wood held

Fig. 707. Etching the prepared board. The etchant must be in a plastic, glass, or enameled tray.

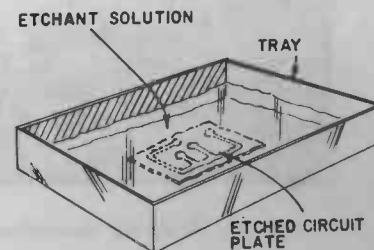

beneath it to provide a firm support. To prevent cracking or other damage, a minimum amount of drill pressure is used, with the bit allowed to work its way through the material at a normal pace. Burrs and stray scraps of material should be removed.

(VI) FINAL ASSEMBLY—Before final wiring is started, the etched board should be cleaned once again to remove *fingermarks*, grease, oil, dirt, and microscopic bits of copper or base material that may remain from the machining operations. Component parts are mounted by feeding their leads through appropriate holes in the board according to the planned layout, crimping, cutting off excess lead, and soldering. A small-tipped, hot, clean and well-tinned soldering iron or gun should be used, as shown in Fig.

708. Best results are obtained with a high quality, thin gauge rosin-core solder.

Until experience is gained, special care must be exercised to avoid damage to the etched wiring. In general, each soldering operation should be carried out as quickly as possible (often, simply by touching the tip of the soldering tool and a bit of solder to the board) for excessive heat will melt the thermoplastic material used to bond the copper foil to the board, causing the copper to blister or to lift and peel.

The components themselves may be mounted on *either* side of the etched wiring board, although common practice is to mount from the insulated (unclad) side. If interruptions in the wiring

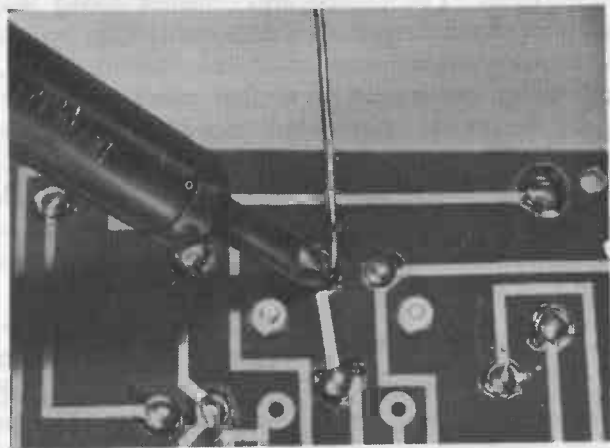

Fig. 708. Soldering connections on a circuit board.

pattern are needed to avoid shorts, small jumpers may be used for interconnections; these may be made of short lengths of insulated hook-up wire or spare scraps cut from component leads and insulated with short pieces of spaghetti tubing. Larger components, such as small transformers, controls, switches, and brackets, may be mounted using standard machine screws and nuts if care is taken not to overtighten. If external connections are to be made to points on the board, such as to a power pack or loudspeaker, and these are of a type that might be changed a number of times, small hollow brass eyelets should be installed. These will prevent damage to the copper foil wiring which might otherwise be caused by repeated soldering and unsoldering.

NEW Skill-building Transistor Projects and Experiments

Louis E. Garner

The ideal way to learn about transistor technology easily and quickly is the practical way: building transistor projects and experimenting with them.

This book begins by describing and illustrating simple practical experiments which demonstrate the ways in which transistors can be used in everyday electronic circuits. These are assembled and wired up in temporary form on perforated circuit boards.

More permanent versions of the most useful projects are also described. The circuits covered in the book include oscillators, detectors, amplifiers, pre-amplifiers, a power megaphone, two-station intercom, an audio booster, a "detectaphone", a light-powered radio receiver, a regenerative receiver, a pocket superhet, a sensitive relay amplifier, an "electric eye", an electric timer, a light flasher, a simple code-practice oscillator for learning Morse, an electronic metronome, a toy electronic organ, etc.

There are also some more ambitious projects including a basic audio amplifier, a basic superhet receiver, a utility amplifier, a portable record-player, and a power inverter, amongst others.

One chapter is devoted to troubleshooting techniques which are applicable to other electronic projects as well as to the selection in this book. The text concludes with data on colour codes etc., some simple math formulas, and practical hints on preparing etched circuit boards.

ISBN 0-7042-0111-9



FOULSHAM-TAB LIMITED