

HAVING FUN WITH TRANSISTORS

BY LEN BUCKWALTER



HAVING FUN WITH TRANSISTORS

by

Len Buckwalter

*With a specially written chapter for
the guidance of the English reader*

by W. Oliver (G3XT)

FOULSHAM-SAMS

TECHNICAL BOOKS

Published and distributed by

W. FOULSHAM & CO. LTD.

SLOUGH BUCKS ENGLAND

W. FOULSHAM & CO. LTD.
Yeovil Road, Slough, Bucks, England.

HAVING FUN WITH TRANSISTORS

Copyright © 1962 by Howard W. Sams & Co., Inc.,
Indianapolis 6, Indiana.

Introduction © 1966 by W. Foulsham & Co., Ltd., Slough,
Bucks, England.

Reproduction or use, without express permission, of editorial
or pictorial content, in any manner, is prohibited. No patent
liability is assumed with respect to the use of the information
contained herein.

Library of Congress Catalog Card Number: 62-16404

Cat. Code No. THF-1

Introduction Printed and Made in Great Britain
by East Midland Printing Company Limited, Bury St. Edmunds.
Balance printed in U.S.A.

It is essential that the English reader should read this chapter.

Unlike very complicated radio or electronic projects, which may be too much like hard work to be regarded as fun, the simple transistorized devices in this book are quick and easy to make. They are amusing, interesting and instructive; and they really *are* fun.

Of the thirteen projects described, two or three are, however, not entirely suitable for the British reader, for various reasons. The items in question are those in *Chapters 5, 6 and 8.*

The device intended for sending Morse Code signals over domestic electric-supply wiring might be liable to cause some unwelcome interference with one's neighbours' radio reception. It would be preferable to skip this project, not only for the reason just stated but also because it is apt to be much less safe on our 240-volt mains than on the American 117-volt ones for which it was designed.

The "eavesdropping" device in *Chapter 6* could be open to serious objection if misused, therefore it should be adapted for a harmless purpose such as that of serving as a legitimate "intercom" between rooms in the house.

This book is of American origin, and one must bear in mind that some of our regulations in force here differ from those in the United States.

Where radio transmission is concerned, our laws are inclined to be stricter in certain respects than the American ones. Broadly speaking, one must not use any sort of transmitting apparatus in a way that contravenes the G.P.O. regulations.

Despite its low power and limited range, the "Home Broadcaster" described in *Chapter 8* is not a lawful device to use in this country.

To operate an amateur transmitting set, one is required to hold an amateur transmitting licence from the G.P.O. To get this, one has to pass a technical examination and, in most cases, a Morse Code test.

Moreover, amateur transmissions are permitted only within the strictly-defined limits of the special wavebands allotted under the terms of the licence. An amateur is NOT allowed to transmit on other wavelengths, such as those allotted to broadcasting stations.

The little set described in *Chapter 8* is designed to work on the broadcast waveband, and this fact in itself makes it illegal in Britain; so it should be treated as being of academic interest only.

Most of the parts and materials required are easy to get, though not necessarily in the actual American types specified. It will probably be necessary to substitute British-made equivalents for many of the items.

The foundation of some of the projects consists of perforated insulating board. Apart from ordinary pegboard, there are some special radio-quality boards available from mail-order firms and retail radio dealers.

Perforated eyelet-board, with holes spaced 0.2 in. apart, is available from Home Radio (Mitcham) Ltd., 187, London Road, Mitcham, Surrey. Packets

of eyelets are to be had from the same firm. Plain board is available for backing the assembly to complete the insulation.

Home Radio Ltd. can also supply perforated strip and perforated sheet taking standard turret-tags (small soldering-lugs which fit into the holes).

Fixed resistors are no problem at all. These can be bought at any radio shop, retail or mail-order, which carries a fairly comprehensive stock of components for the home constructor.

Fixed capacitors, too, are easy to get. Disc ceramics, miniature electrolytics for transistor circuits, etc., can be got from firms such as Home Radio, or from your local radio dealer perhaps.

A firm which, at the time of writing, is offering some attractively-priced bargains in small items such as resistors, capacitors, miniature potentiometers, transistors, etc., is Wentworth Radio, 1a, Wentworth Court, Alston Road, Barnet, Herts. Lists are available for stamped addressed envelope.

The transistors specified for the projects in this book are of two American types, the 2N107 and the CK722. These may be difficult to get under the actual American type-numbers; and some of the American substitutions recommended may be expensive over here.

So it will be advisable to use the nearest equivalents or substitutions from the British range. Try the OC71 for both the American types. This is available at bargain prices from the mail-order firms; study the price-lists and the current advertisements in the technical journals.

The International Rectifier Company produces a useful range of general-purpose transistors which can be substituted for many American and other types. A list of local semiconductor centres in various parts of the country which stock the International Rectifier Company's transistors, diodes and other devices can be had on application. The address is: International Rectifier Company, Ltd., Hurst Green, Oxted, Surrey.

Two of the projects—the Radiomobile and the Radio Clock—use a diode for “detecting” the signals. The type specified is the IN34. This may not be readily obtainable in Britain, but several other types of diode will give similar results and the choice is not at all critical. The OA90 is suggested.

The Radiomobile and the Radio Clock both use a component which, in American terms, is described as a “loopstick antenna coil”. It will probably not be practicable to get the American type specified. But two alternatives are possible. One is to improvise a similar component by fitting a tiny control-knob on a lightweight spindle glued into the adjustable iron-dust core of a tuning-coil.

Another method is to use a normal type of iron-dust (ferrite) cored tuning-coil in conjunction with a miniature single-gang tuning capacitor, which is substituted for the fixed capacitor C1 in *Fig. 2—6* and *Fig. 12—7* (and the relevant parts lists).

Bear in mind that such a simple circuit as a diode-plus-two-transistors is very dependent on aerial, earth and the presence of a reasonably strong signal

such as one gets from a fairly “local” broadcasting station. So if you live in a “difficult” reception area a good many miles from the nearest broadcasting station it would be advisable to make sure that these circuits are adequate for your location before going to the trouble of building them. A local radio dealer may be able to advise you on this; or you may know of people who are already getting good results with equally simple circuits in the locality. Naturally, if you live within a few miles of a broadcasting station there will be no doubt about the success of the projects.

Many simple designs for “reflex” transistor sets using a minimum of transistors and components have been published from time to time in radio journals such as “Radio Constructor” and “Practical Wireless”. There is a possibility that some of these could be used as a basis for a Radiomobile scheme also, if you have the necessary skill and ingenuity to adapt them to such an arrangement.

A sharply-tuned circuit might not be suitable for this idea, however, as the lack of rigidity in a “mobile” construction might cause stray capacity variations which would affect the tuning and cause a fading or “wobbling” effect, such as one associates with a very unstable short-wave receiver.

As regards the Radio Clock, this is an enterprising idea which might well be exploited further. Provided the interior of the clock is big enough and the set is miniature enough, there is no reason why more elaborate circuits than the one shown in this book should not be used as the basis for a radio clock project.

But in any project involving, or in close proximity to, any mains-powered appliances, make sure all is safe. Ensure that there is no contact, interconnection or interaction between the electric clock and the miniature radio. The latter must be safely insulated from the electrical circuitry of the clock.

If you use a “mains earth” in connection with a transistor set, as suggested by the American author (on *p. 19*), be very careful to make sure that the connection is made to the earth terminal of the wall-socket and NOT—repeat *not*—to any other terminal or screw in the fitting. There would be a great risk of lethal shock if the radiomobile were accidentally connected to one of the mains terminals instead of the earth (grounding) terminal. The latter is usually marked with an E on the socket and any three-pin plugs fitted to electrical appliances.

If in any doubt on any point of safety, be sure to seek expert advice from a competent local electrician or radio technician. Never use guesswork or take avoidable risks where mains voltages are concerned.

Some of the projects in this book entail the use of what the Americans call “alligator clips”. In ordering these, remember that the British name for them is “crocodile clips”.

As for the “flea clips” mentioned in some of the projects, these appear to be similar to our “turret clips” which can be inserted in perforated board to form soldering-lugs.

Regarding the "Electronic Eyeball" project in *Chapter 7*, the present writer's experience with some types of photocell suggests that the quarter-inch hole advised may be inadequate and a much larger hole may be needed to let in enough light for the cell to work properly.

If one is far enough away from one's audience, it may be possible to improve on the trick and make it more impressive and mystifying by introducing some variations on the scheme. For example, it may be possible to devise some way of concealing the photocell somewhere about one's clothing in such a manner that it receives the maximum amount of light but is not easily detected by the onlookers.

If this can be done, it enables one to conceal the rest of the apparatus (with the exception of the miniature earphone, of course) in the inside breastpocket of one's jacket. One can then dispense with the "eyeballs" and use a perfectly plain, unprepared blindfold, which can be handed round for inspection to show that there is "no deception" about it. In fact, one could even borrow a large silk handkerchief or a headscarf from a member of the audience, thereby making the whole business even more convincing.

If the cell is concealed on one's clothing, it will of course be necessary to turn one's whole body and not merely the head when searching for the source of light; but this is no drawback.

Suitable cadmium sulphide photocells can be obtained from several different firms; but the types and prices vary. One should study the current advertisements in the radio technical journals. Among the firms advertising suitable cells at the time of writing are:—

Proops Brothers, 52, Tottenham Court Road, London, W. 1.

Service Trading Company, 47-49, High Street, Kingston-on-Thames (for callers and mail orders) and 9, Little Newport Street, London, W.C. 2 (for personal callers *only*).

British equivalents for some of the other items in the Parts Lists may have to be found; and a search through current advertisements, or the catalogues of mail order firms dealing in radio and electronic components for the home constructor, should provide the answers to these problems.

Adapting American designs to suit your needs, and finding suitable components in the British ranges, is in itself an exercise in ingenuity and resourcefulness which can give you valuable training and experience, with the added satisfaction of having overcome any difficulties that arise in scheming the necessary adaptations.

Regarding power supplies, small transistor batteries are needed for some of the projects in this book. The actual American ones specified may not be obtainable here; but suitable equivalents in, say, the British "Ever-Ready" range are on sale all over the country.

PREFACE

Meet Boris the talking skull, Sherlock Ohms the electronic detective, and a singing oatmeal box. These are just a few of the characters which prove that transistors—despite their impure hearts of arsenic—can really be fun!

If some of the devices look suspiciously practical, like the Transistor Telephone, there's a reason. The magic of putting the human voice through a pair of wires or over-the-air (as in the Home Broadcaster) never seems to lose its fascination among electronic hobbyists.

So, all you need is the desire to create the humorous, amazing, or wierd to experience many enjoyable hours with transistor circuits. No knowledge of ohms, volts, or amps is required.

For those who can't suppress their more serious side, a brief theory explanation is provided at the end of each project.

LEN BUCKWALTER

May, 1962

TABLE OF CONTENTS

CHAPTER 1

- Construction Hints 7**
The parts and tools needed, plus helpful hints, for successful construction of the projects in this book.

CHAPTER 2

- The Radiomobile 13**
An amazing demonstration of combined modern-day art and electronics.

CHAPTER 3

- Transistor Telephone 23**
With this project you and another person can maintain conversation up to distances of several hundred feet.

CHAPTER 4

- Lemon-Juice Oscillator 33**
This one will fascinate your friends. An ordinary piece of lemon is the basis for a real audio oscillator.

CHAPTER 5

- Sending Code Over Your House Wires 39**
Send signals from one room to another, or from house to house.

CHAPTER 6

- Sherlock Ohms 49**
Wire a room for sound and "eavesdrop" without being seen.

CHAPTER 7

- Electronic Eyeball 57**
With this project you can actually "see" while blindfolded. A great game for parties.

CHAPTER 8

- Home Broadcaster 65
Ever desire to broadcast your own radio program? Well, here's your chance!

CHAPTER 9

- Musical Oatmeal Box 73
Now you can play music by just waving your hands through the air. No hidden wires or strings, and you never touch a thing.

CHAPTER 10

- The Flip-Flop 81
Here's a versatile project capable of performing many interesting experiments.

CHAPTER 11

- Toddler's Tooter 91
An ideal electronic toy for the preschool-age child. Lots of buttons and switches to push that make different sounds.

CHAPTER 12

- The Radio Clock 99
Not a clock-radio; but a real radio in a clock.

CHAPTER 13

- The Speaker Mike 107
Here's a real microphone for just the price of a few resistors and capacitors.

CHAPTER 14

- "Boris" The Talking Skull 113
Here's a spectacle bordering on the unreal. A skull that talks!

1. CONSTRUCTION HINTS

Although electronic circuits must often be built to the most exacting standards, there's plenty of room for variation in the projects described in this book. They permit the builder to use parts he has on hand or can obtain easily. The following section shows where liberties may be taken with parts and assembly—and when it's a good idea to follow the text closely.

PARTS

Don't overlook the numerous sources for parts that are easily accessible to the electronic hobbyist. You may not have the legendary "junk box" which can yield every component needed, but old discarded radio and TV sets are often rich sources for resistors and capacitors. If your home doesn't harbor one of these antiques, a few inquiries among friends might provide a windfall. You'll find that many of the components in the Parts List for the projects have the same values as the components commonly found in home-entertainment equipment.

There is a small risk involved with old parts, but one that can be reduced considerably if you have an ohmmeter. Both resistors and capacitors can be checked with it. The meter indicates resistance directly. It also gives a fair test of capacitors. Place the meter on its highest resistance range and touch the probes across the capacitor. If the meter moves more than halfway down the scale and remains there, reject the part. Serviceable capacitors cause only a brief movement of the meter needle.

Electrolytic capacitors (the ones marked "plus" and "minus") can produce low-resistance readings and still be good. However, if they read less than 30,000 ohms after the probes have touched them for more than a minute, it's best to reject them.

Those who want to use entirely new components will find them at many electronic parts distributors. This source also must be relied on for more specialized units like a photocell or transistor battery.

Here are some suggestions on each of the major components that recur throughout:

Resistors

The sharp-eyed hobbyist will spot the use of large-valued resistors in some of the photos, even though $\frac{1}{2}$ -watt units are specified in the Parts Lists. This is perfectly acceptable—1- or 2-watt resistors will not affect circuit operation, unless you want the tiny $\frac{1}{2}$ -watt for miniaturization.

It's the value in ohms that counts, and it may vary as much as 20% from the recommended value. The only critical circuits from the standpoint of resistance are in the base bias system of the transistor. This resistor is easily recognized on the schematic. Look for the one that connects the base lead to the negative side of the battery. Anytime a project refuses to work, be sure the base resistor is the value specified.

Tolerance, the fourth band of the resistor color code, may be any standard value. It makes no difference whether the resistor is identified with a gold or silver marking or none at all.

Capacitors

The Parts Lists do not give the voltage rating for capacitors unless they are electrolytics. The reason is that if you purchase a capacitor rated at 15 volts (the working voltage in virtually all these circuits), its cost would be inordinately high. More standard units are suitable, although their ratings may be several hundred volts. What is more important is the capacity, or value in mfd.

Electrolytics do just the opposite: they increase in price with voltage rating. However, a 150-volt unit, say from an old radio, can be used even though a 15-volt capacitor is specified.

Batteries

Batteries are another area where variation is permissible. The current consumption of most projects is less than 5 or 6 milliamperes. Any conventional transistor battery of the nominal 9 volts will last many months. Avoid any units which are less than half the physical size of those shown in the photos.

It's possible to hook a group of flashlight batteries together for power. Five of them connected in series (plus to minus) can produce 7.5 volts. This is somewhat less than 9, but still satisfactory. The governing factor is physical size. The transistor battery makes possible a trim, easy-to-move-about project.

You can solder directly to the terminals of a battery, or use matching clips. The key advantage of clips is that a single battery can be conveniently used for a number of projects.

Wire

The usual hookup wire is No. 20 or 22 solid tinned copper with plastic or cotton insulation. Any lead that will undergo repeated flexing is less likely to break if it is of the stranded type. It can also be employed throughout most of the circuit; but solid wire is much easier to crimp onto a solder lug or terminal strip.

Enamel-covered wire is often listed under the catalog heading of magnet wire. The chief precaution in using it is to scrape the enamel off the end being soldered. This may be done with a knife if you're careful not to nick and thereby weaken the wire. A single-edge razor does a better job. For really professional results, buy a small bottle of "Strip-X." Simply dip the end of the wire into it, and wipe off the enamel with a cloth a minute or two later. Whatever method you use bright copper must show before the wire will accept solder.

Where stiff wire is called for, ask for "piano" wire at a model-airplane or hobby store.

Transistors

One key to success with transistors is correct hookup of their three leads into the circuit. You don't have to take

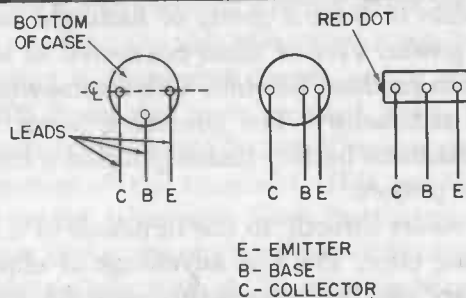

Fig. 1-1. How to identify transistor leads.

great pains to avoid overheating their leads while soldering; tests show that little damage results from a hot iron.

Unless you're certain which transistor leads are the base, emitter, and collector, refer to Fig. 1-1. In the pictorial drawings for each chapter, they are lettered B, E, and C. Always take great care to insert them into their proper circuit locations.

All transistors used in the projects are of the common PNP type, though their lead arrangement will vary. If you're a bargain hunter, watch the electronic distributors for their frequent transistor sales slanted to experimenters and hobbyists. Many of these units are unmarked except for the simple designation "PNP, General-Purpose Audio." The author has used dozens of these in the construction of the projects with success.

Coils

There's a single coil that frequently appears in the various projects. It is used when the circuit operates on radio frequencies. Although designed for transistor receivers, it performs perfectly well in oscillators. The coil is variously marketed as a "tapped antenna coil" or "transistor loopstick" for the standard broadcast band. These units generally have three lugs for connection into the circuit. To identify them, use the diagram customarily supplied in the coil box. Then compare it with the schematic of the coil in the project you're building. The three connections must agree or the circuit won't work. The most important identifying feature is the coil tap; it is closer to one end of the coil than the other.

CHASSIS

In an effort to avoid extensive metalwork, much use is made of circuit boards. Fig. 1-2 illustrates some typical

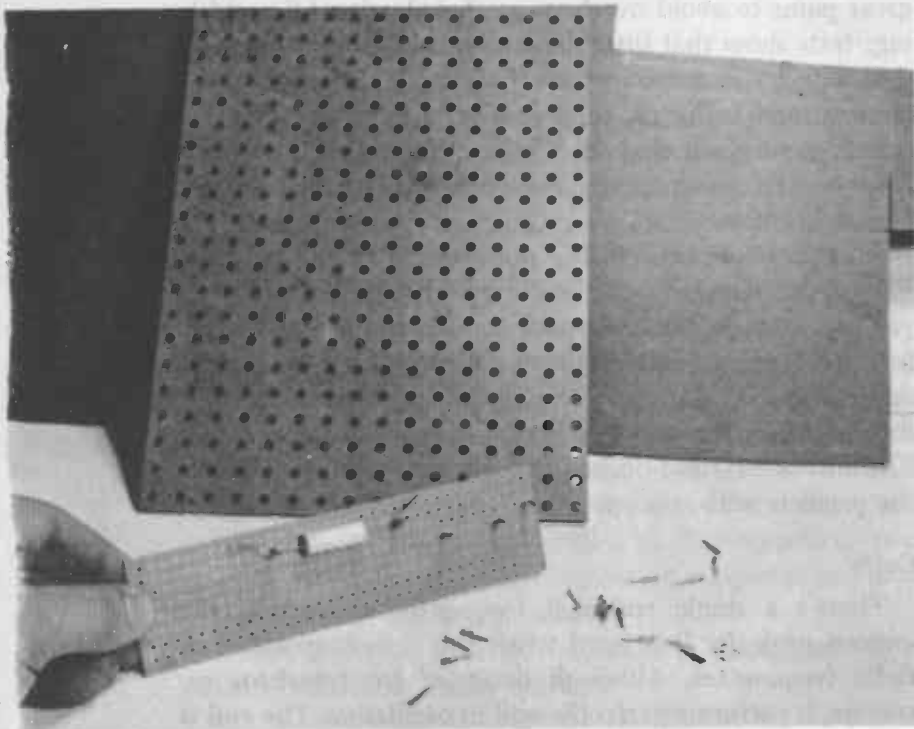
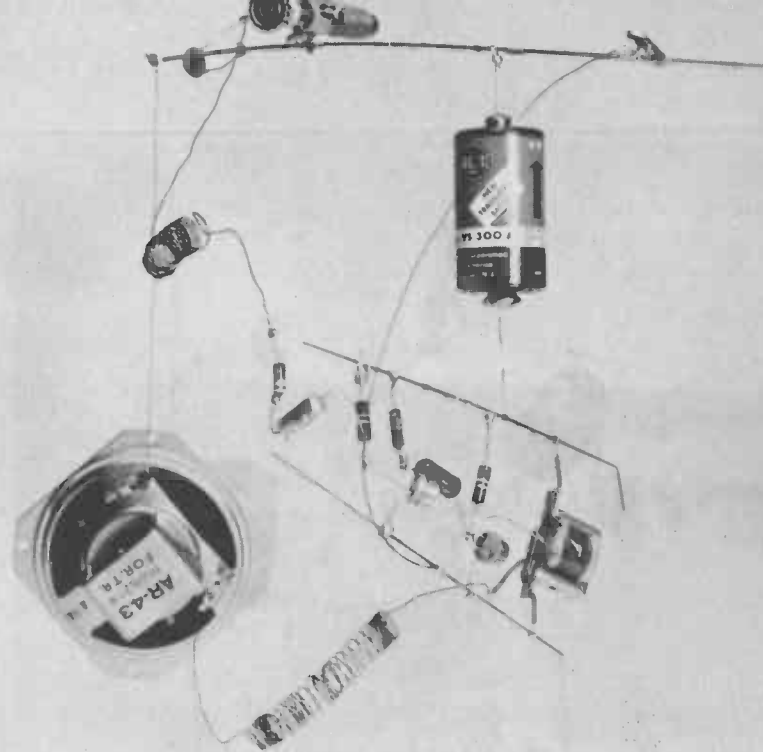

Fig. 1-2. Types of boards.

kinds. Perforated board of phenolic is a standard electronics item. Small holes punched in it permit the use of "flea clips" as circuit solder and tie points. The clips are easily pushed into a hole at any desired location.

Solid hardboard and pegboard are also handy for construction. The latter type is especially useful since nuts and bolts are readily mounted in the holes. Because no high frequencies are involved, circuit layout on these boards is not critical. And they have sufficient insulating qualities so bare wires may touch their surfaces without the problem of shorts.



2 THE RADIOMOBILE

Looking like a cross between a piece of modern art and the day the radio fell apart, the Radiomobile is guaranteed to stimulate a lot of living-room conversation. This eerie project was inspired by the artist's mobile—the ghostly assembly that forms changing patterns as it is nudged by air currents. Fig. 2-1 shows a mobile—only the parts are all electronic and are fashioned in such a way that a radio program is heard from the speaker! It plays as the unit swings from its perch, which can be a bookcase or wall. If you decide to construct the project, you too can express an

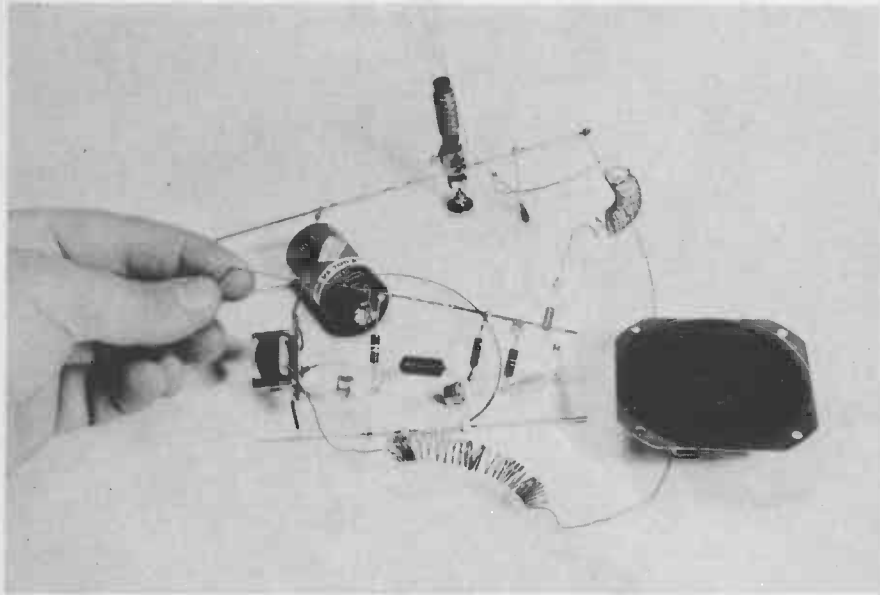

Fig. 2-2. Construction details.

artistic inclination. The model may be followed exactly as shown, or varied in countless ways using the same basic parts and building techniques.

The simplicity of the circuit makes it easy to construct but does limit its performance. The radio plays best if there is a strong local station nearby, since reception on distant stations is weak. However, this has not proved to be a serious drawback. Many people, on first seeing the Radiomobile, doubt that it is more than a novel decoration. Their expression soon changes when it is turned on and they are told to listen.

CONSTRUCTION

The best place to begin construction is on the framework that holds the two transistors (Figs. 2-2 and 2-3). Place

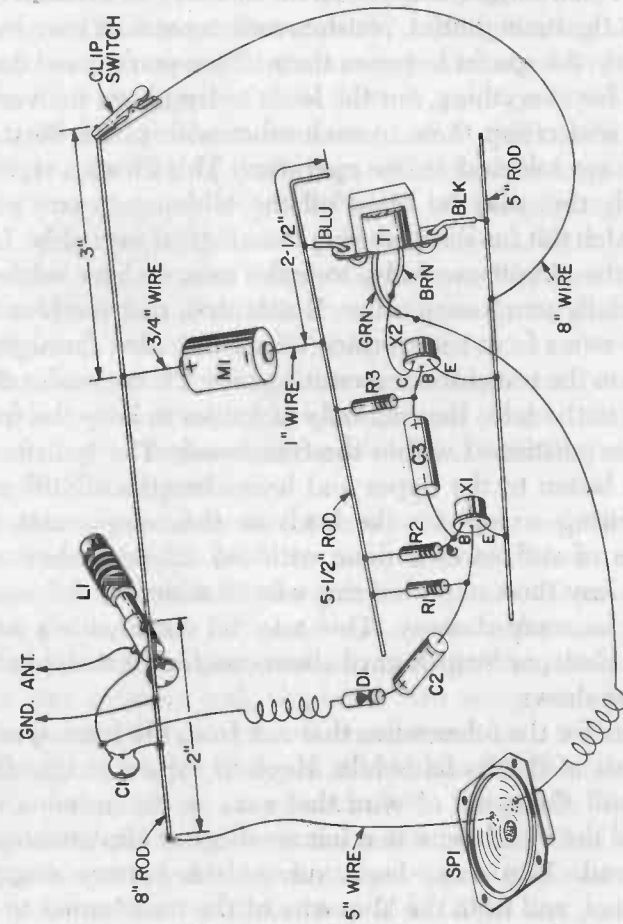

Fig. 2-3. Pictorial diagram.

two stiff wires on the worktable and position them as shown in the drawing. Within this framework you can connect the small parts into their approximate locations before soldering. Using the two transistors and transformer T1 as the main guides, resistors and capacitors may be fitted into the spaces between them. Once you're sure there's room for everything, cut the leads to length on the various parts and crimp them to each other with pliers. Next the joints are soldered in one operation. This forms a rigid assembly that may be lifted off the tabletop in one piece.

Watch out for shorts during this stage of assembly. Look over the circuit carefully, to make sure no bare wires accidentally touch each other. Notice, too, that the blue and black wires from transformer T1 are threaded through the holes in the transformer mounting tabs. Do not solder these leads to the tabs; they act only as guides to keep the transformer positioned within the framework. The transformer leads fasten to the upper and lower lengths of stiff wire. All wiring—except for the leads on the components, and pieces of stiff wire—is done with No. 28 enamel-covered wire. Any time an end of this wire is soldered, the enamel must be scraped away. This may be done with a knife, razor blade, or Strip-X until about one-fourth inch of shiny copper shows.

Now for the other wires that run from the framework to the rest of the Radiomobile. Hook in capacitor C2, diode D1, and the spiral of wire that runs to the antenna coil. Install the 8-inch wire that has an alligator clip attached to one end. Two more leads run to the battery negative terminal, and from the blue wire of the transformer to one of the speaker lugs.

The two spirals of wire visible in the illustrations do not appear in the schematic, since they do not act as electrical coils. Instead they serve to make electrical connections and do impart some springiness between various sections of

the Radiomobile. Between 30 and 40 turns, wound onto a pencil, should give proper action.

Continue the assembly with the 8-inch piece of stiff wire that forms the top part of the project. First insert the wire into one of the lugs of antenna coil L1. Slide the lug about two inches from one end of the wire, and secure it with solder. The antenna coil used here is the standard loopstick used for broadcast receivers; and in this model is a transistor type having three lugs. (The middle lug is not used.) However, any loopstick for the broadcast band and of the same general dimensions can be used. If it is designed for a tube radio, simply use the two lugs provided. Just be sure it has a tunable core and an adjustable knob.

The 8-inch wire is completed by soldering capacitor C1 in place, and also the wires for the speaker and battery. Both battery wires are soldered to the end terminals of the battery. Try to center them as closely as possible so the battery will hang vertically.

The next phase of construction is balancing. Attach both ground and antenna leads to the points indicated, using about a 6-foot length for the ground wire and 30 or more feet for the antenna. Both leads are cut from the same No. 28 enamel wire used previously for wiring. About six inches above the antenna coil, wind the two wires around an anchor point. (This may be an arm formed from a piece of coat hanger.) At this time you should have the 8-inch stiff wire in front of you, suspended above the table. Fasten the speaker lead to one end of the wire and the lead from the positive terminal of the battery near the opposite end. The basic method of balancing is to slide the positive battery connection back and forth over the stiff wire. Once you find the point at which the stiff wire remains near the horizontal position, solder the battery wire to it.

The Radiomobile will be most interesting to view if you adjust the various sections—speaker, framework, etc.—so

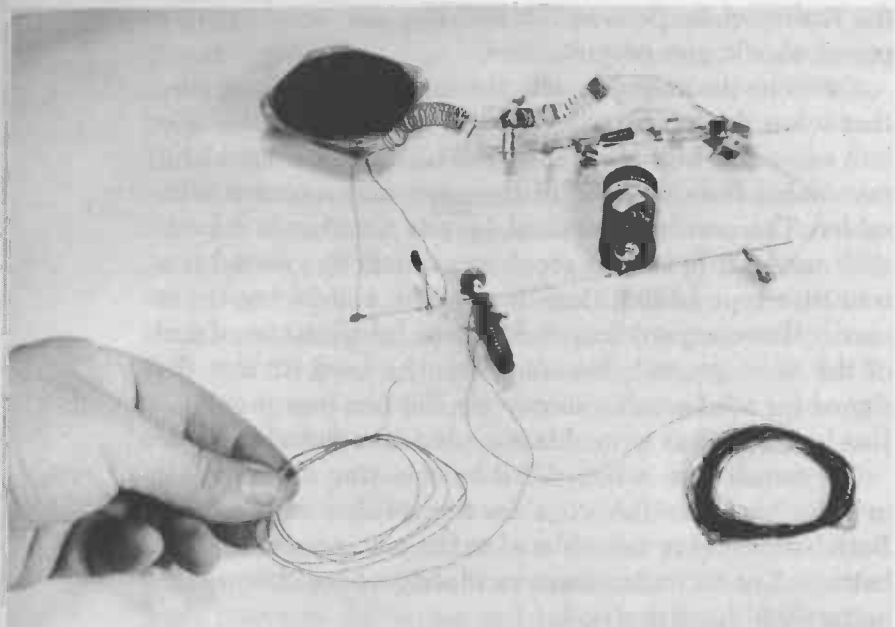
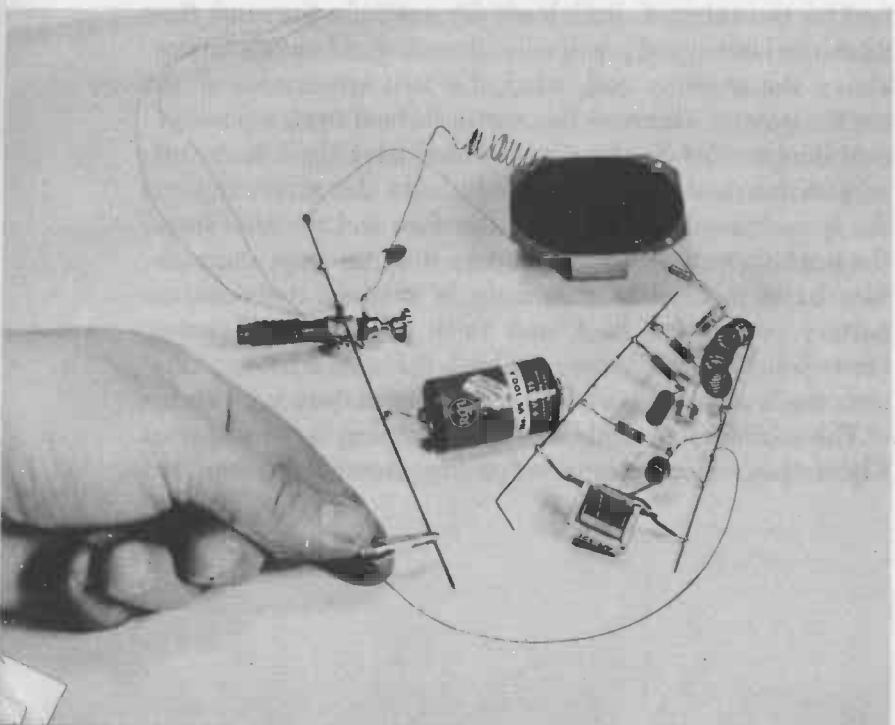

Fig. 2-4. Showing the antenna.

Fig. 2-5. Completing the circuit.



they lie in different planes. Some judicious bending can take care of this.

OPERATION

Choose a location that enables you to mount the unit at about eye level. The coat-hanger arm can be slid under some books or fastened to a wall. It is a good idea to pick a spot near a wall outlet, even though you don't need AC power for the unit. The outlet affords a convenient hookup for the ground wire—loosen the screw that holds the AC outlet cover plate and secure the ground wire to it. Again, it is necessary to scrape away some enamel insulation for good contact.

The antenna show in Fig. 2-4 is strung out for its full length of 30 or more feet. (Its small diameter permits it to be easily hidden.) If you are some distance above ground, the antenna may be hung out a window.

The performance of the circuit depends greatly on the distance of the radio station. Power is applied by hooking the alligator clip to the top wire of the assembly (see Fig. 2-5). With your ear next to the speaker, start turning the knob on the antenna coil. It's important that the knob turn easily, or the complete Radiomobile will rotate with it. Any stiffness or binding can be eliminated by slightly prying apart the metal slits into which the tuning shaft is threaded (be very careful not to break them).

Strong, local stations should develop enough volume to be heard several feet from the speaker. More distant stations require closer listening. Because of differences between models, your Radiomobile may not tune in the complete broadcast band, but may favor the upper half of it. If you are unable to tune in local stations below approximately 700 kc, try replacing C1 with a capacitor in the 330-mmf range.

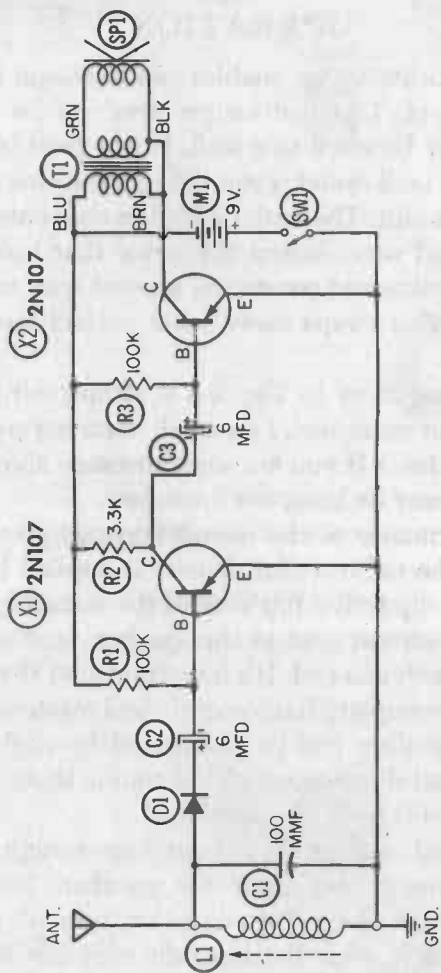

Fig. 2-6. Schematic diagram.

ABOUT THE CIRCUIT

The Radiomobile selects stations by means of tuned circuit L1-C1 (Fig. 2-6). The audio frequencies are removed from the radio wave by diode D1 and are amplified by the two transistors. The speaker reproduces the audio frequencies as sound.

PARTS LIST

Item No.	Description
R1, R3	100K, ½-watt resistor.
R2	3.3K, ½-watt resistor.
C1	100-mmf disc ceramic capacitor.
C2, C3	6-mfd miniature electrolytic capacitors, 15-volt.
L1	Loopstick antenna coil (broadcast type) with knob (Superex VLT-240 or equivalent).
D1	Germanium diode, 1N34.
X1, X2	2N107 transistors.
T1	Miniature transistor audio-output transformer. (400 ohms to voice coil).
SP1	Speaker, 2½-inch.
M1	9-volt battery (RCA VS-300A, or equivalent).
SW1	Alligator clip for switch.
Misc.	Stiff wire; No. 28 enamel-covered wire; coat hanger.

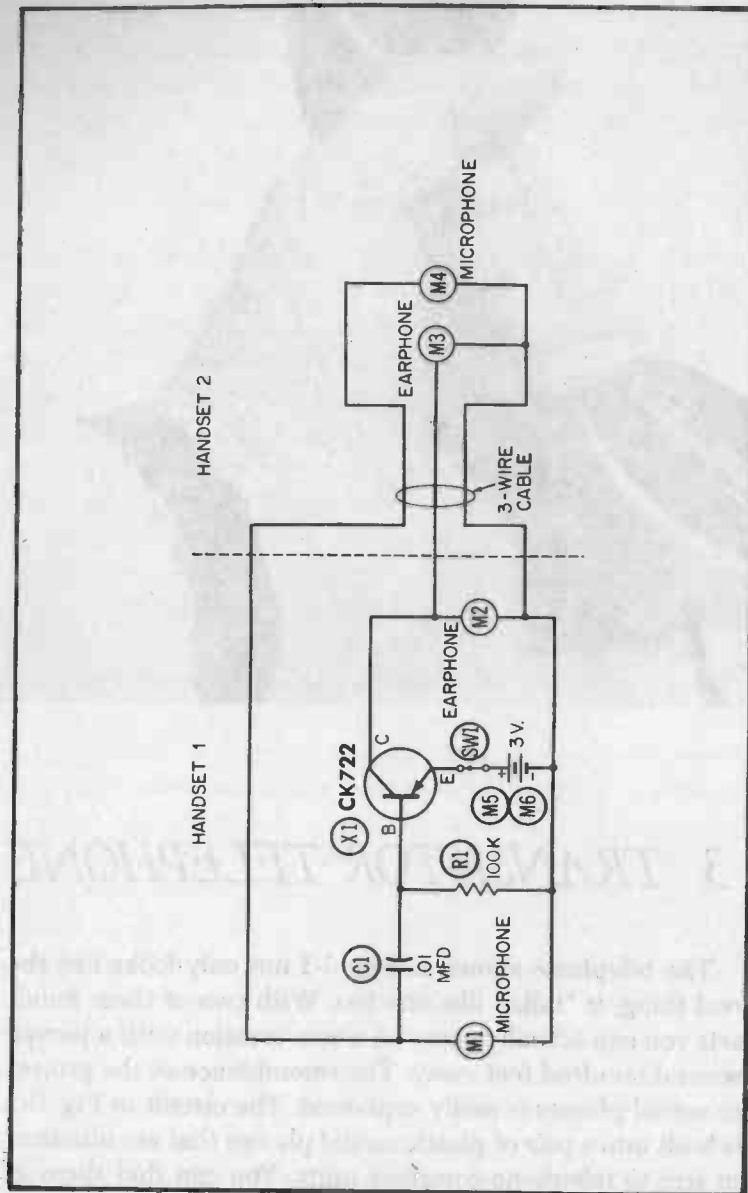

Fig. 3-2. Simplified schematic.

A miniature transistor amplifier is built inside the mouthpiece of one unit. Since the amplifier can be made to work for both sides of the conversation, the second handset merely contains an earphone and microphone.

CONSTRUCTION

After you've gathered all the components given in the Parts List, begin construction by preparing the four earphones. (They're all identical, but two will act as microphones after the circuit is placed into operation.) The cords connected to each earphone will have to be removed; they contain fine, stranded wire that is difficult to strip and solder. Just unscrew the cap (the part with the holes in it), lift off a shiny metal disc, and look for the screws that hold the two cord wires. The screws are located in a tight corner and are impossible to reach with regular pliers; you should use a pair of long-nose pliers that can easily fit into a narrow space.

After the screws are removed, slip off the leads and feed them, one at a time, through the hole in the bottom of the phone. As shown in Fig. 3-3, two lengths of hookup wire replace the original cable leads. Repeat the process for the four earphones, replace the discs and caps, and you're ready to work on the amplifier section.

In the amplifier section, the switch is mounted first (Figs. 3-4 and 3-5). With a pair of scissors, snip a notch in the side of one phone handle. The cutout is approximately $\frac{1}{2}$ by $\frac{7}{8}$ inch, but check it with your switch to be certain. Once the notch is made, insert the switch and mark off the two mounting holes in the switch tabs. A pair of 6-32 \times $\frac{1}{4}$ " nuts and bolts can be used to hold the switch in place.

Some preparation is needed before the batteries can be slid into the phone. Since there is no room for a battery

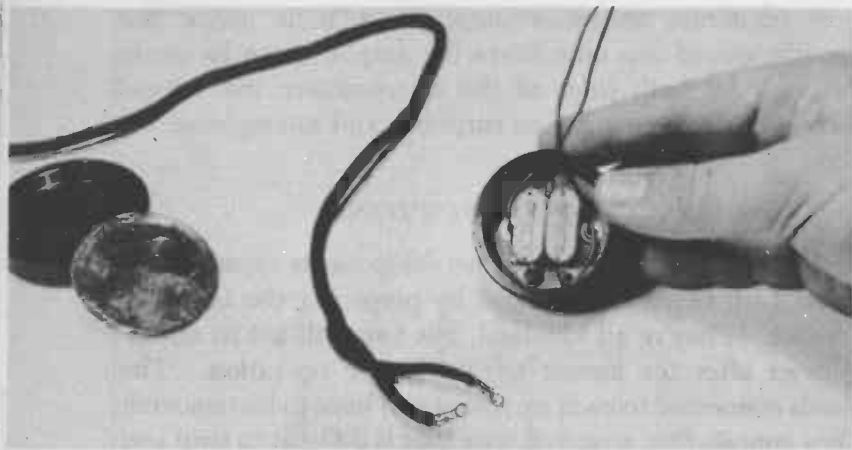

Fig. 3-3. Replacing wires.

Fig. 3-4. Parts layout.

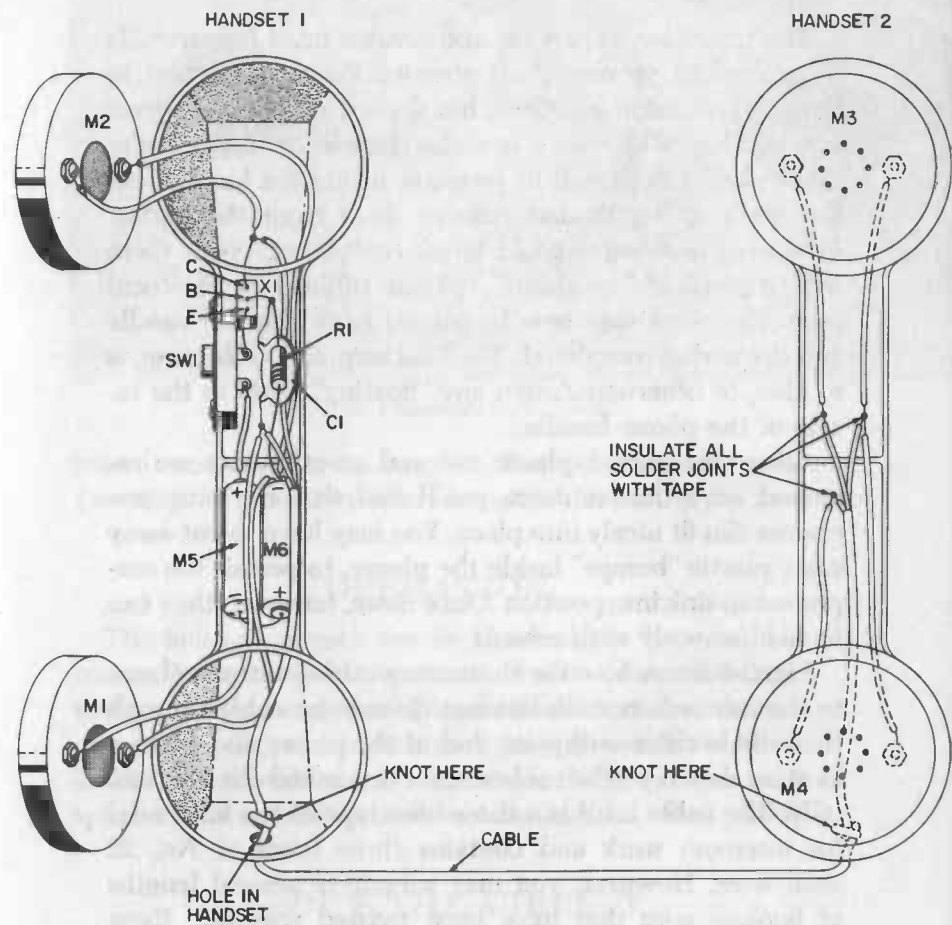
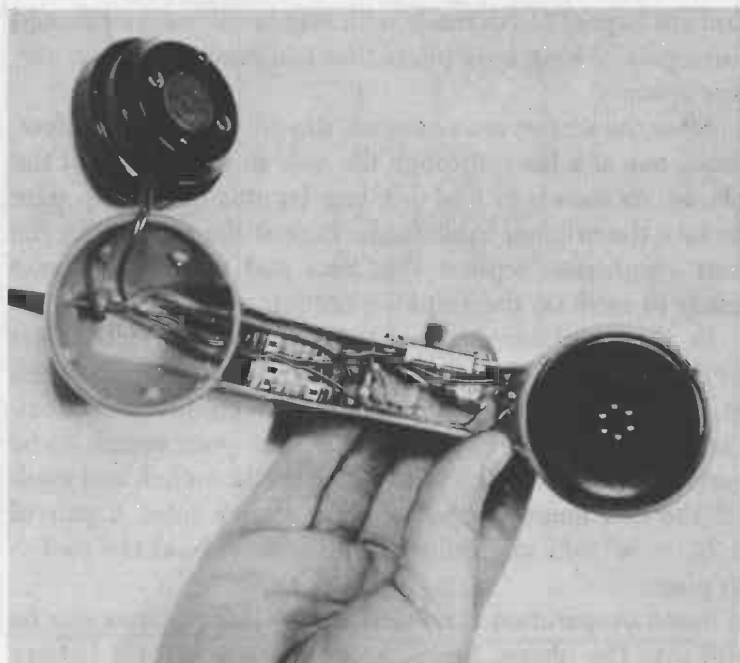

Fig. 3-5. Pictorial diagram.

holder, the wires are soldered directly to the battery terminals. This is done before the batteries are mounted. Follow the wiring guide in Fig. 3-2 for the connections, then fix the batteries in position with a few drops of household cement.

The transistor, capacitor, and resistor must be carefully positioned to prevent short circuits. First place them in their approximate locations, but do not solder. This gives you an idea of how long to make their leads. After you're satisfied that each will fit properly inside the handle, cut the leads to length and remove them from the phone. Wherever bare wires could touch each other, cover them with a piece of "spaghetti" (plastic tubing) or electrical tape. The parts may now be placed back into the handle and the wiring completed. The final step, after soldering, is to glue, or otherwise fasten any "floating" parts to the inside of the phone handle.

After the original plastic ear and mouthpieces are removed from the handsets, you'll find that the four earphones can fit nicely into place. You may have to cut away some plastic "bumps" inside the phone, to permit the earphones to sink into position. Once there, however, they can be held securely with cement.

Fig. 3-6 shows how the connecting cable from one phone to the next enters each handset. Insert the cable through the hole in the mouthpiece end of the phone and make a knot, as shown, so the cable cannot be yanked out accidentally. The cable itself is a three-wire type of the kind used for intercom work and contains three leads of No. 22 solid wire. However, you may substitute several lengths of hookup wire that have been twisted together. Even lamp-cord wire will work, since the cable size is not critical.

Handset No. 2 merely contains two earphones mounted in the same manner as in Handset 1. The various wires are

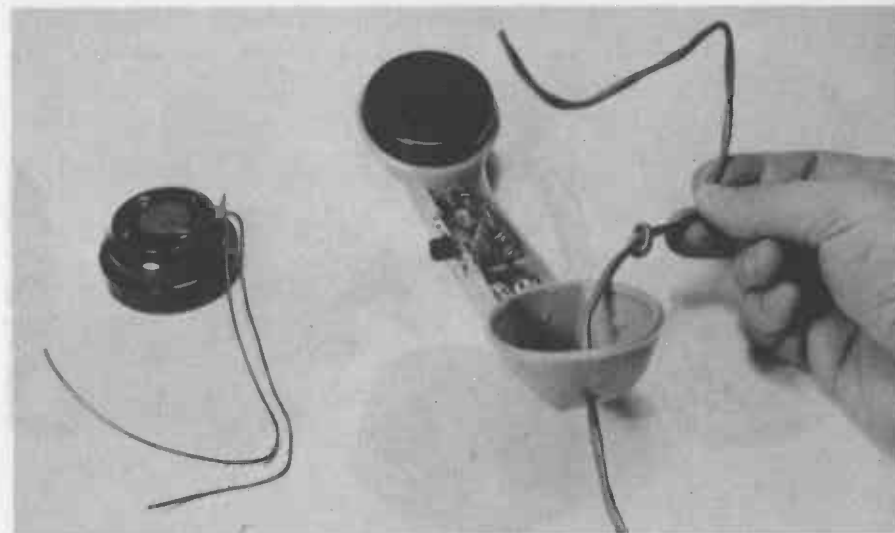

Fig. 3-6. Placement of cable.

joined according to the diagram, then soldered and taped (see Fig. 3-7). No switch is needed at this end of the line.

OPERATION

The finished project can be checked out between two rooms. Turn the switch on and talk into the handset as if it were a conventional telephone. You'll find that there is no need to flip the switch each time you talk or listen. Unlike the "push-to-talk" intercom, both persons may speak at the same time and be heard in the other phone.

ABOUT THE CIRCUIT

The unit in Fig. 3-2 is basically a 1-stage audio amplifier. As sound waves strike the mouthpiece of either phone, small electrical currents are generated (an earphone can act as a microphone). These currents are applied to the

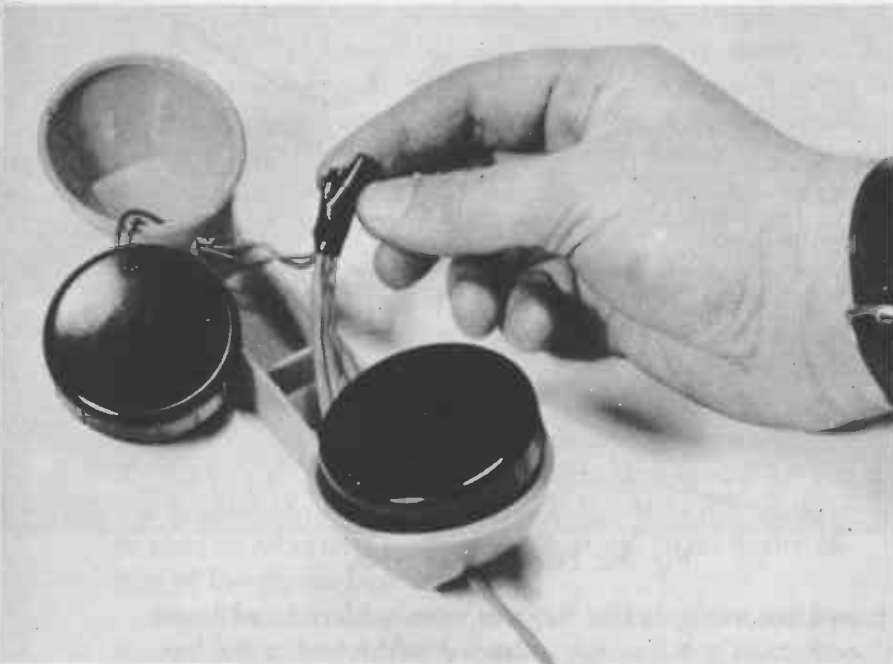

Fig. 3-7. Handset No. 2.

transistor, which boosts their strength many times. Greatly amplified voice currents feed both earphones and are converted back into sound waves.

The miniature batteries used in the circuit should last many months—the current for powering the transistor is less than 1.5 milliamperes, an exceedingly small amount.

PARTS LIST

Item No.	Description
R1	100K, ½-watt resistor.
C1	.01-mfd ceramic disc capacitor.
X1	CK722 transistor.
SW1	SPST slide switch.

(Parts List Continued)

Item No.	Description
M1, M2, M3, M4 M5, M6	Earphones, magnetic type, 1,000 ohms. 1.5-volt miniature batteries (Burgess NE, or equivalent).
Handsets	2 plastic model telephones.
Misc.	Hookup wire; 3-wire cable; tape; spaghetti; 6-32 hardware.

LEMON-JUICE
OSCILLATOR

CANNON

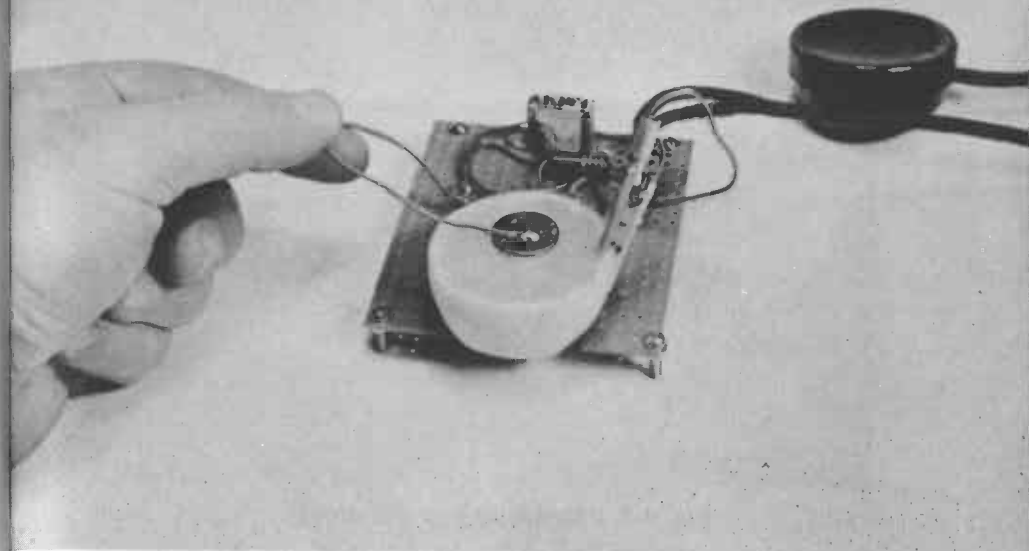

4. LEMON-JUICE OSCILLATOR

The large object in the foreground of Fig. 4-1 is not a new type of electronic component—it's half a lemon! Combined with a transistor circuit that can produce a tone, the juice of this fruit supplies the raw material for a working battery!

It's a surprising demonstration that begins when someone holds the headphone to his ear and you touch the penny to the lemon. A tone is heard each time the penny makes contact.

CONSTRUCTION

The project is built on a piece of perforated board (see Fig. 4-2). The four legs of the board are $\frac{1}{2}$ -inch screws

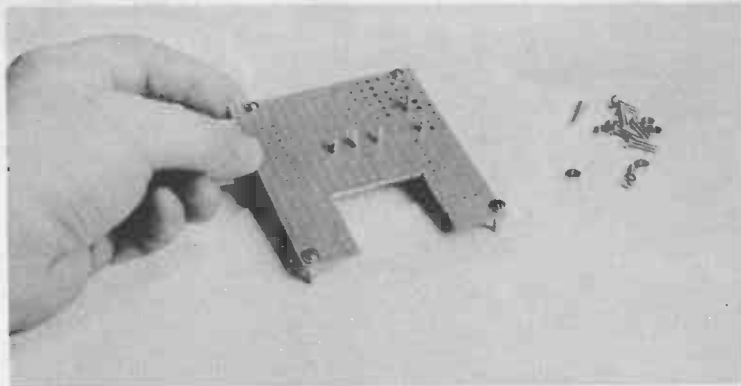

Fig. 4-2. Board with legs mounted.

inserted into the holes and fastened by nuts. Fig. 4-2 also illustrates the use of small "flea" clips to support the main parts of the circuit. Six of them are pushed into holes. The transformer is mounted next. Use small nuts and screws to hold the two mounting tabs to the board. Two red and blue wires, if your transformer is color-coded this way, face toward the rear edge of the board. Hook the transistor and resistor to the correct clips, and begin soldering the circuit together. The headphone tips can be soldered directly to the board clips. Don't remove these tips since they hold solder easier than the headphone wires.

Your transformer may not have the same color coding shown in the drawings. In this instance, the correct connections aren't difficult to figure out. Assuming you have purchased the transistor driver transformer specified in the Parts List, it will have two sets of leads. The secondary (rated at 2K, or 2,000 ohms) usually has three leads. Checking the information supplied with your transformer, connect one secondary wire to the emitter (E) of the transistor (Fig. 4-3 and 4-4) and the other to the lead that goes to the penny. (Do not use the center-tap wire, if the secondary has one.) The primary of the transformer is the

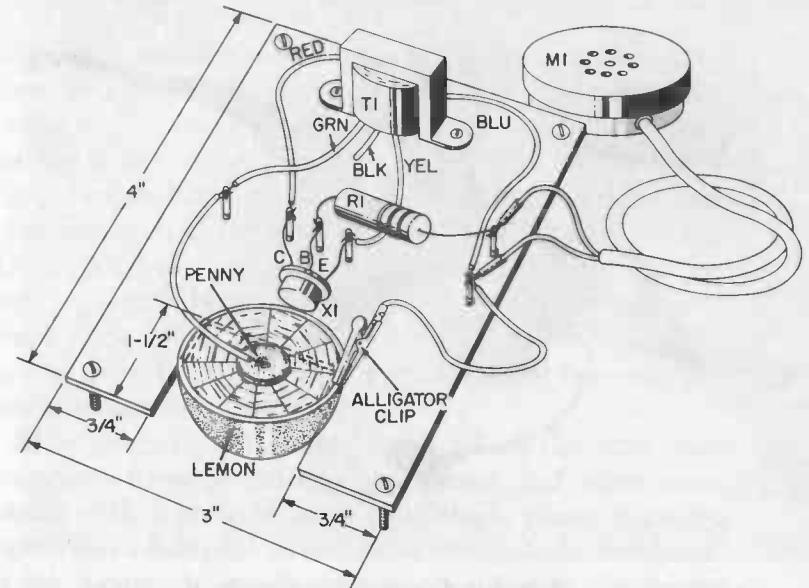

Fig. 4-3. Pictorial diagram.

10K side. Its two leads connect to the transistor collector (C) and to the wire with the alligator clip. Important: If your transformer doesn't have the color coding of the model described here, the circuit may fail to produce a tone after it has been wired in. If this occurs, simply reverse the two secondary wires (yellow and green in the drawing).

As also shown in Fig. 4-5, the two wires going to the lemon are terminated with an alligator clip and a penny. If you clean the penny with a piece of steel wool, there should be little difficulty in soldering the wire directly to it. Be sure the alligator clip is not the copper-colored kind. Pure copper clips, which are rare, will not permit the unit to operate because they interfere with the action of the battery.

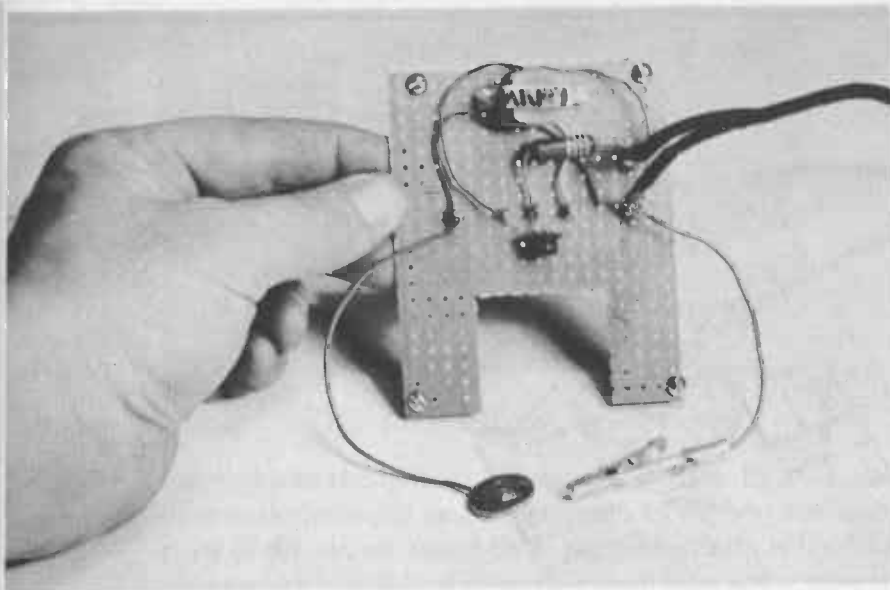
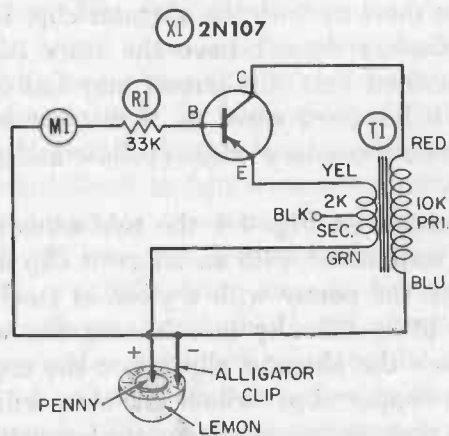

Fig. 4-4. Construction details.

Fig. 4-5. Schematic diagram.



OPERATION

Half of a lemon is shown in Fig. 4-1, but a much smaller piece will power the oscillator. Place it in the notched section of the board. First, press open the alligator clips so one jaw bites into the lemon while the other jaw clamps to the outer skin. Next, press the penny firmly onto the lemon while listening in the headphone. Move it slowly toward the alligator clip until the tone is heard. There must be some separation between the clip and penny, or the battery won't work. Often, the lemon must be squeezed slightly (watch your eye) in order for juice to flow between the penny and clip, and start the tone.

After the unit is operated for a while, the tone may disappear. Remove the clip and penny, and wipe them briskly with a piece of cloth. The single piece of lemon should last a fairly long time, even after it looks dried out. In the model, the oscillator worked although the lemon was left on a worktable for more than a week. Of course you can preserve your lemon battery by wrapping it to keep in moisture and storing it in your refrigerator.

ABOUT THE CIRCUIT

The citric acid in the lemon starts off a chemical reaction that produces electricity. Although only a few thousandths of a watt, the current is enough to trigger the transistor circuit. When the juice contacts the metal of the alligator clip, invisible particles known as ions begin to dissolve. This electrically unbalances the metal and it becomes negatively charged. The penny is not as affected by the lemon. Compared to the clip it becomes positively charged and electrons flow from the clip, through the transistor oscillator circuit and then back into the battery through the penny.

Electrical action is similar to that of an actual battery. Hence, if you have trouble making the oscillator work, try hooking in a regular 1.5-volt flashlight battery temporarily. The penny is touched to the positive, or button end, and the alligator clip to the negative end. You can return to the lemon battery after correcting any errors you may have made during construction.

PARTS LIST

<i>Item No.</i>	<i>Description</i>
R1	33K, ½-watt resistor.
X1	2N107 transistor.
T1	Transistor driver transformer, miniature type, 2K to 10K.
M1	Headphone, dynamic type, 1K.
Misc.	3" × 4" perforated board; four ½-inch screws; hookup wire; flea clips; alligator clip; penny; lemon.

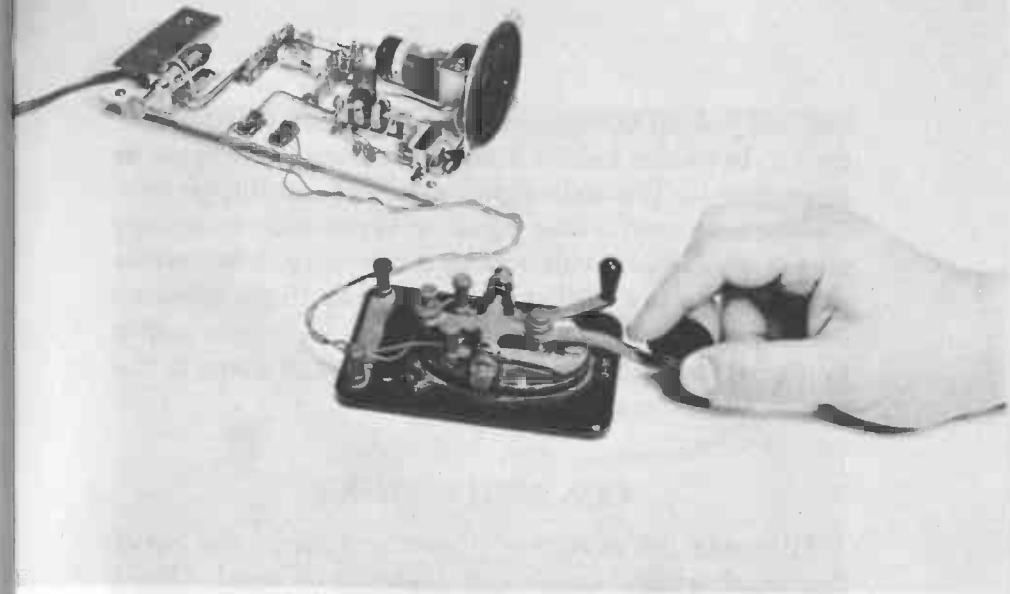

5. SENDING CODE OVER YOUR HOUSE WIRES

The network of wires that carry power to the wall outlets in your home can serve as part of a private communications system. The gadget shown in Fig. 5-1 makes it possible to send code messages over these wires between any two outlets in the house. Sometimes the signal can even be transmitted between two separate apartments, or between nearby homes on the same street, without affecting normal operation of the AC lines.

The project operates on the "carrier-current" principle, a broadcasting system used on many college campuses. A radio signal can be made to ride the power lines and appear at every wall outlet. A regular AM radio plugged into the

line will pick up the signal as if it were being sent out over the air. In similar fashion a table radio is needed to act as a receiver for the code signal produced by this project. The unit can send a tone signal or Morse code to another person who listens with a radio receiver, or it is suitable as a code-practice oscillator. A speaker on the unit sounds the same tone that is sent over the line. It is a simple matter to unplug the unit from the wall and merely listen to the tone as the telegraph key is operated.

CONSTRUCTION

All wiring and mounting of parts is done on the top of the board, which is a piece of *Masonite* or wood. (Don't use a sheet of metal—the board must be an electrical insulator.) Although 6-32 hardware best matches the holes in the parts, any convenient assortment of nuts and screws is suitable for fastening the components. The screws should be about one-fourth inch long, except for the four at the

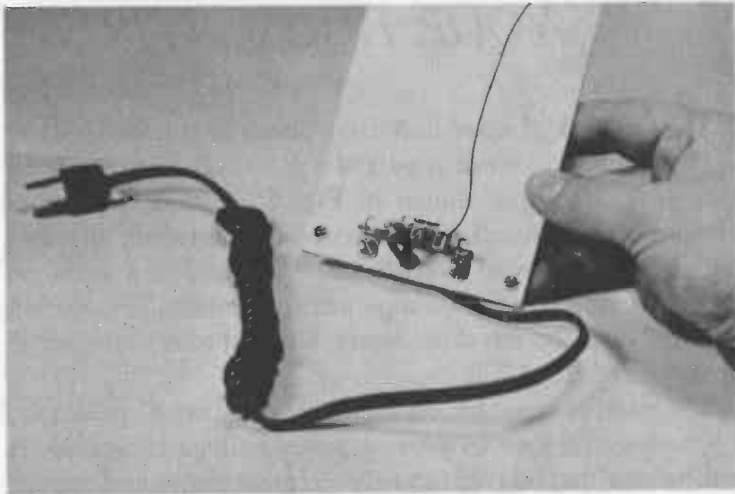

Fig. 5-2. Running line cord (top view).

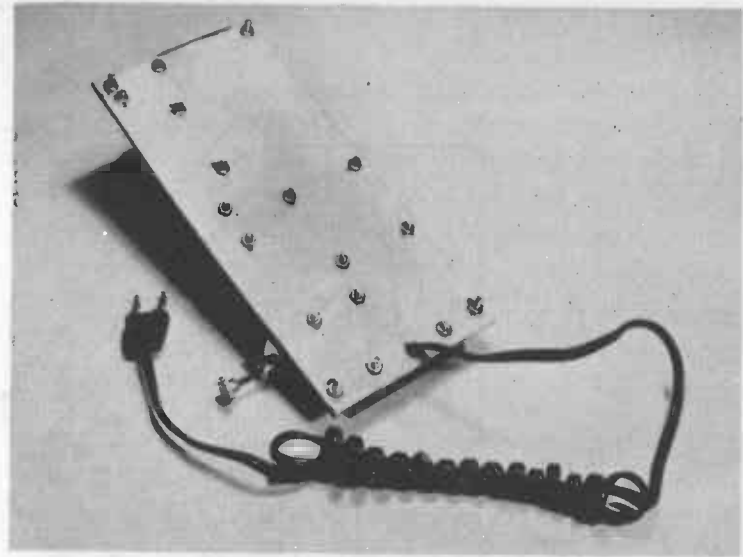

Fig. 5-3. Running line cord (bottom view).

corners of the board. They act as legs and should be longer, to raise the board off the surface of the table.

Construction begins with the terminal strip that receives the AC line cord. As shown in Figs. 5-2 and 5-3 a hole is drilled for the cord, and its two leads are connected to lugs on the terminal strip. This part of the assembly is important since it protects you against shock from the AC line. Next, bend the three middle lugs of the strip so their ends lie flat instead of pointing up. Solder the line cord, capacitor C1, and a length of No. 22 enamel-covered wire to them, as shown in Figs. 5-4 and 5-5. (Be sure to scrape off some enamel before soldering the wire.) The protective cover is then added. It is a small piece of hardboard with two slits (or drill holes) that are pressed onto the outer lugs of the terminal strip. Once the cover is in place, the lugs are bent down to hold it securely. This arrangement should prevent curious fingers from touching the three middle

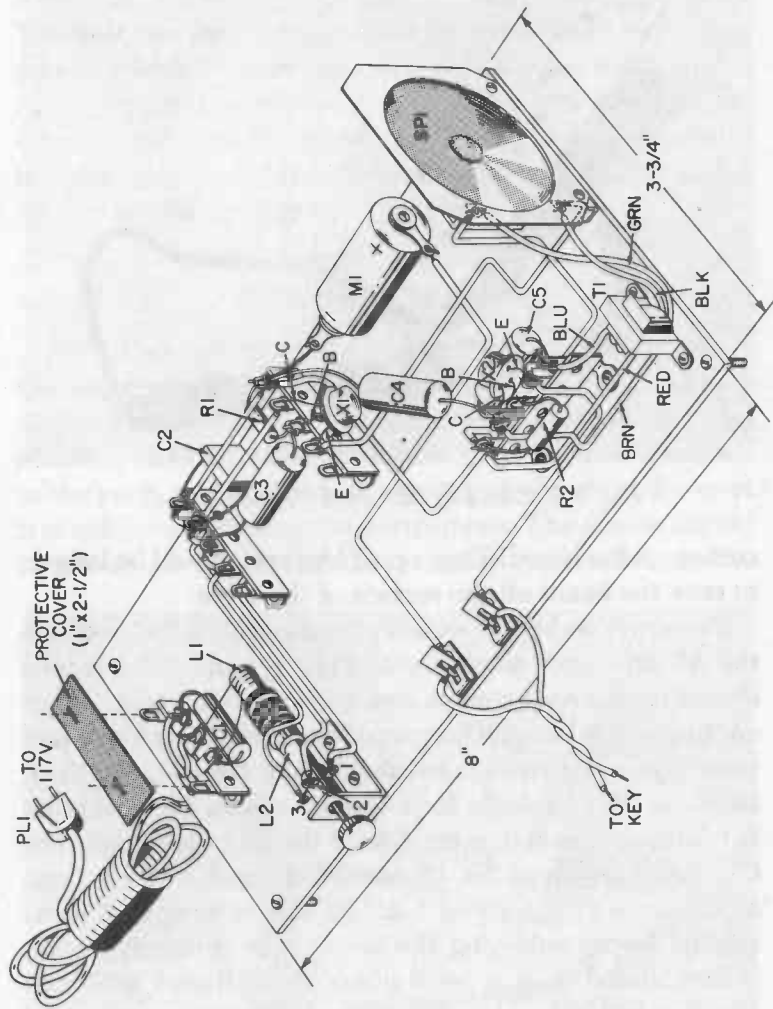

Fig. 5-4. Pictorial diagram.

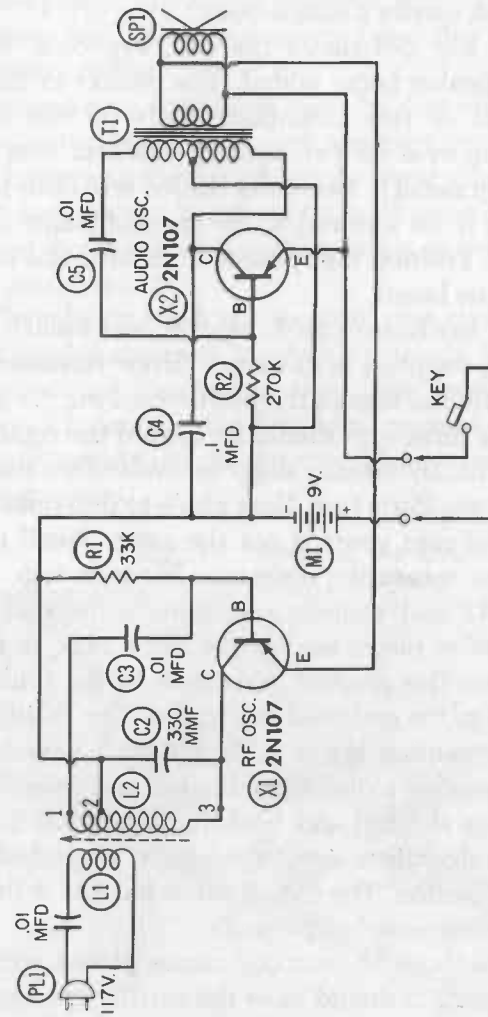

Fig. 5-5. Schematic diagram.

lugs of the terminal strip when the unit is plugged into the AC line. Such protection is not needed for the rest of the circuit, which carries a safe 9 volts.

A look at Fig. 5-6 shows the coil, key clips, terminal strips, and speaker being added. The pointer in the photo indicates one of two mounting points for the speaker, which is supported by two small L-brackets (cut from a piece of scrap metal). Two holes drilled into both brackets permit them to be screwed to the speaker frame and also to the board. Position the speaker so its terminal lugs face the front of the board.

Mounting hardware (an L-bracket and knob) for the coil is usually supplied in its carton. Screw this assembly to the board with the lugs in the position shown. As you face the knob, the three lugs should be toward the right side of the board. This layout may differ for coils other than those suggested in the Parts List. Here's how to determine which lugs to use in case yours is not the same. You'll need an ohmmeter for measuring resistance between lugs. Set the meter to RX1 and connect one lead to the middle lug. Touch the other meter lead to the other lugs, to find out which lug has the greatest resistance to the middle lug. This is lug 3 in the coil used in Fig. 5-4. The middle one is 2 and the remaining lug is 1. If you don't have an ohmmeter, it is possible to find them by trial and error. Connect three wires to the coil and hook them into the circuit in different combinations until it works as described in the "Operation" section. The circuit is not harmed if the coil is accidentally connected improperly.

Another method: If your coil comes placed with a diagram, lugs 1 and 2 should have the smaller spacing on the schematic. Notice that a winding (L1) must be added to main coil L2. This is done by taking the length of enamel wire soldered to the terminal strip which carries the AC line cord, and winding about ten turns around one end of

the coil form. After the turns are completed, cut the wire to length, scrape off some enamel coating, and solder the end to the proper lug on the terminal strip. You may have to remove the protective cover over the strip if it was mounted earlier.

Battery connections are made by snapping two matching clips onto the positive and negative terminals. To hold the battery to the board, apply some glue to the surface that rests on the board. (The total amount of current required is only about 5 milliamperes, so the battery should last many months.)

The telegraph key is a standard unit available from most war surplus stores. It is possible, though, to use two metal strips instead. Fasten one strip to the board and secure the other so it contacts the first when pressed down. Choose a springy metal (copper, for example) so you get the proper keying action.

Fig. 5-6. Mounting the speaker.

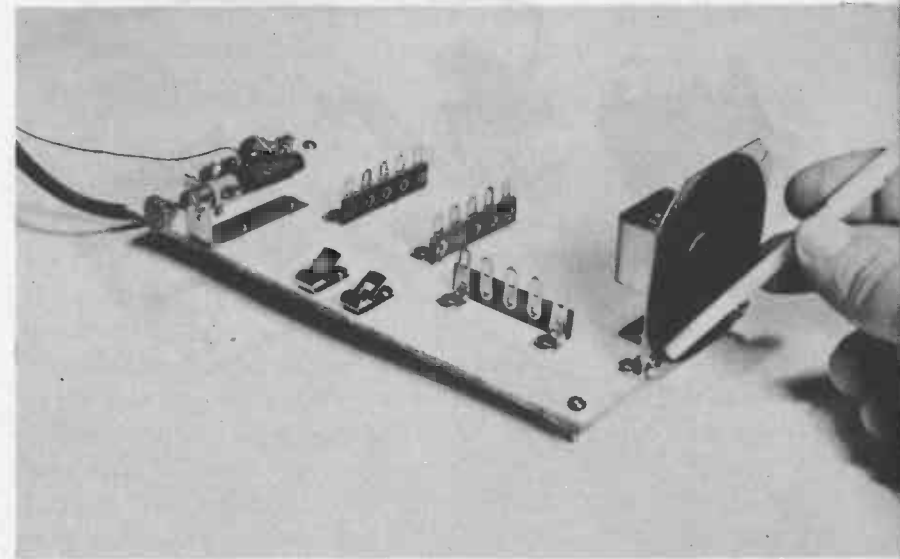

The rest of the project involves soldering the small circuit parts to the various terminal strips. The color coding of the miniature transformer leads is given in the pictorial drawing, as are the connections to the transistors. Leave plenty of lead length on these components if you want to use them for a future project. For example, the transformer wires in the model were coiled instead of cut to the proper length.

OPERATION

The first part of the checkout is done without plugging the line cord into a wall outlet. Press the key as shown in Fig. 5-7, or touch the two key clips together with a piece

Fig. 5-7. Operating the key.

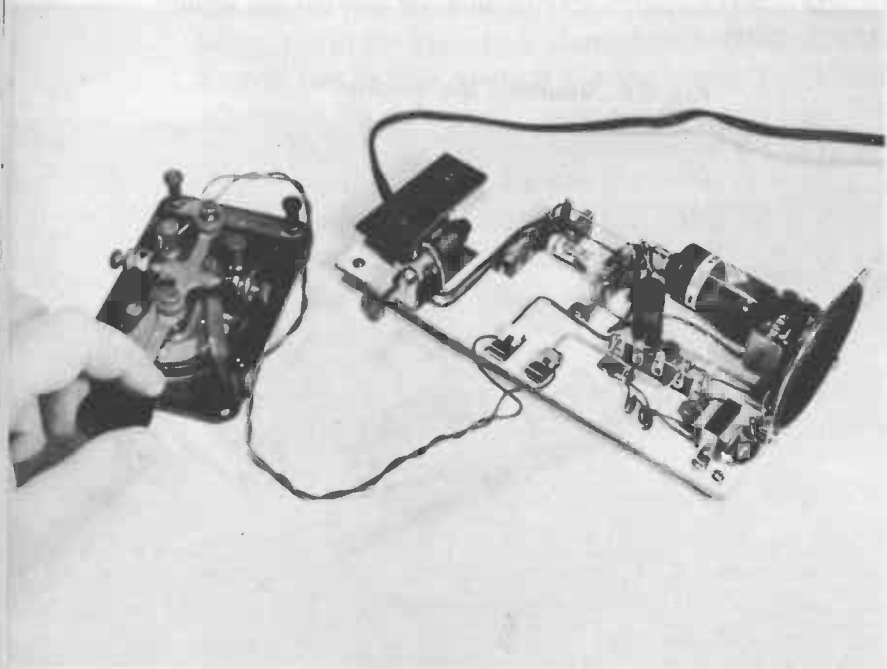

of wire, and listen for a tone in the speaker. (There is no on-off switch, other than the key.) Since transistors require no warm-up time, the tone should be heard instantly each time the key is depressed.

With the tone section working properly, the line cord is ready to be plugged into a wall outlet. But first, be absolutely certain the two AC leads do not touch each other where they connect to the terminal strips or you'll blow a house fuse. Also be sure the protective cover is in place.

Plug the cord into the outlet and do the same for a table radio placed near the unit. Turn the radio on and set its volume control for normal listening level. Tune the radio dial between 55 and 100, but where no radio stations can be heard. Depress the key on the unit, and turn the coil knob. At some point you should hear a tone in the radio speaker, and it should have the same pitch as the tone from the unit speaker. Keep on adjusting the coil until the tone is at its loudest and clearest point.

A few transistors will not work efficiently at the high end of the broadcast band. If you fail to hear the tone, set the radio dial near 55 (550 kc) and tune the coil knob again.

When everything is working properly, check the range of the system by taking the radio to another part of the house and having someone listen for the tone as you key the unit. As mentioned earlier, the signal might travel over the wires to a location quite distant from the unit. This is governed largely by where the power company has located its pole transformer on the street. The signal will go as far as the transformer and then stop. Thus, you should be able to communicate anywhere in your house, and with another area that receives electricity from the same pole transformer. The model here sent and received signals over the wiring of two separate houses.

ABOUT THE CIRCUIT

The unit consists of two oscillators. Transistor X2 generates the audio tone you hear in the speaker. Some of the audio voltage fed to the voice coil of the speaker is diverted to transistor X1, which produces a radio frequency signal in the broadcast band. Here, signals combine in the process of modulation. The resulting signal reaches the power line through coil L1. Traveling on the line, the tone-bearing radio signal is picked up by any broadcast receiver plugged into the line and tuned to the frequency of X1.

PARTS LIST

<i>Item No.</i>	<i>Description</i>
R1	33K, ½-watt resistor.
R2	270K, ½-watt resistor.
C1, C3, C5	.01-mfd paper capacitors, 600-volt.
C2	330-mmf mica capacitor, 500-volt.
C4	0.1-mfd paper capacitor, 400-volt.
L1	11 turns of No. 22 enamel-covered wire wound on end of L2, as shown.
L2	Tapped antenna loopstick (Superex VLT-240 or equivalent).
X1, X2	2N107 transistors.
PL1	AC plug and line cord.
M1	9-volt battery (RCA VS300A).
SP1	Speaker, 2½", 10-ohm voice coil.
T1	Audio transformer, 400-ohm CT to 10-ohm voice coil (Argonne AR-120).
Misc.	Hardboard; battery clips; three 5-lug terminal strips; telegraph key; 2 Fahnestock clips.

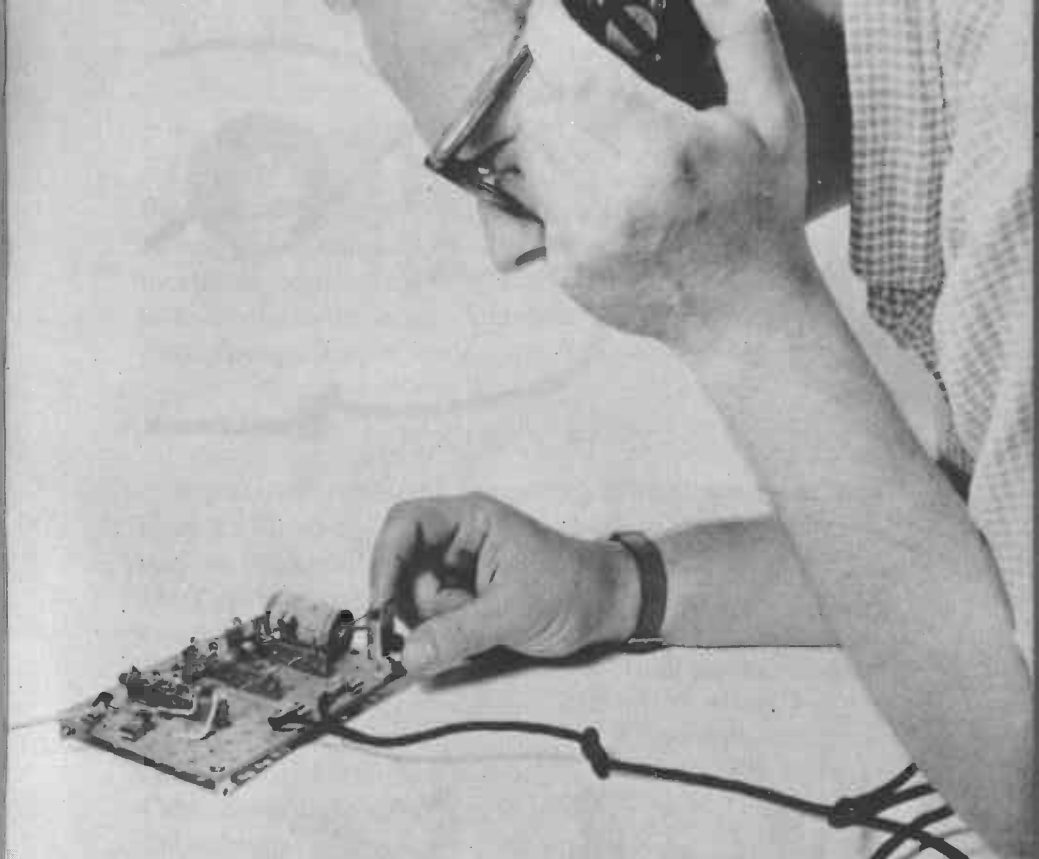

6. SHERLOCK OHMS

If you've ever wanted to play amateur detective, a valuable addition to your bag of tricks is the electronic "bug" shown in Fig. 6-1. With it you become the intrepid "Sherlock Ohms" (a modern-day version of the turn-of-the-century sleuth). Though the original Sherlock relied heavily on powers of deduction, he might have dispatched the villain faster with some electronic aids.

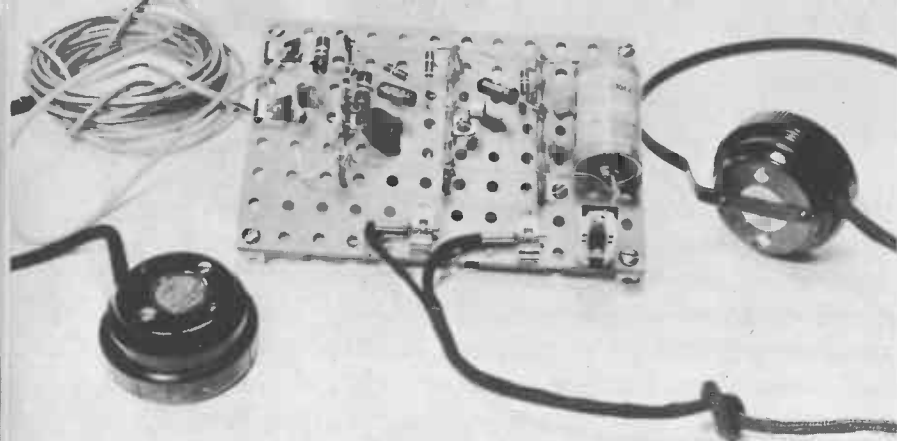
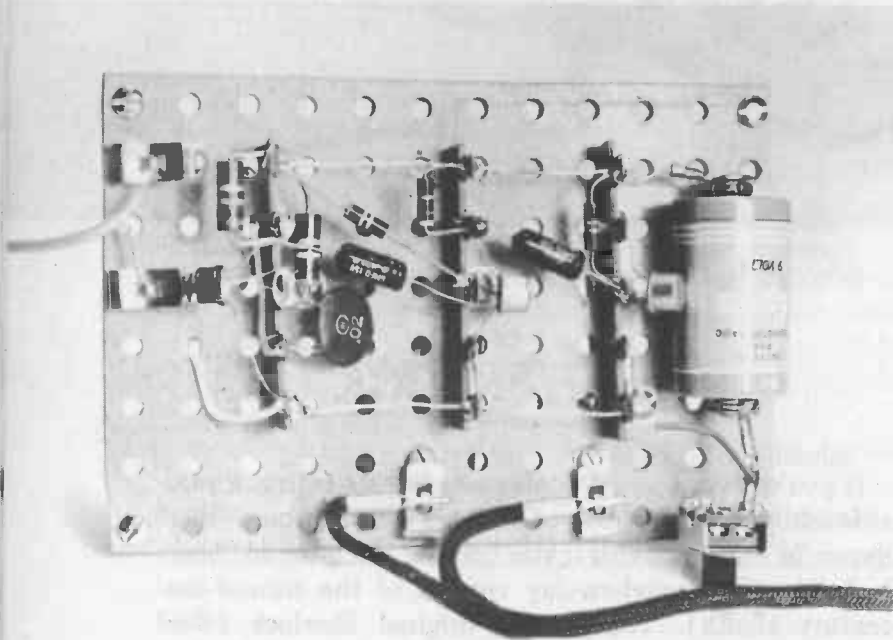

Fig. 6-2. Complete assembly.

Fig. 6-3. Construction details (top view).



The three basic sections of the bug are shown in Fig. 6-2. A circuit board is at the center, with a microphone at the left and an earphone at the right. The coil of wire (15 or more feet) connected to the microphone allows it to be located a considerable distance from the board. Easily hidden, the mike is an electronic eavesdropper sensitive enough to pick up a voice about ten or fifteen feet away.

CONSTRUCTION

A piece of pegboard measuring 6" x 4" serves as the chassis (Fig. 6-3). The predrilled holes make this material easy to work with, but solid board is just as satisfactory. Most of the components are arranged on the lugs of three terminal strips. Notice how a common lead of bare wire from the negative battery terminal joins all top lugs, while another length joins the lower ones. After these are installed, the various resistors, capacitors, and transistors are hooked to the terminal lugs and soldered in place. Four Fahnestock clips afford a convenient method for fastening the mike and earphone wires to the board.

As shown in Fig. 6-4 little wiring is done on the underside of the board. The four solder lugs which slip under the screws that hold the Fahnestock clips provide a means of connecting the four wires which go to the mike and earphone.

The legs are an important part of the construction. These are added to the four corners of the board to prevent any bare wires or contact points from touching a metal surface upon which the board might rest. This could interfere with circuit operation, or short the battery and quickly exhaust its energy. Use four small "L" brackets to keep the bottom of the board about one-half inch above any surface. The legs may be wood strips, or pieces of scrap metal bent into right angles and drilled for mounting screws.

OPERATION

You can make a quick check of the completed project by turning on the power and listening in the earphone. If the circuit is functioning properly, a hum should be heard when you touch a fingertip to the base (B) terminal of the first transistor, X1 (Fig. 6-5).

Next, the microphone cable is slipped into the Fahnestock clips at the left side of the board. Unravel the cable and hide the mike in any desired location. Try not cover the small holes through which the sound enters.

For best operation, the mike cable should be shielded, as shown in the drawings, to prevent picking up hum radiated by the AC house wiring. If the cable lengths are only 10 to 15 feet, regular hookup wire will work if the two

Fig. 6-4. Construction details (bottom view).

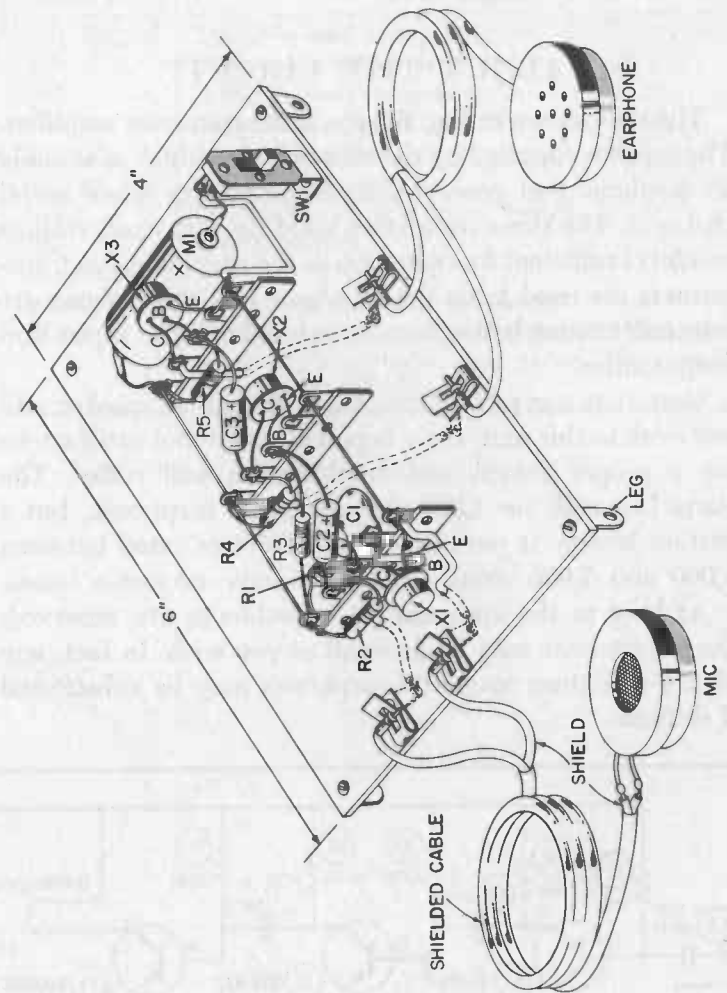
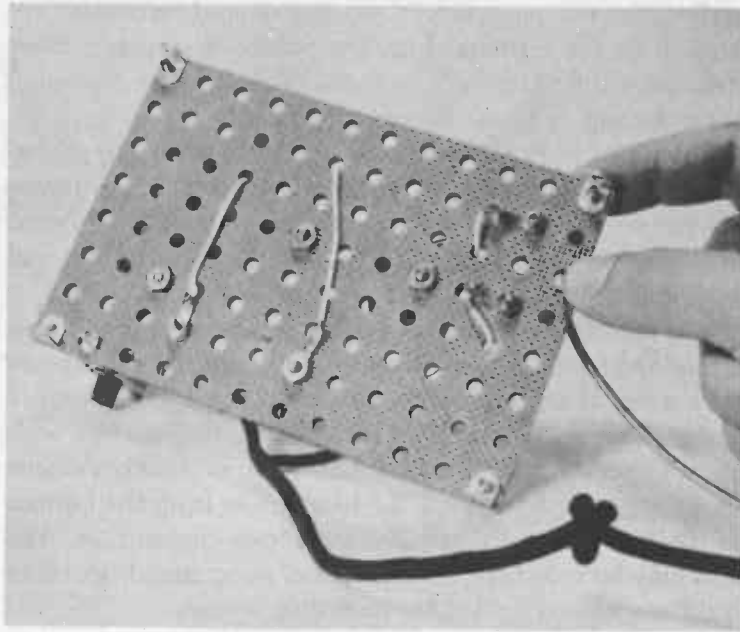

Fig. 6-5. Pictorial diagram.

leads are twisted together tightly. For longer distances, however, a shielded phono cable must be used to prevent hum pickup.

ABOUT THE CIRCUIT

The unit shown in Fig. 6-6 is a three-transistor amplifier. The input is supplied by the microphone, which is actually an earphone that generates an audio voltage when sound strikes it. The three transistors build up this small voltage to a level sufficient for operation of the earphone. No transformers are used since the earphone and microphone are selected to match the transistors on both the input and output sides.

Note that a crystal microphone or regular speaker will not work in this unit; their impedances are not satisfactory for a proper match and amplification will suffer. The Parts List calls for 1,000-ohm magnetic earphones, but a certain leeway is permitted here. Devices rated between 1,000 and 3,000 ohms should not have excessive losses.

As long as the approximate impedances are observed, the microphone may be as small as you wish. In fact, one of the miniature magnetic earphones may be substituted if desired.

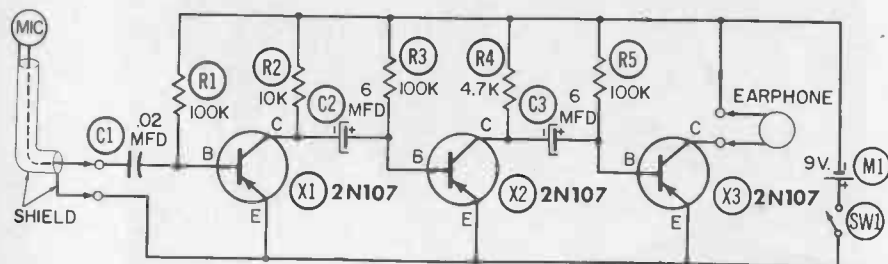

Fig. 6-6. Schematic diagram.

PARTS LIST

Item No.	Description
R1, R3, R5	100K, 1/2-watt resistors.
R2	10K, 1/2-watt resistor.
R4	4.7K, 1/2-watt resistor.
C1	.02-mfd disc capacitor.
C2, C3	6-mfd electrolytic capacitor, 15-volt.
X1, X2, X3	2N107 transistor.
SW1	Single-pole, single-throw switch.
M1	9-volt battery.
Earphone, microphone	1,000-ohm magnetic earphone.
Misc.	Pegboard; shielded phono cable; hookup wire; 4 Fahnestock clips; three 5-lug terminal strips; 4 solder lugs.



7. *ELECTRONIC EYEBALL*

Here is an amusing example of how electronics can act as a substitute for a human sense. The fellow in Fig. 7-1 (with the "other-world" eyeballs) is demonstrating a gadget that can actually "see." It works this way: First a room is completely darkened except for a single light source, either a lamp, flashlight, or a window through which outdoor light is shining. A blindfolded person wearing the device is led into the room and, with a searching movement of his head, can find the light source in minutes!

CONSTRUCTION

Assembly begins with the two "eyeballs" made from a single ping-pong ball. Carefully saw the ball in half and then cut a $\frac{1}{4}$ -inch hole in the center of each. A simple method of cutting these holes is to place each half of the ball (hollow side up) on a piece of wood and make four slits in a square with the tip of a screwdriver; then push out the square piece and file the hole into a circle. Only one of the halves receives the photocell, or light-sensing element, but holes are made in both for the sake of appearance. (See Figs. 7-2 and 7-3.)

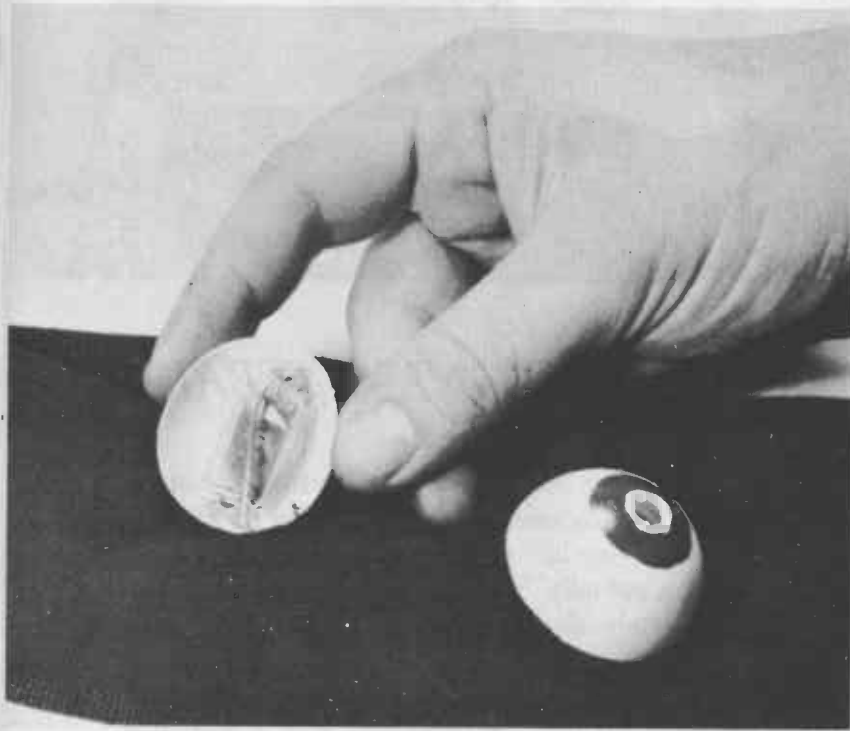

Fig. 7-2. "Eyeball" construction.

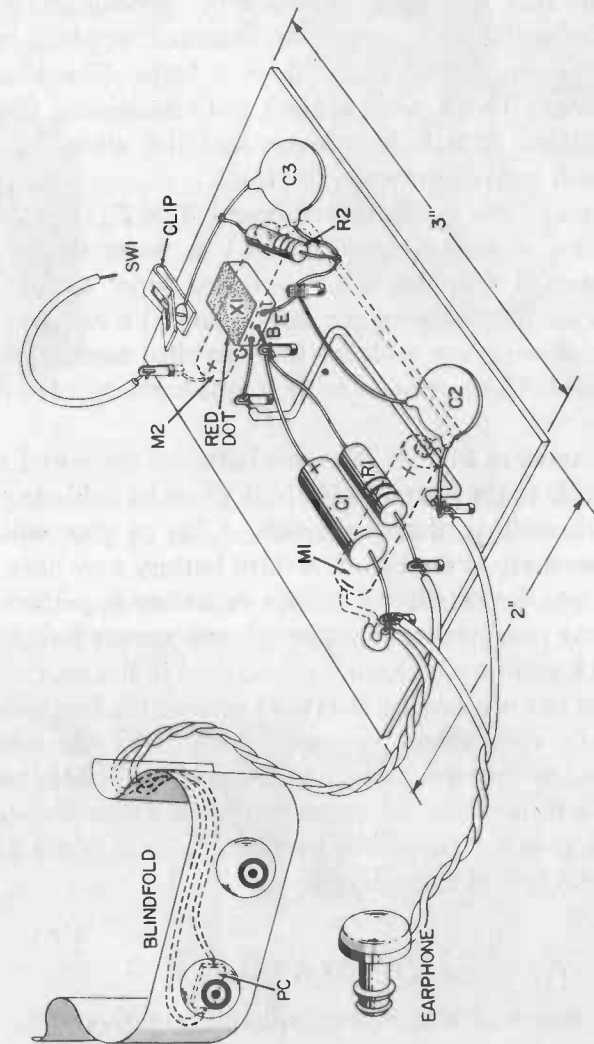

Fig. 7-3. Pictorial diagram.

The photocell is glued into one of the "eyeballs," and two flexible wires about a foot long soldered to its terminals. Be sure that light can enter the eyeball and fall on the photocell. Both "eyes" are fastened in place on the blindfold by thread or small wire loops. The blindfold itself is cut from a piece of dark cloth measuring 6" x 36". It is folded in half lengthwise and the wires from the photocell hidden between the folds.

A small piece of perforated board, 3" x 2", serves as the electronic chassis. (See Fig. 7-4.) A series of flea clips are inserted into the board holes to serve as mounting points for the components; notice how the earphone and photocell wires are soldered to three clips near one end of the board. The earphone cable is approximately ten inches long.

As shown in Fig. 7-5, the two batteries are wired to the underside of the board and held in place by soldering their leads directly to their terminals. A bit of glue will hold them securely to the board. A third battery may have to be wired into the circuit to even out variations in performance from one transistor to the next. If your circuit fails to produce a tone in strong light, as described in the next section, another battery may be inserted between the first two. Just keep the connections in series; (Fig. 7-6) the negative terminal of the new battery to the positive of M1, and the positive terminal to the negative of M2. There is no on-off switch; power is turned on by sliding a wire into a Fahnestock clip bolted to the board.

OPERATION

The first trial with the completed unit should be done about six or seven feet away from a 75-watt bulb. Point the photocell to and away from the light source and listen in the earphone. As the cell lines up with the light, the

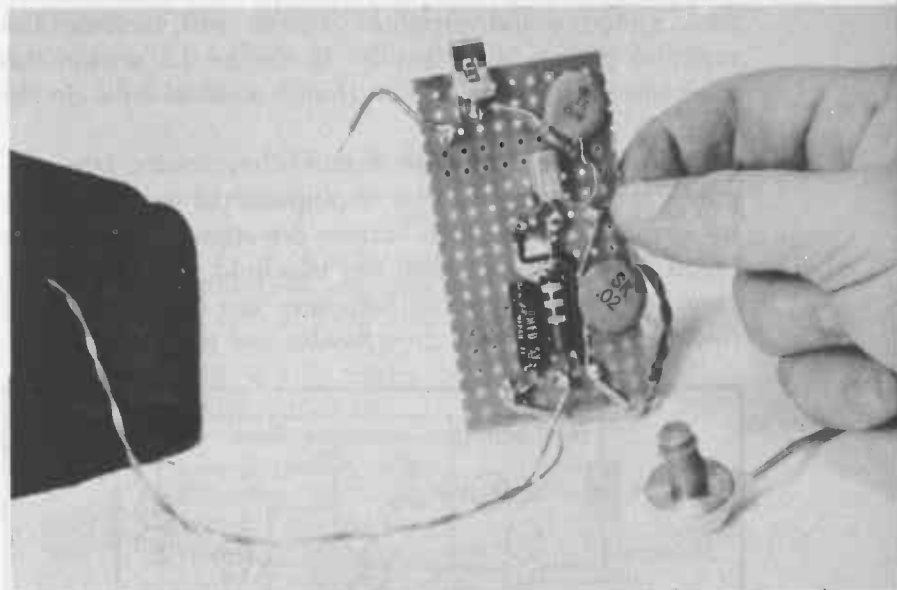
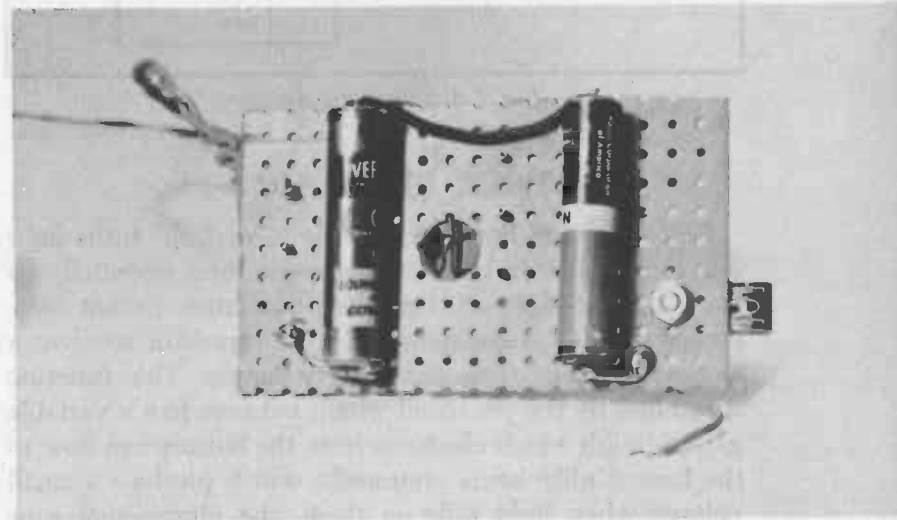

Fig. 7-4. Construction details (top view).

Fig. 7-5. Construction details (bottom view).



tone should sound. Brighter sources will increase the range of pickup considerably. In the model shown, the tone was heard about 12 feet from a window on a cloudy day.

When you are certain the circuit is functioning properly, put on the blindfold and try to pinpoint the source of light by moving your head in various directions. (The circuit board may be tucked into the blindfold, at the back of your head.) The tone can help zero you in. As you walk toward the light it will grow louder and rise in pitch.

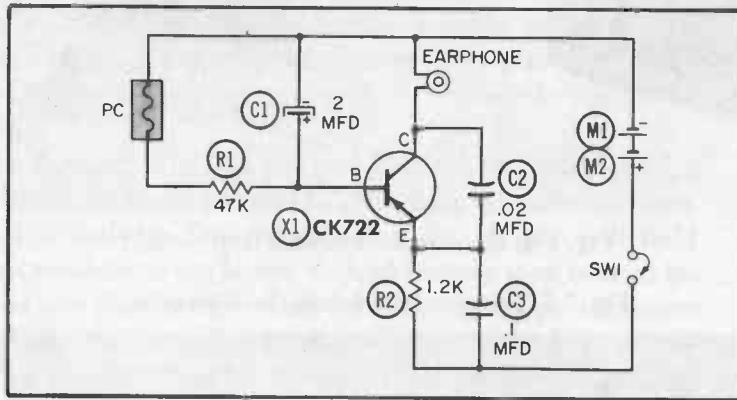

Fig. 7-6. Schematic diagram.

ABOUT THE CIRCUIT

Fig. 7-6 shows how the electronic "eyeball" turns light into tone. The transistor and earphone form essentially an audio-oscillator circuit. However, oscillation cannot commence until the base element of the transistor receives a negative voltage from the battery supply. This function is fulfilled by the photocell which behaves like a variable gate through which electrons from the battery can flow to the base. Unlike some photocells, which produce a small voltage when light falls on them, the photoresistive or

cadmium sulphide type used here exhibits a drop in internal resistance, from a high of about 1 megohm to a low of 1,500 ohms.

PARTS LIST

Item No.	Description
C1	2-mfd electrolytic capacitor, 6-volt.
C2	.02-mfd disc capacitor.
C3	0.1-mfd disc capacitor.
R1	47K, ½-watt resistor.
R2	1.2K, ½-watt resistor.
X1	CK722 transistor.
PC	Photocell, cadmium sulphide type.
M1, M2	1.5-volt penlite cells.
E	Earphone, 2000-ohm magnetic type.
SW1	Switch (see text).
Misc.	Ping-pong ball; perforated board; Fahnestock clip; flea clips; dark cloth; hookup wire.

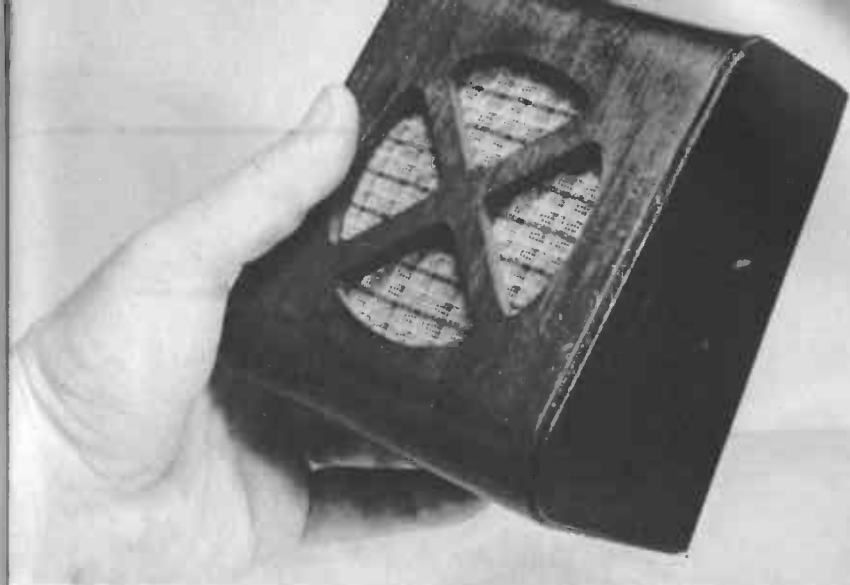

8. HOME BROADCASTER

Built inside the cabinet of the small speaker shown in Fig. 8-1 is a miniature broadcast station that can provide hours of entertainment for kids as well as adults. Talk into the speaker and radio waves carry your voice to any nearby AM radio. It's just the thing for the amateur disc jockey, and a novel surprise for visiting friends. Turn on a radio and leave the room, then start talking into the gadget. By mentioning some familiar names "on the air," you're sure to get a surprised reaction from your listeners.

The range of the broadcaster is about twenty or thirty feet. Although power is extremely low, there's enough to penetrate walls or to travel between floors. It's completely portable and may be used outdoors to transmit to a car radio.

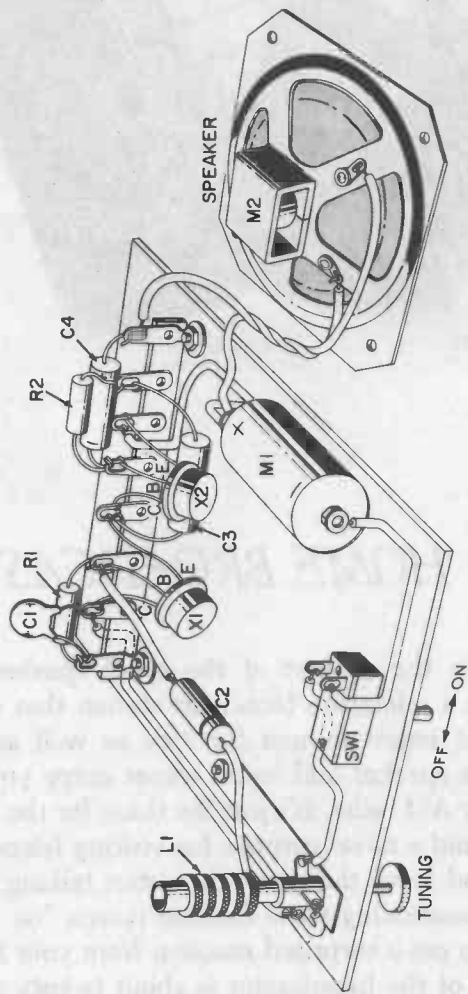

Fig. 8-2. Pictorial diagram.

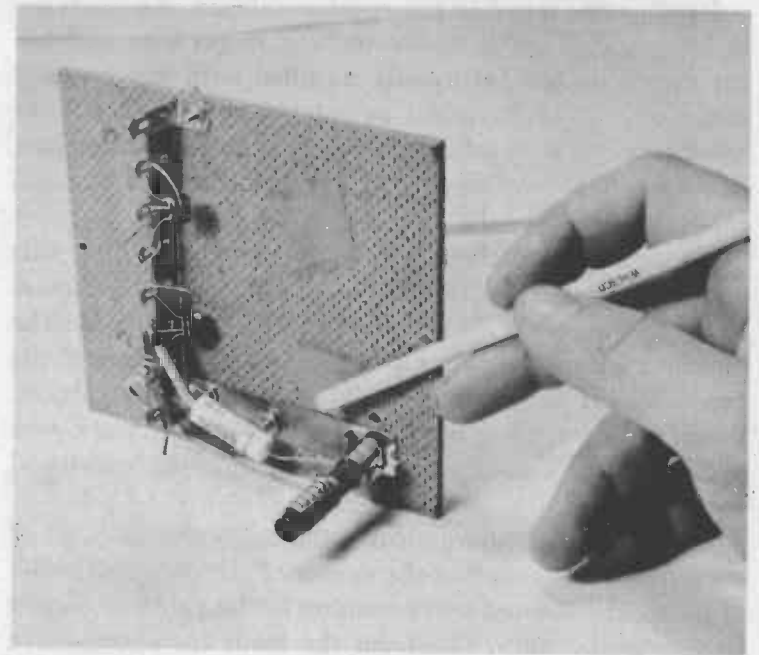

Fig. 8-3. Mounting the coil.

CONSTRUCTION

In the unit shown, all parts are housed in a small speaker case (including the original speaker, which acts as a microphone). Any homemade enclosure will do as long as it is not made of metal. And any permanent-magnet speaker that can produce sound may be pressed into service as the microphone. The old field-coil type speaker won't work—it needs a power source.

Whatever you choose as the chassis (a piece of hard-board is ideal), lay out the components as suggested in Fig. 8-2. If need be, you may shift them around to fit your space requirement. The following step-by-step instructions describe the model shown here.

Remove the panel of the speaker cabinet; the parts are to be mounted on its inside surface. Begin with coil L1; the mounting bracket usually supplied with it is screwed near one edge of the panel, as pointed out in Fig. 8-3. An 8-lug terminal strip is fastened at the same time. As shown, one mounting foot of the strip and one end of the coil bracket are held by the same nut and bolt.

It's important to check the clearance between the parts and the rear of the speaker beforehand. Fig. 8-4 indicates the position of the speaker frame. This accounts for the various components being laid out along the edges of the panel. When the panel is finally fastened to the cabinet, there will be a clear area for the speaker. Arrange your parts so there is no obstruction when the unit is fastened together.

Fig. 8-5 reveals more clearly the edge arrangement of components. Notice that the center of the panel is devoid of parts. The twisted wires running to the cabinet connect to the speaker lugs. Don't cut the leads too short; leave enough so the panel can be removed from the cabinet without strain.

Most parts are soldered to each of the eight lugs on the terminal strip. Drill several small holes for nuts and bolts, plus two large enough for the shaft of tuning coil L1 and the on-off switch (Fig. 8-6). The battery is glued into place, or held by a metal strap—a good idea if the unit is likely to be handled roughly.

OPERATION

After checking the wiring, replace the panel. A table radio should be within three or four feet of the broadcaster during this initial trial. Tune it to a dead spot in the vicinity of 500 to 700 kc and leave the volume control at its normal listening position.

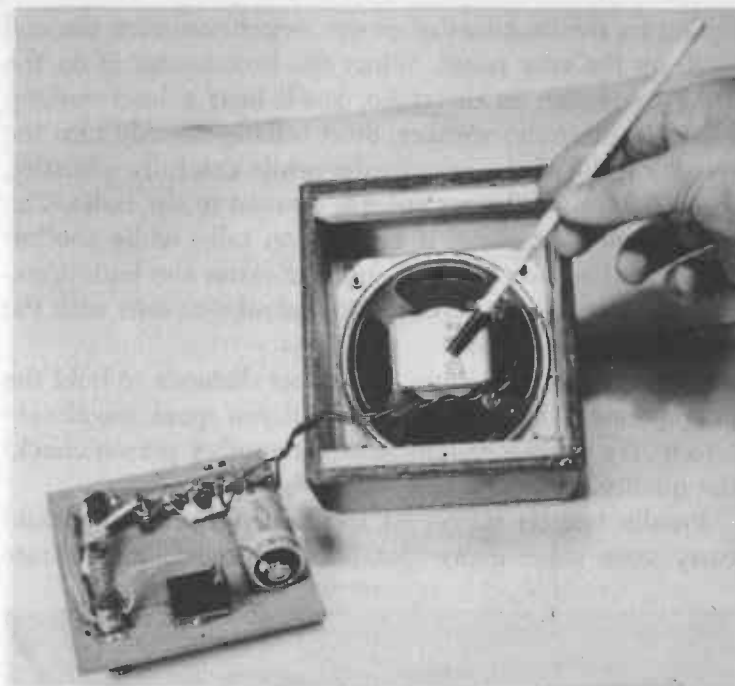

Fig. 8-4. Speaker position.

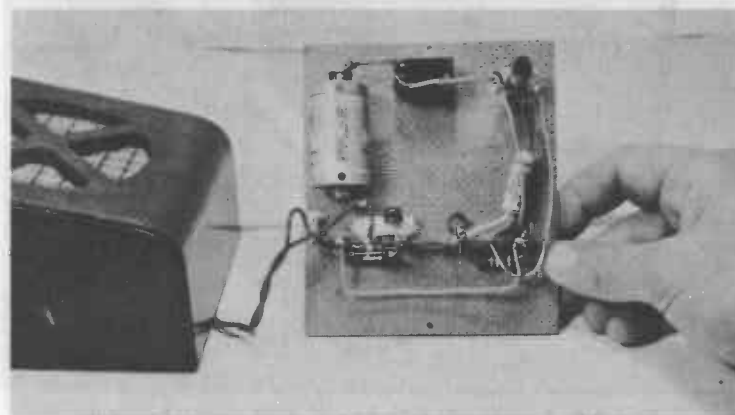

Fig. 8-5. Component arrangement.

Flip on the broadcaster power switch and turn the coil knob on the rear panel. When the broadcaster is on the same frequency as the radio, you'll hear a loud rushing sound in the radio speaker. Start talking directly into the speaker grille of the broadcaster while carefully adjusting the coil knob until your voice is clearest in the radio. The job is somewhat easier if one person talks while another listens and adjusts for voice quality. After the basic tune-up, you'll be able to make additional adjustments with the tuning dial on the radio.

The final step is finding the proper distance to hold the microphone. Distortion can result if you speak too closely into it. Try various distances, while another person checks the quality.

Finally test its range. As mentioned earlier, it should carry your voice many feet between rooms or separate

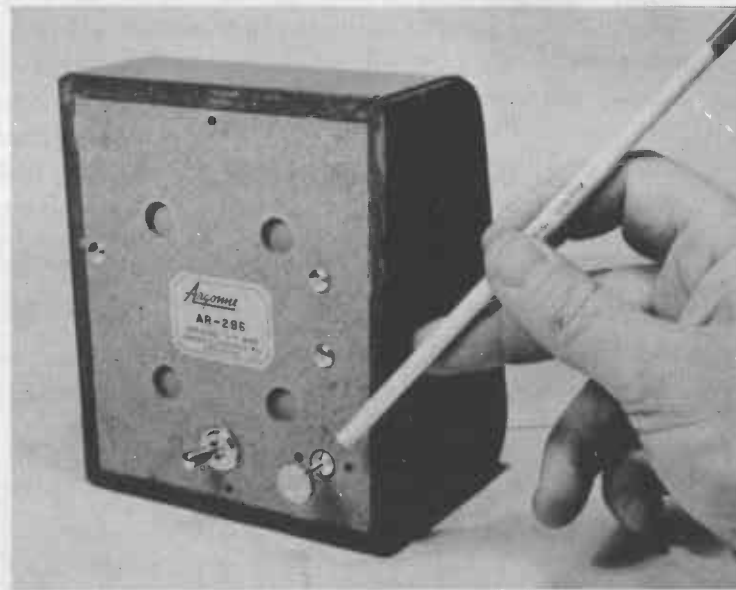

Fig. 8-6. Location of coil knob and control switch.

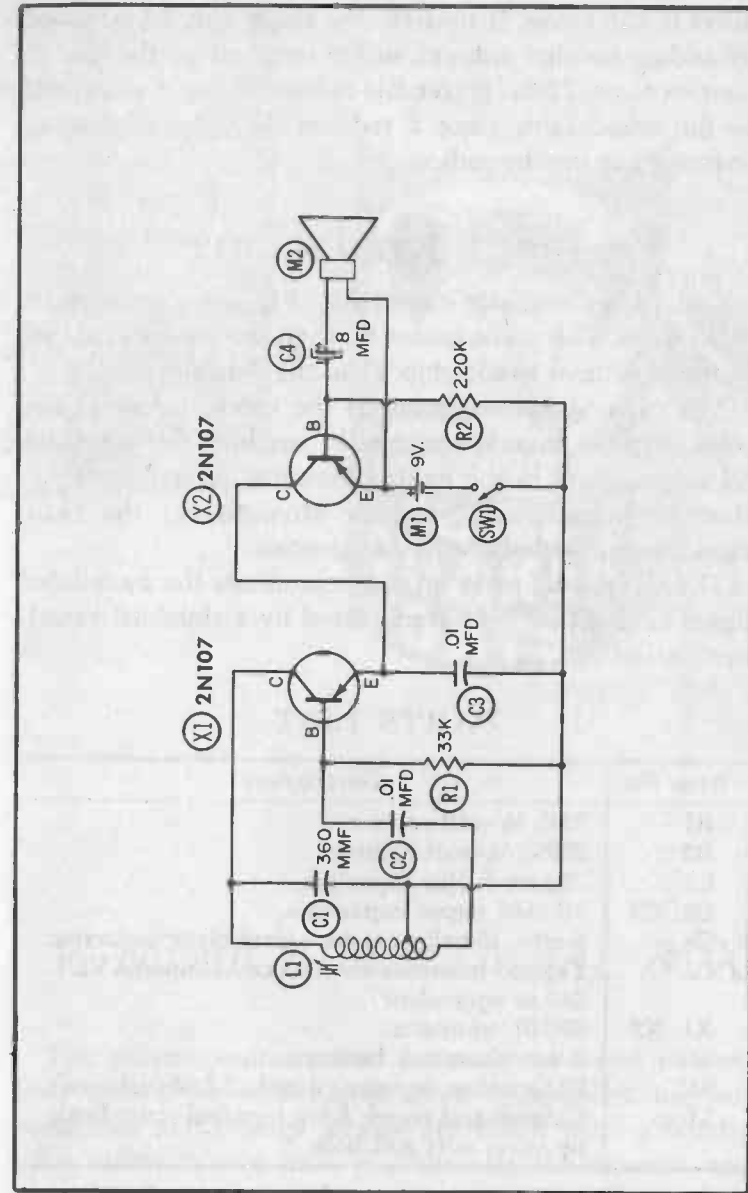

Fig. 8-7. Schematic diagram.

floors in the home. If desired, the range can be extended by adding another antenna to the terminal on the rear of your receiver. This is preferable to lengthening the antenna on the broadcaster, since it reduces the possibility of interference in nearby radios.

ABOUT THE CIRCUIT

Coil L1, in oscillator circuit X1 (Fig. 8-7), generates a radio wave. This wave passes through the wooden cabinet (a metal cabinet would stop it) to the outside.

The voice signal originates at the speaker. Audio (i.e., voice) signals from it are greatly amplified by transistor X2 and applied to the emitter terminal of transistor X1. Here they modulate (vary the strength of) the radio signal in step with the voice frequencies.

The table radio picks up and reproduces the modulated signal as if it had been transmitted by a standard broadcast station.

PARTS LIST

Item No.	Description
R1	33K, 1/2-watt resistor.
R2	220K, 1/2-watt resistor.
C1	360-mmf disc capacitor.
C2, C3	.01-mfd paper capacitors.
C4	8-mfd, 15-volt miniature electrolytic capacitor.
L1	Tapped transistor antenna coil (Suprex VLT-240 or equivalent).
X1, X2	2N107 transistor.
M1	9-volt transistor battery.
M2	PM speaker, any size (4-inch, 3.2-ohm shown).
Misc.	Cabinet and panel; 8-lug terminal strip; hook-up wire; nuts and bolts.



9. MUSICAL OATMEAL BOX

This project ventures into the realm of weird musical instruments. Wave your hand at an innocent-looking oatmeal box, and strange sounds are heard from a nearby table radio! With a little practice you, the maestro, can actually play tunes and mystify onlookers. Never does your hand leave your body! . . . or touch anything but the

air surrounding the jolly character pictured on the box in Fig. 9-1.

As you become a more accomplished musician, you'll be able to play requests from the audience or even generate the eerie sounds of a science-fiction movie. Much of the fun is in watching the quizzical look of friends or family as they try to decide whether you're mad, a genius, or a combination of both.

CONSTRUCTION

Take an oatmeal box, hold the on-off switch against the side, and outline its mounting holes in pencil. Cut out the shape (Fig. 9-2) with a razor or other sharp instrument, then puncture two holes for the nuts and bolts that hold the switch in place. Attach the switch with its two terminals near the top mounting screw of the switch (once the switch is in position). This is done so the power goes on when the switch handle is thrown upward.

Connect two leads to the battery, (Fig. 9-2 and 9-3) by soldering to the terminals directly or by using matching battery clips. Then apply glue to the bottom of the battery and press it to the bottom of the box (Fig. 9-4).

Fasten trimmer capacitor C1 to the box by making small slits in the box and pushing the capacitor into them. Dab some glue on loop coil L1 (Fig. 9-5) and hold it to the inside of the box until it remains firmly in place.

Now solder 8-inch lengths of hookup wire to the components within the box. The loop has its own leads. If they are too short, unravel them so they extend about five inches.

The box is now put aside while the circuit board is wired. Cut the perforated board to the dimensions given in Fig. 9-2, and thread in the leads of the various components. Coil L2 will remain in place after its lugs are soldered to

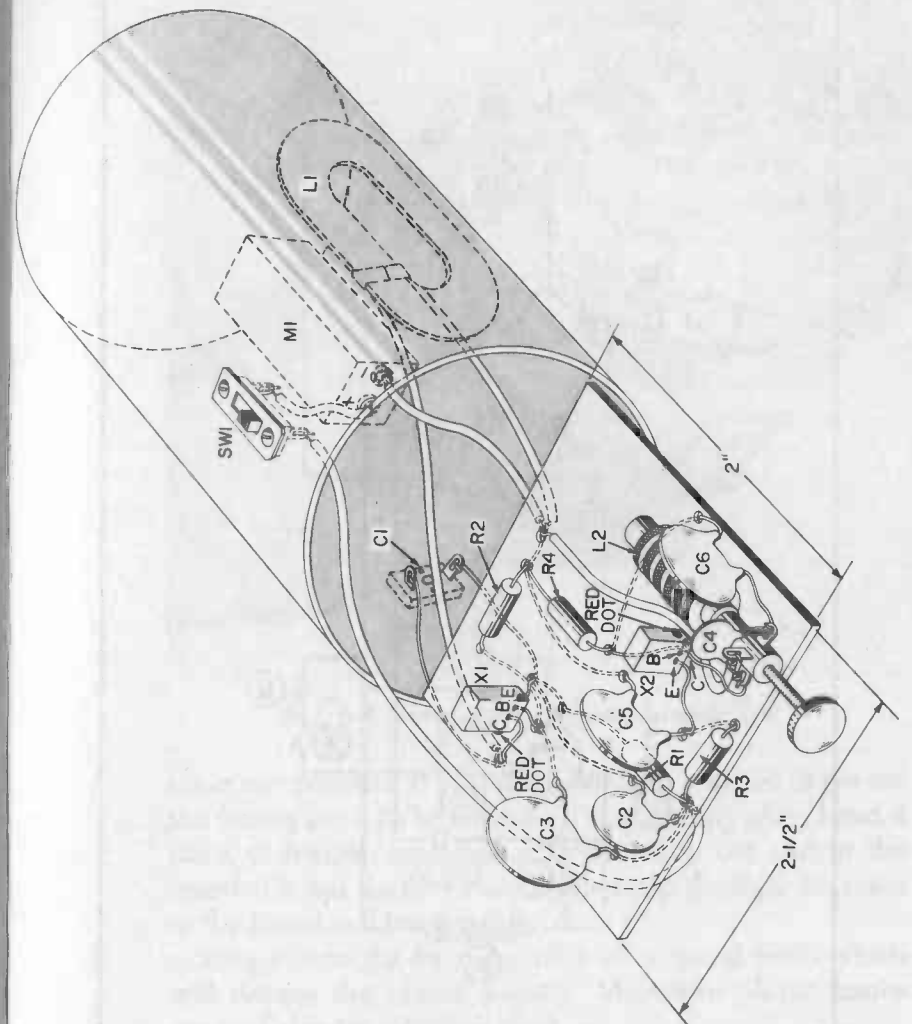

Fig. 9-2. Pictorial diagram.

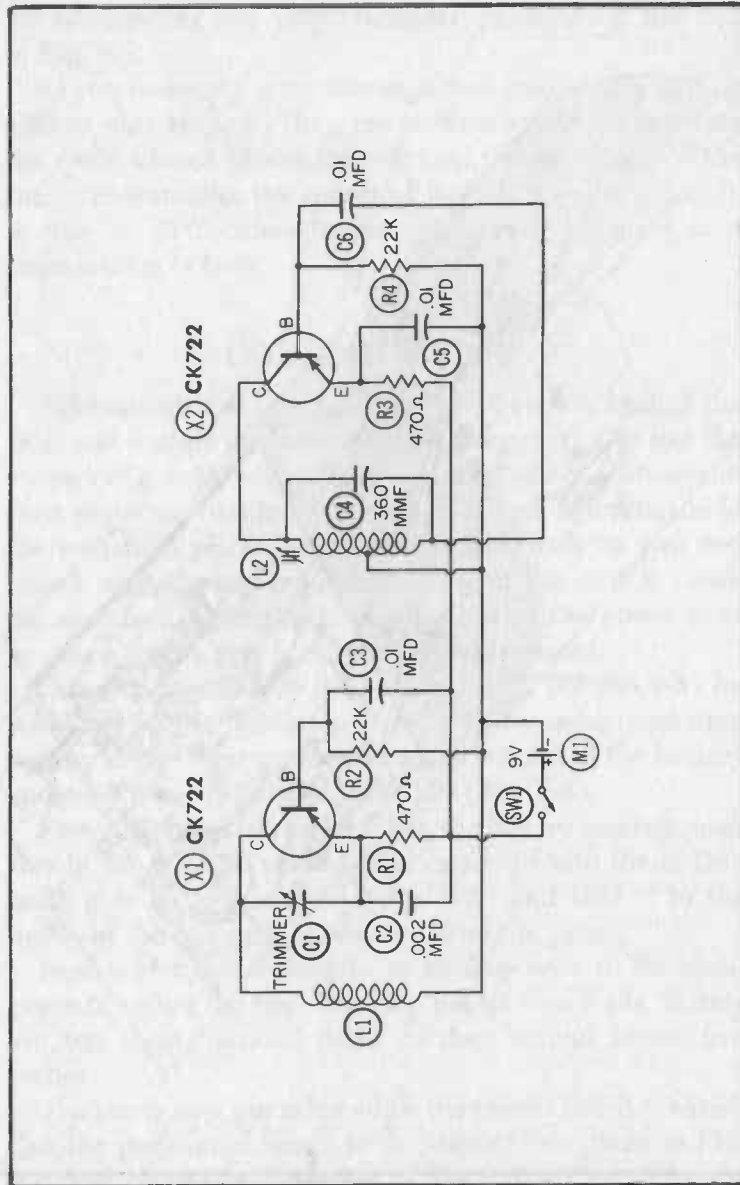

Fig. 9-3. Schematic diagram.

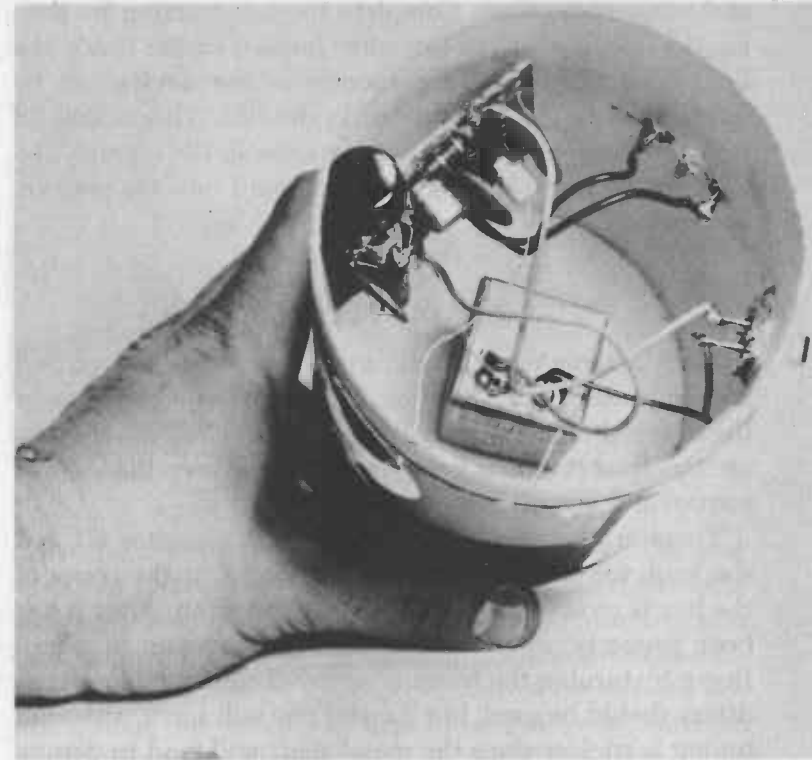

Fig. 9-4. Components mounted inside box.

other components. It must stay firmly in position to permit the tuning knob to be rotated. If there is any play, bend a piece of hookup wire into a U and strap the coil to the board. Thread the free ends of the strap through the holes in the board and twist tightly.

Your coil might be supplied with a metal knob which will detune the circuit slightly. Miniature plastic knobs are available for a 1/8-inch shaft.

Other small parts can be threaded to the board and interconnected. As shown in Fig. 9-6, there are no components on the underside of the board, just several solder joints

and wire connections. Complete the construction by joining the circuit board to the wires hooked earlier inside the box. Keep the leads long enough so the device can be operated with the board outside the box. This is helpful if you want to check for a wiring error in the circuit. The final step in assembly is gluing the board into the position shown in Fig. 9-4.

OPERATION

Place a table-model radio near the completed project and flip power switch SW1 on. The radio should be set near the low end of the dial, between 600 and 700 kc. Be sure no broadcast station is being received and keep the volume control at a normal listening level.

There are two tuning steps: trimmer capacitor C1 and the knob for coil L2. Notice in Fig. 9-4 that the cover of the box is removed to gain access to the knob. After it has been properly adjusted, the cover may remain in place. Begin by turning the trimmer screw. A nonmetallic screwdriver should be used, but a metal one will serve, although tuning is trickier since the metal shaft will tend to detune the circuit. Find the adjustment that produces a fairly strong hum in the radio speaker. It should drown out any static or background noise. Then adjust the knob of coil L2. If the hum is lost as this is done, readjust the trimmer to bring it back in. (There is some interaction between the two adjustments.) During this tune-up procedure, be sure neither hand is held near loop coil L1 hidden in the box, or you'll be unable to tune the device properly. To play it safe, grasp the box at the opposite side.

There should be a point where a loud tone is produced in the radio speaker as the knob is turned. On either side of this point, the tone should change in pitch. As the knob is rotated in one direction, the tone will be very high in



Fig. 9-5. Gluing the antenna.

pitch. As it is rotated in the opposite direction, the tone will drop to zero (known as the zero beat), then rise until no longer audible. The setting you want is near the zero beat, where the tone is very low in pitch. Some trial-and-error tuning is needed to keep the tone at the desired low pitch, since the circuit will tend to lock on zero (between the two audible points).

Now, slowly bring your open hand toward the side of the box. When it touches, it should be directly over the loop coil (mounted inside the box). As this is done, the sound in the speaker will change gradually from a low to a high pitch. You'll need practice, but with experience you'll be able to play simple tunes with a minimum of sour notes. The musical effect is greatly enhanced if your hand quivers as it moves back and forth.

If the number of tones is too limited to permit playing a complete musical selection, retuning is in order. Find the coil adjustment that makes the tone swing over the greatest range of highs and lows as your hand moves back and fourth.

ABOUT THE CIRCUIT

As illustrated in Fig. 9-3, the transistors are wired in two circuits that are quite similar in design. Each generates a radio frequency. Trimmer capacitor C1 and coil L2 are used to set each signal on nearly identical frequencies in the broadcast band. The radio picks up energy from both circuits and mixes them. If the two signals are identical, no tone is heard in the speaker (the zero-beat position). But when a slight frequency difference occurs, a tone is audible. A 1,000-cycle tone, for example, means the difference between the original radio signals is 1,000 cycles.

After the circuits have been adjusted for the lowest possible audio tone, the hand near coil L1 (the loop) alters the circuit inductance, and the output of transistor X1 changes in frequency. Since the frequency of transistor X2 remains constant, a varying audio tone is heard from the speaker.

PARTS LIST

Item No.	Description
R1, R3	470-ohm, ½-watt resistors.
R2, R4	22K, ½-watt resistors.
C1	25–280-mmf mica trimmer capacitor (Arco-Elmenco No. 464 or equivalent).
C2	.002-mfd disc capacitor.
C3, C5,	
C6	.01-mfd disc capacitors.
C4	360-mmf disc capacitor.
L1	Broadcast loop antenna, miniature type.
L2	Tapped transistor broadcast antenna coil (Superex VLT-240 or equivalent).
X1, X2	CK722 transistors.
SW1	Single-pole, single-throw slide switch.
M1	9-volt transistor battery.
Misc.	Perforated board; oatmeal box; miniature knob; hook-up wire; battery clips.

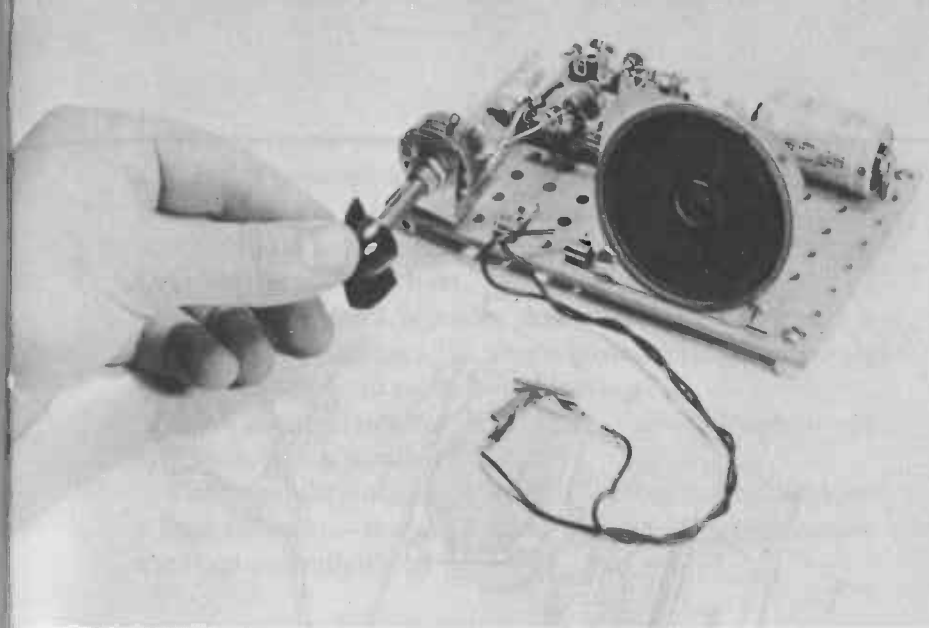

10. THE FLIP-FLOP

Millions of flip-flop circuits operate daily in today's electronic computers. They are actually electronic switches with no moving parts to wear out. Although the flip-flop finds application in highly complicated circuits, you can build and operate a single flip-flop on a piece of pegboard. In fact, you can perform at least seven separate stunts with the flip-flop shown in Fig. 10-1. Once you become familiar with this particular one, perhaps you'll be able to come up with a half-dozen more. This flip-flop is a versatile building block that lends itself to much modification.

The following projects begin with a simple tone oscillator. The flip-flop is made to generate an audio signal which can be keyed for code practice, for example. The circuit switches current to the speaker approximately 400 times per second, which falls into the range of hearing.

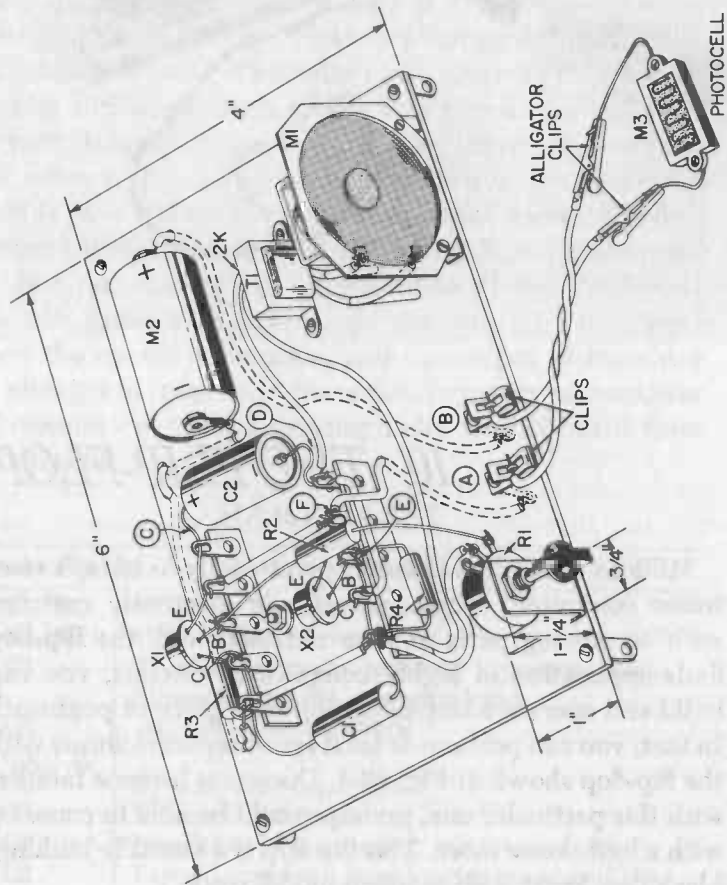

Fig. 10-2. Pictorial diagram.

Next, a minor change is made to greatly slow the flip-flop and it becomes a metronome. It will tick out a regular beat like the pendulum-type devices students use while practicing on a musical instrument. There's even a control knob for varying the beat.

When the circuit is really slowed down, it becomes a timer. The ticking sound can be adjusted to mark intervals of approximately 15 seconds and less.

Two alarm circuits—both open- and closed-circuit types—are also possible.

The capability of the flip-flop is further exemplified by a final alteration—the addition of a photocell which makes the tone controllable by light.

CONSTRUCTION

A piece of pegboard supports the components, and four small L-shaped brackets serve as legs. The bottom of the board should stand about one-half inch above the table top after the legs are fastened. Two similar brackets are attached to the speaker frame so it may be mounted as shown in Figs. 10-2 and 10-3.

Notice in Fig. 10-1 that potentiometer R1 is mounted on a large bracket. Be sure the three lugs on the potentiometer face the center line of the board. Then two terminal strips are bolted on and Fahnestock clips fastened to the front edge at points A and B in Fig. 10-2. Before screwing the clips in place, mount the two solder lugs on the screws underneath the board. This makes a convenient solder point for the connecting wires.

After these parts are secure, wire the circuit. As shown in Fig. 10-4, few leads are run along the bottom of the board, but several connections are made there.

Matching clips hold the battery in place. First solder leads to the clips, insert them into one of the holes on the

board, and push the clips onto the battery terminals. Threading these wires in and out of the holes will help hold the battery in place.

You'll need small screws and nuts for the miniature audio transformer, T1. Notice in Fig. 10-2 that the transformer primary (2K side) has two wires which connect into the main circuit on the board. The other two leads (voice-coil side) are soldered to the speaker lugs.

After a checkout for proper connections from the transistors and for correct polarity of electrolytic capacitor C2, the flip-flop is ready for service. Note that capacitor C3 appears in Fig. 10-5 but not in Fig. 10-2. It is an optional unit used with the timer and is described in a later section.

OPERATION

Turn the potentiometer knob fully counterclockwise and connect a pair of leads (the ones with alligator clips soldered to one end) to clips A and B. Touching the two clips together (Fig. 10-3) should produce a steady tone in the speaker. Notice that the tone may be rapidly turned on and off by making and breaking contact with the clips. This is the code-oscillator function of the flip-flop. If you want to use it this way, simply connect the clips to a code key.

There is no power switch in the circuit. Whenever the unit is not in use, snap the alligator clips along the edge of the board so they do not make contact with each other.

Next you might want to try out the circuit as an open-circuit alarm, where the tone will sound in the speaker when a connecting wire is broken. If the circuit were protecting a door or window, for example, a very thin, easily breakable connecting wire would be used. It can be tacked in place across the area to be protected. (The alarm is checked out on a table by placing a single wire across

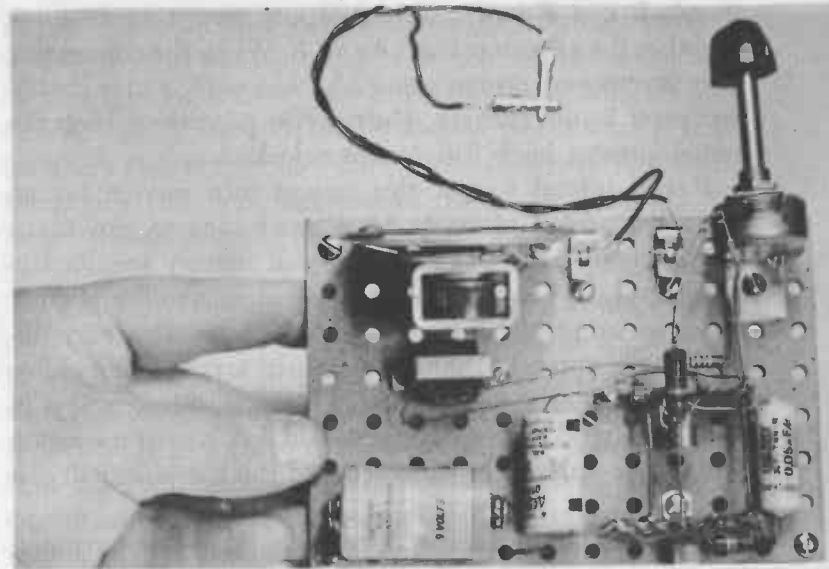
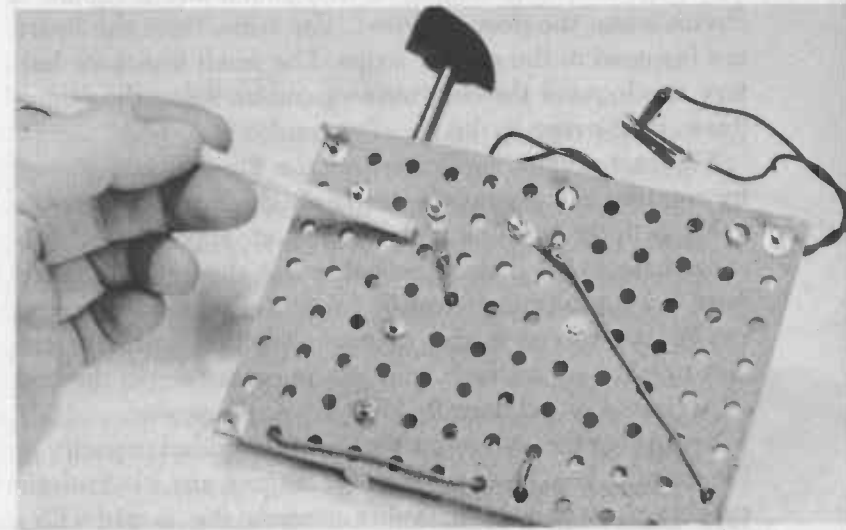

Fig. 10-3. Showing components mounted.

Fig. 10-4. Underside of board.



points *E* and *F* in Fig. 10-2.) Apply power by clipping together the alligators from *A* and *B*. When the connecting wire is removed, representing a broken wire, a tone should be heard in the speaker. During this procedure keep the potentiometer knob fully counterclockwise.

If you intend to put this circuit into service for an extended period of time, it's a good idea to provide a heavier power source than the 9-volt battery specified in the Parts List. Though the unit is silent on standby (before the connecting wire is broken), it still draws about 2 milliamperes of current. A more permanent arrangement is five 1.5-volt cells (the kind used for home buzzers) wired in series. Only 7.5 volts will be supplied, but circuit operation will not be appreciably affected and the batteries will last far longer.

The closed-circuit alarm operates in the reverse manner, sounding a tone when the two wires from *A* and *B* make contact. Let's say you want to be warned when a door is closed. Two copper strips can be fastened, one to the door, and the other to its frame, so they touch and complete a circuit when the door is closed. The wires from the board are fastened to the copper strips. The small transistor battery is adequate for long-term operation since the circuit draws no current in the standby condition.

The metronome application of the flip-flop is achieved by rotating the potentiometer knob clockwise. When the knob is fully open, a tick sounds at approximately 1-second intervals. This is probably the slowest rate you'd need for establishing a music beat. Faster rates occur as the knob is turned in the opposite direction, until the circuit breaks into a steady tone. As in earlier steps, the two clips from *A* and *B* must be joined to apply power.

Setting up the unit as a timer calls for added capacity in the circuit. You have a choice of almost any electrolytic capacitor, as long as its value exceeds the 4 mfd (*C2*)

already wired in. The new capacitor, (*C3* in Fig. 10-5) is soldered across points *C* and *D* on the board. In this flip-flop, the timing pulses were 8 seconds apart with 25 mfd added, and 16 seconds for a 50-mfd capacitor. In both instances the potentiometer was fully clockwise. The additional capacitor only determines the longest interval between pulses; you still have the potentiometer for varying their rate.

Another interesting use of the flip-flop is in controlling its tone by light. The photocell (*M3* in Fig. 10-5) is of the photoresistive type, which changes resistance when light waves of varying intensities strike it. (Don't use the other type which generates voltage.) Turn the potentiometer fully counterclockwise so the flip-flop is set to produce a steady tone. Then insert the photocell across points *A* and *B* with the aid of alligator clips. By waving your hand or a flashlight over the photocell, you'll find that you can hear the tone when bright light falls on the sensitive surface of the cell. It may not be as loud as in earlier projects, but this is normal.

ABOUT THE CIRCUIT

The flip-flop operates like an electronic "seesaw." In Fig. 10-5, a pulse of current travels through transistor *X1*, is amplified, and passes on to *X2*, producing a click in the speaker. But notice that part of the current can return to *X1* through capacitor *C2*. This allows a second pulse to pass over the same path, and the action is repeated. The energy to the speaker is continuous, since the pulses are amplified as they are applied to the transistor bases. A steady tone indicates the pulses are making approximately 400 trips, or cycles, per second.

In the code-oscillator application, a key across points *A* and *B* is depressed to close the power-supply circuit and

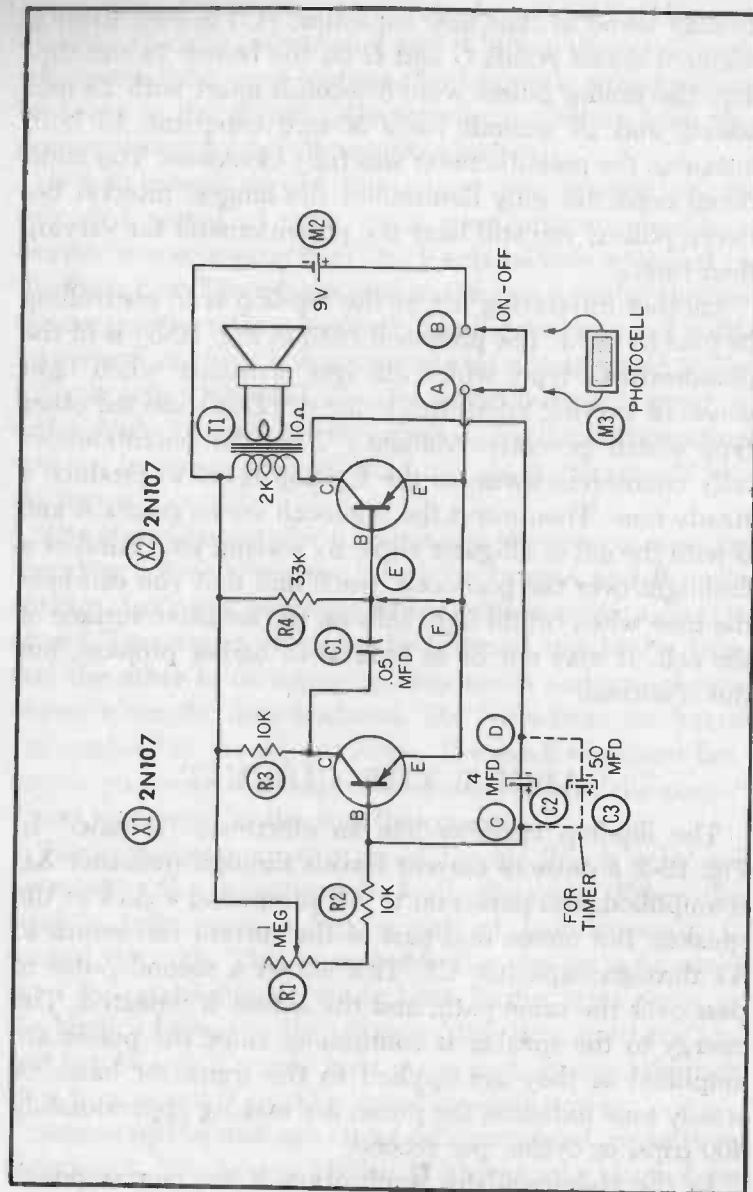

Fig. 10-5. Schematic diagram.

thereby sound a tone. When the key is raised, power from the battery is cut off and no tone is heard.

The metronome and timer operate by slowing the pulse rate. The metronome depends on the variable resistance provided by the potentiometer and C2, which both delay the pulse signal. The timer requires the addition of capacitor C3 for a longer delay.

The open-circuit alarm is a variation of the code-oscillator idea; instead of a key, the connecting wire controls the battery power source. The closed-circuit version uses a different principle. A wire across E and F prevents the pulse from traveling from X1 to X2. When the wire is broken, normal flip-flop action resumes and the tone again sounds.

The last project, using light control, relies on the ability of the photocell to change resistance with illumination. Notice in Fig. 10-5 that it is in series with the positive battery lead. In subdued light, the cell resistance is too high and the battery current too small to permit flip-flop action. However, strong light rays lower the resistance of the photocell sufficiently for current to flow and thus produce a tone.

PARTS LIST

Item No.	Description
R1	1-megohm potentiometer, carbon type.
R2, R3	33K, ½-watt resistors.
C1	.05-mfd paper tubular capacitor.
C2	4-mfd electrolytic capacitor, 15 volts or higher.
C3	50-mfd electrolytic capacitor, 15 volts or higher (see text).
X1, X2	2N107 transistors.
M1	2½-inch speaker; 3.2- or 10-ohm voice coil.
M2	9-volt transistor battery.
M3	Photocell, cadmium-sulphide type.

(Parts List Continued)

Item No.	Description
T1	Audio output transformer, miniature transistor type; 2K to 3.2- or 10-ohm voice coil.
Misc.	Pegboard, 6" × 4"; L-bracket for pot, 1" × 3/4" × 1 1/4"; 2 alligator clips; 2 Fahnestock clips; 2 battery clips; two 5-lug terminal strips; four small L-brackets for legs; knob for 1/4-inch shaft.

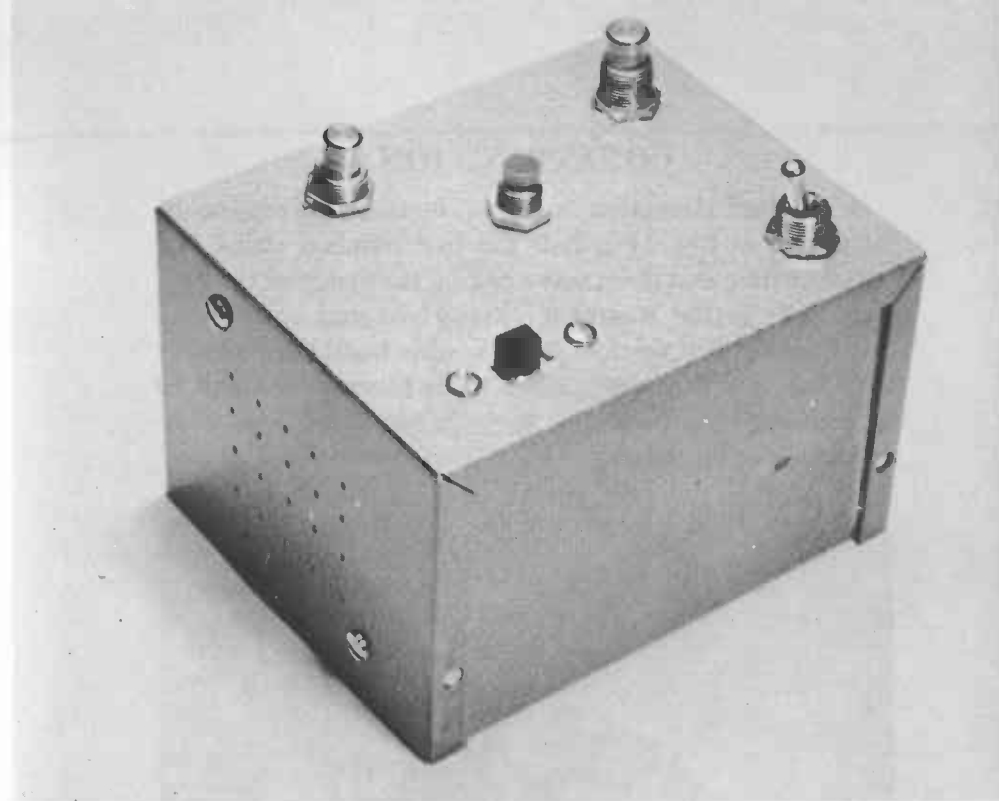

II. TODDLER'S TOOTER

Pushing buttons and flipping levers seem to have a strange fascination for the toddler set. With the gadget shown in Fig. 11-1, they can play to their heart's content. As they push the buttons mounted on its top panel, an unending series of tones is emitted from a speaker inside the box. Not only are there five separate "toots," but dozens of different tones can be produced from the different switch combinations.

CONSTRUCTION

A standard aluminum "minibox" houses all components. As shown in Fig. 11-2, bolt the two terminal strips, the on-off switch, and the transformer on the inside of the box. Next wire in the transistor (Fig. 11-3) and other small parts, and attach the four long, flexible leads that connect both halves of the box together. Make these wires about 10 inches long so the box may be easily separated later without unsoldering connections.

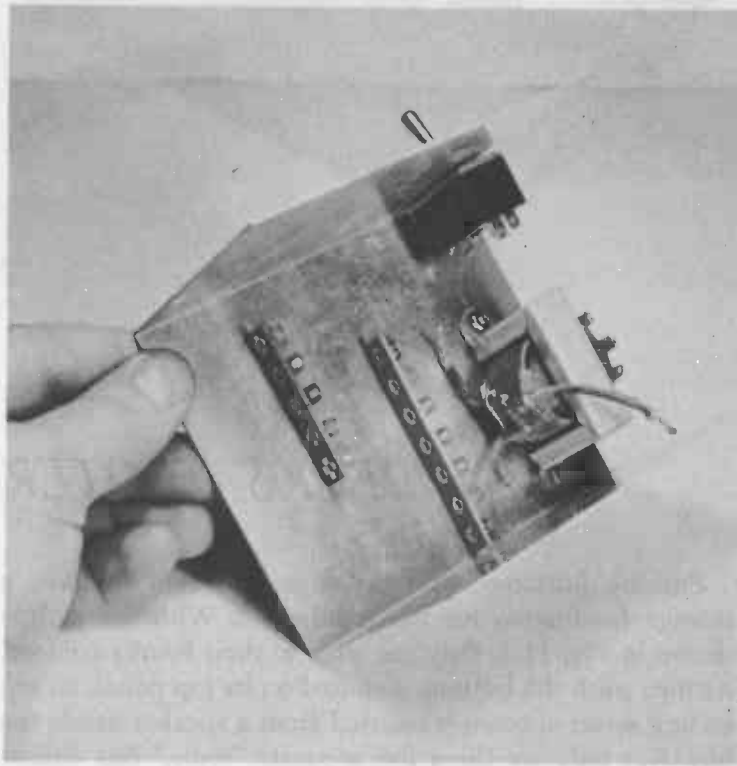

Fig. 11-2. Mounting the terminal strips, switch, and transformer.

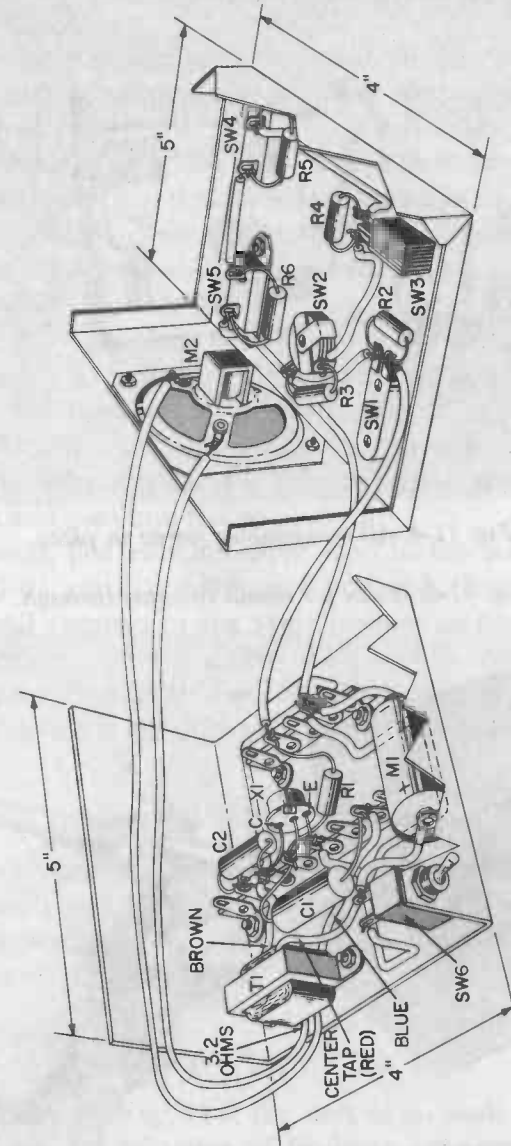

Fig. 11-3. Pictorial diagram.

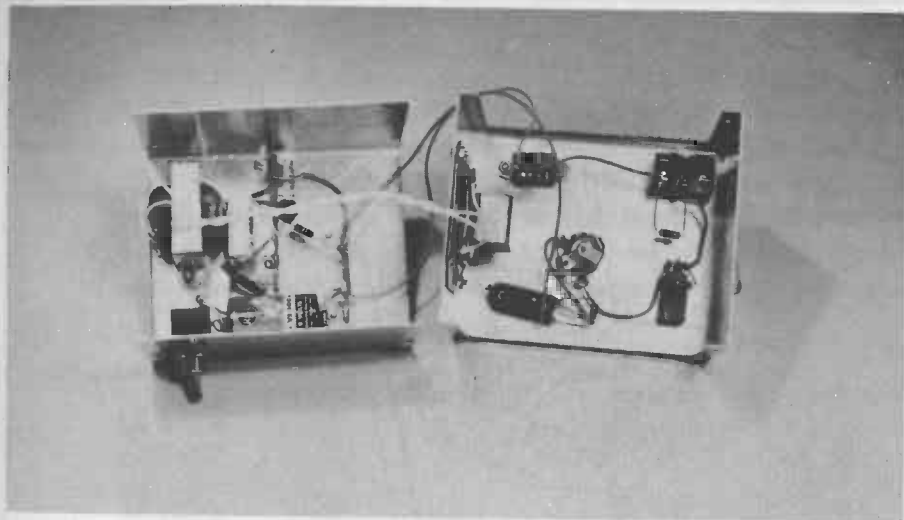
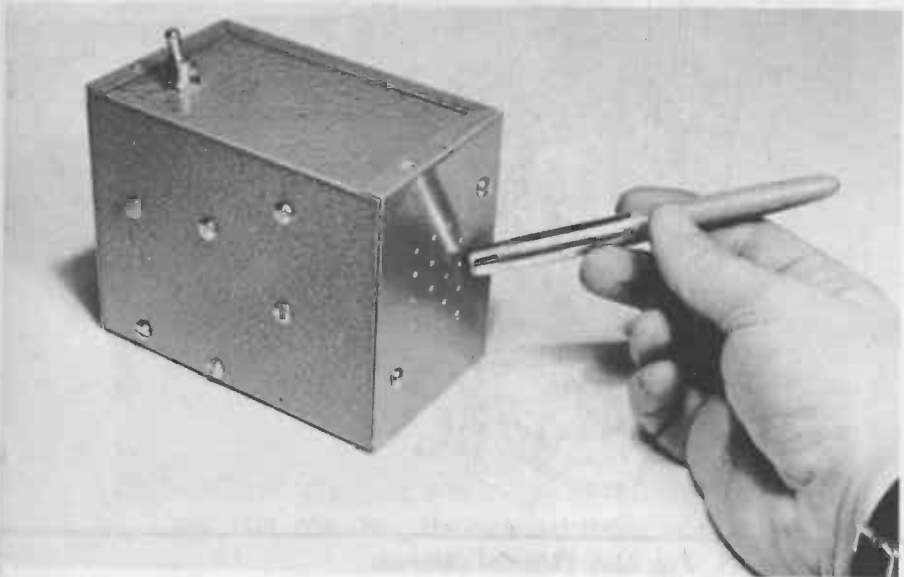

Fig. 11-4. All components wired in place.

Fig. 11-5. Holes for sound to come through.



T1 can be almost any push-pull audio-output transformer; it need not be the kind used for transistor circuits. Its primary winding has three leads, usually color-coded red, blue, and brown; and these are connected as shown in Fig. 11-3. The rating for this side of the transformer may be any value from 4,000 to about 8,000 ohms; while the secondary winding, which is connected to the speaker, must be 3.2 ohms. However, if you use a 10-ohm speaker, as in the original model, the mismatch will not significantly affect circuit performance.

The major components in the other half of the box are the switches and speaker (Fig. 11-4). Before mounting the speaker to the side panel, drill a series of small holes as shown in Fig. 11-5 so the sound may reach the outside. Keep the holes small so the kids can't poke anything into the box and puncture the speaker.

Although five switches were used in the original unit (Fig. 11-6), you may add more if you wish. Simply connect additional resistors in the same manner as the first five. Any resistor between 1,000 ohms and 1 megohm will change the tone as its associated button is pressed. The type of switch is not critical either.

OPERATION

Turn on power switch SW6 and try all the switches. You should hear a number of tones. Notice that their complete register, or range, will change if any switch is held down as others are pressed.

ABOUT THE CIRCUIT

As shown in Fig. 11-6 the unit is an audio oscillator which operates by virtue of feedback between the transistor collector and base. The output signal is fed to the

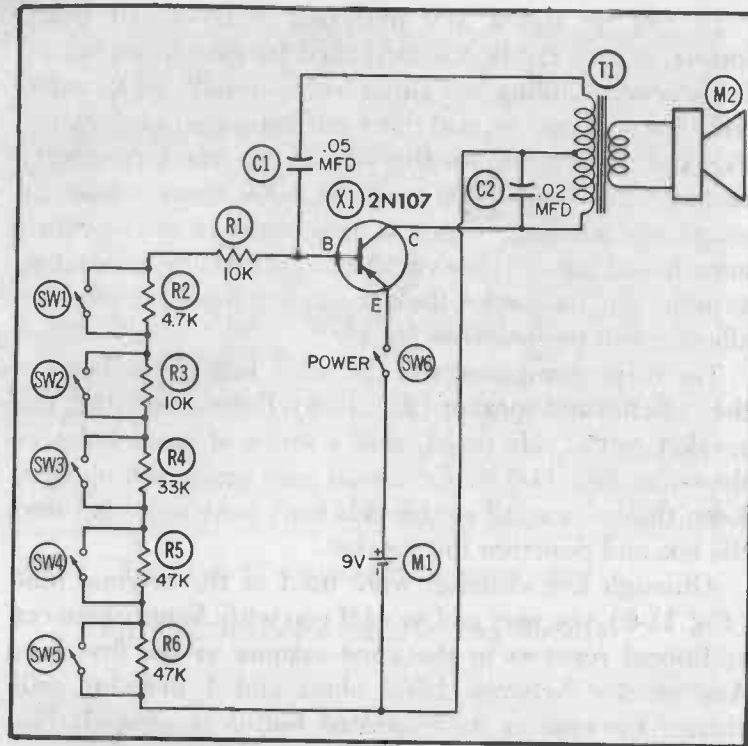

Fig. 11-6. Schematic diagram.

base through capacitor C1, and a steady tone is heard from the speaker. The frequency of the signal is controlled by switching resistors in and out of the base circuit. As SW1 through SW5 are closed in different combinations, the time constant of the circuit—and thus its frequency—is varied. Resistor R1 is in series with the base to protect the transistor from overload. Even if all the switches were to short, R1 would limit the current that flows from the negative battery terminal to the base element.

(See page 97 for Parts List)

PARTS LIST

Item	Description
R1	10K, ½-watt resistor.
R2	4.7K, ½-watt resistor.
R3	10K, ½-watt resistor.
R4	33K, ½-watt resistor.
R5, R6	47K, ½-watt resistor.
C1	.05-mfd paper capacitor.
C2	.02-mfd paper capacitor.
X1	2N107 transistor.
T1	Push-pull audio-output transformer (see text).
M1	9-volt transistor battery.
M2	Speaker, 2½-inch.
SW1 through SW5	Any type of SPST switch (push button, slide, toggle, etc.)
SW6	SPST toggle switch.
Misc.	Aluminum box 5" × 4" × 3"; one 7-lug terminal strip; one 5-lug terminal strip; hookup wire.

PARTS LIST

Description	Item
10K, 1/2-watt resistor.	R1
47K, 1/2-watt resistor.	R2
10K, 1/2-watt resistor.	R3
33K, 1/2-watt resistor.	R4
47K, 1/2-watt resistor.	R5, R6
.05-mfd paper capacitor.	C1
.02-mfd paper capacitor.	C2
2N107 transistor.	X1
Push-pull audio-output transformer (see text).	T1
9-volt transistor battery.	M1
Speaker, 2 1/2-inch.	M2
Any type of SPST switch (push button, slide toggle, etc.)	SW1
SPST toggle switch.	SW2
Aluminum box 5" x 4" x 3"; one 7-lug terminal strip; one 2-lug terminal strip; hookup wire.	Misc.

ies can be reduced by using a smaller speaker and battery. No matter what instructions given here are only suggestions, since the dimensions are almost certain to vary from clock to clock. Fig. 12-1 shows radio is tunable and has an on-off switch. Fig. 12-1 shows the tuning knob located behind the face of the clock being turned by hand.

The first step is to cut a piece of board (Fig. 12-2) to the general outline of the rear surface. (This turned out to be 3" x 3 1/2" in the original model.) Next, mount the speaker with two screws and nuts. The coil-mounting bracket, which should be supplied with the coil, is held to the board by one of the screws that holds the



12 THE RADIO CLOCK

Unlike the usual approach where a clock is built into a radio, the radio in this project is assembled within a clock. The result greatly extends the function of the kitchen timepiece. From its position on the wall the clock not only gives the time of day, but entertains as well.

The radio section consists of a 3-transistor circuit, which delivers adequate volume on strong local stations. No attempt was made to miniaturize the project so the clock must be about 3 1/2 inches or more in diameter. However, if you wish to use a smaller clock, the size of the electron-

ics can be reduced by using a smaller speaker and battery. No matter what you decide to use, the instructions given here are only suggestions, since the dimensions are almost certain to vary from clock to clock. The completed "clock" radio is tunable and has an on-off switch. Fig. 12-1 shows the tuning knob, located behind the face of the clock, being turned by hand.

CONSTRUCTION

The first step is to cut a piece of perforated board (Fig. 12-2) to the general outline of the clock's rear surface. (This turned out to be 3" x 3½" in the original model.) Next, mount the speaker with two screws and nuts. The coil-mounting bracket, which should be supplied with the coil, is held to the board by one of the screws that holds the

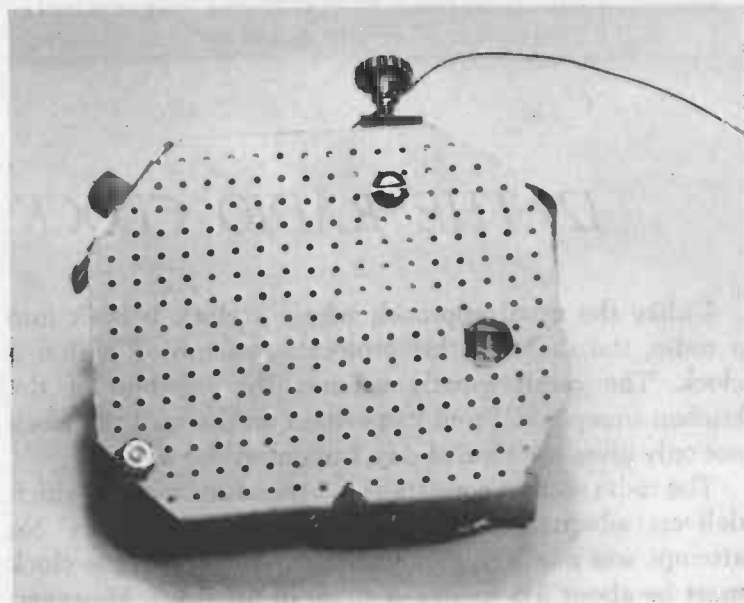

Fig. 12-2. Circuit board shape.

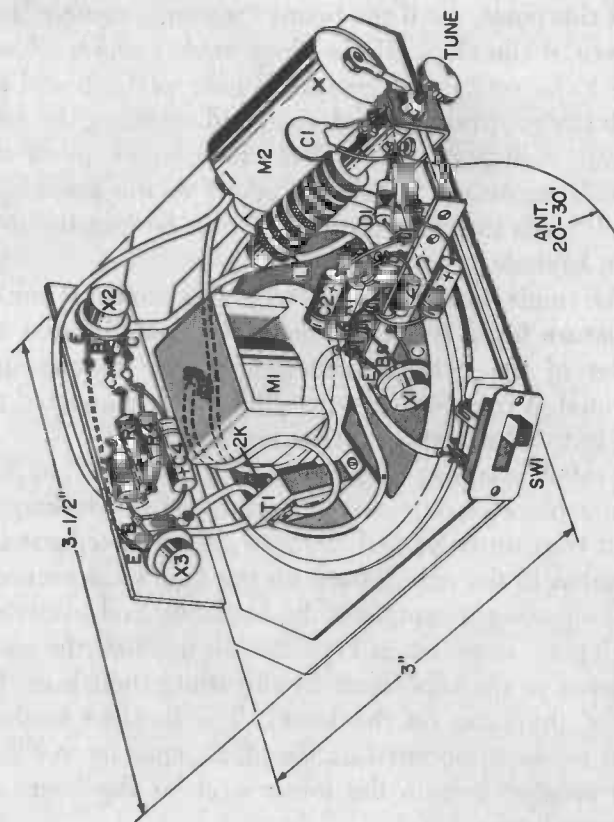

Fig. 12-3. Pictorial diagram.

speaker. The other speaker mounting screw holds one tab of transformer T1. Only a single screw is necessary because of the lightness of T1. Also fastened to the speaker is the on-off switch; it is soldered to the speaker frame in the position shown in Fig. 12-3.

At this point, see if the board fits snugly against the rear surface of the clock. If the clock knob (which allows the time to be set) interferes, cut a hole in the board so the knob can protrude through it. A lid covering the keyhole opening which permits the clock to be mounted on the wall. If necessary, notch the board so the screw or nail which holds the clock to the wall may be inserted into the clock keyhole.

The single terminal strip used in this project is one of the miniature 6-lug types. Its mounting foot, located in the center of the strip, is soldered directly to one speaker terminal. A transformer wire will also be connected to this lug, but will not affect the performance.

A subchassis (Fig. 12-4) measuring about $2\frac{1}{2}'' \times 1''$ is cut from a piece of perforated board. This subchassis, which holds transistors X2 and X3, may be wired separately and mounted to the main board during final construction.

The project is completed by installing and soldering the small parts as shown in Fig. 12-3. Notice that the parts are fastened to the subchassis by threading their leads in and out of the holes on the board. The finished model, just prior to being mounted on the clock, appears in Fig. 12-5. The long wire from the lower edge of the board is the antenna lead.

The board may be mounted to the rear of the clock in several ways. (See Fig. 12-6.) One is to fasten small metal tabs to the board by screwing them into the rear panel of the clock. Just be certain that any screws mounted to the clock itself do not touch the two AC wires from the wall outlet. Another workable system is simply to glue the

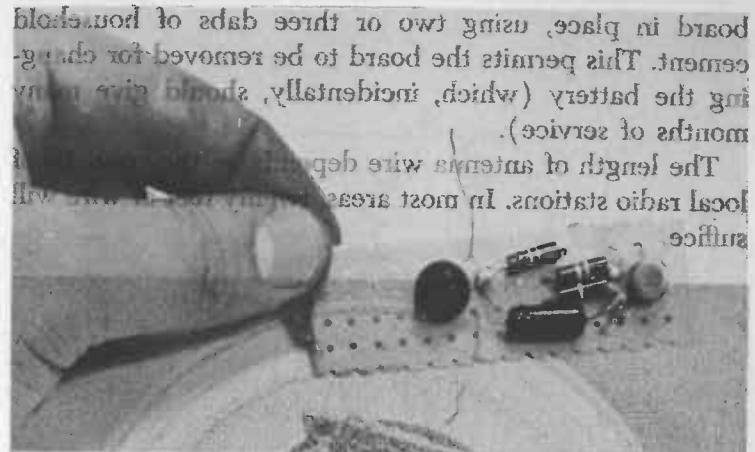

Fig. 12-4. The transistor subchassis.

Fig. 12-5. The completed circuit with antenna.



OPERATION

As shown in Fig. 12-7, the radio is powered by an on-off switch S1 and the tuning knob of T1 allows the station to be changed. There is no volume control, but the tuning knob allows you to cut the strength of the station if over-

board in place, using two or three dabs of household cement. This permits the board to be removed for changing the battery (which, incidentally, should give many months of service).

The length of antenna wire depends on the strength of local radio stations. In most areas, twenty feet of wire will suffice.

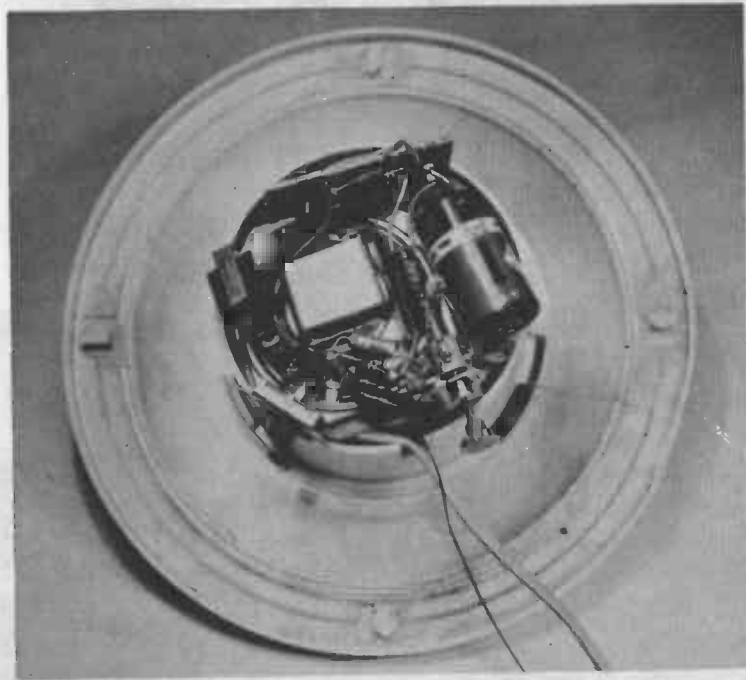

Fig. 12-6. The radio mounted on the clock.

OPERATION

As shown in Fig. 12-7, the radio is powered by on-off switch SW1, and the tuning knob of L1 allows the stations to be changed. There is no volume control, but the tuning knob allows you to cut the strength of the station if it over-

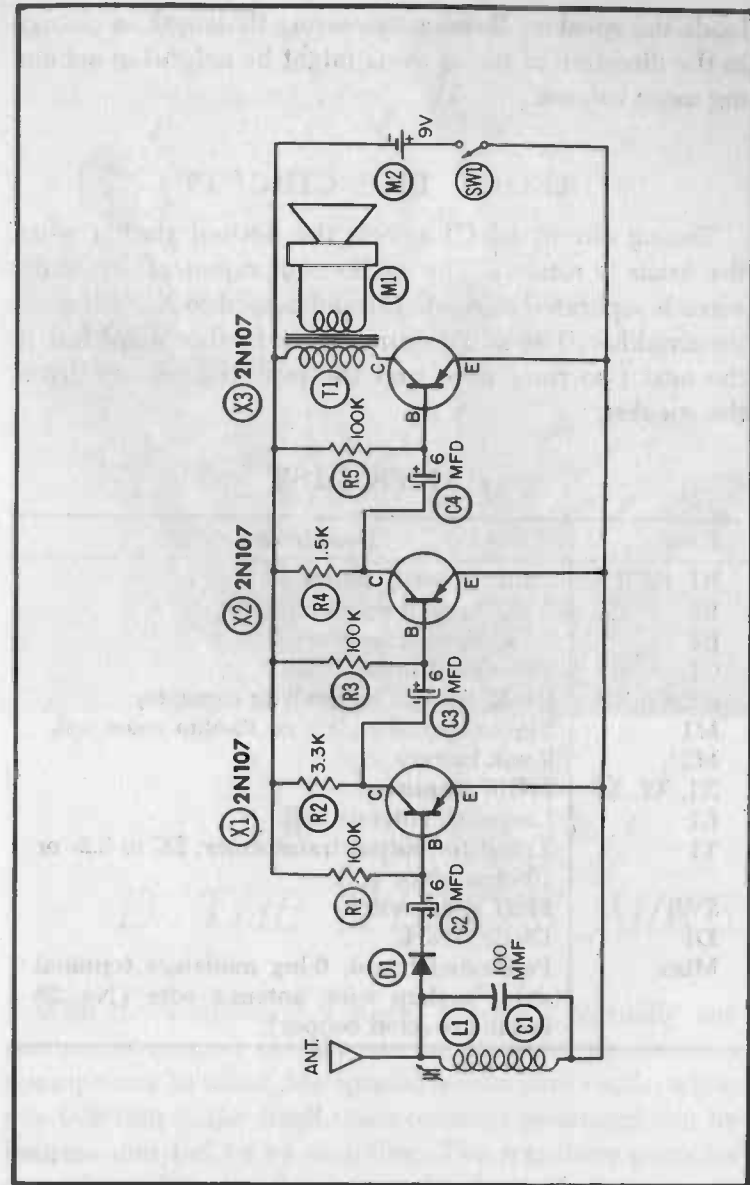

Fig. 12-7. Schematic diagram.

loads the speaker. Besides increasing its length, a change in the direction of the antenna might be helpful in achieving more volume.

ABOUT THE CIRCUIT

Tuning circuit L1-C1 selects the desired station when the knob is rotated. The audio component of the radio wave is separated at diode D1 and passed to X1, a transistor amplifier. The audio currents are further amplified in the next two transistors, and the resulting energy drives the speaker.

PARTS LIST

Item	Description
R1, R3, R5	100K, 1/2-watt resistor.
R2	3.3K, 1/2-watt resistor.
R4	1.5K, 1/2-watt resistor.
C1	100-mmf disc capacitor.
C2, C3, C4	6-mfd, 15-volt electrolytic capacitor.
M1	2 1/2-inch speaker; 3.2- or 10-ohm voice coil.
M2	9-volt battery.
X1, X2, X3	2N107 transistor.
L1	Loopstick antenna coil.
T1	Transistor output transformer; 2K to 3.2- or 10-ohm voice coil.
SW1	SPST slide switch.
D1	Diode, 1N34.
Misc.	Perforated board; 6-lug miniature terminal strip; hookup wire; antenna wire (No. 28 enamel-covered copper).

Fig. 13-7. Schematic diagram.

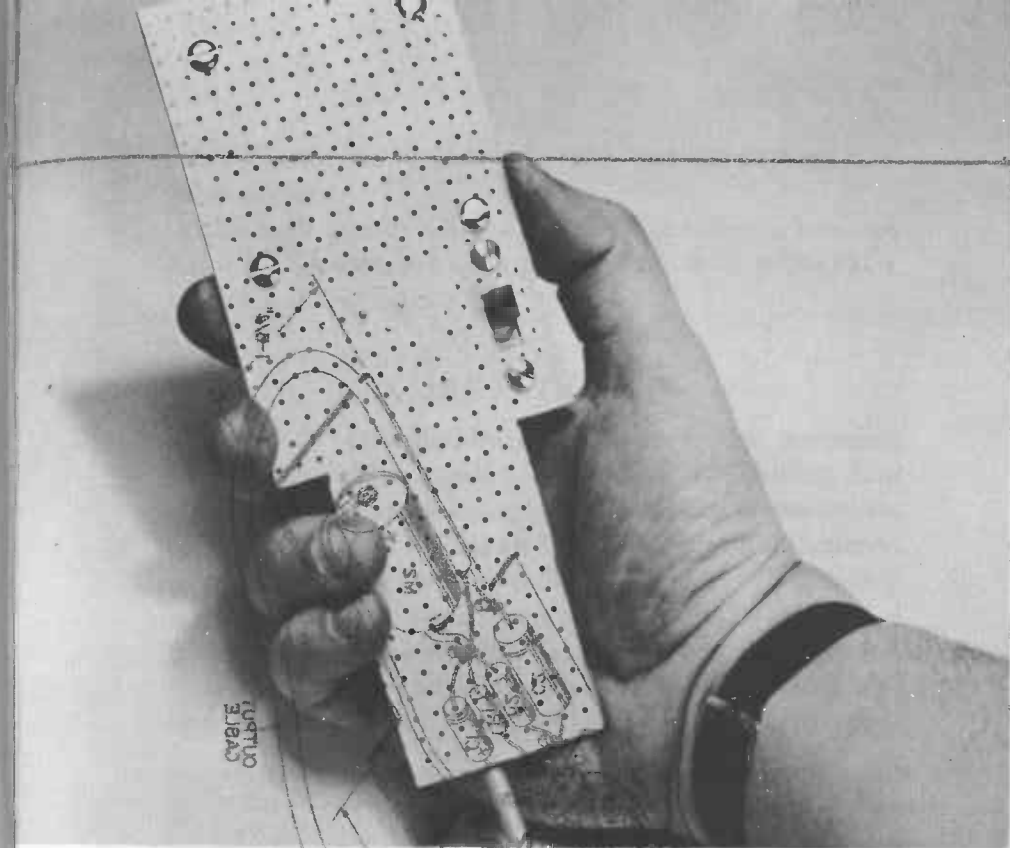

13. THE SPEAKER MIKE

With the addition of a single transistor, virtually any permanent-magnet speaker can be made to operate as a microphone. In effect, the speaker works backwards; when you talk into it, the small voice currents generated can be boosted and fed to an amplifier. The transistor provides enough amplification to permit the device to be plugged into any hi-fi or similar amplifier. Unlike other low-output

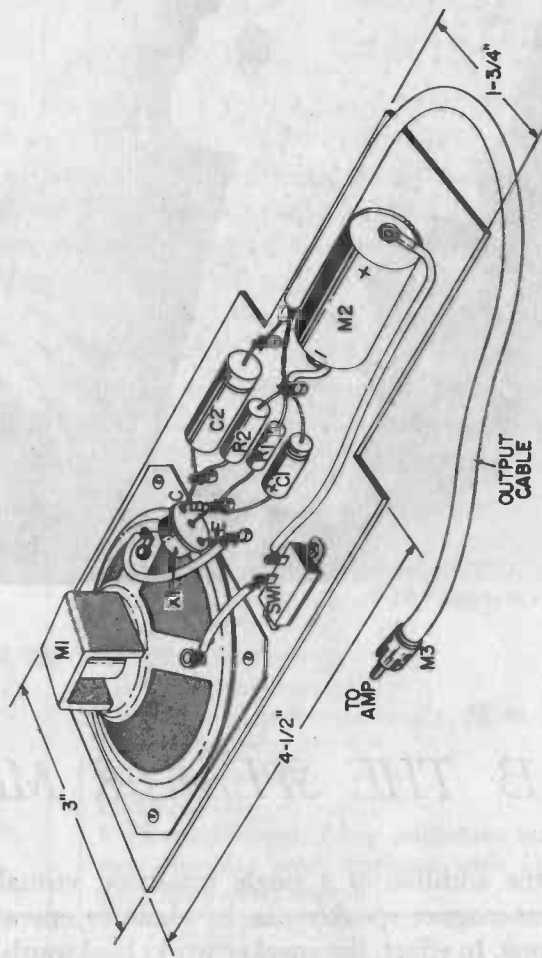

Fig. 13-2. Pictorial diagram.

microphones, the speaker mike does not need an external preamplifier.

Although you can use any size of speaker, a 2½-inch unit makes a compact microphone easily held in the hand, as shown in Fig. 13-1.

CONSTRUCTION

A piece of perforated board is first cut to size, according to Fig. 13-2. The speaker is mounted by driving four screws into the corner holes in the metal frame. An oblong opening is cut out for the switch, and the switch fastened in place. A simple method of doing this is to drill a ¼-inch hole and file it to shape. Two additional holes are drilled in the board for the switch mounting tabs.

The transistor is wired to three flea clips inserted into appropriate holes in the board. Locate another two flea-

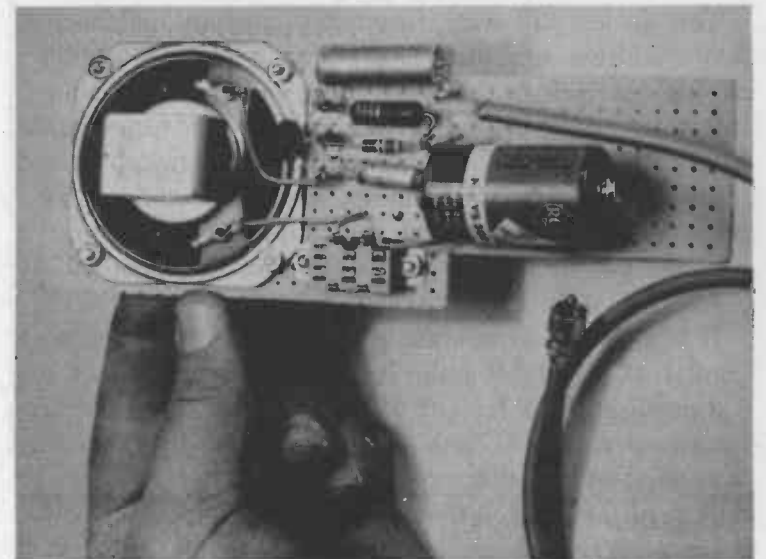

Fig. 13-3. The completed project.

clip points, near the battery and the circuit is ready for wiring. Notice that the output cable is shielded; its braided lead is connected to the flea clip that receives the negative wire from the battery. Glue or matching clips hold the battery in place.

The output cable must terminate in the same type of plug used for the amplifier through which the device will be operated. (This is almost always a phono-type plug.) The cable may be any convenient length since its operation is not critical; nor is it subject to excessive hum pickup. If the cable run is six feet or less, you can substitute two leads of ordinary hookup wire, which must be tightly twisted together. The lead connected to capacitor C2 also must go to the "hot" side (center pin) of the phono plug. The completed project appears in Fig. 13-3.

OPERATION

The device will work through a conventional hi-fi or public-address amplifier. Don't plug it into an amplifier microphone jack, or the overloading will distort the sound. Select either the crystal phono, auxiliary, or tuner input. After making the connection, turn the on-off switch on and speak closely into M1 (the speaker, now working as a microphone). If you hear a loud tone or squeal from the speaker, you're getting feedback. This is remedied by moving the mike and speaker farther apart.

It is possible to operate the unit through a radio. A regular AC-DC table radio is not recommended, as there is a possible shock hazard. However, if you have a transformer-operated (AC only) radio, the mike output can be connected to the volume control. There are three lugs on the rim of the control; the output cable is wired to the two outer ones. Don't use the two lugs on the back; they act as the on-off switch. If you hear a strong hum in the radio

speaker after the unit has been wired to the radio, reverse the two connections to the volume control.

ABOUT THE CIRCUIT

The speaker-mike operation in Fig. 13-4 is based on the fact that a permanent-magnet speaker generates a current as its paper cone moves. Sound waves from your voice supply the necessary force. The speaker output is small; however, the transistor serves as a preamplifier which raises the voice currents to many times their original level.

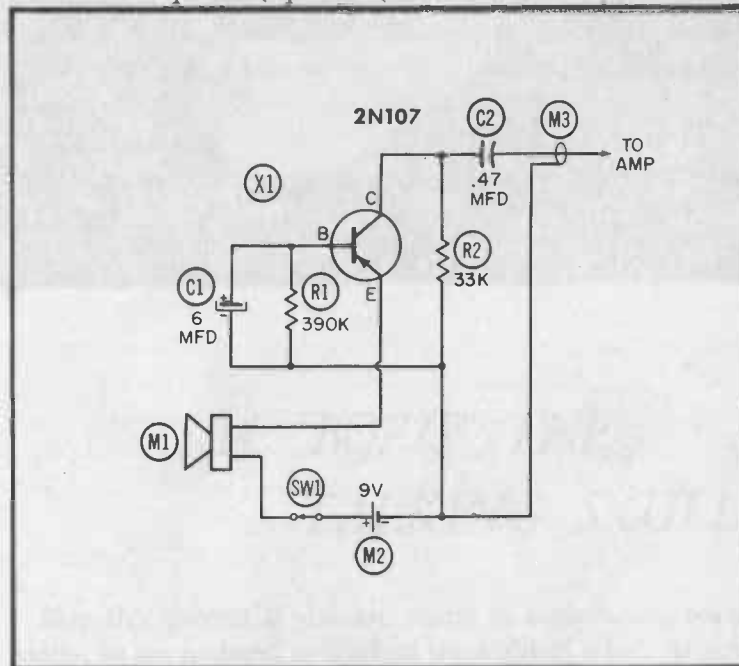
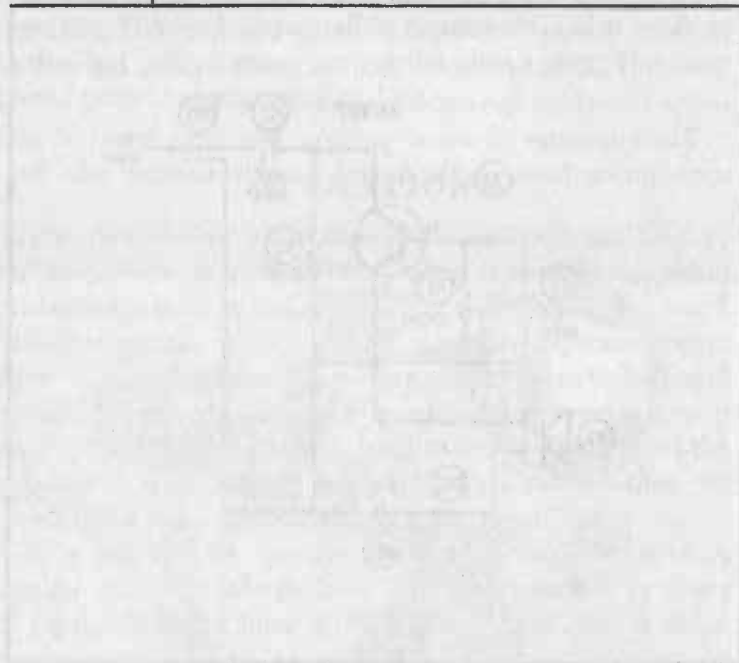

Fig. 13-4. Schematic diagram.

(See page 112 for Parts List)

PARTS LIST

<i>Item</i>	<i>Description</i>
R1	390K, ½-watt resistor.
R2	33K, ½-watt resistor.
C1	6-mfd, 15-volt electrolytic capacitor.
C2	.47-mfd paper capacitor.
M1	2½-inch speaker; 3.2- or 10-ohm voice coil.
M2	9-volt transistor battery.
M3	Phono plug.
X1	2N107 transistor.
SW1	SPST slide switch.
Misc.	Perforated board; flea clips; hookup wire.



14. "BORIS" THE TALKING SKULL

Skip this project if you are prone to nightmares, scare easily, or are inclined to duck at the sight of a bat. As you can see in Fig. 14-1, Boris is a weird sight. He'll sit on a shelf or in the palm of your hand and shock, entertain, or puzzle everyone within earshot. He speaks—a faculty rare among bodyless boneheads.

The voice of Boris is provided by some tricky transistorization packed inside his cranium. The effect is greatly enhanced by the fact that you can walk around the room with Boris as he clacks his mandibles and gabs away. There are no trailing wires to kill the illusion. It's a fun project that convinces any group that a spook actually spoke.

Boris derives his verbal powers from a wireless audio system. The source of his voice can be one of a variety of devices. Basically, anything that has a speaker output can serve as a voice sender. This includes a tape recorder, phonograph, amplifier, or radio receiver. The speaker is disconnected, and the audio signal fed into a loop of wire strung around the room. The audio signal instead of being heard in the usual manner through a speaker, is converted into a varying magnetic field.

Boris contains an induction-type receiver. Installed where his brain used to be is a pickup, the kind used for recording telephone conversations. It intercepts the

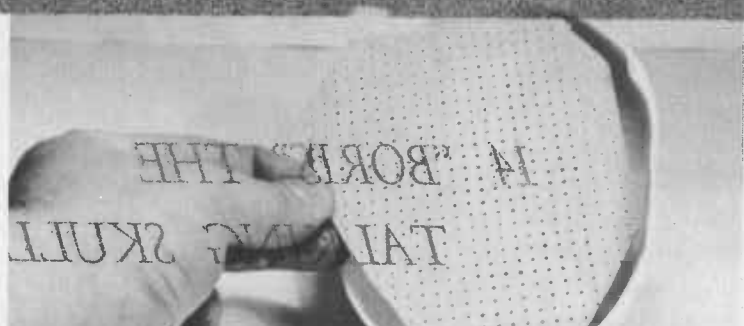

Skip this project if you are unable to read, write, or are unable to work at the sight of a bat. As you can see in Fig. 14-1, Boris is a weird sight. He'll sit on a shelf or in the palm of your hand and shock, enter, or buzz everyone within earshot. He speaks—a faculty among body

Fig. 14-2. Shaping the circuit board.

magnetic field from the loop and drives a transistor amplifier and speaker. The original signal emanates from the skull. The various ways Boris can use his electronic voice are described later in the section on "Operation." He can recite poetry, carry on a conversation with you, or simply sit and skulk.

Where does one obtain a skull? Though Boris is lifelike in every respect, you don't have to look far to dig one up. Any well-stocked stationery or department store sells them in kit form as scientific projects. Molded from plastic, they are anatomically correct down to the *foramen magnum*—the big hole in the head where it meets the neck. Assembly of the skull takes just a few minutes and is mostly a job of gluing the teeth in place.



CONSTRUCTION

A piece of perforated board (Fig. 14-2) supports most of the circuitry. The exact dimensions of the board can't be given since it will have an irregular shape that must be fitted into place.

The board is held in the top, or removable part, of the skull and the edges trimmed accordingly. Fig. 14-3 gives the approximate dimensions, the final fitting is up to you.

Notice the oblong hole cut into the board to accommodate the pickup (the long black object). The opening is made by drawing the shape in pencil, drilling some large holes inside it, and cutting them out with a hacksaw. Another hole is cut out for the ON-OFF switch.

Next, flea clips for supporting the small parts are pushed into the board holes. Notice in Fig. 14-3 that two pieces of bare wire are strung nearly the full width of the board. These are bus bars used for bringing the positive and negative leads of the battery onto the board. The leads of several small components are soldered directly to them.

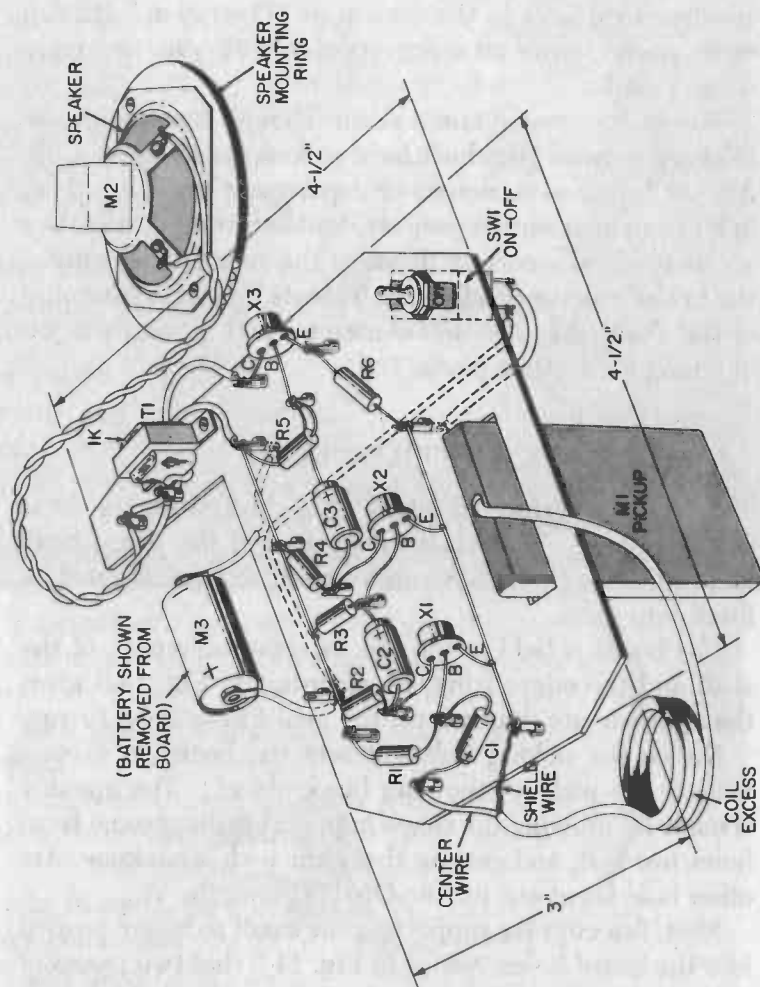

Fig. 14-3. Pictorial diagram.

(Bare wire may be secured by stripping the insulation from a piece of hookup wire.)

The battery is held to the underside of the board by its matching terminal clips. The negative battery clip is pushed onto the battery terminal. Then it is soldered to the underside of the same flea clip that holds one of the bare bus wires on top of the board. (This is the clip near resistor R5 and transformer T1.) The positive battery clip is connected to the flea clip that has a wire running to one of the switch terminals.

While performing the following steps, be sure the switch is turned off in order to prevent accidental shorting of the battery.

The pickup has a cable consisting of a center lead shielded by an outer conductor shield. After the wire and shield are wired to the board, unravel some of the shield and solder it to the clip that supports the bus wire running alongside the large oblong cutout.

The remainder of the board assembly consists of soldering resistors and capacitors to the proper points, as shown in the pictorial drawing. The 1,000-ohm transformer leads must face inward toward the board, and the 3.2- or 10-ohm voice-coil wires are run close to the edge of the board.

The completed circuit should look like Figs. 14-4 and 14-5. In Fig. 14-5, the pointer shows how the battery's negative terminal clip is soldered directly to a flea clip. Upon completion of the wiring, the circuit board may be lowered into the skull, as illustrated in Fig. 14-6.

The board is held in place by several drops of glue on its edges, but it's best to wait until you are certain everything is operating correctly before applying it. Fig. 14-6 also shows how the pickup is placed into the oblong cutout in the board so that it protrudes from the board about two inches. This is no obstacle, since the top of the skull affords ample room for it.

(bare wire may be secured by stripping the insulation from a piece of hookup wire.)

The pickup is held to the underside of the board by its matching terminal clips. The negative battery clip is pushed into the battery terminal. Then it is soldered to the underside of the same flea clip that holds one of the bare wires on top of the board. The positive battery clip is connected to the other end of the wire running to one of the switch terminals.

The pickup has a cap consisting of a center lead shielded by an outer conductor shield. After the wire and shield are wired to the board, unravel some of the shield and solder it to the wire running along the large oblong cutout.

Fig. 14-4. Completed pickup (top view)

The transformer and capacitors to the proper points, as shown in the pictorial drawing. The 1,000-ohm transformer leads must face inward toward the board, and the 3- and 10-ohm voice-coil wires are run close to the edge of the board.

The completed circuit should look like Fig. 14-4 and 14-5. In Fig. 14-5 the pictorial shows how the battery's negative terminal is soldered directly to a flea clip. Upon completion of wiring the board may be lowered into the skull as illustrated in Fig. 14-6. The board is held in place by several drops of glue on its edges. It's best to wait until you are certain everything is operating before applying it. Fig. 14-7 also shows how the pickup is placed into the oblong cutout in the board so that it protrudes from the board about two inches. This is no obstacle, since the top of the skull affords ample room for it.

affords ample room for it.

The vertical placement of the pickup is important. It located in another position, its ability to respond to magnetic waves will be seriously impaired.

The pickup is supplied with a 30-gauge wire rather than out it to length and thereby insure uniform thickness. It is best to coil the wire around the board. Refer to Fig. 14-4 for details. The pickup is drilled to fit the skull as shown in Fig. 14-7.

The speaker is mounted next. The mounting ring shown in Fig. 14-6 is snug fit for the speaker inside the skull. If mounted this way, sound from the back of the speaker would combine with waves emitted from the front. Some cancellation of energy would occur and reduce the volume.

Cut a piece of corrugated cardboard from a piece of grocery cartons is ideal. Used for grocery cartons is ideal. Cut out $3\frac{1}{2} \times 4$, but again you'll have to trim its edges so the piece approximates a ring. Cut a round speaker hole 2 1/2 inches in diameter in the ring, and fasten the speaker with screws and nuts.

Fig. 14-6. Placement of board in skull

The next step in the mounting procedure is given in Fig. 14-9. Apply glue to the outer edge of the ring, and press the whole assembly into the skull.

Apply enough pressure to force the ring into the skull. The shape of the skull is illustrated in Fig. 14-8. The ring is glued.

The final pair of speaker wires is attached to the halves of the skull. About 1/2 inch of speaker wires. About 1/2 inch of speaker wires serve for each connection. This permits the skull to be removed from the circuitry.

The vertical placement of the pickup is important. If located in another position, its ability to respond to magnetic waves will be seriously impaired.

The pickup is supplied with a long cable. Rather than cut it to length and thereby limit its future usefulness, a better idea is to coil the excess of the cable and tuck it under the board.

Referring to Fig. 14-7, prepare the top of the skull by drilling a series of small holes into it, as shown. This allows sound to reach the outside.

The speaker mounting is prepared next. The mounting ring shown in Fig. 14-8, provides a snug fit for the speaker inside the skull. If not mounted this way, sound from the back of the speaker would combine with waves emitted at the front. Some cancellation of energy would occur and thus reduce the volume.

Cut the mounting ring from a piece of corrugated cardboard (the thick kind used for grocery cartons is ideal). The over-all size is about $3\frac{1}{2}'' \times 4''$, but again you'll have to do some fitting. Snip its edges so the piece approximates a snug fit inside the skull. Cut a round speaker hole $2\frac{1}{2}$ inches in diameter in the ring, and fasten the speaker with screws and nuts.

The next step in the mounting procedure is given in Fig. 14-9. Apply glue to the outer edge of the ring, and press the whole assembly into place with your thumb. Use enough pressure so the cardboard conforms to the irregular shape of the skull. Hold the cardboard until it is firmly glued.

The final pair of wires is now installed. Position the two halves of the skull as shown in Fig. 14-10, and prepare the speaker wires. About eight inches of hookup wire will serve for each connection. This length of hookup wire permits the skull to be opened without straining the rest of the circuitry.

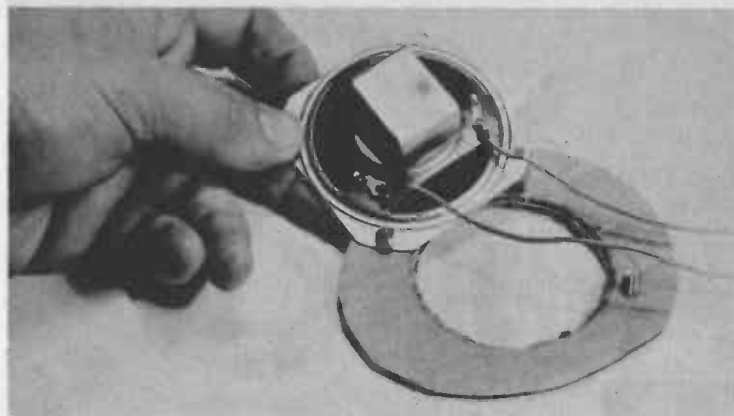
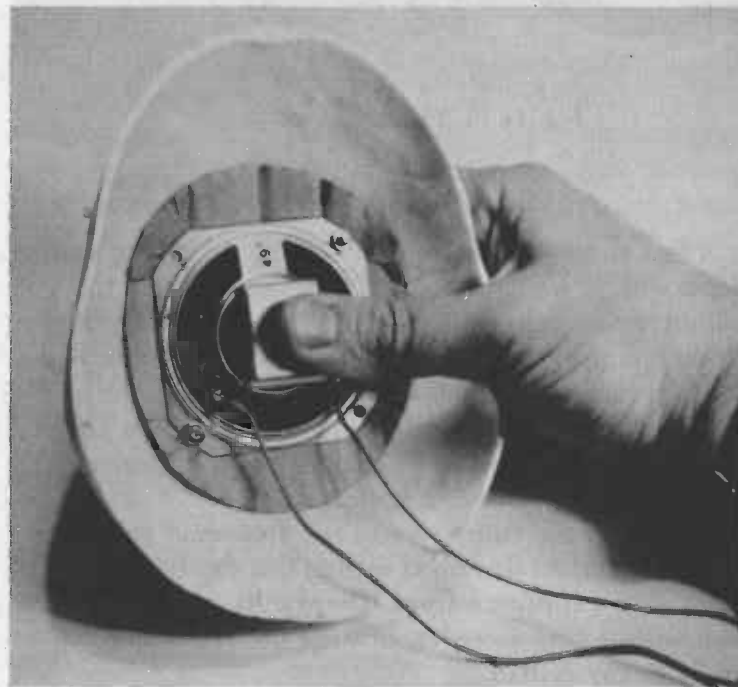

Fig. 14-8. Preparing the speaker mounting.

Fig. 14-9. Mounting the speaker.



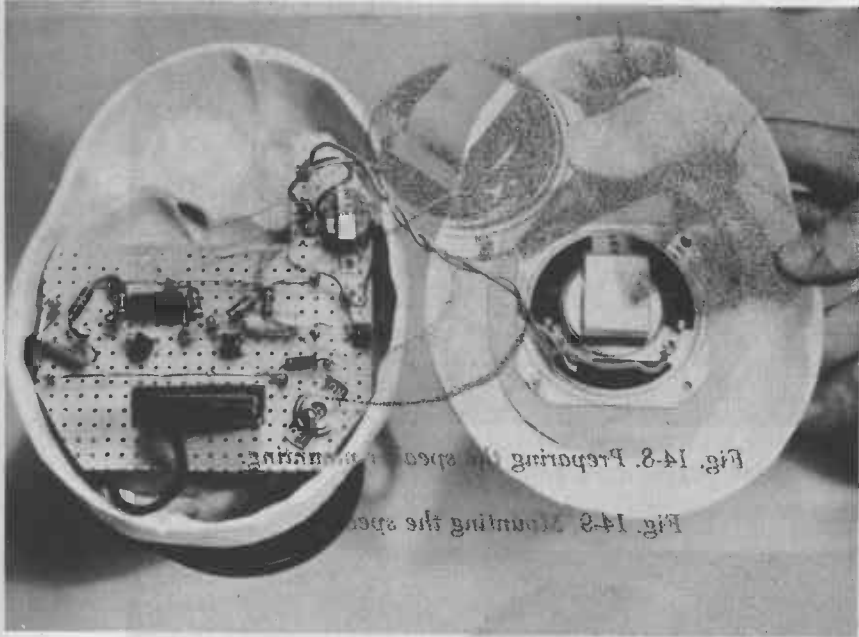

Fig. 14-10. The completed project.

OPERATION

A fast check for proper operation of the circuit can be done with a soldering gun. Place the body of the gun within two inches of the pickup coil and press the trigger. A loud hum should sound in the speaker. Another test is to tap a coin or key against the flea clip, where the center wire of the pickup cable is soldered. With each tap you should hear a corresponding "click" in the speaker. The power must be on during both tests.

Setting up the entire system requires some preparation of the sender. As described earlier, this can be any equipment with a speaker output. The results are most impressive with a tape recorder, but the following suggestions apply to any system.

The effect of your talking skill is considerably heightened if the lower part of the words issue

Fig. 14-11 shows the essential hookup. Unless the speaker has a jack designed for external speaker output, you'll have to remove one speaker wire. Connect one end of a long length of No. 28 enamel wire to the free end of the speaker wire, loop it around the room, and solder it to the other speaker wire. The connections divert the output of the audio amplifier to the wire loop.

The length of the loop is not critical. In fact make it long enough so it can go to another room and be laid out along its walls or baseboard.

Now operate the tape recorder or other device being used as the sender. If Boris is carried with the container of the loop, sound should be heard from the speaker.

It's a good idea to check each section of the room for proper pickup. If you hit a dead spot, simply avoid it when Boris is put into service. Try to stay in areas that produce ample volume. Varying the volume control on the tape recorder, too, can affect the loudness of sound.

Boris is run from a tape recorder concealed in another room. His comments may be pre-recorded with a tape recorder. A very effective performance is to record questions—which he promptly answers. Of course, this is done while you are talking, but it's worth the effort.

Another opportunity for extending your talents is to use an amplifier. Many amplifiers have a microphone input. In this instance, an amplifier speaks into the mike while you carry on the dialogue with Boris.

If neither of these alternatives is available, a satisfactory show can be put on with a phonograph. It does require the cutting of a record, but there are inexpensive acetate discs for home use.

Fig. 14-11. System hookup.

Fig. 14-11 shows the essential hookup. Unless the equipment has a jack designed for external speaker output, you'll have to remove one speaker wire. Connect one end of a long length of No. 28 enamel wire to the free end of the speaker wire, loop it around the room, and solder it to the other speaker wire. These connections divert the output of the audio amplifier to the wire loop.

The length of the loop is not critical. In fact make it long enough so it can run to another room and be laid out along its walls or baseboard.

Now operate the tape recorder or other device being used as the sender. If Boris is carried within the confines of the loop, sound should be heard from the speaker.

It's a good idea to check each section of the room for proper pickup. If you hit a dead spot, simply avoid it when Boris is put into service. Try to stay within areas that produce ample volume. Varying the volume control on the tape recorder, too, can affect the loudness of sound.

Boris is most fun when operated from a tape recorder concealed in another room. His comments may be pre-recorded with suitable remarks. A very effective performance is to ask him questions—which he promptly answers. Of course, this is done by leaving pauses on the tape while you are talking. It takes some rehearsing but is worth the effort.

Another opportunity for exploiting Boris' talents is to use an amplifier. (Many hi-fi amplifiers have a microphone input.) In this instance an accomplice speaks into the mike while you carry on the dialogue with Boris.

If neither of these alternatives is available, a satisfactory show can be put on with a phonograph. It does require the cutting of a record, but there are inexpensive acetate discs for home use.

The effect of your talking skull is considerably heightened if the lower jaw is made to move as the words issue



Fig. 14-12. Working the jaw with a rubber band.

forth. You could use a small, battery-operated motor, but Fig. 14-12 shows a simpler approach. The skull is already equipped with a movable jaw which is held closed by a rubber band. If you discreetly slip a finger around the band, you can work the jaw much like a ventriloquist's dummy. The base of the skull rests in the palm of your hand, and you can roam about the room while Boris chatters away.

ABOUT THE CIRCUIT

For those interested, Fig. 14-13 shows a detailed schematic of the amplifier in Boris' head. The audio signals emitted from the wire laid around the room are received

emitted from the microphone are received by the amplifier in Boris' head. The audio signal for those interested, Fig. 14-13 shows a detailed schematic of the amplifier in Boris' head. The audio signal is received from the microphone and is amplified in three stages by M1 pickup and transformed into electrical signals. These signals are then amplified in the three-stage resistance coupled amplifier and heard in the speaker as audio.

ABOUT THE CIRCUIT

chatters away. The base of the first stage is in the palm of your hand, and you can feel the room while Boris band, you can work the law much like a ventriloquist's rubber band. If you directly a finger around the equipped with a movable jaw which is closed by a Fig. 14-12 shows a simpler approach. The skull is already forth. You could use a simple, battery-operated motor, but Fig. 14-12 Working the law with a rubber band.

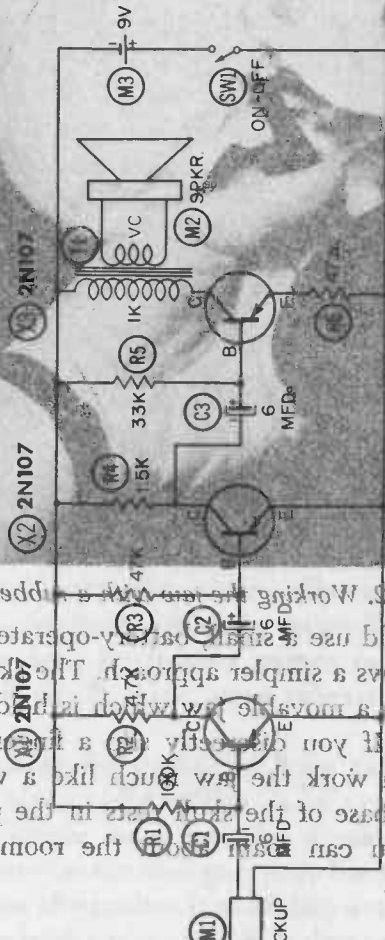

PARTS LIST

Item No.	Description
R1	100K, 1/2-watt resistor.
R2	4.7K, 1/2-watt resistor.
R3	47K, 1/2-watt resistor.
R4	1.5K, 1/2-watt resistor.
R5	33K, 1/2-watt resistor.
R6	47-ohm, 1/2-watt resistor.
C1, C2,	6-mfd, 15-volt electrolytic capacitors.
C3	
X1, X2,	2N107 transistors.
X3	
T1	Transistor output transformer, 1K to 3.2 or 10 ohms.
M1	Telephone pickup coil.
M2	Speaker, 2 1/2-inch.
M3	9-volt transistor battery.
SW1	SPST toggle switch.
Misc.	Perforated board; No. 28 enamel-covered wire; skull (see text); flea clips; corrugated cardboard; hookup wire; hardware.

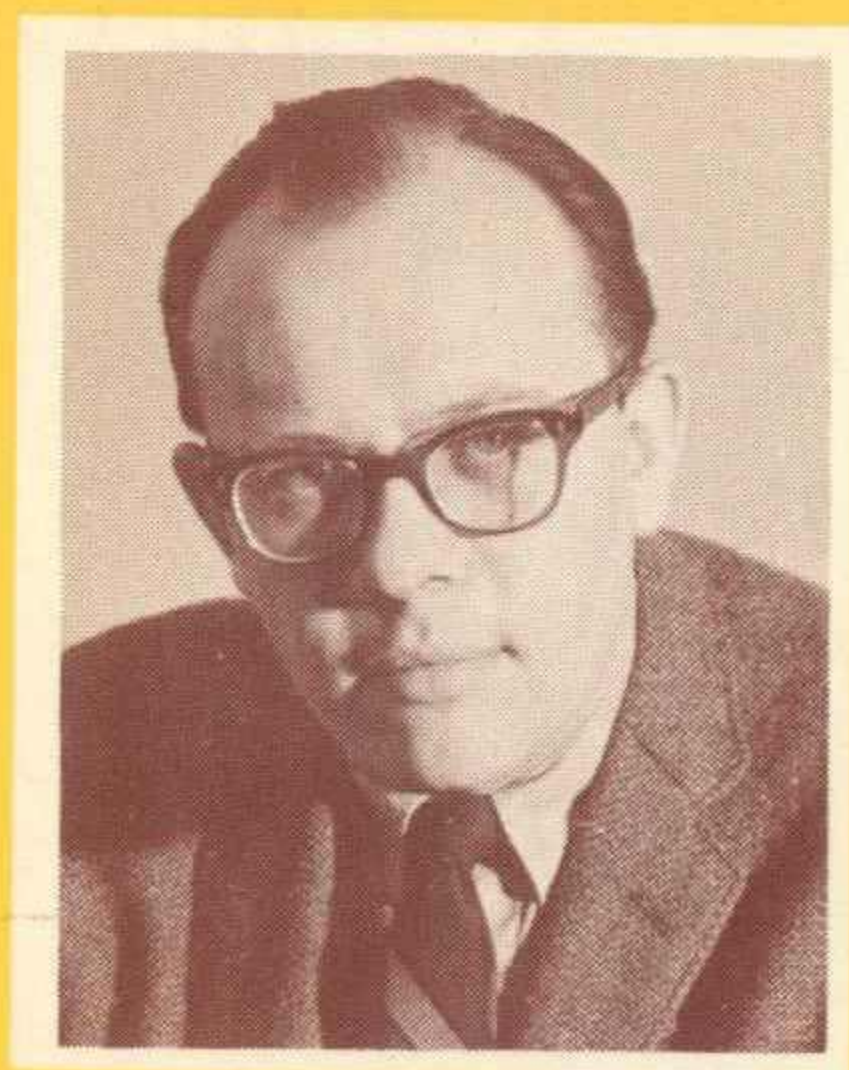

HAVING FUN WITH TRANSISTORS

BY LEN BUCKWALTER

Author Len Buckwalter is a well-known creator of electronic "build-it-yourself" devices, and is a regular contributor to numerous magazines. A graduate of New York University, Mr. Buckwalter was formerly Chief Engineer at radio station WCRB, Boston. He also holds a radio amateur ticket as well as a CB license. Other SAMS books by Mr. Buckwalter include *Electronic Games & Toys You Can Build*, *Electronics Experiments & Projects*, *Electronic Gadgets for Your Car*, *99 Ways to Improve Your CB Radio*, *abc's of Citizens Band Radio*, and *abc's of Short-Wave Listening*.

"Uncanny, weird, unique, a real conversation piece"—these adjectives all apply to the 13 exciting transistorized projects presented in this book.

While creating, one can learn; and while learning, one can find enjoyment for himself, his family, and friends as he builds such unusual items as "Boris, the Talking Skull" or a unit that enables you to "see" while blindfolded.

Using his imagination and his knowledge of electronics, Len Buckwalter has come up with an assortment of "gadget-building" projects which not only provide many fun-filled hours of entertainment, but also demonstrate the basic principles of transistors. Each project is laid out in simplified form so even a youngster can understand it. A detailed description of each project is given, and operation of the circuits is fully explained. All parts used are inexpensive and readily available.



HOWARD W. SAMS & CO., INC.
THE BOBBS-MERRILL CO., INC.