

THE OUTLINE OF RADIO

(What Radio Is and How It Works)



By
JOHN V. L. HOGAN

Consulting Radio Engineer; Fellow and Past
President, Institute of Radio Engineers; Member,
American Institute of Electrical Engineers

NEW REVISED EDITION

The Useful Knowledge Books
Edited by George S. Bryan

THE OUTLINE OF RADIO

New Revised Edition

By

JOHN V. L. HOGAN

THE need of an authoritative book on radio fundamentals, one which is both complete and easily understandable, was met by "The Outline of Radio," written by John V. L. Hogan, one of the best-known radio engineers in the United States. It explains simply and clearly the fundamental features of the operation of radio transmitters and receivers.

No other book on radio has had such unqualified endorsement from recognized authorities in the radio field.

New developments in radio, since Mr. Hogan's book was first published in 1923, necessitate a new revised edition. This new edition contains much new material, including full information about the tuned radio frequency and superheterodyne receivers that have attained such great popularity.

In this book Mr. Hogan has explained the basic principles on which the whole science rests and must largely continue to rest. His volume makes clear the ground work that forms the solid foundation of the whole of radio. Both in scope and method it differs from any other radio book yet published. It will be of value to a wide variety of readers.

With illustrations and diagrams

*Authoritative Comments on
the first edition of*

THE OUTLINE OF RADIO

By

JOHN V. L. HOGAN

"The Bureau of Engineering has approved 'The Outline of Radio.' They recommended it very highly."—*Navy Department, Bureau of Navigation, Washington, D. C.*

"The logical sequence in which the subjects are handled, the generous number of illustrations and particularly the simple and understandable style of diagrams which have been selected, combine to make a book remarkably easy to read and to comprehend."—*Kendall Banning, Editor of Popular Radio.*

"Mr. Hogan has succeeded, very well indeed, in presenting the scientific elements of radio in a very plain and simple language so that even the most untechnical person can understand it."—*M. I. Pupin, Professor of Electro-Mechanics, Columbia University.*

"What appeals to me particularly in this book is the success with which scientific accuracy is combined with simplicity of statement—a result which unfortunately has been rare."—*Professor L. A. Hazeltine, inventor of the Neutrodyne circuit.*

"The book is interestingly written and a well-laid-out plan is followed logically throughout. There are no technicalities or formulae to confuse the fan who is in search of knowledge concerning the wonderful art in which he is interested."—*Jack Binns in The New York Herald.*

THE USEFUL KNOWLEDGE BOOKS
EDITED BY GEORGE S. BRYAN

THE OUTLINE OF RADIO

BY

JOHN V. L. HOGAN

CONSULTING RADIO ENGINEER; FELLOW AND PAST
PRESIDENT, INSTITUTE OF RADIO ENGINEERS;
MEMBER, AMERICAN INSTITUTE OF
ELECTRICAL ENGINEERS

NEW REVISED EDITION

*With Many Full-page Illustrations and Numerous
Diagrams in the Text*



BOSTON
LITTLE, BROWN, AND COMPANY
1925

Copyright, 1923, 1925,

BY JOHN V. L. HOGAN.

All rights reserved

First Impression September, 1923

Second Impression January, 1924

Third Impression February, 1924

New Revised Edition

Published November, 1925

PRINTED IN THE UNITED STATES OF AMERICA



TOWERS AND AËRIALS OF THE BROADCASTING STATION AT AEOLIAN HALL, NEW YORK CITY

Two transmitters (WJY and WJZ) have been installed, so that two independent programs may be simultaneously transmitted on different wavelengths.

to
E. M. H.

EDITORIAL INTRODUCTION

THE Useful Knowledge Books make a comprehensive appeal. They have been designed for persons with favorite hobbies; for laymen (and women, as well) who wish to be more intelligent and effective in some phase or phases of their daily living; for all those general readers who seek to keep in touch with the progress of human achievement and the increase of information. This wide audience is not looking for professional texts or elaborate and difficult treatises. Neither is it content with the inadequate volumes of a so-called "popular" character. It is seeking compact, simplified books that may be read with confidence and kept at hand for reference; for, says an anonymous author, "To know where you can find anything, that in short is the largest part of learning."

To meet this need, the present series has been planned. The individual books are to be by authoritative writers. They will be of handy size, but not superficial. They will aim to present the main features of their respective subjects in a thorough, clear, and distinctive manner; to be not only reliable but readable. They will

be generously supplied with illustrations that really illustrate. Acknowledgment should here be made of the coöperation of the Publishers, who have striven to render these books truly helpful and have spared no pains to give them an attractive dress.

“The Outline of Radio” is by John V. L. Hogan, who, as engineer, inventor, lecturer, and writer for the technical press, has long been prominently identified with the development of radio in this country. Mr. Hogan has brushed aside the more or less ephemeral details that have collected so thickly about the radio art, and has explained the basic principles on which the whole science rests and must largely continue to rest. His is a fundamental book — original in plan and individual in method. It is that much-sought thing, a satisfactory radio volume for progressive amateurs and general readers.

G. S. B.

FOREWORD

THE radio skeptics of a few years ago have largely disappeared. People in general are no longer "tired of hearing about radio", for after a mushroom-like development the service of radio communication has become more stable and consequently more satisfactory. Possessing not only inherent merit, but also a lively appeal to the imagination, radio was almost riotous in its first growth. The tremendous fascination of stretching out one's personal contacts far enough to intercept wireless messages arriving, over continents and high seas, from points hundreds or even thousands of miles distant, attracted millions of people all about the world to the study and use of radio. New books and new periodicals appeared in quantity; by this time many of the meritless publications have been forgotten.

By the greater part of this huge increase of popular interest came as a consequence of radio-telephone broadcasting. There is now no village in the United States where it is impossible to intercept wireless music or speech. So rapid an expan-

sion necessarily gave radio something of the appearance of a fad; and undoubtedly many who took up radio receiving did so because it was a craze. Fortunately, underlying the perhaps more transient attraction of hearing radio concerts is the valuable and permanent essence of a vital public service. The modern wireless is not merely an amusement or a toy, though on occasion it may be both of these. Radio is daily performing its man's-size tasks, including transoceanic communication; the guidance of ships along fog-bound coasts; the tracing of criminals who, without the wireless, would have made good an escape by sea; the transmission of time signals and meteorological data of immeasurable importance to mariners and the pilots of aircraft; and the distribution of entertainment and instruction to thousands who are home-bound or otherwise isolated.

If the first rush of radio publications wearied you, take heart. Beneath the froth of writing that was stirred up to meet (but hardly to satisfy) the wants of radio users, exists a substantial literature of the art and science. Not all of this may interest you, for much is highly technical and therefore unpalatable to many readers. A good deal of what is both dependable and clearly phrased is also somewhat out of date; for the progress of the past few years has taken radio forward in great strides. A large part of the

material recently published has already been forgotten, for it was neither accurate nor readable. However, the fact remains that radio is accomplishing great things. Its principles and uses are well worth a little attention by any of us. You, for instance, will not have to read far to experience something of the fascination that comes with a knowledge of how radio works.

The radio faddist who gains an understanding of how the apparatus operates becomes a devotee of the art. The radio reader who finally arrives at a knowledge of the physical principles embodied in the instruments becomes an adept, even though he may have had to wade through reams of "popularized" and pseudo-scientific writings. The listener who realizes just what happens inside his radio receiver becomes a true lover of this newly applied science, a veritable amateur, striving for improvement and development.

If you are using a radio instrument, but are not quite sure how it works, study the science of radio. If you would like to put a receiver into your home, first find out what to expect of it. If you are merely curious about this new topic of conversation, read a little concerning it. But now for a word of warning: Don't expect any one book, or any five books, to tell you all there is to know about radio. Begin with an outline of what radio has done; and next, find out how to-day's radio accomplishes its surprising results. Then you

will be ready to think about special applications and subdivisions of the science and the art; you may go into details of construction or operation, concentrating upon problems of generation, modulation, application, or what-not. But, primarily, get in mind the groundwork that forms the solid foundation of the whole of radio. From these fundamentals you can carry forward your investigation and, with astonishing ease, gain a vivid picture of the philosophy of nature upon which our daily lives are built. No other practical scientific accomplishment embodies so wide a variety of natural phenomena as does radio, which extends into the provinces of heat, light, sound, magnetism, electricity, and the properties of matter both at rest and in motion. Because it thus embraces the whole field of physics, radio is forever interesting.

Imagine that you are spending a week-end at my home; that we have drawn our chairs before the fire; and that you have asked me, "Just what is this radio, anyway? How did it happen? What makes it work?" — and that, after a long pull at my pipe, I've said, "Well . . . it's like this . . .". If you wish answers to those questions, read on. I am going to give you a somewhat informal (but, I hope, none the less helpful) introduction to radio.

JOHN V. L. HOGAN

FOREST HILLS, LONG ISLAND.

ACKNOWLEDGMENT

FOR courtesies in supplying the special photographs reproduced in the half-tone illustrations of this volume, the author's appreciative acknowledgment is made to the American Telegraph and Telephone Company; the Bell Telephone Laboratories; Professor R. A. Fessenden; the General Electric Company; the Radio Corporation of America; the Western Electric Company; the Westinghouse Electric and Manufacturing Company; and the Wireless Specialty Apparatus Company.

NOTE TO SECOND EDITION

IN revising this "Outline" to include developments of the past two years, I have been influenced mainly by the increase in the number of broadcasting stations and the consequent growth of interference between their radiated waves. The new conditions have thrown emphasis upon the more selective designs of receiver, such as the tuned radio-frequency and super-heterodyne types, and I have added material as to these. Improvements in transmitters, amplifiers, and loud speakers have also been made; and these are reflected in the new text and illustrations. However, the fundamental treatment of radio in general has not been changed, for neither my kindly and constructive critics nor I myself have been able to suggest a better arrangement.

J. V. L. H.

CONTENTS

	PAGE
EDITORIAL INTRODUCTION	vii
FOREWORD	ix
CHAPTER	
I A BRIEF HISTORICAL REVIEW	3
The inception and development of radio.	
II THOUGHTS PASS BETWEEN US	26
The basis of all communication systems.	
III AN INTANGIBLE CARRIER	48
Electro-magnetic waves as a medium of transmission.	
IV RADIO WAVES ARE CREATED	65
The generation of high-frequency currents and carrier waves.	
V MESSAGES ARE SENT FORTH	87
How code, speech, and music are impressed upon the radio waves.	
VI THE SIGNALS FLASH THROUGH SPACE	106
The passage of electro-magnetic waves from sender to receiver.	

CHAPTER		PAGE
VII	A MILLION LISTENING EARS	127
	Intercepting and selecting the signal waves.	
VIII	THE INAUDIBLE IS HEARD	147
	Separating the signals from the silent radio-frequency currents.	
IX	THE WHISPER BECOMES A SHOUT	166
	Intensifying the feeble received signals.	
X	RADIO AS A PUBLIC SERVICE	198
	What wireless is doing in the world.	
XI	LOOKING FORWARD	217
	Extensions of radio service that are warranted by to-day's technical progress.	
	GLOSSARY	233
	BIBLIOGRAPHY	251
	Radio Books Worth Reading.	
	INDEX	259

ILLUSTRATIONS

Towers and Aërials of the Broadcasting Station at
 Aeolian Hall, New York City . . . *Frontispiece*

FACING PAGE

Fessenden's Brant Rock Radio-Telephone Installation	16
The Radio-Telephone Transmitting Apparatus used at Arlington (Va.) for the Long-Distance Experiments of 1915	20
Broadcasting Transmitter at "Old WJZ", Newark, N. J.	24
Transatlantic Radio-Telegraph Receivers at Riverhead, Long Island, N. Y.	56
A 200-Kilowatt Radio-Frequency Alternator	74
Audion Oscillators	86
The New York Broadcasting Station (WEAF) of the American Telephone and Telegraph Company	120
Two Types of Variable Tuning Condensers	140
Radio Detectors, Old and New	162
Types of Relays	170

	FACING PAGE
Loud Speakers for Radio Reproduction . . .	180
Studio of the Radio Corporation's New York Broadcasting Station WJZ	190
Transatlantic Radio-Telephone Amplifiers . . .	204
Intermediate Power Amplifier	208
The Twelve 400-Foot Transatlantic Towers of the Radio Corporation's Station at Rocky Point, Long Island, N. Y.	218

THE OUTLINE OF RADIO

THE OUTLINE OF RADIO

CHAPTER I

A BRIEF HISTORICAL REVIEW

SCIENTISTS in many countries have helped in the development of radio signaling; but neither the United States, Great Britain, France, Italy, nor Germany need be unduly modest over the contributions of its workers. A chronological record of the art's advances will skip from one country to another; a bit suggested by one man here has been adopted and improved upon by another investigator there, and the combination of ideas has marked an additional step forward. Radio as we know it to-day is no single invention or discovery; modern instruments utilize the novelties devised by a host of engineers and physicists whose work extends over the past seventy years or more.

In outlining the growth of radio, one hardly knows where best to begin. It does not seem worth while to go back of the first electrical

methods of signaling. We have all heard of or seen (or perhaps experimented with) many of the crude schemes which some writers have called "wireless telegraphy." Waving lanterns at night or flags by day; blowing whistles according to some code dependent upon the number and length of the blasts; striking stones together under the surface of a lake and listening to the sound transmitted through the water; building huge fires visible from one mountain top to another, — all of these ancient plans are, in a sense, wireless telegraphy. That is, they are forms of signaling over substantial distances by the use of arbitrary codes, and they do not use wires connecting the transmitting and receiving points. They are not, however, in the least suggestive of radio, and they do not even involve electrical effects. Certainly they contributed nothing to the growth of radio.

The Inception of Wireless. Let us, then, begin with the first electrical arrangement for wireless telegraphy. It was not long before Samuel F. B. Morse transmitted (May 24, 1844) his famous first message, "What hath God wrought!" over the experimental telegraph wire line from Washington to Baltimore — indeed, quite soon after he built his earliest wire telegraph — that he began trying to telegraph without complete wire circuits. In 1842 he succeeded in sending messages across a canal at Washington, using

the slight conducting power of the water to carry the electric telegraph current from one side to the other. The same plan was tried out by others in the decade following; but although distances of nearly one mile were covered by the use of large amounts of power, it seems never to have passed beyond the experimental stage.

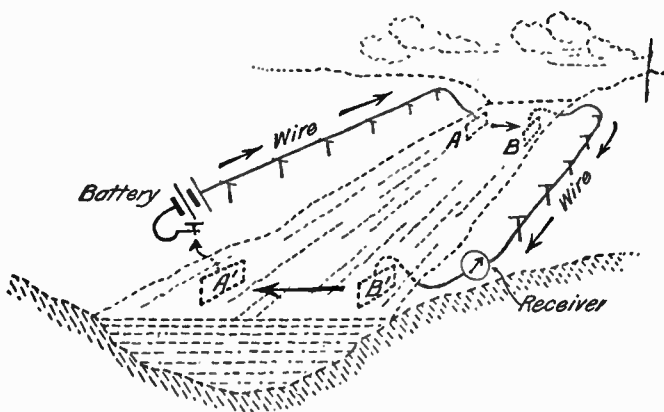

FIG. 1: How Morse Telegraphed across a Canal.—When the key was pressed, current from the battery flowed along the wire on the left-hand bank, across the canal through the water from submerged plate *A* to *B* (in the distance), back along the wire on the right-hand bank, through the receiver, and across the canal again from plate *B'* to *A'*. Some current was lost by diffusing from *A* to *A'*, but enough reached the receiver to operate it.

More than thirty years later, in 1875, Alexander Graham Bell built his first telephone. This surprisingly sensitive instrument could reproduce musical signal sounds from comparatively feeble currents of electricity, and was in many ways far superior to the receivers used by earlier investigators of the telegraph. John Trowbridge, of

Harvard University, in 1880 applied the Bell telephone to the study of Morse's scheme of wireless telegraphy by diffused electrical conduction through rivers or moist earth. He found that if he interrupted the signaling current rapidly, so that its variations could produce a musical tone, messages could be transmitted through earth or water much more effectively than Morse had thought possible. In 1882 Bell succeeded in sending messages about a mile and a half to a boat on the Potomac River, using his telephone receiver connected to plates submerged below the water surface.

Developments in England. Contemporaneously with Trowbridge and Bell, Sir William H. Preece applied to wireless signaling his knowledge of "cross talk" between neighboring circuits carrying telephone and telegraph messages by wire. Perhaps his first practical installation was that between Hampshire, England, and the Isle of Wight when in 1882 the submarine cable across The Solent (averaging a little over one mile in width), broke down. Preece got good results in much the same way as did Morse and Bell. Preece also experimented with the magnetic effects between circuits having no interconnection by wire, earth, or water; and with the assistance of A. W. Heaviside succeeded in transmitting both telegraph and telephone messages by wireless in this way as early as 1885. However, by combining

the two arrangements and taking advantage of both magnetic induction between the circuits and diffused conduction between their terminals, he was able to increase working distances to more than six miles.

This magnetic induction between completely closed circuits was only one of the actions sug-

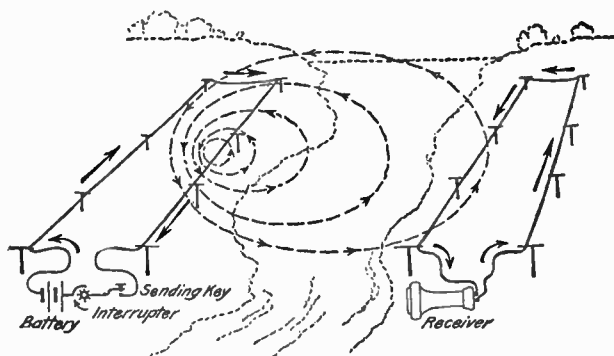

FIG. 2: One of Preece's Magnetic Induction Systems. — Two huge loops of wire, hundreds of feet on each side, were set up, and interrupted currents were driven around one of them. As suggested by the dotted lines, magnetic forces spread out and reached the second loop, inducing in it similar interrupted currents that caused the telephone receiver to produce buzzing sounds signifying telegraphic dots and dashes.

gested for, and practically applied to, electric signaling without connecting wires, during these early years. In 1885 Thomas A. Edison and his associates devised a different sort of wireless telegraph, which bore a closer resemblance to the radio of to-day. Edison's proposal was to support, high above the earth's surface and at some distance from each other, two metallic

plates. At the sending station one of these was connected to earth through a coil that would produce a high electrical pressure; the other, at the receiving station, was connected through a Bell telephone to the ground. In operation, the intense electric strains produced in space about the sending plate (by reason of its high voltage) were supposed to extend outward as far as the receiving plate and to produce currents of sufficient strength to give off signal tones from the telephone. A modification of this system, by which the receiving plate was mounted on the roof of a railway car and the telegraph wires beside the tracks were utilized to help out the transmission, was used on the Lehigh Valley Railroad in 1887. It operated satisfactorily, and this was probably the first instance on record of telegraphing to a moving train.

Signaling with Electric Waves: A New Kind of Wireless. So much for the several types of electrical signaling, without connecting wires, which preceded radio-telegraphy and radio-telephony. There were other suggestions, notably those of Mahlon Loomis (1872), Professor Amos Dolbear (1886), and Isidor Kitsee (1895); but so far as is known, none of them attained even the degree of practical success achieved by Morse in 1842. However that may be, all these plans dependent upon electrical conduction or induction were utterly eclipsed soon after Guglielmo Marconi's experimental demonstrations of electric-wave teleg-

raphy in 1896 and 1897. This new form of wireless signaling, depending upon radiated electro-magnetic waves, showed so much promise and made such rapid development that interest in the earlier types soon vanished. The new wireless art quickly gained an importance so great

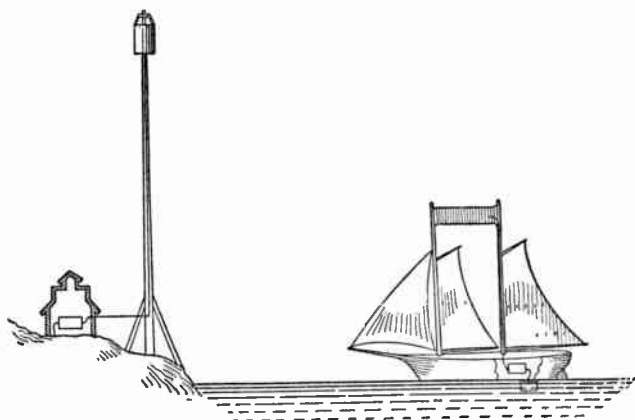

FIG. 3: An Arrangement Suggested by Edison. — Because the apparatus was not adapted to generate or receive electro-magnetic waves, the distance over which messages could be sent was relatively limited.

that it required a characteristic name to distinguish it from the earlier conduction and induction systems. The name given to it is “radio communication.” Radio, therefore, is only one part of the subject of wireless electrical signaling. It is, however, by so much the largest and most important part that “radio” has become practically synonymous with “wireless”, and sight

has largely been lost of the fact that, strictly speaking, radio includes electro-magnetic wave transmission and nothing else.

The Work upon Which Radio Is Founded. Curiously enough, although radio did not reach practical success until about 1896, its underlying principles had been matters of scientific development for many years before. In 1842, the same year that Morse telegraphed through the canal at Washington, Professor Joseph Henry at Princeton University showed that the magnetic effects of an electric spark could be detected some thirty feet away. In 1867 Professor James Clerk Maxwell, of the University of Edinburgh, propounded a radically new conception of electricity and magnetism, outlined theoretically the exact type of electro-magnetic wave that is used in radio to-day, and predicted its behavior. Twelve years later Professor David E. Hughes discovered the sensitiveness of a loose electrical contact, both to sounds and to electrical spark effects which he suspected might be waves. He found it possible to indicate the passage of electric sparks nearly one third of a mile away. But it was not until 1886 that the existence of veritable electro-magnetic waves was demonstrated beyond the possibility of misunderstanding or criticism. In that year, Heinrich Hertz, working at Karlsruhe, Germany, confirmed Maxwell's theory by creating and detecting these electric waves. With

the instruments he devised, it was possible to reflect and to focus the new waves. Their similarity to the waves of light and heat was clearly shown.

Hertz's electric-wave generator consisted of a spark gap to which was attached a pair of out-

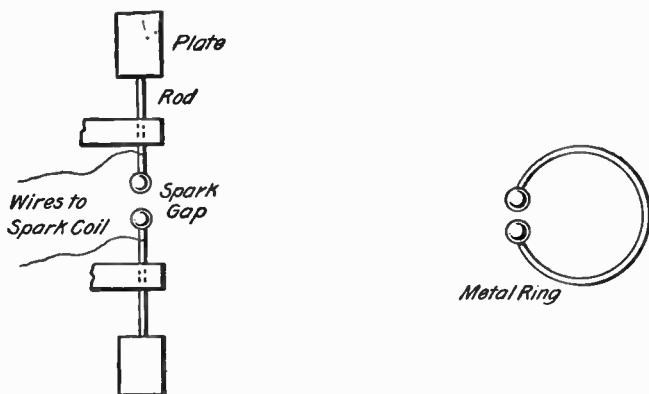

FIG. 4: Hertz's Oscillator and Receiver. — The rod-and-plate oscillator at the left produced radiant electro-magnetic waves that could be intercepted by the ring-shaped resonator shown at the right. He found it important to make the resonator of a size properly corresponding to the size of the oscillator used.

wardly extending conductors, corresponding in a miniature way to the aerial and earth wires of a modern radio transmitter. His receiver was a wire ring having a minute opening across which, when electro-magnetic waves arrived, tiny sparks would pass. This wire ring was in some respects like the loop receiver of to-day; with it Hertz was able not only to indicate the receipt of waves, but also to determine their intensity and direction of travel. Heinrich Hertz, despite the fact that

his work was limited to laboratory distances and that he did not suggest the use of his waves for telegraphy, is the pioneer whose experiments laid the foundation for radio as we now know it.

A few years after Hertz's first work with invisible electro-magnetic waves, Elihu Thomson, of Lynn, Massachusetts, proposed (1889) their use for signaling through fogs or even through solid bodies that would shut off light waves. Sir William Crookes in 1892 made a startling prophecy of electric-wave telegraphy and telephony. Meanwhile, Hertz's experiments had been taken up and extended by a number of scientists, chief among whom were Professor Édouard Branly, of Paris; Sir Oliver Lodge, of London; and Professor Augusto Righi, of Bologna, Italy. Branly and Lodge devised numerous forms of "radio conductors", or receivers utilizing some of the phenomena also discovered by Hughes, for the delicate reception of electric waves; Righi invented various types of wave producers and confirmed and added to Hertz's observations.

The Earliest Experiments with Radio. Guglielmo Marconi, who is justly called the inventor of radio-telegraphy, was a pupil of Righi's. To him came not merely the idea that invisible electric waves could be used for telegraphic signaling, but also the inspiration that led to practical solutions of the many problems involved in producing a set of sending and receiving instruments capable of

reasonably reliable operation. As early as 1894 he recognized the defects in the indicators previously used to show the arrival of electric waves.

He applied himself to the building of a sensitive and, for those days, dependable device that would receive and record a message in the dots and dashes of the Morse code. Such a receiver was made; and, having come to England, Marconi carried on the famous Salisbury Plain demonstration in 1896. There he telegraphed by radio a dis-

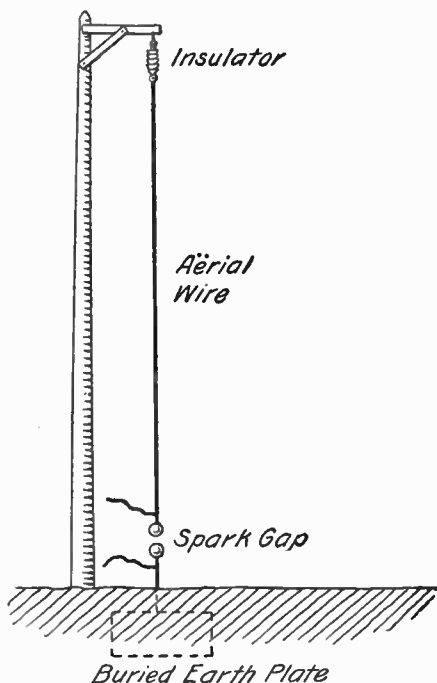

FIG. 5: Marconi's Grounded Transmitter. — The wires from the gap led to a spark coil, as used by Hertz. When sparks jump across the gap, quite powerful radio waves are emitted by the vertical aerial wire.

tance of nearly two miles. This spectacular performance resulted from the sensitiveness of Marconi's new receiver, but perhaps no less depended

upon his idea of connecting one side of his spark gap to the ground and upon his use of comparatively large elevated or aërial conductors at both the sending and the receiving station.

Before the end of the next year (1897), Marconi had sent radio messages to and from ships at sea over distances as great as ten miles, and between land stations at Salisbury and at Bath, 24 miles apart, in England. This was sufficient to settle beyond cavil the economic importance of radiotelegraphy, and to bring to bear upon its puzzles the best scientific minds of Europe and America. The earlier systems of wireless, none of which utilized electric radiation, had never been capable of such results as these.

Later Developments. In the quarter-century that has passed since Marconi sent the first messages by radio, the complexion of the art has changed in great measure; yet one has no difficulty in recognizing many of Marconi's fundamentals as they reappear in the instruments now used. The high aërial wires at the transmitter, the ground connection, either direct or through a wire network, as suggested by Lodge in 1898, and the invention of "tuning" (dating from 1900) all persist in the apparatus of to-day.

Marconi's original transmitter was simply an enlarged wave-producer of the sort used by Hertz. Very soon, however, Marconi found that greater distances could be covered by connecting

one side of the generating spark gap to an earth wire and the other to a high vertical aërial wire or antenna. Even this form was limited in power; and the next important step seems to have been made by dividing the sending assembly into two parts, — a driving circuit and a radiating circuit. Sir Oliver Lodge, in 1897, partially applied to radio the idea of electrical tuning, the principles of which had been stated by Professor M. I. Pupin, of Columbia University, in 1894; but his method was greatly improved upon in 1900 by carefully adjusting the two divisions of the transmitter to work harmoniously together. This advance in powerful and non-interfering transmission appears to have been made independently by Marconi and by Professor R. A. Fessenden, of the University of Pittsburgh.

Overcoming a Serious Defect. The spark transmitter of 1900, with, of course, practical improvements, is still in quite extensive use. The type has a number of defects, however, which will probably render it obsolete in the not distant future. As first built, it sent out signal energy for less than one one-thousandth of the time during which it was supplied with power. This source of inefficiency led Fessenden, in 1902, to invent the continuous-wave system, and to devise various ways of radiating signal energy continuously instead of in short groups. The principal generator of Fessenden's is the radio-frequency

alternator. By 1906 he had built, with the assistance of E. F. W. Alexanderson, such generators in sizes capable of transmitting messages several hundreds of miles. Since then, Alexanderson has produced alternators large enough to work reliably in transoceanic radio service.

The third general type of radio transmitter, in point of time, is the special arc light invented by Valdemar Poulsen of Denmark. This instrument also generates continuous streams of waves, and embodies principles used by Elihu Thomson in 1892 and by William Duddell about 1900 for the production of slower alternating currents. Poulsen, however, seems to have been the first to obtain practical radio waves from an arc generator. The Poulsen arc has been a strong competitor of the radio-frequency alternator, and is now much used for both long and short distance radio-telegraphy.

The latest and most interesting radio generator is the oscillating vacuum tube or incandescent lamp. This device may be traced back to experimental lamps made by Edison in 1884 and to the incandescent-lamp receiver of J. A. Fleming, which Fleming applied to radio reception in 1904; but it did not become a practical transmitting element until after Lee de Forest had added a third electrode, called the "grid", in 1906, and E. H. Armstrong had applied to it a special relay circuit in 1912. Since then, the vacuum tube

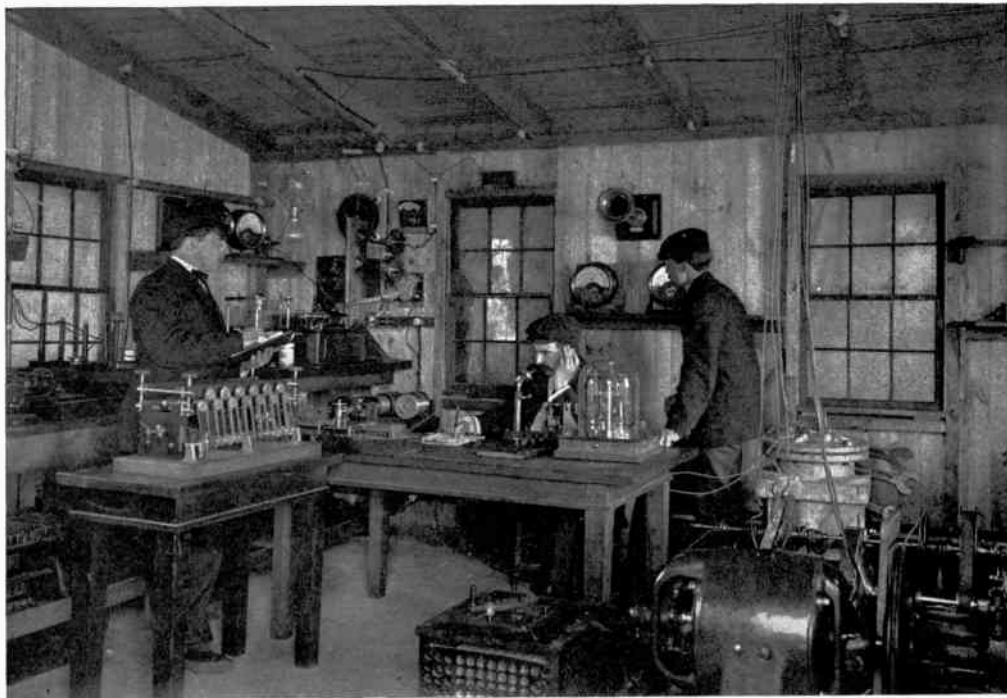

FESSENDEN'S BRANT ROCK RADIO-TELEPHONE INSTALLATION

As used in the first practical experiments in 1906. Note the alternator, the transmitters, the glass-covered relay, and the phonograph. This pioneer radio-frequency alternator was built by Fessenden and Alexanderson in 1906, and generated about one kilowatt of power at 50,000 cycles per second.

has made great progress as a transmitter, largely on account of technical improvements made by H. D. Arnold, Irving Langmuir, W. D. Coolidge, and others. In 1912 vacuum tubes could be used to transmit for only a few miles, whereas now they are produced in units rivalling the huge alternators of the trans-Atlantic radio stations.

The Improvement of Receiving Apparatus. Turning to the development of receivers, we find that the delicate instrument used by Marconi in 1896 was the subject of much investigation and that many other forms of "loose contacts" were invented up to 1900 or thereabout. The erratic action of these devices, however, forced the investigators into other channels. By 1902 Marconi had produced a magnetic detector that was entirely dependable but not exceptionally sensitive. In the same year Fessenden patented a uniformly operating thermal receiver of about the same sensitiveness. In 1903 Fessenden brought forward his liquid receiver, which had such great responsiveness and stability that it was generally adopted in practical radio and became the U. S. Navy's standard of sensitiveness. Fleming's incandescent-lamp receiver came out in 1904, but in its original form could not compete with the simple liquid detector. Of the "crystal" detectors, now so common, one of the first to attain practical use was the electric-furnace product, carborundum, which General Henry H. C. Dunwoody, of the U. S.

Army, applied to radio in 1906. Contemporaneously, G. W. Pickard found that silicon and other substances might be utilized in the same way, and lead ore (galena) and iron pyrites were also much used. The best of these so-called crystal receivers were nearly equivalent in sensitiveness to the earlier liquid type, and because of their ease of manipulation they almost entirely superseded the older devices.

In 1906 and 1907 de Forest introduced the grid audion, which proved to be a substantially improved form of Fleming's incandescent-lamp receiver. This vacuum-tube detector showed surprisingly great sensitiveness from the very first; its earlier forms were unstable, however, and it was not accepted practically until about 1912. With the structural improvements that followed — the addition of the Armstrong feed-back circuit, and the discovery (about 1913) that the same three-electrode bulb could be used as a delicate but powerful magnifier of signal strength — the vacuum tube has now replaced all other receivers at stations where extreme sensitiveness is desired. The modern forms do not closely resemble the designs of 1906; and in special types of tube, such as those named the "magnetron" and the "dynatron", there is also a departure from the earlier operating principles. All of these tubes are, however, incandescent-lamp detectors or amplifiers.

Improvements at the receiving end of radio were by no means confined to the sensitive wave-detecting elements. The Pupin-Lodge-Fessenden-Marconi tuning improvements were applied to receiving systems as well as to transmitters. There was also an effort to replace the ink recorder used in Marconi's first work. Lodge in 1897 adopted the siphon recorder, which Lord Kelvin had devised for cable working; while other investigators (and notably those in the United States) put the Bell telephone into use as a signal indicator as early as 1899. In 1902 Fessenden showed how the ordinary detector could be replaced by a special telephone receiver operated by two simultaneously transmitted streams of continuous waves. Not long thereafter he invented the strikingly novel and ingenious "heterodyne" receiver which, with later improvements, is well-nigh universally used in modern radio-telegraphy.

Sending Speech by Radio. The technical developments of radio outlined in the preceding pages have been discussed mainly from the viewpoint of Morse signaling, or "dot-and-dash" telegraphy, although in connection with induction and conduction wireless the possibility of telephony has been indicated. In the growth of radio it appears that voice transmission was not proposed until Professor Fessenden in 1902 suggested that his continuous-wave method of trans-

mission was suitable for radio-telephony. There seems to be some evidence that Fessenden made practical trials of speaking radio even before this date. John Stone Stone, of Boston, has stated that, using a species of arc-lamp generator, he transmitted speech by electro-magnetic waves early in the decade dating from 1900. It is well known, however, that in 1906 Fessenden gave numerous practical demonstrations of radio-telephony between his experimental stations at Brant Rock and Plymouth, Massachusetts, and that in 1907 he increased his range from this distance of about twelve miles to such an extent that Brant Rock was able to communicate with New York, nearly two hundred miles away, and Washington, about five hundred miles. In these tests it was shown that speech carried to the radio station over a wire line could automatically be relayed to the radio and sent broadcast on the wings of the electro-magnetic waves. At the receiving end, Fessenden demonstrated the feasibility of transferring speech, arriving by radio, to telephone wires and thus carrying it to a home or office remote from the wireless installation.

From 1907 to 1912 or thereabout, radio-telephony developed slowly. The Poulsen arc lamp was used to some extent as a power source, but proved an unsatisfactory substitute for the generators used by Fessenden. On the other hand, the radio alternators were expensive and bulky,

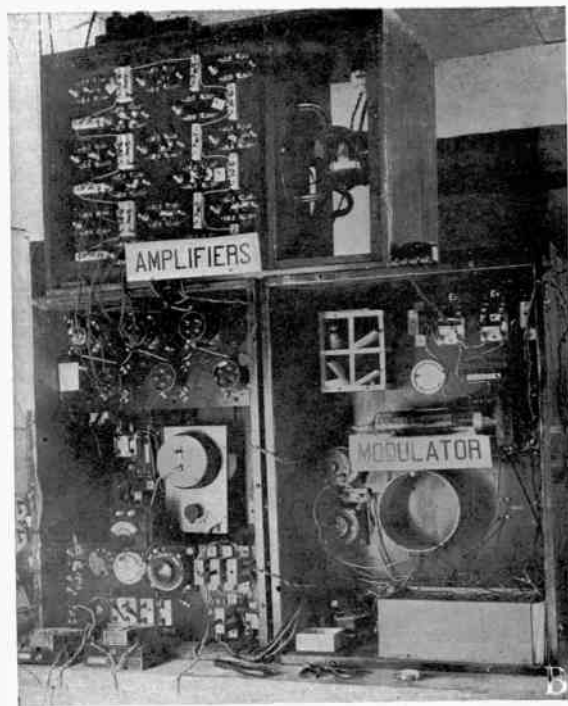
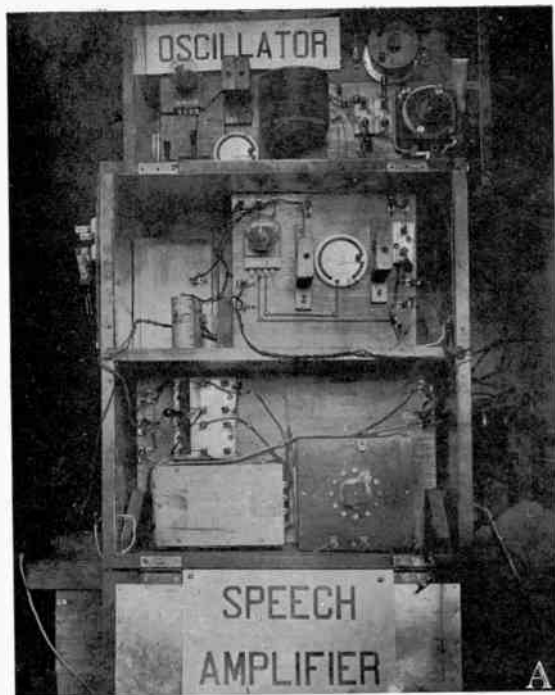

THE RADIO-TELEPHONE TRANSMITTING APPARATUS USED AT ARLINGTON (VA.) FOR THE LONG-DISTANCE EXPERIMENTS OF 1915

and had definite practical limitations of power and wave length. Further, and regardless of whether arc or generator were used, the voice-controlling instruments were not highly refined. Thus it was that when the modified incandescent lamp was found to be a reliable wave-producer and power-magnifier, progress in radio-telephony came with rapid strides. By 1915, the engineers of the American Telephone and Telegraph Company had succeeded in talking by radio from the huge naval station at Arlington, Virginia, to Paris, and in the opposite direction, to Honolulu. This great experimental feat was accomplished by using vacuum tubes as oscillators and voice-magnifiers. The power of the transmitter was utterly inadequate to signal over so huge a distance except under the most favorable conditions, but the work indicated possibilities which nothing but the demonstration would have made credible. Since 1915, the trend in radio-telephony has been toward dependable operation over shorter distances. The greatest single advances are probably the control systems devised by R. A. Heising and E. F. W. Alexanderson.

The Field of Practical Operation. To conclude this necessarily rather sketchy historical review, a glance at progress in the application of radio to operations, rather than its scientific growth, may be interesting. After Marconi's demonstrations in 1897, a number of commercial installations

were made on both ship and shore. The first instance of reporting a marine accident by radio was in March, 1899, when the s. s. *R. F. Matthews* collided with the East Goodwin light vessel. In the same year British naval vessels communicated over distances as great as 85 miles, and the international yacht races between the *Shamrock* and the *Columbia*, in America, were reported to the press by wireless. In 1901 radio stations on the Isle of Wight and the Lizard, 196 miles apart, intercommunicated successfully; and construction of the Poldhu (England) and Newfoundland stations for trans-Atlantic signaling was well under way. December, 1901, marked the first transoceanic radio signaling, for then Marconi succeeded in intercepting repetitions of the single letter "S", in the Morse code, sent from Poldhu to an experimental receiver at St. John's, Newfoundland. The next year, 1902, Poldhu's signals were heard aboard the s. s. *Philadelphia* over more than 2,000 miles, complete messages having been received up to more than 1,500 miles.

In January, 1903, a trans-Atlantic radio message was sent from President Roosevelt to King Edward VII by way of the stations at Cape Cod, Massachusetts, and Poldhu, England; but it is not generally known whether this message was relayed by ships on the Atlantic or whether it was received directly from Cape Cod in complete form. A station even larger than that at

Poldhu was begun in 1905, at Clifden, Ireland, and in 1907 this plant and a twin station at Glace Bay, Nova Scotia, were opened for a limited commercial trans-Atlantic radio service. January 23, 1909, was the date of the collision between the steamships *Florida* and *Republic*, which was reported to neighboring ships by radio in time to save all the passengers and crew of the *Republic* before she sank. In 1910 messages from the powerful Clifden station were heard aboard the s. s. *Principessa Mafalda* over more than 6,500 miles.

On the morning of April 15, 1912, over seven hundred passengers of the s. s. *Titanic* were rescued through the aid of radio when the vessel was sunk by striking an iceberg. During the next year, radio messages were successfully sent from and received on moving trains of the Delaware, Lackawanna and Western Railroad. In 1914 commercial trans-Pacific radio-telegraphy was inaugurated between San Francisco and Honolulu, and direct radio communication between the United States and Germany was made available over the Tuckerton-Hannover and Sayville-Nauen channels. In 1915 the United States Government took over the operation of the Sayville and Tuckerton stations to prevent their unneutral use. Commercial service between the United States and Japan was begun in 1916, but development of American-European commercial

communication was prevented by the World War until after the armistice was signed on November 11, 1918. Wartime applications of radio on aircraft, in long-distance service, for location of ships' positions, etc., were rapidly adapted to peaceful public uses in 1919 and 1920; the trans-Atlantic fliers in the "NC-4" succeeded (1919) in sending messages 1,800 miles from the plane while in the air. During 1920 and 1921 radio services with Europe were recommenced from the newly equipped, powerful stations along the Atlantic coast of the United States, and 1922 saw the opening and commercial use of the largest plant in the world, located at Port Jefferson, Long Island. In the past few years the ship-and-shore services of radio have reached a new degree of perfection. It is now uncommon for a well-equipped vessel to be out of communication with land at any point of the trans-Atlantic voyage.

Radio Broadcasting. Last, but by no means least, the years 1921-1923 brought the commencement and organization of broadcast radio-telephone services, which send out, for whoever desires to listen, scheduled programs of music, lectures, news bulletins, and other recreational and informative material. Hundreds of these broadcasting stations are in operation throughout the United States, and the number of regular listeners has been estimated to be well up in the millions. This broadcasting of spoken words

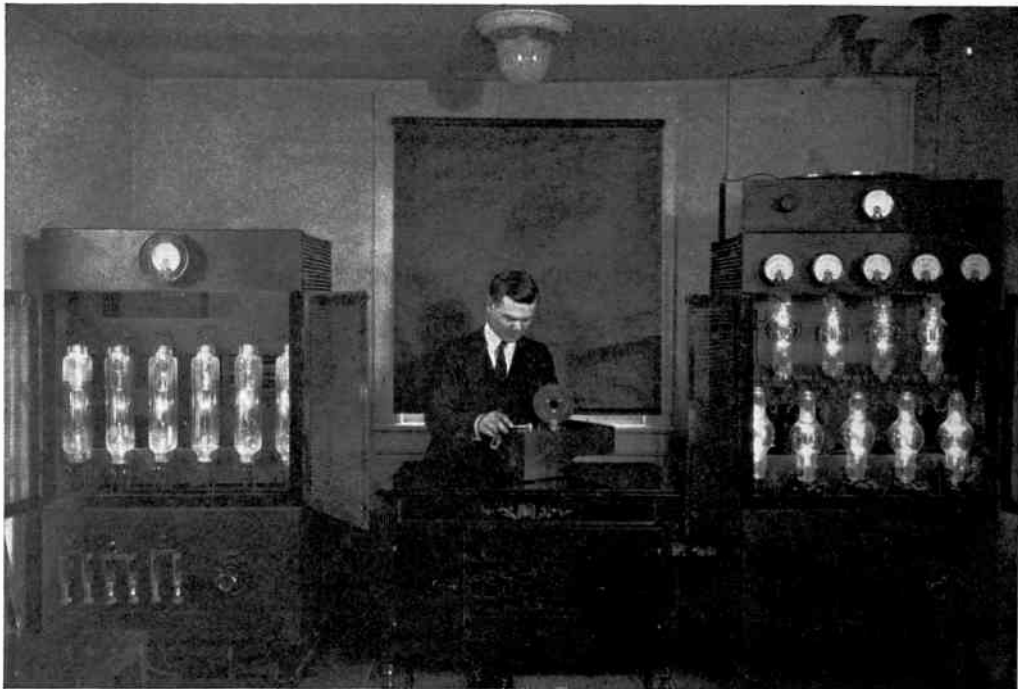

BROADCASTING TRANSMITTER AT "OLD WJZ", NEWARK, N. J.

Six tubes at the left supplied high-voltage direct current to operate the set at the right, in which are shown four oscillation-generating tubes and five others that impressed the voice-waves upon the radio currents. "Old WJZ" was the first short-wave radio-telephone transmitter to be heard across the Atlantic. Its place has now been taken by the new WJZ station at New York.

and of music is by far the most popular application of radio. It began in November, 1920, by the transmission of election returns from the Westinghouse station at Pittsburgh, Pennsylvania, and has spread not merely over the United States but to other nations in a way which proves that the service meets a true human need. Broadcast radio-telephony may not yet have the economic value of the transoceanic or marine radio-telegraph; nevertheless, it has aroused a great general interest in radio, and, as its character and scope improve, it is becoming more and more strongly knit into our ways of living.

A historical introduction is certainly no place for prophecy or speculation. Radio is here and is doing valuable work. We now have glanced at a somewhat broad outline of what radio is and the way in which it has reached its present estate. Let us next find out how radio operates and what the principles are upon which it depends.

CHAPTER II

THOUGHTS PASS BETWEEN US

IF you were in Chicago, how could you communicate with a friend in New York? By mail, certainly; or by telegraph or telephone. These are well-established systems of communication, and are the first that come to mind. There are, however, other entirely feasible plans. You might make a phonograph record of your message and send it on by express. More fantastically, you might have a motion picture taken of your hand while it spelled out the communication in the thumb-and-finger alphabet used by the deaf and dumb, and send the film to New York. Either of these schemes, and dozens of others, would carry the thoughts you desired to send, for each of them has in it the three things that are essential in any system for transmitting intelligence from one mind to another. Each has a transmitting mechanism, an instrumentality for receiving, and a message-conveying medium that connects the two.

For shorter distances, the problem of communication is much less complex. One can shout

across the street, or can signal a few miles by waving a flag or blowing a steam whistle. Our ordinary daily speech is just as much an exchange of thoughts or ideas as is the sending of a cablegram, though we are not accustomed to look upon it in that light. Even a wink or a wave of the hand carries its message. Here, again, we have the three important elements; each method embodies a sender, a connecting medium, and a receiver. It is safe to say that without these three things, and all of them, intelligence cannot be transmitted from one person to another.

Perhaps it would be a good idea to settle just what we mean by this "intelligence" that is to be sent from point to point. The word is not used to denote that abstract quality which is the opposite of ignorance or mental density; it means, in the communication arts, simply thoughts or impressions or ideas. "Information" would be a fair synonym, in this usage. Consequently, when you "transmit intelligence" from Chicago to New York, you are merely sending an understandable message that has some definite meaning or carries specific knowledge.

Signaling Codes. When one thinks about it for a moment, it seems odd that the clicks of a telegraph sounder or the buzzes in a radio receiver can possess a real meaning. The rattling of train wheels, as they pass rapidly over the switches of a railroad terminal, sounds a great deal like

the clicking of a telegraph instrument; yet it has no especial significance. How can one series or arrangement of sharp, tapping sounds mean "Come home at once", while another series of almost identical sounds means nothing whatever? The reason is that, by general agreement, certain groups of clicks have come to signify certain letters of the alphabet; by combining these groups we can spell out words and complete messages. The agreed-upon arrangement of clicks is a signaling code. When the sounds follow the code, they can convey intelligence; but when they do not, they cannot carry a message.

What is true of the clicks of the telegraph is also true of the sounds we use in speech. The syllable G-E-N has no meaning to us; neither has T-R-O nor N-I. But if we combine the three in a particular order, NITROGEN, we have produced a sound that means to us a particular thing; we have produced a word that, according to the code we call the English language, has one and only one meaning. A language is nothing but a code. We have generally agreed that certain sounds shall have certain meanings, but there is no reason, other than our general agreement, for fastening those meanings upon those sounds. CAT might just as well signify something hard and silent, instead of the soft and occasionally vocal animal we have agreed to call by that name. Other peoples use other language codes. Our adjective "bright"

(or "clear") becomes HELL in its German equivalent, but that sound has a quite different meaning to us. Youngsters who have not yet learned any nationally adopted codes for speech signaling, frequently make up their own, which none but their parents pretend to understand.

Written Messages. An interesting thing about our language codes is that they can be written as well as spoken; a code word may appear as a living sound or simply as a series of marks on paper. Any one who can read and write is able instantly to transfer the words from one form to the other, or to send or receive in either method. Learning to talk is simply mastering the spoken code; learning to read and write is nothing but memorizing the symbols we have agreed to let stand for certain sounds of the spoken code. Again, the significance of our written or printed characters is purely a matter of general agreement or convention; the symbols EYE might as well stand for the blowing of the wind as for the sound describing the organ of vision, had we not agreed upon the second.

Perhaps you are beginning to weary of this view of languages, of this emphasis on codes in general. Just bear in mind that without these codes, without these ways of conveying thoughts from one mind to another, our civilization not merely would be lost but could never have been attained. The systematic arrangement of thought

and sound symbols is the life of our intercommunication; the codes that we have agreed to use constitute a most important part of our artificial signaling systems, such as radio.

Postal Communication. Let us examine some of our more usual methods of sending messages, working out for each the inter-relation of transmitter, conveying means, and receiver. Consider first the letter or postal card. Here our sending operation consists of marking a sheet with a series of symbols having, according to our language code, the meaning we desire to transmit. The conveying operation comprises delivering the written page to agents of the government and their carrying it bodily to its destination; the mailing system and the card (or letter) together form the interlinking medium between sender and receiver. The receiving operation is the reading of the communication by the person to whom it is delivered. The joint working of these three fundamental parts of all intelligence-transmitting systems is sufficient to carry to the mind of one person the message of another.

Telegraphy. Another common way of sending information is by the telegraph. Here we really have three communication systems in series. To all intents and purposes, you write a letter to your local telegraph operator; you hand it to him; and he reads it. That is one complete system. He then spells out your message, letter

by letter, on his telegraphic sending key; the key being connected by a wire circuit, over which an electric current may flow, to a telegraphic sounder or receiver at a distant point. The receiving operator understands the coded clicking of his sounder to represent, letter by letter, the words of your telegram. This completes the second communication system having the three essential parts. Next, the man at the receiving instrument writes your message on a blank, and gives it to a boy to deliver. The person for whom the telegram is intended reads it. Your ideas are conveyed to him by the words of the dispatch, as his reading completes the third three-part system and, simultaneously, the entire communication chain.

The first and third parts of the telegraph system are simply letter-writing, delivery, and reading; thus each embodies the three important elements needed for carrying information. It is the second part of the telegraph system that has the most interest for all of us, and it will be worth while to find out how the sending telegrapher can indicate letters and spell out words over the telegraph wire to the receiving operator.

The Telegraph Code. In the first place, this telegrapher will not be able to use our spoken language for transmission of the message, because the sounds his instruments can produce are only clicks. He must, then, resort to the written lan-

guage; moreover, he must use a secondary code instead of our alphabetic forms themselves, for

A	· —	U	— · — ·
B	— · — · —	V	— · — — ·
C	— — · — —	W	— — · —
D	— — · —	X	— — · — · —
E	· —	Y	— — · — — ·
F	· — — · —	Z	— — — · —
G	· — — — ·		
H	· — — —	1	— — — — — ·
I	· — · —	2	— — — — — · —
J	· — — — — ·	3	— · — — — —
K	— — — — ·	4	— · — — —
L	· — — — —	5	— · — — —
M	— — — —	6	— — — — · —
N	— — — · —	7	— — — — · —
O	— — — —	8	— — — — — · —
P	· — — — — ·	9	— — — — — · —
Q	— — — — — ·	0	— — — — — · —
R	· — — — —		
S	· — — —	.	· — — — — · —
T	— — —	,	— · — — — · —

FIG. 6: The International Morse Code. — The combinations of dots and dashes that have been accepted all over the world for radio and cable telegraphy. As shown, a dash is equal in time-length to three dots, and the space between successive dots and dashes is the same in length as a dot.

his simple instruments cannot write or print our letter symbols. This secondary code is that which Morse devised for signaling with his original apparatus, and which bears his name. It consists of combinations of two elements, the "dot" and the "dash", a separate combination having been assigned to each letter of the alphabet. Dots and dashes of the Morse code are not periods and hyphens. From one viewpoint, the terms are misnomers; and it would be more nearly accurate to say (as do the English) "shorts" and "longs." A dot is a short impulse, and a dash is an impulse about three times as long.

In ordinary telegraphy, the sending operator is provided with a "key", which is really a light, pivoted lever having a knob so that one end may conveniently be pressed downward against a spring that normally holds it up. At the receiving station is a "sounder", which includes another pivoted lever working against a spring that ordinarily holds it in the upper position. When the telegrapher at one end of the line presses his key, the sounder lever at the other end of the line moves down with a strong click; when the sending key is released, the sounder lever is also released, producing another (but weaker) click. Thus the two levers move up and down in unison, as though they were mechanically fastened together.

A Mechanical Telegraph System. If we imagine a simple mechanical telegraph of the sort shown in Figure 7, it is not difficult to see how messages can be spelled out in the Morse code.

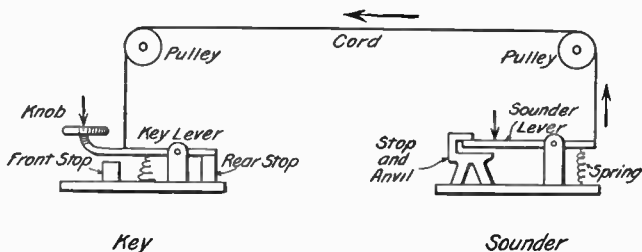

FIG. 7: A Mechanical Telegraph. — Pressing the key knob down moves the key lever against the front stop, draws the cord over the pulleys, and forces the sounder lever down on the anvil. Releasing the key allows the springs to bring the system back to the original position, as illustrated.

To send a dot, the operator presses the key knob for an instant and immediately allows it to spring up again. In the mechanical telegraph illustrated, this results in a short pull on the cord in the direction of the arrow; and an immediate release, with the consequent return to the original position. The tug on the cord pulls the sounder lever sharply downward on the anvil, making a loud click; the quick release allows the lever to spring back against the upper stop, with a gentler click. Thus a single dot sounds like “CLICK, click” on the sounder, the two sounds being only about one tenth of a second apart. To send a dash, the operator simply holds his key down a little longer, so that the interval be-

tween the initial **CLICK** and the final click of the signal will be about three tenths of a second. The dash heard on a sounder sounds like “**CLICK . . click.**” To send the combinations corresponding to the letters of the alphabet, dots and dashes are formed in rapid succession; the space between two signals being equal in length to a dot. Thus the combination for A, which is dot-dash,

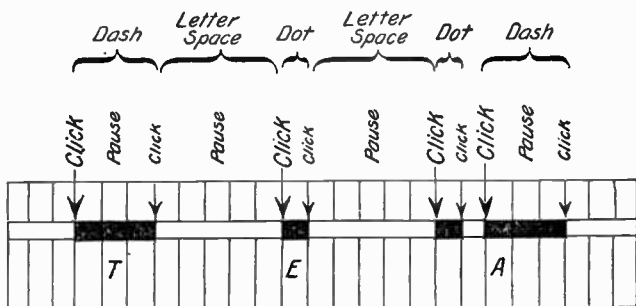

FIG. 8: "Tea" in the Morse Code. — The pause, or space, between letters is here shown as equal to the time of five dots. In practice, this "letter space" is usually shortened to equal three dots; and a five-dot "word-space," or pause, is used between successive words.

sounds like “**CLICK, click, CLICK . . click.**” When the receiving operator hears this particular combination, he writes down A; when he hears a single dash standing alone, he writes T; a single dot signifies the letter E. In sending, the letter groups are separated by a short pause, and words by a longer pause. The word **TEA** would be dash, pause, dot, pause, dot-dash; it would sound to the receiving telegrapher like “**CLICK . . click**”

. CLICK, click CLICK, click, CLICK
. . click."

The Simple Electric Telegraph. All of the foregoing applies equally well to the electric telegraph. Instead of having a moving cord passing over pulleys from key to sounder (short and long pulls on that cord being employed to indicate dots and dashes), the electric telegraph has a wire connecting sender and receiver. This wire does not move mechanically, but serves to guide short and long electrical impulses from one station to the other. As shown in Figure 9, the sending key is arranged to complete an electric circuit when the knob is pressed; and to interrupt the circuit, so that no electric current will pass through it, when the knob is released and the lever springs up again. The path or circuit that is provided when the key is pressed includes the wire line to the receiving station, and a coil of wire wound upon a soft iron core in the receiving sounder. When the sending key is held down, an electric current flows along the line wire to the receiving point, through the coil of the sounder, and back by the return line wire to the sending station. So long as the key is down, current flows; it stops flowing the instant the sending-key knob is released and the lever springs up, separating the contact points.

The most interesting action in the whole telegraph system is that which takes place in the

sounder. When electric current flows through the wire coiled around the soft iron core, that piece of iron becomes quite strongly magnetized and therefore capable of attracting another piece of iron fastened to the sounder lever. As soon as the sending key is pressed and the current starts flowing, the magnetism of the sounder coil pulls down the lever, and a sharp **CLICK** is produced when the lever strikes the anvil. So long as the

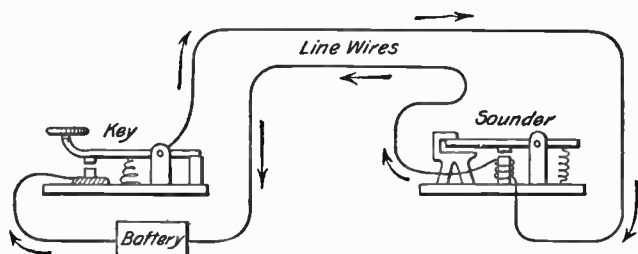

FIG. 9: The Simple Electric Telegraph. — The arrows indicate the direction in which the electric current will flow around the circuit as soon as the sending key is pressed down.

key is held down, the current flows and the coil remains magnetized; hence the sounder lever stays down also. As soon as the sending key is released, the circuit is broken; the current stops; and the core of the sounder coil at once loses its magnetism, so that the spring can pull the sounder lever up against the back stop with the characteristic weaker click that marks the end of a dot or dash. Thus the sounder lever, controlled by the magnetism produced by the flowing current, moves up and down exactly as does the lever of

the sending key. As we have seen, this is all we require in order to spell out messages with the aid of the Morse code. Wires to convey the pulses of magnetizing current are needed; but as far as we can string these wires and force an electric current through them, whether it be for one mile or a thousand miles, we can send our ideas by telegraph.

Signaling by Means of Speech. Suppose, however, that we do not desire to be limited to the written code. What if we should like to send our messages in spoken words, using the word symbols of our language instead of the clicks of the telegraph? Evidently we must find some way of transmitting sounds that are vastly more complex, — for speech has in it a tremendous range of tones and inflections; and for the speaker to be understood and recognized, all (or nearly all) of these must be carried from sender to receiver.

The simplest of the speech-transmitting systems is used in our everyday conversation. Here the speaker's vocal cords, oral cavities, and lips constitute the transmitter. The air is the transmitting medium between sender and receiver, for it conveys the sound vibrations that are created by the vocal cords in speaking. The listener's ear is the receiver of this simple communication system. Here, again, we have the three elements necessary for passing ideas from one person to another. If we examine the transmitter and re-

ceiver more closely, we find that, except for the inscrutable nervous system that controls the sender and interprets for the brain of the listener the vibrations intercepted by the ear, the process of oral conversation is a simple mechanical thing.

When we say a word, air from our lungs is driven across our vocal cords and causes them to vibrate. If the sound to be uttered is of a relatively high pitch, we hold the cords tightly stretched and they vibrate rapidly. If a lower tone is desired, we relax the vocal cords somewhat, so that they will vibrate more slowly. In oscillating back and forth, these muscular cords push the air particles near them back and forth; the near-by air particles (for air is composed of molecules that have weight and that can be driven about, as we all recognize when a strong wind is blowing) in turn strike others near to them, and thus the initial vibration is transmitted outward from the speaker's mouth. Each time the vocal cords swing back and forth, they strike the air molecules a blow; this blow will be transmitted by collision of one particle against the next, and finally will reach the eardrum of the listener, which will be moved slightly by the impact of the air molecules nearest to it.

The Relation between Pitch and Vibration Rate. If the vocal cords are vibrating slowly, relatively few impulses will be given to the air, and hence to the eardrum, in any particular

length of time. A slow vibration of the eardrum, acting on the brain through the auditory nerves, produces the sensation of sound having a low pitch. If the vibration rate of the vocal cords is gradually increased, so causing more and more air impulses per second, the rapidity of the impacts on the eardrum will also be increased and the little diaphragm (the drumhead of our ears) will be moved back and forth faster and faster. The increasing rapidity of vibration will produce the sensation of a tone of rising pitch; the greater the number of vibrations in each second, the higher the pitch of the sound we hear.

One of the most interesting things about this transmission of sound is that the rate of vibration remains the same throughout. If the vocal cords swing 256 times per second, they strike that many blows, in each second, upon the air particles. Each air molecule that transmits the vibration will therefore be impulsed 256 times per second. Finally, the ear diaphragm will be moved back and forth at this same frequency of 256 swings per second. The pitch of tone which this particular rate produces is that of middle C in the musical scale. Thus we have, for the transmission of sound, a vibrating body (the eardrum) at the receiver exactly duplicating the movements of another vibrating body (the vocal cords) at the transmitter. You will see at once the similarity between this and the telegraph, in which

the sounder lever duplicates the movements of the lever of the distant sending key. For transmitting sounds, however, the mechanical movements involved are necessarily far more rapid and delicate than those of the telegraph sounder.

Simple and Complex Sounds. All sounds may be represented by mechanical vibrations. As we have seen, a simple movement of the eardrum 256 times per second produces the sound sensation of the pitch of middle C. If the vibrations

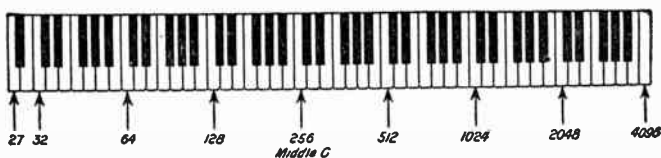

FIG. 10: The Note-Frequencies of the Piano. — The lowest note of the keyboard vibrates only 27 times per second, but the highest has 4,096 vibrations per second. The illustration gives the values for C in each octave, the instrument being tuned to the scientific pitch. International pitch is slightly higher.

are cut in half, to 128 per second, the sound produced is one octave lower; if they are doubled in frequency, becoming 512 per second, the pitch is that of the C an octave higher than middle C. If the vibrations are slowed down to less than about sixteen per second, they cannot be heard at all, for the pitch becomes too low for our ears; if they are increased to more than about sixteen thousand per second, they are too rapid and the pitch is too high for most human ears to recognize as sound. Simple vibrations produce single pure tones if their frequencies are between these lim-

its of audibility (*i.e.*, from about sixteen to about sixteen thousand vibrations per second). When two or more frequencies of vibration are produced simultaneously, the resulting tone is more complex and may be a musical chord, a discord, or only a noise. If the frequency relations are quite complicated and are changing from instant to instant, the sound produced may be a spoken word. In any event, the air vibration (however simple or complex) is set up by the vibrations of the transmitting element of our sound-conveying system, and produces an identical vibration of the receiving eardrum.

So much for the mechanism of speech and listening. Let us now find out what can be done to transmit vocal sounds over distances so great that the loudest shout is inaudible. We have seen that the general requirement for sound transmission is to make a distant diaphragm vibrate in the same manner as does the air that is impulsed by the vocal cords of the speaker. To increase the distance of transmission, we need a new medium to convey the vibrations.

An Acoustic Telephone. Suppose we were to support a pair of flexible steel diaphragms at points a thousand feet apart, and stretch tightly between their centers (as in Figure 11) a thin steel wire. If you spoke against the near-by diaphragm, the air vibrations of your voice would strike it and cause it to vibrate just as though it

were an eardrum. To consider a single impulse: as the diaphragm moved away from you, it would, by a slight amount, relieve the tension on the connecting wire; this release would permit the distant diaphragm to spring out slightly and to give an impulse to the air before it. The air impulse would strike and move the eardrum of a



FIG. 11: An Acoustic Telephone. — The tension at both ends of the line wire bends the diaphragms outward from the cylindrical casings used for mouthpiece and earpiece.

listener close to the distant diaphragm, just as though it had come to him directly from your vocal cords.

If these impacts were repeated 256 times per second (as they would be if you sang a note of the pitch of middle C before the near-by diaphragm), they would pass over the wire at this rate, and the distant diaphragm would vibrate at the frequency of 256 times per second. The listener would therefore hear the sound that you were singing. Similarly, if you spoke against the transmitting diaphragm, the wire would faithfully transmit, by variations in tension, the complex vibrations of speech; these would be reproduced by the distant receiving diaphragm and could be heard by a listener.

In this simple mechanical or acoustic telephone, we have not only the three essentials for convey-

ing intelligence (the sending diaphragm, the connecting wire, and the receiving diaphragm) but also the essential for transmitting sounds, *viz.*, separated bodies moving in unison at the rapid rates of sound oscillations.

An Elementary Electric Telephone. For transmitting speech over distances greater than would be practical with the acoustic telephone, we have the electrical type. In principle the electric telephone is not so very different from the acoustic form. The sound vibrations are simply converted into undulations of electric current, which are passed over connecting wire lines and reconverted into mechanical vibrations of a receiving diaphragm. Figure 12 represents a simple form of electric telephone in which these operations can easily be traced. The transmitter is a diaphragm that carries one of a pair of small polished carbon plates, between which lies loosely a quantity of carbon granules. A battery is provided to produce a continuous flow of electric current. The circuit through which the current passes is led to the diaphragm and one of the carbon plates, across the loose granules to the other plate, and then over one wire line to the receiver. At the receiver is a second diaphragm, mounted close to the poles of a magnet, the attractive power of which produces a slight concavity of the diaphragm. Around the ends of the magnet, on pieces of soft iron attached to the poles, are wound

coils of wire. The current from the transmitter passes through these coils and returns to the battery over the other wire line. Thus a small electric current generated by the battery will constantly flow across the carbon granules, through the upper line wire, around the coils wound upon the magnets of the receiver, and back to the battery. So long as no sounds strike the trans-

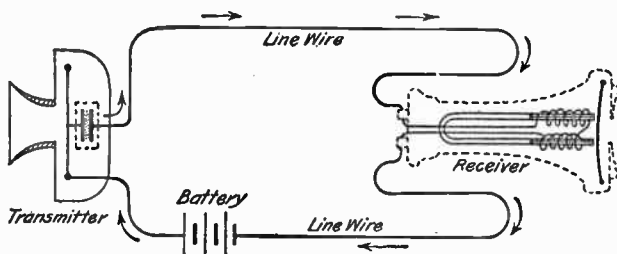

FIG. 12: The Elementary Electric Telephone. — Voice waves striking the transmitter diaphragm produce variations in the pressure on the loose carbon granules behind it. These cause current variations that pass over the line wires to the distant receiver and change the attractive power of the receiver magnet, so moving the receiver diaphragm and thereby reproducing the original voice waves.

mitter diaphragm, this current remains of uniform strength.

You will perhaps recall that we found that when an electric current passed around the coil of wire in the telegraph sounder, it made a magnet of the soft iron core on which the coil was wound. That same effect is utilized in the electric telephone receiver. The current passing through the receiver coils increases or decreases the pulling power of the receiver magnet, which acts

upon the receiver diaphragm, by an amount depending upon the current strength. A sound wave striking against the transmitter diaphragm moves it in and out; and the motion alternately compresses and releases the carbon granules between the two carbon plates. The amount of electric current which the battery can force through the circuit depends upon the looseness or tightness of these carbon granules. Consequently, when the transmitter diaphragm moves back and forth, the amount of current alternately increases and decreases at the same rate. The variations of current strength traverse the wire lines to the receiver, where they alternately increase and decrease the pulling power of the receiver magnet. The resulting variations in strength of the magnet move the receiving diaphragm back and forth, so reproducing the exact motions of the transmitter diaphragm; and (as in the acoustic telephone) giving off a reproduction of the sounds that were initially impressed upon the transmitter. In the electric telephone, again, we have the essential transmitting device; the connecting medium consisting of wire lines and the current flowing over them; and the receiving mechanism. Also, since sounds created at one point are repeated at another, we have the two diaphragms capable of rapid motion in unison.

Are Connecting Wires Essential? Having outlined what communication is, what things are

necessary for its establishment, and how it may be carried on by Morse code or by speech electrically conveyed over wire lines, we are ready to consider radio. Suppose that you have a telegraph key in New York and some one else, to whom you wish to signal, has a sounder in Chicago. How can you make the lever of his sounder move up and down in accordance with the motions of your sending key, if you have no wire connection? Or imagine that you have a telephone transmitter diaphragm in your house and that you want to talk with a friend at sea, — a friend who has a telephone receiver in his stateroom but to whom there is no possibility of extending a wire line. How can you force the metal disc in his telephone receiver to vibrate in unison with the oscillations of the similar disc in your transmitter? The all-essential middle link, which we must have to exchange messages, is missing. To supply it and to utilize it, — those are the problems of radio.

CHAPTER III

AN INTANGIBLE CARRIER

WHAT we need for wireless communication is, in addition to the sending and receiving instruments, some impulse-conveying medium that is present at both ends of the transmission system and is continuous throughout the whole distance between them. If the medium did not extend continuously from one point to the other, we could no more expect our messages to jump across the interruptions than we can expect the wire telegraph to work when the lines are broken.

There are several things which spread over great surfaces of the earth and which we might use to carry messages from one place to another. The ground itself will transmit sound or electric currents to some extent; Morse, Trowbridge, and Preece experimented (see Chapter I) with electric conductivity of this sort, but could not signal over substantial distances without using wastefully large amounts of power. Sound transmission through the earth has been found even less practical. The same comments apply to signaling through large or small bodies of water. Although the ocean might appear to be an ideal

medium for signaling over great distances, yet the use of either salt or fresh water for electrical or acoustic transmission has not thus far been worked out for telegraphing over many miles. For telephony, the earth and water methods have proved even less satisfactory.

The Atmosphere. Perhaps we might be able to use the air for our wireless transmission? This also has been suggested and tried out in several ways. As we know, there is around the earth a layer of air forming a veritable ocean some twenty or more miles deep. We live along the bottom of this sea of air. The atmosphere reaches all over our globe; and, if some feasible way of using it were found, it should be an exceedingly valuable medium for wireless communication. Sound signaling through the air will work for distances of a few miles (the loudest foghorns reach out about fifteen or twenty miles); but to signal farther, it would be necessary to make more noise at the transmitter. This would, of course, be intolerable. Foghorns and whistles are bothersome enough; a huge, sonorous telegraph transmitter, creating sound waves that could be heard even twenty miles away, would be a neighborhood nuisance and would not be endured, — except perhaps in localities where very few people lived. In such places the signaling system would probably not be of enough value to make it worth installing and operating.

Another way of using the air to transmit power or signals, was suggested by Nikola Tesla a number of years ago. Recognizing that at, or near, sea level it requires a tremendous electric pressure to drive a current through air for even a few feet, but that as the atmosphere becomes more highly rarefied (as it is several miles above the earth's surface) much less pressure is needed, Tesla proposed to build tall towers upon mountain tops and literally to force electric power through the higher levels of our atmosphere. If this were done, the sky would become luminous where the current traveled. It is possible that the plan could be put into practice, but apparently it has never been considered sufficiently economical to make worth while the erection of a working system.

Sending Messages on Air Waves. Air-wave signaling does possess, however, some other and perhaps more practical possibilities, which have not been put into use. Since our ears are not able to hear air vibrations of frequencies below about sixteen per second (which is a good deal deeper in pitch than the lowest key on a piano), it is at least conceivable that a very intense air wave of something like ten vibrations per second could be generated without disturbing anybody. This air wave would spread out in all directions from the generating point, just as the sounds of a whistle or a bell spread out in all directions. Like

sound waves in air, the inaudible wave would travel at the rate of 1,140 feet per second, and would become weaker and weaker as it passed farther away from its source. To receive it, one would have to build some sort of intercepting system, which might be imagined as a huge megaphone-like ear trumpet. Attached to this there

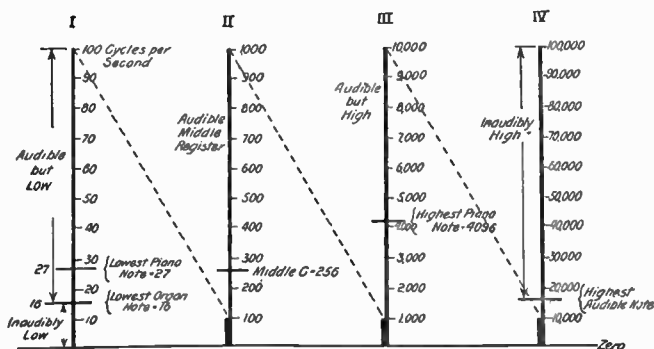

FIG. 13: Sound Equivalents of Vibration Frequency. — Each vertical scale contains ten times the range of frequency of its left-hand neighbor, as is indicated by the slanting dashed lines. Notes much higher than the highest of the piano (4,096 vibrations per second) can be heard, but the lowest note of the organ (16 vibrations per second) marks the deepest tone that can ordinarily be recognized as musical.

would be required some sort of artificial ear that would be sensitive to these slowly vibrating air waves and that would not merely detect their arrival but also indicate either their starting and stopping (for telegraphic signaling) or their variations in intensity (for telephony). Probably the best way to do this would be to provide an instrument to transform their inaudibly low frequency of ten per second to a higher frequency (say one

hundred or two hundred vibrations per second), such as would be within the range to which our ears can respond. It would not be very hard to build an air-wave wireless system of this kind, but its commercial value is somewhat doubtful. It would probably be much less economical than is the radio of to-day.

Another possibility in air-wave signaling is to use vibrations at the other end of the audible range; that is, so high in pitch that they cannot be heard. Suppose we built a transmitter which, when controlled by a telegraph key, would emit powerful air waves of a frequency of twenty-five thousand vibrations per second, in "short" and "long" groups corresponding to Morse dots and dashes. These waves would not, in spite of their great intensity, be heard by human ears. They would spread outward in all directions; and at any particular receiving point could be intercepted and converted to a frequency only $\frac{1}{100}$ as high (two hundred and fifty vibrations), and translated by a listening operator. If the receiving station were not so far from the transmitter that the air waves (in traveling from the sender) grew too weak to be heard when reduced to an audible pitch, dots would be received as short musical tones and dashes as longer tones of the same kind. How far these exceedingly high-frequency air waves could be forced to travel without becoming unrecognizably feeble is, again, a matter

of some doubt. We know that sound waves (which are simply air waves of frequencies that can be heard) rapidly grow, to our hearing, weaker and weaker as we move away from the point at which they originate. It is fair to assume that these air waves of twenty-five thousand vibrations would also rapidly weaken as the distance of transmission increased; and the probabilities are that, even to start with, it would be difficult to make very intense vibrations. Thus it seems likely that the atmosphere would not prove to be a really good medium for conveying messages by air-wave wireless.

Waves in Space. We have considered and discarded the earth (its solid portions, that is to say); the great bodies of water on the earth; and the air surrounding the earth. None of these will do as an ideal transmission medium for signals. One may well ask what remains. What is there left that extends from any one point of our terrestrial globe continuously to any other point to which we may wish to send messages? The answer is almost paradoxical. Having eliminated air, water, and soil, we have left nothing but empty space; and it is this intangible space (devoid of all material substances) that carries the waves used in radio.

It is hard to imagine waves passing from one place to another in mere emptiness; and largely for that reason, scientists built up a theory in-

volving something termed the "ether", supposed to fill all space and to permeate all matter. According to the theory, this so-called ether was not limited to a layer around the earth. It extended outward across the ninety million miles that separate us from the sun; and beyond the sun to the boundaries of the universe (if the universe has boundaries!). The ether could not be blocked out by walls; it was supposed to penetrate everything, and to be present as much in what we call a vacuum as anywhere else. This ether was thought to carry all waves of light and of heat. The speed of these waves has been measured and found to be about 186,000 miles per second. To permit such tremendous velocities, the ether had to be imagined as more rigid than the hardest steel; yet it obviously could not be assumed to interfere with the free movement through it of ordinary bodies, since we all live and move in the midst of it. The consideration of conflicting properties of this general sort has gone a long way to discredit the idea of a universal ether. It seems simpler to conceive the light waves and the heat waves merely as existing in and passing through space than to reconcile all the opposing views of the imaginary ether; and the tendency to-day is to drop all talk about "ether waves" and to say that no such thing as the ether exists. On the other hand, the ether theory has still many staunch defenders, who contend that if

“empty space” is really empty, it can transmit nothing whatever; and who say not only that something more than mere space conveys the waves of light, but that this something is the ether.

Perhaps the conflict is mostly a matter of words and their definitions. In any event, we know that nothing material, nothing tangible, is required to carry light and heat. We know this because both light and heat reach our earth from the sun, over a distance of which by far the greater part is marked by the absence even of air. We know that one can see straight through the evacuated bulb of an incandescent lamp or X-ray tube, — that light will pass freely through the most nearly perfect vacuum that can be made.

Light Waves. What is this light, which can travel in free space where there exists “nothing at all”? We have spoken of light waves; but why is light a “wave” motion? Why might it not be a very fine substance thrown off in almost evanescent particles by the sun? All these questions were asked many years ago, and it has taken many years to learn the answers to them. The experiment that finally proved light to be a wave motion was one in which two beams of light were mixed with each other. It was found that by moving one beam very slightly with respect to the other, the resulting effect might be made either a doubly bright light or absolute darkness (which is the absence of light). This

adding of two things together in such a way that they may destroy each other partially or completely, or may augment each other in whole or in part, cannot be accomplished when material things are involved; matter added to more matter always results in still more, so long as its form is not changed. The effect is a characteristic of wave motions, however, and the evidence is that light and heat (which behaves in the same way) are wave motions; whether electro-magnetic waves in ether or simply in free space, we do not know.

Light waves have been suggested and used as a basis of signaling. They flash from sender to receiver at the terrific speed of 186 miles in $\frac{1}{1,000}$ of a second, and they may be used for telegraphy (as in the heliograph) or for telephony. However, they are absolutely stopped in their travels when they strike opaque objects, such as hills or buildings; and their effectiveness is greatly diminished when they have to pass through semi-transparent bodies, such as fogs, steam, or smoke. Moreover, beams of light travel in practically straight lines. They do not bend easily around large obstacles; and even over the clear surface of the sea their progress would be stopped by the earth's curvature at distances of twenty miles or so, unless high towers were built for flashing and watching (receiving) the signals.

All of these objections may be overcome, however, and the advantages of signaling by space

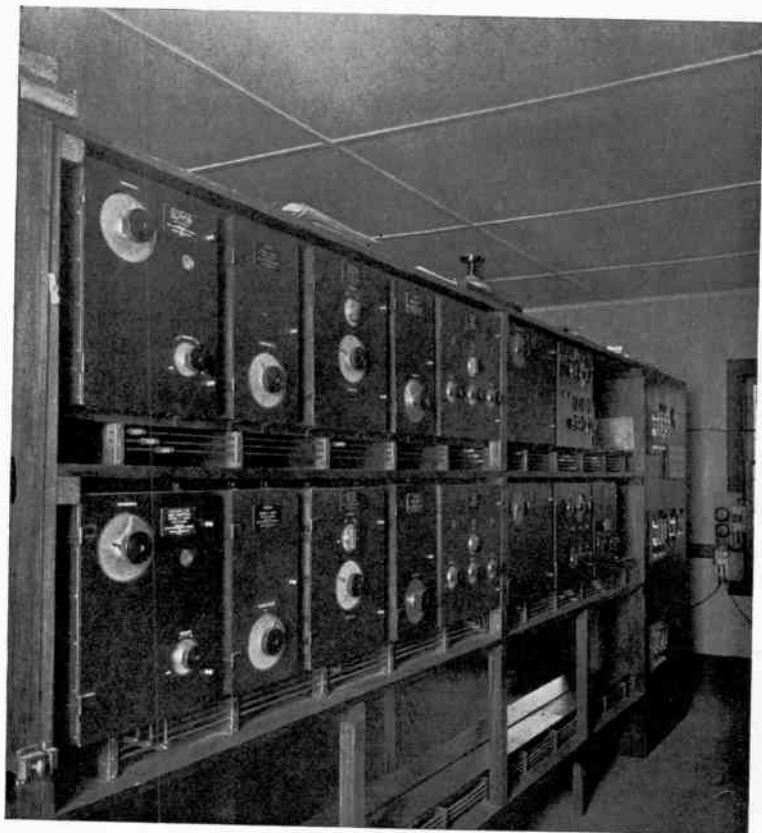

TRANS-ATLANTIC RADIO-TELEGRAPH RECEIVERS AT RIVERHEAD, LONG ISLAND, N. Y.

Used in conjunction with the Rocky Point transmitter.

waves retained, if we use the sort of vibrations first demonstrated by Hertz. These are electro-magnetic waves that travel through space at the speed of light, and that are in fact identical with light waves except that they vibrate at much lower frequencies. It is not hard to create these Hertzian waves, nor to control their emission, nor to detect their arrival at a receiver; neither is it difficult to see how these operations could be coördinated into a wireless-telegraph signaling system.

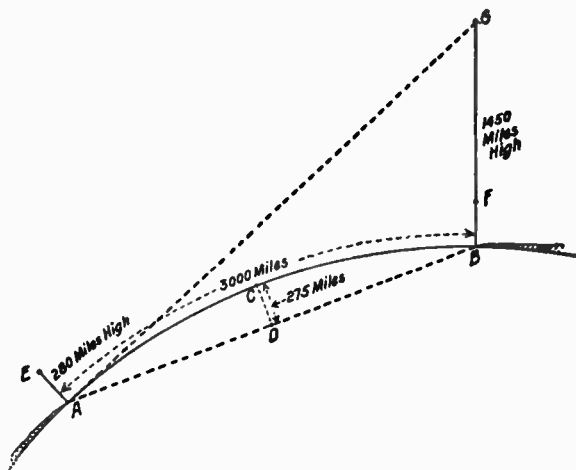

FIG. 14: The Earth's Curvature across the Atlantic. — Between points like *A* and *B*, 3,000 miles apart over the sea, (*A-C-B*), a straight line (*A-D-B*) would pass 275 miles below the surface (*C-D*) at mid-ocean. To look or signal by straight-moving light waves across the Atlantic, we should require towers 280 miles high on each side (*A-E* and *B-F*), so placing *E*, *C* and *F* in a straight line; or a single tower 1,450 miles high at one side (*B-G*) to receive signals from the surface of the earth at *A*. Since radio waves bend around the earth's surface as they travel over it, transoceanic radio signaling can be accomplished with radiating towers only a few hundred feet in height.

The Matter of Frequency. It will be worth while to examine a little more closely these various vibrations in space. We have seen that electro-magnetic waves include light and heat, as well as the Hertzian or radio signaling waves. All of these are similar except in the matter of frequency, which is simply the rapidity with which they vibrate. Frequency of vibration is usually stated as the number of complete to-and-fro vibrations occurring in one second of time. One such complete vibration is called a cycle, and any particular wave motion may be said to have a frequency of so many cycles per second. A frequency of ten cycles per second (often written merely "10 cycles", it being understood that the time of one second is meant) signifies that the element under consideration swings from one extreme to the other and back again ten times in one second.

We can imagine a log floating on the ocean's surface, rising and falling as the waves of a ground swell pass under it. If it goes up and down twelve times in each minute (which is a fair value for such an ocean wave), it would be proper to say that it is vibrating at the frequency of twelve cycles per minute, and that the waves moving it have this same frequency. Air waves have, as we have already seen, considerably higher frequencies, and these are more conveniently measured in the number of cycles per second.

Electro-magnetic waves in space have still higher frequencies of vibration.

Invisible Rays. The most rapid vibrations about which we have much information are those of a sort of invisible light given off by radium, and called "gamma rays." These oscillate at the almost inconceivable rate of about 480 quintillion cycles in one second. X-rays utilized to penetrate the densest tissues of the body vibrate only about one twentieth as rapidly, or at twenty-

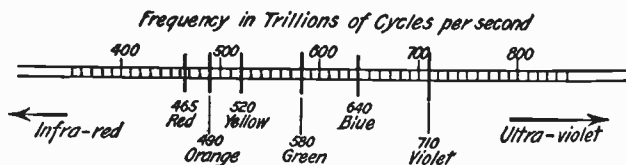

FIG. 15: The Color Scale of Frequencies. — Colors, like tones, have individual frequencies. Between the values indicated, lie the blended colors. A bluish-green might have a frequency of 610 trillion vibrations per second.

four quintillion cycles per second. Softer X-rays (as they are called), used for photographing bones in the fingers and so on, may have only about one eighth of this frequency, or about three quintillion cycles per second. As the frequency of oscillation becomes slower, the next useful waves encountered are the ultra-violet rays. These have certain rather obscure and often overestimated curative powers, but are of the greatest practical value in disinfecting liquids. Their vibrations are less than $\frac{1}{2,000}$ as rapid as those of the slower X-rays; beginning at about 1,500

trillion cycles per second and extending downward to somewhat more than one half this frequency, or 800 trillion cycles per second.

Waves We Can See and Feel. All of these exceedingly rapid wave motions, although identical in character with light, are invisible to our eyes. As soon, however, as we slow down the vibrating frequency a little more, we pass from the ultra-violet into the range that we can see as violet-colored light. This color sensation is produced when electro-magnetic waves of frequency about 710 trillion reach the eye. As the frequency is further reduced, the color we see gradually changes into blue at about 640 trillion cycles; green at 580 trillion cycles; yellow at 520 trillion; orange at 490 trillion; and finally red at 465 trillion cycles per second. Slowing the vibrations down below a frequency of approximately 400 trillion, takes them once more outside the visible range, but in the opposite direction. These infra-red rays we can feel as heat, when they reach us strongly enough. The warmth we feel in sunlight, even though it falls upon us through window glass (which would prevent warmed air from passing), is due to the slower waves, which have frequencies from that of red light down to about one quarter its value, or 100 trillion cycles per second. Heat waves that we can feel, but that are even slower than those contained in the radiations reaching us from the sun, extend down to about

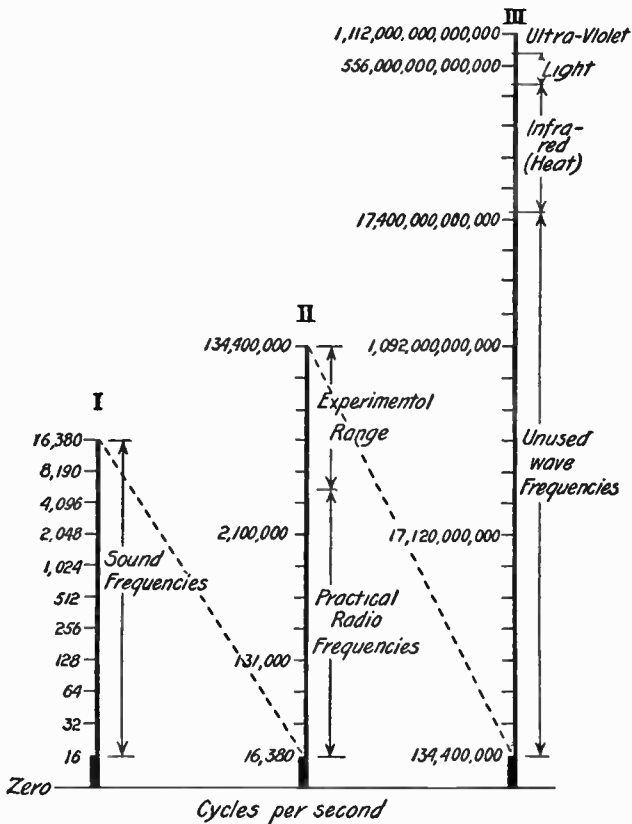

FIG. 16: Radio Frequencies Compared to Light and Sound. — This chart is arranged in octaves, i.e., each division represents a doubling of frequency. Sounds used in music cover about eight octaves, and audible sounds about ten octaves, as shown by scale I. These are usually air or other mechanical vibrations. Radio frequencies overlap the higher sound frequencies to some extent; but practical values run upward some eight or nine octaves from 16,000 cycles. These are usually electro-magnetic vibrations. Experimental frequencies extend a few octaves higher; and then come about seventeen octaves of frequencies not in everyday use. The whole scale of visible waves (light) extends over only about one octave.

one fifth of this figure, or twenty trillion cycles. Such waves are sent out by bodies heated to approximately the temperature of boiling water.

Lower Frequencies Used for Radio. Far below the lowest heat frequencies we come to the electro-magnetic waves used in radio signaling. Like all the others, they travel through space at the speed of light (186,000 miles per second) and have vibration rates much above those we usually think about. Marconi's early work was done with waves of about ten million cycles. This is as high as any radio frequency used to-day, though it is only $\frac{1}{200,000}$ as rapid as the lower heat frequencies just mentioned. Radio waves whose frequency is one tenth as high as those of Marconi's experiments, or one million cycles, are common in ship-and-shore communication to-day. Frequencies of one and a half million cycles are used by amateur radio operators. The broadcast radio-telephone services were first conducted mainly at 833,000 and 750,000 cycles; other wave frequencies from 550,000 to 1,350,000 cycles are now used in the same way.¹ The usual marine signaling frequency is 500,000 cycles per second. International time signals and weather reports

¹ The frequencies given above in cycles per second may even more conveniently be expressed in kilocycles per second (thousands of cycles per second); e.g., 833,000 cycles equals 833 kilocycles, 750,000 cycles equals 750 kilocycles, etc. This terminology is advocated by modern radio engineers, and will be quickly and easily adopted by all who are familiar with the metric system.

are sent out on waves of still lower frequencies, having 120,000 vibrations per second. The great transoceanic stations use the lowest frequencies encountered in radio, from about 50,000 cycles down to only 15,000 cycles or so. At this point we begin to trespass upon the vibrations that are slow enough to produce air waves of audible frequencies; and we have exhausted the practical range of present-day radio.

Waves That Keep On Going. The fact that the air in which we live and the space about our earth are filled with vibrations flashing in all directions with the speed of light and having frequencies from a few tens of thousands to many millions of millions, is one we do not usually appreciate. Only the few vibration rates that affect us as light and heat make any direct appeal to our senses. We have no sensation power to detect the others. Yet they are all about us; no matter where we ordinarily go, some of these electro-magnetic waves can reach us.

Light of all colors, and heat, penetrate clear glass windows; red light and heat pass through red glass; X-rays go through materials opaque to light. Radio waves can travel through fogs, buildings, rocky cliffs, and many other obstacles that would stop the waves of higher frequencies. And what they cannot go through, they are usually able to bend around; so that if they can be started off with enough power, they will speed

across the surface of the earth to receivers located thousands of miles away, — hurdling or shooting directly through forests, cloud banks, cities, or mountains that may lie in their path of travel. Thus in the electro-magnetic wave of comparatively low frequency (as contrasted with light and heat waves) we have a carrying medium that can be used to flash messages from point to point along the earth's surface, or from the earth to a plane or a dirigible high in the air, or even between airships. This is the basis of modern radio communication. To see just how it is accomplished, we need only to consider how these electro-magnetic waves are created; how the messages are impressed upon the waves; and how the message-bearing waves are intercepted and interpreted. The first of these topics is the subject of our next chapter.

CHAPTER IV

RADIO WAVES ARE CREATED

To understand how electro-magnetic waves for radio signaling may be generated, we shall have to look into some of the simpler actions of electric circuits; for it is by means of electric currents that we produce the radio waves. Let us begin, then, by agreeing that there are some substances (like copper and most other metals) through or along which an electric current can flow freely, and which are therefore called "conductors." There are other materials (like glass, porcelain, and rubber) which quite effectively prevent the flow of current, and which are called "nonconductors" or "insulators." It is, to be sure, difficult to draw an exact and definite line between conducting and nonconducting materials. Glass, for instance, is insulating at normal temperatures but becomes a fairly good conductor when heated. Nevertheless, it is not hard to classify most bodies well enough to meet all practical purposes.

The most common conductor used to convey electric current is the copper wire. Copper is the best current carrier of the ordinary metals; it is nearly as good as the far more expensive metal,

silver, which is the best conductor we know. Nothing is perfect, however; even copper and silver tend to hold back the flow of electric current, and this property is called their "electric resistance." The longer a piece of wire, the more it will hold back the current; and the smaller its cross section (*i.e.*, the thinner the wire), the more resistance will be encountered in forcing current through it.

Forcing the Current to Flow. Evidently something is necessary to drive electric current to flow against this resistance exhibited by all conductors. The driving force that tends to produce a flow of current is called "electromotive force." We should expect that the greater the electromotive force we apply to a circuit having some definite amount of resistance, the greater would be the quantity of current driven through it. This is the fact, as has been many times proved by experiment. We should also expect that any definite amount of electromotive force would be able to drive more current through a low-resistance circuit than through another circuit having a higher resistance. This, also, is the fact.

There is one other fundamental that must be realized. This is simply that, in order for a current to flow, it must be provided with a complete conducting path from the high-pressure side of the source of electromotive force back to the low-pressure side. Such a complete path is called a "closed circuit." If broken at any point by

insertion of an insulator, the circuit is said to be "opened" and no current will flow.

If we take a length of copper wire and twist the ends together, we form a loop, or a closed circuit, through which current can flow. No current does pass, however, for there is no source of "e.m.f." (electromotive force) in the circuit. If we cut the closed loop at some point, thus forming two wire ends, and attach these, one to each of the two terminals of a battery, a different state of affairs exists. The battery is a source of e.m.f., and it develops a "potential", or electric pressure, which tends to make a current flow. The amount of e.m.f. produced by any battery or generator may be measured in units of electrical pressure called "volts." The higher the voltage, the greater the electric pressure. If the battery we use is an ordinary dry cell, it will apply to the wire circuit a pressure of one and one half volts; if it is a single lead storage cell of standard type, the pressure will be about two volts.

How the Amount of Current Varies. Let us suppose that our wire circuit is fifty feet long and that we used wire of Number 20 gauge. This will have a definite electrical resistance, which may be measured and expressed in "ohms"; the ohm being the unit of electrical resistance. The resistance of the circuit having been determined, it is easy to find how much current will be forced

through by a battery of any particular voltage. One simply divides the pressure in volts by the resistance in ohms; and the result is the amount of current in terms of "amperes"; the ampere being the practical unit of current flow. Thus, if the resistance measures one half an ohm (which is about right for fifty feet of 20-gauge copper wire), the current will be $\frac{1.5}{0.5}$ or three amperes for the

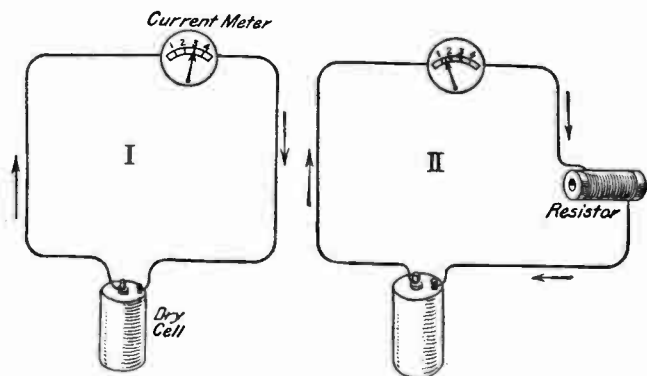

FIG. 17: The Effect of Resistance. — The simple circuit at I passes 3 amperes as shown by the meter. When a resistor of $\frac{1}{2}$ an ohm is inserted in the circuit, as at II, the $1\frac{1}{2}$ volt dry cell can force only $1\frac{1}{2}$ amperes through the circuit. The arrows indicate the direction of current flow, according to the usual convention.

dry cell; and $\frac{2}{0.5}$ or four amperes, for the storage cell. This current will flow from the "positive", or high potential, end of the battery through the circuit to the "negative", or low potential terminal, according to the usual convention.

Now, suppose that we wind another fifty feet of this same wire upon a spool (the copper wire would, of course, have to be insulated, or

covered, in order to keep the successive turns from touching each other) so as to form a compact unit. Obviously, this will have, from end to end, the same resistance as our fifty-foot loop circuit. If we cut the loop at some point and connect the new unit into the circuit, the current will have to traverse the wire wound on the spool in addition to that in the loop itself. The resistance of the circuit will be of twice its original value, and hence (for the same driving potential) the amount of current will be halved.

We could easily rig up a circuit containing three two-volt storage cells in series, so that each would add its electromotive force to the others to produce a total pressure of six volts. If this circuit contained a current-measuring instrument, or "ammeter", we could read on its scale the amount of current flowing. Further, if we put in the circuit a coil of high-resistance wire fitted with a sliding contact, so that the current could be directed through any desired number of turns, we could control the amount of current very handily. Suppose that this variable resistance coil (which is usually called a "rheostat") could be altered from zero resistance (when all the turns were idle) to a maximum of six ohms; and that in the same circuit there was also connected the filament of a small incandescent lamp having a resistance of six ohms. The current from the positive end of the battery would then flow through the part

of the rheostat connected in the circuit, on through the filament, thence through the ammeter, and back to the negative terminal of the battery. If the entire rheostat were active, the circuit resistance would be twelve ohms; the six ohms of the rheostat being added to the six of the filament, and the connecting wires being neglected because they are usually short and thick and therefore of very small resistance. The current flowing would be one half an ampere, as we can easily determine by dividing the total resistance of twelve ohms into the total e.m.f. of six volts. If the rheostat were all idle, the circuit resistance would be six ohms (due to the filament alone) and the current would be one ampere. Current values between these extremes of one half an ampere and one ampere could be had at will by varying the amount of the rheostat in circuit.

Direct and Alternating Currents. That is all there is to the simple battery or direct-current circuit. The current in such an arrangement is called "unidirectional", or continuous, or direct, because it is assumed to flow directly (in one direction) from the positive to the negative terminal of the source. The relation between the current, the voltage, and the resistance is stated by Ohm's law. This is simply the division of volts by ohms to determine amperes, such as we have been doing.

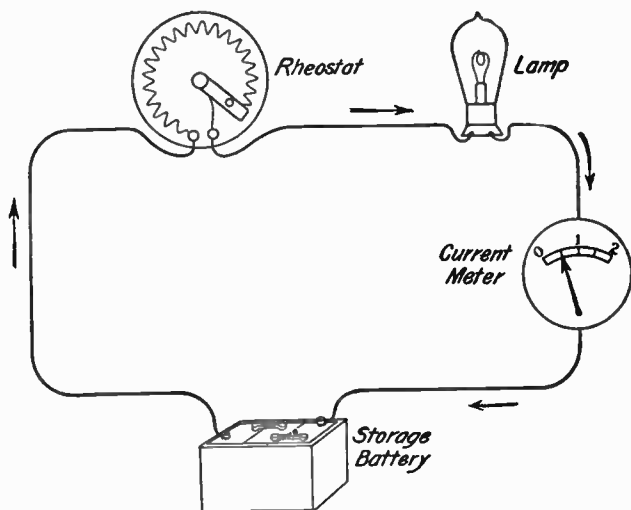

FIG. 18: A Battery Circuit of Variable Resistance. — With all of the rheostat (6 ohms) in series with the lamp (also 6 ohms), the 6-volt storage battery will force $\frac{1}{2}$ an ampere of current through the circuit. As the handle of the rheostat is turned to the left, so reducing the amount of resistance in circuit, the ammeter (current meter) will show the current increasing to 1 ampere.

Now, let us consider alternating currents. If the battery in the circuit just discussed were reversed, the positive terminal being connected where the negative had been, it is easy to see that the resulting current would flow in the opposite direction. If it were again reversed, so assuming once more the original connections, the current would flow as before. By changing the connections back and forth rapidly, the current in the circuit could be caused to alternate in direction of flow or to travel first one way around the circuit and then the other. This sort of rapidly

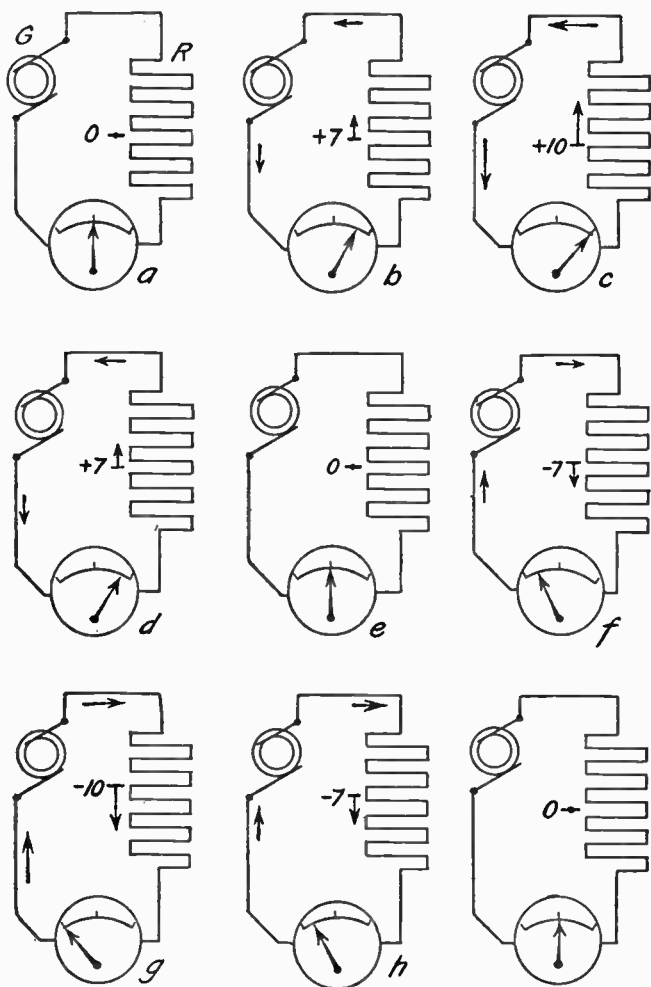

FIG. 19: The drawings indicate the instantaneous values of current at equal intervals of time during one alternating current cycle. G is an alternator and R a resistor; an ammeter is at the bottom. At first (a), no current flows. One-eighth of a cycle later (b), the current is 7 amperes positive (to the right through the ammeter). At successive eighths of a cycle (c, d, e, etc.), the values are +10, +7, 0, -7 (to the left through the meter), -10, -7, and, finally, zero at the end of the cycle. This sequence is repeated cycle after cycle.

reversing current is called an alternating current. It could not be produced practically by transposing the connections of a battery; but by using a special generator or dynamo machine, called an "alternator", we can easily set up such alternating currents in a circuit.

The usual alternating current builds up in strength gradually in one direction, reaches a maximum, and then gradually falls off to zero. From nothing, it builds up to a maximum in the

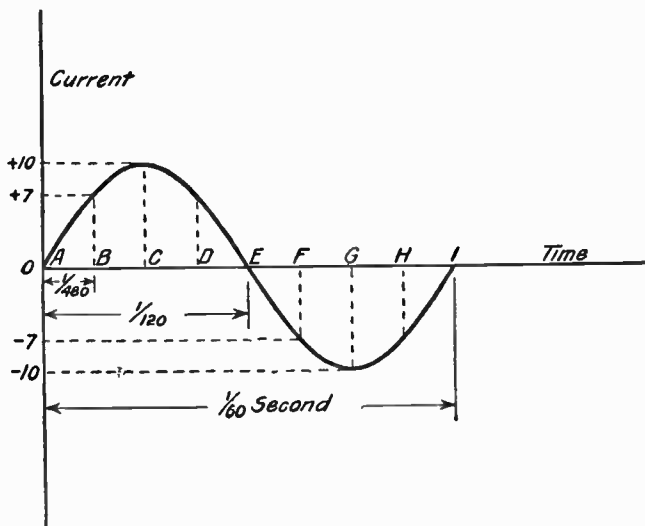
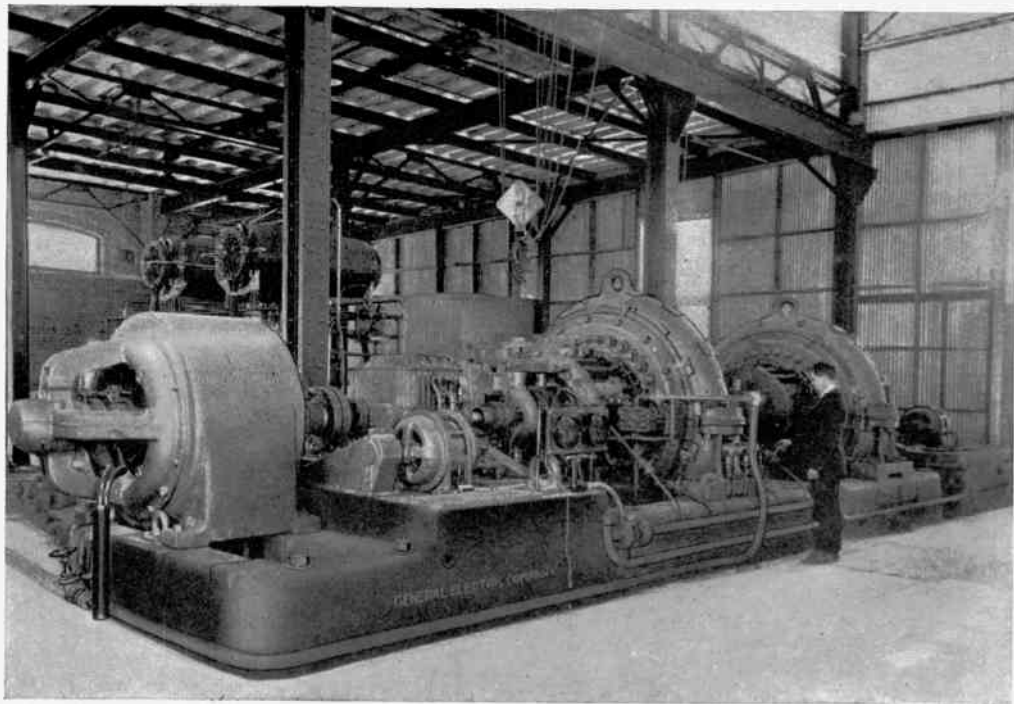

FIG. 20: A Chart of Alternating-Current Flow. — By representing the instantaneous current values (at *A*, *B*, *C* and the following eighth-cycles) of Fig. 19 as vertical lines of appropriate length (7 units upward for instant *B*, 10 downward for instant *G*, etc.), we can plot a wavy line showing the current value at any instant. This curve pictures one cycle of a 60-cycle-per-second current; the time of one cycle (from *A* to *I*) being $\frac{1}{60}$ of a second, and the time of each eighth-cycle being $\frac{1}{480}$ of a second. Curves of this sort are very useful for showing wave-motions.

opposite direction and then returns to zero value again, only to commence a repetition of its increase in the first direction. The double swing from nothing to full value in one direction, back to zero and down to full value in the other direction, and back to zero again, is called a "cycle." The number of these cycles that takes place in one second measures the frequency of the alternating current in cycles per second. Everyday alternating currents, used for supplying power and electric light, have frequencies of fifteen, twenty-five, sixty, and sometimes as high as 120 or 133 cycles per second.

The Property Called Impedance. In a simple circuit, the amount of alternating current can be figured out by dividing the voltage by the total resistance, just as in the case of direct current. In contrast, however, to direct current, which requires a complete metallic circuit in order to flow continuously, alternating currents can be transferred from one circuit to another even though there is no direct conductive connection between these circuits. Further, in a single circuit a coil of wire that would freely pass direct current may strongly hold back one whose direction rapidly reverses. On the other hand, a thin insulating plate, having flat sheets of metal on either side, may be inserted into an alternating current system without stopping the flow, whereas it would set up an insuperable obstacle to unidirectional



A 200-KILOWATT RADIO-FREQUENCY ALTERNATOR

Installed at the Rocky Point station and used for trans-Atlantic radio-telegraphy.



currents. These differences in behavior between alternating and direct currents are of tremendous importance in radio, but we cannot go into them in detail at this point without passing too far from our main subject. For the present, it will be enough to keep in mind that a coil of wire possesses in exaggerated amounts an electrical property called "inductance"; and that extensive conducting surfaces placed close together, yet insulated one from another (so that no direct current can pass between them), constitute an electrical condenser, or have the property called "capacitance."

These two new electrical characteristics or properties combine with ordinary resistance to determine the amount of alternating current that an alternating e.m.f. can produce in any circuit. In combination, they measure the virtual resistance of a circuit to alternating current. To distinguish it from plain resistance, this combined value is called the "impedance" of the circuit, though (like resistance alone) it is measured in ohms. Ohm's law applies to alternating-current circuits if we divide the applied voltage by the impedance, instead of by mere resistance, to compute the current flow.

We have seen that alternating-current dynamos may be designed to generate electromotive forces that reverse at any of several frequencies, and so to produce electric currents that alternate in direction at those frequencies. If an ordinary

alternator is run faster, by rotating its shaft at a higher speed, it will generate currents of a higher frequency. By choosing the speed of rotation and the number of magnets and coils in an alternator, we can cause it to produce currents of ten cycles, one hundred cycles, one thousand cycles, ten thousand cycles, or even one hundred thousand cycles per second.

Electrical Resonance. If we connect an alternator of variable frequency in series with a circuit containing a current-measuring ammeter and a coil of wire having electrical inductance, we shall find that for any definite voltage the current through the circuit will become less and less as the current frequency is increased. This is because the impedance of an inductance coil increases as the frequency goes up. The opposite effect is shown by a condenser. If we substitute for the coil a large sheet of glass having tinfoil cemented to its opposite sides, we shall find the current increasing as the frequency of the applied alternator voltage is increased. This is for the reason that the impedance of a unit having electrical capacitance goes down as the current frequency becomes greater.

Suppose we were to combine these two effects by putting both the inductance coil and the condenser in the circuit to which the alternator is connected. What would happen to the current as the generator frequency was gradually in-

creased? It is not hard to see that for the low frequencies not much could pass, because of the large impedance offered by the condenser. In the same way, only a very little high frequency current could pass through the circuit because of the high impedance that the coil offers to these rapid alternations. For intermediate frequency

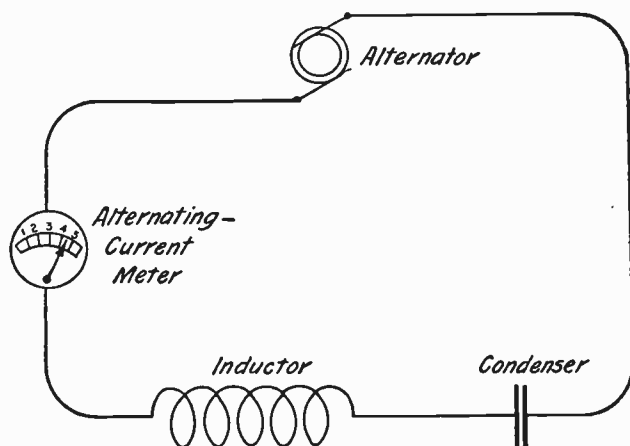

FIG. 21: A Resonant Circuit. — An alternating-current ammeter averages the reversing current that passes through it, and disregards the direction of flow. In a circuit of this kind, such a meter will register the maximum current when the alternator frequency is the same as the resonant frequency.

values, the current would be larger; for neither the coil nor the condenser would exhibit excessively high impedance. But the most striking fact, and one that could hardly be foreseen, is that for some one particular frequency the effects of the condenser will actually neutralize those of the inductance coil. For this frequency, the

circuit impedance will be very small; and consequently the current will increase to a comparatively large value. Moreover, we may give to this frequency of greatest current-flow any value we desire, simply by choosing inductance coils and condensers of the proper size. The condition that prevails when the impedance contributed by capacitance neutralizes that due to inductance is called "resonance", and the frequency for which this neutralization takes place is called the "resonant frequency."

If we have a condenser circuit through which we desire to force the greatest possible amount of current, we need only to connect in series with the condenser a coil of proper size to produce resonance at the current frequency we propose to use. The proper proportioning of the coil inductance and condenser capacitance so as to obtain resonance for the applied frequency of alternating e.m.f., is called "tuning the circuit" to that frequency, and results in the reduction of impedance to the minimum, so that the largest amount of current will flow.

Condensers of All Kinds. Electrical condensers take many forms. The type we have mentioned, in which a glass plate is coated with tin or copper foil on both sides, was quite common in radio a few years ago. When larger amounts of capacitance are required, it is necessary to increase the metallic areas that face each other, or to bring

them closer together (for instance, by using thinner glass). If less capacitance is needed, the plates may be reduced in size or separated farther, or the glass between them may be removed. Any two conductors which are insulated from each other possess together some electrical capacitance; even two wires laid side by side a few inches apart and some yards in length may be used as a condenser of easily measurable size. In fact we may extend a single wire upward into the air for a hundred feet or so, and connect another to the conducting surface of the earth (by means of a buried plate, for instance); and this pair of conductors will form a condenser with a useful amount of capacitance. If we increase the size of the vertical aerial wire, either by lengthening it or by enlarging its diameter, we do what is equivalent to increasing the area of the metallic plates of an ordinary condenser, and therefore increase the capacitance. The greater the capacitance of any condenser, of course, the lower its impedance will be for alternating currents of any frequency and the less inductance will be required to produce the resonant condition.

Suppose that we had a vertical steel tube, some three feet in diameter and four hundred feet high, supported with guy wires and carefully insulated from the ground. Despite the fact that the capacitance of such a tower would be many times that of a small wire, its impedance to alternating cur-

rent of ordinary power frequencies would be so high that practically no current could be forced to flow into it. On the other hand, if we connected to it and to the earth a special alternator capable of producing an alternating e.m.f. of several hundred volts at one hundred thousand cycles per second frequency, the current flow might become appreciable. If we added, between the alternator and the aerial tower, a coil of wire having just the right amount of inductance to produce (in combination with the capacitance of the tower) the resonant adjustment for this frequency of one hundred thousand cycles, a very considerable current would flow. The thing about this that at first sight appears curious is that in such an arrangement we have tens or even hundreds of amperes of electric current (more than enough to light a house) flowing in and out one end of a vertical wire or tower, and apparently going nowhere. This is a peculiarity of the high frequency used in radio; the simple elevated wire is a big enough condenser or reservoir to permit a large amount of current to flow in and out. If we realize that one plate of a condenser is just as much insulated from the other as this elevated wire is insulated from the ground, and that alternating current can pass freely in and out of a condenser of a size suitable to the frequency used, there is no difficulty in seeing how current may flow in the vertical wire.

Producing Radio Waves. You have perhaps been wondering why we have gone into so much detail about getting a current of one hundred thousand cycles to flow up and down a huge metal tube standing above the earth's surface. The reason is that a system of this kind sends out electro-magnetic waves of the sort used to carry

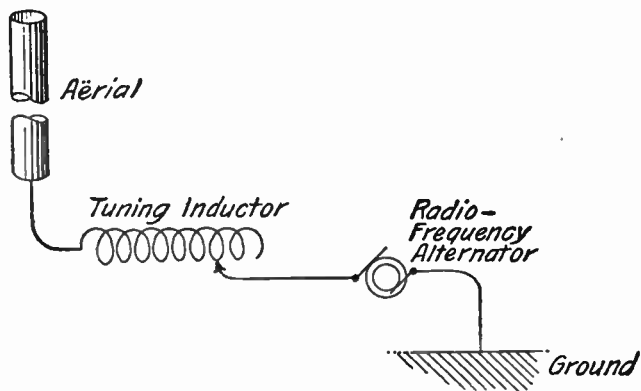

FIG. 22: A Radiating Aërial Circuit. — By adjusting the tuning inductor to the proper number of turns, the aërial-ground circuit may be made resonant to the alternator frequency. Under this condition, a substantial radio-frequency current will flow through the system.

the messages in radio. You will recall that, in the previous chapter, we found that radio waves have vibration frequencies of from about fifteen thousand cycles to about ten million cycles per second. We set ourselves the problem of finding out how these radio waves could be generated. The answer is, Produce rapid alternating currents in a system of aërial wires, and preferably

in one that is connected to the earth. Therefore, we have had to think a little about what such alternating currents are, how they behave, and how they can be made to flow in the vertical conductor.

Whenever "radio-frequency currents" (which is what we call alternating currents of more than about ten thousand cycles) flow between an elevated wire and the earth, they generate electromagnetic waves of their own frequency. As we shall see, these waves spread out over the earth's surface in all directions from the generating aerial system.

Electrons and Charges. What we now wish to know is how the radio-frequency alternating currents produce the waves in the first place. To grasp this operation, we need primarily to realize that an electric current is really a stream of electrons, or minute electric charges, within a conductor; and that an electric generator is simply an electron pump forcing these tiny charges to move around a circuit. In the system we have been considering, the generator forces a flood of electrons from the earth into the aerial wire, and then (a fraction of a second later) pumps them out of the wire and into the earth.

If it were not for the generator, the electrons would distribute themselves evenly throughout that part of the system which is electrically conductive, and no electrical effects would be ob-

served. The generator forces them to congest, — first in the aerial wire, and then in the earth. Where electrons are crowded together, we say the conductor is “negatively” charged; where they are abnormally scarce (having been pumped into the negatively charged portions), we say the conductor is charged “positively.” Curiously enough the flow of electrons in a circuit is always opposite to the direction in which (according to the old convention) we say the electric “current” flows. The electrons themselves try to pass from negative (or crowded) places to positive (or uncrowded) places, but they move along only paths that are electrically conducting. Nevertheless, we can imagine more direct lines along which they would travel if conductive paths were provided for them; and these imaginary lines will always extend from the centers where electrons are most densely assembled to the points where there are fewest of them. Such lines are called “lines of electrostatic force”; and they can be pictured according to definite rules, for they represent the paths electric charges would take if permitted to move freely.

The accompanying drawings illustrate the main lines of electrostatic force in space around an elevated wire to which a grounded radio-frequency generator is connected. Better than words alone can tell the story, they show how some of these electrostatic lines are crowded away from the

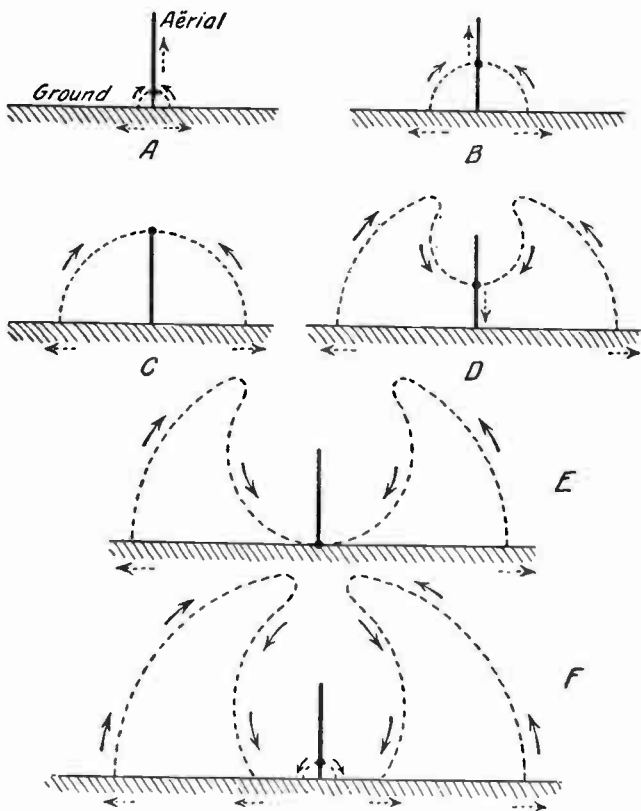

FIG. 23: Lines of Electrostatic Force around an Aërial. — We may imagine the feet of the lines of force to extend outward from the base of the aërial, as indicated by the dotted arrows; while the force-lines themselves follow the electric charge up and down the vertical wire. As suggested in A to E, the up-and-down cycle of charge movement creates a loop of electric force in the space surrounding the aërial. At F is indicated the casting-off of the first loop and the beginning of another. The act of freeing the first loop represents the creation of a radio wave. The solid arrows indicate the direction in which an electron would be urged by the electrostatic force whose intensity is traced by the dashed lines.

vertical aerial as the generator pumps electrons into and out of it. And the freed lines of force (in space except for their ends, which touch the surface of the earth) are the basis of the electromagnetic waves used in radio. The word "magnetic" comes into their name because moving or varying electrostatic forces in space are always and inseparably accompanied by magnetic forces that travel with them. These will be discussed further in a later chapter.

The Essentials of a Radio Transmitter. We have now worked out the process of generating radio waves. All that is needed is a generator that will produce alternating currents having the frequency of the waves we desire; and an elevated conductor, connected to ground, in which these currents can be forced to flow. It does not matter what sort of generator we use. It may be a magneto-mechanical alternator built like those common in power houses, but designed for the much higher frequencies of radio; it may be an arc lamp burning in an atmosphere of hydrogen and provided with circuits to produce radio-frequency currents; or it may be a vacuum tube so connected as to develop the requisite electric oscillations.

Although for the sake of simplicity we have considered the elevated conductor to be simply a vertical wire or tube, it is entirely feasible to add horizontal wires at the top, so as to increase its

capacitance and thus require only small inductance coils to tune it to resonance and secure the greatest current flow. Any of these arrangements will produce a practically uniform stream of radio waves that will pass out from the sending aërial wires and may be used to carry telegraphic or telephonic messages. We must now find out how the messages can be so loaded upon the radio waves as to be carried to their destination.

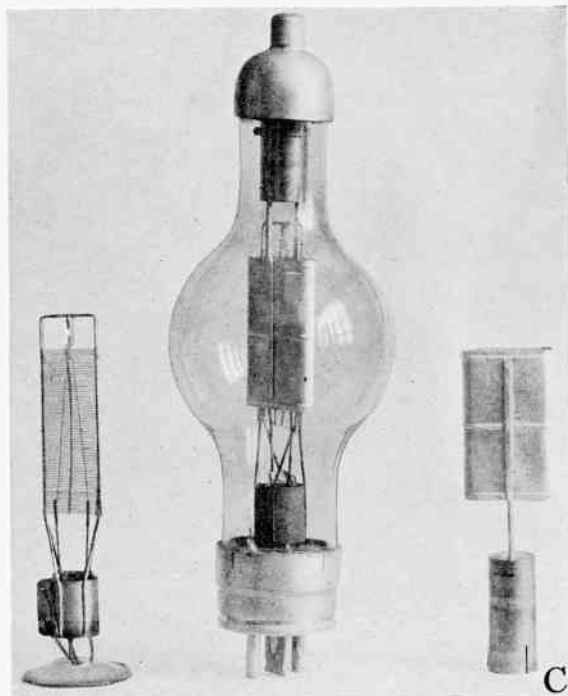
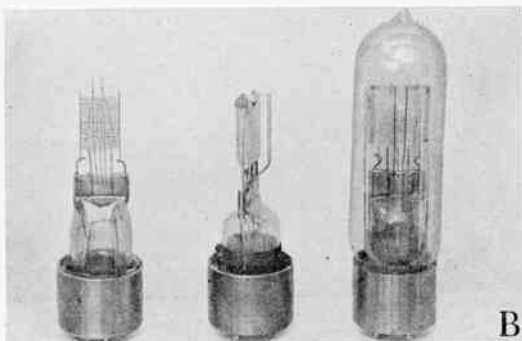
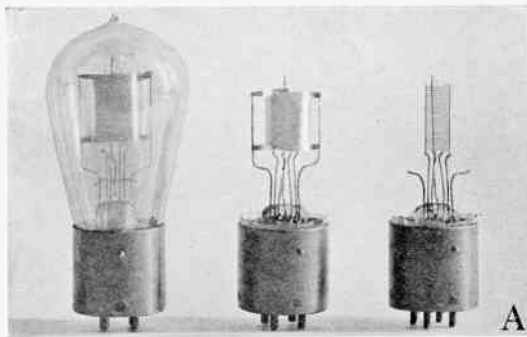

AUDION OSCILLATORS -

Audion oscillators are replacing radio-frequency alternators for radio transmission. These views show the filament, grid, and plate structure of modern standard transmitting tubes. *A* is the 5-watt size; *B*, the 50-watt; *C*, the 250-watt radiotron.

CHAPTER V

MESSAGES ARE SENT FORTH

THERE are two kinds of signaling that concern us in radio: first, the spelling out of words by the dots and dashes of the Morse code; and second, the sending of messages spoken in the words of our language. Of these two, telegraphic signaling is by far the simpler, and we may best begin by considering it.

As you will remember, the Morse code is made up of combinations of dots and dashes, — one combination for each letter or figure or punctuation mark. Between the dots and dashes of a single letter-combination, occur spaces, each equal in length to a dot. Between letters, a longer space is left; between words, a still longer space. In the wire telegraph, a dot is signaled by pressing the sending key for an instant (it being held down for perhaps a tenth of a second) and then releasing it. This allows the telegraph battery to force a pulse of direct current around the wire circuit from sender to receiver and back; for while the key is held down, the circuit is metallically closed. A dash is transmitted by holding down the key for about three times as long, and thus sending a

longer flow of current out and back over the circuit. While the key is up, no current passes. These idle times correspond to spaces in the Morse code.

Forming Dots and Dashes. Suppose we were to put a telegraph key in the aërial-to-ground circuit of the alternator transmitter described in the previous chapter. When the key was held down, its contacts being pressed together, the circuit would be complete; and the alternator would force 100,000-cycle alternating currents to rush up and down between the vertical wire and the ground. If the key were released, its contacts would spring apart and the circuit would be opened by the air gap between them. Then no current would flow in the aërial wire system. We see at once that no electro-magnetic waves would pass out from the station into space while the key lever was up, for there would be no radio-frequency currents in the elevated conductor. But so long as the key was depressed, the currents would continue to oscillate back and forth, and a continuous stream of waves would shoot off from the transmitting aërial.

It is not hard to imagine what would happen if the key were worked up and down rapidly, so as to form a series of Morse dots. With the key held down for, let us say, one tenth of a second, the alternator would produce ten thousand successive cycles of current in the aërial and ground

system. A train of 100,000-cycles-per-second waves would be sent out, lasting one tenth of a second and containing ten thousand wave cycles. Then the key would be released, and for a tenth of a second the circuit would be broken. The generator would continue to run, and to produce its 100,000-cycle voltage; but the voltage could force no current through the open circuit, and for this tenth of a second no waves would be generated. The key would next be depressed again for a tenth of a second, and ten thousand more wave cycles would flash out; again there would occur an idle period of the same length; and so it would continue. Dots, each being a series of ten thousand waves, would be separated by code spaces of one tenth of a second, in which there would be no radiation.

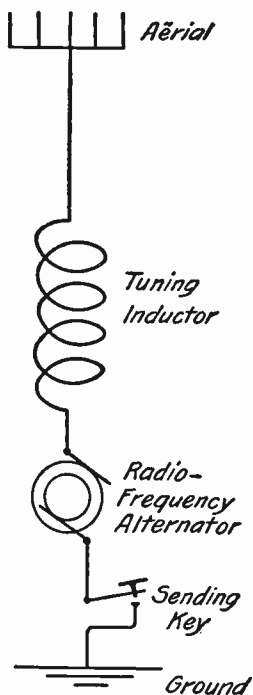

FIG. 24: Continuous-Wave Radio-Telegraph Transmitter. — This circuit is the same as that of Fig. 22, except that a sending key is added to make and to break the current path and so to control the radiation of waves. Note the conventional symbols used to represent aerial, key, and earth.

Much the same sort of thing would happen if the impulses were longer, so as to form successive dashes. The key would remain down for three tenths of a second, so permitting thirty thousand cycles of 100,000-cycles-per-second current to flow in the aërial wires, and thirty thousand wave cycles to be radiated into space. The intervals between dashes would be, as before, one tenth of a second long; thus the alternator would again and again be active for thirty thousand cycles and idle for ten thousand cycles, so long as the series of dashes was being transmitted.

The Waves Are Cut into Sections. In this way the constant stream of waves that would flow out, were the alternator continuously generating current in the antenna circuit, can be cut up into short and long groups, corresponding to the Morse dots and dashes. As in the wire telegraph, messages can be spelled out letter by letter and word by word. Although in radio there is no circuit between sender and receiver, the short and long wave groups flash out in all directions from the transmitting station and (still in groups) may reach hundreds or thousands of radio receivers within a zone whose radius is hundreds of miles in length.

If the generator frequency were not one hundred thousand cycles per second, or if the dot-and-dash speed were not the same, the number of waves in the groups might be widely different. A gen-

erator producing 750,000 cycles per second (a frequency used in modern broadcasting) would produce 75,000 wave cycles for each tenth-second dot and 225,000 cycles for each dash. If the sending key were worked twice as fast, so as to signal twice as many words per minute, dots would be only one twentieth of a second long and would each contain 37,500 cycles. The numerical values are altered as the frequencies change, but the principle is the same. One merely interrupts the continuous stream of waves into a discontinuous stream of wave groups, corresponding in length to dots and dashes. These wave groups are separated by idle periods, corresponding to the spaces of the Morse code.

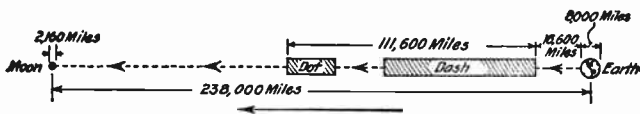

FIG. 25: Dots and Dashes in Space. — The shaded blocks indicate the distance along the path from earth to moon that would be reached by the dot and dash of the letter "A" in Morse, six-tenths of a second after starting. The first waves would have traveled 130,200 miles from the earth.

It is interesting to visualize the groups of waves in space, as they pass from a sending station to some particular receiver. In order to picture a complete dot-and-dash (the Morse symbol for the letter A), we shall have to imagine the two stations as being tens of thousands of miles apart. For this purpose, we might suppose the receiver to be on the moon, some 238,000 miles away, and the radio waves to pass off directly from the earth

into free space. If a dot lasts for a tenth of a second, the first wave would have traveled 18,600 miles toward the moon by the time the last wave of the dot had left the sending aërial; the whole gap of 18,600 miles would be filled with waves constituting the Morse dot. Then would come an idle time of one tenth of a second; by the time it was over, the dot-train of waves would have moved another 18,600 miles toward the moon. The first wave of the dash would then start out, following up the dot at the speed of 186,000 miles per second, but, of course, never catching it because all the waves move with the same velocity. Three tenths of a second later, the dash-train of waves would be completed. As its last wave left the earth, its first would already be 55,800 miles on its journey; and the first wave of the dot would be 93,000 miles off, or over one third of the way to the moon. In less than four fifths of a second later, the dot would have arrived. Of course we have no radio stations that can transmit two hundred thousand miles; but since we have already sent messages across the greatest superficial distance that can be measured on our earth (12,500 miles), who is to say that even greater spans will not be covered?

Sound Frequency and Intensity. But we must get our feet on the ground again, and find out how radio-telephony forces the electro-magnetic waves to carry the sounds of a speaking voice. It will

help us a little to analyze further the vibrations that produce the sensation of sound. In Chapter II we discussed the matter of frequency, and found that less than about sixteen cycles per second produced a tone too low in pitch (that is, too deep) for our ears to recognize. Many persons cannot hear tones below about thirty vibrations per second; thirty-two vibrations give low C, at the very bottom of the musical scale, written five lines below the staff of the bass clef. An organ pipe vibrating at only thirty-two cycles makes a tone whose motions we can easily feel. At the other end of the musical scale we have the highest note of the piccolo, which is of about five thousand vibrations per second. Most people cannot even hear air waves of more than about three times this frequency, although some very acute human ears can recognize notes having thirty thousand vibrations per second. It is not hard to make a whistle that will give off air vibrations of even as high as forty thousand cycles per second; and there is a story of a man who used to call his dog with such a whistle. No one, not even the dog's owner, could hear these waves; but the dog's delicate ears picked them up, and he would trot to his master.

There is, however, more than mere frequency to sound waves. We must consider their loudness or intensity, and their quality or tone color. Loudness is, almost obviously, a matter entirely of

the amplitude or extent of vibration; in carrying a strong tone, the air particles vibrate back and forth farther than in transmitting a weak sound. If the pitch of the loud and soft tones is the same, the air molecules will make the same number of trips per second in each case, but the trips will be longer in the case of the louder sound, and adjacent molecules will collide with greater force.

The Quality of Sounds. The matter of quality or tone color is perhaps a little harder to understand. This quality is what musicians call *timbre*. It may be illustrated by the difference between tones of the same pitch and loudness played, let us say, alternately on a flute and on a violin. Or one might strike the note of middle C on the piano, and then play the same note with exactly the same loudness on a clarinet. No one could fail to notice the difference between the qualities of the two tones, even though the tones were of the same frequency and the same intensity. What is it that makes these tones so unlike in sound?

The clearest way to explain differences of quality is by using pictures of the sounds we are comparing. Comparatively few people have seen photographs of sounds, but these are not hard to make. We can imagine a delicate diaphragm carrying a bit of mirror mounted just off center; the apparatus being so arranged that a fine ray of light admitted through a pinhole is reflected by the

mirror to a photographic film. If the diaphragm is still, the ray of light remains fixed on the film, marking a small round spot. If a sound falls on the diaphragm, the mirror will swing back and forth slightly as the diaphragm vibrates; and the light beam, by swinging up and down, will trace a vertical line on the film. It is as easy to visualize this as to picture the flashing beam of sunlight which a child swings up and down the side of a house merely by moving a pocket mirror.

Making a Sound Picture. Suppose, now, that the film is moved along rapidly but smoothly, a new portion being continually unrolled and passed under the tiny spot of light. One can easily see

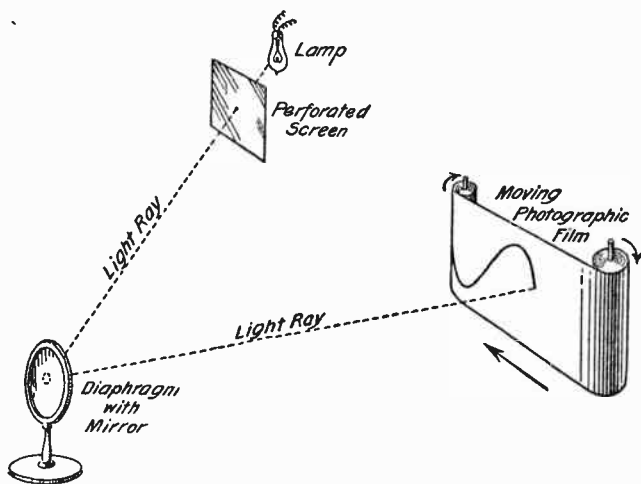

FIG. 26: Making a Sound Picture. — Sound-waves striking the diaphragm will vibrate the small mirror mounted upon it, and thus cause the beam of light reflected to the film to swing up and down.

that if the diaphragm is at rest (the light beam also being stationary), the movement of the film will cause the light to record photographically a horizontal central line. With the film moving, if the diaphragm starts vibrating and the light spot consequently swings up and down at right angles to the direction of film travel, a snaky line will be traced that will necessarily be a photograph of the sound vibration.

Such a sound photograph will show all three of the characteristics we have discussed; namely, frequency, intensity, and quality. Frequency of vibration will be indicated by the number of times the recorded line swings up and down in a given length of film. Manifestly, if the film moved three feet per second and the diaphragm were swinging to a seventy-two-cycle note, there would be seventy-two up-and-down images of the light spot on three feet of the film, and the individual cycles would each show as half an inch long. If the photographed tone were of twice this pitch (the film moving at the same speed), the sound cycles in the picture would be only one quarter of an inch in length. Thus the frequency of any tone might easily be measured. As to intensity, it is clear that the extent of the swings on each side of the central line will give an indication. A tone of some certain volume may move the light spot up and down a total distance of one inch; a louder tone will strike the mirror diaphragm harder and

move the spot farther, so widening the oscillations that are photographed.

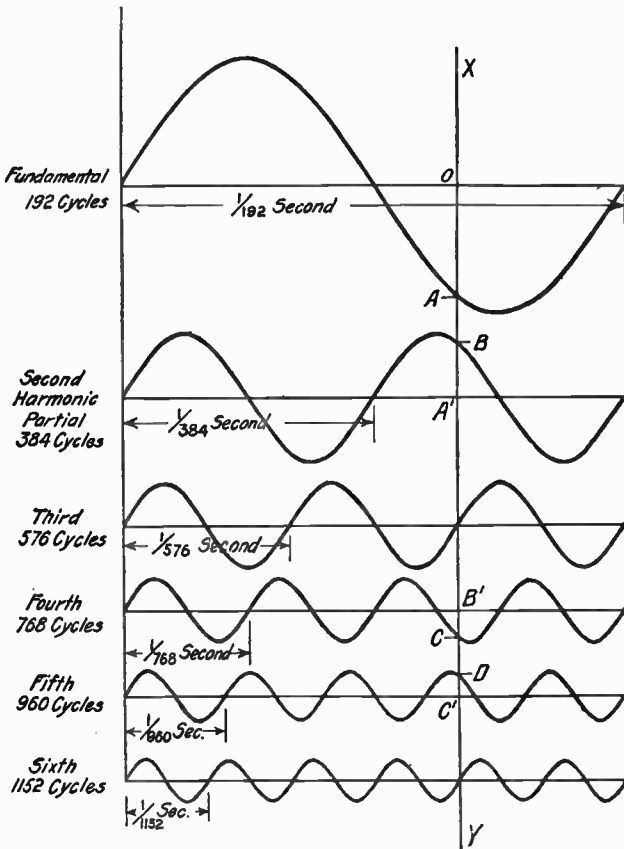

FIG. 27: A 192-Cycle Tone and Its First Five Harmonic Overtones. — The top curve, marked "Fundamental," alone represents a simple or pure tone. When this is combined with the five harmonic (or multiple) overtones drawn below it, the six components (or partials) together produce a resultant wave of the type shown in Fig. 28.

Harmonic Frequencies. And now we return to the matter of quality. The smoothly drawn curves of the accompanying illustrations, which represent the changes in sound pictures, as the tones are varied in pitch and loudness, are "sinusoidal" or simple waves. Tones corresponding to these

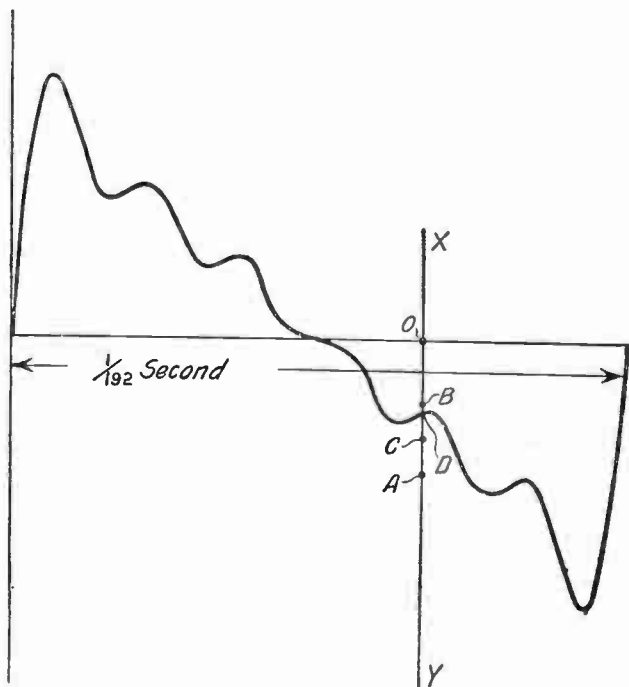

FIG. 28: A Violin Tone of 192-Cycle Pitch. — Such a curve-trace could be produced by playing a violin before the recording diaphragm of Fig. 26. Here it is drawn by adding together the six curves of Fig. 27. The process of adding is indicated in both figures at the lines $X-Y$, where the distances OA , AB , BC , and CD (Fig. 28) correspond in length and direction to the distances OA , $A'B$, $B'C$, and $C'D$ (Fig. 27). The third and sixth harmonic partials contribute nothing to the resultant curve for this particular position of the "line of addition" $X-Y$.

are produced by the flute; they each represent single frequencies standing alone. When we add to these single frequencies certain additional tones, feebler in intensity, which are exact multiples of the original or fundamental frequencies, we change the tone color or quality. Figure 27, for example, shows a basic tone of 192 cycles (the lowest note of the violin); and drawn with this basic tone is a series of five overtones of progressively multiplied frequency and proportionally reduced intensity. The first is of double frequency (384 cycles) and one half intensity; the second of triple frequency (576 cycles) and one third intensity, and so on. Adding these together gives the trace of Figure 28, which is almost exactly like the photograph of a violin tone of 192 cycles per second. Comparing this with the fundamental 192-cycle curve of Figure 27, we see at once the difference between flute and violin tones. The flute gives a pure, simple note and the violin a rich, complex one, full of upper or harmonic multiple-frequencies.

Other instruments produce tones representing other combinations of the basic and harmonic frequencies. The thing that gives rise to differences in tone quality is, then, the variation in the form of the sound waves. Curiously enough, we do not musically enjoy the pure sinusoidal tones; a flute played alone is soft, but its tone color is dull. If there are added to the basic tone, how-

ever, reasonably intense overtones up to the fifth or sixth multiple-frequency, we say at once that the sound has become "rich" or "full." Omitting the even multiples (second, fourth, and sixth) will give a hollow tone; adding more of the higher multiples will make the sounds nasal in tone; and overemphasizing those above the seventh harmonic will result in a piercing, brassy, clanging sound of the cymbal type.

Speech and the Combination of Waves. So



A



B

FIG. 29: Illustrations of Vowel Sounds.—The upper curve shows the sound of "oo" in *spoon*; the lower, that of "a" in *father*—as they might be recorded by the device of Fig. 26. (Traced from photographs by Miller.)

far, we have discussed only musical tones. The same sound properties of frequency, intensity, and quality occur, however, in the speaking voice, as may easily be recognized. Speech is exceedingly complicated in wave form, for the pitch and loudness (as well as the number and strength of the harmonics or overtones) are continually changing. Nevertheless, we can make a photograph of a speech wave with the instrument just described, and with a facility as great as that with which we pictured the musical tones. The wavy line representing speech is much more irregular, as we should expect on account of its constant variations, and as we can see from the photographs of even the clear and uniform vowel sounds that are redrawn in Figure 29.

Since we desire to combine sound waves with radio waves, so that the tones can be carried through space to some distant receiver, let us look at the two together. Figure 30 shows in the upper part a violin tone of two thousand cycles per second, which would be played high on the E string. In the central part is drawn, to the same scale, a radio wave of twenty thousand cycles per second. This is the sort of constant-intensity (shown by the uniform height of the swings), continuous series of waves that an alternator would send out if connected to an aërial ground system and left to run undisturbed. The lower portion of this same figure illustrates what

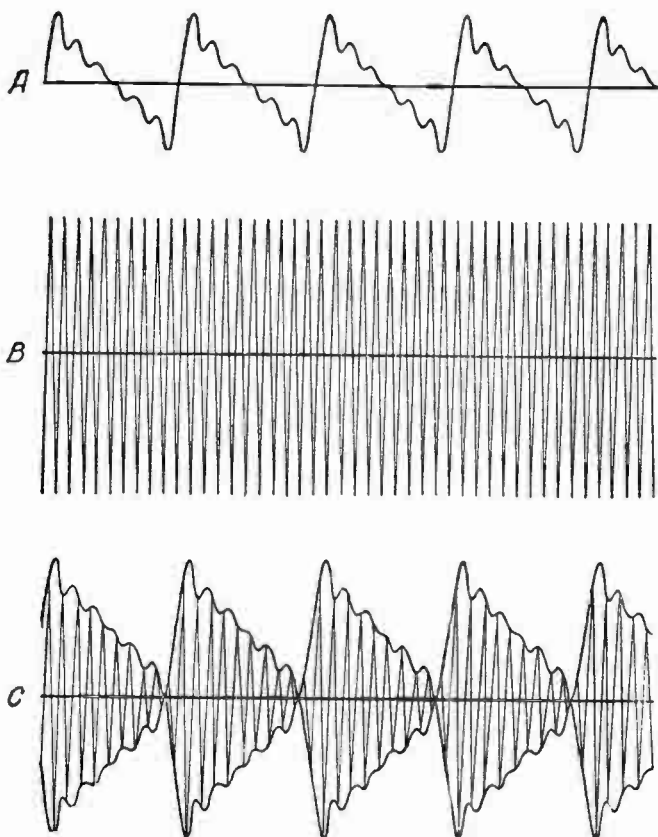

FIG. 30: Combining a Violin Tone and a Radio Wave. — The 2000-cycle violin tone shown at *A* will mold or modulate the stream of continuous 20,000-cycle radio-frequency current *B* into the form illustrated at *C*. The intensity of the radio wave thus produced varies from instant to instant exactly in accordance with the vibrations of the original tone. The principle is the same whether the radio frequency current is of 20,000 cycles, as here drawn, or of 750,000 cycles. Modulation forces it to vibrate between boundaries that are fixed by the tone transmitted.

would happen if the wave intensity were caused to fluctuate, from instant to instant, in exact proportion to the strength of the sound wave. We have pictured here the practical result of loading the musical tone upon the radio wave in this way. The formerly uniform radio oscillation has been molded, or modulated, into the shape of the sound wave.

What must be done, thus to modulate a radio wave? You will recall that we found that the intensity and frequency of the electro-magnetic waves sent out by an aërial system correspond to the intensity and frequency of the rapidly alternating currents flowing in the aërial wires. It follows that to mold our radio waves into the outlines of speech or music, we need only to impress the sound variations upon the radio-frequency current that generates the waves.

Practical Radio-telephonic Transmission. There are many useful ways of modulating the flow of current in the aërial system, and the growth of high-powered radio-telephone transmitters has unavoidably complicated the apparatus used for this purpose. The simplest system, one entirely practical within its limits of power, is shown in Figure 31. Here we have the radio transmitter with which we have already become familiar, consisting of the high tower, the tuning inductance coil, the radio-frequency alternator, and the ground connection. The only new element we have added

is an ordinary telephone transmitter connected into the aërial wire circuit. If one remembers

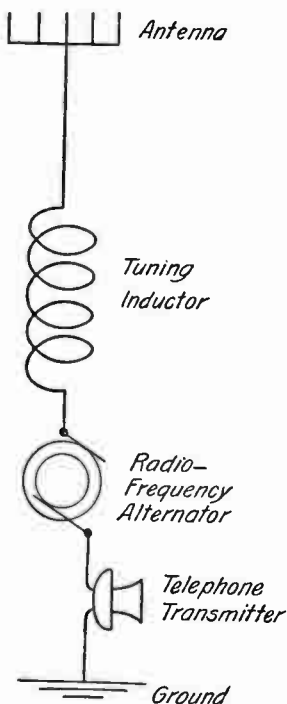

FIG. 31: A Simple Radio-Telephone Transmitter. — This is identical with the telegraph transmitter of Fig. 24, except that a microphone, or telephone transmitter, is substituted for the sending key. Instead of breaking up the continuous stream of current produced by the alternator, into dots and dashes, the microphone modulates it without interrupting its continuity.

that the alternator delivers power at a uniform potential, that the resistance of the telephone transmitter varies with the voice waves, and that the amount of current flowing depends upon the voltage divided by the resistance, it is not hard to see how the aërial-circuit current will fluctuate as one speaks, sings, or plays into the transmitter mouthpiece.

Sound waves cause the transmitter diaphragm to vibrate back and forth. The movements of the diaphragm control the resistance of the transmitter. When the transmitter has little resistance, a large current from the alternator flows in the aërial-to-ground circuit; as the resistance increases, the current falls off. Thus the fluctuations in current reproduce the

air-wave vibrations striking the diaphragm of the transmitter. The stronger the aërial currents, the stronger the radio waves sent out. In this way we have succeeded in modulating these waves telephonically, in altering their intensity from instant to instant just as the sound waves vary in their strength. Let us now follow the electro-magnetic waves into space, and see how they behave after they have left the transmitting station behind them.

CHAPTER VI

THE SIGNALS FLASH THROUGH SPACE

IN Chapter IV we found that when a series of high-frequency alternating currents flowed in a grounded aerial wire system, there was radiated outward from the wires a series of electro-magnetic or radio waves. These waves begin in lines of electrostatic force that extend from the aerial to the earth's surface and are accompanied by lines of magnetic force; the static and magnetic lines are simply imaginary, but the forces they represent are not in the least imaginary. The radio waves are really electric and magnetic "fields of force" which are shot away from the transmitter, and which, as they travel through space, rapidly increase and decrease in intensity.

Such a field of force is nothing more than a place where such a force exists. An electric or electrostatic field is one in which there are electrostatic forces that would tend to move an electric charge in some definite direction with some definite strength. Similarly a magnetic field is one in which magnetic forces are present, so that a free magnetic particle in the field would be impelled in some direction with a certain strength.

In different parts of the force field, the intensity and direction may be different, so that the electric charge or magnetic pole particle might be acted on differently as it passed from point to point in the field.

Since we have already examined the arrangement of the electrostatic-force lines around a sending antenna as waves are being detached (in Figure 23), we may now limit our investigations to the freed waves which have left the aerial wires. We cannot see these radio waves, as we can see waves on the surface of water; and they are quite complicated in their make-up. Probably the best way to get some idea of their structure and movement is to take up separately their two important parts.

The Electric Part of Radio Waves. If we confine ourselves at first to the electrostatic portion of the radio waves, we shall be concerned with the electric forces that would tend to move an electric charge. To study these forces, we might use a small globe of aluminum foil mounted on the end of a pivoted insulating lever fitted with a spring and scale, as in Figure 32. Clearly, if this globe were crowded with electrons (which could not escape rapidly because of the insulating lever), it would be negatively charged; and if, when so charged, it should be placed in a strong electrostatic field, it would try to move along the lines of force. By turning it so that its pivot would

allow it to move, we could find out in what direction the force was strongest. Moreover, by noting how strongly it was pulled against the spring, we could determine (from the scale reading) how intense the field might be at the point of measurement. Such an experiment is con-

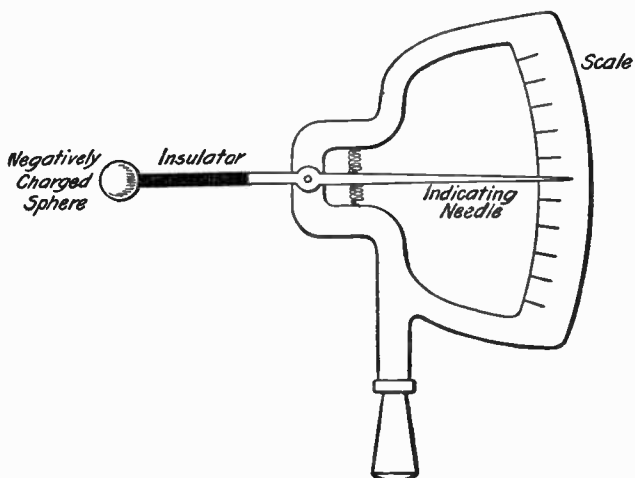

FIG. 32: A Crude Exploring Sphere. — The direction and extent of movement of the charged globe, under the action of an electric force, will be indicated by the pivoted indicating needle on the scale at the right.

ceivable, though the practical difficulties of carrying it out with a radio wave would be well-nigh insuperable, if only because of the immense velocity of the wave itself. In fact, to make our examination of the electro-magnetic wave, we must imagine it to stand still in space for an instant.

As appeared from the diagrams in Chapter IV, the radio waves do not free themselves directly at the antenna wires, but begin a little distance away. Suppose, therefore, that we take our charged globe to a spot at about one hundred meters (about 328 feet, since one meter is equal to 39.37 inches) from the sending aërial wires. Waves have been shooting away from this transmitter. We must now imagine them to stop their movements, but to hold the intensity values that they had at the instant of stopping. Thus we can make our measurements. Holding the charged globe so that it can swing up and down, we observe that at this distance of one hundred meters it is drawn upward by the electrostatic force of the wave for ten scale divisions.

How the Field Strength Varies. If we now walked away from the aërial wires, still holding the globe so that it could move vertically, we should note a gradual falling of its position. At a distance of 150 meters (about 492 feet) it might indicate only seven scale divisions, thus showing that here the electrostatic field of the wave was weaker. If we walked still farther away, the force acting on the globe would grow rapidly less and less; until at 200 meters the pointer would register zero, thus indicating that the electric field had weakened to the vanishing point. Moving on farther, we should note that the negatively charged globe was being forced downward. At

250 meters distance it might register seven divisions in the opposite direction; and at 300 meters (about 984 feet) the deflection might be ten divisions downward. As we continued to walk away, the globe should again begin moving up; at 350 meters the indication might be seven in the down direction, and at 400 meters (about 1,312 feet) it might again read zero. At 450 meters away the scale should show seven divisions upward and at 500 meters distance (just 400 meters from our starting point) the reading should again be ten divisions in the upward direction. Thus, with the wave standing still, we should have walked through a complete cycle in a space of 400 meters.

Continuing to walk directly away from the transmitter, we should find these cycles repeated. Every 200 meters, there would be a zero point. At 900, 1,300, and 1,700 meters (and every 400 meters thereafter), the sphere would show a maximum tendency to move upward; and at 700, 1,100, and 1,500 meters (and every 400 meters thereafter), a maximum tendency to move downward. We should also find the maxima to grow less and less as we went farther away. Instead of from ten divisions up to ten divisions down, the swing would be from nine to nine, then from eight to eight, and so on; because the waves become weaker and weaker, the farther one passes from the sending station.

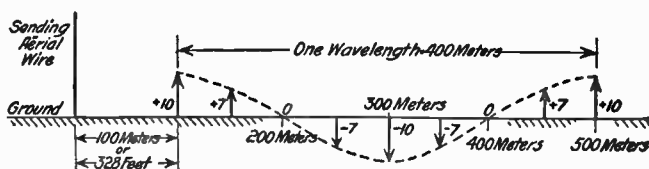

FIG. 33: The Variation of Field Intensity. — The length and direction of the vertical arrows indicate the deflection of the exploring sphere under the electric force of a 400-meter radio wave, as we pass to the right from a sending aërial. Note the dashed line connecting the arrows, which represents the intensity at intermediate points.

We have now measured the electrostatic field of a 400-meter (the length of one cycle in space) radio wave, along one particular line, as it existed at the particular instant we imagined the wave to stand still. Figure 34 shows in curve form the de-

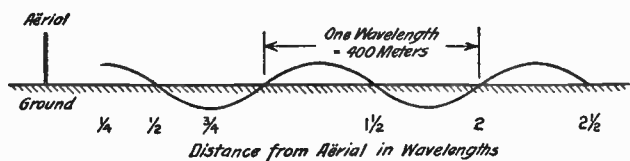

FIG. 34: Curve of Field Strength. — This shows the observations of Fig. 33 in curve form and continued for a distance of $2\frac{1}{2}$ wavelengths (1,000 meters or 3,280 feet) from the aërial. The distance of the curve from the horizontal line represents the instantaneous intensity of the electric field at the point of measurement.

flections of our measuring sphere as the distance increases. If we walked away from the transmitter in any other direction, we could repeat the same measurements; for the waves normally go out with the same intensity in all directions. Even if we could make our measurements along a line at an angle from the earth's surface (for instance, by building a series of scaffolds of increasing height),

we should find a similar cycle of field values in the space above the earth. The same wave cycles occur along all the radial lines extending outward from the transmitter, although in the space directly above the aërial wires they are somewhat more complicated.

The Electric Wave Itself. It would not be hard to draw a series of lines representing the state of the wave in any vertical plane around the sending station. Figure 35 is such a drawing. The wave was moving away from the aërial to right and left before we stopped it for examination. The heavy looped lines represent the points, in the slice of space we are considering, where our test globe would be moved with full intensity; and the arrowheads indicate whether the motion would be upward or downward. Similarly, the dashed loops show where the globe would be moved with an intensity of $\frac{7}{10}$ the full value, as we found would be the case at distances of 150, 250, and 350 meters (and each additional hundred meters) from the transmitter. Here again, the adjacent arrow heads indicate whether the force is up or down.

The loops of Figure 35 are partial pictures of the electrostatic component of radio waves. They are merely indicative of something we cannot see, although it is fair to say that the wave forms are like this illustration. Of course, this drawing is only a cross-sectional view. To visu-

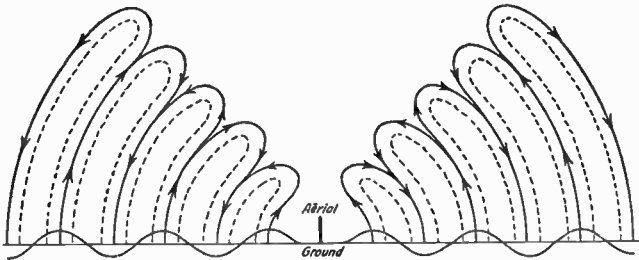

FIG. 35: The Electrostatic Force-Lines of the Wave. — The curve along the ground-line represents the field intensity, as in Figs. 33 and 34. The loops above the ground-line indicate the points in space where the same intensity might be observed at the instant of measurement. The solid lines show places of maximum field-strength, and the dashed lines correspond to $\frac{1}{10}$ of the maximum.

alize the whole wave, we must imagine Figure 35 to be rotated completely around the axis of the sending aërial in the center, so that the bowl-like outline traced by the wave loops may be

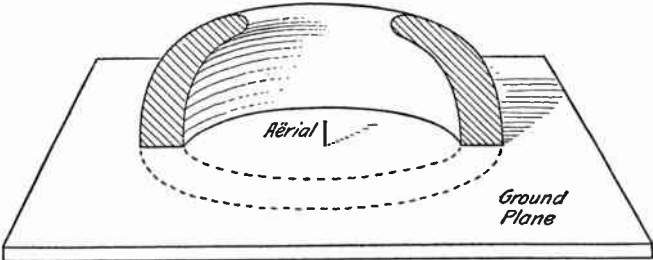

FIG. 36: A Perspective View of One Wave-Loop. — If a model of one of the electrostatic loops (Fig. 35) were made, it would look something like this. The model has been cut in half to show how its cross-section agrees with the idea illustrated by the preceding figure.

pictured. Figure 36 is a drawing in perspective of such a wave-solid, corresponding to the third wave loop of the preceding figure. The whole series of waves would be represented by a number

of smaller but similar inverted bottomless bowls within the one shown, and a gradually larger series surrounding it. This may easily be grasped by considering Figures 35 and 36 together

When the Waves Begin to Move. So far, we have held our radio waves still, in order to examine them. Suppose that we now imagine them to begin moving, first slowly and then at an increased speed, until finally they attain their normal velocity of 186,000 miles (300,000 kilometers) per second. Nothing actually moves except the force-lines illustrated in Figure 35. These travel radially away from the sending aërial; so that at some definite point (for instance, on the ground at five hundred meters distance) where the force was at first ten units upward, it would become, at successive fractions of a second, seven units upward — zero — seven downward — ten downward — seven downward again — zero again — seven upward — ten upward. The same cycle would be repeated over and over.

Perhaps this will be clearer if we consider ourselves to be standing at the point marked five hundred meters, at the right of the sending aërial wire in Figure 33, holding our charged measuring globe. When the wave was stationary, we obtained a deflection of ten scale divisions upward at this point. If now the waves start moving slowly, the intense upward electrostatic force in which we were standing will move off toward

the right and the field will become weaker. Our measuring globe will consequently commence to drop.

Suppose the waves to move very slowly, — say, fifty meters in one second. At the end of one second, the shorter line (which is fifty meters behind the full-length solid line in the figure) will reach us, and the globe scale will indicate seven units upward. After another second, the wave will have moved one hundred meters, and we shall be just halfway between successive loops, where the field intensity (and our scale reading) is zero. In another second, the loop that was originally 150 meters nearer to the transmitter will have reached us, and our globe will indicate seven divisions downward.

So it will go until, at the end of eight seconds, the strong upward field of the next wave will have reached us, and an entire cycle of values will have been completed. A snapshot of the waves taken at this instant would look exactly like Figure 35, taken eight seconds earlier; but the third wave away from the sender in the later picture would be the one that was second in the earlier view. Each wave would have moved onward a distance corresponding to one cycle, or four hundred meters; and a brand-new wave would have been thrown off by the transmitter to replace the original number one, which now takes the second position.

How the Waves Expand. If you have ever blown a hemispherical soap bubble on a plate

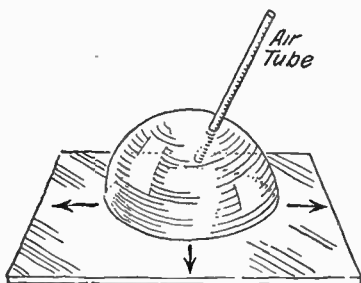

FIG. 37: An Expanding Spherical Bubble. — The bubble, as air is blown into it, expands in all directions, much as does a radio wave. When you try this experiment, be sure to have the plate and the outside of the glass tube well wet with soapy water; otherwise the bubble will break.

wet with suds, you have a fair idea of how these waves expand in space. If you haven't, it is worth the experiment. The bubble begins as a small half-globe, as in Figure 37. As you blow air into it, it becomes larger, the film sliding outward

in all directions over the soapy plate and simultaneously extending upward in all directions into space. You can imagine the plane surface to be the earth, the transmitting aërial to be at the center of the plate, and the bubble to represent the ever-expanding radio wave. The base of the bubble, where it contacts with the wet plate, describes a circle that expands as the bubble grows larger. So, too, the radio waves, viewed from above, might be seen as constantly spreading circles that travel over the countryside in all directions from the sending station. The successive waves, like bubbles one within the other and all expanding at the same rate, would trace concentric circles, all having their mid-points

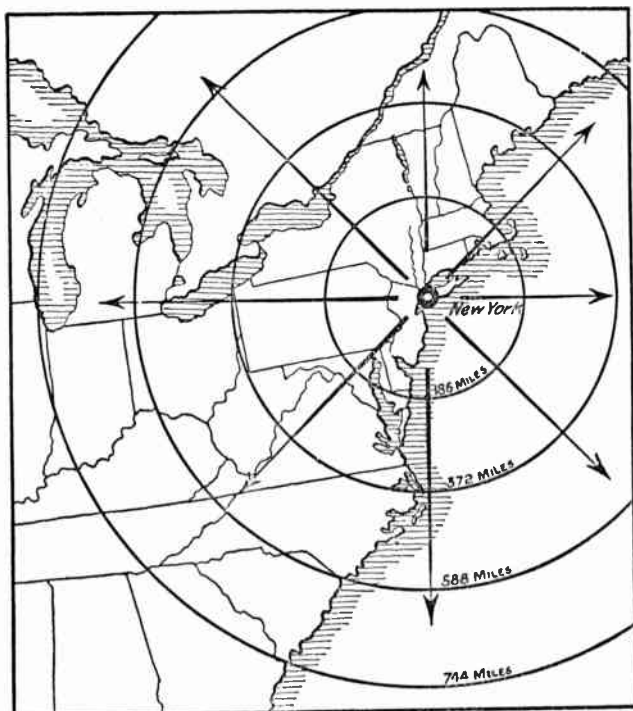

FIG. 38: Top View of a Radio Wave Originating in New York. — If a broadcasting station in New York sent out a single radio wave, the wave would have expanded to the points on the first circle (186 miles from the center) in $\frac{1}{1,000}$ of a second. The second, third, and fourth circles (372, 588, and 744 miles in radius) would be reached in $\frac{2}{1,000}$, $\frac{3}{1,000}$ and $\frac{4}{1,000}$ of a second, respectively. All the waves spread out in this same way, as indicated by the arrow, although various partial obstacles may prevent a perfectly circular distribution.

at the transmitter. Figure 38 is a map centering in New York and showing in successive circles the growth of a radio wave as it would appear if we could see it from the celestial viewpoint of a chart-maker.

In the few preceding paragraphs, before we digressed to talk about bubbles, we assumed the radio waves to move outward at the speed of only fifty meters (164 feet) per second. This is about 110 miles per hour, — a good airplane speed, but nothing at all for radio waves. We chose this relatively low velocity so as to give our crude measuring globe time to swing up and down in order to indicate for us the changing field intensities.

The natural radio-wave speed, as we have seen, is 186,000 miles (or 300,000,000 meters) per second. This is six million times as fast as our assumed velocity of 110 miles per hour. At their true speed, the waves traveling outward from the transmitter would reach the points marked by the circles of the map (Figure 38), which are 186 miles or 300 kilometers apart, at intervals of only $\frac{1}{1,000}$ of a second. They would travel the distance of 400 meters, which is one wavelength in Figure 33, in $\frac{1}{750,000}$ of a second. This means that at any point, such as the position we chose at 500 meters from the sending aerial wires, the static field of force would pass through a whole cycle of values (from ten upward to ten downward, and back) in $\frac{1}{750,000}$ second. Of course, no measuring globe that we could build and charge with electrons could possibly move up and down so rapidly. An electron, however, if free to move in a conductor, could do so. If our eyes were keen enough, we could see

it swing up and down at this enormous frequency, just as our measuring globe did at the slower frequency.

Wavelength and Frequency. We come now to the interesting relation between the frequency and the wavelength of electro-magnetic waves. As we know, the frequency is the number of complete swings the wave (or the current creating it) makes in one second. For radio waves, the frequency may be between ten million cycles and fifteen thousand cycles or so, per second. The wavelength, as was explained in connection with Figure 33, is simply the distance the wave travels in the time of one complete cycle. This is the same thing as the distance between corresponding points in successive waves. At these points, the successive waves have the same intensity and force direction. Since all radio waves travel three hundred million meters per second, the distance they move in the time of one cycle must be this figure divided by the number of cycles they complete in one second. In other words, wavelength is equal to velocity divided by frequency. Also, the frequency is equal to the velocity divided by the wavelength. Of course, all three must be given in the same units. To get wavelength in meters, we divide velocity in *meters per second* by frequency in *cycles per second*.

Following this simple rule, we find that as the frequency of the wave increases, the wavelength

decreases. The 400-meter waves that we have been studying have a frequency of 300,000,000 divided by 400, or 750,000 cycles per second. A wave of 1,000,000 cycles per second has a wavelength of 300,000,000 divided by 1,000,000 or 300 meters. A wave of 1,500 meters wavelength has a frequency of 300,000,000 divided by 1,500, or 200,000 cycles per second. The following table shows some of the wavelengths largely used in the various services of radio, with their frequencies:

USE	WAVELENGTH	WAVE FREQUENCY
Experimental . . .	30 meters	10,000,000 cycles per second
Army Field Signaling	75 meters	4,000,000 cycles per second
Amateur Radio Transmission	200 meters	1,500,000 cycles per second
Broadcast Radio-telephony	222 meters	1,350,000 cycles per second
Marine Signaling, small ships	300 meters	1,000,000 cycles per second
Broadcast Radio-telephony	360 meters	833,000 cycles per second
Broadcast Radio-telephony	400 meters	750,000 cycles per second
Marine Signaling	450 meters	666,000 cycles per second
Broadcast Radio-telephony	545 meters	550,000 cycles per second
Marine Signaling	600 meters	500,000 cycles per second
Direction Finding	800 meters	375,000 cycles per second
Marine Signaling, long distance	1,800 meters	166,000 cycles per second
Time and Weather Reports	2,500 meters	120,000 cycles per second
Overland Radio-telegraphy	5,000 meters	60,000 cycles per second
Transoceanic Radio-telegraphy	15,000 meters	20,000 cycles per second

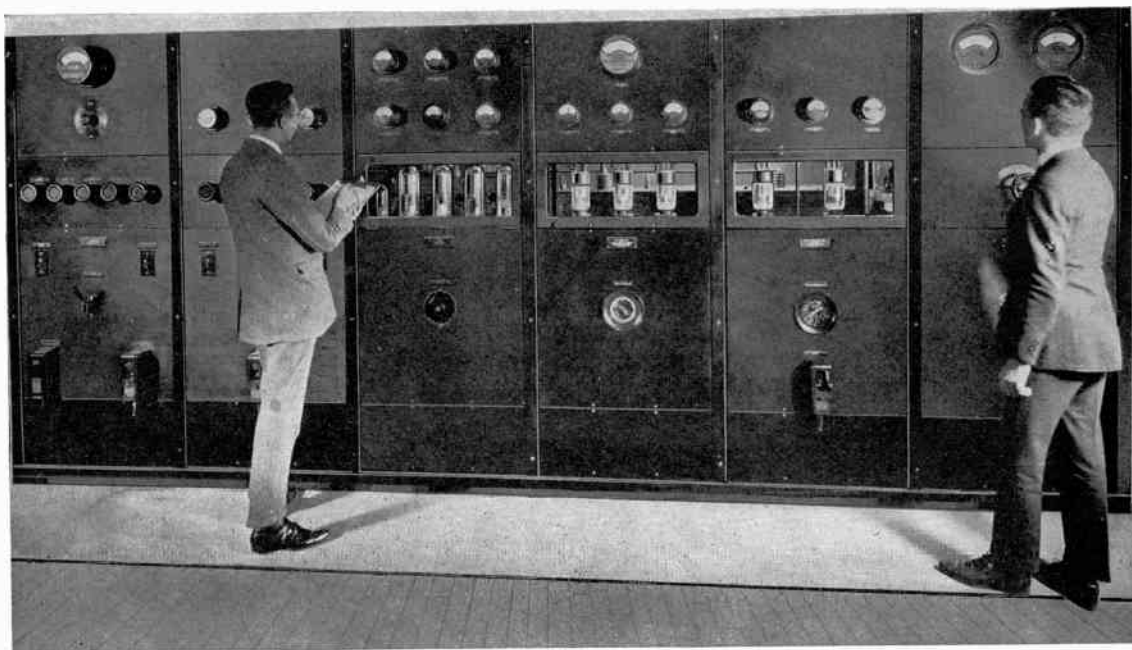

NEW YORK BROADCASTING STATION (WEAF) OF THE AMERICAN TELEPHONE AND TELEGRAPH COMPANY

This well known station contains one of the first higher-powered transmitters used in broadcasting. The vacuum tubes in the third panel are amplifiers, and those in the fourth and fifth panels are high-powered, water-cooled oscillators and modulators.

The Magnetic Part of Radio Waves. So far, we have considered only the electrostatic portion of the radio waves. The other part is called the "magnetic component", and moves along hand in hand with the first. It will not be necessary for us to analyze this magnetic portion in great detail. The electrostatic component alone gives us a fair idea of how the wave travels through space and how it will exert a force that will tend to move an electron (or a number of these minute negative electric particles) *up-and-down* at the wave frequency. The magnetic part of the wave would exert a similar but magnetic force upon magnetic particles or poles which it encountered; but the magnetic force would not try to move these poles up and down. The field of magnetic force in a radio wave is at right angles to the electric force, and hence acts *horizontally*. Moreover, it appears at right angles to the line of travel of the waves.

Figure 39 represents these magnetic forces as viewed from above. The dotted radial lines indicate directions of wave travel away from the sending station at the center; and (in a manner analogous to that of Figure 33) the little arrows show, by their direction and length, the direction and strength of the magnetic field at successive points, each fifty meters farther from the transmitter. As before, the diagram is drawn for a 400-meter or 750,000-cycle wave. It can easily

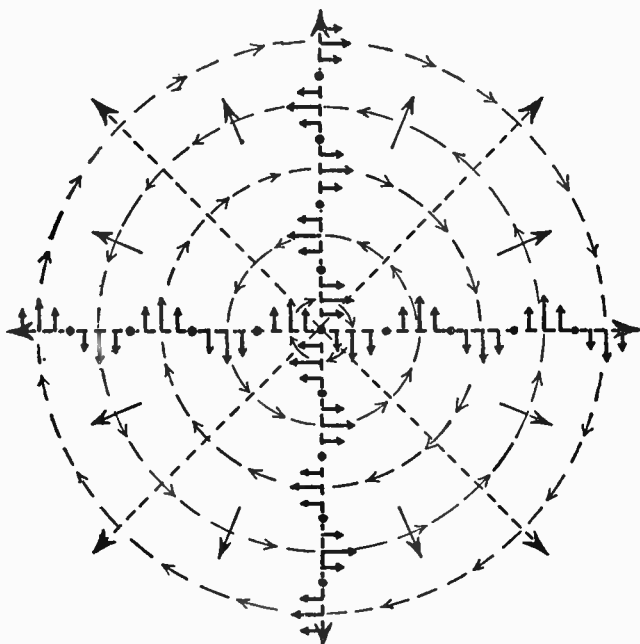

FIG. 39: A Chart of the Wave's Magnetic Forces. — This part of the wave tends to sweep back and forth in ever expanding circles, first clockwise and then counter-clockwise (as viewed from directly above the sending aerial in this illustration). Here the circles are 200 meters, or $\frac{1}{4}$ wavelength, apart. The radial arrows indicate the direction of wave expansion, and the others show the direction of the magnetic force at the instant of observation.

be seen that the magnetic field lies in concentric circles which expand with the wave, and that its force would tend to sweep magnetic particles alternately to the right and to the left, viewed along the line of wave travel. These magnetic-force circles are not limited to a layer near the earth's surface, but also occur upward in space as high as the radio wave may reach.

Some idea of the relation between the magnetic and electrostatic components of an electromagnetic wave may be grasped from Figure 40, which is a representation of their relative strengths and directions as one looks along a single line of wave travel. This is a sort of perspective view, in which

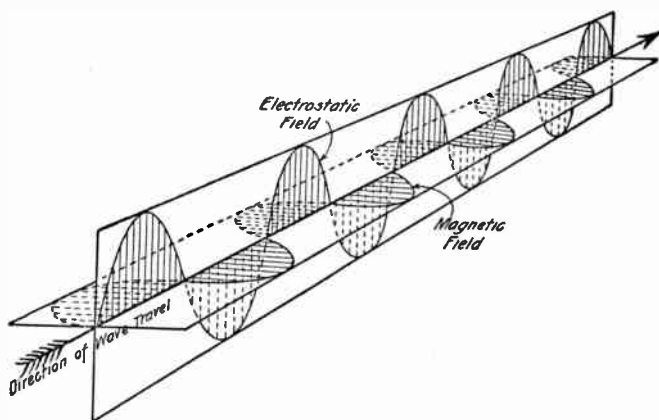

FIG. 40: The Magnetic and Electrostatic Effects that together form a radio or electro-magnetic wave are related in the way here suggested. This looks for $4\frac{1}{2}$ wavelengths along a radio wave traveling in the direction of the central arrow, and indicates the simultaneous up-and-down variations of electric field that accompany the right-and-left changes in the magnetic field. Note that the two components go hand in hand, so to speak.

the vertical lines represent by their length the *static field intensity* (the strength of the force tending to move an electron or electric charge), and the horizontal lines show similarly the magnetic forces. Neither loops of static field nor circles of magnetic field are indicated. The drawing simply serves to point out how the two

kinds of force travel along together in a radio wave, but does not aim to be in any sense a picture of the wave itself.

Wave Intensity at Great Distances. There is only one thing left for us to consider in this chapter, and that is how the strength of the wave varies as the distance over which it has traveled becomes greater and greater. We know that a sound wave becomes fainter as we listen at points more and more removed from its origin, and that a light appears more and more dim as we look at it from increasing distances. We should expect something of this sort to happen to radio waves, since we have at the outset only a certain amount of power and this becomes distributed over a greater and greater wave surface as the waves fly through space away from the transmitter.

Such a weakening of the electrostatic and magnetic forces in a radio wave does occur as the distance from the sending station increases. If we consider the amount of energy available in a certain part of the wave at a distance of ten miles, we shall then find that in the same-sized piece of wave surface at twenty miles (double the distance) there will normally be only one quarter of that energy. At three times the distance, the amount will become one ninth the original value; at four times, one sixteenth; and so on. The normal reduction is thus quite rapid and the waves become weaker fairly quickly. Beyond this taper-

ing-off in strength, which is due simply to the wider distribution of the originally available energy, there is a further loss resulting from *absorption* of wave energy by the atmosphere through which it passes and by the ground or water over which it travels. This additional loss may be even greater than that caused by distribution; in amount, it varies with the seasons and with the time of day, as well as with the character of country between transmitting and receiving stations. Further, this absorption of wave energy is greater for some wavelengths than for others.

As a general rule, less absorption is experienced in winter than in summer; and less at night than during the day. Also, radio waves pass more easily over sea water than over land. Long waves are usually absorbed less than are short waves. However, these last two statements are subject to important exceptions; for short waves traveling over land occasionally (and especially at night during the winter months) encounter marvelously favorable conditions, such as not only appear to be entirely free from the effects of absorption but are so good that the wave energy decreases less rapidly than it would if there were uniform hemispherical (*i.e.*, normal) distribution of the transmitted power and no absorption whatever. These exceptionally good states of the space through which the waves pass may be due to

reflection, which sends back some of the wave energy normally traveling in other directions and adds it to the expected amount arriving at some particular place. In any event, they explain many of the long-distance signaling records made in radio working.

In discussing the weakening of radio waves that ordinarily occurs as the transmission distance increases, we are not considering the sort of intensity-variation or modulation which may be impressed on the wave at the sending station in order to reproduce signals. Here we are concerned with the change during transmission. If the wave starts with an intensity of ten thousand, it may arrive at some distant point with an intensity of only ten. If the modulation reduces the initial value to five thousand, the final value will be proportionately reduced to five during the passage of the wave through space. But this proportionality remains, regardless of the total reduction. Hence signaling is possible over distances as great as will permit the interception of useful amounts of wave energy. In the next chapter we shall see how the signal-carrying waves, whose creation, modulation, and radiation we have now studied, are forced to produce electrical indications at a radio receiving station.

CHAPTER VII

A MILLION LISTENING EARS

LET us suppose that we are at a point 186 miles away from some radio-telegraph transmitting station to whose signals we desire to listen. We have already seen that if the telegraph operator at this distant sender presses his key, there will flow in and out of his aërial wires an alternating current of many cycles per second. So long as he holds his key down, this aërial current will flow; and so long as the rapidly alternating currents rush up and down the transmitting wires, radio waves of that identical frequency will shoot forth into space.

These radio waves, as was explained in the preceding chapter, will travel outward in all directions over the earth's surface around the sending station. Each wave will expand to a circle of 186 miles radius in $\frac{1}{1,000}$ of a second after it starts from the sender. The waves will, of course, pass on, in growing circles; and any point within communicating distances will be reached in a very short time after the transmitting key has been pressed.

We cannot see, hear, or feel these radio waves as they pass by us. How, then, shall we detect their arrival? How shall we get some indication of their presence?

Effect of the Electric Wave Field. You will remember that an electrostatic field that was slow and intense but otherwise like that of a radio wave, could move our negatively charged aluminum-foil testing globe up and down. Because of mechanical limitations, such a globe would not respond to the radio waves having thousands or millions of alternations per second, though it might prove a perfectly good detector of a more slowly changing field. However, an electron is simply a small negative electric particle or charge, and it is very easily moved by small or rapid electrostatic forces. We might expect that the electric force of a radio wave would be strong enough to move an electron, even though the wave had been greatly weakened by traveling over a distance of many miles. We might also feel that an electron is sufficiently mobile to vibrate back and forth at the highest radio frequencies when it is acted on by the rapidly alternating forces of a radio wave. As a matter of fact, both of these suppositions are justifiable. All we need to do in order to determine the presence or passage of an electro-magnetic wave is to provide some electrons which the wave forces can set into motion, and also an instrument for

indicating the resulting movements of the electrons.

To do this is not so hard as it sounds. In the first place, a copper wire is a good electric conductor because it offers a low resistance or easy path for the flow of electrons. In a conductor of this kind there is, according to our modern views, a constant movement of electrons, even when no electric current is flowing. If the ordinary movement of these electrons, which is more or less at random, is so controlled that they all flow in one direction, we say that an electric current is flowing in the wire.

The Receiving Aërial Wire. Suppose we project a conducting wire up into the air, where it will be more or less parallel to the loop lines of electric force in the passing radio waves. Is it not easy to see that the same electrostatic field that tended to raise our testing globe will similarly force in an upward direction the free electrons within the vertical wire? And that the succeeding downward-acting force will drive them down again in this receiving wire? If the lower end of the vertical wire is connected to earth, so that the electrons can easily flow from the wire into the ground and back, the orderly vibrations of the electrons in the wire (as they are alternately swung up and down by the changing forces of the radio wave) will constitute an alternating current of the same frequency as the wave. The

frequency must necessarily be the same, for it is the wave forces that cause the alternate flow of electric current. If the wave force alternates 750,000 times per second, the current it produces must do likewise.

We may say that the vertical intercepting wire is a receiving aërial or antenna wire; and that the wave forces induce in it an alternating electromotive force, which tends to produce an alternating flow of electrons (or, in other words, an alternating current). Remembering that the greatest amount of current flows, as a result of any definite electromotive force, in a circuit having the least possible resistance, we see at once that in order to get a large radio-frequency current in the receiving antenna circuit, the resistance of that circuit must be made small. Even at best, with the resistance as little as is practically attainable, this current will clearly be much smaller than the current in the transmitting aërial wires, because the voltage or electromotive force produced by such small part of the radio wave as we can intercept at any one receiver will be much less than the voltage which set up the wave-generating current at the sending station.

Listening to the Waves. The receiving aërial wire is, then, a sort of radio ear, which listens for passing radio waves and shows their arrival by vibrating electrically at the wave frequency. Since the radio waves pass out in all directions, many

such receiving wires can listen at the same time to the same transmitted wave; just as many people may simultaneously listen to a single speaker whose voice waves travel away from him in all directions. The listening wires do not disturb the passing waves much (if any) more than our ears disturb the sound waves that go by us. Beyond this, radio waves travel so far that many, many more people can listen to one radio transmitter than to one human speaker. If receiving wires were set up around the 186-mile circle which the waves reach in $\frac{1}{1,000}$ second, each wire being about two city blocks from the next, there would be over one million listening stations in the ring. All of these could easily hear signals from a single small transmitter at the center. Moreover, enough of each radio wave would pass by them to permit a good many more millions of receivers to listen outside the circle.

But what can we do with the rapid alternating currents which the waves produce in the receiving antenna circuit? Also, how can we make our receiving wire listen to only one sending station, if a number of stations are transmitting at the same time and their waves all go past our receiver?

The first of these questions will have to wait until the next chapter, which will go into detail about converting the radio-frequency currents into signals that we can hear. The second point,

however, is intimately connected with the matter of building up the antenna current to its highest possible value.

Because the radio wave arriving from any particular sending station has a definite field intensity at any particular instant, we cannot at that instant get more than a certain corresponding voltage in our receiving aërial wire. We are able, nevertheless, to vary the amount of current which this electromotive force can cause to flow. This we may do by changing the impedance of our aërial-to-ground circuit at the receiving station. Impedance, as was explained in Chapter IV, is simply the apparent total resistance that alternating currents encounter, and includes the holding-back effects of inductance and capacitance. By making the impedance of our receiving system a minimum, we can get the greatest possible flow of radio-frequency current from any radio wave. As we shall see, the larger this antenna current-flow can be made, the louder will be the signals heard.

Tuning to Reduce Impedance. The problem of adjusting the receiving aërial, then, is to produce in it the least possible impedance for the waves we desire to receive, so that the greatest amount of current may flow. Perhaps you recall that we had before us, in Chapter IV, a practically identical problem in connection with the transmitting station. There we had a special

alternator generating a radio-frequency alternating voltage in the aërial wire, and we desired to get the greatest possible flow of current for that available voltage. Here we have the same condition, except that the voltage is produced by the arriving radio waves, and we desire to at-

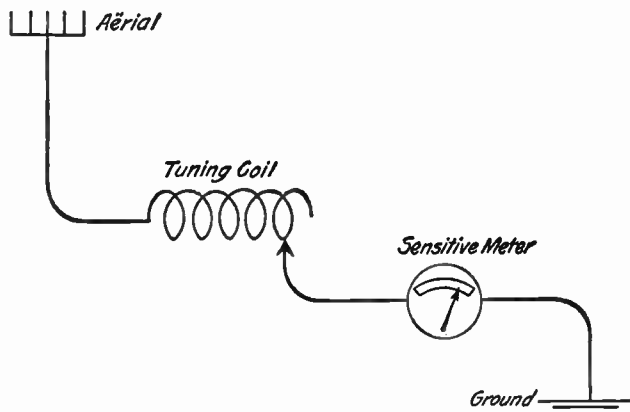

FIG. 41: The Simplest Type of Radio Receiver. — When the tuning coil or inductor is of the proper size, the arriving waves will generate the greatest amount of radio-frequency current in the system. This result may be indicated by the largest scale-reading of the sensitive current-meter in the circuit. Note the similarity between this receiver and the sender shown in Fig. 22.

tain the same result, *i.e.*, maximum current flow. In the transmitter we solved the problem by tuning the antenna system to the impressed radio frequency. The aërial circuit was made resonant by adjusting the inductance of a coil to coöperate with the capacitance (condenser action) of the antenna itself, in order to get the smallest impedance value. There is no reason why this same

process of tuning should not be used for a similar purpose at the receiver.

Tuning, or the resonant adjustment to minimum impedance, gives us maximum current flow for only one applied frequency of electromotive force. If we desire to tune to another frequency, we must change the amount of capacitance or of inductance in the circuit. This situation may be clearer if we look into a practical case. Suppose that our receiving aerial consists of a vertical wire fifty feet long, hung from the top of a flagpole and running down to the ground connection. This wire will necessarily possess a certain amount of capacitance; that is, it can act, in conjunction with the earth's surface, like an electrical condenser of a certain size. Now imagine that we insert, between the lower end of the wire and the ground connection, a coil of wire and a very sensitive radio-frequency current meter. By using various numbers of turns of wire in the coil, we may change the inductance of the coil and consequently that of the circuit. From the scale of the meter we may determine the amount of current flowing at any time.

Operating a Tuning Coil. Let us imagine that the coil has forty turns of wire; that the inductance for twenty turns will neutralize the capacitance reaction of the antenna for a frequency of 833,000 cycles; and that the inductance for thirty turns will be just right to produce this

neutralization or resonance effect for 750,000 cycles. Since 833,000 cycles correspond to a radio wave of 360 meters wavelength, and since a frequency of 750,000 cycles is the frequency of a 400-meter wave, it becomes evident that to get the minimum impedance (or greatest current flow) for the first wavelength we should put twenty turns of the coil in circuit, and that we should use thirty turns to tune to the second wavelength.

The problem of obtaining, in the aërial circuit, the greatest flow of current from a desired radio wave of some particular frequency, while at the same time suppressing current that another wave of somewhat different frequency may tend to produce, is of the greatest importance. It is easily solved by proper adjustment of a tuning element, such as inductance or capacitance, in suitably arranged circuits; and by such tuning it is feasible to build up to a maximum the current from one wave while at the same time preventing the other wave from generating any measurable current.

We can demonstrate this practically by setting up such a system and arranging to have a constant stream of 360-meter waves and another of 400-meter waves pass by while we make our measurements. If, then, we connected the turns of the tuning coil into circuit one at a time, and observed the amount of current flowing in the aërial wire as each turn was added, we should get a set of values something like this:

	NUMBER OF TURNS	CURRENT IN MILLIONTHS OF AN AMPERE
	0	0
	1	0
	2	0
and so on to	13	0
	14	0
	15	0
	16	1
	17	5
	18	15
	19	35
	20	50
	21	35
	22	15
	23	5
	24	1
	25	0
	26	1
	27	5
	28	15
	29	35
	30	50
	31	35
	32	15
	33	5
	34	1
	35	0
	36	0
	37	0
	38	0
	39	0
	40	0

Tuning to Different Frequencies. The interpretation of this experiment is very easy. It simply means that the aërial wire alone (connected to ground), or with any number of turns of the coil up to and including fifteen, had such a high impedance that the arriving 360- and 400-meter waves could not generate in it even one millionth of an ampere of current. Some current necessarily was flowing, and more as the turns

were added; but not enough to be useful or to operate our meter. When we use sixteen turns, however, the capacitance effect of the antenna wire is sufficiently neutralized (or in other words, the impedance of the system is sufficiently re-

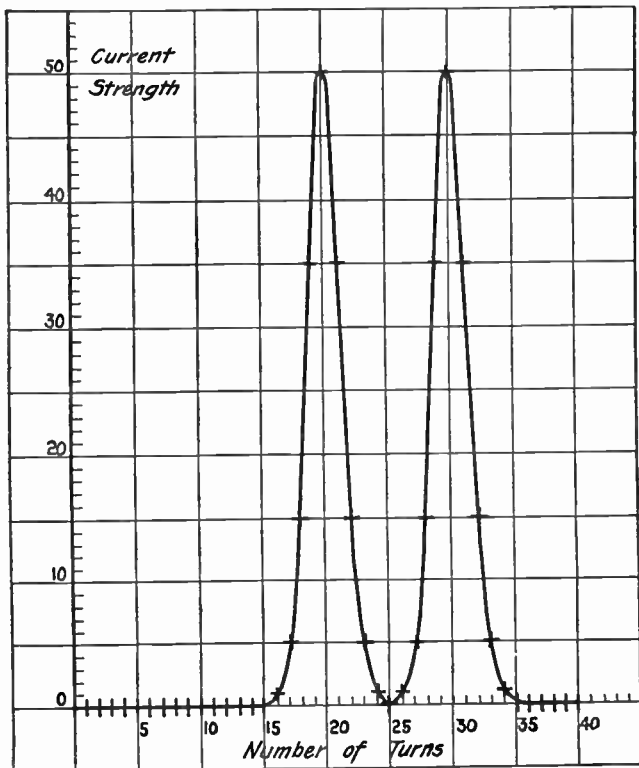

FIG. 42: A Chart of the Tuning Table. — If, along the vertical line corresponding to each turn, we draw a small cross at the altitude indicating the amount of current flowing, we may connect these crosses by a smooth, heavy line and form such a resonance curve as is here shown. Such a curve may be plotted for any resonant circuit.

duced) to permit the 360-meter wave to generate one microampere (millionth of an ampere) of 833,000-cycle current. With seventeen turns in circuit, the capacitance reaction was further neutralized, and five microamperes could flow. So, for eighteen and nineteen turns the impedance became still lower, and first fifteen and then thirty-five microamperes of current were produced. At twenty turns the capacitance portion was exactly compensated for and the impedance for 833,000 cycles reached its resonant minimum; hence the greatest current for this frequency (fifty microamperes) was observed.

As the number of turns was further increased, the point of resonance or lowest impedance was passed; and because the larger amount of inductance in the coil was not balanced by the condenser action, it began to hold back the current. Thus, for twenty-one, twenty-two, twenty-three, and twenty-four turns the impedance to 833,000 cycles increased and the current became smaller. For twenty-five turns, neither the 360-meter nor the 400-meter wave could generate enough current to move the pointer of the meter. At twenty-six turns, however, the greater amount of inductance began to neutralize the aërial capacitance reaction enough to let the slower 750,000-cycle currents develop in measurable amounts, and one microampere was registered. As in the case of the other wave, the currents increased

until the resonant maximum of fifty microamperes was reached when (at thirty turns) the system was tuned to 400 meters wavelength or 750,000 cycles frequency; and then fell off again to less than one microampere as additions of inductance increased the impedance of the circuit for this frequency.

Selection by Resonance; Condenser Tuning. Thus we see that two of our problems have been solved together. We can get the greatest current from any particular length of wave by tuning our receiver to its frequency; and at the same time we can keep the impedance sufficiently high to prevent waves of other lengths (other frequencies) from generating enough current to disturb us. We can tune to any wavelength in radio by changing the amount of inductance in circuit with a given size of condenser, using more inductance to produce resonance for longer waves and less inductance (fewer turns on the tuning coil) for shorter waves.

There is another convenient way to tune to various frequencies; and that is by leaving the amount of inductance unchanged while we vary the capacitance of the circuit. Of course, it is not easy to vary the capacitance of an aerial wire. We should ordinarily have to change its length or height or size. But we can use an instrument called a "variable condenser", in which, when a knob is turned, two plates will approach

each other more or less closely or two series of interleaved semicircular plates will overlap each other to a greater or less extent. The capacitance of such a device is greater as the plates move more closely together, or as they are further overlapped; and we may make the value of capacitance anything we desire (within the work-

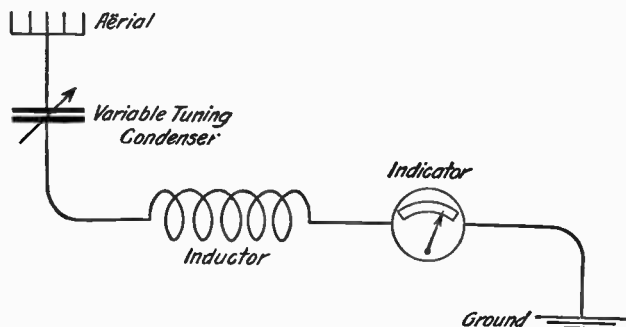
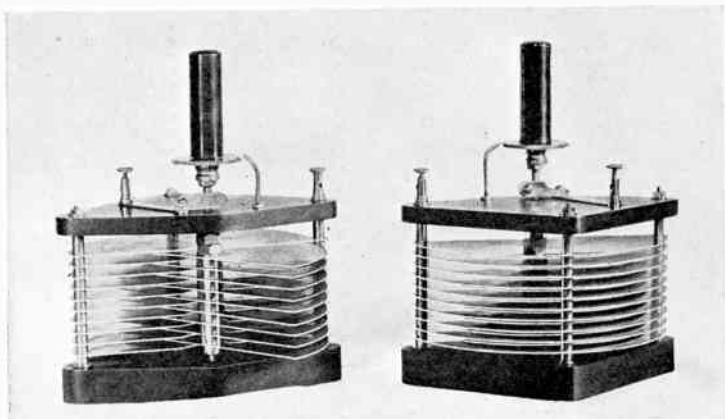

Fig. 43: An Example of Tuning with Variable Condenser. — This is like the receiver of Fig. 41, but has an added variable condenser for tuning. If the inductor is left at a constant value, the resonant frequency of the receiver may be changed by altering the capacitance of the condenser shown. The indicator is, as before, a very sensitive ammeter.

ing range of the instrument), by simply moving the adjusting handle.

If a condenser is connected in series with the receiving aërial, the resultant capacitance will be less than that of either alone. The series condenser may be made variable; and if its values are all less than the capacitance of the aërial wire, it will be the important or controlling condenser of the combination. By putting such an adjustable condenser in the antenna circuit



A

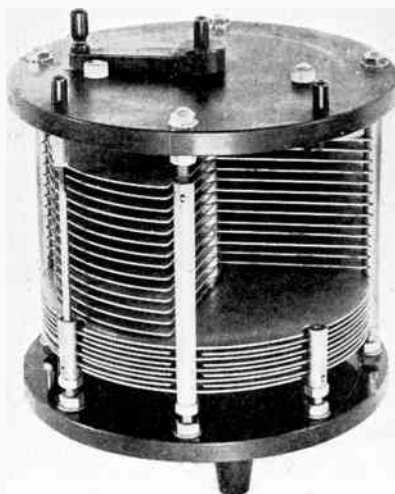

B

TWO TYPES OF VARIABLE TUNING CONDENSERS

These old designs, less compact than more modern forms, illustrate clearly how the two sets of plates interlace.

with the coil and current meter just studied, we may leave the full forty turns of the coil active and do our tuning by changing the capacitance of the condenser. A proper choice of sizes would make it possible to reproduce the tuning effects of the table on page 136; the left-hand column being considered to represent degrees on the condenser scale (or units of capacitance) instead of turns of the inductance coil. With this arrangement we may use nonvariable coils and yet tune our circuits to resonance for any wave frequency by adjusting the condenser. Greater values of capacitance give the resonant reduction of impedance for the longer waves, and smaller values for the shorter wavelengths.

Sharpening the Tuning. A set of tuning conditions corresponding to the tabulated data would obviously make it possible to receive waves of 360 meters, and at the same time completely to exclude waves of 400 meters length, or vice versa. By this adjustment of resonance, we are able to select between waves of different frequencies coming from different stations, and to confine our attention to the radiation from a single transmitter. But suppose that instead of selecting between 360 and 400 meters, we wished to pick out either a 360-meter wave or one of 368 meters length, both being transmitted continuously and both arriving at our receiver with the same intensity. Referring again to the table

on page 136, we note that ten turns of the coil (or ten degrees of the tuning condenser) separate the resonant points for 360 (20) and for 400 (30) meters. We may therefore assume that at each turn (or degree) above 20, the resonant wavelength is four meters longer than 360 meters, and that 22 turns (or degrees) would tune exactly to 368 meters. At this point we should expect to get a current of 50 microamperes from the 368-meter wave. From our earlier experiment we know that 15 microamperes of current from the 360-meter wave would be flowing at this setting of 22 turns (or degrees), and hence we should have in our circuit 65 microamperes from both waves. Neither would be selected exclusively; for at 20 degrees (or turns) there should be 15 microamperes of current flowing from the 368-meter wave in addition to the maximum of 50 produced at 833,000 cycles by the original 360-meter radiation.

To select either of these waves to the exclusion of the other, we should have to arrange our receiving circuit so that practically no 833,000-cycle current would flow at 22 degrees (or turns) and no 815,000-cycle current (corresponding to the 368-meter wave) at 20 turns or degrees. In other words, we should have to make greater changes in impedance occur for each alteration of the tuning condenser or inductance coil. There are several ways of "sharpening the tuning",

as this is called; and one of the simplest and most effective is to provide two successive tuned circuits at the receiver.

The Double-Circuit Tuner. If we take the tuned aërial circuit with fixed coil and variable condenser, shown in Figure 43, and add to it a second coil and a second condenser, as in Figure

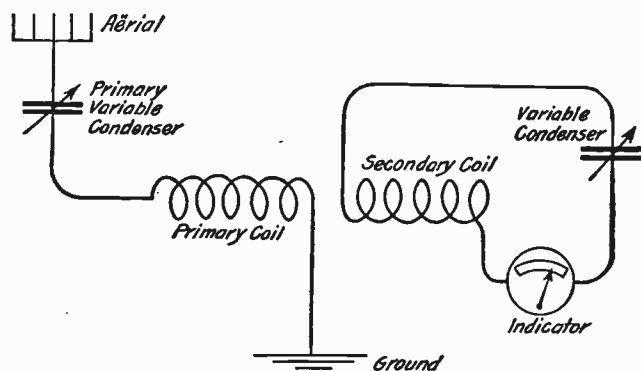

FIG. 44: A Double-Circuit Tuner. — By the placing of the indicating instrument in a secondary circuit as here shown, the ability of the receiver to select desired wave-frequencies from interference is ordinarily much improved. The primary and secondary coils constitute an *inductive coupler*.

44, we have two such successive circuits. Each has capacitance and inductance, and each may be tuned. In this new arrangement, our current-measuring meter is placed in the second circuit, since it is there that we wish to observe the resonant effects. The coil of the second circuit, called the “secondary”, must be placed relatively near to (but preferably not too close to) the coil of the aërial circuit, called the “primary.” This

is because we rely upon the magnetic forces developed around the primary coil by the radio-frequency currents passing through it, to produce radio-frequency voltages in the secondary circuit. The magnetic forces can do this only when they can reach the secondary coil on which they are to act; and since these forces are strongest comparatively near the primary, the two coils must not be too far apart.

Assuming that a 360-meter wave is setting up maximum-strength 833,000-cycle currents in the aërial and primary coil (the circuit having been carefully tuned to this frequency), we may vary the condenser in the secondary circuit and watch for indications of current in the meter. We shall find that at the value of capacitance which neutralizes the inductive effect of the secondary coil for this frequency, a large current will flow in the secondary circuit. Moreover, a very slight "detuning", or movement of the condenser away from the resonant setting, will cause this current to drop practically to zero. The impedance change per degree of condenser movement is much greater than in the simple circuit. Hence the tuning is much sharper, and (by a careful adjustment of both the tuned circuits to the desired wavelength and the choice of a proper separation between the coils) it becomes feasible to discriminate between waves even as close together as 360 and 368 meters.

The Loop Antenna. An interesting point in connection with this circuit arrangement is that we may enlarge the secondary coil to a diameter of three or four feet (using relatively fewer turns) and do away entirely with the receiving aerial wire. The enlarged coil forms what is called a "loop antenna", and the magnetic-force component of the radio wave itself generates electromotive forces in this loop, much as the more compact but similar magnetic forces of the primary coil generated voltages in the smaller secondary coil. "Loop reception", as this direct use of a large coil excited by the magnetic force of the wave has been called, is usually much less effective than aerial-wire reception of the kind we have been discussing. It is entirely practical, but it requires the use of exceptionally delicate receiving instruments.

One last word about receiving aërials. In our study of how arriving radio waves produce currents in the receiver circuits, we have considered only simple vertical wires. The effects are practically the same if the receiving wire is bent into an inverted L shape or made in T formation. A number of T's may be combined to form an umbrella-like structure; or the wires may be arranged in parallel lines. All these are standard forms of receiving aërials. The multiple-wire types are best suited for fairly long waves and the single-wire forms for short waves. For broadcasting

radio wavelengths, it is hard to beat a single wire from one hundred to one hundred and fifty feet long, arranged in the inverted L shape with the horizontal portion about three times as long as the vertical.

Having found out how to build up strong radio-frequency currents from the particular wave we desire to receive, we are ready to look into the ways by which these inaudible high-frequency vibrations of electricity may be converted into signal sounds.

CHAPTER VIII

THE INAUDIBLE IS HEARD

IN electric telegraphy over line wires, a direct current is led along a conductor from the signaling key to the magnet coils of a sounder. Dots and dashes of the Morse code are represented by short and long periods of current-flow; and so long as the current circulates, the sounder lever is magnetically held down. When the current stops, the magnetism in the sounder grows weak and the sounder lever flies up. Each motion down and up is indicated by a sharp click; and the operator, listening to the clicks, pieces together the dots and dashes they represent, and so spells out the complete message.

If we connected the coils of a telegraph sounder into the antenna circuit of a radio receiver, and then expected to have it operated as in line telegraphy, we should be disappointed. In the first place, the electric power produced in a receiving aerial by the arriving waves is ordinarily far too feeble to work a telegraph sounder. In the second place, even if the power were sufficient, it is not of the right form. A sounder works best on direct current, which flows steadily in a

single direction; whereas the current in a radio-receiving antenna alternates in direction at high frequency. Thus the sounder would be exceedingly unsatisfactory as an indicator of radio currents.

Evidently we need either something that will directly show the presence of high-frequency currents, or something that will convert the radio currents into a form which can operate some ordinary indicator like a sounder or a telephone receiver. In practical radio, both plans have been used. Special telephones that would work when supplied with high-frequency currents have been built, and many forms of receiving converter have been devised. The latter plan, based on conversion, has been found the most valuable and is the foundation of radio receiving to-day.

Operating a Telephone Receiver. The ordinary telephone receiver is an extremely sensitive instrument, and one that will give off fairly loud sounds in response to even the small amounts of power ordinarily generated in receiving aërials by the arriving waves. But we cannot use the telephone receiver directly in the aërial circuit, if we expect anything like satisfactory performance; for it will not work well on radio-frequency alternating current. We can see the reason for this quite easily if we bear in mind that current flowing in one direction through the telephone windings tends to strengthen the tele-

phone magnets and attract the diaphragm, whereas a current flowing in the opposite direction tends to weaken the magnetism and release the diaphragm. Thus, if a 750,000-cycle current were forced through the windings, the diaphragm would be driven by forces pulling it in and pushing it out 750,000 times in each second. Of course no iron diaphragm could be moved back and forth very far at this enormous rate; and even if the disc would move so rapidly, the air waves it produced would be of a frequency far higher than we could hear. The telephone connected in this way is practically useless as a signaling device.

But the conditions would be very different if we could convert the rapidly alternating radio energy into a series of currents flowing in one direction. Such "pulsating currents", as they are called (because they increase and decrease in pulses, but do not change their direction of flow), would tend to move the telephone diaphragm in one direction only, and would produce strongly audible sound waves. If we remember that alternating current flow is really a flood of electrons surging back and forth within the aerial wire, it becomes evident that what we need, in order to get from it currents flowing in only one direction, is a sort of electric turnstile that will let electrons through one way but not the other.

Converting the Radio Currents. Curiously enough, a number of materials have been discovered that will do this trick. A piece of natural lead sulphide (galena) in contact with a bit of wire will form a very effective electron turnstile. So also will carborundum (made of sand and car-

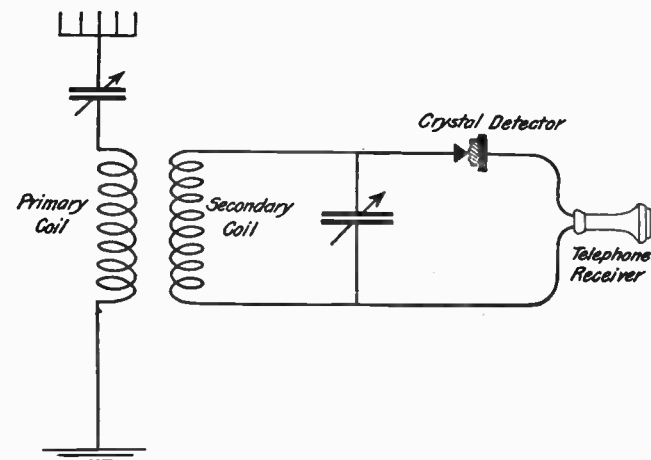

FIG. 45: A Two-Circuit Tuner with Crystal Detector. — Because the detector and telephone are of high resistance, they are connected around (or in *shunt* to) the secondary variable condenser. The low-resistance ammeter of Fig. 44 was placed directly in series in the resonant circuit. Note the variable condensers for tuning the primary and secondary circuits.

bon fused in an electric furnace), iron pyrites, red oxide of zinc, and a host of other minerals that are used in the so-called “crystal detectors” of radio. These detectors are simply converters. They change the radio currents developed by the arriving waves into pulsating currents suitable for operating a telephone receiver.

Let us see how one of the electron turnstiles works. In Figure 45 we have taken the double-circuit tuner described in the previous chapter and added a crystal detector and a telephone receiver. You will remember that the received waves produced alternating currents of their

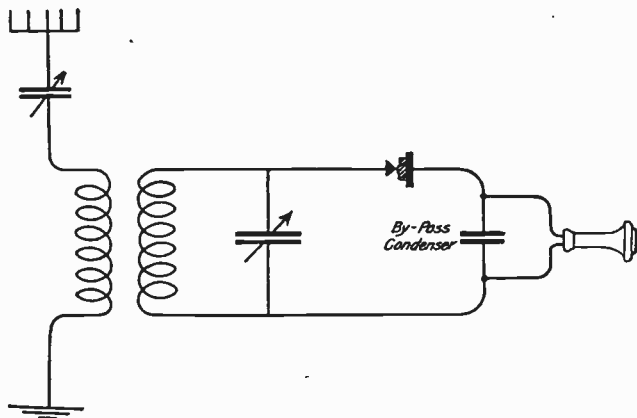

FIG. 46: How the By-Pass Condenser Is Used. — Except for the additional condenser in shunt to the telephones, this is the same as Fig. 45. Note that the arrow drawn through the parallel line symbol means that the condenser is *variable*. Here the by-pass condenser is of fixed (or constant) capacitance, and the arrow is omitted.

own frequency in the aerial circuit and in the secondary circuit (coupled by the magnetic field of the coils), and that this current was strongest when both circuits were exactly tuned to the wave frequency. We may consider that in the secondary circuit, as the current oscillates, a flood of electrons piles up first on one plate of the condenser and then on the other.

The additional circuit, containing the crystal detector and the telephone receiver, gives these crowded electrons another path through which to distribute themselves. For example, when the upper plate of the condenser is overcrowded and the electrons start back to the other plate through the secondary coil, a number of them will try the other route through the crystal detector and the telephone. On the next reversal, however, when the lower plate is charged with electrons, all must pass out by way of the coil, because the crystal detector will permit them to go through in one direction only. From this it is not hard to see that current will be sent through the telephone in rapid unidirectional pulses, all of which will tend to affect its magnetism and move its diaphragm in the same way. Since the pulses follow each other at the radio frequency, and since the windings of the telephone receiver tend to hold back such rapid current fluctuations, our receiver will work more effectively if we add a "by-pass" condenser (as in Figure 46), through which the impulses may flow around the telephones.

When Waves Are Received. With the outfit so arranged, what would be the effect of sending out from the distant radio transmitter (to which our receiver is tuned) a series of short and long wave groups corresponding to dots and dashes? When no waves are being sent forth, no currents

will flow in the receiver, and the diaphragm of the telephone will lie at rest. When the sending key is pressed, waves will shoot from the transmitting to the receiving antenna and radio-frequency currents will at once build up in the tuned circuits of the receiver. Consequently, the crystal turnstile will begin to pass current impulses through the telephone windings in one direction and the diaphragm will be sharply moved. Thus the down stroke of the sending key will produce, by the receiver diaphragm motion, a distinct click. When the sending key is released, the waves will stop and the currents will stop, and the telephone diaphragm will promptly move back to its position of rest. This will produce a second click, marking the up-stroke of the key and the end of the wave train. If the interval between the clicks is short (say, $\frac{1}{10}$ of a second), we shall know that the sending key was pressed down and at once released, so signaling a Morse dot. If the interval is longer, we shall recognize the signal as a dash. So we may telegraph by radio, spelling our messages out, letter by letter, in the Morse code.

In practical radio-telegraphy it has been found easier to read the dots and dashes as short and long musical tones of constant pitch. These short and long notes are much clearer than the clicks, and can better be distinguished from disturbing sounds. There are several ways of

modifying the system so as to produce these tone signals, as, for instance, by inserting an "interrupter disc" in the aerial circuit of the receiver. Such an arrangement is illustrated in Figure 47. If the disc is rotated by clockwork,

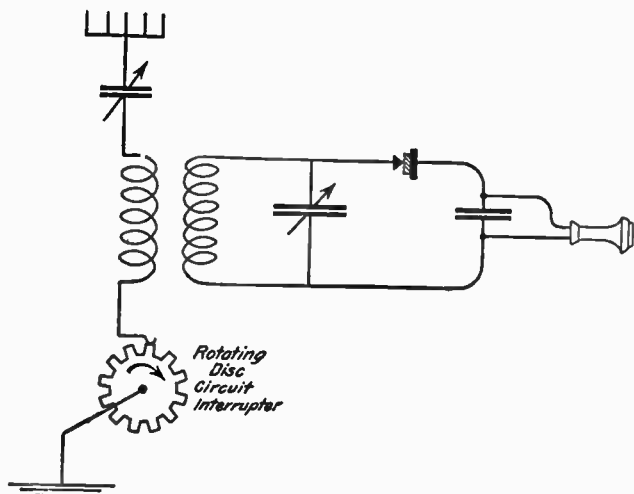

FIG. 47: Receiver Having a Tone-Producing Interrupter. — This is exactly the same as Fig. 46, except for the added interrupter that is provided to chop up the continuous radio-frequency currents produced by the received waves.

let us say, so as to open and close the aerial circuit five hundred times per second, the wave currents will be broken up at this frequency. Let us suppose that a 750,000-cycle wave is arriving, and that the interrupter has just closed the circuit. In $\frac{1}{1,000}$ of a second, 750 cycles of current will flow in the aerial. Then the disc will open the circuit for $\frac{1}{1,000}$ of a second, and no current

can flow even though the waves continue to strike the antenna. When the circuit is closed for another $\frac{1}{1,000}$ of a second, 750 more current cycles will be generated. Thus the current in the system is turned on and off five hundred times a second, each period of flow being $\frac{1}{1,000}$ of a second long and containing current corresponding to 750 wave cycles.

Producing a Musical Signal Tone. It is not difficult to see that the groups of impulses applied to the telephone windings must also occur five hundred times per second, and that the diaphragm must move in and out each time. So there is set up, so long as the waves are arriving, a diaphragm vibration of five hundred per second, which produces a note about one octave above middle C on the piano. A short train of waves (a dot) will cause a short tone of this pitch; a longer train of waves (a dash) will create a longer tone. On this plan, a dot will sound (in the telephone receiver) like an eighth note in musical notation, and a dash



FIG. 48: The Letter "A" in Musical Notation. — The other letters of the Morse alphabet can, of course, be similarly represented.

like a dotted quarter note; both played on an organ key. By change in the speed of the interrupter disc, the pitch of the signal tone may be altered at will.

Of course, our musical-tone interrupter need not be located at the receiving station. If it were placed in the aërial-ground circuit at the transmitter, it would cause the radiation of waves chopped up into groups of the interrupter frequency. If the sending generator frequency were 750,000 cycles and the interrupter made and broke the circuit five hundred times per second, as before, we should have five hundred groups of 750,000-cycle waves sent out each second. Each group would last for $\frac{1}{1,000}$ of a second and would contain 750 wave cycles. A quiet interval, $\frac{1}{1,000}$ of a second long, would separate each wave group. Signals produced by such a group-wave sender and heard in a simple receiver like that of Figure 46, would sound the same as those which the arrangement of Figure 47 produced when a perfectly continuous stream of waves was intercepted. These musically toned signals, whether arising from the chopping-up of a continuous wave after it reaches the receiver or from the reception of a wave broken into tone groups at the sending station, are characteristic of radio-teleggraphy as practiced to-day.

Signal Intensity and Response. So far, we have not considered strength of signal at all. Nevertheless, it should be almost obvious that the greater the amount of current flowing through the telephone windings, the louder will be the signal tones given off. We have already seen

that the stronger a transmitter is and the stronger the wave intensity it produces, the stronger will be the currents generated by the waves when they strike the receiving aërial wires. Consequently, the more powerful the transmitter to which we are listening, the louder the signals will sound at any particular distance. We have also learned that as the waves travel farther from the sender, they become weaker and weaker, and hence capable of setting up only more and more feeble currents in a receiving aërial wire. It follows that the signals heard in the telephone receiver will be fainter as one listens over greater distances. In other words, the radio receiver is a quantitative or measuring type of instrument, and the strength of the signals it gives off is proportional to the strength of the radio waves it receives. If the wave intensity varies from moment to moment, the signal intensity will also vary simultaneously.

This matter of proportional response is exceedingly important to us, for it is what makes radio-telephony possible. In Chapter V, a simple radio-telephone transmitter was described. There we found that the essential for sending out speech or music by radio was an instrument that would modulate or control the energy radiated, from instant to instant, exactly in accordance with the sound waves to be transmitted. Once started with their proper relative intensities, these radio

waves maintain their proportional values, although all of the vibrations become weaker as they travel away from the sending aerial. They must necessarily induce, at the receiver, currents proportional to their original sound-modulated intensities, since the relative values remain unchanged throughout. Consequently, the changes in magnetism in the receiver, and the motions of the diaphragm which they produce, will recreate the original sound vibrations; and the receiving telephone will give off reproductions of the speech or music impressed upon the transmitter.

The Variations in Radio-telephony. This may be clearer if we consider a specific example. Suppose that the musical tone of the second C above middle C, played on a flute, is to be transmitted. This note has a frequency of about one thousand vibrations per second. Let us imagine that the normal, unmodulated antenna current at the transmitter is five amperes. This will be the value when no sound strikes the sending microphone. Starting with one complete vibration of the tone, and considering the antenna current at intervals of $\frac{1}{10,000}$ of a second (one tenth of the tone cycle), the successive values might be 5, 8, 9, 9, 8, 5, 2, 1, 1, 2, and 5 amperes, as indicated in Figure 49. Each of these intensities would produce, at its instant of occurrence, a wave of proportional strength. All

the waves would pass outward from the sender ; and all would grow feebler in the same way, as they traveled mile after mile. For simplicity, let us assume that at our receiver the wave strength, corresponding to five amperes at the sender, could generate fifty millionths of an ampere of current in the receiving aërial circuit. Then the 8-ampere (transmitted) intensity would produce eighty microamperes, and so on. The cycle of values at intervals of $\frac{1}{10,000}$ of a second would thus be 50, 80, 90, 90, 80, 50, 20, 10, 10, 20, and 50 microamperes in the receiving aërial. If, on account of resistance and so forth, nine tenths

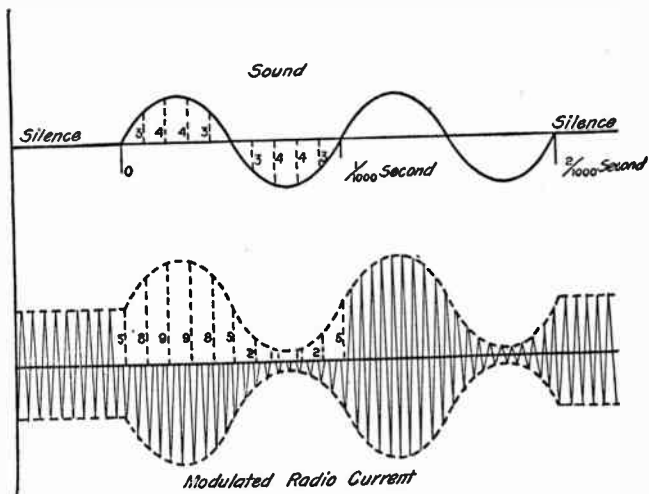

FIG. 49: How the Antenna Current Varies in Radio-Telephony. — The 1,000-cycle pure tone current, indicated along the upper line, will add its values to, and subtract them from, the average strength of the 20,000-cycle radio current shown below. When the radio current remains of constant intensity, no sounds are transmitted.

of the current were lost before reaching the telephone windings (the proportionality being, however, retained), the corresponding telephone currents measured at the same intervals would be 5, 8, 9, 9, 8, 5, 2, 1, 1, 2, and 5 microamperes. This variation is clearly like that at the transmitter, though much reduced in absolute strength. It would necessarily produce a motion of the receiver diaphragm like the original motion of the transmitter's vibrating disc, and this is all that we need for accurate radio transmission of speech or music or any other sounds. Thus the third essential of the communication system (the receiver) is supplied, and we have all the instrumentalities required for radio-telephony.

Where the Power Comes from. A particularly interesting thing about the action of the crystal-detector receiver, in either telegraphy or telephony by radio, is that the power which moves the telephone diaphragm must come entirely from the received radio wave itself. We might almost imagine the wave's ghostly fingers reaching through our receiving instruments and bodily shaking the little metal disc to which we listen. Of course there is a definite limit to the intensity of signals we can hear in this way; at any given time the wave has only a certain strength, and can move the diaphragm no more than that strength allows. If we could provide some instrument so arranged that the wave power

would merely be called upon to turn off and on another form of energy, by which the work would be done of making audible signals, it ought to be possible to obtain much louder sounds. Just as a man cannot hit very hard with a hammer, but can easily control the energy of a pile driver, so we might expect the waves to be able to control power much greater than they themselves possess.

The Vacuum-tube Detector. The "audion", or interposed-electrode vacuum tube, is a sort of radio pile driver. It looks like an incandescent lamp, but around the filament have been placed two additional metal parts. The outer part is usually a cylinder (which may be flattened) and is called the "anode" or "plate." Between the filament and the anode is interposed a spiral wire or screen-mesh electrode called the "control" or "grid." All of these are insulated from each other, and they are contained within an ordinary glass globe from which practically all the air has been pumped. The fascinating thing about such a vacuum tube is that when the filament is heated to incandescence by a current passed through it, large quantities of electrons are thrown off into the evacuated space and may be drawn through the meshes of the control-grid to the anode or plate. To do this most effectively, one connects an additional battery between the filament and the plate. With this circuit, as in Fig-

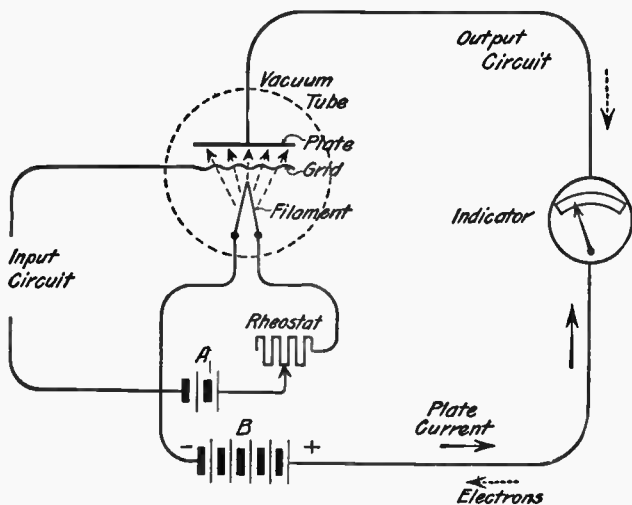
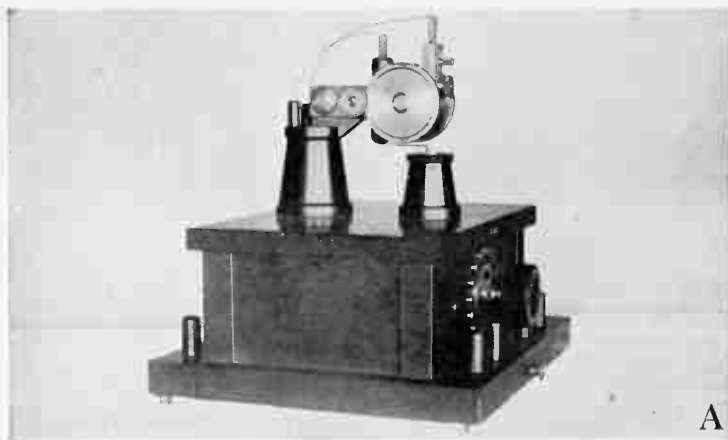

FIG. 50: Fundamental Circuits of the Audion. — The filament is heated by current from the battery marked *A*; and its temperature controlled by the rheostat shown, as in Fig. 18. The plate-circuit battery *B* has its positive terminal connected to the plate, and its negative terminal to the filament, thus completing the output circuit containing the indicating device. The current in this output (or plate) circuit is made up of electrons that flow across the space from filament to plate within the vacuum tube, as indicated by the dashed arrows. The direction of electron flow is opposite to that conventionally assumed for electric "current" (positive to negative), as is shown by the solid arrows. By varying the potential applied to the grid by way of the input circuit, the amount of current flowing in the plate circuit (and registered on the indicating meter shown) can be controlled.

ure 50, the electrons move uniformly from the filament to the anode and constitute an electric current flowing directly across the vacuous space.

The space current thus set up is very easily controlled by relatively small electric charges applied to the grid electrode. If electrons from outside are loaded on the grid, they tend to break up the space current by a kind of overcrowding action, and less current passes in the anode cir-



A

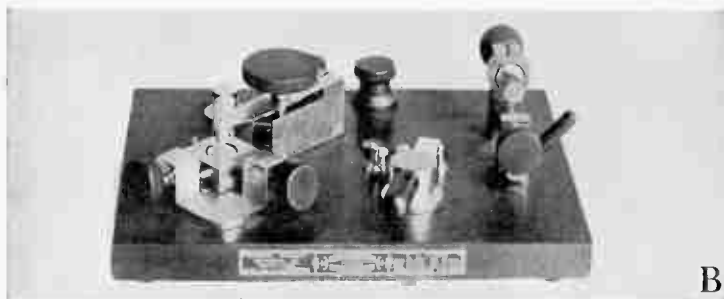

B

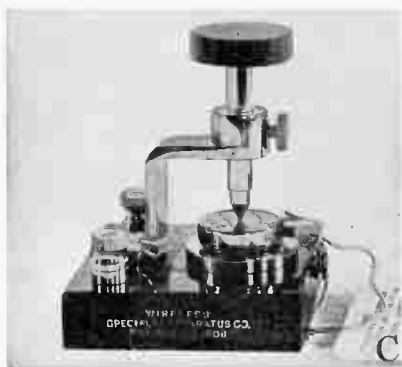

C



D

RADIO DETECTORS, OLD AND NEW

(A) The Fessenden electrolytic (or liquid) detector. A minute platinum wire dips into an acid solution held in the cup at the right. (B) Modern forms of crystal detector. Note the adjusting screws provided for accurate setting of the point-of-contact. (C) The Pickard polished-silicon crystal detector. (D) The WD-11 Westinghouse vacuum-tube detector and amplifier, used with dry cells instead of storage batteries; one of the modern types of audion.

cuit. If electrons are drawn away from the grid, more than usual pass from the filament to the anode and the plate-circuit current increases. The changes so produced in the anode current are many times greater than would be caused by the direct addition or subtraction of the same number of electrons as are moved in the control-grid circuit. Consequently, a small amount of electric power used to alter the number of electrons on the grid will create a current change representing, in the anode circuit, considerably more power.

How the Audion Works. To utilize this pile-driver vacuum tube as a radio detector, all we need do is to connect the control circuit to our receiver and put our telephones in the anode circuit. Figure 51 shows how this is usually done. As the waves arrive, the wave currents attempt to pass between the grid and the filament. Since all the electrons must leave the filament and none can enter it, these two elements of the tube form another kind of radio turnstile which (like the crystal detector) will pass current in one direction only. The electrons that do get through the detector are not, however, used to operate our receiving telephones. They are caused to accumulate upon the grid and the blocking condenser shown. This overcrowds the space with electrons and breaks up the current in the anode circuit, so reducing it and moving the diaphragm

of the telephone receiver. When the signal stops, the wave currents no longer supply electrons to the grid. The excess that was accumulated leaks

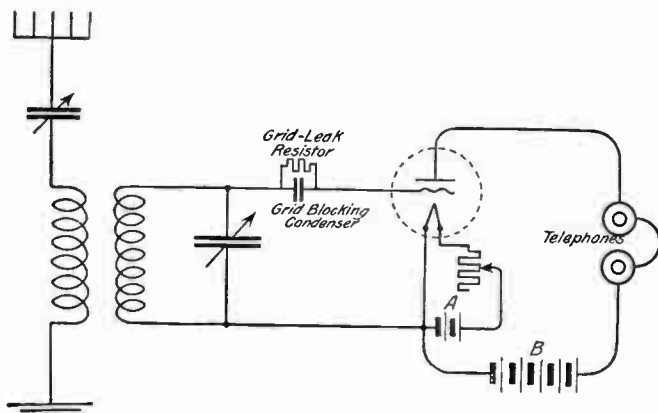

FIG. 51: An Audion Detector in the Two-Circuit Tuner. — Here we have replaced the crystal detector of Fig. 45 by an audion connected through the leak resistor and blocking condenser shown in the grid (or input) circuit. The *A* and *B* batteries, and the filament rheostat of Fig. 50, are also included. A pair of head-telephone receivers is included in place of the indicating meter used in Fig. 50. Note the square-sided zigzag symbol for resistance units, with the arrow-headed contact representing variability; also remember the symbols used for batteries and head-telephones.

off through the grid-leak resistance shown, and the current through the telephones comes back to normal.

By balancing the size of the blocking condenser, the resistance of the grid leak, the temperature of the filament, and the voltage of the battery in the anode circuit, it is easy to make the reductions of telephone current exactly proportional to the wave power arriving at any instant. The tube receiver is, therefore, all right for radio-teleph-

ony as well as for telegraphic signaling. But its greatest value lies in the fact that it magnifies the effects of the received waves, and so produces stronger signals than would any ordinary receiver under the same conditions.

We have now traced the basic operations of radio communication through the transmitters, the intervening space, and the receivers. To round out our survey, we need to discover only how the signal sounds to which we listen in our telephone receivers may be made to speak up loudly, so that they may be heard and understood without our holding the receivers to our ears.

CHAPTER IX

THE WHISPER BECOMES A SHOUT

IT is not unfair to compare the intensity of ordinary radio-telephone signals, as heard in a telephone receiver, with a whisper. Of course there is in them none of the sibilant huskiness of a whisper. Their sounds reproduce the spoken words a great deal more clearly than does the line-wire telephone that we use every day. But so far as loudness is concerned, radio signals as usually heard are very feeble. As a matter of fact, we should not enjoy listening to them directly in the receiver if they were as loud as the normal speaking voice. You can determine the truth of this very quickly by letting some one speak directly into your ear. If he (or she) speaks as loudly as in ordinary conversation, you will find the sound painfully intense.

A direct consequence of the feebleness with which signals are heard in a common receiver is that the listener is disturbed or interrupted by noises that are ordinarily overlooked. If you are listening to a rather weak radio signal, perhaps straining your attention a bit to catch every word, you are likely to lose patience when some one

else in the room rattles a newspaper or scrapes a chair leg along the floor. Even such slight sounds as these may drown out the signal you are anxious to hear. Louder sounds, made by people running on a staircase, by trolleys or trucks passing the house, or by a typewriting machine busily clicking in the next room, may be sufficient to interfere with your "reception" of signals for minutes at a time.

There are only two cures for these troubles. One is to do your receiving in a nearly (or completely) sound-proof room; the other is to make the signals louder. The first plan is hardly practical in one's home, although it was often followed out in important radio stations some years ago. However, since signal-magnifiers have become so well developed and so easy to operate as they are to-day, no one bothers with sound-proofing for ordinary radio receiving; the second method is used almost universally.

When Magnification Is Not Needed. We must bear in mind that, under many conditions, one may receive radio signals amply strong enough to be heard distinctly and continuously in spite of the usual interfering noises, even though only a simple detector and head telephones are used. The double telephone "head set" is a great help in this direction, since it supplies signals to both ears and excludes a good deal of sound that might be disturbing. A good vacuum-

tube detector with well-made telephones, used with a reasonably large receiving aerial and properly adjusted, will give satisfactorily loud signals from broadcasting radio-telephone stations thirty or forty miles away and from average marine radio-telegraph plants one hundred or more miles distant. Signals arriving over greater distances are, however, likely to be so weak that "room noises" at the receiver will interfere with their reception unless they are magnified.

There are two other reasons why intensifying the received radio signals is important to us, even though we may have our instruments so close to the stations to which we desire to listen that a fairly strong signal may be heard with detector and telephone alone. The first is that if two or more persons wish to hear what is coming in by radio, additional telephone receivers must be provided. If six or seven people are listening, this arrangement becomes cumbersome and annoying. The second reason is that after an hour or so one grows tired of wearing a head receiver, although he may wish to listen for an entire evening. The way to take care of these troubles is to increase the signal intensity so greatly that the dots and dashes, or spoken words, or music being received can be heard all over the room. Then any reasonable number of people can listen in comfort.

How can we amplify our received signals to this extent? How can we get a shouting response,

clearly understandable at fifty or a hundred feet from the receiving instruments, out of a tiny sound that is just audible when one listens directly at the telephone earpiece? Easily, if we take further advantage of the pile-driver-control properties of the audion.

How the Vacuum Tube Amplifies. We have already seen that by applying a small radio-frequency alternating potential to the grid or control electrode of a vacuum tube, we can produce multiplied intensities of response in a telephone connected in circuit with the anode or plate of the tube. It seems reasonable to suppose that, having once in this way controlled a larger output power by a relatively smaller applied power, we could deliver the larger output to the control electrode of a second vacuum tube and get from it still greater results. As a matter of fact, this is exactly what we do in order to amplify our received signals.

In using the vacuum tube as a detector, we put, you will recall, a blocking condenser in its grid circuit, so as to force electrons to pile up and overcrowd the space between filament and plate in such a way that whenever radio signals arrived, the current through the telephones would be reduced. By this plan, we took advantage of the turnstile effect that lets electrons pass in only one direction, — from filament to grid; and we produced an audibly pulsating telephone current.

Having procured these pulsating or undulating currents, which are very much like the currents passing over an ordinary telephone line, we must be careful not to distort them if we wish to preserve accurately the voice or other sound vibrations. In applying them to a second vacuum tube in order to magnify their effects, we must

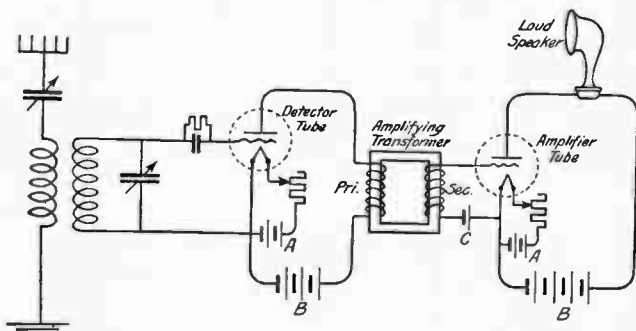
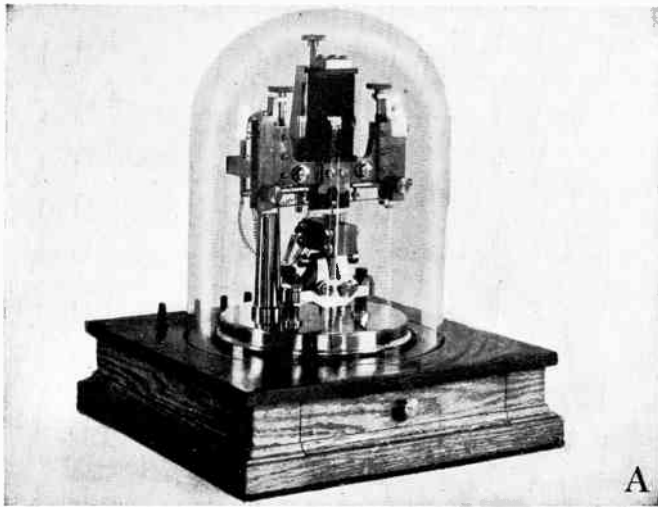

Fig. 52: Transformer-coupled Single-Tube Amplifier, with Audion Detector. — This is the circuit of Fig. 51, with the primary coil of an audio-frequency amplifying transformer substituted for the telephones, and the amplifier tube and its associated instruments (including a loud-speaker) added. Separate filament (A) and plate (B) batteries are shown for each tube, to simplify the circuit. Notice that there is no grid condenser or leak in the amplifier-tube circuit, but that a small third battery, marked C, has its negative terminal connected to the grid through the transformer secondary coil.

not, then, artificially crowd the electron stream. Consequently, the blocking condenser should be omitted from the grid circuit of the amplifying tube.

What we wish the amplifier to do is to produce in its plate circuit a perfect but enlarged copy of the electrical variations that we apply to its control electrode. By leaving out the block-



A

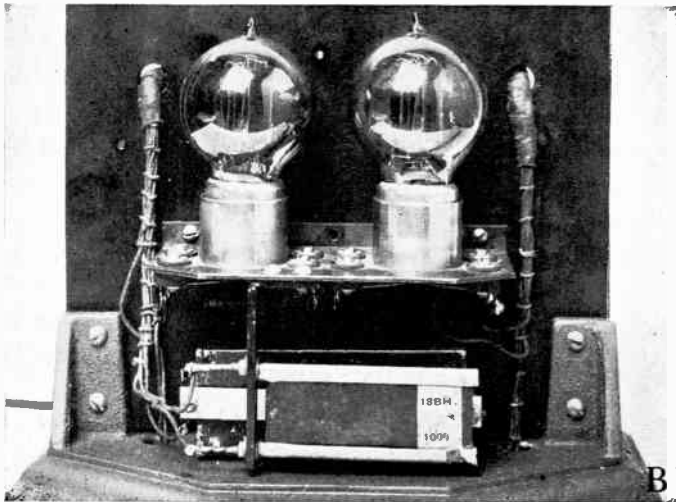

B

TYPES OF RELAYS

(A) A specially built transmitter-relay, used in Fessenden's early radio-telephone work for interlinking wire lines and radio, and for loud speaking. (B) A modern vacuum-tube relay of the type now used for the latter purpose.

ing condenser and (if the particular tube we use happens to be so designed as to require it) adding in its place a small battery that tends to hold a certain surplus of electrons on the grid, we can arrange matters satisfactorily. The effect we desire, and the effect we attain in this way, is a reduction in plate-circuit current when and while the negative swing of our voice-current pulsations places additional electrons on the grid; and an increase in plate current when the opposite (or positive) swing subtracts electrons from the control electrode. Thus the variations we deliver to the grid cause simultaneous and identical variations in the current of the plate circuit; and, because of the amplifying power of this interposed-electrode device, the reproduced variations are much more intense than the originals.

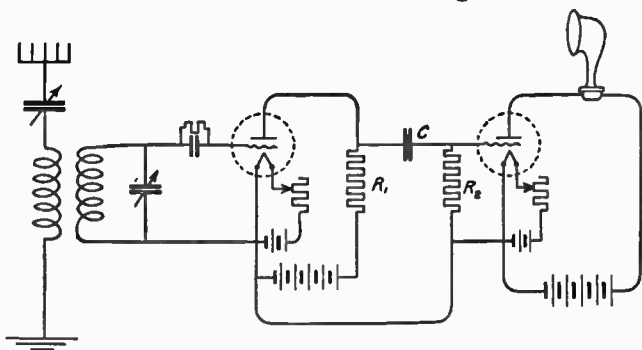

FIG. 53: Condenser-coupled Single-Tube Amplifier, with Audion Detector. — A circuit arrangement like that of Fig. 52, except for the use of fixed condenser C and resistors R_1 and R_2 in place of the amplifying transformer, for linking the detector to the amplifier. R_1 is usually of about 50,000 ohms resistance, and R_2 (a leak resistor) of about 2,000,000 ohms. The fixed condenser may be relatively large, or about one microfarad.

In order to keep the battery circuits of successive tubes properly classified and separated, it is good practice to interconnect them through transformers or condensers, either of which will pass alternating currents (sound variations) but will hold back direct currents. Single-tube amplifiers coupled in both ways are shown in Figures 52 and 53. The transformer coupling permits somewhat better amplification efficiency because the windings may be chosen to correspond to the circuits of the particular tubes used. On the other hand, unless the transformers are very carefully designed, an amplifier of this type may distort the variations somewhat more than would the form shown in Figure 53.

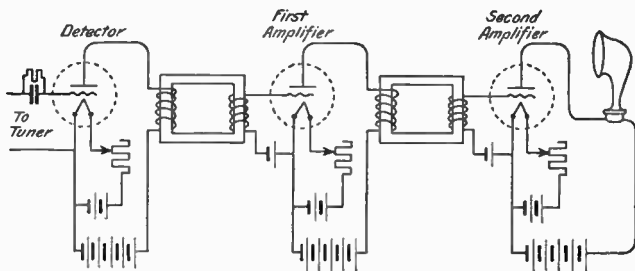

FIG. 54: Two-Tube Transformer-coupled Amplifier. — The tuning circuits of Fig. 52 are not shown here, and a second stage of amplification is added.

You will see at once that there is no reason why a second amplifying tube should not be added, to produce still larger current variations from the arriving signals. Such double-tube (or two-stage) amplifiers, of both the condenser-resis-

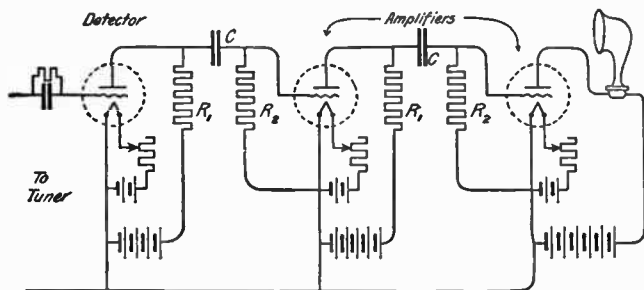

FIG. 55: Two-Tube Condenser-coupled Amplifier. — As in Fig. 54, the tuning circuits are omitted. This is a similar extension of the amplifier illustrated in Fig. 53.

tance and the transformer-coupled types, are illustrated in Figures 54 and 55. Instead of using separate batteries for heating the filament, supplying electrons to the grid, and furnishing plate-circuit current for each tube, we may combine them as in Figures 56 and 57. Since the detector tube ordinarily requires only a part of the voltage

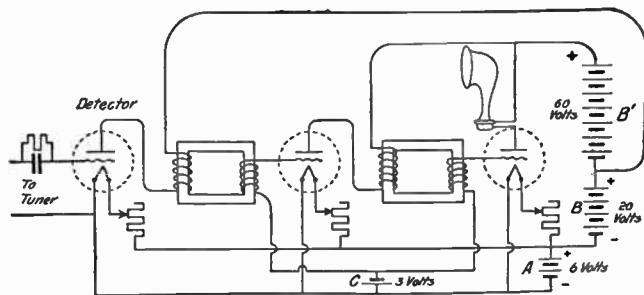

FIG. 56: Two-Tube Transformer-coupled Amplifier, with Common Batteries. — This is identical with the outfit of Fig. 54, except that a single 6-volt storage battery *A* is used in common by all three tubes (including the detector); a single grid battery *C* supplies both amplifiers; and a single set of plate batteries provides the anode current throughout. The anode battery is divided into the two sections *B* and *B'*; the first alone being connected to the detector tube, and the entire battery being used for the amplifiers.

applied to the plates of the amplifying tubes, the anode-circuit battery is divided as shown.

Signal magnification of the sort we have been considering, is called "tone-frequency" or "audio-frequency" amplification, since the current variations that are successively multiplied in strength have frequencies within the audible range. This type of amplification may be made very effective; so effective, in fact, that it is generally unwise to use more than two stages because the extreme magnification may multiply all sorts of objectionable noises to an undesirable extent. If maximum amplification is not had in each tube or stage, it may be feasible to use three or more; but great care will ordinarily be necessary in order to avoid distorting the sounds finally reproduced.

Radio-frequency Amplification. Since the amplifying power of these vacuum tubes depends

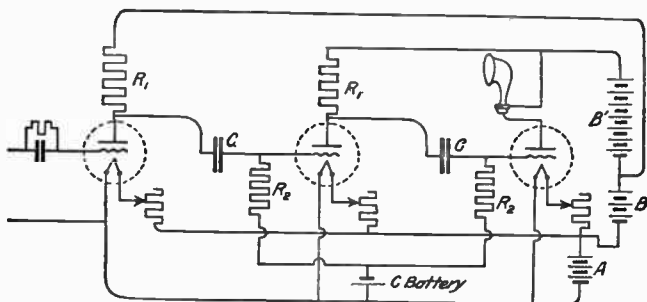

FIG. 57: Two-Tube Condenser-coupled Amplifier, with Common Batteries. — Here the same principle of using single *A*, *B*, and *C* batteries in common for all the tubes, is applied to the amplifier of Fig. 55. A *C* or grid-circuit battery may be inserted between *R*₂ and the filament connection in either Fig. 53 or Fig. 55, and will frequently give improved results.

upon the ease and rapidity with which electrons may be moved by small electromotive forces, and since electrons are fully capable of vibrating at the highest radio-frequencies, it would appear that we might amplify the radio currents just as they come from the receiving antenna. These are exactly like the audio-frequency currents we have been amplifying, except that they vibrate far more rapidly. Because of this difference in frequency, we would expect to use differently designed transformers to interconnect the amplifying tubes. With proper modifications of that kind, however, we can get very effective amplification of radio-frequency current by using ordinary

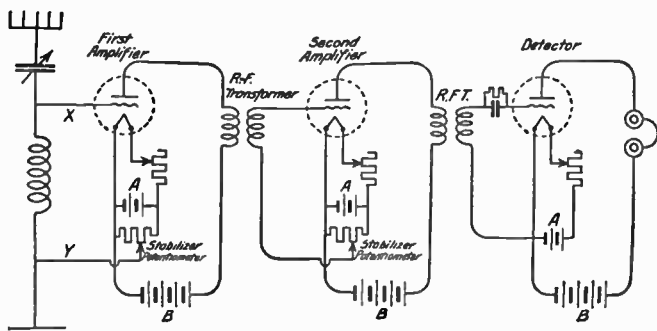

FIG. 58: Two-Stage Radio-Frequency Amplifier and Audion Detector. — In this circuit, the radio-frequency currents are twice amplified *before* they reach the detector. The coupling radio-frequency transformers are usually best made without iron cores; hence the use here of a symbol different from that used in Fig. 52. A new element in this arrangement, is the *stabilizer potentiometer* provided for each tube. This is simply a resistor of some 300 ohms connected across the A battery and having a sliding contact in the grid circuit; and it is used to prevent the amplifiers from becoming unstable or generating oscillations. Note the simple tuning circuit shown, corresponding to that of Fig. 43. The wires X and Y may, however, be connected to a secondary circuit condenser instead, as in Fig. 51. The simple circuit is much easier to adjust than is the double circuit, but is not so sharply selective.

three-electrode vacuum tubes. As in audio-frequency amplification, more than one tube may be used for additional magnification; and the several stages may be connected by means of condensers or transformers.

A two-stage radio-frequency amplifier, with a third tube used as a detector, is shown in Figure 58. For clearness, the several circuits are there illustrated with independent batteries; but for practical working, the connections of Figure 59 may be used with just about as good results. The next drawing, Figure 60, illustrates a three-stage radio-frequency amplifier and detector. Here no receiving aërial wire is shown, and the first amplifying tube is connected to a loop or coil antenna, which picks up energy from the magnetic component of the radio wave (as explained in Chapter VII). Still more radio-frequency tubes could of course be added between the aërial

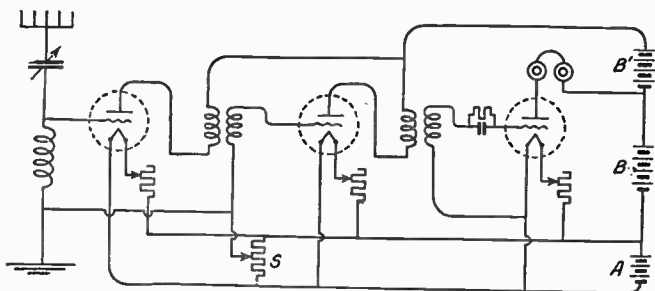

FIG. 59: Two-Stage Radio-Frequency Amplifier and Audion Detector, with Common Batteries. — A single set of batteries supplies current to all the tubes; and a single stabilizing potentiometer regulates both radio-frequency amplifiers. Otherwise the circuit resembles that of Fig. 58.

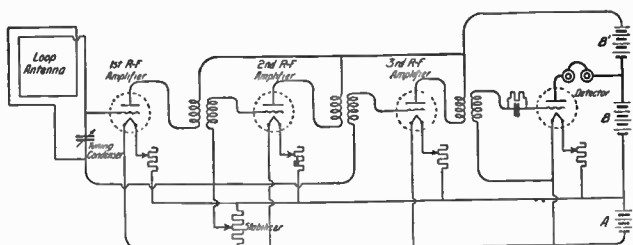

FIG. 60: Three-Stage Radio-Frequency Amplifier, with Audion Detector.—The loop antenna and its tuning condenser are equivalent in many ways to the secondary circuit shown in earlier figures. Here the feeble radio currents generated in the loop are amplified three times before reaching the detector. Common batteries and stabilizer are used, as in Fig. 59.

(or the loop) and the detector; but in everyday experience it has been found that three stages of radio-frequency amplification mark about the economic limit. More may be used, but they generally give less increase in signal strength than one would expect.

Tuned Radio-frequency Amplification. The circuit arrangements shown in Figures 58 to 60 inclusive are of the type that use broadly tuned transformers to couple the tubes. Such arrangements rely upon tuning the grid circuit of the first tube in order to discriminate between desired and undesired signals of different wave frequencies. The coupling transformers are designed to transfer radio energy with more or less equal facility over a substantial range of frequencies and so are sometimes called “untuned” transformers. Usually they are most effective for a group of frequencies in the central portion of the band or range for which they are designed, and many designs are

relatively inefficient at the frequencies that limit the working range. It is therefore better to refer to the system as containing "broadly tuned", rather than "untuned", transformers.

With coupling transformers that are not tuned to the working frequency, radio-frequency amplifiers are generally inefficient at the higher frequencies. Even at frequencies used in broadcasting they often show little or no gain except by reason of the "feed-back" or regenerative amplification that may take place within their circuits and that is explained later in this chapter.

The amplifying power of radio amplifiers at these high frequencies may, however, be greatly improved by tuning the circuits of each tube instead of tuning the grid circuit of the first tube only. To do this requires as a rule a variable condenser or inductor for each tube to which radio-frequency energy is applied; and also in-

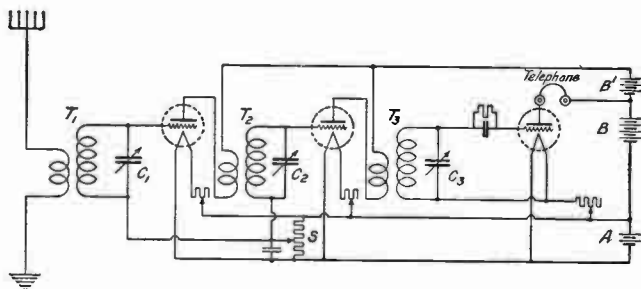

FIG. 61: A Tuned Radio-Frequency Amplifier. — This circuit has two stages of amplification, with stabilizer-potentiometer control of regeneration. The circuits affected by the three variable condensers C_1 , C_2 , and C_3 must be adjusted in accordance with the received wave frequency.

volves a change in the design of the intertube transformers. A number of circuit variations have been proposed, and one useful form is shown in Figure 61.

Another great advantage which is had by tuning the radio-frequency amplifier circuits in succession is that the selective power of the receiver is substantially increased. So many broadcasting stations are now in operation that the single-tuned circuit of Figures 58, 59, and 60, which does not possess great discriminating ability, is not adequate to prevent "cross talk" between transmitters in many localities. On the other hand, the larger selectivity of such arrangements as are typified by Figure 61 will, if the receiver is well designed, take care of all but the most severe interference conditions. The only disadvantage of the adjustably tuned radio-frequency amplifier is the requirement of some considerable care and skill in manipulating the tuning elements of the three or more tuned circuits. This disadvantage is much more than compensated for by the gain in amplifying and selective powers. Moreover, as suggested by the author a number of years ago,¹ it may be overcome by the expedient of arranging the several tuned circuits so they are controlled by a single knob that operates the variable condensers or inductors simultaneously and alike.

¹ U. S. Patent 1,014,002; issued January 9, 1912.

Which Type Is the Better? Radio-frequency amplification, even with the advantages of the adjustably tuned type, may not be so effective in increasing the loudness of signals produced by waves of very high frequency as is audio-frequency magnification. If one starts with a detector alone, the addition of one audio magnifying tube will ordinarily make the signals much stronger than would one radio amplifying tube used with the detector. On the other hand, if we were satisfied with a moderate intensity of signal in the telephone receiver and desired to increase our receiving distances (rather than to magnify the signals already audible with detector alone), we should do better to use a radio-frequency amplifying tube. In other words, radio-frequency amplification helps the detector to pick up very weak signals to which it might not in itself be capable of responding, but does not add a great deal to the intensity of such signals as are fairly loud when received on the detector alone. In contrast, audio-frequency magnification is particularly effective in making an easily audible signal (as heard in the telephones used with detector alone) speak right out so loudly that its volume will fill a room or lecture hall; but it does not help very much in building up the strength of signals that are too weak to operate the detector effectively.

It is a logical conclusion that the ideal arrange-

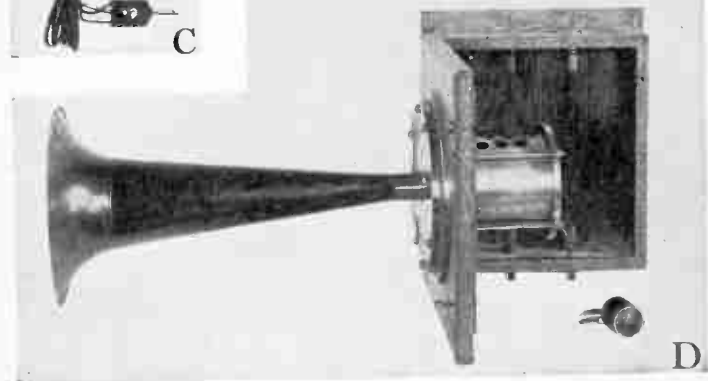
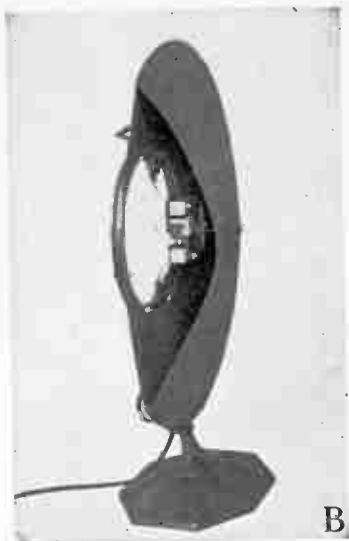
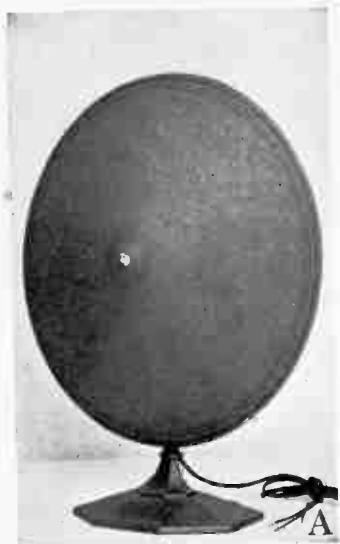

LOUD SPEAKERS FOR RADIO REPRODUCTION

A is a modern development that uses a large conical diaphragm of paper and no horn; *B* shows the interior construction of this cone-type speaker; *C* is a radio-reproducing attachment that may be fitted in place of the sound-box on any phonograph, so as to make use of the horn; and *D* shows a moving-coil instrument used in Fessenden's early work.

ment of a receiver, if one is looking for both maximum sensitiveness and signal strength, will combine these two types of amplification. The radio amplifying tubes will multiply the feeblest received wave currents before they reach the detector, so that (to put it crudely) all signals will seem to be strong. The audio-frequency tubes will take the moderately intense responses produced by the detector and will multiply them very greatly. A five-tube receiver, combining two tuned radio-frequency amplifiers, a detector, and two audio-frequency magnifiers, is shown in Figure 62. Batteries are used in common for all of the tubes, and the transformer type of coupling is illustrated in both amplifiers.

Additional stages of either type of amplification might be added to the receiver of Figure 62,

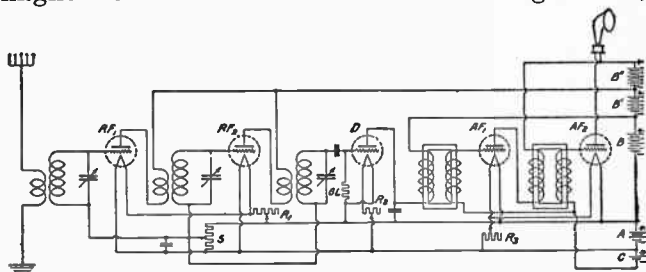

FIG. 62: A Complete Five-Tube Receiver of the Tuned Radio-Frequency Type. — There are several points of interest in this arrangement. Since the resistor GL fixes the potential of the detector grid by direct connection to the positive-filament terminal, the lower plates of the three tuning condensers may be wired directly to the moving contact of the potentiometer S . The three condensers may therefore be replaced by a triple-unit multiple condenser having its common shaft so connected, for single-control tuning. The B battery is divided into three parts so that the most favorable plate potentials may be chosen. Only three rheostats are used, R_1 controlling both radio-frequency tubes RF_1 and RF_2 , R_2 providing adjustment for the detector, and R_3 being associated with both audio amplifiers AF_1 and AF_2 .

though for most purposes this arrangement is of ample size and power. As shown, it is capable of reproducing, at about the intensity of a good phonograph, broadcast radio-telephone speech or music received from stations fifty or more miles away, and for shorter distances it does not require an outdoor aerial.

In planning to use amplifiers, one should remember that for listening in a telephone head set the best practice is to use radio-frequency tubes and a detector, without audio magnification. One stage of audio may be used if very loud signals are desired, but the usual output of a second audio-frequency tube is so loud that it is absolutely distressing to hold the earpieces against one's ears. Moreover, the signal power from a two-stage tone magnifier is often so great that the ordinary telephones cannot handle it. Some more rugged diaphragm and magnetic system, such as are used in well-designed "loud speaking" telephones, are necessary to prevent the buzzing and rasping noises that occur when the standard earpieces are overloaded. These special reproducers, capable of using the large output of an efficient magnifying system, are particularly suitable for combination with megaphone-like horns. The ordinary telephone receiver cannot reproduce signals with a loudness even approaching phonograph intensity, without buzzing or otherwise distorting the tones.

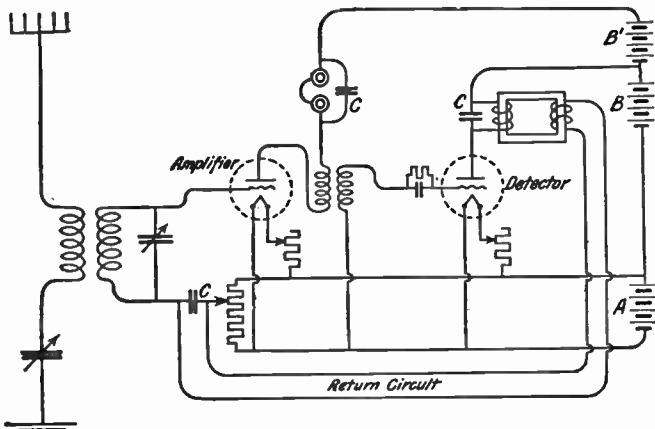

FIG. 63: A Two-Tube Reflex Amplifier. — The order of connecting the instruments in each circuit is very important; and the size of the three by-pass condensers marked *C* must be carefully chosen. Note how the rectified audio-frequency current from the detector is brought back through the return circuit from the transformer secondary coil to the grid circuit of the first tube, to be amplified again before reaching the telephones.

Reflex Amplification. Using the same magnifying tubes for both kinds of current, we may make two tubes do the work of three, or three do the work of five (Figures 63 and 64). The radio-frequency currents from the loop (or antenna) are applied to the amplifying tubes, there magnified, and then led to the detector, which converts them into audio-frequency signal currents. These audio-frequency currents are returned to the amplifying system and multiplied; then, before the detector is again reached, delivered to the reproducer. In this so-called "reflex" system, the amplifying tubes thus handle two widely different current frequencies

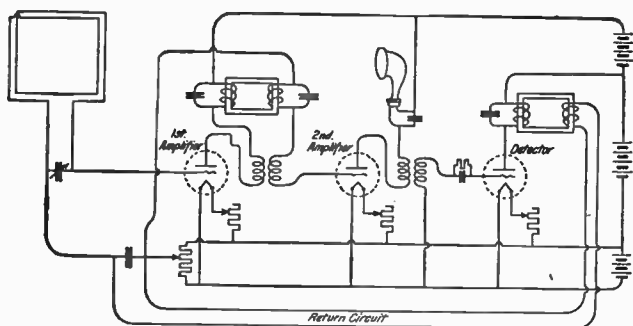

FIG. 64: A Three-Tube Reflex Amplifier. — This arrangement, by double use of the first two tubes, gives four amplifications in addition to detection. Bypass condensers of about 0.002 of a microfarad usually work well. The same principle is applicable to tuned radio-frequency amplifier systems. Very strong loud-speaker signals cannot ordinarily be produced without hampering the radio-frequency amplification.

at the same time. It is hardly possible with three tubes in the reflex set-up to duplicate the performance of five tubes used as in Figure 62, since some compromise adjustments that partially destroy efficiency are usually necessary; but much better results can often be had from the same number of tubes when used in a reflex circuit than when used for simple radio or audio amplification.

Regeneration. There is another sort of double use of receiving vacuum tubes that is much simpler than reflex amplification and that has come into large use. This is called regeneration, and, as ordinarily used, is essentially a combination of radio-frequency amplification with the other functions of the "detector" tube in a radio receiver. It is not hard to understand. We need only have in mind that radio-frequency currents

from the receiving antenna, when they are impressed upon the grid of the vacuum-tube detector, produce a lowering of plate current (caused, as we have seen, by the piling-up of electrons on the grid condenser) and also generate a ripple of radio-frequency oscillations in the plate circuit. Generally speaking, this ripple would be unnoticed; but if we connect a condenser around our telephone receivers so that their windings will not block the tiny oscillations, these may be built up to substantial strength. Now, if we feed some of the energy of these oscillations back into the grid circuit of our detector tube, and arrange for the fed-back impulses to go hand in hand with the currents supplied from the an-

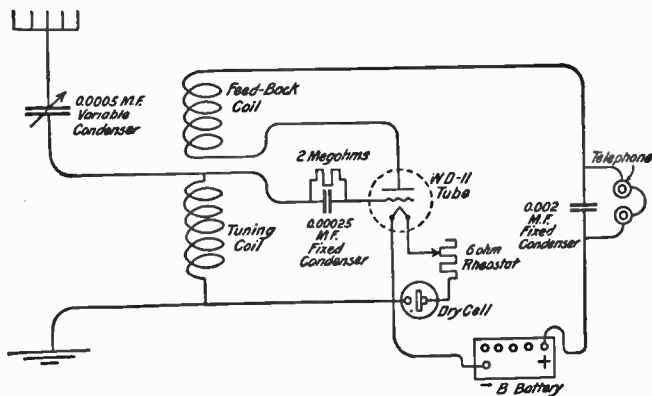

FIG. 65: The Simple Inductively-coupled Regenerator. — This easily built and adjusted circuit is giving excellent results in the hands of thousands of radio novices, and is a good one to begin with. The WD-12 tube, which fits a standard socket, may be substituted for the WD-11 tube shown. By suitably modifying the filament battery and rheostat, any other tube may be used.

tenna, it is almost obvious that the two will coöperatively produce greater changes of grid potential, and hence larger variations of plate current. That is what actually happens. The fed-back oscillations generate larger ripples in the plate circuit; a part of these larger ripples is again fed back to the grid, and regenerates still larger ripples in the plate circuit. Such regeneration continues to the limit set by the percentage of the plate ripples fed back, and by the efficiency of the tube as an amplifier. The larger regenerated radio-frequency currents retain an intensity proportional to the wave impulses that start them off and maintain them. Clearly, the larger currents applied to the grid must have the same effect as would a stronger wave received; and the final result is a great gain in signal strength.

The Simple Regenerator. Figure 65 shows one of the simplest regenerative circuits, in which it is easy to trace all the actions we have just discussed. If the feed-back coil of the plate circuit is brought too near to the coil in the grid circuit, too much power will be fed back and the circuit will generate radio-frequency oscillations. These are likely to react with the incoming waves and produce a loud musical tone that will interfere with the reception of telephonic signals. For radio-telephony, it is therefore important to allow these coils to approach each other only so closely as to provide the desired amplification, but not

closely enough to set the system into the unstable or oscillating state. For radio-telegraphy, it is often desirable to make the regenerative system produce oscillations, for then the loud musical tone (so bothersome when listening to speech or music) may be caused to reproduce the dots and dashes. No interrupter disc of the kind described in Chapter VIII is then necessary. The desired signal tone is created by interaction between the received wave currents and those produced in the regenerator, according to what is called the "heterodyne" method of receiving.

A regenerating detector system of this kind can easily have added to it a few stages of audio-frequency amplification, so that loud-speaker signals may be produced. Such a combination,

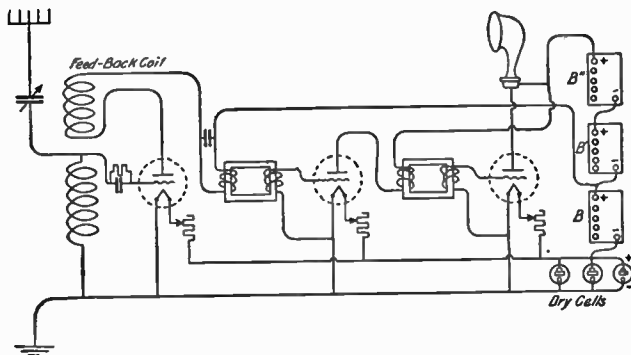

Fig. 66: Regenerator with Two-Stage Audio Amplifier. — This is the simple circuit of Fig. 65, combined with the amplifier of Fig. 56, which has been modified by eliminating the 6-volt storage battery *A* and using three WD-11 or three WD-12 "dry-cell tubes." Note the three dry cells connected in *parallel* to supply filament current to all three tubes. By placing the three dry cells in series and substituting 30-ohm rheostats, UV-199 tubes may be used.

which makes a good all-around receiver for either radio-telephone or radio-telegraph use, is shown in Figure 66. The type of circuit illustrated requires an ordinary receiving aërial for best results; and although it is possible to utilize regenerative effects in connection with loop antenna reception the aërial wire gives much stronger signals.

Regeneration in Radio-frequency Amplifiers. In connection with each of the radio-frequency amplifying circuits (Figures 58 to 64 inclusive), is shown a potentiometer for stabilizing the operation of the receiver. This stabilizer, as it is turned to make the potential applied to the grids of the amplifier tubes approach more and more nearly that of the negative-filament battery terminal, will increase the amplifying power of the tubes. As the amplifying power increases, the signals will increase in intensity, not merely to the relatively small degree that results from the greater relaying ability of the tubes, but to a much greater extent because the effects of regeneration are increased at the same time. As explained in the preceding sections, when radio-frequency energy is fed back from a plate circuit to a grid circuit so as to assist the oscillations existing in the grid circuit, the signal strength may be multiplied many times. This is true whether the regenerative tube is used simultaneously as a detector (as in Figures 65 and 66) or as a simple radio-frequency amplifier.

When the feed-back effects are increased in a radio-frequency amplifier (as, for instance, by turning the potentiometer contact nearly or all the way to the negative terminal), the circuit is likely to generate radio-frequency oscillations at the frequency to which it is tuned. This corresponds to the generation of oscillations that occurs in a regenerative detector like that of Figure 65 when the feed-back coil is brought relatively near to the coil in the grid circuit. The local oscillations thus produced in the amplifier circuits may be controlled as to frequency by means of the tuning elements, and are useful for heterodyne reception of radio-telegraph signals or for the initial interception of radio-telephone signals by the whistle or beat-note that is heard when the receiver is nearly in tune with the desired carrier wave.

Amplifier Efficiency. Since it is often desirable to use the greatest possible amplifying power of which a receiver is capable, it is clearly not the best practice to control both the vacuum-tube amplification and the regenerative amplification simultaneously, unless a design can be chosen in which the maximum results from both are had at the same adjustment. Consequently a number of schemes have been devised according to which the simple or relay amplification of the tube circuits can be built up to the greatest possible extent without at the same time causing

the system to generate strong oscillations by regeneration. This implies a control of regenerative effects apart from adjustment of the relay amplification. Among the most successful arrangements are those in which the tendency to produce oscillations is "neutralized" in part, or even completely, by inductive couplings that oppose the direct regenerative effects. These counter-feed-back coils may be used alone, as suggested by R. V. L. Hartley, or in combination with fixed or variable compensating condensers, according to the proposals of C. W. Rice and L. A. Hazeltine. A very satisfactory receiver utilizes one or two stages of radio-frequency amplification in which the regenerative effects are purposely minimized, and obtains the additional feed-back amplification to any extent desired by associating a variable "tickler" or feed-back coil with the circuits of the detector tube.

Since one of the most useful results of regenerative amplification is the reduction of energy losses by its virtual cancellation of resistance in its circuits, it is often extremely helpful to use regeneration in the antenna-to-ground circuit. In many receiver installations the effective resistance to currents flowing in the antenna is quite high, and consequently a large reduction in the resistance is possible by means of regeneration. This will, in such cases, produce large gains in signal strength. It is therefore desirable to be



STUDIO OF THE RADIO CORPORATION'S NEW YORK BROADCASTING STATION WJZ

The control desk at the right is fitted with pick-up transmitters that may be switched into service either for announcing or for addresses by a seated speaker.

able to control the amount of feed-back that is effective in the tube to which the antenna-ground system is connected.

The Super-heterodyne. Interference conditions in many localities, and particularly in the zones within a mile or two of a powerful broadcasting transmitter, may be so severe that it is difficult to receive weak signals coming from a distance at the times when a near-by station is sending at a neighboring wave frequency. The most effective receiver for use in such circumstances is, generally speaking, the super-heterodyne. A well-designed instrument of this type has not only the extreme sensitiveness that permits long-distance reception with only a small loop antenna to intercept the arriving waves, but also a degree of selective power that it is difficult,

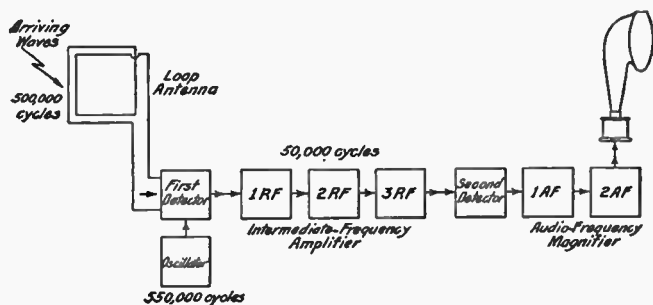

FIG. 67: Illustrative Diagram of Super-heterodyne Receiver. — The arrows represent the path of the signal currents and local oscillations through the system. Three general values of frequency are utilized: (1) a high radio frequency in the first-detector circuits; (2) a medium radio frequency in the intermediate amplifier; and (3) the audible or relatively low frequencies after the second detector.

if not impossible, to match by any other receiving method.

Figure 67 illustrates the super-heterodyne principle. The typical receiver has eight tubes, though of course the audio-frequency amplifiers may be omitted or the functions of several of the tubes combined (as, for instance, by the reflex plan) to reduce the number. In this drawing, the boxes represent functionally the several tubes and their circuits. If we imagine, for example, that radio-frequency currents of 500,000 cycles per second are generated in the loop antenna by the arriving waves, and that the oscillator system is permitted to produce continuously (by close feed-back coupling in its circuits) an alternating current of 550,000 cycles per second, it is not hard to see that the combined effects of these two currents will be impressed upon the first detector tube. Their joint action produces current variations of 50,000 cycles per second, this being the difference between the two fundamental frequencies, according to the heterodyne or "beats" principle referred to above. The 50,000-cycle variations are transformed into alternating currents of that same frequency and applied to the intermediate-frequency amplifier, where they are magnified many-fold by the successive tubes. On reaching the second detector, these intermediate-frequency (50,000-cycle) currents are stripped of the audio-frequency sig-

nal variations that come through with them, which, after magnification in the audio tubes, will operate the loud speaker to produce speech or music.

Tremendous amplification is obtainable in the super-heterodyne because the intermediate-frequency system may be adjusted once and for all at a value where the tubes can do their best. The relatively low radio frequency (of from 10,000 to 100,000 cycles) commonly used is one for which the circuits can be designed, often with the aid of regeneration, to give enormous responses. This intermediate amplifier may also be adjusted to magnify only currents at a frequency near the chosen value of, say, 50,000 cycles, and thus to exclude substantially all currents of frequencies lower than 45,000 or higher than 55,000 cycles. It is this feature that, with the differential or heterodyne operation, results in such great selectivity.

The frequency of the local radio-frequency currents generated by the oscillator tube should be controllable by the user. Thus, when the intermediate circuits are fixed at 50,000 cycles, if one desires to pick up a wave at 610,000-cycle frequency, he will adjust the oscillator to produce either 560,000-cycle or 660,000-cycle currents. In either case the differential frequency is 50,000 cycles, which is the value that is best magnified by the intermediate amplifier. Under these con-

ditions, if interference comes in at 600,000 cycles, which is the nearest broadcast wave frequency below 610,000, the differential frequency of the interfering wave will be either $660 - 600 = 60$ kilocycles (60,000 cycles) or $600 - 560 = 40$ kilocycles, according to whether the oscillator setting of 560,000 or 660,000 may have been chosen. Neither 40,000 nor 60,000 cycles will pass effectively through the system tuned to 50,000 cycles, and hence the interfering signals will be practically if not entirely excluded.

In the typical super-heterodyne receiver, the first detector-tube circuit is substantially like that of Figure 51, the antenna and transformer at the left being replaced by the loop as shown in Figure 60. The oscillator-tube circuits are much like those of Figure 65, if we imagine the antenna, the grid-circuit resistor and condenser, and the telephone and its condenser to be omitted. The second detector and audio amplifiers are arranged as shown in Figure 56. The intermediate-frequency amplifier follows generally the circuit of the first three tubes in Figure 60, but of course the transformers are designed specifically for the medium frequency to be utilized. Many variations in detail are found, and an analysis of them would be out of place here. The characteristics of arrangement and operation of all super-heterodyne receivers, however, are in line with the description that has been given.

Radiating Receivers. Although receiving outfits that in themselves are capable of generating oscillations of radio frequency are extremely useful, their abuse may give rise to the production of much harmful interference. This is because whenever a receiver generates radio currents in its antenna system, it is acting for the time being like a small transmitter. The waves radiated from such receiving aërials are relatively feeble, but they do in many cases have sufficient strength to set up strong beats or whistling noises in other receivers located within a radius of a mile or more.

Owners of simple regenerators, or of radio-frequency amplifying receivers that can be caused to produce oscillations in their antenna circuits, are strongly inclined to pick up the waves from distant stations by the heterodyne or whistle method. In this practice they are exceedingly inconsiderate of their radio neighbors, for whenever the set so adjusted produces a chirp or "tweet" as its tuned frequency swings into and out of agreement with the frequency of an arriving carrier wave, similar noises are caused in all near-by receivers that are tuned to that wavelength. The fair thing to do is to operate receivers in the oscillation-generating condition as little as possible. If receiver oscillations are to be used for intercepting waves coming from a great distance, one should use an outfit in which one or two non-oscillating radio-frequency amplifier tubes

(so-called "blocking tubes") are arranged between the antenna and the strongly regenerative circuit in which the oscillations are generated.

Poorly designed super-heterodyne receivers may also be responsible for interference if their oscillator circuits are permitted to feed into radiating antenna systems. This is particularly pernicious, for the local oscillation is of a frequency differing somewhat from the wave being received and consequently gives the operator no warning that he is making trouble for others. Nevertheless, his continuously operating oscillator may, if allowed to radiate some of its energy, be interfering seriously with reception of waves very near to it in frequency. Super-heterodynes used with small loop aërials, or fitted with blocking tubes or non-radiating circuits, will cause very little trouble of this sort. Unless the outfit is especially balanced to prevent radiation, however, a super-heterodyne should never be used with a simple open-wire antenna.

So much for our review of the technology of radio. We have studied transmission, modulation, wave propagation, reception, selection, detection, and amplification; but in getting a bird's-eye view of how the systems work, we have not been able to go into great detail as to any particular items, however interesting their development might have been. Nevertheless, you should by now feel a certain familiarity or intimacy with

the principal operations of radio signaling. If you own a receiver, some of the things it does may be clearer to you than they were before you picked up this book. You will perhaps like to know more about what radio is doing, and a little of what it can be made to do. These matters are the subjects of our next chapters.

CHAPTER X

RADIO AS A PUBLIC SERVICE

PUBLIC utilities are often considered to include only those organizations that supply some specialized service to the people at large and demand compensation in return. Thus, gas and electric companies furnishing light, heat, and power are public utilities in this narrow sense; so also are telegraph, telephone, and radio companies that transmit messages for pay. In a broader sense, however, the phrase may be applied to any activity that is of utility to the public generally. Radio is in this sense a public utility; for beyond its purely commercial use in furnishing communication that may be sold, it is daily performing other and vast public services.

The practical applications of radio are numerous, because the science has already shown itself useful in many different ways. It would be an exceedingly long task to examine in detail all of the suggestions that have been made for putting radio to work. They range all the way from automatically lighting smudge pots scattered about orchards, when a sudden drop in temperature occurs, to operating block systems on railroads.

We can, however, take up the general divisions into which to-day's important uses of radio signaling naturally fall, and find out something about the service rendered in each classification.

Amateur Communication. Almost as soon as anything was published about radio, amateur enthusiasts began to crop out all over the world. At first, these nonprofessional radio workers were almost entirely among the college professors and other scientists who were able to piece together some sort of wireless equipment as an interesting study. Men of this type alone found enough meat in the fragmentary printed descriptions to realize how and why radio worked. To the rest, "wireless" was merely another incomprehensible and therefore marvelous thing.

As more radio-telegraph stations were put into service, and as more fully intelligible descriptions of the system were printed, greater numbers of people began to take a marked interest in experimenting with electro-magnetic wave transmission. By 1906 or so, high-school boys, the country over, had been able to learn enough about radio design and construction to enable them to build quite satisfactory sending and receiving stations. Even in those days, it was not uncommon for a lad of sixteen to own a homemade plant with which he could communicate with a friend thirty or forty miles away or intercept messages arriving from the more powerful com-

mercial stations over distances of hundreds of miles. By 1912, when the first law "to regulate radio communication" in the United States was passed, amateur stations had grown in number to the point where they demanded a definite legal status. The government then assigned to amateur transmitters the wavelength of two hundred meters, and arranged to inspect and authorize by license stations that were well constructed.

Amateur activities in radio have grown along two closely interwoven lines, — first, the development of superior apparatus; and second, the establishment of noncommercial long-distance communication routes. Many of the most competent men who now make radio their profession were first interested in the art from the amateur viewpoint. Many substantial technical improvements that have been commercially adopted were first worked out in amateur stations. On the second point, amateurs have succeeded in both telegraphing and telephoning by radio over very long distances. It is not unusual, under favorable conditions, for homemade receivers on the Atlantic coast to intercept messages sent directly from the Pacific. Transcontinental relay routes have been organized and are in daily operation. An amateur member of the American Radio Relay League can send a message from his home installation, almost any evening, with confidence that it will be carefully passed on from station

to station along the prescribed lanes and after a reasonable time be delivered in correct form to the person to whom he has addressed it. Such relay services have already proved themselves of inestimable value in providing communication with towns whose wire connections were wiped out by storm or flood.

In the United States there are something like twenty thousand officially recognized and licensed amateur radio stations that contain transmitters. It is safe to say that in addition to these there are fifty times as many *receiving* stations operated by their owners simply because of interest in radio or for other nonbusiness reasons. This army of radio users is, by its very existence, an incontrovertible proof of the fascination that may be found in studying and operating wireless apparatus.

Radio-telephone Broadcasting. In the earlier days of radio, the amateur listener could hear nothing but the dots and dashes of Morse as radio-telegraph messages flashed through space from station to station. To identify the origin of the signals he heard, he had to learn to translate the code. As his ability increased, he became able to read the government weather reports and the news summaries that were sent broadcast to ships at sea from powerful wireless-telegraph sending-stations. Experiments in radio-telephonic transmission became more and more frequent from

1907, and amateurs who lived near the testing stations were occasionally treated to radio music which, without any knowledge of Morse, could be enjoyed as a novelty (if not for any other reason) by the rest of the family. The main interest of the nonprofessional radio operator was, however, in the transmission of telegraph messages and their reception over greater and greater distances.

All this was changed, and quite suddenly, in November, 1920. At that time the Westinghouse Company, from its radio-telephone station in East Pittsburgh, Pennsylvania, began to broadcast concerts, speeches, news bulletins, and church services. These gave the owners of radio receivers something to listen to that was entertaining and interesting, something they could understand without learning the telegraph code. The public welcome of this daily service was so great that it has been widely extended. To-day there are some six hundred central broadcasting radio-telephone stations scattered over the United States. Each supplies to its audience a scheduled and previously announced program of general interest. Listeners who live within range of several such transmitters using somewhat different wave-lengths, are able (if their receivers have reasonably good selective power) by tuning to select whichever program they may prefer at any particular time.

It is safe to say that more radio receivers are being used to listen to radio-telephone broadcasting than for any other purpose, and the number is continually growing. The more powerful stations serve zones of some two hundred miles in radius, though they are frequently heard much farther; and in each such zone there may be fifty thousand or more receivers. Partly, no doubt, as a result of rather keen rivalry between the managements of the various transmitters, the character of programs rendered is steadily growing better and the technique of reproduction has already been improved to the point where speech is heard more clearly than over a wire telephone and music is more nearly perfectly received than from a phonograph. The value of such a service, reaching thousands of people who are isolated in the country or shut within the sick-room, may well be imagined. At first, its popularity depended in large part upon the element of novelty; but the improvement in entertainment and information provided has long ago given broadcasting the right to be called a public service.

Marine Signaling. One of the first practical applications of radio-telegraphy was to "ship-and-shore communication", and this branch is probably in many ways the most important. Without radio, a vessel on the high seas can have no way of signaling to shore or to distant ships.

To-day the laws of progressive nations require their larger vessels to carry effective radio outfits on all but the shortest voyages, simply as a matter of protecting the lives of passengers and crews.

Coastal radio-telegraph stations have been erected at or near most of the seaports all over the world, and the great majority of these stations are kept open night and day for exchanging messages with ships at sea. These plants, and nearly all the ship installations, have a working radius in excess of two hundred and fifty miles. Some of the larger vessels, and a few well-located shore stations, are still more powerfully equipped and can signal halfway across the Atlantic or even farther. Thus many passenger ships keep in radio contact with shore at all times during their transoceanic passages.

Although the greatest value of marine radio is potential, in its contribution to the safety of life at sea, yet the service is much used for the ordinary business of making appointments, sending market reports and instructions, and the thousands of other details that are sent over any telegraph system. In time of emergency, however, the signal "SOS" is sent out and immediately receives right of way. All message traffic not relating to the distress condition is forthwith held up, and every radio operator within range bends his energies toward aiding the signaling vessel.

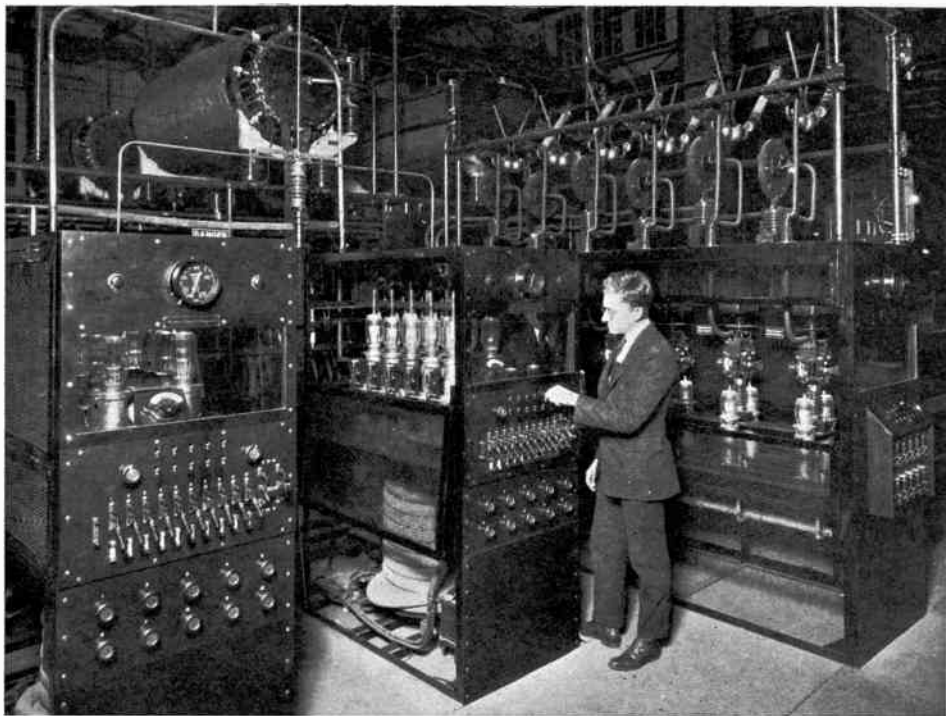

TRANS-ATLANTIC RADIO-TELEPHONE AMPLIFIERS

The final amplifiers used by the American Telephone and Telegraph Company in the 1923 trans-Atlantic radio-telephone demonstrations between Rocky Point, New York, and London, England. Twenty 10-kilowatt tubes deliver wave-currents to the aerial wires.

Ship-position Finding. One of the recent contributions that radio has made toward increasing the safety of ships at sea, is a position-determining system. The governments of several of the larger nations have put up, near various channel entrances or at other points important in navigation, sets of "radio-compass" stations. These installations are usually made in groups of three, interconnected by wire lines; each station being fitted with a loop-antenna receiver, which may be used to determine the direction along which arriving radio waves travel. When a ship at sea calls for a position report, each of the three direction-finding stations simultaneously locates the bearing along which it receives the signal waves. This information is forwarded over the telegraph lines to a control station, where the three direction readings are transferred to a chart. By the intersection of the lines of wave travel the position of the ship is found on the chart, noted in latitude and longitude, and sent by radio from the control station to the master of the vessel. Thus the navigator of any radio-equipped ship can learn his position at sea, provided only that he is within range of a set of radio-compass stations. Vessels as much as one hundred and fifty miles from shore are frequently aided in this way, though the accuracy of location increases as the shore is approached.

Another system has also been provided for assisting ships at sea to determine their positions. This

is an inversion of the compass-station scheme above described, and uses three "radio beacon" stations in each set. A radio beacon is simply a radio transmitting station that sends out characteristic signals continuously during foul weather. Each station differs from the others of its set. For example, one may signal groups of three dots; an-

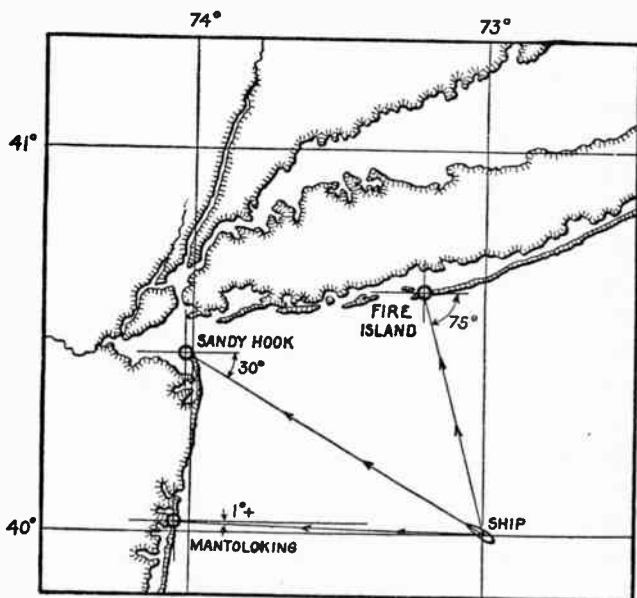

FIG. 68: Determining a Ship's Position by Radio. — The Radio Compass station at Fire Island finds that radio signals from the ship illustrated, come in along a line 75° south of east. Sandy Hook hears the same signals along the line running 30° south of east. When these two lines are drawn on a chart, their point of crossing will be found to be at 73° longitude and 40° latitude, which is the ship's position while sending. A third observation from Mantoloking (in this case a little over 1° south of east) will check the other two readings. If the three lines cross in a single point, the determination is accurate; but if they enclose a large triangle, the position of the ship will not be definitely known.

other, pairs of dots; and the third, single dots. Using only an ordinary radio receiver, one cannot make much use of such radio beacons; but if a vessel is fitted with a good loop-antenna receiver, the operator can quickly determine the directions in which the beacons lie. By drawing lines on a map in the correct direction from each station, he can locate his ship's position at the intersection point.

The beacon method gives quicker results than does the radio compass plan, but it is of course subject to the individual errors that may be made aboard the ship. According to either system, only two stations are necessary to determine a position; but the third bearing is valuable as a confirmation. If the three lines cross at a single point, the location is very definitely fixed. If they do not coincide, it becomes evident that there has been an error somewhere, and the measurements may be repeated.

Time Signals and Weather Reports. One of the most important contributions that radio makes to the safety of navigation is the organized system of time signals and meteorological reports, extending the world over. Powerful radio stations of all nations have been designated to send out signals at certain exact times of the day and night, and by comparison with these the accuracy of chronometers may be checked to the fraction of a second. Important stations

also send out, at scheduled times, full reports on weather conditions, as well as forecasts and storm warnings. This information includes barometer and temperature readings, wind strength and direction, sky and sea conditions, etc., for various points; and is supplemented by notice of icebergs, derelicts, or other maritime hazards. The value of such services, which are available almost all over the globe to ships carrying radio receivers, is indeed tremendous.

Military and Naval Uses. Applications of radio in the armies and navies of the world are so extensive that an entire chapter, if not a book, would be necessary to describe them in detail. These defending arms of our government were quick to recognize the work that radio could do for them, and from its earliest days they have been developing special adaptations of wireless signaling for their particular purposes.

In the army, one finds radio depended upon mainly for short-distance communication in the field. The outfits designed for this service are necessarily efficient, rugged, and easily portable. Many types of sets have been developed, so light that their units may be carried by one or two men. For signaling longer distances, such as between various headquarters, complete stations are mounted on motor trucks. Of course, the armies also have need for permanently installed plants at aëro landing-fields, fortifications, and

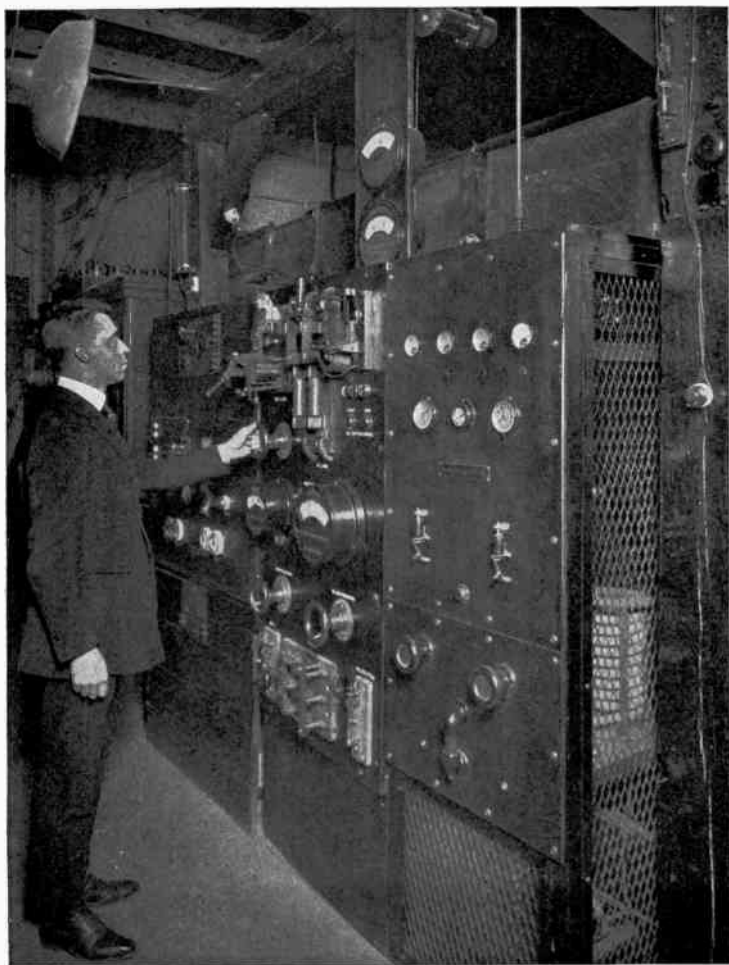

INTERMEDIATE POWER AMPLIFIER

Using two 10-kilowatt vacuum tubes, that supply wave-currents to the larger amplifier shown in plate facing page 204.

camps. In the United States there exists a well-developed military network of such stations, covering the entire country.

Naval uses of radio are, quite naturally, even more extensive than those of the military service. Electro-magnetic waves constitute the only reliable means of transmitting orders to and receiving reports from warcraft at sea; and the navy departments of most nations have developed extensive communication chains, so that messages may be interchanged with ships thousands of miles away. As in armies, small radio sets also are needed. For landing parties and for intercommunication between vessels traveling in fleet formations, it has been necessary to develop low-powered outfits that can be operated without disturbing the longer-distance communications simultaneously in progress between a flagship and the coast. Radio signaling to and from submarines has also had to be worked out to the practical stage. To-day nearly every naval vessel, from tiny sub-chaser to super-dreadnaught, carries its radio equipment.

In the United States, it has fallen to the lot of the Navy Department not merely to provide facilities for ship-and-shore signaling, but also to furnish radio communication between the mainland and outlying island possessions. As a result of this, the navy owns and operates a chain of huge stations extending from the Pacific islands

to the Canal Zone and the West Indies, and along both coasts of the continent. Some of these large plants are used for direct governmental communication across the Atlantic with other nations.

The military air forces of progressive countries have also put radio into extensive service. Special receivers that will work in spite of the noise and vibration of an airplane in flight; transmitters light enough to be carried easily, yet powerful enough to signal over a thousand miles; sending keys and switches protected against the possible igniting of gasoline fumes, or of hydrogen leaks in dirigibles; aërial systems that will not hamper flight and can be used by a seaplane while resting on the water — all these have been worked out by and for the airmen.

Overland Radio. A pair of intercommunicating radio stations (say, five hundred miles apart) can be erected for a comparatively modest sum and without any worry as to rights of way for lines. Once in service, maintenance expense is concentrated at the two points, and one need not keep a crew of linemen working in order to prevent breakdowns. Moreover, if a third station is set up, any one of the trio can signal directly to either of the others, and (if they are five hundred miles apart) 1,500 miles of lines are eliminated. As more stations are added, the saving in line-maintenance cost becomes more and more marked.

Arguments of this sort have often been advanced in favor of setting up radio links between important cities, to compete directly with the wire lines in public telegraph service. A few attempts to use radio for such inter-city telegraphy have been made; but the only networks that have thus far attained even partial success seem to be on the west coast of the United States, in England, and in Germany. German stations are rendering a very satisfactory service with Spain, Italy, and Rumania. Of the other groups of stations installed for overland working, some have been pitifully inadequate in power or general equipment and some have been badly managed. On the whole, there has been little development of radio in competition against telegraph lines.

It is interesting to consider that point-to-point radio of this sort does not take advantage of the way in which wireless waves spread themselves over the countryside. In fact, the natural distributing characteristic is a distinct disadvantage for inter-city radio; and if the waves could be practically focused into a single beam traveling in a single direction, the results would be much better. The wire telegraph line, with a minimum of waste, leads its currents directly to the place where they are wanted; and it is reasonable to suppose that the feature which makes radio so satisfactory for broadcasting is in large part re-

sponsible for its backwardness in station-to-station services. To be sure, the technical advance of radio has reached the point where good and reliable communication can be furnished. This is demonstrated by the satisfactory results that are had from radio plants installed to communicate over mountainous or heavily-forested country where wires cannot easily be strung or maintained. But for ordinary overland communication, it is likely that radio is still more expensive than wire lines, if one makes the comparison for installations such as will give equally good service between a single pair of stations; and consequently it is probable that wire telegraphy will be predominant in this field for a long time.

Transoceanic Radio. The most spectacular among the applications of radio, and that which perhaps appeals most to the imagination, is what has been called "cable-less" signaling. To telegraph by radio across three thousand miles of sea requires extensive transmitting and receiving plants, but of course does away with the costly laying of heavily armored and insulated wire cables along the ocean bed from one shore to the other. In the decade closed by 1922, transoceanic radio advanced from what was hardly more than experimental transmission (when distances in excess of two thousand miles were to be spanned) to a public service that carries a large proportion of the message traffic

from continent to continent. This progress has been made possible by increases in transmitted power, in receiver sensitiveness, and in the effective reduction of the disturbing effects of interfering waves at the receiving stations.

In the spring of 1923, the following pairs of transoceanic radio sending stations were in daily commercial operation :

Marion, Massachusetts — St. Assize, France
 Rocky Point, Long Island — Eilvese, Germany
 Port Jefferson, Long Island — Nauen, Germany
 New Brunswick, New Jersey — Carnarvon, Wales
 Tuckerton, New Jersey — Stavanger, Norway
 Bolinas, California — Koko Head, Hawaii
 Koko Head, Hawaii — Funabashi, Japan

These seven pairs of stations, working day and night in direct competition with the eighteen Atlantic and two Pacific cables, were handling about twenty-five per cent of the total number of words telegraphed between the communicating countries. The grouping of stations into the pairs indicated above is, of course, arbitrary, — simply a matter of convenience in operation. There is no reason why the Tuckerton station, for example, should not exchange its messages with St. Assize instead of with Stavanger; and such shifts in the traffic organization are sometimes made to meet unusual demands for service.

The first attempts at radio-telegraphy over

distances of three thousand miles or so were made with transmitters that radiated only ten kilowatts or so of power. Under favorable conditions, such as at night in the wintertime, when comparatively little absorption of wave energy was felt, signals and messages got across the Atlantic. Before daytime communication could be established, it was necessary to multiply the power of the transmitters some ten times and to devise more sensitive receivers. Even then the absorption was found to be too great in some parts of the day during the summer months; and the delicacy of the receivers made prominent the troubles resulting from atmospheric electric discharges or (as they are technically termed) "strays."

These strays are the bugbear of long-distance radio. Their effects are made apparent in the production of more or less continuous rattles, crashes, or clicks of noise in the receiving telephones. They are caused by natural electrical disturbances in the air (and perhaps in the earth and in space beyond our atmosphere), which produce random electro-magnetic waves very much like radio signal waves. One can easily understand that in long-distance telegraphy, where the received signals are very weak, the irregular noises of strays, or, as they are sometimes called (loosely), "static", may easily be so loud as to prevent message reception. To overcome them,

it is essential either to increase the loudness of signal by enlarging the power of the transmitter, or else to provide some sort of receiver that will intercept feeble signal waves without picking up corresponding amounts of energy from the stray waves.

In the past few years, a substantial advance has been made in both methods. In fact, it is not too much to say that with modern stray-reducing receivers, the full transmitting power (about two hundred kilowatts radiated) of the largest stations need be utilized only for overcoming the very worst conditions of absorption and stray-wave interference. This is evidence of the progress made by our radio engineers; for the maximum power of two hundred kilowatts is not far from the amount that is required to light one of the big electric advertising signs seen along the "white ways" of the larger cities. Such a sign, if set up on the shore, might send out light waves that would be visible twenty miles at sea. The same amount of power put into the longer radio waves would span the ocean. And so much power as this is needed for only the worst signaling conditions. When absorption and static interference were favorable, trans-Atlantic messages have been transmitted with waves representing no more power than is required to light a single incandescent lamp.

Thus we complete a somewhat hasty sketch of what radio is doing in the world to-day. New-

comers whose only immediate concern is the reception of broadcast concerts are often surprised to learn that so much of the burden of national and international communication is carried by radio; and even the older workers in the field sometimes marvel that in so short a time the applications of the system have been developed to their present magnitude. Beyond all this, however, every indication is that in another decade radio will be performing, as a matter of daily routine, tasks that to-day would seem to us almost miraculous.

CHAPTER XI

LOOKING FORWARD

WHAT is radio coming to? In another ten years, or in fifty years, shall we be able to receive in our houses not merely operatic music but also a visualized image of the performance of the opera itself? Will it be possible for us to press a combination of buttons on a small control box and instantly be put into telephonic communication with some one else, no matter where? Can we hope to drive flying machines at undreamed-of speeds by generating on earth the requisite power and then transmitting it by radio to the plane? If there are intelligent beings on other planets of our solar system, shall we one day speak with them? Nobody knows the answers to any of these questions.

We do know, however, that in the short quarter-century of its existence the technology of radio signaling has developed so far that the practical applications are lagging a great distance behind it. The lag is not, perhaps, so large in transoceanic radio, for the huge stations are not only telegraph plants but also practical laboratories in which new inventions are put to test as soon as they pass the early stages of development.

But it is not too much to say that, with the advent of the powerful oscillating vacuum tubes now being made, the increased facility and accuracy of adjustment and the economies of operation will permit the opening of more radio-message channels and will offer still stronger competition to the cable services. With present-day operating systems, only a limited number of long waves can be available to carry the long-distance radio communications of the world; but already methods have been devised whereby each of these waves may be forced to carry many times its normal number of messages. Further, we may expect increases in the sensitiveness of receivers and in the ability to discriminate between desired signal waves and undesired signals or stray waves, so that smaller transmitting plants will be able to communicate over longer distances.

Successful Overland Working. In overland radio, there seems to be no reason why the United States should not duplicate and even better the successful operations going on in Europe. Automatic transmission and recording, which make it possible to send ten or even twenty messages per minute (instead of the usual sixty an hour that marks the limit of ordinary hand-key working), are entirely feasible. Land wires for the distribution of messages to towns and villages can be linked up to inter-city radio channels,

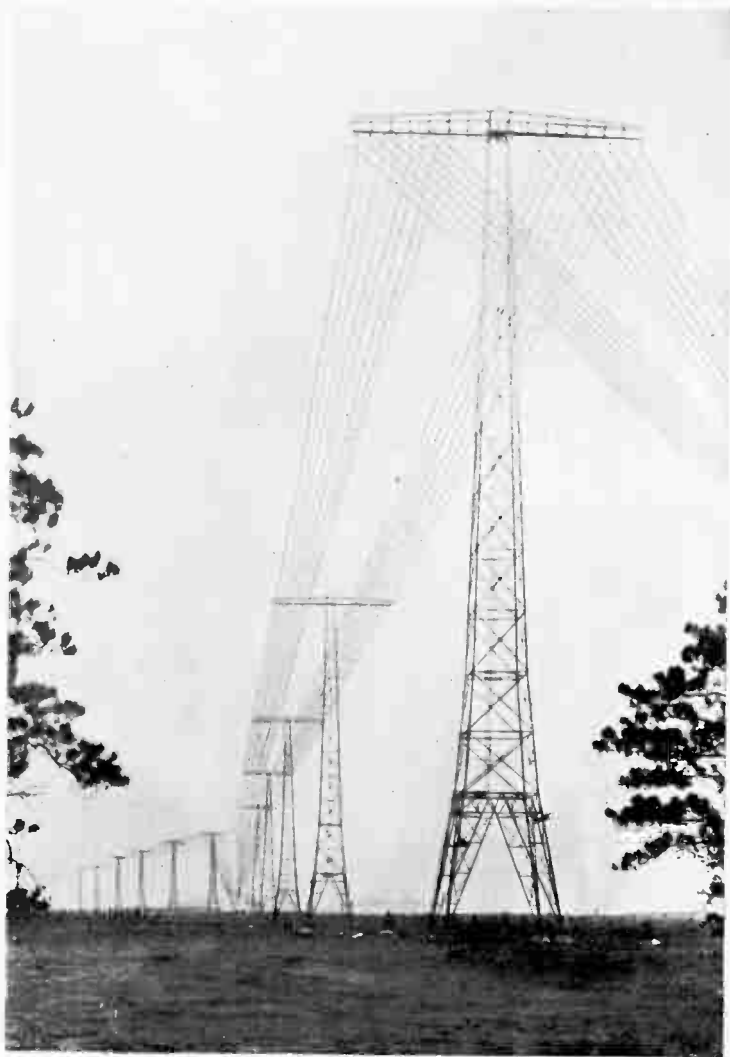

THE TWELVE 400-FOOT TRANS-ATLANTIC TOWERS OF THE RADIO CORPORATION'S STATION AT ROCKY POINT, LONG ISLAND, N. Y.

Successful radio-telephone communication between New York and London has been established through this plant.

and the maintenance of long-distance trunk lines thus be avoided.

The broadcast distribution of radio waves is a feature capable also of business use. Press services, supplying news to hundreds of papers published all over the country, can reach their subscribers directly and simultaneously by using radio. Secrecy, which is an essential of much private or semi-public work, is as easy to insure in radio as on the wires, by the use of automatic coding and decoding machines.

Marine radio-telegraphy, useful as it is in protecting ships at sea, could be vastly improved as a service if modern radio instruments were more fully utilized. Older forms of transmitters, carried by many vessels, interfere badly with ship-and-shore radio, especially when several ships collect near an important seaport. Occasionally this interference, and the delays enforced by the requiring of vessels to send in succession, hold up transmission so long that an inbound ship reaches harbor or even her dock before disposing of all her messages. This can be avoided, and the delivery speed increased, by use of the newer types of apparatus. We may some day have marine radio stations so interconnected with land telegraph lines that the operator on a ship at sea may, for example, call for a wire to Chicago, and deliver his message directly to that city without the relaying (sending, copying, and re-sending)

operations that now prevent the highest transmission speeds.

Another recent development has made it possible to generate quite powerful radio waves of exceedingly high frequency, — even above ten million cycles per second. These very short waves are easily reflected into beams traveling almost wholly in one direction, thus avoiding the broadcasting of energy that for so many years has been characteristic of longer-wave radio. Such directed transmission is applicable to both overland and marine radio. In point-to-point signaling its especial value resides in its economy; for a low-powered transmitter whose energy is concentrated upon a single distant receiver will, of course, be able to signal as far as can a much more powerful station that broadcasts its waves.

An Improved Beacon System. One of the most important uses of directed radio waves in marine work will doubtless be for an improved sort of radio beacon. Such a plant would send out a beam of radio waves sweeping the ocean, — constantly rotating around the sending station, just as does the beam of a flashing lighthouse. A concentrated radio wave of this kind would be heard most strongly when it was directed toward the listening station. If the beacon station indicated (by Morse signals, for instance) in which direction its beam was being projected at any given moment, a listener would be able to deter-

mine his bearings from the transmitter by noting which signal was heard the most loudly. To consider a simple case, we might imagine the beacon automatically to signal the letter "N" when shooting the radio beam northward, "NE" when sending to the northeast, "E" when radiating in an easterly direction; and so on around the compass. If we were listening in an ordinary radio receiver tuned to the wavelength used by the beacon station, we might hear "SE" faintly, then "S" loudly, and then "SW" faintly. It would then be evident that we were located somewhere on a line extending southward from the beacon. In the same way, we might get a bearing from another beacon station; and then, charting the two lines, might determine our exact position by noting their point of intersection. The interesting features of this system are that it requires no special directional receiver on board ship, that it is automatic in its operation, and that by it ship locations may be found with ease and rapidity. The scheme has been demonstrated as feasible, but to concentrate medium-length or long waves into a beam was found to be very difficult if not practically impossible. With good generators of short and easily reflected waves available, there is no reason why the system should not be used.

The Railroad Field. Radio for railway communication and signaling offers many possibilities.

It has already been used for sending telegraphic and telephonic messages in both directions between moving trains and fixed stations; and there is nothing to prevent the installation of outfits that would allow a passenger on one train to talk with a friend traveling on another. Aside from such conveniences for persons riding on the railroads, there are opportunities in train dispatching. Radio will permit delivery of orders to engineers without requiring them to halt their trains; and it is possible that before long the cost of radio equipment for such purposes will be so low that the saving effected through curtailment in the stopping and starting of heavy freight and passenger trains will make the use of radio a substantial economy.

Radio also has an insurance value in railway service. It is no uncommon occurrence for railway lines to be blocked by trains that have been delayed because of trouble with the telegraph or telephone wires used for dispatching. If, through sections where storms are particularly frequent or severe, railway telegraphs were paralleled by a radio system, communication could be maintained and trains moved even though the wires were down.

The suggestion has been made that moving block systems could be established by fitting each train with a constantly operating radio transmitter, from which a warning signal would

be flashed to the engine of any following train that approached within a certain distance (say, half a mile). The apparatus available to-day could hardly be applied to such a signal service in a way which would be both economical and dependable; but the plan has important features that may urge its development to a thoroughly practical stage in less time than we may imagine.

Military and naval uses of radio are already highly developed in the communication services; and, as in transoceanic radio, there is a tendency to put into use quite promptly the newest ideas as they come forward. Although highly directive short-wave signaling, using the newest types of receivers that are so well adapted for exceedingly high wave-frequencies, has not yet been widely applied to regular working, it is nevertheless almost certain that we shall soon see this extended. The saving in power that accompanies telegraphing along wave beams, as well as the additional privacy of communication thus afforded, should offer a strong appeal in the services of the army and navy.

Radio Control. There is another field of radio development that shows promise of practical and important military application. It is possible to send a vessel to sea, or an aëroplane into the air, with no crew aboard, and to control its speed and direction of travel from a radio station that may be either at a fixed point on shore or on an-

other ship or plane. The same scheme can be used to start, stop, and direct an armored tank carrying no crew; or even to discharge its guns, or to blow up a charge of explosive carried by it within an enemy's lines. The necessary controlling transmitters and the selectively operating switches for the controlled receiver have been devised; and some interesting demonstrations of their possibilities have already been made. Most of the work up to the present has been limited to guiding by radio the movements of a boat remaining near enough to shore to be seen from the control station; but there seems to be no technical reason why a crewless airplane carrying a huge torpedo (or, indeed, a veritable squadron of planes) might not automatically be held to its course in this manner, even though used in night attacks, or when traveling by day so far from the controlling transmitters as to pass out of sight.

Uses in Power Distribution. Returning to less warlike uses for radio, we may consider the electric power companies and their tremendous networks of transmission lines. Radio does not yet hold out any promise of superseding these high-voltage wires for the delivery of electric energy; but it is especially suitable for providing communication between the generating plants and substations. Ordinary telegraphs and telephones, working over wires strung along with the power-

carrying conductors, suffer severe interference from the high electric pressures, and service is frequently interrupted by the failure of the lines. Radio is free from these difficulties. Moreover, the high-frequency waves will pass along the same wires that carry the high-tension power from station to station, jumping any gaps made by the falling or breaking of the lines. We may therefore expect to see a rapid expansion of radio-telephony for communication along power lines.

Another possibility of wireless control that interests the power-distributing organizations is its use for switching. When energy from one plant is supplied over different lines at different times, it is ordinarily considered necessary to keep switchmen at the various junction points, and to signal to them when the connections are to be changed. Automatic and selective relays and switches have been devised in forms that may be installed at remote junction points and may be operated by radio waves sent to them either through space or along the power wires from the main generating stations. It should not be long before such systems come into widespread use.

The Growth of Broadcasting. It is in radio-telephone broadcasting, however, the branch of radio in which far the greatest number of people are interested, that we shall probably see the earliest and most rapid development. Up to

October, 1922, the United States Department of Commerce would permit broadcast radio-telephony upon no other wavelength than that of 360 meters. Over five hundred sending stations were licensed to use that wavelength. Ordinary radio receivers cannot select between the signals from different stations unless those signals have different wavelengths. Consequently, there was a good deal of interference between broadcasting stations that attempted to operate over the same zone at the same time and on about the same wavelength. When several transmitters were broadcasting at the same time, listeners were compelled to receive from only the nearest (and consequently the loudest) station, unless there happened to be enough difference in wavelength to permit some choice by tuning. Fortunately, sending plants that were supposed to be using the 360-meter wavelength actually transmitted waves whose lengths varied from 340 to 380 meters or so. Thus the owners of selective receiving apparatus were able to some extent to choose among the several stations that might be heard at the same time.

This interference situation was somewhat improved when, in October, 1922, the Department of Commerce permitted certain well-equipped broadcasting stations to use a 400-meter wavelength. By the use of a narrow band or group of wavelengths centering on 400 meters, it was

found feasible to permit the simultaneous operation of two 400-meter stations (actually using, let us say, 398 and 402 meters respectively) within the same zone without mutual interference. Reasonably good receiving tuners are necessary for such selectiveness, but nothing of a higher grade than is now on the market at medium prices. With poor receivers, it may not, of course, be possible to select between even 360- and 400-meter wavelengths received simultaneously; but such interference is experienced only when one attempts to use crude or badly adjusted instruments, and there is no reason why good simultaneous transmission should not be had on not only 360 and 400 meters but also 370, 380, and 390 meters at the same time and in the same locality.

But a greater step forward in the broadcasting situation was made by the National Radio Committee called together by Secretary Hoover in March, 1923. By rearrangement of wavelengths allotted to various radio services, the committee opened to broadcasting about fifty independent radio-telephone wave channels between 222 and 545 meters wavelength. Definite waves from 222 to 345 meters have been assigned by the Department of Commerce to low-powered, or Class A, broadcasters. Other definite waves from 375 to 545 meters have been allocated among the Class B high-powered broadcast stations. The 360-meter wave is still used by Class C stations.

We may expect not only that these Class C stations will all be transferred to operate on wave channels assigned to the other classes, but that additional definite waves will be diverted from other services and made available for broadcasting.

All this semi-historical discussion is simply to point out that we may now expect the element of choice to enter more widely into radio-telephone broadcasting. The services are to-day being so organized that one may listen at different wavelengths to different sorts of program. Merely by adjusting a receiving tuner, then, one will select dance music; lectures; bulletins of news, weather forecasts, and market conditions; chamber music; or orchestral and operatic offerings. At first we were forced to listen to whatever was sent out by the nearest broadcasting station (or else hear nothing at all). A little later we were able to choose whichever of two programs pleased us the more. Now we shall have a choice of five or more kinds of entertainment in the air at the same time.

Better Musical Reproduction. It is not merely in variety and selection that broadcasting programs will improve, but also in the quality of reproduction. One need only contrast the character of tone sent out by a high-grade station with that transmitted from one of the inferior establishments (of which several are unfortunately still in operation), in order to appreciate what has already been done toward the true rendering of

speech and music by radio. Even with such technical developments as are now available, one has no difficulty in recognizing the individual instruments of an orchestra as heard over the radio; and the reproduction of both music and speech is rather better than that afforded by the best phonographs. This is by no means true of all radio receivers, nor even of to-day's average; yet the possibility not only exists, but has been repeatedly demonstrated.

Much to the hurt of radio in general, a great many persons get their first impression of it by hearing a "loud speaker" operated in some radio shop or department store. Usually the intensity is all that could be desired, but the quality of spoken words and musical tones is so terribly bad as to make a musician shudder. However, you would not judge the possibilities of the high-grade phonograph by the tin-panny noises that you hear as you hurry past record-selling agencies along the street. Why not be equally charitable toward radio? The time is coming when the amplifier and reproducer for home use, and the transmitter used at the broadcasting station, will be so nearly perfect that radio will let us hear every shading and inflection, every nuance of tone of the soloist or the ensemble whose artistry is being sent broadcast.

Nation-wide Broadcasts. One more thought, and we shall have done with our little excursion

into the future of radio. Most broadcasting stations have been maintained by universities; by the government; by organizations that find the indirect advertising obtained through giving the programs is worth their expense; and by public service corporations that make their plants available for such indirect advertising. It is generally agreed that there are too many broadcasting plants in operation, and that the majority of them are poorly equipped and managed. To serve the public most effectively, it will probably be necessary to restrict the use of certain wavelengths to a limited number of high-grade and perhaps quite powerful plants. For the simultaneous broadcasting of important programs, these might well be interconnected by wire lines as at present. However, it would indeed be feasible for a single high-powered central station to provide superior programs for the whole nation. By transmitting on the longer waves that are not so highly absorbed, and automatically retransmitting from a large number of smaller repeating sub-stations radiating much shorter waves, it would be possible for listeners in every part of the country to hear the Metropolitan Opera directly from the stage in New York. Some such well-organized system of broadcasting, at first perhaps using three or four strategically located main plants, could provide us with radio-telephonic distribution of a sort only feebly ap-

proximated by to-day's broadcasting, good as that often is.

* * * * *

So let us rest. We have found out something about what radio is accomplishing in the world, and about how that work is done. We have looked forward a bit, to see what we may reasonably expect of radio in the next decade or two. If this outline has answered some of the questions that puzzled you when you began reading, part of its task is finished. I hope, however, that I have also succeeded in interesting you in the possibilities of this youngster among the applied sciences, and that you will want to know more than could possibly be told in an introduction of this kind. Radio, whether practiced as a pastime or studied as a profession, is one of the most fascinating subjects on this world of ours. Whatever your particular outlook upon it may become as you go forward, good luck to you!

GLOSSARY

Every human activity seems to gather to itself a set of words and symbols that have special meanings when used in its own particular field. So it is with farming, with music, with golf, with poetry, and with radio. These specialized words are really a sort of shorthand; each stands, in the mind of one who is familiar with its significance, for a concept that may require a paragraph or a page for adequate definition. As you dig into the subject of radio, you will find a host of such words, used in ways perhaps unintelligible to you.

The definitions that follow are intended to clarify this group of technical and semi-technical terms. Included with them are other words that, though not confined to radio but generally used in connection with electrical matters, have, however, somewhat specialized meanings in radio work. The definitions in some cases are not scientifically complete, but they contain about all that can be given without impairing the clearness of an elementary and simplified glossary. You would do well to consult Herbert T. Wade's "Everyday Electricity", a companion volume in this series of Useful Knowledge Books, for further explanations of electrical terms and ideas that are not more or less limited to radio usage.

- AËRIAL.** A device for radiating or absorbing radio waves. The tendency is to restrict the term "aërial" to elevated conductors. *See* ANTENNA.
- AIR CONDENSER.** A condenser that utilizes air as the insulator or dielectric between its oppositely charged plates.
- ALTERNATING CURRENT.** An electric current that reverses in direction at regular intervals of time.
- ALTERNATOR.** A generator of alternating electromotive forces, which produce alternating current when applied to a circuit.
- AMMETER.** An instrument for measuring electric current strength in amperes.
- AMPERE.** The practical unit of electric current strength; the current produced by a potential of one volt in a circuit having one ohm resistance.
- AMPLIFIER.** An instrument that modifies the effect of a local source of energy in accordance with applied variations, to produce a greater effect than could be had from the applied variations alone.
- ANODE.** (1) An electrode leading current into a device. (2) An electrode from which current passes within a device. (3) An electrode toward which electrons flow within a device. (4) A positively charged electrode.
- ANTENNA.** A device for radiating or absorbing radio waves. The tendency is to use the term "antenna" to describe any radiating or absorbing system, whether elevated or not. *See* AËRIAL.
- APERIODIC CIRCUIT.** A circuit having no natural period of oscillation; a circuit in which an impulse of potential will produce a current that gradually

dies away and does not reverse in direction of flow; an untuned or nonresonant circuit.

ARC. (1) An electric discharge of high intensity through gas separating two electrodes, and largely depending for its continued passage upon the heat it produces at one or both electrodes. (2) An oscillation generator utilizing an arc discharge.

ARMATURE. (1) An iron member located in the field of a magnet. (2) Either plate of a condenser. (3) The rotating part of a stationary-field motor or dynamo.

ATMOSPHERICS. Interference-producing stray waves of natural origin, usually causing clicks, rattles, or hissing sounds in radio receivers; also called "strays."

AUDIBILITY. The loudness of radio signals as reproduced in a telephone receiver; usually stated as some number of times audibility, — meaning so many times louder than a signal that could barely be heard or distinguished.

AUDIO FREQUENCY. A frequency of vibration that is within the normal audible range; usually taken as between 16 and 16,000 cycles per second.

AUDION. A vacuum tube containing a heated filamentary cathode, a cold anode, and a screen or grid control electrode interposed between them.

AUTO-TRANSFORMER. A transformer in which the same winding acts as part of both primary and secondary coils.

"B" BATTERY. A battery for the plate or anode circuit of a vacuum tube; usually made up in blocks of

fifteen small dry cells connected in series, producing an e. m. f. of approximately $22\frac{1}{2}$ volts.

BEATS. The regular waxing and waning of intensity produced by the interaction of two similar wave motions having slightly different frequencies. The beat frequency is equal to the difference between the interacting frequencies. For example, in radio a 1,000-pitch beat note will be heard when two waves having frequencies of 750,000 and 751,000 cycles interact upon a receiver.

BUZZER. An electro-magnetic circuit interrupter having a vibrating armature.

BY-PASS CONDENSER. A condenser of sufficient capacitance to offer low impedance to radio-frequency current, but much higher impedance to audio-frequency current than does the instrument across which it is connected.

CAGE ANTENNA. An antenna in which the wires are arranged to outline a cylinder.

CAPACITANCE. The property exhibited by electric condensers which permits storage of an electric charge; often called *capacity*.

CAPACITIVE COUPLER. An electric linkage permitting the transfer of energy between two circuits by the agency of capacitance.

CAPACITIVE REACTANCE. The component of impedance to alternating current that is contributed by capacitance; equal to the reciprocal of the product of $6.28 (= 2\pi)$ times the frequency of applied e. m. f. times the capacitance in farads.

CASCADE AMPLIFIER. A series of two or more amplifiers connected to magnify in succession.

- CATHODE.** (1) An electrode leading current out of a device. (2) An electrode toward which current passes within a device. (3) An electrode away from which electrons flow within a device. (4) A negatively charged electrode.
- CHANNEL.** (1) A noninterfering and independent line of communication between two or more stations. (2) A narrow band of radio wavelengths.
- CHOKE.** A coil of relatively low resistance to direct current, but of high impedance to alternating current.
- CIRCUIT.** A path in which electric current will flow when potential is applied.
- CLOSE COUPLING.** An intimate linkage permitting the rapid transfer of electrical energy between two circuits.
- COHERER.** A radio detector in which electromotive force produced by arriving waves causes a sudden decrease in the resistance of a loose mass of conducting particles.
- COIL ANTENNA.** An antenna in coil form, both ends of the coil being connected to opposite terminals of the receiver.
- CONDENSER.** An instrument possessing substantial and useful capacitance.
- CONDENSIVE COUPLER.** *See* CAPACITIVE COUPLER.
- CONDENSIVE REACTANCE.** *See* CAPACITIVE REACTANCE.
- CONDUCTANCE.** The reciprocal of electric resistance.
- CONTINUOUS WAVES.** Successive waves having, at any given point in space, uniform intensity; also called "undamped waves" and "sustained waves."

- CONTROL.** The electrode of a vacuum tube to which controlling variations are applied; the grid or screen electrode of an audion.
- COUNTERPOISE.** An artificial or substitute earth connection, usually a network of conductors somewhat resembling an aerial but nearer the earth's surface.
- COUPLER.** A linking apparatus used to transfer electric energy between two circuits.
- CRYSTAL DETECTOR.** A sensitive contact, usually between a metal and a mineral (or so-called "crystal"), capable of delivering unidirectional current when radio-frequency alternating current is applied to it.
- DAMPED WAVES.** Waves whose intensity, at any given point in space, more or less gradually dies away.
- DAMPING.** The dying-away of the intensity of a damped wave. If the intensity falls off rapidly, the damping is said to be high or large.
- DECREMENT.** A measure of damping, based upon the ratio of amplitude of successive oscillations.
- DETECTOR.** An instrument that translates the radio-frequency energy of received waves into a form suitable for giving an indication.
- DIELECTRIC.** The insulating medium separating the plates or armatures of a condenser.
- DIELECTRIC CONSTANT.** A measure of the effectiveness of a dielectric in storing energy. The capacitance of an air condenser will be multiplied by 5 if an insulator having a dielectric constant of 5 is substituted for the air dielectric.

- DIELECTRIC STRENGTH.** A measure of the ability of a dielectric to withstand high potentials without breaking down (becoming conductive).
- DIPLEX WORKING.** The transmitting or receiving of two messages simultaneously at a single station.
- DIRECT COUPLER.** An inductive coupler having a portion which is common to both of the linked circuits.
- DIRECT CURRENT.** An electric current that does not change in direction of flow; also called "continuous current" and "unidirectional current."
- DIRECTIONAL ANTENNA.** An antenna that transmits toward or receives from certain directions more vigorously than toward or from other directions.
- DIRECTIVE ANTENNA.** An antenna that transmits more vigorously in certain directions than in others.
- DISCHARGER.** A spark gap, vacuum tube, or intermittent contact arranged to discharge a condenser through an oscillatory circuit.
- DOWNLEAD.** The approximately vertical part of an aerial, leading from the top down to the instruments.
- DUPLEX WORKING.** The transmitting and receiving of two messages simultaneously at a single station.
- EARTH CONNECTION.** The wire leading to water pipe, buried plates, or other conductors used as the ground terminal.
- ELECTROLYTE.** A conductive liquid, such as the sulphuric acid solution in a storage cell.
- ELECTROMOTIVE FORCE.** The electric force that tends to produce a flow of electric current in a circuit;

abbreviated e.m.f.; also called "potential difference", "electric pressure", "voltage."

ELECTRON. The smallest electric charge, and negative in potential. A drift of electrons proceeds from negative to positive parts of a circuit, and constitutes a flow of electric "current" that is conventionally taken as proceeding in the opposite direction (*i.e.*, from positive to negative).

ELECTRON TUBE. A vacuum tube depending for its operation upon electrons passing through it.

FADING. The irregular weakening of radio signals received over long distances, especially at night.

FARAD. The "practical unit" of CAPACITANCE (*q.v.*). Since the farad is a unit of very large value, radio workers usually measure capacitance by the MICROFARAD (*q.v.*).

FEED-BACK CIRCUIT. A radio-frequency amplifying circuit in which part of the output power of an amplifier is suitably fed back into the INPUT CIRCUIT (*q.v.*); a regenerative circuit.

FILTER. A system of condensers, coils, and resistors, or some of them, offering low impedance to certain frequencies but high impedance to others.

FLAT-TOP ANTENNA. An aerial whose upper portion consists of horizontal wires, usually parallel.

FORCED ALTERNATING CURRENT. A current produced by an alternating electromotive force acting upon a circuit; usually of constant amplitude.

FREE ALTERNATING CURRENT. A current produced by applying a potential impulse to a freely oscillating circuit; usually of decreasing amplitude.

- FREQUENCY.** The number of cycles of oscillation in each unit of time, usually given in terms of cycles per second; the reciprocal of PERIOD (*q.v.*).
- FREQUENCY CHANGER.** A device that converts alternating current of one frequency into alternating current of another frequency; the usual conversion being a doubling or tripling of frequency.
- GRID.** The interposed screenlike control electrode of an AUDION (*q.v.*).
- GRID LEAK.** A resistor connected across a condenser in the grid-filament circuit of an audion.
- GROUND CONNECTION.** See EARTH CONNECTION.
- GROUP FREQUENCY.** The number of groups of waves radiated per second, when radiation is not continuous; usually within the audible range and often called "tone frequency." When each wave group is produced by a spark discharge, the term "spark frequency" may be used.
- HARD TUBE.** A vacuum tube from which practically all gas has been exhausted.
- HARP ANTENNA.** An aerial having a vertical part composed of parallel wires.
- HENRY.** The practical unit of self-induction or INDUCTANCE (*q.v.*).
- HETERODYNE.** A receiving system utilizing beats produced by the interaction of two radio-frequency forces.
- IMPEDANCE.** The quality that tends to hold back the flow of current produced by an alternating electromotive force. It includes the effects of RESISTANCE, CAPACITANCE, and INDUCTANCE (*qq.v.*).

- INDUCTANCE.** The magnetic energy-storing property exhibited by coils of wire. See **MUTUAL INDUCTANCE**; **SELF-INDUCTANCE**.
- INDUCTIVE COUPLER.** A coupler depending upon self or mutual inductance for its linkage.
- INDUCTIVE REACTANCE.** The opposition that inductance produces to the passage of alternating current; that component of impedance which is contributed by inductance. It is equal to $6.28 (= 2\pi)$ times the frequency of applied e.m.f. times the inductance in henrys.
- INDUCTOR.** A conductor, usually a coil of low resistance, in which inductance is prominent.
- INPUT CIRCUIT.** The circuit through which power is led into a device; in an **AUDION** (*q.v.*), the grid-filament circuit.
- INSULATOR.** A practical nonconductor; a body of exceedingly high resistance, through or over which only an inappreciable current flows at the working voltage.
- INTERFERENCE.** The disturbance produced when undesired radio waves are received along with the desired signals.
- ION.** An atom or molecule having an electric charge, either positive or negative.
- IONIZATION.** The process of producing ions.
- JACK.** A spring-contact receptacle into which a plug may be inserted for completion of one or more circuits.
- KEY.** A switch designed for easy and rapid manipulation.
- KILOCYCLE.** One thousand cycles. Radio frequencies are conveniently expressed in kilocycles per

second (abbreviated kc.). A frequency of 500,000 cycles per second may be written 500 kc.

KILOWATT. A unit of electric power equal to one thousand watts. *See* WATT.

"L" ANTENNA. A flat-top aerial having its downlead at one end of the horizontal portion.

LEAD-IN. The lower end of the aerial downlead, usually passing through the station wall to the instruments within.

LIGHTNING ARRESTER. A device designed to lead high potential discharges, such as would be caused by lightning, directly to earth.

LOADING COIL. An inductor connected in an oscillatory circuit, such as an aerial-to-ground circuit, to produce resonance at lower frequencies.

LOOP ANTENNA. A coil antenna having only a single turn; frequently used, however, as synonymous with COIL ANTENNA (*q.v.*).

LOOSE COUPLING. A coupling in which the two circuits are not intimately linked together.

LOUD SPEAKER. A telephone receiver designed for relatively large powers, and capable of producing sounds of sufficient volume to be heard throughout a room; usually fitted with a horn.

MEGOHM. A unit of electrical resistance equal to one million ohms. *See* OHM.

METER-AMPERES. A measure of the radiating effectiveness of a transmitting station; equal to the antenna current in amperes multiplied by the aerial effective height in meters.

MICROAMPERE. A unit of electric current equal to one millionth of an AMPERE (*q.v.*).

- MICROFARAD.** A unit of electrical capacitance equal to one millionth of a FARAD (*q.v.*).
- MICROHENRY.** A unit of electrical inductance equal to one millionth of a HENRY (*q.v.*).
- MICROPHONE.** (1) A loose electrical contact of variable resistance. (2) A telephone transmitter containing such loose contacts.
- MILLIAMPERE.** A unit of electric current equal to one thousandth of an ampere, or to one thousand microamperes. *See* AMPERE; MICROAMPERE.
- MILLIHENRY.** A unit of electrical inductance equal to one thousandth of a henry, or to one thousand microhenrys. *See* HENRY; MICROHENRY.
- MODULATION.** The process of impressing an audio-frequency variation, such as that of speech, upon a radio-frequency carrier; the control of carrier energy in accordance with signal variations.
- MUTUAL INDUCTANCE.** That part of the inductance of either of two inductively coupled circuits that is due to the coupling magnetic field.
- NATURAL WAVELENGTH.** The length of a space wave corresponding in frequency to the free alternating current produced when an oscillatory circuit is acted upon by a voltage impulse; the wavelength to which an oscillatory circuit is resonant.
- OHM.** The practical unit of electrical RESISTANCE and IMPEDANCE (*qq.v.*).
- OSCILLATING CIRCUIT.** A circuit containing inductance and capacitance, and of sufficiently low resistance to oscillate (carry a free alternating current) when acted upon by a voltage impulse; an oscillatory circuit; a resonant circuit.

- OSCILLATIONS.** Free or forced alternating currents of radio-frequency.
- OSCILLATOR.** A device capable of generating oscillations.
- OSCILLOGRAPH.** An instrument designed to trace visibly the wave forms of alternating currents or potentials.
- OUTPUT CIRCUIT.** The circuit into which a device delivers energy; in an audion, the plate-filament circuit.
- PARALLEL.** The side-by-side connection of several electrical devices, especially of battery cells having all the negative cell terminals connected together and all the positive cell terminals likewise connected together.
- PERIOD.** The length of time required to complete one cycle of oscillation; the reciprocal of oscillation frequency.
- PLATE.** The anode or output electrode of an AUDION (*q.v.*).
- PLUG.** A connecting device for use in conjunction with a JACK (*q.v.*) for convenient and rapid alteration of circuits or transfer of instruments.
- POTENTIAL.** See ELECTROMOTIVE FORCE.
- POTENTIOMETER.** A potential divider; a resistor arranged for convenient alteration of the electromotive force applied to a circuit.
- PRIMARY.** The input coil or circuit of a transformer.
- RADIATION.** The wave emission of an antenna system; sometimes incorrectly used to designate the radio-frequency current flowing in a transmitting aerial.

- RADIO BEACON.** A radio transmitter kept in continuous operation for use in direction finding; more specifically, a directive radio transmitter that automatically signals the direction in which its maximum radiation travels.
- RADIO COMPASS.** A directional receiver calibrated to indicate the direction from which waves are received.
- RADIO FREQUENCY.** A frequency of vibration that is within the range normally used in radio waves; usually taken as above the audible range and as between 16,000 and 300,000,000 cycles per second.
- REACTANCE.** The portion of IMPEDANCE (*q.v.*) due to both INDUCTANCE and CAPACITANCE (*qq.v.*). Total reactance equals inductive reactance minus capacitive reactance.
- REACTOR.** An inductor of large value, usually having an iron core.
- RECTIFIER.** A device capable of producing direct-current effects when supplied with alternating current.
- REGENERATIVE CIRCUIT.** *See* FEED-BACK CIRCUIT.
- RELAY.** A device by means of which electric power in one circuit controls electric power in another circuit.
- RESISTANCE.** The opposition to the passage of current which a conductor exhibits when acted upon by an electromotive force.
- RESISTOR.** A unit or element in which resistance is prominent.
- RESONANCE.** Agreement or harmony in frequency; the condition under which the natural frequency

of an oscillating circuit equals the frequency of an applied alternating electromotive force.

RESONANCE CURVE. A chart showing the change in voltage, current, or power in a resonant system as the condition of resonance is approached and reached.

RESONANT CIRCUIT. *See* OSCILLATING CIRCUIT.

RHEOSTAT. A resistor connected to control the current in a circuit to which substantially uniform electromotive force is applied.

SECONDARY. The output circuit or coil of a transformer.

SELECTIVITY. The ability of a radio receiver to discriminate between waves having different frequencies.

SELF-INDUCTANCE. The part of the inductance of a circuit produced by the magnetic field of the current in the circuit.

SERIES. The tandem or successive connection of several electrical devices in one circuit, especially of battery cells having the positive of one cell connected to the negative of the next throughout the battery.

SHIELD. A plate or casing, usually connected to ground, for preventing changes in capacitance.

SOFT TUBE. A vacuum tube containing a slight residuum of gas, *i.e.*, not so thoroughly exhausted as a **HARD TUBE** (*q.v.*).

SPARK FREQUENCY. *See* GROUP FREQUENCY.

SPARK GAP. A discharger across which the current flow disrupts air or other gas filling the "gap."

- STATIC.** Interference-producing natural discharges in an antenna system, usually caused by contact of charged snowflakes, water particles, or dust; sometimes used as synonymous with **ATMOSPHERICS** and **STRAYS** (*qq.v.*).
- STOPPING CONDENSER.** A by-pass condenser used to block the passage of direct current in a circuit.
- STRAYS.** *See* **ATMOSPHERICS**.
- SUSTAINED WAVES.** *See* **CONTINUOUS WAVES**.
- "T" ANTENNA.** A flat-top aerial in which the down-lead is taken from the approximate center of the horizontal portion.
- TICKLER.** The primary coil of an inductive coupler used to feed back power from the plate to the grid circuit of a regenerative audion.
- TONE FREQUENCY.** *See* **GROUP FREQUENCY**.
- TRANSFORMER.** An alternating-current device for changing the ratio of voltage to current in two interlinked circuits, a primary and a secondary.
- TRIODE.** A three-electrode vacuum tube.
- TUNER.** The portion of a radio receiver which is used in adjusting to resonance.
- TUNING.** The process of adjusting an oscillating circuit to resonance.
- TUNING COIL.** A variable inductor used in adjusting to resonance.
- UMBRELLA ANTENNA.** An aerial in which a central down-lead is connected at its upper end to a number of radial wires arranged in cone-like formation.
- UNDAMPED WAVES.** *See* **CONTINUOUS WAVES**.
- VARIOCOUPLER.** An inductive coupler of variable mutual inductance, usually having a primary coil

fixed in position and a secondary coil that may be rotated.

VARIOMETER. A variable inductor consisting of two coils whose mutual inductance may be changed and which are connected in series or in parallel. The two windings are usually arranged concentrically, one being fixed in position and the other being rotatable.

VELOCITY. The rate at which electro-magnetic space waves travel, — 186,000 miles or 300,000,000 meters per second.

VOLT. The practical unit of **ELECTROMOTIVE FORCE** (*q.v.*); an electric pressure capable of producing a current of one ampere through a resistance of one ohm. *See* **AMPERE**; **OHM**.

WATT. The practical unit of electrical power; the power represented by the flow of one ampere at a potential difference of one volt. *See* **AMPERE**; **VOLT**.

WAVE BAND. A continuous range of wavelengths extending from one stated wavelength to another.

WAVE CHANGER. A switching device used to change the electrical constants of one or more resonant circuits in a radio transmitter, so as to alter the wavelength radiated.

WAVELENGTH. The distance a wave travels in the time of one cycle.

WAVE METER. A device calibrated to indicate the wavelength corresponding to radio-frequency currents or e.m.f.'s applied to it.

WAVE TRAIN. A continuous succession of radio waves.

BIBLIOGRAPHY

RADIO BOOKS WORTH READING

The list of radio books given below is arranged as a sort of progressive reading course, beginning with introductory works that supplement the present volume, and leading on by not very difficult stages to engineering texts. By no means all of the good books on radio and its branches have been included, but all those cited are dependable. They stand head and shoulders above much of the material that has recently been rushed into print because of a sudden public demand for information about radio. You may not wish to read all of them, nor even to take them up in sequence, though the order indicated is a good one for the newcomer into radio. Each will be found to be an excellent presentation of the portion of the art that it treats, and all are written by men who know whereof they speak.

MILLS, JOHN: *LETTERS FROM A RADIO ENGINEER TO HIS SON*. Harcourt, Brace & Company, New York, 1922. 265 pages. An elementary explanation of radio instruments and their actions, in twenty-four short chapters; with special regard to the vacuum tube. Mills describes, very simply, the way in which electric conduction takes place, how batteries work, what goes on inside the audion, and much more of interest to radio users. His discussion of how molecules are composed and the parallel he draws between graphs and street maps, are noteworthy. The "one-syllable" style may not be particularly appealing to some readers; but the book is clear, concise, and authoritative.

HAUSMANN, ERICH, Editor: RADIO PHONE RECEIVING. D. Van Nostrand Company, New York, 1922. 183 pages. A correlated and specially written group of seven chapters by authorities in the radio field. The first chapter describes radio-telephony, the second is a discussion of tuning, and the third is about crystal receivers. The next three chapters are on the vacuum tube and its applications. Although they are somewhat more technical than Mills' book, no great difficulty should be had in understanding them. The final chapter is devoted to radio-telephone broadcasting, and includes a description of a typical radio-telephone central station.

DELLINGER, J. H., and WHITTEMORE, L. E.: LEFAX RADIO HANDBOOK. Lefax, Inc., Philadelphia, 1922. 130 pages. This is a loose-leaf book divided into eight sections, written by the heads of the Radio Laboratory of the U. S. Bureau of Standards. The plan is to issue supplementary information from time to time, the loose-leaf binder permitting its insertion at the logical points in the volume. The page size and punching is uniform with that of the Lefax data sheets, which contain a wealth of information of value to engineers and students, and with that of a number of useful blank forms. The divisions of the book are on the uses of radio, the principles of reception, antenna construction, fundamentals of transmission (including typical instruments), the lines of advance, and available apparatus; and a series of appendices gives underwriters' rules, the locations of active broadcasting stations, etc. Several supplements, to keep the list of stations up-to-date, have already been issued. The book abounds with practical suggestions.

BALLARD, W. C., JR.: ELEMENTS OF RADIO TELEPHONY. McGraw-Hill Book Company, New York, 1922. 132 pages. Beginning with a comparison of the wire telephone and the radio-telephone, the author proceeds to the production of high-frequency currents, the principles of the vacuum tube

and its use as an oscillator, and the more important modulation schemes used in radio-telephony to-day. Thereafter are given some further details on transmitting and receiving equipment, and the book is concluded with a miscellaneous chapter on storage batteries, wave-meters, and other accessories. Professor Ballard writes in a clear and straightforward manner, and his diagrams and technical references should be intelligible to any one who has studied the three books reviewed above.

GOLDSMITH, A. N.: RADIO TELEPHONY. The Wireless Press, New York, 1918. 247 pages. Although this book is several years old, it is of considerable interest to-day. The growth of radio-telephony is traced, with particular regard to the historical development of the various generating and modulating instruments that have been devised. The book is written for those who already have a fair knowledge of radio-telegraphy, and consequently does not give much space to explanation of fundamental operations. As a quite full description of the apparatus and methods devised for radio-telephony up to the year of publication, this volume will be found of exceptional interest.

SLEEPER, M. B.: CONSTRUCTION OF RADIO PHONE AND TELEGRAPH RECEIVERS FOR BEGINNERS. Norman W. Henley Publishing Company, New York, 1922. 142 pages. With the background of the five books listed above, possibly supplemented by some experience with complete receiving outfits, the radio student is likely to wish to try his hand at building various accessories or sets adapted to different wavelength ranges. This book differs from many of the "how to make" publications in that it describes apparatus that has actually been put together and tried out. It is well illustrated with photographs and working drawings, and with its aid any one who has some degree of mechanical aptitude should be able to make usable receiving tuners, detector mountings, radio-frequency and audio-frequency amplifier

sets, and even the somewhat elaborate cabinet types including loud speakers.

BANGAY, R. D. : *THE OSCILLATION VALVE : ELEMENTARY PRINCIPLES OF ITS APPLICATION TO WIRELESS TELEGRAPHY.* The Wireless Press, Ltd., London, 1920. 215 pages. This is among the best of the books that are devoted to simple explanation of the vacuum tube in radio. The three-electrode tube has so many useful features that a full treatment of them would require not only one but many books. The present volume does not discuss vacuum tubes as radio-telephone modulators, but it is exceedingly lucid in presenting the action of receivers, amplifiers (both radio-frequency and audio-frequency), and oscillators. Since, as we have already learned, radio-telephony is identical with electro-magnetic wave telegraphy in many particulars, the treatise will be valuable even to those who are interested principally in the radio transmission of speech and music.

DELLINGER, J. H., Editor. : *THE PRINCIPLES UNDERLYING RADIO COMMUNICATION (Second Edition).* Government Printing Office, Washington, 1922. 619 pages. This is a careful compilation of sections specially written by a number of authorities, and is issued as the standard textbook, on radio communication, of the Signal Corps, U. S. Army. It is divided into six chapters, each of which is in reality a section concerning an important general topic. Chapter 1, on elementary electricity, discusses the properties of circuits; and Chapter 2, on dynamo-electric machinery, describes the operation of electric motors and generators. Chapter 3 is about radio circuits, including tuning and damping effects, and Chapter 4 takes up electro-magnetic waves and their creation and reception by antenna systems. Chapter 5 is concerned with transmitting and receiving apparatus in general; Chapter 6 covers the various applications of vacuum tubes in radio. The book is an important reference volume for any radio library.

ZENNECK, J.: WIRELESS TELEGRAPHY. McGraw-Hill Book Company, New York, 1915. 422 pages. This work (translated into English by A. E. Seelig) is one of the radio classics. Although not a recent publication, its treatment of the engineering fundamentals of radio communication is important to us to-day for the reason that the author has written his book as does a physicist. However much the appearance and detailed design of radio apparatus may change from year to year, certain physical bases will always be used in the instruments. These basic effects constitute Doctor Zenneck's subject matter, though he treats them in an essentially practical way and describes much apparatus to show how they are utilized. To get the most out of the volume, a reader should have at least some knowledge of mathematics and physics.

MORECROFT, J. H.: PRINCIPLES OF RADIO COMMUNICATION. John Wiley and Sons, Inc., New York, 1921. 935 pages. A clearly written engineering text on the whole subject of radio, including two introductory chapters that serve to bring out and explain the sometimes puzzling behavior of electric circuits carrying radio-frequency currents. The third chapter is a general discussion of radio communication. Thereafter follow sections on oscillating circuits, spark telegraphy, vacuum-tube operation, continuous-wave telegraphy and radio-telephony, antennas and radiated waves, wave meters, amplifiers, and, finally, a set of most instructive laboratory experiments. Professor Morecroft has the knack of turning into descriptive words the mathematical relations that he states in algebraic shorthand; and throughout the book he refers to easily observable effects in practical instruments. Consequently, even the student who has difficulty with the more highly technical portions will find a great deal of valuable material that he can readily understand.

* * * * *

The following books, pamphlets, and periodicals will be useful to any one interested in the applications of radio :

THE YEARBOOK OF WIRELESS TELEGRAPHY AND TELEPHONY. The Wireless Press, Ltd., London. Issued annually. About 1,500 pages. The most complete compendium of information relative to international uses of radio; containing digests of the radio laws of various nations, lists of ship and shore stations through the world, details of time and weather signals, annual résumés of technical development, special articles on technical problems, lists of patents issued, data, tables, etc.

RADIO COMMUNICATION LAWS OF THE UNITED STATES. Government Printing Office, Washington. 102 pages. This pamphlet, issued by the Department of Commerce, gives the requirements for station and operator's licenses, the regulations governing operation, etc.

COMMERCIAL AND GOVERNMENT RADIO STATIONS OF THE UNITED STATES. Government Printing Office, Washington. Published annually by the Department of Commerce. 120 pages. Lists of licensed radio stations (including the broadcasting stations) classified by locations and by call letters, giving particulars as to wavelengths used, type of service furnished, ownership, etc.

AMATEUR RADIO STATIONS OF THE UNITED STATES. Government Printing Office, Washington. Published annually by the Department of Commerce. 299 pages. A similar list of noncommercial licensed transmitting stations.

RADIO SERVICE BULLETIN. Issued monthly by the Bureau of Navigation, Department of Commerce, and obtainable (as are the other Government publications mentioned) from the Superintendent of Documents, Government Printing Office, Washington. This is useful in keeping up-to-date on changes in the radio laws and regulations, licensing of new stations, etc. Each issue contains a list of references to radio in current periodicals.

RADIO BROADCAST and POPULAR RADIO. Monthly magazines, published respectively by Doubleday, Page & Company, Garden City, N. Y., and by Popular Radio, Inc., New York. They contain carefully edited and dependable articles on modern radio developments.

PROCEEDINGS OF THE INSTITUTE OF RADIO ENGINEERS. A bi-monthly publication of the Institute of Radio Engineers, New York, containing technical papers presented before that society and its branches. The newest work in radio is usually first described in these articles, and associate membership in the Institute is open to all who are interested in the development of the art. The Proceedings are mailed to all members, or may be subscribed for as a publication.

INDEX

- Absorption of radio waves,** 125
- Aërial,** considered as a condenser, 79; in radio reception, 129; in radio transmitters, 89, 104; tuned by inductance, 81; various forms of, 145. *See also* Antenna.
- Aircraft radio,** present-day applications of, 210; use of, in trans-Atlantic flight, 24
- Air vibrations,** basis of sound transmission, 38; impractical for long-distance signaling, 49; inaudible, possibilities of, for signaling, 50 *et seq.*; limits of audibility of, 41; reproduced in radio-telephony, 158
- Alexanderson, E. F. W.,** contributes control system, 21; work by, on radio-frequency alternator, 16
- Alternating current,** common frequencies of, 74; compared with direct current, 70; controlled in aërial circuits, 89, 104; converted to pulsating current in reception, 149; frequencies of, in radio transmitter, 81; produced by generator, 73
- Alternator,** frequency of, dependent on speed, 76; in radio-telephone transmitter, 104; radio-frequency, first produced, 16; used for generation of alternating current, 73; used in a radio transmitter, 81
- Amateur radio,** growth of, 199
- Ammeter,** use of, 69
- Amplifiers,** audio and radio, compared, 177; audio-frequency, 170-174; of radio signals, 169 *et seq.*; of radio frequency, tuned and "untuned," 174-183; reflex, 183; with regeneration, 178, 188
- Anode.** *See* Plate.
- Antenna,** conventional symbol for, 89; loop, and other forms of, 145, 183. *See also* Aërial.
- Arc generator,** radio-frequency, invented by Poulsen, 16; used in radio-telephony, 20; use of, in simple transmitter, 85
- Arlington station,** pioneer transoceanic radio-telephone tests at, 21
- Armstrong, E. H.,** devises special relay circuit, 16;

- invents feed-back circuit in receiving, 18
- Arnold, H. D., improves vacuum tube, 17
- Atmosphere, considered as transmission medium, 49
- Atmospherics. *See* Strays.
- Audion, amplifying properties of, 18, 163, 165; as radio detector, explained, 161 *et seq.*; as radio-frequency amplifier, 174 *et seq.*; as tone magnifier, 169 *et seq.*; as transoceanic transmitter, 218; devised by de Forest, 18; genesis of, in Fleming valve, 16
- BELL, A. G., builds first telephone, 5
- Bibliography, 257
- Branly, É., devises receiving instruments, 11
- Brant Rock station, pioneer radio-telephone demonstrations at, 20
- Broadcast radio-telephony, best aerial for receiving, 146; growth of, 201, 225; initiation of organized service of, 25; national, 229
- CAPACITANCE, a component of impedance, 75; of an aerial wire, 79, 133
- Circuit, closed and opened, 67; combined audio and radio, 180; condenser-coupled single amplifier, 171; double, in receiving, 143, 151; double, in transmitting, 15; double radio-frequency amplifier, 175; fundamental, of amplifier, 170; fundamental, of audion, 162; practical, using audion detector, 164; practical, using crystal detector, 151; reflex amplifier, 183-184; regenerator, 184-185; simple aerial, 81; simple receiving, 133, 140; transformer-coupled double amplifier, 172; transformer-coupled double amplifier, with common batteries, 173
- Code, as received in radio-telegraphy, 153; language considered as a, 28; Morse, signals of, produced in radio-telegraphy, 90; telegraphic, 32; written, 29
- Color, sensation of, based on frequency, 59, 60; so-called, of tones, 94
- Communication systems, postal communication a type of, 28; problem of radio, 47; space an ideal medium for, 64; speech a type of, 38; telegraphy a type of, 30; telephony a type of, 43, 46; three essentials of, 26, 27
- Condenser, by-pass, in receiving circuit, 151; grid, in audion circuit, 163; in

- amplifying circuits, 172; variable, used for tuning, 139; various types of, 79
- Conduction, in a simple circuit, 67; inefficient as basis of wireless, 48; of air, suggested for transmission, 50; tried for wireless telegraphy, 5
- Conductors, examples of electrical, 65
- Continuous waves, basis of radio-telephony, 101; broken into dots and dashes, 90; invented by Fessenden, 15; produced by simple transmitter, 86, 88
- Control electrode. *See* Grid.
- Control, radio, 223
- Coolidge, W. D., improves vacuum tube, 17
- Crookes, Sir W., prophecy of, regarding radio signaling, 11
- "Cross talk", basis of inductive wireless telegraphy, 6
- Crystal detectors, first used in radio, 17; practical operation of, 150
- Current, convention as to direction of flow of, 68, 83, 162; conversion of, in radio reception, 149; direct, compared with alternating, 70; modulation of, 104; produced in an aerial wire, 80; radio-frequency, defined, 82; relation to electron flow, 83; unit of, 68; variation of, with e.m.f. and resistance, 67 *et seq.*
- DASH, element of Morse code, 33; formed by key in radio-telegraphy, 88; reproduction of, in radio receiver, 153; sound of, in telegraphy, 34
- De Forest, L. *See* Forest, L. de.
- Detectors, audion, explained, 161; crystal, explained, 150
- Direct current, compared with alternating current, 70
- Directed radio waves, 220
- Distance, average, in marine services, 204; increased, under favorable conditions, 125; of normal radio reception, 168; reached by normal broadcasting, 203
- Distribution of energy of radio waves, 124
- Dolbear, A., suggests wireless signaling, 8
- Dot, element of Morse code, 33; formed by key in radio-telegraphy, 88; reproduction of, in radio receiver, 153; sound of, in telegraphy, 34
- Double-circuit receiver, 143 *et seq.*; with audion detector, 164; with crystal detector, 151
- Double-circuit transmitter, independently developed by Marconi and Fessenden, 15

- Duddell, W., contributes to development of arc generator, 16
- Dunwoody, H. H. C., uses carborundum in radio detector, 17
- Dynatron, a special vacuum tube, 18
- EARTH, THE**, considered as a transmission medium, 48. *See also* Ground connection.
- Edison, T. A., contributes to vacuum-tube development, 16; early work of, in wireless, 7
- Electric waves, basis of radio, 8; Hertz's experiments with, 11; predicted by Maxwell, 10. *See also* Electro-magnetic waves; Radio waves.
- Electro-magnetic waves, frequencies of radio, 62; Hertzian, or radio, 57; light and heat forms of motion of, 56. *See also* Radio waves.
- Electromotive force, explained, 66; of dry and storage cells, 67
- Electron, basis of electric current, 82; in audion amplifier, 169; in audion detector, 161; in receiving aerial affected by waves, 128; relation of, to lines of electrostatic force, 83; "turnstile" for, 150
- Electrostatic force, lines of, basis of radio wave, 85, 105; explained, 83
- Electrostatic portion of radio waves, 107; effect of, at receiver, 128; relation of, to magnetic portion, 123
- Ether, the, theory of wave transmission by, 54
- Exploring sphere, for visualizing radio waves, 108
- FEED-BACK CIRCUIT**. *See* Regeneration.
- Fessenden, R. A., develops double-circuit transmitter and continuous-wave system, 15; devises liquid receiver, 17; early work of, in radio-telephony, 20; produces radio-frequency alternator, 16
- Field of force, explained, 106
- Field strength, variation of, near antenna, 109
- Fleming, J. A., devises incandescent-lamp receiver for radio, 16, 17
- Forest, L. de, improves vacuum tube by adding grid, 16, 18
- Free space, waves in, frequencies of radio, 62; Hertzian or radio, 57; light and heat as, 55. *See also* Radio waves.
- Frequency, as commonly used in radio, 120; of alternat-

- ing current, 74; of current in radio transmitter, 81; of fundamental and harmonic tones, 99; of heat waves, 60; of light waves, 59; of radio waves, 62, 85; of radio waves compared with light and sound, 61; of sound waves, 41, 51, 92 *et seq.*; of tones used for code signals, 154-155; of vibration, defined, 58; related to wavelength, 119 *et seq.*
- "GAMMA RAYS", frequency of, 59
- Glossary, 233
- Grid, added to vacuum tube, 16, 18; effect of, in audion amplifier, 169; effect of, in audion detector, 161
- Ground connection, indirect form of, suggested by Lodge, 14; use of, by Marconi, 14; use of, in a radiating circuit, 80-81, 89, 104; use of, in receiving circuits, 133, 140, 143, 150 *et seq.*
- HARMONICS, musical tones, 98 *et seq.*
- Heat, a form of motion of electro-magnetic waves, 56; a form of motion of waves in free space, 55; frequency of waves of, 60
- Heaviside, A. W., co-worker with W. H. Preece, 6
- Heising, R. A., contributes modulation system, 21
- Henry, J., experiments of, on magnetic effects of spark, 10
- Hertz, H., demonstrations by, of electric waves, 11; wave generator and receiver of, 12
- Heterodyne receiver, invented by Fessenden, 19; regenerative circuit as, 186; used as "pick-up", 189, 195
- High-speed transmission, 218
- Hughes, D. E., discovers sensitive contact, 10
- IMPEDANCE, dependence of, on frequency, 76; in radio receiving aerial, 132; reduction of, to produce resonance, 78 *et seq.*; to alternating current, explained, 74
- Incandescent-lamp detector. *See* Audion.
- Inductance, a component of impedance, 75; used to tune an aerial circuit, 81
- Induction. *See* Magnetic induction type of wireless telegraphy.
- Inductor, variable, used for tuning, 81, 134
- Insulators, examples of electrical, 65
- Intensity, increase of, by amplification, 169 *et seq.*; of radio signals, 156, 166; of radio waves at great distances, 124; of sound, 92

- et seq.*; reproduced in radio-telephone transmitter, 104
- Interference, from radiating receivers, 195; tuning to reduce, 135, 139 *et seq.*
- Interrupter in radio reception, 154
- KEY**, telegraph, action of, 36; used in radio-telegraph transmitter, 88
- Kilocycles, used to measure radio wave frequency, 62
- Kitsee, I., suggests wireless signaling, 8
- LANGMUIR, I.**, improves vacuum tube, 17
- Light, a form of motion of electro-magnetic waves, 56; as a basis of signaling, 57; found to be a form of wave motion in free space, 55; frequency of, 60
- Lodge, Sir O., devises receiving instruments, 12; suggests indirect ground, 14; uses siphon recorder, 19
- Loomis, M., suggests wireless signaling, 8
- Loop antenna, in radio reception, 145; with radio-frequency amplifier, 177
- Loud speakers, 180
- MAGNETIC DETECTOR**, devised by Marconi, 17
- Magnetic force, lines of, in radio waves, 106; in receiving tuner, 144
- Magnetic induction type of wireless telegraphy, 6, 7
- Magnetic portion of radio waves, relation of, to electrostatic portion, 123
- Magnetron, a special vacuum tube, 18
- Magnifiers of radio-signal intensity, 167, 170 *et seq.*
- Marconi, G., demonstrates new form of wireless, 8; devises magnetic detector, 17; pupil of Righi, 12; Salisbury Plain demonstrations by, 13
- Marine radio, first accident reported by, 22; future of, 208; growth of, 203; position-finding by, 205
- Maxwell, J. C., new theory of electricity advanced by, 10
- Modulation of radio waves, 103 *et seq.*; 126
- Morse, S. F. B., code bearing name of, 33; first electrical wireless telegraphy by, 4
- Musical tone, advantages of, in radio-telegraphy, 153; first used in wireless, 6; frequencies of, 51; magnification of, in reception, 169 *et seq.*; production of, in reception, 155; simple and complex, 98 *et seq.*; vibration rate determines pitch of, 40

- OHM, the unit of resistance, 67
- Ohm's law, applied to alternating-current circuit, 75; applied to direct-current circuit, 70; in radio receiver, 130
- Overland radio discussed, 210 *et seq.*
- Overtones in music, 97 *et seq.*
- PARTIALS, harmonic, 98 *et seq.*
- Penetration of light and radio waves, 63
- Pickard, G. W., uses silicon in radio detector, 18
- Pitch, examples of, 93; frequency values of, 41, 51; relation of, to vibration rate, 40
- Plate, in audion detector, 161
- Point-to-point radio, 210, 218; use of directed waves in, 220
- Potential. *See* Electromotive force.
- Poulsen, V., invents radio-frequency arc generator, 16
- Preece, W. H., inductive wireless telegraphy by, 6
- Pulsating current, defined, 149; produced from radio-frequency alternating current, 150
- Pupin, M. I., states principles of tuning, 15
- QUALITY of sound waves, 94 *et seq.*; preservation of, in broadcasting, 228
- RADIO BEACON, application of, 206; improvements in, 220
- Radio communication, considered as a public utility, 198 *et seq.*; distinguished from conduction and induction, 9; long-distance records of, 126; military and naval uses of, 208 *et seq.*; production of waves for, 81; use of electromagnetic waves in, 57; wave frequencies used in, 63; work that laid foundation of, 10-11
- Radio compass, application of, 205
- Radio services, broadcasting, described, 201, 225; in control and switching, 223-224; marine, discussed, 203, 219; ship-position finding included among, 205; time signals and weather reports supplied by, 207; wavelengths and frequencies used in, 120
- Radio-telegraphy, early experiments in, 12; first transoceanic experiments in, 22; high speed in, 218; simple receiver for, 151; simple transmitter for, 89
- Radio-telephony, based upon proportional response, 157; broadcast, future of, 225; broadcasting service in, organized, 25, 201; early work

- of Fessenden and Stone in, 20; first transoceanic transmission by, 21; simple transmitter for, 104; variations of intensity in, 159
- Radio waves, absorption and reflection of, 125, 126; combination of, with sound waves, 101; corresponding to dots and dashes, 91; directed, modern use of, 220; electrostatic portion of, 107; expansion of, 114, 116; intensity of, at great distances, 124; interception of, 128; magnetic portion of, 121; practical modulation of, 103, 126; production of, 81 *et seq.* See Electro-magnetic waves; Free space, waves in.
- Railroads, first use of wireless for, 8; possibilities of radio in connection with, 221 *et seq.*; use of radio on, 23
- Receiver, action of simple, in radio, 152; improvements of, in early years, 17; new form of, devised by Marconi, 13; practical forms of, 170 *et seq.*; regenerative, 184 *et seq.*; tuning applied to, 19; used by Hertz, 11. *See also* Telephone receiver.
- Reflex amplifier, 183
- Regeneration, explained, 184 *et seq.*; in radio-frequency amplifiers, 178, 188-190; producing radio-frequency current, 189; simple circuit for, 186
- Resistance, electrical, component of impedance, 75; defined, 66; unit of, 67
- Resonance, in a transmitting aerial, 81; in radio receivers, 132 *et seq.*; in simple alternating-current circuits, 76; of a circuit, sharpening the, 141; selection by means of, 139
- Resonance curve, example of, 137
- Response, proportional, to signals, basis of radio-telephony, 157
- Rheostat, example of use of, 69; in audion filament circuit, 162, 164
- Righi, A., investigates electric waves, 12
- SALISBURY PLAIN, early demonstrations by Marconi at, 13
- Secrecy in radio, 219
- Siphon recorder, used by Lodge, 19
- "SOS", right-of-way for, 204
- Sound, combination of, with radio waves, 101; complex forms of, 42; frequency and intensity of, 92 *et seq.*; fundamental and partial frequencies of, 97; photographing waves of, 95 *et*

- seq.*; quality of, 94; simple forms of, 41; transmission of, explained, 43 *et seq.*; transmission of, through earth or water, impractical, 48; vibration frequency, equivalents of, in, 51; vibrations of, reproduced in radio-telephony, 158
- Sounder, action of, 37; telegraph, 33; unsuitable for radio reception, 147
- Space, the medium of transmission of heat, light, and radio, 53 *et seq.*
- Space waves. *See* Free space, waves in.
- Speech, a communication system, 38; a complicated sound wave, 101; impressed on radio waves, 104; mechanism of, 39; reproduced in radio-telephony, 160; transmission of, over long distances, 42 *et seq.*
- Static. *See* Strays.
- Stone, J. S., early work of, in radio-telephony, 20
- Strays, interference from, 214; reduction of effects of, 215
- Super-heterodyne receiver, explained, 191; interference from, 196
- TELEGRAPHY, a communication system, 30; electric type of, 36; mechanical type of, 34
- Telephone receiver, conversion of radio currents to operate, 148; double "headset" as, advantages of, 167; invented by Bell, 5; modifications of, for loud speaking, 180; operation of, explained, 44; use of, with amplifiers, 182; used in radio reception, 19
- Telephone transmitter, operation of, explained, 44; used for modulation, 104
- Telephony, acoustic type of, 42; electric type of, 44
- Tesla, N., suggests transmission of electric power through air, 50
- Thomson, E., contributes to development of arc generator, 16; proposes to use Hertz waves for signaling, 11
- Time signals, sent by radio, 207
- Trans-Atlantic radio signaling. *See* Transoceanic radio signaling.
- Transformer, in double-circuit receiver, 143, 151; in radio-frequency amplifier, 175 *et seq.*; in tone amplifiers, 170 *et seq.*
- Transmitter, continuous-wave types of, 16; Marconi's early forms of, 14; radio,

- essentials of, 85; simple, in radio-telegraphy, 89; simple, in radio-telephony, 104; tuning applied to, 15; used by Hertz, 11. *See also* Telephone transmitter.
- Transoceanic radio signaling, early radio-telephone tests of, 21; first commercial service in, 23; first radio-telegraphic transmission of, 22; present-day uses of, 212
- Trowbridge, J., uses telephone in conduction wireless, 5
- Tuning, applied to radio, 15; applied to radio reception, 19; for selection, 135, 139; in a simple circuit, 76-78; of a radio transmitter, 81; of radio receivers, 132 *et seq.*; sharp, in reception, 141 *et seq.*; simplified control of, 179
- Tuning coil. *See* Inductor, variable.
- ULTRA-VIOLET RAYS, frequency of, 59
- VACUUM TUBE. *See* Audion.
- Valve, vacuum. *See* Audion.
- Velocity, in relation to dots and dashes, 92; of sound waves, 51; of waves in free space, 54, 118; reduced for explanation, 115
- Vibration, frequencies of, and sound equivalents, 51; mechanical, as representation of sound, 41; rate of, defines pitch of sound, 40; sound, conversion of, to electrical, 44; sound intensity dependent upon extent of, 94
- Volt, the unit of electromotive force, 67
- Vowels, sounds of, 100
- WAVELENGTH, bands of, assigned to broadcasting, 227; commonly used in radio, 120; of radio wave explained, 111, 118; related to frequency, 119 *et seq.*; short, used in modern signaling, 220
- Waves. *See* Electro-magnetic waves; Free space, waves in; Radio waves.
- Weather reports sent by radio, 207
- Wireless telegraphy, by diffused conduction, 5; by induction, 6; crude schemes of, 4; first electrical, 4; radio form of, supreme, 8. *See also* Radio-telegraphy.
- X-RAYS, frequency of, 59