

PRACTICAL WIRELESS, MARCH, 1946.

SHORT-WAVE REACTION CIRCUITS

Practical ^{9^D} EVERY MONTH Wireless

Editor
F. J. CAMM

Vol. 22 No. 477

NEW SERIES

MARCH, 1946

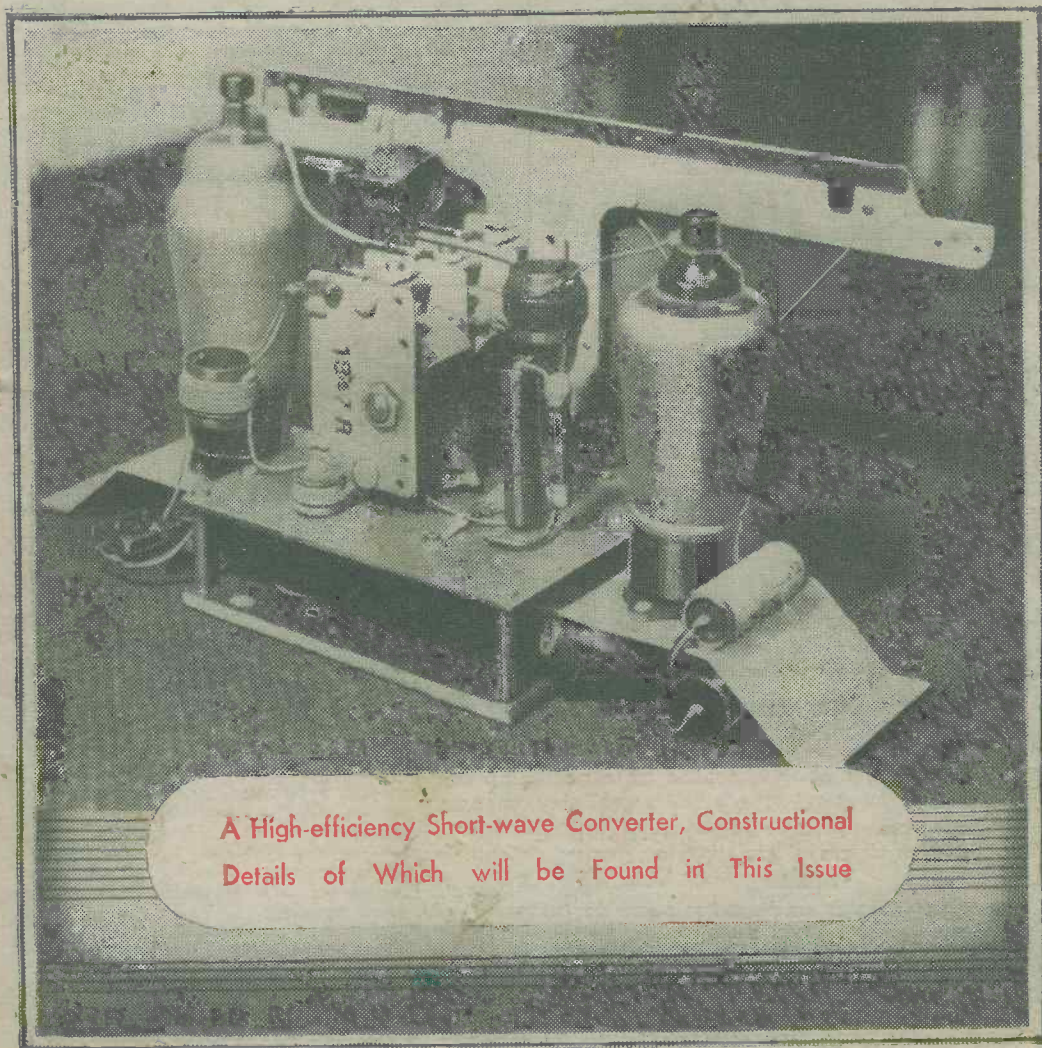

A High-efficiency Short-wave Converter, Constructional
Details of Which will be Found in This Issue

RADIO BOOKS



RADIO UPKEEP AND REPAIRS

By Alfred T. Witts, A.M.I.E.E. Enables the average radio receiver owner to diagnose the ordinary troubles of his wireless set and to remedy them himself. Sixth Edition. 7s. 6d. net.

PROBLEMS IN RADIO ENGINEERING

By E. T. A. Rapson, A.C.G.I., etc. A classified collection of examination questions set from time to time by some of the more important examining bodies in Radio Communication, together with some useful notes and formulae bearing on the different groups of questions and answers to those questions which are capable of a numerical solution. Sixth Edition. 5s. net.

RADIO SIMPLIFIED

By John Clarricoats. Provides a useful background of fundamental radio knowledge. Chapters deal with such subjects as Series and Parallel, the Measurement of Current, Voltage and Resistance, the Magnetic Effect of an Electric Current, etc. Second Edition. 4s. 6d. net.

WORKED RADIO CALCULATIONS

By Alfred T. Witts, A.M.I.E.E. Comprises over three hundred worked examples, giving the solution to typical mathematical problems occurring in examinations for radio mechanics and wireless operators. 6s. 6d. net.

N.B.—Paper rationing means a shortage of books. The one you want may be temporarily out of stock.

Pitman House, Parker St.,
Kingsway, London, W.C.2

PITMAN



3 CORES
OF
ERSIN
FLUX

Radio Experimenters are now able to use "The finest Cored Solder in the World," Ersin Multicore. The three cores of extra active non-corrosive flux ensure speedy soldering and eliminate high resistance or dry joints.

Available from electric and radio shops, ironmongers, etc.

Size 2 cartons: 16 S.W.G. 6d. ea.

Nominal 1-lb. reels: { 13 S.W.G. 4/10 ea.
16 S.W.G. 5/3 ea.

MULTICORE SOLDERS LTD.,
Mellier House, Albemarle Street, London, W.1.
Telephone: REGENT 1411 (P.B.X. 4 lines)

THE PERFECT
EXTRA SPEAKER
FOR ANY SET



Stentorian

EXTENSION SPEAKERS

now available again **29/6**
FROM

The benefits of specialisation make possible really amazing values. The efficient permanent magnet speakers, giving remarkably pleasant reproduction, are housed in most attractive cabinets, complete with VOLUME CONTROL.

Supplies are limited so please be patient if your dealer cannot supply immediately.

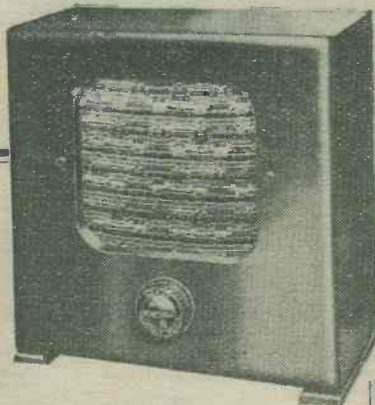

CABINET MODELS NOW AVAILABLE

MINOR TYPE MX (for low impedance extension)	29/6
MINOR TYPE MC (with universal transformer)	35/6
BABY TYPE BX (for low impedance extension)	43/6
BABY TYPE BC (with universal transformer)	49/6

WHITELEY ELECTRICAL RADIO CO. LTD., MANSFIELD, NOTTS

Practical Wireless

14th YEAR
OF ISSUE

EVERY MONTH
VOL. XXII. No. 477. MARCH, 1946

and PRACTICAL TELEVISION

Editor F. J. CAMM

COMMENTS OF THE MONTH.

BY THE EDITOR

Early Start on Television

IT is expected that the B.B.C. will resume television transmissions from the Alexandra Palace in May or June of this year. It is announced that the programmes will include a high proportion of sporting and topical events such as cricket matches, boxing, racing, and tennis.

Great improvements have been made in the transmitting cameras during the war and it is claimed that these will give clearer and sharper pictures than before, as well as greater depth of focus and better illumination. The standard of definition is to remain as in 1939.

Mr. Maurice Gorham, the new television director, thinks that outside broadcasts through the television screen of sporting events is likely to be more appreciated by the public than plays and variety turns. We personally do not think so, but no doubt when the service has been going a few months the matter will be viewed in the light of experience. The balance of the programmes, we are informed, will be on much the same lines as before. The length of the programme will be from three to four hours daily.

The reliable range of the reconditioned station is estimated to be from 40 to 45 miles, as against the 25-mile range of 1939. The problem of recording television programmes in a manner similar to that now used for sound transmission has yet to be

solved, but we believe that some of the new methods and materials developed during the war will make this possible. In the days of the 30-line transmission, programmes were successfully recorded on wax and a record was sold for a few shillings, which gave reasonable results. In this case, recording was effected by means of connecting photo electric cells to an amplifier which was in turn connected to the recording device. Fluctuations in the electrical circuit were transmitted to a cutting stylus, which recorded their wave-motions in exactly the same way as the wave-motion of sound is recorded on an ordinary gramophone disc. Television signals recorded on a disc can be reproduced as television signals by playing through the normal pick-up and amplifier, the variations being applied to a standard neon lamp. The

microphone of the gramophone recorder is replaced, thus, by the photo-electric cells of the television signal recorder, and the loudspeaker of the reproducing gramophone is replaced by the neon or similar apparatus used to translate the television signal into terms of light and shade for the production of the actual image.

Whilst that could be accomplished on 30 lines, the difficulty with high definition transmissions, which embrace a much wider frequency-band, are multiplied enormously, and the frequency-response which may be accommodated on a standard record is extremely limited. A high-class output is essential and this cannot be guaranteed with most records and pick-ups as at present used. The spacing of the grooves on the former, and the response curve of the latter present serious complications, which, however, are not insuperable. At the expense of halving the running time of the record it should be possible to use a double pick-up head so that the two grooves are traversed simultaneously, one for sound and one for vision.

The delayed television system, in which a cinematograph film was taken of the event and transmitted 30 seconds or so later, presented serious problems and was never entirely satisfactory. Our scientists, therefore, will have to get down to the problem of the recorded television programme. At

present programmes radiated from the studio need too much rehearsal beforehand and, of course, the dressing of the artistes, the scenic effects, and the preparation of the studio itself are factors which must make television inevitably more expensive than the ordinary sound broadcasts.

However, a start is being made, and, no doubt, as the difficulties of the immediate post-war period recede and our technicians return to the laboratories they will be able to apply themselves to the task.

"Newnes' Engineers' Reference Book"

WE have just published an important work of reference covering all branches of mechanical engineering, under the above title. It costs £2 2s. and contains 1,326 pages, fully indexed.

Editorial and Advertisement Offices:
"Practical Wireless," George Newnes, Ltd.,
Tower House, Southampton Street, Strand,
W.C.2. Phone: Temple Bar 4363.
Telegrams: Newnes, Rand, London.
Registered at the G.P.O. for transmission by
Canadian Magazine Post.

The Editor will be pleased to consider articles of a practical nature suitable for publication in "Practical Wireless." Such articles should be written on one side of the paper only, and should contain the name and address of the sender. Whilst the Editor does not hold himself responsible for manuscripts, every effort will be made to return them if a stamped and addressed envelope is enclosed. All correspondence intended for the Editor should be addressed: The Editor, "Practical Wireless," George Newnes, Ltd., Tower House, Southampton Street, Strand, W.C.2.

Owing to the rapid progress in the design of wireless apparatus and to our efforts to keep our readers in touch with the latest developments, we give no warranty that apparatus described in our columns is not the subject of letters patent.

Copyright in all drawings, photographs and articles published in "Practical Wireless" is specifically reserved throughout the countries signatory to the Berne Convention and the U.S.A. Reproductions or imitations of any of these are therefore expressly forbidden. "Practical Wireless" incorporates "Amateur Wireless."

ROUND THE WORLD OF WIRELESS

"Restogram" Pre-war Privilege Extended

THE arrangement by which travellers abroad may have telegrams intended for them addressed to the local offices of Cable and Wireless, Ltd., to be held till called for, has now been reintroduced by the company.

In telegrams for most countries the addressee's name should be followed by the word "Restogram" and the name of the town of destination. For travellers in Australia, Argentina, Suva (Fiji) and San Juan (Porto Rico), "Cablerest" should be used.

The restored facility is available at 158 offices in over 70 Empire and foreign countries—more than before the war.

Wireless Receiving Licences

THE following statement shows the approximate numbers of licences issued during the year ended November 31st, 1945.

Region	Number
London Postal	1,793,000
Home Counties	1,292,000
Midland	1,407,000
North Eastern	1,547,000
North Western	1,353,000
South Western	836,000
Welsh and Border	585,000
Total England and Wales	8,813,000
Scotland	989,000
Northern Ireland	150,000
Grand Total	9,952,000

Miss Philco for 1946

A BEAUTY-CONTEST was held during the New Year Ball at Ealing Town Hall in January. The winner was elected Miss Philco for 1946 and presented with a silver cup.

In private life Miss Philco is Joyce Oughton, of 1, Birkbeck Avenue, Greenford, Middlesex. She is a petite



Mr. Fred Williams, Director of Philco, during his recent visit from America, presenting the cup to the winner of "Miss Philco 1946" competition.

brunette, and helps to assemble radio parts at the Philco works.

The judge was Mr. Frederick D. Williams, American director of the Philco Company, who is over here on his first visit since 1939. To help him he had two assistant judges, the managing director, Mr. L. D. Bennett, and the joint-managing director, Mr. E. M. Benjamin. The choosing of Miss Philco was the climax of the ball, which



A much-travelled G.E.C. receiver. See the story below.

was held by Philco for Philco personnel to celebrate the first peacetime new year. All the girls who entered the competition were formed into a circle in the centre of the hall, and Mr. Williams and his two assistants walked slowly round, pausing to compliment some of the girls or ask them to pull up their evening skirts to ankle length. When Miss Oughton had been proclaimed the winner, she was presented with a silver cup and given a necklace.

The surprise of the evening followed. Al Morgan and his Band played for the first time a new song, written and devised by Mr. Morgan. Peter Gray, the singer and pianist, sang the lyric. Its title was: "I'm Going Home to My Philco." It promises to be a "hit."

There was dancing all the evening and competition dances were arranged by the three M.C.s, who awarded prizes to the winners. Paper hats and novelties were thrown to the dancers from the platform. The hall was gaily decorated with red, white and blue lamps, and coloured spotlights played on the dancing crowd. Round the walls hung maroon and yellow banners, lettered "Philco Radio"; and Al Morgan's music was relayed by Philco sound-equipment.

Five-and-a-half Years on Tour

A G.E.C. "Overseas Ten," owned by Major M. J. Thorpe, was originally sent to him in Malaya and worked perfectly in the steamy heat of that country. Later it was shipped at Shanghai to Kove, and thence transhipped to Vancouver, B.C. On unpacking the set in Vancouver, Major Thorpe found that it worked perfectly. Its next move was a 3,000-mile trip across Canada at 20 deg. below zero to Ottawa. Finally, it was again packed and came by freight to England, still working perfectly on its arrival here. Throughout this

time the only attention the set received was minor valve replacements.

New Year Honours

THE radio industry was well represented in this year's Honours List, and the awards marked the development of Radar and the results of good organisation in the various branches of the Trade.

Dr. Robert Cockburn and Mr. J. A. Ratcliffe, who superintended the Ministry's telecommunication research establishment, are made O.B.E.s, as are Mr. E. Harle, Mr. K. C. Sinclair, Mr. W. F. R. Camping, and Dr. D. N. Truscott.

Four officials of radio companies become O.B.E.s.—Mr. C. S. Agate, of the Gramophone Co.; Mr. C. A. W. Harmer, Pye's; Mr. J. W. Ridgeway, Edison Swan, and Mr. W. H. Peters, of the G.E.C., Coventry. Many others become M.B.E.s, and representative factory operatives have been awarded the B.E.M.

Animal Sound Levels

THE old adage "the barking dog seldom bites" was proved in reverse in New York recently when the "bitingest" and most ferocious beast of Ringling Brothers—Barnum and Bailey circus, was scientifically found to have almost the meekest "bark" or voice of any animal in the big show.

A General Electric sound-level meter, which measures quantity of sound, tested the vocal offerings of "Toto" and "Gargantua," gruesome gorillas, and found the hulking duo, most feared of all circus animals, to have a voice slightly less in sound intensity than that of a chirping canary. "Toto" and "Gargantua," at best, could grunt only to the intensity of 73 decibels. A canary, tested under similar conditions, chirped loud enough for 77 decibels.

"Leo the Lion," as far as voice is concerned, came close to losing his sceptre as king of the beasts, but finally won out by a hair—rather a decibel. "Toby," the elephant, offered a serious challenge by raising the counter on the indicator to 109 decibels. After falling short of this mark several times, "Leo" finally issued a roar worth 110 decibels. The top sound intensity of each equalled the noise at two feet of four men hammering a steel plate.

Except for the giraffe, which has no vocal cords, the meekest voice of the circus proved to be that of a boa constrictor, whose hiss at two feet registered only 60 decibels. Low conversation at the same distance from the meter is the equivalent in volume.

The G.E. sound-level meter found that the Bengal tiger, usually considered second only to the lion, could emit a roar worth only 89 decibels, likened in volume to noise of a pneumatic drill at roof. The hippopotamus, although dubbed the "Silent Joe" of the circus, co-operated with a pectoral grunt that registered 90 decibels.

A black leopard, a kangaroo and a chimpanzee succeeded in moving the meter indicator to 79 decibels. A small macaw, however, trumped this with a reading of 84, similar in intensity to noise of a telephone ringing.

The circus barker topped everything but the lion and elephant with a volume of 100 decibels. This is as loud as an automobile horn at a distance of two feet.

Various pitches or tonal qualities have no effect on the sound-level meter as a different frequency is used for every range. The meter seeks out and registers only the strength or volume of the sound.

W.B. Gift to Hospital

THE staff and employees of Whiteley Electrical Radio Co., Ltd., recently contributed £2,179 to the Mansfield (Notts.) Hospital. This represented the largest individual gift received by the hospital in the £50,000 Appeal Fund, and the managing director of W.B.—Mr. A. H. Whiteley—made the total up to £2,500 as a thank-offering for the safe return of his son from overseas service.

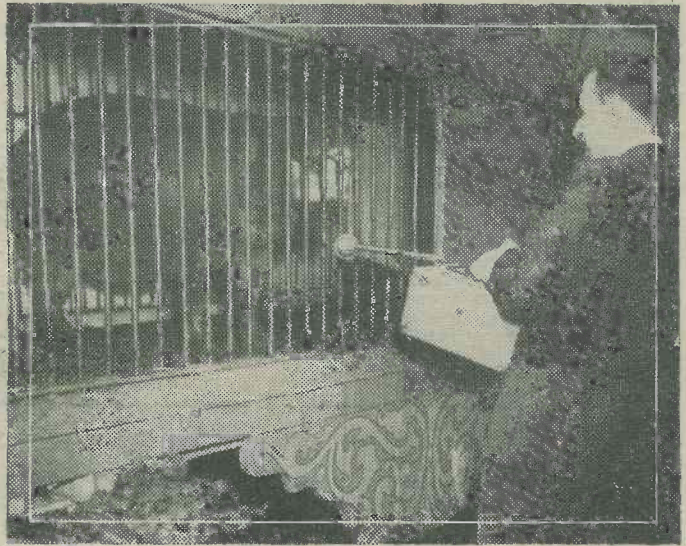

The hippopotamus, recording his sound level during a recent American experiment.

B.I.R.E. Meeting

AT a meeting of the British Institution of Radio Engineers (N.W. Section), held at the College of Technology (Reynolds Hall), Sackville Street, Manchester, 1, on Tuesday, January 29th, Flight Lieutenant C. Bovill read a paper on "Aircraft Radio."

B.B.C. Photographic Studies

MOST readers are familiar with the photographs produced by the B.B.C. publicity department, and these have set such a high standard that an exhibition of special subjects is being held in London at the Ilford Gallery, 101, High Holborn, W.C.1.

Television

PRODUCTION of vision receivers has not yet begun. Recommendations on the future of the service has been made by the Government Committee set up under the chairmanship of Lord Hankey. The Lord President of the Council, Mr. Herbert Morrison, announced in the House of Commons recently that the Government had given general approval of the recommendations. The necessary action has been set in train.

Apart from sound and vision receivers, many firms are producing transmitters, communications equipment, medical and industrial electronic apparatus and many other highly specialised products for which there is likely to be a heavy demand, both in this country and overseas. No manufacturing licences are required by firms engaged on production of this character, but every effort is being made by the Board to assist the manufacturers concerned in the reconversion of their production programmes to peacetime needs.

A High-efficiency S.W. Converter

An Easily-built Short-wave Unit for Use with a Standard Receiver

By G. W. BROWN

A GREAT many short-wave circuits have been designed to meet the needs of the keen enthusiast who has time and patience to juggle with several controls in an attempt to "bring in" that elusive, far-off signal on headphones. Without wishing to detract from that very real thrill of exploration, I submit that, for "family" listening at least, what is required is a fairly strong speaker-signal, easily tunable and yet from sufficiently far away to be interesting; and since most homes possess a reasonably good superhet or H.F.-stage receiver, the obvious answer to entertaining S.W. listening is the converter.

The writer has experimented with numerous converter circuits—autodyne, separate oscillator, etc.—in an attempt to estimate their relative merits and, perhaps, to establish an ideal. The circuit given below may not be ideal, but it approaches an ideal in so far as it largely reconciles the conflicting claims of "distance" on the one hand and "ease-of-control" on the other.

The circuit was built around a normal 3-gang tuning condenser, with oscillator section, taken from a commercial superhet chassis. The only stipulation in the use of such a condenser is, of course, that it should possess a good slow-motion drive.

With care, the coils can be made accurately enough to render trimming very easy or even unnecessary. This is explained below.

Circuit Considerations

The circuit was intended for use with a mains superhet, hence the supply of H.T. presented no problem. The current drawn is only a few milliamperes and is easily tapped off from a suitable point in the receiver itself. The point chosen must, of course, be adequately decoupled.

It will only be in rare cases that the converter heaters can be fed from the receiver transformer. Therefore, a separate transformer that will supply 2-3 amp at 4 volt is probably necessary. The cost of this item is more than justified in the extra power obtainable from mains valves. The necessary information for the construction of this transformer and also of short-wave coils of various ranges is given in "Wireless Coils, Chokes and Transformers," obtainable from the offices of this paper.

The circuit is fairly straightforward and should present no difficulty provided that components are mounted in such a way that all connections are short and direct.

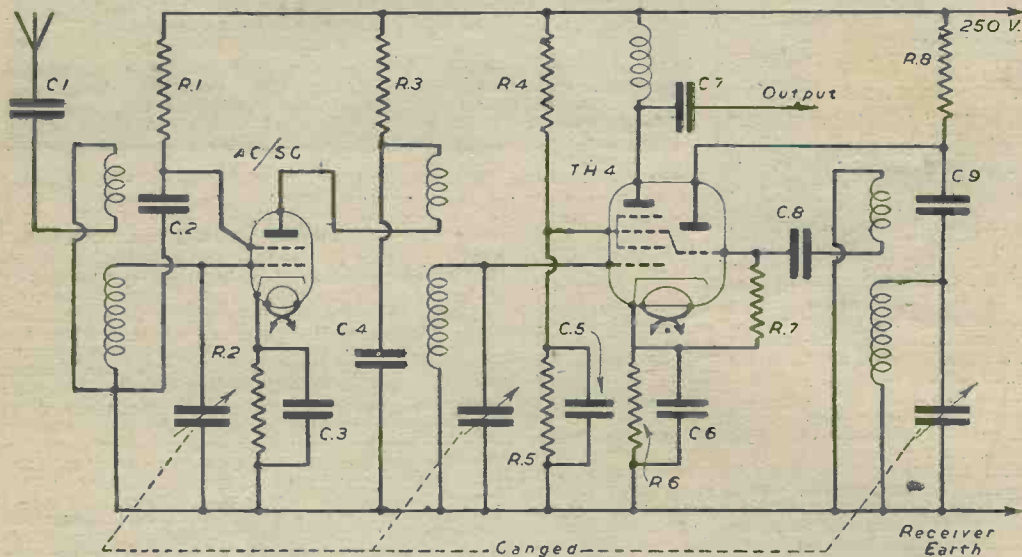

Theoretical circuit of the converter. The illustration on our cover shows the completed unit.

Coil Construction

The three coils were hand-made and, as nearly as possible, identical. Plug-in or multi-range coils can be used, but a view of the range obtainable with the .0005 condensers these were not considered necessary. Furthermore, increased efficiency was obtained by soldering the coils direct to the associated components, without the use of long connecting wires. Note the method of "staggering" the coils, as shown in the photograph (on the cover) to avoid unwanted coupling.

The coils were wound on identical formers, cut from the same $\frac{3}{8}$ in. diameter paxolin tubing. The wire used was 22 s.w.g., enamelled and d.c.c., 10 close-wound turns for the grid winding and six for the aerial winding, giving an approximate range of 17-50 metres.

The somewhat unusual shape of the chassis shown here is due partly to an attempt to reduce all leads to a minimum and partly to enable it to be fitted into a rather restricted space.

Operation

The appearance of the three tuned circuits will, no doubt, suggest tedious trimming; but actually this is far from being the case. When the converter has been connected to the receiver, switch on and tune the receiver to the long-wave band (to, say, 1,800 metres). Rotate converter tuning until a signal is heard. Now move receiver tuning slowly along the long-wave band, keeping the signal in tune by adjusting the converter tuning. A point will thus be reached when the signal is at its

maximum. Repeat at other settings of the converter tuning.

The receiver dial reading will now indicate the I.F. of the converter and the receiver will thenceforth be tuned to that frequency when the short-wave converter is in use. Best results are obtained in the writer's case on an I.F. of 240 kc/s, i.e., on 1,250 metres, but this depends on the actual circuit constants and on the size of the oscillator section of the particular tuning condenser used.

Having arrived at a suitable I.F., the trimmers on the first two sections of the ganged condenser can be adjusted for maximum results on speaker, and the I.F. finally rechecked. If the tuning condenser to be used has not an oscillator section, experiments can be made to determine a suitable size of oscillator coil which will provide an I.F. between 160 kc/s and 250 kc/s, i.e., on the long-wave band. This perhaps most easily done by stripping the coil, say, half a turn at a time and testing it in circuit. But make sure that the oscillator section is functioning and that no autodyning is taking place instead. Difficulties in calibration will indicate this latter fault.

Certain technical friends have expressed disapproval of the tight coupling employed as shown in the photograph of the coils. My argument in favour of it has been based solely on results; the effectiveness is at least capable of demonstration. The connections as shown in the circuit are for coils wound all in the same direction.

Special S.W. Components

It will be noted that, with the exception of the coils, no purely short-wave components have been used. This does not, of course, preclude their use where available. The circuit gives ample scope for interesting experiment. The H.F.C. is a normal "broadcast" component and functions perfectly satisfactorily, although slightly improved results can be obtained with a tuned rejector circuit. But this refinement and its more ambitious brother, the screened-winding output transformer, have been omitted for the sake of simplicity.

No wiring diagram is given, since no special difficulties arise and much depends on the components available. Provided the values given are adhered to reasonably closely, the circuit will provide strong DX signals. Instability and hand-capacity effects are conspicuously absent.

COMPONENT VALUES.

R1: 100,000 ohms.	C1: 0.00005 μ F.
R2: 750 ohms.	C2: 0.1 μ F.
R3: 10,000 ohms.	C3: 0.1 μ F.
R4: 40,000 ohms.	C4: 0.1 μ F.
R5: 20,000 ohms.	C5: 0.1 μ F.
R6: 300 ohms.	C6: 0.1 μ F.
R7: 50,000 ohms.	C7: 0.0002 μ F (mica).
R8: 75,000 ohms.	C8: 0.0001 μ F.
	C9: 0.01 μ F.

G.P.O. Frequency Standard

ONE of the principal applications of the Post Office frequency standard has been to assist the development of stable oscillators. This it has done in two main ways, first by providing a source of stable frequency for comparison with new types of oscillator, and secondly by incorporating the finished designs in the standard and so providing information about their performance over long periods. The most stable oscillators are at present crystal-controlled, and development work accordingly takes two paths, the improvement of the crystals—particularly the methods of mounting them—and the improvement of the temperature control and oscillator circuits. The effects of varying the oscillator circuit or components may usually be determined in a few days. Variations in the technique of crystal production are, however, much more difficult to assess, and it is usually necessary to test the behaviour of batches of crystals over several months.

Other applications of highly stable oscillators, of types similar to those incorporated in the standard, may be illustrated by two examples. The first is the generation of synchronising signals for line carrier systems. The second is the operation of several independent radio transmitters on a common frequency relying on the stability of the separate oscillators instead of on synchronisation to minimise interference.

The Post Office is responsible for ensuring that all transmitters operating in the British Isles observe the internationally agreed frequency tolerances. For this reason a frequency checking station is maintained at Baldock, and the standard in use at Baldock is regularly compared with the primary standard. For those transmitters under direct Post Office control, as well as for some which are not, the standard has been more intimately connected with their frequency control, since the transmitter exciters and the crystals used to control them have, for the most part, been developed and produced in the laboratory associated with the primary standard. The frequency of GBY (66.5 kc/s) is controlled by a $+5^\circ$ X-cut quartz bar mounted *in vacuo* by its soldered connection wires and has remained within the limits $\pm 1 \times 10^{-7}$ without adjustment during a period of 10 months. Experience has, in fact shown that it is now possible to obtain an annual stability of this order at a fixed transmitting station

without the high degree of specialised maintenance available in a standards laboratory. A frequency range of 15–30,000 kc/s can be covered, usually by a crystal frequency of about 50–150 kc/s, using regenerative modulator frequency dividers or harmonic generators as required.

Since September, 1942, the three oscillators operated at primary standards have been used by the Royal Observatory as quartz-crystal clocks. The crystal clocks have been compared with other clocks maintained by the Observatory through the intermediary of the time signal, and have been used to assist the control of the GBR time signal. In some ways the use of a frequency standard for time-keeping purposes (quartz clock) is more exacting than its normal use for frequency measurement. Thus, for a high accuracy of time prediction it is essential that the clocks shall operate for long periods (two years or more) without stoppage. Again, as a frequency standard the frequency of the crystal is the important quantity, but as a clock the total number of cycles of oscillation is important. In consequence, frequency aberrations under fault conditions may be only of temporary importance to a frequency standard, whereas with a clock they have a permanent effect upon the indication, and the magnitude and duration of all such deviations must be known. It has recently been stated that "in so far as the long-period performance of a clock arises from the integrated effects of the short-period erratics, good quartz clocks are very superior in long-period performance to the best clocks of the standard free-pendulum type." (*Proc. I.E.E.*).

A NEW VEST POCKET BOOK

MATHEMATICAL TABLES & FORMULÆ

3/6, or 3/9 by post from

George Newnes, Ltd. (Book Dept.), Tower House,
Southampton Street, Strand, W.C.2.

Designing Your Own Portable—II

Concluding the Article on Portable Design, the Practical Aspects are Dealt with This Month.
By C. BEGG, M.Sc., A.M.I.E.E.

WITH the audio circuit alteration suggested in the first part of this article (Jan. issue), the gain is much better, but probably not yet good enough. Can anything be done about the R.F. side?

Well, R.F. stage gain is given approximately by: R.F. stage gain = (Mutual conductance) × (Effective load impedance in the anode circuit).

The mutual conductance we know of old. Let us look at the anode circuit. The arrangement of Fig. 1 is normal in a tuned radio frequency amplifier of a receiver where the loose coupling with the untuned primary is used to achieve selectivity. In a portable such as this, though, the selectivity is likely to be adequate without adopting this gain-wasting method. For one thing, the overall sensitivity is rather low so there will not be many stations of sufficient volume to cause worry, and then the directive properties of the frame aerial can often be used effectively in eliminating any unwanted signal.

Where:

L is the inductance of the coil in henrys.

C is the tuning capacitance in farads.

R is the R.F. resistance of the coil in ohms.

Now, in order to tune nicely over the whole medium waveband, a variable tuning capacitance having a maximum value of 0.0005 mfd., and a coil with a fixed inductance of about 250 μ H, is found to be suitable, so that L and C in the above formula are decided and we are left with the problem of producing a coil of 250 μ H with as small a resistance R as possible.

Now, this resistance R is the resistance to radio frequency currents and depends not only upon the material and gauge of the wire, but upon the shape of the coil and the type of winding (single layer, spaced or close wound, honeycomb, etc.). The lowest resistance (for a given inductance) is obtained by winding the coil as a single layer solenoid with its diameter about twice its length. In the portable receiver the coil must

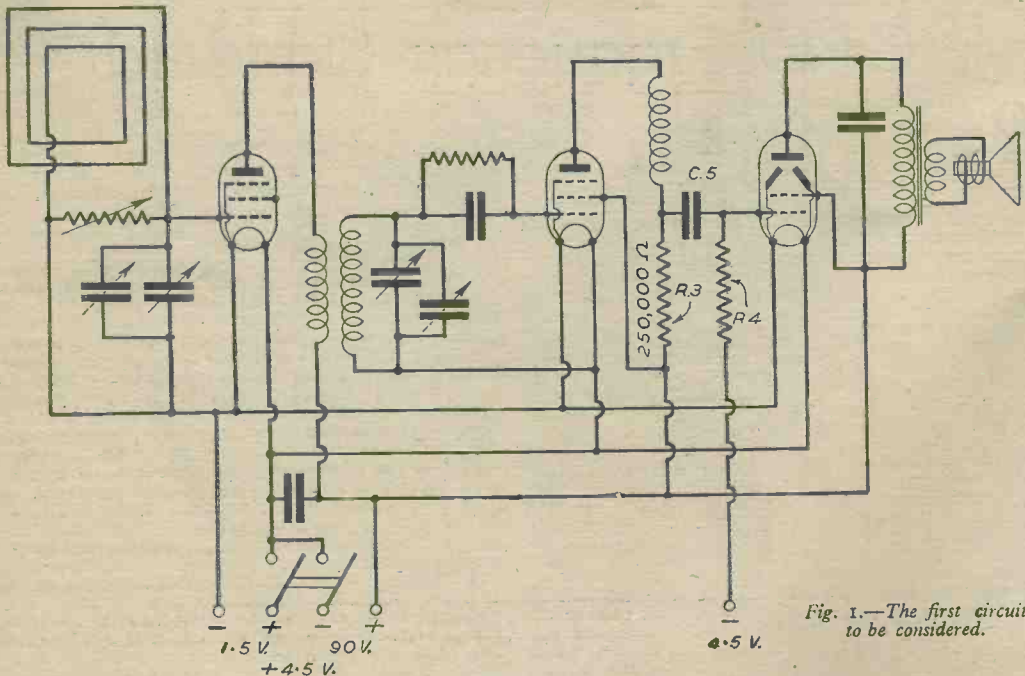

Fig. 1.—The first circuit to be considered.

Let us therefore cut out the transformer coupling and feed the anode directly to a good tuned circuit. This is shown in Fig. 2; C₂ and C₃ are simply blocking condensers to keep the H.T. voltage off the tuning condenser.

Referring back to the formula for R.F. stage gain, what is the effective impedance in the anode circuit? Well, imagine for a moment that C₄ is disconnected, that is, that there is no coupling to the next stage. The anode load impedance is then simply that supplied by the tuned circuit, and this is given by:

$$\text{Tuned circuit impedance} = \frac{L}{R.C} \text{ ohms.}$$

be shielded from the frame aerial which forms the tuning coil for the first valve. Here comes another trouble; the can used for shielding must be at least twice the diameter of the coil or up goes the R.F. resistance of the coil again. Well, with our limited space we obviously cannot have a coil of large diameter surrounded by an even larger can, and a compromise is necessary. I managed to pack a coil of 120 turns close wound on a paxolin former of 1.25in. diameter. I was lucky enough to find some Litz wire (many strands of very fine wire twisted together in a certain way—I used 9/45 gauge) which lowers R still more, but ordinary 36 s.w.g. double silk-covered wire will be almost as good. The shielding

can may be picked up cheaply at almost any radio junk shop. This simple cheap single layer coil in its can will be probably almost twice as good as the small honeycomb wound bought coil costing about 2s. 3d. Unfortunately, though, when we couple our nice high gain coil to the detector by condenser C₄, Fig. 2, it is shunted by the grid-filament impedance of the valve and this, for a

number of turns. A way toward this is to space the turns of the aerial a little; this will allow you to wind on more turns before the required inductance is reached.

Reaction

Sensitivity can still further be increased by the use of properly controlled reaction, but with ganged tuning

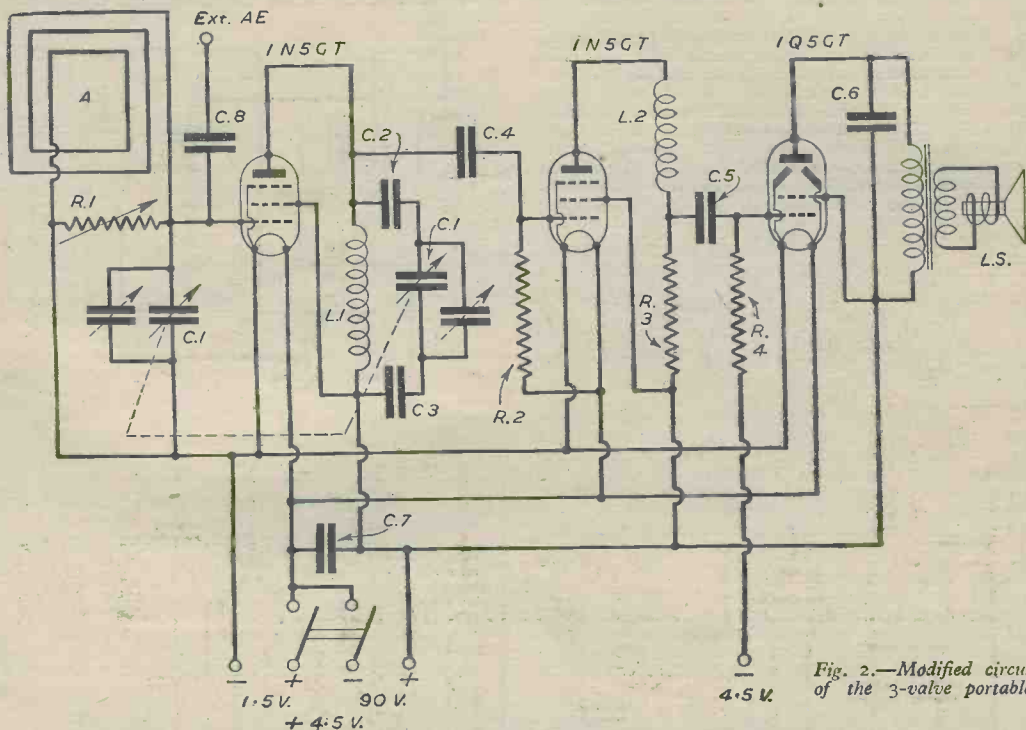

Fig. 2.—Modified circuit of the 3-valve portable.

grid-leak detector, is not a very high impedance, so that the effective load impedance in the anode circuit is not as high as we would like it to be. In fact, making our own coil, although making a noticeable improvement in gain and being cheaper, has not been much better in the end than the small bought coil. An anode bend detector in place of the grid leak one would eliminate the shunting effect and so get the full benefit from the good tuning coil, but due to the poor detecting efficiency of the anode bend detector the overall gain is actually better with the leaky grid arrangement. The final R.F. and detector arrangement, therefore, is as shown in Fig. 2.

In contrast to the A.F. stage, you will notice that since the D.C. resistance of the tuning coil is small, the full H.T. voltage appears on the anode of the R.F. valve and the full allowable voltage may be applied to the screen grid, so that the mutual conductance of the valve is the full value given in the valve data, i.e., about 0.75 micromhos.

The Frame Aerial

There is still one place which is worth looking at if we want the best sensitivity, that is the frame aerial.

This must be of the same inductance as the tuning coil in order that we may use a ganged condenser for tuning. The physical shape and size will be determined by the size and shape of case used so the method will be to wind on more than sufficient turns and then remove them gradually until the ganging is correct. But the voltage delivered by the aerial is directly proportional to the number of turns, so it would be good if we could arrange to get the required inductance by using a large

as used here it is not at its best since altering the amount of reaction affects the tuning and so upsets the ganging. The sensitivity will probably be sufficient without reaction, but it may be tried out if desired. I did not use it.

The method would be to wind about 35 turns close to the H.T. end of the coil (this should be the chassis end of the coil) and connect a small differential reaction condenser across as shown in Fig. 3. If tests show no increase in volume as the reaction knob is rotated, reverse the connections to the reaction coil. If there is still not enough effect, add a few more turns to the reaction coil.

The ganging should be adjusted with the reaction set just short of the oscillation point.

In use the reaction knob should be kept at minimum and used only if some particularly bad reception conditions make it necessary.

Volume Control

The leaky grid detector works well with weak signals, so that a good and simple form of volume control may be obtained by connecting a variable resistance across the aerial.

External Aerial

The receiver is completely self-contained and sufficiently sensitive for normal use, but if an outside aerial is available advantage may be taken of the superior collecting power of this by making connection to the receiver via a small condenser. In Fig. 2, C₈ is this small condenser. This would enable the small receiver to be used in a very out of the way place.

Practical Notes

The most suitable batteries are: One 1½ volt Bell type dry cell, one 90 volt H.T. battery, and one 4.5 or 9 volt grid bias battery.

Alternatively, the Ever Ready "All Dry" battery, which combines H.T. and L.T. in one rectangular block.

Using a 3½ in. permanent magnet moving-coil speaker and the first battery arrangement, my portable measured 14½ in. long, 9½ in. high, and 5½ in. deep. If I had been able to make it about an inch deeper, the length could have been reduced by perhaps 3 in., and this, I believe, would have been about the ideal size and shape.

The aerial, the volume control, and the external aerial condenser C8 with its terminal, were all mounted on the removable back of the receiver.

The only controls are: the tuning condenser (a very simple dial with knob mounted directly on the condenser spindle), the small toggle ON/OFF switch, and (on the back) the volume control.

Adjusting the Aerial and Ganging

To line up the tuning, the trimming condensers should be set about half-way and the aerial wound to rather more than the expected size (my aerial was 15 turns slightly spaced on a rectangle measuring about 10 in. by 8 in.). The Home Service or one of the lower frequency (longer wavelength) stations should then be tuned in and turns gradually removed from the aerial (retuning for maximum volume each time with the tuning condenser) until the best number of aerial turns is found. Now tune to the Light Programme (1,149 kc/s) or some other station near the high frequency end of the dial and alter the trimmers slowly while rocking the tuning condenser gently back and forward through the position for maximum volume. The trimmers should then be left in the position which gives the best result. If you have used reaction, remember to set it to nearly oscillation point before making an adjustment.

Filament Wiring and Grid Return

Notice that filament pin number 7 (marked on the socket) should be the negative one for each valve, and that the grid return of the first and last valves should be taken to the negative filament, but that the detector grid leak should be taken to the positive end of the filament.

Operating Hint

The frame aerial does not receive equally well from all directions, and when a station is tuned in you will

find it possible to rotate the receiver until the volume reaches a minimum. This point of minimum signal strength is much sharper than the point of maximum signal strength (maximum and minimum positions are at right angles to each other) so that it is often possible to cut out an interfering station which lies in a different direction from the wanted station by turning the receiver round until the interfering signal is a minimum.

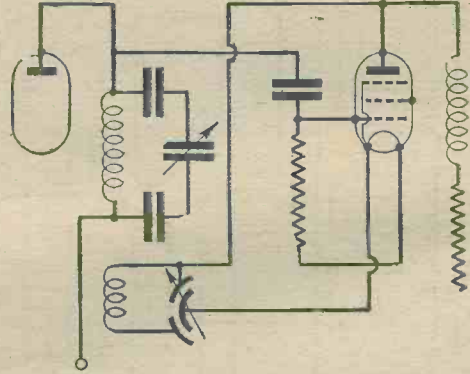

Fig. 3.—The coupling arrangement found to be ideal.

LIST OF COMPONENTS

A:	Frame aerial.		
L1:	Medium wave tuning coil approximately 250 μ H.		
L2:	Medium wave R.F. choke.		
R1:	50,000 ohms variable.		
R2:	3 megohms.		
R3:	50,000 ohms.		
R4:	1 megohm.		
C1:	0.0005 mfd. tuning condenser with trimmers.		
C2, C3:	0.01 mfd.	"	"
C4:	0.0001 mfd.	"	"
C5:	0.01 mfd.	"	"
C6:	0.02 mfd.	"	"
C7:	0.5 mfd.	"	"
C8:	0.0001 mfd.	"	"

Beam Approach Beacons (BABS)

EIGHT-TON Hamilcar gliders of the type which carried tanks and Bren guns to Normandy, Arnhem and the Rhine during the war are being put to their first peacetime use, towed by Halifaxes of R.A.F. Transport Command, carrying "Babs" Radar vans to France. The vans are being installed at three airfields: Istres (near Marseilles), Bordeaux, and Rennes, by arrangement with the French Government. Istres is the first stop on the trunk troping route to India and the Far East, but all three airfields can be used for landings if weather or engine trouble prevent troping aircraft from going on to the U.K. Each airfield will have two "Babs" radar vans, so that one will always be available in an emergency.

"Babs"—or beam approach beacon system—is a blind-landing device which enables aircraft to land when visibility is as low as 85 yards. Eight troping terminals used by Transport Command in this country have already been equipped with "Babs" and fourteen others are having the system installed.

In the aircraft the "Babs" counterpart, known as

"Rebecca," consists of a control box with press-studs for changing frequencies, a compact transmitter-receiver and an indicator unit incorporating a cathode ray tube. By watching the tube, which is graduated in miles, the navigator knows how far the aircraft is from the runway on the way down, and can keep on the beam leading him in to land. The "Babs" van on the ground can be driven to whichever runway is in use, and from which the beam is to be transmitted.

The whole installation costs about £1,500, compared with £7,000 to £8,000 for the old standard beam approach Lorenz installation, which was the R.A.F.'s standby during the war.

"Babs" is easy to operate. The pilot knows his position in relation to the beam all round the landing

TWO USEFUL BOOKS FOR STUDENTS

By F. J. CAMM

REFRESHER COURSE IN MATHEMATICS

8/6, by post 9/-

THE SLIDE RULE MANUAL

5/-, by post 5/6

From GEORGE NEWNES, LTD., Tower House,
Southampton Street, Strand, W.C.2

circuit and his range to within 250 yards. Any "Rebecca" set—a radar homing device now almost a standard fitting in most Transport Command aircraft—can be used for "Babs" purposes, while the H2S set—a device used by Pathfinder to locate their bombing targets—can be adapted for "Babs."

S.W. Reaction Circuits

Some of the Important Details of S.W. Receiver Design Explained by F. G. RAYER

THE obtaining of smooth and adequate reaction in a S.W. receiver is very necessary, and it is a matter in which the constructor sometimes experiences difficulty. A receiver with ploppy, insufficient or too-violent reaction is useless for DX reception, and is nothing but a source of irritation to the user. Because of this, it is proposed to consider reaction in all its aspects and show how a smooth control can be obtained.

must be remembered that the anode resistor will cause a voltage drop. Too high a voltage will cause the reaction control to be too sudden in action for delicate adjustment.

Another cause of ploppy reaction is unsuitable values of grid leak and grid condenser. Values shown are average for a normal H.L. type of detector. If the set is to operate upon wavelengths below 12 metres, the

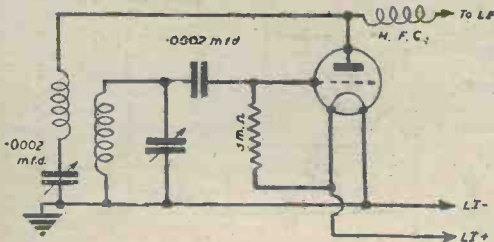

Fig. 1.—The simplest reaction arrangement.

The simplest circuit is shown in Fig. 1. Although this is quite straightforward, several points may cause trouble. Assuming that the coils are commercially-made (faults in home-made coils will be mentioned later), the most likely cause of trouble is in the H.F.C. If this component does not function efficiently over the

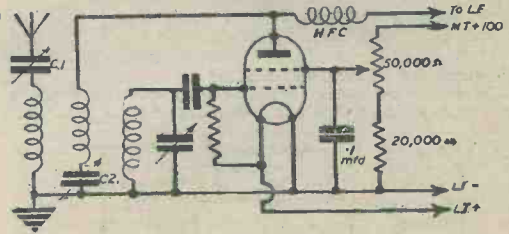

Fig. 2.—Reaction in this circuit is controlled by a potentiometer.

whole tuning range, it will not be possible to obtain proper reaction. If there is any doubt, it can be experimentally replaced by a resistor of about 5,000 to 10,000 ohms. If the reaction fault then disappears,

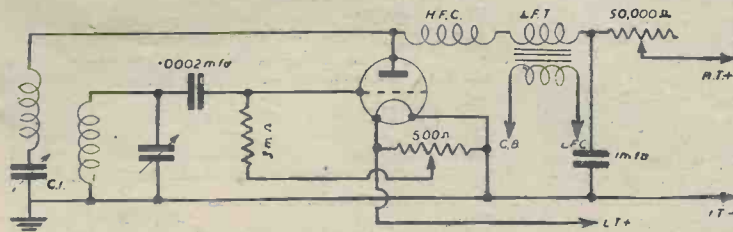

Fig. 3.—Smoothness of reaction can be ensured by means of the potentiometer across the filament.

when adjusting reaction, and the reaction potentiometer may be in any convenient position on the panel as its purpose is only to control the S.G. voltage.

condenser may be decreased to .0001 mfd. and the leak increased to 5 megohms.

In Fig. 1 the reaction condenser is shown at the earthed end of the reaction coil, and this method should always be used, unless the reaction condenser is fitted with an insulated extension spindle. If not, removing the hand from the control knob will cause the receiver to go into oscillation. The value of .0002 mfd. is usual and very seldom requires modifying.

Voltage-controlled Reaction

This method is especially suitable for a S.G. or pentode detector, as shown in Fig. 2. It does not of itself give more gain, but has three advantages. The reaction condenser is replaced by a pre-set, and this often allows a better layout, especially in U.S.W. apparatus. The tuned circuit is not affected in any way

In use, the condenser C2 is adjusted until operating the 50,000 ohm potentiometer permits adequate reaction to be obtained throughout the tuning range. In some cases this condenser may be replaced by a fixed one of

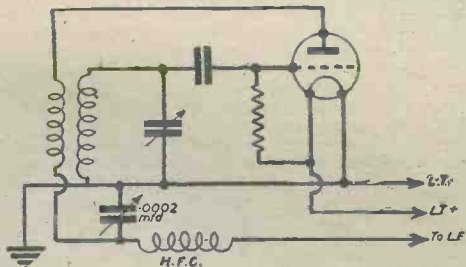

Fig. 4.—This arrangement is known as "throttle-controlled reaction."

the choke was not suitable, and should be replaced by a better one.

The anode voltage is also important. Generally about .60 volts is best, and if R.C. coupling is used it

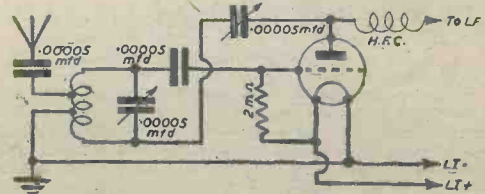

Fig. 5.—For U.S.W. reception this reaction scheme has much to recommend it.

about .0001 mfd. A good-quality potentiometer is required, and the H.T. minus line of the receiver will have to be switched off when the set is not in use, to avoid unnecessary H.T. drain.

The H.T. 100 volts connection is approximately correct if the valve is choke or transformer coupled to the L.F. stage. If R.C. coupling is used, this connection should be taken to approximately 60 volts positive instead.

Attention must be drawn to the aerial condenser Cr, which affects all receivers not fitted with H.F. stages. If the aerial is at all long and this condenser is set at too high a value, the damping will prevent reaction, especially upon the H.F. end of the bands tuned. .0001 mfd. maximum is generally suitable, but if the aerial is not a special S.W. one .00005 mfd. may be used with advantage.

The smooth potentiometer control of reaction may be obtained on a triode valve as shown in Fig. 3. In this case the anode voltage is controlled through the potentiometer (connected as a variable resistor). In this circuit the 1 mfd. condenser must not be omitted.

Here again, as in Fig. 2, the reaction condenser may be connected to the anode end of the reaction coil, as it will be a pre-set and not require touching when operating. In some cases this permits of a better layout, as both

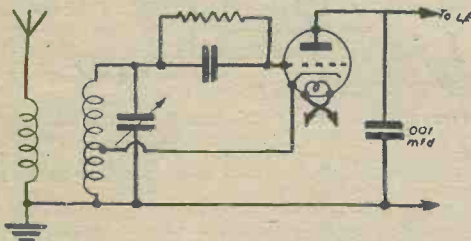

Fig. 6.—With mains valves, this cathode-tap arrangement will be found very effective.

grid and reaction coils may be one winding, tapped at a suitable point for earth.

A potentiometer across the L.T. supply is also shown in Fig. 3. This alters the grid voltage via the leak and considerably influences reaction. Making the grid more negative by turning the slider towards L.T. minus smooths reaction, but makes the detector less sensitive. The potentiometer is a baseboard pre-set type.

Throttle Control

A reaction circuit sometimes distinguished by the name "throttle control" is shown in Fig. 4. It will be found that the main advantage of this is experienced at the higher frequencies. In this case, any stray H.F. by-passing effect (such as by stray capacity in the H.F.C. or wiring) does not damp reaction, but actually increases it because the connection is taken through the reaction coil. It does tend to produce easy reaction, because the anode lead is connected to the reaction winding only. If the H.F.C. has inefficient frequency peaks reaction will be more fierce upon these—just the reverse of the case when the choke is connected in the usual manner.

This method of reaction may be used in conjunction with any of the circuits so far discussed.

U.S.W. Circuits

A circuit particularly suitable for U.S.W. reception is shown in Fig. 5. The coil is in one winding, centretapped for the earth connection. For 5-7 metre reception 5 turns of 18 S.W.G. wire wound five-eighths of an inch in diameter, and with each turn spaced by the thickness of the wire, is suitable. The aerial tap should be about $\frac{1}{4}$ turn from the centre tap.

A very compact layout can be obtained, and in construction about the only point to bear in mind is that the tuning condenser must be insulated from the chassis, and upon an insulated extension spindle. All connections must be short, and a valve such as the Osram HL2 used.

The H.F.C. must be of the ultra-short-wave type. Incidentally, this circuit lends itself very well to voltage-controlled reaction, with a consequent improvement in the layout.

It may also be used in S.W. receivers, but is not generally worth while because of the inconvenience of having to insulate the tuning condenser spindle from earth.

Cathode-tap Circuits

Fig. 6 shows a popular and efficient circuit for mains valves. Instead of having the grid and anode at H.F. potentials, and the cathode earthed, the anode is earthed (so far as H.F. is concerned by the .001 mfd. condenser) and the cathode tapped up the tuning coil. This circuit is useful for both S.W. and U.S.W. reception within certain limits. It is a ready oscillator, and the absence of H.F. circuits connected to the anode of the valve has obvious advantages.

In Fig. 7 the battery circuit is shown, but this is not so simple. The results obtained depend upon the filament choke Ch. This must be efficient over the tuning range, but of a low enough resistance to permit

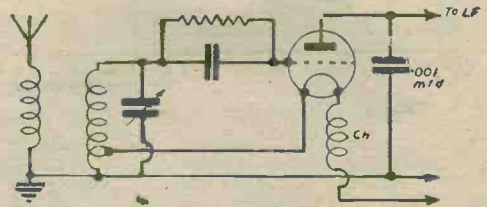

Fig. 7.—A similar scheme to that of Fig. 6, but for use with battery-operated valves.

the filament current to pass. An ordinary H.F.C. is useless here, and one of the special chokes must be used.

In both these circuits reaction may conveniently be controlled by means of a potentiometer, connected after the L.F. coupling as in Fig. 3. As an alternative, a S.G. valve, as shown in Fig. 2, may be used for screen control. Under these conditions, both the circuits in Fig. 6 or 7 will oscillate upon all the normal S.W. and U.S.W. bands.

Coil Faults

This subject cannot be finished without mention of reaction faults caused by bad coil design. This is not a likely cause of trouble, of course, except in homemade coils. Although it is possible to wind coils as efficient as ready-made ones, a beginner is recommended to work from published data, or he may not be able to decide if the fault lies in the coils or circuit.

Generally, more turns upon reaction winding than grid should never be used in an attempt to obtain oscillation, for if the natural frequency of the reaction winding comes within the tuning range very peculiar results will arise. About two-thirds as many reaction turns as there are grid turns is usual.

The degree of coupling is also important. Very tight coupling will not only cause fierce reaction, but the reaction control will also affect tuning. Because of this the reaction winding could be at the earthed end of the grid coil.

Too-tight aerial coupling will also cause reaction trouble, and inter-wound windings are especially troublesome. An aerial winding of about one-third the grid winding, about $\frac{1}{4}$ in. from the grid winding, is usually quite suitable. If necessary, coupling may be reduced by including a small pre-set in the aerial lead.

If reaction is lacking, and the other parts of the circuit are found to be in order, then the reaction winding should be moved closer to the grid winding, or the turns increased.



ON YOUR WAVELENGTH

By THERMION

Radar or Radiolocation?

SIR EDWARD APPLETON, speaking to the Physical Society recently on the subject of Radar, said: "I see that this lecture has been announced as being on Radar, but I imagine that every one of you will know that Radar is the same thing as radiolocation—a term I, myself, prefer, because it is almost self-explanatory and also because it is British." I would add that I prefer the word radiolocation, too. The word Radar is of American origin and I think we should set some limit to the extent to which we adulterate the English language. Surely we have no need to go to America for our technical terms. It is likely to give the impression in a few years' time that the Americans invented radiolocation, when it was invented and developed over here and presented to the Americans during the war by the British Government.

As a race we are prone to borrow words from other languages. The motor-car industry is full of them—automobile, garage, chassis, are good examples, whilst the aircraft industry reeks of foreign words—fuselage, cabane, volplane, and so on. It really is too bad, however, when the country which is the birthplace of the language has to go to another English-speaking nation for its terms. I do not like the word Radar for other reasons. It sounds slangish, it is non-descriptive, it is ugly sounding, it seems incomplete, and it is not euphonious. I am glad that Sir Edward Appleton has drawn attention to it. Perhaps the B.B.C. will take the hint and, in future, refer to radiolocation. It has been most concerned in the past to see that English is correctly pronounced over the air and funnily enough it appointed a committee, largely composed of Welshmen and Scotsmen, to teach us how to pronounce English. Americanese is not English.

Barbara Ward Again!

THE B.B.C. has allowed Miss Barbara Ward to express her views on the atomic bomb over the air to millions of people. You will remember that some time ago I criticised this lady for expressing her views on another matter. Since then I have somewhat forcibly expressed my views in person to representatives of the B.B.C. on the question of the fantastic Brains Trust programmes, which are anything but Brains Trusts. I do not know why the B.B.C. should presume that the views of Miss Barbara Ward on the atomic bomb are of any greater value than those of the man-in-the-street. It is true, as "Truth" says, that Miss Barbara Ward "once spoke in a tentative fashion, as though aware of the vastness of her audience and of her own human limitations. At a recent gathering of the so-called Brains Trust, however, Miss Ward threw aside her intellectual modesty and harangued the listening world on atomic energy with a dogmatic assurance which took no account of the gigantic issues involved. Her first demand was that the secret of the bomb should be shared—not with her native England, but with Russia. If the United States refused, then Britain should place her own knowledge of atomic energy with Russia—no doubt as a reward for the latter's alliance with our enemies against Poland in the first years of the war, and to mark our appreciation of her subsequent annexation of all Eastern Europe. That Britain having been sold down the Mississippi ought to think twice about being sold down the Volga, is a sordid consideration which apparently finds no place in Miss Ward's blithe philosophy. Then came her second demand. It was that a world government should be formed to control the atom. She did not tell us where such a government would sit, where it

would manufacture its bombs, of whom it would be composed, and whose secret interests it would serve. The name, 'world government' was doubtless sufficient for Miss Ward who thus escaped the pain of having to sit down and think what she really meant." I do seriously suggest to the B.B.C. that the Brains Trust should not be used for the dissemination of political or dangerous views by those not qualified to express opinions. The future of atomic energy is a matter for governments, but allowing Barbara Ward, Bertrand Russell and others to express these opinions is not only embarrassing to the respective governments, but it is offensive to scientists, who know far more about the atom bomb than any member of the Brains Trust ever will. I for one do not care two figs for the opinions of these persons, or Professor Joad, or Aldous Huxley, or any of the others who so freely express views on topics quite outside their knowledge and experience.

Tame!

I HAVE received a copy of Hugo Gernsback's annual Christmas card. For many years past these cards have taken the form of miniature magazines, burlesquing the style of well-known American magazines. This season "Time" magazine was selected, but Mr. Gernsback departed from his former humorous style and turned deadly serious. The occasion is, of course, the atomic age, hence this issue of "Tame" carries the dateline of Xmas 2045, one hundred years of Atomic Age. In this amusing journal, which can be taken seriously, will be found a number of unique predictions, including odour music, atomic batteries from plutonium, an individual atomic reaction engine which straps to the back, details of world war three, radiofluoritate lamps, telepathy via radio, televue teaching, perpetual watches atomic driven, and a machine operated by the mind! Gernsback has certainly let himself go this year.

COMPARISONS ARE ODIOUS

THE Columbia Broadcasting System, which caters for 120,000,000 listeners, employs a staff of 874 persons.

The B.B.C. employs 11,303.

Columbia Broadcasting System pays up to £200 for plays for broadcasting. The B.B.C. average £10 10s.

Columbia Broadcasting System pays artists up to £1,000 per broadcast.

On what a truly regal scale Is B.B.C. recruited.

And yet, in spite of this huge staff, Listeners are not well suited.

Eleven thousand salary list,

Yet programmes growing worse,

Enough to make most patient listeners

Tear their hair and curse.

May, they suggest, this bloated staff

Be drastically cut down.

Because on building "dug-in caves"

They definitely frown.

They wish to see their money spent

In ways which they prefer.

Administration costs well clipped,

Star artists on the air.

For this main object every year

They pay their money over,

And not by any means to keep

Redundant Staffs In Clover.

"TORCH."

An Electron-coupled S.W. Receiver

A Three-valve Set of Novel Design, Utilising Home-made Coils and Other Components.
By G. ELLIOTT, B.Sc., A.R.I.C.

ON reviewing all the literature to hand on the subject of the theory and practical construction of the "straight" type of S.W. receiver, the author was impressed by the following points on features of design:

- (1) The electron-coupled reaction circuit is very rarely recommended in published designs for S.W. receivers, and to the author's knowledge is not often used by constructors. The conventional reaction circuit is invariably given, in which the R.F. energy is taken from the anode, through a coil coupled with the grid coil, to earth via a variable capacitor, which serves to control the reaction.
- (2) The use of R.F. tetrodes or pentodes as detectors, while more popular in recent years, is still not so common as the use of the conventional triode.
- (3) Whatever type of detector valve is used, the reaction circuit usually involves capacity control, as described above, and, less frequently, voltage control, using a variable resistor connected to one of the valve electrodes.
- (4) In the literature available there are no references to practical circuits for regenerative R.F. stages in straight receivers.
- (5) Single-control tuning, using precision-type low-

geared tuning dials, is much less recommended than bandspread tuning, using two variable capacitors.

All the above features have been found to offer great advantages over the conventional types of construction, and are in use in the S.W. equipment used by the author. It is proposed in this article to discuss these unusual constructional aspects from a practical point of view, with relation to the S.W. receiver and preselector in use. The special features of the equipment are, therefore:

- (1) Electron-coupled regeneration in detector circuit.
- (2) R.F. tetrode detector.
- (3) Voltage-controlled regeneration, using potentiometers.
- (4) Regenerative R.F. stages, with electron-coupled circuit.
- (5) Single-control tuning, with precision-type dial.

The Receiver Section

We will discuss the receiver unit first. This is a 1-v-1 circuit, and the theoretical diagram is given in Fig. 1. The aerial system is coupled to the first tuned circuit by inductive coupling, and provision is made for both end-on and dipole antenna—when the end-on

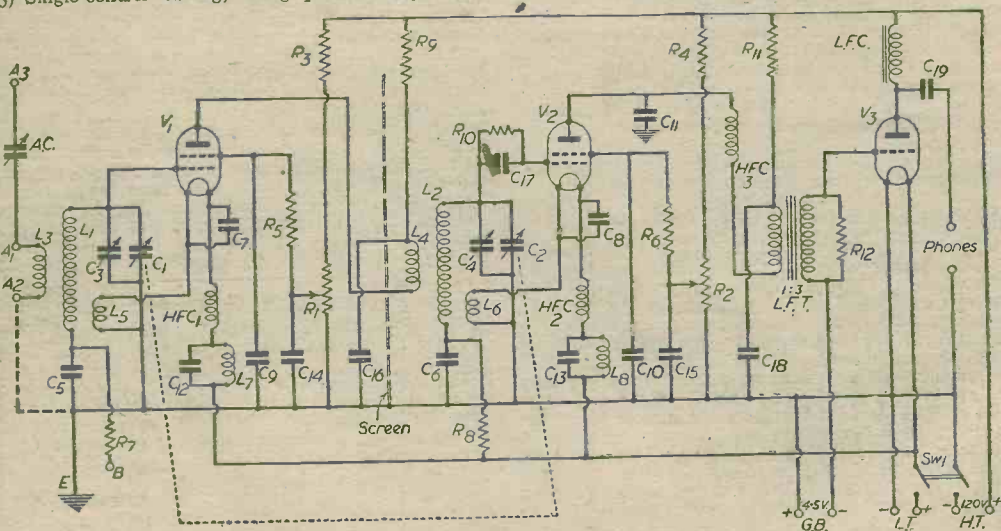

Fig. 1.—Theoretical circuit of the 3-valve short-wave receiver.

VALUES OF COMPONENTS

C ₁ , C ₂	— 160 pf. ganged.
C ₃	— 15 pf.
AC, C ₄	— 60 pf. max. air-trimmer.
C ₅ , C ₆	— 0.005 mf. mica.
C ₇ , C ₈ , C ₁₁	— 0.001 mf. mica.
C ₉ , C ₁₀	— 0.01 mf. mica.
C ₁₂ , C ₁₃	— 0.005 mf.
C ₁₄	— 0.1 mf.
C ₁₅	— 0.5 mf.
C ₁₆	— 0.002 mf. mica.
C ₁₇	— 100 pf. mica.
C ₁₈ , C ₁₉	— 2 mf.

R ₁ , R ₂	— 100KΩ potentiometers.
R ₃ , R ₄	— 30KΩ
R ₅ , R ₆	— 5KΩ
R ₇ , R ₈	— 0.5MΩ
R ₉ , R ₁₁	— 10KΩ
R ₁₀	— 5MΩ
R ₁₂	— 1MΩ
V ₁	— 1A4.
V ₂	— 1B4.
V ₃	— LP2.

very similar to the R.F. stage. C₄ is a preset air-trimmer for lining up the two tuned circuits and is of 50 p.f. The grid leak R₁₀, of 5MΩ, is connected across the grid capacitor C₁₇, instead of one end being taken to L.T.—, but the decoupling resistor R₈ is connected to L.T. + to produce the same potential across R₁₀. This arrangement is employed mainly to assist in

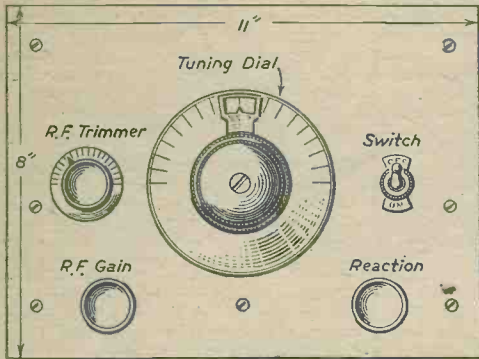

Fig. 3.—Details of the Panel Layout.

exactly balancing the two tuned circuits. The R.F. choke in the anode circuit of the detector (HFC₃) is of the high-inductance type, and R.F. currents are bypassed to earth via C₁₁, of 0.001 mf. C₁₅, across the potentiometer control, is larger than the corresponding capacitor in the R.F. stage to ensure noiseless operation of the reaction control and has a capacity of 0.5 mf.

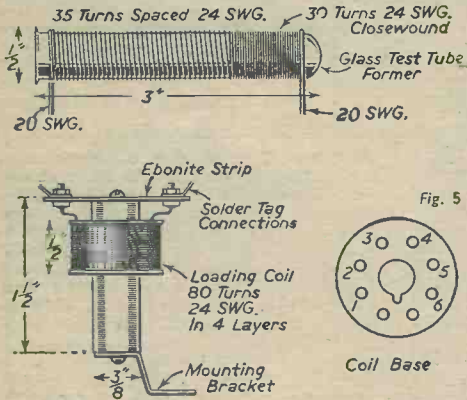

Fig. 4 (above) and Fig. 5 (right).—Constructional details of the chokes and coil base connections.

The L.F. Circuit.

Directly fed transformer coupling to the L.F. stage ensures a high voltage on the detector anode, giving efficient regeneration and good L.F. amplification. R₁₁ and C₁₈ form the decoupling for the detector anode circuit. The detector valve is a 1B₄, a short grid-base R.F. tetrode, which is highly suitable for detector circuits.

R₁₂ across the transformer secondary has a value of 1MΩ, and is used to prevent any tendency towards threshold howl on the higher frequency ranges, due to stray R.F. currents. A small power valve of the LP₂ type is used in the output stage for 'phone reception, and should have a fairly high slope, such as 3 mA/volt or more, to give good L.F. gain. The power output is not important for 'phone reception and need only be low. Choke-capacity output is employed to minimise any tendency for hand-capacity effects, by keeping the

'phones at earth potential. A double-pole switch is required for the receiver, as current flows from the H.T. supply through the potentiometer network.

The main points of the theoretical circuit have now been covered, and it remains to discuss some of the practical details. It is not proposed to describe the complete practical construction of the receiver unit, as most S.W. experimenters have their own ideas on construction and wiring, but the more unusual practical points will be covered. The general layout of the receiver is shown in Figs. 2 and 3, only the main components being shown. Metal chassis and panel construction was employed, but there is no objection to using a wooden chassis, provided it is lined with some screening material. A metal panel should be used, if possible, as apart from improving appearances it forms an efficient earthed screen between the operator and the receiver wiring, and so eliminates hand-capacity effects. The screen between the R.F. and detector stages is essential for stable operation, and is extended below the chassis as well as above, although the complete screening of each stage is not necessary. The screens should extend to the same height as the front panel, both above and below the chassis.

Construction and Wiring

With regard to the wiring, all wires which have to pass through the metal chassis and which carry R.F. currents can be of 18 or 16 s.w.g., when they will be self-supporting and rigid, and no insulating sleeving is required. By drilling a large diameter hole for the passage of the wire, there will be an air gap between it and the earthed chassis, ensuring low dielectric losses. This applies particularly to wires leading to the R.F. coil-holder, which is mounted above the chassis on pillars. The use of valves with top-caps connected to grids enables short connections to be made from the grids to the tuned circuits. No screened wiring, which usually reduces efficiency, was found necessary.

The insulation requirements for capacitors, valve-holders and coil-holders are usually a matter of some dispute in short-wave receivers. In the receiver described, only the variable and semi-variable capacitors (C₁, C₂, C₃, C₄, AC) have ceramic insulation. The valve-holders are of paxolin and the coil-holders and coil-formers are of high-grade bakelite. Ceramic materials can be used throughout if desired, but it is doubtful if any noticeable improvement would result. The coil-holders, which are of the octal type, should preferably be of the "Amphenol" variety, which is much more rigid than the corresponding paxolin variety. The fixed capacitors should be the mica dielectric type where indicated in the list of component values, on p. 144. All resistors are ½ watt.

The tuning capacitors should preferably have the specially shaped vanes, which give a smaller capacity variation for a given movement of the dial at the minimum capacity end than at the maximum capacity end of the dial. This gives a fairly open frequency

TABLE OF COIL WINDINGS

Coil No.	Range (approx.) metres	Grid coils (1-6)	Coupling coils (4-5)	Reaction coils (2-3)		
				Det. Stage	R.F. Stage	Pre-selector stage
1	9-19m.	2½	2	1	½	½
2	11-25m.	3½	3	1	½	½
3	18-43m.	8½	4	1	½	½
4	38-85m.	23½	Pre-selector 4 9	2	1	1
5	75-172m.	34½	14	10	10	8

scale. Using the simple semi-circular type vanes, the frequency range is compressed at the high-frequency end of the dial, and extended at the low-frequency end. Capacitors are rigidly ganged together, using an extension spindle and a shaft-coupler, and care is required in the setting of the mounting bracket for C₂, in order to place it exactly in line with Cr. A flexible coupler is not recommended here to help with the alignment problem, as it may result in tuning back-lash. The detector tuning capacitor C₂ is mounted close to the coil and valve to ensure short wiring. By fixing C₂ in a sideways position, use can be made of two solder tags from the fixed vanes, and the wiring to both the coil and the topcap of V₂ is shortened. The wire from C₂ to the top of the grid coil socket is only about $\frac{1}{2}$ in. length, and this results in a low minimum wavelength for a given coil and is especially useful on the highest frequency range.

The tuning dial employed is a large $\frac{1}{2}$ in. type with direct and 80:1 slow-motion drive. This has a dial calibrated 0-180 deg., and with the hair-line cursor it is possible to read $\frac{1}{10}$ deg. A vernier dial would be an extra refinement, but is not essential.

The intervalve transformer is a direct feed type, but need not be of heavy construction as the anode current of the detector valve is quite small. The low-frequency choke also need only be of small construction.

Making the Coils and Chokes

The filament chokes and loading coils are home-made, no suitable commercial articles being available. These are shown in Fig. 4. The choke is wound on a $\frac{1}{2}$ in. \times $\frac{3}{16}$ in. test tube and consists of a total of 65 turns of 24 s.w.g. enamelled copper wire, of which 30 are close wound and 35 are wound with spacing about equal to the diameter of the wire, as shown in Fig. 4. The wire ends are made from 20 s.w.g. tinned-copper wire—two turns are wrapped tightly around the test tube and solder is run on to them. On cooling, the wire is tightly fixed to the tube, and the ends of the coil can be soldered directly to it. This is similar to the method used in the manufacture of wire-end resistors. In order to fix the windings permanently, the choke can be painted with an insulating varnish or dipped in a hard-setting electrical wax. The space-wound section of the choke gives improved performance on the higher frequency ranges covered by the receiver.

The loading coil is wound on a piece of wooden dowel, $\frac{1}{2}$ in. \times $\frac{1}{16}$ in. A terminal strip is screwed into one end, and a mounting bracket into the other. The winding is about $\frac{1}{2}$ in. in length and consists of four layers of 24 s.w.g. enamelled copper wire each containing 20 turns. The ends of the winding are brought out to solder tags on the terminal strip, and insulation tape is wrapped around the winding when complete. The coil is finished by dipping in molten wax. In the receiver, the loading coils are mounted in convenient positions and the filament chokes are suspended between them and the respective valve-holders. The valves used take 0.06 A. filament current, and with this current the voltage drop in the loading coil and choke is negligible.

Modifying the Coils

The tuning coils used are commercial products with octal bases, but slight modifications of the windings are required. Details of the windings are given on p. 146. The wavelength ranges given are those obtained on the author's receiver and not those quoted by the manufacturers. It is to be noted that due to the very short wiring in the receiver, the minimum wavelengths obtained on each coil are lower than those usually quoted for the coils, in spite of the fact that the trimmer C₄ raises the minimum tuning capacity. The effect is also partly due to the removal of some of the turns of the winding inter-wound with the grid coil. The figures for the coils used in the preselector are also given in the table—the preselector is described in detail later. No alterations are made to the grid or coupling coils with the exception of coil No. 4 in which the coupling coil is

reduced. It is observed that in commercial coils all types similar to No. 4 have a much higher efficiency and a correspondingly lower selectivity than any of the other coils in the range. Accordingly, the coupling coil has been reduced in size to produce the right balance between selectivity and sensitivity comparable with the other coils. The numbers in the table refer to the base connections, shown in Fig. 5. It can be seen from the small reaction windings in the detector stage how efficient is the electron-coupled regeneration circuit. The values of all reaction windings have been found experimentally and are arranged to give the best combination of efficient reaction control and good L.F. amplification in the detector stage. Regeneration will occur with between $\frac{2}{3}$ and $\frac{3}{4}$ of a turn of the potentiometer R₂.

Care should be taken to wire the various coils in the correct "sense," as shown in the theoretical diagram, Fig. 1. In the case of the reaction coils, the bottom (earthed) end of the winding is connected to pin No. 2 and the wire is wound in the same direction as the other coils, finishing at pin No. 3, which is connected to the valve filament. Connections to the coupling coil from the R.F. stage should be anode of V₁ to pin No. 4, which is the bottom of the winding. (Diagrams are frequently shown with the anode connected to the top of the coupling winding, which is not correct.)

Operation

To provide for the use of various antenna systems, provision should be made for shorting the aerial capacitor AC with a crocodile clip, to give direct connection of the aerial to L₃ if required, and also for connecting the other end of the coil to earth when an end-on type antenna is used. The trimmer C₄ should be adjusted so that on all coils it is possible to bring the R.F. stage into resonance with the detector stage by adjustment of C₃ on the front panel. The R.F. gain control should be given about a two-thirds turn and C₃ rotated. When a slight peak occurs in the reaction strength, the R.F. stage is in resonance. The position where a dip in reaction strength occurs is not usually the resonant point except where there is heavy damping on the R.F. stage, such as when the antenna is connected directly to L₃ on the longer wave-ranges, to give improved signal strength. Usually the antenna should be connected via AC on coils 1, 2 and 3, to avoid heavy damping of the R.F. stage (except when a dipole antenna is used). On coils 4 and 5 good selectivity is obtained with AC in circuit. When AC is shorted with a clip much higher sensitivity, but reduced selectivity, is obtained, and so the connection must be adjusted to suit varying conditions. An important point to note is that while the adjustment of the antenna connection makes a slight alteration to the R.F. trimmer reading, it makes no difference to the calibration of the tuning dial.

In case the term "regenerative R.F. stage" conveys any misleading impressions, it is pointed out that the stage is not fully regenerative in the same way as the detector stage. It is not possible to increase regeneration to the verge of oscillation, as instability sets in before this point is reached, and one has to be content with a limited amount of regeneration. On no account should the R.F. gain control be increased to a point where an unduly large increase in reaction strength occurs in the detector stage. The best position of the control will be found by experiment. With regard to the setting of the R.F. trimmer control, it will be found that this remains fairly constant over the range of any particular coil, especially if care is taken in adjusting the preliminary gauging of the two tuning capacitors. For any one waveband the control, when once adjusted, will not require to be touched when tuning over the band.

(To be continued)

AN IMPORTANT NEW WORK
NEWNES ENGINEER'S REFERENCE BOOK

Edited by F. J. Camm

1,326 pages; Two Guineas, or 43/- by post.

Vibrators for Car Radio

An Explanation of Their Function and Use.

By E. G. BULLEY

THERE are many types of car receivers already in use, and there will later be more advanced models which incorporate all the new ideas developed during the war period. The construction of a vibrator varies, consequent largely upon patent rights, but the basic principle is the same. They are assembled on well-designed jigs by well-trained personnel, and their assembly is a precision job.

A vibrator consists of two or more contacts which are mounted and correctly spaced either side of a spring steel reed. This reed has to vibrate between the contacts, and it is essential that they shall be made from an extremely hard material of good conductivity, i.e., tungsten, or they would not stand up to the operation of making and breaking at a great number of times per second.

The reed is vibrated by means of a magnetic field which is set up when the specified voltage is fed into a magnetic coil. This coil is usually mounted in a steel frame and is supported above the contacts and the reed, the core projecting slightly so as to influence the reed.

MC, Y automatically makes contact with one of the vibrator contacts, namely Z. Because of this, a current will flow through load A. Now, as Y is in direct contact with Z, this short-circuits the magnet coil which becomes de-energised, resulting in E being released from MC. Carried by its own inertia, Y now makes contact with X, and current flows through load B and not through A. Now, as the current is flowing through load B, the magnet coil becomes energised again resulting in E being attracted back again to MC, and contacts Y and Z come together again. This phenomena will be repeated so long as the battery switch remains closed, and thus an alternating effect is produced.

Let us assume, therefore, that the vibrator interrupts at a frequency of 10 times per second and that we have two suitable loads connected to the vibrator as shown in Fig. 1. The current flows alternately through loads A and B but, owing to the interruptions being 10 times per second, it is more or less impossible to differentiate one from the other; that is to say, both loads will appear to be working simultaneously.

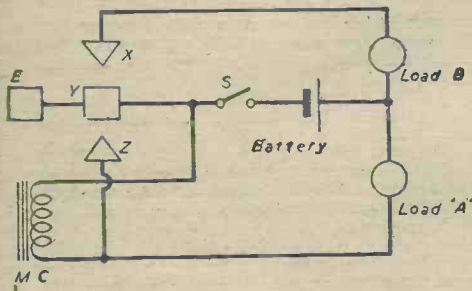

Fig. 1.—Basic circuit of vibrator.

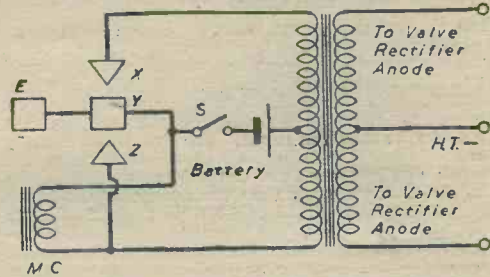

Fig. 2.—Basic non-synchronous vibrator circuit.

How the Vibrator Works

So much for a brief description of vibrator construction. Let us now consider how a vibrator operates and what it does.

Vibrator power packs are found in all car receivers, and it is this unit that we are particularly interested in, because high-tension supplies to the receiver depend upon it. Vibrators are made in various sizes, i.e., driving voltages. The most common types in use in car receivers are for 4, 6 and 12 volt operation, although models for 24 and 32 volts can be obtained.

By passing a current from the car battery through the vibrator, the current is interrupted, and fed into the primary of the transformer, resulting in a magnetic field which is continually changing. It is this change that is utilised, for an E.M.F. can be induced in any wire that is situated in or near a changing magnetic field. The wire in this case is the secondary winding of the transformer, so that, as the primary has a fluctuating magnetic field, an induced voltage flows in the secondary winding.

Vibrators are made in two distinct types, one being synchronous and the other non-synchronous. The former is self-rectifying, whereas the latter requires a full-wave valve rectifier in circuit to obtain the necessary D.C. output.

A vibrator (sometimes known as an interrupter) can really be described as a switch. As to the actual working of the vibrator, let us study Fig. 1. This represents a fundamental circuit incorporating a non-synchronous vibrator. When the switch S is closed, a current will flow through the magnet coil MC which becomes energised and so attracts the contact E. As E makes contact with

This explains why the output from a vibrator has to be rectified by a valve rectifier unless a synchronous vibrator is used.

The Complete Power Pack

Figs. 2 and 3 show the principle of a vibrator power pack suitable for use with a car receiver. It is as well to remember, however, that it is essential to have all leads as short as possible and well screened so as to prevent R.F. transmission into the receiver.

Vibrators, whether non-synchronous or synchronous, are sealed in metal cans, to prevent R.F. radiation caused by the making and breaking of the contacts. However, this type of interference can be suppressed to a great extent by incorporating R.F. chokes and condensers in the unit—these are discussed later in this article.

The transformer should be correctly designed and it is advisable to purchase this direct from the vibrator manufacturer, as the laminations need to be of special material having a low flux density.

It is of the utmost importance that the vibrator pack be carefully designed, otherwise the life of the vibrator will be affected. For instance, the overloading of a vibrator will cause excessive sparking at the contacts and result in R.F. being generated throughout the receiver, and finally in a transference of metal from one contact to another (Fig. 4), thus rendering the vibrator useless.

Some service engineers still attempt to repair a vibrator suffering from this fault, but it is not advisable to do so, as true spacing of the contacts is essential to the correct operation of the vibrator.

If the vibrator coil is operated below the rating.

(Continued on page 164)

R.A.F. RADIO !

Further supplies of the World's Finest Radio Gear made for the World's Finest Air Force—offered at

VERY LOW PRICES

R.A.F. VALVES. Every one guaranteed. EK32, EF36, EF39, VL63, X66, ECM35, MHL6, L63, SP41, EBC33, EB34, EL32, E1192, KT44T, all at 5/6 each. 8D2, Mag Eye, D1, EA50, EF50, KTW62, AC6PEN, all at 7/6 each. Ask our prices for 3, 6, and 12 doz. lots.

R.1155 CHASSIS. Packed with valuable components worth nearly £15. Includes 3 gang condenser, calibrated dial, variable switches, resistances, coils, chokes, condensers, fixed resistors, trimmers, etc. The finest bargain we have ever offered. Have already sold over 400 to very satisfied readers. 25.

R.1125B. RECEIVER CHASSIS. 2 7-pin, ceramic valveholders, 8 condensers, 8 resistors, 2 transformers, coils, plugs, sockets, etc. All on totally enclosed metal chassis. All to Air Ministry specifications. 17/6.

R.A.F. 3-GANG CONDENSERS. Same as used in R1155 chassis. .0005 mfd. 12/6.

R.A.F. MIDGET VOLUME CONTROLS. 100,000 ohms. 1/9 each or 16/- doz.

R.A.F. TWIN VOLUME CONTROLS. 500,000 ohms each section. 5/6 each.

R.A.F. 2 mfd. CONDENSERS. Mansbridge type, 500 v. wkg. 1/3 each.

R.A.F. TUBULAR CONDENSERS. 1, .15 and .25 mfd., 350 v. wkg. 7/6 doz.

R.A.F. TUBULAR CONDENSERS. Metal-cased. .1+1+.1 mfd. 500 v. wkg. 2/3 each.

R.A.F. TUBULAR CONDENSERS. .5 and .25 v., 350 v. wkg. with short wire ends. In 25 lots only. 5/6.

R.A.F. .02 MFD. CONDENSERS. 1,000 v. wkg., 7/6.

R.A.F. SELECTOR SWITCHES. Useful for remote control. 21/6.

R.A.F. 10-POINT DEWAR SWITCHES. 2/6.

R.A.F. PARCEL 1. Six each .1, .15, .25 mfd. Tubular Condensers, three .1+1+.1 mfd. Tubulars, metal-cased, three Midget Volume Controls, 100,000 ohms, two Toggle Switches. 20/-.

R.A.F. PARCEL 2. Twelve each .1, .15, .25 mfd. Tubular Condensers, six Midget Volume Controls, 100,000 ohms, three Volume Controls, one gross 6BA Nuts and Bolts, one gross 4BA screws, one gross Rivets. 30/-.

D.C. MOTOR GENERATOR. Input 9 v. 6.26 amps. Output 450 v. at .05 amps. Complete with cooling fan and switching device. Fitted on chassis 12½ x 8 x 2½, weight 17lb. Also 18 v. and 24 v. input, similar output. 53 17s. 6d.

SPECIAL OFFER

VOLTMETERS. We have purchased a large quantity made for the Air Ministry to their stringent specifications. Type No. 5A/1693 0-40 volts. New, in original boxes, marked A.M. To clear, 19/11.

MULTI-RANGE MOVING COIL TEST METERS. New. First grade Army type in bakelite case. Ranges: 10, 50, 100 and 500 volts at 1,000 ohms per volt A.C. and D.C.

1, 10, 100 and 500 mA and 0-10,000 ohms. 28 15s.

NEW UTILITY RECEIVER CABINETS. 2 sizes. 12½ x 11½ x 6½ and 17½ x 11 x 7½ in., each 30/-.

NEW 6 and 8in. LOUDSPEAKERS in beautiful polished Plastic and Wood Cabinets; 6in., 30/-; 8in., 35/-.

NEW 0.2 mfd. CONDENSERS, 250 v., 8d. each, 6/5 doz.

SINGLE SCREENED CABLE, 12 yds. 7/6.

MAINS DROPPERS, 1,000 ohms, 2 amp., 5/6.

7-PIN PAXOLIN VALVEHOLDERS, 7/6 doz.

MAZDA OCTAL AMPHENOL VALVEHOLDERS, 6/- doz.

AN OPEN INVITATION

It is impossible to list all the R.A.F. radio gear we have for sale. You are invited to call and see the stocks of chassis, receivers, transmitters, components and instruments. It will pay you to come in and walk round.

Closed
THURS.
1 p.m.

**LONDON CENTRAL
RADIO STORES**

Open
all
Sat.

23, LISLE STREET, W.C.2 GER. 2969.

Exide

IN

PARLIAMENT

In the House of Commons :

Mr. EVELYN WALKDEN asked the President of the Board of Trade why 120-volt Exide Batteries which are sold at 11s. 1d. are in short supply and other 120-volt batteries of less reliable make, and sold at 15s. 6d., only are available . . .

Mr. DALTON : Wireless batteries are now in short supply, owing to the heavy demands of the Services, and it is necessary, therefore, to make use of the output, although small, of the higher cost producers. Prices are controlled under the Price of Goods Act, 1939, and those charged for both classes of battery referred to by my Hon. Friend have been investigated and approved by the Central Price Regulation Committee.

Mr. WALKDEN: While appreciating what my Right Hon. Friend has said, is he not aware that batteries are used largely by people in small homesteads who cannot understand why good batteries cannot be obtained while there is a plentiful supply of inferior ones. . . ?

Mr. DALTON : I am very anxious to get a fair distribution of whatever supplies there are, but the best batteries are required for the Services in a very great and increasing quantity. . . .

(Extracts from Hansard, Jan. 16)

**THE CHLORIDE ELECTRICAL STORAGE
COMPANY LTD.**

GROSVENOR GARDENS HOUSE · LONDON · SW1

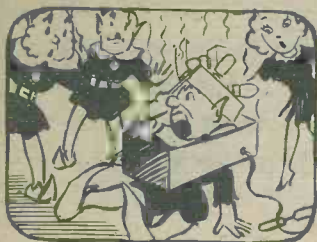

The "Fluxite Quins" at Work.

"Hullo! What's happened in here?
The end of our wireless, I fear.
Fixing wires with FLUXITE
is perfectly right,
But not with the current on, dear!"

See that FLUXITE is always by you—in the house—garage—workshop—wherever speedy soldering is needed. Used for over 30 years in government works and by the leading engineers and manufacturers. Of all ironmongers—in tins, 8d., 1/4 and 2/8.

Ask to see the FLUXITE POCKET BLOW LAMP, price 2/6.

To CYCLISTS: Your wheels will NOT keep round and true unless the spokes are tied with fine wire at the crossings and SOLDERED. This makes a much stronger wheel. It's simple—with FLUXITE—but IMPORTANT.

The FLUXITE GUN puts FLUXITE where you want it by a simple pressure. Price 1/6, or filled, 2/6.



ALL MECHANICS WILL WANT

FLUXITE

IT SIMPLIFIES ALL SOLDERING

Write for Book on the ART OF "SOFT" SOLDERING and for Leaflets on CASE-HARDENING STEEL and TEMPERING TOOLS with FLUXITE, also on "WIPED JOINTS." Price 1d. EACH.

FLUXITE LTD. (DEPT. W.P.)
BERMONDSEY ST., S.E.1.

YOU can become a first-class RADIO ENGINEER

We are specialists in Home-Study Tuition in Radio Television and Mathematics. Post coupon now for free booklet and learn how you can qualify for well-paid employment or profitable spare-time work.

T. & C. RADIO COLLEGE NORTH ROAD, PARKSTONE, DORSET.

(Post in unsealed envelope, 1d. stamp.)

Please send me free details of your Home-Study Mathematics and Radio Courses.

NAME.....

ADDRESS.....

P. 69.....

COULPHONE RADIO

"THE RETURN OF POST MAIL ORDER SERVICE."

Station Road, New Longton, Near Preston.

New Goods Only—no surplus or used material stocked. Over 15,000 satisfied clients. Most comprehensive stock of radio service gear in the country. C.O.D. or cash with order. All orders over 5/-, post free. A few of our lines are listed below, send stamped addressed envelope for latest stock list.

Valves.—All B.V.A. and Tungstram, including American.

Mains Transformers.—Interleaved and Impregnated. For 200, 250 v. mains, 300 v. 60 mA. 4 v. or 6 v. L.T.s, 17/6; 350 v. 100 mA. 4 v. or 6 v. L.T.s, 24/-; 450 v. 200 mA. with three L.T.s, 4 v. or 6 v., 42/6.

Smoothing Chokes.—40 mA., 4/6; 60 mA., 6/-; 90 mA., 7/-; 100 mA., 12/6; 200 mA., 21/-.

Speaker Transformers.—Midget Pen., 40 mA., 4/6; Midget Power/Pen., 40 mA., 5/-; 56d. size Push-Pull Universal, 60 mA., 6/-; Heavy Duty, P.-P., 21/-; Extra H.D. 100 mA., 37/6.

Mains Dropper Resistors, with feet and two sliders, 2 amp., 4/3; 3 amp., 4/6.

Loud Speakers P.M., 2 1/2in., 24/-; 3 1/2in., 27/6; 5in., 19/6; 6 1/2in., 20/-; 8in., 21/-; 10in., 30/-; With Trans., 6 1/2in., 24/-; 8in., 25/-; 10in., 36/-.

Tuning Coil Pack.—Completely wired on sub-chassis, with 4 position switch and all trimmers and padders. Short, Medium and Long Wave Superhet type for 465 kc/s. I.F., 32/6.

Line Cord, 60.70 ohms per foot. 3 amp. Note price per yard, 2 way, 1/6; 3-way, 1/9.

Tuning Condensers.—Midget 2-gang .0005 with trimmers, 11/6.

And everything from a grid clip to a 50 watt amplifier. Send NO for that list and save yourself 5's.

M. WILSON Ltd.

(Late Austerly Radio Ltd.)
Same Management
Everything we sell is absolutely new.

No surplus or secondhand goods
NEW UNIT SYSTEM OF
RADIO CONSTRUCTION

WE have developed and are now placing on the market a UNIT system of radio construction, which will give you a radio receiver of any range or power desired by utilising any combination of these Units.

UNIT NO. 1 (A and B)

A.—A.C. Complete H.F. and I.F. stages, 3-waveband coil unit (16-50, 185-550 and 500-2,000 metres), 3-gang, ceramic insulated rubber-mounted condenser, R.F. stage with R.F. gain control, H.F. and Oscillator all A.V.C. controlled feeding into an I.F. stage of 465 kc/s., and fitted with I.F. gain control. Cathode-ray tuning indicator (tuning eye), dial lamps, dial and slow-motion drive, pointer and knob, mounted on 16 S.W.G. aluminium chassis with output plug. The Unit is complete in itself, ready wired up, calibrated and tested. All parts brand new, standard components Octal valves.

B.—A.C. Complete L.F., output and power stages, comprising 2nd detector A.V.C. and 1st I.F. amplifier, feeding into output tetrode 41 watts output complete including tuning former 350-0-350v., 80-100 mA., L.F. choke and 8in. P.M. speaker with multi-ratio transformer.

UNIT NO. 2 (A, B, C and D)

A.—As No. 1, but with 6-waveband coil unit, 5-2,000 metres.

B.—A second I.F. stage, 465 kc/s.

C.—Second detector A.V.C. and 1st I.F. phase inverter, 3 output tetrodes in push-pull, 12 watts output.

D.—Power pack consisting of mains transformer (400-0-400v., 150 mA.), high-voltage surge-proof electrostatic condenser, 20-henry choke, 12in. P.M. speaker with output transformer, mains fuses. The above unit can also be supplied for A.C./D.C. working.

This system gives a good theoretically correct application to practical radio, as each stage is completely screened from the others, making possible reproduction of the very highest quality. A theoretical blueprint is issued with each unit (separate blueprints not available). Prices on application. Photographs and further details in next month's PRACTICAL WIRELESS.

SPECIAL!

RADIO CHASSIS (riveted corners)
in 18-S.W.G. "ALCLAD," undrilled, specially manufactured for us by a well-known firm of aircraft manufacturers, to Aircraft (A.I.D.) standards. Strong as steel, rigid yet easy to work. Dimensions 12 x 7 x 4 in. Price 12/6
Post and packing 1/-.

I.F. TRANSFORMERS, 465 kc/s., permeability tuned iron core, centre-tapped, colour-coded, screened, 15/- per pair.

350-WAVEBAND COILS, on one former: Long (800-2,000 m.), Medium (200-550 m.) and Short (12-20 and 19-50 m.), 15/- per pair.

NOW READY

COMPLETE SUPERHETERODYNE SCREENED COIL UNIT, colour-coded, wired-up and tested. Includes 3-waveband coils for R.F. stage H.F. and Oscillator, short 14-50, medium 200-550 and long 800-2,000 metres. (465 kc/s.) 3 gang condenser, 3 banked 500 p.f. variable capacitors (R.F.-F.C.), all trimmers, padders and resistances together with blueprint. With calibrated dial and slow 55 motion drive. Price £5
Tuning units for all standard circuits supplied.

TO OVERSEAS TRADERS

Wholesale and retail enquiries are invited. Orders can be executed for B.A.O.R., C.M.F. and S.E.A.C. customers.

307, HIGH HOLBORN,
LONDON W.C.1. Phone: HOLborn 4631

Easily-made Headphones

Constructional Details of Efficient Apparatus for the Constructor

THERE is still some difficulty in obtaining new or second-hand headphones in many districts.

What about making your own 'phones, assuming the need is urgent? Headphones, of course, are just as interesting to construct as any other radio component, and as one is able to use odds and ends that are to be found in the junk box, this makes them very inexpensive indeed.

The 'phones illustrated will, if made as described, give a good performance, even without the magnets. However, in this case, the writer is thinking of Morse practice sets and valve wireless sets. With the magnets, the 'phones will reproduce the faint signals from crystal

an outlet hole for the coil leads, see enlarged top plan at Fig. 2.

Having thus assembled the case, the lid, or cover, parts G and F are glued together. Note the six pin holes marked on the cover piece. These holes, of course, are for the entry of pins and, when cutting out the diaphragm (H) from tin, corresponding holes need to be drilled in it.

When the glue sets, smooth the case sides by rubbing with medium and fine grades of glasspaper. The latter should be held on a proper cork block or could be wrapped around a flat piece of wood. In regard to the cover, the edges are rounded over to form a bead. The cover should be a neat fit on top of the casing; avoid rubbing the latter unnecessarily.

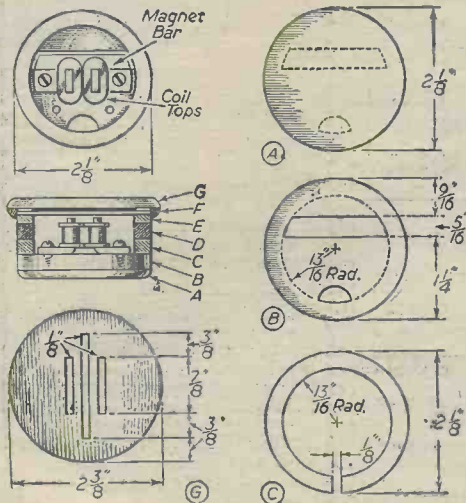

Fig. 1.—Top view, sectional side view, with details of cover piece and case parts.

sets clearly enough. So, you can build the 'phones one way or the other, according to your immediate needs. Try, if possible, to include the bar magnets, as they make the units more sensitive for all purposes.

A recess, or aperture, is provided in the casework of each unit for the magnets. These cases are built on the shaped-layer principle, meaning that various discs and rings of wood are cut out, then glued evenly together in their respective order. The 'phones are of a normal size, with a special headband and adjustable holder lugs. With the 'phone cases finished ebony black, and the headbands (made from brass or aluminium) highly polished, together with the use of new twin flexible cord for the leads, the completed work looks rather professional.

Making the Cases

The first thing to make is the case. A description of one will serve for the other. Therefore, cut out the parts marked A, F, G, Figs. 1 and 2, from, preferably, 1/4 in. birch plywood, using a fret-saw. Parts marked B, C and E are cut from 1/4 in. plywood. A repeat of D, cut from 1/4 in. wood, makes part E, see sectional side view at Fig. 1.

Now, the bottom piece is A. Upon this is glued B, C, D and E, the parts going together as drawn in the diagrams. The 1/4 in. gap in ring C, incidentally, provides

The Coils

The coil bobbins are formed in the usual manner by means of pole pieces, shaped like brackets, with neatly-fitting tops or flanges, see Fig. 2. The brackets are made from 3/4 in. thick by 3/4 in. wide metal bar, either iron or mild steel. Iron, however, is preferred. A piece of iron valance rail, as used for hanging curtains, etc., is ideal stuff to use.

Having bent and drilled the brackets, the coil flanges are prepared from 1/16 in. thick celluloid sheeting, fibre sheeting or paxolin sheeting. They must be a neat fit. The slots are cut by either drilling a series of 1/16 in. holes closely together and filing away the waste or by cutting with a fretsaw, such as a handframe fitted with a metal-cutting fretsaw blade. The anchor holes in the flanges are made with a fine Archimedeian drill point, or a beheaded panel pin fitted to the chuck of a hand drill.

The Coil Windings

To prepare one bobbin, fit on one flange, wind on a strip of gummed paper about 1/4 in. wide, then add the top flange. The winding of paper, apart from separating the bobbin flanges, also acts as an insulation, of course, in case parts of the fine enamelled wire is exposed in places. Insulation tape could be used, if desired.

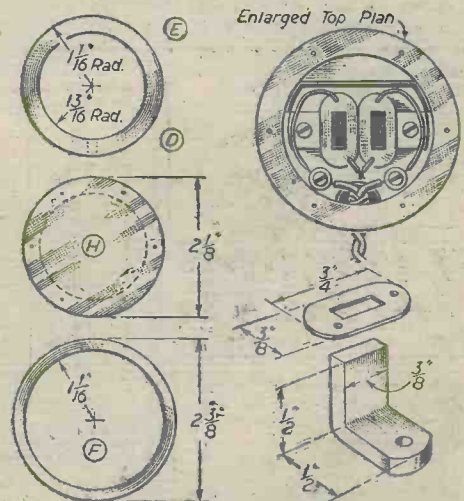

Fig. 2.—Case ring, diaphragm and cover flange sizes, with top plan showing wire connections, plus detail of coil top and bracket.

The wire used by the writer was taken from an old loudspeaker coil. Similar wire is to be found in wireless transformers. The wire, needless to say, is as delicate as a hair and great care must be exercised throughout its winding on the bobbins. Slight tugs and the formation of tightened "loops" in it are dangerous.

A length of 32 S.W.G. cotton-covered wire is joined to the thinner stuff. Have the joint strengthened and protected by covering it with gummed paper $\frac{1}{2}$ in. wide, folded along the length. Bring the free end of the thicker wire through the hole provided in the top flange, then proceed to wind on the finer wire in a clockwise direction.

Rather than count the number of turns, work to a depth of about $\frac{1}{16}$ in. or $\frac{3}{32}$ in. Have the windings neat and even, free from kinks. Having almost completely filled the bobbin, join on a second cotton-covered wire and bring its free end through the second anchorage hole provided. Have the joint protected the same as the first one. The winding is then covered with a strip of gummed paper, or leatherette paper could be cut into a strip and glued on.

The second coil is made in a similar way, with the exception that the wire is wound on in an anti-clockwise direction. Having constructed the four coils necessary, test the continuity of each by means of a flashlamp battery and bulb; if the latter fails to light, there is a break in the winding somewhere and it is best that the fault should be traced and repaired at this juncture before proceeding. A repair can be made to the finer wire by scraping off the enamel gently and connecting the wires by twisting them together, then by pressing the twist lightly with pliers. This is as good as soldering, which is apt to be tedious and difficult.

Mounting the Coils

Assuming you possess two bar magnets $1\frac{1}{2}$ in. long by $\frac{1}{2}$ in. wide by $\frac{1}{8}$ in. thick, fit them into their apertures in the cases. The coil brackets are attached, with round-head screws, in line with the edge of the magnet apertures to be in contact with the magnets, the latter drawing themselves against the brackets. A thin machine screw could be employed to force the magnets in close contact with the brackets. Such a screw is driven in via the casing side facing the wire lead inlet hole.

When secured, it may be necessary to file the top ends of the brackets flat so that the diaphragm lies above each by about $\frac{1}{32}$ in. evenly. If the diaphragm is rather distant from the tops of the poles, the rim of the casing can be glasspapered to reduce the distance.

Connecting the Leads

Before going further, the leads need to be prepared. You want a 3 ft. length of twin flex and a 20 in. length of

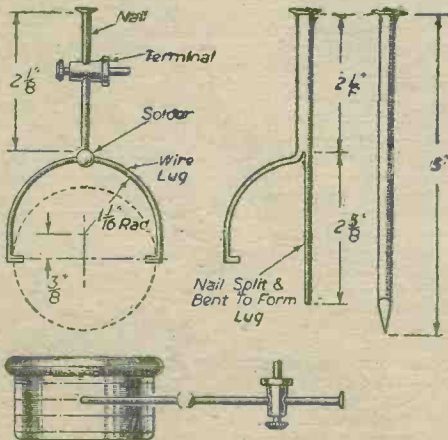

Fig. 3.—How the 'phone lugs are made up from wire or a nail, with side elevation.

single flex. Unravel one end of the longer twin stuff about roins, and tie with a strong thread. Form loops at the ends, this applying to the single, shorter length.

The shorter length is twisted with the single ends of the longer length, then the "fork" bound with thread. Much of this can be gathered from the view at Fig. 5.

Force the looped ends through the inlet holes in each

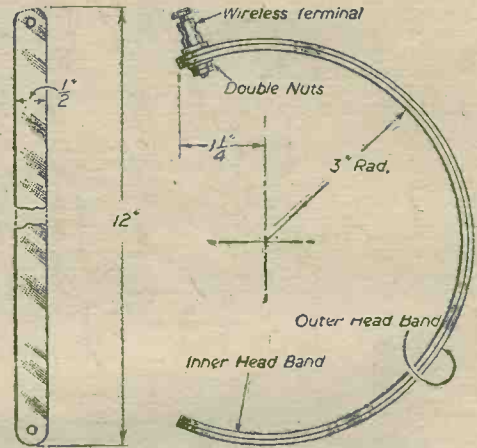

Fig. 4.—Approximate dimensions of headband strips, showing how both strips are connected at the ends by means of the wireless terminals.

'phone case and tie together by a single knot. The knots prevent undue "chugging" on the loops when these are fixed to their terminal screws (see enlarged top plan). The terminal screws are ordinary $\frac{1}{8}$ in. by 6 round-head iron screws. Note how the coil wires are connected. Have these wires and the flex loops going beneath small metal washers.

A couple of spade ends are fixed to the opposite ends of the main lead, as shown.

The Diaphragm

The diaphragm is cut from a flat piece of tin, then drilled. Having set it upon the rim of the 'phone case, cut out a thin cardboard ring, $2\frac{1}{2}$ in. in diameter, with an inner hole $\frac{1}{8}$ in., and place it on top, then fit on the cover piece and drive in the six panel pins. If the cover is a neat, tight fit, the need for panel pins is unnecessary.

The connections are, at this stage, tested by applying the spade ends to a small dry battery. A distinct "popping" will, or should, be heard in the 'phones, or a "scraping" sound, if you have omitted to include the magnets.

Making the Headband

The headband, of course, carries the "lug" pieces, the pins on the latter fitting, by springy pressure, into suitable holes bored in the 'phone cases. Therefore, prepare the lugs first.

There are two ways the lugs can be made. The lugs can be bent to shape from wire, with a nail for the adjustable stem, it being soldered on, as shown at Fig. 3. The other method is to split a 5 in. wire nail with a fine hacksaw, then bend the split portions into lugs, as indicated. The 5 in. nail, if used, needs to be reduced by $\frac{1}{8}$ in., thus enabling the point to be cut away.

It is imperative that the adjusters (wireless terminals) are placed upon the stems prior to bending them to shape, as this, obviously, cannot be done afterwards owing to the nail heads. You will, if you use the 5 in. nail, probably have to enlarge the plug holes in the wireless terminals to suit the thickness of the nail.

The headband consists of two strips of $\frac{1}{16}$ in. thick

brass, or aluminium $\frac{1}{16}$ in. wide, by about 12 ins. long. It is essential that one band fits into the other one, as seen by the view at Fig. 4. Therefore, having drilled the terminal screw hole at one end of each strip, attach the terminal to both by means of a washer and two nuts. The nuts are "locked" together by twisting in opposite

directions, to allow a sufficient amount of freedom for the opening and closing of the headband strips.
Bend the double strip into a 6 in. semi-circle and remove the necessary waste from one of the bands, then drill the hole for the second terminal which is immediately attached. You should have the edges of the headband strips smoothed by rubbing with emery cloth, or the burr could be removed by filing.

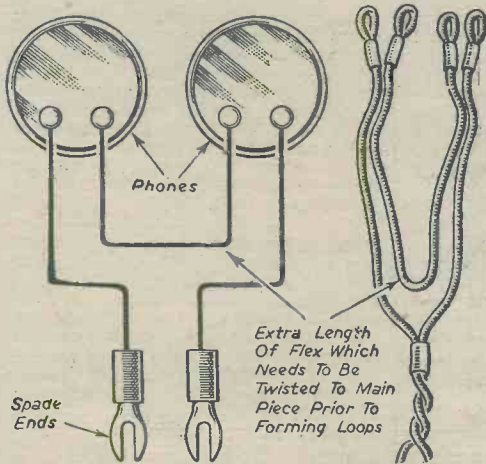

Fig. 5.—How the leads are connected to 'phone terminals, with view showing methods of twisting the leads together.

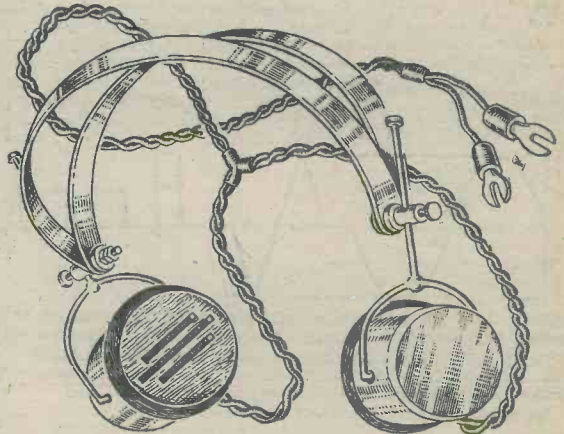

Fig. 6.—The completed headphones.

Ersin Multicore Solder in Wartime

Interesting Details of the Part Solder has Played During the War

THE stupendous effort of the British radio, electrical and telephone industries during the war was much facilitated by the production of 77,383 miles of Ersin Multicore Solder Wire.

This solder wire, containing three cores of non-corrosive flux, has become so widely adopted in the radio, electrical and allied industries that few realise that the Multicore patent was only taken out in 1935, and it was not until late 1938 that Ersin flux was evolved and Ersin Multicore Solder in its present form manufactured.

The need for an activated flux-cored solder instead of the usual rosin-cored solder had become evident even before the war when highly-skilled assembly labour had been available. The production of Ersin Multicore Solder in substantial quantities in early 1939 showed that it was superior to all foreign products and provided an all-British cored solder which would be particularly advantageous for unskilled labour.

During 1942 the rapid expansion of the radio and electrical industries with the consequent wide use of unskilled labour proved that the use of Multicore solder, which obviated separate fluxing operations, was of material assistance in ensuring that highly complex soldering processes on radiolocation and other intricate radio and electrical apparatus could be undertaken by girls and women after only the briefest training. Vast quantities of Multicore solder were used in outwork jobs, by which women undertook soldering operations for Government contracts in their own homes.

Of the 20,429 million joints approximately that were made with Ersin Multicore Solder during wartime, the bulk of supplies was used by practically every radio, electrical, telephone and lamp manufacturers in the production of war equipment. However, many Government organisations, including the R.A.F. Maintenance Units and General Post Office, used substantial quantities for maintenance purposes.

The National Physical Laboratory, B.B.C., and various

departments of the Admiralty, employed Multicore for many specialised soldering processes. It was, however, the Ministry of Supply that adopted and specified Multicore solder for one of the most novel forms of soldering.

"Sleeve, Self-soldering"

For telephone communication the Army, of course, used thousands of miles of field telephone cable of a type usually consisting of several strands of steel wire and one of copper. The satisfactory jointing of this cable, often under fire, had always been a problem. The Army "drill" method of making a joint in the field took about 15 minutes, and owing to the difficulty of heating did not use solder. In conjunction with Bryant & May, the match manufacturers, a method of jointing was evolved by the Ministry of Supply which took one minute per joint. A copper tube 2 in. long had two-thirds of its length inside filled with Ersin Multicore Solder, and the same length outside was covered with igniting material similar to that on the head of a match. It was only necessary to remove the insulation for about $\frac{1}{16}$ in. off each end of the cables that were to be jointed, insert them in each end of a "Sleeve, Self-soldering" (in the War Office terminology) and strike the edge of the box in which they were packed across the sleeve. The covering ignited immediately, heating the tube, solder and cable, to over 375 deg. C. The Multicore solder and Ersin flux became molten, the cables were pushed into the tube, until they overlapped and a perfect soldered joint resulted. A few turns of insulation tape over the tube and a better joint had been made in one-fifteenth of the time taken previously.

Extensive tests carried out by the Ministry of Supply proved conclusively that only the Ersin flux contained in Multicore solder was sufficiently active enough to overcome the oxidised and often rusty field telephone cable and Ersin Multicore Solder was specified exclusively for these sleeves, and many millions were made before production ceased.

Pulse Communication

An Explanation of Pulse Formation and Circuit Analysis

By P. FREEMAN, B.Eng.

Morse and Modulation

WHEN we speak of "radio communication," we refer to the transmission of intelligence by means of radio waves; but our long dependence on the B.B.C. has made some of us apt to forget that there are other ways of conveying intelligence than by modulating a continuous carrier wave. Most of us know the system of communication called Morse. In its dot and dash structure Morse telegraphy possesses the elements of

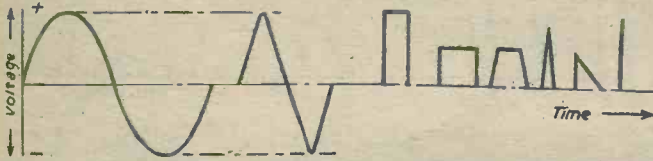

Fig. 1.—On the left is a normal sine wave, compared with a triangular pulse. At the right are respectively a rectangular, square, trapezoidal, triangular, saw-tooth and line or sharp pulse.

pulse communication, and its range and reliability provide us, moreover, with a system of communication when other methods fail. Just as a correctly radioed SOS signal sets automatic alarms ringing on ships at sea, so pulse transmissions of greater complexity can signal intelligent instructions to robot machinery, operate delicate electronic apparatus by remote control, or probe the universe for physical information.

Pulse Communication

Pulse communication is a technique based on the translation, transmission and interpretation of various kinds of pulses. A wireless enthusiast used to the present circuits in radio design would no doubt be revolted by the maze of networks and unconventional circuits of pulse generators and receivers, but we shall endeavour to show in this article how these strange circuits, stripped of their complexity, present the familiar aspects of radio technique.

Sine Waves and Pulses

We have called these pulse circuits "unconventional," but they are only so because pulses differ in their nature

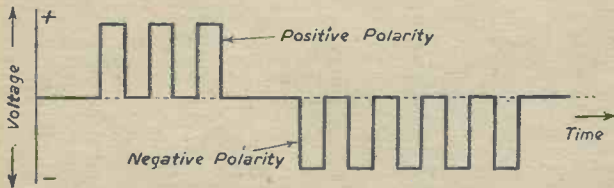

Fig. 3.—By utilising similar pulses, but of different polarity, a discriminating device may be operated.

from the more usual kinds of waves found in broadcasting practice. The fundamental waveform is the sine curve, and we take its shape for granted as it is the familiar wave naturally generated by electronic oscillators, radio transmitters and power-supply stations. It is, of course, only one of the many characteristic forms an electrical wave may take. The essential difference between a sine wave and a pulse is, that whereas the former exhibits

a smoothness and continuity of outline, the latter shows straight edges and a definite "discontinuity." This can be readily seen in the comparison between a sine wave and a triangular pulse on the left of Fig. 1. This also shows on the right some of the more important of the variety of pulse shapes which can be produced by electronic means. It will be shown later how these different pulse shapes are obtained, how they may be analysed by special circuits, and how they may be made to perform separate functions according to their shape.

Mathematical Differences

A very striking difference between sine waves and pulses can be seen if we examine their respective mathematical formulae. Let us take the sine wave and the square pulse as examples; then, when e is the instantaneous voltage at time t , E is the maximum voltage and f is the frequency we have: for a

$$\text{sine wave } e = E \sin 2\pi ft \text{ and for a square}$$

$$\text{pulse } e = \frac{4E}{\pi} (\sin 2\pi ft + \frac{1}{3} \sin 6\pi ft + \frac{1}{5} \sin 10\pi ft + \dots)$$

It will be noticed that the sine wave formula only contains one term, whereas the square wave has an infinite series of terms each one representing a progressively

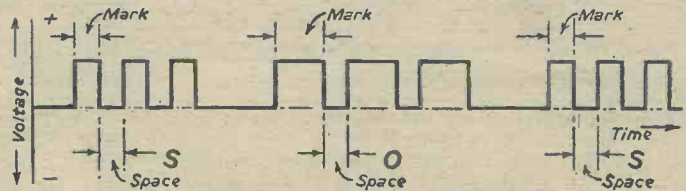

Fig. 2.—The morse letters S O S showing how the mark/space ratio varies with different letters.

higher frequency. This latter formula is characteristic of pulses which all contain frequencies ranging from the fundamental to infinity.

Discrimination Between Pulses

If we are to transmit intelligence by means of pulses we must have means of identifying the intelligence with the pulses concerned, and ability to discriminate later between such pulses. In the Morse code, as we mentioned above, two types of pulse are used—the dot of short duration and the dash of long duration. Discrimination between dots and dashes rests entirely on duration; no other identifying feature need be specified either for aural, or automatic reception. On consideration we shall realise that duration is only one of the several ways of discriminating between pulses and that other identifying features which could be used to discriminate between pulses are as follows:

- (a) Duration.
- (b) Polarity.
- (c) Amplitude.
- (d) Shape or wave form.

Any one of these features in a complex train of pulses can be selected by appropriate design of an electronic discriminating device, and the technique of communication becomes one of attaching a particular operation to

a particular feature of the pulses concerned. Take, for example, the Greenwich Time Signal. A series of pulses of definite spacing and duration enables us to adjust our clocks to Greenwich Time. But it is quite feasible to design an electronic adaptor to our clocks which will do the job for us. This robot time setter would have to discriminate against all spurious pulses transmitted during the course of the current radio programme and its mechanism respond only to the particular pulse code of the Time Signal.

We shall now discuss each of the discriminating features of pulses in turn and explain how these features may be identified and selected.

Duration

There are two factors to be considered under duration—the duration of the pulse itself, and the duration of the time interval between pulses. These are called respectively the “mark” and “space” intervals. The mark interval divided by the space interval is technically termed the mark/space ratio. Thus in the Morse letter S, the mark and space intervals each equal one dot and the mark/space ratio is unity, while in the letter O the mark interval is equal to two dots and the mark/

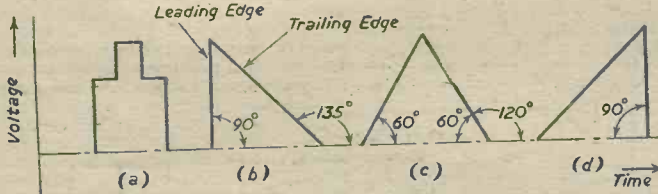

Fig. 5.—A diagram of a composite pulse, showing the slope or rate of change of the wave-form.

space ratio equals two (see Fig. 2). The duration factors of Morse transmission are made use of in automatic code writing systems, radio beacons and homing devices for planes.

Polarity

The Morse signals shown in Fig. 2 are all of the same polarity, that is to say, each pulse represents an increase of signal. It is also possible to arrange for pulses that cause a decrease in signal and these pulses are, in effect, negative. Fig. 3 shows a train of three positive pulses, followed by five negative pulses, the former might convey the operation of guiding a remote controlled ship to port and the latter to starboard. Polarity is thus another simple discriminating feature.

Amplitude

Difference in amplitude is an obvious means of discrimination between pulses. Delayed-automatic volume-control is a well-known example of this application. Fig. 4 shows a pictorial representation of the way in which automatic bias comes into operation when the carrier pulses exceed a predetermined level.

Shape

Shape is perhaps the most important feature of pulse discrimination, and it is largely to the development and understanding of shaping technique that we owe the success of wartime advances in remote control.

The basic pulse shapes have already been shown in Fig. 1, and their number and variety may be increased by superimposing one on another, or by varying their geometrical proportions. In Fig. 5 we see a composite pulse made up of a rectangular pulse superimposed on a square pulse, and three distinct forms of triangular

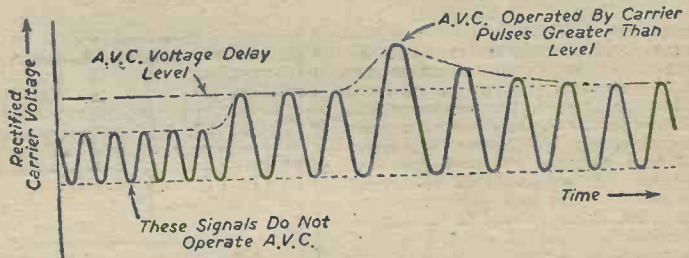

Fig. 4.—Delayed-automatic volume control, as shown here, is a well-known application of amplitude difference acting as a discriminator.

pulse, each one of which could be utilised to perform a distinct operation. The important feature which distinguishes various pulse shapes is the slope or rate of change of their wave-forms. The slope of a wave at any point on its outline is defined as the slope of the tangent drawn to the wave at that point, which may be positive or negative according to its relation to the time axis. The tangent to the leading edge of triangular pulse (b) slopes at 90 deg. to the time axis, and since the voltage is increasing it is positive. Mathematically, its rate of change is expressed by $\frac{dv}{dt}$ or $\tan 90^\circ$, which equals plus infinity. This means that, electrically speaking, the pulse voltage is increasing at an enormous rate compared with the time interval. The trailing edge of triangular pulse (b) has a negative slope of $\frac{dv}{dt} = \tan^{-1} 135^\circ = -1$. Similarly the leading edge of pulse (c) has a slope of $\tan^{-1} 60^\circ = 1.73$ and the trailing edge a slope of $\tan^{-1} 120^\circ = -1.73$. A pulse edge parallel to the time axis has a slope of $\tan^{-1} 0^\circ = 0$. Thus the edges of the composite pulse (a) from left to right have slopes of $+\infty, 0, +\infty, 0, -\infty, 0, -\infty$ respectively. An electronic circuit which can differentiate between pulse slopes can thus discriminate between a great variety of pulses.

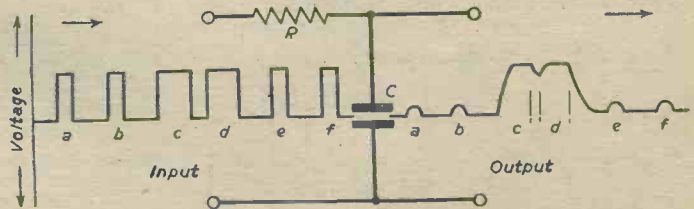

Fig. 6.—Diagrammatic representation of an integrating circuit.

Having considered the identifying features in pulses we shall now explain the mechanism of some of the basic circuits which succeed in selecting particular features and discriminating against others.

Duration Discriminators

The circuit which separates pulses according to their duration is the integrating circuit shown in Fig. 6. It

consists of a series resistance R and a shunt capacitance C so chosen that the time constant CR is large compared with the duration of short pulses against which it is proposed to discriminate. If pulses of short duration and long interval (small mark/space ratio) are applied to this circuit, the energy stored in the condenser C by each individual pulse will be discharged through R before the next pulse arrives. Thus the mean potential across C will be zero or very small. If, however, pulse of long duration and short interval (large mark/space ratio) are applied, the condenser will be charged by the first pulse and only a portion of the charge will have time to leak away before the next pulse arrives. This energy is accumulated in the condenser and may be used to excite a further circuit.

Polarity Discriminators

A circuit which separates pulses according to their polarity is the diode separator shown in Fig. 7. Since the conductivity of a diode is unilateral, it may be so connected that it passes positive or negative pulses as required. Fig. 7 (left) shows the diode connected to pass

Shape Discriminators

If one pulse is to be distinguished from another because of its different shape, we must use a circuit which accentuates this difference in order to effect separation. This is to be found in the differentiating

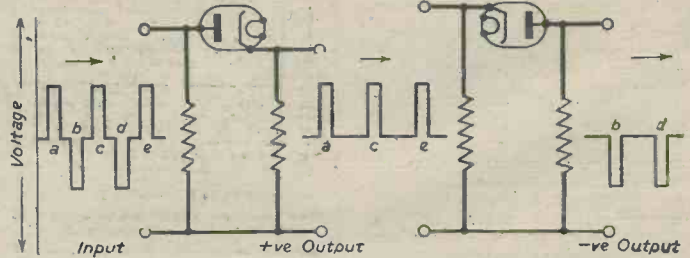

Fig. 7.—A diode separator circuit showing how it may be made to pass either positive or negative pulses.

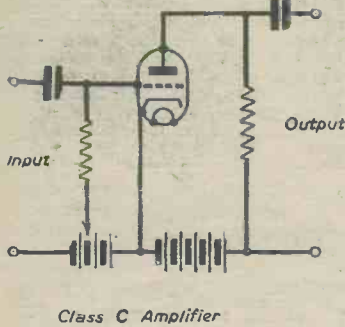

Fig. 8.—If this type of circuit is employed, then only pulses exceeding a certain amplitude will be passed.

positive and reject negative pulses and in Fig. 7 (right) the diode passes negative and rejects positive pulses.

Amplitude Discriminators

There are several circuits which enable pulses of small amplitude to be separated from those of large amplitude.

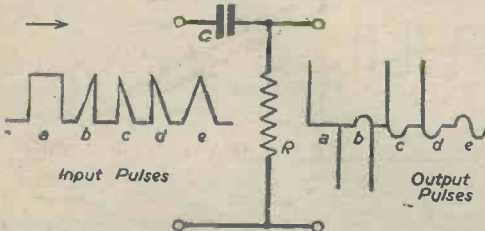

Fig. 9.—Diagrammatic representation of a differentiating circuit which, as its name implies, operates on the pulses according to their slope.

One of the most common is the triode biased to beyond cut-off. Only pulses exceeding a certain positive amplitude will then cause plate current to flow in the output circuit. This is illustrated in Fig. 8.

circuit shown in Fig. 9, which, as its mathematical name suggests, operates on pulses according to the slope of their wave-form. The result of passing a train of various pulse shapes through a series condenser C and a shunt resistance R is shown in this figure. The equation of the pulse train has in actual fact been mathematically differentiated. It will be noticed that the leading edges of pulses produce a positive output potential whereas the trailing edges produce a negative output. Moreover, the greater the slope of the pulse (the more vertical the edge) the larger the output potential developed. A truly vertical edge should theoretically produce an infinite potential though this is never so in practice. Having secured an exaggeration and distortion of wave shape by differentiation, it is then possible for succeeding circuits to select by methods previously explained any particular kind of pulse.

Generation of Pulses

The production of pulses having the accurate geometrical shapes of those illustrated in Fig. 1 is a difficult process and the complete circuits are extremely involved. One of the reasons is that electronic feedback oscillators tend naturally to produce sine-wave shapes, whilst relaxation oscillators (gas-discharge valves, multi-vibrators, etc.) produce waves which, although they may approximate to the desired pulse shape, have a good deal of inherent curvature. The usual method of pulse generation is to start with a sine-wave oscillator, or with the output wave of a relaxation oscillator of the correct frequency, and "shape" the wave to the pulse outline required. The circuits which perform this operation are termed "wave-shaping" circuits.

Wave-shaping Circuits

One type of circuit used for wave shaping is the "limiter" or "clipper," which utilises the voltage-limiting action of valves. It is usually not possible to obtain a close approximation to a pulse shape until the wave has passed through a number of shaping circuits in cascade.

(To be continued)

WIRE AND WIRE GAUGES

By F. J. CAMM. 3/6 or by post 3/9 from George Newnes, Ltd., Tower House, Southampton St., London, W.C.2.

Practical Hints

Dual-purpose Safety Relay

THE dial lamps of a Universal mains receiver are usually rated to withstand the initial surge which occurs when the set is first switched on, with the result that the dial is normally poorly lit.

The enable the dial lamps to be run at their full rating without "blowing," a relay was used, as shown in the diagram. A pair of normally closed contacts, wired in series with a shunt resistance across the dial lamps, are arranged to open when the set has warmed up. The coil of the relay may be wired in any suitable part of the circuit according to its operating current, due regard being paid also to the coil resistance. In the sketch it is shown in the cathode circuit, the bias

THAT DODGE OF YOURS!

Every Reader of "PRACTICAL WIRELESS" must have originated some little dodge which would interest other readers. Why not pass it on to us? We pay half-a-guinea for every hint published on this page. Turn that idea of yours to account by sending it in to us addressed to the Editor, "PRACTICAL WIRELESS," George Newnes, Ltd., Tower House, Southampton Street, Strand, W.C.2. Put your name and address on every item. Please note that every notion sent in must be original. Mark envelopes "Practical Hints."

SPECIAL NOTICE

All hints must be accompanied by the coupon cut from page 111 of cover.

A Home-made Midget Battery

IN ultra-midget receivers the H.T. supply is often a problem, owing to the comparatively large dimensions of the H.T. battery. An efficient battery of small dimensions can be made from "pencil" torch batteries.

Break the batteries in half, so that you have the required number of 1.5 volt cells. First glue the cells together into the required shape, and with a really hot iron, wire them in series as shown in the diagram. When all the connections are completed, bind the battery round with insulating tape—this will also give extra strength. Plugs are the battery to the receiver.—J. N. DOBBS (Oxford).

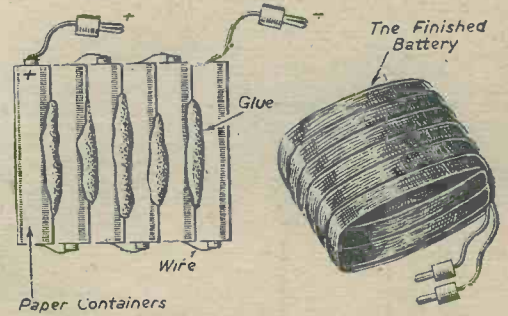
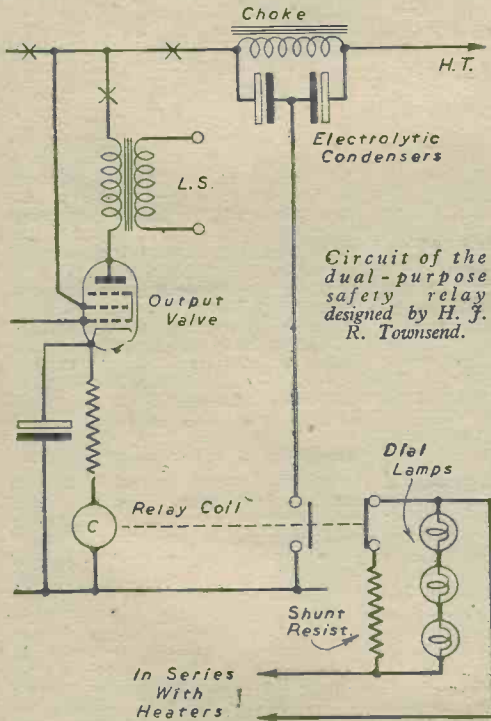

A home-made midget battery.

Long-range Adjuster.

HAVING constructed a rather sensitive superhet, I was in need of a tool for trimming purposes, etc. The coil trimmers were of 2BA hexagonal shape, so I devised the adjuster illustrated. I found a piece of copper tubing $\frac{1}{2}$ in. to 1 in. in length, of $\frac{1}{16}$ in. inner diameter. By opening the tube slightly with a centre-punch, I was able to insert a 2BA nut, hammering it in flush with the end of the tubing. I then proceeded to hammer the

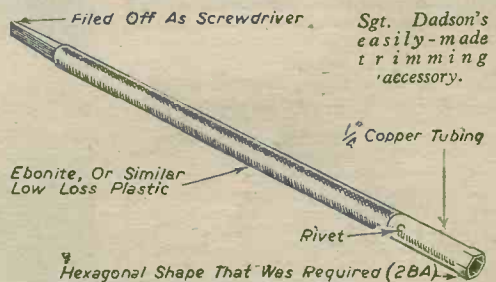

resistance being altered to maintain the correct bias. Other suitable positions are marked X.

A second pair of contacts, normally open, were used to protect the electrolytic smoothing condensers against application of mains of incorrect polarity when the set was being used on D.C. mains without a rectifier in use.

The condensers are normally disconnected from earth. When the set is switched on with mains of correct polarity, the valves warm up, H.T. current will flow, and the relay operates, connecting the condensers and disconnecting the dial lamp shunt resistance. If, however, the mains are connected wrongly, the valves will warm up but no H.T. will flow and the relay will not operate, so that the smoothing condensers will remain disconnected and the dial lamps remain dim.—H. J. R. TOWNSEND (Adderbury, Oxon).

tubing around the nut's sides, withdrawing it when finished with by screwing in the appropriate bolt and fastening it in a vice.

I then riveted the tubing to a length of ebonite—actually, in my case, about 9 in. long, but this, of course, depends upon individual requirements.

Seeing the usefulness of this tool I filed the unused end into a screwdriver for other trimmers.

I found this a very useful twin-purpose tool, especially as it may be used for various inaccessible nuts and screws.—SGT. DADSON (London, N.W.11).

On the Beam-4

Some Details of the Ground Transmitter Installations for Standard Beam Approach, and an Explanation of the Need for Extreme Care in Siting and Aligning

THE three preceding articles in this short series have attempted to give a clear outline of the S.B.A. receiving equipment, and of the manner in which that equipment is used. It is now desirable to obtain a clear impression of the purpose and general layout of the transmitters.

There has been in use a variety of transmitters for both the main and marker beacons, and it is not proposed to describe these in detail. Instead, just one type of main and marker transmitter will be described briefly. Before doing so, it should be pointed out that development in connection with the transmitters has been just as intensive as with the receivers. As a result, the transmitters at present in use are vastly better than those employed at the beginning of the war. Not only are they more efficient and less complex, but they are much easier to maintain and to adjust.

The type of transmitter which has been most widely used for the main beacon is of a transportable nature and is housed in a trailer, as shown in accompanying illustration (Fig. 1). The latest equipments supplied, however, are in transportable form, designed for easy shipment. These are weather-proofed by being installed in a transit case, which also serves as a beacon house. In addition, this form of assembly makes for speed in putting the equipment into use.

Both transmitters can be tuned over a range of 30.5 to 40.5 mc/s., and the earlier model has a rated carrier output of 500 watts. Operation in both cases is from 230-250 volts, 50 c/s A.C., the earlier transmitter having a consumption of about 4.0 kW. for full output. There are provisions for reducing the output, however, and it is seldom that the full 500 watts is required or used—50 watts is generally the most suitable output.

In addition to the transmitter itself there is a 1,150 c/s audio-frequency modulator and a remote control unit, quite apart from the various ancillary items and test equipment. The trailer will also house the two marker transmitters and two 1,000 watt petrol electric sets, with waterproof covers, for supplying the marker transmitters.

The main transmitter has a Pierce crystal-oscillator stage, followed by four doubler stages and a power amplifier.

In the modulator unit there are an audio-frequency oscillator and a Class B A.F. amplifier. Rack mounting is used for both the transmitter and modulator units, and all power supply items are adequately protected by a variety of safety devices.

A valve layout for the transmitter unit is shown in Fig. 2, from which it will be seen that a double triode is used as crystal oscillator and first doubler stage. The second doubler stage uses a single linear tetrode, whilst a push-pull pair of similar valves is used for the third doubler stage, which develops in the output circuit the eighth harmonic of the crystal. A fourth and final doubler, the output from which is at the 16th harmonic of the crystal employs two U.H.F. triodes in push-pull. Two type 4357-A triodes comprise the power amplifier stage. These are used in a Class C circuit and are plate-

modulated by the audio output from the modulator.

A double-diode is coupled into the output circuit and is used for monitoring.

The transmitter is tuned, stage by stage, by adjusting for minimum anode current and maximum grid current; these readings are shown on meters mounted on front of the transmitter, and the meters can be switched into the appropriate circuits as required. A neutralising condenser is provided for the P.A. stage, and this is adjusted so that the needle of the grid-current meter does not "kick" when the stage is tuned through resonance.

Valve details for the audio-frequency modulator are given in Fig. 3. Two linear tetrodes are used in push-pull as an oscillator, whilst a pair of triodes in a Class B push-pull circuit provide audio amplification. The output from this stage is fed through a transformer, to the anode circuit of the R.F. power amplifier.

In the marker transmitter (the same transmitter is used for both inner and outer marker after making appropriate adjustments to the keying circuits), a 4.75 mc/s crystal oscillator is followed by three stages of frequency-doubling to obtain a final frequency of

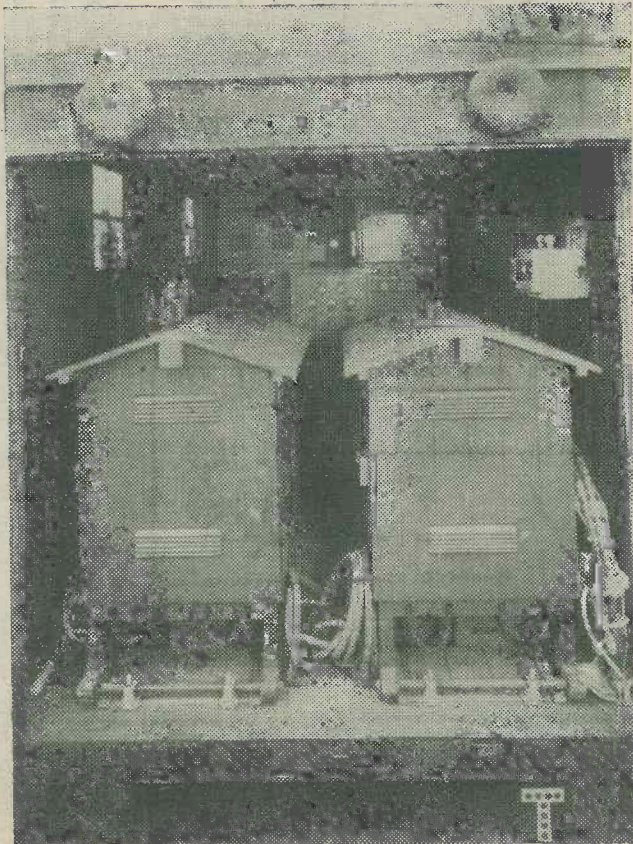

Fig. 1.—Interior view of the trailer showing the marker beacons in the foreground. The main beacon transmitter may be seen at the rear left.

38 mc/s—the eighth harmonic of the crystal. The modulator portion comprises a double-triode tone oscillator, followed by a double-triode Class B amplifier. Fig. 5 shows the valve layout.

The total power input of the marker transmitter is about 210 watts, and the output carrier power into the aerial feeder is approximately 5 watts.

It is essential that there should be no metal structures or wires within a 200yd. radius of the aerial and that within 500yd. there should be no obstruction which subtends an angle greater than one in 15 with the main beacon site. This includes houses and other buildings which, although mainly of non-conducting material, contain wiring and pipes which can act as

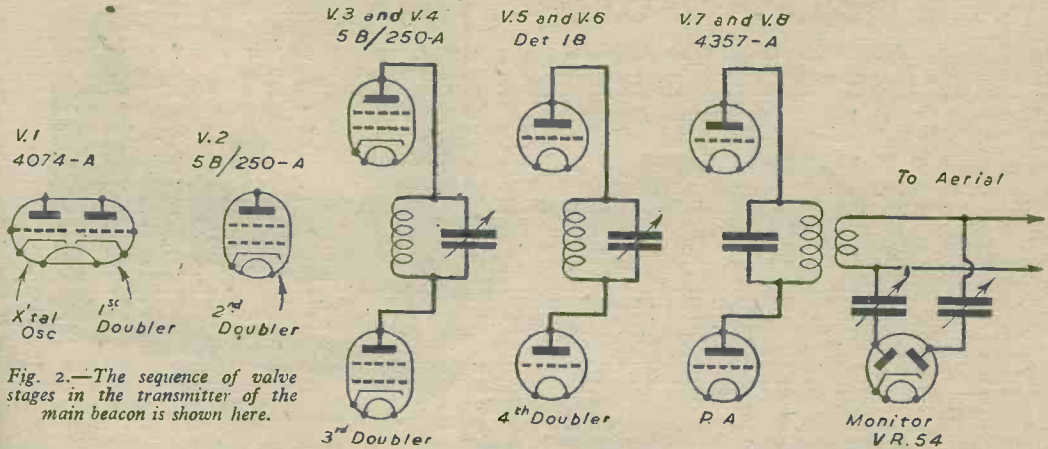

Fig. 2.—The sequence of valve stages in the transmitter of the main beacon is shown here.

It will be seen from the accompanying illustrations that the marker transmitters are housed in small V-roofed wooden huts which provide the necessary protection against the weather. The transmitters can be operated from either a 230-250 volt, 50 c/s A.C. mains supply or from the petrol-electric power units

spurious reflectors. Within the lower distance limit there should not be any ferro-concrete structures of any kind; this includes roadways. Similarly, any overhead wires should be replaced by buried cables.

In some instances, which may have been noticed, it is necessary to site the main beacon across a road running

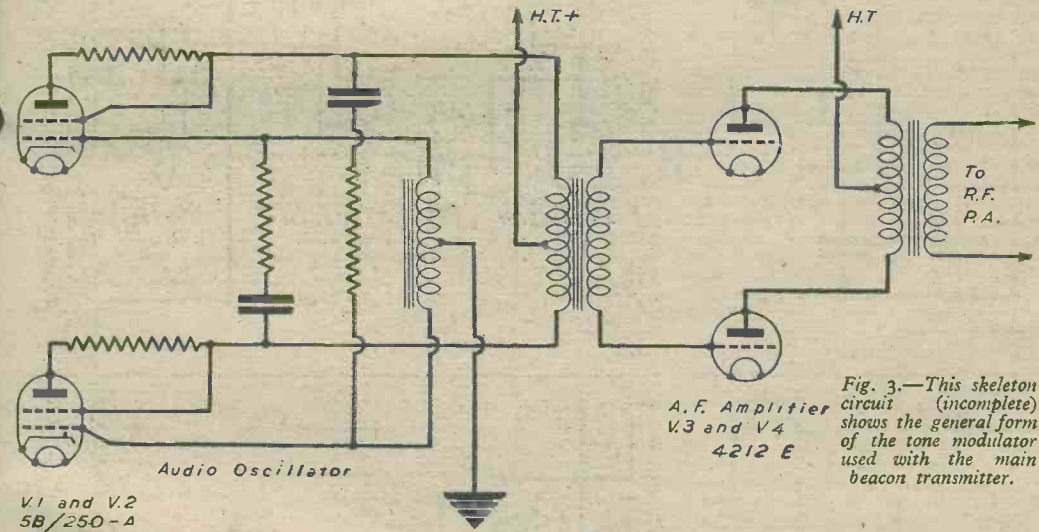

Fig. 3.—This skeleton circuit (incomplete) shows the general form of the tone modulator used with the main beacon transmitter.

already mentioned. In general, a mains supply is used and the petrol-electric sets are held for stand-by use in the event of power failure.

The siting of the transmitters, particularly the main beacon transmitter, is clearly a matter of the first importance, for it is essential that the beam alignment shall be accurate within extremely small limits. For reasons which will already be apparent, the main beacon must be in line with the main runway and fairly close to the upwind end. It is normally sited within rooyds. of the end of the runway, in such a position that it is well clear of any aircraft dispersal sites.

close to the end of the runway. If the road is to remain open to traffic it is essential that the beacon should be at least 200yds. back from it, since moving vehicles can cause deflections in the beam, while stationary ones are even more "mischievous." An example of the care which must be exercised was given by one installation which was sited in a wheat field. After the corn had been cut and stooked it was found each morning that the beam was deflected or "split." By mid-morning everything was again normal. It was found eventually that the dew-covered stooks were acting as fairly good reflectors, although they caused no trouble once the

dew had evaporated. The removal to a greater distance from the beacon of a hundred or so of the stools effected a complete cure.

The siting of the marker beacons does not normally present a serious problem, for they are invariably located well out in the country and generally in open fields. As long as they are accessible to the servicing mechanics, the more "isolated" they are the better.

It is, of course, essential that the markers be positioned in the exact centre of the "line of shoot" of the main beam, and accurate surveying is necessary to ensure this. In many cases a check is made by taking a series of aerial photographs from the outer marker to the main beacon along a line running down the centre of the runway and projected right out to the outer marker.

Alignment of the main-beacon aeriels is carried out by using a test set of the valve voltmer pattern. It is transportable and fitted with a dipole aerial. Tests are made at a standard distance of 57ft. 9in. from the aerial and in line with the centre of the beam; a marking post is generally placed in this position. Each reflector is shorted in turn and the reflector lengths adjusted until an exact equi-signal is obtained at the test point. This test is made at regular intervals, and immediately after any adjustment to the transmitter.

Although the explanation of S.B.A. which has been given in the four articles of this series is by no means complete, it is hoped that sufficient has been written to give the reader a fairly clear impression of the operation of the system as a whole.

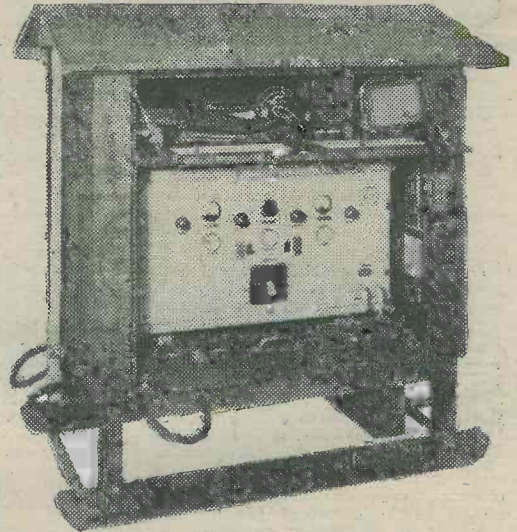

Fig. 4.—The marker beacon in its hutch.

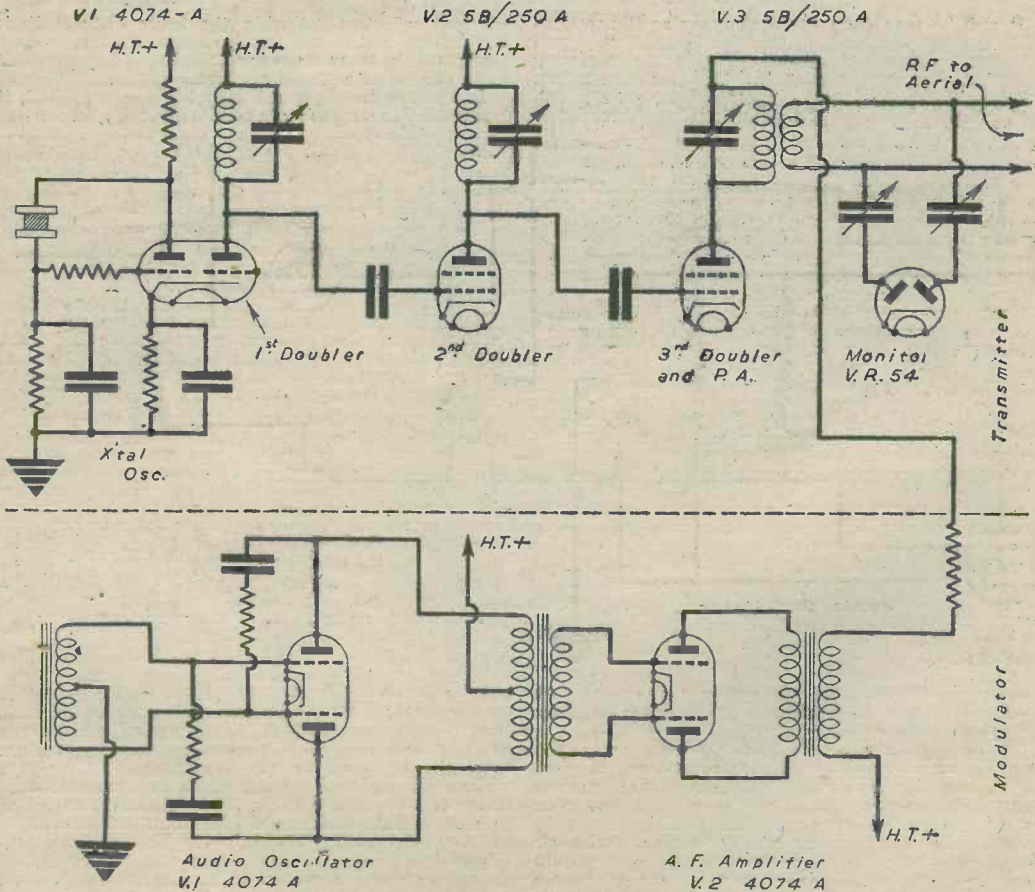

Fig. 5.—Skeleton circuit of the marker transmitter and its tone modulator.

Servicing of Radio and Television Receivers

Précis of a Discussion at a Recent Meeting of the Radio
Section of the Institution of Electrical Engineers

THE difficulty of repairing broadcast receivers during the war years has brought home to the general public the great importance of an efficient maintenance service. That this need is also appreciated by the industry was made apparent at a discussion meeting of the Radio Section of the Institution of Electrical Engineers which took place on December 11th.

The discussion was opened by R. C. G. Williams, Ph.D., B.Sc.(Eng.), M.I.E.E., who said:

"The engineering aspects of all equipment necessarily involve an assessment of the expected 'life.' Servicing facilities are essential to safeguard the interests of the user during that life and to provide forward information to design and production engineers. Broadcast radio and television receivers are typical cases and it is the manufacturer's obligation so to arrange his organisation that speedy and efficient service is available for all the receivers he has made and distributed. Many of the present hazards of radio servicing are due to the rapid growth of the industry.

Before 1930 radio manufacture was largely in the hands of home constructors, a few pioneer radio dealers, manufacturers of kit sets and a few manufacturers of high-priced luxury models. Most sets were battery driven, and the principal form of service was the provision of charging facilities for accumulators; maintenance repairs were regarded as a necessary evil. The early 1930's saw the growth of mass-production manufacture and its associated national distribution. Dealers were called upon to provide service, although the rapid growth of technique tended to stimulate set replacement, which in consequence eased the service situation. In the later 1930's, sets became very much more complex with the introduction of short waves, special tuning devices, push-buttons, band spreading, and, immediately before the war, of television. Dealers' service facilities were improving, but on the whole were unable to cope with the increasing complexity of the product. During the war years, staff and supply difficulties, coupled with a lack of new sets, led to the growth of "free-lance" servicing, in many cases by individuals working on a part-time basis.

Service Department

The basic responsibility for service can be met by either centralized and decentralised organisations, the latter being on the whole the better from the point of view of the customer. Manufacturers' service departments provide a "repair base" for faults beyond the capacity of the dealers, and for assisting dealers' service departments with technical advice and service literature. Statistics of faults show that the majority are of a simple nature and require familiarity rather than knowledge on the part of the serviceman. A smaller proportion are more complex electrical faults, while the residue are troublesome intermittent faults.

Much is being done to provide and improve educational facilities for radio service technicians. Many technical schools and manufacturers provide courses, and examinations of proficiency are held. Full-time or part-time courses undoubtedly provide the best training, but many servicemen already in the trade have taken correspondence courses or gained factory experience. Varying opinions have been expressed about the effect of wartime training, but it is doubtful whether the specialised experience acquired can be directly applied in the commercial field.

Modern receivers require a dealers' service department to be equipped with proper measuring gear. Capital cost and lack of trained staff have resulted in few departments having even essential gear available.

Without a radical change in attitude and quantity production of standard measuring gear, which will make it economic for a dealer properly to equip and staff his service department, dealer servicing is bound to lag behind the progress in technique.

Repair information transmitted by dealers to manufacturers' design sections alone enables the designer to assess the real first-cost of reliability. Not only is component reliability influenced, but also equipment design for affording ease of access and fault location. Further rationalisation of component designs, which has made considerable progress during the war through the "preferred-type" specifications, should ease replacement-part stocking problems.

Variation in the population density over the country is an important economic factor. Country dealers have a large low-density area to consider, compared with the town dealers' small area of high density; the ideal balance is seldom realised. The wide differences found have contributed to the difficulties of drawing up standard repair charges such as has been attempted in the motor industry. Maintenance schemes and manufacturers' guarantees form part of this rather complex problem.

Television Servicing Problems

Television, with its higher frequencies and operating voltages, special aerial rigs and new principles such as time-base and synchronising circuits, provides many servicing problems. Television dealers were limited in number to guard against receivers being handled by unskilled service departments. The restoration of the television service immediately raises the problem of overhauling all receivers sold before the war; many manufacturers are making special arrangements for this. The future growth of television emphasises the importance of proper professional interest in the training of service engineers.

Predominant post-war problems are the orderly absorption into the service field of wartime trained engineers, the proper equipment of departments and a sound outlook on the economics of servicing without which neither staff nor equipment can be supported. It is essential that the principles evolved are properly applied to the setting up of service facilities abroad for the export trade."

In the ensuing discussion, most speakers touched in one way or another on the training of servicing technicians. The general opinion was that the emphasis during training should be on the practical side. It was agreed that a good grounding in principles was essential, but that familiarity with the actual technique of fault finding was exceedingly important in any commercial organisation. The need for a diploma or other recognised qualification for the competent man was emphasised and several speakers took the view that the maintenance branch of radio should be regarded, not as a blind-alley occupation, but as a stepping-stone, and that some of the personnel of the manufacturer's research and development laboratories should be recruited from this source.

Many speakers expressed doubt about the value in the commercial field of the technical training given in the Services during the last six years. It was recognised, however, that while the experience on particular Service equipment might have few direct applications, the basic training in principles would form a foundation on which broadcast maintenance technique could be built.

There were many pleas for better liaison between the repair organisation and the development personnel, and it was pointed out that such liaison was of great value to the manufacturer in giving him early warning of

unreliable components. Standardisation of components especially capacitors and knobs—was demanded in order to reduce the number of parts which a repairer had to stock. This was, at present, often over 1,000 items, and the matter was especially important overseas. Very many speakers advocated the adoption of plug-in electrolytic capacitors.

Maintenance Information

The view that more complete maintenance information should be provided by the manufacturer was expressed. It was suggested that both complete and simplified circuit diagrams should be provided and that the handbook should explain the functions of circuit details. A further suggestion to help the service technician was that diagrams of the component lay-out should contain

an indication of which end of a part was which, and it was shown that this could be done very simply.

On the test equipment necessary, there were two schools of thought. Perhaps the majority took the view that a multi-range testing meter, a signal-generator, a valve-voltmeter, an A.F. oscillator and an output meter were essential. Others felt that most of these functions might well be combined into a single multi-purpose test set, but those of the first opinion thought it was advantageous to have separate instruments. All agreed that a signal-generator rather than a test oscillator was necessary.

The advantages of an electronic ohmmeter were stressed by many, and the need for a high-voltage source for insulation testing in television apparatus was pointed out. Everyone agreed that the employment of first-class equipment was essential.

Programme Pointers

By MAURICE REEVE

THE experiment of having a weekly piano recital at the fixed hour on Tuesdays of 10.15 p.m. has proved such a success that the question of reviving the "Foundations of Music" series may be of interest.

Many readers will recall that up till a year or so before the war they were able to switch on every evening from Monday to Friday, throughout the year, and, for 20 minutes between 6.30 and 6.50 in weekly periods, listen to the specialised presentation of some feature of classical music.

During the course of many years, the keen student, as well as the more ordinary music lover, was able to listen critically to such a varied assortment of favourite subjects, both of study and entertainment, as the different sets of Chopin's works, Bach or Beethoven, songs in groups and cycles, chamber music classics, violin or cello masterpieces, etc., etc.; in fact, most things were covered except the totally impractical masterpieces of symphony or opera, etc., for reasons too obvious to need explanation.

Complaints were received on such points as the inconvenience of the hour chosen, the undesirability of dividing the important works in sonata or variation form into halves and spreading them over two performances, and the stereotyping of the programmes generally. These and other criticisms should, however, be easy to iron out. The main consideration is: Are there a sufficient number of music lovers and specialist students wanting to listen in for 20 minutes on five consecutive nights to Bach's Preludes and Fugues, Beethoven's Violin and Piano Sonatas, or Schubert's Songs to warrant the restoration of what used to be considered an attractive and useful feature?

The enormous success of the concerts in honour of Sibelius's eightieth birthday proved beyond a scintilla of doubt that, even during his lifetime, this great master has succeeded in winning for himself such a secure position in the classical concert repertory that he is already a classic and in the direct line of succession of the great symphonists. Notably the first, second and fifth are safe for all time in the hallowed company of Mozart, Beethoven, Schubert and Brahms. The applause at the conclusion of Sir Thomas Beecham's performance of the second was so great that it was still going on after most of the lights had been put out and the orchestra starting to wend their homeward way. Not even Beethoven or Shakespeare can command more.

Television Programmes I

The imminent commencement of television programmes prompts much speculation as to the lines likely to be adopted for their completion. I may have more news for you on the subject later. In the meantime we are

left wondering as to whether completely new ground will be broken in programme building.

Firstly, we should surely clear up the not unimportant point of what those of us who become the possessors of television sets are to be called. Clearly we are entitled to rise one in the hierarchy of entertainment. From having been mere "listeners-in" for nigh a quarter of a century, how shall we be addressed or referred to whilst we watch the Derby winner flash past the winning post, or Mademoiselle Tra-la-la delight us with her charming frock equally with her delightful voice? Watchers? No, that won't do for a moment. Tele-watchers, hardly any better. And watchers-in sounds even worse than listeners-in. Perhaps the French, ever helpful in such matters, will coin a word when they get their own service going. They have, after all, often come to our help in past instances, and the words are now part and parcel of the world's dictionaries. Looker-on, or onlooker, is the very feeble best I am capable of figuring out. Fireside watcher savours too much of wartime watching this, that and the other.

Presumably, for some time to come whilst a continuous studio-staged programme is being worked out and devised, our staple diet will be sporting events, pageants, ceremonies and the like; together, perhaps, with a specially mounted studio item such as a famous opera or concert star. But the fun will commence when the studio television programmes become a regular feature and a daily habit.

The great fear that looms up before me is that a Hollywoodish view may be taken of programmes, and that no one who isn't beautiful and oomph-ish, and nothing, in fact, that doesn't please the cinema-going public will gain inclusion. This would be a fatal blunder and one we must all trust will not be made. Doubtless, dazzling reputations could quickly be made, and many a pleasing eye-ful lined up in the studio for sequential presentation, just as our cinemas are largely the medium for featuring an unending consecution of glamour girls and playboys.

"Talent to be Served"

We shall all expect talent to be served, as hitherto on the wireless. And we shall also expect "lookers-on," "watchers-in"—or whatever we become—to seek talent irrespective of its appearance. Gone will be the day when artists could work in their shirt sleeves, and collarless, too, sometimes, and when the stee to a red light was the most informal of proceedings. Gone, as well, will be the days when actors could read their scripts sitting in front of the "mike," and when the passionate throb imparted to "Darling, I adore you; will you be mine," and similar noble and gratifying sentiments,

could remain unaccompanied by the slightest appropriate gesture.

Turns of all descriptions will have to be produced, I imagine, just as for a theatrical or concert performance, with artists taking their bows and acknowledging the unheard applause of their unseen audience. Possibly, a fading-in-and-out system, as on the screen, will be evolved, leaving artists in the act of being "played on" or "off," as the case may be. But, whatever happens when television becomes as regular and continuous a feature as broadcasting now is, studio work and its production and presentation is bound to be very different. Even artists' contracts will specify the dress to be worn in all its details. They will have to increase the number of boiled shirts, and other appurtenances, in their wardrobes. All will need time and practice in which to get accustomed to the new conditions. Just as a musician nowadays is apprehensive of a wrong note being heard away in Perth or Plymouth, so will a lady be in a high state of nerves lest her lipstick or rouge be not considered perfect in Adelaide or Accrington.

Well can I remember those seemingly far-off days when a Scotch-and-soda was about eightpence and standing inside a bus more or less compulsory rather than verboten; I mean, in other words, the early days of broadcasting from Savoy Hill, when Rex Palmer used

to announce artists, who either awaited their turn in the only studio, or outside in a waiting-room; and who used to read notices hanging on the wall such as "Don't forget the audience, which is there though you cannot see it" (my words), during their waiting-for-the-dentist-like ordeal.

It was pleasant then, and I don't think the Regent Palace Hotel atmosphere, subsequently introduced, has changed it to its benefit, though it doubtless has improved its amenities.

Programme-building

Programme-building must be an exceedingly difficult task, especially under our monopolistic one-company system. Complete satisfaction is probably unobtainable. In view of the multitude of hurdles to be jumped—the tastes, wants, prejudices, likes and dislikes encountered by the programme department of the B.B.C. must be as revealing as staggering—wonders are done every week. But with the coming of more normal conditions and the advent of post-war developments approaching, new ideas and points of view will be bound to obtrude themselves both on the department and the listening public, whose wishes and tastes they constantly study. I will try and touch on some of these in a future article.

A Self-contained Midget Receiver

Constructional Details of a Neat One-valve Battery-operated Set

THIS receiver combines the advantage of small size with that of cheapness of construction. Its dimensions are 7in. by 4in. by 2½in. No midget parts are used. The set is particularly suitable for travelling as no batteries or earphones have to be carried externally.

A small throw-out aerial is normally used, but the set works quite well using a bed-spring as an aerial. An earth is not necessary but may be found useful in some areas, so a terminal has been fitted for it.

Components Required

The valve used is a Mullard P.M.2, but nearly any 2-volt detector or L.F. triode will do. Although the valve is of the two-volt type it works quite efficiently on 1½ volts L.T. This is supplied by one cell of a No. 8 battery. The holder for the battery is a bent piece of

metal which is anchored to the valve-holder by a right-angle piece of metal as shown in the diagram. Bakelite dielectric condensers are used for both tuning and reaction, and in order to economise space the spindles are

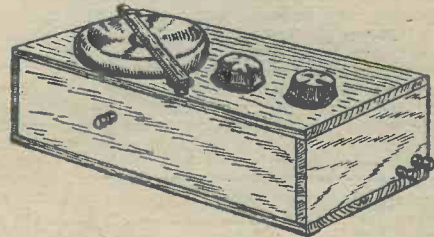

Fig. 2.—The completed receiver—showing the earphone in its holder.

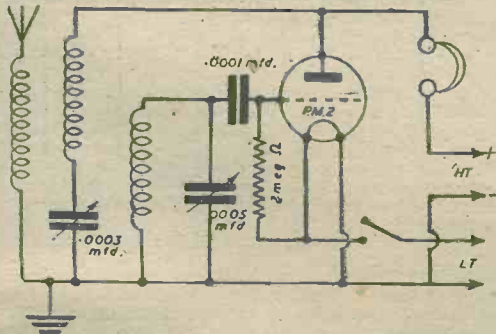

Fig. 1.—Theoretical circuit of the receiver.

cut short until they are only just long enough for the knobs.

The earphone fits into a hole in the case and is held in position when not in use by a bar of wood. For details of this, see diagram. It will be found necessary to remove the earphone leads and substitute thinner wires or there will not be enough room for them in the case.

metal which also acts as the negative terminal. The positive connection is made by a small valve cap clip bent to size. The H.T. is 9 volts and this is supplied by two No. 1289 4½ volt batteries in series.

The coil can be wound by the constructor or a small commercial one used. The home-made one used by

LIST OF COMPONENTS

- One variable .0005 mfd. bakelite-dielectric condenser.
- One variable .0003 mfd. bakelite-dielectric condenser.
- One coil.
- One base-board mounting valve-holder.
- One valve, Mullard P.M.2 (or similar).
- One .0001 mfd. fixed condenser.
- One 2 megohm resistance (half watt).
- One switch (push-pull type).
- Two terminals.
- One earphone.
- Wire, wood, screws, brads, etc.
- Two No. 1289 Ever-Ready batteries.
- One No. 8 Ever-Ready battery.

Order of Assembly

No difficulty should be found in the construction of the set. The positions of all components are shown in the diagram. It is best to start by mounting the valve-holder and coil on a piece of plywood 4in. by 2½in. The earphone and condensers are then fixed to another piece of wood 7in. by 2½in. The two are fitted together and all possible connections carried out. The remainder of the components are mounted as the rest of the case is built up around these two pieces of wood. Wire of approximately 26 s.w.g. should be used and the shortest possible connections made. The wood for the case is held in position by small cabinet pins or brads.

Switching is carried out by a push-pull switch in the L.T. positive lead. This type of switch was chosen

Fig. 3.—How the ear-
phone is held in position
on the containing case.

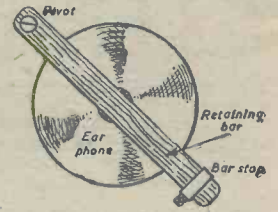

because the ordinary "toggle" switch has a nasty habit of getting turned on when in a confined space. This is impossible with the push-pull switch as it is off in the "in" position.

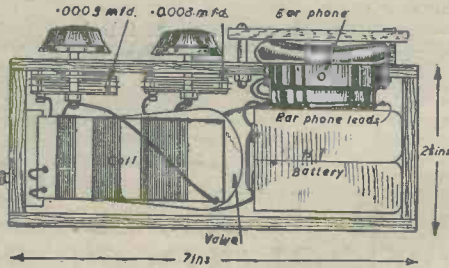

Fig. 4.—Side view of the receiver.

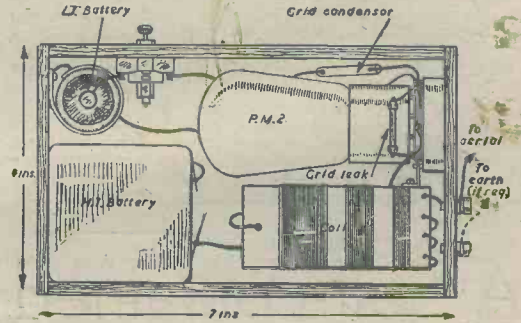

Fig. 5.—Plan view of the completed receiver.

Vibrators for Car Radio

(Continued from page 148.)

specified, the contacts tend to wear more quickly because of the reduction of contact pressure, that is to say, the magnetic field will not be of sufficient strength to attract the reed properly.

Smoothing, and Removing Interference

Whether or not one decides to use a non-synchronous or synchronous vibrator power pack, it is advisable to incorporate a small condenser between the positive

heated rectifier is used to prevent core polarisation, and so that the cathode can be used as the H.T. positive feed to the receiver concerned, whilst the negative feed is taken direct from the centre tap of the secondary winding. It is good practice to incorporate an R.F. choke in the positive battery feed to the valve filaments in the receiver. One must not forget, however, to ensure that the battery can supply the total filament current.

The smoothing and filter unit is similar to that of any

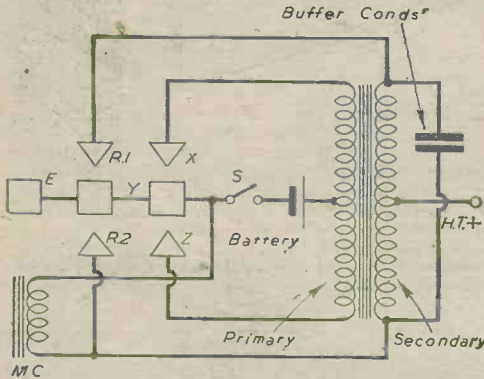

Fig. 3.—Basic synchronous vibrator circuit.

battery terminal and the chassis, the latter being at earth potential. This condenser will help to prevent R.F. generation and arcing at the contacts when they are undergoing their make and break action.

Another condenser is usually found connected directly across the secondary output terminals, this being used as a buffer condenser, which not only suppresses R.F. interference, but acts as a control over a high-voltage surge which might occur when the contacts make and break.

In the non-synchronous packs; a full-wave indirectly-

Metal Transferred to
Reed Contact Due to
Overloading

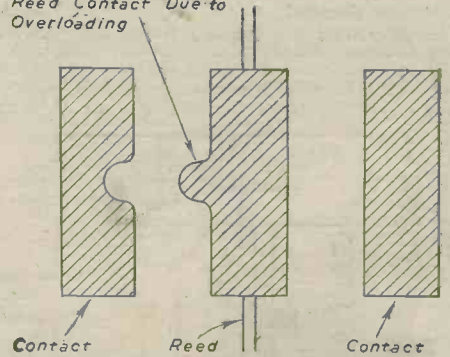

Fig. 4.—A common vibrator fault shown in section.

A.C. mains receiver, comprising two or more electrolytic condensers for smoothing and with the usual L.F. choke, but in this case preceded by an R.F. choke, the latter to help suppress any R.F. that may have been generated.

Similar precautions must be taken in the case of synchronous power packs, but it must be remembered that the centre tap of the secondary windings in this case is the H.T. positive feed, a definite difference from the non-synchronous packs. The reason for this is that the output from the secondary winding is fed back through another pair of contacts, "R.1" and "R.2," in the vibrator, and results in it being rectified (Fig. 3).

GALPINS

ELECTRICAL STORES

408, HIGH STREET,
LEWISHAM, LONDON, S.E.13
Phone: LEE GREEN 0309

TERMS: Cash with Order. No C.O.D.
All prices include carriage or postage.

ELECTRIC LIGHT CHECK METERS, first-class condition, electrically guaranteed, for A.C. mains, 200/250 volts 50 cy. 1-phase 5 amp. load, each 12/6.

AUTO TRANSFORMERS. Step up or down, tapped 0-110-200-220-240: 1,000 watts, £5.

TRANSFORMER CORE for rewinding only, complete with clamps, size approx. 2½ kW., price 25/-.

LARGE PAXOLINE PANEL, size 14 x 7 x ½ in., fitted massance switch arm, 12 large studs and contact blade, very smooth action, price 7/6 each.

LARGE OUTDOOR BELLS, 110 v. D.C. working, 6in. dia. gong, 17/6.

LARGE FAN MOTORS, all direct current, approx. ¼ h.p. 110 v. series wound, in first-class condition, 15/- each.

D.C. MOTORS, as above, only for 220 volt, in perfect order, 20/- each.

ROTARY CONVERTERS; 230 v. D.C. input, 230 v. A.C. output, 50 cycle single phase 1,250 watts, for heavy duty, £35.

H.T. TRANSFORMER, input 110-220 v., output 90,000 v. at 2½ kW. Price £35.

FIXED RESISTANCES, size 12ins. by 1in., 2 ohm to carry 10 amps., 2/6.

PRE-SELECTOR SWITCHES, ex G.P.O., eight bank, each 25 contacts, complete with actuating relay, 50/-.

MOVING COIL METERS, 2in. dia., flush mounting, 0-5 mA., 35/-; 0-50 mA., 32/6; 2in. dia., 0-100 mA., 27/6.

MOVING COIL VOLTMETERS by Famous Maker, type 301, reading 0-10 volts, 2in. dia., panel mounting, as new and unused, nickel plated finish, price 45/-.

ROTARY CONVERTOR, input 230 v. 4½ A., direct current; output, 80 v. 6½ A., single phase, 2,000 cycles, £7/10/-.

HEAVY DUTY CHOKES by Famous Maker, weight 14 lbs., wound 19 gauge wire, two equal coils, 4 terminals, total resistance 10 ohms, price 35/-; Ditto, 12 lbs., single winding, 22 gauge, 15 ohms, 30/-; Ditto, 10 lbs., 20 gauge, two coils, 6 ohms, 25/-.

METAL RECTIFIERS, large size, output 50 v.-1 A., 35/-; Ditto, 12 v.- 4 A., 50/-.

EX. G.P.O. RELAYS, Multi-leaf, very low current working, 10/- each.

CLOSED half-day Thursday.
OPEN all day Saturday.

WEBB'S Radio

A few useful items from our Comprehensive Stock

EPICYCLIC reduction gears, ratio 5-1 ... 2/9

WESTINGHOUSE Metal Rectifier—type H1, half-wave, 3.5 v., 15 mA., useful for meter work ... 2/-

RELAYS sensitive, operating on 57v.-5 mA., resistance 15,000 ohms 12/6

SCREENED CONNECTORS for octal top-cap ... 6d.

PUSH-BUTTON UNITS 6-way, complete with escutcheon, etc. ... 8/6

KEYS Operating keys, G.P.O. bar types ... 28/6 22/6

Practice Keys, moulded bakelite ... 2/-
G.P.O. bar type ... 5/-
U.S.A. streamline metal ... 3/6

CONDENSERS T.C.C. paper 4 mfd., 750 v. working ... 9/6

BROWN'S TELEPHONES Lightweight, 2,000 ohms. ... 24/6

U.S.W.

COMPONENTS

For 5 metres (and below) refer to EDDYSTONE leaflet, available on request. Send 2d. stamp.

Use

DURALUMIN TUBE

for your 5 metre aerial, available in 8-foot lengths. 4/- each.

but — CALLERS ONLY!

WEBB'S RADIO, 14, Soho St., Oxford St., London, W.1. Telephone: Gerrard 2089

We are available 9 a.m. till 5.30 p.m. for OFFICIAL business, but please note our SHOP HOURS—9 a.m. to 5 p.m. (Saturdays, 9 a.m. to 1 p.m.)

For ABSOLUTE RELIABILITY—use EDDYSTONE SHORT WAVE COMPONENTS

WRITE for CATALOGUE AND CURRENT PRICES



H.F. & V.H.F. CHOKES

Wound on special grade D.L.9 bakelite former with rigid wire ends moulded in. 4 13/16 in. long. Dia. ½ in. approx. Type 1010, 4-section. Type 1011, single layer wound. Type 1022, 5-section.

MICRODENSERS

Type 1094 Series. All brass construction, soldered vanes for low series resistance at H.F. Heavily silver plated to prevent oxidation. Constant capacity assured by D.L.9 end plate. ½ in. dia. extension spindle. Single hole fixing. (See range in catalogue.)

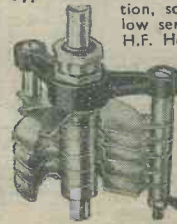

COIL FORMERS

Moulded in D.L.9. 8 ribs. Outside dia. 1 ½ in. Winding space of 2 ½ in. For low loss inductance for receivers and transmitters, Type 1002 Plain. Type 1003 Threaded.



COILS

Type 959. Three windings for comprehensive frequency coverage. Nine coils (from 9-2,000 metres). See catalogue for details and current prices.

FLEXIBLE COUPLERS



Type 1009. Free from back-lash. Banishes alignment troubles. D.L.9 Insulation for ½ in. spindles.

London Agents:

WEBBS, 14, SOHO STREET, W.1.

STRATTON & CO. LTD
EDDYSTONE WORKS
ALVECHURCH ROAD
WEST HEATH BIRMINGHAM.



With the weather off the 'secret' list and petrol back in the tank we begin to feel ourselves again. True, Dagenite and Pertrix Batteries are still in short supply—they have been busy 'on the job' in the East. Now that is over they'll soon be plentiful again in shops everywhere.

DAGENITE AND PERTRIX

BATTERIES FOR CAR AND RADIO

HOLSUN BATTERIES LTD
137 Victoria Street, London, S.W.1

D15/45

Varley

SLIDER RESISTANCES



WE KNOW

YOUR CHOICE WILL BE VARLEY. The name which has stood for quality, reliability and good service for over twenty years.

TEST EQUIPMENT · LABORATORIES
BATTERY CHARGING · SPEED CONTROL

OLIVER PELL CONTROL LTD

CAMBRIDGE ROW · WOOLWICH · S.E.18

TELEPHONE: WOOLWICH 1422

CONCORDIA L.V. TRANSFORMERS

Designed by transformer specialists to suit given conditions of service.

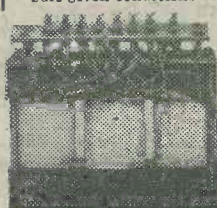

Types available for Radio, Bell, Lighting, Mines; type, phase changing. Concordia also design and make transformers up to 50 kVA, to customers' requirements, air or oil cooled, and arrange for any enclosures (damp-proof, totally enclosed, etc.).

Sole Agents: **ELCORDIA LTD.**,
225, Westminster Bridge Road,
London, S.E.1.
Tel.: WATerloo 5502/3.
Grams: Elcordia Lamb London.

ENQUIRIES INVITED

WE ARE MANUFACTURING

RADIO SETS, COIL PACKS (3-WAVE),
I. F. TRANSFORMERS, MAINS TRANSFORMERS,
L. F. CHOKES, 3-WAVE COILS,
HIGH-FREQUENCY COILS OF ALL DESCRIPTIONS.

WEYMOUTH RADIO MANUFACTURING CO., LTD.

CRESCENT ST., WEYMOUTH, DORSET

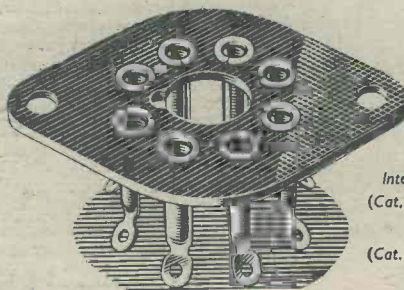

International Octal
(Cat. No: VH 232/B)

Mazda Octal
(Cat. No: VH 92/B)

CLIX SINGLE PLATE OCTAL VALVEHOLDERS

(Standard 1½" fixing centres)

These valveholders, incorporating the latest "CLIX" resilient sockets, will retain the valve under most exacting conditions. In use by leading Set Manufacturers for Home and Export Sets.

RETAIL PRICE 4d. EACH

also available in Tropical Grade

See current Price List for details of all Clix Components

BRITISH MECHANICAL PRODUCTIONS LTD.

21 BRUTON STREET, BERKELEY SQUARE, W.1

Grams: TROLINX, WESDO, LONDON Phone: MAYFAIR 5543

Impressions on the Wax

Review of the Latest Gramophone Records

WHEN I reviewed 27 records last month, I stated that it seemed more like old times to have such a wide selection from which to choose new additions to our record libraries. Well, the good work is, I am glad to see, continuing. In fact, this month brings 28 new releases of such a widely varying nature, that once again there is something good for everyone. At least, that is the impression which I obtain from a study of the titles, but, as a reader has pointed out, this does not mean that you and every other record enthusiast will agree. This raises, once again, that moss-covered and rather pointless controversy: "How or why can a critic or reviewer state that this or that record is good, indifferent or bad when the ultimate verdict really rests with innumerable people of such widely varying tastes and ideas?" The people who put that question fail to realise, through allowing their own particular opinions to swamp their judgment or understanding of anything which does not conform to what they find pleasing, that the lot of a reviewer is not a happy one. It is assumed that the critic or reviewer has sufficient experience and knowledge of the subject he writes about, and that by virtue of these qualifications he is in a position to say whether a performance or recording is perfect or otherwise.

H.M.V.

LOVERS of the great works by Sibelius will welcome and appreciate five 12in. Red Label H.M.V. records which head the list of their releases this month. I refer to *H.M.V. DB6244-48*. The first four of these cover the three movements of "Concerto in D Minor (Op. 47)," by Sibelius, performed by Ginette Neveu (violin), and The Philharmonia Orchestra, conducted by Walter Susskind. The fifth record (*H.M.V. DB6248*) is "Karelia Suite (Op. 11)," Intermezzo and Alla Marcia, by the same composer. These five records form a fine example of the perfect combination, namely, a performance and presentation of a high order.

On *H.M.V. C3478-80* Phyllis Sellick (pianoforte) and the City of Birmingham Orchestra have made an enjoyable recording of Walton's "Sinfonia Concertante," the orchestra being conducted by the composer. Five sides of the three records are devoted to the three movements of this work, which takes the form *maestoso*, *andante con moto* and, finally, *allegro vivo sempre scherzando*. Miss Phyllis Sellick plays with precision and delightful expression, and she is ably supported by a first-class performance from the orchestra. On the remaining side of the third record, the Philharmonia String Orchestra have recorded incidental music to the film *Henry V.* (a) "Death of Falstaff," and (b) "Touch her Soft Lips and Part," both compositions being by Walton.

In the 10in. H.M.V.s, there is *BD1118*, recorded by Perry Como (baritone with orchestra) singing "I'll Always Be With You" and "I'm Confessin'." On *H.M.V. BD1119*, Pat McCormac with Joe Loss and his Orchestra, offer "Silent Night, Holy Night" and "Santa Lucia."

Columbia

HERE are five 12in. Columbia records which should have a very wide appeal, so much so that I strongly recommend them for your hearing. The first two, *Columbia DX1225-6*, are recordings by the City of Birmingham Orchestra, conducted by George Weldon, of "Spanish Dances Nos. 1-5," by Moszkowski. The next, *Columbia DX1228*, is an exceptionally fine recording of a pianoforte solo by that talented artist Denis Matthews, playing "Nocturne in E Minor" and in "Nocturne in E Major," "Midi in Rondo Form," both works being by Johu Field.

On *Columbia DX1227*, Debroy Somers' Band have made a most enjoyable recording of "A Stanford Rhapsody," which is founded on Charles Villiers

Stanford's "Songs of the Sea." It introduces "Drake's Drum," "Homeward Bound," "Devon O' Devon in Wind and Rain," and "The Old Superb."

In a still lighter mood, *Columbia DX1229* offers Nos. 22 and 23 of the Old Time Dance Series by Harry Davidson and his Orchestra, playing in their inimitable style "The Saunter" (Underneath the Stars), and "The Florentine" (Valse Florentine). Recommended for those carefree moments, and easy enjoyable listening.

Here is my selection from the *Columbia* 10in. releases. For a vocal I advise you to listen to *Columbia DB2201*, on which you can hear a fine performance by Isobel Baillie (Soprano) and Kathleen Ferrier (Contralto), accompanied by Gerald Moore at the piano, singing, in the true sense, (a) "Let Us Wander," (b) "Shepherd, Shepherd, Cease Deceiving," and "Sound the Trumpet." Rawicz and Landauer provide two of their brilliant pianoforte duets on *Columbia DB2198*. They have selected for this recording, "Goliwogs Cake Walk" from Children's Corner Suite, and "Clair de Lune" from Suite Bergamesque. A topping record.

Frank Sinatra swoon-croons two numbers from "Anchors Aweigh," the titles of which are "What Makes the Sunset" and "The Charm of You," on *Columbia DB2200*. This will, no doubt, be welcomed by Frank's many fans, but personally, I cannot rave about him. Victor Silvester and his Ballroom Orchestra have recorded two good dance numbers on *Columbia FB3176*. They are "Gotta Be This or That," a Quick-step, and "I'll See You Again," a waltz. Lou Preager and his Orchestra, on *Columbia FB3180*, are recommended for a fast waltz and a slow foxtrot, as they have recorded "Cruising Down the River" and "Did You Ever Get That Feeling in the Moonlight," the vocals being taken by Paul Rich and Rita Williams.

Parlophone

AS usual, I open my *Parlophone* selection with Richard Tauber's latest recording, and this month he is well up to form with his rendering of "My Most Romantic Memory" and "For This I Pray," on *Parlophone R020544*. A nice record.

On *Parlophone F3356*, Jimmy Shand and his Band have struck rather a new or refreshing note, and they have made a good recording of "Scottish Country Dances in Strict Tempo." They introduce "Strip the Willow," "The Girl I Left Behind Me," "Miss Forbes' Farewell to Banff," "The 93rds Farewell to Edinburgh," and three rather thrilling Scottish jigs.

Following this, we can hear "Selection of Strathspeys and Reels" and "Eightsome Reel," played by the City of Glasgow Police Pipe Band, on *Parlophone F3355*. These two records will naturally have their greatest appeal north of the border, but I do advise all to hear them, as, as mentioned before, they come as a refreshing break and a tonic after so much of the modern dance music.

Sam Browne, with orchestra, puts up a good show with "Life is Nothing Without Music," sentiments with which I strongly agree, and "I'm So All Alone," on *Parlophone F2112*.

Now here are four good foxtrots for the dance enthusiasts. Gerardo and his Orchestra, on *Parlophone F2113*, playing "Ev'ry Time" and "Nancy." Jack Simpson Sextet, on *Parlophone F2111*, offers "Carolina" and "Did You Ever Get That Feeling in the Moonlight." All of these numbers are well orchestrated and presented.

Regal

HARRY LEADER and his Orchestra, from the Astoria Ballroom, London, have recorded "Two Can Dream as Cheaply as One," and Joe Murgatroyd with Harry, etc., in "Let's All be Miserable Together," on *Regal MR3769*.

Modified Midget Portable

Details of a Reader's Adaptation of a Novel Portable. By J. SWEENEY

SINCE my letter was published detailing certain modifications of the excellent little set described in the October, 1944, issue, I have had more enquiries for fuller particulars.

The original measurements are adhered to excepting depth of box—front to back—which needs to be 4in. instead of 3½in. to take long-wave winding. Windings must be raised 1/16in. from box by four layers of ¼in. insulating tape at the corners. This improves results to an almost incredible extent.

Being too far from a B.B.C. station for good results with the frame aerial alone, I carried out

insulating tape over the corners affords a firm bed for the windings.

Amended Coil Connections

Start of coil goes to tuning and grid condensers. Aerial

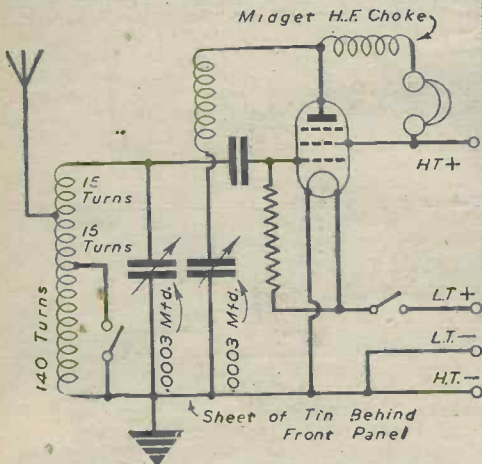

Theoretical circuit giving coil details.

experiments using this as the tuning coil; finally employing 30 gauge enamelled copper wire, which allows sufficient turns for the long-wave winding. The

is tapped at the 15th turn. The 30th turn goes to wave-change switch—two midget terminals with shorting strip on piece of paxolin with aerial socket, clearly seen in photograph in front of the valve. This is secured to a strip of copper bent at right angles, by the centre terminal, which is earthed, outside terminal going to 30th turn.

The original low tension supply recommended was found to run down very quickly indeed, but by making the little valve chassis 1½in. high instead of 1¼in., there is ample room in the opposite corner for a standard U2 dry cell—1½ volt, 2¼ x 1¼in., with small terminal lightly soldered to centre contact. This cell is held in place by a metal band bolted to box, a strip of springy metal ensuring good contact with H.T.— and earth. It will then be seen that the toggle switch must be fitted to the opposite side, near the valve chassis, a lead being taken across to L.T.+, as shown in photograph. The little dry cell will give an average of 80 to 100 hours useful service.

H.T. and L.T. Supplies

The two grid bias batteries in series, giving 18 volts, provide ample high tension for the amazing little IC5GTG valve now apparently in good supply.

It is essential to solder all connections and leads carefully, including joints to wander plugs. Earth connections to metal plate behind panel should be duplicated wherever possible, and separate earthing leads soldered to earth contacts on the two reaction type condensers. The centre pillars alone should not be relied upon.

Avoiding Difficulties

It pays to be very thorough indeed in the
(Continued on page 174)

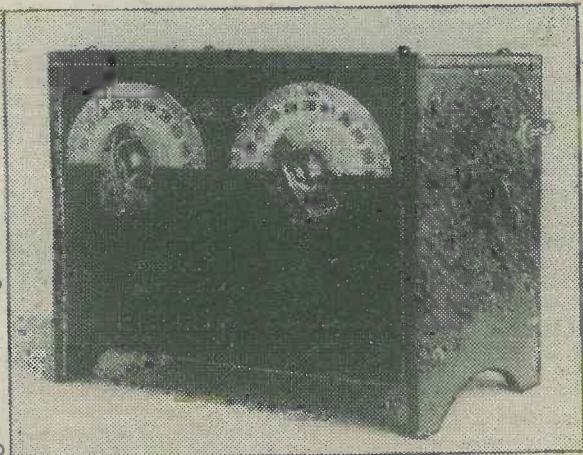

The finished receiver in its new cabinet.

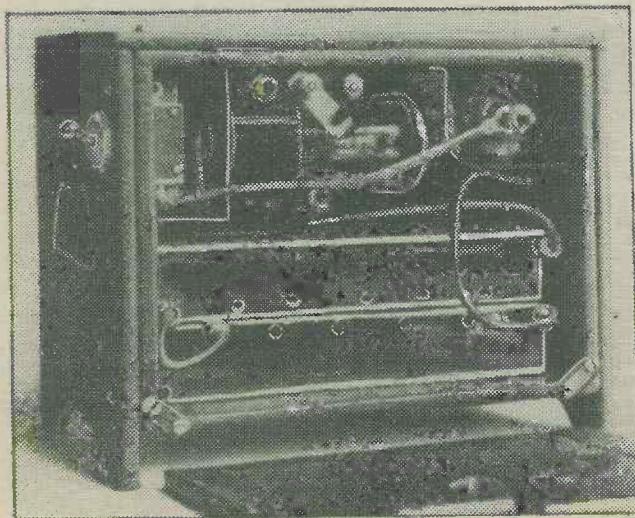

In this illustration the alteration to switching, etc., may be seen.

Economy Battery Charger

A Useful Accessory for Use on D.C. Mains Supplies

By "EXPERIMENTALIST"

IN the January issue of PRACTICAL WIRELESS for 1946, a reader gave details for a simple trickle battery charger for use on A.C. supplies, the maximum current obtained being $\frac{1}{2}$ amp. The charger incorporated a bell transformer and a variable resistance in its make-up, the rectifier itself (working on the vibrating reed system) consisting of an armature and contact, a small electro-magnet and a permanent magnet.

The $\frac{1}{2}$ amp. of D.C. current is ideal for charging a single 2 volt wireless accumulator which, assuming it is of 20 ampere-hour capacity, will take approximately 45 hours to be fully charged. Thus, there is considerable waste of useful electricity, but since the supply is A.C., the wastage is inevitable. The A.C. supplies must be rectified and reduced to produce a suitable D.C. charging current, and the trickle charger mentioned is a useful, simple type.

A Simple D.C. Charger

Charging small accumulators at home from the mains is a comparatively simple matter if the supply is D.C. In this case, it is usual to employ a suitable rheostat or a "bank" of electric lamps, such as the carbon-filament type, these taking more current per candle-power than those having metallic filaments. Here, again, we have considerable waste of electricity, although no rectification is necessary.

If you merely want to charge a small 2 volt cell at home from the D.C. mains supply, it can be done very conveniently — and without any waste. One merely makes use of the shed, attic, or workshop lamp. As it

burns, it produces useful illumination in the normal way, but at the same time, it is a small rheostat which allows a $\frac{1}{2}$ amp. of D.C. to pass through the accumulator.

As stated previously, it takes about 45 hours to charge a 20 A.H. cell. If, therefore, one adopts the simplified charging principle in one's "den" or home workshop, there is no wastage of electricity. Assuming the lamp is burned six hours each evening, the accumulator can be charged in a week—intermittently, of course. The principle is thus a slow but economic one, and to save

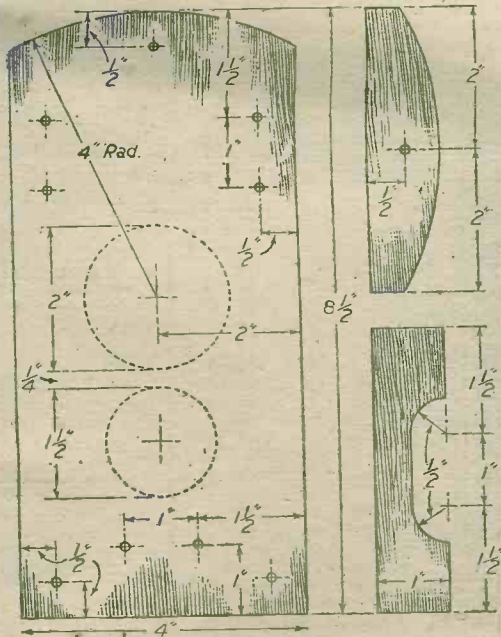

Fig. 1.—Details of mounting board, with back end pieces.

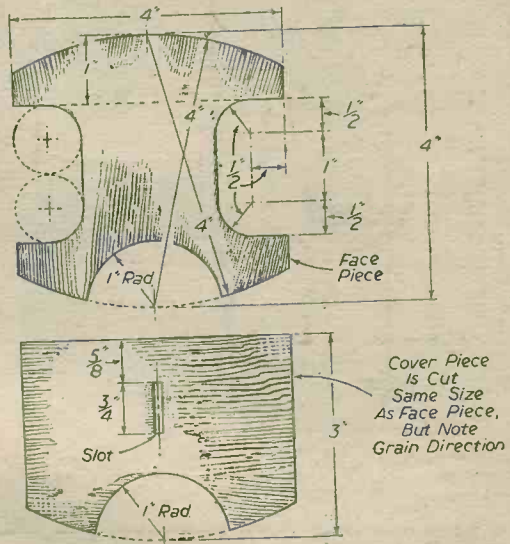

Fig. 2.—Terminal housing piece and part cover piece.

a lot of bother, the writer has designed a special switch-board which enables the lamp to be used for illumination only, with a "cut-in" for re-charging an accumulator, when necessary.

The Switchboard Parts

The switchboard is an easily-made affair consisting of a back piece cut to the size and shape shown at Fig. 1 from $\frac{1}{4}$ in. wood. The top and bottom end pieces are cut from $\frac{1}{4}$ in. wood, then glued and nailed to the back piece as seen by the side view (Fig. 3).

A terminal housing piece is required, this being cut to the shape and dimensions shown at Fig. 2 from $\frac{1}{4}$ in. wood (if you possess suitable pieces of plywood, use them). A protective cover piece, which is hinged over the terminal housing piece, is cut the same size as the latter to provide a top hinging piece, this resembling the top back end piece shown at Fig. 1.

All shapes are best cut with a coarse fretsaw (toy-making) blade fitted in a hand-frame. Having separated the cover shape from its top hinging strip, the latter is glued and nailed to the top, face side of the back board.

Terminals and Switches

At this stage you need six good terminals and a 2in. diameter and a 1½in. diameter bakelite shockproof switch, such as the conventional surface type. Terminals consisting of a round-headed bolt, nut, washer and milled edged circular nut are the best for the purposes in hand. The maximum height of the terminals, when attached, must not be more than ¼in.

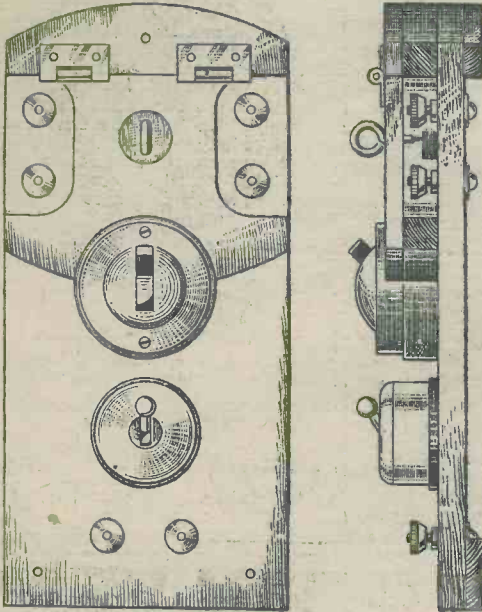

Fig. 3.—Front view of charger (with cover removed) and side view.

Having drilled the terminal holes and attached the terminals, the switches are placed in position and screwed on and the wire socket holes marked on the board. Unscrew the switches and drill ¼in. holes in the board to correspond with the switch sockets, then replace again.

The Wiring

The theoretical wiring plan gives a good ideal of the circuit, a back view showing the actual wiring (see Fig. 4). Use ordinary black and red flex wire, the ends being bared and looped under the terminal washers prior to tightening the bolts with a screwdriver.

Incidentally, to prevent dampness attacking the wood, the parts should be brushed with shellac polish, a single application sufficing. A feature with the polish is its quick-drying properties. It is best applied before adding the terminals, switches and the cover piece.

The Cover

The reason for a cover over the terminals is, of course, to prevent getting a shock when, for instance, groping for the switch in the darkness. So, attach the cover in place with two 1½in. long butt hinges.

A simple fastener is made by inserting a ¼in. diam. brass hook-eye, or screw-eye, into the back board so that the eye, when turned vertical, is in alignment with the cover slot and thus allows the hinged cover to be lifted upwards. It will be necessary to glue a disc of wood to the face side of the back board for the screw-eye (see Fig. 3).

Using the Charger

The completed switchboard, as suggested at Figs. 5 and 6, is attached to the shed, attic or workshop wall in a convenient position, the best position being determined by the wall-plug sockets or an existing switch (one could make use of the latter in making the switch board, by the way). If the bench, or a similar support for the accumulator, is not at hand, a small shelf could be attached to the wall close to the switchboard.

The mains wires, after the supply has been switched off, are connected to the top left-hand terminals on the switchboard. Wires, leading from the ceiling pendant lamp fitting, are connected to the top right-hand terminals. The two bottom terminals are for the accumulator leads, using a short length of twin flex having spade-ends at one end, or both ends, if desired.

Negative and Positive Terminals

Before going further, it is necessary to ascertain the negative and positive terminals, because these must correspond with those on the accumulator in the matter of supply, the negative and positive wires from the switchboard terminals always being connected to the negative and positive terminals on the accumulator.

A simple way to find the polarity of the supply is to connect the accumulator leads to the switchboard terminals. Fill a tumbler with cold water and add a teaspoonful of common salt. Switch on the supply (via the larger switch, the smaller switch being at the "off" position) and dip the ends of the accumulator leads in the salty solution.

The negative wire is the one on which gas bubbles form, the positive remaining unchanged. If you have used black and red twin flex for the leads and fitted red and black spade-ends to same, it will be easy to make a note of the negative wire which, if black, is correctly attached to the switchboard terminal, the red wire going to the other terminal. *Be sure to have the lamp in its fitting before making this test.*

Best Lamp to Use

To allow a current of ½ ampere to pass, a 200-volt, 100-watt gas-filled lamp is used. Other types of lamps

(Continued on page 172)

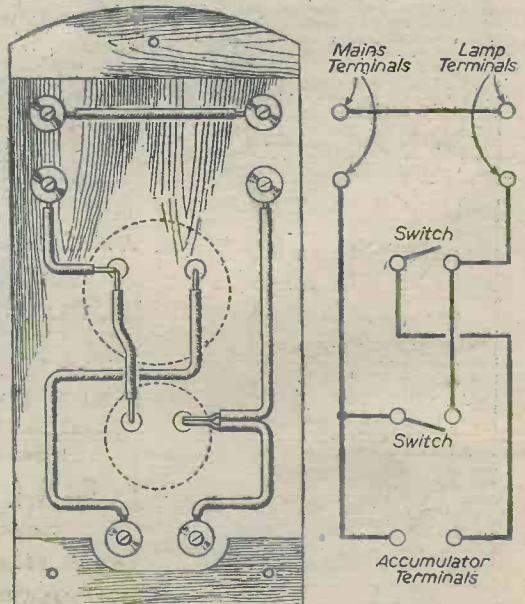

Fig. 4.—Details of wiring, and theoretical circuit.

VALLANCE'S PROMPT MAIL ORDER SERVICE

for Best Quality Radio Components.
MIDGET FOUR-VALVE A.C./D.C. TRF RECEIVER.—Medium waveband circuits, 9d. ea., from stock. Complete kit of parts, wire, screws, chassis, etc., less valves and cabinet, 25. Undrilled polished cabinet, size 10 1/2 x 6 1/2 x 5 1/2. Speaker hole cut and fitted with silk fret, 25/- Valves 6L7 and 6J7 at 12/10, KT32 14/8, U31 11/-.
PUSH-PULL OUTPUT TRANSFORMERS.—Speaker matching from 1-30 ohms, valve loads 1,500 to 16,000 ohms. Will match almost all types valves single-ended stages. Push-pull Class A. AB1, AB2 and B, 15 watts, 39/9, 37 watts 49/6. Full instructions with each.
CHARGERS.—2v, 6v, and 12v, at 1 amp., 24 10s., 2v, 6v, and 12v, at 2 amp., 25 18s. Varley Home Chargers 2v, at 1 or 1 amp., 25/-.
MAINS TRANSFORMERS.—All types supplied to specification.
CHEST TOP AMPHENOL VALVE HOLDERS.—English Types: 4-pin 11d., 5-pin 1/-, 7-pin 1/4, Octal 1/-, 9-pin Loctal 1/5. American Types: 4-pin 11d., 5-pin 1/-, 6-pin 1/1, 7-pin 1/4, Octal 1/-, 9-pin Octal 1/5, 11-pin Octal 1/5.
CERAMIC VALVE-HOLDERS.—English Types: 4-, 5- and 7-pin 1/8, Octal 1/6, 9-pin Loctal 2/-. American Types: 4-, 5- and 7-pin 1/6, Octal 1/6, Acorn 2/6.
SMOOTHING CONDENSERS.—8 mfd. 500v. 4/-, 8-8 mfd. 6/-, 8-16 mfd. 8/8, 25 mfd. 25v. 2/3, 50 mfd. 25v. 2/3, 50 mfd. 50v. 2/9.
TEST EQUIPMENT.—Wee-Merger Testers complete in leather case. Ever-shed/Vignoles, £10 15s. Mullard capacity resistance bridges, £15 15s. Hunts capacity resistance bridges, £19 18s. Avo valve testers, £16 10s. Avo Minor D.C. meters, 24 4s. Avo Minor A.C./D.C. meters, 29 10s. Avo meter 40 at £17 10s. Avo meter 7, £19 10s. Signal Generator Avo A.C., £13 10s. Taylor model 65B Signal Generator, £15 10s. **DELIVERY FROM STOCK.** All enquiries and orders dealt with immediately. We are always pleased to assist you.

VALLANCE'S
 144, BRIGGATE, LEEDS, 1.

PRATTS RADIO

1070 Harrow Road, College Pk.
 HARLESDEN, N.W.10
 (Nr. SCRUBS LANE)

VARIABLE CONDENSERS, small, .0005 mfd., 2-gang with trimmers, 11/3 each.
MAINS TRANSFORMERS, 350-0-350v. 4v., 4v., or 5v., 6.3v., 25/- each.
VOLUME CONTROLS (most values), less switch 3/6 each, with switch 5/- each.
LINECORD, 3 amp. 60 ohms per ft., 2-way 7d. per ft., 3-way 8d. per ft.
SPEAKERS, P.M. less transf., 2 1/2in. 25/-, 3 1/2in. 28/6, 5in. 21/-, 6 1/2in. 21/6, 8in. 22/-, With Pen transf., 6 1/2in. 25/-, 5in. 25/8, 8in. 27/6. Mains 2in., 2,000 ohm field, 8in. 30/-, inc. transf.
SPEAKER TRANSFORMERS, Midget 5/9, Heavy Duty or Multi-Ratio 7/6, universal 6/- each.
COILS, Medium Wave 5/6 pair. Superhet coils, L.M.S. wave, Aerial and Osc. 465 kc/s, 12/6 per set. Long and Medium wave with reaction 9/- per pair. (Diagram with all coils).
I.F. TRANSFORMERS, 465 kc/s, 15/- per pair.
INTERVALVE TRANSFORMERS, ratio 3/1 or Driver class "B", 7/- each.
SMOOTHING CHOKES, midget, 360 ohm 5/9 each, 380 ohm 60 ma. 6/6 each.
ELECTROLYTIC CONDENSERS, 450v. wkg. 8 x 8 mfd. 5/6, 16 x 8 mfd. 6/3, 8mfd. 4/- each, 25 mfd. 2bv. 1/9 each.
PAPER CONDENSERS. Most values in stock.
MISCELLANEOUS. Voltage Droppers, 3 amp. 5/-, 2 amp. 4/8 Valve bases 7d. each. Control knobs 8d. each. Toggle switches, S. or D.P.S.T., 2/- each.
VALVES. Large selection, inc. 2A6G, 252A, 6J7G, 6J5, 6K8, 6K7, 1D5, 1C5, 1H5, 1N5, 1A7, 8A7, 77, 75, 43, 8V6.
 S.A.E. for list or enquiries. Orders over 15/- post free, C.W.O. or C.O.D. Buses 662, 664, 18B pass door.
NEW GOODS ONLY.



The Universal AvoMinor.—An accurate moving coil meter providing 22 ranges of readings of A.C. voltage, D.C. voltage, current and resistance, on a 3in. scale. Complete with leads, testing prods, crocodile clips and instruction booklet. £8 10s.

MULTIMETER, Universal Instrument made by British Physical Laboratories. 1,000 ohms per volt, 1 m.a. full scale deflection, A.C./D.C., 10, 50, 100, 500 volts. M.A. 1, 10, 100, 500. Ohms 0-10,000. £8 15s.

MILLIAMMETER, 2 1/2in. Flush, Moving Coil D.C. Range 0-1. 46/9.

VOLTMETER, 2in. Flush, Moving Iron D.C. Range 0-120. 13/9.

BATTERY TESTER, tests all Radio Cells: Acid and jelly types, Varley and similar Accumulators. 49/6.

AMMETER, Moving Coil, 30 amps. charge, discharge, as fitted to cars, and suitable when external shunt has been removed, for Circuit Testers, Trickle Chargers, etc. 19/6.

TESTSCOPE, the Vest Pocket Tester, makes 30 Tests on A.C. and D.C. 37/6.

DUAL-TESTSCOPE, 50 Tests. 47/6.

BATTERY CHARGERS, "Over-night" Model 6 or 12 volts 1 amp. With ammeter, £4 14s. 5d.; without, £3 19s. 6d.

HOME CHARGER, Input 200-250 volts A.C. Output 6 1/2 volts 1.0 amps. D.C. £4 10s.

ELIMINATORS, Output 120 v. and 75 v. on 2 tappings at 20 m.a. Regulated transformer. For A.C. Mains. 45/-.

TRIMMER TOOL KITS, an improved product. Includes 1 each 6BA-5BA-4BA-3BA and 2BA aligning tools. 1 each 6 mm. and 8 mm. aligning tools (for Philips' receivers). 1—5in. Flexible turncrew which eliminates hand capacity. 1—6in. turncrew and 1—3in. turncrew catering especially for I.F.'s in cans with small adjustment. Complete Kit in carrying Wallet. 30/-.

SOLDERING IRONS, 100/120 v., 200/220 v., 230/250 v. All 60 watts. 13/6. Universal model with Steatite-clad Element, High Bit Temperature 300 deg. C., 50 watts. 22/-.

SPEAKERS, 8in., less Tr., 23/-; 6 1/2in. w. Tr., 27/-; 3 1/2in., less Tr., 30/-.

VALVES. See list in February issue. Just out: "Radio Upkeep and Repairs," by A. T. Wits. 7/6.

Order C.O.D. stamp with enquiries. Under 10/- C.W.O.

EXPORT ORDERS INVITED
 Forces and Demobilised—
 Special Attention.

J. BULL & SONS
 (Dept. P.W.)
 246, High Street,
 Harlesden, N.W.10

Get this Catalogue NOW!



BERRYS
 (SHORT WAVE LTD.)

25 HIGH HOLBORN
 LONDON, W.C.1
 (Opposite Chancery Lane)
 Telephone: HOLBORN 6231

The House for
 Quality Radio and
 Electronic Products

VALVES!

1L4, 1R5, 1T4, 1S5, 2A3, 2V3G, 2X2, 354, 6A7, 25Y5, 77, 78, 80, 83, 1A5GT, 5U4G, 5X4G, 5Y3G, 5Y4G, 5Z4G, 6A8G, 6AC7, 6AG7, 6B8G, 6F6G, 6J5G, 6K7G, 6V6G, 6L6G, 6Q7G, 6R7G, 6V6G, 6SC7GT, 6SK7GT, 6SN7GT, 6SL7GT, 6X5G, 12J5GT, 12Q5GT, 12Y4, 16L6, 6H6, 6L6, 6L7, 6N7, 6S5, 6SG7, 6S17, 6V6, 807, 829B, 866A, 879, 884, GL8020, VR105-30, VR150-30, 50L6GT, 954, 955, 956, APP4, AC1PA, AC1PEN, AC5PenDD, PMLF, EA50, D1, FW4, L2, L63, PenA4, Pen36C, U4U, VP4, VP4B, X42, Z62 or equivalents at List Prices.

25 uf. 50 v. Micropack Electrolytics, 2/2 each. 2 1/2in. C.R.T.s, 50/-; 5in. C.R.T.s, 105/-.

Electric Fires, 1,000 watt, 230/250 v., 30/-.

Mains Receivers (4 v. TRF with band-pass), £14 (including Purchase Tax).
ORDER C.O.D. OR C.W.O.
POSTAGE UNDER £1.

M. O. S. Co.

(Mail Order Supply Co.),
 24, NEW RD., LONDON,
 E.1
POST ORDERS ONLY

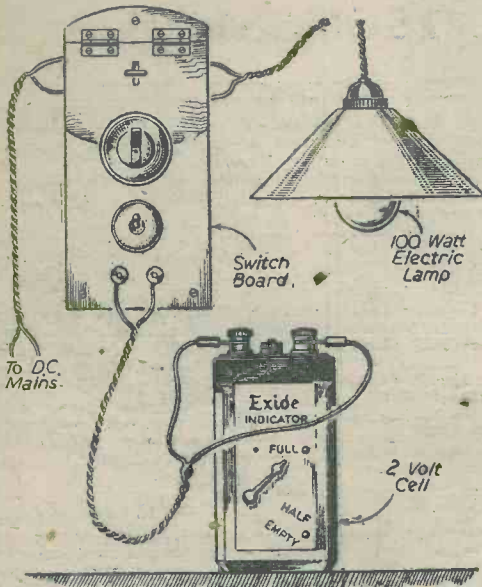

Fig. 5.—The board in use.

will produce varying amperages as shown by the following table :

Watts	Current in Amps. at 100 v.	Current in Amps. at 200 v.	Current in Amps. at 240 v.
20	.4	.2	.17
40	.6	.3	.25
100	1.0	.5	.41
150	1.5	.75	.62

The above table applies only to gas-filled lamps having ordinary filaments. The advantage of the low charging-rate is that it errs on the right side, i.e., does not exceed the usual charging-rate. Knowing the amperage of certain lamps, an ammeter is unnecessary.

The accumulator should be a visual-charge type, as shown in the diagram at Fig. 5, this indicating when the cell is exhausted, half-charged and fully-charged. If your cell is without an indicator, it should be remembered

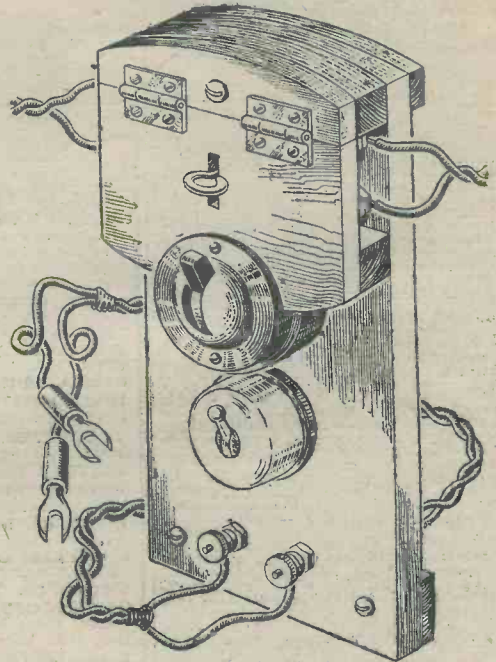

Fig. 6.—The completed charging board.

that the colour of the positive plates of a fully-charged cell is generally a rich chocolate-brown, whereas the negatives plates are a bright, silver-grey colour. Both negative and positive plates will—or should—gas freely, the positive plates commencing to gas some time before the negative plates.

Using the Switches

To save confusion in regard to the switches, have both at the "off" position when connecting the accumulator. When connected, put the larger switch to its "on" position; this lights the lamp and current will pass through the accumulator.

If you want illumination only put the smaller switch at the "on" position, and turn off the larger switch. Current passes through the lamp only. Consequently, it is only necessary to put the smaller switch at the "off" position to turn out the lamp.

Books Received

MODERN PRACTICAL RADIO AND TELEVISION. By C. A. Quarrington. Published by The Caxton Publishing Co., Ltd.

THIS is a practical and comprehensive treatise dealing with all aspects of radio, and is published in three volumes, attractively bound and printed. Vol. I deals with Sound, Electricity, Magnetism and other elementary subjects and passes on to the Design of the Superhet and details of valve theory and design. Vol. III deals with the Oscillograph, Fault Finding, etc., and concludes with two Appendices on Radio Mathematics and an abridged Technical Dictionary. The three volumes are available at £3 ros. cash and, if required, may be obtained on the instalment system for £3 15s.

ELECTRONIC EQUIPMENT AND ACCESSORIES. By R. C. Walker, B.Sc., A.M.I.E.E., A.M.I.Mech.E.

393 pp. Published by Geo. Newnes, Ltd. Price 25s.

AFTER dealing with thermionic valves and their fundamental characteristics, this valuable treatise goes on to deal with amplification, applications of thermionic valves, light-sensitive devices, cathode-ray tubes, switchgear, etc. With 343 illustrations, this will be found a most valuable book of reference for those who are interested in the modern application of electronics to industry.

PHYSICS AND RADIO. By M. Nelkon, B.Sc., A.K.C. 388 pp. Published by Edward Arnold & Co. Price 8s. 6d.

THIS is intended to be an elementary text-book of those principles of physics which concern basic radio. It is attractively written, and each chapter concludes with a summary, thus making it very valuable for the student. It contains a fair amount of mathematics, and in certain cases, exercises, some of which are taken from C. & G. papers.

Open to Discussion

The Editor does not necessarily agree with the opinions expressed by his correspondents. All letters must be accompanied by the name and address of the sender (not necessarily for publication).

A Good Log

SIR—Here is another list of s.w. stations which I have received recently on my 1-v-2 portable rig which uses the 1.4 volt valves, three H.F. pens and 1C5GT output:

HCJB, 34.09 m.; FZI, 25.06 m.; PRL8, 25.6 m.; WCRC, 25.3 m.; VLG, 30.99 m.; CHOL, 25.6 m.; ZPA3, 25.2 m. (approx.); WCBN, 26.9 m.; WOOW, 25.3 m.; WOOO, 38.5 m.; WCBN, 16.8 m.; CKNC, 16.84 m.; CKTA, 19.71 m.; TAP, 31.7 m.; VUD, 48.47 m., 41.24 m.; Moscow, 25.8 m., 25.36 m., 31.64 m.; Singapore, 31.44 m.; Madrid, 32.2 m.; Prague, 49.62 m.; Belgrade, 49.83 m.; Poland, 49.9 m. (approx.); Luxemburg, 48 m.; CB180, 25 m. (not certain this is correct call sign); CB7BE, 30.5 m.

I have just received a QSL from HCJB and they give their frequencies as 12.455, 15.115, 9.958, 4.107 and 974, with a power of 10 kW.

Prague is testing its new TX on 49.62 metres and calls Canada at 01.00 G.M.T. R5+.

Singapore is a good signal at 15.00 G.M.T. and calls B.B.C. at 15.25.

HCJB, by the way, is best received on 9.958 at present, as there is a fade-out below 25 metres on most nights.

—R. ALDRIDGE (Amersham).

A Message from Hungary

SIR—I am writing this in the hope that the message I have been asked to send will be of interest to some of your readers.

Owing to my past-experience as a concert singer, I was transferred soon after the end of hostilities to Div. Welfare Section and attached to the Div. theatre. However, my knowledge of radio and electricity soon found me fast becoming stage electrician and general technician which brings me to the point of interest.

Yesterday afternoon I was on duty at my switchboard during an excellent show by Hungarian artists for the entertainment of Hungarian Displaced Persons. I got into conversation (a rather mixed language one, it's true) with a member of the male voice choir and by speaking a mixture of English, German, Italian and also using the Q code I found that the man I was talking to was, before the war, lecturing on radio science at a well-known technical college in Hungary and a keen amateur transmitter. He is Demján Sándor, HA8G. He used to send morse on 7.2 mc/s and 7.7 mc/s, and wishes to send his regards to his friends in England. I must say that he made it very clear that he meant "friends" too. He remembers particularly a G6 in Glasgow, but without his old log book could not remember the full call sign. I explained to him that I would write to the editor of our favourite radio periodical and send his greetings to all his old contacts. He was highly delighted at my suggestion and wishes all his old friends in England to know that he is well and is now more keen than ever before. He is looking forward to the day when he will be allowed to go to his own home again and re-erect his TX. Until then he says "QRX and 73's to all my English friends."

I would also like to add that after two years of travelling through North Africa, Italy, Egypt, back to Italy, and through to Austria the only copy of P. W. that has failed to reach me to date is August of last year.—E. J. COOPER (C.M.F.).

Condenser as Voltage Dropper

SIR—An explanation of current and voltage conditions during a period of transience would occupy far too much of your valuable space, so I would refer Mr. Baker and others interested to the following books: "Theory

and Practice of Alternating Currents," Dover (Pitman), page 547; "Electrical Measurements and Measuring Instruments," Golding (Pitman), page 566; "Alternating Current Electrical Engineering," Kemp (MacMillan and Co.), page 555 et seq., where they will find the information they seek.

I would, however, point out that the heating effect of the transient current is of such small magnitude compared to the total required for the initial heating of the filaments as to be negligible.

It may surprise your readers to learn that many years ago this method of control was put forward (Aston, "Journal I.E.E.," vol. 49, pp. 703 et seq.) as a means of utilising the high lumen efficiency of low-voltage lamps as opposed to the relatively low efficiency of 230 volt lamps. Lamps were switched off by being short-circuited. The method did not come into general use, one reason being that mentioned by Mr. Cooper, i.e., the resultant damage to filaments following condenser failure.

As a supply engineer, I would say there are few undertakings running at unity power factor during peak periods and, as an enormous capacity reactance would be necessary to bring the undertakings power factor to unity, I cannot envisage the objection mentioned by Mr. Dobson being raised by supply authorities. There are, however, obvious reasons why apparatus should be switched off when not in actual use.

I trust these few remarks may be helpful to those taking part in this most interesting discussion.—JAMES F. EDGELL (Gloucester).

[This correspondence is now closed.—ED.]

Australian Stations

SIR—I would like to know whether any of your readers could tell me anything about reception elsewhere of the programme in English from Melbourne, which comes over VLA3 in the 25 m.b., VLC6 and VLG in the 31 m.b., and VL14 in the 41 m.b. at 2 o'clock.

VLA3 is very poor here. It is seldom heard, and then fades badly, is only R3-4, and suffers from QRM from a nearby American.

VLC6, when I first heard it, on November 4th, was very good, no QRM, no fading, and R8-9.

As the month progressed, it has become progressively worse, until it now fades badly and is only R5-6.

VLG has always been about R4. It is distinct and does not flutter.

VL14 varies from R7 to R4. It has gradually got worse, too. It suffers from bad QRM on both sides. Delhi is directly below it, and a Daventry transmission directly above.

I would also like to know of times of transmission of any other Australian stations your readers may have heard.—H. M. PANTIN (Marlboro', Wilts).

Commercial Set Design

SIR—I have been an amateur radio constructor since 1923, and though unable to claim being a reader of PRACTICAL WIRELESS since No. 1, I have at least in my possession a set of B.A. spanners, also a combined metal drill and valve marking gauge which you gave away many years ago.

Can you give the reason for manufacturers still using, in my opinion, a totally unnecessary item of equipment in radio sets, viz., a mains transformer? I know you will say it is used to step up the H.T. voltage and supply the valve heaters. But consider the efficiency and quality that can, and is, obtained with the Universal sets. Given a well-made A.C./D.C. set the results, in my opinion, are every bit as good as the conventional

A.C. sets, with the added advantage that the most troublesome and frequent cause of breakdowns, the electrolytic condenser, need never be subjected to greater strain than the mains voltage. We also lose the cumbersome and weighty mains transformers.

During my efforts to help keep my friends' sets in running order during the last four years, I have dealt with many sets and the above is the conclusion I have arrived at.—CHARLES H. HAMMOND (Sutton, Surrey).

Amateur Transmitters

SIR,—For the 10 days prior to joining the R.A.F. I have been listening to the American 10 m. (28 mc/s) amateurs, who have just recently been allowed to transmit on the band again. The following is a log for a battery 0-v-1 (triodes) with a 3 half-wave indoor aerial. It may be of interest to others who are interested in U.S.W. listening.

Log 18-27.14.45: N. America. District W1: DLC, AXL, BB, NIC, LEA, BFT (cw), KON, HXU, FNL, CQR, MYO, AKR, BGG, AW, DEO, NBM, APO, AFG (cw), AGX, CH, BBM, GOU, AEP, IAS, NVO, LOP, LWE (port. 2), MUA.

W2: JIH, MRO, MAF, DWJ, DLO (port. 3), FGV, VH, OQL, MBL, MTW, GK, FID, IKZ, BYM, AHX, AJE, MPA, IJC, BXA, NLN, MEF, JHX, AYS.

W3: FIL, GRO, JJB, HNZ (port. 8), PV, AFJ, NA, BWQ, HOH, HFD, BSY (port. 1), HN, CBT, EAI, HFW, HQG, E2K (port. 8), MV, EGA, GPM, GVZ, DO, DOU, BVL, IGW, DYS, IEG, PK, IU, FIL (port. 8), HQJ.

W4: FLT, BSS.

W5: GNV (port. 1).

W6: QWI (port. 2).

W8: RLT, GEF, OGT, CKY, AXN, SOL, CK, SOE, WSB, CMW, DYY (port. 1), CFD, QBK, QBF, SDD, KYY, PK, UZJ (cw), NNC (cw), LYQ, AFO, AHC, NG (cw), UUG, SGX, RNC, RLO, TXQ, RTX, TNO, LWH, MBC.

W9: HWF, OAF, EXT (port. 8), FS (cw), PK (cw), BDD (port. 2), MDQ, ODW, QTN (Ill.), ARK (Indianapolis), ERE, IFB.

Also heard are: VE's (Canada), 2KE (cw), 3KE, 3QU (cw), and SU (Egypt), 1MW.

Some of these stations in America have, from what I have heard them say, had good QSOs with stations in Egypt, France, Germany, Spain (EAD) and England (!). I heard one station (W3NA) in QSO with G7AD, which is a new call to me, as is G3C (!). G7AD was apparently not very keen on giving his fellow "ham" his name and address and I'm not surprised.

Hoping this is of interest and encouragement to others.—JOHN A. S. WATSON (Rickmansworth).

Station Frequencies

SIR,—In your January edition of PRACTICAL WIRELESS Mr. G. C. Bagley asked for the frequencies of a long list of W/T stations. I have been able to find a few of these:—

CUD2 Lisbon, 13,345 mc.; CNR2 Rabat F and Morocco, 11,940 mc.; CUS Lisbon, 15,890 mc.; CUL Lisbon, 12,537 mc.; EPB Teheran, 15,095 mc.; GFA3 Air Ministry, London, 8,600 mc.; HBH Geneva, 18,480 mc.; HBJ Geneva, 13,205 mc.; HBO Geneva, 11,402 mc.; HBQ2 Geneva, 6,945 mc.; HBS, Berne, 14,945 mc.; ICF Naples, 11,695 mc.; ODE Beirut, 11,625 mc.; ODD Beirut, 16,075 mc.; ODK Beirut, 10,575 mc.; TFJ Reykjavik, Iceland, 12,235 mc.; XOH Shanghai, 18,140 mc.; YVR Maracaay, Venezuela, 18,294 mc.—B. T. D. CUMNER (Hadley Wood, Herts).

Birmingham and District S.W. Society

SIR,—The Birmingham and District Short-Wave Society was formed on January 7th, 1946. This society is also the Midland Chapter of "The British Short-Wave League." One need not be a member of the B.S.W.L. to become a member of the Birmingham and District Short Wave Society.

Meetings will be held on the first Monday of each month at "The Hope and Anchor" hotel, Edmund Street, at 7.45 p.m. Anyone interested may attend as a visitor, or, if they send me a S.A.E., I would be pleased to forward them further particulars.—Geo. HODGKISS, Hon. Sec., 30, Townyn Road, Moseley, Birmingham, 13.

Labour Shortage

SIR,—Your comment of the month in the February issue of PRACTICAL WIRELESS upon the component shortage interests me. I, too, have suffered.

However, I should be glad to know where this mysterious shortage of labour exists. Having been recently demobilised from the Army after six years' service, I was interested in changing my vocation as my pre-war trade was scheduled to receive the benefits of nationalisation. Having some knowledge of wireless I approached the Ministry of Labour and National Service, only to be offered labouring on building and the advice to go back from whence I came, as nothing would be available for a year to eighteen months. So much for my ambitions!—R. J. PURR (Croydon).

Correspondent Wanted

SIR,—Although a regular reader of your journal, since I became interested in wireless, this is my first letter to you, and I feel that it is my duty to apologise for the delay in expressing my appreciation for the really good practical knowledge your paper has imparted to me.

The dealers here don't seem to be of much assistance and I have to rely on your valuable paper for all the information.

Like many readers I would like to see a really efficient superhet circuit incorporating short-waves, to be entirely constructed at home, giving full constructional details of coils and component values. We have seen many such circuits, but as ready-made components, such as coil units, were not available, we had to be content with only reading the article. So considering our difficulties, I hope you will comply with this request.

Finally, I shall be greatly obliged if you will kindly put me into touch with a wireless enthusiast about 18 years of age.—MAHINDA WANIGASURIYA ("Siri-Wasa" Mount-Lavinia, Ceylon).

Modified Midget Portable

(Continued from page 168)

construction of such a tiny set as this. A breakdown due to a faulty connection can be very annoying when it means taking everything to pieces again before it can be dealt with.

As the coil windings round the box need protection, three pieces of 3/16in. ply wood were cut to cover the top and two ends. Two half circles were cut in the end pieces with a fretsaw, the lower half circles forming four feet—raising the set 3/4in. from the table. These three cover pieces must again be raised another 1/16in. clear of the coil windings by strips of insulating tape, or serious losses will occur.

The little set was covered with brown American cloth—carefully cut and glued to avoid no more moisture than really necessary. The result is very effective indeed. With a few feet of throw-out aerial, British and foreign stations come racing in all round the tuning condenser—many of them almost too loud for headphones.

A good earth is essential for good results. Quite respectable strength can be obtained without an aerial, if the earth connection is good. This can be taken to wave-change switch.

If more selectivity is needed in certain areas, an aerial series condenser .0003 tubular type should improve matters, though the centre tapping on the medium-wave coil should meet most requirements.

CLASSIFIED ADVERTISEMENTS

LITERATURE, MAPS, etc.

RADIO SOCIETY OF GREAT BRITAIN invites all keen experimenters to apply for membership. Current issue "R.S.G.B. Zullestin" and details, 1/- below.

AMATEUR RADIO HANDBOOK (300 pages), paper cover, 4/-; cloth, 6/6. Radio Handbook Supplement (140 pages), paper cover, 2/6; cloth, 5/-. R.S.G.B., 28-30, Little Russell Street, London, W.C.1.

BRITISH SHORT-WAVE LEAGUE—S.A.E. for membership details and sample "Review." "Amateur Radio Simply Explained," 1/6 post free. Write NOW to H.Q., 53, Madeley Rd., Ealing, London, W.5.

"SHORT WAVE NEWS" is now on sale. Constructional, technical, topical and DX news. Published monthly at 13s. Yearly subscription, 16/-—Obtainable through W. H. Smith and Son, Ltd., locally, or from Head Office, Strand House, Portugal Street, London, W.C.2.

WEBB'S Radio Map of the World. Locates any station heard. Size 40in. by 30in., 4/6, post 6d. Octagon, 10/- post. Webb's Radio, 14, Soho Street, London, W.1. GERARD 2089.

MORSE & S.W. EQUIPMENT

MORSE Practice on equipment for class-room or individual use. Keys, audio oscillators for both battery and street operation. Webb's Radio, 14, Soho Street, London, W.1. Phone: GERARD 2089.

"H.A.C." Short-wave Receivers. Famous for over ten years. Improved one-valve model now available. Complete kit of components, accessories, with full instructions, now 18/3, post 9d. Easily assembled in one hour. S.A.E. for free catalogue.—A. L. Bacchus, 105, Hartington Road, London, S.W.8.

RECEIVERS & COMPONENTS

REWINDS and Radio Spares. Armatures, Field Transformers, Pick-ups, Fractional H.P. Motors, Speakers, New Cones and Speech Coils fitted. All work guaranteed and promptly executed. C.O.D. Postal Service. Send S.A.E. for list Valves and Radio Bargains.—A.D.S. Co., 261-5, Lichfield Road, Aston, Birmingham, 6.

REWINDS—Repairs to moving-coil speakers. Cones Coils fitted. Fields wound or altered. Mains Transformers, Eliminators and Clock Coils rewound. Competitive prices. Speaker-Transformers and Freq-ups rewound. 4/6 each Post Free. Guaranteed Satisfaction. Prompt Service.—L.S. Repair Service, 49, Trinity Road, Upper Tooting, London, S.W.17.

MALLOY 6-volt, 4-pin, UX Vibrators. New and Guaranteed, 10/- each.—H. English, The Maltings, Rayleigh Road, Hutton, Essex.

MAINS TRANSFORMERS, first grade brand new; 350/0, 350v, 80 ma. 6.3v. 3a. CT 5v. 2 amp. or 4v. 2 amp. 6v. 3a. 60v. each, post 1/-—Aneloy Radio, Hindmans Road, E. Dulwich, S.E.22.

ALL makes and kinds of Electrical and Radio Instruments repaired by skilled technicians A.I.D. approved. Over 60,000 instruments repaired for R.A.F. All work quoted by return without charge.—C. Gertler, Dept. B, 71-73, Waterside, Chesham, Bucks.

BUY DIRECT AND SAVE: Complete Kits: Victory 4 v. A.C.D.C. 26/19/6; L/MW. 7/6 extra; Victory 3 v. G.C. Battery automatic bias, 25/19/6; L/MW. 7/6 extra; S.M. diaks with escutcheon, glass, 3/1n. round, 4/1n. oval, 10/-; full vision, round, 4/1n. x 3/1n., 10/9; M.T. 350-350 60 ma., 6v., 4v., shrouded, 2/3; 2-gang Midget trimmers, 12/-; S.M. Drives, 3/- each; line cord, 2-way, 1.6 yd., 3-way, 2/-; speaker cones, all 6/3; 1 lb. enam. wire, all 2/3; 6 dnd. 150 ft., 2-pair, 6/3; 60 ma., 6v., "P" coils, 2/3; 0.5 amp. 2v. characters, 25/-; chassis, 4/6; send for full lists.—Buccleuch Radio Manufacturers, 1 and 2, Melville Terrace, Edinburgh.

(1) EXCHANGE Model 40 Avometer for Universal Avominor—cash adjustment. (2) For sale 30 copies of "Practical Wireless." (3) Brand new valves (unused for sale): Mullard VP13A, G.P. 213, Mazda, Pen. 383, Mullard URIC, Philips Barreter CI (Cost 6/4. What offers?) (4) A.C.D.C. 4-valve set with speaker (less cabinet). Cost 1/0, accept 2/10s. (5) Wanted urgently to buy or borrow "Practical Wireless" dated February 1944. S. B. PLANT, Tossion Tce., Heaton, Newcastle-on-Tyne, 6

FRED'S RADIO CABIN

COIL UNITS. Super all-wave Coil Units complete with Trimmers and Padder condensers and wave-change switch. Ranges covered: 19-50 metres, 200-550 metres, 950-2,000 metres. Also position on switch for Pick-up connection. Only 5 leads to be connected. A pair of matched I.F. Trans. 465 k/c's are included together with a large easy-to-read circuit giving full details and instructions on tuning and trimming without the aid of a Signal Generator. Results guaranteed. Delivery within four days of receiving order. 22/5.

MED. WAVE Litz wound T.R.F. coils, 4/6 pair.

FAX COIL FORMERS, 1in. x 4in. 3d. each.

2 PIN COIL HOLDERS, 6d. each.

DUAL RANGE COILS in large square can. No reaction. 2/- each.

PANOLIN Resistor Panels—3in. x 2 1/2in., 3d.; 5in. x 2 1/2in., 5d.

FAX STRIPS, Blank 4in. x 1 1/2in. 3d.

TAPPED TONE CONTROLS, 2/- each.

CENTRALAB V.C.'s, 2 meg. only, with switch, 3/6 each.

VOLUME CONTROLS. Less switch, 3/- each, most values; volume controls with switch, 4/6 each, most values.

ODD SECONDHAND V.C.'s with and without switch, 7/6 doz.

STANDARD SPEAKER FIELDS. 1,500 ohms and 2,000 ohms, 7/6 each.

WAX DROPPERS. 2 and 3 amp., 5/6 each.

OCTAL Base Vhs. 7 pin English, 5, 6 and 7 pin U.X., 8d. each 7/6 doz.

RESIN-CORED SOLDER, 3/9 lb. reel; multi-core solder, 5/- lb. reel.

465 K/C I.F. TRANS., 12/6 pair.

3 WAVEBAND COILS, with Circuit, 11/- pair.

MIDGET H.F. CHOKES, 2/- each.

SQUARE I.F. COIL CANS, 3in. x 1 1/2in., 6d. each.

MIDGET FIELD COILS. 5,000 ohms, 1/- each.

I.F. SMOOTHING CHOKES. 240 ohms, 10 Hy., 90 ma., 5/6 each.

MULTI-RATIO O.P. Trans., 6/- each.

CONDENSERS, 0005 mfd. Condenser with Trimmers, 2 1/2in. x 2 1/2in., 12/6 each.

RESISTORS, new 1 watt, 47, 82, 150, 220, 820, 1,000, 2,800, 7,500, 22,000, 35,000, 39,000, 82,000, 100,000, 250,000, 470,000 ohms., 1 meg., 6d. each, 5/6 doz.

MIDGET speaker transformers, power and pentode, 5/6 each.

RESISTANCE Colour Code Charts, 1/- each.

VIBRATORS, 6 volt car type, 4 pin, 9/6 each.

THE HALL ELECTRIC HOME CHARGER. For A.C. mains 200-250v. 2 volts at 1 amp. Brand new 25/- each. Superior sleeving in all colours. 3 doz. yard lengths mixed colours and sizes, 7/6. Enquiries for Hivac Midget valves and Avo test instruments invited. Send S.A.E. for new revised list of radio goods. Postage must be included. No C.O.D.

FRED'S RADIO CABIN FOR BARGAINS, 75, Newington Butts, S.E.11. Rodney 2130.

VALUE! MATT has it

SPECIAL OFFER FOR FEBRUARY WHILE EXISTING STOCK LASTS.

SPEAKERS, "Celestion," P.M., 6in., less trans. 16/6; 6in. P.M. with multi-ratio trans. 20/6; 8in. M. energised (1,500 coil) 18/11.

Centralab Volume Controls, less switch 2/6, with switch 3/6.

Condensers—1, .01, .05, .002, 6/0 doz. Stancelo and Solon Soldering Irons—13/6 each.

Two- and Three-Gang Condensers, .0005, 2-gang, 11/6. 2-gang slow-motion, 13/6. 3-gang, 14/6.

Rothermel (Crystal) Pick-Ups, de Luxe, 23/18/9.

LINE CORD, 3 amp. (60 ohms, per foot)—2-way, 1/6 per yd.; 3-way, 2/6 per yd.

T.R. Cable, 1,044 assorted lengths, 7d. per yd.

Elec Resistances—1 watt, 1 meg., 1 mag., 4/00 etc., 4/6 doz.

All Goods are NEW. Many other lines in stock. Large assortment B.U.A. and U.S. Valves

MATT RADIO SERVICE (Kingston 4881)

162, Richmond Road, Kingston-on-Thames, Surrey

B.A. thread screws, gross useful sizes, 2/6; ditto, nuts, 2/6 gr.; ditto, brass washers, 1/6 gr.; fibre washers, 1/6 gr.; assorted soldering tags, 2/- gr.; assorted small eyelets and rivets, 1/3 gr. Rubber-covered stranded copper wire, 1d., 1 1/2d., 2 1/2d. vard. 1 1/2d. 3rd. 4th. 5th. 6th. 7th. 8th. 9th. 10th. 11th. 12th. 13th. 14th. 15th. 16th. 17th. 18th. 19th. 20th. 21st. 22nd. 23rd. 24th. 25th. 26th. 27th. 28th. 29th. 30th. 31st. 32nd. 33rd. 34th. 35th. 36th. 37th. 38th. 39th. 40th. 41st. 42nd. 43rd. 44th. 45th. 46th. 47th. 48th. 49th. 50th. 51st. 52nd. 53rd. 54th. 55th. 56th. 57th. 58th. 59th. 60th. 61st. 62nd. 63rd. 64th. 65th. 66th. 67th. 68th. 69th. 70th. 71st. 72nd. 73rd. 74th. 75th. 76th. 77th. 78th. 79th. 80th. 81st. 82nd. 83rd. 84th. 85th. 86th. 87th. 88th. 89th. 90th. 91st. 92nd. 93rd. 94th. 95th. 96th. 97th. 98th. 99th. 100th. 101st. 102nd. 103rd. 104th. 105th. 106th. 107th. 108th. 109th. 110th. 111th. 112th. 113th. 114th. 115th. 116th. 117th. 118th. 119th. 120th. 121st. 122nd. 123rd. 124th. 125th. 126th. 127th. 128th. 129th. 130th. 131st. 132nd. 133rd. 134th. 135th. 136th. 137th. 138th. 139th. 140th. 141st. 142nd. 143rd. 144th. 145th. 146th. 147th. 148th. 149th. 150th. 151st. 152nd. 153rd. 154th. 155th. 156th. 157th. 158th. 159th. 160th. 161st. 162nd. 163rd. 164th. 165th. 166th. 167th. 168th. 169th. 170th. 171st. 172nd. 173rd. 174th. 175th. 176th. 177th. 178th. 179th. 180th. 181st. 182nd. 183rd. 184th. 185th. 186th. 187th. 188th. 189th. 190th. 191st. 192nd. 193rd. 194th. 195th. 196th. 197th. 198th. 199th. 200th. 201st. 202nd. 203rd. 204th. 205th. 206th. 207th. 208th. 209th. 210th. 211st. 212nd. 213rd. 214th. 215th. 216th. 217th. 218th. 219th. 220th. 221st. 222nd. 223rd. 224th. 225th. 226th. 227th. 228th. 229th. 230th. 231st. 232nd. 233rd. 234th. 235th. 236th. 237th. 238th. 239th. 240th. 241st. 242nd. 243rd. 244th. 245th. 246th. 247th. 248th. 249th. 250th. 251st. 252nd. 253rd. 254th. 255th. 256th. 257th. 258th. 259th. 260th. 261st. 262nd. 263rd. 264th. 265th. 266th. 267th. 268th. 269th. 270th. 271st. 272nd. 273rd. 274th. 275th. 276th. 277th. 278th. 279th. 280th. 281st. 282nd. 283rd. 284th. 285th. 286th. 287th. 288th. 289th. 290th. 291st. 292nd. 293rd. 294th. 295th. 296th. 297th. 298th. 299th. 300th. 301st. 302nd. 303rd. 304th. 305th. 306th. 307th. 308th. 309th. 310th. 311st. 312nd. 313rd. 314th. 315th. 316th. 317th. 318th. 319th. 320th. 321st. 322nd. 323rd. 324th. 325th. 326th. 327th. 328th. 329th. 330th. 331st. 332nd. 333rd. 334th. 335th. 336th. 337th. 338th. 339th. 340th. 341st. 342nd. 343rd. 344th. 345th. 346th. 347th. 348th. 349th. 350th. 351st. 352nd. 353rd. 354th. 355th. 356th. 357th. 358th. 359th. 360th. 361st. 362nd. 363rd. 364th. 365th. 366th. 367th. 368th. 369th. 370th. 371st. 372nd. 373rd. 374th. 375th. 376th. 377th. 378th. 379th. 380th. 381st. 382nd. 383rd. 384th. 385th. 386th. 387th. 388th. 389th. 390th. 391st. 392nd. 393rd. 394th. 395th. 396th. 397th. 398th. 399th. 400th. 401st. 402nd. 403rd. 404th. 405th. 406th. 407th. 408th. 409th. 410th. 411st. 412nd. 413rd. 414th. 415th. 416th. 417th. 418th. 419th. 420th. 421st. 422nd. 423rd. 424th. 425th. 426th. 427th. 428th. 429th. 430th. 431st. 432nd. 433rd. 434th. 435th. 436th. 437th. 438th. 439th. 440th. 441st. 442nd. 443rd. 444th. 445th. 446th. 447th. 448th. 449th. 450th. 451st. 452nd. 453rd. 454th. 455th. 456th. 457th. 458th. 459th. 460th. 461st. 462nd. 463rd. 464th. 465th. 466th. 467th. 468th. 469th. 470th. 471st. 472nd. 473rd. 474th. 475th. 476th. 477th. 478th. 479th. 480th. 481st. 482nd. 483rd. 484th. 485th. 486th. 487th. 488th. 489th. 490th. 491st. 492nd. 493rd. 494th. 495th. 496th. 497th. 498th. 499th. 500th. 501st. 502nd. 503rd. 504th. 505th. 506th. 507th. 508th. 509th. 510th. 511st. 512nd. 513rd. 514th. 515th. 516th. 517th. 518th. 519th. 520th. 521st. 522nd. 523rd. 524th. 525th. 526th. 527th. 528th. 529th. 530th. 531st. 532nd. 533rd. 534th. 535th. 536th. 537th. 538th. 539th. 540th. 541st. 542nd. 543rd. 544th. 545th. 546th. 547th. 548th. 549th. 550th. 551st. 552nd. 553rd. 554th. 555th. 556th. 557th. 558th. 559th. 560th. 561st. 562nd. 563rd. 564th. 565th. 566th. 567th. 568th. 569th. 570th. 571st. 572nd. 573rd. 574th. 575th. 576th. 577th. 578th. 579th. 580th. 581st. 582nd. 583rd. 584th. 585th. 586th. 587th. 588th. 589th. 590th. 591st. 592nd. 593rd. 594th. 595th. 596th. 597th. 598th. 599th. 600th. 601st. 602nd. 603rd. 604th. 605th. 606th. 607th. 608th. 609th. 610th. 611st. 612nd. 613rd. 614th. 615th. 616th. 617th. 618th. 619th. 620th. 621st. 622nd. 623rd. 624th. 625th. 626th. 627th. 628th. 629th. 630th. 631st. 632nd. 633rd. 634th. 635th. 636th. 637th. 638th. 639th. 640th. 641st. 642nd. 643rd. 644th. 645th. 646th. 647th. 648th. 649th. 650th. 651st. 652nd. 653rd. 654th. 655th. 656th. 657th. 658th. 659th. 660th. 661st. 662nd. 663rd. 664th. 665th. 666th. 667th. 668th. 669th. 670th. 671st. 672nd. 673rd. 674th. 675th. 676th. 677th. 678th. 679th. 680th. 681st. 682nd. 683rd. 684th. 685th. 686th. 687th. 688th. 689th. 690th. 691st. 692nd. 693rd. 694th. 695th. 696th. 697th. 698th. 699th. 700th. 701st. 702nd. 703rd. 704th. 705th. 706th. 707th. 708th. 709th. 710th. 711st. 712nd. 713rd. 714th. 715th. 716th. 717th. 718th. 719th. 720th. 721st. 722nd. 723rd. 724th. 725th. 726th. 727th. 728th. 729th. 730th. 731st. 732nd. 733rd. 734th. 735th. 736th. 737th. 738th. 739th. 740th. 741st. 742nd. 743rd. 744th. 745th. 746th. 747th. 748th. 749th. 750th. 751st. 752nd. 753rd. 754th. 755th. 756th. 757th. 758th. 759th. 760th. 761st. 762nd. 763rd. 764th. 765th. 766th. 767th. 768th. 769th. 770th. 771st. 772nd. 773rd. 774th. 775th. 776th. 777th. 778th. 779th. 780th. 781st. 782nd. 783rd. 784th. 785th. 786th. 787th. 788th. 789th. 790th. 791st. 792nd. 793rd. 794th. 795th. 796th. 797th. 798th. 799th. 800th. 801st. 802nd. 803rd. 804th. 805th. 806th. 807th. 808th. 809th. 810th. 811st. 812nd. 813rd. 814th. 815th. 816th. 817th. 818th. 819th. 820th. 821st. 822nd. 823rd. 824th. 825th. 826th. 827th. 828th. 829th. 830th. 831st. 832nd. 833rd. 834th. 835th. 836th. 837th. 838th. 839th. 840th. 841st. 842nd. 843rd. 844th. 845th. 846th. 847th. 848th. 849th. 850th. 851st. 852nd. 853rd. 854th. 855th. 856th. 857th. 858th. 859th. 860th. 861st. 862nd. 863rd. 864th. 865th. 866th. 867th. 868th. 869th. 870th. 871st. 872nd. 873rd. 874th. 875th. 876th. 877th. 878th. 879th. 880th. 881st. 882nd. 883rd. 884th. 885th. 886th. 887th. 888th. 889th. 890th. 891st. 892nd. 893rd. 894th. 895th. 896th. 897th. 898th. 899th. 900th. 901st. 902nd. 903rd. 904th. 905th. 906th. 907th. 908th. 909th. 910th. 911st. 912nd. 913rd. 914th. 915th. 916th. 917th. 918th. 919th. 920th. 921st. 922nd. 923rd. 924th. 925th. 926th. 927th. 928th. 929th. 930th. 931st. 932nd. 933rd. 934th. 935th. 936th. 937th. 938th. 939th. 940th. 941st. 942nd. 943rd. 944th. 945th. 946th. 947th. 948th. 949th. 950th. 951st. 952nd. 953rd. 954th. 955th. 956th. 957th. 958th. 959th. 960th. 961st. 962nd. 963rd. 964th. 965th. 966th. 967th. 968th. 969th. 970th. 971st. 972nd. 973rd. 974th. 975th. 976th. 977th. 978th. 979th. 980th. 981st. 982nd. 983rd. 984th. 985th. 986th. 987th. 988th. 989th. 990th. 991st. 992nd. 993rd. 994th. 995th. 996th. 997th. 998th. 999th. 1000th.

M.C. Mikes or earphones, 7/6 ea. Complete assemblies, less diaphragms, 2/6 ea. R.A.F. S.P.D.T. amp., 10/-; 10in. dia. PVC Coaxial U.H.F. cable, 2/- yd; 7ft. lengths, 6/ ea. 4in. diam. 2-way ditto, 1/- yd. Twin flex, 30yds., 5/- 5 amp. circular rubber twin flex, 4in. yd. 3-way line cord, 70 ohms ft., 10d. ft. 5-way cable, 6d. yd. 1- and 2-way screened flex, heavy quality, 1/- yd. 5,000v., 01 cons., 5/- ea. 12v.-230v. D.C. rotary converter, 30 m.a., 30/-; ditto, 60 m.a., £3; ditto, 450v., 40 m.a., 30/-; Resistors, 1 to 10 watt, assorted values, 10/- for 50. A.C. magnet coils, 20oz. 3/6. 5/- ea. Iron cored H.F. chokes, 2/6. Autocouplers, 12-24v. 25 amp., 10/- ea. Stringed instrument pick-ups, 12/6 ea. E.F.50 valves. All glass locals, 10/- ea. Luminous paint, 1/- tin. Undercoat, 10/- tin. Assorted knobs, 3/- doz. 4in. Silver-plated copper tube, 1/- 6ft. Petrol or oil taps with unions, 1/- ea. Covered wire, 1/- 100ft. Coloured P.V.C. flex, 2/6 doz. yds.—H. ENGLISH, The Maltings, Rayleigh Rd., Hutton, Brentwood, Essex.

VALVES—Mullard, Mazda, Osram, Brimar, Hivac: 1H5GT, TDDA, 354V, 9.2, 1N5GT, 1C5GT, VP2, SP2, PM2A, KT2, URIC, U31, U50, U5, 5Z4G, 1W4 350, 80, URIC, 11/-; PX4, AC/044, TDDA, 67G, 67Q, 11/7, X24, PM2B, 24GT, 67C, 67D, 67G, 7, 6V6G, 6F6G, 5A6G, 25L6G, VP, SP4, Pen. 4A, AC/VP1, AC/5 Pen. 12, 10, FC4, TH4B, AC/TP, 6K8G, 1A5, Pen. 4DD, 45DD, AC/2 Pen. 1D, 15/3.

CONDENSERS—1, .01, .05, .002, 500v.w., .001 to .01 mfd., 8d.; .02 to 1 mfd., 1/-; .25, 5 mfd., 1/6. **ELECTROLYTICS**—8 mfd. 500v., 4/6; 450v., 2/-; 350v., 3/6; 25mfd. 25v., 2/-; 10v. 50v., 3/-; 32 mfd. 320v., can type, 8/6; Variable, .0005 mfd., 3 sds. 1/6. Midget L.F. trans. 4: 1. 4. 6. Midget multi-ratio output trans., 6/-; Valveholders, 9d.; Insulated staples, 1/- per 100; wire, single screened, 6d. per yd., twin screened 10d. per yd.; push-back wire, 1

ALIGNED INSTRUMENTS SERVICES,
25, Park Grove Road, Leytonstone, E.11.
Phone: Leytonstone 380.
MODEL 10 Superhet Coil Pack, 16-47,
200-550, 800-2,000 metres, complete with
trimmers, padders and switching. Aligned
and tested ready for use, only 6 connections.
35/-; Aligned I.F. Trans., 465 kc., iron-
cored, permeability tun., high "Q."
Aligned with model 10 Coil Pack ready for
use, 17/6 pair; 2-Gang Cond., capacity law
checked with Model 10, matching and tracking
assured, 15/-; Set of Valves for above,
6K6, 6X7, 6B4, 6V6, and 2A 4 (supplied
separately at B.O.T. prices); Mains Trans.
for above, 350-0-350 H.T., 30/-; All-Wave
Superhet Kit, including all above, speaker,
chassis and all components, £11 10s.;
High Fidelity Amplifier Kits as follows:
A.C./D.C., 8 watts, £8; 15 watts, £12.
A.C. 6 watts, £7; 12 watts, £11. All with
multi-ratio *OP* Trans. Can be supplied
assembled and tested at 30/- extra; Circuit
diagrams and constructional information
supplied with all above, or separately at 2/-
each, post free. We can supply all radio
needs from large stocks, send I.d. for list.
Post Trade Only at present. Terms:
Cash with order, C.O.D. No C.O.D. under
£1. Post free over £5.

EXCHANGE—British Radiophone Super-
het Radiopak for ditto Band Pass Radiopak.
Wanted purchase—Multitone Fuco, 1-6,
Q.P. P. input transformer and Puchos
three ratio output choke.—Powell, 46, Old
Street, Ludlow, Salop.

£5/10/0 buys complete kit and instructions
for 3-valve A.C.-D.C. radio. Kits supplied
for your own circuit. 2-12v. 1 amp. chargers,
£3.—R. Halls, 48, Raglan Rd., London,
S.E.18.

A NUMBER of all dry battery portable
receivers as new; less cabinets.—142, Mill
Hill, Deal, Kent.

AMATEUR RADIO PRODUCTS have
now available a 4-waveband Coil Unit,
already wired and switched for a 2-valve
S.W. battery Receiver. Coils, 9.8 to 24,
18.7 to 45.4, 38.4 to 95, and 92.3 to 206 metres
Only four watts to be considered. Complete
Unit with blueprint, 30/-. All coils have
reaction winding, individual coils, 3/3
each.—Amateur Radio Products, 50, Glass-
lyn Road, Crouch End, London, N.8.
Phone: MOUn View 4745.

CHARLES BRITAIN RADIO. This month's
offers! **SPEAKERS.** Phileco
mains energized, fitted with new cones,
with trans., 3,000, 5,000 fields, 21/-, Goodmans
P.M., 8in., with multi-ratio trans., £1.10.0.
Celebration P.M., 8in., with pentode trans.,
25/-, R.A., P.M., less trans., £1. Mains
transformers type E1, 350-0-350, 6v. or 4v.
types, usual prims., new 2A 4 type D1,
350-0-350, 120 ma., can be used for 2v., 4v.,
6v. heaters, shrouded, £1.10.0.; mains taps
for above, 1/- **CABINETS** as used for the
utility radios, either model, £1.10.0. Dials,
all wave, Ivorine, complete with eschelon
drum driver, 1/-. pointer, 5/6. Marconi
vertical type, 2/-, small dials for midgets,
8/- doz. Tuning conds., two-gang Midget,
12/- ea. Three-gang, 10/- ea. Small steel
chassis, 3/9 ea. Coils, 2 band with reaction,
7/-, pr. All-wave coils superhet with
diagram 14/-, pr. I.F. trans., 465 kc/
12/6 pr. P. type coils, M.W. only, A. & H.F.,
2/- ea. **ELECTROLYTIC Condensers.**
16 mfd. T.C.C. wet cans 440v. wkg., 7/6 ea.
8 mfd. dry cans 500v. wkg., 6/-, Hants
Blocks, 8 mfd. 200v. wkg., 8/6 ditto tubulars,
3/7 ea., 4 mfd. 200v. wkg. Micropac, 2/6 ea.
25 mfd. 25v., 2/6. 50 mfd. 12v., 2/6. Valves,
slightly used, ex R.A.F., all at 6/- ea.
X65, KTW61, Y63, 6J5, EF50, EF93, EF36,
EB33, EL32, 6D, Valveholders, Amp. and
Int. Octal and Brit. Octal, 1/6 doz. Paxolin,
all types, 6/- doz. **RESISTANCES.** New
Eric and Dubilier, 4/6 doz. (our selection),
5/6 doz. to your requirements; 1 watt,
6/6 doz. Tubular conds., new, 4/6 doz.
Send for List "P" Terms: Cash or
C.O.D. over £1. Note our New Address.—
Charles Britain Radio, 2, Wilson Street,
London, E.C.2. *Phone: BIS, 5985, Ext. 7.

MIDLAND INSTRUMENT CO.

Comprehensive range of Lewcos instrument
wires, resistance wires, flexes and cables,
sleeving, Empire tape, rubber grommets,
L.T. selenium rectifiers and transformers,
Avometers, speakers, chassis, dual range
and s.w. coils, var. conds., counters, syn-
chronous motors, microphones, etc., etc.
Lists, I.d., s.a.e. Enquiries, 2/4d. s.a.e.—
18, Harborne Park Road, Birmingham, 17.

POST-WAR TELEVISION

The advance in Radio Technique will
offer unlimited opportunities of high
pay and secure posts for those Radio
Engineers who have had the foresight
to become technically qualified.
How you can do this quickly and easily
in your spare time is fully explained
in our unique handbook.
Full details are given of A.M.I.E.E.,
A.M. Brit. I.R.E. City & Guilds Exams.
and particulars of up-to-date courses
in Wireless Engineering, Radio
Servicing, Short Waves, Television,
Mathematics, etc., etc.
We guarantee "NO PASS—NO FEE."
Prepare for to-morrow's opportunities
and post-war competition by sending for
this very informative 112-page guide
NOW—FREE and without obligation.
**BRITISH INSTITUTE OF
ENGINEERING TECHNOLOGY**
(Dept. 242),
17, Stratford Place, London, W.1.

A FREE BOOK

for all interested in

MORSE CODE TRAINING.



There are Candler Morse
Code Courses for
Beginners and
Operators.

Send for this Free
"BOOK OF FACTS"
it gives full details con-
cerning all Courses.

THE CANDLER SYSTEM CO. (S.L.O.)
121, Kingsway, London, W.C.2.

Candler System Co., Denver, Colorado, U.S.A.

DUAL TESTSCOPE



This new
indicates 2 to 30
volts and 100 to 750 volts.

Send for leaflet (A 24) on "Testing."

RUNBAKEN-MANCHESTER

SOUND EQUIPMENT.

The First A.C./D.C. Post-war
Miniature 12-watt Amplifier now
available from stock, Mike and
Gram. mixing, output for 2-3,
8 and 15 ohms to match up to
six speakers, attractive cream
chassis on rubber feet. 170/-
Our latest productions include
multi-wave band Communica-
tion Receivers, Portable Dance
Band and Guitar Amplifiers,
High Fidelity Radio Installa-
tions for Factory or Entertain-
ment.

**UNITED ELECTRONICS,
LIMITED,**

156, North End Road,
West Kensington, W.14

THE SIMPLEX FOUR.

Still the best complete constructional
details of 4-valve A.C./D.C. medium wave
midget receiver, complete with all con-
structional details, layout diagrams,
theoretical circuit, etc., at per copy, 4/6.
MIDGET CHASSIS. The "Simplex"
chassis, fully drilled for the above midget,
with speaker cut-out, electro zinc finish,
11 x 4 1/2 x 2 1/2. 7/6.
MIDGET COILS.—M. wave, high gain,
T.R.F. coils, per pair, 7/6; the latest iron-
cored, M. and L. wave, T.R.F. coils, with
adjustable iron cores complete with cir-
cuit, pair, 12/6; iron-cored aerial and
oscillator coils, M. and L. wave, I.F. at
465 kc/s for the pocket receiver, with
circuit, 17/6 pair; midget S.M.L. wave
aerial and oscillator coils, ditto with I.F.,
with circuit, pair, 15/-.
MIDGET DIALS.—Coloured all-wave
dials, 4 x 3 1/2 in., transparent, 2/6; coloured
all-wave dials on glass, 9 x 4 1/2 in., 3/6.
MIDGET CONDENSERS.—2-gang, varia-
ble 0.0005 mfd. with trimmer, 13/6.
MIDGET CHOKES.—The ultra midget
choke, 40 ma., 6/-; midget choke, 50/60 ma.,
6/-; standard choke, 80 ma., 8/6; heavy
duty choke, 150/200 ma., 12/6.
MIDGET TRANSFORMERS.—Ultra mid-
size speaker trans., high gain, 8/-;
midget trans., 6/6; standard ditto, 8/-;
heavy duty P.P. output trans., 6,800 ohms
A to A load, tapped output; 7.5 and 15
ohms, 21/-.
CONDENSERS.—Tubular, 8 mfd., 450v.
wkg., 4/- ditto, 8 x 3 mfd., 450v. wkg.,
8/-; 25 mfd., 25v. wkg., 2/- each; 0.1 mfd.,
9d. each; 0.01 mfd., 9d. each; silver mica,
0.0001 mfd., 9d. each; 0.0005 mfd., 9d.
each.
Comprehensive lists issued monthly, 2d.
stamp with enquiries please, postage all
orders.
**O. GREENLICK, LTD., 34, Bancroft
Road, Cambridge Heath Road, London,
E.1.
Stepney Green 1334.**

SITUATIONS VACANT

"ENGINEERING OPPORTUNITIES"
—FREE 112-page guide to training for
A.M. Mech. Eng. and A.M.E.E. at all
branches of Engineering and Building. Full
of advice for expert or novice. Write for
free copy and make your peacetime future
secure.—B.I.E.T. (dept. 242B), 17, Stratford
Place, London, W.1.

TUITION

LEARN MORSE CODE the Candler Way.
See advertisement on this page.
RADAR.—Be prepared for the boom in
post-war developments. We train students
of both sexes for appointments in all
branches of radio. Low inclusive fees.
Boarders accepted. 2d. stamp for Pros-
pectus.—Wireless College, Colwyn Bay.

The Tuitionary Board of the Institute of
Practical Radio Engineers have available
Home Study Courses covering elementary,
theoretical, mathematical, practical and
laboratory tuition in radio and television
engineering; the text is suitable coaching
matter for I.P.T.E. Service entry and
progressive exams; tuition fees at
pre-war rates—are moderate. The Syllabus
of Instructional Text may be obtained, post
free, from the Secretary, 20, Fairfield
Road, Crouch End, N.8.

L.R.'S

Can supply from stock
**AVOMINOR
TEST METERS**

UNIVERSAL A.C./D.C. Mod. £8 10 0
D.C. Model £8 10 0
(Regd. Post 10d. or C.O.D. 1/10)
Stock is limited.
HIGH GRADE TOWERS WATCHES
Especially Suitable for Radio and Electrical
Engineers.
Waterproof, Non-Magnetic. Shock-
resisting, 17 JEWEL, centre second
hand and luminous dial.
Controlled price £12 5 8
15 JEWEL Controlled price £10 4 6
Fitted with best leather straps. In case.
Also in stock at time of going to press:
Morphy-Richards Auto Electric
domestic irons; Stuart Turner cen-
trifugal electric pumps
THE LONDON RADIO SUPPLY CO.
BALCOMBE, SUSSEX.
Established 1925.

Practical Wireless BLUEPRINT SERVICE

SPECIAL NOTICE

These blueprints are drawn full size. The drawings containing descriptions of these sets are now out of print, but an asterisk beside the blueprint number denotes that constructional details are available, free with the blueprint.

The index letters which precede the Blueprint Number indicate the periodical in which the description appears: Thus P.W. refers to PRACTICAL WIRELESS, A.W. to Amateur Wireless, W.M. to Wireless Magazine.

Send (preferably a postal order to cover the cost of the Blueprint (stamps over 8d. unacceptable) to PRACTICAL WIRELESS, Blueprint Dept., George Newnes, Ltd., Tower House, Southampton Street, Strand, W.C.2.

PRACTICAL WIRELESS		No. of Blueprint.	F. J. Camm's A.C. Superhet 4 ..	—	PW69*
CRYSTAL SETS					
Blueprints, 6d. each.			F. J. Camm's Universal 64 Super- het 4 ..	—	PW60
1927 Crystal Receiver ..	—	PW71*	"Quinton" Universal Four ..	—	PW73*
The "Junior" Crystal Set ..	—	PW94*			
STRAIGHT SETS. Battery Operated.			SHORT-WAVE SETS. Battery Operated		
One-Valve : Blueprints, 1s. each.			One-valve : Blueprint, 1s.	—	PW88*
All-Wave Unipen (Pentode) ..	—	PW31A*	Simple S.W. One-valver ..	—	PW85*
Beginners One-valver ..	—	PW85*	Two-valve : Blueprints, 1s. each.	—	PW38A*
The "Pyramid" One-valver (HF Pen) ..	—	PW93*	Midget Short-wave Two (D, Pen)	—	PW91*
Two-valve : Blueprint, 1s.			The "Plect" Short-wave Two (D (HF Pen), Pen) ..	—	PW30A*
The Signet Two (D & I F) ..	—	PW76*	Three-valve : Blueprints, 1s. each.	—	PW63*
Three-valve : Blueprints, 1s. each.			Experimenter's Short-wave Three (SG, D, Pow) ..	—	PW65*
Selectone Battery Three (D, 2LF Trans) ..	—	PW10	The Perfect 3 (D, 2 LF (BC and Trans) ..	—	PW68*
Summit Three (HF Pen, D, Pen)	—	PW37*	The Band-spread S.W. Three (HF Pen, D (Pen), Pen) ..	—	
All Pentode Three (HF Pen, D (Pen), Pen) ..	—	PW39*			
Hall-Mark Cadet (D, LF, Pen (RC))	—	PW48*	PORTABLES		
F. J. Camm's Silver Souvenir (HF Pen, D (Pen), Pen) (All-Wave Three) ..	—	PW49*	Three-valve : Blueprints, 1s. each.	—	PW65*
Cameo Midget Three (D, 2 LF Trans) ..	—	PW51*	F. J. Camm's ELL Three-valve Portable (HF Pen, D, Pen) ..	—	PW77*
1936 Sonotone Three-Four (HF Pen, HF Pen, Westector, Pen)	—	PW53*	Parvo Flyweight Midget Portable (SG, D, Pen) ..	—	PW86*
Battery All-Wave Three (D, 2 LF (RC)) ..	—	PW55*	Four-valve : Blueprint, 1s.	—	
The Monitor (HF Pen, D, Pen) ..	—	PW61*	"Imp" Portable 4 (D, LF, LF (Pen) ..	—	
The Tutor Three (HF Pen, D, Pen)	—	PW62*			
The Centaur Three (SG, D, F) ..	—	PW64*	MISCELLANEOUS		
The "Colt" All-Wave Three (D, 2 LF (RC & Trans) ..	—	PW72*	Blueprint, 1s.	—	PW48A*
The "Rapide" Straight 3 (D, 2 LF (RC & Trans) ..	—	PW82*	S.W. Converter-Adapter (1 valve)	—	
F. J. Camm's Oracle All-Wave Three (HF, Det. Pen) ..	—	PW78*			
1938 "Titland" All-Wave Three (HF, Pen, D, Pen) ..	—	PW84*	AMATEUR WIRELESS AND WIRELESS MAGAZINE		
F. J. Camm's "Sprite" Three (HF Pen, D, Tet) ..	—	PW87*	CRYSTAL SETS		
T. "Hurricane" All-Wave Three (SGD, Pen), Pen) ..	—	PW89*	Blueprints, 6d. each.		
F. J. Camm's "Push-Button" Three (HF Pen, D (Pen), Tet) ..	—	PW92*	Four-station Crystal Set ..	—	AW427*
Four-valve : Blueprints, 1s. each.			Laocaine Ring Coil for A.W.427, 6d.	—	AW444
Beta Universal Four (SG, D, LF, Cl. B) ..	—	PW17*	1934 Crystal Set ..	—	AW450*
Nucleon Class B Four (SG, D SG), LF, Cl. B) ..	—	PW34B*	150 Ohm Crystal Set ..	—	
Fury Four Super (SG, SG, D, Pen)	—	PW34C*			
Battery Hall-Mark 4 (HF, Pen, D, Push-Pull) ..	—	PW46*	STRAIGHT SETS. Battery Operated.		
"Aime" All-Wave 4 (HF Pen, D (Pen), LF, Cl. B) ..	—	PW68*	One-valve : Blueprint, 1s.	—	AW367*
The "Admiral" Four (HF Pen, HF Pen, D, Pen (RC)) ..	—	PW90*	B.C. Special One-valver ..	—	AW383*
F. J. Camm's "Limit" All-Wave Four (HF Pen, D, LF, F) ..	—	PW67*	Two-valve : Blueprint, 1s. each.	—	AW393*
			Melody Ranger Two (D, Trans) ..	—	WM409*
			Full-modern Two (SG det. Pen) ..	—	
			A modern Two-valver ..	—	
			Three-valve : Blueprints, 1s. each.	—	
			£5 5s. S.G. 3 (SG, D, Trans) ..	—	AW419*
			Lucerne Ranger (SG, D, Trans) ..	—	AW422*
			£3 5s. Three De Luxe Version (SG, D, Trans) ..	—	AW435*
			Transportable Three (SG, D, Pen) ..	—	WM271
			Simple-Tune Three (SG, D, Pen) ..	—	WM327*
			Economy Pentode Three (SG, D, Pen) ..	—	WM337
			"W.M." (1934 Standard Three (SG, D, Pen) ..	—	WM351*
			£3 3s. Three (SG, D, Trans) ..	—	WM354
			1935 50 6s. Battery Three (SG, D, Pen) ..	—	WM371
			PTF Three (Pen, D, Pen) ..	—	WM389*
			Certainty Three (SG, D, Pen) ..	—	WM393
			Mini-tune Three (SG, D, Trans) ..	—	WM396*
			All-wave Whining Three (SG, D, Pen) ..	—	WM400
			Four-valve : Blueprints, 1s. 6d. each.	—	AW370
			6s. Four (SG, D, RC, Trans) ..	—	WM331
			Self-contained Four (SG, D, LF, Cl. B) ..	—	WM350
			Lucerne Straight Four (SG, D, LF, Trans) ..	—	WM381*
			£3 5s. Battery Four (HF, D, 2LF, Pen) ..	—	WM384
			The H.K. Four (SG, SG, D, Pen) ..	—	WM404*
			The Auto Straight Four (HF, Pen, HF, Pen, DDT, Pen) ..	—	
			Five-valve : Blueprints, 1s. 6d. each.	—	
			Super-quality Five (2 HF, D, RC, Trans) ..	—	WM320
			Class B Quadradyne (2 SG, D, LF, Cl. B) ..	—	WM344
			New Class B Five (2 SG, D, LF Cl. B) ..	—	WM340
			Mains Operated		
			Two-valve : Blueprints, 1s. each.	—	AW403*
			Conoelectric Two (D, Pen) A.C.	—	WM286
			Economy A.C. Two (D, Trans) A.C.	—	
			Three-valve : Blueprints, 1s. each.	—	
			Home Lover's New All-Electric Three (SG, D, Trans. A.C.) ..	—	AW363*
			Mantovani A.C. Three (HF, Pen, D, Pen) ..	—	WM376*
			£15 15s. 1936 A.C. Radiogram (HF, D, Pen) ..	—	WM401*
			Four-valve : Blueprints, 1s. 6d. each.	—	WM329
			All-Metal Four (2 SG, D, Pen) ..	—	
			Harris Jubilee Radiogram (HF, Pen, D, LF, F) ..	—	WM386*
			SUPERHETS		
Battery Sets : Blueprints, 1s. each.					
F0 Superhet (three-valve) ..	—	PW40*			
F. J. Camm's 2-valve Superhet ..	—	PW52*			
Mains Sets : Blueprints, 1s. each.					
A.C. £6 Superhet (Three-valve) ..	—	PW43*			
D.C. £6 Superhet (Three-valve) ..	—	PW42*			

SUPERHETS	
Battery Sets : Blueprints, 1s. 6d. each.	
"Variety Four" ..	WM395*
The Request All-Waver ..	WM407*
Mains Sets : Blueprints, 1s. each.	
Heptode Super Three A.C. ..	WM359*

PORTABLES	
Four-valve : Blueprints, 1s. 6d. each.	
Holiday Portable (SG, D, LF, Class B) ..	AW393*
Family Portable (HF, D, RC, Trans) ..	AW447*
Tyco Portable (SG, D, 2 Trans.) ..	WM367*

SHORT-WAVE SETS. Battery Operated	
One-valve : Blueprints, 1s. each.	AW429*
S.W. One-valver for America ..	AW452*
Roma Short-Waver ..	
Two-valve : Blueprints, 1s. each.	
Ultra-short Battery Two (SG, det Pen) ..	WM402*
Home-made Coil Two (D, Pen) ..	AW440

Mains Operated	
Three-valve : Blueprints, 1s. each.	
Experimenter's 6-metre Set (D, Trans, Super-regen) ..	AW438
The Carrier Short-waver (SG, D, F) ..	WM390*

Mains Operated	
Four-valve : Blueprints, 1s. 6d. each.	
A.W. Short-wave World-beater (HF, Pen, D, RC, Trans) ..	AW436*
Standard Four-valver Short-waver (SG, D, LF, F) ..	WM383*
Superhet : Blueprint, 1s. 6d.	
Simplified Short-wave Super ..	WM397*

Mains Operated	
Two-valve : Blueprints, 1s. each.	
Two-valve Mains Short-waver (D, Pen), A.C. ..	AW453*
Three-valve : Blueprints, 1s.	
Emigrator (SG, D, Pen) A.C. ..	WM352*
Four-valve : Blueprints, 1s. 6d.	
Standard Four-valve A.C. Short- waver (SG, D, RC, Trans) ..	WM391*

MISCELLANEOUS	
S.W. One-valve Converter (Price 6d.) ..	AW320
Enthusiast's Power Amplifier (1/6)	WM387*
Listener's 5-watt A.C. Amplifier (1/8) ..	WM382*
Radio Unit (2v.) for WM392 (1/-)	WM398*
Harris Radiogram battery am- plifier (1/-) ..	WM399*
De Luxe Concert A.C. Electro- gram (1/-) ..	WM403*
New Style Short-wave Adapter (1/-) ..	WM398
Short-wave Adapter (1/-) ..	AW436*
B.L.D.L.C. Short-wave Converter (1/-) ..	WM405*
Wilson Tone Master (1/-) ..	WM406
The W.M. A.C. Short-wave Con- verter (1/-) ..	WM408*

HINTS COUPON

This coupon is available until March 11th, 1946, and must accompany all Practical Hints.

PRACTICAL WIRELESS, March, 1946

All applications respecting Advertising in this Publication should be addressed to the ADVERTISING DIRECTOR, GEORGE NEWNES, LTD., Tower House, Southampton Street, Strand, London, W.C.2. Telephone: Temple Bar 4363.

CONDITIONS OF SALE AND SUPPLY: This periodical is sold subject to the following conditions, namely, that it shall not, without the written consent of the publishers first given, be lent, re-sold, hired out or otherwise disposed of by way of Trade except at the full retail price of 9d.; and that it shall not be lent, re-sold, hired out or otherwise disposed of in a mutilated condition or in any unauthorised cover by way of Trade; or affixed to or as part of any publication or advertising, literary or pictorial matter, whatsoever.



FOR THE RADIO SERVICE MAN, DEALER AND OWNER

The man who enrolls for an I.C.S. Radio Course learns radio thoroughly, completely, practically. When he earns his diploma, he will KNOW radio. We are not content merely to teach the principles of radio, we want to show our students how to apply that training in practical, every-day, radio service work. We train them to be *successful!*

INTERNATIONAL CORRESPONDENCE SCHOOLS

Dept. 94, International Buildings,
Kingsway, London, W.C.2.

Please explain fully about your instruction in the subject marked X

Complete Radio Engineering
Radio Service Engineers
Elementary Radio

If you wish to pass a Radio examination, indicate it below.

British Institute of Radio Engineers
P.M.G. Certificate for Wireless Operators
City and Guilds Telecommunications
Wireless Operator, R.A.F.
Wireless Mechanic, R.A.F.

Special terms for members of H.M. Forces and discharged
and disabled members of H.M. Armed Forces.

Name..... Age.....
(USE BLOCK LETTERS)

Address.....



(Use penny stamp on unsealed envelope.)

CELESTION

LOUDSPEAKERS VALVE HOLDERS

Celestion Limited
Kington-upon-Thames

Telephone: KINGSTON 5656-7,8

The

TAYLOR A-C BRIDGE

MODEL 110A

These instruments give quick and accurate measurements of Capacity and Resistance. There are six Capacity ranges covering from .0001 to 120 mfd. and the Power factor can also be measured on each range. Six Resistance ranges are available measuring from 1 ohm to 12 megohms. This bridge is A.C. mains operated and a leakage test is also available for detecting leaky paper or mica condensers.

Price £14 14s. 0d.

Please write for technical leaflet.

Taylor
electrical instruments Ltd.



6 RANGES OF CAPACITY RANGES OF RESISTANCE

Send your enquiries to:—

TAYLOR ELECTRICAL INSTRUMENTS LTD.

419-424 MONTROSE AVENUE, SLOUGH, BUCKS.

Tel: Slough 21381 (4 lines) Grams: "Taylins", Slough.