

PRACTICAL WIRELESS, FEBRUARY, 1946.

WIDE-BAND COUPLING CIRCUITS

Practical ^{9^D} EVERY MONTH Wireless

Editor
F. J. CAMM

Vol. 22 No. 476

NEW SERIES

FEBRUARY, 1946



A 5-50 Metre Receiver. Full
Constructional Details are Given
in This Issue.

Practical Wireless

14th YEAR
OF ISSUE

EVERY MONTH
VOL. XXII. No. 476. FEBRUARY, 1946

and PRACTICAL TELEVISION

Editor F. J. CAMM

COMMENTS OF THE MONTH.

BY THE EDITOR

The Component Shortage

A FEW months ago we complained that our readers were unable to obtain replacement parts for British receivers and that it was practically impossible to obtain replacements for American receivers. We do not recant those criticisms in spite of a letter which we have received from the Board of Trade taking us to task for having made them. If the Board of Trade needs any confirmation of the accuracy of our remarks, it can be provided from the files of letters received from readers of this journal. These letters not only indicate that it is almost impossible to obtain American valves, electrolytic condensers, and similar parts, but also that American receivers seem more prone to breakdown than British receivers. In other words, a satisfactory method of adapting American receivers designed to operate on 110 volts for operation on English voltages of 200-250 volts has not yet been found. The resistance cord has many defects, not the least of which is its liability to damage, and also that the resistance does not remain constant. There is also the risk of fire.

Some of the letters we have received indicate that readers have spent months writing round to almost every likely source of supply after they have tried their dealer, who in turn has tried the wholesaler. It is somewhat naïve, therefore, for the Board of Trade to suggest that readers should place their orders with the retailers from whom the sets were purchased, and that the wholesaler who supplied them should pass his order to the distributor "who will then deliver the necessary components or suitable equivalents." We ourselves have tried the two main distributors who handle the receivers imported under Government auspices from America during the war. We asked them to supply certain of the components which our readers have been endeavouring to obtain. Each of these distributors told us that these components are quite unobtainable and would remain unobtainable for some months to come.

American Receivers

FROM our own records we were, of course, able to trace in some cases English alternative equivalents, but the

demand for these as replacements for English receivers has been so enormous that none can be spared as replacements for American receivers.

We mention these points because readers who may be considering the purchase of an American receiver should do so in the knowledge that if it goes wrong they may be kept waiting for many months before spares may become available.

It can be said that some of the American receivers are quite satisfactory whilst they work, but that they do not last for anything like the same period as English receivers. We know of many cases of English receivers which have been in daily use for over ten years without replacement or repair of any sort. We do not know of one American receiver that can equal this. The answer is, of course, that American receivers are adapted for our mains, and are not designed for them, and an adaptation can never be so good as a correctly designed article.

Not that the component shortage is peculiar to American components. A large proportion of our correspondence is concerned with tracing sources of supply of components, not only for home-constructed receivers, but also for commercial receivers. Most manufacturers have closed down their technical query and service departments and their customers have turned to us for help. We, too, are suffering from acute staff shortage and the position has not

been eased, although the war has been over for over eight months, due to the Government's pugnacious adherence to the absurd Bevin demobilisation scheme which was based on an arithmetical system of inverted logic, born in ignorance and somewhat spitefully administered. It has not taken into consideration the consumer needs of the home market, and whilst manufacturers owing to shortage of material and labour have not been enabled to make new goods, it has prevented the replacement of components which would keep existing apparatus in reasonable working order.

According to Sir Stafford Cripps, this state of affairs is going to continue for some time. Almost everything we make must be sent abroad to the countries which have been "liberated" from their coalition with Hitler.

Editorial and Advertisement Offices:
"Practical Wireless," George Newnes, Ltd.,
Tower House, Southampton Street, Strand,
W.C.2. Phone: Temple Bar 4363.
Telegrams: Newnes, Rand, London.
Registered at the G.P.O. for transmission by
Canadian Magazine Post.

The Editor will be pleased to consider articles of a practical nature suitable for publication in "Practical Wireless." Such articles should be written on one side of the paper only, and should contain the name and address of the sender. Whilst the Editor does not hold himself responsible for manuscripts, every effort will be made to return them if a stamped and addressed envelope is enclosed. All correspondence intended for the Editor should be addressed: The Editor, "Practical Wireless," George Newnes, Ltd., Tower House, Southampton Street, Strand, W.C.2.

Owing to the rapid progress in the design of wireless apparatus and to our efforts to keep our readers in touch with the latest developments, we give no warranty that apparatus described in our columns is not the subject of letters patent.

Copyright in all drawings, photographs and articles published in "Practical Wireless" is specifically reserved throughout the countries signatory to the Berne Convention and the U.S.A. Reproductions or imitations of any of these are therefore expressly forbidden. "Practical Wireless" incorporates "Amateur Wireless."

ROUND THE WORLD OF WIRELESS

"Blue Train" in Jerusalem

IN view of the heavy volume of telegraphic traffic arising in Palestine, Cable and Wireless, Ltd. have transferred a mobile wireless unit from Italy to Jerusalem to supplement the cable circuit from Haifa (connected with Jerusalem by Government landline) via Cyprus, Alexandria, Malta and Gibraltar to London.

This "Blue Train"—equivalent to the Army's "Golden Arrow" train—is capable of handling up to 40,000 words a day and is available to carry all classes of traffic.

Equipment is being shipped to enable the unit to transmit and receive pictures by wireless.

The "Blue Train" is manned by 10 Cable and Wireless "Telcom" staff, under Mr. C. F. Furnston-Evans, Engineer-in-charge.

Tokio and Bangkok Wireless Communications

CABLE AND WIRELESS, LIMITED, have opened wireless telegraph circuits with Tokio (Government and Ordinary Press traffic only) and Bangkok (all classes of traffic). Full ordinary telegraph rates are 1s. 11d. per word to Bangkok—as before the war—with proportionate charges at reduced rates for Code, Deferred and Press messages. The Ordinary Press rate to Tokio is 8d. per word.

B.I.R.E. Meetings

AT a meeting of the British Institution of Radio Engineers (Scottish Section), held at Heriot Watt College, Chamber Street, Edinburgh, on December 11th, a paper on "Ultra-high Frequency Techniques" was read by Professor M. G. Say, Ph.D., M.Sc.

Another paper on "A Review of Industrial Electronics" was read by J. Hare (Associate) at a meeting of the North-eastern Section held at the Neville Hall, Westgate Road, Newcastle-on-Tyne, on December 12th.

Far East Telegraphic Communications

COLOMBO, capital of Ceylon, is to-day the principal centre of telegraphic communications between London and the Occupation forces in the SEAC and Far East areas.

The Cable and Wireless, Ltd. office in Chatham Street, Colombo, with its peacetime complement of staff considerably augmented by Telcom personnel and locally trained junior operators, is operating 13 circuits as indicated in the diagram on opposite page; wireless with London, Shanghai, Chungking, Hong Kong, Rangoon—where the Company's "Blue Train" mobile wireless unit is operating—Singapore, Soerabaya, Batavia, and Padang; cables with Penang, Alexandria and London. In addition, two teleprinter circuits are connected with the Naval Office.

During November the staff in Colombo handled more than a million words including hundreds of thousands of words in Press telegrams.

Studio Opera

MONTHLY productions of opera by the Music Productions Department are planned. Listeners have already heard Weinberger's "Schwanda the Bagpiper," conducted by Stanford Robinson. On December 2nd, Mascagni's well-known "Cavalleria Rusticana" was broadcast by the B.B.C. Theatre Orchestra and Chorus. Stanford Robinson conducted; H. Proctor, Gregg wrote the narration. The two were jointly responsible for production. The cast included Edna Hobson as Santuzza, the young peasant girl, Tudor Davies as the peasant, Turiddu, also Winifred Lancaster, George Hancock, and Gladys Ripley.

The production on December 19th of Borodin's "Prince Igor" was a notable event for it was conducted by Sir Thomas Beecham, who is identified with many memorable performances of this work. This was the first time that Sir Thomas has conducted an opera in a B.B.C. studio. "Prince Igor" is best known to the general public for the Polovtsian Dances but its brilliance spills over into love-music, and scenes both comic and tragic. Indeed, the whole work glows and glitters. "Prince Igor" by Borodin ranks among the finest of national operas.

On January 30th, 1946, the opera will be Puccini's "Tosca," under the baton of Stanford Robinson. Founded on Sardou's tragedy "Tosca," first produced in Rome in January, 1900, it is a powerful story of passion and revenge, with music to match the theme. Studio opera has gained a strong hold on the ear of the musical public; and during the war years there were some outstanding productions, including



Radio relay towers are being used in a new communications system in the United States. Automatic, unattended radio towers are symbols of one of the most significant advances in communications in modern times. These towers may ultimately replace thousands of miles of telegraph and telephone lines in America. Our illustration shows a radio antenna of a tower on the roof of the 24-storey Western Union building.



Nautical training is part of the future programme of the National Association of Training Corps for Girls, who are leasing a small island in Poole Harbour as a national training centre. Our illustration shows members of the G.T.C. receiving instruction in telegraphy.

"Hansel and Gretel," "Tales of Hoffmann," "Il Seraglio," "La Traviata," "The Barber of Seville," "Eugene Onegin." Other important operatic works will be heard in the New Year.

New General Manager for Britannic

MR. F. D. SMITH has been appointed General Manager of Britannic Electric Cable and Construction Company, Limited. Previously Mr. Smith was Works Manager of Aero Engines, Limited, Kingswood.

Prior to that he had extensive experience in South America, where he was employed in various capacities by the Telephone Trust, Limited, Venezuela Telephone Company and International Telephone and Telegraph Company.

Swedish Wireless Engineers to Study British System

THREE members of the Swedish Directorate of Telegraphs are to visit London during January to study the British overseas system controlled by Cable and Wireless, Limited, who operate a direct phototelegraph circuit with Stockholm.

The party will comprise Mr. S. A. Gejer and Mr. K. J. T. Ekstrom, engineers of the Board of Swedish Telegraphs, and Mr. G. T. A. Widlund, Superintendent of the Stockholm Radio Centre.

The visitors are expected to arrive on January 11th.

Wireless for the Blind

THIS year's Christmas Day appeal for the British "Wireless for the Blind" Fund was broadcast by Mr. Christopher Stone in the B.B.C. Home programme.

The appeal was not made last year for a curious reason. Radio manufacturers whose plant had been wrecked by flying bombs could not supply sets, so the Fund could not spend its cash in hand. It was

decided to waive the broadcast. That was the first Christmas Day without its "wireless for the blind" appeal since the series was started in 1929 by Mr. Winston Churchill. The National Institute says that 71,000 sets have been given to blind listeners by the Fund.

Braille "Annuals"

BLIND people had their usual Braille "annuals" this Christmas, thanks to paper economies at the N.I.B. works during the past 12 months. They included a Christmas Annual, an almanac, a pocket diary, Scripture Text Calendar, the Scripture Union Portions, and a 1946 diary in two sizes.

New Transmitter for Moscow

IT is reported from the U.S.S.R. that a powerful new transmitter has been completed in Moscow, and is now working on 360.6 metres.

New Eire Station

THE Eire Government is to erect a high-power short-wave broadcasting station of modern type, which will probably be in operation early this year.

Wireless Receiving Licences

THE approximate numbers of wireless licences issued during the year ended October 31st, 1945, are as follows:

Region	Number
London Postal	1,768,000
Home Counties	1,285,000
Midland	1,399,000
North Eastern	1,536,000
North Western	1,346,000
South Western	832,000
Welsh and Border	585,000
Total England and Wales ..	8,751,000
Scotland	982,000
Northern Ireland	151,000
Grand Total	9,884,000

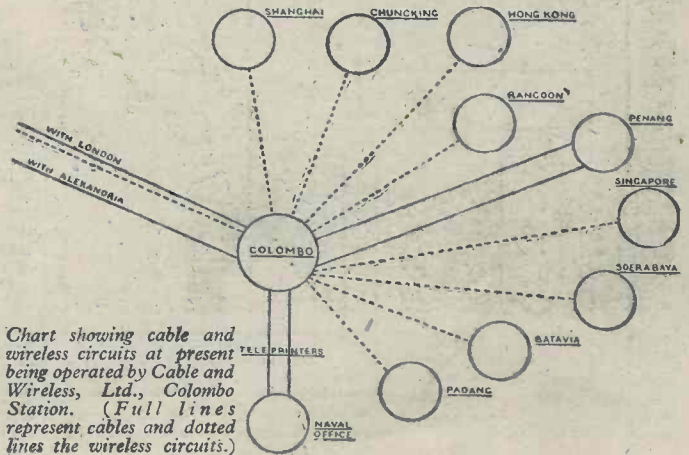
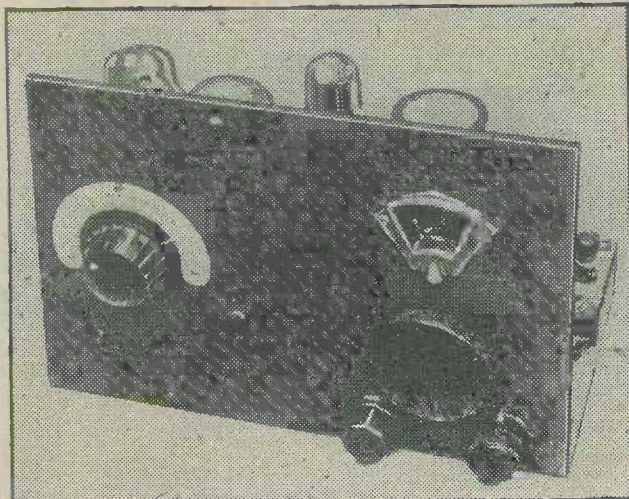

Chart showing cable and wireless circuits at present being operated by Cable and Wireless, Ltd., Colombo Station. (Full lines represent cables and dotted lines the wireless circuits.)

A Compact S.W. Three

Constructional Details of a Compact Set for S.W. Operation
By "LONGDON"



Front view of the S.W. Three

THIS receiver is a good example of a compact chassis layout for S.W. operation and gives very good results upon wavelengths from 10 to 100 metres. All-metal construction is used with advantage, for the use of a metal panel removes the possibility of hand-capacity effects, while the chassis gives a much neater and more compact layout than would a baseboard. The panel arrangement shown in the above photograph gives a convenient operating position for tuning and reaction controls when searching for DX stations.

The circuit is shown in Fig. 1. Two R.C.C. stages

follow the detector, and the output stage is a pentode. This gives sufficient amplification for speaker reception of the more powerful stations in America, Africa and the Near East. Although Australian stations have been received at sufficient speaker volume to be clearly audible in a large room, it is best to use 'phones for DX listening with a receiver of this type. With a speaker signals may be completely missed when tuning unless the operator is very careful. The L.F. amplification is ample for 'phones, of course, and in most cases the volume control will require to be turned to something less than maximum.

In the detector stage plug-in coils are used so that any waveband may be tuned. A .0001 mfd. pre-set reduces aerial damping, and in addition coils with an aerial-coupling winding are used so that tuning is reasonably sharp. Direct tuning with a slow-motion drive is used, but if band-spreading is wanted this can be added as explained later.

Constructing the Receiver

Fig. 2 shows the top of the chassis. A manufacturer's chassis 4in. by 9in. is used. It should be about 1 1/4 in. deep, as if it is too shallow there will not be room for the potentiometer used for L.F. gain, unless the latter is a mid-geet component. For the panel a stout sheet of metal 6in. by 9in. is wanted, although plywood with foil glued to the rear could be used instead.

The panel is secured to the right of the chassis by the fixing bushes of the on/off switch and potentiometer. A small bolt secures the left side of the panel. When the panel has been drilled and fitted in position a stout panel bracket is added as shown in Fig. 2. There is not

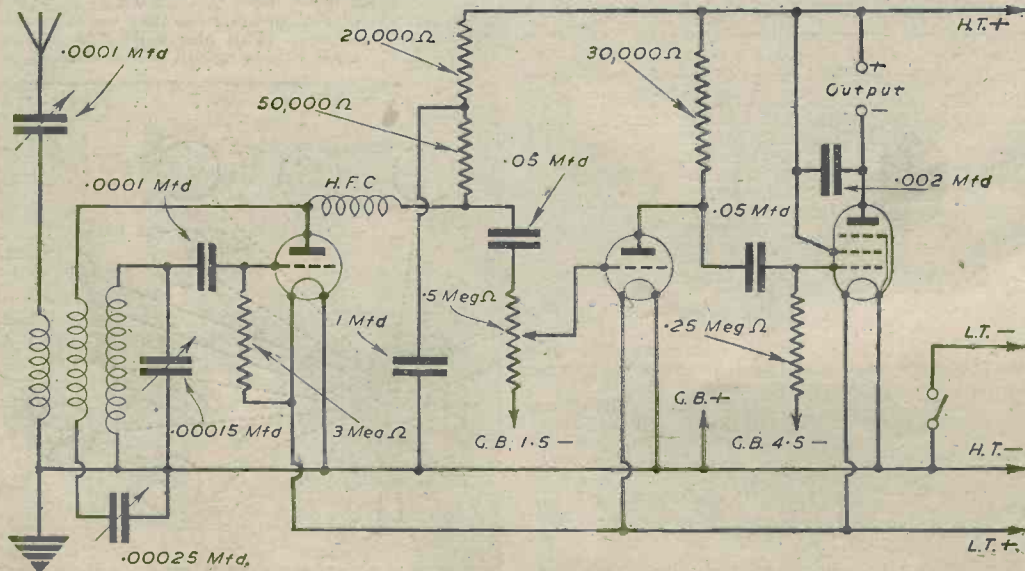

Fig. 1.—Theoretical circuit diagram.

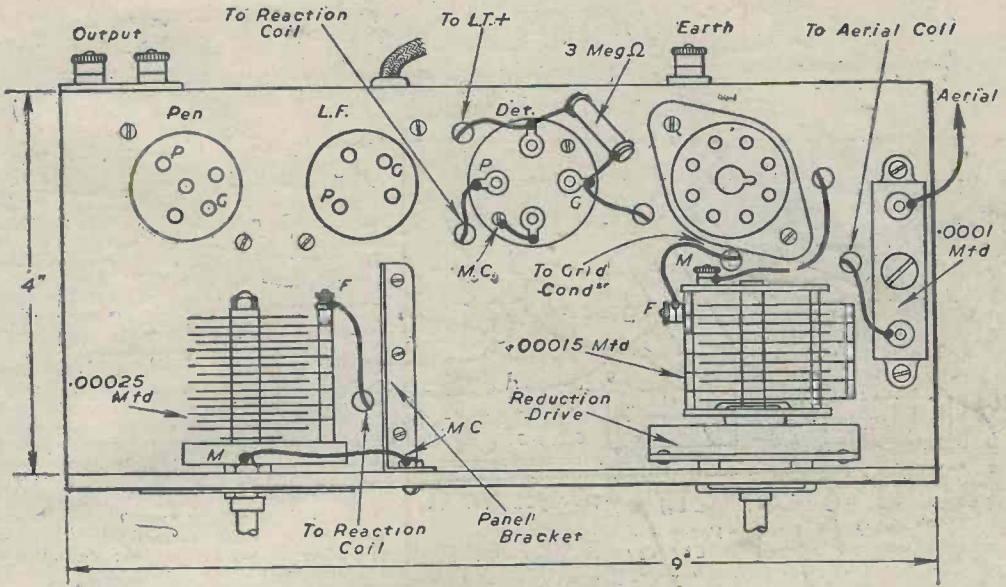

Fig. 2.—Top of chassis layout.

room for two brackets, and one near the centre will amply brace the panel to prevent tuning alterations due to pressure upon the control knobs bending the panel when operating. The bracket is fixed by bolts, and they should be tight to secure good electrical connection.

The .0001 mfd. pre-set in series with the aerial lead-in is mounted about $\frac{1}{4}$ in. above the chassis to decrease the capacitance to earth via the chassis. No aerial terminal is employed, the lead-in being taken directly to the pre-set. The remaining terminal of the pre-set is connected to the aerial coupling winding of the coil. The earth terminal is in contact with the rear runner of the chassis.

The tuning condenser and drive are fitted to the right as shown, and the reaction condenser to the left. The latter has a fairly large knob, complete with pointer and scale, and the condenser should be smooth and free in operation. To make the earth-return certain a lead is taken from the tag contacting the moving vanes to a bolt holding the panel bracket.

L.F. and output valveholders are normal paxolin types, secured below the chassis. The detector valveholder is a low-loss baseboard type bolted to the top of the chassis. The one filament is connected to the chassis; the other to the L.T. plus line of the other valves. The plate is connected to the H.F.C. and reaction coil. The grid-leak is above the chassis, and the last lead from the detector-passes through a hole to the grid-condenser.

A lead is also taken from the moving-vanes terminal of the tuning condenser directly to the coil holder, as shown in Fig. 2. This provides a shorter earth-return than that via the chassis and panel and helps the receiver to tune to a low minimum wavelength.

Sub-chassis wiring is depicted in Fig. 3. The output terminals are insulated from the chassis. All the battery leads pass out through a hole in the rear runner. All the resistors and small condensers can be suspended in the wiring in the approximate positions shown. The 1 mfd. decoupling condenser is bolted to one side runner. The H.F.C. should be kept as far from the chassis as possible and should not need supporting if the leads to it are short and of stout wire.

The detector grid-condenser is also kept away from the chassis, and the leads from it pass through fairly

large holes in the chassis. All wires passing through the chassis must be insulated.

It must be noted that the volume control spindle is in contact with the chassis and panel, so if this component is of the type having the spindle connected internally to the slider, insulating washers must be added. Failure to attend to this will result in complete lack of signals, and the constructor might be at a loss to find the fault.

One contact of the on/off switch is connected to the chassis. The L.T. minus lead is taken to the other.

Notes on Operation

If 'phones are being used, they should be connected in the correct polarity, or otherwise they will eventually become demagnetised. (This also applies to moving-iron speakers, but not to moving-coil 'phones or speakers.)

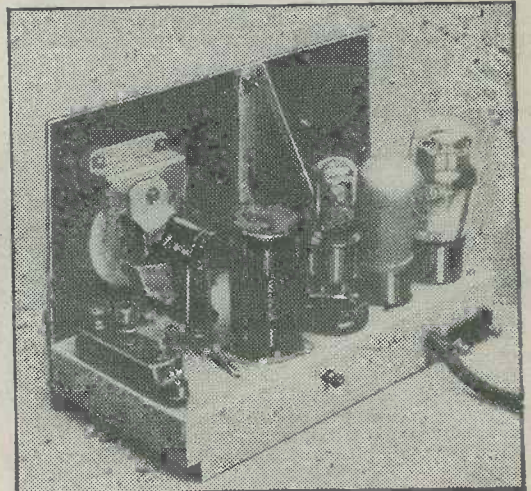

Rear view of the S.W. Three.

On the Beam-3

Continued from Last Month, this Article Describes the Aircraft Receivers Used for Standard Beam Approach—a Radio Aid for Landing Aircraft in Conditions of Poor Visibility.

IN considering the general circuit arrangement of the main-beacon receiver, it is necessary also to take some note of the marker receiver details. This is because the output from the second detector of the main receiver is fed into the grid circuit of the marker receiver through the volume control fitted on the pilot's control panel.

Thus, the output valve of the two-valve marker receiver serves as an audio amplifier for both receivers, and performs the function of an audio mixer stage.

Fig. 1 gives a schematic layout of the valves, the valve types being indicated. From this it will be seen that of the six valves in the main receiver, V6 is provided for the sole purpose of operating the kicker meter. The remainder of the circuit comprises an R.F. stage, frequency-changer, two I.F. stages and a second detector. Two pentodes are used in the marker receiver, of which the first is fixed-tuned to 38 mc/s and has fixed regeneration to ensure adequate sensitivity.

There are three principal types of main receiver available at the present time, and there have been many previous types which have been superseded as important modifications were introduced during the development period. The type R1124A has been used most extensively; the other two types are described as the R1466 and R1544. The two latter receivers have continuously-variable tuning instead of covering only six pre-selected frequencies, and have been developed from the earlier model.

Referring to the R1124A, then, the R.F. stage has pre-set tuning in both grid and anode circuits. An H.F. transformer is connected in the anode circuit and the secondary of this also has pre-set tuning. The fourth bank of pre-set condensers is for tuning the Hartley oscillator portion of the frequency-changer. There are thus four banks of six pre-set condensers, all controlled by a frequency-selection switch, operated through a Bowden cable from the selector knob on the P.C.P.

As already stated, the oscillator has a fine-tuning device on the P.C.P., consisting of a variable resistor in the supply line from the neon-stabilised 120-volt H.T. line to the tapping on the Hartley coil.

An intermediate frequency of 7 mc/s is employed. The band width is so adjusted in setting-up the receiver that it is not less than 70 kc/s for 3dB attenuation, and not greater than 400 kc/s for 40dB attenuation.

Standing bias (derived from a potential divider across the

13-volt L.T. heater supply) is applied along with A.V.C. bias to the grids of the R.F. and two I.F. valves. In addition, a cathode-bias resistor is provided for the first I.F. valve (V3), but there is provision for short-circuiting this by means of the "Normal-Test" switch on the P.C.P. In the "Normal" position the resistor is short-circuited, whereas in the "Test" position it is open-circuited, so that the standing bias on V3 is increased from about 4.5 to 14.5 volts. This is sufficient to render the A.V.C. virtually non-operative.

The second I.F. stage (V4) is a normal R.F. amplifier and is included to increase the I.F. gain, and also to introduce additional tuned circuits in order to ensure an adequate degree of selectivity.

An R.F. pentode is used as an anode-bend detector, operating with a standing bias of 7 volts negative. This valve does not itself provide the A.V.C., which is obtained separately from a "Westector" circuit. The signal-strength meter forming the "nose" of the visual indicator is connected in the cathode circuit of the second detector; it will be remembered that the cathode current of an anode-bend detector is proportional to the amplitude of the signal applied to the grid.

An audio-frequency transformer is connected in the anode circuit of the second detector. The secondary winding of this feeds, through a volume control, into the grid circuit of the A.F. valve in the marker receiver.

The final valve (V6) is used only to operate the kicker meter and has no effect on the audio circuits. It takes its input from the anode of the second detector and has automatic bias.

As the action of the A.V.C. and kicker circuits are closely allied, a brief explanation will be given of the two together. Fig. 2 gives the circuit arrangement.

A small portion of the output from the second detector is applied to the "Westector" marked W2, where it is rectified and used as A.V.C. bias. An 18-volt delay is provided by the P.D. developed across R1. Now when an incoming signal produces a positive half-cycle in excess of 18 volts a P.D. is developed across R2, and this is added to the standing bias.

Resistor R3 and condenser C1, which form a series

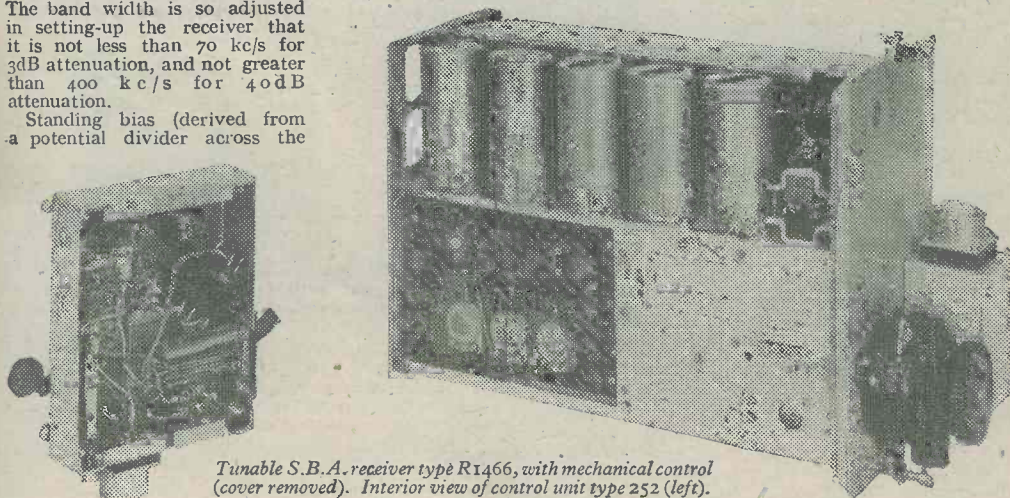

Tunable S.B.A. receiver type R1466, with mechanical control (cover removed). Interior view of control unit type 252 (left).

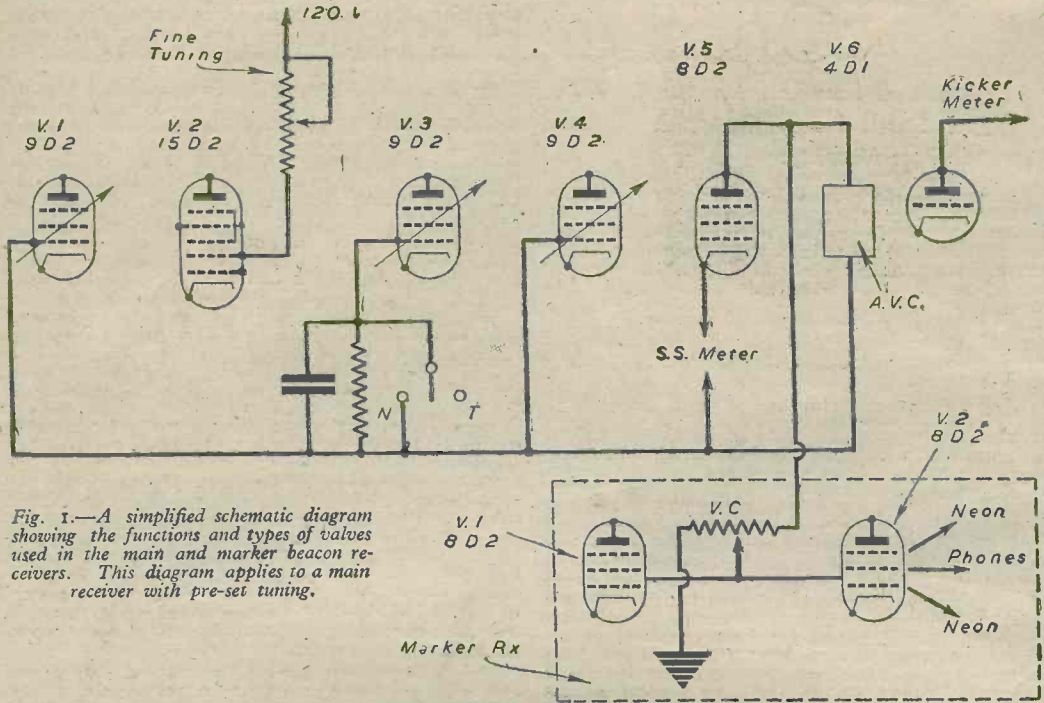
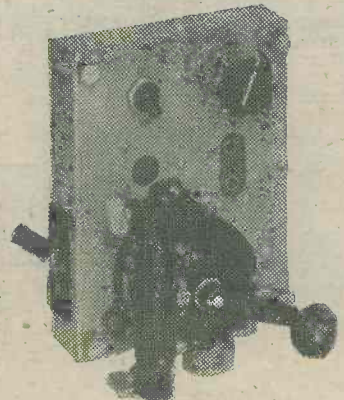
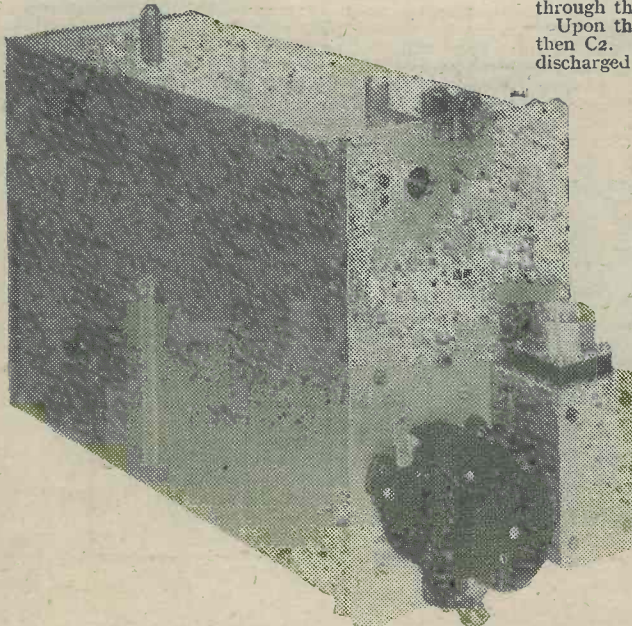

Fig. 1.—A simplified schematic diagram showing the functions and types of valves used in the main and marker beacon receivers. This diagram applies to a main receiver with pre-set tuning.

circuit across the output from the second detector, smooth both the 1,150 c/s audio and also the applied A.V.C. voltage when dots or dashes are being received. When A.V.C. is removed—in the absence of a signal

of sufficient amplitude, or in the "Test" position—the resistance of W_2 and R_9 in parallel is almost 5 megohms, and C_2 is immediately charged to the full standing-bias voltage through the "Westector" marked W_3 . Condenser C_1 is then slowly charged to the same potential through the resistance network.

Upon the re-application of A.V.C. C_1 is charged, and then C_2 . Later removal of A.V.C. results in C_2 being discharged slowly. The A.V.C. delay time should be between 15 and 20 secs. and can be checked on the signal strength meter by switching to "Test" and then back to "Normal."



Tunable S.B.A. receiver, type R1466, with mechanical control. Outer view of control unit (right).

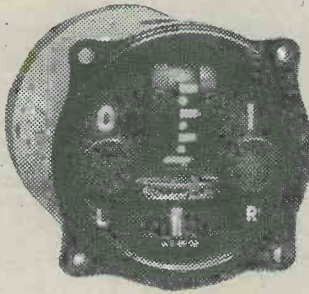

Visual indicator for S.B.A. receivers.

During the reception of dots and dashes the grid condenser of V6, marked C3 in Fig. 2, is charged and discharged alternately, with the result that a fluctuating bias voltage is developed across R5. When the grid is made more negative there is, of course, a reduction in the anode current passed by V6. Conversely, when the grid is made more positive the anode current rises.

The anode current of V6 is drawn through the primary of an iron-core transformer, the secondary of which is connected to the centre-zero kicker meter through a pre-set amplitude control. Each time the anode current through the primary undergoes a change there is a pulse of current through the secondary winding and hence through the meter; the meter is entirely unaffected by a steady flow of anode current.

When receiving dots, or when the signal has "dot predominance" (in the "dot" twilight zone) the needle of the meter kicks to the right. At this moment the bias to V6 is positive-going. The needle returns to zero after 1/3 sec. due to hair springs acting against normal inertia, and again kicks to the right when the next dot is received.

During the reception of dashes the needle kicks to the left when the bias to the grid of V6 becomes more

negative at the end of a dash. It returns to zero during the interval between dashes and remains there until the end of the next dash, when it again kicks to the left.

The mechanically-operated continuously tunable receiver type R1466 is similar in main details to the R1124A. The 24 pre-set condensers are, however, replaced by a three-gang condenser which tunes the grid and anode circuits of the R.F. stage and also the Hartley circuit of the oscillator. This gang condenser is driven through a torsional cable from the handle on the P.C.P.

A normal tuned-anode coupling is used between V1 and V2. Fine tuning is not required in addition to the main tuning circuit and therefore the oscillator takes its H.T. directly from the 130 volt stabilised line.

A frequency coverage of 33.5 to 40.5 mc/s. is given, which means that more than 30 frequencies are available, allowing for a channel separation of 200 kc/s., which is usual. A different type of Pilot's Companion Panel is used, and is illustrated in one of the accompanying half-tones. In addition to the on-off switch, "Normal-Test" switch, volume control and tuning handle, the panel includes the components fitted in the mixer box used with the R1124A.

The advantages of continuously-variable tuning are apparent, for the pilot has a choice of every S.B.A. frequency in use. Despite the accuracy of the tuning-scale calibration, it is not necessary to rely on correct reading of this (and the pilot of a night bomber has very little light) for main beams are now coded. In other words, the reflectors are made "dead" at intervals of 1, 2 1/2 or 5 minutes and a two-letter call sign is radiated. The pilot is thus able to identify the airfield, for he carries a list of call signs.

This keying is carried out automatically by fitting a so-called code sender to the main beacon installation.

The receiver type R1544, which is electrically tuned over the same range as the R1466, combines all of the advantages of the latter with many others. For example, there are three I.F. stages, which give sufficient selectivity to permit of 100 kc/s. separation between transmitters; this is twice the selectivity provided by the other

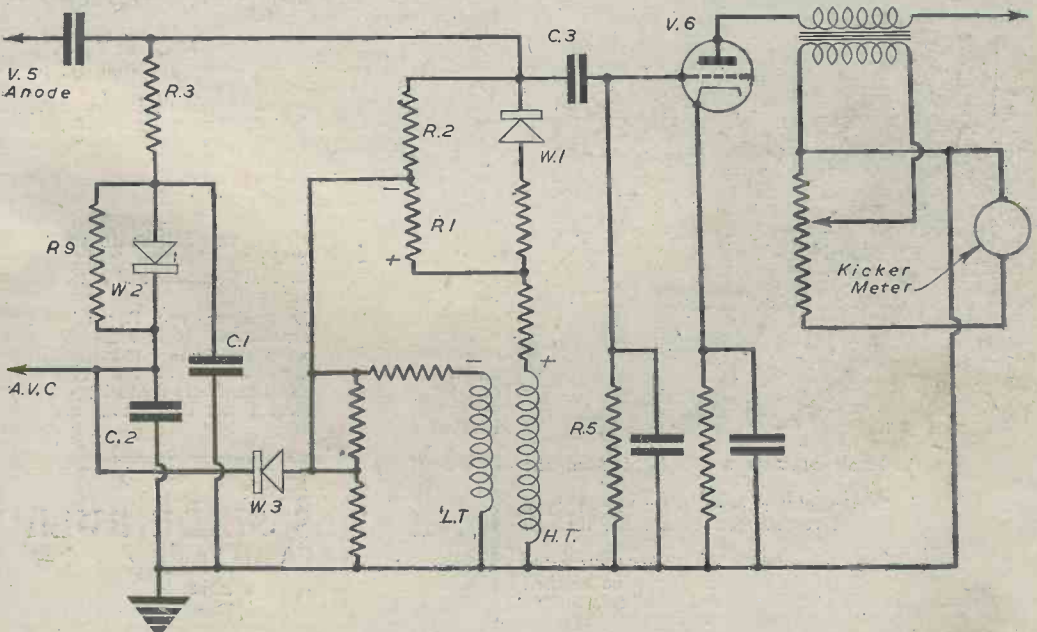

Fig. 2.—A skeleton diagram to illustrate the principal components associated with the A.V.C. and kicker-meter circuits of the main beacon receiver.

receivers. The I.F. stages operate on a frequency of 5 mc/s., instead of 7 mc/s.

In addition, "Westectors" are replaced by the diode sections of a double-diode triode, and these provide the A.V.C. voltage as well as rectification of the input to the kicker-meter amplifier. The amplifier is the triode section of the same valve—a type EBC33.

The valve arrangement is: H.F. pentode R.F. amplifier; heptode mixer, with electron-coupled oscillator portion; three H.F. pentodes as I.F. amplifiers; H.F. pentode as anode-bend second detector; double-diode triode for A.V.C. and kicker-meter operation. The additional bias resistor for "Normal-Test" switching is included in the cathode lead of the third I.F. valve, and the signal strength meter (sometimes called a "come-go" meter) is included in the cathode circuit of the second detector.

Most of the other circuit details are similar to those of the mechanically-tuned receiver type R1466.

Remote Control Unit

For remote tuning use is made of a special type of motor designed by Evershed and Vignoles. The motor unit is fitted in the receiver and is arranged to drive the rotor of the three-gang condenser. There is a six-pole stator, the three windings of which are connected by three leads to a commutator in the Pilot's Control Panel;

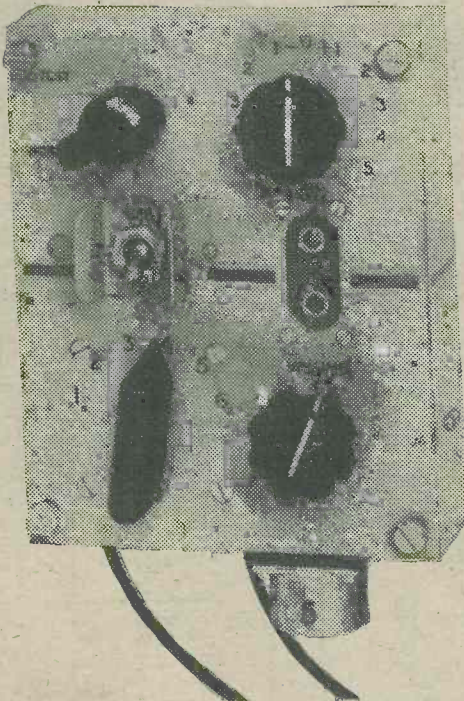

thus, all make-break contacts are isolated from the receiver itself.

Pivoted within the stator is a plain, band type armature, and this drives the condenser shaft through a reduction gearing.

The commutator in the remote control panel is rotatable by means of the tuning handle, which drives the beveled drum scale. As it rotates the polarity and connections to the three motor stator windings are changed. Phasing is adjusted so that the armature is rotated in synchronism with the rotation of the remote tuning handle.

Thus it is moved alternately to a position in line with a pair of pole pieces, and to a position midway between two pairs of poles.

This means that the armature is moved round in steps of one-twelfth of a revolution, or 30 degs. Gearing is included between the armature and the condenser drive shaft so that the condenser is moved in steps of only one-tenth of a degree; this is equivalent to a frequency change of approximately 10 kc/s.

The commutator is geared 3 : 1 to the remote tuning

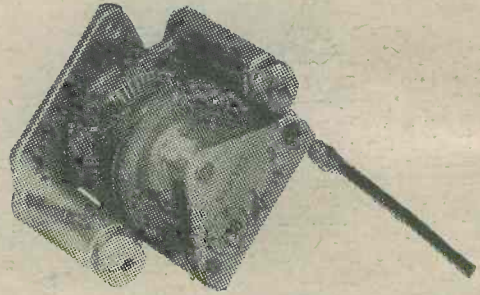

Control and remote control units for S.B.A. receivers.

handle with the result that the full 300 degs. represented by the calibrated portion of the tuning scale is swept by 42 revolutions of the tuning handle. It should be mentioned that synchronisation of the remote control to the tuning condenser can be effected very easily—if and when this should be necessary—by rotating the tuning scale to its end stop in one direction and then to the other end stop by turning it in the opposite direction.

In practice such synchronisation is seldom required except after the receiver or P.C.P. has been removed from the aircraft for servicing. This is because a D.C. switch is included in the tuning handle assembly so that current is not applied to the tuning motor until the handle is pressed inward against a light spring. A further safeguard consists of a mechanical interlock, with relay control, which prevents the handle from engaging with the drive unless the main switch is "on."

Details of the remote control unit are illustrated in an accompanying half-tone. From this it will be seen that the tuning scale is large, clearly marked and set at an angle of 45 degs. to the face of the control unit, to ensure easy visibility from almost any angle. The scale itself is translucent, and may be indirectly illuminated by a small 12-volt lamp mounted inside the scale assembly.

The control unit carries, in addition to the tuning handle and scale, the main on-off switch, "B.A.—Mix—I/C" switch, "Normal-Test" switch and a test socket for telephones.

In every respect, the receiver type R1544 is a great advance over its forerunners. It is somewhat more efficient, is easier to operate and easier to instal. Installation is greatly simplified due to the replacement of Bowden or mechanical torsional control by a three-way electrical cable which can be bent at any angle without ill effect.

A New Handbook

NEWNES SLIDE RULE MANUAL

By F. J. CAMM

5/- or 5/6 by post from George Newnes, Ltd.,
Tower House, Southampton St., Strand, W.C.2

Remote Control

The Principles Explained.

By S. A. KNIGHT

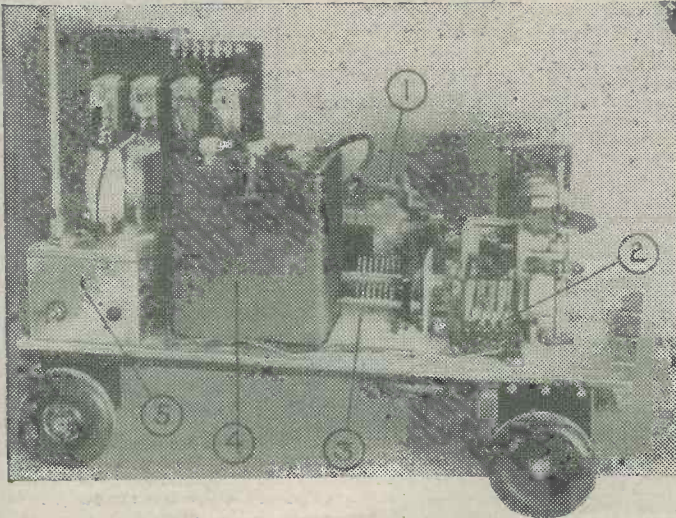

Fig. 1.—General layout of the remote controlled trolley.

THE following account might be of some interest to readers who have experimented, or intend to experiment, in single systems of remote radio control. The writer has experimented with a small remote-controlled trolley, the operations demanded being kept at the minimum of six, namely, start, increase speed, turn left, turn right, straight ahead and stop. These operations, once the machine has been set in motion, can be carried out in any order at the discretion of the controller, each command being distinct and foolproof in that no two contrary commands are capable of affecting the device at one and the same instant. The photographs, while they do not show the details of the machine, at least give a general idea of its layout and mechanism. The short account which follows will give the principles of working and will probably enable those interested among readers to incorporate ideas and suggestions of their own. The principle is, of course, adaptable to a radio-controlled model speed boat, and used in such the difficulties associated with steering experienced with the trolley would be largely overcome.

Operational Details

Simple radio control may be carried out in two ways: (a) by modulation tones, and (b) by separate carrier wave selection. The former method is, perhaps, slightly the easier of the two, but the second method embodies such interesting features that it was employed by the writer on the present trolley.

Briefly, the tone system consists of a transmitter whose carrier can

be modulated with a series of spot, low frequency tones, each tone corresponding to a particular command. On the machine to be controlled is situated the receiver which detects and amplifies the transmitted tones in the ordinary manner, passing the output to a bank of relays, the reeds of which are adjusted to be sharply resonant (mechanically) to certain L.F. tones. Each relay then operates a corresponding slave, i.e., heavier, relay which in turn performs the particular command.

The carrier wave selection consists of a transmitter capable of transmitting on a number of spot frequencies (preferably in pulse form), each frequency corresponding to a particular command. On the machine to be controlled is situated the receiver, which is continuously tuned by means of a driven condenser, throughout the band covered by the transmitter. On reception of a burst of R.F. on a particular frequency, one particular position of the tuning condenser will receive the signal and pass it on for detection and amplification. An output selector switch, synchronised with the tuning condenser, then passes the signal to one particular relay, which operates the corresponding slave, which in turn performs the particular command to which it is associated.

Fig. 1 shows the general layout of the trolley which operates on the above carrier wave system. (1) Indicates the driving motor, driven from the 6-volt motorcycle battery (4), this motor being connected through a single series of reduction gears to the rear driving wheels, to the variable tuning condenser (3), and to the output

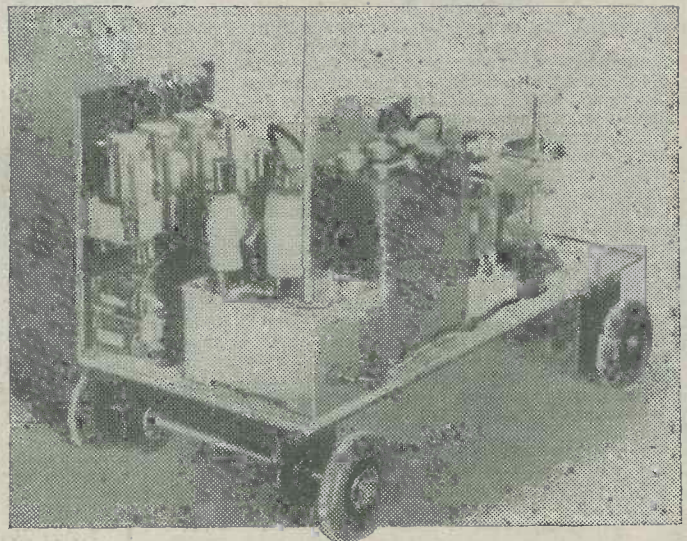

Fig. 2.—Showing the vertical rod aerial and the relay bank to its left.

selector switch (2). The receiver, with rod aerial, is seen to the left of the photograph at (5), the relay bank being situated immediately behind. This section of the machine is best seen in the second photograph, Fig. 2.

A block diagram of the receiver is shown in Fig. 3 and from this a good general idea of the operational details can be obtained. The receiver itself consists of a three valve circuit, all R.F. pentodes, heater voltage being derived from the driving battery, with H.T. supply from a small 90-volt battery normally housed above the driving motor (not shown on the photographs). The first valve is a normal leaky grid detector with a fixed amount of regeneration to ensure selectivity, with the L.F. amplifier consisting of a multivibrator and output bridge circuit. The multivibrator principle ensures an extremely rapid lifting of the output bias necessary for "snap" relay operation, and the output bridge circuit is arranged to give considerable unbalance for any small change in the anode current conditions of the output valve. This unbalance current operates the requisite relay, which in turn operates the heavy duty slave. The system calls for a certain amount of patience in setting up, but once adjusted gives a remarkable snap action for each of the received frequencies. The following account will perhaps best describe the operational details of the system.

Starting with the machine at rest, all relays are "open," and the receiver is tuned by a fixed condenser across the tuning coil. The command "start" is transmitted as a short pulse of R.F. on the same frequency at that to which the receiver is then tuned, and on reception of this pulse a relay in the output circuit is made to close. This in turn operates a slave which performs three functions. One, it completes the motor circuit and so applies power to the driving mechanism; also, since these are geared to the driving shaft, the variable condenser and the output selector switch are set rotating. Two, the variable condenser is switched in place of the fixed condenser across the receiver tuned circuit, and the receiver is henceforth being tuned continuously through a given range of frequencies. Three, the output selector switch takes over from the single "starting" relay in the output anode circuit.

Suppose now, as an example of the control process, it is desired to steer the machine to the left. The transmitter sends a pulse on the requisite frequency, and at one position of its rotation the receiver variable condenser selects this pulse and passes it on to the detector. This position of the variable condenser also corresponds to one position of the output selector switch, and the output pulse therefore actuates one particular relay. This relay operates the corresponding slave, which in turn controls the steering mechanism. This latter, which incidentally proved one of the most difficult points in construction, is solenoid operated and is ratchet controlled so that approximately 10 deg. of steering is accomplished at a time. The transmitter pulse is simply repeated the requisite number of times to control the amount of turn. At the end of the turn the "straight ahead" frequency is transmitted to the receiver, operating events exactly similar to those described above, and releasing the ratchet mechanism which allows the steering to take up a straight course again.

The "increase speed" control simply shorts a resistance from the motor field winding; the "stop" control breaks the motor input from the accumulator. Once the machine is at rest, the fixed tuning circuit takes over from the variable condenser, and the output switch is replaced by the single "starting" relay. In this position only the command "start" will have any effect on the machine.

All relays are self-holding and are arranged so that no signal can affect one without breaking the circuits to the others (with, of course, the exception of the stop relay which is only affected by the direct signal). This precaution ensures that no conflicting operations can take place at one and the same time—even allowing for great operating speed on the part of the controller at the

transmitter! Complete electrical and mechanical details are, of course, beyond the scope of these brief notes, but those readers who are interested in remote control will find, I trust, plenty of scope for mechanical and electrical ingenuity in the construction of such a trolley as the one described above.

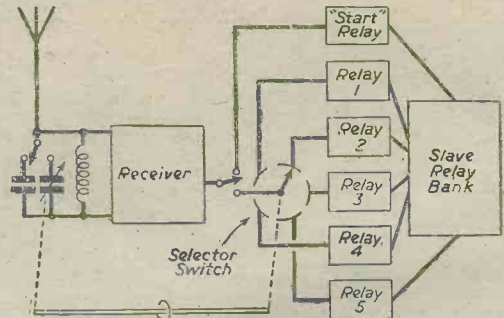

Fig. 3.—Diagram showing essential operating mechanism of the radio-controlled trolley.

The Decibel

THE comparative unit of sound strength. The value chosen for 1 decibel is the sound which can just be discerned by the trained ear.

Due to the fact that the human ear does not perceive simple increases of sound intensity as such, but tends to follow approximately a logarithmic law, the decibel is logarithmic in character and is independent of frequency.

If P_1 is the input power to an amplifier or attenuator, and P_2 the output power, then the simple power ratio is $\frac{P_2}{P_1}$. The logarithmic unit, the bel, is the logarithm of the simple power ratio, so that the power ratio (bels) is $\text{Log}_{10} \frac{P_2}{P_1}$ (common logarithms to the base 10 being used). Since the bel, as a unit, is too large for practical purposes, the decibel is used, this being a tenth part of a bel. Thus power ratio (decibels) is $10 \text{Log}_{10} \frac{P_2}{P_1}$.

Since the power output is proportional to the square of the voltage or current, when dealing with these units the power ratio becomes

$$10 \text{Log}_{10} \frac{I_2^2}{I_1^2} \text{ which is } 20 \text{Log}_{10} \frac{I_2}{I_1}$$

In the case of loudspeakers it is becoming common practice to give a graph of the power output over the entire audio-frequency range in decibels above and below the output at some standard frequency, such as Middle C (256 cycles per sec.). If the output is greater than the standard frequency, then the ratio in decibels is positive, whilst if less it is negative.

It is interesting to note that a change of power output of three decibels is the smallest change in intensity that can be detected by the average ear.

The decibel is also used to express power level transmitted in a circuit. It is necessary to refer it to an arbitrary standard called zero level or 0 decibels, it being recognised that this shall represent .006 watt of audio-frequency power. Thus 10 decibels is .06 watt and 20 decibels .6 watt, etc. To express values below the zero level a negative sign is put in front of the sign for the decibel, so that -10 decibels is .0006 watt and -20 decibels .00006 watt.

NEWNES TELEVISION MANUAL

By F. J. CAMM

6/-, or 6/6 by post.

From GEORGE NEWNES, LTD., Tower House, Southampton Street, Strand, London, W.C.2.

Wide-band Coupling Circuits

Notes on the Modification of Broadcast Receiver Circuits to Meet the Needs of Television

By P. FREEMAN, B.Sc.

THE reopening of the London Television Station and the probable transmission of frequency modulated sound programmes will encourage those interested in television and high-fidelity reception to avail themselves of the new facilities. The purpose of this article is to discuss briefly the way in which the basic coupling cir-

cuits of the long- and medium-wave broadcast bands together! Such a task is only made possible by the adoption of what are known as wide-band amplifying stages in the receiver. These wide-band coupling circuits are of two distinct kinds, those which precede the demodulator stage, i.e., R.F. and I.F. amplifiers, and those which follow the

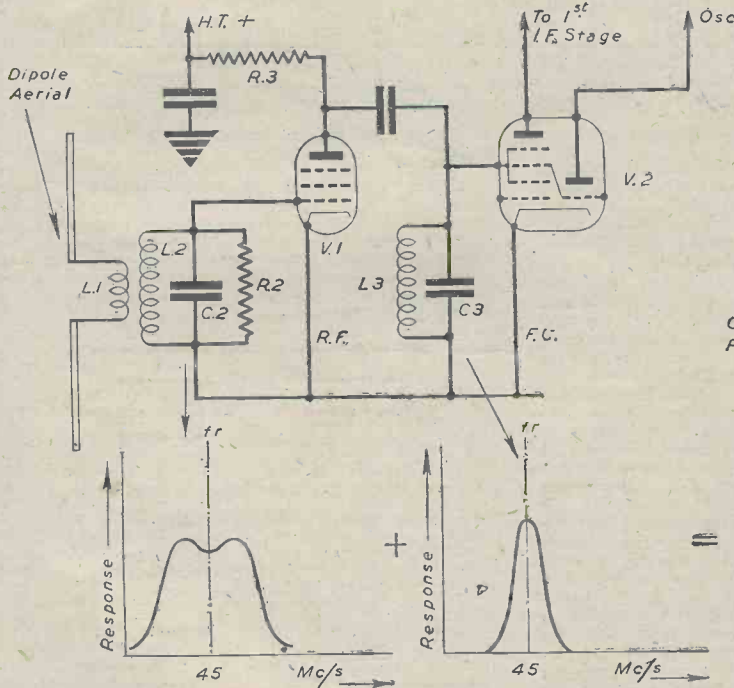

Fig. 1.—R.F. wide-band coupling circuits with response curves.

cuits of the familiar broadcast receiver are modified and developed to meet the requirements of television and frequency modulation reception.

For the purpose of illustration a typical ultra-short wave superheterodyne is shown as a block diagram in Fig. 2. This receiver is assumed to be operating on the Alexandra Palace television channel of 45 mc/s with the intermediate frequency stages tuned to 13 mc/s. A similar layout would be appropriate in the case of a frequency modulation receiver except that two additional stages, the limiter stage and the discriminator stage, are interposed between the I.F. stage and the demodulator or second detector. As the function of these two stages does not concern the discussion in this article, they will, for the sake of simplicity, be omitted.

High fidelity reception of sound and much more so of vision demand the use of intervalve coupling circuits which deal with a much wider range of frequencies than is met with in normal broadcast receiver design. The R.F. and I.F. stages must not only select and amplify the required signal at the resonant frequency but handle sidebands which, in the case of television, have a coverage greater than the entire frequency spectrum of

demodulator, i.e., A.F., or in the case of television V.F. (video frequency) amplifiers. The former circuits are always some kind of bandpass filter which should amplify the carrier or intermediate frequency and its sidebands to an equal extent yet have rapid attenuation below and above the limits of the transmitter sidebands, whereas the latter must amplify uniformly a band of frequencies extending ideally from zero to the highest modulation frequency. In Fig. 2 are shown the ideal response curves of the various stages in a perfectly designed receiver. It will be noted firstly that all the response curves have a "flat" top, and secondly that the sides of the curves for the R.F. and I.F. stages are vertical. The "flat top" signifies that all modulation frequencies are amplified to an equal extent, while the "vertical sides" indicate very abrupt attenuation at the limits of the passband, ensuring freedom of interference from any adjacent transmission. The need for such abrupt attenuation is not yet experienced in Britain, where only one television channel exists and the only adjacent transmission is the accompanying sound on 41.5 mc/s, whereas in the U.S.A. the ultra-short wave ether is already crowded and numerous television stations are

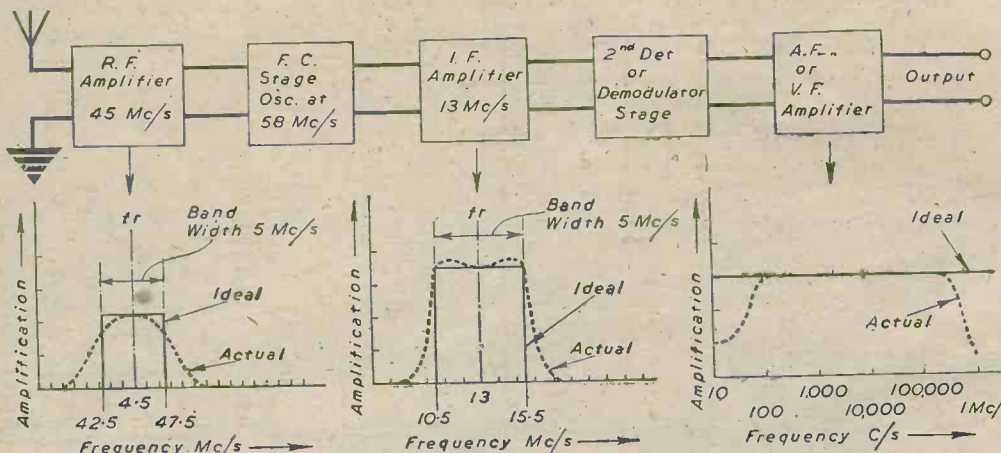

Fig. 2.—Block diagram of ultra-short wave receiver with wide-band response curves for each stage.

allotted channels 6 mc/s apart. In practice the response curves from even the best designed receiver would never be the ideal ones of Fig. 2 (full line), but would probably resemble the dotted line curves. It will now be explained how these response curves are obtained by suitable design of the coupling circuits.

The Loaded Tuned Circuit

The basis of design is the "loaded tuned circuit," an example of which is shown in Fig. 4, together with the response curves obtained with different values of resistance load. The tuned circuit must have as large an L/C ratio as possible, and in practice the condenser C is often omitted, the inductance being designed to resonate with the stray circuit and valve capacities. The value of R, the damping resistance, is chosen in relation to the bandwidth required. The lower the resistance, the flatter the response and the greater the bandwidth, but it should be noticed that a simple tuned circuit, no matter how loaded, cannot produce perfectly uniform response over a frequency range which includes the resonant frequency. The sloping response either side of the resonant frequency apparent in Fig. 2 cannot be avoided. However, if two loaded tuned circuits are coupled closely together, it is possible to produce a response that is higher at frequencies off resonance than at resonance (the familiar double-humped bandpass filter). The response of such an overcoupled stage can be made to compensate for the loss of response of a simple tuned circuit stage by operating the two stages in cascade, the "peak" of the single circuit filling up, as it were, the "valley" in the double-humped response.

The R.F. Coupling Circuits

The skeleton R.F. circuit of the receiver would be as shown in Fig. 1, with the respective response curves drawn under each coupling stage. No loading resistance is required in the aerial transformer as the dipole aerial itself loads this coil. The anode coupling resistance R₃ of the first R.F. valve V₁, although apparently apart from the tuned circuit L₃C₃, is actually the loading resistance as far as A.C. voltages are concerned. At frequencies as high as 45 mc/s the gain of a wide-band R.F. stage is small and only one stage of R.F. amplification is usually found in superheterodynes. The small gain is due to the fact that, at high frequencies, the input resistance of the R.F. valves decreases rapidly (it varies in inverse proportion to the frequency) and at frequencies above 40 mc/s it is low enough to damp the tuned circuit so heavily that worthwhile amplification cannot be obtained.

The R.F. stage does, however, perform two useful

functions, it provides a great improvement in the signal/noise ratio and it reduces second-channel interference. R.F. amplification is always included in frequency modulation receivers, since an extremely high signal/noise ratio is a feature of their performance. In television receivers a low signal/noise ratio causes a "dirty" background to the picture, and omission of the R.F. pre-selection may cause wavy lines across the screen due to interference from the adjacent sound channel.

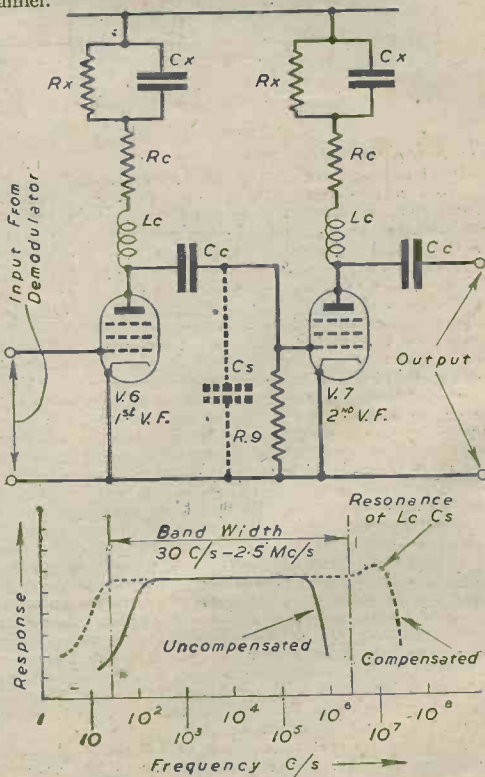

Fig. 3.—Two-stage video amplifier with response curve.

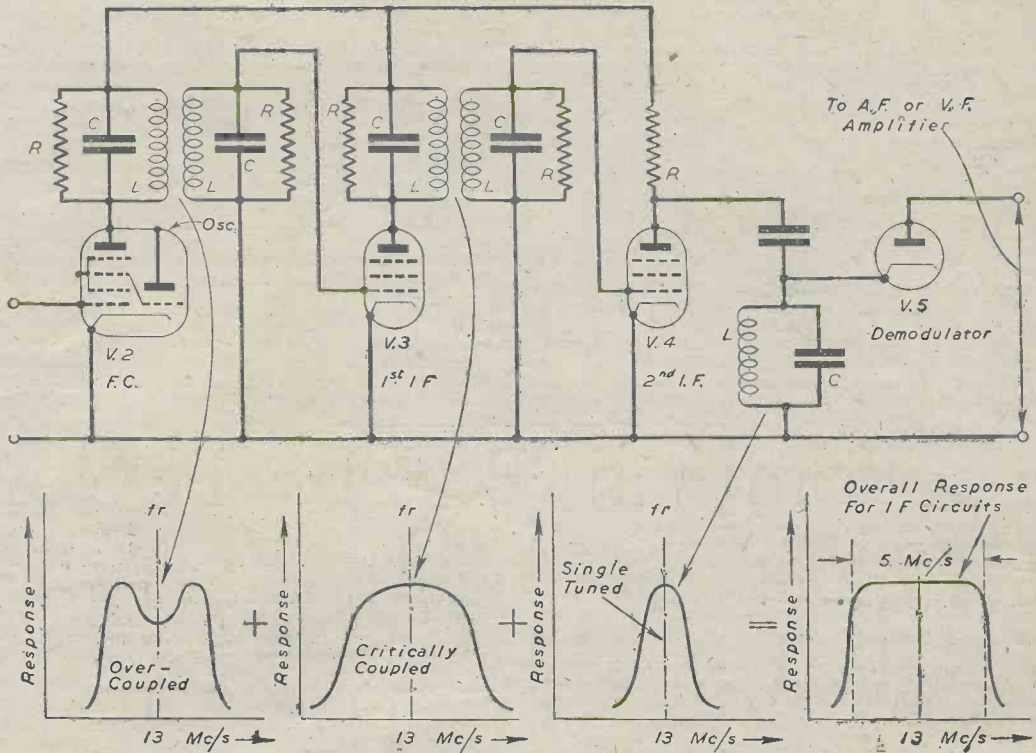

Fig. 4.—I.F. wide-band coupling circuits with response curves.

The I.F. Coupling Circuits

It is the design of the I.F. stages which contributes most to the performance of the receiver with regard to selectivity, sensitivity and fidelity, and hence their design must be such as to give as close a resemblance to the ideal square-shaped response as possible. It is found in general that the wider the band of frequencies to be amplified, the lower the value of the loading resistance and the smaller the gain of each individual stage. The stage gain is roughly proportional to $g_m R$ where g_m is the mutual conductance of the valve and R the loading resistance. In order to increase the stage-gain values of high mutual conductance, the so-called "television" pentodes have been developed (SP41, SP42, 1852, 1853, etc.). Even so, the stage gain does not usually exceed 15 as compared with several hundred in a broadcast receiver, so three to five I.F. stages are generally required to bring the signal up to the required strength to be demodulated. The process of frequency changing automatically enables a higher stage gain to be received from the individual I.F. stages, as at the intermediate frequency of 13 mc/s the damping effect of the valve input resistance, though not negligible, is considerably reduced. This fact explains one of the chief reasons why straight receivers are rarely employed for ultra-short wave reception. A typical three-stage I.F. amplifier with the respective response curves below each stage is shown in Fig. 4. The combined response curve of the three stages bears a tolerable resemblance to the flat-topped vertical-sided ideal. In American television receivers, the I.F. coupling circuits usually contain a more complex system of inductances and capacitances arranged according to the theory of band-pass filter design in order that the sides of the response curve may be made still more nearly vertical.

The Audio or Video Coupling Circuits

The stages following the demodulator valve are invariably a modification of the well-known resistance-capacity coupled type of amplifier. A video amplifier in a television receiver must have level response from near zero to 2.5 mc/s, an impossible feat for straight-forward R.C. coupling which, with optimum design,

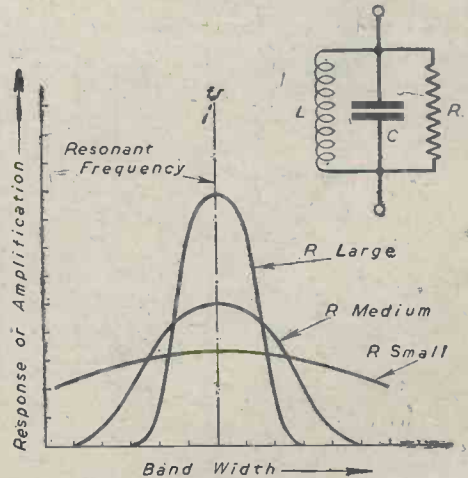

Fig. 5.—Response curves for a loaded tuned circuit.

produces a response similar to that shown by the full line in Fig. 3. It will be noted that at frequencies above 1 mc/s and at frequencies below 100 c/s, the level responses fall off sharply. The loss of high-frequency response is due to the combined shunting effect of the input capacity of V₆, and the stray wiring capacity represented by a dotted capacity C_s. As this shunting capacity cannot be reduced below a certain minimum value even in the best designed pentodes, it is necessary to compensate for it in some way. This is done by including a small inductance L₀ in series with the anode coupling resistance R₀; when correctly chosen the inductance L₀ resonates with the shunt capacity C_s at a frequency higher than the maximum modulation frequency to be reproduced, say at 3 mc/s. This prevents the attenuation at 1 mc/s and extends the response curve in the manner shown by the dotted curve in Fig. 3. The low-frequency response could be improved by increasing the capacity of the coupling condenser C_c, but a condenser of sufficient capacity (several microfarads) would introduce a large additional stray capacity to earth by reason of its sizeable physical dimensions, and this would spoil the high-frequency

response. The coupling condenser is therefore not made higher than about .01 μfd., and a compensating network consisting of a resistance R_x and a condenser C_x in parallel is introduced in series with the anode load. At frequencies above 100 c/s C_x provides little impedance, thereby effectively short-circuiting R_x and producing a level response as though R₀ were the sole anode load.

As the frequency is lowered, however, C_x provides an ever increasing impedance, and the total anode load is proportionately increased, giving increased amplification to compensate for the attenuation below 100 c/s. The resultant response at the low frequency end of the band is shown in Fig. 3 which also shows the skeleton circuit of a fully compensated two-stage video amplifier.

The fidelity of the complete receiver depends, of course, on the synthesis of all the response curves in the various stages described. This final response curve is known as the overall response, and it should be perfectly level and extend throughout the desired range of modulation frequencies.

Economy in Battery Power

BECAUSE a large amount of actual listening time is spent tuned to the local stations the writer has originated several useful and interesting circuits for this purpose. They are additions or modifications of standard circuits and can be added to almost any receiver. Moreover, the receiver can be restored to normal operation immediately as a switch is used for the change over. Some of the circuits can be used with short-wave receivers with advantage when using earphones; with others ample speaker volume will be obtained even when the set is operated in the "local" distance condition.

Cutting Out an H.F. Stage

After various experiments the circuit shown in Fig. 1 was arrived at. It has the advantage that no switching is required in the grid leads of the valves or the aerial circuit. Looking at Fig. 1 it will be seen that a standard H.F.-Detector circuit is used, but the coils are connected together at the earth end of the windings and to the filament of the H.F. valve. A switch is included between this line and the earth line of the receiver. The gang condenser and other parts are left connected as originally, and either tuned grid or H.F. transformer coupling may be used. Tuned anode coupling is not suitable.

When the switch S is closed the circuit will function exactly as before, but when it is opened the H.F. valve will cease to operate and the two tuned circuits will become a bandpass pair with bottom common-impedance coupling. The common-impedance is provided by the H.F. valve filament and low tension wiring and was found to be just right in two receivers upon which this modification was tried.

A single pole switch only is required, and in

one receiver use was made of the switch upon the V.M. volume control, so that when this was turned to minimum the circuit was opened for bandpass operation. When closed operation was normal, with the volume control functioning in the usual way. An additional switch was added to the L.T. supply for switching the receiver on and off, and to avoid drilling the cabinet this was one of the electric-light pear type on a length of flex.

One point must be noted in conjunction with this circuit—the V.M. bias cannot be applied to the H.F. valve through the tuning coil, but a leak must be used as in Fig. 1.

Optional L.F. Stage

In a receiver with two L.F. stages it will be found very convenient to be able to cut one out at will. A satisfactory circuit is shown in Fig. 5. A double-pole-double-throw switch is added to the receiver as shown. When the switch is in one position the L.F. valve filament

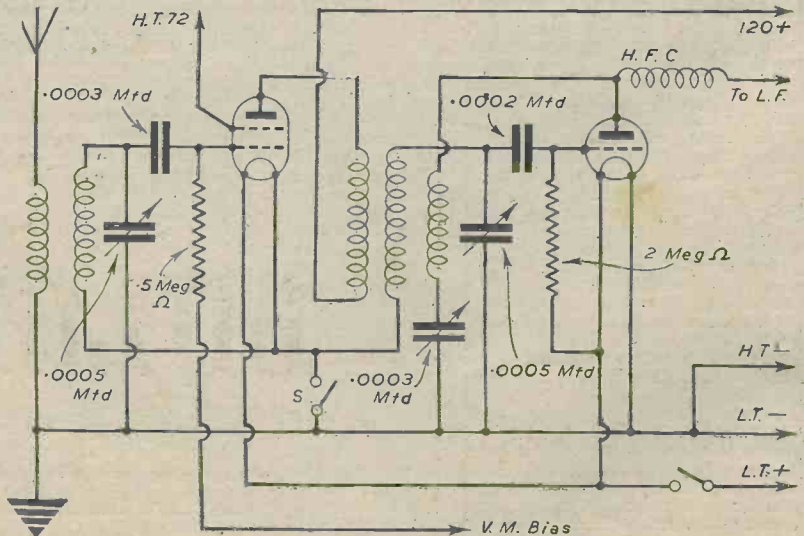

Fig. 1.—Experimental circuit.

VALVES

10,000 Popular and Rare Radio VALVES, exact type or suitable Replacement, ACHLDD, ACP, AC2HL, ACpen, AC2pen, AC2penDD, AC5pen, AC5penDD, ACSGVM, ACTP, ACVPI, ACVP2, ACO44, APP4A, APP4B, APV4, AZ1, AZ31, CI, CIC, CBL31, CCH35, CY1, CY1C, CY31, D63, DA30, DCP, DD41, DD207, DDT, DH63, DH73M, DL, DL63, DO24, DW2, DW41350, DW41500, EB34, EBC3, EBC33, EBC, EBL1, EBL31, ECH35, ECR30, EFS, EF6, EF8, EF9, EF39, EL2, EL3, EL32, EL33, EL35, FC4, FC13, FC13C, H63, HD24, HL2, HL13C, HL21DD, HL23, HL23DD, HL41DD, HL133DD, HL1320, HL1DD1320, IW41350, KT2, KT24, KT33C, KT61, KT63, KT66, KTW61, KTW63, KTZ41, KTZ63, LP2, MH4, MH1118, MH4105, MHD4, MHL4, ML4, MS4B, MSP4, MSPen, MSPenB, MU14, OM4, OZ4, P2, P215, P650, PA20, PM2A, PM2HL, PM22A, PM22D, PM24A, PM24B, PM24M, PM256, PP31250, PP51400, PP3521, PT41, PX4, PX25, Pen4DD, Pen4VA, Pen25, Pen45, Pen45DD, Pen46, Pen141, Pen383, Pen428, Pen1340, PenA4, PenB4, PenDD4020, QP22B, QP25, QP230, R4, S4VB, S215VM, SP13, SP2, SP2BS, SP4, SP4B, SP41, SP42, SP2220, TDD13C, TDD2A, TDD4, TH2, TH21C, TH30C, TH4B, TH41, TH2321, TP25, TP26, TX41, U5, U1B, U14, U16, U18, U21, U31, U50, U52, U403, U4020, UR1C, UR3C, UUS, UU6, UU7, V914, VHT4, VMP4G, VMS4B, VP2, VP4, VP4A, VP23, VP41, VP133, W21, XSG, XP, XL, XLO, X24, X41, X61M, X63, X65, Y63, Z22, -01A, IA4, IA5, IA6, IA7, IB4, IB5, IC5, IC7, ID5, ID6, ID7, IE5, IE7, IF4, IF5, IF6, IF7, IH4, IH5, IH6, IJ5, IJ6, ILC6, IQ5, IT5, 2A7, 2B7, 2D13C, 2D4A, 2P, 5U4, 5V4, 5Y3, 5Z3, 5Z4, 6A4, 6A7, 6A8, 6AB7, 6AE6G, 6A3, 6B7, 6B8, 6C7, 6C6, 6C8, 6D5, 6D6, 6F6, 6H6, 6J5, 6J7, 6J8, 6K6, 6K7, 6K8, 6L5, 6L6, 6L7, 6N6, 6P5, 6Q7, 6R7, 6S7, 6SK7, 6T7, 6U7, 6V6, 6X5, 6Z5, 7A7, 7A8, 7B5, 7B6, 7B7, 7B8, 7C5, 7C6, 7D3, 7D5, 8D2, 9D2, 10, 10D1, 11D5, 12A, 12A5, 12E5, 12J5, 12Q7, 12SQ7, 12Z3, 12Z5, 13SPA, 14, 15, 18, 19, 20, 20D2, 22, 24, 25A6, 25L6, 25Y5, 25Z4, 25Z5, 25Z6, 26, 27, 29, 31, 32, 35, 35Z4, 35Z5, 33, 37, 38, 39I44, 40, 40USA, 41MP, 41MTL, 41STH, 43IU, 42, 42MPpen, 43, 45, 46, 48, 50, 53, 55, 57, 59, 71A, 74, 75, 76, 79, 80, 81, 82, 83, 85, 89, 99, 164v, 210DDT, 220TH, 301, 302, 303, 304, 354v, 954, 955, 956, 1821, 1853, 4020T, 506BU.

All at list prices. Order C.O.D. Stamp with enquiries. Under 10/- orders C.W.O.

EXPORT ORDERS INVITED
Forces and Demobilised—
Special Attention.

J. BULL & SONS
(Dept. P.W.)

246, High Street,
Harlesden, N.W.10

EVERY MILE OF THAT LONG, LONG ROAD . . .

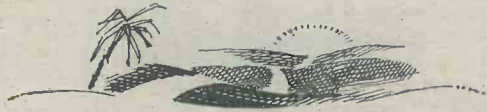

*EL ALAMEIN, Tunis, Sicily, Rome, Normandy and
over the Rhine . . .*

Bulgin Components have travelled every mile of that road. With the tanks and guns, in the planes that blasted the way ahead, in the little ships that covered our landings. It was a long, bitter road, through dust, heat and sandstorms. The road that stretched so far, through rain and cold and slush, that only the strong could make it.

Those hardships were Bulgin's finest test. With everything against them, grit, mildew and rough handling, they did their job. Right from the word "Go" until the white sheets were fluttering in Berlin.

You could not buy that Bulgin coil, condenser or resistance you wanted while they were on vital work. You couldn't rebuild your old set or start planning that new one. Now the news is good news—

BULGIN COMPONENTS ARE ON THE MARKET AGAIN

A steady trickle, not much at first, but enough to be going on with. Ministry requirements are tapering off. That means more for you at home, more for export overseas. Winter evenings and Bulgin components to build that dream set are something special to look forward to.

YOU CAN NOW GET

BULGIN

RADIO & TELEVISION COMPONENTS

A. F. BULGIN & CO. LTD., Bye-pass Road,
Barking, Essex

Tel. R1Ppleway 3474 (5 lines)

LET ME BE YOUR FATHER

You need help and fatherly advice in difficult times like these. I am in the position to give that to you free.

We teach nearly all the Trades and Professions by post in all parts of the world.

The most progressive and most successful Correspondence College in the world.

If you know what you want to study, write for prospectus. If you are undecided, write for my fatherly advice. It is free.

Distance makes no difference.



EARNING POWER IS A SOUND INVESTMENT

DO ANY OF THESE SUBJECTS INTEREST YOU ?

- | | | | | | | | | | | | | | | | | | | | | | | | | | | | | | | | | | | | | | | | | |
|--------------------------|----------------------------------|--------------------------------|-----------------------------|-------------------|--------------------------------|-------------------------------|----------------------|-------------------|--------------|------------------------|------------------------|---|------------------------|---|----------------------|-------------------------------------|------------------------|-----------------------------|-------------------------|----------------|---------------------------|-------------------------------------|-------------------------------|--|----------------------|---------------------|-------------------------|----------------------|------------------------|-----------|-------------------------|--------------------------|-------------|------------------------|------------------------------|----------------------|-----------|---------|-----------------------------------|----------------|
| Accountancy Examinations | Advertising and Sales Management | Agriculture | A.M.I. Fire E. Examinations | Applied Mechanics | Army Certificates | Auctioneers and Estate Agents | Aviation Engineering | Aviation Wireless | Banking | Blue Prints | Bollers | Book-keeping, Accountancy and Modern Business Methods | B.Sc. (Eng.) | Building, Architecture and Clerk of Works | Builders' Quantities | Cambridge Senior School Certificate | Civil Engineering | Civil Service | All Commercial Subjects | Commercial Art | Common Prelim. E.T.E.E. | Concrete and Structural Engineering | Draughtsmanship, All Branches | Engineering, All branches, subjects and examinations | General Education | G.P.O. Eng. Dept. | Heating and Ventilating | Industrial Chemistry | Institute of Housing | Insurance | Journalism | Languages | Mathematics | Matriculation | | | | | | |
| Metallurgy | Mining, All subjects | Mining, Electrical Engineering | Motor Engineering | Motor Trade | Municipal and County Engineers | Naval Architecture | Novel Writing | Pattern Making | Play Writing | Police, Special Course | Preceptors, College of | Press Tool Work | Production Engineering | Pumps and Pumping Machinery | Radio Communication | Radio Service Engineering | R.A.F. Special Courses | Road Making and Maintenance | Salesmanship, I.S.M.A. | Sanitation | School Attendance Officer | Secretarial Exams. | Sheet Metal Work | Shipbuilding | Shorthand (Pitman's) | Short-story Writing | Short-wave Radio | Speaking in Public | Structural Engineering | Surveying | Teachers of Handicrafts | Telephony and Telegraphy | Television | Transport Inst. Exams. | Viewers, Gaugers, Inspectors | Weights and Measures | Inspector | Welding | Wireless Telegraphy and Telephone | Works Managers |

If you do not see your own requirements above, write to us on any subject. Full particulars free.

COUPON-CUT THIS OUT



To DEPT. 104, THE BENNETT COLLEGE, LTD., SHEFFIELD.

Please send me (free of charge)

Particulars of } (Cross out line
Your private advice } which does
about } not apply.)

PLEASE WRITE IN BLOCK LETTERS

Name.....

Address.....

COVENTRY RADIO

COMPONENT SPECIALISTS SINCE 1925.

A few items from our new Id. 1946 list, the most comprehensive published to-day.

RESISTORS, 1 watt display card of 50	17/6
ELECTROLYTIC CONDENSERS, 8 mfd.	3/-, 4/- & 4/6
METERS, 0-10 ma 2" flush mounting	15/6
TRIMMERS, 3-30 pf. 6d. 30-80 pf.	8/-
MAINS TRANSFORMERS, good range	21/- & 25/-
OUTPUT TRANSFORMERS, 20 watt C.T.	20/-

PROMPT SERVICE, COMPLETE SATISFACTION.

COVENTRY RADIO

191, DUNSTABLE ROAD, LUTON

Soldering-

then **ELCO**

Elco design and build soldering irons, machines, melting pots, and special furnaces for all soldering needs to suit any voltage from 24v. up. Illustrated are four interchangeable



units. There are many others. Write for leaflet to Sole Agent:

ELCORDIA LTD.,
2, Caxton Street, London, S.W.1.
Tel: ABBey 4286.



Stentorian

EXTENSION SPEAKERS

now available again FROM

29/6



The benefits of specialisation make possible really amazing values. The efficient permanent magnet speakers, giving remarkably pleasant reproduction, are housed in most attractive cabinets, complete with VOLUME CONTROL.

Supplies are limited so please be patient if your dealer cannot supply immediately.

CABINET MODELS AT PRESENT AVAILABLE

Minor Type MX (for Low Impedance Extension)	29/6
" " MC (with Universal Transformer)	35/6
Baby " BX (for Low Impedance Extension)	43/6
" " BC (with Universal Transformer)	49/6

WHITELEY ELECTRICAL RADIO CO. LTD.
MANSFIELD, NOTTS.

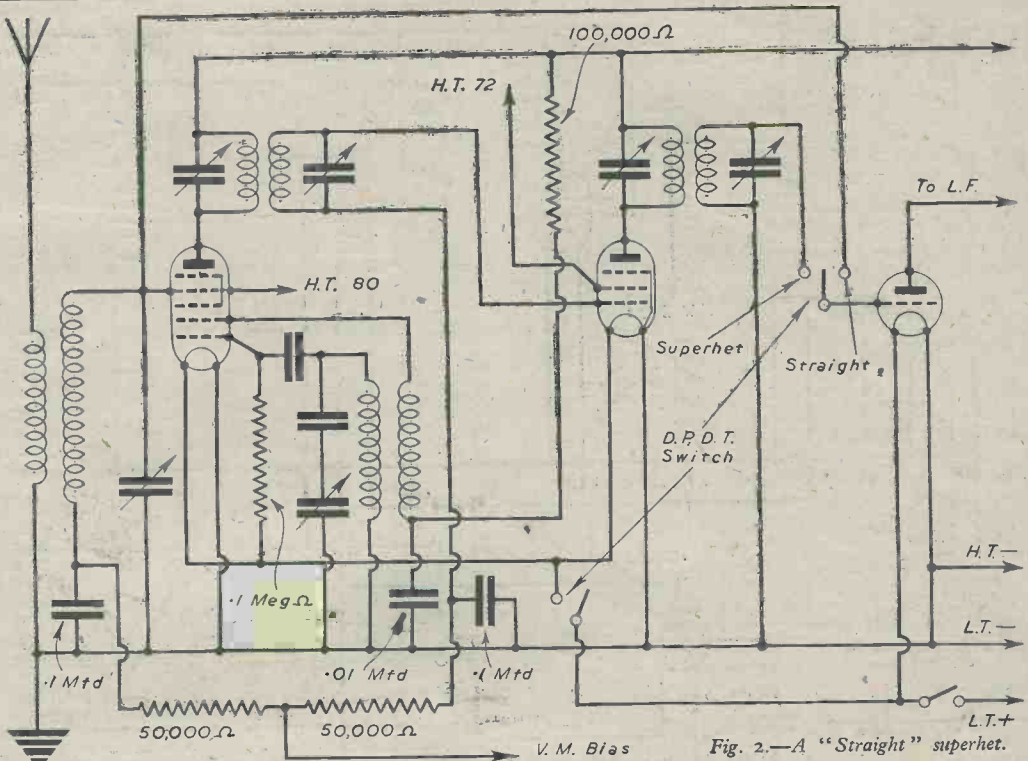

Fig. 2.—A "Straight" superhet.

is connected and also the coupling condenser is connected to the valve grid. Results are then normal. In the other position the valve filament is disconnected and the connection from the coupling condenser transferred

to the anode. The L.F. transformer will then be parafed and the L.F. stage by-passed.

As with circuit 1, this will result in a saving of both H.T. and L.T. current. There is also the advantage that the anode load of the detector is not modified so that different reaction effects due to changed voltage, for example, are not produced. It is a very useful circuit for a short-wave receiver. The L.F. valve can then be of high-gain type, such as the Osram HL2, and can be switched out when powerful stations tend to overload it.

Speaker-'phone Listening

'Phones are often connected in place of the speaker for S.W. listening, but sometimes this brings disadvantages. Excessive amplification may cause background noise, while sometimes the 'phones may be incapable of carrying the anode current of the output valve.

A useful circuit to overcome these difficulties is shown in Fig. 3. The only additional parts required are a .05 mfd. coupling condenser and single-pole-double-throw

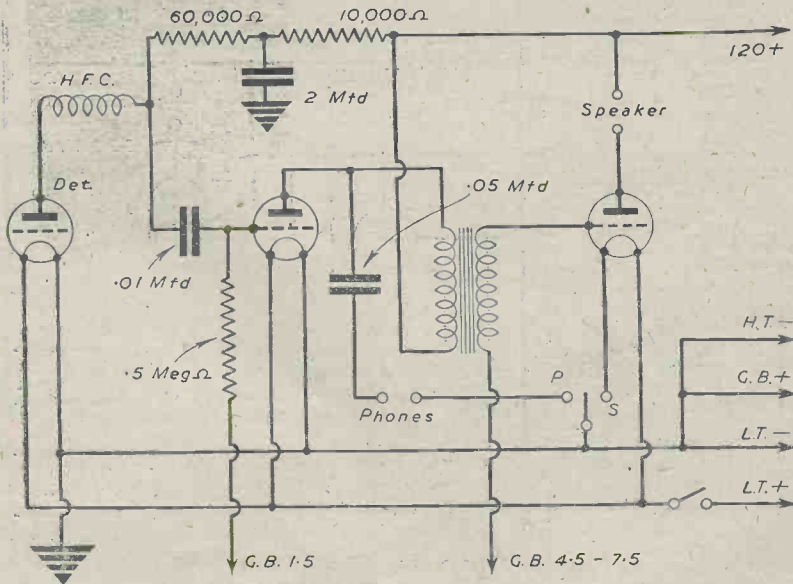

Fig. 3.—Circuit with switching for L.F. and 'phones.

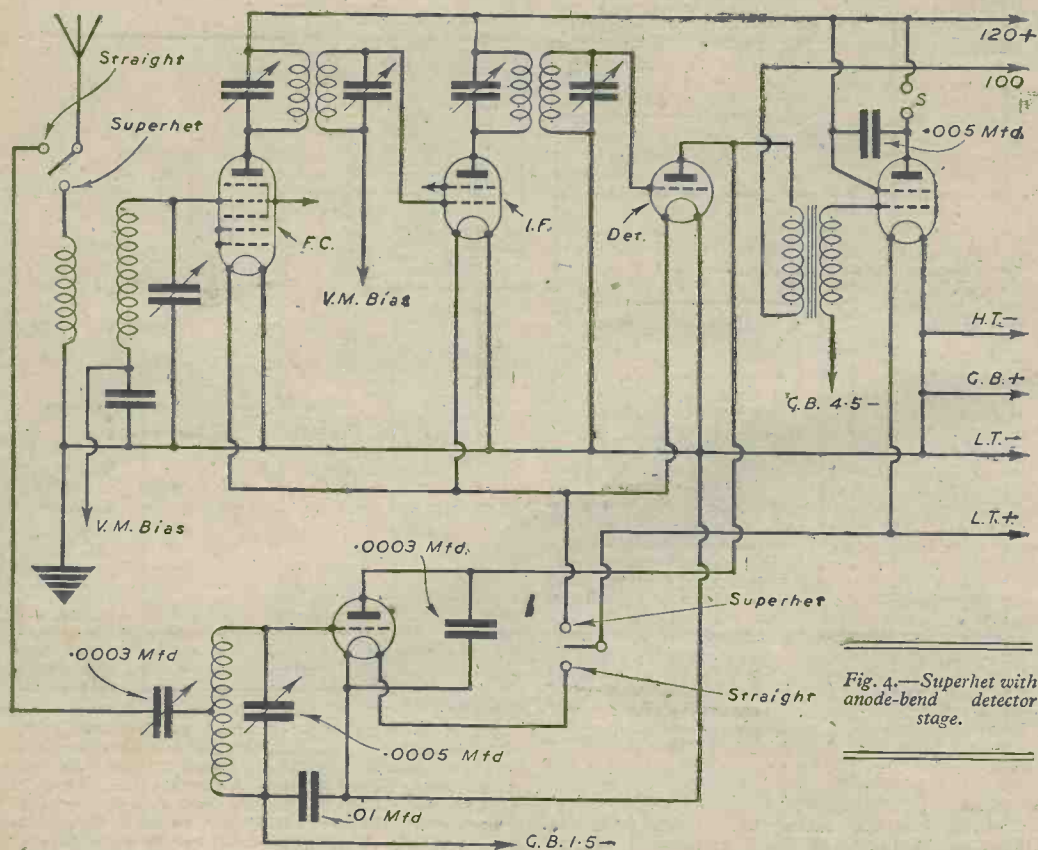

Fig. 4.—Superhet with anode-bend detector stage.

switch. They are connected as shown, and it will be seen that in one position the 'phones are cut out and the circuit operates normally. In the other position the output valve ceases to operate and the 'phones are fed through the condenser from the L.F. stage.

This circuit may also be used if a transformer is employed between detector and L.F. stages and the modifications will be just the same.

Straight-superhet Listening

The circuit is shown in Fig. 2, and again a D.P.D.T. switch is required. This should be mounted so that the lead from the second I.F. transformer to the detector is not unduly long, for this connection is now taken via the switch as will be seen. The other contact of this section of the switch is taken to the

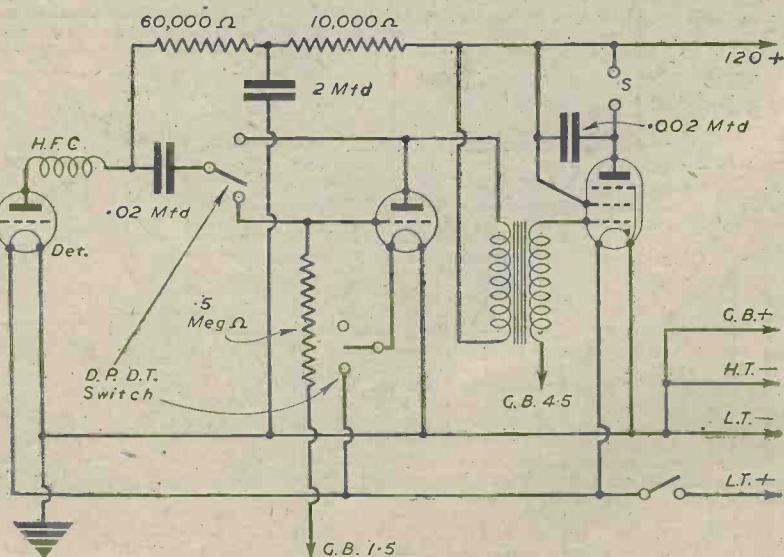

Fig. 5.—Circuit with optional L.F. stage.

control grid of the frequency changer. It will probably be best to screen this wire to prevent risk of instability. The filament circuit of the P.C. and I.F. valves is now modified as shown, and there is little risk of introducing instability by these leads. When the filament circuits of the F.C. and I.F. valves are completed and the detector grid connected to the I.F. transformer, results will be as before. In the second, or "straight" circuit position, the F.C. and I.F. stages will cease to operate and the second detector will operate directly from the aerial circuit. Local stations can then be tuned in as when operating normally, but the circuit will be merely a detector followed by L.F. amplification. When listening in the "straight" position the V.M. volume control will have to be turned so that little or no bias is applied to the coil, or distortion will arise in the detector. If desired, this can be obviated by inserting a grid leak and condenser in the detector grid circuit.

Superhet-anode-bend

A circuit favoured by the writer, is shown in Fig. 4. Here a standard superhet of all-wave design has an additional le-bend detector added. The superhet P.C. circuit is not shown in full because it is as in Fig. 2.

If the connections are followed it will be seen that when the switch is in one position all-wave superhet reception as usual will be obtained. In the other position the F.C., I.F. and second detector stages will cease to function and the anode-bend detector will become operative as its filament is connected by the switch. The aerial is also transferred to the anode-bend detector coil, which is pre-set tuned to the local station. The .0003 mfd. pre-set in the aerial connection is for volume control, and once set does not need to be altered.

In one position, therefore, the set functions as a normal 4-valve superhet, but in the other becomes a detector-pentode tuned to the local station. This will be found a very useful circuit and the switch may be marked "Superhet Reception" and "Local Station Reception." The anode-bend detector will give good volume and quality, and there is no reason why reaction should not be added to the circuit if desired.

Bias Notes

It will be seen that battery bias is used in all the circuits and this is because the changing anode current caused by manipulating the economy switch would upset automatic biasing circuits. This could be overcome by having additional resistors to be switched into circuit but the use of battery bias is the simplest and best solution.

Radar Receivers

THE problem of the receiver for radar is a complex one. In practically all radars the superheterodyne principle is employed, which involves generating at low power a radio frequency fairly close to that received, and "beating" this against the received signals, forming an intermediate frequency which is then amplified, many times. Curiously enough, the old-timer's crystal of the 1910-1920's, used, as a detector and mixer, has again come into its own in microwave receivers. The peculiar characteristics of pulse signals require that receivers be built with extremely fast response, much faster even than that required in television. The final stages must prepare the signals for suitable presentation in the indicator. The receiver normally occupies a relatively small box in the complete radar set, and yet this box represents a marvel of engineering ingenuity. A particularly difficult piece of development is concerned with a part closely connected with the receiver. This is a method of disconnecting the receiver from the antenna during intervals when the transmitter is operating so that it will not be paralysed or burned out by the stupendous bursts of radio frequency energy generated by the transmitter. Within a millionth of a second after the transmitter has completed its pulse, however, the receiver must be ready to receive the relatively weak echo signals; but now the transmitter part of the

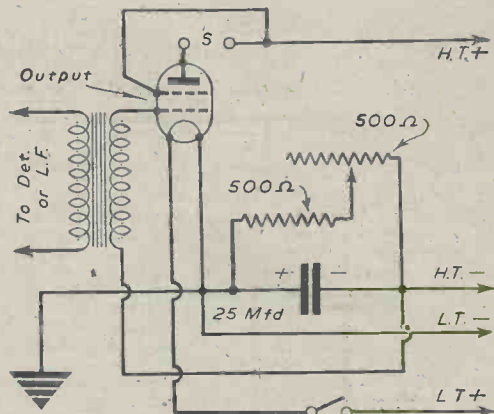

Fig. 6.—Addition to auto-bias circuit.

In any case the use of a little additional bias results in economical running. A new Mullard PM22A was tested and the results of altering bias were as follows:

Bias	Anode Current
3 volts	8mA.
4.5 volts	4.4mA.
6 volts	1.75mA.

This was with 120 volts on both anode and screen and the saving is easily seen. When listening with the volume control a little below maximum it was found impossible to determine orally whether 3 or 4.5 volts bias was in use. Six volts bias gave some reduction in volume and quality, but both were still surprisingly good.

Fig. 6 shows an addition which can be made to an auto-bias circuit. A 500 ohm. wire-wound potentiometer or variable resistor is added to the fixed one already used. (500 ohms is shown for this, which is average for a battery set, although it may vary, of course, with different circuits and valves.) When this resistor is adjusted to zero results will be as before, but when it is rotated towards maximum the bias will be gradually increased. The effect while measuring anode current is very noticeable, and it will generally be found some additional bias can be used without any appreciable loss of quality or volume.

circuit must be switched off so it will not absorb any of the energy.—Radio-Craft.

Output Matching

FOR any given output valve there are certain limits within which the load of the speaker must fall if the full output of the valve and good-quality reproduction are to be obtained. But suppose that we have a pentode, requiring an anode load of 8,000 ohms, and a speaker the impedance of which is only 2,000 ohms. Or, again, suppose we have a valve the optimum load of which is 2,000 ohms and a moving-coil speaker of low resistance—say, 6 ohms only.

Obviously, it will not do to connect the speaker direct in the anode circuit of the valve, as its impedance is far too low. What must be done is to employ an output transformer so designed that the impedance of the primary (which is connected in the anode circuit of the valve) matches the valve resistance, while the secondary is wound to match the speaker impedance. The correct ratio for such a speaker is found by dividing the optimum value of the load, as recommended by the valve-maker, by the impedance of the speaker, and extracting the square root.

It should be noted that it is the impedance of the speaker and not its resistance figure in the case of a moving-iron instrument, or one and a half times the resistance in the case of a moving-coil speaker.



ON YOUR WAVELENGTH

By THERMION

The Supply of American Valves, etc.

PERHAPS I can add something to the discussion on the supply, or rather the absence of supply, of American radio valves and components. The valves imported for the maintenance of receivers imported before the war are distributed through firms who were accustomed to importing radio valves before the war, and also through valve manufacturers. It has not been possible to import valves in quantities sufficiently to enable retailers throughout the country to carry stocks of all types. Therefore, should a retailer want a valve of a type which he does not have in stock he must place an order for it with his usual supplier of American type valves who, if he is not an importer-distributor or a valve manufacturer, should in turn pass it on to his usual supplier of these valves.

With regard to components for receivers imported before the war it has generally been found possible to obtain suitable equivalents manufactured in this country, and according to the Board of Trade it has not been necessary to arrange special importation of components other than valves. With this I profoundly disagree. Where there has been a suitable English equivalent it has been practically unobtainable since the demand for it as a replacement in the receiver for which it was originally designed has far exceeded the supply. It has not, therefore, except in theory, been possible to find suitable equivalents.

The receivers imported under Government auspices during the war were distributed to the trades through two main distributors. Owing to the small numbers of a wide variety of valve types, and the particular types of electrolytic condensers with which these receivers were equipped, it was considered to be more satisfactory from the purchaser's point of view, to distribute the valves and components through these two firms. To obtain parts for such receivers users should place their orders with the retailers from whom the sets were purchased. The retailer in turn should pass on the order through the wholesaler who supplied him to the main distributor of the receiver, who will then deliver the necessary components or a suitable equivalent.

Whilst I am dealing with American type receivers I should like to recall that they have not been found entirely satisfactory when operated under English conditions. They are all designed for 110 volts, necessitating in most cases the use of a resistance cord between the mains and the set. This has not been found satisfactory here, and the components used in general seem to give plenty of trouble. I cannot see, therefore, that American receivers, unless specially designed for this market, will ever find a ready sale over here.

Wireless Licences and Prosecutions

THE number of wireless receiving licences in force in Great Britain and Northern Ireland continues to increase, and has now reached the record total of 9,884,300.

Even so, the Post Office is constantly detecting unlicensed sets, and users of such sets should remember that they run the risk of prosecution and consequent fines.

Some cases recently brought before the courts resulted in fines of as much as £6, with the alternative of 30 days' imprisonment, and the confiscation of the offenders' sets.

Motorists are reminded that it is necessary for them to take out a separate wireless receiving licence for a wireless set fitted in a motor-car.

Australian Radio Day

THEY rodeo on Radio Day each year on December 12th when they celebrate Radio Founders Day as a tribute to those who gave radio to the world.

It was on December 12th, 1901, that the famous "S" signal sent out by Marconi from Poldhu, in Cornwall, was received by his assistants Kemp and Paget with their elementary Kite Aerial on Signal Hill, Newfoundland. Radio had spanned 1,700 miles of ocean from one British territory to another British territory—the critics were confounded—and radio as we know it to-day was born.

Thus radio was given to the world like so many other blessings through British enterprise, for it was in fact that Marconi found the faith and support he needed.

Australia realises, perhaps more than any other country what radio means to the world, for it eliminated the vast spaces between her and the older world.

During this year's Australian celebrations of Radio Founders Day, H.R.H. the Duke of Gloucester and the President of the Australian Institution of Radio Engineers broadcast to Great Britain and the rest of the world.

Romford Radio Society

MR. R. C. E. Beardow, of 3, Geneva Gardens, Whalebone Lane North, Chadwell Heath, Essex, tells me that the Romford and District Radio Society are moving to new premises, the Y.M.C.A. Red Triangle Club, late Masonic Hall, Western Road, Romford, near Romford station. Meetings are held every Tuesday evening at 8 p.m. and new members are welcome.

Radar Directional Antennas

THE problem of antenna design is one of the major problems in radar, incomprehensible as this may seem to the operator of a home radio receiver, who finds a few yards of wire strung up on his roof adequate for his purpose.

The scanning of the portion of space which the radar set is intended to cover must usually be done by mechanical motion of the antenna structure itself. This means that the structure, whatever its size, must swing around or up and down to direct the beam in the necessary direction. In certain cases where one needs to scan only a small sector, techniques have been worked out for rapid electrical scanning not requiring the motion of the whole antenna structure itself. So far, however, there has been no method for extending this rapid electrical scanning to cover more than a relatively small sector. Radars for directing guns which need accurate and fast data in a small sector are making use, however, of this valuable technique.

To carry the radio-frequency energy from the oscillator to the antenna, and the echo from the antenna to the receiver, wires and coaxial cables are used at ordinary wavelengths. For microwaves, however, it is more efficient to use wave guides, which essentially are carefully proportioned hollow pipes—and the transmission system hence is called "plumbing," by radar men.

NEWNES SHORT-WAVE MANUAL

6/-, or 6/6 by post from

GEORGE NEWNES, LTD. :: Tower House, Southampton St., London, W.C.2

Auxiliary Equipment for the Amateur Transmitting Station

Apparatus which will increase the Efficiency of the Amateur Station

By A. D. TAYLOR

NEWS that the wartime ban on the use of amateur transmitting apparatus is about to be lifted will no doubt mean that quite a number of readers of PRACTICAL WIRELESS will shortly be applying for their first transmitting licence. This article has, therefore, been written to give an outline of certain auxiliary equipment, the use of which will both greatly increase the

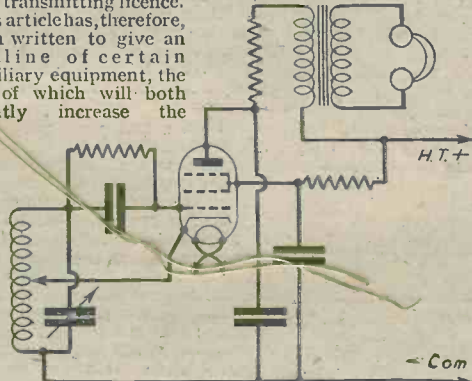

Fig. 1.—Circuit for electron-coupled frequency meter-monitor.

efficiency of an amateur station and also allow of much more accurate experimental work being carried out.

The first instruments suggested are two multi-range test instruments built up around two 0.1 M/a. moving coil milliammeters. The use of two of these instruments may seem an extravagance at first, but it is suggested that one be permanently installed in the transmitter, with suitable switching to allow of all D.C. voltages and currents in the set being checked, while the other be made up as a portable test instrument which, besides being used for ordinary test and service work, can also be plugged into some of the apparatus described later in the article. The principles of this type of instrument will probably be known by the average amateur, but if help is required reference should be made to an article by the writer in a previous issue of PRACTICAL WIRELESS.

A stable and accurately calibrated frequency meter is essential in any amateur station. An economy can be

effected, however, by constructing an instrument which besides being a frequency meter can also be used as a monitor for C.W. transmissions. The circuit for an electron-coupled frequency meter-monitor is shown in Fig. 1. The meter should be carefully constructed on a sturdy metal chassis and mounted in a stout metal screening box. A really good slow motion dial must be used and the power supply should be well regulated.

It is usual to calibrate the frequency meter with the aid of a 100 kc. crystal oscillator, but another method which the writer has tried seems just as accurate and eliminates the cost of the crystal. A small single valve oscillator is built which will tune to 200 kc/s. With the aid of an ordinary broadcast receiver it is then tuned to zero beat with the B.B.C. Light Programme transmitter on 200 kc/s and its harmonics will give marker points at every 200 kc/s throughout the tuning range of the frequency meter. Owing to the high frequency stability of B.B.C. transmitters this is a very accurate method of calibration.

One of the most useful pieces of apparatus in an amateur station is the artificial aerial. A useful circuit is shown in Fig. 2. C and L should be suitable for the transmission frequency in use, and R can consist of an ordinary 25 watt electric light bulb. M is the 0.1 M/a. range of the portable multi-range test meter, and W is

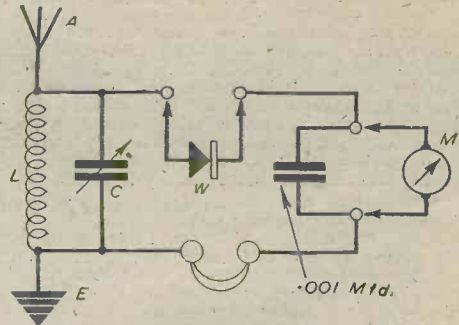

Fig. 3.—Circuit diagram of a simple field strength meter.

an ordinary receiving type Westector. This Westector should be mounted on a suitable plug, as it is also used for plugging into the instrument described in the next paragraph. The size of L₂ and its coupling to L must be determined by experiment, and should be adjusted until M reads half scale with the transmitter running normally and L at the optimum coupling distance from the transmitter output stage anode coil. Once this is done, any variations in the transmitter output during tests or modifications can be immediately checked on M.

The last piece of apparatus to be described is a simple field strength meter, which can also be used as a telephony and key click monitor, and as an absorption wavemeter. L and C should be suitable for the frequency in use, M is as described for the artificial aerial and W is the Westector. A is 2ft. of copper rod mounted on a suitable stand-off aerial and E is an earth pin which can be pushed into the ground when taking field strength readings in the neighbourhood of the aerial.

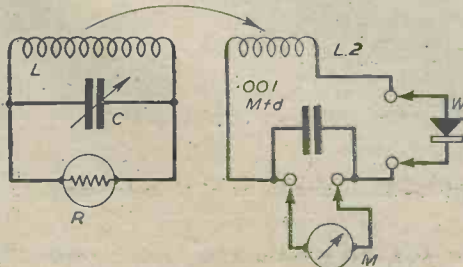

Fig. 2.—Artificial aerial circuit diagram.

A 5-50 Metre Set

A Receiver Capable of Providing Good Results upon All Frequencies. By F. G. RAYER

As amateur activity is increasing it was thought that a receiver capable of providing good results upon all the frequencies of interest would prove useful. As it was intended that the set should function very well upon 10 metres, and even retain a high degree

and thicker wood for the remaining side. The arrangement of these pieces will be seen in Fig. 2.

A hole is drilled in the side, near the top, for the detector holder (which should be a ceramic type), and a second hole in the top piece for the coil holder. The holders are bolted in position and small brackets secure the box to the baseboard.

The tuning condenser is entirely within the box, as shown in Fig. 3. The reaction condenser is just outside so that the vanes can open beyond the edge and close proximity of the fixed plates to the tuning condenser does not give undesired anode-to-grid coupling.

If Figs. 2 and 3 are examined in conjunction with the circuit no difficulty will arise in wiring. The appropriate tags of the coil holder are wired directly across the tuning condenser, and 1/4 in. of wire will be ample for both these connections. The wire from detector anode to coil will be about 1 in. long and from reaction coil to reaction condenser 1 1/4 in. long. These connections should be direct and well soldered. 18 S.W.G. tinned copper wire is used. Note that the reaction condenser is earthed directly to the tuning condenser and that a

short wire is taken from the filament of the detector to the earth lead of the coil. The shortness of these connections is also important as they form part of the tuning and reaction circuit.

The leak is soldered on as shown, and the grid condenser is suspended between the tuning condenser and grid socket of the holder. To complete the detector circuit the aerial pre-set is added, with a small insulator for aerial connection, and the 1,000 ohm resistor is joined to the fixed plates of the reaction condenser.

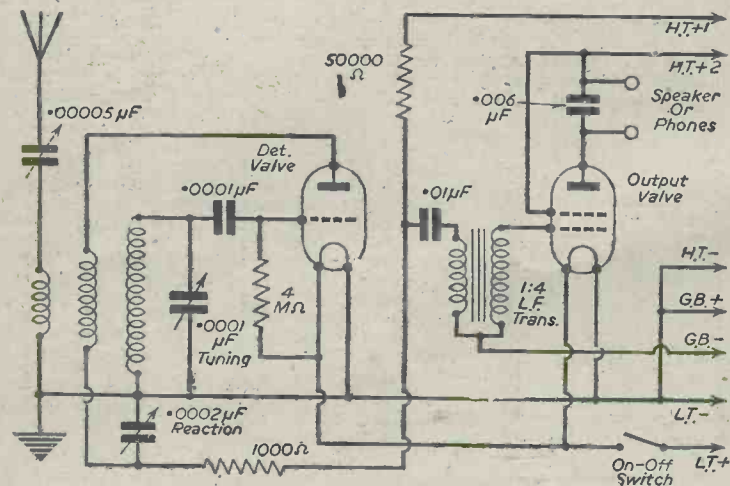

Fig. 1.—Theoretical circuit.

of efficiency upon the U.S. wavebands, some thought and experiment was given to the layout—particularly in the detector stage. The result is a layout it would be difficult to beat. Upon wavelengths from 10 to 50 metres operation is everything that can be desired from such a circuit; upon wavelengths near 5 metres tuning becomes a little critical, due to the use of a tuning condenser capable of giving a good tuning range upon the higher wavelengths, but efficiency is still high.

Circuit

This is shown in Fig. 1. The two valves will provide good speaker volume of the more powerful stations, and phones are used for listening to weak transmissions. Bandspreading has been discarded, due to the losses introduced by using two condensers and a dual-ratio epicyclic reduction used instead. A reaction choke is not used due to the danger of encountering resonant peaks, and instead a 1,000 ohm resistor is incorporated. The detector circuit is taken through the reaction coil to avoid any possibility of weak reaction upon U.S.W. A reduction drive is also added to the reaction condenser to facilitate operation.

Construction

The layout is shown in Fig. 3. A 5-ply wooden baseboard 9 in. by 10 in. is used, and a panel 10 in. by 8 in. Both are covered with foil, although in final experiments it was found that the foil could be omitted and that no hand-capacity was introduced. This is because the tuning and reaction condensers are set well back from the panel. Brackets hold panel and baseboard together, and to raise the controls to a more convenient height for operating the baseboard is fixed about 1 in. from the bottom edge of the panel.

The small box affair, which enables such short wiring, should now be made. It is 3 in. high and 3 1/4 in. long. It is about 2 in. from front to back. Plywood is used for the top and side carrying the coil and valve holders,

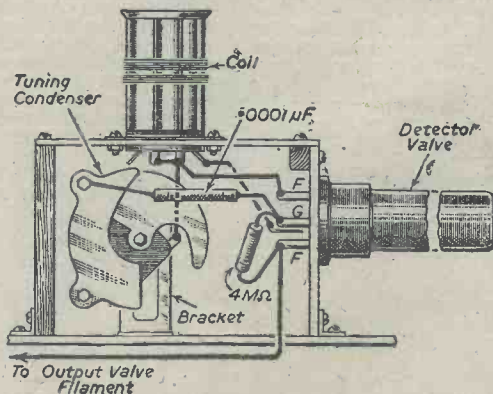

Fig. 2.—Shows arrangement of pieces for carrying coil and valve holders in box form.

Both the variable condensers are mounted upon brackets, and further brackets support the lugs of the epicyclic reduction drives. A smoothly-finished clearance hole in the panel is suitable for the reaction spindle (the metal foil being cleared away from the edges of the

hole to prevent noises). A $\frac{1}{2}$ in. diameter hole is drilled for the tuning control spindle. A bearing is made up to support this so that there is a clear space left around the top half of the hole. This enables a thick wire to be bent as shown in Fig. 3 to form a pointer. The portion lying in line with the spindle travels around the axle without touching either panel or axle, and if it is firmly supported by a screw in the rear section of the reduction drive this will be found perfectly satisfactory. A celluloid dial completes this item.

The L.F. stage is very simple and Fig. 3 shows all connections. All the battery connections are taken to a 6-way terminal block beside the L.F. valve (not shown in Fig. 3 for clarity). This may be seen from the cover photograph, and can be omitted if desired. The terminals upon the .006 mfd. condenser are used for speaker connections. If an earth is used, it can be connected to L.T. minus. A fibre washer insulates the on/off switch from the foil to avoid shorting the L.T. supply.

Notes on Coils and Operation

The ordinary plug-in coils are used for the higher wavelengths. For U.S.W. reception it would be possible to wind coils upon similar formers, but self-supporting coils were made for the set described as follows: Take a base from a discarded octal valve and saw off the sleeve portion to leave a flat disc with pins attached. The coils are now wound and the ends so bent that when they are slipped down the centre of the pins and soldered the coils lie in a proper position. The coils are wound $\frac{1}{2}$ in. in diameter from 16 S.W.G. tinned copper wire. Grid windings are 4 and 6 turns. Reaction 4 and 5 respectively. No aerial coupling is used, the aerial pin being taken to a tapping upon the coils ($\frac{1}{2}$ turn and 1 turn from earthed end respectively). These coils may be plugged in as desired. Examining one of the ready-made plug-in coils will show how the ends of the various windings are connected, and the "sense" in which the windings must be.

An Osram HL2 is suitable for detector (or HL2/K if available because of its slightly different internal

ably 120. Grid bias must be adjusted according to the valve in the L.F. stage.

As the reaction condenser is closed the detector should slip into oscillation. If not, the aerial pre-set may require opening, or slightly more H.T. applied. It is

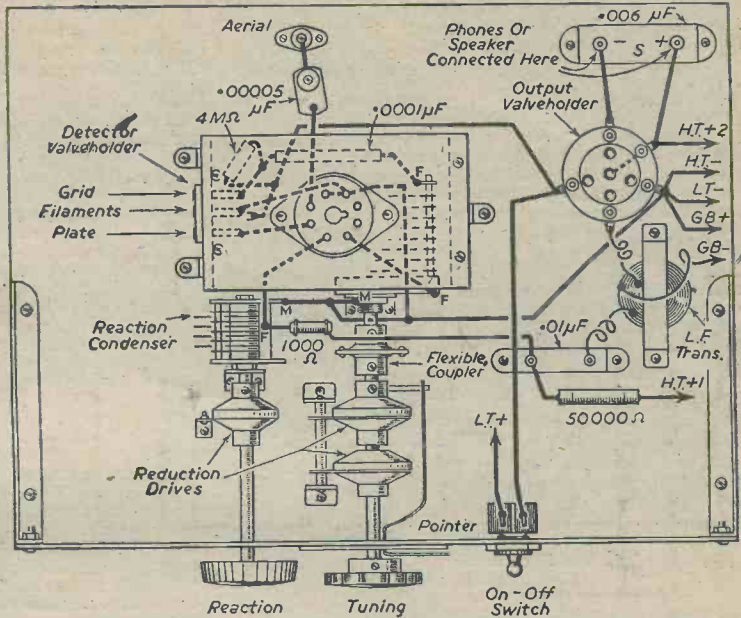

Fig. 3.—Wiring diagram.

very necessary reaction should be smooth and adequate. However, little difficulty should arise here unless reception is attempted upon wavelengths below 5 metres. If the user has not previously operated upon U.S.W., it should be noted that tuning should be carried out with extreme care. Reaction should be barely upon the point where the detector commences to hiss or stations may be swamped. It should also be remembered that no transmissions are available upon large sections of the U.S.W. bands and in consequence all dial readings should be noted down for reference.

Reception upon 10 metres and upwards will be found simple and satisfactory, provided normal regard is taken of times of transmission, etc.

LIST OF COMPONENTS:

- .00005 mfd. pre-set (mica); .0001 mfd. (mica); .006 mfd. and .01 mfd. fixed condensers.
- .0001 and .0002 mfd. low-loss variables.
- 4-pin ceramic holder.
- 5-pin standard holder.
- 4 megohm, 1,000 and 50,000 ohm resistors.
- Paraflex transformer.
- Coil holder and coils.
- Two drives.
- Switch, brackets, flexible coupler, etc.

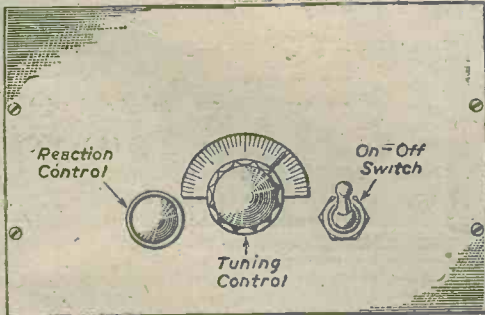

Fig. 4.—Panel layout.

construction). A tetrode or pentode is used for L.F., or a L.F. valve of the triode type if phones only are to be used.

H.T.1 will require about 100 volts, and H.T.2 prefer-

REFRESHER COURSE IN MATHEMATICS

8/6 by post 9/-

From : **GEORGE NEWNES LTD.**

Tower House, Southampton Street, Strand, W.C.2

Multiplicative Mixing

A Further Discussion on Frequency Changing. By H. REES

THE term multiplicative mixing first appeared in accounts of the triode-hexode frequency-changer, and various erroneous ideas seem to be held about its meaning.

Owing to the unfortunate terminology used in many textbooks, there is a widespread belief that a process of modulation is somehow employed to generate a difference-frequency in these modern mixers. Indeed, one finds quite authoritative references to "sidebands" ($f_1 \pm f_2$) being generated, where f_1 and f_2 are the local oscillator and incoming frequencies.

The definition of side-frequency given in British Standards, 204, 1943 ("Glossary of Terms used in Telecommunication") admits of a pretty wide meaning to the term. Yet modulation and detection are two very different things, and if H.F. sidebands are generated in one case, it is hardly correct to say the same is true of the other.

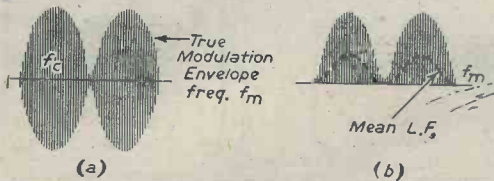

Fig. 1.—Modulated H.F. carrier (a), and extraction of L.F. component (b).

There is this much in common: Any device such as a detector operating in a non-linear condition can also be used for modulating, if the appropriate frequencies are applied, i.e., H.F. and L.F. Sidebands ($f_c \pm f_m$) are then generated, for each A.F. "tone." But if the same non-linear device is used for demodulating (a not very satisfactory Americanism for detection), how are we to say further "sidebands" are generated?

A detector gives rise to harmonics, it is true, and also "sum" and "difference" frequencies ($f_1 \pm f_2$) in the case of beat rectification. Is it true to say that ($f_1 \pm f_2$) is a sum or difference of the same "kind" as ($f_c \pm f_m$) when modulating? In other words, do both represent sidebands?

Here are those who would dismiss such questions as mere "verbal quibbles." That is one way of making light of an untenable position! Since students derive their ideas from language, the answer should be obvious, e.g., if the same term is used to denote concepts as different as the proverbial "chalk and cheese."

The logic of the matter is somewhat as follows: On the one hand, a sideband is a high-frequency—the sum or difference of a carrier f_c and relatively low modulating frequency f_m . In fact, the word is understood to mean "H.F. side-frequencies." Note, carefully, that a sum and difference of this type cannot be explained by any theory of "beats," or simple harmonics.

When we beat two frequencies f_1 and f_2 , a "difference" ($f_1 - f_2$) is obtained after rectification. This can be an audible note, and not a radio-frequency at all. For example: If $f_1 = 1,000$ kc/s, $f_2 = 999$ kc/s, we shall get after detection an audible note of 1 kc/s = 1,000 c/s. This is certainly not an H.F. sideband, in the above sense, but a low frequency of 1,000 cycles/sec.

If not an H.F. sideband, is it correct to describe ($f_1 - f_2$) as a sideband, in any sense of the term? We cannot get things both ways; if ($f_c - f_m$) is an H.F. quantity, ($f_1 - f_2$) is not necessarily so. In fact, as already stated, a lower side-frequency ($f_c - f_m$) is not anything in the nature of a beat-difference.

Hence the importance of logical definitions. If

technical terms are used in a loose manner, contradiction and confusion must result. So "verbal quibbling" often makes for clear thinking.

The "First Detector"

However, to get back to the triode-hexode. Should this be described as the equivalent of a detector, or of a modulator generating "upper and lower sidebands" ($f_1 \pm f_2$)?

The above comments on ($f_1 - f_2$) partly answer the question. But let us look at the matter from another standpoint.

In the old days we used to speak of the first detector in a superheterodyne. There was no question whatever as to whether or not it was a detector. It would be considered quite fantastic to talk of modulation and sidebands, because it was perfectly obvious that what occurred was extraction of a beat envelope of frequency ($f_1 - f_2$), just as any detector extracts a modulation envelope of frequency f_m .

The writer gave an account of beat principles in a previous article. In a sense, any regular amplitude variation of an H.F. wave is a "modulation envelope," and, also, a beat envelope.

Carrier modulation by an L.F. tone is again illustrated in Fig. 1 (a). The envelope may be regarded as resulting from a beat between either sideband and the carrier, i.e., $f_m = (f_c + f_m) - f_c$, or, $f_c - (f_c - f_m)$. A detector is essential to give a separate current component at the envelope frequency, as in (b).

Suppose, however, the carrier was suppressed at the transmitter. The sidebands only would then be radiated, and, being two waves of equal amplitudes, they will heterodyne to give a resultant envelope of the form shown in Fig. 2 (a). Actually, this is an envelope at twice the modulating frequency f_m , i.e., a simple beat-difference $(f_c + f_m) - (f_c - f_m) = 2f_m$.

However, if instead of two H.F. sidebands we consider any other heterodyning frequencies f_1 and f_2 , the envelope frequency is similarly the beat difference ($f_1 - f_2$). It will be exactly the same as Fig. 2 (a) for two beating waves of equal amplitudes. Clearly, a detector is again essential to give an independent current component at the "modulation" frequency ($f_1 - f_2$), as shown in 2 (b).

We have deliberately used the word "modulation" here, because there is an obvious similarity between Figs. 1 (a) and 2 (a), in the sense of a periodic amplitude

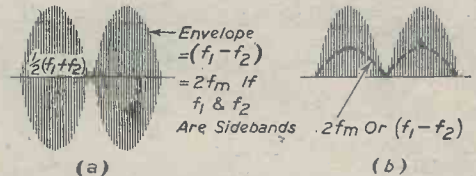

Fig. 2.—Beat resultant of two frequencies f_1 and f_2 , which may be the sidebands ($f_c + f_m$) and ($f_c - f_m$) in Fig. 1. Frequency doubling of the modulation envelope would then occur, i.e., $2f_m$

variation. Also, both envelopes arise as a result of a beat between high frequencies: in one case, between three frequencies—a carrier and two sidebands.

Fig. 2 (a) illustrates what may be called a simple beat, between two frequencies. There is really no modulating frequency at all, as in Fig. 1 (a): i.e., no separate frequency corresponding to f_m , but simply f_1 and f_2 which heterodyne to give an envelope ($f_1 - f_2$). Of course, in modulation proper, f_1 and f_2 would be

upper and lower H.F. sidebands ($f_c + f_m$), and ($f_c - f_m$).

Thus, if we have two beating waves of equal amplitudes produced, say, by two oscillators, we might regard the frequencies f_1 and f_2 as the sidebands of a non-existent carrier, but why talk of "sidebands" at all in such a case? There is no modulating frequency f_m , and no carrier to which it is added and subtracted!

If the amplitude of the heterodyning waves are unequal, as is generally the case, the resultant beat envelope will be more like a true modulation envelope, Fig. 1 (a)—though still not of true sine shape. This is a more complicated case to explain, but the envelope is still at the frequency ($f_1 - f_2$), and a detector is again necessary to extract this difference.

Hence, the first detector in the orthodox superhet. It extracts the beat envelope, or gives rise to a separate current component at the intermediate frequency. The latter carries the incoming modulation f_m , so a second detector is essential to extract f_m .

Now, the hexode mixer, and similar types, has taken the place of the first detector. In fact, the word detector has disappeared, although, be it noted, no fundamental change in principle is involved. The "superheterodyne" is still a receiver employing heterodyne principles, e.g., beating an incoming carrier by the local oscillator frequency, and the equivalent of a first detector is still essential to extract the beat frequency.

Actually, in the triode-hexode nothing that looks like ordinary detection process is employed. The "mixing" is done in such a way that the equivalent of detection is accomplished simultaneously. This is what multiplicative mixing really means, but it is quite erroneous to translate it modulation. Let us consider this in more detail.

Some Graphical Experiments

Take, first, two relatively "high" and "low" frequencies, Fig. 3 (a).

If we carried out the laborious job of adding the instantaneous values of these two waves, and plotting the results on squared paper, we would get simple superposition as in (b). It is fairly easy to see how this comes about. The L.F. wave is positive (or negative) for several cycles of H.F., which has the effect of "lifting" (or depressing) successive H.F. cycles, about the L.F. wave as a mean value.

Obviously, there is no amplitude modulation. "Additive mixing" leaves the component frequencies entirely separated, while there can be no question of beating when the frequencies differ so widely.

But if we multiplied instantaneous values and plotted the results, the waveform would become that shown in (c)—the H.F. wave modulated at low frequency! It is not too difficult to explain mathematically how this comes about, instead of (b), but we will not worry about that now.

The interesting fact which emerges from this graphical experiment is that amplitude modulation involves multiplicative mixing. Merely adding instantaneous values gives simple superposition, (b), without modulation. It is seen, therefore, that the word "multiplicative" signifies something quite real, and the question is: How can a valve or other modulator perform this arithmetic operation?

The answer is quite easy, though it would require trigonometry to prove it clearly: Any non-linear circuit element, such as a valve having curvature of a characteristic or otherwise arranged to rectify, gives rise to multiplicative products of instantaneous values of two alternating voltages applied to it simultaneously.

In this sense, every rectifying device is a "multiplicative mixer," capable of giving rise to modulation if appropriate frequencies are applied. This is only repeating from another standpoint what we said earlier—every detector can be a modulator. But other complicated "products," as well as harmonics, are also produced.

It would be interesting to speculate how the sums and differences called sidebands are generated, but the writer knows of no simple physical explanation apart

from fairly simple mathematics. When we come to think of it, a physical picture of how harmonics are generated is by no means easy!

But let us proceed with our graphical observations. Suppose, instead of a high and a low frequency, we have two high frequencies f_1 and f_2 which will beat. No multiplicative mixing is necessary to produce the beat effect. If we add successive instantaneous values, as we did in Fig. 3 (b), a beat resultant will be obtained directly—of the form of Fig. 2 (a) for two waves of equal amplitudes. The waves heterodyne on simple superposition; a non-linear device, detector, is required only for extracting the beat-difference, Fig. 2 (b).

Again, superimposing this beat resultant upon a carrier whose frequency is midway between f_1 and f_2 , i.e., the mean frequency $\frac{1}{2}(f_1 + f_2)$, would give a true

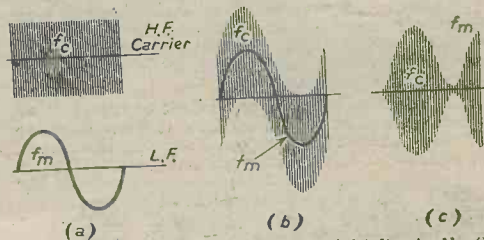

Fig. 3.—"Additive" (a) and "Multiplicative" (b) mixing of H.F. and L.F.

modulated resultant. Remember, however, that in actual modulation, the H.F. sidebands, corresponding to f_1 and f_2 , must be generated in a non-linear device.

And, now, we come to the real secret of the triode-hexode mixer. Taking the same two beating frequencies again, f_1 and f_2 , let us multiply the successive instantaneous values, as we did in Fig. 3 (c). There, we got a modulated resultant, but if we plotted our results in the present case, the effect would be rather surprising!

It would take the same form as Fig. 3 (b)! The beat difference ($f_1 - f_2$) exists as a separate "L.F. component," like the modulating frequency f_m in simple superposition.

The important point is that what we get is a beat-difference. The heterodyne principle is still part of the process, but an effect like that in Fig. 2 (a) does not appear as an intermediate waveform, requiring rectification.

In other words, beating, together with the equivalent of demodulating, have been accomplished at one and the same time. No separate detection of a beat-wave (Fig. 2 (a)), is necessary. So, in a sense, a triode-hexode performs the demodulating process without anything that looks like an ordinary "detector."

Nevertheless, the mechanism is equivalent to detection. The anode current (A.C. component) is proportional to the product of the instantaneous potentials of two internal electrodes, e.g., the signal grid, and a "virtual cathode" whose potential is varying at the oscillator frequency.

In saying this, we are implying a non-linear relationship between I_a and the internal instantaneous potentials referred to. The A.C. component depends, not upon the sum, but the product of the potentials.

What it really means is that the mutual conductance (or "transconductance"), with respect to the signal grid, depends also upon the instantaneous voltage of the oscillator section. A characteristic connecting I_a and E_g will be a function also of the oscillator potential—if various values could be given to the latter while the signal grid potentials are varied, the resulting characteristic will be curved.

Meaning of "Curvature"

This brings us right back to the language of detection. In an ordinary valve a curved characteristic between I_a and E_g simply means that the mutual conductance g_m is not constant, but varies with the grid potential. A linear characteristic shows I_a and E_g in direct proportion, and therefore g_m will be a constant.

It is because some third factor, namely g_m , depends upon the instantaneous values of grid potential that modulation by means of a non-linear device is possible. Thus, if E_g is an audio-frequency e.m.f., application of an H.F. voltage simultaneously will give an output H.F. current whose amplitude is varying at A.F., because the valve mutual conductance is already changing at A.F.

It also explains demodulation. Because of curvature the mutual conductance varies more with respect to positive H.F. cycles than the negative ones, giving a separate current component whose mean value is changing at the frequency of the amplitude variation.

In each case the mathematical explanation is the multiplicative effect previously referred to. It is merely another way of stating that use is made of some non-linear relationship. It would not be possible, of course, to use the multiplicative effect in a triode-hexode directly for detection, since it depends upon the action of the oscillator portion.

But the inherent action is equivalent to detection all the same. We have explained how it boils down to much the same thing as operating on a curved characteristic. A rather crude illustration would be to insert a rectifier in a linear tuned circuit, when the difference ($f_1 - f_2$) would be extracted at the same time as "mixing."

It should be said, however, that a triode-hexode is more of a pure multiplicative device than any ordinary rectifier. The latter has a complex curvature which gives rise to a large number of harmonics and by-products. We should find these less in evidence in the output of an electron mixer, though the oscillator

harmonics may still be troublesome if not guarded against.

The "Sum Frequency"

One component that will be found in the output of every mixer is, in addition to ($f_1 - f_2$), the sum frequency ($f_1 + f_2$), and this indicates a strong second harmonic output, as will be explained in a moment.

This "sum" lends considerable colour to the idea that it is of the nature of an "upper sideband," and, therefore, arises as a result of a process of modulation! The difference-frequency can be explained along well-known heterodyne principles, i.e., two waves having a continuous phase-shift (because their frequencies are slightly different), and therefore working into phase and out of phase to give the effect illustrated in Fig. 2 (a).

But how does the "sum frequency" arise? Its existence could be readily demonstrated by inserting a tuned-circuit(s) set to ($f_1 + f_2$) kc/s., instead of ($f_1 - f_2$) as in the ordinary superhet. This, however, is nothing peculiar to a triode-hexode. A sum frequency will be found in every case where an ordinary detector is used.

It is not anything like an upper H.F. sideband of the type ($f_c + f_m$). Consider first demodulation of an ordinary carrier, Figs. 1 (a) and (b). The detector generates harmonics of the carrier, so in the output circuit we might find the second harmonic of frequency $2f_c$ by tuning to it.

This is equally true in the rectification of a beat, Figs. 2 (a) and (b). There is no carrier f_c , but as mentioned earlier the resultant H.F. takes up the mid-value $\frac{1}{2}(f_1 + f_2)$. The second harmonic of this is ($f_1 + f_2$), which is our sum frequency.

It is perhaps the best demonstration that no sidebands whatever are involved!

Wind Chargers

ANOTHER method of charging, which has much to recommend it, consists of driving a dynamo or generator by means of wind sails. Although wind power in this country is apt to be rather erratic, far too much of it at times and not enough of it at others to provide any useful results, it is a notable fact that, taken over a long period, careful observations have proved that serviceable wind power is available for an average of eight hours per day in the majority of localities, if the site is carefully chosen.

The problem with wind motors is, of course, to control the variations in speed arising from extreme weather conditions, such as periods of calm on the one hand, and tempests on the other. A wind motor to be successful must be so constructed as to resist disaster in a gale and yet be sufficiently sensitive to develop useful power in winds of light or moderate velocity.

This brings us to the necessity for some definition as to what constitutes the difference between a breeze and a hurricane. The Meteorological Office has compiled a table known as "Beaufort Scale Numbers," which are attributed to winds of varying forces according to their characteristics as below:

Beaufort Scale	Corresponding Wind	Velocities in M.P.H.
0	Calm	Under 2
1 to 3	Light breeze	2 to 12
4 to 5	Moderate wind	13 to 23
6 to 7	Strong wind	24 to 37
8 to 9	Gale	38 to 55
10 to 11	Storm	56 to 75
12	Hurricane	Above 75

The indispensable parts in any such outfit comprise: (1) the constant-voltage dynamo, (2) the propeller, (3) a tailpiece to keep the propeller in the wind, (4) the collector rings for conveying current from the movable head to fixed terminal points, and (5) the mast upon which the whole is mounted.

So far as the generator is concerned there are plenty of good second-hand car lighting dynamos to be picked up cheaply.

The Propeller

Item (2), the propeller, will no doubt demand some little patience and several modifications before a satisfactory home-made article is arrived at. Lightness and strength is, of course, essential, as the centrifugal effect and thrust will be considerable at high speeds. A well-seasoned piece of straight-grained pine or cedar will be required, in one piece 6ft. long and 2½ in. thick, tapering from 6¼ in. wide at the hub to 3¼ in. or 4 in. at the tips, the pitch of the blades being about 35 deg. measured from the plane of rotation. The boss needs strengthening by a flanged double-arm casting, keyed to the dynamo shaft and retained by an end lock nut.

The Rotatable Head

The rotatable head with the collector rings needs planning out with a view to utilising whatever material happens to be available in the workshop, and dimensions are of secondary importance, so long as the collector is not too small, say, 3 in. in diameter.

Mechanical Governor

Some attempts have been made to steady the charging current by the addition of a mechanical governor or wind-diverter, or even a small wind-vane attached to the tail to move the propeller into less effective positions with increasing force of the wind.

Electrical Circuits

Apart from details of design, the electrical circuit is similar in all outfits, and in its simplest form without any switches, instruments or other complications consists of placing the dynamo and battery in parallel.

But there must be some automatic means of preventing current from the battery discharging back to the dynamo when the latter is not running fast enough to charge. Also, switches are required to control individual lamps and an ammeter to measure the charge or discharge current in the accumulator circuit.

Any lighting system to be practicable must be so designed as to allow a reasonably constant voltage to be maintained at the terminals.

Practical Hints

Pickup Rest with On/Off Switch
TO make the operation of a home-built radiogram more simple, I incorporated the on/off switch in the pickup rest, as shown in the accompanying sketch.
 When the pickup is placed on the

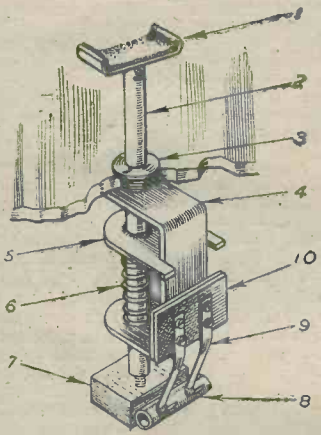

Details of a pickup rest with an on/off switch incorporated.

strips, mounted on insulation (10) which also acts as a stop to the downward motion of the guide shoe (5). The unit is fixed to the motor board by the panel bush (3) which also holds the bracket (4).—H. J. R. TOWNSEND (Adderbury, Oxon).

Centring Speaker Cones

I HAVE devised a simple system for centring speaker cones consisting of a neon tube lamp (a small Osglim indicator lamp) which is connected in series with the speaker output primary and the A.C. mains, as shown in the sketch. When in use a low-pitched hum will be reproduced.
 The speech coil centring screws should be loosened with the A.C. ripple still being heard and the centring

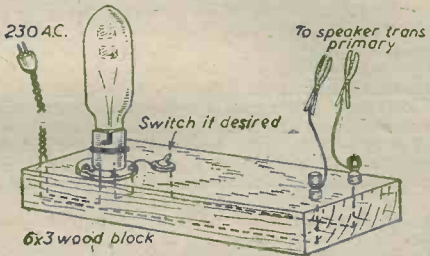
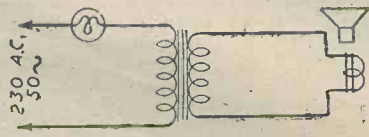

Circuit diagram and complete unit for centring speaker cones.

THAT DODGE OF YOURS!

Every Reader of "PRACTICAL WIRELESS" must have originated some little dodge which would interest other readers. Why not pass it on to us? We pay half-a-guinea for every hint published on this page. Turn that idea of yours to account by sending it in to us addressed to the Editor, "PRACTICAL WIRELESS," George Newnes, Ltd., Tower House, Southampton Street, Strand, W.C.2. Put your name and address on every item. Please note that every notion sent in must be original. Mark envelopes "Practical Hints."

SPECIAL NOTICE

All hints must be accompanied by the coupon cut from page 111 of cover.

velvet covered rest (1), the brass rod (2) moves against the action of spring (6), thus opening contacts (8) and (9) and stopping the motor. Contact (8) is the interior of a 15-amp. porcelain connector fixed by long screws to the fibre block (7). Contacts (9) are springy brass

angles to a flat wheel which is sweated on to the driving shaft of the tuning condenser. Both wheels were obtained from a well-known mechanical toy construction outfit. The other wheel is sweated on to a rod which passes through two threaded bushes (taken from old condensers) which are in turn supported by brackets. The rod is rubbed down with smooth emery cloth until the whole is a good sliding fit in the bushes.

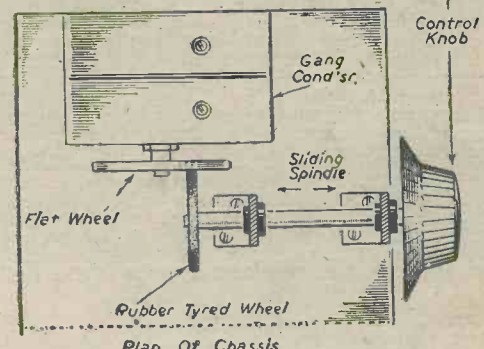
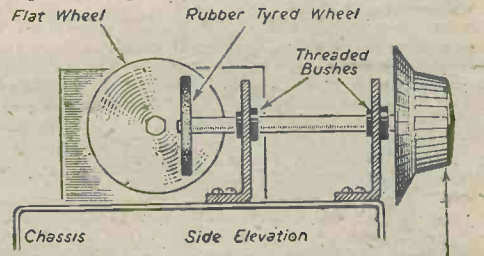

Side view and plan of a variable slow-motion drive.

It will then be found that a good drive can be obtained if care is taken in the setting up of the unit. It is obvious that the ratio of slow-motion drive is decreased as the rubber-tyred wheel is pushed farther in towards the centre of the flat wheel. The wheels can be made any convenient sizes to suit individual requirements.—R. S. GRANT (Godalming).

MATHEMATICAL TABLES AND FORMULAE

3/6, or 3/9 by post from
 George Newnes, Ltd. (Book Dept.), Tower House,
 Southampton Street, Strand, W.C.2.

Programme Pointers

By MAURICE REEVE

JEAN SIBELIUS, whose eightieth birthday celebration concert was broadcast from the Albert Hall towards the end of 1945, was born at Tavastehus, Finland, on December 8th, 1865. Finland was then, and until 1919, a province of the Russian Empire.

Son of a doctor and, on his mother's side, coming from a clergyman's family, he was of sturdy peasant stock. Unlike his predecessors in the founding of a Finnish national school of music, who were either settlers from North Germany or Sweden, Sibelius was wholly Finnish.

Defeating attempts to give him a classical education, he entered the Helsingfors Conservatoire. Later he went to Berlin and Vienna.

His strong nationalist individuality asserted itself immediately he started composing on his return to Finland in 1893. He had already some work to his credit, including the first of his works, "Kullervo," based on the Finnish national epic, the "Kalevala." But he never allowed this to be published.

Recognition was such that, in 1897, the State awarded him a life grant, thus enabling him to devote his time to composition free of economic anxieties.

He has visited England many times, also the U.S.A. and other countries.

His chief works are as follows: Seven symphonies; the Kalevala pieces, which include the Kullervo Symphony and the "Origin of Fire" for male voices and orchestra. The Legends, "The Swan of Tuolena" and "The Return of Lemmenkainen." Also "Pojola's Daughter." Tone poems: "A Night Ride and Sunrise," and "The Bard." A Violin Concerto and symphonic poems, "The Ferryman's Brides" and "The Captive Queen."

Not omitting Valse Triste, the two works for which, perhaps, he is most widely known, are the two nationalistic symphonic poems, "En Saga" and "Finlandia."

There are, of course, many smaller works, as well as a large number of very highly esteemed songs.

Sibelius has long been recognised as a musician of outstanding genius. If not quite of the rank of the greatest German masters, he is the equal of such masters of national idiom as Dvorak, in whose struggle for freedom of nationalistic expression he resembles at many points.

Imbued with this strong patriotic current, Sibelius's music is modern in the best sense of the word, inasmuch as whilst extremely personal and never hesitating (as in his conception of symphonic form) to be new when such a powerful and original mind would naturally strike out for itself, it is largely built on those foundations from the past which are ignored or violated at our peril.

Symphonies

The symphonies have, of recent years, held an honoured place in orchestral repertoires, and the second, than which there are few more exciting yet noble examples extant, is a close rival in popularity with the longest established classics. Few can hear the magnificent theme and the passionate climaxes without feeling that posterity will accord it a place in the direct line of succession.

All seven have been performed at the Promenade Concerts in one season, an honour they share only with Beethoven and Brahms.

Sibelius's mood is generally one of grandeur and majesty, with struggle, longing, and occasional gloom intruding. The limitless northern night and cold would seem to be typified. In this he frequently resembles Tchaikowsky. But the glittering scherzos and the seductive waltz themes, etc., of the Russian master are often lacking.

But stirring melodies abound in Sibelius, together with climaxes of the utmost thrill and intensity, whilst the throbbing and ardour of his Kalevala pieces would stir the pulse and quicken the imagination of all those for whom music is the incomparable medium for portraying the romantic and glamorous.

In honouring Sibelius we honour not only one of the foremost musicians of our own day, but one who will unquestionably take his place in the classical repertory of days to come.

Fashions in Music

Fashions in music are an interesting subject and would be an excellent theme for an article en solo. Casting my mind back over 40 years of concert programmes, I can see certain composers and individual works passing through strange vicissitudes. Also the unflinching loyalty given to others, which transcends both political passions and musical "progress."

The present unfashionableness of Scriabine is, I trust, only temporary. This Russian pianist and composer died in 1915 at the age of 44. For about a decade later his name served as a magnet for both concert givers and goers alike. Possibly to too great an extent, he was looked upon as the quintessence of all that was best and most likely to survive in modern music.

Albert Coates used to give scintillating performances of his provocative and mystic symphonic poems, whilst pianists vied with each other for including his brilliant piano works in their programmes. Scriabine has left an indelible mark on piano literature.

But perhaps it is a combination of his regrettably early death and the glittering career, since then, of that other great Russian composer-pianist, Rachmaninow, which have tended to push Scriabine into the background to-day.

Almost uninfluenced by the contemporary Russian nationalist school, Scriabine should be due for an early and, what will be to me, a welcome revival.

Pianoforte Concertos

Amongst pianoforte concertos seldom if ever heard nowadays are those of Paderewski, Tcherépine Pere, Scriabine himself, and an excellent burlesque of Richard Strauss. These, and probably others (I nearly omitted Rimsky-Korsakov's), could well be done, even occasionally, in preference to the lamentable and almost nauseatingly constant repetition of certain other examples these days—no names, no pack drill.

They are all very fine and, I venture to suggest, vastly superior to Tchaikowsky No. 2 and Rachmaninow No. 1, both in the repertory to-day presumably for variety's sake and "a change."

The everlasting popularity of the masterpieces of Beethoven is as understandable as commendable. This incomparable master, who, like Shakespeare, ranges over the whole gamut of human experience, is to-day, ever has been, and I trust ever will be, the biggest magnet in the concert world.

Wagner, who always has been his closest rival; had to retire a few paces into the background through "circumstances beyond his control." Like Beethoven, Wagner is in a category quite his own, and, although still prominent in programmes, I pray that he will shortly be again to the same extent as formerly.

"Danse Macabre"

On the other hand, I do not regret seeing Saint-Saëns in eclipse. (Although very fascinating and glittering,

(Continued on page 124)

Receiver Noises

Their Cause and Cure.

By T. FREEMAN, B.Sc.

A Programme of Noise

NEXT time you switch on the radio, tune in to a spot on the dial where there is no station, turn the volume control to maximum, set the tone control to treble and shake the cabinet sharply. If you live in a busy street and choose a hot sultry morning in summer for this unusual treatment, you will be amazed at the resulting variety programme of noise. How many different noises can you identify? Crackles, clicks,

they come into the category of external noise transferred via the power supply.

External Noise

External noise is due to voltages induced in the aerial or power supply lines by either natural or man-made sources of interference. This type of noise may enter the receiver in several possible ways; through the aerial-earth system, along the power line to the mains transformer, or very occasionally by direct pick-up of the receiver itself.

Natural Static

Radio waves generated by natural causes are referred to as "static" or "atmospherics" and produce irregular bursts of noise in the receiver in the form of rumblings and crashes. Static has its origin in thunderstorms and similar electrical disturbances. A large part of the static observed in summer in Great Britain is due to thunderstorms within a radius of a few hundred miles of the receiver, but the static observable all the year round originates in tropical regions particularly in Equatorial Africa. Static consists of electromagnetic waves in the form of sharp impulses or transients, the energy of which is distributed throughout the whole range of radio frequencies. The energy level of static is at its greatest on wavelengths in the neighbourhood of 20,000 metres and decreases steadily as the wavelength is lowered until at wavelengths below 10 metres it is barely noticeable. A great

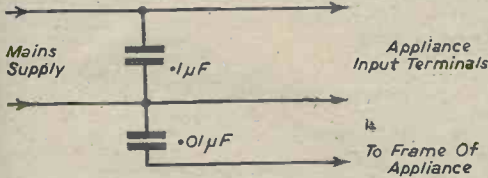

Fig. 1a.—Suppression circuit for motor interference, for use where the appliance has no direct earthing terminal.

irregular crashes, whirring, buzzing, high-pitched hum, low-pitched hum, continuous hissings—each noise has its particular cause and cure. But neither the cause nor the cure can be found unless the various noises are isolated and identified in a systematic way. To simplify matters, we first of all divide noise into two main categories according to its origin. Noise from outside the receiver is termed "external noise" and noise from within the receiver "internal noise." The set designer is not to blame for external noise, rather is it the duty of the owner to find a cure, and such a cure is usually applied outside the receiver. Internal noise, on the other hand, may often be the designer's fault and where a cure is possible it is always applied within.

Distinguishing Between External and Internal Noise

The first test is to disconnect the aerial and earth. If the set is a battery model, all remaining noise is almost certainly due to internal noise in the receiver itself. In the case of a mains set, however, it is not always possible to tell whether or not certain noises are being brought into the receiver via the mains supply. The simplest test is to borrow another mains set and use it in the same location without aerial or earth, noting whether the suspected noises persist. If they do, then

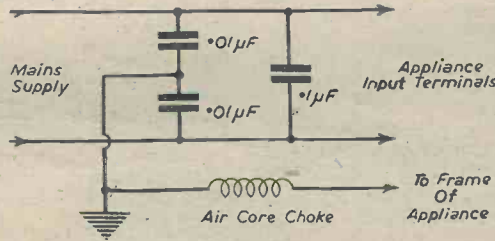

Fig. 1b.—Suppression circuit for use where earth is available.

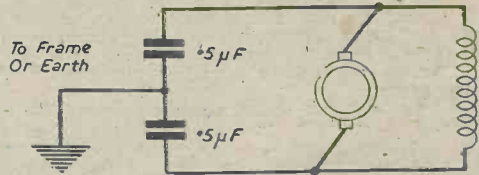

Fig. 1c.—For D.C. motors and A.C. series motors of larger size than those used in connection with domestic appliances, condensers are connected from the brushes to the frame or earth as shown above.

deal of effort has been expended in trying to devise "static eliminators" but all of these devices have been failures. There are, however, ways of considerably reducing the level of the static background in reception. One method is to use a directional aerial, but this is only successful where the static and signal arrive from different directions. Another method is to use a receiver with the narrowest r.f. response band allowable for the reception of intelligible speech. Since static is spread throughout the whole frequency range, such a highly selective receiver will obviously receive proportionally less noise than an unselective one.

Man-made Static

Man-made static is due to the interference radiated by various electrical appliances, chief of which are electric motors, vacuum cleaners, hair dryers, flashing signs, light switches, diathermy apparatus, automobile ignition

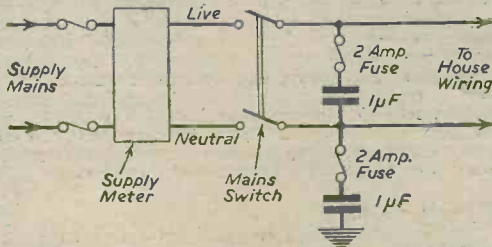

Fig. 2.—Condenser filter to isolate house wiring systems in the case of mains-borne interference.

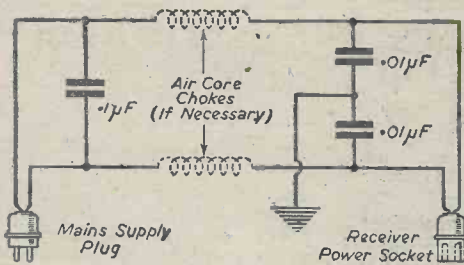

Fig. 3.—Filter for the elimination of radiated interference.

systems, electric trains, trams and trolley buses. Like static the interference waves are caused by spark discharge and are present as transients over a wide range of frequencies though the radiation is often predominant at one particular frequency.

Suppression of Man-made Static at the Source

The obvious and most effective way to cure man-made static is to trace it to its source and suppress it on the apparatus concerned.

Noise originating from rotating appliances, such as electric motors, is usually easy to diagnose, owing to the regularity and continuity of the sound. In most cases it is a rasping hum or whirring, and the receiver often responds most strongly at one particular frequency. Unfortunately, motor interference, unless inside the owner's house, is not so easy to locate unless direction-finding apparatus is used. Where it can be traced, however, one of the suppression circuits shown in Fig. 1 will provide an excellent cure. Fig. 1(a) is used where the appliance has no direct earthing terminal. Where an earth is available or a 3-pin plug is fitted to the appliance, Fig. 1(b) is very effective. For D.C. motors and A.C. series motors of larger size than those found in domestic appliances, condensers are connected from the brushes to the frame or earth as shown in Fig. 1(c).

Switches

Switches in frequent use and carrying a heavy current often arc between the contacts and give rise to loud clicks whenever they are operated. A similar source of annoying interference is the intermittent clicking due to the make and break contacts of thermostats in domestic refrigerators and water heaters. To prevent this trouble a .1 mfd. condenser in series with a small resistor should be connected across the contacts. The size of the resistor is critical, and values from 50 to 200 ohms should be tried.

Diathermy Apparatus

Ordinary suppression methods are not effective. The only practical cure on the spot is to enclose the

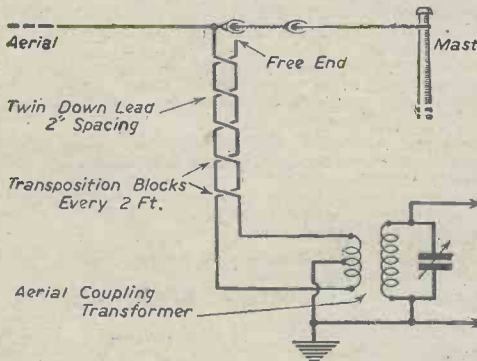

Fig. 5.—Transposed feeder for short-wave reception.

entire room containing the apparatus with a wire mesh screen.

Faulty Contacts

Electrical apparatus used in the same house as the receiver occasionally gives rise to mysterious intermittent noises. Loose plugs, ill-fitting electric light bulbs, broken wires are examples of this type of fault.

Cars, Trolleybuses, Trams, Trains

All these vehicles can be readily fitted with suppressors, but there is, unfortunately, no obligation on the part of the owners to do so, and other means of suppression must be sought.

Suppression of Man-made Static at the Receiver

It is clear that man-made static, consisting as it does of high-frequency impulses, can be picked up by the aerial-earth system by direct radiation from the source, or on the other hand it can travel in the form of high-frequency currents along the power supply mains and into the house wiring system and so to the receiver mains transformer. There is, however, a third possibility

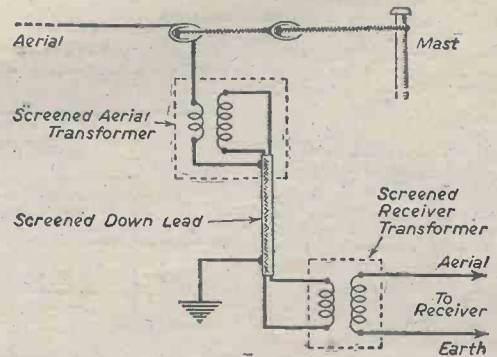

Fig. 4.—Connections of commercial "anti-static" aerial.

which is often overlooked. H.F. currents having entered the house via the power mains can themselves radiate interference from the house wiring, which may be picked up by the lengths of aerial and earth wire within the house or occasionally by direct pick-up of the set.

Mains-borne Interference

The first thing to do in a case of mains-borne interference is to isolate the house wiring system from H.F. currents in the district supply mains. This is done by means of the condenser filter shown in Fig. 2, which is mounted on the meter board. Each condenser should have a 2-amp. series fuse and very short connecting leads. The whole unit should be enclosed by a protective cover. This filter does not exclude radiated interference, which may be picked up by the house wiring and transmitted to the set, and in order to eliminate this a simple filter, such as that of Fig. 3, should be placed across the receiver power supply socket. In severe cases of mains interference it may be necessary to supplement the condenser filter with H.F. chokes in series with each power line. These must be designed to carry the full line current, and may be bulky and expensive.

Aerial Borne Interference

When noise-free operation has been secured with the aerial disconnected, any interference which still occurs when the receiver is in use must be due to pick-up by the aerial or its lead-in. The ideal remedy is to employ an aerial which will pick up signals and reject noise, but since both signal and noise are waves in space, no such aerial can exist. The only course is to compromise by erecting the aerial proper as far outside the field of interference as possible and prevent pick-up by the

GALPINS

ELECTRICAL STORES

408, HIGH STREET,
LEWISHAM, LONDON, S.E.13
Phone: LEE GREEN 0309

TERMS: Cash with Order. No C.O.D.
All prices include carriage or postage.

ELECTRIC LIGHT CHECK METERS, first-class condition, electrically guaranteed, for A.C. mains, 200/250 volts 50 cy. 1 phase 5 amp. load, each 12/6.

AUTO TRANSFORMERS. Step up or down, tapped 0-110-200-220-240: 1,000 watts, £5.

METAL RECTIFIERS, large size, output 50 volts 1 amp., 35/-.

METAL RECTIFIERS, large size, output 12 volts 1 amp., 17/6.

TRANSFORMER CORE for rewinding only, complete with clamps, size approx. 2½ kW., price 25/-.

MOVING COIL METERS, all 2in. dia., flush mounting, 0-5 m/A., 40/-; 0/20 m/A., 40/-; 0-25 m/A., 40/-; 0-50 m/A., 37/6.

COOLIDGE TUBE filament transformers. 230 v. input, 11 v. output, fitted H.T. insulator, insulation 100,000 volts to earth, £5.

LARGE PAXOLINE PANEL, size 14x7x¾in., fitted massane switch arm, 12 large studs and contact blade, very smooth action, price 7/6 each.

BLOCK CONDENSERS, 2 mf., 1,500 v. D.C. working, 7/6 each.

LARGE OUTDOOR BELLS, 110 v. D.C. working, 6in. dia. gong, 17/6.

LARGE FAN MOTORS, all direct current approx. ¼ h.p. 110 v. series winding, in first-class condition, 20/- each; ditto complete with stand, starter, cage and fan, 30/-.

D.C. MOTORS, as above, only for 220 volt, in perfect order, 25/- each; ditto complete with stand, starter, cage and fan, 35/-.

ROTARY CONVERTORS; 230 v. D.C. input, 230 v. A.C. output, 50 cycle single phase 1,250 watts, for heavy duty, £35; ditto, 200 v. D.C. input, 130 v. A.C. output, 1,000 watts, £15.

MOVING COIL METER, 2½in. dia., flush mounting, reading 0-100 milliamps, 5 m/A F.S.D., 30/-.

H.T. TRANSFORMER, input 110-220 v., output 90,000 v. at 2½ kW. Price £35.

FIXED RESISTANCES, size 12ins. by 1in., 2 ohm to carry 10 amps., 2/6.

PRE-SELECTOR SWITCHES, ex G.P.O., eight bank, each 25 contacts, complete with actuating relay, 50/-.

EX G.P.O. RELAYS, as new, multi leaf, 200 and 500 ohm, 15/- each.

CLOSED half-day Thursday.
OPEN all day Saturday.



LOUDSPEAKERS

Vitavox K12/10, heavy duty high-fidelity handling 8/10 watts, net weight 12½ lbs. P.M. Speech coil 15 ohms £7 0 0

PICK-UPS

Rothermel Crystal "Senior" with new flat type cartridge and improved ball-face bearing ... £3 18 9

VARIABLE CONDENSERS

Four-gang .0003 ceramic insulation 17 6

METERS

Sangamo Weston 0/1 milliammeters, internal resistance 100 ohms £2 11 0
"M.I." 3½in. square faced 0/1 milliammeters foundation instruments, £4 9 0
with circuit details for multi-range A.C.-D.C. 0/500 microamps operation. £5 3 0

EDDYSTONE

SHORT WAVE COMPONENTS

New lines now available:

S550 Insulated flexible shaft Drives through 90 deg.
Length adjustable, 4½in. to 6in., 5/-
S550 "Midget" flexible coupler, 1/-
Write for "EDDYSTONE" leaflet

MICROPHONES

"Meico" Moving Coil high-fidelity, sensitivity: 56db. Below 1 volt per bar when loaded with 25 ohms. Chrome finish ... £5 5 0

"Meico" Transverse current, robust and recommended for general purpose work ... £3 15 0

TRANSFORMERS

WODEN range of mains and L.F. transformers cover most requirements. List available.

These monthly advertisements are not intended to sell special lines, but rather to indicate the comprehensive nature of our stocks—our "Interim" Catalogue will be of additional interest (2½d. post free).

EVERYTHING FOR RADIO
WEBB'S RADIO, 14, Soho St., Oxford St., London, W.1. Telephone, Gerrard 2089

Note our revised SHOP HOURS:—
9 a.m. to 5 p.m. Sats., 9 a.m. to 1 p.m.

ELECTRADIX

D.C. DYNAMOS. Car type, circular body for charging 6 volts 10 amps. £4, 12 volts 10 amps. £4 10s., 12 volts 15/17 amps. £5, 24 volts 40 amps. £10, 30 volts 5 amps. £7 10s., 80 volts 12 amps £10.

SOLENOIDS. 24 volt D.C. Solenoids, lift 14lb., 15/- Gemi Solenoids, 6 volts 1½ amps., 6/6. 12 volt Rotax type, pull 1 oz. lin., 10/-.

MOTOR BLOWERS. Small valve cooling or lab blowers, 12 volts input, £5 10s. 32 volt D.C. motor blower, ½ H.P. motor, 500 cub. ft. per min., £8 10s. Table model A.C. or D.C. fans 200/230 volts, 10in. blade and guard, 45/- Large mains motor blowers A.C./D.C.; send us your enquiries.

SUPERSEDERS. H.T. Battery Super-seders for Radio Receivers. 6 volts input, 110 v. 15 m.a. output, 12 volts input, 230 v. 30 m.a. output. The Army, the Navy and the Air Force use small Rotary Super-seders, a 5½lb. midget type taking less space than your old H.T. battery. Last for ever and cost little more than a few months run on H.T. battery. Size is only 5½ x 3½ x 3½in., beautifully made, model finish, ball bearings, etc., and takes small current from your accu. Latest model and guaranteed 12 months. Price £3 15s.

BATTERY CHARGERS. "Lesdix" Nittaday models, metal rectification, 2 volts ½ amp., for wireless cells, to large chargers for your car accumulator. Send for special Leaflet "W."

ROTACEPTORS. Pre-war type for E.H.T. at 50 cycles from 12 volts D.C., two sizes 5,000 volts and 10,000 volts at 20 m.a. for portable neon luminous tubes or daylight colour matching lamps. Completely ironclad with small interruptor motor at top, transformers and condensers below. Overall size 6in. x 4½in. x 13½in. high, £6 10s. each.

A.M. CUT-OUTS on base with bakelite cover, 4in. x 3½in. x 3½in., D.C. 12 volts, 40 amps., or 24 volts 40 amps., 35/- each. 12 volt triple auto car type cut-outs, dynamo control boxes, armature field and battery, 21/-.

MIKES: Recording and announcer's hand-mikes, multi-carbon, metal clad, service type, by Tannoy and Truvox, with neck switch in handle, 21/-.

MAGNETS. Midget ALNI perm steel disc magnets, ¾in. dia. with centre hole 3/16 in. dia., of tremendous magnetic force; unlimited uses, 3/6 each. Horse-shoe permanent-steel magnets, various sizes from 3/6 each.

SUNDRIES. Pocket thermometers, 6in. in metal case, vet. type, 90/110 degrees, 1/6. Hand wind clock movements, can be set to run for 30 minutes or less, new, 8/6 ea. Small bakelite Vee pulleys, 3in. diam. ¾in. hole, 1/6 ea. R.A.F. 10-way terminal strips, 2/9 ea.

Please include postage for mail orders.

ELECTRADIX RADIOS

214, Queenstown Road,
London, S.W.8.

Telephone MACaulay 2159

RADIO SPARES

MAINS TRANSFORMERS.		Primarys	200/250
		vols.	Secondaries 350.0-350 vols.
TYPE C.	100 ma. 4v. 5a., 4v. 3a.		34/6
TYPE D.	100 ma. 6.3v. 5a., 5v. 3a.		34/6
TYPE E.	120 ma. L.T.s as Type C		37/6
TYPE F.	120 ma. L.T.s as Type D		37/6
TYPE H.	200 ma. Three L.T.s of 4v. 6a.		
	-4v. 3a. Rectifier		47/6
TYPE I.	200 ma. Three L.T.s of 6.3v. 6a.		
	-5v. 3a. Rectifier		47/6
		Secondaries 500.0-500.	
TYPE J.	200 ma. Three L.T.s of 6.3v. 6a.		
	-5v. 3a. Rectifier		52/-
TYPE K.	200 ma. Three L.T.s of 4v. 6a.		
	-4v. 3a. Rectifier		52/-
TYPE L.	250 ma. Three L.T.s of 6.3v. 6a.		
	-5v. 3a. Rectifier		56/-
TYPE M.	250 ma. Three L.T.s of 4v. 6a.		
	-4v. 3a.		56/-
		Secondaries 400.0-400.	
TYPE R.	120 ma. 4v. 5a., 4v. 3a.		40/-
TYPE S.	120 ma. 6.3v. 5a., 5v. 3a.		40/-

SPECIAL UNITS MANUFACTURED TO FRIENDS' REQUIREMENTS.

Please note that, owing to dimensions and weight of TYPES H to M, kindly add 2/6 for carriage and packing.

HEAVY DUTY MULTI-RATIO OUTPUT TRANSFORMER. 120 ma. 15 watts; tappings for 6Ls in push-pull, Pk4s in push-pull, low impedance triode, low impedance pentode, high impedance triode, 27/6; complete instructions with each unit.

SPEAKERS. Rola or Celestion. 8in. P.M. with transformer 28/6. Less transformer 24/-, 10in. with transformer 45/-.

OUTPUT TRANSFORMERS. Special offer. Multi Ratio 30 : 1, 45 : 1, 60 : 1, 90 : 1, 6/-.

SMOOTHING CHOKES. 20 henrys 100 or 120 ma. 10/-; 20 henrys 150 ma. 12/6; 30, 35 or 40 henrys 200 ma. or 250 ma. 21/6.

DRIVER TRANSFORMER, Class B. 8/-.

LINE CORD. Special offer, 3 amp. 3-way, 180 ohms per yard 18/-, best quality.

BAKELITE PANELS, 18in. x 6in. x 1/4in., polished brown, 4/6.

Orders accepted by post only. Please help us to eliminate clerical work by sending cash with order. Please include postage with order. **PRICE LIST 1d.** stamp.

H. W. FIELD & SON, Colchester Road, HAROLD PARK, ESSEX

M. WILSON Ltd.

(Late Austerity Radio Ltd.)
Same Management
Everything we sell is absolutely new
No surplus or secondhand goods

SPECIAL!

RADIO-CHASSIS (riveted corners) in 18-S.W.G. "ALCLAD," undrilled, specially manufactured for us by a well-known firm of aircraft manufacturers, to Aircraft (A.P.) standards. Strong as steel rigid yet easy to work. Dimensions 12 1/2 x 7 1/2 x 4in. Price **12/6** Post and packing 1/-.

I.F. TRANSFORMERS. 465 k/c/s., permeability lined iron-pored, centre-tapped, colour-coded, screened, 15/- per pair.

COILS, 3 wavebands on one former: Long (800-2,000 m.), Medium (200-500 m.) and Short (16-50 m.). Aerial and Osc., 12/6 per pair. A. & H.F. with reaction, 12/6 per pair.

POLE-WAVEBAND COILS, on one former: Long (800-2,000 m.), Medium (200-500 m.) and Short (12-20 and 19-50 m.), 15/- per pair.

NOW READY

COMPLETE SUPERHETERODYNE SCREENED COIL UNIT, colour-coded, wired-up and tested. Includes 3 waveband coils for R.F. stage H.F. and Oscillator, short 15-50, medium 200-500 and long 800-2,000 metres. 465 k/c/s., 3 gang 500-2,000 metres. 445 k/c/s., 3 gang condenser, 3 bank switch, 2 valve holders (R.F.-F.C.), all trimmers, padders and resistances together with blueprint. With calibrated dial and slow £3 motion drive. Price Tuning units for all standard circuits supplied.

INPUT TRANSFORMERS. (Push-pull) Midget parallel-feed split secondary 4 to 1 ratio, 6/- Standard, 9/6. Heavy Duty, 12/6.

CIRCUIT No. 17

7-VALVE SUPERHETERODYNE A.C. or (No. 18) A.C./D.C. RECEIVER. Valve sequence: Radio-frequency stage (6K7), first detector and oscillator (6K8), intermediate-frequency amplifier (6K7), second detector A.V.C. and first A.F. (6Q7), output beam tetrode (6V6) with negative feedback, Y63 tuning eye if required. Six wavebands covering 5 to 2,000 metres, including television sound, A.V.C. rapid, normal and off. Controls: R.F. gain; wave-change switch; B.F.O. on/off; A.V.C. on/off; audio-gain control and on/off switch; tone-control; radio-gramophone switch. 6 watts output. Full-wave rectifier (5U4G).

CIRCUIT No. 20

10-VALVE SUPERHETERODYNE A.C. or (No. 21) A.C./D.C. RECEIVER. Brief specification: Valve sequence: Radio-frequency stage (6K7), first detector and oscillator (6K8), intermediate-frequency amplifier (6K7), second detector A.V.C. and first A.F. (6Q7), phase inverter and B.F.O. (6C8), output (two 6V6's) in push-pull with negative feedback, Y63 tuning indicator. Six wavebands covering 5 to 2,000 metres, including television sound, A.V.C. rapid, normal and off. Controls: R.F. gain; wave-change switch; B.F.O. on/off; A.V.C. on/off; audio-gain control and on/off switch; tone-control; radio-gramophone switch. 12 watts output. Full-wave rectifier (5U4G) and noise-limiter valve (6K7).

Complete Sets of Blueprints (two practical and one theoretical), full size, with complete price list of components, all of which we can supply, for circuits Nos. 17, 18, 20 and 21; 5/- per set for each circuit.

Look out for Special Television Advertisement

To OVERSEAS TRADERS

Wholesale and retail enquiries are invited. Orders can be executed for B.A.O.R., C.M.F., and S.E.A.C. customers.

307 HIGH HOLBORN
LONDON W.C.1. Phone: HOLborn 4631

ELECTROLYTIC CONDENSERS

LASKY'S RADIO offer for sale the following condenser made by well-known manufacturer, new and tested:

8 mfd., 450 volt working, tubular	4/6
8 mfd., 550 volt working, tubular	4/6
8 mfd., 350 volt working, tubular	3/6
8 mfd., wet can type, 500 volt working	8/6
16 mfd., wet can type, 450 volt working	7/6
8 x 8 mfd., tub. cardboard, 450 volt working	6/9
4 mfd. block type, 650 volt d/c working	5/9
2 mfd. tubular, 600 volt	2/9
50 mfd. 12 volt biasing condensers	each 2/-
2 to 25 mfd. wet biasing condensers	each 2/6
0.01 mfd., .02 mfd., .01 mfd. and 1 mfd., 400 volt working	per doz. 8/6

P.M. Speakers.—Rola 5, less trans., 21/-; 6 1/2" Rola, less trans., 22/6; 8" Rola, less trans., 23/6. 3 1/2" Goodman, 3 or 15 ohm, 7 coil, as required, 23/6; 5", less trans., 22/6. P.M. speaker, with transformer or pentode, 26/6; 10 and 12", prices on application.

Volume Controls, all values, long spindle, with switch, 5/9, less, 3/6 Special type volume control for midgets 5/-; meg. with switch, 5/9 each; few only.

Tuning Condensers.—2-gang, as per 0005 Midget trimmer, 13/6; ceramic insulation; less trimmers, 10/6, all with fixing feet. Complete with slow motion drive and dial as required, m/w, m/w and s/w, etc., 4/6 extra.

Toggle Switches, all types, 2/6, 2/9 and 3/6 each.

Systoxol, all sizes, 2/6 to 3/6 dozen yards, best quality. Mains droppers, 2 and 3 amp., with fixing feet, 1,000 ohms, 6/6.

Coils, medium wave, high gain, matched 5/6 pair, for T.R. long and medium wave coils, with circuit reaction, 10/6 per pair. P.M. of 36 assorted resistors, 1 watt, all useful values, 22/6; also 36 tubular condensers, carded, .0004 to 1 mfd., 26/6.

TRANSFORMERS.—Mains standard 4 volt, 29/6 with feet; 6.3 volt, 32/6. Output types for speakers, midget pentode, 5/9; universal, medium size, 7/6; large pentode type, 5/6.

Midget Smoothing Chokes, 500 ohm 60 m/a, 6/8. Line cord, 3 and 2 amp., 70 ohm per foot, 2 and 3-way, 3/11 yard, guaranteed.

V.A.C.S.—We have over 5,000 new, boxed and guaranteed V.A.C. valves in stock at list prices plus tax. Please send your queries. Send us your requirements. Terms, C.O.D. pro forma or cash with order. Send 1d. for price list of all goods.

LASKY'S RADIO
364, 370, Harrow Road, London, W.9

THESE ARE IN STOCK

- RADIO LABORATORY HANDBOOK.** By M. G. Scroggie. 12/6. Postage 5d.
 - TIME BASES (SCANNING GENERATORS).** By O. S. Puckle. 16/- Postage 5d.
 - NEWNES' TELEVISION MANUAL.** By F. J. Camm. 6/- Postage 4d.
 - FOUNDATIONS OF WIRELESS.** By M. G. Scroggie. 7/6. Postage 4d.
 - RADIO ENGINEER'S POCKET BOOK.** By F. J. Camm. 3/6. Postage 3d.
 - TELEVISION RECEIVING EQUIPMENT.** By W. T. Cocking. 10/6. Postage 4d.
 - SHORT WAVE RADIO.** By J. H. Reynier. 10/6. Postage 4d.
 - "WIRELESS WORLD" VALVE DATA.** 2/- Post 2d.
 - PROBLEMS IN RADIO ENGINEERING.** By Rapson. 5/- Postage 4d.
 - VALVE REPLACEMENT MANUAL FOR RADIO SERVICE ENG.** By A. C. Farnell and A. Woffenden. 6/- Postage 3d.
 - WORKED RADIO CALCULATIONS GRADED PRACTICAL EXAMPLES.** By A. T. Witts. 6/6. Postage 4d.
 - AMERICAN MIDGETS (RADIOS & VALVES).** By J. Bull. 2/6. Post 2d.
 - RADIO CIRCUITS.** By W. E. Miller. 3/6. Postage 3d.
 - ELECTRONIC EQUIPMENT AND ACCESSORIES.** With 343 Illustrations. By R. G. Walker. 25/- Postage 6d.
 - CLASSIFIED RADIO RECEIVER DIAGRAMS.** By E. M. Squire. 10/6. Postage 4d.
- Write or Call for Complete List, 1d.
- THE MODERN BOOK CO.**
(Dept. P.6.)
19-23, Prad Street, London, W.2.

VALLANCE'S PROMPT MAIL ORDER SERVICE

In best quality Radio Components

FOR CATHODE RAY OSCILLOSCOPE described in PRACTICAL WIRELESS for Nov., 1945. From 8/-.

COMPLETE OSCILLOSCOPE KIT including all parts, wire, screws, solder, etc., less valves, chassis and cabinet. Price 26 post free.

CATHODE RAY TUBE & VALVES for above V.C.R. 30 and base, 70/-; GTIC, 25/-; W42, 12/0; U19/14, 11/- Any item sold separately.

LEGG SUPER CHARGER for 2, 6 or 12 v. batteries. This charger is suitable for any voltage batteries which, when series connected, do not exceed 100 volts. Charging rate 2 amps maximum. Ideal nucleus for a battery charging service. Price 28 7s. carriage forward. Other types available.

UNIVERSAL TEST METERS. First grade Army type in shockproof bakelite cases, ranges 10, 100, 500 volts at 1000 ohms per volt, A.C. and D.C. 1, 10, 100, 500 m/a D.C. 0-10,000 ohms with internal battery 35 12/6.

HIGH ACCURACY METERS, 3 1/2in. diam 1 milliamm, 52/-; 4 1/2in. 1 milliamm, 65/-; 500 microamps, 71/6; Westinghouse metal rectifier for either type, 15/-; BP 12 way switches, 5/-.

SPECIAL LINE IN WARS TRANSFORMERS, few only, 450-0-450 v. 200 m/a. 5 v. 5 a. 6 s. v. 5 a. C.T. 42/8. plus 2/6 post and packing.

MOVING COIL PERMANENT MAGNET SPEAKERS, Rola 5in., 21/6; 6 1/2in., 22/6; 8in., 24/-; 10in., 38/9; Celestion, 2 1/2in., 27/-; Goodman, 2 1/2in., 32/6; 3 1/2in., 30/-; 5in., 32/6; 12in., 185/-; Wharfedale, 4in., 28/8; 12in., 130/-; B.T.H. 12in., 120/- All above are less output transformer.

OUTPUT TRANSFORMERS power/pentode, 6/9; multi-ratio, 8/8; midget types, ratio 32/1 and 37/1 combined, 6/6; 32/1 and 80/1 combined, 6/5; midget power/pentode with 15 ohms secondary, 7/6.

PUSH-PULL OUTPUT TRANSFORMERS speaker matching from 1-30 ohms, valve loads 1,500 to 16,000 ohms. Will match almost all types of valves single ended as well as push pull class A, AB1, AB2 and B. 15 watts, 28/3; 30 watt, 49/6. Full instructions with each.

Please send cash and postage with order, otherwise C.O.D.

VALLANCE'S
144 BRIGGATE, LEEDS 4

lead-in which has to pass through the field of interference. (Nothing much can be done about indoor aerials, which have a notoriously bad signal/noise ratio, except to find by experiment a more noise-free position.)

The Outdoor Aerial

The pick-up wire of the aerial system should be erected at least 10ft. clear of the house, and not lie parallel to power or telephone lines in order to prevent pick-up of re-radiated interference. A high aerial will give greater signal pick-up and also freedom from man-made interference fields, which tend to spread over the earth and buildings rather than extend in a vertical direction. A horizontal aerial is usually preferable since it does not respond to car ignition interference, which is vertically polarised. The design of the down lead is of the greatest importance in the anti-interference type of aerial, and there is a choice of several systems. Commercial "anti-static" aerials consist of two matching transformers and a lead-in of screened cable connected as shown in Fig. 4. Unless exceptionally well designed multi-range transformers are used this system only gives good results on one waveband. For short-wave reception the transposed feeder shown in Fig. 5 has much to recommend it. Two lead-in wires about 2in. apart and transposed every 2ft. are used. At the aerial end one wire is left free and at the receiver the feeder is connected

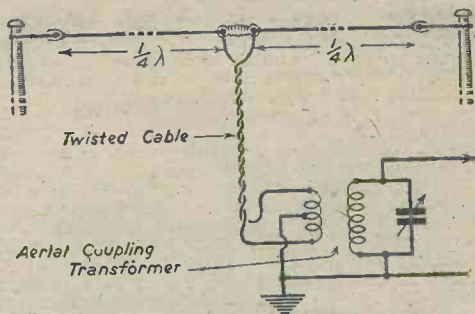

Fig. 6.—An anti-noise aerial which works well on short-waves.

Internal Noise

Having dealt with all sources of noise external to the receiver we will now consider what type of noise can be generated in the receiver itself. (Interference due to whistles, sideband splash, a simultaneous reception of several programmes and the hum caused by defective mains smoothing do not strictly come under the heading of internal noise, and will not be dealt with here.)

Modulation Hum

There is one peculiar type of high-pitched hum which will be mentioned because it is sometimes mistaken for defective smoothing or external interference. This hum is only apparent when the receiver is tuned to a strong signal which is in some way modulated by hum voltages or L.F. currents in the mains supply. If the rectifier circuit is to blame then the circuit of Fig. 7 will effect a cure. Otherwise, a mains input filter such as that in Fig. 3 must be used.

Microphony

Microphonic noise is a source of trouble which frequently occurs in amateur built receivers; more particularly in S.W. adaptors and portable sets. This noise usually consists of a low-pitched howl which fluctuates in intensity according to the output from the loudspeaker. The howling is due to acoustic feedback from the loudspeaker causing valves or other components to vibrate in such a manner that the signal currents in the components concerned are modulated by the mechanical vibration. Microphonic valves can be located by gentle tapping with a pencil and noting the character of the response from the speaker. As valve microphony is due to defective electrode structure the best course is to replace the valve, but remedies such as packing the valve with cotton wool or mounting it in an anti-microphonic valveholder may first be tried. In S.W. receivers microphony is usually caused by the vibration of the vanes of the tuning condenser or of the tuning coil

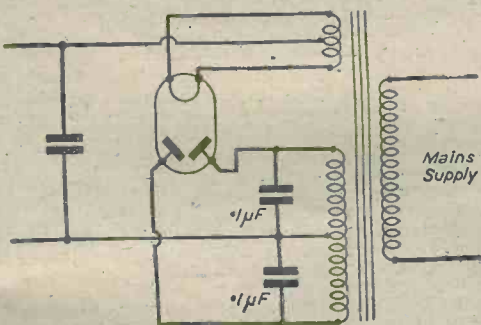

Fig. 7.—Cure for modulation hum when the rectifier circuit is to blame.

across the two ends of the aerial coil. As the centre point of the aerial coil must be earthed a slight modification of the wiring may be necessary. Interference is picked up by both lead-in wires, but the effects in each wire are equal and opposite, causing mutual cancellation of noise voltages. Another anti-noise aerial which works well on short waves is the doublet shown in Fig. 6. The lead-in can be twisted rubber lamp flex or twin coaxial cable. This aerial is particularly efficient when the length of the top is made half a wavelength.

Where trolleybuses or trams cause interference none of the above systems will be effective unless the aerial is high and well clear of buildings. If a horizontal aerial cannot be erected due to the unfavourable site, it is best to use a short vertical "sky rod" fitted to the highest point of the building and connected by a transmission line to the receiver. This type of aerial has poor signal pick-up, and should only be used where interference is exceptionally severe.

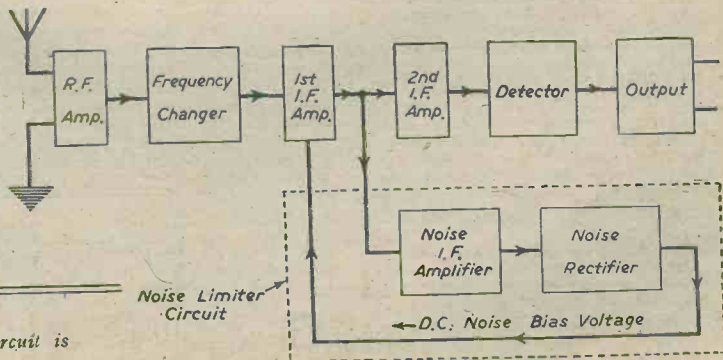

Fig. 8.—How the noise limiter circuit is introduced.

assembly. To effect a cure the whole tuning unit should be floated on blocks of sponge rubber. If this proves ineffective the speaker must be acoustically isolated from the chassis, either by means of an absorbent baffle or by mounting it in a separate cabinet.

Crackling

The individual sources of crackling noises in receivers are numerous, and only a brief survey is possible. There are, however, three outstanding causes—dirt in components, bad wiring connections and faulty components. Dust between the vanes of the tuning condenser and greasy or rusty switch contacts are distinctive examples of crackling due to "dirt." Dust may be expelled by means of a vacuum cleaner; while grease, rust or other dirt can usually be removed by soaking the components in carbon tetrachloride and wiping it dry with a clean rag. Faulty components and bad connections are not easy to trace. Prodding with a wire dressing tool will often assist in localising the fault, but if this fails the circuit must be systematically analysed stage by stage. The analysis is carried out by earthing the control grid inputs of the receiver stages, working successively from the R.F. to the output stage, until the crackling ceases. Having found the offending stage the components in it are tested individually.

Inherent Circuit Noise

The one remaining source of internal noise is that produced by atomic activity within the valves, wires and components of the receiver. From the point of view of the designer the magnitude of this noise sets a limit to the overall amplification from a particular circuit, though the source of noise is ultimately outside his control. "Inherent circuit noise" is the continuous hiss heard when the receiver is adjusted for maximum sensitivity and is markedly noticeable in multi-valve superheterodynes. It is present over the entire tuning range but rises in intensity when the receiver is brought into resonance with an unmodulated signal due to the heterodyne action between the circuit noise voltages and the carrier wave. Inherent noise is of two classes, thermal effects in the conductors and shot noise in the valves. In both instances it is usually only the first stages in the receiver that have to be considered as in later stages the signal is amplified and is much greater than any noise likely to be produced in these stages.

Thermal Noise

All wires, resistances and coils, in fact all conducting substances, contain free electrons in a state of random motion. The average velocity of these electrons is proportional to the temperature and is only zero at 0 deg. Absolute (-273°C). Each electron in motion constitutes a minute electric current, and although the resultant total of their currents over a long period of time is zero, at any given instant there is a net current in one direction or another. These transient currents produce voltages having frequencies which extend from zero to infinity across the ends of the conductor.

Shot Noise

The other important source of circuit noise is shot noise produced by the streams of electrons flowing from cathode to anode in the valves. These electrons are emitted in groups that represent small irregular pulses of current and have an effect analogous to a rain shower on a corrugated iron roof. These pulses excite the anode circuit over the entire frequency range to which it is responsive. Shot noise is strongest in multi-electrode valves, particularly in frequency-changers where the oscillator contributes to the noise voltage.

Reduction of Circuit Noise

Both shot and circuit noise cause interference over an infinite band of frequencies. Their magnitude can therefore be lessened by reducing the response band of the receiver, i.e., using more selective circuits. The magnitude of both types of noises depends on the size of the resistance in which they are developed, making

careful proportioning of the load resistances in the first stage desirable. The frequency-changer in low noise level or communication receivers should always be preceded by an R.F. stage in order to minimise the excessive shot effect in the former.

Noise Limiter

By systematic tests and careful design most external noise and all internal noise, with the exception of circuit noise, can be eliminated. There remain, however, two types of external interference which, despite all anti-noise devices, cannot be entirely prevented; namely, atmospheric and severe man-made static. It is in these cases that resort must be made to a receiver incorporating a "noise limiting" stage. This is an extra I.F. stage, where the noise is amplified like a signal, rectified and thus made to produce a D.C. voltage which is proportional in magnitude to the strength of the noise. This D.C. noise voltage is applied as a bias voltage to the usual I.F. stages of the receiver in the same way that A.V.C. is applied. A burst of noise puts a heavy bias on the I.F. valves and suppresses the signal for the few instants during which the noise lasts. As most atmospherics are of extremely short duration the programme continuity is not lost. This type of receiver suppresses severe interference by passing electric vehicles and permits broadcast reception in tropical countries where atmospherics are prevalent (see fig. 8).

Programme Pointers

(Continued from page 118)

and very grateful for instrumentalists to play, his is not great music, and certain works of his—"Danse Macabre" always being an exception—done to death in recent seasons, can do with their well-earned rest.

His works, especially those for violin and violincello, have a sensuous charm and do not lack beautiful melodies and themes. The bowed instruments are particularly suited to bring out these qualities. But even Casals seems to have put the cello concerto on the shelf during his present tour. He used to play it regularly.

Fauré is being performed more than was wont, but not yet half enough. Debussy, one of music's great masters, is not amongst those subject to fashion's caprice.

The great Beethoven interpreter Artur Schnabel is with us again, and is going to do all five concertos. Possessing small hands compared to some notable pianists, but fingers of steel, he has an ideal touch for broadcasting and gramophone recording. A pre-war performance by him of the "Emperor" was one of the best I ever heard.

A word of advice regarding the volume of tone you listen-in to. Expediency, and the demands of family life apart, don't be afraid of turning it on. All the best effects, such as muted strings and quiet string playing generally, woodwind, etc., will be partially lost. And as for climaxes, they will be non-existent. After all, a hundred musicians in the Albert Hall produce a pretty big, earful, and sometimes we pay the equivalent of a year's wireless licence to hear them just once. There you hear the real thing. Although we may not want the Albert Hall in our back parlour, don't cease to bear the original in mind.

WIRE AND WIRE GAUGES

By F. J. C.A.M.M.

3/6 or by post 3/9 from

George Newnes, Ltd., Tower House, Southampton St., Strand, W.C.2.

Impressions on the Wax

Review of the Latest Gramophone Records

H.M.V.

THIS month is, so far as record releases are concerned, more like old times. I have before me a selection of 27 records; 18 12in. and nine 10in. and I shall be very surprised indeed if anyone finds any difficulty in finding one or more to suit their taste, whether he be high- or low-brow. There is one snag about a good list of fine recordings, one just does not know which not to purchase, or should I say, how to refrain from adding just another one to the monthly addition to one's record library. For most of us, our budget is the deciding factor. Nevertheless, this does not eliminate the problem of having to decide which shall be put on the waiting list. For example, in the H.M.V. latest recordings, there is a truly delightful recording by the B.B.C. Symphony Orchestra, conducted by Sir Adrian Boult, of Mendelssohn's "A Midsummer Night's Dream," consisting of the Overture (Op. 21) in three parts, and the Wedding March (Op. 61, No. 9). These will be found on *H.M.V. DB6242-43*, and I strongly recommend them for your hearing as the Overture possesses great beauty, revealing the delicate tone patterns, and the stirring majestic passages so closely associated with the master touch of Mendelssohn. The Wedding March with its delightful martial air is too well known and calls for no comment, other than for me to say that it completes two exceptionally fine records of a first-class performance by the B.B.C. Symphony Orchestra.

After hearing the above, *H.M.V. DB6241* will tempt you to add it to your list of purchases. It is "Les Troyens" Royal Hunt and Storm, by Berlioz, recorded by the London Philharmonic Orchestra, conducted by Sir Thomas Beecham, Bart. Once again, this forms another recording of exceptional quality. In the opening, the wood wind and strings create an atmosphere of calm and peace, and then, augmented by the horns and brass, build up the tense expectation of the hunt and the coming storm, which develops with dramatic intensity.

This brilliantly descriptive phase is followed by a return to the serenity of the quiet calm following, as in nature, the fury of the tempests. The performance and recording call for special mention.

The next seven H.M.V. records have been recorded under the auspices of the British Council, and they present "Dido and Æneas" (Tate and Purcell), edited by E. J. Dent. The records are *H.M.V. C3471-77*, and in this instance brief details must suffice, as lack of space prevents anything like a comprehensive review. The orchestra is the Philharmonia String Orchestra, conducted by Constant Lambert, with harpsichord by Boris Ord.

C3471 consists of (a) "Overture," (b) "Shake the Cloud From Off Your Brow," the singer being Isobel Baillie (soprano). On the other side is recorded (a) "Ah, Belinda!" (b) "When Monarchs Unite," the singers being Joan Hammond (soprano) and Isobel Baillie. On *C3472* we have (a) "Whence Could So Much Virtue Spring," and (b) "Fear No Danger"; artists, J. Hammond, I. Baillie and J. Fullerton. On the opposite side is recorded "See, See, Your Royal Guest Appears"; I. Baillie, J. Hammond and Dennis Noble (baritone).

Part 5 (*C3473*), "Wayward Sisters"; E. Coates (contralto) and E. Hobson (soprano). Part 6, "Ruin'd Ere the Set of Sun?"; E. Hobson, G. Ripley (contralto) and E. Coates. Part 7 (*C3474*), (a) "In Our Deep Vaulted Cell," (b) "Echo Dance of the Furies." Part 8 (a) "Thanks To These Lonesome Vales," (b) "Off She Visits This Lone Mountain"; I. Baillie. Part 9 (*C3475*), "Behold Upon My Bending Spear"; D. Noble, J. Hammond, I. Baillie and S. Patris (soprano).

Part 10 (a) "Come Away, Fellow Sailors," (b) "Sailors' Dance," and (c) "See The Flags and Streamers," T. Jones, E. Coates, G. Ripley and E. Hobson.

Part 11 (*C3476*), (a) "Our Next Motion," (b) "Destruction's Our Delight," and (c) "Dances of Witches and Sailors"; Edith Coates. Part 12 (a) "Your Counsel All Is Urged In Vain," (b) "Great Minds Against Themselves Conspire"; J. Hammond, I. Baillie and D. Noble. Part 13 (*C3477*), (a) "Thy Hands, Belinda," (b) "When I Am Laid In Earth"; J. Hammond. Part 14, "With Drooping Wings, Ye Cupids."

The artists mentioned are supported by a full chorus, and great credit is due to all concerned for the exceptional recording of a work of such magnitude.

In the 10in. series, I have only two H.M.V.s, the first being a Red Label, *D41841* which has been recorded by Jussi Bjorling (tenor) who sings, in Italian, "La Mattinata" and "Messun Dorma (None Shall Sleep)," from Act 3 "Turandot." This is a record which all who appreciate a tenor voice of the first quality will be eager to add to the vocal section of their library. While speaking about vocals, the second H.M.V. 10in. must also be considered, as it is by Joan Hammond (soprano) singing, with piano accompaniment by Gerald Moore, "Black Roses" and "The Tryst," two songs which Miss Hammond renders in a delightful manner.

Columbia

COLUMBIA offer this month a very varied and attractive programme, and I hesitate to say which is the high-light, as each item stands to the fore in its particular class. If you fancy pianoforte recordings I strongly advise you to hear *Columbia DX1214*, on which you will hear Cyril Smith giving a splendid performance—solo pianoforte—of "La Campanella" (Paganini-Liszt), and "Triana" from Suite "Iberia." Or, if you like Gershwin's "Rhapsody in Blue" then put *Columbia DX1212* on the turn-table and enjoy Oscar Levant (pianoforte) and the Philadelphia Orchestra, conducted by Eugene Ormandy, playing in brilliant style that ever popular rhapsody.

For those whose fancies turn to something more in the, shall we say, light classical, there is *Columbia DX1221*, which is a charming recording by the Philharmonia String Orchestra of "Roumanian Folk Dances Nos. 1 to 7," by Bela Bartok—arr. Wilmer.

For the vocal section, might I draw your attention to the latest recording by John McHugh (tenor), who, on *Columbia DX1224*, has recorded "Liebestraum" (featured in the film "I'll Turn To You") and "Serenade" from the "Goldsmith of Toledo." In both recordings the artist is supported by chorus and orchestra under the baton of Henry Geehl.

On *Columbia DX1223* the City of Birmingham Orchestra, conducted by George Weldon, have made a good recording of the popular "Ruy Blas—Overture," by Mendelssohn. Finally, in the 12in. series, we have another of the light cheerful recordings by Harry Davidson and his Orchestra of "Naval Three Step" and "The Ladbroke," which form Nos. 20 and 21 of Old Time Dance Series.

Albert Sandler and his Palm Court Orchestra provide a first-class light music record by their latest recording on *Columbia DB2199*. For this, "Waltz Time—Selection" forms the subject, and it introduces "The Waltz"; "Only To You"; "Little White Horse Polka"; "Break of Day" and "You Will Return to Vienna." A most pleasing record well up to Sandler's standard.

(Continued on page 128)

A Universal "Utility"

A Wartime Civilian Receiver Converted to A.C./D.C. Operation

THE wartime civilian receiver, in spite of its looks, has proved to be a very efficient little set. Listeners on D.C. mains, however—and there are still many of them—are unable to use the A.C. model, while the idea of using the battery version where there is a mains supply available in the house is distasteful to many people. For their benefit, the standard "Utility" receiver can be easily converted to work on direct current mains as well.

The alteration consists of removing the mains transformer, replacing the A.C. output and rectifier valves with "universal" equivalents, and adding one valveholder and a mains-dropping resistance.

The frequency-changer and I.F. amplifier valves may be retained, but the heater current taken by each of them is important. In the various choice of valves listed by the manufacturers of this set to work in these two positions, there are some with heaters rated at 6 volts, 0.2 amp, and some at 6 volts, 0.3 amp. In all other respects the valves are identical, and on A.C. supplies they may be interchanged freely. On D.C. supplies, however, all valve heaters are connected in series, and while the *voltage* of each heater may be, and often is, different, the *current* taken by each must be the same. Thus it is essential to determine the heater ratings of the frequency-changer and I.F. amplifier in the set before anything else is begun.

Resistance readings of the heaters are not very conclusive, and the actual current should be measured with a good meter reading up to at least half an amp. The simplest way is to connect each valve heater in turn in series with the meter across a 6-volt battery (two "800" cycle lamp batteries in series will do). If no meter is available, any radio serviceman will be able to make the check for a small fee.

If both heaters are found to take the same current, either 0.2 or 0.3 amp., select an output and rectifier valve having the same heater current rating from the list shown opposite.

If one heater takes 0.2 amp. and the other 0.3 amp., which is quite likely, the lower-rated heater must be shunted by a 60-ohm 2-watt resistor, preferably wire wound. It may then be treated in the same way as a 0.3 amp. valve, and the rest of the circuit adjusted to

Output Valve (V.3)	0.2 amp. Mullard CL33 (Oct.)	0.3 amp. Osram KT32 (Oct.) American 25L6G (Oct.) American 25A6G (Oct.) (With 25A6G, incr. bias resistor to 500 ohms.)
	No change in the existing valveholder connections is necessary with any of the above valves.	
Rectifier Valve (V.4)	Brimar 1D5 (Br. 5-pin) Cossor 40SUA Mazda U4020 Mullard UK1C Mullard CY31 (Oct.) Tungsram V20 (5-pin) Tungsram V30	Osram U31 (Oct.) American 25Z6G (Oct.)*
	* Strap each anode together and each cathode, i.e., as a half-wave rectifier.	

this current value. The circuit diagram shows an example of a shunted heater.

A 0.3 amp. mains dropper will be suitable for either 0.2 amp. or 0.3 amp. valves. Its resistance may be worked out by adding together the heater voltages of all valves (including the shunted heater, if any, which still requires 6 volts) and subtracting it from the mains voltage on which the set is to operate. This will determine the number of volts to be dropped by the resistor; and, by Ohm's Law, the necessary resistance will be equal to this voltage divided by the heater current.

Having settled this question of the valves, remove the mains transformer completely, mounting the mains dropper, adjusted to its correct resistance, in the space now left on the chassis. (Remember this resistor will run hot, so mount it away from the edge of the chassis to protect the wooden side of the cabinet.) As the A.C. rectifier is mounted on the transformer tag panel, a new valveholder will be required, either International Octal or British 5-pin, according to the valve chosen. In most cases an unused hole in the chassis will be found (normally concealed by the transformer) in which the new valveholder may be fitted. When there is no such hole, mount the valveholder on small pillars

(Continued on page 128)

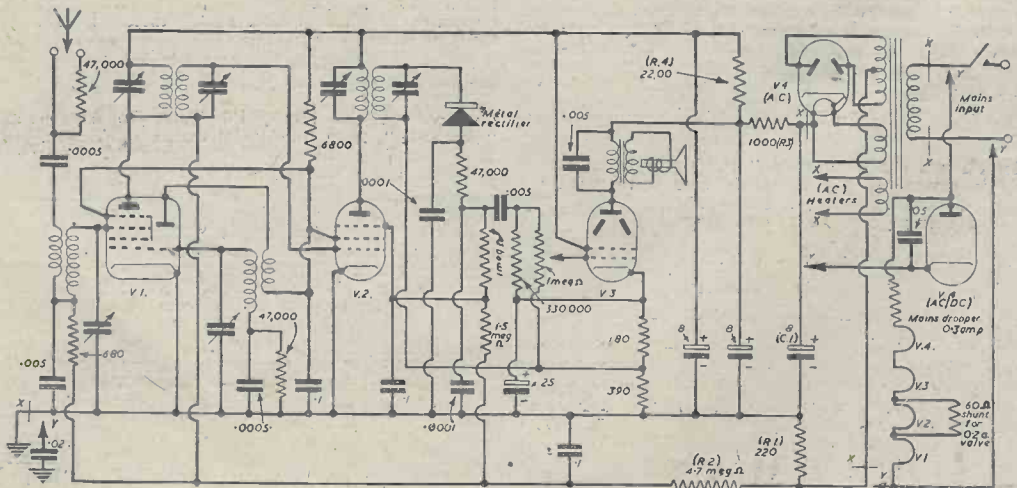

Theoretical circuit.

TRANSFORMERS

Amplifiers—Microphones—Stands
Horn Speakers—P.A. Speakers:

Mains Transformers 350-0-350v.
U.4. 100 ma 4v 2a & 4v 4a ... 30/-
U.6. 100 ma 5v 2a & 6.3v 4a ... 30/-

Amplifier types

K450H. 450-0-450v 4/5v 3a and
6.3v 6a ... 48/-
OPI2 K.50 watt multi-ratio... 52/-

Write for 20pp. Illustrated Catalogue, 6d
describes over 50 transformers, also all other
equipments now available.

OUR A.20 AMPLIFIER.

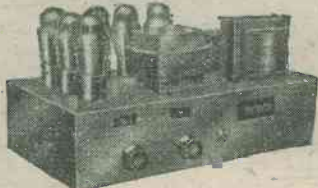

Six valves, with 6V6's in push pull, triode
cathode coupled phase changing, with
pre-amp. stage. Two inputs with mixer.
Output 26 watts 6 per cent. Full details in
List A/105/1.

KIT OF PARTS ready to as-
semble, complete with chassis, 6
valves and carrying case. **£14**

RADIO INSTRUMENT CO.,

294, Broadway, Bexleyheath, Kent.

THE NEW "LUCERNE" PERMANENT CRYSTAL DETECTOR

The latest and most efficient
PERMANENT CRYSTAL DETECTOR
NO ADJUSTMENT NECESSARY
JUST CONNECT and RECEIVE
Every detector tested on broadcast and
GUARANTEED

Complete with brackets and screws
PRICE 2/- POSTAGE 3d.

FOR BEST RESULTS USE THE

"LUCERNE" CRYSTAL SET COIL NO VARIABLE CONDENSER REQUIRED

TESTED and GUARANTEED
Complete with wiring instructions
PRICE 3/6 POSTAGE 3d.

POST RADIO SUPPLIES
33, Bourne Gardens, London, E.4.

MIDLAND INSTRUMENT CO.

Comprehensive range of Lewcos instrument
wires, resistance wires, flexes and cables,
sleeving, Empire tape, rubber grommets,
L.T. selenium rectifiers and transformers,
Avometers, speakers, chassis, dual range
and s.w. coils, var. conds., counters, syn-
chronous motors, microphones, etc., etc.
Lists, 1d., s.a.e. Enquiries 2/1d., s.a.e.—
18, Harborne Park Road, Birmingham, 17.

COULPHONE RADIO

PROMPT MAIL ORDER SERVICE
NEW GOODS ONLY. C.W.O. or C.O.D.
Orders over 5/- post and packing free.
Tungsram and B.V.A. Valves. Over
2,000 in stock. List prices.

Mains Transf. 350v.-0-350v. 100 mA.,
4v. 6a., 4v. 21a., or 6.3v. 3a., 5v. 2a., 24/-
Transf. Bobbins, as above ... 15/6
P.M. Speakers less transf., 21in., 24/-;
3in., 27/6; 6in., 20/-; 5in., 19/6; 8in.,
21/-; 10in., 30/- With pen. transf.,
6in., 24/-; 8in., 25/-; 10 3/6/-
8in. M.E. 1,200 ohm. field pen. trsf., 30/-
Power-Pen, Output Transf., 40mA. 6/6
Parafed L.F. Transf., 4:1 ... 5/-
Push-Pull L.F. Transf. ... 17/6
5-way Cable, 10d. yd., 3-way 6d. yd.
Mains Dropper Resistors, 800 ohms,
2/4d. taps, 3 amp. with fixing feet 4/6
Push-back Wire, 2d. per yd., 50ft., 2/6
Carbon Resistors, 1 w., 6d., 1 w.,
9d., Standard values 50 Ω to 5 meg.
Resin Cored Solder ... 4/- lb.
Tinned Copper Wire, 1lb. ... 2/-
Sleeving, 2mm. A.I.D. Specd. 2d. yd.
Moving Coil Microphone ... 95/-
Mica Floor Stand, chromium ... 39/6
Tubular and Silver Mica, all sizes.
Valve-holders, Eng. & Amer. 6d. each.
Vol. Controls with sw., 4/9, less sw. 3/6
Smoothing Iron Elements, 450v. 2/3
Fire Spirals, 750 w., 2 - 1,000 w. 2/6
Staneto Soldering irons, 230v., 15/6
Speaker Field Coils, 2,000 ohms. 6/6
Smoothing Chokes, 15 Hy. 200 mA.
200 ohms 21/-; 60 mA. 7/6; 100 mA. 12/6.
Tuning Condensers, .0005 with trim-
mers, 2 gang, 11/6; 3 gangs, less tr. 13/6
Tuning Coils, M. & L. wave, with
reaction circuit ... Pair 12/6
Milliammeters, 41in., B.S., 1st grade,
0-1 mA. Knife edge pointer ... 70/-
Electrolytic Condensers, 8mf. 450v.,
4/6; 8-8mf. 7/6; 2mf. 350v., 3/-;
25mf. 25v., 50mf. 12v., 2/-; 25mf.
50v., 2/9; 50mf. 50v., 3/-
Line Cord, 3 amp., 60 ohm per ft.,
2 way, 1/6 per yd., 3 way, 1/9 per yd.
Stamped addressed envelope for list.

NEW LONGTON, Nr. Preston

Radio Books

WORKED RADIO CALCULATIONS

By ALFRED T. WITTS, A.M.I.E.E.

Consists of a total of 302 numerical problems on radio
matters, very carefully worked out, the various steps
in each calculation being given in full. Apart from its
obvious value to training classes, the book will be
particularly useful to home-study workers and service
engineers who may have a problem to solve in
connection with their everyday work. 6s. 6d. net.

RADIO QUESTIONS AND ANSWERS

Basic Radio

By E. M. SQUIRE

Covers the preliminary part of radio training. It is
compiled in the form of questions and answers, and
the questions given are suitable for those taking
training courses for radio mechanics and wireless
operators. Diagrams illustrate the context and help
clarify the meaning. 5s. net.

PITMAN

PARKER ST., KINGSWAY, LONDON, W.C.2.



FOR THE RADIO SERVICE MAN, DEALER AND OWNER

The man who enrolls for an I.C.S. Radio Course learns radio
thoroughly, completely, practically. When he earns his
diploma, he will KNOW radio. We are not content merely
to teach the principles of radio, we want to show our
students how to apply that training in practical, every-day,
radio service work. We train them to be successful!

INTERNATIONAL CORRESPONDENCE SCHOOLS

Dept. 94, International Buildings,
Kingsway, London, W.C.2.
Please explain fully about your instruction in the subject
marked X

Complete Radio Engineering

Radio Service Engineers

Elementary Radio

If you wish to pass a Radio examination, indicate it below.

British Institute of Radio Engineers

P.M.G. Certificate for Wireless Operators

City and Guilds Telecommunications

Wireless Operator, R.A.F.

Wireless Mechanic, R.A.F.

Special terms for members of H.M. Forces and discharged

and disabled members of H.M. Armed Forces.

Name..... Age.....

(USE BLOCK LETTERS)

Address.....



(Use penny stamp on unsealed envelope.)

or spacers above the chassis, high enough to clear the sockets.

Remove the on/off toggle switch at the rear of the chassis and mount it in a suitable hole cut in the fibre back of the set. This is to isolate it from the chassis, which, in A.C./D.C. receivers, may be live; with the new mounting there is no danger of shock when operating the switch. Alternatively, the 1 megohm volume control may be replaced by one of the same value, but fitted with an on/off switch, so that rotation of the volume knob also switches the set.

The mains lead should be connected as shown in the diagram, one side to one switch contact, the other to the junction of R1 and R2. (Note that one side of the mains is *not* connected direct to chassis.) Join the remaining switch contact to the anode socket of the rectifier valveholder and also to one side of the mains dropper. Connect the rectifier cathode socket to the junction of R3 and Cr. The .005 μ F condenser shown between anode and cathode of the rectifier helps to eliminate hum.

Alter the wiring of all heaters from parallel to series connection, as indicated in the circuit diagram. The rectifier should be highest in the chain, wired next to the mains dropper, and remember that the lowest point in the chain (the earthy side of the frequency-

changer heater) is joined to the junction of R1 and R2, *not* to the chassis.

A condenser of about 0.02 μ F must be inserted between the "Earth" socket and the chassis, to prevent any possibility of the mains being earthed via R1. On some models a 47,000 ohm resistor is connected from the top of the 0.0005 aerial series condenser to the chassis, and this should be removed so that no D.C. connection to chassis is possible when adjusting the aerial input. The performance of the set will not be materially affected.

With the same idea of preventing contact with the metal parts of the set, a piece of mica, talc, perspex or other tough transparent material must be placed, on the inside of the cabinet to cover the dial opening and a piece of cardboard or other similar insulating sheet must cover the exposed part of the chassis under the fibre back. Appropriate holes must be made for the aerial and earth connections, but they should not be large enough to expose any part of the chassis. The grub screws in the knobs must be sunk well below the surface, and preferably sealed with wax.

If these simple precautions are taken, the set will be quite safe to operate, and has been found most satisfactory on either A.C. or D.C. mains.

New Radar Developments

USE of "television technique" marked a great step forward in the versatility of this new instrument. The use of the very high frequency technique for the detection of low-flying aircraft had made it practicable to mount the whole aerial system (now smaller because of the shorter wavelength) on a turntable and to concentrate the energy into a beam rather like a widely dispersed searchlight. This beam could sweep the horizon if necessary through the whole 360 degrees, and by suitable devices on the cathode-ray tube line, a map-like view of the scene below could be traced out in synchronism, says *Radio Craft*.

If the echo signal returned from an aircraft were made to brighten the line instead of deflecting it, the position of any aircraft encountered by the beam could be shown as a bright spot on the circular face of the cathode-ray tube which could then have a map of the surrounding terrain superimposed on it. This technique is known as P.P.I. (Plan Position Indicator).

Moreover, by other almost fantastic developments, it became possible to project the map optically, plus aircraft indications and handwritten plots—all together on a translucent screen. The dream of many commanders is realised in this—the ability to sit in a room at headquarters and actually see all the movements of hostile and friendly aircraft displayed before their eyes on a map.

The ground controller is able to note the relative positions of the enemy 'plane or 'planes as well as the 'planes under his control. By means of "vector" directions, his 'planes could then be manoeuvred directly toward the enemy. The pilots, informed when and where to expect the enemy, had a great advantage over him—so great that the small R.A.F. (Royal Air Force) was able not only to turn back vastly superior forces of Nazi raiders but to shoot down what to the Germans seemed to be altogether disproportionate numbers of them.

A still later development was the smaller AI, or Aircraft Interceptor, a short-range radar which is carried in the 'plane. The fighter receives "vectors" from his ground-control station till within AI range of the enemy, and is then directed to "flash his instrument" and proceed on his own. An ingenious adaption permits the pilot to see the image of the opposing fighter reflected on his windshield. As he approaches, the enemy image

becomes broader—"grows wings." By centering the image dead ahead, the flyer approaches till the actual enemy 'plane is seen, superimposed on its own radar image. Again the advantage of knowing just where the enemy would appear gave the defending 'plane an immense advantage in the darkness, and the luckless Nazi's first warning of the presence of fighters might be a fatal burst of fire.

IMPRESSIONS ON THE WAX

(Continued from page 125)

Frank Sinatra, on *Columbia DB2197*, offers two film feature numbers, namely, "I Begged Her" and "I Fall in Love Too Easily."

Parlophone

NOT for a long time have I had a 12in. Parlophone record, therefore, this one, *Parlophone R20543* is welcomed, and doubly so when I played it over. It is by Richard Tauber (tenor), and a particularly fine example of his skill and production. He sings, "In Native Worth" (Haydn, from "The Creation," and "Joseph's Aria" (Mein Vaterland), by Mehul from "Joseph." The first is in English, and the latter in German. In the rosin series, I recommend Billy Thorburn—solo Pianoforte—playing "In A Monastery Garden" and "Dearest of All" on *Parlophone F2103*.

Geraldo and his Swing Orchestra—with Ivor Mairants on the Guitar—swinging "Two Moods" and "In Charlie's Footsteps," on *Parlophone F2105*.

Ivor Moreton and Dave Kaye provide No. 68 of "Tin Pan Alley Medley," on *Parlophone F2109*, while Dorothy Squires, with Orchestra conducted by Billy Read, offers "I'll Close My Eyes" and "Let the Rest of The World Go By," on *Parlophone F2102*.

Regal

TO finish this month's review, here is one Regal record which will have great appeal to those dance enthusiasts who followed the recent All-Britain Amateur Dance Band Championships (1945), as it has been recorded by the winning band—Billy Weedon's Eltham Studio Band. They play "Two O'Clock Jump" and "Song of The Volga Boatmen." The number of the record is *Regal MR3766*.

Open to Discussion

The Editor does not necessarily agree with the opinions expressed by his correspondents. All letters must be accompanied by the name and address of the sender (not necessarily for publication).

Dance Music?

SIR,—I used the word "jazz" in my letter referred to by Mr. Saunders, in the general way that it is usually thought of, when perhaps "dance-music" was the word.

"Jazz," we are told by Mr. A. McGugan, of Belfast (PRACTICAL WIRELESS, January, 1943), is a development of the folk-music of the State of New Orleans, and presumably is, or was originally, a definite musical form, as Mr. Saunders says. I can sympathise with him in wishing to enlighten the ordinary listener, therefore, and it seems he also dislikes the "anæmic music, the incessant song plugging of tuneless, uninspired musical combinations, etc.," and which seems, in my humble opinion, a very good description of the type of thing I meant to refer to, and not necessarily dance-music.

An interpretation of some of the modern compositions was made by Dr. Malcolm Sargent (and it may have included dance-music), in a recent broadcast of the Brains Trust, when he said that it represented the restless spirit of the age, and that he thought the composers had made a very good job of it.

As is probably known, a certain type of "music" has been banned here for some time, and it is an advantage, especially during our limited hours of broadcasting, to be able to listen without the risk of having to switch off in disgust, or listen elsewhere.

The enjoyment of Beethoven, Mendelssohn and Brahms, for instance, may be an acquired taste, but such music, I imagine, is "the one incorporeal entrance into the higher world of knowledge," as, we are told, Beethoven said.

Maurice Reeve is welcome back, with his interesting "Programme Pointers."—M. K. HUGGARD (Dublin).

Station Frequencies

SIR,—In reply to G. C. Bagley's request for the frequencies of W.T. stations he has logged, I hope the following will be of use in calibrating his set. I have not listed all the calls he mentioned but the list covers most of them.

In some cases the frequency I have given may not be correct, as several of the stations mentioned work on numerous channels.

CGX2, Canada, 13,000 kc/s.
 ICD, Italy, 13,250 kc/s.
 CUL, Lisbon, 12,535 kc/s.
 EAK, Aranjuary, 13,790 kc/s.
 EAW, Spain, 13,980 kc/s.
 CZG7, Prince Rupert, B.C., 14,700 kc/s.
 TTFJ, Reykjavik, Iceland, 12,235 kc/s.
 THA, Algiers, 12,120 kc/s.
 SDA3, Varberg, 13,845 kc/s.
 SDE3, Varberg, 13,815 kc/s.
 FYJ, 15,455 kc/s.
 CNR2, Rabat, Fr. Morocco, 11,940 kc/s.
 FZK3, Dakar, Senegal, 15,800 kc/s.
 ICA, Rome, Italy, 11,550 kc/s.
 HBW, Geneva, 11,465 kc/s.
 HBU3, Geneva, 11,220 kc/s.
 ODK, Beirut, Syria, 10,575 kc/s.
 HBO, Geneva, 10,400 kc/s.
 YVR, Maracay, Venezuela, 9,147 and 18,294 kc/s.
 HBJ, Geneva, 13,205 kc/s.
 ICD, Italy, 13,250 kc/s.
 HVJ, Vatican City, 15,120 kc/s.
 ODD, Beirut, Syria, 16,075 kc/s.
 CUS, Lisbon, 15,890 kc/s.

I'm afraid I cannot help as regards the American telephone station as I don't know the frequency myself,

although one of these stations operates on about 29 metres.
 —R. REYNOLDS (Anfield).

A.C./D.C. Amplifier

SIR,—I should like to point out that the rectifier used in the "A.C./D.C. Amplifier," described in the January, 1946, issue, should be a URIC, not a CYI, as the CYI is only made with a "side contact" and an international octal base, not a 5-pin base as shown in the wiring diagram; the only suitable one in the Mullard range is the URIC.—G. KNIGHTS (Ipswich).

A Super without the Het

SIR,—With reference to the article in your December issue, "A Super without the Het," it can be seen that there is a great disadvantage in the employment of such a method of frequency changing described as compared with the normal arrangement. The method suggested entails the actual rectification of the input signal which is then used to modulate the local I.F. supplied. Due to this process of rectification and modulation it will be seen that if poor selectivity exists before the frequency changer, then by no amount of selective I.F. stages employed after this stage can greater selectivity be obtained. Sideband attenuation will as usual be obtained, but any interference on a neighbouring frequency to the input of the frequency changer will appear in the output.
 —H. G. KING (Reigate).

SIR,—I read with interest the description of "A Super without the Het" in your December issue. Although, however, this circuit may work as a frequency changer, it is unlikely to supersede the present type as used in superhet receivers. It is obvious from the description that all frequencies reaching the frequency changer grid will be converted to the I.F. frequency and consequently, however selective the I.F. circuits may be, they will not remove any interfering signals which were present at the frequency changer. These signals will, in fact, be amplified with the wanted signals. No additional selectivity is therefore introduced to the set and the whole advantage of the superhet is lost. For similar reasons the system of detecting the signals and then feeding them into the frequency changer seems to be of little value. With the usual type of frequency changer there are only two frequencies which can normally be converted to the I.F., and with reasonably selective R.F. circuits preceding the frequency changer the image frequency can be so reduced in strength as to cause no trouble.

As to the use of this device in a double superheterodyne receiver, I should point out that the second frequency changer has all its tuned circuits fixed in any case; those on the input side being tuned to the first I.F., and the oscillator to the first I.F. plus or minus of the second I.F.

I should like to point out a misprint in your "Ultra Midget Battery Loudspeaker Receiver" (December issue). The 3-ohm resistor should obviously be in the common L.T.+ line and not just in the L.T.+ line for the XY valve; in addition it should have been stated that the 2v. valves were to be used, as Hivac make two series with the same numbers; differing only in the filament voltages. I would suggest, however, that the 1.4 v. types are used, with the XL and XD in parallel with each other and in series with the XY, this dispenses with the wasteful dropping resistance and takes less current from the L.T. battery. In any case, the circuit seems somewhat unorthodox to me; using a triode R.F.

amplifier with no form of neutralisation. Surely an R.F. pentode would be more suitable.—H. STERN.

International Radio Language

SIR,—In spite of the interesting arguments put forward by Mr. Dutton in last month's issue, I think most readers will agree with you about immense difficulties to be faced and overcome before there is any International Radio Language, or at least one of a synthetic nature. And is there any real need for such a language if one could be devised and perfected?

Have we not what is an almost universally spoken language in our own native tongue . . . for there are very few parts of the world in which English is not understood and is entirely unspoken.

And as English is the native language of the two greatest commercial nations of the earth, Britain and America, its increasing use is not to be wondered at. Already, many nations are teaching English as a secondary language in their national schools, and many philologists are of the considered opinion that the English language will become the one great international language, used and understood by all the peoples of the whole world for the conduct of their external trading operations and radio communications also.

The world-wide benefits which would accrue from an international language are obvious, and its use would be the greatest safeguard against the outbreak of further wars, but if the authorities referred to prove to be reliable prophets, and English becomes the universal language of the whole world, would not the time and labour of learning any synthetic and artificial language be largely wasted? Would not many who had gone to the trouble of learning the "artificial" language still find it very necessary to learn English as well? Unless it was possible to get every nation to agree on a common "artificial" language and teach it in its schools, such a language could never become international at all.—R. T. HARDMAN (Birkenhead).

Sackville

SIR,—The Canadian shortwave station at Sackville uses 11 frequencies, as shown below with corresponding call letters. CKOB, 6,090 kc/s; CHAC, 6,160 kc/s; CHLS, 6,910 kc/s; CKLO, 9,630 kc/s; CHMD, 9,640 kc/s; CKXA, 11,705 kc/s; CHOL, 11,720 kc/s; CKCX, 15,190 kc/s; CHTA, 15,220 kc/s; CKNC, 17,820 kc/s; CHLA, 21,710 kc/s. These calls and frequencies are official and although the aerial system on some frequencies is not yet completed, I understand it is practically finished.

The European beam, which is reversible to serve Mexico, Central America and New Zealand, has five separate arrays, 6, 9, 11, 15 and 17 mc/s. The African beam, which is reversible to serve Australia and New Zealand, uses three separate arrays, 6 mc/s, 9 or 11 mc/s, 15 or 17 mc/s. The South American beam also uses three separate arrays, and is reversible to Asia and part of Australia, 6 mc/s, 9 or 11 mc/s, 15 or 17 mc/s.

The aeriels are multi-element curtains of the resonant type and consist of four vertical stacks of four pairs of horizontal elements in each stack. Each element has an electrical length of one half wavelength. The vertical spacing between elements is also one half wave length. All four dipoles in a vertical stack are fed in-phase by means of transposed two-wire feeders.

I noticed the other day that one of your readers was inquiring about signals on and above 28 mc/s. The following may be of interest.

13-14.00 G.M.T., 28 mc/s., November 29th, 1945. W1AF, W2MAF, W4BN, WME, W8RTX, EA10, SUMIL, SUIMW, W4EM, W2LAF, W4BFS, WL2M, ON4X, B. Congo.

19 mc/s 15.45 G.M.T., November 29th, 1945. ZSS, Capetown.

American Telegraph and Telephone Co., testing.

All the above were heard through a loudspeaker.—F. J. W. WALTERS (Bristol).

Sheppey Amateur Radio Club

SIR,—It is proposed to hold a meeting of the above club in the very near future, and it is the intention to publish date, time and place of this meeting in the local paper at least seven days before. All keen short-wave enthusiasts on the Isle of Sheppey, and likewise to all licensed amateurs, A.A. and fully licensed stations are invited.

The general idea is to re-form the above club on a very sound basis and, upon the return of our licences by the G.P.O. authorities and impounded apparatus, commence activities in amateur radio. Prior to the outbreak of war the club had just been formed and was getting into its stride in a real worthy fashion. Membership grew and grew and interest was keen. With the war many of us were called up under the C.W.R., R.A.F.V.R., etc.; schemes and club meetings were "suspended for the duration."

But now so many of us are coming back to civilian life a few of us feel we would like to start the club going again.

Before the war we had a fair number of licensed stations (e.g., G3GW, G8BO, G8BJ, G8GR, G2VA, G4OU), as well as a number of A.A. stations, etc.

It is felt with confidence that the interest and practice of the hobby on this island is sufficient to warrant the formation of a fine radio society. I shall be pleased to hear from anyone interested in this subject and pass a cordial invitation to all S.W. enthusiasts (transmitting and/or receiving) to attend our first meeting to re-form the old Sheppey Amateur Radio Club.—F. G. MAYNARD (G4OU), 160, Invicta Road, Sheerness, Isle of Sheppey.

"A Cathode-ray Oscilloscope"—Correction

SIR,—There was an error in the circuit diagram of the article "A Cathode-ray Oscilloscope," printed in the November number.

The cathode of the GT1B as well as being strapped to the anode of the W42 should be joined to the C.T. of the heater winding B. Unless this connection is made the time base will not operate.

The Osram 4081 tube recommended for use with the circuit is being replaced by the Osram 4102 tube. Either tube will work in the circuit as both are electrically the same.—E. P. HARRIS (Harrow).

Condenser or Line Cord?

SIR,—In reply to David Homa's letter in your December issue, he is incorrect in stating that the power consumption in the type of circuit mentioned may be found by multiplying the mains voltage by the current taken. In the circuit to which he refers, resistance and capacity in series, the current taken will lead the applied voltage by a certain phase angle depending upon the relative amounts of resistance and capacity and upon the frequency.

The calculations briefly are as follows:—
Reactance of condenser in ohms, C in μf , f the frequency.

$$Z = \frac{10^6}{2\pi f C} \Omega$$

$$\text{Tangent of Phase Angle} = \frac{\text{Reactance}}{\text{Resistance}}$$

From a book of tables the phase angle may be found. Next, the power factor for the circuit is found by looking up in the tables the cosine of the phase angle.

The true power taken from the mains is found thus: Mains voltage \times mains current \times cosine of phase angle. The power factor in such a circuit must be less than unity. The power factor (cosine of phase angle) may be directly calculated thus:

$$\text{Power factor} = \frac{\text{True Power}}{\text{Apparent power}}$$

which is the method I commend to Mr. Homa.

A full treatment of the subject can be found in any textbook on A.C. theory.—JAMES DOYLE (Liverpool).

CLASSIFIED ADVERTISEMENTS
LITERATURE, MAPS, etc.

BRITISH SHORT-WAVE LEAGUE. S.A.E. for membership details and sample monthly "Review." The S.W. Listener's Handbook, 2/9 post free. Write NOW to H.Q., 53, Madeley Rd., Ealing, London, W.5.

"SHORT WAVE NEWS" is now on sale. Constructional technique, topical and DX news. Published monthly at 1/3. Yearly subscription, 16/-. Obtainable through W. H. Smith and Son, Ltd., locally, or from Head Office, Strand House, Portugal Street, London, W.C.2.

RADIO SOCIETY OF GREAT BRITAIN invites all keen experimenters to apply for membership. Current issue "R.S.G.B. Bulletin" and details, 1/- below.

AMATEUR RADIO HANDBOOK (300 pages), paper cover, 4/-; cloth, 6/6. Radio Handbook Supplement (140 pages), paper cover, 2/9. Cloth, 5/-—R.S.G.B., 28-30, Little Russell Street, London, W.C.1.

WEBB'S Radio Map of the World. Locates any station heard. Size 40in. by 30in., 4/6, post 6d. On linen, 10/6, post 6d.—Webb's Radio, 14, Soho Street, London, W.1. GERARD 2089.

MORSE & S.W. EQUIPMENT

MORSE Practice equipment for class-room or individual tuition. Keys, audio oscillators for both battery and main operation.—Webb's Radio, 14, Soho Street, London, W.1. Phone: GERARD 2089.

"H.A.C." Short-wave Receivers. Famous for over ten years. Improved one-valve model now available. Complete kit of components, accessories, with full instructions, now 19/3, postage 9d. Easily assembled in one hour. S.A.E. for free catalogue.—A. L. Bacchus, 109, Hartington Road, London, S.W.6.

RECEIVERS & COMPONENTS

POLAR 3-gang condensers .0005 ceramic, 10/- ea.; .0005 reaction, 1/6; Moving-coil milliammeters, 100mA., 2in., 30/-; Mains transformers, 230v./250v./2mA., 2v./2A., 4v./1.4A., suitable CRO, 30/-; Nicore H.F. Chokes, 1/6; 50 asstd. carbon resistors, 10/6; 12 asstd. condensers, tub. mica elec., etc., 7/6; 50uF/50v. elect. 2/6; volume controls, 1 and 2 meg., 2/-; Trolley switches 2 bank 3-way, S.A.E. full list.—Heathcote, 24, Durnford Avenue, Urmoston, Manchester.

"VALVES."—IN5GT, IC5GT, VP2, 6P2 PM22A, U50, U14, U31, 1V4/350, 80, at 11/-; 6K7G, 6U7G, 6J7G, 7V, 6V8G, 25A6G, 18, VP4, 6P4, Pen A4 at 10/10. Write for full list of valves and supplies, Varley chokes and transformers. Wearite "P" coils and I.F. Trans., Raymart short-wave components. Avo testing instruments.—Radio Supplies, 56, Hughes Ave., Horwich, Lancs.

REWINDS and Radio Spares. Armatures, Field Transformers, Pick-ups, Fractional H.P. Motors, Speakers, New Cones and Speech Coils fitted. All work guaranteed and promptly executed. C.O.D. Postal Service. Send S.A.E. for list Valves and Radio Bargains.—A.D.S. Co., 261-5, Lichfield Road, Aston, Birmingham, 6.

REWINDS. Repairs to moving-coil-speakers. Cones Coils fitted. Fields wound or altered. Mains Transformers, Eliminators and Clock Coils rewound. Competitive prices. Speaker-Transformers and Pick-ups rewound, 4/6 each Post Free. Guaranteed satisfaction. Prompt Service.—S. Kemp, Servico, S.A.E. full list, Royal Upper Tooting, London, S.W.17.

MALLOY 6-volt, 4-pin, U.X. Vibrators. New and Guaranteed, 10/- each.—H. English, The Maltings, Rayleigh Road, Hutton, Essex.

35 mm. Sound Films from well-known features, musicals, etc. Suitable for experimenters, test film, etc. 2/6. 9/5; 30ft., 15/6.—H. Jones, 51, Cranford Drive, Hayes, Middx.

TRADE SERVICE. Fully qualified engineer with own car and equipment will collect, service, and deliver, any part of West London.—Harvey, 200, Fernhead Road, W.9.

3-WAVE Coil pack with iron core, 112 wound, impregnated, I.P. Transformers, complete with circuit and all instructions for building into set complete—a sure seller. Enquiries to: The Weymouth Radio Manufacturing Co., Ltd., Crescent Street, Weymouth, Dorset.

BARGAINS for Amateurs. Send S.A.E. for list.—W. Robertson, "Ardmor," Stranraer.

R.A.F. RADIO!

Exceedingly low prices for the very finest radio gear.

R.A.F. VALVES. Every one guaranteed. EK2, EP36, EP39, VL63, X66, ECM36, MHL26, L63, SP41, EBC33, EB34, EL32, EL192, KT44T, all at 5/6 each. 8D2, Magic Eye, D1, EA50, EP50, KTW62, ACPEN, all at 7/6 each. Ask our prices for 3, 6, and 12 doz. lots.

R.1155 CHASSIS. Packed with valuable components worth nearly £15. Includes 3 gang condenser, calibrated dial, variable switches, resistances, coils, chokes, condensers, fixed resistors, trimmers, etc. The finest bargain we have ever offered. Have already sold over 400 to very satisfied readers. 5s.

R.1125B RECEIVER CHASSIS. 2 7-pin, ceramic valveholders, 8 condensers, 8 resistors, 2 transformers, coils, plugs, sockets, etc. All on totally enclosed metal chassis. All to Air Ministry specifications. 17/6.

R.A.F. 3-GANG CONDENSERS. Same as used in R1155 chassis. .0005 mfd. 12/6.

R.A.F. MIDGET VOLUME CONTROLS. 100,000 ohms. 1/8 each or 16/- doz.

R.A.F. TWIN VOLUME CONTROLS. 500,000 ohms each section. 5/6 each.

R.A.F. 2 mfd. CONDENSERS. Mansbridge type, 500 v. wkg. 1/3 each.

R.A.F. TUBULAR CONDENSERS. 1, 15 and 25 mfd., 350 v. wkg. 7/8 doz.

R.A.F. TUBULAR CONDENSERS. Metal-cased. 1+1+1 mfd., 500 v. wkg. 2/3 each.

R.A.F. TUBULAR CONDENSERS. .5 and 25 v. 350 v. wkg., with short wire ends. In 25 lots only. 5/6.

R.A.F. 02 MFD. CONDENSERS. 1,000 v. wkg. 7/8.

R.A.F. SELECTOR SWITCHES. Useful for remote control. 21/8.

R.A.F. 10-POINT DEWAR SWITCHES. 2/8.

R.A.F. PARCEL 1. Six each 1, 15, 25 mfd. Tubular Condensers, three 1+1+1 mfd. Tubular, metal-cased, three Midget Volume Controls, 100,000 ohms, two Toggle Switches, 20/-.

R.A.F. PARCEL 2. Twelve each 1, 15, 25 mfd. Tubular Condensers, six Midget Volume Controls, 100,000 ohms, three Volume Controls, one gross BA Nuts and Bolts, one gross 4 BA screws, one gross Rivets. 30/-.

MULTI-RANGE MOVING COIL TEST METERS. New. First grade Army type in bakelite case. Ranges: 10, 50, 100 and 500 volts at 1,000 ohms per volt A.C. and D.C. 1, 10, 100 and 500 mA and 0-10,000 ohms. 38 15s.

NEW UTILITY RECEIVER CABINETS. 2 sizes. 12½ x 11½ x 9 and 17½ x 11½ x 7½in., each 30/-.

NEW 6 and 8in. LOUDSPEAKERS in beautiful polished Plastic and Wood Cabinets: 6in., 30/-; 8in., 35/-.

NEW 02 mfd. CONDENSERS, 250 v., 8d. each, 6/6 doz.

SINGLE SCREENED CABLE, 12 yds. 7/6.

MAINS DROPPERS, 1,000 ohms, 2 amp., 5/6.

7-PIN PAXOLIN VALVEHOLDERS, 7/6 doz.

MAZDA OCTAL AMPHENOL VALVEHOLDERS, 6/- doz.

INTERNATIONAL AMPHENOL VALVEHOLDERS, 9/- doz.

CARBON RESISTORS, Assorted values, 22/6 per 100.

ALL P.W. READERS SHOULD CALL AT

LONDON CENTRAL RADIO STORES

23, LISLE STREET, W.C.2
GER. 2969. Closed Thurs. 1 p.m.
Open all Sat.

SALE.—Few Technical Books. Useful student City and Guilds. Tele Communications.—Clarke, 129, Sutton Road, Kirkby-in-Ashfield, Notts.

RADIO ENGINEER SELLING OUT.—Valves 3/6. Volumes (Switched) 1/6. M.C. Speakers 7/6. New Stuff. Send 3d. for lists.—19, Booths Farm Road, Birmingham, 23.

FOLLOWING NEW GOODS FOR SALE.—Grampan amplifier, Batt. and Mains. Complete £33. Also other amplifiers, speakers, misc., etc. Send stamp for details and lists to: Potter, 9, White Hart St., Theford, Norfolk.

EXCHANGE K.B. All-waver for Trophy Factory 3.—Spearman, Stansfield, Sudbury, Suffolk.

MAINS TRANSFORMERS, first grade and brand new; 350/0/350v. 80 ma. 6.3v. 3A. CT 5v. 2 amp. or 4v. 4a. CT 4v. 2.5a. 20/- each, post 1/-—Aneloy Radio, Hindmans Road, E. Dulwich, S.E.22.

WANTED urgently. October, 1945, issue of "Practical Wireless."—Looe, Hotel, Looe.

WANTED.—12A 7 or 25A 7 valve. Good work on 6d.—KING, 153, Sudellside St., Darwen, Lancs.

WANTED service details Halford 9 valve A.C. Radio-gram.—Radio House, 51, Warwick Way, S.W.1.

FOR SALE 24 unsorted copies P.W., November, 1943 to October, 1945. What offers.—Stewart, 43, Southill Road, Broom, Beds.

AVONINORS, 24/40; Universal Avoninors, 28/10/0. Order early, only a few left. Write with order to: O. J. Jones, for other Avo equipment, S.A.E. with enquiries.—R. Massey, 58, Wakefield Av. Hull.

SPARKS DATA SHEETS Full constructional details, circuit, and full-size prints of assembly and wiring plans of Tested and Guaranteed Designs.

LATEST RELEASES.—Three-valve T.R.F. Set (Battery), Medium and Long waves. P.P. results, 2/6. Four valve T.R.F. Set (Battery), Medium and Long waves, P.P. Output, Quality and Power, 2/6.

PORTABLES AND MIDGETS.—One-valve Midget Portable All-dry batteries, 9 v. H.T. Medium and Long wave aerial, 9 v. H.T., good 'phone sigs., 2/6; Three-valve All-dry battery Midget Portable, Medium waves, L.S. sigs., 2/6; Midget Two-valve All-dry battery Set, powerful 'phone sigs., 9 v. H.T., size 5x5x3 1/2ins., 2/6.

SETS.—With full coil details. Crystal Set, 1/6; Three-valve "Straight" Set (Battery) 2/-; A.C. Two-valve, 2/6 (all Medium wave only). S.W. Super Two-valve (Battery) Eddystone or Premier coils, 2/6. Radio Unit "H.F. Stage plus "Infinite Impedance Det." for use with A.C. or A.C./D.C. quality amplifiers, 2/6.

AMPLIFIERS.—Two-valve Battery 2/6; Three-valve P.P. (Battery) 2/6; 31-watt A.C. 2/6; 6-8 watt A.C./D.C. Portable Amplifier, 2/6; 6-watt feed-back, P.P. 3/6; 3-watt A.C. Model, Neg. feed-back, Phase-inverter, P.P. output, 2/6.

RADIOGRAM.—8-watt A.C. Radiogram, Medium waves, quality reproduction, 3/6.

ELECTRONIC.—Electric Guitar Units, 5/-; Electronic One-string Fiddle, 3/6; Trans-current Mike, 2/6; A.C. Charger, 2 or 6 volts, 2/6; Shocking Coil, 2/6.

Other designs in hand. Send stamp with order or for full list.—L. ORMOND SPARKS(S), The Constructor's Consultant, 9, Phoebeth Road, Brockley, S.E.4. Phone: Lee Green 0220.

FRED'S RADIO CABIN MED. WAVE, T.R.F. Coils, 2/6 pair.

MED. WAVE Lits wound T.R.F. coils, 4/6 pair.

PAX COIL FORMERS, 1in. x 4in., 3d. each.

1IN. COIL HOLDERS, 6d. each.

DUAL RANGE COILS in large square can. No reaction, 2/- each.

BRASS Coupling Links, 9d. each.

BRACKET and Clip Pilot Lampholders, 8d. each.

1IN. ADAPTORS, 8d. each.

2IN. BAMP KNOBS, 1in. bore, 10d. each. Small black pointer knobs, 9d. each; large black pointer knobs, 1/- each; Midget black knobs, 6d. each, 5/6 doz.

PAXOLIN Resistor Panels—3in. x 2 1/2in., 3d.; 5 1/2in. x 2 1/2in., 5d.; 9in. x 2 1/2in., 6d.

PAX STRIPS, Blank, 4in. x 1 1/2in., 3d. LATEST CRYSTAL DETECTOR on ebonite base, 2/6 each. CRYSTAL and Catwhisker, 6d. TAPPED TONE CONTROLS, 2/- each. CENTRAL-BA V.C.'s, 2 meg. only, with switch, 3/6 each.

(Continued overleaf)

VOLUME CONTROLS. Less switch, 3/- each., most values; volume controls with switch, 4/6 each, most values.
ODD SECONDHAND, V/C's. with and without switch, 7/6 doz.
STANDARD SPEAKER FIELDS. 1,500 ohms and 3,000 ohms, 7/6 each.
MAINS DROPPERS. 2 and 3 amp., 5/6 each.
OCTAL BASE V/bs. 7 pin English, 5, 6 and 7 pin U.K., 8d. each, 7/6 doz.
7 and 8 WAVE P.C. units. 2/- each, no knobs.
RESIN-CURED SOLDER. 3/5 lb. reel; multi-core solder, 5/- lb. reel; 465 K/c. I.F. TRANS., 12/6 pair.
3 WAVEBAND COILS, with Circuit, 11/- pair.
MIDGET I.F. CHOKES, 2/- each.
SQUARE I.F. COIL CANS, 3 1/2 in. x 1 1/2 in., 6d. each.
COVERED CONNECTING WIRE. 6d. per coil; 18 and 20 gauge tinned copper wire, 2/- lb. reel.
HEAVY DUTY Twin Screened Cable, 9d. yard.
MIDGET FIELD COILS. 5,000 ohms, 1/- each.
SYSTOFLEX SLEEVING. 2 mm., 3/- doz. yards.
WELDON SOLDERING IRON. Straight bit, 13/6; pencil bit, 14/6.
METAL CHASSIS, drilled for 3 valves, 7 in. x 7 in. x 2 1/2 in., 2 valves, 7 in. x 5 1/2 in. x 2 1/2 in., 3/- each.
L.F. SMOOTHING CHOKES. 240 ohms, 10 H.v., 90 ma., 5/6 each.
MULTI-RATIO O.P. TRANS., 6/- each.
2 GANG .0005 mfd. Condenser with Trimmers, 2 1/2 in. x 2 1/2 in. x 1 1/2 in., 12/6 each.
RESISTORS, new, 1 watt, 47, 52, 150, 220, 330, 1,000, 2,800, 7,500, 22,000, 33,000, 38,000, 82,000, 100,000, 470,000, 250,000 ohms., 2 meg., 6d. each, 5/6 doz.
MIDGET speaker transformers, power and pentode, 5/6 each.
RESISTANCE Colour Code Charts, 1/- each.
CROCODILE Clips, 2/9 doz.
VIBRATORS, 6 volt car type, 4 pin, 9/6 each.
 Postage must be included. No C.O.D.
FRED'S RADIO CABIN FOR BARGAINS, 75, N. Kingston Butts, S.E.11. Rodney 2180.

ALL makes and kinds of Electrical and Radio Instruments repaired by skilled technicians A.I.D. approved. Over 60,000 instruments repaired for R.A.F. All work quoted by return without charge.—C. Gertler, Dept. B, 71-73, Water-side, Chesham, Bucks.

CHARLES BRITAIN RADIO. This month's offers! **SPEAKERS.** Philco mains energised, fitted with new cones, with trans., 3,000; 5,000 fields, 21/-, Goodmans P.M., 8 in., with multi-ratio trans., £1.10.0. Celestion P.M., 8 in., with pentode 6/- ea., 25/-, R.A., P.M., less trans., £1. Mains transformers type El. 350-0-350, 6v. or 4v. types, usual prima., new, £1. Type D1, 350-0-350, 120 ma., can be used for 2v., 4v., 6v. heaters, shrouded, £1.10.0; mains taps for above, 1/-, **CABINETS** as used for the utility radars, either model, £1.10.0. Dials, all wave, Ivorine, complete with escutcheon drum drive and pointer, 5/6. Marconi vertical type, 2/-, small dials for midgets, 8/- doz. Tube cond., two-gang Midget, 12/- ea. Three-gang, 10/- ea. Small steel chassis, 3/9 ea. Coils, 2 band with reaction, 7/- pr. All-wave coils superhet, with diagram 14/- pr. I.F. trans., 465 K/c, 12/6 pr. P.C. units, M.W. only, A. & H.F., 2/- ea. **ELECTROLYTIC Condensers** 16 mfd. T.C.C. wet cans 440v. wkg., 7/6 ea. 8 mfd. dry cans 500v. wkg., 6/-, Hints Blocks, 8 mfd. 450v. wkg., 3/6, ditto tubulars, 3/- ea. 4 mfd. 200v. wkg. Micropac, 2/6 ea. 25 mfd. 25v., 2/6. 50 mfd. 12v., 2/6. Valves, slightly used, ex R.A.F., 4/- ea. X65, KTWG1, Y63, 6J5, EF50, EF39, EF36, EBC33, EL32, 1D8. Valveholders, Amphenol Int. Octal and Brit. Octal, 7/6 doz. Paxolin, all types, 6/- doz. **RESISTANCES,** New Erie and Dubilier, 4/8 doz. (our selection), 5/6 doz. to your requirements; 1 watt, 6/6 doz. Tubular cond., new, 4/6 doz., incl. 0.1, 0.05, etc., ass'd. Chokes, 100 ma., 350 ohm, 8/- ea. Multi-ratio speaker transformers, 3 ohm sec., 7/- ea. Large type 30 watt 10 r.f. coils, £1.10.0. Push-back wire, various colours, 2/- doz. yds. Rubber-covered wire, 2/- doz. yds. Slewing, 2/- doz. yds. **SPECIAL Offers.** 2 mid. Mansbridge condensers, 100v. wkg. with fixing feet, new, 6/6 doz. Small moving coil mikes, damaged, 1/6 ea.; undamaged, 5/- ea. Send for List "P." Terms: Cash or C.O.D. over £1. Note our New Address.—Charles Britain Radio, 2, Wilson Street, London, E.C.2. Phone: BIS. 5985, Ext. 7.

VALUE/MATT has it

LINE CORD, 2-way 2/6 per yd.; 3-way, 3/- per yd. (Approx. 60 ohms per foot).
SPEAKERS, "Celestion," P.M., 2 1/2 in., less trans. 27/-; 8 in. P.M., with trans. 27/6; 6 in. P.M. (multi-ratio trans.) 28/6.
Two-gang Condensers, .0005, 12/6. Midget Coils, H.F. and Aerial, 4/6 per pair.
Valve Holders (all types).
Volume Controls, less switch, 2/9, with switch, 3/9.
Mains Transformers, 1 v. and 6 v., 27/6.
Rothermal (Crystal) Pick-Ups, metal, 58, £3/13/6. Senior de Luxe, £3/13/9.
Condensers.—All types in stock, 2's, 8's, 16's, 500 v. working; .1, .01, .25, .05, 25 x 25, etc.
Resistances, 1 and 1 watt. All values. 1 watt, 9/- doz.; 1/2 watt, 6/8 doz.
ACCUMULATORS.—Glass, 2 v., 45 amp., 14/6.
 All types American and B.J.A. valves in stock.

Let us quote you for ALL your requirements. Cash with order, plus postage.
MATT RADIO SERVICE
 (Kingston 4881)
 152, Richmond Road, Kingston-on-Thames, Surrey.

A FREE BOOK

for all interested in

MORSE CODE TRAINING.



There are Candler Morse Code Courses for Beginners and Operators. Send for this Free "BOOK OF FACTS" It gives full details concerning all Courses.

THE CANDLER SYSTEM CO. (S.L.O.)
 121, Kingsway, London, W.C.2.
 Candler System Co., Denver, Colorado, U.S.A.

POST-WAR TELEVISION

The advance in Radio Technique will offer unlimited opportunities of high pay and secure posts for those Radio Engineers who have had the foresight to become technically qualified. How you can do this quickly and easily in your spare time is fully explained in our unique handbook. Full details are given of A.M.I.E.E., A.M.Brit.I.R.E. City & Guilds Exams, and particulars of up-to-date courses in Wireless Engineering, Radio Servicing, Short Waves, Television, Mathematics, etc., etc. We guarantee "NO PASS—NO FEE." Prepare for to-morrow's opportunities and post-war competition by sending for this very informative 112-page guide NOW—FREE and without obligation. **BRITISH INSTITUTE OF ENGINEERING TECHNOLOGY** (Dept. 242), 17, Stratford Place, London, W.1.

NEW DUAL TESTSCOPE

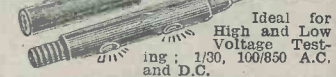

Ideal for High and Low Voltage Testing: 1/30, 100/850 A.C. and D.C. Send for interesting leaflet (A2A) on Electrical and Radio Testing, from all Dealers or direct.

RUNBAKEN-MANCHESTER

THE Arrow Home Constructors Kit. 4-valve T.R.F., complete kit of parts with full instructions, 26/- Set of slightly used valves for same, 26/- extra. Charles Britain Radio, 2, Wilson Street, London, E.C.2.

AMATEUR RADIO PRODUCTS have now available 4 Waveband Coil Unit already wired and switched for 2-valve S.W. Receiver.

9.83 metres—24 metres.
 38.4 metres—35 metres.
 48.7 metres—47 metres.
 92.3 metres—206 metres.
 Only four wires to be soldered. Complete Unit with 2-valve (Battery) S.W. Receiver blueprint, 30/- each. All coils for above Unit have reaction winding. Individual coils, 3/3 each.—50, Glasslyn Road, Crouch End, London, N.8. Phone: Mountview 4745.

SITUATIONS VACANT

WANTED, lad interested in radio, to learn trade. Call at Charles Britain Radio, 2, Wilson Street, London, E.C.2.

ENGINEERING OPPORTUNITIES.—FREE 112-page guide to trainings for A.M.I.Mech.E., A.M.I.E.E., and all branches of Engineering and Building. Full of advice for expert or novice. Write for free copy and make your peacetime future secure.—B.I.E.T. (Dept. 242B), 17, Stratford Place, London, W.1.

OVERSEAS EMPLOYMENT

BROADCAST OFFICER required for the Gold Coast Government Broadcasting Department for one four of 12 to 24 months with possible permanency. Salary £450 rising to £720 a year plus local allowance of £48 and separation allowance for married men between £94 and £204 according to number of children. Outfit allowance £60. Free passage and quarters. Candidates should be of good education and have had a thorough training in the theory and operation of wireless broadcast transmitters and in studio technique; should be thoroughly conversant with the system of distributing radio programmes by wire and have a knowledge of modern superheterodyne short-wave receivers. A knowledge of gramophone disc recording is desirable. Applications, which must be in writing, stating date of birth, full details of qualifications and experience, including present employment; also identity and National Service and other registration particulars, and quoting reference No. OS.875, should be addressed to the Ministry of Labour and National Service, London Appointments Office, 1-6, Tavistock Square, London, W.O.1.

TUITION

LEARN MORSE CODE the Candler Way. See advertisement on this page.

WIRELESS.—Students of both sexes prepared for appointments in all branches of Peacetime Radar developments will offer tremendous opportunities. Low inclusive fees. Boards accepted. 2d. stamp for Prospectus.—Wireless College, Colwyn Bay. **THE** Tuitionary Board of the Institute of Practical Radio Engineers have available Home Study Courses covering elementary, theoretical, mathematical, practical and laboratory tuition in radio and television engineering; the text is suitable coaching matter for I.P.R.E. Service entry and progressive exams.; tuition fees at pre-war rates; are moderate. The Syllabus of Instructional Text may be obtained, post free, from the Secretary, 20, Fairfield Road, Crouch End, N.8.

RELAYS

for **A.C. and D.C.**



The wide range of LONDEX Relays covers especially the Wireless and Electronic fields. Ask for details and leaflet 205/PW.

LONDEX LTD.
 Anerley Works, 207, Anerley Road, London S.E.20. Phone: SYD 0258/9

Practical Wireless BLUEPRINT SERVICE

Practical Wireless	No. of Blueprint	F. J. Camm's A.C. Superhet-4		PW59*
Blueprints, 6d. each.		F. J. Camm's Universal 44 Superhet 4		PW60
1927 Crystal Receiver	PW71*	"Qualitone" Universal Four		PW73*
The "Junior" Crystal Set	PW94*			
CRYSTAL SETS				
STRAIGHT SETS. Battery Operated.		SHORT-WAVE SETS. Battery Operated		
One-Valve: Blueprints, 1s. each.		One-Valve: Blueprint, 1s.		PW88*
All-Wave Unipen (Pentode)	PW31A*	Simple S.W. One-valver		PW85*
Beginners' One-valver	PW85*	Two-valve: Blueprints, 1s. each.		PW38A*
The "Pyramid" One-valver (HF Pen)	PW93*	Midget Short-wave Two (D, Pen)		PW91*
Two-valve: Blueprint, 1s.		The "Met" Short-wave Two (D HF Pen, Pen)		PW30A*
The Signet Two (D & I F)	PW76*	Three-valve: Blueprints, 1s. each.		PW63*
Three-valve: Blueprints, 1s. each.		Experimenter's Short-wave Three (SG, D, Pow)		PW68*
Selectone Battery Three (D, 2LF Trans.)	PW10	The Prefect 3 (D, 2 LF RC and Trans.)		PW65*
Summit Three (HF Pen, D, Pen)	PW37*	The Band-spread 8-W. Three (HF Pen, D (Pen), Pen)		
All Pentode Three (HF Pen, D (Pen), Pen)	PW30*	PORTABLES		
Hall-Mark Cadet (D, LF, Pen (RC))	PW48*	Three-valve: Blueprints, 1s. each.		
F. J. Camm's Silver Souvenir (HF Pen, D (Pen), Pen) (All-Wave Three)	PW49*	F. J. Camm's 8LF Three-valve (SG, D, HF Pen, D, Pen)		
Cameo Midget Three (D, 2 LF Trans.)	PW61*	Parvo Lightweight Midget Portable (SG, D, Pen)		
1936 Sonotone Three-Four (HF Pen, HF Pen, Westcote, Pen)	PW53*	Parvo Lightweight Midget Portable (SG, D, Pen)		
Battery All-Wave Three (D, 2 LF RC)	PW55*	Four-valve: Blueprint, 1s.		
The Monitor (HF Pen, D, Pen)	PW61*	"Imp" Portable 4 (D, LF, LF (Pen))		
The Tutor Three (HF Pen, D, Pen)	PW62	MISCELLANEOUS		
The Centaur Three (SG, D, F)	PW64*	Blueprint, 1s.		PW48A*
The "Celt" All-Wave Three (D, 2 LF RC & Trans.)	PW72*	S.W. Converter-Adapter (1 valve)		
The "Rapide" Straight 3 (D, 2 LF RC & Trans.)	PW82*	AMATEUR WIRELESS AND WIRELESS MAGAZINE		
F. J. Camm's Oracle All-Wave Three (HF, Det. Pen)	PW78*	CRYSTAL SETS		
1938 "Triband" All-Wave Three (HF, Pen, D, Pen)	PW84*	Blueprints, 6d. each.		
F. J. Camm's "Sprite" Three (HF Pen, D, Tet)	PW87*	Four-station Crystal Set		AW427*
Three "Hurricane" All-Wave Three (SGD, Pen, Pen)	PW89*	Loecene Radio-Collor A.W.427, 6d.		AW444
F. J. Camm's "Push-Button" Three (HF Pen, D (Pen), Tet)	PW92*	1934 Crystal Set		AW450*
Four-valve: Blueprints, 1s. each.		150-nickel Crystal Set		
Beta Universal Four (SG, D, LF, Cl. B)	PW17*	STRAIGHT SETS. Battery Operated.		
Nucleon Class B Four (SG, D, SG), LF, Cl. B)	PW34B*	One-valve: Blueprint, 1s.		AW387*
Fury Four Super (SG, SG, D, Pen)	PW34C*	B.B.C. Special One-valver		AW388*
Battery Hall-Mark 4 (HF, Pen, D, Push-Pull)	PW46*	Two-valve: Blueprints, 1s. each.		AW392*
"Aeolus" All-Wave 4 (HF Pen, D (Pen), LF, Cl. B)	PW83*	Melody Master Two (D, Trans.)		WM409*
The "Admiral" Four (HF Pen, HF Pen, D, Pen (RC))	PW90*	Full-volume Two (SG det. Pen).		
F. J. Camm's "Limit" All-Wave Four (HF Pen, D, LF, F)	PW67*	A modern Two-valver		
Mains Operated				
Two-valve: Blueprints, 1s. each.		Three-valve: Blueprints, 1s. each.		AW412*
A.C. Twin (D (Pen), Pen)	PW16*	Lucerne Ranger (SG, D, Trans.)		AW436*
Selectone A.C. Radiogram Two (D, Pow)	PW19*	25 5s. Three De Luxe Version (SG, D, Trans.)		WM327*
Three-valve: Blueprints, 1s. each.		Transportable Three (SG, D, Pen)		WM337
Double-Diode-Triode Three (HF Pen, DDT, Pen)	PW23*	Simple-Tune Three (SG, D, Pen)		WM351*
D.C. Ace (SG, D, Pen)	PW26*	Economy Pentode Three (SG, D, Pen)		WM354
A.C. Three (SG, D, Pen)	PW29*	"W.M." (1934 Standard Three (SG, D, Pen)		WM371
A.C. Leader (HF Pen, D, Pow)	PW50*	43 3s. Three (SG, D, Trans.)		WM389*
D.C. Premier (HF Pen, D, Pen)	PW36B*	1935 46 6s. Battery Three (SG, D, Pen)		WM393
Unique (HF Pen, D, Pen, Pen)	PW36A*	PTF Three (Pen, D, Pen)		WM396*
F. J. Camm's A.C. All-Wave Silver Souvenir Three (HF Pen, D, Pen) "All-Wave" A.C. Three (D, 2 LF (RC))	PW50*	Certainty Three (SG, D, Pen)		
A.C. 1938 Sonotone (HF Pen, HF Pen, Westcote, Pen)	PW54*	Miniature Three (SG, D, Trans.)		
Mains Record All-Wave 3 (HF Pen, D, Pen)	PW66*	All-wave Winning Three (SG, D, Pen)		
Four-valve: Blueprints, 1s. each.		Four-valve: Blueprints, 1s. 6d. each.		
A.C. Fury Four (SG, SG, D, Pen)	PW20*	65s. Four (SG, D, RC, Trans.)		AW370
A.C. Fury Four Super (SG, SG, D, Pen)	PW34D	Self-contained Four (SG, D, LF, Cl. B)		WM331
A.C. Hall-Mark (HF Pen, D, Push-Pull)	PW45*	Lucerne Straight Four (SG, D, LF, Trans.)		WM350
Universal Hall-Mark (HF Pen, D, Push-Pull)	PW47*	25 5s. Battery Four (HF, D, 2LF)		WM381*
SUPERHETS				
Battery Sets: Blueprints, 1s. each.		The H.K. Four (SG, SG, D, Pen)		WM384
70 Superhet (three-valve)	PW46*	The Auto Straight Four (HF, Pen, HF, Pen, DDT, Pen)		WM404*
F. J. Camm's 2-valve Superhet	PW52*	Five-valve: Blueprints, 1s. 6d. each.		
Mains Sets: Blueprints, 1s. each.		Super-Hility Five (2 HF, D, RC, Trans.)		WM320
A.C. 45 Superhet (Three-valve)	PW43*	Class B Quadradyne (2 SG, D, LF, Class B)		WM344
A.C. 45 Superhet (Three-valve)	PW42*	New Class B Five (2 SG, D, LF, Class B)		WM340
Mains Operated				
Two-valve: Blueprints, 1s. each.		Cono-electric Two (D, Pen) A.C.		AW402*
A.C. Twin (D (Pen), Pen)	PW16*	Economy A.C. Two (D, Trans) A.C.		WM286
Selectone A.C. Radiogram Two (D, Pow)	PW19*	Three-valve: Blueprints, 1s. each.		
Three-valve: Blueprints, 1s. each.		Home Lover's New All-Electric Three (SG, D, Trans. A.C.)		AW385*
Double-Diode-Triode Three (HF Pen, DDT, Pen)	PW23*	Mantovani A.C. Three (HF, Pen, D, Pen)		WM374*
D.C. Ace (SG, D, Pen)	PW26*	£15 15s. 1936 A.C. Radiogram (HF, D, Pen)		WM461*
A.C. Three (SG, D, Pen)	PW29*	Four-valve: Blueprints, 1s. 6d. each.		WM320
A.C. Leader (HF Pen, D, Pow)	PW50*	All-Metal Four (2 SG, D, Pen)		
D.C. Premier (HF Pen, D, Pen)	PW36B*	Harris' Jubilee Radiogram (HF, Pen, D, LF, P.)		WM386*
Unique (HF Pen, D, Pen, Pen)	PW36A*			
F. J. Camm's A.C. All-Wave Silver Souvenir Three (HF Pen, D, Pen) "All-Wave" A.C. Three (D, 2 LF (RC))	PW50*			
A.C. 1938 Sonotone (HF Pen, HF Pen, Westcote, Pen)	PW54*			
Mains Record All-Wave 3 (HF Pen, D, Pen)	PW66*			
Four-valve: Blueprints, 1s. each.				
A.C. Fury Four (SG, SG, D, Pen)	PW20*			
A.C. Fury Four Super (SG, SG, D, Pen)	PW34D			
A.C. Hall-Mark (HF Pen, D, Push-Pull)	PW45*			
Universal Hall-Mark (HF Pen, D, Push-Pull)	PW47*			

SPECIAL NOTICE

THESE blueprints are drawn full size. The issues containing descriptions of these sets are now out of print, but an asterisk beside the blueprint number denotes that constructional details are available, free with the blueprint.

The index letters which precede the Blueprint Number indicate the periodical in which the description appears: Thus P.W. refers to PRACTICAL WIRELESS, A.W. to Amateur Wireless, W.M. to Wireless Magazine.

Send (preferably) a postal order to cover the cost of the Blueprint (stamps over 6d. unacceptable) to PRACTICAL WIRELESS, Blueprint Dept., George Newnes, Ltd., Tower House, Southampton Street, Strand, W.C.2.

SUPERHETS

Battery Sets: Blueprints, 1s. 6d. each.		WM395*
Vanity Four		WM407*
The Request All-Waver		
Main Sets: Blueprints, 1s. each.		WM359*
Heptode Super Three A.C.		

PORTABLES

Four-valve: Blueprints, 1s. 6d. each.		
Holiday Portable (SG, D, LF, Class B)		AW393*
Family Portable (HF, D, RC, Trans.)		AW417*
Tyers Portable (SG, D, 2 Trans.)		WM367*

SHORT-WAVE SETS. Battery Operated

One-valve: Blueprints, 1s. each.		AW420*
S.W. One-valver for America		AW452*
Rouin Short-Waver		
Two-valve: Blueprints, 1s. each.		
Ultra-short Battery Two (SG, det. Pen)		WM402*
Home-made Coil Two (D, Pen)		AW440
Three-valve: Blueprints, 1s. each.		
Experimenter's 6-metre Set (D, Trans, Super-regen)		AW438
The Carrier Short-waver (SG, D, P)		WM390*
Four-valve: Blueprints, 1s. 6d. each.		
A.W. Short-wave World-beater 3 (HF, Pen, D, RC, Trans)		AW436*
Standard Four-valve Short-waver (SG, D, LF, P.)		WM383*
Superhet: Blueprint, 1s. 6d.		
Blindfold Short-wave Super		WM397*

Mains Operated

Two-valve: Blueprints, 1s. each.		
Two-valve Mains Short-waver (D, Pen), A.C.		AW453*
Three-valve: Blueprints, 1s.		
Emigrator (SG, D, Pen) A.C.		WM352*
Four-valve: Blueprints, 1s. 6d.		
Standard Four-valve A.C. Short-waver (SG, D, RC, Trans.)		WM391*

MISCELLANEOUS

S.W. One-valve Converter (Price 6d.)		AW329
Enthusiast's Power Amplifier (1/6)		WM367*
Listener's 5-watt A.C. Amplifier (1/8)		WM392*
Radio Unit (2v.) for WM392 (1/-)		WM386*
Harris Electogram battery amplifier (1/-)		WM399*
De Luxe Concert A.C. Electrogram (1/-)		WM403*
New Style Short-wave Adapter (1/-)		WM388
Short-wave Adaptor (1/-)		AW450*
E.L.D.L.S. Short-wave Converter (1/-)		WM405*
Wilson Tone Master (1/-)		WM406
The W.M. A.C. Short-wave Converter (1/-)		WM408*

HINTS COUPON

This coupon is available until February 11th, 1946, and must accompany all Practical Hints.

PRACTICAL WIRELESS, February, 1946

All applications respecting Advertising in this Publication should be addressed to the ADVERTISEMENT DIRECTOR, GEORGE NEWNES, LTD., Tower House, Southampton Street, Strand, London, W.C.2. Telephone: Temple Bar 4363. CONDITIONS OF SALE AND SUPPLY: This periodical is sold subject to the following conditions, namely, that it shall not, without the written consent of the publishers first given, be lent, re-sold, hired out or otherwise disposed of by way of Trade except at the full retail price of 9d.; and that it shall not be lent, re-sold, hired out or otherwise disposed of in a mutilated condition or in any unauthorised cover by way of Trade; or affixed to or as part of any publication or advertising, literary or pictorial matter, whatsoever.

The

TAYLOR A-C BRIDGE

MODEL 110A

These instruments give quick and accurate measurements of Capacity and Resistance. There are six Capacity ranges covering from .00001 to 120 mfd. and the Power factor can also be measured on each range. Six Resistance ranges are available measuring from 1 ohm to 12 megohms. This bridge is A.C. mains operated and a leakage test is also available for detecting leaky paper or mica condensers.

Price £14 14s. 0d.

Please write for technical leaflet.

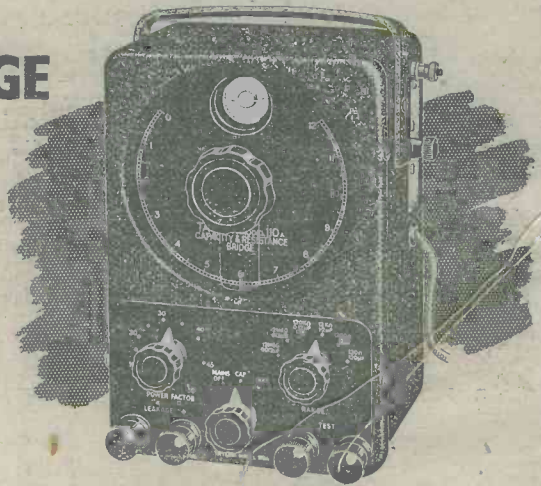

6 RANGES OF CAPACITY
RANGES OF RESISTANCE

Send your enquiries to:—

TAYLOR ELECTRICAL INSTRUMENTS LTD

419-424 MONTROSE AVENUE, SLOUGH, BUCKS.

Tel: Slough 21381 (4 lines) 'Grams: "Taylins"; Slough.

Taylor
electrical instruments Ltd.



AMBITIOUS ENGINEERS

HAVE YOU HAD YOUR COPY OF "ENGINEERING OPPORTUNITIES"?

Whatever your age or experience—whether you are one of the "old school" or a newcomer to Engineering anxious to hold your position under post-war conditions—you must read this highly informative guide to the best paid Engineering posts.

The Handbook contains among other intensely interesting matter, particulars of B.Sc., A.M.I.C.E., A.M.I.Mech.E., A.M.I.E.E., A.M.I.A.E., A.M.I.P.E., A.M.Brit.I.R.E., CITY & GUILDS, CIVIL SERVICE, and other important Engineering Examinations, outlines courses in all branches of CIVIL, MECHANICAL, ELECTRICAL, AUTOMOBILE, RADIO, TELEVISION, AERONAUTICAL and PRODUCTION ENGINEERING, DRAUGHTSMANSHIP, GOVERNMENT EMPLOYMENT, BUILDING and PLASTICS (the great peacetime careers), MATRICULATION, etc., and explains the unique advantages of our Employment Department.

WE DEFINITELY GUARANTEE 'NO PASS—NO FEE'

If you are earning less than £10 a week you cannot afford to miss reading "ENGINEERING OPPORTUNITIES"; it tells you everything you want to know to make your future secure and describes many chances you are now missing. In your own interest we advise you to write for your copy of this enlightening guide to well-paid posts NOW — FREE and without obligation.

BRITISH INSTITUTE OF ENGINEERING TECHNOLOGY

409, SHAKESPEARE HOUSE, 17, 18 & 19, STRATFORD PLACE, LONDON, W.1.

THE B.I.E.T. IS THE LEADING INSTITUTE OF ITS KIND IN THE WORLD

Published on the 7th of each month by GEORGE NEWNES, LIMITED, Tower House, Southampton Street, Strand, London, W.C.2 and printed in England by THE NEWNES & PEARSON PRINTING CO., LTD., Exmoor Street, London, W.10. Sole Agents for Australia and New Zealand: GORDON & GOTCH, LTD. South Africa: CENTRAL NEWS AGENCY, LTD. Subscription rates including postage: Inland 10s. 6d. per annum; Abroad 10s. per annum. Registered at the General Post Office for the Canadian Magazine Post.