

First in small format.

AIRCRAFT DIRECTION FINDING

Practical Wireless

9^D EVERY MONTH

Editor
F. J. CAMM

and PRACTICAL TELEVISION

Vol. 18. No. 426.

NEW SERIES.

DECEMBER, 1941.

**'Still keep
going
when the
rest have
stopped'**



Exide BATTERIES

● THE CHLORIDE ELECTRICAL STORAGE COMPANY LTD.
Grosvenor Gardens House, Grosvenor Gardens, London,
S.W.1

Telephone: VICToria 2299. *Grams: Chloridic, Sowest, London

Lord Hankey's Appeal TO THE WIRELESS TRADE

Multi-range Measuring Instruments wanted
immediately for vital war training work.



46-range Model 7 Universal AvoMeter

"I appeal to you to-day to assist by selling or presenting this type of equipment if you have any surplus or if you know of any of your retailer friends whom you can persuade to part with such apparatus. The instruments I refer to are of the AvoMeter and AvoMinor class."

LORD HANKEY AT THE R.M.A. LUNCHEON, Sept. 17.

Radio is playing a vital part in the war. . . . Thousands more men must be trained as wireless mechanics—the schools and instructors are there—but multi-range measuring instruments are needed at once. Lord Hankey has appealed to wireless engineers and traders to help. If you have a meter of the type required that is not doing a full day's work every day, please give or sell it immediately.

This space appears by courtesy of the Automatic Coil Winder and Electrical Equipment Co., Ltd. (Makers of "Avo" Instruments), to reinforce Lord Hankey's recent appeal, which is urgent and essential to the war effort.

TYPES OF INSTRUMENT REQUIRED: The instruments most urgently needed are multi-range A.C. and D.C. meters such as the Model 7 AvoMeter, the Model 40 AvoMeter, and the Universal AvoMinor. Offers of other makes of multi-range instruments of similar grades and capabilities are also welcomed.

WHAT TO DO: If you can release any of these types of instrument please communicate at once with Mr. R. P. Browne, B.Sc., Secretary, Radio Manufacturers' Association, 59, Russell Square, London, W.C.1, giving the details enumerated below. Only instruments in working order should be offered. Do not send the actual meter until advised.

PLEASE GIVE THESE DETAILS: (1) Type of instrument. (2) Approximate age and condition. (3) Whether it is a gift or for sale. (4) If the latter, the price desired. (5) Name and full address.

PREMIER RADIO

Please Note.—All Short-wave Kits include Purchase Tax

NEW PREMIER S.W. A.C. RECEIVER

In response to many requests we have now produced an A.C. version of the popular Premier Short Wave SQ3 Kit. Circuit: Pentode H.F. Stage Pentode Detector, Pentode Output, and F.W. Rectifier. 200-250 v. A.C. Operation. Built-in Power Pack. Hum-free operation. For use with 'Phones or P.M. Speaker. Complete Kit of Parts with drilled chassis, all components, Plug-in Coils covering 13-170 metres, 4 valves and full instructions and circuits **£6.14.6**

Battery Version also available, Kit £4/15/4.
★ "The Wireless World" said they were "very much impressed. . ."
See full Test Report, pp. 492-3, December issue, Send for details.

DE LUXE S.W. KITS FOR BATTERY OPERATION

Complete Kit of Parts, with Ready Drilled Chassis, 4 Coils Tuning from 13 to 170 metres, Valves and Diagrams.
1 Valve Receiver or Adaptor, 25/6.
1 Valve Battery Converter, 28/-.
2 Valve Receiver, 35/6.

PREMIER BATTERY CHARGERS FOR A.C. MAINS

6 volts at 1 amp., 26/-.
12 volts at 1 amp., 28/-.
6 volts at 2 amp., 43/6.

MATCHMAKER UNIVERSAL OUTPUT TRANSFORMERS

Will match any output valves to any speaker impedance. 11 ratios from 13:1 to 80:1,
5/7 watts, 16/10.
10/15 watts, 21/10.
20-30 watts, 36/10.
60 watts, 49/6.
Push - Pull Drier Transformer 3:1 Ratio .. 6/6
Universal Output Transformers 11 Ratios. Single or Push-Pull .. 6/6

"LEARNING MORSE?"

Then purchase one of the new practice Oscillators. Supplied complete with Valve, on steel chassis, 27/6; Practice Key, 3/3; TX Key, 5/9.

PREMIER 1941 HIGH FIDELITY AMPLIFIERS

Each amplifier is individually tested and supplied with specially matched valves. All diagrams and instructions. Completely Wired and Tested.

4-watt A.C. Amplifier .. £3 11 6
8-10-watt A.C./D.C. Amplifier .. £7 9 0
15-watt A.C. Amplifier .. £9 8 0
Black Crackle Steel Cabinet 17/6 extra.

PREMIER MICROPHONES

Transverse-Current Mike. High grade large output unit. Response 45-7,500 cycles. Low hiss level, 23/-. Moving Coil Mike. Permanent magnet model requiring no energising. Response 90-5,200 cycles. Output .25 volt average. Excellent reproduction of speech and music, 49/-.
Microphone Transformers. Suitable for all mikes. Tapped primaries. A, 20 and 40:1; B, 30 and 60:1; C, 50 and 100:1, 6/6 each.

SHORT-WAVE CONDENSERS

Troital insulation. Certified superior to ceramic.
All-brass construction. Easily ganged.
15 m.mfd. 2/4 100 m.mfd. 3/-
25 m.mfd. 2/6 160 m.mfd. 3/7
40 m.mfd. 2/8 250 m.mfd. 4/-

ALL ENQUIRIES MUST BE ACCOMPANIED BY 2d. STAMP.
ALL ORDERS LESS THAN 5/- 6d. POST EXTRA.

ALL POST ORDERS TO: JUBILEE WORKS, 167, LOWER CLAPTON ROAD, LONDON, E.5. (Amherst 4723)
CALLERS to: Jubilee Works, or 169, Fleet Street, E.C.4. (Central 2838), or 50, High Street, Clapham, S.W.4. (Macaulay 2381)

Practical Wireless

EVERY MONTH

Vol. XVIII. No. 426. DECEMBER, 1941.

and PRACTICAL TELEVISION

Editor F. J. CAMM

Staff:
L. O. SPARKS.
FRANK PRESTON.

COMMENTS OF THE MONTH

BY THE EDITOR

The Status of Radio Engineers

THE radio industry is a comparatively young one. It is, in fact, not more than 20 years old. Like all new industries, it offered opportunities for racketeers who perceived a method of extracting easy money from an understandably gullible public. For, of course, the public could not be expected to have expert knowledge at the dawn of broadcasting. They were easy victims of those who offered fancy crystals and cats-whiskers, wonderful transformers, new aerial systems, special tuning coils, remarkable loudspeakers, valves which would do the work of three. Very few, if any, of the early radio manufacturers knew more than the man-in-the-street about radio technique; the latter was sufficiently satisfied if he could get signals at all, and shady manufacturers cashed in on his ignorance, for he was susceptible to the purchase of anything which promised an improvement.

Easy Money

THE days of easy money in radio have gone. No longer is it possible to sell a hank of wire posing as a tuning coil, or a hedgehog transformer costing at most a few pence, for 30s. or more. By this time the public are radio conscious, and they examine the claims of products before they part with their money. It was inevitable in an industry with such a high percentage of quacks that such should look around for some means of impressing the public with their knowledge. And so several societies were started which, for a few guineas a year, would grant quacks the right to use a string of letters after their name. There are many legitimate institutions fortunately still in existence, but membership of them is not easy. There is an Entrance Examination which demands a standard of knowledge, and education, before you are admitted as a member. The Institute of Mechanical Engineers, the Institute of Electrical Engineers, and similar recognised societies do not grant membership without examination, and any society of a scientific or technical character which has not an Entrance Examination is not worthy of support.

Bogus Societies

WE have, in the past, exposed many of these bogus societies and clubs. Most of them are founded by one man who is the proprietor, secretary, treasurer and committee. There are no officers, members have no say in the conduct of the society, and the advantages of membership are nebulous or non-existent. Such a society was the "Royal" Institution of Radio Engineers, which incorporated the Institution of Radio Engineers, and it is due largely to the efforts of a legitimate institution known as the British Institution of Radio Engineers, with which is incorporated the Institute of Wireless Technology,

that the proprietor of the "Royal" Institution of Radio Engineers was brought before a judge who put a period to his activities by sentencing him to 12 months' imprisonment. He was charged with conducting a bogus concern, and it was stated that he knew so little about radio that he could not repair his own wireless set. Seven charges of obtaining sums totalling over £20 by false pretences with intent to cheat and defraud men who sought either to become members of the Institution, applied for its diplomas, or were induced to increase their subscriptions, were brought against him. The man himself constituted the Institution. In his circulars and letters he claimed that it was a technical society for radio engineers, founded for the advancement of the industry and operated entirely without profit unto itself. Evidence was given showing that all the money went into his own pocket, and that contrary to the announcements he issued there were no lectures, no papers were read, and there were no examinations. Some of the diplomas issued, it was stated, were signed by a chairman, who, finding that it was merely a money-making concern, resigned after attending his first meeting. Other diplomas were signed by a 17-year-old girl typist, who was made to appear as the Registrar of the Institution. Several kinds of degrees were awarded, according to what was paid by the intending members. No applicant who had sent money had been refused membership. The judge said he had no hesitation in describing the "Royal" Institution of Radio Engineers as a rump. About 1,800 people had joined the Institution, and defending counsel said that if a man sent £3 3s. for the pleasure of putting a string of letters behind his name, he must know that the whole thing was not genuine.

It is to the credit of the British Institution of Radio Engineers, with which is fused the Institute of Wireless

Technology, that they have been successful in exposing this flagrant racket, and thereby not only defending their own bona-fide institutions, but also the good names of other institutions.

Readers will observe that the gentleman now doing time was sufficiently cunning to add the word "Royal" to his bogus institution, and also to use a title somewhat similar to the legitimate institute, and thus to lend a cachet to his nefarious practices. We hope this will be a lesson to racket institutes in other industries.

Our New Style

HOW do you like PRACTICAL WIRELESS in its new form? Actually, you are getting more reading matter than in a normal issue, for the advertisement space has been restricted. You will observe that all the regular features continue to appear. We shall welcome a letter from you informing us of your views.

Editorial and Advertisement Offices:
"Practical Wireless," George Newnes, Ltd.,
Tower House, Southampton Street, Strand,
W.C.2. Phone: Temple Bar 4363.

Telegrams: Newnes, Rand, London.
Registered at the G.P.O. for transmission by
Canadian Magazine Post.

The Editor will be pleased to consider articles of a practical nature suitable for publication in PRACTICAL WIRELESS. Such articles should be written on one side of the paper only, and should contain the name and address of the sender. Whilst the Editor does not hold himself responsible for manuscripts, every effort will be made to return them if a stamped and addressed envelope is enclosed. All correspondence intended for the Editor should be addressed: The Editor, PRACTICAL WIRELESS, George Newnes, Ltd., Tower House, Southampton Street, Strand, W.C.2.

Copyright in all drawings, photographs and articles published in PRACTICAL WIRELESS is specifically reserved throughout the countries signatory to the Berne Convention and the U.S.A. Reproductions or imitations of any of these are therefore expressly forbidden. PRACTICAL WIRELESS incorporates "Amateur Wireless."

ROUND THE WORLD OF WIRELESS

Broadcast for Maltese

A SPECIAL weekly programme for Malta is to be broadcast by the B.B.C. and will be in addition to the one for the British Forces serving there.

Valves in a Bible

A WORKMAN who always carried a Bible under his arm when he went to work was questioned recently by his employers during an inquiry into the pilfering of wireless valves. It was discovered that the Bible was merely a case for the man to carry away a valve every time he left the works.

Overseas Radio Change

THE B.B.C. overseas services have been reorganised and divided into two sections—the first for enemy and enemy-occupied countries, and the second for other countries.

Radio-controlled Aerial Torpedo

A RADIO-CONTROLLED aerial torpedo is being developed by a U.S. Navy yard engineer, and Service officials have seen a 6ft. model at work.

Operated on the gyroscope principle, the winged torpedo is designed to fly at 30,000ft. Carrying a load of bombs, it would be set at the starting-point to power-dive at terrific speed into a designated enemy target, spraying bombs.

Super-sensitive Television Set

A TELEVISION set—seven times more sensitive than normal ones—is reported to have been completed by two Japanese professors in Tokio after nine years' work.

Radio Mechanics Wanted for R.A.F.

MEN are still urgently required to train for radio wireless mechanics at R.A.F. bases for testing and checking radio gear. The age is 18-34, but older men will be accepted if they know something about radio. Application should be made to Air Ministry, Information Bureau, Kingsway, London, W.C.2.

School Broadcasts

SINCE the beginning of the school year recently, over 2,500 more schools listen-in to the B.B.C.'s broadcasts for children.

In England and Wales over 10,000 schools have registered with the councils for school broadcasting, and in Scotland over 1,000. The last peace-time figures for the whole country were about 2,800.

The children's B.B.C. is a complete service on four wavelengths, including one short-wave. There are special series for Scottish and Welsh schools, and for rural areas.

Radio 'Flu Cure

SUCCESSFUL experiments have been carried out by a large Northern engineering firm in anti-cold treatment for their workers, in which short radio waves play a part.

Workers affected by colds, despite preventive treatment, are now cured in one day, in nearly 70 per cent. of the cases treated, and in less than 20 per cent. is the treatment unsuccessful. Research has been carried on in three directions—short radio waves, prophylactics and one other about which details are not available.

Empire Radio Chain

NEW short-wave radios being built in Australia with a power of 100 kilowatts will complete a chain of British Empire stations for the dissemination of authentic news.

Sweden Listens to the B.B.C.

A RECENT broadcast in the B.B.C.'s Swedish transmission described a visit to Swedish sailors now marooned in Britain owing to the torpedoing of their ships by the enemy, and mentioned that the International



Women and girls are now being trained as radio operators by the B.B.C. Our illustration shows students being taught the principles of transmitter operation with a small table set and wægometer.

Library of the Seamen's Union only contained one book in Swedish. Results were very soon to be noticed. The Swedish Archbishop was listening, and at once took steps to remedy the position. The Swedish Seamen's Union got into touch with the Swedish Foreign Office, who granted a subsidy to finance the sending of a large number of books from North and South America to Britain.

Sent SOS and Died

THE traditional stick-to-your-post spirit of a wireless operator saved a Norwegian ship and most of the crew when they were machine-gunned and dive-bombed in the Atlantic.

"When we were attacked," said one of the men recently, "our wireless operator sent out the SOS and then died. A British plane and a Dutch destroyer answered the call."

Lights in Darkened France

A FEW days ago a Wellington bomber was flying over France and, going down low over a French town, gave the "V" signal with its recognition lights. At once the answer came back. From motor-car lamps in the streets and from windows and skylights there was flashed in morse a succession of twinkling "Vs."

Russian Broadcasts

BULLETINS in English from Russia are available at the following times and wavelengths: 6.34 a.m., 10.76 m., 19.29 m.; 9.5 a.m., 10.29 m. and 19.76 m.; 1.5 p.m., 19.76 m.; 4 p.m., 19.76 m.; 7 p.m., 31.51 m.; 8 p.m., 31.51 m.; 10.15 p.m., 31.51 m.; 11.50 p.m., 19.76 m. (British Summer Time.)

Making Your Own Coils

An Interesting and Instructive Section of Radio, and One Which is Topical in View of the Coil Shortage

By L. O. SPARKS

Coil design and construction are very extensive subjects, therefore, in view of the number of requests received for *practical* help and, as space and time are important factors, reference to theoretical considerations must be brief. The general requirements should be appreciated, and these can be summed up in the following manner: When we speak of coils in connection with radio apparatus, we have in mind components which, by virtue of their construction, possess a certain value of inductance. This value is usually a fixed quantity, but it is normally used in conjunction with a condenser the capacity of which can be varied, thus allowing the complete circuit to be tuned to any desired frequency or wavelength according to the formula: Wavelength (λ) = 1884.9 \sqrt{LC} . when L equals the inductance of the coil in microhenries and C equals the capacity in microfarads. Although capacity is essential in this consideration, it is equally essential to avoid its presence in the coil itself or, in other words, the construction must be such that the coil has very low "self-capacity." If this vital point is ignored, the overall efficiency and characteristics of the tuned circuit will be directly affected, and this applies in particular to short-wave components. The best way to avoid self-capacity is to use coil formers of reasonable diameter and, wherever possible, single layer windings (Fig. 1). Other detrimental items are resistance, poor insulation, fragile construction, and H.F. losses.

Resistance

The frequency of the alternating current flowing through the coils used in aerial and H.F. coupling circuits is high, and owing to the fact that such currents do not flow *through* a conductor in the same manner as direct currents, but pass along the surface or "skin" of the material, the resistance offered to such currents becomes an important item. It might be many times the D.C. resistance of the circuit, and as it is undesirable, from the point of view of efficiency, attention must be given to the matter in the form of careful selection of gauge of wire. It is for this reason that large gauge and silver-plated wire is used for S.W. coils, whilst multi-strand wire known as Litzendraht is often used for inductances in high efficiency circuits. Broadly speaking, therefore, it is best to use the largest gauge wire consistent with other governing factors, such as winding area, etc.

Insulation

Perfect insulation is essential. This applies to wire and formers, as one is not solely concerned with insulation from the D.C. point of view, but also with high-frequency currents. Severe losses can be introduced by using wire and formers having doubtful insulation, so one cannot be too careful in the selection and examination of materials. The wire should be scrutinised during the actual winding for any defects in its insulating covering, and formers must be *quite dry* and of material which will not absorb moisture. If cardboard or wood is used for this purpose, it should be coated—after being baked to drive out every trace of moisture—with good shellac or bakelite varnish. It is a very good plan to apply this treatment to completed coils, especially when cotton or silk-covered wire has been used. The baking must be done with care, and at a temperature which will not

harm the covering, and the shellac or varnish applied very sparingly whilst the coil is still warm.

Formulae

For those who wish to calculate the number of turns, etc., required to produce a coil having a certain value of inductance, the following formulae will be found useful:

To determine the inductance (L) of a coil, it is necessary to have three known factors, namely, the mean diameter of the coil (A), the length of the winding (B), and the number of turns (N).

$$L \text{ (microhenries) then equals } \frac{0.2 A^2 N^2}{3A + 9B}$$

When constructing coils, one is more likely to be concerned with the number of turns required to give a certain inductance, so the above formula can be rearranged to give N.

$$N = \sqrt{\frac{3A + 9B}{0.2A^2}} \times L$$

To determine the length of the winding (B) for any particular gauge of wire, reference should be made to a reliable table of wire gauges and associated data.

Equipment

If one is going to make coil construction a part of one's radio activities, and there is much to recommend it, it is very advisable to give the preliminary preparation reasonable consideration. For example, one should be handy with a soldering iron, preferably one having a small pencil-shaped bit. Resin-cored solder should be used, and very fine emery or sandpaper kept for removing the covering of the wire. A clean, smooth work table is necessary, and it is a good plan to have a small square of felt or baize on which to rest coils during the constructional work. A fine bradawl, or, better still, a small archimedean drill, is necessary with which to make anchoring or tapping point holes in the former. A stock of wire of various gauges and coverings, formers of different diameters, small soldering tags and an assortment of nuts and bolts (6 or 8 B.A.) together with suitable washers, will form a useful collection of material with which to start.

Simple winding machines are, of course, most useful, especially if they are designed to take any size former and provided with an automatic turn counter. Such pieces of apparatus are not difficult to make, and their construction can usually be completed from parts found in most "spares-boxes."

Before commencing any practical work, certain items must be decided, such as overall coil size, length of winding space, gauge of wire to be used, and number of turns required. From these, the former can be prepared, holes drilled and anchoring tags fixed in position.

Data

It is not possible to give in this article complete constructional details and winding data for various types of coil, but a table has been prepared which gives the number of turns required for a medium-wave winding (when used in

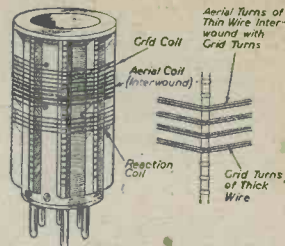

Fig. 2.—Showing the relative positions of grid, aerial and reaction windings on a S.W. coil.

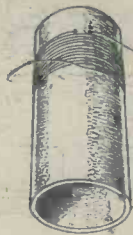

Fig. 1.—A plain solenoid type of winding, as shown here, has much to recommend it.

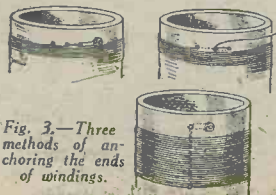

Fig. 3.—Three methods of anchoring the ends of windings.

conjunction with a tuning condenser having a capacity of 0.0005 mfd.) using formers of various diameters and wire of various gauges. This information provides the essential details to enable several simple circuit coils to be made, which, in turn can form the basis of more elaborate designs and interesting experimental work. For example, to obtain greater selectivity, the aerial should be tapped into the coil commencing from the top end, i.e., that opposite the earth end, and as the tapping point is taken down the winding, so will the selectivity increase but the signal strength developed across the coil will decrease. Another item to note in this respect is more turns will be required on the coil as the tapping point is lowered. For H.F. transformers, aerial coupling and reaction coils, Fig. 2, it is always advisable to use finer wire than that of the grid or secondary winding, as this helps to reduce capacity coupling. Such windings can be wound over or at the earth end of the original coil. The smaller the primary winding, i.e., the less number of turns, the weaker will be the coupling, but the greater will be the selectivity. For reaction circuits, approximately 6/10ths to 7/10ths of the grid winding turns will usually be found satisfactory, but the actual number is best determined by experiment as so much depends on the complete circuit characteristics.

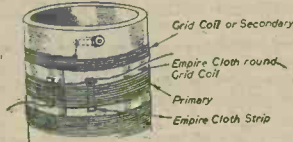

Fig. 4.—An effective and neat method of securing the ends of primary windings.

Construction

Fig. 3 shows suitable methods of anchoring the ends and tapping points of windings. Small bolts (6 or 8 B.A.) fixing neat soldering tags, provide the best and most secure anchorage, and it should always be used if the coil is to be employed in experimental circuits. If the bolt is of the right length, an additional nut or terminal head can be used to make fast external connections, thus allowing frequent and easy wiring alterations to be made without damage to the windings.

It should be noted that the wire passes through two small holes in the former before being soldered to the tag. This is advisable to remove any direct strain on the connection, as the soldering tends to make fine wire brittle and liable to fracture. A neater method is to fix the tags inside the coil former, thus allowing more space on the outside and the winding to be started or terminated closer to the bolt.

An alternative system of anchorage is that which relies on the wire being looped through two or three holes drilled in convenient parts of the former. The diagram shows the idea, but it is essential to see that the wire is threaded through the holes once or twice to prevent it slipping, a fault which can ruin the best work and cause much annoyance. Always make sure that the windings are kept taut, though extreme strain must be avoided otherwise the wire will stretch and, after several days, the windings will become loose and unsightly.

Primary Windings

If these are wound over the grid coil, they should have as their base a strip of insulating material such as empire cloth, thin card, or celluloid. The width of this will depend on the number of turns and gauge of the wire used for the primary, a small margin being allowed on each side. Fixing the ends of such windings is often a difficult problem for the inexperienced; the method shown in Fig. 4 is simple and effective; especially if a spot of shellac is used to cement the anchoring points. The loop if made from a 1/4 in. wide strip of empire cloth or thin tape, and it is actually placed in position before the winding is started. After one or two turns are completed, it will stay in position and, when the winding is finished, tighten the loop of tape by gently pulling

the under end of it, until it (the loop) is bedded down alongside its adjacent turn. Another such loop should be used, if no other method is available, for fixing the finish of the primary.

Short-wave Coils

These components need greater consideration when selecting coil formers and holders, and gauge of wire to be used. On the short waves, the frequency of the signal current is many times greater than that of medium-wave transmissions; therefore it is essential to take the necessary precautions to avoid H.F. losses. Formers having a high insulating value, and preferably of the ribbed type, should be used whenever possible. Cardboard tube, when properly treated, should only be used if it is impossible to obtain paxolin, ebonite or one of the recognised insulating materials used by the commercial firms. Self-supporting air-spaced windings are very efficient, and as several ways of making these have been described in past issues, constructors are well advised to use this form of construction rather than tubing of doubtful value.

Connecting pins should be well spaced, all windings securely anchored in position and turns spaced by an amount equal at least to the diameter of the wire used. For the 40-metre band, 22 S.W.G. enamelled wire is best, whilst 20 S.W.G. should be used for the 20-metre section. For frequencies higher than these, it is an advantage to use even heavier gauge, say, 18 S.W.G., provided the turns are spaced as mentioned above.

Large diameter formers have much to recommend them, and if space permits their use they are worthy of consideration; in fact, all experimenters are advised to compare their efficiency with those of smaller diameter coils, by undertaking a series of reception tests.

Wire: 26 S.W.G., Enam. or S.S.C. 28 S.W.G., D.S.C. or S.C.C. 31 S.W.G., D.C.C.					
D.	1	1 1/4	1 1/2	2ins.	
B.	2 1/2	1 1/2	1 1/2	1in.	
N.	147	101	70	58	
Wire: 28 S.W.G., Enam. or S.S.C. 30 S.W.G., D.S.C. or S.C.C.					
D.	1	1 1/4	1 1/2	2ins.	
B.	1.7	1 1/4	1	0.7in.	
N.	124	91	73	51	
Wire: 24 S.W.G., Enam. or S.S.C. 28 S.W.G., D.C.C.					
D.	1	1 1/4	1 1/2	2ins.	
B.	3 1/2	2 1/2	1.9	1 1/4ins.	
N.	172	115	87	63	
Wire: 22 S.W.G., Enam. or S.S.C.					
D.	1 1/4	1 1/4	2	2 1/2	3ins.
B.	3 1/2	2.8	1.8	1.4	1.2ins.
N.	138	103	67	52	44
Wire: 20 S.W.G., Enam. or S.S.C.					
D.	1 1/4	1 1/4	2	2 1/2	3
B.	4 1/4	3 1/2	2.7	2	1.7
N.	123	94	78	58	49
				36	36

KEY.

S.S.C. = Single silk covered. Enam. = Enamelled covered.
D.S.C. = Double silk covered. D = Diameter of former.
S.C.C. = Single cotton covered. B = Length of winding.
D.C.C. = Double cotton covered. N = Number of turns.

Although copper tubing is used for the construction of coils for very high frequencies and in transmitters, its advantage is of doubtful value when one is concerned with the normal S.W. bands. It is difficult to use, from the constructional point of view, and, for any frequencies lower than, say, 30 Mc/s, the bulk or mass of metal raises many objections.

The absence of self-capacity is of prime importance; therefore the gauge of the conductor can only be increased up to certain limits which are governed by this consideration, the field produced around the coil and the permissible overall size of the inductance.

Receiver Maintenance and Testing

An Outline of the Methods of Avoiding Receiver Faults and of Tracing and Curing Them When They Do Occur

IN these days of economy, and when there is difficulty in obtaining new components, it is often necessary to keep comparatively old receivers in use for a number of years. And although there is no reason why a good receiver should not give satisfactory service for several years it is important that it should be properly maintained. Additionally, minor faults are more likely to arise than when using a new receiver. In consequence it is also worth while to make a closer study of the correct methods of maintenance, diagnosing faults and making quick repairs.

Periodic Cleaning

In general, all that is required in the way of maintenance consists of dusting out the receiver once every few months, checking the soundness of connections and

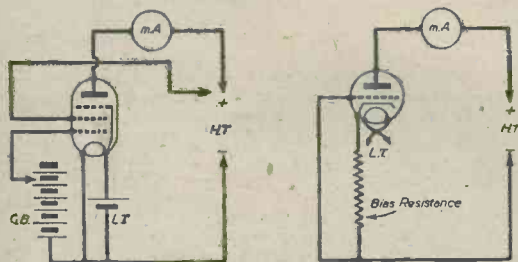

Fig. 1.—How valves can be checked by measuring the anode current when applying the correct L.T. and known values of H.T. and G.B. In the case of a mains valve (right) the supplies may be taken from the mains unit of the receiver or from batteries. The tests can be carried out without removing the valves from the receiver if the associated components are first tested and found to be in order.

making sure that the valves have not deteriorated to a serious extent. When removing dust it is generally best to remove the receiver chassis from the cabinet, if this can be done fairly easily. A good soft brush can then be used to sweep out the dust. Take care to clean well between valve-holder legs and sockets, and pay particular attention to non-enclosed variable condensers, especially when the receiver covers short waves.

When the dust has been loosened it is a good plan to suck or blow it away with a vacuum cleaner fitted with a small nozzle. Dust between condenser vanes can best be removed by first loosening with a pipe cleaner and then blowing with the vacuum cleaner or even with a tyre pump.

Wiring Connections

Soldered connections are apt to be the source of bad contact after the set has been in use for a long period, especially if the soldering was not done well, using non-corrosive flux, in the first place. Joints which are becoming "dry" can often be recognised by the dull appearance of the solder, and by a crystalline appearance on the surface. If any doubt exists, hold the wire used to make the connection and give it a firm, steady pull. If the joint cannot be severed in this way it is probably good, but should there be any sign that the connection is likely to come away, it is best to smear it lightly with Fluxite and then to apply a hot soldering iron. In some instances it might be necessary to break the joint after heating with the iron, clean the wire end and the soldering tag, and then to re-tin the two and make a new joint; afterwards take care to remove all traces of flux.

Clean Contacts

While checking the connections it is well to remember wiping and rubbing contacts such as those of switches, valve pins and coil pins. It is seldom possible to clean these by what might be described as "mechanical" means, but a spot of carbon tetrachloride will do the job admirably. This liquid, which is non-inflammable, can be obtained from chemists, and a one-ounce bottleful will last for a very long time. It can be applied to the parts referred to above with either a small camel-hair brush or the tip of a pipe cleaner. After applying it, turn the switch backward and forward a few times, or carefully move the valve or coil up and down in its holder. If a fair amount of dirt is loosened when this is done it is a good plan to wipe off the dirt, apply another small spot of the fluid and to repeat the cleaning process.

Similar steps can be taken with battery and mains plugs, the flexible leads of which should also be examined. If it is found that the ends of the leads have frayed it is best to cut them away and make new connections. It will often be found that a few strands of the flex have become broken near the point at which they emerge from the plug, and if the joint is not re-made cracking will probably develop later. Other leads which may require similar attention are those from the aerial and earth; see also that these have not been kinked, causing breakage of some of the strands. A fairly good test can be made by running them between the fingers, bending the wire backward and forward meantime. Any weak spot can be recognised in this way.

Valve Tests

It is not an easy matter for the amateur to test the valves, but a good indication of their condition can be obtained if it is known what total H.T. current was consumed by the receiver when new. Any marked falling off, provided that the power-supply voltages are in order, will suggest that one or more of the valves is losing its emission. A more accurate test can be made by a dealer who has a properly-calibrated valve tester. Alternatively, a rough "hook-up" of H.T., L.T. and G.B. supplies can be arranged, as shown in Fig. 1, and the H.T. current measured with a milliammeter; comparison with the makers' figures will give a guide as to the condition of the valve. Remember, however, that the figures given by the makers are for an average valve, and that if the current is within 80 per cent. of that given in the data the valve is probably in normal condition.

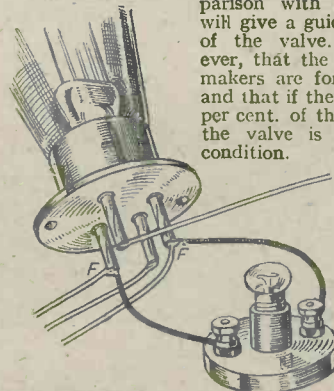

Fig. 2.—A fairly satisfactory test of filament voltage (and also of continuity of L.T. wiring and on-off-switch contacts) can be made on a battery set by connecting a 2.5 volt bulb to the filament legs of a valve-holder, as shown.

Tracing Faults

Having dealt briefly and in general terms with the question of maintenance, we can consider the correct procedure when fault-tracing. We are not going to deal with the subject from the point of view of the service-man who may have a complete "analyser" or an

abundance of meters and other equipment, but from the aspect of the average amateur who probably has nothing more pretentious than a milliammeter and voltmeter—if that.

The subject comes naturally under four or five headings according to the symptoms of the fault. None of these can be treated exhaustively in the available space, besides which to make the treatment complete it would be necessary to compile a separate set of instructions for almost every receiver type. We will therefore set out some rules of general application, which can be followed in conjunction with a circuit diagram of the receiver, or when the basic circuit arrangement is known.

Study the Circuit

The most common mistake made by amateurs when investigating a fault is to start by probing inside the receiver and, perhaps, dismantling parts of it. The correct procedure is to study the fault, make a mental note of the possible causes and then to examine each of these in relation to the circuit employed. Even though the circuit is known by heart it is a good plan to look over it at this stage, or to draw out the part or parts in which it seems probable that the fault may occur. A simplified drawing of one small section of the circuit will often make it much easier to spot a likely cause of the trouble.

If it appears likely that the fault could be in almost any part of the circuit (when there is an absence of signals, for example), it is best to isolate as many sections as possible so that the fault can be localised or traced to one particular sub-circuit.

When the Receiver is "Dead"

Assuming that the set is completely "dead": that is, that there are no signals nor even any background noise from the speaker, first make sure that the speaker is connected, that the power supplies are connected and that the aerial and earth connections are sound. Although these points appear very obvious and almost childish when read about, they are very often overlooked. In the case of a battery set, check the leads from the accumulator and high-tension battery, making sure that the wander plugs are correctly inserted both with regard to contact and polarity. With a mains set, see that the mains plug is tightly fitted and that the main switch is on. When a pilot light is fitted it will generally give a good indication of the condition of the L.T. supply.

With a battery set it is wise to test the voltage of the accumulator and H.T. battery while the set is switched on. If the L.T. is much below two volts, this may be the cause of trouble. When a meter is not available a 2.5-volt flash-lamp bulb connected between two filament terminals of a valve-holder will give a fair indication.

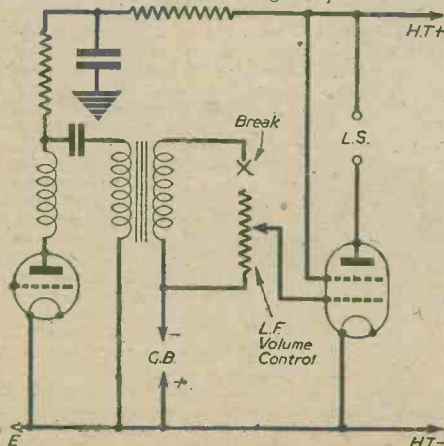

Fig. 4.—Absence of signals may be due to a break in the L.F. volume control, as indicated.

In the case of a mains set it is generally possible to see a glow from each of the valve cathodes if the supply is in order. If a glow cannot be seen check any fuses in the mains and H.T. circuits.

Should the trouble persist, in spite of the fact that the above-mentioned items seem to be in order, it may be worth while to check the speaker by switching the set on and off—after allowing time for indirectly-heated

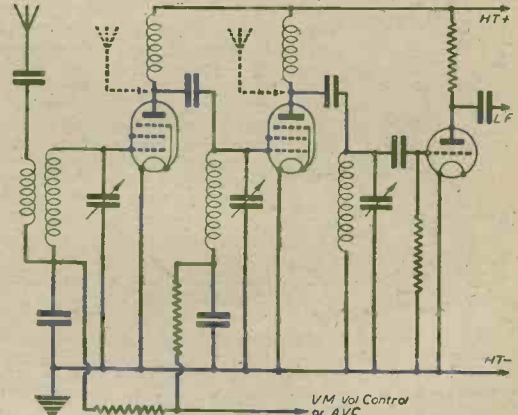

Fig. 3.—For purposes of test, H.F. stages can be cut out by transferring the aerial lead as shown by broken lines in this skeleton circuit.

valves to warm up. There should be a "click" or "plonk" in the speaker when the switch is opened and closed.

Valve and Speaker Temperature

Another simple test that can well be applied to a mains receiver is to leave it switched on for a short time, and then to switch off and feel the temperature of the glass bulbs of the valves. All should be warm, whilst the rectifier and output valves should be fairly hot; a cold valve will probably indicate a bad connection with the holder or a faulty valve. The only general exception to this is a simple diode second detector. If the speaker is of the energised type the "pot" should also be warm. If it is not there is a possibility that H.T. is not being applied to the valves.

When signals are absent and there is a certain amount of background noise it is a good plan to try the effect of connecting a pick-up or microphone. Should the output from that be satisfactory the fault is in the stages prior to the valve into which the pick-up terminals feed. With a "straight" set the H.F. valves can be isolated by transferring the aerial to the anode of the valve immediately preceding the detector (see Fig. 3). With a superhet it may be possible to cut out the oscillator—and, therefore, the superhet action—by connecting the grid of the first detector through a small fixed condenser to the grid of the second detector, or to the anode in the case of a diode.

Tuning Faults

When the receiver fails to tune, first see that the condenser drive is actually turning the rotor of the tuning condenser, and then ascertain that the coil connections are good. If the tuning is operative on one waveband and not on another examine the wave-change switch, and see that it is being operated and that all contacts are closing and opening. When tuning is unusually flat it may be that the wave-change switch is not operating on one of the coils, that there is a bad connection to one coil, or even that a connection has broken or come adrift. A similar result may be observed if the grid leak has become defective so that it acts as a comparatively low resistance across the tuned circuit. Another possible fault is a short-circuit between some of the turns of an H.F. choke, when tuned-grid coupling is employed.

Distortion

Poor reproduction can be caused by any number of faults, but it is best to start by checking the L.T., H.T. and G.B. voltages. In a mains receiver break-down of the condenser across the cathode bias resistor may be the cause of trouble, whilst if this has become open-circuited there will probably be distortion and a certain amount of mains hum. A valve which is old and is losing its emission may be responsible; in that case a temporary remedy may be obtained by reducing the bias voltage on that valve.

When reproduction becomes "cracked" on certain loud notes it may be the speaker which is responsible, due to the need for re-centring the cone. This fault, incidentally, can easily be confused with that of excessive bias or insufficient H.T. on an L.F. valve.

Crackling Noises

A noisy background, intermittent signals and general crackling is probably one of the most common faults, and one which can generally be overcome very easily. The natural thing to do first is to find whether the noise is caused by a fault inside or outside the set, and removal of the aerial and earth leads will generally settle this point. Next, bump the cabinet with the heel of the hand. If the crackling then alters it can be reasonably supposed

that there is a bad connection in the wiring, or between a plug and a socket. Before looking inside the set, however, move the external flexible leads and see if this affects the trouble, due to there being a break in one of the wires.

If it is then established that the fault is inside the receiver, tests can be made to isolate it by eliminating one section or stage at a time as mentioned above.

When the noise is not affected by vibration of the cabinet it will usually be traced to a break in the internal winding of a component such as a transformer or choke. Once the fault has been traced to one stage the precise cause of trouble will generally be fairly evident, and individual components can be tested.

Failure on "Gram"

When dealing with absence of output it was assumed that the receiver operated correctly when using the pick-up terminals. If it does not, and yet works normally on radio it will generally be found that the "gram" volume control is open-circuited, or that the radio-gram switch is not making contact. In passing, it is also worthy of mention that failure of the L.F. portion of the receiver in all conditions may be due to nothing more serious than a faulty volume control. This is explained by Fig. 4.

A Midget A.C. Receiver

Details of a Useful Stand-by Receiver Constructed by a Reader

IN our issue for September, we published details of several sets designed and constructed by readers, and submitted to Thermion in response to a request he made about war-time "hook-ups." Since that date we have received from many readers interesting information about their sets, but quite a number utilised parts, or a particular component, which are now no longer obtainable, therefore their designs failed to be of general interest. As correspondence has proved that quite a number of readers have made up (and are obtaining very satisfactory results) some of the published designs, we are giving the details of an A.C. set constructed by a member of the B.L.D.L.C., Mr. Preece (6,227). He describes it thus:

"I am submitting a simple circuit of an A.C. stand-by midget portable which, although employing three valves, including rectifier, functions as a 4-valver. The circuit comprises a triode pentode acting as an H.F. amplifier and detector, the latter being transformer coupled to a pentode output. Reaction is controlled by means of a variable resistance in series with a fixed condenser, plus the usual reaction winding. This method gives better stability, gain and smoother control than the usual variable condenser control.

"Smoothing of the H.T. supply is performed by the field of a midget, 6in. energised speaker having a resistance of 600 ohms. Variable

bias to the H.F. stage is provided by a 5,000 ohm potentiometer in the cathode circuit of the first valve, this also acting as a very efficient volume control. After the set had been properly trimmed, many foreign transmissions, in addition to the usual British stations, were received at good strength and quality."

Mr. Preece does not give type number of coils, but it would appear that any reliable make of dual-range components would be satisfactory; therefore we would suggest that those readers interested in the design use such coils as they might have on hand, or those obtainable from some of our advertisers.

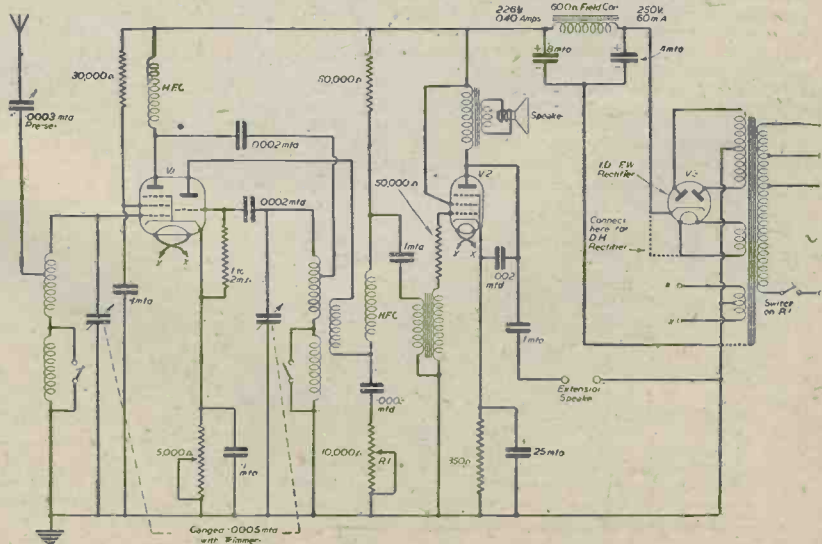

Theoretical circuit diagram of a midget A.C. receiver.

Supply Mains as Aerials

A Useful and Efficient Alternative to Frame and Indoor Aerials

PROGRESS made in receiver design has been so rapid during recent years that an outside aerial is by no means so essential to good reception as was thought formerly; coupled with this fact, we must remember the general increase in power of the principal broadcast stations has done much to make the set independent of the large and unsightly aerial. In spite

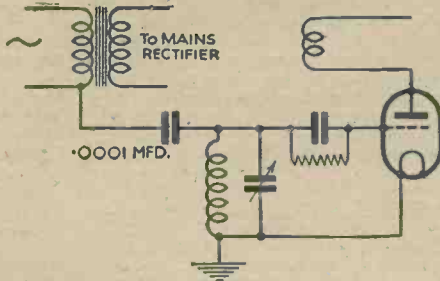

Fig. 1.—The simplest way of using the mains as an aerial.

of this, few receivers are sensitive enough to dispense with this entirely by relying on the relatively small pick-up of the frame. Apart from this, the only alternative is an indoor aerial system. Whilst such an arrangement can be extremely satisfactory from a sensitivity point of view, it rarely happens that the necessary wires can be erected without causing some inconvenience to the rest of the household. Few listeners realise, however, that where electric lighting is installed they have ready to hand an aerial system which, used in the proper manner, can yield very fine results, as proved by its popularity several years ago. Not only may the wiring system serve its primary object of providing the ordinary household current, but it will also serve as an excellent aerial provided certain precautions be taken.

Using the House-wiring System

Obviously no direct metallic connection may be made between the mains and the grid coil on account of the probability of short circuit, which will not only blow the house fuses, but also burn out your tuning coil. In order to guard against this a condenser must be joined in the lead from the mains; this will offer no barrier to the H.F. currents, but will act as an effective stop to the mains current, provided, of course, in the case of A.C., its value is not too high. The circuit in its simplest form is shown in Fig. 1. There are, however, several serious drawbacks. If the coupling condenser is at all large, the mains ripple will be passed on to the detector and subsequently amplified; even a quite small condenser can cause this trouble if the voltage ripple is of the high-frequency commutator type; admittedly the reactance of a capacity of the order of .0001 mfd. is very high to audio-frequencies, but it must be remembered that a powerful mains receiver will give a good account of a tiny input to the detector. Bearing this in mind it will be appreciated that we are compelled to use a condenser which is of such a value to seriously limit the

effectiveness of our aerial; the coupling is far too weak to be efficient. There is another aspect of the matter.

A long and low aerial, of which the mains type is a good example, has a high capacity to earth and a consequent low resistance. On the other hand, a small series condenser has a very high effective resistance. This would be unimportant if our aerial were of the small high resistance type—a little extra resistance would be but a small part of the whole. We cannot increase the size of this capacity without introducing mains hum; furthermore, it will be found that damping on the grid-coil is severe, and it is very doubtful whether good oscillation can be maintained over the tuning range with the aerial connection to the "top-end" of the grid-coil as shown. Fortunately, we have a way out of our difficulties. By arranging for a tap on our grid-coil we immediately reduce aerial damping. The arrangement (shown in Fig. 2) may be considered as an autotransformer where the aerial tap to earth is the primary, and the secondary the whole of the tuning coil. We have very considerably increased the efficiency of the system by "matching" the low-resistance aerial to the low-resistance primary. Provided the aerial tap is well down the grid-coil (not more than a quarter up), we may increase the value of the coupling condenser to a value where its equivalent resistance no longer swamps the total circuit resistance; at the same time we need have no fear that mains hum will be apparent with the tapping point well down to the low potential end. In these circumstances it may be found that the series condenser can be increased to about .01 mfd. with advantage. There is no point in increasing it beyond this value, as the reactance to broadcast frequencies is but 15 ohms or so. It must be emphasised that it is quite useless to take all these precautions to keep the circuit resistance low if we neglect our earth connection; so be sure to see that this is above reproach.

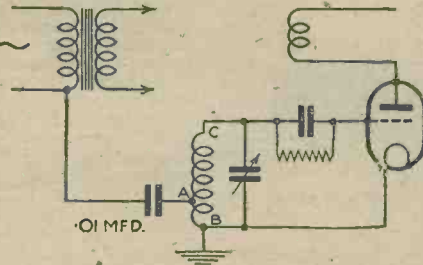

Fig. 2.—A better method than that shown in Fig. 1.

An Alternative Arrangement

Perhaps a better system than that described above is drawn in Fig. 3. Here we have a coupling coil in series with the mains lead. This may be of the so-called aperiodic type or tuned. As a general rule, no trouble will be experienced with hum—the effective coupling for

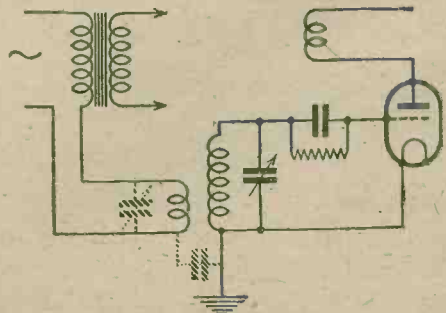

Fig. 3.—Diagram illustrating what generally proves to be the best form of mains aerial connection.

audio-frequencies is far too weak. Should it be desired to tune the coil, it will be found advisable to "tie" down one end to earth potential, otherwise hand-capacity effects will prove troublesome; a condenser for this purpose is shown in broken lines.

A mains aerial constructed on the several lines suggested above should be every bit as effective as the more conventional indoor variety, and should, in fact, bear comparison with a small outside one. It is definitely not recommended for short-wave work, however. The high capacity to earth makes it totally unsuitable for the

job; even if the pick-up were good we should find that the inter-winding capacity of the mains transformer would make a very effective short to earth. As a point of fact, the greatest efficiency will generally be obtained on the medium-wave band. On the long waves it is always found that stronger aerial coupling is necessary. For reasons outlined above, this may bring in its train heavy damping and mains ripple. The small loss in efficiency is hardly likely to be very noticeable on these frequencies, however, and certainly should not act as a deterrent to an effective solution to the aerial problem.

L.F. Choke Construction

Component Construction Overcomes Supply Problems, so Here are Simple Instructions on How to Make Two Efficient Chokes

THE great amount of interest which is shown by readers of PRACTICAL WIRELESS in the home-construction of their own components is clearly indicated by the large number of letters we receive in regard to this matter. And, despite the fact that it is not usually any cheaper to make components than it is to buy them, the constructional work certainly forms a most interesting and fascinating pastime, besides giving a very good insight into the functioning of the parts.

Actually, chokes are very simple components consisting essentially of nothing else than a length (it is a very long length) of wire wound on a former built up from a number of laminations of iron. But to make a really efficient choke, of inductance, resistance, and current-carrying capacity, suitable for a particular purpose entails a certain amount of initial design, and it is the points which require special consideration that are dealt with in this article.

A Low-frequency Choke

The simplest type of iron-core choke is one intended for coupling together two valves on the choke-capacity principle, or for connecting a loud-speaker to the output valve. The essentials of such a component are: An inductance of not less than 50 henries at the normal working current, a resistance to D.C. current of 2,000 ohms or less, and a safe current-carrying capacity of not less than 20 m.A. It is also an advantage, if the choke is provided with a tapping point, to enable alternative ratios to be obtained when it is employed to feed a loud-speaker.

In order to cover all the above requirements with an ample "reserve," the first choke I shall describe has an inductance of about 50 henries when carrying 25 milliamps. and a D.C. resistance of 1,700 ohms. The winding is centre-tapped, and consequently the components can successfully be employed for a wide variety of purposes.

The core consists of about 3½ dozen pairs of No. 5 Stalloy stampings of "T" and "U" shape, whilst rather less than ½ lb. of 38-gauge enamelled wire is used for the winding. The dimensions of the stampings are shown in Fig. 1, and by referring to these it will be an easy

matter to tell if the core of an old burnt-out transformer which happens to be on hand can be made use of.

The Winding Spool

The first thing is to make a winding spool, which may have either a square or circular section "tunnel." If it is square it should be of the dimensions shown in Fig. 2, and can be made up by bending a strip of stout card in the manner indicated. When the card has been bent to shape it should be fitted with two end cheeks 2in. square. The latter can be fixed in position with "tacky" glue, after which the complete spool should be given a coat of thin shellac varnish to make it rigid. Before winding is commenced it is a good plan to wrap a layer of insulating tape round the spool to cover the otherwise sharp corners which might tend to cut the fine wire. A circular spool is somewhat easier to make, but is not quite so efficient. It is built up on a cardboard tube ¼in. inside diameter, and fitted with a pair of 2in. diameter end cheeks, after which shellac is applied as before.

Winding the Spool

After the winding spool has been made, two small holes should be made near the inside of one end cheek and a short length of rubber-covered flex threaded through these, leaving about ¼in. projecting outside and 6in. projecting inside the spool. Next carefully solder the bared end of the 38-gauge enamelled wire to the end of the flex which is on the inside of the spool. It then only remains to wind on the wire. As there are a total of approximately 12,000 turns of this fine wire to be put on, however, it is best to give some thought to the most convenient way of winding. The complete job can be done entirely by hand, provided that a reasonable amount of patience is exercised, by making a wooden handle which will fit tightly into the spool. Should a lathe be available, this work may considerably be simplified and speeded up by gripping the handle between the jaws of a chuck. Yet another way is to make a short piece of wood to fit into the spool, and to fit this with a stout nail or bolt which can be held in the chuck of a hand-drill mounted in a vice. In any case, the bobbin of wire should be fitted into a small stand or on to a spindle, so that it can rotate freely whilst the wire is being drawn off. Also, when winding in the lathe, it is essential that a speed

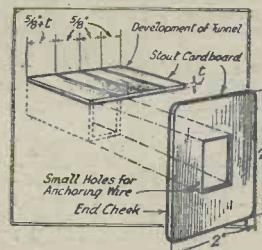

Fig. 2.—Constructional details of the winding spool for the choke.

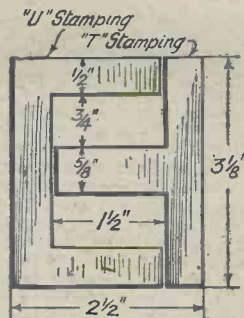

Fig. 1.—Sketch showing the dimensions of the No. 5 Stalloy stampings required for the first choke described.

not greater than 50 or 60 revolutions per minute should be employed.

Insulation

After winding on one-quarter of the wire the turns should be covered with a layer of insulation, such as waxed paper, oiled silk, or empire tape, and this should be so put on that it will be impossible for later turns to slip past it. The winding should then be continued to 4,000 turns (it is not necessary to count, and an approximation based on the total quantity of wire will suffice) at which a tapping point should be made. To make this, scrape the insulation away from the wire for a short distance, make a loop and then solder on a short length of flex, covering the joint with a blob of sealing wax, or with insulation tape. Fit another layer of insulation, continue to the 8,000th turn, again insulate, and then complete the winding. Solder a third length of flex to the last turn, pass this once round the spool, and then anchor it in a pair of holes made in a convenient position in the end cheek. It is a good plan to finish off the wound spool by applying a liberal coat of thin shellac varnish; this will keep out all traces of dampness. The winding should finally be covered with a protecting layer of empire tape.

Once the coil has been wound the stampings can be fitted into the spool. The method of fitting is perfectly simple if it is remembered that "T" and "U" shaped pieces are alternated throughout. Another point to remember is that each stamping is insulated on one side, and, to ensure that this shall be effective, the insulated (white or grey) side of every stamping should face in the same direction. To make the idea quite clear, the method of assembly is shown in Fig. 3. The core should be a really tight fit in the spool to prevent the possibility of vibration, and because of this it is best lightly to tap the last few stampings into position. The component is finally finished off by fitting a pair of core clamps made according to the dimensions given in Fig. 3. These are made from $\frac{1}{4}$ in. wide by $\frac{1}{4}$ in. thick brass strip, and are held in place by means of 2 B.A. bolts, $1\frac{1}{2}$ in. long.

It has been stated that the choke described above can be used for various L.F. coupling purposes, but it should be added that it is also entirely suitable for H.T. smoothing in mains equipment, where the total current does not exceed about 50 milliamps. When passing the maximum current, the choke will have an inductance of rather more than 30 henries, and will produce a voltage drop of eighty-five. The choke is really most suitable for use in an eliminator supplying about 30 milliamps., and under such conditions its inductance is sufficiently high to give adequate smoothing, whilst the voltage-drop produced will be fifty-one (a reasonably low figure).

A Gapped-core Choke

When dealing with currents in excess of some 50 milliamps., it is advisable to employ a smoothing choke of greater dimensions and having a lower resistance to D.C. It is also an advantage to make the component of the so-called constant-inductance type, so that its inductance varies by only the very slightest amount when the current passing through the winding is varied. In order that a choke should show such characteristics, there must be an air-gap in the core; that is the "T" and "U" shaped stampings should not touch each other, but should be arranged with a small gap between them. Particulars will be given of a component of this type which has an inductance of 50 henries, a D.C. resistance of about 1,300 ohms, and a maximum current-carrying capacity of nearly 100 milliamps.

Six dozen pairs of No. 4 Stalloy stampings are required for the core, and the winding should consist of approximately 12,000 turns, or $1\frac{1}{2}$ lbs. of 36-gauge enamelled wire. The winding arm of the core will measure $1\frac{1}{2}$ in. by $1\frac{1}{2}$ in. by $2\frac{3}{8}$ in. long, so a spool of these dimensions and fitted with end cheeks measuring $2\frac{3}{8}$ in. by $2\frac{3}{8}$ in. should first be made. This will be wound in exactly the same manner as was described for the smaller component, taking tappings if desired.

The only real difference occurs when the core stampings are to be fitted, since arrangements have to be made to provide the necessary air gap. This is easily done by fitting all the "T" stampings into the spool from one end, and then arranging all the "U" stampings opposite to them. The necessary gap is fixed by slipping strips of card $\frac{1}{16}$ in. thick between the ends of the "U" stampings and the sides of the "T's." Additionally, to prevent the gap being short-circuited, slips of paper must be placed between the core clamps and the core itself. When the clamps have been tightened up the cardboard slips may be removed if preferred, but there is no reason why they should not be left in place, because they have precisely the same magnetic properties as air.

Uses

The gapped-core choke can be used for any purpose which demands a choke, but it is especially suitable for use in powerful mains receivers for smoothing, or feeding the loud-speaker. It can also be used very successfully as a loud-speaker field replacement choke. Very often, it is desired to make use of a permanent magnet speaker which might be more convenient, and in that case the choke having characteristics similar to those of the speaker field is called for. Most speakers of the type under consideration have a D.C. resistance of approximately 2,500 ohms; thus, to make our choke suitable it must be wired in series with a 3-watt (minimum), 1,000-ohm resistance. As an alternative, and where the maximum current does not exceed some 50 milliamps.; the choke may be wound to almost exactly the correct resistance (2,500 ohms) by using approximately 1 lb. 20zs. of 38-gauge enamelled wire. This amount will run to just about 13,500 turns.

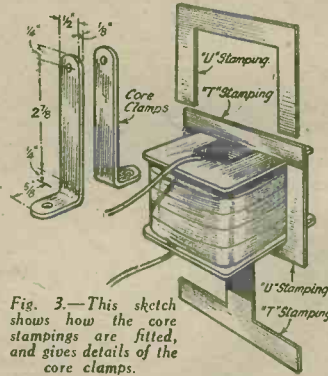

Fig. 3.—This sketch shows how the core stampings are fitted, and gives details of the core clamps.

PRIZE PROBLEMS

Problem No. 426

WHEN Jones completed a three-valve A.C.-operated receiver of the 1-9-1 type, using components, etc., from his spare-box, he found, on testing it, that the circuit was unstable. After spending an evening trying to locate the cause of the trouble, he reached the conclusion that it was due to interaction between the S.G. anode lead and adjacent wiring. After much searching he failed to find any metallised sleeving with which to screen the suspected lead, so he was forced to adopt an idea which he thought would serve the same purpose. Taking some enamelled wire from an old medium-wave tuning coil, he wound it most carefully over the insulated lead, making sure that all turns were contiguous so that a perfect metal sleeve was formed, the bottom end of which was connected to the earth via the chassis. On testing after this modification, he was dismayed to find that the trouble had not decreased but actually increased. Can you account for this?

Three books will be awarded for the first three correct solutions opened. Envelopes must be marked Problem No. 426 in the bottom left-hand corner, and must be addressed to The Editor, PRACTICAL WIRELESS, George Newnes, Ltd., Tower House, Southampton Street, Strand, London, W.C.2. Entries must be received not later than the first post on Monday, November 17th, 1941.

Solution to Problem No. 425

Wilson should have obtained a fixed resistance of approximately 30,000 ohms and a variable potentiometer of about 50,000 ohms. One end of the fixed resistance should be connected to the H.T. 120/150 terminal of the eliminator, the other end to one of the end terminals of the potentiometer, the other end terminal of the latter to H.T.—of the eliminator, and the centre terminal to the screening grid lead of the S.G. valve.

The following three readers successfully solved Problem No. 424, and books have accordingly been forwarded to them: J. Ross, 26, Southdown Road, Upper Portlisle, Sussex; E. Berry, 13, Boscombe Avenue, Barton-on-Irwell, Manchester, Lancs.; Cpl. A. Silvester, Hut 24, 20, O.T.U., R.A.F., Lossiemouth Morayshire, Scotland.

P.A. EQUIPMENT—7

Portable and Mobile Equipment. By "SERVICE"

ALL the equipment we have reviewed in earlier articles in this series is condensed in equipment designed for portability, or for use in cars and vans.

Portable equipment may be used not only for outdoor functions but also for indoor work for use where permanent wiring is not available; perhaps a local hall has been rented by a political party and loudspeakers are required to amplify the voices of the speaker and also to provide sound for any overflow crowds outside the actual hall. For outdoor occasions, hospital fêtes, A.R.P. demonstrations and similar functions, portable equipment can generally prove of great assistance in making available to large crowds the announcements of items in the programme, or sounds picked up by a microphone at the official tables during the prize giving, or speech-making periods.

For both indoor and outdoor work portable equipment, the amplifier may be similar and comprise a 5 or 10 watt amplifier unit and control panel in a carrying case with provision in the lid for holding the microphone and folding microphone stand.

Loudspeakers may be of the directional baffle type for outdoor work, as these are light, and by means of the lugs generally provided on the speaker they may be easily tied to trees, lamp standards, flag poles, etc.

When the location is entirely flat, then one or two poles may be erected with suitable guy ropes, and the loudspeakers fixed to the top of the pole at an angle of between 45 to 90 degrees from each other.

For indoor work the same type of speaker is quite suitable, but may be more difficult to suspend, and portable cabinet loudspeakers are very handy, as two or more may be placed on a platform, dais, etc., and do not look so obtrusive for indoor work, especially on small stages where there may be floral decorations. Horn type speakers would look very much out of place in such surroundings.

Amplifier Equipment

The type of amplifier equipment which will be found most useful in areas where A.C. and D.C. mains are mixed will be of the universal type in which the amplifier circuits conform to D.C. practice, but have a rectifier in the H.T. circuit for rectifying A.C. when the instrument is used on this type of supply. An example of this type of equipment is shown in Fig. 1.

The amplifier in this equipment comprises three stages of high amplification giving 8 watts from two output pentodes in push-pull. With a good input from the transverse-current carbon microphone two 5w. speakers may be used for reproduction, or four could be used when a low diffusion sound distribution is required. This arrangement is often to be preferred to one or two loudspeakers blaring away at full volume.

Vibrator Unit

Similar equipment to that shown in Fig. 1 may be obtained incorporating a turntable and pick-up which is useful for dances, or for providing music during the intervals. To obtain large audio outputs in districts where there is no electrical supply, amplifiers operating from a small rotary convertor or vibrator unit are very useful, as they can be run from a 6v. or 12v. car accumulator.

The vibrator unit is similar in action to a bell movement which constantly interrupts the direct current and so

breaks it up into a pulsating unidirectional current. When this current is passed through the primary of a suitably designed transformer with H.T. and L.T. secondary windings on it, voltages will be produced across the secondaries just as if A.C. was being applied to the primary winding.

This type of equipment is primarily designed for use with P.A. vans or police cars for traffic control but, as previously stated, it is very valuable for use in village halls and outdoor functions where it is difficult, or impossible, to run a cable from the nearest mains supply point. An example of this type of equipment is shown in Fig. 2, which is a 5w. mobile equipment for operation from a 12v. car accumulator. 13v. valves are used, and the L.T. for them obtained directly from the 12v. accumulator, while the rotary convertor which may be seen on the left of the Fig. 2 is also driven from the accumulator and provides 200v. at 100 milliamps. for the H.T. circuit. The total consumption from the accumulator of such an installation is about 4 amps. and the audio output from the amplifier is 5w., which is sufficient to load one large 5w. speaker, or two or more smaller units.

Larger equipment than that illustrated in Fig. 2 is



Fig. 1.—An A.C./D.C. portable amplifying equipment with transverse-current carbon microphone and cabinet loudspeaker, with carrying handle.

available, of course, giving row or more of audio output, but naturally the consumption becomes rather heavy, rising to 8 amps. or more, which is a heavy drain on the accumulator for hours on end.

Portable Generator Set

Due to this heavy current taken from the accumulator when portable equipment is used, the lead from the accumulator to the amplifier must be as short as possible in order to avoid any serious drop of voltage along the cable. For this reason if a mobile or van equipment is being pressed into service at a dance, or meeting in a hall, the amplifier should be kept in the van and the microphone and loudspeaker extended to the appropriate positions. Alternatively, the car accumulator should be taken out of the van together with the amplifier, and placed at a suitable location in the building where the engineer in charge can adjust the controls when necessary.

On no account should any attempt be made to take the amplifier into the hall, and then extend the accumulator lead from the van to the amplifier.

A very useful source of supply when a fairly large installation is to be carried out in a hall with no mains

supply or in a field where a horticultural meeting or suchlike function is being held, is a small portable engine generator set. Many P.A. engineers make these units up themselves from an old motor-bike engine and dynamo which charges an accumulator, which in turn will feed the P.A. equipment. Alternatively, one of the small petrol driven units designed specially for the purpose of providing L.T. and H.T. for mobile radio stations may be used.

Sometimes the generator may be wound so that half the armature winding gives H.T. from a commutator at one end of the armature shaft, while the other half of the winding gives L.T., which is taken from the generator via a commutator at the other end of the armature shaft.

Another arrangement is to provide two generators, one for L.T. and one for H.T., with the shafts coupled in tandem and both driven by one petrol engine.

Microphone Mountings

In Fig. 2 the microphone is of a similar type to that shown in Fig. 1 except that it is mounted by means of rubber bands in a handle mounting; such a microphone can easily be unhooked from its handle and mounted on a floor stand when required.

For car or van work the handle type mounting is essential so that the announcer sitting beside the driver can speak into the microphone. The fact of holding it in his hand while announcing protects it from shock and the vibrations of the car movements.

When it is desired to provide music from gramophone records a spring-driven motor may be used mounted in a record-playing cabinet fitted with a pick-up which may be connected to the amplifier in place of the microphone. These spring-driven record players are very useful for this purpose, and—in passing—provide a ready means for reproducing gramophone records for owners of battery receivers who have no mains supply available for the more usual type of record player.

Carbon microphones are nearly always used in portable and mobile equipment, owing to their robustness, sensitivity and lightness. If the equipment is to be used for reproducing music, there is, of course, no reason why other types of microphones should not be employed, provided that a suitable matching transformer is available for matching the microphone to the input impedance of the amplifier.

Speaker Installations

For mobile installations on vans or cars a light-weight loudspeaker with a rectangular flare is very convenient for mounting on the roof as the sound is level with the heads of the people being addressed and thus can be heard by them over a wide area.

A very interesting installation is the Tannoy power microphone used in conjunction with one of the firm's Co-Ax speakers. This specially designed power microphone operates without an amplifier and is constructed to operate with a large current of 4-5 amps. flowing through it. Thus a great output is obtained which may be connected via a suitable matching transformer to any type of loudspeaker, although the ideal combination is the Co-Ax speaker.

By means of the button on the handle of the microphone the heavy operating current is only used whilst the microphone is actually being spoken into.

Cable Protection

Cables used with mobile and portable equipment must be of stout construction with armoured sheathing which should not only physically protect the conductors, but also shield them from electrical interference. It is

advisable that the shielding itself should be protected by an outer rubber covering, not only for weather-proofing, but also to prevent scraping of the metal shielding against metal work, or other grounded objects which will give rise to noisy backgrounds in the reproduction.

The cable should be periodically inspected and should be discarded immediately any fraying is noticed, or the frayed part cut out and a workmanlike joint made between the two pieces of good cable. A break in the cable during a public address job is a very difficult and embarrassing fault to find, and serious business connections can be lost through this type of breakdown, so that it is well worth while to scrap any suspicious looking cable rather than to wait for it to break down.

Wherever possible, cable should be run out of sight and where it cannot be damaged by crowds, although

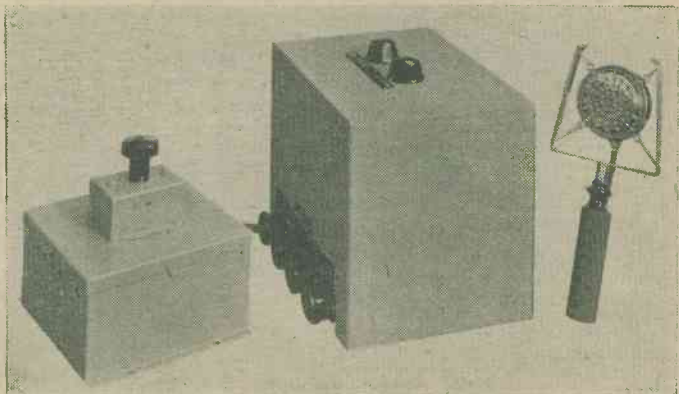

Fig. 2.—A 5-watt mobile equipment with rotary convertor for use with a car battery.

this cannot always be arranged for in outdoor P.A. jobs; hence the need for stout armoured cable that will withstand being trodden on.

Details of cable and loudspeaker wiring distribution networks in permanent installations will be dealt with in the next article.

Personal Paragraphs

The Postmaster-General has appointed Mr. S. D. Sargent to be his Principal Private Secretary, Secretary of the Post Office Board and of the Post Office Advisory Council, in place of Mr. C. J. Miles, M.B.E., who has been promoted.

E. W. Seabourne, who covered Sussex for McMichaels, and learned to fly long before the war, has been promoted to Pilot Officer. He is now fit again after having been wounded. Pilot Officer Wiseman, who covered Middlesex for McMichaels, is having excitement as an officer rear-gunner.

E. F. E. O'Connor, technical engineer of Radio Maintenance Services, of Nottingham, is engaged on instructional work with the Services, but he retains his connection with the firm in an advisory capacity.

Mr. Albert Parsons, who recently took up his duties on appointment to the Technical Information Department of the B.B.C., was the Senior Lecturer in Radio Engineering at Portsmouth Municipal College. After being invalided out of the Navy at the end of the last war, he took up an appointment as assistant in the Radio Section at the Municipal College in 1919. In 1922 he left the College to go to the Electrical and Wireless School, Royal Air Force, in a civil position, and returned to the College in 1930.



ON YOUR WAVELENGTH

By THERMION

The Fly on the Ceiling

AS far as the Brains Trust is concerned I have pointed out in previous issues the flies in the ointment, or the beetles in the beer. As I have raised the question of flies, I presume that I must have inspired the Brains Trust in their revival of the hoary old question as to how a fly lands on the ceiling. The question has been answered many times in the technical press; slow motion pictures have been shown of the phenomenon and I am surprised that no member of the Brains Trust answered the question, nor had any of them apparently heard of the film. None of them, in fact, knew the answer. Meantime, my own Brains Trust is functioning. I claim to give satisfactory answers to serious questions, but I can be as flippant as my correspondents in dealing with flippant queries.

Lord Hankey's Appeal

LORD HANKEY is issuing an appeal for multi-range measuring instruments which are required for vital war work. He says: "I appeal to you to-day to assist by selling or presenting this type of equipment, if you have any surplus, or if you know of any of your radio friends whom you can persuade to part with such apparatus. The instruments I refer to are of the AvoMeter and AvoMinor class. The instruments most urgently required are multi-range A.C. and D.C. meters, such as the Model 7 AvoMeter, the Model 40 AvoMeter and the Universal AvoMinor. Offers of other makes of multi-range instruments of similar grades and capabilities are also welcomed. If you are able to offer them you should communicate with Mr. R. P. Browne, the Secretary of the Radio Manufacturers' Association, 59, Russell Square, London, W.C.1, stating the type of instrument, approximate age and condition, whether it is a gift or for sale, if the latter, the price desired, and your name and full address."

Bogus Degrees

I HAVE always held in extreme contempt the individual who, without qualifications or education, likes to use a string of letters after his name in order to impress his fellows. In America scholastic degrees are considered insufficient in the engineering and practical industries. It is necessary for the holder also to possess a degree in practical applications, and over 42 American States insist upon this. In this country a man who attends school sufficiently long to pass an examination is entitled to call himself an engineer. When they obtain a job in an engineering works, they are hopelessly lost, and usually are quite unable to apply their text-book knowledge. Do not think that this is my own biased point of view. Ask the proprietor of any engineering establishment, or any chief designer; they will tell you that they would rather have a practical man with a knowledge of elementary mathematics than a man with an academic degree, but lacking in practical training. Nearly all industries, as you know, have been for many years victims of those who sell degrees without examination. One such man I see in the Press is spending 12 months in gaol reflecting upon the matter. It is insufferable that legitimate institutions should be penalised in this way, for the good often suffer with the bad. Do not therefore part with your guineas unless there is an entrance examination; you are only deceiving yourself by using a string of letters to give the impression that you possess knowledge which you have not. The use of such letters is in itself a form of fraud, and you label yourselves as frauds if you use them. I look for-

ward to the time when radio engineering will be regarded as a profession, and the time is not far distant when it will be illegal to use purchased "degrees." If you are a doctor, or a lawyer, or a chemist, you must pass examinations and you may not practice in any of these professions until you have passed examinations. Members of the public are entitled to be protected against the quack. You are entitled to believe when you take your wireless set to be repaired that the man is capable of repairing it. You are equally entitled, when you take your motor-car or your watch, your bicycle or your sewing-machine, or your spectacles to be repaired, to expect they will be competently dealt with. Apart, therefore, from the question of degrees there is the question of fraudulent designation of a man's trade or capabilities. It should be an offence for a man to trade as a wireless engineer if he is not a wireless engineer. I am glad to see that there are those who are watching over these things.

The Radio War.

I STILL think that the suggestion made in this journal that we should butt in on the enemy's wavelength only when we have silenced their station by the presence of our bombing aircraft, is the best. I do not think interjecting remarks into the programme is good, for such remarks are not taken seriously. If enemy aircraft were sent over Berlin their stations will go off the air. We know the precise second when a station goes off the air, and at that precise second we should radiate on that wavelength a perfectly serious propaganda programme.

Picrofarad

I NOTICED that the term *Picrofarad* is coming into use to replace the more clumsy *micro-microfarad*. I first observed this term many years ago in an Eddystone catalogue, and went to some trouble at the time to trace its origin. I was unsuccessful, and so refused to use it. A number of firms, however, are adopting it, so do not be surprised if you meet the word in these pages. It has found its way into the pages of at least one technical dictionary, and it will appear, I understand, in future editions of the *Practical Wireless Encyclopaedia*. Perhaps readers can assuage my curiosity as to the origin of the term. None of my dictionaries define the prefix *Picro* in the sense in which it is here used. In fact, the word does not appear in any work which I possess dealing with radio. It does appear in an electrical dictionary, and I suppose was first used in connection with that industry.

Zoological Madrigal

[Thermion says: A lecture by a professor is merely a piece of intellectual cud-chewing. They regurgitate—after the manner of a ruminative quadruped.]

RUMINATIVE quadrupeds,
Moo-cows chewing cuds,
Know at least the job they're on
We cannot call them duds.
But dry-as-dust professors,
Regurgitating gas,
In all too many instances,
Remind us of the ass!

Now, when an ass is "quadruped"
We just ignore its Bray;
But with the "biped" asses
No patience let's display.
And when to find their "provender"
They raid our hard-earned pence,
Most surely we've the right to say:
"Shut up! Or else talk sense!"

—"TORCH."

Aircraft Direction Finding

A Simple Explanation of the Underlying Principles

YOU have probably often wondered how our long-range bombers are able to return directly to their bases after attacks on Germany. Much can, of course, be done by navigation based on time, speed and compass direction, whilst in many cases good use can be made of the stars. In addition, however, radio navigation is used very extensively, and its use is increasing. By taking a bearing on two or more known stations with his direction-finding apparatus, the wireless operator can give the navigator sufficient information to enable him to plot the position of the aircraft with a high degree of accuracy. And when the exact position is known it is not difficult to plot a "homing" course.

A standard radio receiver can be used for direction-finding by the addition of a simple unit and by making use of a frame aerial (generally referred to as a loop) and also a fixed aerial of the type employed for normal reception. There have been many improvements made during this war in the way of increasing the accuracy of

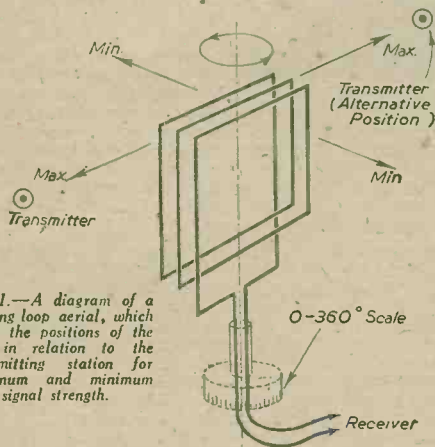

Fig. 1.—A diagram of a rotating loop aerial, which shows the positions of the loop in relation to the transmitting station for maximum and minimum signal strength.

D.F., but obviously the nature of these cannot be revealed. But since all direction-finding as applied to aircraft is based on the same principles, an explanation of those principles will suffice to give a good impression of the methods which are in regular use. Here we may point out that a good wireless installation is one of the most valuable aids to safety with which the modern aeroplane is fitted.

Properties of the Loop Aerial

The principle of direction-finding in aircraft is based on an important property of the rotating loop aerial. When the plane of the loop is in the line between the aircraft and a ground transmitter to which the receiver is tuned, signal strength is at a maximum; by turning the loop through 90 degrees, signal strength is reduced to a minimum. In fact, theoretically signal strength should be zero, as it often is. This point is illustrated in Figs. 1 and 2. From Fig. 1 it will be understood that the loop is mounted in such a manner that it can be rotated through a full circle, and that the spindle or pivot is fitted with a 360-degree scale, so that the angle of the loop can be read off when the minimum-signal position has been found.

Here it may be asked why use is made of minimum instead of maximum signal position. This can be seen

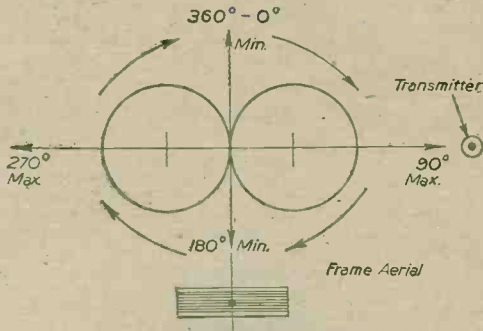

Fig. 2.—The "figure-of-eight" diagram which shows the relationship between the position of the loop and signal strength.

from Fig. 2, which is generally known as a figure-of-eight diagram: It shows, in graphical manner, the signal voltage picked up by the loop while it is turned through a full circle. It can be seen from this that the minimum position, or rather the position for minimum signal, is sharply defined, whereas there is little change in maximum signal strength over a fairly wide angle.

Determining the Position

By taking two readings from the same station while the aircraft is flying along a straight line at a known speed, it is possible to find the position of the aircraft by drawing lines on a map, as shown in Fig. 3. The fact that the transmitter may be in either of two directions—on either side of the loop—is not very important, since the correct direction can be found by trial and error when drawing the lines. At the same time, the fact that the transmitter may be in one of two diametrically opposite directions is a definite disadvantage. Time is lost in carrying out the trial-and-error plotting, and it is necessary for reasonable accuracy that the aircraft shall fly for a good distance along a straight line to obtain a good "base" for the triangle.

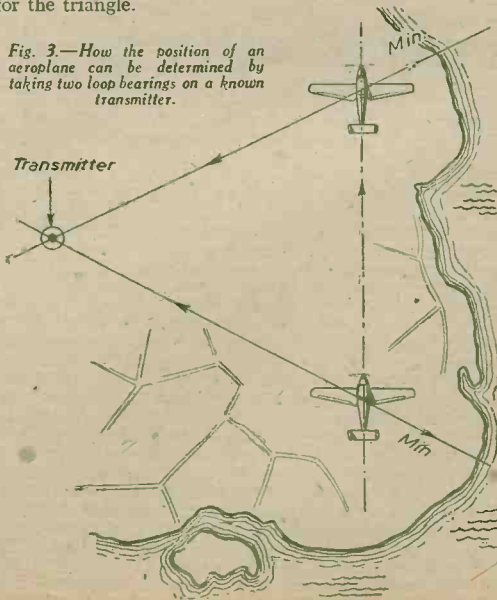

Fig. 3.—How the position of an aeroplane can be determined by taking two loop bearings on a known transmitter.

"Sense" Finding

If it were possible to find the correct direction of the transmitter, greater accuracy could be ensured and much time saved. Additionally, it would be possible to take two bearings on two widely-separated transmitters, so obtaining the "base" on the transmitters themselves. This could be done so quickly that the distance travelled by the aircraft between taking the two bearings would be almost insignificant; in any case, suitable allowance could easily be made for this. Such a state of affairs can be brought about by using both the loop aerial and a

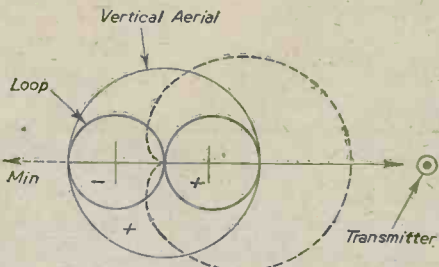

Fig. 4.—How "sense" is obtained by combining the pick-up from the loop and from a fixed aerial.

fixed aerial in taking a bearing. When this is done, it is said that not only the bearing, but the "sense" is known; that is, the direction of the transmitter.

A Single Minimum

It is clear that in order to do this, modifications must be made so that there is only one minimum signal position. The theory of "sense-finding" is somewhat involved, and a full understanding of it calls for a knowledge of the principles of propagation of wireless waves. For these reasons, and because of the large amount of space which would be required to cover the subject fully, we do not propose to go into full details, but only to show what happens in practice.

Fig. 4 shows the essential diagram, which is a combination of three diagrams. First there is our figure-of-eight relating to the signal pick-up by the loop; then there is a circle which represents the pick-up by the fixed aerial, which is considered to be omni-directional; lastly, there is the heart-shaped (so-called cardioid, meaning relating to the heart) diagram which is found by geometrically adding together the first two diagrams. To simplify the illustration, the cardioid diagram is shown by a broken line. It will be appreciated that the polarity of the voltages picked up by the loop is reversed when the loop is swung through 180 degrees, so the two halves of the figure-of-eight are marked with the conventional + and - signs. The circle representing the voltage pick-up by the fixed aerial is marked with a + sign. It must be understood that these signs are merely conventional, and serve to show how the cardioid is built up.

Method of Operation

Now we can see the practical application of the principles just described. The simplified circuit details are shown in Fig. 5, where it will be seen that the fixed aerial can either be switched into or out of circuit, while in addition a resistance in series with the lead from the fixed aerial can be varied. The loop is connected through a double-pole change-over switch to a coupling coil on the aerial tuner. The purpose of the change-over switch is to reverse the "sense" of the loop in relation to the input circuit.

In the first place a moderately strong signal, which can be received at steady strength, is picked up in the usual manner and accurately tuned. Then, the fixed aerial is switched out of circuit and the loop brought in. The loop is "swung" or rotated until the two positions of minimum signal are found; the readings as given on the loop scale are then noted. Actually, there are two

sets of calibrations on the scale, one displaced from the other by 90 degrees. One of the minimum readings is chosen—it does not matter which—and the loop turned so that the second scale reading is the same as that of the minimum position on the first scale. The fixed aerial is then brought into circuit, so that both aerials are connected. If the loop is in the correct "sense" the signal should then be at a minimum. In any case, the reversing switch is moved backward and forward. It is marked "Bearing" and "Reciprocal," and if the minimum signal is obtained with the switch in the "Bearing" position the correct minimum has been chosen and indicates the correct bearing and direction of the transmitter being received. If minimum signal is received with the switch in the "Reciprocal" position the wrong minimum has been chosen and the other should be tried.

Correct Phasing

The phasing resistor in series with the fixed aerial can be used if a sharp minimum signal is not obtained. As its name implies, the resistor varies the phase of the signal received on the fixed aerial, but it is sufficient to understand that when it is correctly adjusted a sharp minimum should be obtained. If the reading is not sharp, whatever the setting of the resistor, it is a sign that an unsuitable transmission has been chosen, and that another should be used. After a little experience an operator can easily recognise a suitable signal, and finds it necessary to make only a small adjustment on the phasing resistor. What is more, a bearing can be taken in a few seconds.

The value of the loop method of direction-finding cannot be stressed too much, because it means that the pilot of an aircraft can obtain his bearing or even his position without giving away his presence to the enemy as he would if he called up one or more ground stations and asked them to plot him and give him his position. For that reason, wireless operators are strongly urged to make the best possible use of their loop.

D.F. Developments

It will be appreciated from what has been written above that it would be possible to "home" on the

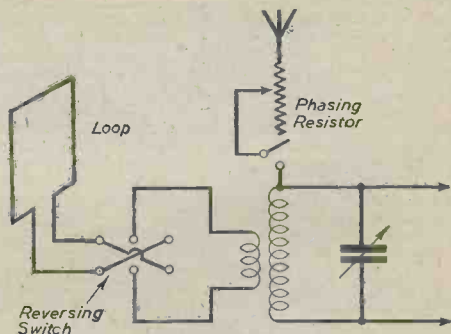

Fig. 5.—Simplified circuit connections for the sense-finding portion of a receiver used for D.F.

loop by setting it at right angle to the line of the aircraft and flying in such a direction that the minimum signal were maintained. It is also possible to introduce visual indicators which will show when the aircraft deviates from the proper course and to show when the exact minimum position has been found.

There are many other ingenious variations which are used in practice, but which must be regarded as of a secret nature during the war. After the war, it will probably be possible to reveal a startling number of outstanding radio developments which have already taken place, and which will have taken place between now and the time that we are writing this.

Simplified Gain-control Circuits

Modified Methods of Applying A.V.C.

THE conventional diode-triode detector circuit can easily be modified to apply A.V.C. to the triode amplifier, and at the same time some of the circuit elements usually required may be eliminated.

In the accompanying illustrations Fig. 1 will be recognised as the usual diode-triode detector circuit modified in one respect, namely, that the grid blocking condenser 13 and the grid potentiometer 11 have been transposed. So far as the audio frequency signals are concerned, the impedance of the condenser 13 is negligible, but it will be observed that the full D.C. voltage set up across the diode load 4 is applied to the grid of the amplifier valve 10. Thus, as the strength of the received carrier varies, the bias on the grid of the valve 10 is automatically varied so as to make the audio frequency output more constant in amplitude. This circuit consequently provides A.V.C. on the pre-detector, and post-detector amplifier stages.

The amplitude of the audio frequency signal may be regulated manually by adjusting the position of the slider 12 on the potentiometer 11 in the usual way. It will be appreciated that the slider 12 will normally be adjusted to a position remote from the end connected to the condenser 13, so that the effective D.C. resistance in the grid circuit of the valve 10 will be relatively low, and the effects of grid current will be minimised.

Manual Volume Control

In the arrangement shown in Fig. 2 the potentiometer resistor 11 and the condenser 13 function simultaneously as the manual volume control device and the automatic volume control filter network. The automatic volume control connection 7 is made to the junction of resistor 11 and condenser 13, so that the lead 7 derives the direct current voltage from the load impedance 4 through the potentiometer resistor 11. At high volume control settings of tap 12 the direct current resistance of the grid circuit of amplifier 10, which is common to the controlled pre-detector valves, is considerably reduced so that, in this condition, any undesirable grid

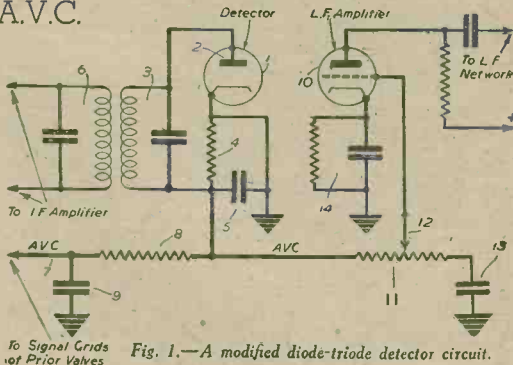

Fig. 1.—A modified diode-triode detector circuit.

current flow in valve 10 has but little effect on the operation of the pre-detector valves.

It is frequently desirable to add a bass-compensating network to the volume control circuit of Fig. 2, and

Fig. 3 shows a resistance 15 and condenser 14 constituting such a network connected to a fixed tap on the volume control 11. The A.V.C. voltage for the pre-detector stages is taken from lead 7, which is connected to the junction of elements 14 and 15, so that the time constant of the A.V.C. network is not too large, as it might be if it were connected to the junction of elements 11 and 13 of Fig. 3. The circuit of Fig. 3 has an advantage over that of Fig. 2 in that the audio volume at minimum setting of the slider 12 is considerably less, and, in fact, may be

made negligibly small.

These circuits have been developed in the laboratories of the Radio Corporation of America.

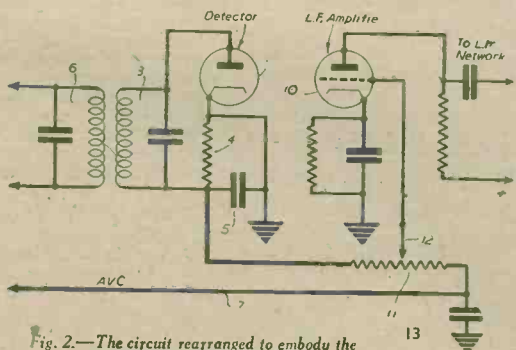

Fig. 2.—The circuit rearranged to embody the manual control described in the text.

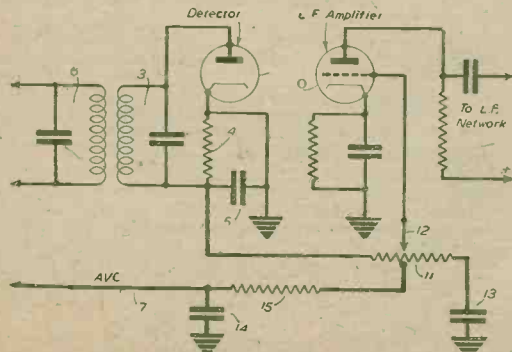

Fig. 3.—The resistor 15 and the condenser 14 have been added to form a bass-compensating network.

A COMPLETE LIBRARY OF STANDARD WORKS

By F. J. CAMM

- MASTERING MORSE 1/-, by post 1/3.
- GEARS AND GEAR CUTTING 5/-, by post 5/6.
- WATCHES: ADJUSTMENT AND REPAIR 6/-, by post 6/6.
- NEWNES' ENGINEERS' MANUAL 6/-, by post 6/6.
- PRACTICAL MOTORISTS' ENCYCLOPEDIA 10/6, by post 11/-.
- PRACTICAL WIRELESS ENCYCLOPEDIA 10/6, by post 11/-.
- RADIO TRAINING MANUAL 6/-, by post 6/6.
- EVERYMAN'S WIRELESS BOOK 6/-, by post 6/6.
- PRACTICAL WIRELESS CIRCUITS 5/-, by post 5/6.
- COILS, CHOICES AND TRANSFORMERS 5/-, by post 5/6.
- PRACTICAL WIRELESS SERVICE MANUAL 5/-, by post 5/6.
- WORKSHOP CALCULATIONS, TABLES & FORMULÆ 5/-, by post 5/6.
- NEWNES' SHORT-WAVE MANUAL 6/-, by post 6/6.
- WIRELESS TRANSMISSION 5/-, by post 5/6.
- DICTIONARY OF METALS AND THEIR ALLOYS 6/-, by post 6/6.
- THE SUPERHET MANUAL 6/-, by post 6/6.
- PRACTICAL MECHANICS HANDBOOK 10/6, by post 11/-.
- RADIO ENGINEER'S VEST-POCKET BOOK 3/6, by post 3/6.
- WIRE AND VOLT GAUGES (Vest Pocket Book) 3/6, by post 3/6.
- DISEL VEHICLES: OPERATION, MAINTENANCE AND REPAIR 5/-, by post 5/6.
- NEWNES' ENGINEERS' VEST-POCKET BOOK 7/6, by post 8/-.

All obtainable from or through *Newnes and Co., Ltd.*, Tower House, Southampton Street, Strand, W.C.2.

Instability; and Its Cure

An Explanation of the Fundamental Cause, and Details of Effective Remedies

INSTABILITY is a term used far too loosely to describe a number of varied defects. Not always is the application correct. Therefore, to avoid further misuse it would be well to analyse its meaning, in the stricter sense, before proceeding with the investigation into possible causes.

A normal circuit carrying alternating currents at high or low frequencies, when connected across the input electrodes of a thermionic valve, will cause the latter to perform certain functions, the exact nature of which will depend on the wave-form of the input, the characteristics of the valve and the operating potentials. Assuming all factors are satisfactory, the complete circuit will form an oscillatory circuit, this state depending on the alternating currents being applied, for example, a radio signal. If this source of energy is

the prefix H.F. or say H.F. instability. For the circuits on the output side of the detector, we add L.F. to the term, thus securing, in each case, a more accurate definition of the source or cause of the trouble. The line of demarcation must not be considered too critically, as at the detector stage one is concerned with high and low frequencies.

Causes

If Fig. 1 is examined, it will be seen that it depicts a simple transformer coupled H.F. stage, the aerial circuit L and C being connected across the grid and filament of the valve. The value of C is adjusted until the circuit is tuned to the frequency of the incoming signal, i.e., it resonates at that particular frequency. The primary of the H.F. transformer L₂ is virtually untuned, and is used to pass on the signal from the anode of the H.F. valve to the grid circuit of the next. Normally, this would be quite satisfactory providing the two coils are screened and that no interaction is allowed between the grid and anode wires. It is possible, however, for the primary winding to have a certain self-capacity which can be represented as a small fixed condenser in parallel with the winding. This is denoted by the dotted symbol. If, then the inductance of the primary and the capacity indicated happened to be of such values that they caused that circuit to resonate or peak at the frequency of the incoming signal, there would be a great danger of the valve acting as a "tuned-grid tuned-plate" oscillator and causing oscillations to be generated with most unpleasant results. Fortunately, this does not happen too often with modern screened coils and valves, but it should be remembered in other instances.

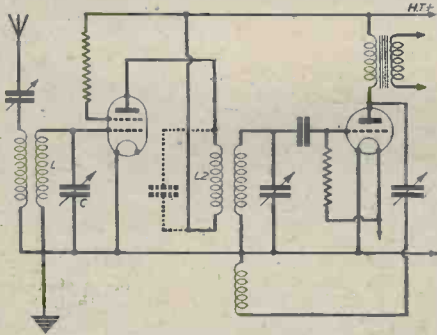

Fig. 1.—A standard form of H.F. transformer coupling in which the dotted condenser indicates self-capacity of primary winding.

removed, the oscillatory action will gradually die down, owing to the energy being expended or absorbed by the inherent resistance of the circuit. The circuit mentioned above is under perfect control of the operator; it is functioning at the frequency of the incoming signal and it can be stated to be perfectly stable. If, however, operating conditions become changed, it is possible for the valve, and its associated circuit, to set up oscillatory currents in addition to the original input signal. The frequency of these new oscillations can be above or below those of the signal, and their presence will be due to the valve acting as a generator (oscillator) of oscillations. If the input signal is removed, i.e., the original energy responsible for the oscillatory circuit, the self-generated oscillations would still remain, though they may not manifest their presence in an audible manner, and one would say that the circuit was unstable or that instability was present.

This description is of necessity brief, but it is hoped that it will enable the fundamental cause of instability to be understood.

More Practical Considerations

Instability in its most common forms usually denotes its presence by audible means, causing weird noises, shrieks and whistles to emanate from the speaker. In such instances one is given a fair warning, but it must be understood that it can also be present in a more obnoxious form, when such spurious frequencies as are produced are above audible frequency and would not, therefore, be heard.

The latter form is invariably concerned with the basic trouble when it is associated with the stages preceding the detector, and to such instability we add

High-frequency Chokes

When two or more H.F. chokes are in the same set, as in the case of two H.F. stages, an H.F. stage using tuned-grid coupling, or in a short-wave receiver using a short-wave H.F.C. across the grid circuit of an H.F. stage, it is possible for these to "peak" or resonate at the same frequency. If these conditions should exist, and it is quite feasible, especially if the components happen to be of the same type and make, they would form a source of instability which, to the unsuspecting,

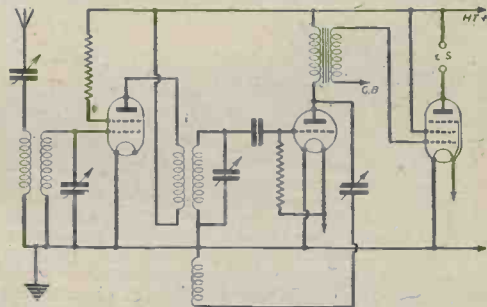

Fig. 2.—Showing how the anodes and screen-grids are made common to the positive H.T. supply line.

would be difficult to trace. In such circuits, it is, therefore, advisable to use chokes of a different make, or having different characteristics, for the anode and grid or adjacent anode circuits.

Even when a single H.F. choke is in use, it is essential for it to be capable of performing the task for which it is intended, otherwise it will be worse than useless. Now

that many constructors are having to use parts of early design and production, this point should be borne in mind.

Batteries

Many circuits are perfectly stable when the H.T. and G.B. batteries are new, but become unstable when they have been in use for some while. This is due to partial or complete breakdown of the cells and an increase in the internal resistance of the batteries. A large capacity condenser across the H.T. supply will help to reduce the trouble, but it is far better to concentrate on the actual circuit as described below. Too often is the grid-bias battery ignored; this source of voltage should be checked frequently and replaced as soon as any appreciable voltage drop is noticed.

A Danger Path

The circuit shown in Fig. 2 is a skeleton form of an average three-valve set of the r-v-r type. It is unimportant whether we think of it as battery or mains operated, as the details given below apply equally well to both types.

It will be seen that the three anode circuits and the screen grids of the H.F. and output valves are made common to one line, namely, that supplying the positive H.T. This line, or rather the source of the H.T., offers, so far as alternating currents are concerned, a certain impedance (resistance) and, from the diagram, it is obviously common to all the electrodes mentioned. This fact forms a great danger, as it provides an ideal path whereby interaction between H.F. and L.F. currents and individual stages can take place, thus breeding instability in one form or other. The only certain way to eliminate these prospects is to employ efficient decoupling, which is shown in Fig. 3.

The decoupling resistances R_1 , R_2 , R_3 , etc., are inserted to stop or trap H.F. currents and prevent them from getting into the common H.T. line, and, in the case of the "grid-stopper" R , on to the grid of the output valve. It will also be noted that an H.F. choke has been added in the anode circuit of the detector. Now it is no use trapping the H.F. currents at the points shown, unless some means are provided to carry them off out of harm's way. This is done by the decoupling condensers C_1 , C_2 , C_3 , etc., and, in the case of the detector H.F.C., by the reaction condenser as well.

The values of the resistors will depend on the H.T. available and that required by the valves, bearing in mind the current flowing in each circuit, and the voltage drop produced according to $E = I \times R$ when I represents the current expressed as a decimal or fraction of an ampere. The best plan is to use the highest value possible consistent with the above consideration. If a low value has to be used, then it is advisable to employ double-decoupling by using two resistors each of half the value, together with two condensers. The resistors, and the H.T. feed, in the normal manner.

The condenser values, whilst not being supercritical, must be selected with care, as they will be useless unless they offer an easier path to the undesired currents than the resistors. When dealing with A.C., it must be appreciated that a condenser offers resistance to the current flow due to its "reactance," and this opposition is inversely proportional to the frequency of the alternating current. It can be calculated from the formula, X_c (capacitive reactance) = $\frac{10^6}{6.28 \times f \times C}$ when f is the frequency, C the capacity in microfarads, and $10^6 = 1,000,000$. As the reactance of a condenser decreases as the frequency increases, it is permissible to use smaller capacities for H.F. circuits than those required on the L.F. side. When taking a value of f for the purpose of calculating the reactance, it is always advisable when dealing with

L.F. circuits to assume the lowest frequency likely to be handled, say, 100 or 50 cycles. An approximate general rule governing the relationship between values of decoupling resistor and reactance of condenser, is that the value of the latter should be 1-20th that of the resistor.

Layout

Insufficient attention to layout of components, inefficient screening and careless wiring, can all contribute to instability. Coils and H.F. chokes, especially those of the unscreened type, call for most consideration when planning the layout, as it is possible for them to interact with other components owing to the "field" produced around them.

Adequate screening between H.F. and Det. stages is also very important, and this includes the use of metallised sleeving for screening anode and, in some cases, grid leads.

Scrambled wiring of components should be avoided at all costs, as this can be the source of trouble often difficult to trace. Grid and anode wires should be kept apart and not run parallel with each other. Leads from I.F. transformers should be spaced out and so fixed or wired that they will not be free to drift about. The grid lead of a double-diode-triode should also be kept short and covered with metallised sleeving and, finally, all earth connections should be of low resistance and taken to a bus-bar of heavy gauge wire.

L. F. Instability

This usually denotes its presence by an audible note which can vary in pitch from a shrill whistle to a frequency so low that the individual beats can be heard. When the latter is produced it is often referred to as "motor-boating," and it forms one of the most common indications of L.F. instability. The remedy is to attend to all the circuits requiring decoupling, check operating conditions of the L.F. valves, and, if L.F. transformers are in use, make sure that they are not interacting with each other or adjacent components. Reversing the connections to the secondary or con-

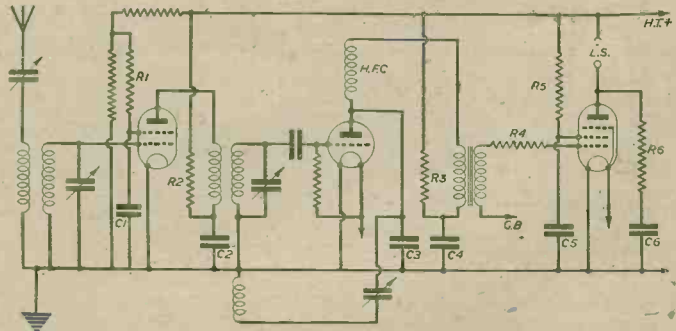

Fig. 3.—The components necessary to secure efficient decoupling and stability are indicated by R_1 , C_1 , R_2 , C_2 , etc.

necting a $\frac{1}{2}$ -megohm resistor across that winding will often improve matters, but if resistance-capacity coupling is used, attention should be given to the value of the coupling condenser and its associated grid-leak.

When valves in push-pull are employed in the output stage, a resistor having a value of 100 ohms should be connected in each anode circuit, as close to the anode pin of the valveholders as possible. With pentodes, the tone corrector arrangement shown in Fig. 3 (R_6 and C_6) should be incorporated.

In mains-operated sets, parallel-feed should always be used for the primary of L.F. transformers, not only to protect the primary winding from excessive current, but to provide a certain measure of decoupling. In this respect, the same applies to battery sets.

Radio Examination Papers.—I

This is the First of a Series of Specimen Question Papers Which Will Help Readers to Pass Radio Examinations. By the Experimenters

NOW that you have tried your hand at the questions given in the panel at the top of this page, we will give you our idea of suitable replies. We do not suggest that our replies are the only correct replies, but we believe that they would suffice in most oral examinations, or in written examinations of elementary standard. The questions and answers will probably prove helpful to those applying for employment in the Signals branch of one of the Services, as well as to readers contemplating an entrance examination to a wireless college.

This means that the output from the stage is reduced, and therefore that volume can be controlled.

An alternative method of applying the bias, by using a grid condenser and leak, is shown in Fig. 2. This gives a similar result. This method is more convenient in some instances, and is slightly cheaper, due to the use of a condenser of low capacity; the grid leak provides the necessary decoupling.

The method of applying variable bias to an indirectly-heated valve is shown in Fig. 3. Control is effected by varying the resistance in the cathode

lead across which there is a voltage drop because of the anode current flowing through it. The upper end of the resistor is positive in relation to the lower, so that the cathode is made positive in relation to the grid. This is precisely similar in effect to making the grid negative in respect of the cathode.

SPECIMEN QUESTIONS

- 1.—Describe a satisfactory form of H.F. volume control.
- 2.—Explain the principle of reaction.
- 3.—Give a simple explanation of crystal frequency control.
- 4.—What is the essential purpose of an H.F. choke?
- 5.—State and briefly explain the formula for finding the reactance of a condenser. Using your formula find the reactance of a .001-mfd. fixed condenser at a frequency of 1,000 kc/s.

Well, here we go. The answers below are numbered to correspond with the questions in the panel.

1.—H.F. Volume Control

The form of manual volume control most widely used to-day, and that which has proved most satisfactory for general use depends upon the use of variable- μ valves. These valves are so designed that the

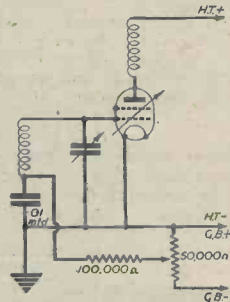

Fig. 1.—The simplified diagram shows the essentials of the usual method of variable- μ volume control in a battery receiver.

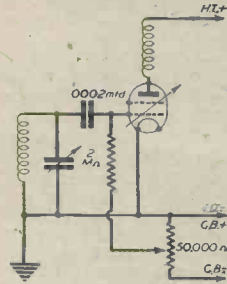

Fig. 2.—An alternative method of applying variable- μ volume control to an H.F. stage of a battery set.

effective amplification or gain which they provide can be varied by alteration of the negative bias voltage applied to the grid.

In the case of a battery set, the usual method is to break the earth-return connection from the grid coil, as shown in Fig. 1, and to take a lead from the lower end of the coil to the slider of a potentiometer connected across the G.B. battery. To avoid instability due to the same battery being used for both H.F. and L.F. valves, and often also for two or more H.F. or I.F. stages, decoupling is necessary. This takes the form of a fixed resistor of about 100,000 ohms in series with the variable-bias tapping point; this is shown in Fig. 1. A fixed condenser of about .01-mfd. capacity is also joined between the "earthy" end of the coil and the earth line to provide a low-resistance path for circulating H.F. currents.

As the slider of the potentiometer is moved from the end connected to G.B.+ toward the other end, a gradually-increasing bias is applied to the controlled valve, with the result that the gain of the valve is reduced.

2.—The Principle of Reaction

When reaction control is applied to a detector valve of the triode type, additional H.F. amplification is obtained. This is because a portion of the amplified H.F. current appearing in the anode circuit of the valve is passed back to the grid circuit. This is again passed through the valve, where it is further amplified, due to the normal operation of the three-electrode valve.

The usual method of feeding back the H.F. current from the anode to the grid circuit is by including an inductance coil in the anode circuit and placing this so that it is inductively coupled to the grid-circuit coil. If this coupling is too great the valve will fall into self-oscillation, and therefore a means of controlling the feedback is necessary. This may take the form of a variable condenser as shown in Fig. 4, or the reaction coil may be movable in relation to the grid coil. Coupling is increased by increasing the capacity of the variable reaction condenser or by bringing the two coils closer together.

So that the current in the reaction circuit may "assist"

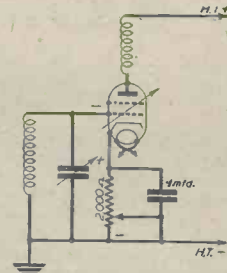

Fig. 3.—The method of applying variable- μ volume control to an indirectly-heated valve.

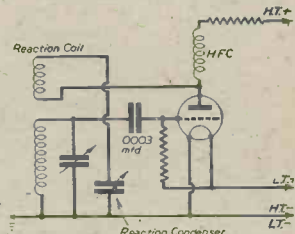

Fig. 4.—The usual method of applying reaction to a grid-leak triode detector.

that in the grid circuit, it is necessary that the coils should be wired in the correct "sense." Expressed in more technical form, the H.F. voltage fed back must be

in phase with that in the grid coil. This is ensured by connecting the coils as illustrated in Fig. 1, assuming that both are wound in the same direction.

3.—Crystal Frequency Control

This is normally applied to transmitters, but it can be used in the intermediate-frequency stages of a super-heterodyne receiver, which operate at a fixed frequency. Slices of quartz crystal are found to possess properties similar to those of a coil-condenser tuning circuit, in that they resonate at, or tune to, a particular frequency. The actual frequency depends chiefly upon the thickness of the crystal "slice."

The resonance of the crystal is due to the fact that it alters its physical form (the alteration is extremely slight) when its two opposite faces are connected across

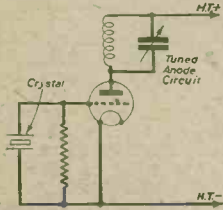

Fig. 5.—The simplest method of connecting a quartz crystal in the grid circuit of an oscillator. Compare this circuit with that in Fig. 6.

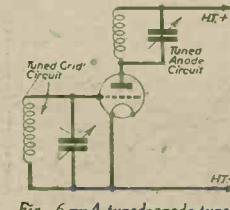

Fig. 6.—A tuned-anode tuned-grid oscillator. By comparing this with Fig. 5 it will be seen that the crystal in that circuit replaces the tuned-grid circuit.

a source of alternating voltage. It can be stated generally that any one crystal will oscillate at one frequency only, although this is not strictly true, due to reasons which need not be explained here.

Now if a crystal of suitable thickness, mounted between two metal plates, is connected in the grid circuit of a valve having a tuned anode circuit, its application can be seen. Fig. 5 shows the connections of the crystal just described, while Fig. 6 shows a corresponding circuit. It is known that if the grid and anode circuits of a triode valve are tuned to approximately the same frequency the valve will fall into self-oscillation. This is because of the feed-back (in correct phase) through the capacity existing between the grid and anode of the valve. When using a crystal, the frequency of the grid circuit is positively fixed, and thus if the anode circuit is tuned to that frequency the valve will oscillate. But if the anode circuit is mistuned, even slightly, self-oscillation will cease. Thus the crystal stabilises the frequency.

It should be added that the crystal is not affected by vibration and only to a negligible extent by temperature variations; a coil-condenser circuit is by no means as good in these respects.

In any case, a crystal can be made to a very much higher degree of frequency accuracy than can a coil, and therefore it is possible to ensure that a number of transmitters work on exactly the same frequency by fitting each with a similar crystal.

4.—Function of an H.F. Choke

An H.F. choke is nothing more than an inductance or coil. It is generally wound on a paxolin or ebonite spool and is, therefore, said to have an air core. This is to distinguish it from an iron-cored choke of the type normally used in low-frequency circuits. The choke offers resistance or reactance to alternating currents, while having negligible resistance to direct current. It can therefore be used in the anode circuit of an H.F. or detector valve, where it passes the D.C. anode current, but opposes the passage of H.F. current.

Consider first an H.F. circuit as shown in Fig. 7: since the choke has a high reactance to H.F. currents a high H.F. voltage will be developed between its ends. This means that a high H.F. voltage will be developed across the tuned-grid coil which follows it. This is because

one end of the choke is connected through a fixed condenser to the top of the tuning circuit, and the other to the lower end of this circuit—through the H.T.—supply system.

In the case of a detector with reaction, as shown in Fig. 4, the H.F. choke prevents the passage of H.F. currents into the H.T. circuit so that they can be used to provide reaction. The reaction circuit has a comparatively low impedance and therefore provides an easy path for the H.F.

The reactance of a choke is equal to $2\pi fL$, where π is 3.14, f is the frequency in cycles per second and L is the inductance in henries. It will be seen from this that the reactance of the choke increases with frequency, and is zero on D.C. In practice this is not strictly true, because there is a certain amount of D.C. resistance in the wire and there is a total capacity across the choke made up of the capacity between the various turns. It is to minimise this capacity that short-wave chokes required to operate at high frequencies have comparatively few turns, these being wound side by side and sometimes with a small space between them.

5.—Condenser Reactance

The reactance, or resistance to alternating current in ohms, of a condenser can be found from the formula:

$\frac{1}{2\pi fC}$ ohms, where π is 3.14, f is the frequency of the alternating current in cycles per second, and C is the capacity in Farads.

This formula shows that the reactance goes down as the frequency is increased, and that it is infinity (one divided by zero) on D.C., which is of zero frequency. It may also be seen that the reactance is zero at an infinitely high frequency.

Applying the formula to the question we have: X_c (condenser reactance) =

$$\frac{1}{2\pi fC} = \frac{1}{6.28 \times 1,000,000 \times \frac{1}{10^9}}$$

This can be simplified by re-writing it as $\frac{10^9}{6.28 \times 10^6}$

By cancelling, we get $\frac{10^3}{6.28}$, or $\frac{1,000}{6.28}$ which is approximately 160 ohms.

For those readers who are not accustomed to arithmetic it should be explained that 1,000,000 equals 10^6 , which is expressed in words as ten to the sixth, just as 100 equals 10^2 . The expression 10^6 means ten multiplied by itself six times. The figure of .00000001 is obtained by dividing the capacity in microfarads by one million; one microfarad is equal to one-millionth of a farad, the unit with which the formula is concerned. And our .00000001 (eight-noughts-one) is 10^9 , but we can transfer this from the bottom of the equation to the top and change the minus sign to a plus, because dividing the bottom line by 10^9 is the same as multiplying the top line by 10^9 .

If this explanation is not fully understood the reader can still obtain the correct answer by working out in full the first fraction obtained, but this is laborious, and readers not familiar with the working are advised to look up one of their old school arithmetic books.

Well, how did you fare with your answers? We hope that they were all correct. We will give you some more questions and answers in a later issue.

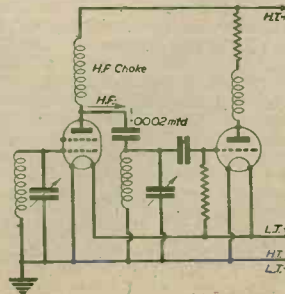

Fig. 7.—Connections for an H.F. choke in the anode circuit of a valve which is tuned-grid-coupled to a grid-leak detector.

Bonding and Screening in Aircraft

A Paper Read Before the Institute of Practical Radio Engineers

By J. F. TOMLIN

THE meticulous care taken when bonding and screening metallic elements in aircraft may, from a layman's viewpoint, seem somewhat stressed or perhaps overstressed in its application. This is not so, and it is the purpose of these notes to briefly, yet concisely, outline the reasons why the operation has to be regarded as one of the most important of all relative to the assembly as a whole.

These reasons may be divided, into three groups, as follows:

- (1) To alleviate or possibly eliminate any interference with the reception of wireless signals from other aircraft or from numerous ground transmission systems.
- (2) To provide a capacity counterpoise that will effectively act as an "earth" for radio apparatus installed in the aircraft when in flight.
- (3) To minimise the risks of fire which may be caused by atmospheric or other electrical phenomenon.

Fire Precautions

Dealing with (3), it should be understood that relatively large surfaces of metal, such as the wings, etc., of an aeroplane, collect charges of atmospheric or static electricity quite high in voltage values; so that were these metal surfaces not all bound or bonded together their tendency to develop large differences of potential would finalise in the creation of spark discharges of a magnitude sufficient to set fire to the aircraft when in flight. This alone illustrates how important it is to provide for a complete, low-resistance "earth-bond" of all the metal surfaces and bodies incorporated in the aircraft structure.

Surface Contacts

These must be bare and clean; that is, where panels are riveted to a framework care should be taken to make sure that a good metal-to-metal contact is obtained; at frequent intervals or spacings, protective coverings or anodisings must be removed, either by emery paper or a suitable chemical, before the bond is attempted; then the surfaces re-treated or anodised again.

Should this, however, not be possible, such surfaces must be bonded together by aid of external connectors, these usually consisting of multi-stranded or plaited phosphor bronze (or copper) wires, quite flexible, terminating at either end in round-holed tags or connectors which are clamped and soldered to the wires or cable and thus used in conjunction with 4 or 6 B.A. bolts, screws and spring washers to effect the bond from metal-to-metal. In some instances fibre-covered aircraft nuts, specially manufactured for the purpose, are used.

Bonding Movable Elements

This type of flexible connector is also used to bridge turnbuckle joints in control wires, movable flaps and elevators, the latter, say, every 18 ins. or so. Additionally, where control wires must pass through a metal member, the hole is insulated with a fibre bushing to serve the dual purpose of minimum friction to lessen wear and tear and to alleviate disturbance from an otherwise metal-to-metal threading.

Tail Wheel Discharges Static on Ground Contact

Every metal section, component or wire is bonded as a complete one-piece body to act as an "earth" for the wireless installation, transmitter and receiver or receivers, the whole network or bridge-work then being connected to the tail wheel of the aircraft, which discharges resident static through a metal-dust tyre thread



View of the interior of the pilot's compartment of a Curtiss-Wright aircraft (Model 20), showing arrangement of instruments, new type control wheel and the "tell-tale" instrument panel.

on ground contact—when landing, or a spring-like wire brush trails the ground for this same purpose.

Bonding Composite Constructed Aircraft

Civil, and some "trainer" aircraft are composite in construction, that is, wood and fabric comprise the greater part of their surface areas generally, with a corresponding lessening of metal surface to act as an "earth." In these instances an artificial counterpoise is incorporated as a substitute, this usually being effected by attaching a strip of copper foil or other metal, of say, 26 s.w.g. x $\frac{1}{16}$ in. or $\frac{1}{32}$ in. along the full length of longeron and wing spars, bonded together so as to supply one "earth-frame." Then, all other metal parts of the aircraft, such as metal engine seats, instrument panels, etc., are incorporated into the bonding network and the whole, as one unit, bonded to the tail wheel.

Fuel Pipes and Tubing

These must be included in the bonded net, and where rubber joints are found in the conduit lines they are bridged by the flexible connectors; this not only to complete the binds, but for the additional reason that moving liquids cause potential differences to be set up or come into force.

Corrosion Guards

Connections to this artificial counterpoise must not only be thoroughly made, but zinc washers inserted between cable tags and the framework, a special type of wood screw being employed; the object of the zinc being to prevent copper corrosion from electrical action, all such fastenings being anodised or over-varnished.

Interference Suppression from Incorporated Electrical Devices

While the work thus far reviewed minimises fire risks from high-potential static charges of electricity and furnishes an "earth" or counterpoise for the radio equipment installed, it serves the further purpose of reducing considerably extraneous noises when receiving signals, more especially from any friction present owing to rubbing or vibratory metal elements. But, of course, it does not suppress that interference emanating from the sometimes elaborate electrical systems found in modern aircraft, neither does it suppress that magnitude of radiated interference set up by the ignition system as a whole, and which reaches the radio receivers via the electrical wiring installed.

Wiring Enclosed in Metal Ducts

Wiring cables are threaded through metal ducts or conduit which is earthed at intervals or entirely to provide an effective screen. Should electrical wiring not be thus enclosed, that known as metallised cable is employed, the metallising being carefully earthed. This also applies to battery cables, the screening being also applied to the batteries, which are enclosed in an earthed metal case or box.

Ignition Interference

Logically, the most effective way to alleviate ignition interference is to treat it at its source, though, admittedly, this presents some puzzling problems, inasmuch as the performance of the system, including that of the engine, must remain unimpaired. The system in operation to-day is to screen the entire H.T. ignition network, then earth the screening; heavily metallised "breeze" or flexible cable being utilised, securely bonded by aid of glands, to say, the metal body of a plug, the whole in metal tubing kept well clear of a cylinder block, but terminating in seven collars for attaching to a magneto. This complete string of leads is designated as the H.T. Harness, being the product of considerable research carried out by a pioneer manufacturer of radio equipment for aircraft.

Generator Suppressors

Generators installed in aircraft are of special design, being totally enclosed in metal and all casing earthed, metallised leads from them being also metal-covered with the cover earthed adequately at intervals.

Generator leads, too, are fitted with suppressors, these also being included between field coils and voltage regulators; really, these are low-pass filters offering little impedance to the passage of low-frequency currents, the design being such to permit the suppression of all radio-frequencies used, this without affecting the overall efficiency of the generator system; quite an achievement when one considers the all-important factor governing weight of such apparatus for inclusion in aircraft. The D.C. resistance and consequent voltage drop of such a generator is quite low.

Iron-dust Cored Inductances Used

Generally, inductances employed in the make-up of such suppressors employ iron-dust cores in order to reduce size and weight to the minimum, fixed condenser leads for them being kept as short as possible to minimise inductive efforts at high frequencies, so that such units are fitted in close proximity to the generator, or to

screening, or additional precautions may be applied to the radio apparatus proper in order to eliminate electrical noises which would seriously interfere with C.W. or R/T communication.

Receiver Screening

Radio receiving apparatus is enclosed in metal cabinets with low-resistance earth connections made up from large gauge copper bus-bars fitted with stout terminals; and should remote controls be attached to the apparatus their outer casing is earthed to avoid frictional or other interference when tuning, a condition of importance when apparatus is resonating on high frequencies or possibly weak reception of signal.

Aerial Screening

The screening of aerial leads is strictly necessary if the lead-in runs for any distance inside the aircraft, though in the main the installation is planned as to layout with a view to keep such leads as short as possible. Coaxial cable may be met with in the more modern aircraft.

D.F. Cables

Extremely effective screening of D.F. cables must be carried out, more especially when high-gain receiving systems are installed, both for visual indication or sound, and the screening must not reduce signal strength of the high radio frequencies, so that here again coaxial cable is used.

In military or multi-seater aircraft it is of paramount importance for the crew to be in constant inter-communication, so that in this type of aeroplane inter-communication amplifiers are installed. In smaller aircraft, the L.F. stages of a receiver may be used for a similar purpose.

Microphone and Telephone Cables

Where such amplifiers are in use microphone and telephone wiring must run through the interior of the aircraft, this presenting another screening problem, and one often needing constant inspection to assure smooth functioning. Admittedly, within certain limits, liberties may be taken with telephone wiring; but not if it is to carry a lot of H.T.; in any case where cable screening was not employed cable insulation would have to be very reliable.

Extension of microphone leads needs to be judiciously carried out, otherwise feedback troubles will be in evidence at defined frequencies more especially with carbon-button and electric-magnetic microphones, more so with the latter, since, due to a much lower output, greater amplification is needed for inter-communication or modulation operation.

So that metallised cables housing such leads are earthed approximately every eighteen inches, and where one side of the microphones or headphones may be found earthed at the source only, it is good practice, where a long lead is encountered, to extend the earth-return at every three feet or so. Headphone leads are, too, adequately screened and earthed, the cables being generously insulated. The main objective to reach when undertaking this class of installation, that is, bonding and screening as a whole, is to bear in mind that a uniform electrical potential is absolutely necessary to get efficiency from the radio apparatus installed. This, together with the precautions against fire, constitutes the purpose of the binding together of all the metal parts and terminating them at the tail wheel for discharge, including the connecting of all screening metals to the one or common bond.

Testing and Maintenance

The work needs frequent testing and inspecting for breaks in the system due to vibration; close inspection and appropriate continuity and insulation tests being undertaken with either a battery and buzzer equipped with test prods, from which the expert recognizes changes in resistance values from changes in buzzer note, or a meter and battery arrangement is used, possibly incorporating a milli-voltmeter and an ammeter, the former calibrated in ohms, for obtaining a reading between bonded sections of the aircraft that shall not read in excess of 0.025 of an ohm.

Practical Hints

A Motor Wavemeter

RECENTLY I wished to make up a wavemeter and, not wanting to go to the trouble and expense of the valve type, I hit upon the following novel arrangement.

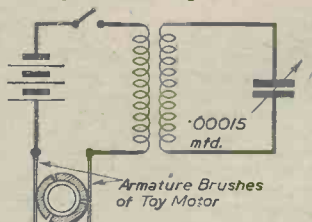

A novel idea for a motor wavemeter.

A small toy electric motor was used as the "signal generator," and this was coupled to a short-wave coil in the manner shown in the diagram. I used a low-consumption motor, which drew about half an ampere, and this was mounted in a box with a 3-volt cycle lamp battery as the motive power, the coil protruding from the box as is normal in this type of instrument.

It is, of course, necessary that the motor should be self-starting, and a three-pole armature ensures this. In use, the wavemeter is calibrated by tuning in half a dozen stations on any short-wave receiver, the stations being spaced over the dial. The wavelength of the stations being known, it is a simple matter to calibrate the instrument.—WM. NIMMONS (Belfast).

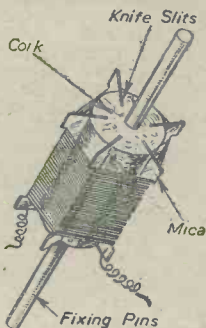

An inexpensive choke made from odd parts.

Easily-made H.F. Choke

HERE is a cheap and easily made H.F. choke from parts taken from the junk box. The advantage of this choke is that it may easily be made, or altered, to suit any desired frequency. By boring a small hole in the baseboard or panel of a set, the choke may be plugged in at any desired angle, to offset stray magnetic influences, or the coil could be so wound to bring about the same effect. I have used this type of coil since the very early days of wireless, and the capacity losses are very low.—R. HEATON (Halifax).

Combined Radio and Telephone

AFTER seeing the hint from Wm. Nimmons (Belfast) in the May PRACTICAL WIRELESS, I thought the accompanying circuit of the combined radio and easily operated two-way telephone I have been using would be of interest. A radio set, preferably having an L.F. volume-control, is used and the speakers are choke-capacity fed to enable an earth-return to be used, and also to make possible the use of only one D.P.D.T. switch, which, if of the quickly operated type, makes conversation easy. An ordinary inter-valve transformer can be used to feed the pick-up terminals, and, with many battery sets, one winding of an L.F. transformer can also be used for the output feed choke. The two-way switch switches the extension speaker from microphone to radio.

In these days when H.T. batteries are scarce and expensive, the old idea of shunting them with a large (2 mfd.) condenser is well worth while, as, by preventing

THAT DODGE OF YOURS!

Every Reader of "PRACTICAL WIRELESS" must have originated some little dodge which would interest other readers. Why not pass it on to us? We pay £1-10-0 for the best hint submitted, and for every other item published on this page we will pay half-a-guinea. Turn that idea of yours to account by sending it in to us addressed to the Editor, "PRACTICAL WIRELESS," George Newnes, Ltd., Tower House, Southampton Street, Strand, W.C.2. Put your name and address on every item. Please note that every notion sent in must be original. Mark envelopes "Practical Hints." DO NOT enclose queries with your hints.

SPECIAL NOTICE

All hints must be accompanied by the coupon cut from page 38.

crackling and L.F. instability, it extends the life of the battery by several months by enabling the set, especially if fitted with automatic G.B., to use it down to the last few volts. I fit a large condenser in all my sets and have often had its value brought home to me. The condenser should also enable old and new H.T. batteries to be connected in series, although I have never had occasion to do this as, by using a condenser, the few volts (10 or less) left in the old battery has never made it worth while. If tapping points are used on the H.T. battery it is advisable to connect a 2mfd. condenser between these and the negative.—R. V. GOODE (York).

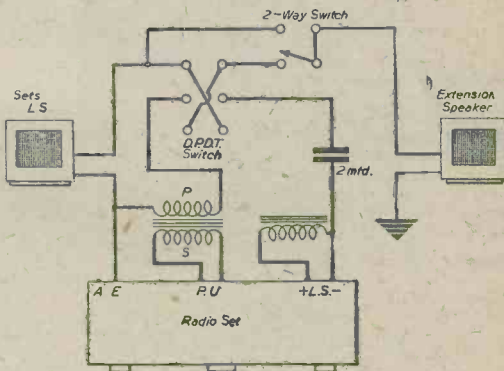

A simple system for a combined radio and telephone.

A Pocket Morse Key

A FRIEND of mine recently joined the R.A.F. as a wireless operator, and he was very keen on keeping his morse sending up to standard, but the usual complaint cropped up: the ordinary morse key wasn't very handy for carrying around. I therefore decided to make a compact lightweight key which could be carried very easily in a pocket, and which, when finished, proved to be very efficient. The construction of the key is very simple, the components needed being an old push-pull switch and a wall switch combined. The sketch clearly shows how the parts of the new key are put together.—DUNCAN MCINTYRE (Bonnybridge).

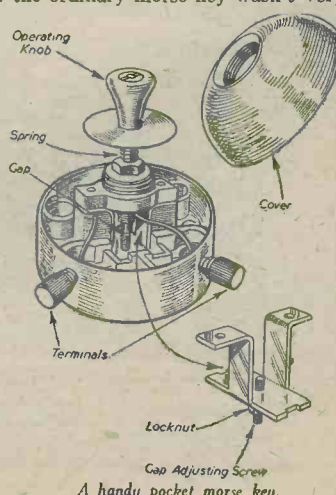

A handy pocket morse key.

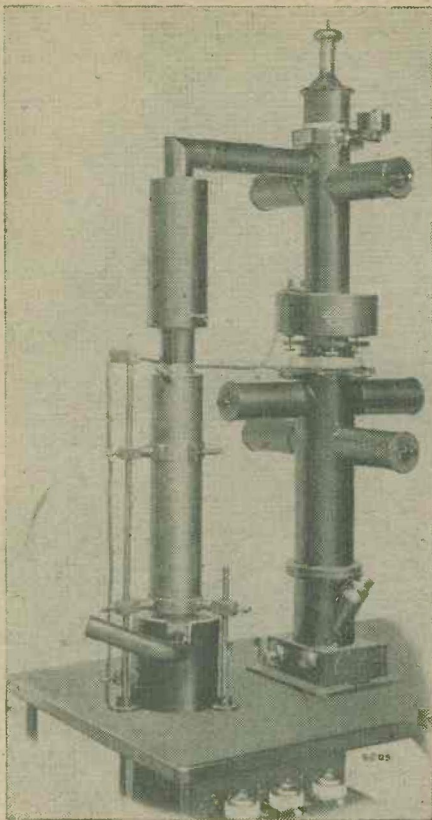

Fig. 1.—The Finch Cathode-ray Oscillograph.
Photograph by courtesy of Cambridge Instrument Co.

MODERN electrical engineering demands the investigation not only of very high frequency phenomena, but also of the behaviour of equipment when subjected to transients whose rate of rise may be several thousand kilovolts per second. To meet these requirements the Cambridge cathode-ray oscillograph of the Finch type was developed.

The cathode-ray instrument enters the field of oscillography where the Blondel and Duddell mechanical types, owing to the inertia of their moving systems, meet a frequency recording limit at about 5,000 cycles per second. Although the cathode-ray oscillograph may be used on power and audio-frequency circuits, it is

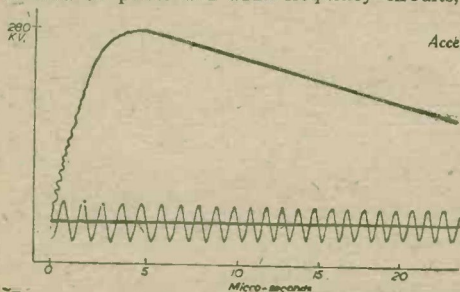

Fig. 4.—270 kv. Impulse Wave. Oscillogram taken to determine time constant of wave. Time constant about 37 microseconds.

The Cathode-ray

A Brief Description of the Construction of Various Parts of the Finch

chiefly intended for work at radio frequencies or for recording transient phenomena. The high velocity of the cathode stream permits the distortionless recording of transients having a total duration of less than one microsecond, and, since the deflection of the ray may be brought about electrostatically, negligible loading is imposed on the circuit under investigation.

Instruments of the sealed-off glass tube hot-cathode type are limited in their performance by the low accelerating voltages used, and by the gas focusing method employed. These factors prevent the clear recording or even viewing of high-speed transients or phenomena at frequencies over 100 kilocycles per second. Records with these instruments are obtained by photographing with a camera and lens the trace visible on a fluorescent screen at the end of the tube. The loss of recording speed by this method is severe. In addition this type suffers from the disintegration of the cathode under bombardment, and the burning and fatigue of the fluorescent screen. Neither of these is renewable.

These difficulties are overcome in the cold-cathode type of instrument, by employing the movement, in a high vacuum, of a pencil of high-speed cathode rays to record by direct impact on a photographic plate or film placed in the vacuum. In addition, since the whole instrument is of metal and is demountable, cathode and screen are readily renewable at will.

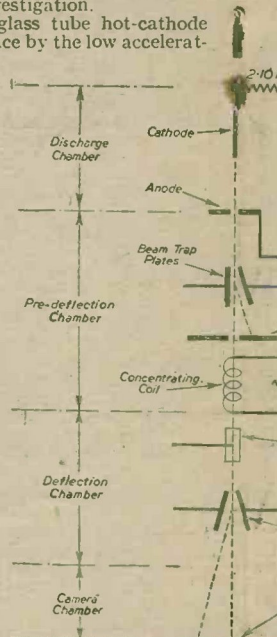

Fig. 2.—Schematic diagram illustrating the construction of a cold-cathode-ray oscillograph.

The Cathode Beam

The cathode beam is generated in a gas discharge tube (Fig. 2) and consists of a stream of rapidly moving electrons which may be deflected by a magnetic field or by a system of charged electrodes placed near their path. The cathode is maintained at a potential varying from 10 to 70 kilovolts negative to the earthed anode

Reproduction of Typical Records

Accelerating voltage 48-50 kv. Discharge tube current 1.5-2mA.
Anode diaphragm 0.25mm. diameter.

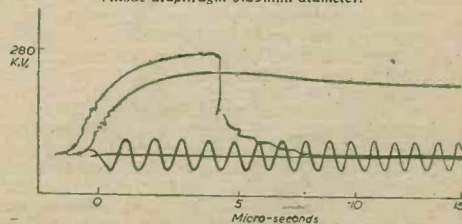
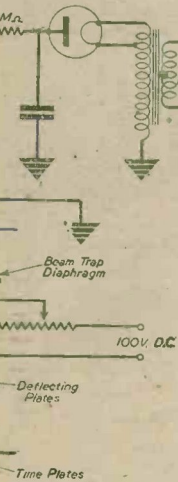

Fig. 5.—Insulator test record showing (a) Impulse wave used. (b) Breakdown.

Cathode-ray Oscillograph

Construction and Functions of the Finch Type of Instrument

which is pierced with a small hole or diaphragm; the part of the discharge passing through this orifice forms the cathode ray beam from which the instrument derives its name. An axial magnetic field produced by a solenoid surrounding the tube concentrates the slightly divergent electron beam and brings it to a sharp focus on a photographic plate or film, or on to a fluorescent screen in the camera. During its passage from anode to screen the beam passes between two pairs of deflecting plates set at right-angles to each other. Potentials applied to these plates cause a deflection of the beam which is proportional to the voltage.



The range of a cathode-ray oscillograph is limited in the main by two factors: the electrostatic sensitivity and the photographic sensitivity. The former limits the deflection on the screen for a given potential applied to the deflecting plates and the latter limits the recording speed. The electrostatic sensitivity (in millimetres deflection on the screen per volt applied to the deflecting plates) is directly proportional to the length of the deflecting plates, to the distance of the mid point of the plates from the screen, and inversely proportional both to the accelerating voltage applied between the anode and cathode and the distance apart of the deflecting plates. The photographic sensitivity is proportional to the square of the accelerating potential. As there is a practical limit to the length of the deflecting plates and the distance to the screen, the only two factors which may be conveniently varied are the accelerating voltage and the distance apart of the deflecting plates. In the oscillograph described, provision is made for both of these adjustments. For visual work or for comparatively low frequencies, a cathode to anode voltage of as low as 10 kilovolts

Showing the working of the oscillograph.

accelerating voltage and the distance apart of the deflecting plates. In the oscillograph described, provision is made for both of these adjustments. For visual work or for comparatively low frequencies, a cathode to anode voltage of as low as 10 kilovolts

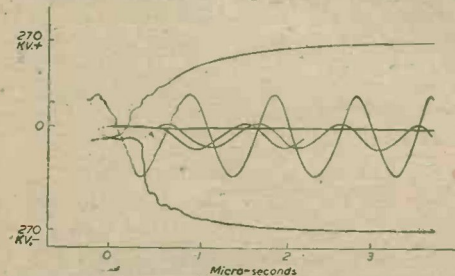

Fig. 6.—Showing (1) Negative impulse wave. (2) Positive wave front showing how a series damping resistance lengthens the wave.

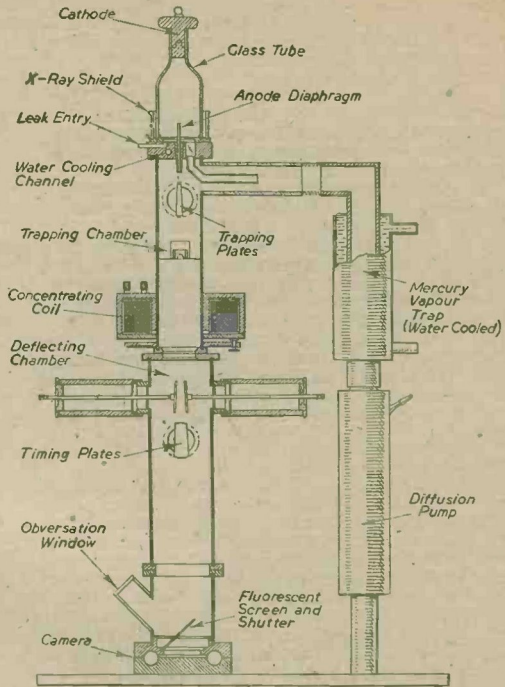

Fig. 3.—Sectional view of the instrument as described in the text.

may be used, whilst for short-duration transients or for steep-fronted surge recording, the voltage may be raised to a maximum of 70 kilovolts. The maximum voltage sensitivity at different accelerating voltages is shown in the table below.

Accelerating voltage	Deflection in mm. per volt (max.)
10 Kilovolts	0.4 mms.
30 "	0.12 mms.
50 "	0.08 mms.
70 "	0.06 mms.

The Finch Oscillograph

Fig. 1 shows the complete oscillograph which has been constructed on the lines suggested by Prof. G. I. Finch. It is composed of four sections—the cathode or discharge

chamber, the predeflection chamber containing a beam trap device, the deflection chamber, and the camera. The joints between sections are accurately ground metal to metal greased seals. With the exception of the glass tube of the cathode chamber and the electrode supports, the oscillograph is constructed entirely of metal. By the substitution of another section for the deflection chamber, the oscillograph may be converted into an electron diffraction camera for the examination of metallic surfaces or films, etc.

The discharge chamber consists of a glass tube supporting at one end a heavy metal flange carrying the cathode

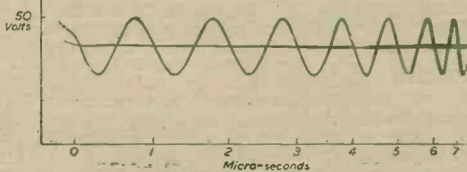

Fig. 7.—Oscillations 1,000,000 cycles per second: approximate exponential time base.

in the form of an aluminium rod. This rod has a removable tip so that when the cathode surface becomes pitted, another tip may be easily fitted. Lead shielding of the lower portion of the discharge chamber affords protection to the operator from X-rays generated at the anode. The "anode block" (see Fig. 3) is water cooled and holds, in a removable taper plug, the anode diaphragm. The aperture used largely depends upon the speed of the phenomena to be recorded. Three diaphragms which may be interchanged in less than one minute are normally supplied, having diameters of 1.0, 0.5 and 0.25 millimetres respectively, the largest diameter being for the fastest recording speed. The anode block also contains the inlet of a specially designed "leak" by means of which air is slowly admitted to the discharge chamber to maintain the correct degree of vacuum for the gas discharge forming the beam. The discharge chamber is evacuated by means of a tube which leads into the main evacuation pipe of the oscillograph (see Fig. 3). This tube acts as an "injector," and any mercury vapour tending to diffuse through to the apparatus from the pump is driven back. A butterfly valve, placed in the opening to this injector tube and situated in the anode block, enables a fine control of the gas pressure in the discharge chamber to be obtained.

Predeflection Chamber

In the predeflection chamber is a "beam trap", or relay to prevent photographic fogging by withholding the beam from the film or plate until the phenomena is to be photographed. The trap consists of a pair of small deflecting plates below which is placed a diaphragm (Fig. 2). When these deflecting plates are at earth potential, the beam passes between them and through the hole in the diaphragm to the screen. If, however, a d.c. potential is applied to one plate, the beam is drawn aside and is arrested by the diaphragm. In practice, the trap circuit is so arranged that the random transient to be recorded itself releases the beam, which, after traversing the photographic plate, is automatically withdrawn. It can also be arranged that just before a transient voltage is applied to the deflecting plates, the trap releases the beam and the whole of the transient is recorded. A concentrating coil (Fig. 3) surrounds this section of the oscillograph, and focuses the electron beam. The normal current for this coil is approximately 0.15 ampere, with a maximum of 0.25 ampere at 100 volts. Below the concentrating coil, and immediately above the deflecting plates, a set of two pairs of biasing coils are placed for centring or moving the beam to give multiple records with different zeros on the same plate.

The deflection chamber contains two pairs of aluminium deflecting plates carried on double sheathed clear quartz tubes held in highly insulating discs cemented into ports in the main tube of the oscillograph. The deflecting plates are insulated for a steady applied potential of 40 kv. and will safely withstand transient voltages of 60 kv. If required, deflecting plates may be fitted whose distance apart, and thereby sensitivity, can be continuously adjusted whilst the instrument is under vacuum. Protecting covers of ebonite are normally placed over the projecting quartz tubes, but are removed when high voltages are applied. Timing plates are placed below the deflecting plates so that the beam may be moved in a direction at right-angles to that due to the deflecting plates. The timing plates may be connected to circuits arranged to give the spot either an exponential or linear sweep across the plate. When any one of the deflecting, timing or trapping plates is earthed, screening covers can be supplied for complete electrostatic shielding.

Camera Details

The camera is designed to take a 6 × 9cm. plate or an eight-exposure roll film, the plate or film being inserted by sliding aside a brass plate. When films are used the camera is daylight loading, but a darkened room is necessary when plates are used. The aperture beneath which the film or plate is situated is covered by a lead-lined shutter, the upper side of which carries a removable aluminium plate covered with fluorescent material. After-fluorescence persists for a few seconds

after the transit of the electron beam, so that even the fastest transient to be photographed may thus be inspected visually before exposing the film or plate. Two observation windows are provided, enabling two observers to view the screen from different angles. Light-tight caps cover these windows before exposing the photographic surface. The instrument is capable of a photographic recording speed of at least 20,000 kilometres per second.

The D.C. accelerating voltage is obtained from the secondary side of a transformer through an X-ray type rectifying valve, the combination being capable of giving a voltage from 10-70 kv. to the oscillograph.

The instrument is evacuated continuously by either a 3 or 4-stage mercury vapour diffusion pump backed to a few millimetres of mercury by a small oil-sealed rotary pump. When the pumps are warm, the oscillograph can be evacuated from atmospheric pressure in 6 minutes. A water-cooled mercury vapour trap is included in the evacuation system, the injector previously described sufficing to keep back the mercury vapour, provided the temperature of the cooling water does not exceed 20°C. A carbon-dioxide snow-cooled trap is provided if desired.

Applications

The advantage of the cold-cathode type of oscillograph over other types of cathode-ray instruments is primarily its high recording speed. It is capable of clearly recording photographically rapid transients and recurring phenomena at frequencies above 100 kilocycles per second. Typical applications are:

1. Transient phenomena associated with high voltage generators.
2. Switching surges on high voltage transmission lines.
3. Lightning surges on high voltage transmission lines.
4. Fault location on transmission lines.
5. Determination of wave shapes of artificial lightning surges.
6. Flash over characteristics of insulators.
7. Lightning arrester operating characteristics.
8. Investigation of circuit breakers operating under abnormal conditions.
9. Surge-voltage performance of induction motor or transformer windings.
10. Determination of wave-shapes—high or low frequency.
11. Characteristics of mercury vapour rectifiers and lamps.
12. Behaviour of Piezo crystal oscillators.
13. Characteristics of power amplifiers.
14. Characteristics of high-frequency oscillators.
15. Investigation of "wireless echoes."

A SIMPLE BAND INDICATOR

WHEN using a set of plug-in coils I find it necessary to keep checking which range I am working on. In an effort to facilitate this, I adopted the following dodge, which may be of interest to other readers:

Instead of using a four-pin coil-former, a six-pin

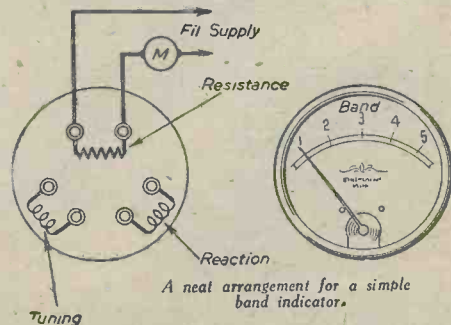

holder is used, the extra two pins being bridged by a small resistance. A cheap voltmeter is re-calibrated, and included in the circuit, as shown. The wire for the resistance is taken from a burnt-out volume-control and a different value included in each coil-holder. These values can be calculated from Ohm's Law, knowing the resistance of the meter, and the voltage of the filament supply.—H. D. SMITH (Kirkby-in-Ashfield).

The Importance of Harmonics

An Article Which Makes Clear the Meaning and Effect and Their Importance to Radio Reception

THE term "harmonics" is so frequently associated (in technical literature) with distortion, that listeners may be pardoned if they form the impression that harmonics are noxious things to be avoided at all costs. Yet this is quite an erroneous idea, for harmonics are perfectly normal phenomena and, when naturally produced, are in no way an annoyance—indeed they are essential to good reproduction. Distortion, in one of its most distressing forms, is simply a matter of harmonics in the wrong place.

There are few listeners who do not know that sound is the result of air vibrations, that these vibrations have definite frequencies ranging up to about 20,000 per second, and that the frequency determines the pitch of a note, shrill notes being of higher frequency than deep notes.

Notes and Harmonics

It is, perhaps, not quite so well known that a simple note consisting of a single frequency is of comparatively rare occurrence, in fact, is only experienced in certain scientific instruments specially designed to give a simple frequency.

All normal musical notes are more or less complex in nature, consisting of the basic frequency or "fundamental" which gives them their general pitch, and a varying number of additional frequencies bearing simple numerical relationships to the fundamental, such as twice, three times, four times the fundamental frequency, and so forth. The number and relative strengths of these additional frequencies of "harmonics," as they are termed, give the note its characteristic "tone," and enable a differentiation to be made between the notes of a violin and, say, a piano.

It will, therefore, be obvious that if for any reason the proportion of harmonics is upset either by the suppression or partial suppression of some or by the addition of others, a form of distortion will occur, and the ear will recognise that the sound is not of the tonal quality which one would expect.

Two further things must be explained, the first being in connection with the nature of music and noise. It has been explained that practically all musical notes are of complex harmonic structure; but that structure is still sufficiently simple for the ear to analyse it and recognise its characteristic quality; and a musical note is therefore more or less pleasing to the ear. If, however, a sound is of such a type that the ear cannot analyse and appreciate it, we no longer call it a musical note, but a noise. A sound becomes a noise if either or both of two things occur; first, if the number and strengths of the harmonics are such that the sound is too complicated or unfamiliar for the ear to recognise it as music; second, if the duration of the sound is so short that the ear has not time to analyse it.

The other point is that certain harmonics are more distasteful to the ear than others. It is not difficult to understand why this should be, if the table included here is examined.

In this table there are four columns, the first giving the number of the different harmonics, the second the musical name of the corresponding note, taking the C below middle C of the piano as the fundamental, the third giving the mathematical value of the corresponding

frequency, and the fourth the actual frequency of the note as tuned on a piano.

The Effects of Odd and Even Harmonics

It will be observed that by successively doubling the frequency the pitch is raised one octave, so that the second, fourth, eighth and sixteenth harmonics of the fundamental correspond to the different "Cs" on the piano, each one octave above the other. Clearly these harmonics cannot produce a discord, and an excess of them merely produces the effect of a shriller overall pitch. Moreover, the true pitch and the tuning pitch of all these Cs are identical. Now take the third harmonic—it is the G above the first octave, and the sixth and twelfth harmonic and so on are also Gs. Sound these notes together on your piano—the fundamental C, the upper Cs and the Gs, and you will not find them unpleasant. Even the fifth and tenth harmonics representing the Es are not too bad, and in all these notes the true and musical pitches are not very different. But now try playing the seventh, ninth, eleventh, and thirteenth harmonics as shown in the table, together with the fundamental, and you will be rewarded with "a horrid noise." So we see that if harmonic distortion is present, that due to the even harmonics is not so unpleasant as that due to the odd harmonics, and this has an important bearing on the design of "quality" radio equipment.

To see how spurious harmonics may be produced in a radio receiver refer to Figs. 1 and 2, which show respectively a fundamental wave with a second and third harmonic, and how these three waves can be combined into a single wave. Now just as fundamentals and harmonics can be combined to produce a more complicated wave form, so can any complicated wave form be analysed into a fundamental and a number of harmonics. So the musical wave form of the signal in a radio set represents the combination of the various harmonics forming the notes broadcast, and can be analysed by suitable apparatus. But if anything should occur in the set to distort the wave form, to change its shape, then the new wave form, if analysed, would show quite a different combination of harmonics—harmonic distortion would have occurred.

Overloading

The usual form which harmonic distortion takes is due to partial rectification of a low-frequency signal, commonly known as overloading, and it can be proved both mathematically and experimentally that the practical result of overloading is to introduce additional

harmonics. This gives a spurious shrillness to the reproduction and, if distortion is considerable, a very unpleasant quality results.

Several important and interesting points now arise. In the first place, overloading a triode valve produces in the main a range of even harmonics which, as has been shown, is not quite so unpleasant as odd harmonic contamination. A pentode, on the other hand, produces a greater proportion of odd harmonics than a triode. Thus, when it is stated that a pentode is more easily overloaded than a triode, this is only part of the story. On account of its greater sensitivity a pentode is over-



Fig. 1.—Curves of the fundamental frequency and its second and third harmonics.

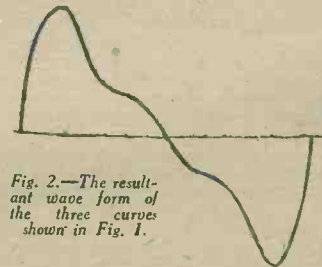

Fig. 2.—The resultant wave form of the three curves shown in Fig. 1.

loaded before a triode, but, in addition, the result of overloading a pentode is far more disastrous from the quality point of view than in the case of a triode, owing to the greater odd harmonic content of the output.

Valve Limits

Valve manufacturers quote optimum loads, maximum signal handling capacities, and similar data based upon reasonably good reproduction. This is usually taken as five per cent. second harmonic distortion in the case of triodes, but a pentode may be operated at five per cent. second harmonic distortion, or even less, and still give very bad reproduction, simply because the more deadly third and other odd harmonic distortion is very much greater. It is as well, therefore, to obtain the fullest possible information concerning the characteristics of any valve used in the output stage. No one wants three watts of output containing, say, ten per cent. total harmonic distortion if, by limiting the input and taking a slightly smaller maximum output, the harmonic content could be reduced to five per cent. or even less.

The next point of interest is that certain valve arrangements automatically produce a lower degree of harmonic distortion than others. The most important of these is the push-pull circuit in which the even harmonics in the outputs of the two valves cancel out each other. As a result, two triode valves operated in push-pull will give an output remarkably free from harmonic distortion, even when they are slightly more heavily loaded than is permissible with single valves.

On the other hand, push-pull with pentodes, while quite successful from most points of view, does not give so great an improvement.

Other Causes

It has been indicated that harmonic distortion is

mainly due to partial rectification of the audio-frequency signal, and usually occurs as the result of applying to the grids of valves signals too great for them to amplify with perfect fidelity owing to the curvature of their characteristics. It may also be due to insufficient or excessive negative grid bias, or to the failing emission of an amplifying valve. The remedy in each case is obvious, namely, a judicious use of the volume control, correct adjustment of grid bias, and a watchful eye on the anode currents of the various valves, particularly the detector and low-frequency stages.

Another cause of harmonic distortion is saturation of

Harmonic Fundamental	Notation	Mathematical Frequency.	Piano Frequency
	C	129	129
2nd	C	258	258
3rd	G	388	388
4th	C	517	517
5th	E	647	652
6th	G	776	775
7th	B Flat	905	922
8th	C	1035	1035
9th	D	1164	1161
10th	E	1293	1304
11th	G Flat	1423	1463
12th	G	1552	1550
13th	G Sharp	1681	1642
14th	B Flat	1811	1843
15th	B	1940	1953
16th	C	2070	2070

a low-frequency transformer by the passage of an excessive D.C. component of the anode current. This can be obviated by the use of generously-designed transformers, or by adopting the resistance-fed arrangement of coupling.

Voltage Regulation

What the Term Means, and How it Affects Performance

MUCH has been said of the necessity for good voltage regulation in the power pack, and few amateurs seem to know what trouble accrues if the voltage regulation is not good. First and foremost, bad voltage regulation adversely affects quality of reproduction. The effects of bad voltage regulation will be more readily understood when it is realised that a power pack deficient in this quality changes its voltage output with current. The greater the current drawn, the lower will be the voltage. The power valve invariably takes the bulk of the H.T. current, so we can consider the behaviour of this valve as being primarily important. As the grid of the power valve is modulated, it becomes alternately negative and positive. When the grid becomes negative, the anode current is small, and when the grid is positive, the anode current is considerable. If the voltage regulation of the anode supply is bad, it follows that when the grid becomes negative the voltage between anode and cathode rises more than is justified by the input, and when the grid swings positive the anode voltage falls to a value dependent upon both the load in the anode circuit and the drop in H.T. voltage from the power pack.

Distortion Introduced

This results in the wave-form in the output circuit being unequal on the negative and positive half-cycle the distortion introduced in this way affects not only the power valve, but the detector valve, where the rise and fall in the anode supply voltage results in an effect that may be likened to low-frequency reaction. This, if in phase, results in a tendency for reproduction to have a fringe of ragged edge, or if out of phase, a falling off in sensitivity, which is, however, too small to be seriously considered.

The H.F. Circuits

The effects of bad voltage regulation in the H.F. side can be equally serious, but manifests itself in another way. Assuming that a receiver is of the superheterodyne type, where several valves are controlled by the automatic volume control, the effect is to offset somewhat the functions of the latter. When the incoming signal starts to fade, the bias of those valves with variable-mu characteristics automatically recedes and the anode current rises, and the magnification of the valve increases, the latter overcoming or partially overcoming the effects in the fall of the signal strength; but with bad voltage regulation, as the anode current rises the anode voltage falls, and so does the amplification of the valve, particularly as the screen voltage falls at the same time. Where automatic volume control is not in use, no serious results are apparent. Those readers who use a neon tuning indicator can see the effects of bad voltage control by a movement of the neon light in sympathy with the music being received, e.g., the six time pips from Greenwich result in the light popping up six times. Care should be taken, however, that the fluctuations in the light are not due to detector overloading, as the behaviour of the light is similar.

NEWNES' SHORT-WAVE MANUAL

6/-, or 6/6 by post from

George Newnes, Ltd., Tower House, Southampton St., London, W.C.2.

How Meters Work

An Instructive Description of the Operating Principles of Various Types of Meters Used for Radio Work.

ENGINEERS recognise two methods of testing, namely qualitative and quantitative. The two terms are almost self-explanatory, but a simple example will serve to show the real difference between the two. Suppose you find that your radio receiver is not giving the volume to which you are accustomed; for some reason or another you suspect that all is not well with the output stage. You remove the output valve from its holder and replace it temporarily with one borrowed from a confiding friend. It operates perfectly and volume is restored; you had hit upon the faulty spot first time.

Apt to be Slow

But it does not always work out thus. Suppose that when you fitted the substitute valve things were no better than before. Then you would have to suspect some other part of the equipment and examine or replace each in turn until at last you found the seat of the trouble. Or, worse still, what if the original trouble was that your valve had been ruined by some wrong connection or short circuit within the set, and that when you experimented with your friend's valve you ruined that too? No, except for a few simple and obvious faults, qualitative testing is too slow, too uncertain, and sometimes too dangerous.

On the other hand, imagine that you possess some simple and cheap measuring instruments—a milliammeter, say, and a voltmeter. When your set showed symptoms of trouble you could have measured the anode current of the output valve. If you found the reading was below normal, you would know at once that one of a certain number of things had occurred. Either the valve had lost a part of its emission, or the high-tension voltage had fallen considerably, or the grid-bias voltage was too high, and so on. Then you could make further tests in order to discover the exact cause of the poor performance. Quantitative testing is quick, simple, and final.

In the early days of radio, when sets and circuits were comparatively simple and the average standard of performance low, qualitative testing was sufficiently speedy and accurate for most amateur needs. To-day, however, circuits are relatively complicated, and components have a high order of efficiency. Mathematically accurate adjustment is the order of the day, and very small errors in adjustment bring serious consequences in loss of selectivity, sensitivity, stability, and quality.

A Mistaken Impression

It is often thought that testing instruments are an expensive luxury, and this accounts for the fact that only a very small proportion of even those who call themselves serious radio amateurs possess even the simplest gear for carrying out accurate tests. This is, however, quite a mistaken notion, for quite valuable results can be obtained by means of most inexpensive and simple equipment.

Before describing the various types of instruments available and the quickest methods of conducting tests

with their aid, it may be of assistance to outline briefly what quantities are most suitable for measurement, and the principles involved in the process.

In the first place it is necessary to realise that all the happenings in a radio set are, in effect, the passage of electric currents of different kinds, some constant in value, and some of varying strength. It is upon the correct values and behaviour of these currents that the set operates.

Like all electric currents, those occurring in a radio receiver are primarily due to the existence of electric pressure—voltage—applied by some apparatus capable of developing that pressure. This may be an electric battery, as in the case of an accumulator for low-tension supply, or a dry high-tension battery; or again, it may be the electric light mains, the pressure of which is generated by a dynamo at the power station. In any case, there must be a voltage before an electric current can pass.

Two Factors

Further, however great the voltage, no current can exist unless there is a complete circuit along which it can pass. The breakage of a wire, the disconnection of some component, or the fracture of a soldered joint will interrupt the path along which a current should travel, and the current will no longer exist.

The strength of the current depends upon two factors: first the amount of the voltage, and second the extent to which the circuit offers opposition to the passing of the current. This opposition is termed resistance, which is a property possessed by all materials to a greater or less degree. It is clear, therefore, that for a large current to pass through a circuit of a given resistance a bigger voltage will be required than for a small current; and similarly for a current of given value to pass through a high resistance a larger voltage will be required than will be necessary to drive the same amount of current through a smaller resistance.

Thus it will be seen that, in the great majority of instances, tests upon the condition of a receiver will consist of ascertaining whether currents of the correct strength are passing in the different circuits forming the set; so that it is desirable to have at hand apparatus for measuring fairly accurately the strength of electric currents.

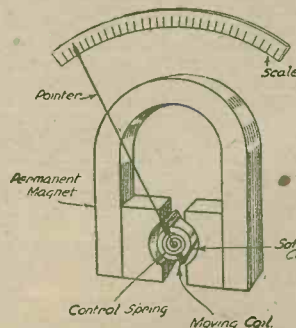

Fig. 2.—Illustrating the elementary principles of a moving-coil instrument.

Then, if our current tests show that the current values are not correct, we shall know for certain that one or other of the factors which govern the correct strength is at fault.

In order to measure anything, be it length, weight, or electrical quantities, it is necessary to have a standard or unit of comparison. Thus lengths are measured in feet or yards; weights in pounds or tons; and electrical quantities have a special set of units of their own.

Electric current strength is, as most listeners know, expressed in amperes. Very few currents in a receiver amount to more than a fraction of an ampere—the

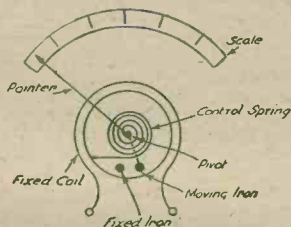

Fig. 1.—Simple diagram explaining the principle of a moving-iron instrument. This illustration does not show the actual form of movement.

exception is the low-tension current of an A.C. mains set which amounts to about one ampere per valve. So quantities less than a tenth of an ampere are usually measured in milliamperes, one milliamp. being one thousandth part of an ampere.

Electric pressure is measured in volts. Very small voltages may be expressed in millivolts (thousandths of a volt) or even micro-volts (millionths of a volt) but such delicate measurements need very expensive instruments usually beyond the reach of amateur listeners.

Finally, resistance is measured in ohms, very high resistances being sometimes expressed in megohms. A megohm is, of course, one million ohms.

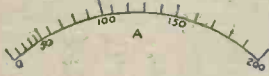

Fig. 3.—Comparison between scales of moving-iron and moving-coil instruments. A. Moving-iron (crowded at bottom). B. Moving-coil (equally divided).

commonly known as Ohm's Law, which states that the current in amperes is equal to the pressure in volts, divided by the resistance in ohms.

The simplest form of measuring instrument, and that upon which all other indicating meters are based is the ammeter or milliammeter (the name depends upon whether it will measure currents of large or small intensity). Of the many types of these instruments, only two are likely to be handled by the amateur, namely, moving-iron instruments and moving-coil instruments.

Following a Law

Next, it is important to remember that there is an exact and never varying relation between the direct current flowing in a circuit, the voltage producing it, and the resistance which limits its value. This relation is contained in a formula,

In the moving-iron instrument the current to be measured is passed through a fixed coil of wire within which are two pieces of iron, one fixed in position and the other capable of moving about a central pivot, see Fig. 1. When the current to be measured passes through the coil it produces a magnetic field, and both pieces of iron are magnetised in the same direction. They consequently repel each other, with the result that the piece which is pivoted moves away from the fixed piece.

The movement of this piece is opposed by a spiral spring, and the amount of movement depends upon the magnetising force which, in its turn, depends upon the strength of the current. A pointer attached to the pivot moves over a scale, thus indicating the amount of deflection of the iron and hence the strength of the current.

Moving-coil Instrument

The second type of instrument is known as the moving-coil instrument. It consists of a permanent magnet, usually of the horse-shoe type, between the poles of which is pivoted a coil of wire as indicated in Fig. 2. The current to be measured passes through the coil of wire which is, of course, magnetised. Mutual attraction and repulsion between the poles of the magnet and the poles of the coil takes place, and the coil, being free to move against the pressure of a spiral spring, is deflected to an extent depending upon the current strength, its deflection being indicated by a pointer which passes over a graduated scale.

In practice the moving-coil instrument is preferred to the moving iron, chiefly because it is more accurate, and because the scale is more "open." (Fig. 3.)

It must be remembered, however, that moving-coil instruments are only serviceable for direct current measurements, while moving-iron instruments may be used for either direct or alternating currents.

An A.F.C. Condenser Drive

A Motor-driven Unit for the Experimenter

IN automatic frequency control (A.F.C.) circuits using a motor-driven condenser to do the automatic fine tuning, difficulty is often experienced due to the inertia of the moving parts causing the condenser to over-run the correct position and produce "hunting." This disadvantage may be overcome by using the arrangement shown in the accompanying illustration.

Referring to the diagram, a reversible electric motor 1 with rotor shaft 2 is connected to a vernier condenser 4 through the coupling member 3. The vernier condenser shaft 5 is in turn coupled to the main condenser 6, but through a lost motion coupling device 5a, 5b. The lost motion coupling comprises a slotted sleeve 5b secured to the main condenser shaft, and a pin 5a on the vernier condenser shaft, which fits loosely in the slot and so permits lost motion to occur between the main and vernier condensers.

Both condensers are included in the circuit to be tuned by the A.F.C. arrangement, the fixed vanes being electrically coupled together by the wire 7 and connected to the live side of the circuit to be tuned, the moving vanes being earthed.

Operation

In operation the motor is started by current or voltage derived from the discriminator circuit of the A.F.C. apparatus, and the motor rotates in the proper direction to correct the tuning error.

The initial rotation of the motor shaft 2 will normally

be transmitted only to condenser 4, since lost motion occurs between the pin 5a and the sleeve 5b, and the tuning error may be corrected before the pin 5a engages a wall of the slot in sleeve 5b. If not, then the main condenser comes into operation, and the circuit is coarsely tuned until the correct tuning position is reached. At this point inertia of the moving parts will probably cause slight over-running beyond the correct position, with the result that the discriminator circuit will cause rotation of the motor in the reverse direction, so that the vernier condenser makes the final tuning adjustment. Any slight over-running of the motor while driving the vernier condenser only causes insufficient capacity variation to bring the discriminator circuit into operation again.

It will be seen that the vernier condenser 4 takes care of small frequency variations, but in the case of a large drift of frequency the main condenser 6 is brought into action and moved to a new position, where it is left while the vernier condenser 4 again assumes control.

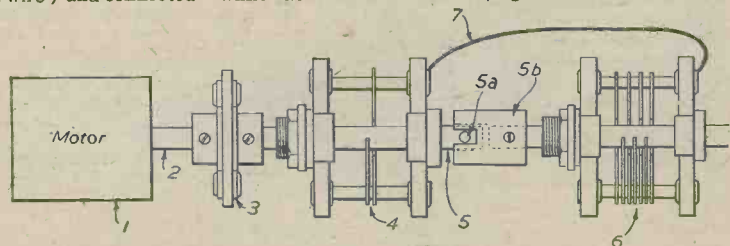

A motor-driven condenser unit as described in the text.

YES! BE PREPARED

Times are difficult, but that is no reason why you should not be looking confidently forward to the future. Your future will be what you make it. Use your spare time to increase your earning power, then war or no war your future will be secure.

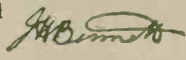

EARNING POWER IS A SOUND INVESTMENT

DO ANY OF THESE SUBJECTS INTEREST YOU ?

- | | | |
|---|--------------|--|
| Accountancy | Examinations | Metallurgy |
| Advertising and Sales Management | and Sales | Mining. All subjects |
| Agriculture | | Mining. Electrical Engineering |
| A.M.I. Fire E. Examinations | | Motor Engineering |
| Applied Mechanics | | Motor Trade |
| Army Certificates | | Municipal and County Engineers |
| Auctioneers and Estate Agents | | Naval Architecture |
| Aviation Engineering | | Novel Writing |
| Aviation Wireless | | Pattern Making |
| Banking | | Play Writing |
| Blue Prints | | Police, Special Course |
| Bollers | | Preceptors, College of Press Tool Work |
| Book-keeping, Accountancy and Modern Business Methods | | Production Engineering |
| B.Sc. (Eng.) | | Pumps and Pumping Machinery |
| Building, Architecture and Clerk of Works | | Radio Communication |
| Bulliders Quantifies | | Radio Service Engineering |
| Cambridge Senior School Certificate | | R.A.F. Special Courses |
| Civil Engineering | | Road Making and Maintenance |
| Civil Service | | Salesmanship. I.S.M.A. |
| All Commercial Subjects | | Sanitation |
| Commercial Art | | School Attendance Officer |
| Common Prelim. E.J.E.B. | | Secretarial Exams. |
| Concrete and Structural Engineering | | Sheet Metal Work |
| Draughtsmanship. All Branches. | | Shipbuilding |
| Engineering. All branches, subjects and examinations | | Shorthand (Pitman's) |
| General Education | | Short-Story Writing |
| G.P.O. Eng. Dept. | | Speaking in Public |
| Heating and Ventilating | | Structural Engineering |
| Industrial Chemistry | | Surveying |
| Institute of Housing | | Teachers of Handicrafts |
| Insurance | | Telephony and Telegraphy |
| Journalism | | Television |
| Languages | | Transport Inst. Exams. |
| Mathematics | | Viewers, Gaugers, Inspectors |
| Matriculation | | Weights and Measures Inspector |
| | | Welding |
| | | Wireless Telegraphy and Telephony |
| | | Works Managers |

If you do not see your own requirements above, write to us on any subject. Full particulars free.

IF YOU ATTEND TO THIS NOW IT MAY MAKE A WONDERFUL DIFFERENCE TO YOUR FUTURE

COUPON

CUT THIS OUT

To DEPT. 104, THE BENNETT COLLEGE, LTD., SHEFFIELD.

Please send me (free of charge)

Particulars of (Cross out line which does not apply.)
 Your private advice about.....

PLEASE WRITE IN BLOCK LETTERS

Name.....
 Address.....

DAGENITE & PERTRIX

—the dependable

BATTERIES

FOR RADIO, CARS, MOTOR CYCLES, COMMERCIAL VEHICLES, ETC.



DAGENITE

are used for London's Buses, Rolls-Royce and Bentley Cars, Britain's Lifeboats and Aircraft.

PERTRIX

are supplied to His Majesty's Government and, like Dagenite, are used in every other connection where the utmost dependability is essential. You, too, should use Dagenite or Pertrix in your car or radio.



OBTAINABLE FROM HOLSUN SERVICE STATIONS AND USUAL DEALERS

Sales Concessionaires :

HOLSUN BATTERIES LIMITED

137 Victoria Street, London, S.W.1



D4/41

Impressions on the Wax

Review of the Latest Gramophone Records

Parlophone

QUITE an array of talent appears in the new Parlophone releases for this month. In the Odeon Series Richard Tauber has made one of his best records yet on *Parlophone R02051*. He sings "Agnus Dei" and that famous classic "Ave Maria" with instrumental accompaniment and chorus. Both songs are sung in Latin. Another interesting tenor record is supplied by Neil Mclean. He sings "Muile Nam Mor-Bheann" (Mull of the Mountains) coupled with "Mo Shuil a D'Dheith" (Repining for Thee) on *Parlophone F3354*. Before passing on to the orchestral records there is one other vocal record that I would mention, and this time the singer is Don Marino Barreto, who puts quite a lot of feeling into his recording of "To-night" and "Amopola" on *Parlophone F1857*. Gaelic waltzes are rather delightful, and William Hannah and his Band play two typical examples, "Highland Scheitische" and "Chi Mi Na Morbheanna," on *Parlophone F3352*. Also an attractive record is the Orchestra Mascotte playing the "Waltz of the Dolls" (after Motifs from the ballet "The Fairy Doll") and "Oranges from Spain" on *Parlophone F1837*.

Ivor Moreton and Dave Kaye play a medley of some of the latest tunes on two pianos on *Parlophone F1864*. The title of the record is "Tin Pan Alley Medley, No. 38," and introduces such tunes as "Dolores," "Pretty Little Busybody," "The Hut Sut Song," "Just a Little Cottage," "I Hear a Rhapsody" and "The Things I Love." Records in the Jazz Classics Series are always popular, and the latest release in this series is The Chicago Rhythm Kings playing "Someone Stole Gabriel's Horn" and "Who Stole the Lock?"—*Parlophone R2812*.

Columbia

Quite a number of vocal recordings appear in the new Columbia releases. First is Raymond Newell, the famous baritone who is often heard on the "air," singing two patriotic songs, "Our Land" and "When the Home Bells ring Again," on *Columbia DB2039*. Another radio and film star, Turner Layton, follows with "At the Baby Show" and "Mister Brown of London Town," on *Columbia FB2682*, whilst Bing Crosby sings two sentimental numbers, "Ridin' Around in the Rain" and "Good-night, Lovely Little Lady," on *Columbia DB2043*. Bing Crosby is accompanied on both sides of the record by Nat Finstone and his Paramount Orchestra.

Outstanding in the orchestra recordings is "The Barber of Seville" (parts 1 and 2), played by The Hallé Orchestra, conducted by Malcolm Sargent. The number of the record is *Columbia DX1033*. Howard Barlow, conducting the Columbia Broadcasting Symphony Orchestra, also makes a fine orchestral recording of "Champagne Polka" and "Mail Express Polka" on *Columbia DX1030*.

Dance music played in strict dance tempo is supplied by Victor Silvester's Strings for Dancing with "Tell me I'm Forgiven" and "Bambina" (tango) on *Columbia FB2696*, and Felix Mendelssohn and his Hawaiian Serenaders play two typical Hawaiian melodies, "Aloha de" (Farewell to Thee) and "Song of the Islands," on *Columbia FB2690*. Other bands who have made new recordings are Carroll Gibbons and his Savoy Orpheans, who play "Daddy" and "Heart's Don't Lie" on *Columbia FB2693*, and Eric Winstone and His Swing Quartet with two swing numbers—"Whispering Grass" and "Down Forget-me-not Lane"—on *Columbia FB2687*. There is one other record I must recommend, and that is a new recording by Stanley Holloway on

Columbia FB2680. His two humorous monologues "Up'ards" and "Sam Goes to It" are extremely funny.

H.M.V.

As with the Parlophone records, I start off by recommending a vocal recording. This time the singer is none other than that famous Irish tenor John McCormack. The songs he has chosen suit his voice admirably. They are "Our First Hour" and "Faith," on *H.M.V. DA1803*. That well-known pianist and composer Sergei Rachmaninoff is heard to advantage playing his own compositions "Etude in E Flat Major (Op. 33, No. 7)" and "Etude in C Major (Op. 33, No. 2)," on *H.M.V. DA1788*. In the orchestral recordings I have no hesitation in recommending Bach's "Air (From Suite No. 3 in D Major)," played by the Ave Maria Boston Promenade Orchestra. The orchestra is conducted by Arthur Fielder, and the organ and harp are featured in this record. You should also hear Gwen Catley, with Gerald Moore at the piano, singing "Estrellita" and "Ciribiribin" on *H.M.V. B0213*.

For those who like dance tunes there is "Body and Soul" and "Mr. J. B. Blues," in the Swing Music 1941 Series, by Duke Ellington and Jimmy Blanton; "I'm the Lonesome Gal in Town" and "My Sister and I," sung by Bea Swain with orchestral accompaniment; "Violin" and "Dolores," played by Joe Loss and his Orchestra, on *H.M.V. BD5701*; "Perfidia" and "The One I Love," played by Glenn Miller and his Orchestra, on *H.M.V. BD5698*, and "Marcheta" and "Deep Night" played by Tommy Dorsey and his Orchestra on *H.M.V. BD5703*.

My final selection from the new H.M.V. records is a new recording by Leslie Hutchinson ("Hutch"). He sings "Hearts don't Lie," from the film "Fun and Games," and "I'll Never let a Day Pass By," from the film "Kiss the Boys Good-bye," on *H.M.V. BD949*.

Decca and Brunswick

An interesting record by this company is one featuring both Bud Flanagan and Frances Day. On one side they sing a duet—"But in the Morning, No"—whilst on the reverse side they "swap" songs. Bud Flanagan sings "It's D'Lovely" and Frances Day sings "Underneath the Arches." The number of the record is *Decca F7951*. Vera Lynn, who has become a firm favourite with the Forces on the radio, revives two evergreens for her latest recording on *Decca F7940*. On one side she sings "The Bells of St. Mary's," accompanied by Rae Jenkins's Quartet, and on the other "Two Eyes of Grey," accompanied by Arthur Young on the Novachord. There is a fine selection of dance music played by most of the popular bands from which to make a selection. I rather liked "Oasis" and "Moonlight in Mexico," played by Ambrose and his Orchestra, with Anne Shelton singing the vocals, on *Decca F7936*; "London Pride" (vocal by Sam Browne) and "They're Building Another Alley for Sally" (vocal by Stella Roberts), played by Mantovani and His Orchestra on *Decca F7937*, and "Nola" and "Marigold," played by Billy Mayerl and his Grosvenor House Band, on *Decca F7945*. Judy Garland, the popular young film star, has recorded two tunes from a recent film of hers, "Little Nelly Kelly." The tunes are "A Pretty Girl Milking her Cow" and "It's a Great Day for the Irish"—*Brunswick 03211*. The Andrew Sisters harmonise very well in "Aurora" and "Music Makers" on *Brunswick 03213*; and finally, among the Rex releases I recommend "Russian Rose" and "They're Building Another Alley for Sally," played by Billy Cotton and his Band on *Rex 10024*, and Denny Dennis singing "Boa hoite" (Good night), from the film "Night in Rio," and "To-night my Heart will Sing," on *Rex 10027*.

Universal Oscillator Unit

Testing and Adjusting

By F. DAY-LEWIS

(Concluded from November issue)

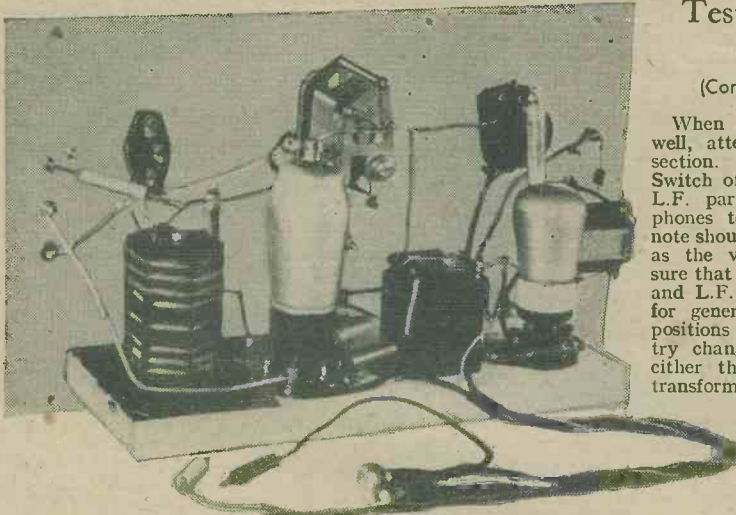

Rear view of the oscillator unit, showing the layout of components.

AFTER the wiring has been completed the connections should all be checked to be quite certain that all is correctly done. A two-volt L.T. and a 90-volt H.T. battery should now be connected to the battery leads and the whole unit placed near a receiver which is already switched on. The voltages may be checked at the various valve socket connections to see that this part of the unit is in order. Place the valves in position with the L.T. switches at "off."

Tune the receiver to about the middle of the M.W. band, and switch on the H.F. switch of the unit. Rotate the tuning condenser (making sure that the W/C switch on the unit is also at M.W.) and see if there is a rushing sound at any point in the receiver as the knob of the unit is rotated. If not, it will be necessary to reverse the connections of the reaction winding on the coil; just change the leads around to the connections.

Now try tuning both the receiver and unit over the complete M.W. band, and if the unit will not tune low enough it will be necessary to remove turns from the M.W. winding on the coil, but be very careful about this. It is hardly likely that it won't tune high enough up the band, as in the completed unit it went well past the usual receiver's wavelength.

When the medium-wave band is satisfactory, repeat the operations on the L.W. band, remembering to change the wave-change switches in the receiver and unit. If the instrument will not oscillate on L.W. and is O.K. on the M.W., then more turns may be necessary on the L.W. reaction winding (lower one); this, however, is most unlikely.

Now connect up a length of wire (several yards) to the aerial or H.F. socket on the panel, to see if the unit will still function, and then reduce the H.T. voltage to about 50 volts. This will test the power of the instrument to provide a useful signal with aerial damping (and stronger radiation) and low H.T. voltage. The model described worked well with an indoor aerial and earth with only 45 volts, and could be received on a set about roof away, the receiver using an indoor aerial and earth. The reader must bear in mind that, owing to existing conditions and regulations, it will be illegal to use any form of external aerial in conjunction with the unit, as such would allow radiation to take place and the oscillator would virtually become a transmitter.

When the whole H.F. side is working well, attention can be given to the L.F. section. The testing of this is much easier. Switch off the H.F. side and switch on the L.F. part. On plugging in a pair of phones to the L.F. and earth sockets, a note should be heard. If no note is heard as the volume control is rotated, make sure that the switch for changing for input and L.F. oscillator is in the correct position for generating an L.F. signal; try both positions to test. If still no note, then try changing around the connections on either the primary or secondary of the transformer in the anode circuit of V_2 , that is, the 3:1 transformer for load purposes.

When the note is heard in the phones, rotate the volume control to see that it varies in strength; it may also vary in pitch. Should it stop at very low volume, then try altering the values of either C_6 or R_4 or both, making the former smaller and the latter bigger in value. A change in R_5 to a lower value might also help. When the note is working well it also should function at a low value of H.T., although it may vary in pitch as the H.T. is made higher. In this connection some experiment may be necessary to determine the 'best combination of resistances, etc., to use with a wide range of H.T. voltages to give the best results. Some interesting tests will suggest themselves to the constructor.

Next switch the "input-oscillator" switch to the "input" position and, using a separate L.F. source such as a microphone or pick-up, test the valve as an amplifier. No difficulty should be encountered here, but don't expect much from this amplifier as, due to its dual functions, a compromise was inevitable.

When both parts of the unit are working well separately the two should be tried together, and it will be found that they invariably perform perfectly satisfactorily this way. The H.F. signal should not vary when the L.F. modulation is on or off, and vice versa. The H.F. signal should be easily modulated with a good strong modulation either when the L.F. oscillator or a separate L.F. source is used.

Calibrating and Using

Calibrating the H.F. side of the instrument is useful when it is desired to use it on a wave-meter or calibrated modulated oscillator for re-tuning receivers. With the aid of an accurately tuned set, or another well-calibrated oscillator, a graph may be drawn for the readings on the condenser dial in degrees against wavelengths, or frequencies. It should be noted that in this case large variations in H.T. voltage will not be possible although the frequencies are fairly constant for quite large changes.

Calibration of the S.W. band is possible by using the harmonics of the M.W. band, and down to 20 metres is possible.

When using the instrument for P.U. work near the receiver no aerial will be necessary, and when using as a wave-meter the same applies. When using for trimming purposes it may be necessary to loosen the coupling between the instrument and the set being

trimmed by moving the instrument and set away from each other; earthing the instrument may also be necessary to prevent hand-capacity effects.

It is always advisable to arrange one's test bench and equipment in such a manner that the oscillator will provide sufficient output coupling without any direct connecting lead being used, but, if circumstances necessitate the latter, then it should be covered with a metallised sleeving to prevent unwanted radiation, the sleeving being earthed.

It will be found that the input from a pick-up will overload in most cases and cause distortion, and lower volume will give good strong modulation without this distortion.

With a microphone, greater volume will be required, and usually a step-up transformer to the input is also wanted. Although there are times when it is desirable to use a microphone, it is really better to employ a pick-up and a frequency record, as the output is more consistent and volume level can be adjusted by the operator.

In the description of the instrument the writer has tried to offer hints in the case of non-working, but these are not intended to imply that trouble may be encountered, but rather to help those who may be unable to obtain the exact parts, and who are trying to use what they have in hand.

The Cabinet

This is made of wood, and the inside dimensions take the panel which is held in position against wood slips by screws. The depth of the cabinet is 9in., and it will be found that the L.T. battery, and either a 60- or 90-volt H.T. block, will also fit inside. A dividing strip of wood should be screwed or nailed inside the cabinet

to prevent the batteries from falling into the wiring, etc. The cabinet is provided with a removable back, and a carrying handle completes this part of the unit.

A Simple Microphone

When using this instrument some constructors will already possess a pick-up of some sort, but few have good "mikes," and the writer has found one that is much better than a carbon type, has no background noises, needs no battery, and is sensitive enough to amplify the ticking of a clock two yards away.

Nearly all constructors have, or can obtain cheaply, a small moving-coil loudspeaker, and this acts as a

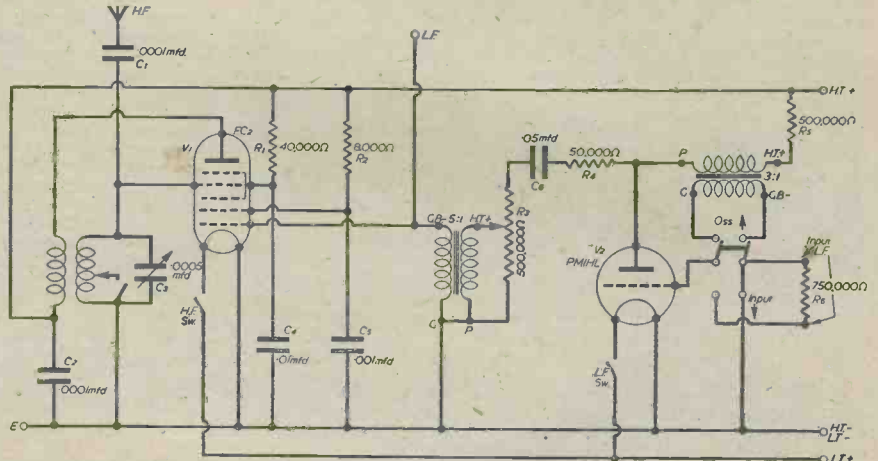

Theoretical circuit diagram of the oscillator unit.

"mike." Use it with a matching transformer suitable for a pentode valve, and if the signal strength is wanted higher still, then couple this transformer to a 5:1 step-up transformer, which will increase the voltage to the input to the instrument.

It will be found that this speaker will provide a very satisfactory substitute for a dynamic microphone, is very sensitive, and will reproduce voice or music very faithfully. In fact, in most cases the volume will need attenuating if one stands nearer than a yard when speaking.

LATEST PATENT NEWS

These particulars of New Patents of interest to readers have been selected from the Official Journal of Patents and are published by permission of the Controller of H.M. Stationery Office. The Official Journal of Patents can be obtained from the Patent Office, 25, Southampton Buildings, London, W.C.2, price 1s. weekly (annual subscription £2 10s.).

Latest Patent Applications

- 9073.—Corbould, W. H.—Wireless reception.
- 9080.—Hayter, A. C.—Means for eliminating electrical interference from radio apparatus.
- 9271.—McLean, F. C.—Protective devices for electrical transmitters.
- 9532.—Philips Lamps, Ltd. (Naamlooze Venootschap Philips' Gloeilampenfabrieken).—Superheterodyne receiving arrangements.
- 9531.—Philips Lamps, Ltd. (Naamlooze Venootschap Philips' Gloeilampenfabrieken).—Cathode-ray tubes.
- 9652.—Philips Lamps, Ltd. (Naamlooze Venootschap Philips' Gloeilampenfabrieken).—Soldering irons.

- 9653.—Philips Lamps, Ltd. (Naamlooze Venootschap Philips' Gloeilampenfabrieken).—Piezo-electric laryngophones.
- 9519.—Standard Telephones & Cables, Ltd., and Maddock, A. J.—Thermionic valves.

Specifications Published

- 538056.—Johnson Laboratories Inc.—Mounting for radio valves.
- 537986.—Marconi's Wireless Telegraph Co., Ltd. (Radio Corporation of America).—Radio receivers.
- 538064.—Hazeltine Corporation.—Periodic wave generators, particularly for television.
- 538039.—General Electric Co., Ltd., Francis, V. J., and Kettlewell, E.—Circuit arrangements for operating HPMV electric discharge devices.

Printed copies of the full published Specifications may be obtained from the Patent Office, 25, Southampton Buildings, London, W.C.2, at the uniform price of 1s. each.

A Microphone Transformer

Complete Constructional Details of an Efficient and Useful Component are Given in This Article

PREVIOUS articles have described the making and methods of connecting sensitive carbon-type microphones, but many readers appear to experience some difficulty over the coupling transformer. Some cannot decide what type of transformer is required, whilst others do not appreciate the need for a transformer and inquire if it is really essential. As a matter of fact, a transformer is essential—quite essential—because the resistance of any ordinary type of microphone is very low, being in the region of but a few ohms. If such a low-resistance component were connected across the grid circuit of a valve it would act as a short-circuit, with a result that the valve would be prevented from functioning at all. On the other hand, if a resistance were wired in series with the microphone to increase the grid circuit resistance, the output from the microphone would be reduced to so great an extent that it could not operate the valve. Additionally, a direct current (generally taken from a small dry battery or accumulator) must be passed through the microphone, and this could not be done if the high resistance were in circuit. The only way to combine the requirements of high grid-circuit resistance and low microphone resistance is to employ a transformer with a low resistance primary and a high resistance (or more correctly, impedance) secondary. Besides giving the effects mentioned above, the transformer performs another important duty by increasing, or stepping up, the comparatively small fluctuating voltages passing through the primary and the microphone; this naturally results in a greater signal voltage being applied to the grid of the amplifying valve, and a consequent increase in output volume.

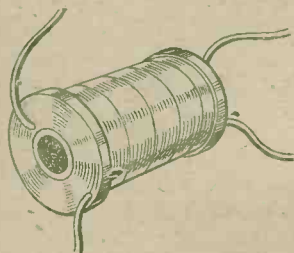

Fig. 1.—The finished transformer
Note the core of soft iron wire.

Transformer Requirements

The actual requirements of the transformer depend to a certain extent upon the particular microphone employed, but in nearly every case the principal need is for a primary having a resistance of no more than about 5 ohms and a secondary having an impedance, at average speech frequencies, of upwards of 50,000 ohms. These conditions are fulfilled by making transformers according to the particulars which are to be given, the component in this case having a step-up ratio of 100 to 1.

There are, of course, innumerable ways of making an efficient transformer, but the simplest and least expensive is to employ a core consisting of a bundle of soft iron wires fitted into a suitable bobbin containing the correct windings. A sketch of a component made according to the particulars just given is shown at Fig. 1. In making the transformer, a winding spool or bobbin must first be prepared, and details of this are given in Fig. 2. The first requirement is a cardboard tube about 1/2 in. internal diameter and 2 in. long, and if a suitable ready-made tube is not available it can be made quite easily by winding a 2 in. wide strip of paper on to a wooden rod. Whilst the paper is being wound on, glue or shellac varnish should be applied liberally to it. When the adhesive has properly set, the tube should be perfectly rigid, and then a pair of 1/8 in. diameter card-

board end cheeks should be fitted. If a hole is punched in the middle of these so that they fit tightly on to the tube, no further strengthening should be required, but if they fit fairly slackly it is best to apply "tacky" glue and to give the whole bobbin a few coats of thin shellac varnish. After varnishing, the bobbin should be "baked" by placing it in a warm oven.

The Windings

The next step is to put on the windings. The primary comes first, and consists of 100 turns of 24-gauge d.c.c. wire. Start by making two holes through one of the end cheeks, and anchor the wire in these. After winding the correct number of turns, the other end of the wire can be anchored in the same way as before. Then cover the primary with a layer of empire cloth or insulating tape, taking care that it fits well up against the end cheeks. One hundred times as many turns are required for the secondary, and they are of 38-gauge enamelled wire. This wire is very thin, and the end must be soldered to a short length of flex anchored through a couple of holes in an end cheek, after which winding may be commenced. Attempt to keep the turns fairly even and approximately in layers, and after about every 2,000 turns, insulate with a layer of thin waxed paper or oiled silk. It is rather a tedious task to wind on and count 10,000 turns, but the process is considerably simplified if the bobbin can be fitted on to a wooden rod which is gripped in the chuck of a hand-drill held in a vice. In that case it is most expedient to find the gearing ratio of the drill and to count the revolutions of the handle rather than the number of turns put on to the bobbin. It will be more helpful to know, however, that the weight of wire required for the full 10,000 turns will be slightly over four ounces, and therefore, provided a four-ounce reel of 38-gauge wire is obtained, there will be no need whatever to count the turns, especially since the exact number is by no means critical.

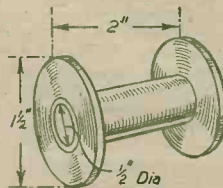

Fig. 2.—Showing the formation and dimensions of bobbin.

Fitting the Core

When the winding has been completed the wire should be covered with a few layers of insulating tape to protect

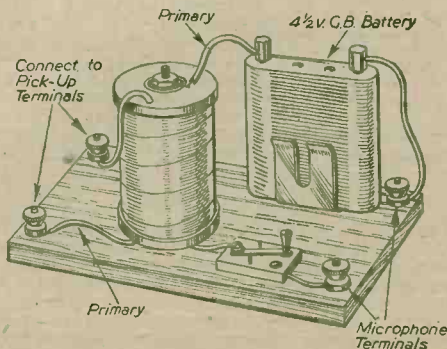

Fig. 3.—The assembled microphone coupling unit; consisting of transformer, energising battery and switch.

the fine wire from injury. After that the core must be fitted, and this will consist of a bundle of soft iron wires 2 in. long. Suitable wire can be obtained from most ironmongers, being sold by weight in lengths of about 9 in. to roin., for use by florists and butchers. It is essential that the wire should be really soft, and if any doubt exists in regard to this it should be tied in a bundle, placed in a low fire on going to bed, and left until morning; this will anneal it perfectly. Cut the wire into suitable lengths and then fit it into the wound bobbin, packing it as tightly as possible to prevent any possibility of vibration.

The finished transformer can be mounted on a small board by means of brass straps, or by using the method illustrated in Fig. 3. In the latter instance a length of 4 B.A. screwed brass rod is fitted through the middle of the core and is used to mount the component in an upright position on a baseboard or on the chassis of the amplifier.

A Neat Microphone Unit

The complete unit shown in Fig. 3 is a convenient little microphone accessory, consisting of the transformer just described, a 4.5-volt G.B. battery for operating the microphone, and a simple on-off switch. The drawing is almost self-explanatory, but it might be mentioned that

the switch is made from a narrow strip of brass attached to the hard-wood baseboard by means of a screw. The brass strip is made to pivot so that it can make or break contact with a small terminal screw. By using this idea the microphone can permanently be left connected to the terminals arranged for it, whilst the other terminals are joined directly to the pick-up terminals of the receiver or amplifier. It is, of course, necessary to "open" the switch contacts when the microphone is out of use, so that the dry battery is not run down unnecessarily.

Other Forms of Construction

If an old and burnt-out L.F. transformer is available, a slightly better component than that described above can be made by using the core stampings and winding spool. The core clamps should first be removed, and then the core stampings are withdrawn and the spool unwound. After that, the spool should be rewound, using 50 turns of 24-gauge d.c.c. wire for the primary and 5,000 turns of 38-gauge enamelled wire for the secondary. The method of winding is exactly as described above. It should be pointed out that the reason for employing only half as many turns in this case is that the iron core is "closed," so giving a similar inductance and impedance with fewer turns of wire.



Showing the delicate electrode construction of a modern output pentode valve.

The lay ear cannot, as a rule, differentiate between the various valve noises (commonly termed microphonics), but the experienced wireless engineer can immediately decide in what part of the valve the fault lies, from the type of noise heard in the speaker when the valve is tapped.

Cathode Rattle

The most frequent offender is the cathode, or filament in the case of the directly-heated valve. As is well known, the cathode is held at its top and bottom extremities by thin strips of mica: it is forced into a small hole in the mica, and appears to be tightly fixed. After the valve has been in use for a short period, however, the cathode tends to become loose in the hole, thereby causing cathode rattle. This form of valve trouble has been minimised to a great extent, however, by riveting

Valve Noises

The Absence of a Dead Silent Background might be Due to Valve Defects, as This Article Explains

THE valve is, undoubtedly, the most important component in a wireless receiver, but it is also one which can cause a certain amount of trouble which, by virtue of its origin, is sometimes very difficult to trace. During the past two or three years, great improvements have been effected in valve design and construction, and although they are as near perfect as production difficulties permit, it is possible for them to be responsible for certain background noises. With the older types—those that are now obsolescent—the trouble was common, therefore, if during these days of shortage one is forced to bring back into commission a valve which had been retired to the spares-box, it is well to bear in mind the remarks given below.

the cathode to the mica, or by arranging a small spring to hold it against one side of the hole.

In the battery type valve the filament is stretched between two hooks, and, as in the case of a violin string, has a natural frequency according to its mass and tension. When the receiver or valve is tapped the filament vibrates at its natural frequency—generally between 500 and 1,500 cycles. This tendency to vibrate could be obviated by stretching the filament very tightly, of course, but it has been found that this procedure tends to shorten the life of the valve, and therefore the designer has to strike a compromise in this respect.

Should the filament be very slack, and the valve is in a position to catch the direct sound waves from the speaker, sufficient energy may be fed back from the speaker to the valve to form a sound couple. It is, therefore, found that when this form of microphonic noise is experienced, placing the speaker in a separate cabinet provides a remedy.

Frame Rattle

A less common valve trouble is frame rattle, caused by badly-welded joints, or loose eyelets. The frame tends to vibrate at a resonant frequency, and whenever this frequency is emitted by the speaker, the valve-frame resonates in sympathy with it.

Crackling

Most of the crackles which are heard in the speaker when the valve is tapped are due to a leakage between cathode and anode. This often occurs in pentodes, where the outer screen, at low potential, is very close to the anode, at high potential. Indeed, so short is the mica path from the outer screen to the anode, with the resultant likelihood of a leak across it, that some manufacturers use two micas, one to hold the cathode and grids, and the other to hold the cathode and anode, in order that a comparatively long path may be obtained from cathode to anode.

The obvious remedy in every case, of course, is to replace the offending valve, but where this is not possible, a temporary improvement may be effected in most cases by using springy (or anti-microphonic) valve-holders, and housing the set and speaker in separate cabinets.

COMMUNICATIONS DEPEND . . .

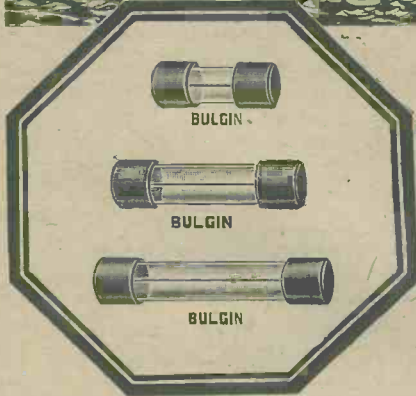
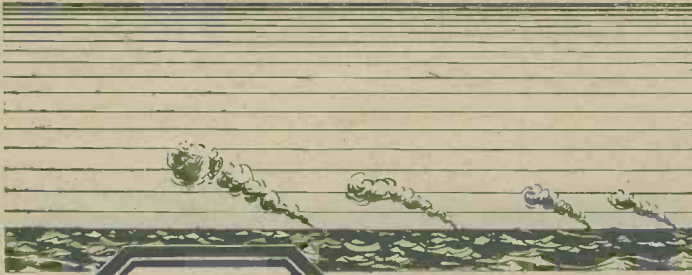

ON SMALL PARTS . . .

In countless instances quite intricate pieces of apparatus are wholly dependent on the proved reputation and reliability of their component parts.

All products from the House of Bulgin are pre-eminent for superior design and workmanship, and every article bearing our Trade Mark has to pass exacting and exhaustive tests during the course of its production.

We ask the kind indulgence of the public in delivery until peaceful conditions return.

The Choice of Critics

BULGIN FOR FUSES

THE finest Radio and small Electrical glass-enclosed Fuses in the World. The comprehensive range, from 60 mA. to 25 A., covers every requirement. Accurate and uniform in characteristics and made to British Standard Specification No. 646, R.M.A.—and R.C.M.F.—specification. Absolutely fireproof and safe, sure in action upon 50-75% overload. It is better to be safe than sorry!

ALWAYS DEPEND ON

BULGIN

REGISTERED • TRADE • MARK

A. F. BULGIN & CO., LTD., BY-PASS RD., BARKING, ESSEX
TEL RIPPLEWAY 3474 (4 lines).

The "Fluxite Quins" at Work

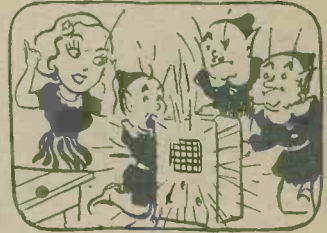

"The nightingales sound sweet to-night,"
Coed OO with unbounded delight!
Said the lads with deep growls,
"We hear nothing but 'owls,
Be a good girl and fetch the FLUXITE."

See that **FLUXITE** is always by you—in the house—garage—workshop—wherever speedy soldering is needed. Used for 30 years in government works and by leading engineers and manufacturers. Of Ironmongers—in tins, 4d., 8d., 1/4 and 2/8.

Ask to see the **FLUXITE SMALL-SPACE SOLDERING SET**—compact but substantial—complete with full instructions; 7/6. Write for Free Book on the art of "soft" soldering and ask for Leaflet on **CASE-HARDENING STEEL** and **TEMPERING TOOLS** with **FLUXITE**.

To CYCLISTS! Your wheels will NOT keep round and true unless the spokes are tied with fine wire at the crossings and **SOLDERED**. This makes a much stronger wheel. It's simple—with **—FLUXITE—but IMPORTANT.**

THE **FLUXITE GUN** puts **FLUXITE** where you want it by a simple pressure. Price 1/6, or filled, 2/6.

FLUXITE LTD. (DEPT. W.P.),
BERMONDSEY ST., S.E.1.

FLUXITE
SIMPLIFIES ALL SOLDERING



FOR THE RADIO SERVICE MAN, DEALER AND OWNER

The man who enrolls for an I. C. S. Radio Course learns radio thoroughly, completely, practically. When he earns his diploma, he will KNOW radio. We are not content merely to teach the principles of radio, we want to show our students how to apply that training in practical, every-day, radio service work. We train them to be successful!

INTERNATIONAL CORRESPONDENCE SCHOOLS

Dept. 94, International Buildings, Kingsway, London, W.C.2.

Please explain fully about your instruction in the subject marked X.

- Complete Radio Engineering
- Radio Service Engineers
- Elementary Radio
- Television

If you wish to pass a Radio examination, indicate it below.

- Institute of Radio Engineers
- P.M.G. Certificate for Wireless Operators
- Provisional Certificate in Radio Telephony and Telegraphy for Aircraft
- City and Guilds Telecommunications

Name..... Age.....

Address.....

(Use penny stamp on unsealed envelope.)

DO NOT BLAME YOUR DEALER—

Unfortunately this is war-time and our speaker output must of necessity be restricted, for reasons which you will doubtless appreciate.

Your Dealer, when asked to demonstrate Stentorians, may have to keep you waiting for a few days—do not blame him—he is doing his best.

The waiting will be well worth while. With a Stentorian Extension Speaker you will enjoy a new thrill from your listening—the fine balance of tone and the vivid reality of reproduction will delight you.



Cabinet Models from 21/6



Stentorian

THE PERFECT EXTRA SPEAKER FOR ANY SET
WHITELEY ELECTRICAL RADIO CO. LTD.,
MANSFIELD, NOTTS.

FREE ADVICE BUREAU COUPON

This coupon is available until December 6th, 1941, and must accompany all Queries and Hints. PRACTICAL WIRELESS, December 1941.

RELAYS

Ask for Leaflet SPN/PR.W.

LONDEX LTD.

ANERLEY WORKS,
207, ANERLEY RD.,
LONDON, S.E.20.
Phone: SYD. 6258/7



TAYLOR ELECTRICAL INSTRUMENTS

The range of Taylor British made precision built instruments includes the following: UNIVERSAL METERS—VALVE TESTERS—SIGNAL GENERATORS—AND THE TAYLOR OSCILLOSCOPE

TAYLOR Electrical Instruments, Ltd.,
419-422, Montrose Avenue,
SLOUGH, BUCKS.

ALL ADVERTISED LINES ARE STILL AVAILABLE

See October issue.

RADIO CLEARANCE LTD.
95, High Holborn, London, W.C.1

MASTERING MORSE

By the Editor of PRACTICAL WIRELESS.

Thousands of technicians entering the radio branches of the various services need an expert knowledge of the Morse code, especially now that radiolocation has become part of our aerial defence. This handbook, written with special regard for service requirements, will enable even the beginner rapidly to become proficient in sending and receiving.

1/- net

Of all Booksellers, or by post 112 from GEORGE NEWNES, LTD. (Book Dept.), Tower House, Southampton Street, London, W.C.2.

1/- net

Copper Wire Production

Some Interesting Facts Regarding the Drawing and Covering of Fine Instrument Wires as Used for Radio Components

MANY humorous things have been said about the use of the word "Wireless" to describe that set of phenomena which is now almost universally termed Radio. It is quite true that the actual signals travel from the transmitting aerial to the receiver without conveying wires, but wire plays a most important part in the complete process. For example, on a ship's transmitting apparatus there are about 300 miles of wire in the transformer. Even in our receiving sets the amount of wire employed is considerable.

Few realise the art which is employed in the manufacture of wire. Copper plays, perhaps, the most important part in wire manufacture, but, of course, there are other materials used in the manufacture of special or resistance wires. Copper is shipped to this country in large quantities, principally from America.

Copper

Copper, as we all know, plays its part in the currency, and with gold and silver is recognised as one of the universal equivalents in our exchange system. The price of copper may vary from day to day, and for this reason a constant watch has to be kept by the wire manufacturers and electrical firms on this aspect of the case. When the copper bars are to be made into wire, or copper strips as employed in commutator segments, etc., they are placed in a container and put into a crucible and melted at a temperature which makes the copper liquid glow at a white heat.

All round these furnaces are large tubs of water, into which the workmen can jump if, as often happens, their overalls catch on fire owing to the heat from the ingots. The latter are about 5ft. in length and gin. thick, they are grabbed by the operators with long pincers and propelled along the steel floors, thence to be placed between rollers, which shape and flatten the metal to a workable size. If it is to be strip, the whitened metal will be run backwards and forwards until, like a snake from the nether regions, it is 60ft. to 70ft. in length, sliding over the polished steel floor, sending sparks hither and thither during its progress, a most awe-inspiring sight.

When round wire is required the metal is run through different shaped rollers and, owing to the enormous length it reaches, is turned back on itself through adjacent rollers, so that it actually travels through several rollers at a time, with many loops all over the floor. It is during the latter process that men have had their legs trapped in the loops of white-hot metal, with disastrous results. Having obtained a length of copper sufficiently reduced in diameter, the next job is to draw it cold, down to the size of wire required, and this is done in easy stages.

Wire Drawing

The first stage sees the copper, the size of a man's wrist, being drawn by a chain, the links of which would do justice to a steam-roller transmission system, through a tapered reducer. When the wire is drawn down to really fine sizes, such as those used for making radio tuning coils or transformers, etc., it is taken through numerous diamond dies, each successive die having a smaller diameter hole than its predecessor. During the latter process the wire passes through cooling baths. Having reduced the conductor to the requisite size, it now remains to cover it with suitable insulation.

We may have cotton covering, silk, rubber, cellulose compound, in fact there is a galaxy of insulations at our disposal. In radio the commonest forms of insulation are enamel, silk, cotton, cotton and cellulose, cotton and wax, and, of course, oiled cotton sleeving (i.e., systoflex), and V.I.R. (vulcanised india-rubber). To

enamel the wire it has to be run through several baths of the insulating material and baked after each bath. The general temperature plays a very important part in this process, as does local climatic conditions.

It is interesting to note that one well-known transformer concern insists on an enamel insulation which will have a "breaking point" beyond that of the wire conductor. This means that when the wire is stretched it will actually break before the enamel surface. One can appreciate the reason for this precaution owing to the number of bends in a length of wire employed in the secondary winding of the transformer and the enormous pressure existing in the internal turns.

Covering the Wire

In cotton covering the wire travels horizontally, and reels of cotton are arranged radially around the conductor. There has to be a correct relationship between the velocity of the wire and the revolutions per minute of the cotton reels which spin round and round in a big circle, lapping the core with the right amount of cotton. D.C.C., or double cotton covered wire, necessitates two sets of reels revolving in opposite directions. In order to impart a braided covering the reels move around a vertically travelling wire. Actually the reels take an eccentric course similar to children playing "in and out the windows."

The famous Litzendraht wire, or Litz as it is known, is composed of three sets of three wires, each set of three being twisted and then the three lots twisted together; this ensures that each conductor shall come to the surface alternately, and since H.F. currents travel on or "near" the surface of conductors, Litz reduces the H.F. resistance as compared with ordinary wire. It is important to note that genuine Litz has each conductor separately insulated either by silk covering or enamel.

Preventing Electrolysis

It very often happens that when a coil is employed in a humid atmosphere a green spot appears on the wire which finally eats it away and causes a breakdown; this is known as electrolysis, and is due to the passage of a steady current through a conductor in a damp environment. Especially did this "green spot" occur in the early "spaghetti" resistances. A cure has been found by winding the wire on a non-absorbing-core, sealing the ends and last, but not least, by the employment of a wire free of iron content.

Such is the care exercised in modern wire production that it was found in one factory that breakdowns were due to the peculiar moisture on the skin of the hands of two sisters employed in handling the wire.

"WIRELESS ARITHMETIC"

A CORRECTION:—In our issue for October, the above article appeared, and on page 17 a worked example of finding the wavelength was given using the formula $\lambda = 1884 \sqrt{L \times C}$ with the values of .005 mfd. for the capacity and 2,200 microhenries for the inductance.

The first step shows how L and C are multiplied together, and that the result is 22/20. The writer of the article then shows how that is multiplied by 1884, getting a final figure of 2,082.4. The error which we wish to correct is this:—Before multiplying 22/20 by 1884, the square root of the former (as shown in the formula) should have been determined, and that multiplied by 1884. The square root of 22/20 or 1.1 is 1.0488 and when we multiply this by 1884 we get 1975.939, and not 2,082.4 as shown in the article. Finally, the figure 2,082.4 should read 2,072.4.

Clubs and Societies

THE ASHTON-UNDER-LYNE AND DISTRICT AMATEUR RADIO SOCIETY

Headquarters: Beaconsfield Conservative Club, Stalybridge Road, Ashton-under-Lyne.

Meetings: Wednesday and Friday at 7.30 p.m.

Secretary: K. Gooding (G3PM), 7, Broadbent Avenue, Smallshaw, Ashton-under-Lyne.

THERE was an excellent attendance at the annual general meeting, when the following officials were appointed for the ensuing 12 months: J. Partington (G5PX), President; W. P. Green, Chairman; J. Cropper (G3BY), Treasurer; K. Gooding (G3PM), Secretary; W. Taylor, Assistant Secretary; W. A. Kershaw, Librarian; Messrs. C. Noke (G6DV) and J. Partington, Morse instructors. The reports of the retiring officials were read and accepted, and the treasurer's report, showing a balance in hand of £5 Gs. 3d., was particularly gratifying, considering that 18 members were on active service, and several members were unable to attend meetings owing to war work and/or black-out travelling restrictions. The secretary stated that the present total active membership was 21, including four junior members.

Owing to "postings," etc., several members on active service are "lost" to the secretary, and as the "gang" at home are anxious to know how they are faring: will such members communicate with the secretary as soon as conveniently possible if this paragraph should catch their eye? Although many serving members are scattered to the four points of the globe, it is believed that sooner or later these notes will come to their notice, and in the next report it is hoped to include the names of members serving in H.M. Forces or engaged on work of national importance.

One group of members are busy with receiver building, and G8BY and G6DV report particularly interesting results on the U.H.F. bands; 3BY was, incidentally, responsible for a very instructive evening at the last meeting, when he demonstrated his portable all-dry "Simple Super." The Rx. was a three-valve combination consisting of mixer (1A7), 2nd detector (1N5), and out. pen. (1A5), with 1.5v. L.T. and 90v. H.T. The I.F. frequency used was 1,600 kc/s, and the performance was remarkable for such a small unit.

On his return from a course with the R.A.F. at No. 1 Signals School, the secretary said he had effected many personal QSO's with amateurs from VE, VK and ZL, and had scores of "skeds" for the post-war era.

WHITEFIELD SERVICE OF YOUTH CLUB (RADIO SECTION)

Headquarters: Stand High School for Girls, Higher Lane, Whitefield.

Assistant Supervisor: R. Lawton, 10, Dalton Avenue, Whitefield.

UNDER the Government's Service of Youth plan, the branch of the Whitefield Service of Youth Club opened on Monday, September 22nd, with its new winter programme, which includes two classes which are of interest to young radio enthusiasts. Every Tuesday from 8.30 to 9.30 p.m. there is a Morse class (sending and receiving), and every Friday a wireless receiver construction class: In addition to these fixed classes, time will be allowed for interested radio members to meet and discuss radio, etc.

Apart from these wireless classes, there are many others, including drama, P.T., dancing and a Service squad. Social activities including dancing and indoor games take place every night. The club is open every Monday, Tuesday, Wednesday and Friday from 7 p.m. until 9.30 p.m., and the membership fee is 3d. per week. All young people (male or female) in or near the area between the ages of 14 and 20 are invited to become members. A branch of the Women's Junior Air Corps has just been formed, and is working in co-operation with this club, particularly for taking lessons on radio. Further particulars can be obtained by calling at the club headquarters or by writing to the assistant supervisor at the above address.

AMERICAN RADIO RELAY LEAGUE

MR. LAWTON, the secretary of the North Manchester Radio and Television Society, recently received the following interesting letter from John Huntoon, the assistant secretary of the American Radio Relay League:

"It was with great pleasure that we received via our Department of State the greetings which you sent to all radio amateurs in our country. Amateur radio's shut-down in many foreign countries affected us most deeply in the case of Britain, towards whose amateurs we have always felt especially close.

"Many of our amateurs, like those in your country, have been called for military service or to factories and research for the design and production of equipment, some of which will go to you.

"We are glad to see the friendly relations maintained between the Post Office Department and British amateurs, and the way the radio amateur is to-day proving himself a worthy asset should ensure his return to previous privileges and rights when the present situation has ended. Until that pleasant day, our cordial 73's."

TRADE NOTES

Torch Battery Prices Fixed.

THE Board of Trade have made an Order under the Goods and Services (Price Control) Act, 1941, fixing revised maximum prices for imported torch batteries. The retail prices fixed for batteries imported from the United States and from Canada remain the same as in the existing Order. Small changes have been made in the prices of batteries imported from other countries. In addition, the maximum prices at which manufacturers or importers and wholesalers respectively may sell those batteries are now prescribed.

The Order—S. R. & O. 1941, No. 1438—came into operation on September 22nd, and provides that any trader who sells batteries to which it applies must take certain steps to bring to the notice of his customers the maximum prices fixed for those batteries. The existing Order is revoked from the above date. Copies of the new Order can be obtained from H.M. Stationery Office and through booksellers.

W.B. Senior Output Transformer

THE illustration accompanying gives a good idea of the sturdy and well-finished construction of the new W.B. Senior Service Universal Output Transformer, a component which should meet with approval from service engineers and others who have to provide or replace a speaker transformer.

It is universal in a true sense, as its tapped primary and secondary enable ratios from 10 : 1 to 75 : 1 to be obtained. Other ratios are 12.5, 20, 25, 30, 37, 40, 50, and 60 : 1, the last three being suitable

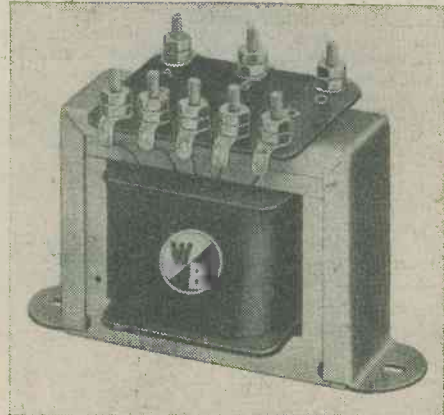

The new W.B. Senior Universal output transformer.

for use with Class B, etc., where a primary centre-tap is required.

The transformer will pass a current up to 50/60 mA's or double this with Class B or Push-pull output, and the ratios will enable the majority of speakers to be matched to any type of high-resistance output.

More details can be obtained direct from the makers, Messrs. Whiteley Electrical Radio Co., Ltd., Mansfield, Notts.

BRITISH LONG DISTANCE LISTENERS' CLUB

Your Test Gear

ON looking through the numerous letters we receive from members, one item stands out with such prominence that we feel it is worthy of mention. The majority of members report the results they have obtained with their particular installation, and give details of their equipment and shacks. Such information is, of course, appreciated, but, speaking in a general sense, it is too stereotyped and letters lack news of individual experiments and constructional work. Reading about the other fellow's log is quite interesting up to a point, but if we are to obtain the greatest general service from the publication of members' letters, it is really essential that they should contain information which is likely to be of help and interest to all members. For example, too little attention is being given to the vital question of test apparatus. No one can undertake serious short-wave listening and experimental work without a certain amount of equipment with which results can be verified, check tests made, and reliable data compiled. It is useless, from the point of view of progress, and, after all, that is what we are all interested in, to spend every available hour listening for or to transmissions. A certain amount of time should be devoted to the construction of test gear, the actual amount depending on the requirements of the operator. The best plan to adopt is to make up a piece of test equipment as soon as one finds the need for it. Don't let the demand go unnoted, and still carry on with the guessing or rule-of-thumb method; get down to the actual construction, and make the required item, so that next time you will be able to check up properly, and, incidentally, you will have added to your station equipment. How many members, we wonder, have a multi-range meter, a reliable frequency meter, a simple continuity test meter, a field strength test meter or a valve-voltmeter? These items are not complicated or expensive, especially if they are constructed by the station owner, but they are essential to the satisfactory working of a station, and should, therefore, be included in the equipment of every installation.

The Starting Point

THE basic part of all the apparatus mentioned above is some sensitive indicating device, such as a 0-mA meter; therefore, every amateur will be wise if he secures such an instrument at the first opportunity, and, once it is secured, look after it and treat it with every respect. Those mechanically-minded will find that it is possible to make quite a good meter from a small "U"-shaped magnet, a couple of shaped pole-pieces, one or two "hair" springs and such small parts which are usually to be found in the box of bits most of us have. The work is delicate and calls for a fair amount of skill and patience, plus a little head work, but, even so, it is most interesting and, of course, quite a good amount of money can be saved.

There must be some members who have already carried out such work, and others who have made and calibrated other types of test gear, so, in the interest of all members, you not send us in the details and let us pass them along via these columns?

For Your Consideration

THE theoretical diagram on this page shows the circuit of the S.W. three-valver built up by Member 7009, and judging by his remarks, it is capable of putting up a very good performance. In his covering letter he says:

"The following is a description of an experimental S.W. Rx. which may be of interest to other members of our club.

"The incentive to build the set was received from a remark in a past issue of PRACTICAL WIRELESS, to the effect that although a mains unit and accumulator is the best power supply for a S.W. Rx., the unit should be of the valve type as a metal rectifier is liable to hum. Now I use an Ekco Kr8 combined unit, which uses a metal rectifier, and I will guarantee that if any B.L.D.L. in my district visited my Q.R.A. he would not be able to distinguish the performance from that of an all-battery set.

"When the smoothing was completed to my satisfaction, I decided to cure the reaction of "ploppiness," if I may use the term. This I did by inserting a 73 ohm potentiometer, and an H.F. by-pass pre-set condenser from the detector anode; as a result of this, reaction

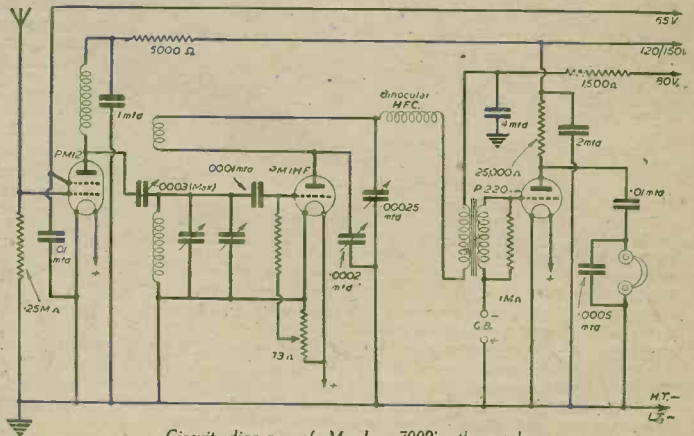

Circuit diagram of Member 7009's three-valver.

control is absolutely silky. In fact, I use a single knob only as a S.M. control is not necessary.

"It will be seen that there is a 25,000 ohm resistance in the anode of the output valve; this is a little unusual, but I found that it works O.K. It was put in originally as I had not room for a choke."

Your suggestions, 7009, are receiving our consideration, and although we do not think that all of them would meet with general approval, we hope to be able to do something along the lines of additional service to members when conditions are more suitable.

Contacts Wanted

MEMBER 7,039 (15 years), interested in D.F. work, wishes to make contacts with other members interested in the subject. His address is Wayend Street, Eastnot, nr. Ledbury.

Member 6,454, 3, Hilltown, Dundee, Scotland, would like members to co-operate in a contest.

Good Progress

CONGRATULATIONS to Member 6,337 whose letter we give below. He has tackled radio in the right manner by combining listening with experimental and constructional work, and we should imagine he has compiled a very useful reference file by adopting the procedure he explains. In view of our opening remarks on the previous page, we are pleased to note that 6,337 has not overlooked test gear, and we hope that in the near future he will be able to let us have some photos of his den and more practical details of his equipment. Here is what he writes:

"My interest in radio began four years ago, when I was fifteen, and I built a crystal set, which was soon followed by a medium-wave single valver, which thrilled me with a few Continental stations. However, I was given a two-valve battery receiver and got my first S.W. experience by using it in conjunction with a S.W. Adaptor built from PRACTICAL WIRELESS circuits. My log with this combination ran to 38 countries, including all U.S. call areas except W6. I experimented with various two and three-valve sets, and then built an eliminator for H.T. supply. My present RX is a 1-V-1 using an S.G. R.F. amplifier feeding a triode detector and Pentode output. The R.F. stage is built as a separate unit and has a switching arrangement whereby the aperiodic winding of the detector coil can be put in series with the H.T. supply in the usual manner or fed through a .0003 mfd. condenser. I have concentrated quite a lot of attention on aerial systems, and this has been fully justified as my log now includes 62 countries, including many Pacific Islands. At present I am using a 20-metre half-wave doublet fed by 12 ohm. transmission line. I had some difficulty in coupling this to the R.F. stage, but after a lot of experiments I found the correct coil ratio. I have also used both end fed and centre fed 'Zepp' aerials with spaced feeders for reception, and found their directional properties very well marked. I have not had much success with reflectors with horizontal systems, but once used a reflector with a vertical 10-metre doublet which worked well. I have not had very much experience with U.H.F. work, except for some occasional 5-metre activity with self-quenched super-regenerative receivers.

"I built the heterodyne wavemeter described in PRACTICAL WIRELESS some time ago and find it very useful both for frequency measurement and as a C.W. beat oscillator. I am now learning morse with the A.T.C. and find it much easier with an experienced operator as tutor. I certainly have to thank PRACTICAL WIRELESS for giving me a fairly good theoretical knowledge of radio and I file all articles of interest under separate headings, such as (a) Complete Receivers, (1) straight, (2) superhet; (b) Component Making; (c) Amplifiers, L.F. and R.F.; (d) Units, such as meters, power packs, etc.; (e) Aerial systems; and finally (f) General Theoretical Articles.

"I have built a multi-range meter which is mounted above the power distribution panel over my bench. The bench is a two-shelf affair with plugs for H.T., L.T. and mains on each and all controlled from one panel.

"I am sorry that I have not yet a station photo to send you, but hope to have one in the near future.

"Finally, may I say that I shall be pleased to meet any readers who happen to come to this district or to hear from anyone interested in S.W. work, my address being 53, Birley Street, Newton-le-Willows, Lancs."

A Super One-valver

MEMBER 6,975 (Penrith), who has recently completed this efficient little receiver, writes:

"I was very interested to read in the November, 1940, issue of PRACTICAL WIRELESS the description of a super one-valver given by member 6,032. A few weeks ago I decided to build the set, and found it very satisfactory. Since then it has been altered, and now I have it working really fine. The main changes were the omission of the H.F. choke. I found that the set worked much better without it. The grid condenser is a variable

.0003 pre-set and the grid lead 5 meg. The set, except for the changes mentioned, is the same, although the two variable condensers are mounted on a metal panel.

"The reception in this district is not very good at any time, but lately reception has been very good from America, and during the past few weeks WRUL (Boston) and WRUW have been received regularly at about R6. The rest of my log for the past few weeks includes WGEO, WRUL, WGEA, WCBX and WNBI (the latter is a good signal). Recently, VLQ (Sydney) was heard very well."

Joining the B.L.D.L.C.

THE membership of the British Long Distance Listeners' Club increases day by day, and it seems necessary now to point out that before any reader of the paper can join it he must satisfy us that he takes the paper regularly. This he can do by sending us in the first place the name and address of the newsagent from whom he obtains his copy. The B.L.D.L.C. Service cannot be extended to the man who merely wishes to hang a certificate on the wall of his den. We do not want to pander to the club maniac who likes to disport badges and certificates.

SIMPLE THERMAL-DELAY SWITCH

THE accompanying sketches show an inexpensive thermal-delay switch I have recently made, which works satisfactorily. The main component is a cheap mercury thermometer with a broken-off stem. A piece of enamel-covered wire, bared at one end, is pushed as far down the bore of the glass tube as possible. It should be well covered by the mercury. Another wire, with bared end, is pushed down as far as A (Fig. 1). The loop B is to allow adjustment of the height of A above the mercury. These two thin wires are connected

in series with a dry battery and relay. A heating coil, wound round the bulb of the thermometer, as shown, is made of thin silk-covered wire, and its size can be found by experiment. A former is not necessary, but if used, it should be of

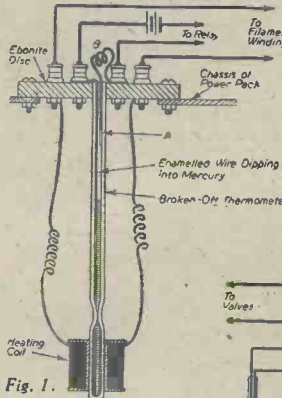

Fig. 1.

Wiring diagram and theoretical circuit of a simple thermal-delay switch utilising an old thermometer.

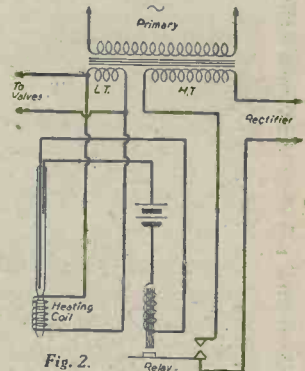

Fig. 2.

metal. This heating coil is connected to the filament winding on the mains transformer (Fig. 2). The relay is arranged to switch on the H.T. supply to a rectifier, and the time of delay can be regulated by raising or lowering the short wire in the tube.

Although a thermometer bore is very small, there is room for the wires mentioned. The largest size permissible can be found by trial. The relay need not be very sensitive. I made mine from an old electric bell. Various means of mounting the switch will suggest themselves to the constructor.—D. J. RINGER (Rowlands Castle).

THE RAF wants **YOU**

If you are keen on radio, the R.A.F. needs your services for Radiolocation and other vital radio work.

This is a wonderful opportunity for you to get into a highly specialised job and gain experience which can be of tremendous value to you after the war.

If you are not liable for military service, there are excellent opportunities for you to earn good money in your spare-time as a Radio Service Engineer.

Never before has there been such a demand for trained radio men.

Even if you know nothing about radio, we can train you. You can study at home in your spare time and become a qualified Radio Engineer.

Now, more than ever before, the outstanding merit of our method of tuition is being proved. Remember, we specialise in Radio, and our Courses are praised and approved by leading Radio Authorities.

Waste no time, but post coupon now for free details of our Modern Home-Study Courses in Radio, Radiolocation and Radio Mathematics.

T. & C. RADIO COLLEGE
29, Market Place, READING

(Post in unsealed envelope, 1d. stamp.)
Please send me free details of your Home-Study Radio Courses.

NAME

ADDRESS

P.22

YOU WILL BE NEEDING THESE!

CATHODE RAY OSCILLOGRAPHS

J. H. Reyner, B.Sc. (Hons), A.C.G.I., A.M.I.E.E., M.Inst.R.E. Here is an easily understood guide to the practical application of Cathode Ray Tubes to numerous purposes, including the examination of oscillations or wave-forms. Radio men, and particularly those about to enter the Services, will find this book a genuine and invaluable guide. It has been given the highest recommendations both for students and teachers. *Electrical Times* says: "Anyone desiring a clear understanding of the Cathode Ray Oscillograph cannot do better than purchase this moderately priced book." 8/6 net

MODERN RADIO COMMUNICATION

J. H. Reyner, B.Sc. (Hons), A.C.G.I., A.M.I.E.E., M.Inst.R.E. Every phase of current radio theory is dealt with in this book. With its clear and concise explanations, its helpful illustrations and the careful arrangement of its subject matter, it is certain to give the greatest possible assistance to students. Volumes I and II together provide a complete groundwork in Radio Engineering, and form an invaluable textbook for all students and practical engineers. "Can be well recommended as a textbook for the student and a useful reference book for the Radio Engineer."—The opinion of a well-known paper.

Vol. i, 7/6 net. Vol. ii, 7/6 net

Parker Street
KINGSWAY, **PITMAN'S**

LONDON CENTRAL
for **RADIO & TELEVISION**
SUPPLIES

TRANSFORMERS. Made by Standard Telephones. Beautiful job, weight 12 lb., 5½ in. by 4½ in., 350-0-350 v., 120 m.a. Four tappings giving 4 v. 2 amps., 4 v. 8 amps., 3 v. 3 amps., and 20 v. 1 amp. Brand new. 25/- each, carriage forward.

Ex-Transformer manufacturer. Heavy duty mains transformers. Input 240 v. A.C. Tappings at 5,000 v. max. 20 amps., and for supplying filament of Mullard HVR 2 (6.3 v. at .65 amps.). Shrouded in metal box, 10/6 each, carriage forward.

CHASSIS. Beautifully finished, highly polished, new cadmium-plated Chassis. Superbly made, 16½ in. x 13½ in. x 4 in. Drilled for 6 valves, transformer, etc., 4/- each. Also heavy gauge metal chassis, finished battleship grey, 12 in. x 5½ in. x 2½ in., 1/3 each. Also 9 in. x 10 in. x 2 in., 1/3 each, and 15 in. x 9 in. x 2½ in., 1/6 each. All drilled for valves, etc.

BATTERY CHARGERS



A new delivery of well-made Battery Chargers. Metal rectification, built with best components. Input 200/245 A.C., output 1½ amps. at 6 volts. As illustrated 35/- each.

COSSOR TELEVISION

Impossible to obtain through ordinary channels. Complete instrument includes time base and sound chassis (television sound waveband only), H.T. transformer for tube supply, transformer for heater and valves. 8-in. energised speaker, 13 valves, 7 variable resistances for volume contrast, trimming, etc., banks of condensers, resistances, etc. On heavy metal chassis, 17½ in. x 10 in. x 3 in. All completely wired ready for use. With C.R. tube electrostatic deflection and focus type, No. 3244, overall length approx. 19 in., diameter of tube, approx. 6 in., in beautiful walnut table cabinet, measuring approx. 12 in. x 21 in. x 16½ in. Price £17, plus 2/6 for packing, carriage forward.

N.B.—Unless items are marked carriage forward or collection by purchaser, sufficient postage must be included with all orders. London readers are invited to inspect our stocks. See also our classified advertisement on page 47

LONDON CENTRAL RADIO STORES
23, LISLE STREET, LONDON, W.C.2.
GERRARD 2969

TELEVISION EQUIPMENT

Power Pack and Amplifier Chassis. Includes transformer 350-0-350, 120 m.a. with 4 tappings. High voltage transformer for C.R. tube. Condensers, including 16 x 16 mfd. 650 v. working, 1-16 mfd. 450 v. working, 50 x 50 x 2 mfd. B.I. electrolytics, etc. Pentode output transformer; chokes; resistors; trimmers; bias electrolytics; mica and tubular condensers; short-wave coils, etc. Brand new, 67/6, plus 2/6 for packing.

Time Base Chassis. For 8-in. C.R. tube. Size 17 in. x 14½ in. x 2 in., containing approximately 13 fixed resistors, from 15,000 ohms to 1 megohm, 5 variable resistors, 2,000 to 20,000 ohms, approximately 14 tubular and electrolytic condensers, also focus and scanning coils and chokes. Price 30/- each. (Complete circuit and service manual, price 6d. each.) Carriage forward, plus 2/6 for packing.

Also Vision Units to fit on above Time Bases. Complete, consisting of 3 Mullard T.G.E.4 and one Mazda D1 valves, about 25 resistances and 30 condensers of various values. Includes chokes, reactor, grid and band-pass coils and a W6 Westector. Completely wired and screened. Valves alone are worth 15/- each. 55/6, plus 2/6 packing, carriage forward. (Complete circuit and service manual 6d. each.)

CATHODE RAY TUBES

Magnetic Type Cathode Ray Tubes available from stock. Unobtainable from ordinary sources, they have many electrical and scientific applications. As examples, we quote the following, all subject to being unsold. Approximately 8-in. diameter, £4; 10-in., £5; 12-in., £6. Cannot be repeated. All tubes must be collected by purchaser. No responsibility accepted for carriage.

SPEAKERS.

Ex-Government. Special horn type projection Speakers. Ideal for factories, A.R.P. and outdoor P.A. Super 6-in. P.M. unit aluminium horn 42 in. long with flare 32 in. diameter. Impedance 20 ohms. Few only to clear, £7/18/6.

AMPLIFIERS.

Three-valve, 3-watt, 220-250 v. A.C. Gramophone Amplifiers. Made for R.A.F. to Government specification. Slightly used. Pentode output, three-position tone control, super P.M. Speaker in mahogany cabinet, £5/5/-.

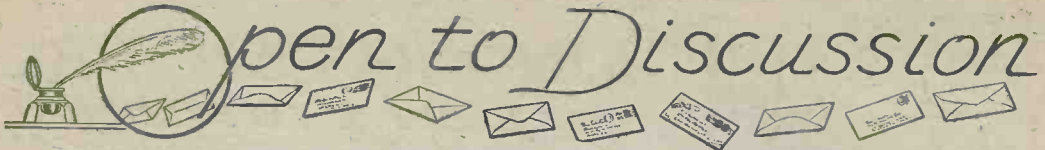

The Editor does not necessarily agree with the opinions expressed by his correspondents. All letters must be accompanied by the name and address of the sender (not necessarily for publication).

Station Identification

SIR,—I shall be glad if any reader can give me any information about the following stations:

I heard a broadcast in English at about 23.00 B.S.T. one Sunday during August. The announcer said it was Station K 45LA; and that it had changed its wavelength to the 19-metre band, but did not give the whereabouts of the transmitter.

A station announced as "The Voice of the Andes" was also heard clearly at 24.00 B.S.T. on Saturday, August 23rd, on about 22 or 25 metres. The broadcast took the form of a short "Evensong," which is supposed to be a daily transmission.

Readers may also be interested to know that WLWO (Cincinnati, Ohio) can be heard giving a news-bulletin in English daily at 17.00 B.S.T. on 19 metres.

With reference to the station mentioned by Mr. L. H. Desmond in his letter in the October issue, I also heard it, but was unable to identify it.—K. R. VEASY (Halesworth).

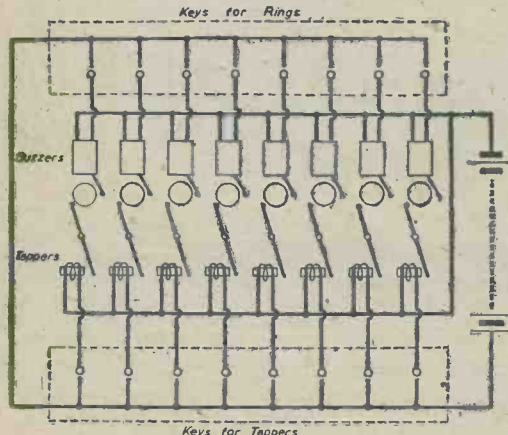

Diagram of connections of R. Neal's novel electrical musical instrument.

Novel Electrical Musical Instrument

SIR,—Not having much to do in the wireless line lately, only having two valves and no H.T., I made up an electrical instrument which works off a 9-volt bias battery. It has 16 keys, 8 mounted in front with 8 more behind, and connected to a series of electric bells and tappers, as shown in the accompanying sketch. I have an assortment of cycle-bell-tops and picked eight which sounded nearest to the musical scale.

These tops were mounted on a wooden board. A buzzer was placed so that it rang the bell-top at the end of the row, and seven more buzzers were placed so that they rang the seven remaining bell-tops. Also, to each bell top I fixed a Morse tapper. Connections are made so that the top row of keys ring the eight buzzers and the bottom row give a single tap on the bell-tops. Some good tunes can be played on the instrument with a little practice.

I am now experimenting with an amplifier to use with the instrument. I hope you will keep up the fine standard maintained in PRACTICAL WIRELESS. It is a fine book and has taught me all I know about radio.—R. NEAL (Peterborough).

Frequency Modulation

SIR,—Apropos Mr. P. Dickenson's letter in the October issue on frequency modulation, I heartily support the idea. Particularly as to circuits and the means by which a valve becomes virtually a variable inductance.—JOHN C. LUCAS (Leicester).

SIR,—I was interested to see the letter by P. Dickenson asking for practical circuits dealing with frequency modulation. I have been waiting for further details myself ever since reading an article about it some time ago. If all the claims made for it are correct it would seem to be streets ahead of our own system. By the way, I wonder if it would make television possible on the medium-waves owing to the possible frequency range of the system? I would like to see in PRACTICAL WIRELESS a series of articles on short-wave coils, H.F. chokes and I.F. transformers, as superhet design for short-wave work seems to be left alone. From my own experience with other amateurs, what is required is an empirical formula, i.e., so many turns on a transformer in conjunction with a .0005 condenser with padding condenser of x value would provide an I.F. of 465 kc/s. Our American cousins seem to have at their disposal information which enables them to build short-wave superhets and wind their own coils. One of the features of your magazine which I think has made it popular has been the provision of information which enables the amateur to help himself. I have enjoyed the articles on the Spares-box Superhet and Problems of Amateur Receiver Design, and hope to see many more similar articles in future.—S. C. FLITCROFT (Bolton).

(Whilst we are keeping in touch with every development of FM transmission and reception, we do not feel that it is a subject offering sufficient general interest, at the present time, to the majority of our readers, to warrant allocation of space for articles on the matter. The fact that it requires a wide band of frequencies and has limited effective range, rather rules out your suggestion concerning medium waves.—ED.)

Replaceable Fuse-box

SIR,—Some while ago I was building an experimental power panel and I required a fuse-box which had to be quickly replaceable, as I was expecting it to be often blown. I hit upon the idea of using an ordinary 5-amp. 2-pin socket in series with the mains supply to the panel and shorting the 2-pin plug with ordinary 5-amp. fuse wire. This works very well, as I keep a spare 2-pin plug already fitted with fuse wire, and when the fuse "blows" the fuse is quickly replaced with the minimum of bother by putting the spare plug in position.—H. SHURLEY (Manor Park).

Colvern Iron-cored Coils

SIR,—I have a set of Colvern iron dust-cored coils (made up of three units) with eight terminals on each unit. The wiring to the terminals is almost impossible to see without pulling the thing down to little pieces. I wonder if any reader could help me by supplying a circuit diagram of the coils. I would like to use them with a V.M.H.F. and H.F. pentode detector.—L. LEACH, 6, Jubilee Street, Llandudno, N. Wales.

Back Number Wanted

SIR,—As I have been unable to obtain an October issue of PRACTICAL WIRELESS, I shall be very glad if any reader would pass on a used copy. Postage will be paid.—G. ANDERSON, "Elmroyd," Bath Street, Dewsbury.

Replies to Queries

RULES

We wish to draw the reader's attention to the fact that the Queries Service is intended only for the solution of problems or difficulties arising from the construction of receivers described in our pages, from articles appearing in our pages, or on general wireless matters. We regret that we cannot, for obvious reasons—

- (1) Supply circuit diagrams of complete multi-valve receivers.
- (2) Suggest alterations or modifications of receivers described in our contemporaries.

- (3) Suggest alterations or modifications to commercial receivers.
- (4) Answer queries over the telephone.
- (5) Grant interviews to querists.

A stamped, addressed envelope must be enclosed for the reply. All sketches and drawings which are sent to us should bear the name and address of the sender.

Requests for Blueprints must not be enclosed with queries as they are dealt with by a separate department. Send your queries to the Editor, PRACTICAL WIRELESS, George Newnes, Ltd., Tower House, Southampton Street, Strand, London, W.C.2. The Coupon on page 38 must be enclosed with every query.

Unusual Crystal Circuit

"In the issue of May 13th, 1939, details were given of a Crystal Receiver which I decided to build. I was unable to obtain the specified coil, so decided to use a Lissen type L.N.5101, which is of the shielded dual-range pattern.

"I tried a number of different ways of connecting it to the crystal detector, phones and 0.0005 mfd. tuning condenser, until quite by accident I got the best results by using the connections shown on Fig. 1. From the technical point of view it appears to

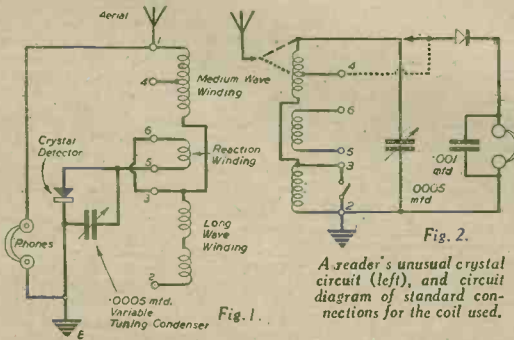

break all theoretical laws or, in other words, to be absolutely out of order, but I thought it might interest other readers.

"Selectivity is quite good, and I can get three stations one after the other as the tuning condenser is rotated through 90 degrees. The Home Service, the Forces, and another in between these two come in at very good strength.

"If you care to suggest any other method of connecting the coil, etc., I shall be pleased to try it."—H. G. Slade (New Southgate, N.11).

THE circuit you are using is certainly rather unusual, and in that respect the details of the results you are obtaining are quite interesting. Although the tuning condenser is actually tuning the medium wave and reaction sections of the coil, it is also in parallel with the crystal. In case you have not tried the normal or correct connections for the coil in use, we show these in Fig. 2. Owing to the fact that the long-wave section is of little use these days, that winding could be permanently short-circuited, thus eliminating the wave-change switch.

Increasing the Volume

"I have a two-valve battery-operated S.W. set with which I am very pleased. I have also a five-valve superhet which covers the medium and long-wave transmissions. What I wish to know is can I couple the output from the short-wave to the pick-up sockets of the superhet so as to gain the advantage of the L.F. stages in the latter? I do not wish to alter the S.W. set, as I have just got the tuning and reaction controls to operate as near perfect as seems possible."—A. S. Constable (Bury).

THIS particular query is often cropping up, and it is generally capable of a simple solution. It must be remembered, however, that the output terminals of a normal set are connected to the anode of the output valve and H.T. positive. The pick-up terminals are usually joined to the grid of the detector or an L.F. valve and earth or a low value of grid-bias. Direct connection between the output and P.U. terminals is, therefore, impossible, as a short-circuit would be produced across the H.T. supply, due to the fact that H.T. negative is common with the earth side of the circuit. The only satisfactory methods of coupling

are those which make use of an L.F. transformer having a ratio of 1:1, or a choke-filter output system. The primary of the L.F. transformer should be connected to the L.S. terminals of the S.W. set, and the secondary to the P.U. input on the superhet.

Metal Rectifier in A.C./D.C. Sets

"As I am unable to obtain a new rectifying valve for my A.C./D.C. receiver, I would like to know if it is possible to use a metal rectifier in its place and, if so, what alterations will have to be made to the circuit. The set is being used on A.C. mains."—G. Parkin (Glos.).

YES, Westinghouse Metal Rectifiers are quite suitable for use in the type of circuit mentioned. As you do not give us any details about the set or enclose a circuit diagram, we cannot supply all the information you require. However, we hope that that given below will enable you to carry out the alteration. The metal rectifier is used in a half-wave circuit and does not require a mains transformer. One side of the mains supply is taken direct to the negative side of the rectifier, whilst the positive side forms the positive D.C. point, and to this is connected the usual smoothing circuit. It is advisable to incorporate a suitable fuse between the mains and the rectifier. The supply for the heater circuit does not flow through the rectifier, but comes direct from the mains via a suitable voltage dropping resistance. It is, of course, essential for the earth and aerial connections to the set to be made through fixed condensers having a voltage rating of, at least, 400 volts D.C. working.

For receivers requiring up to 60 mAs. H.T. current, the Westinghouse Metal Rectifier type H.T. 15 will be suitable. For circuits drawing up to 100 mAs., the H.T. 17 is recommended. If you dispense with the valve rectifier, you must remember to complete its heater connections (it being wired in series with the other valves) and adjust the voltage dropping resistance to compensate for the additional voltage to be dropped, i.e. that previously taken by the heater of the rectifier.

Step-down Transformer

"I have obtained an American receiver which I understand is designed to operate off A.C. mains having a supply voltage of 110 volts. I have been told that the set has been in use on 220 volt mains, the previous owner using a step-down transformer to reduce the voltage to that required by the set. Is this procedure quite in order, and if so, what type of transformer shall I require and from whom might I purchase one?"—J. T. Wilson (Bristol).

IT will be quite in order to use a well designed step-down transformer having a ratio of 2:1. As this component will have to supply the total wattage required by the set, it would be advisable to give complete details concerning the number and type of valves in use. We would suggest that you communicate with Messrs. Premier Radio, who produce a wide range of such components.

Modifying a Voltmeter

"Could you inform me if a 0-30 v. voltmeter could, by means of series resistances, be converted to read 0-3 amperes, and if so, what resistance would be required, and would the resistance need to be of special make?"—A. Shepherd (Fife).

A VOLTMETER is nothing more than a milliamp meter fitted with an internal series resistance. If you wish to modify the meter, you must remove it from its case, and take out the series resistor. After this, you will have to determine its maximum current reading by carrying out comparative tests with a meter of known scale. When the value has been found, you can multiply its effective maximum reading by connecting suitable shunts, i.e., resistances, across the meter's terminals. The value of such resistances must be determined by experiment, unless the actual resistance of the meter winding is also known.

The shunts are usually wire wound and arranged at the back of the meter.

Classified Advertisements

ADVERTISEMENTS are accepted for these columns at the rate of 2s. per line or part of a line. Minimum charge 4s. All advertisements must be prepaid and addressed to Advertisement Manager, "Practical Wireless," Tower House, Southampton Street, London, W.C.2.

CABINETS

WE regret that, owing to all our employees having joined H.M. forces, we are unable to accept orders for cabinets except to callers. Limited stock only. We have a large stock of radio components.—H. L. Smith & Co., Ltd., 289, Edgware Road, London, W.2. Tel.: Pad. 5891.

LOUDSPEAKER REPAIRS

LOUDSPEAKER repairs, British, American, any make, moderate prices.—Sinclair Speakers, 12, Pembroke Street, Copenhagen Street, N.1.

LITERATURE, MAPS, etc.

AMATEUR Radio Handbook. Second edition now on sale. 328 pages, price 4s.—Radio Society of Great Britain, 16, Ashridge Gardens, London, N.13.

WEBB'S Radio Map of the World. Locates any station heard. Size 40" by 30", 4/6, post 6d. On linen, 10/6, post 6d. WEBB'S Radio Globe—12" model. Radio prefixes, zones, etc., 27/6.—Webb's Radio, 14, Soho Street, London, W.1. Phone: GERrard 0289.

RADIO SOCIETY OF GREAT BRITAIN invites all keen amateurs to join. Reduced war-time subscriptions. Send 1s. for latest "T. & R. Bulletin" and details.—16, Ashridge Gardens, London, N.13.

MORSE EQUIPMENT

FULL range of Transmitting Keys, practice sets and other equipment for Morse training.—Webb's Radio, 14, Soho Street, London, W.1. Phone: GERrard 2089.

NEW LOUDSPEAKERS

3,000-Speakers, P.M. and energised, 4in. to 14in., including several Epoch 18in.—Sinclair Speakers, 12, Pembroke Street, Copenhagen Street, N.1.

PUBLIC APPOINTMENTS

WIRELESS TECHNICAL INSTRUCTORS REQUIRED IN ARMY UNITS

Emoluments.—Pay 8s. 9d. per day (7 days a week). Clothing, rations and accommodation or, if this cannot be provided, allowances at authorised rates. If married and otherwise eligible family allowance payable in respect of wife and children, subject to allotment from pay. Candidates should preferably be under 35 and over 24 and—

(a) Hold one of the following qualifications:

Graduateship of the Institute of Electrical Engineers.

Final (Grade III) Certificate of City and Guilds of London Institute Examination in Radio Communication.

Higher National Certificate in Electrical Engineering.

Certificate of City and Guilds of London Institute of Radio Service Work.

OR

(b) Be able to pass an examination on the following syllabus:

Simple algebra, including quadratic equations; simple trigonometrical ratios and identities; vectors.

Continued at top of column 24

CODE COURSES

For Beginners and Operators

The Candler System of Code training is just what one needs for entering or advancing in Army, Navy, Air Force, Amateur Radio work, or the Commercial side of telegraphy.

JUNIOR AND ADVANCED COURSES

on Cash or Monthly Payment terms.

There's no royal road to learning—but there IS a quick, sure way to genuine CODE skill.

J. Clarricoats, Sec., Radio Society of Great Britain—says: "I regard the Candler System as being the most important system of its kind and already large numbers of Members of the Radio Society of Great Britain have intimated to me that they are studying the course of instruction with a view to preparing themselves for service in one branch or another of H.M. Forces."

In the "BOOK OF FACTS," sent FREE on request, full information is given concerning the subjects covered by all Candler Courses.

COUPON for Copy of Candler "Book of Facts."

NAME

ADDRESS

.....

Post Coupon in ld. unsealed envelope to:

CANDLER SYSTEM CO. (5 L.O.),

121, Kingsway, London, W.C.2.

Candler System Co., Denver, Colorado, U.S.A.

(1241)

AUTHORITATIVE ENGINEERING TRAINING

25 FIRST PLACES and Hundreds of Passes were gained by T.I.G.B. students at recent examinations for A.M.Inst.C.E., A.M.I.Mech.E., A.M.I.E.E., A.F.R.Ae.S., C. & G., etc.

Write to-day for "The Engineer's Guide to Success," containing world's widest choice of home-study engineering courses—Wireless, Television, Electrical, Mechanical, Aeronautical, Automobile, Building, Civil, Chemical, Gas, etc., and which alone gives the Regulations governing admission to the Recognised Engineering Institutions. Mention branch, post or qualification that interests you. The T.I.G.B. Guarantees training until Successful for the one fee.

The Technological Institute of Gt. Britain, 211, Temple Bar House, London, E.C.4. (Founded 1917. 99,000 Successful)



(Continued from column 1.)

Properties of electrical currents; heating of conductors; magnetic fields; unit of current; Ohm's Law; resistance in series and parallel; potentiometers.

Magnetic effect of current; fields due to parallel wires; field due to a solenoid; electro-magnets.

Meters.

Induction; effect of rotating a coil in a magnetic field.

Mutual and self induction and inductance; effect of inductance on growth and delay of current.

Capacity; charging storage and discharge of condensers; through resistance and inductance.

Alternating currents; vector diagrams; effect of resistance variation; effects of L and C in A.C. circuit; phase difference of currents; resonance in a series circuit; parallel circuit of L and C; Q factor.

Elementary knowledge of valves; simple theory of amplifiers; oscillators and detectors; general principles of radio practice.

Suitable Candidates will be interviewed at local centres, and, if successful, will be enlisted and appointed Acting Sergeant Tradesmen. For those who are on the Schedule of Reserved Occupations, special arrangements will be made to enable them to be enlisted. In the event of any applicant found to be reserved under Schedule of Reserved Occupations special application will be made for relaxation of the Schedule. No guarantee can be given that this application will be successful.

Application Forms may be obtained by post card from the Under Secretary of State, The War Office (A.G.6c), Whitehall, S.W.1.

RECEIVERS & COMPONENTS

GEE GEE GEE GEE GEE GEE
15, LITTLE NEWPORT STREET, W.C.2.
THE HOUSE FOR QUALITY COMPONENTS AT LOW PRICES

AMERICAN AND B.V.A. VALVES. Many types available. Send lists for quotation. EX-PHILGO Battery Valves, Type 1A4E, 4/- each.

SOLDER. Best quality resincore, 50 per cent. tin, 12 gauge, 6d. a length.

CONDENSERS. T.C.C., 1 mfd, tubular, 350v., 7/6 doz. Also Wego 1mfd. 400 v., 6/- doz. (Dozens only).

VALVE-HOLDERS. 4-pin, 5-pin, 7-pin, 8-pin (octal) and 9-pin chassis type, 6d. each, 5/- doz., or 50/- gross, assorted.

SWITCHES. Q.M.B. 3 amp.; splendid line. 1/6 each, 16/- doz.

FUSES. 1 amp. 2/- doz., 20/- gross.

MAINS DROPPERS. 2 amp., suitable for Lissen, Pye, etc. Brand new, 3/9 each. STAMPED ENVELOPE must accompany all enquiries.

GEE ELECTRIC, 15, LITTLE NEWPORT ST., W.C.2.

KIT of parts for trickle charger, 2v. 1 amp., 11/9d. Post 6d.—Champion, 42, Howitt Road, London, N.W.3.

A. C. ELIMINATORS, as new, 30/-. We pay carriage.—Bunton, 12, Yewcroft Avenue, Newcastle-on-Tyne, 5.

COULPHONE Radio, New Longton, Preston.—Brand new goods only. Latest type P.M. Speakers, with transformers. 8in. Goodman, 20/-. 10in. Rola, 25/-. Electrolytics, 500 v. 8 mfd., 2/9; 8 + mfd. (4 leads), 4/9; 10 + 8 mfd., 6/3; 50 mfd. 50 v., 2/9. Cosmocord Crystal Pick-ups, 30/-. Erie and Dubilier 1-watt resistors, 7/6 doz. Volume controls with switch, 4/9. Tubulars, valve holders, etc. S.A.E. for list.

RECEIVERS AND COMPONENTS

ENGLAND'S GREATEST BUYERS OF SURPLUS RADIO AND ELECTRICAL GEAR. ASSEMBLED FROM GOVERNMENT, G.P.O., ARMY, R.A.F. AND PROMINENT MANUFACTURERS.
GOODMAN'S 3" P.M. Speakers, brand new, boxed, complete with universal transformer, 18/6 each.
ROLA 10" Energised Speakers. 300 ohms, less transformer. With field coil, 12/6, without field coil, 8/6.
PHILIPS Speech transformers for pentode output, 3/6 each.
BEEHOVEN Chassis, 4-valve, 2 wave-band A.C. Superhet, complete with all components. Valve-holders, ready wired, but less valves and speaker, 22/6.
UNIVERSAL A.C./D.C. Chassis, 5-valve, as above, less valves and speaker, 22/6.
MORSE KEYS. Don't confuse these with inferior junk. It's a super job. 8/6 each.
VALVES are in short supply. Stock of Mullard TSP 4's and HYR 2's to be cleared at 15/- each. First come, first served.
TELEVISION diode valves. Surplus quantity to clear at low price. Unused Mullard Type EA50, midget type, size 69 mm. x 12 mm. overall. 6.3 v. heater at 15 amp., 10/6 each.
CONDENSERS.—Special offer of metal cased paper condensers, 300 v. working. All brand new and unused. 2 mfd., 1/9; 1 mfd. x 1 mfd., 1/9; 1 mfd., 1/-; .5, .25 and 1 mfd., 8d.
RESISTORS, 10 watt, 100 ohm vitreous enamelled mains resistors, 1/3 each.
EX-BAIRD. Wax impregnated cardboard panels, 10 1/2" x 6", 1/3 doz. Short-wave coil 7.23 metres mounted on ceramic trimmer, 1/- each. A big range of volume controls, 1 ohm, 200 ohm, 600 ohm, 1,000 ohm, all values 2/6 each.
FLEXIBLE DRIVES. Well made, shielded cable drives for remote control. Ideal for radiogramophones. Approx. 2' long. To clear, 4/- each.
ELECTRO-MAGNETIC COUNTERS. Resistance 500 ohms. From 1-12,999. Size 4 1/2" x 2" x 1 1/4". Ex-G.P.O. Invaluable for countless purposes, 9/6 each. A smaller type, 1-1,999, size 4 1/2" x 1 1/2" x 1 1/4", 5/6.
VALVE HOLDERS. Belling-Lee special H.F. 5-pin chassis mounting in black bakelite, 1/- each, 10/6 doz.
PLESSEY small block type condensers, two tappings, .0005 and 0.1 mfd., 350 v. test, 1/- each, 10/6 doz.
VARIABLE CONDENSERS. Well-made heavy 3-gang superhet condensers. Die cast frames in first class condition. 2/6 each.
SMALL REVERSIBLE A.C. MOTORS (as used for motor tuning). 25-30 volts A.C. Built-in reduction gear spindle. Speed about 60 r.p.m. 8/6.
AUDAK CUTTING HEADS. Heavy duty type. 3-5 ohm coil. A really high-class instrument, 17/6.
YAXLEY type switches, 2-way, 1/-; 2 bank 3-way, 2/-; 4-way, 4/-.
SCREENING shields in aluminium, 6 1/2" x 5" x 5 1/2", brand new and unused, 2/6 pair.
OUTPUT TRANSFORMERS. Primary 300 ohms D.C. Secondary .5 ohm D.C. Brand new, manufacturer's type, 4/6. Also new chokes, 30 henry, 150 ohms, 3/- each.
RESISTANCES. Assorted valves and makes, Erie, T.C.C. American, etc. Low price of 1/6 doz.
E.I. CONDENSERS. Block type oil filled in metal cases with terminals. High quality components. .1 mfd., 1,000 v. D.C. test, 2/6 each and 0.25 mfd., 1,000 v. D.C. test, 2/6 each.
RELAYS. Small relays for operation on 2 v. D.C. with 6-way make and break switches. Brand new, 5/- each.

(Continued at foot of column 2)

ELECTRADIX

Condensers. Fixed, 2 mfd., G.P.O., for smoothing, 2/6. H.T. Mica Fixed Condensers, 1.4 mfd., 4,000 volts, 10/-; Large 1 mfd. 2,000 volts, 10/6. 1 mfd. 6,000 volts, oil-filled B1 Condensers, 35/-; 2 mfd., 4,000 volts, cased, 45/-.
Variable. .0005 mfd. variable short-wave, type F; Condensers in carton, 3/6. Order soon, control limits sales.
Insulators. All shapes and sizes from aerial egg or shell at 2d. to big navy Gin. type. Cleats and pedestal insulators. No list ready. Please specify. Crystal Sets. Mahoz. case 15g.; midget, 7/6; post free. Galvos and circuit testing G.P.O. vertical Galvos, 7/6. Elliott Nalder and Crompton Army E108, with mov. coil meter, 0 to 3A. with glass top theo in lid, 3/6. Sullivan Marine Lab. type Galvo, 27/10/-.
Meter Movements, small type, low current. Few only, 8/6.
Wheatstone Bridge panels less plugs and coils, ex W.D. Works Vac. Cleaners. Pulvo. box cabinet type, on wheels with 1 h.p. motor, 25/15/-.
Electric Towel Rail or Clothes Dryer, Belling Lee, works type 1K.V. 250 volts, 50A. Pumps, New Twin piston 1 h.p. pumps, new, suit motor or belt drive. 43/11/-.
Stuart Turner Shelter Pumps, 12 volt, Shelter Centrifugal, 100 gals. No. 10 in stock, 45/1/6.
Dynamos, A.C. and D.C. All voltages from 10 to 2,600 volts. From 5/-.
Micro Motors to Alternators up to 2 kW periods, 50 to 500 cycles, send your enquiries or call.
Valves. New General Purpose "Weco" 1-volt Triodes, 4-pin base, 3/6. Osram 6-volt Power Triodes, AT40, 4/6.
Neon letter lamps, 250 volt, 2/6. Miniature neons, 250 volt, 2/6.
Photo Cells, RCA 967 are 25/-; Osram CMG, 42/10/-; W.E., 35/-.
Small 3-lens optical systems, 10/-; 500-ohm Counters to 9999, 5/-.
Keys and Buzzers in stock.
Practice Morse. Home Training with a Practice Morse Recorder. Spring drive, no battery wanted, marks direct on tape with dead key. Shows spacing faults. For novice or expert. Govt. model. 23/10/-.
Speakers for use with buzzers for loud signals, short horn, 7/6.

Please add postage for all small orders. Stamped envelopes for all replies, please.
 Please note new address:
 Our new offices adjoin our works at Battersea, 19, Broughton St., Queenstown Rd., S.W.8. No. 137 bus or 31 tram. Rly. Sta. Queen's Rd., Battersea, from Waterloo.

ELECTRADIX RADIOS
 19, Broughton Street, London, S.W.8.
 Phone: MAChulay 2159.

TRIMMERS. Twin trimmers on ceramic base, brand new, to clear 6d. each, 5/- doz.
WEGO CONDENSERS. Tubular type, 1 mfd., 5,000 v. working, 5/6 each.
COIL FORMERS. Cardboard and Paxolin-Assorted sizes, useful for experimenters. 1/6 doz.
CONDENSERS. Metal-cased non-inductive, .5 mfd., 1/6; 1 mfd., 1/9; 1 mfd. x 1 mfd., 2/-; 2 mfd., 2/-.
METAL Rectifiers, by Standard Telephones. Brand new, 12 v. 3 amp., 12/6 each.
VALVE HOLDERS. American 4-pin chassis mounting type, to clear at 1/6 doz.
ACCUMULATORS. Ediswan 2v. 60 amp. Brand new in ebonite cases. Size 8" x 4 1/2" x 2 1/2". Callers only. 17/6 each.
CHARGERS. Small trickle chargers, metal rectification. Input 200/220V. A.C. Output 2v. 1 amp. Shockproof, 17/6. Ditto in metal case for mounting. 19/6.
SPEAKER Mesh, 10 1/2" x 9 1/2", 1/6; also chromium escutcheons without dial, 7 1/2" x 5 1/2", 1/- each.
TUBULAR Wire-end condensers. Brand new, first quality components. .0003 mfd., 8d.; .005 mfd., 9d.; .01 mfd., 10d.; 1 mfd., 1/- each.
SEE ALSO DISPLAY ADVT. PAGE 43. POSTAGE MUST BE INCLUDED. NO C.O.D. ORDERS.

LONDON CENTRAL RADIO STORES,
 23, LISLE STREET, LONDON, W.C.2.
 Phone: GERRARD 2969

RECEIVERS AND COMPONENTS

GALPINS ELECTRICAL STORES
ELEC. LIGHT CHECK METERS, small late type, good makers, fine condition electrically guaranteed, 200/250 volts 5c. cr. 1 ph. A.C., 5 amp., 10/-; 10 amp. 12/6; 20 amp., 15/-; post free.
D.C. ELEC. LIGHT CHECK METERS. 200/250 v., 5 and 10 amps., 7/6, post free.
AUTO. CHARGING CUT OUT AND VOLTAGE REGULATOR, ex-R.A.F., suit any dynamo up to 20 v. at 15 amps., fully adjustable, with wiring instructions complete in metal case, 3/6, post 9d.
SOLID BRASS LAMPS fitted small B.C. double contact holder and 12 volt bulb. price 3/-, post free.
110 VOLT D.C. MOTOR, totally enclosed. rated at 8 amps., ball bearing, in new condition, make good slow-speed dynamo. weight approx. 75lbs., price 45/-, carriage forward.
FLOODLIGHTS, 12in. dia., multi mirror. margin reflector in centre, take any bulb. 15/-, carriage paid.
MILLIAMPMETER by "Werton," 2 1/2in. flush fitting, moving coil, reading 0-200 ma./a, 30/-, post free.
BLOCK CONDENSER, large size, 1 MF., 4,000 v. working, 10/-, carriage 2/-.
2 kW Transformer, complete with clamps, suitable for rewinding, 25/- each; 1 kW. ditto, 17/-, both carriage paid.
STEEL CABINETS, suitable for amplifiers, partly fitted racks, size 40ins. high, 24ins. wide and 16ins. deep, in clean condition, price 30/- each, carriage forward.
DYNAMO for lighting or charging, shunt wound and interpole, output 110 volts 60 amps., price £20, carriage forward.
ZENITH VITREOUS Resistances, assorted, useful sizes, all good, 12/6 per doz., post free.
GALPINS ELECTRICAL STORES, 21, WILLIAM STREET, SLOUGH, BUCKS.
 Cash or C.O.D.
 Telephone: SLOUGH 20855.
DETECTION. Revolutionary theory; circuits; experiments. World-wide circulation. Booklet 2/-.—D'Arcy Ford, Gandy Street, Exeter.
SPECIAL CLEARANCE OFFER OF:—AUTOMATIC Morse Code Senders. Useful to those learning the Code. Used in place of ordinary key for operating buzzer, etc. International Code, 41 characters. Instrument Complete, 3/6.
INSTRUMENT Wire, 20 s.w.g., D.C.C. 5/6 lb., 32 s.w.g. enamelled, 2-lb. reels, 10/-.
TRANSFORMERS, L.T. adjustable tapped, 200/240 v. Output 12 v. at 1 1/2 amp. High-grade job, 10/6.
ELECTRO Magnetic Mechanisms, 6-12 v. A.C./D.C. Energising permits 3 mechanical operations, then locks, 5/6.
COIN-OPERATED Mechanisms. Insertion of penny operates counter 0-9999, and electrical contact. Superior precision Unit, 10/-.
CABINETS. Strong steel, 17 x 9 x 7in. cellulosed grey. Front hinged door fitted lock. Inside compartment with separate cover. First-class job, 10/6.
CRYSTALS. Boxed with Catswhisker, 6d. 1,000 ohm. Resistors, 6d. doz., 3/6 gross.
MICROPHONES. Standard G.P.O. Insets, 2/- Super-sensitive type, 2/9.
KNOBBS, Black screw-on type, suitable for Morse Keys, assorted, doz. 1/6.
 Orders over 10/- post free. No C.O.D.
MIDLAND INSTRUMENT CO., 18, Harborne Park Road, Birmingham, 17.

RECEIVERS AND COMPONENTS

RELIANCE RADIO SERVICE
8, Kennington Park Road, S.E.11.
Phone : REL. 1360.

GRILLES. Chromium-plated. Modern design. Improve the appearance of your set. 8 x 9. 1/- each.

5-WAY Battery Cords. Few to be cleared. 6d. each or 5/- doz.

SCREENED LEADS. Long, with earthing connection. 2d. each or 1/6 doz.

SHORT-WAVE COILS on Paxolin former, 2in. long by 1in. dia., mounted on metal bracket. Grid and reaction winding. 6d. each.

I.F. TRANSFORMERS. In 2in. cans with trimmers. 1/- each.

ASSORTED COILS. I.F., S.W. tuning coils of all description, 3 for 1/6.

VALVE SCREENS. Fit all English valves and some U.S.A. Bargain at 6d. each.

PAXOLIN PANELS. Handy for fixing resistances and condensers, with soldering tags. 3in. by 5in. 6d. each, 5/- doz.

MICROPHONES. Table model can be used with any radio set, that can be switched to gram. Or with phones in conjunction with a grid bias battery. Complete with transformer. Boxed with instructions. Brand-new stock. 7/6 each.

CHASSIS. Small metal chassis as used in Midget sets, fitted with 5 octal base valve holders, with mains adjusting and voltage panel complete, 2/6.

ROTARY SWITCHES. 2-way 12 contact. Very good for use in home-constructed test meter. 6d. each. Also a 2-way 9 contact wave change switch, 6d. each.

BULB-HOLDERS. Standard torch bulb-holder on metal bracket. Make good inspection lamps. 6d. each.

SUPERHET COIL KITS. Consisting of tuning coils, Det. and Osc. with range of 200 to 2,000 metres, and 3 I.F. transformers, completely shielded with trimmers. Complete kit 4/-, 3-gang condensers to suit above kit, 2/- each.

TUBULAR CONDENSERS. 1 mfd. 350 volts working 3d. each, 2/6 doz. 25 mfd. bias condensers, 15 volts working, 4d. each, 3/- dozen. Also 12 assorted condensers, our selection 2/- dozen.

RESISTANCES. Wire end, all values, 12 assorted, our selection, 2/-.

MAINS CHOKES. 60 m.a. 350 ohms. Good substantial job. 2/- each.

VOLTAGE REGULATOR and Fuse Panel, ebonite on metal brackets, 6d. each.

MICA CONDENSERS, tag end, 12 assorted, our selection, 2/6.

TUNING COILS. Superhet coils, Det. and Osc. on one former. Range, 200-2,000 metres. 1/3 each.

DUAL-RANGE tuning coil. Lovely job with screen tuning. Range, 200-2,000 metres. 1/6 each.

COIL FORMERS. 1in. by 3in. cardboard formers. Ideal for winding short-wave coil. 1/- dozen.

METAL-CASED paper type 1 med. 500-volt working condensers. Bargain at 9d. each, 6/- dozen.

Postage must be included with all orders. Regret cannot accept C.O.D. orders.

All letters should be addressed to:
RELIANCE RADIO SERVICE,
Mail Order Dept., 8, Kennington Park Rd., S.E.11. Phone : REL. 1360.

EDDYSTONE Bandsread with 6 Pin Coils 6-94 metres, 10/-; Headphones, new, 15/-; A.C. Eliminator with trickle charger for 2-4 or 6 v. accumulators, 20/-, or exchange with Components value £6 for Piano Accordion.—Details to Clarke, 49, Mellor Street, Washbrook, Chadderton, Nr. Oldham, Lancs.

RECEIVERS AND COMPONENTS

FRED'S RADIO CABIN
75, Newington Butts, S.E.11.
Phone : Rodney 2180.

LINCOLN STEWART Aerial Eliminator. Cut out interference. 1/6 each.

COILS. Bargain line of 6-pin coils, complete with circuit, to be cleared at 2/- each.

WANDER PLUGS, black only, 10d. doz. I.F. COILS. Sets of 3 Ekco I.F. coils fully screened, perfect condition, 2/6 set.

MORSE KEYS. New line of high-class morse keys. Ideal for practice. On oak base with adjustable spring. Low price of 3/6 each.

PLESSY 3-gang .0005 mfd. Superhet screened variable condenser, 3 1/2in. long, 3in. wide, 1/3 each.

VARIABLE CONDENSERS. Parcel of 5 gross to clear, 0005 mfd. job, first-class condition, 2-gang, .0005 mfd., 9d. each.

VOLUME CONTROLS. Various values, some with switches, stripped from chassis. A good bargain. 12 assorted for 5/-.

ELECTROLYTIC Block Condensers. Salvage stock at really low prices. Assorted, 8 x 8 x 2, 24 x 8 x 2, 12 x 8, etc. In some cases one section of block is dead, but these have been cut out. 8/- dozen.

EX-TELEPHONE Microphone Transformers, suitable for microphone buttons advertised below. 1/6 each.

MICROPHONES, complete with transformer. Solid ebonite job. 5/6, with complete instructions.

RESISTANCES. 30,000 ohm, 1 watt, 2d. each, 1/9 dozen.

VOLUME CONTROLS. 2,000 ohm, 2 megohm, either value 1/9 each.

TRANSFORMERS. Burnt-out rejects. When stripped provide perfect laminations, size 4in. x 3 1/2in. x 1in., 1/9 each.

TRIMMERS. Brand new on ceramic base, 50 m.mfd., also 250 m.mfd., 3d. each, 2/9 dozen.

TRIMMERS. New 220 m.mfd. on Frequentite ceramic base. 4d. each.

COIL FORMERS. Cardboard 1in. diam. To clear at 1/- dozen.

EKCO Twin H.F. Mains Filters, 1/6 each.

MAINS CHOKES. Big quantity available, 60 m.a., 350 ohms, 2/- each.

EKCO mains dropping resistances. Total resistance 700 ohms. with 3 tappings, 2/6 each.

PUSH-PULL Switches. 2-pt., 3d. each, 2/6 dozen.

LOW-LOSS Coil mounts, 2-pin, 3d. each, 2/6 dozen.

CRYSTAL and catwhisker in tin box. New stock lower price of 6d. each.

PERMANENT Lucerne Crystal detectors, very good line, 1/6 each. Replacement crystals available at 1/- per set.

TWIN Binocular H.F. Chokes, brand new, to clear at 6d. each, 5/- dozen.

MICROPHONE Insert buttons. Few only to clear at 2/6 each.

CHASSIS. Size 8" x 12" x 2 1/2" include two 7-pin and two 5-pin valveholders, A.E., L.S., and Gram. sockets, 2/6 each.

SPEAKER GRILLES. 7" x 3 1/2" Chromium-plated. Cheap, to clear, 1/6 each.

Postage must be included with all orders. Regret cannot accept C.O.D. orders.

FRED'S RADIO CABIN FOR BARGAINS, 75, Newington Butts, S.E.11. Rodney 2180.

New branch at 17, Hamilton Parade, London Road, North Cheam, Surrey.

USEFUL Components, including few valves. Stamp for list.—Clarke, 129, Sutton Road, Kirby-in-Ashfield, Nottm.

TROPHY 5 S.W. Set, state age and condition.—E. B. Nixon, c/o 20, Harold Avenue, Belvedere, Kent.

COILS.—Colvern 3-gang type, K.G.O., K.G.O., K.G.R. or Telsen W. 288.—Hnghes, Savoy Cafe, Congleton.

RECEIVERS AND COMPONENTS

SOUTHERN Radio's Wireless Bargains: 5/- Parcel. Ass'd. Components. Valve Holders, Volume Controls, Wire, Resistances, Condensers, Circuits, etc., 5/-.

15/- Service kit of Components. Resistances, Tubular and Electrolytic, Condensers, Volume Controls, Chokes, etc. In wooden carrying case, 15/-.

25/- Small trader's Parcel of Components, 100 saleable items, 25/-.

3/- Wooden Tool or Instrument Case, 9in. x 7in. x 7in., ex Government stock, 3/-.

ORMOND Loud Speaker Units, balanced armature type, 6/6; smaller Bakelite type, 3/6; unshrouded type, 2/6; Wireless Crystals, 6d. each, 5/- per dozen tins; Ace P.O. Microphones, complete ready for use with any set, 6/6 each; Vestectors W.2. 2/6; Mica Condensers, assorted sizes, 3/- dozen; assorted terminals, plugs and tag ends, 6/9 gross; Telsen Radio Magazines, complete with 4 blue prints, 6d. post. free; Mainsbridge Condensers, 1 mfd. 1/-, 2 mfd. 1/3, 4 mfd. 2/9 each; Valve Holders, assorted, 9. 7. 5. 4-pin, 3/- dozen; Permanent Magnet Speaker, W.B., 10in., with Transformer, 25/-; thousands of bargains for callers; all goods guaranteed; please add postage to amount of order, approximate postage 7d. on 6/-, to 1/1 on 25/-.

SOUTHERN Radio Supply Co., 46, Lisle Street, London, W.C.2. Gerrard 6653.

MOVING COIL 0-1 mA. milliammeter. Details, etc.—Edwards, "Broome," St. Andrews Road, Bridport.

"**RADIO**" Bargains." Few brand new 1940/41 models in makers' sealed cartons with guarantees, and used models at reduced prices, also valves. State requirements.—"Radio Bargains," 261-3, Lichfield Road, Aston, Birmingham.

SHORT-WAVE EQUIPMENT

"**H.A.C.**" Short-wave Receivers.—Famous for over 8 years. Improved one-valve model now available. Complete kit of precision components, accessories, with full instructions, requiring no soldering, only 16/-, postage 6d. Immediate despatch. Illustrated catalogue free.—A. L. Bacchus, 109, Hartington Road, S.W.8.

TUITION

FREE. "Book of Facts," tells you all about The Candler System of code training. Courses for Beginners and Operators.—Write: Candler System Co. (L.O), 121, Kingsway, London, W.C.2.

PRACTICAL Postal Radio Courses; coaching for I.P.R.E. exams; qualifying for R.A.F. and A.I.D. posts; booklet free.—Secretary, I.P.R.E., Rush House, Walton Avenue, Henley-on-Thames.

"**RADIOLOCATION.**"—Students of both sexes trained for important war-time Radio Appointments. Also for peacetime careers in all branches of Radio and Television. Boards accepted. Low inclusive fees. College in ideal peaceful surroundings. Prospectus free.—Wireless College, Colwyn Bay.

WANTED

WANTED, new or second-hand radio gram motors and record changers, A.C. or A.C./D.C.—Details to Hadley Bros, Anderson Road, Birmingham, 17.

WANTED—Short-wave coils, 4-pin "Eddystone," "Premier," or similar Any quantity.—S, Ashley Court, S.W.1 (Vic. 1838.)

TROPHY 8 wanted, in new condition.—Details Gorde, 4, Clifton, York.

Practical Wireless BLUEPRINT SERVICE

These Blueprints are drawn full size. Copies of appropriate issues containing descriptions of these sets can in some cases be supplied at the following prices which are additional to the cost of the Blueprint. A dash before the Blueprint Number indicates that the issue is out of print.

Practical Wireless (issues dated prior to June 1st, 1940) 4d. Post Paid
(Issues dated June 1st to July 27th, 1940) 5d. Post Paid
(Issues dated September, 1940, to November, 1941) 7d. Post Paid
(Issues dated December, 1941, and after) 10d. Post Paid

Amateur Wireless 4d. " "
Wireless Magazine 1/4 " "

The index letters which precede the Blueprint Number indicate the periodical in which the description appears: Thus P.W. refers to PRACTICAL WIRELESS, A.W. to *Amateur Wireless*, W.M. to *Wireless Magazine*.

Send (preferably) a postal order to cover the cost of the Blueprint, and the issue (stamps over 6d. unacceptable) to PRACTICAL WIRELESS Blueprint Dept., George Newnes, Ltd., Tower House, Southampton Street, Strand, W.C.2.

PRACTICAL WIRELESS No. of Date of Issue, Blueprint. CRYSTAL SETS

Blueprints, 6d. each.		
1937 Crystal Receiver	PW71	
The "Junior" Crystal Set	PW94	27.8.39
STRAIGHT SETS, Battery Operated.		
One-valve: Blueprints, 1s. each.		
All-Wave Unipen (Pentode)	PW31A	
Beginners' One-valver	PW85	19.2.38
The "Pyramid" One-valver (HF Pen)	PW93	27.8.38
Two-valve: Blueprint, 1s.		
The Signet Two (D & LF)	PW76	24.9.38
Three-valve: Blueprints, 1s. each.		
Selectone Battery Three (D, 2 LF (Trans))	PW10	
Sixty Shilling Three (D, 2 LF (RC & Trans))	PW34A	
Leader Three (SG, D, Pow)	PW35	
Summit Three (HF Pen, D, Pen)	PW37	
All Pentode Three (HF Pen, D (Pen), Pen)	PW39	
Hall-Mark Three (SG, D, Pow)	PW41	
Hall-Mark Cadet (D, LF, Pen (RC))	PW43	
F. J. Camm's Silver Souvenir (HF Pen, D (Pen), Pen) (All-Wave Three)	PW49	
Cameo Midget Three (D, 2 LF (Trans))	PW51	
1936 Sonotone Three-Four (HF Pen, HF Pen, Westector, Pen)	PW53	
Battery All-Wave Three (D, 2 LF (RC))	PW55	
The Monitor (HF Pen, D, Pen)	PW61	
The Tutor Three (HF Pen, D, Pen)	PW62	
The Centaur Three (SG, D, P)	PW64	
F. J. Camm's Record All-Wave Three (HF Pen, D, Pen)	PW69	
The "Colt" All-Wave Three (D, 2 LF (RC & Trans))	PW79	18.2.39
The "Rapid" Straight 3 (D, 2 LF (RC & Trans))	PW82	
F. J. Camm's Oracle All-Wave Three (HF, D, Pen)	PW78	
1938 "Triband" All-Wave Three (HF Pen, D, Pen)	PW84	
F. J. Camm's "Sprite" Three (HF Pen, D, Tet)	PW87	26.3.38
The "Hurricane" All-Wave Three (SG, D (Pen), Pen)	PW89	
F. J. Camm's "Push-Button" Three (HF Pen, D, Pen, Tet)	PW92	3.9.39
Four-valve: Blueprints, 1s. each.		
Fury Four (2 SG, D, Pen)	PW11	
Beta Universal Four (SG, D, LF, Cl B)	PW17	
Nucleon Class B Four (SG, D (SG), LF, Cl B)	PW34B	
Fury Four Super (SG, D, Pen)	PW34C	
Battery Hall-Mark 4 (HF Pen, D, Push-Pull)	PW46	
F. J. Camm's "Limit" All-Wave Four (HF Pen, D, LF, P)	PW07	
"Acme" All-Wave 4 (HF Pen, D (Pen), LF, Cl B)	PW83	12.2.38
The "Admiral" Four (HF Pen, HF Pen, D, Pen (RC))	PW90	3.9.38
Mains Operated		
Two-valve: Blueprints, 1s. each.		
A.C. Twin (D (Pen), Pen)	PW18	
A.C.-D.C. Two (SG, Pow)	PW31	
Selectone A.C. Radiogram Two (D, Pow)	PW13	
Three-valve: Blueprints, 1s. each.		
Double-Diode-Triode Three (HF Pen, DDT, Pen)	PW29	
D.C. Ace (SG, D, Pen)	PW23	
A.C. Three (SG, D, Pen)	PW29	
A.C. Leader (HF Pen, D, Pow)	PW35C	7.1.39
A.C. Premier (HF Pen, D, Pen)	PW35B	
Unique (HF Pen, D (Pen), Pen)	PW86A	
Armada Maina Three (HF Pen, D, Pen)	PW38	
F. J. Camm's A.C. All-Wave Silver Souvenir Three (HF Pen, D, Pen)	PW30	
"All-Wave" A.C. Three (D, 2 LF (RC))	PW54	
A.C. 1936 Sonotone (HF Pen, HF Pen, Westector, Pen)	PW56	
Mains Record All-Wave 3 (HF Pen, D, Pen)	PW70	
Four-valve: Blueprints, 1s. each.		
A.C. Fury Four (SG, SG, D, Pen)	PW20	
A.C. Fury Four Super (SG, SG, D, Pen)	PW34D	
A.C. Hall-Mark (HF Pen, D, Push-Pull)	PW45	
Universal Hall-Mark (HF Pen, D, Push-Pull)	PW47	
SUPERHETS.		
Battery Sets: Blueprints, 1s. each.		
£5 Superhet (Three-valve)	PW40	
F. J. Camm's 2-valve Superhet	PW52	

Mains Sets: Blueprints, 1s. each.		
A.C. £5 Superhet (Three-valve)	PW43	
D.C. £5 Superhet (Three-valve)	PW42	
Universal £5 Superhet (Three-valve)	PW44	
F. J. Camm's A.C. Superhet 4	PW59	
F. J. Camm's Universal #4 Superhet 4	PW60	
"Qualitone" Universal Four	PW73	
Four-valve: Double-sided Blueprint, 1s. 6d.		
Push Button 4, Battery Model	£22.10.38	PW95
Push Button 4, A.C. Mains Model		
SHORT-WAVE SETS, Battery Operated.		
One-valve: Blueprint, 1s.		
Simple 8.W. One-valver	23.12.39	PW88
Two-valve: Blueprints, 1s. each.		
Midget Short-wave Two (D, Pen)		PW38A
The "Eleg" Short-wave Two (D (HF Pen), Pen)	27.8.38	PW91
Three-valve: Blueprints, 1s. each.		
Experimenter's Short-wave Three (SG, D, Pow)	PW30A	
The Prefect 3 (D, 2 LF (RC and Trans))	PW63	
The Band-Spread 8.W. Three (HF Pen, D (Pen), Pen)	PW68	
PORTABLES		
Three-valve: Blueprints, 1s. each.		
F. J. Camm's E.L.F. Three-valve Portable (HF Pen, D, Pen)	PW65	
Parvo Flywheel Midget Portable (SG, D, Pen)	3.6.39	PW77
Four-valve: Blueprint, 1s.		
"Imp" Portable 4 (D, LF, LF (Pen))		PW86
MISCELLANEOUS.		
Blueprint, 1s.		
S.W. Converter-Adapter (1 valve)	PW48A	
AMATEUR WIRELESS AND WIRELESS MAGAZINE CRYSTAL SETS.		
Blueprints, 6d. each.		
Four-tube Crystal Set	23.7.38	AW427
1934 Crystal Set		AW444
150-mille Crystal Set		AW450
STRAIGHT SETS, Battery Operated.		
One-valve: Blueprint, 1s.		
B.B.C. Special One-valver	AW397	
Two-valve: Blueprints, 1s. each.		
Melody Ranger Two (D, Trans)	AW388	
Full-volume Two (SG det. Pen)	AW392	
Lucerne Minor (D, Pen)	AW426	
A Modern Two-valve	WM409	
Three-valve: Blueprints, 1s. each.		
£5 6s. S.G. 3 (SG, D, Trans)	AW412	
Lucerne Ranger (SG, D, Trans)	AW422	
£5 5s. Three: De Luxe Version (SG, D, Trans)	19.5.34	AW435
Lucerne Straight Three (D, RC, Trans)	AW437	
Transportable Three (SG, D, Pen)	WM271	
Simple-Tune Three (SG, D, Pen)	WM327	
Economy Pentode Three (SG, D, Pen)	WM337	
"W.M." 1934 Standard Three (SG, D, Pen)	WM351	
£3 3s. Three (SG, D, Trans)	WM354	
1935 £2 6s. Battery Three (SG, D, Pen)	WM371	
PTP Three (Pen, D, Pen)	WM389	
Certainty Three (SG, D, Pen)	WM393	
MiniNote Three (SG, D, Trans)	Oct. '35	WM396
All-Wave Winning Three (SG, D, Pen)	WM400	
Four-valve: Blueprints, 1s. 8d. each.		
A Modern Four (SG, D, RC, Trans)	AW370	
2HF Four (2 SG, D, Pen)	AW421	
Self-contained Four (SG, D, LF, Cl B)	Aug. '33	WM331
Lucerne Straight Four (SG, D, LF, Trans)	WM350	
£5 5s. Battery Four (HF, D, 2 LF)	Feb. '35	WM381
The H.K. Four (SG, SG, D, Pen)	WM384	
The Auto Straight Four (HF, Pen, HF Pen, DDT, Pen)	Apr. '36	WM404
Five-valve: Blueprints, 1s. 6d. each.		
Super-quality Five (2 HF, D, RC, Trans)	WM320	
Class B Quadradyne (2 SG, D, LF, Class B)	WM344	
New Class B Five (2 SG, D, LF, Class B)	WM340	
Mains Operated.		
Two-valve: Blueprints, 1s. each.		
Conoelectric Two (D, Pen) A.C.	AW403	
Economy A.C. Two (D, Trans) A.C.	WM286	
Unicorn A.C.-D.C. Two (D, Pen)	WM394	
Three-valve: Blueprints, 1s. each.		
Home Lover's New All-Electric Three (SG, D, Trans) A.C.	AW383	

Mantovani A.C. Three (HF, Pen, D, Pen)		WM374
£15 15s. 1938 A.C. Radiogram (HF, D, Pen)	Jan. '36	WM401
Four-valve: Blueprints, 1s. 6d. each.		
All Metal Four (2 SG, D, Pen)		WM329
Harris' Jubilee Radiogram (HF, Pen, D, LF, P)	May '35	WM386
SUPERHETS.		
Battery Sets: Blueprints, 1s. 6d. each.		
Modern Super Senior		WM375
Variety Four	Oct. '35	WM395
The Request All-Waver	June '36	WM407
1935 Super Five Battery (Superhet)		WM370
Mains Sets: Blueprints, 1s. each.		
Heptode Super Three A.C.	May '34	WM339
"W.M." Radiogram Super A.C.		WM366
PORTABLES		
Four-valve: Blueprints, 1s. 6d. each.		
Holiday Portable (SG, D, LF, Class B)		AW398
Family Portable (HF, D, RC, D, Pen)		AW447
Two H.F. Portable (2 SG, D, RC, QP2)		WM363
Tyers Portable (SG, D, 2 Trans.)		WM367
SHORT-WAVE SETS, Battery Operated.		
One-valve: Blueprints, 1s. each.		
S.W. One-valver for America P.W.15.10.38		AW429
Roma Short-Waver		AW452
Two-valve: Blueprints, 1s. each.		
Ultra-short Battery Two (SG, det. Pen)	Feb. '36	WM402
Home-made Coll Two (D, Pen)		AW440
Three-valve: Blueprints, 1s. each.		
World-ranger Short-wave 3 (D, RC, Trans)		AW355
Experimenter's 5-metre Set (D, Trans. Super-regen.)	30.6.34	AW438
The Carrier Short-wave (SG, D, P)	July '35	WM390
Four-valve: Blueprints, 1s. 6d. each.		
A.W. Short-wave World-beater (HF, Pen, D, RC, Trans)		AW436
Empire Short-waver (SG, D, RC, Trans)		WM313
Standard Four-valver Short-waver (SG, D, LF, P)	P.W.22.7.39	WM383
Superhet: Blueprint, 1s. 6d.		
Simplified Short-wave Super		WM397
Mains Operated.		
Two-valve: Blueprints, 1s. each.		
Two-valve Mains Short-waver (D, LF, P)	W.W.13.1.40	AW453
"W.M." Long-wave Converter		WM380
Three-valve: Blueprints, 1s.		
Emerigator (SG, D, Pen) A.C.		WM352
Four-valve: Blueprint, 1s. 6d.		
Standard Four-valve A.C. Short-waver (SG, D, RC, Trans)		WM391
MISCELLANEOUS.		
S.W. One-valve Converter (Price 6d.)		AW329
Enthusiast's Power Amplifier (1/2) Lisener's 5-watt A.C. Amplifier (1/2)		WM387
Radio Unit (2v.) for WM 892 (1/-)		WM392
Harris Electrogram-battery amplifier (1/-)		WM398
De Luxe Concert A.C. Electrogram (1/-)		WM399
New Style Short-wave Adapter (1/-)		WM403
Trickle Charger (6d.)		AW462
Short-wave Adapter (1/-)		AW466
Superhet Converter (1/-)		AW457
B.L.D.C. Short-wave Converter (1/-)		
Wilson Tone Master (1/-)	May '36	WM405
The W.M. A.C. Short-wave Converter (1/-)	June '36	WM406

FREE!



This IMPORTANT GUIDE to SUCCESSFUL ENGINEERING CAREERS

After months of intensive effort and research we are pleased to announce that the new edition of our Handbook, "**ENGINEERING OPPORTUNITIES**," is now out of the publishers' hands and ready for *free distribution*.

Containing 208 pages of practical guidance, this book is, beyond argument, the finest and most complete handbook on Successful Engineering Careers ever compiled. It is a book that should be on the bookshelf of every person interested in engineering whatever his age, position, or experience.

The Handbook contains among other intensely interesting matter, details of **B.Sc., A.M.I.C.E., A.M.I.Mech.E., A.M.I.E.E., A.M.I.A.E., A.M.I.P.E., A.M.I.R.E., CIVIL SERVICE**, and other important Engineering Examinations. outlines courses in all branches of **CIVIL, MECHANICAL, ELECTRICAL, AUTOMOBILE, RADIO, TELEVISION, AERONAUTICAL and PRODUCTION ENGINEERING, GOVERNMENT EMPLOYMENT, BUILDING** (the 'great after-war career'), **R.A.F. MATHS.**, etc., and explains the unique advantages of our Employment Department.

**WE DEFINITELY GUARANTEE
"NO PASS—NO FEE"**

If you are earning less than £10 per week you cannot afford to miss reading "**ENGINEERING OPPORTUNITIES**."

In your own interests we advise you to write (or forward the coupon) for your copy of this enlightening guide to well-paid posts—NOW.

There is no cost or obligation of any kind.

BRITISH INSTITUTE OF ENGINEERING TECHNOLOGY

Principal: Professor A. M. LOW

409a, SHAKESPEARE HOUSE,

17, 18 & 19, STRATFORD PLACE, LONDON, W.1

**R.A.F.
PILOTS
OBSERVERS
etc.**

Special rapid Home-study courses in the essential branches of Mathematics. For full details of this scheme apply or write—

B.I.E.T.
(Dept. M 409),
17, STRATFORD PL.
LONDON, W.1

TEAR OFF HERE
FREE COUPON

British Institute of
Engineering Technology,

409a, Shakespeare House,
17-19, Stratford Place, W.1.

Please forward Free of cost or obligation of any kind your 208-page Handbook, "**ENGINEERING OPPORTUNITIES**."

NAME

ADDRESS