

THE PERMA-TUNED TWO—See page 140

A
NEWNES
PUBLICATION

Edited by
F. J. CAMM

Vol. 17. No. 416.

Practical Wireless and

6^d

EVERY
MONTH

February, 1941.

★ PRACTICAL TELEVISION ★

Contents

- Amateur Receiver Design
- ◆
- New Ideas for the Constructor
- ◆
- Thermion's Commentary
- ◆
- Negative Feedback
- ◆
- Factory Production Methods
- ◆
- Making Simple Superhets
- ◆
- Three-range S.W. Coil
- ◆
- Noise Suppression
- ◆
- Readers' Letters
- ◆
- Permeability Tuning



THE A.C. TWO-VALVE
AMPLIFIER

Radio Engineers are at a premium to-day! Equip yourself for a good job by studying:

PRACTICAL WIRELESS SERVICE MANUAL

By
F. J. CAMM.

A Complete, Practical and Up-to-date Work on the Testing of all Types of Wireless Receivers. 288 PAGES and OVER 220 PHOTOGRAPHS, DIAGRAMS and PLANS.

From all Booksellers 6/- net or by post 6/6 direct from the Publishers, George Newnes, Ltd. (Book Dept.), Tower House, Southampton Street, London, W.C.2.

TROUBLE-TRACKING SIMPLIFIED

AVO
Reg. Trade Mark
ELECTRICAL MEASURING INSTRUMENTS

● The Universal AvoMinor and the D.C. AvoMinor put within the reach of the serious amateur a means of rapid precision testing of an accuracy unobtainable with other instruments in their class. Their simplicity and versatility make short work of all the normal trouble-tracking problems. They are worthy members of a range of "AVO" Instruments renowned for their high standard of workmanship and efficiency.

THE UNIVERSAL AVOMINOR

ELECTRICAL MEASURING INSTRUMENT

22 Ranges of Direct Readings

D.C. Volts	A.C. Volts	D.C. Milliamps
0-75 milli-volts	0-5 volts	0-2.5 milli-amps
0-5 volts	0-25 "	0-5 "
0-25 "	0-100 "	0-25 "
0-100 "	0-250 "	0-100 "
0-250 "	0-500 "	0-500 "

RESISTANCE
 0-20,000 ohms 0-2 megohms
 0-100,000 " 0-5 " "
 0-500,000 " 0-10 " "
 Complete with instruction booklet, leads, interchangeable crocodile clips and testing prods.

THE D.C. AVOMINOR

ELECTRICAL MEASURING INSTRUMENT

13 Meters in ONE

Current milliamps	Voltage volts	Resistance ohms
0-5	0-5	0-10,000
0-30	0-12	0-60,000
0-120	0-120	0-1,200,000
	0-240	megohms
	0-300	0-3
	0-600	

In case, complete with instruction booklet, leads, interchangeable crocodile clips and testing prods.
 ● Write for fully descriptive pamphlets and current prices

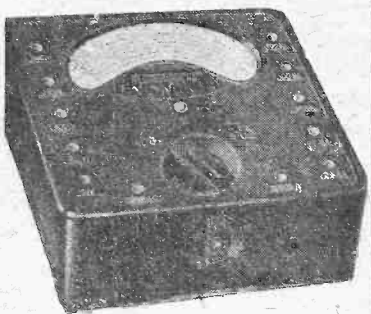

THE UNIVERSAL AVOMINOR

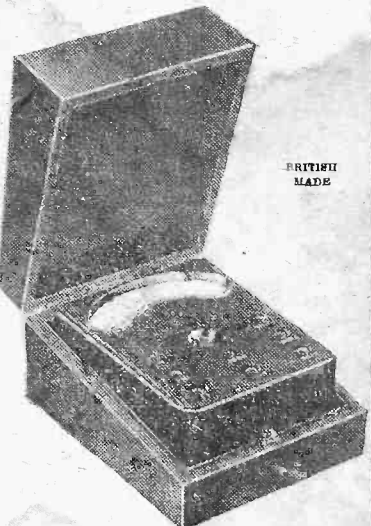

THE D.C. AVOMINOR

Sole Proprietors and Manufacturers:
AUTOMATIC COIL WINDER & ELECTRICAL EQUIPMENT Co., Ltd., Winder House, Douglas Street, London, S.W.1.
 Phone: Victoria 3404/7

ROAMING THE WORLD WITH AN ALL-BRITISH TROPHY

WORLD LISTENING PROVIDES A NEVER ENDING SOURCE OF INTEREST AND ENTERTAINMENT IN THESE HISTORIC TIMES

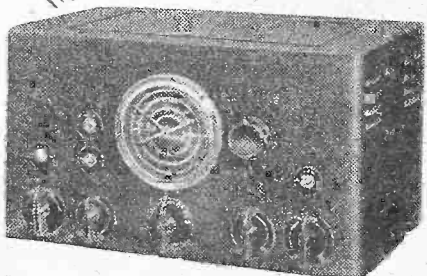

THE TROPHY IS SPECIALLY DESIGNED FOR ALL-WORLD RECEPTION.

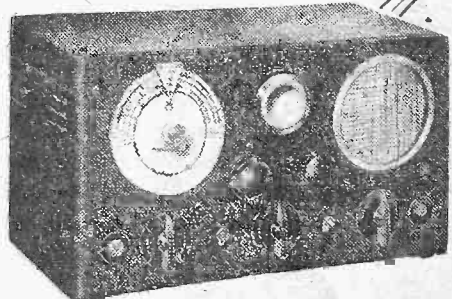

● EXTREMELY SIMPLE TO OPERATE. BOTH MODELS CAN BE ADAPTED TO OPERATE FROM BATTERY CURRENT. SEND FOR DETAILS.

TROPHY 8-VALVE A.C.
 A Super Receiver With Amazing Range.

- 7-550 metres continuous.
- 5 Wavebands.
- Solo Knob Bandspread Tuning.
- Attractive Cabinet.

£18 : 3 : 11

Matched Cabinet Speaker, £2/16/2

TROPHY 6-VALVE A.C.
 Represents Unbeatable Value.

- 10-545 metres continuous.
- 4 Wavebands.
- Independent Bandspread Dial.
- Pitch Control

£14 : 0 : 8

Including Built-in Speaker

Please send details of Trophy Instruments/or
 I enclose.....for Trophy.....
 Name
 Address

PETO SCOTT CO. LTD. (Dept. P8) 77, CITY ROAD, LONDON, E.C.
 PHONE: CLERKENWELL 5911.

The "Fluxite Quins" at Work.



"There's a mouse in the wireless" OO pleaded,
 "It's squealing!"—to her aid the lads speeded.
 "That noise, I deduce
 Is a wire broken loose"
 Explained OH "and it's FLUXITE that's
 needed."

See that FLUXITE is always by you—in the house—garage—workshop—wherever speedy soldering is needed. Used for 30 years in government works and by leading engineers and manufacturers. Of Ironmongers—in tins, 4d., 8d., 1/4 and 2/8.

Ask to see the FLUXITE SMALL-SPACE SOLDERING SET—compact but substantial—complete with full instructions, 7/6.

TO CYCLISTS! Your wheels will NOT keep round and true, unless the spokes are tied with fine wire at the crossings AND SOLDERED. This makes a much stronger wheel. It's simple—with FLUXITE—but IMPORTANT

The FLUXITE GUN is always ready to put Fluxite on the soldering job instantly. A little pressure places the right quantity on the right spot and one charging lasts for ages. Price 1/6, or filled 2/6.

Write for Free Book on the art of "soft" soldering and ask for leaflet on CASE-HARDENING STEEL, and TEMPERING TOOLS with FLUXITE.

FLUXITE LTD. (Dept. W.P.),
 BERMONDSEY ST., S.E.1.

FLUXITE
 SIMPLIFIES ALL SOLDERING

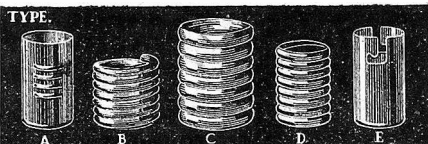

NATIONAL EFFORT

IN these days we are directing our main effort and supplies to the requirements of the Services, but some supplies of components are still available for Constructors and Radio Servicing. If delays occur, we know you will understand that a restoration and continuance of our National Existence depends on the Services' needs being met first, above all things.

We would point out that delays can usually be minimised if orders specify acceptable alternatives.

Prices are being kept as low as possible despite increased costs in every direction. Meanwhile, in the Bulgin Range, you have the largest and the best selection in the United Kingdom from which to choose.

THANK YOU!

Full details of our range of products are contained in 128 pp. Catalogue No. 163, price 6d. post free (stamps accepted). Whatever is required for radio and small electrical work, it is sure to be found in the Bulgin Catalogue.

For clear diagrams (over 280!) of the use of modern components in receivers, modernisation, and testing, the Bulgin "Radio Service Manual" is invaluable. Clear, concise text, and practical as well as theoretical circuits and data. A mine of information, price 1/- post free.

(Mention this paper when writing.)

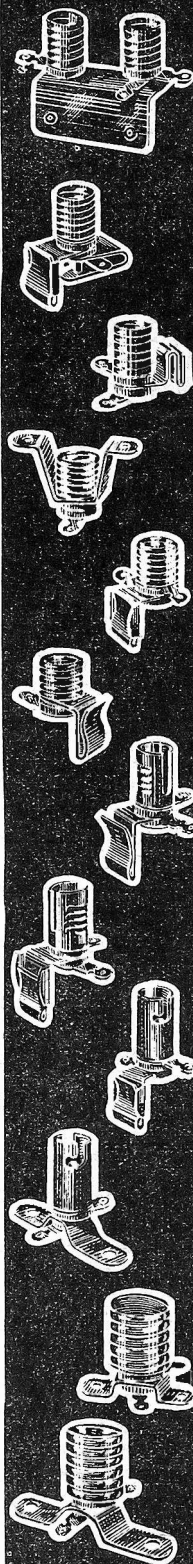

ALWAYS DEPEND ON

BULGIN

Advert of A. F. BULGIN & Co. Ltd., BYE PASS ROAD, BARKING. Tel. RIPpleway 3474 (4 lines)

TAX-FREE STOCKS ARE DWINDLING FAST!

New supplies will be 25% higher.
ORDER - FREE OF TAX NOW!
 L.R.S. EASY TERMS ON REQUEST.

RADIO RECEIVERS, &c.

COSSOR 31—	£ s. d.
Battery 4-valve all-wave Superhet ..	8 2 0
VIDOR all-dry ARP receiver 320 ..	7 7 0
EVER READY all-dry Superhet ..	8 0 0
ULTRA Model 70 ..	9 19 6
Part carr. 2/- extra on receivers.	
HEAYBERD MODEL A 0-5 Battery	5 0 0
Charger, Westinghouse 2-12 v. at 2 a ..	6 10 0
AVO Universal AC/DC Test Meter ..	2 17 6
AVOMINOR Test Meter ..	1 15 6
W.B. LOUDSPEAKER UNITS (Junior)	2 6 0
(Senior)	2 6 0

Post and Packing Charges: 8in. Units 1/6.
 Larger Sizes, 3/- S.S. Auditorium 5/- for case.

DOMESTIC ELECTRICAL GOODS

MORPHY RICHARDS IRONS, Auto-control Safety Model, post 1/- ..	£ s. d.
..	1 5 0
MORPHY RICHARDS FIRES—	
Tubular Major, 1 kW. ..	1 7 6
Tubular Twin Beam, 1 or 2 kW. ..	1 16 0
Cray Twin Beam, 1/4 or 1 1/2 kW. ..	1 1 0
Senior Twin Beam, 1 or 2 kW. ..	1 7 6
ORMOND HAIR DRYER ..	1 12 6
State voltage and include 1/- carr. with order.	
STUART-TURNER AC/DC CENTRIFUGAL PUMPS—A first-class job made for continuous running. (As used on the Queen Mary.) Ideal for A.R.P. Shelters.	
No. 10, 100 gals. per hour ..	4 10 0
No. 11, 280 gals. per hour ..	5 12 0
No. 12, 540 gals. per hour ..	6 15 0
Foot valve and strainer 12/6 and 15/- extra (when water has to be lifted over 15ft.).	
LIONEL ELECTRIC TRAIN SETS.	
High-grade Goods or Passenger sets	4 4 0

CLOCKS, WATCHES, &c.

ACCURATE TIMEKEEPERS WITH TUNEFUL CHIMES

These 8-day clocks, with movements of heavy gauge metal, chime the quarters, half, three-quarters and hour. The Triple Chime Models have three distinct and separate sets of chimes, Westminster—Whittington and St. Michael—selected at will by moving a small lever. They can be silenced and when switched on again automatically adjust themselves with a special self-correcting device.

WESTMINSTER CHIMES CLOCKS—	£ s. d.
With high-grade movements, 8-day, Walnut cases ..	3 0 0
TRIPLE CHIMES CLOCKS—	
A few only are available at Postage 1/- extra. ..	3 12 6
GENTS' HIGH-GRADE 15-JEWEL Chrome WATCHES, Swiss movement (WRIST) ..	1 15 0
GENTS' FLAT POCKET DRESS WATCHES, Chrome, same quality movement ..	1 15 0
LADIES' HIGH-GRADE 15-JEWEL Swiss Movement WRIST WATCHES, Chrome ..	1 15 0
LADIES' MINIATURE, same movement as above quality, Chrome ..	2 7 6
A few Gents' and Ladies' watches in 9-ct. gold also available.	

These clocks and watches are exceptional value. Satisfaction guaranteed or money refunded. (Write for complete watch and clock list.)

VICEROY NON-ELECTRIC SHAVERS (made by Rolls Razors, Ltd.). A welcome present for the Services ..	2 10 0
REMINGTON RAND AC ELECTRIC SHAVERS ..	2 15 0

REjuvenate YOUR SHAVEMASTER by fitting a new 475 Comb and Cutter. Post free, 9/6 per set. Send 2d. stamp for illustrated price lists of any item. Terms: Cash with order or C.O.D.

LONDON RADIO SUPPLY CO.

Established 1925.
 All communications to evacuation address—
 "WINDEN," ARDING ROAD, BALCOMBE, SUSSEX.

PREMIER RADIO

PREMIER SMOOTHING CHOKES

Type	Current	Henrys	Res.	Price
C.40/500	40 mA.	20-34 H.	500Ω	5/3
C.60/180	60 "	8 H.	180Ω	5/3
C.60/400	60 "	25-34 H.	400Ω	7/6
C.60/500	60 "	18-30 H.	500Ω	5/3
C.100/400	100 "	20-34 H.	400Ω	9/6
C.150/185	150 "	20-34 H.	185Ω	13/6
C.200/145	200 "	20-34 H.	145Ω	15/9
C.250/120	250 "	25 H.	120Ω	17/6
C.60/2500	60 "	Speaker Field Re- placement	2500Ω	7/6

PREMIER 1941 HIGH FIDELITY AMPLIFIER KITS

Each Kit is complete with ready drilled chassis, selected components, specially matched valves and full diagrams and instructions.

	Kit of Parts with Valves	Completely Wired and Tested
4-watt A.C. Amplifier	£2 14 0	£3 11 6
4-watt A.C./D.C. "	£3 0 0	£3 17 6
6-watt A.C.	£6 16 6	£7 13 6
8-10-watt A.C./D.C.	£6 11 6	£7 9 0
15-watt A.C.	£7 18 9	£9 8 0

Black Crackle Steel Cabinet 17/6 extra.

MAINS TRANSFORMERS

Wire-ends. All L.T. Windings Centre-Tapped

SP. 250	250-0-250 v. 60 m.a. 4 v. 1-2 a, 4 v., 2-3 a., 4 v. 2-3 a. ...	11/9
SP. 300	300-0-300 v. 60 m.a., 4 v. 2-3 a, 4 v., 2-3 a., 4 v. 2-3 a. ...	11/9
SP. 301	300-300 v. 150 m.a., 4 v. 2-3 a, 4 v. 2-3 a., 4 v. 1 a., 4 v. 1 a. ...	15/-
SP. 350A	350-350 v. 100 m.a., 5 v. 2 a (not C.T.), 6.3 v. 2-3 a. ...	14/-
SP. 350B	350-350 v. 100 m.a., 4 v. 2-3 a, 4 v. 2-3 a, 4 v. 2-3 a. ...	14/-
SP. 351	350-350 v. 150 m.a., 4 v. 1-2 a, 4 v. 2-3 a, 4 v. 3-4 a. ...	15/-
SP. 352	350-350 v. 150 m.a., 5 v. 2 a, 6.3 v. 2 a, 6.3 v. 2 a. ...	15/9

Auto Transformers. Step up or down. 100-125 v. to 200, 230 or 250 v. A.C., 60 watts, 9/11; 125 watts, 13/6; 250 watts, 18/6.

L.T. Transformers, all C.T.

4 v. 2-3 a. ...	9/11	6.3 v. 2-3 a. ...	9/11
2.5 v. 5 a. ...	9/11	7.5 v. 3 a. ...	9/11
5 v. 2-3 a. ...	9/11	12 v. 3-4 a. ...	15/-

Push-Pull Driver Transformers ... 6/6
 Universal Output Transformers. 11 Ratios. Single or Push-Pull ... 6/6

MATCHMAKER UNIVERSAL OUTPUT TRANSFORMERS

Will match any output valves to any speaker impedance.
 11 ratios from 13 : 1 to 80 : 1, 5-7 watts, 15/9.
 10-15 watts, 20/6. 20-30 watts, 35/-.

ELECTROLYTIC CONDENSERS. Cardboard cases. 500 v. working, 4 mfd., 1/9 each. 8+8 3/6, 4+4, 2/8, 8+4, 3/3, 4+4+1 3/9, 4+4+4 4/3, 16+8 4/-, 16+16, 5/-, 25 mfd. 25 volt, 1/2, 50 mfd. 12 volt, 1/2, 50 mfd. 50 volt, 2/-, 15 mfd. 100 volt, 1/3. Mansbridge type, 1 mfd. 250 volt, 1/-, 2 mfd. 250 volt, 1/9, 4 mfd. 500 volt, 4/8.

PREMIER MICROPHONES

Transverse Current Mike. High grade large output unit. Response 45-7,500 cycles. Low hiss level, 23/-.

"LEARNING MORSE"

Premier Morse Practice Key on Bakelite Base and Brass Movement	3/3
General Purpose Morse Key ...	5/10
Heavy Duty TX Key on Cast Base ...	10/-
Bakelite Buzzers ...	2/-
3 Henry Chokes ...	7/6
Complete Kit of Parts for Valve Oscillator as described in W.W. "Learning Morse" ...	25/-

NEW PREMIER S.W. A.C. RECEIVER

In response to many requests we have now produced an A.C. version of the popular Premier Short Wave SG3 Kit. Circuit: Pentode H.F. Stage, Pentode Detector, Beam Power Output, and F.W. Rectifier. 200-250 v. A.C. Operation. Built-in Power Pack. Hum-free operation. For use with Phones or P.M. Speaker.

Complete Kit of Parts with drilled chassis, all components. Plug-in Coils covering 13-170 metres, 4 valves and full instructions and circuits.

£4 - 10 - 0

Battery Version also available Kit £3 8 0
 Complete Chassis wired and tested £3 18 6
 Extra Coils 9-15, 200-2,000 m. also supplied.

★ "The Wireless World" said they were "very much impressed . . ."

See full Test Report, PP. 492-3 December issue. Send for full details

Premier Pick-ups.

Heads will fit any tone-arm	7/6
Premier Pick-up with Volume Control	12/6
Premier de Luxe, 6,000 ohms	17/6

ANOTHER SPECIAL OFFER

Rothermel Brush Piezo Crystal Pick-ups. New Junior P.U. with arm, 24/6. Standard, S.8 Model with arm, 34/9. P.U. head only. De Luxe Model, 24/6.

MOVING COIL SPEAKERS

All complete with transformer. Rola 6 1/2 in. 15/-; 8 in. P.M.s, 17/6; 10 in. P.M.s, 22/6.

ENERGISED MODELS

Plessy 8 in., 175 ohm field, 7/6; G. 12 energised, 2,500 field, 63/-; 10 in. B.T.H. 1,600 ohm field, less transformer, 11/6.

PREMIER BATTERY CHARGERS for A.C. MAINS

Westinghouse Rectification complete and ready for use

To Charge :	6 volts at 1 amp. 22/6
2 volts at 1/2 amp. 11/9	12 volts at 1 amp. 24/6
6 volts at 1/2 amp. 19/-	6 volts at 2 amps. 37/6

Moving Coil Mike. Permanent magnet model requiring no energising. Response 90-5,200 cycles. Output .25 volt average. Excellent reproduction of speech and music. 49/-.

PREMIER SHORT-WAVE KITS for OVERSEAS NEWS

Incorporating the Premier 3-Band S.W. Coil, 11-86 Metres without coil changing. Each Kit is complete with all components, diagrams and 2-volt valves. 3-Band S.W. 1-Valve Kit, 14/9. 3-Band S.W. 2-Valve Kit, 22/6.

DE LUXE S.W. KITS

Complete Kit, including all Valves, coils, wiring diagrams and lucid instructions for building and working. Each Kit supplied with a steel Chassis, Panel and plug-in coils to tune from 13 to 170 metres.

1 Valve Short-Wave Receiver or Adaptor Kit ...	20/-
1 Valve Short-Wave Superhet Converter Kit ...	23/-
1 Valve Short-Wave A.C. Superhet Converter Kit ...	26/3
2 Valve Short-Wave Receiver Kit ...	29/-

SHORT-WAVE GEAR

Short-Wave Coils. 4- and 6-pin types, 13-26, 22-47, 41-94, 78-170 metres, 2/- each, with circuit. Premier 3-Band S.W. Coil, 11-25, 19-43, 38-86 metres. Suitable any type circuit, 2/11.

4-pin or 6-pin Coil Formers. Plain or Threaded, 1/2 each.

Utility Micro Cursor Dials, Direct and 100 : 1 Ratios, 4/3.

Bakelite Dielectric Variable Condensers. .0005 mf. Suitable Tuning or Reaction, 1/6 each.

Short-Wave H.F. Chokes. 10-100 m., 10 1/2 d. each.

Lissen Dual Range Screened Coils. Medium and Long Waves, 2/9 each.

AMERICAN VALVES

We hold stocks of all types at competitive prices.

SHORT-WAVE CONDENSERS

Trolitul Insulation. Certified superior to ceramic. All-brass construction. Easily ganged.

15 m.mfd. ...	1/9	100 m.mfd. ...	2/3
25 m.mfd. ...	2/-	160 m.mfd. ...	2/6
40 m.mfd. ...	2/-	250 m.mfd. ...	2/11

REPLACEMENT VALVES FOR ALL SETS

Europa Mains Valves. 4 v. A.C. Types A.C./H.L., A.C./L., A.C./S.G., A.C./V.M.S.G., A.C./H.P., A.C./V.H.P., A.C.P., all 5/6 each. A.C./H.P., A.C./V.H.P., 7-pin, 8/6. A.C./Pens, I.H., 10/6; A.C./P.X.4, 9/-; Oct. Freq. Changers, 9/6; Double Diode Triodes, 7/6; 3 1/2-watt D.H. Triode, 12/-; 350 v. F.W. Rect., 6/6; 500 v., 8/9. 13 v. 2 amp. Gen. Purpose Triodes, 5/6; H.F. Pens. and Var.-Mu. H.F. Pen., Double Diode Triodes, Oct. Freq. Changers, 8/6 each. Full and Half-wave Rectifiers, 6/6 each.

WRITE FOR LATEST LISTS.

ALL TYPES OF BATTERY VALVES AT COMPETITIVE PRICES.

Microphone Transformers. Suitable for all mikes. Tapped secondaries. A, 20 and 40 : 1; B, 30 and 60 : 1; C, 50 and 100 : 1. 6/6 each. Microphone Stands. Bakelite table stand, 9 in. ring, 7/6 each.

ALL ENQUIRIES MUST BE ACCOMPANIED BY 2 1/2 d. STAMP.

PREMIER RADIO CO.

ALL POST ORDERS to: JUBILEE WORKS, 167, LOWER CLAPTON ROAD, LONDON, E.5 (Amherst 4723).

CALLERS to: Jubilee Works, or 169, Fleet Street, E.C.4 (Central 2833), or 50, High Street, Clapham, S.W.4 (Macaulay 2381).

Practical and Wireless

* PRACTICAL TELEVISION *

EDITED BY
F. J. C AMM

Staff:
FRANK PRESTON, W. J. DELANEY.
L. O. SPARKS.

EVERY MONTH.

Vol. XVII. No. 416. February, 1941.

COMMENTS OF THE MONTH

By THE EDITOR

Colour Television Demonstration

WE recently witnessed a demonstration, given by Mr. R. L. Baird, of colour television. He rightly points out that the television industry will give employment to thousands when television broadcasting is started at the critical period which will follow the cessation of war. Television was first achieved in this country, which has maintained the leadership, a leadership which must be retained.

Reports which have recently appeared in the Press have dealt with colour television demonstrations in America. Wide claims have been made for them, but further investigation shows that only coloured lantern slides have been radiated. It is clear that America has not solved the difficulty of radiating studio scenes in colour. Moreover, the pictures transmitted are of relatively low number of lines, namely, 343, and the system employed appears to be on the same principle as that demonstrated to the Press by Mr. Baird 20 months ago.

The system demonstrated by Mr. Baird in December employed 600 lines, and artists in an outdoor studio enacted a scene which was transmitted to a receiving set in an adjoining house. This transmission was in colour and the results were good. The transmitter used was based on Mr. Baird's original spot light system, consisting of a cathode-ray tube, in front of which revolved a disc fitted with blue-green and red filters. After passing through the disc the light spot on the cathode-ray tube is projected on to the scene to be transmitted by means of a lens. The person who has been televised is thus scanned by blue-green and red light beams in succession. The light from the coloured light spots traversing the scene operates three large photo electric cells, and the

current is amplified and sent by land line or wireless to the receiver.

In the demonstration a land line was used owing to the war, for the use of transmitters is prohibited by the Government.

Large Screen Colour Tele-Radiogram

AT the receiver end the transmitted pictures corresponding to blue, green and red are superimposed, as in the well-known colour printing process, to form a complete television picture in colour. Apparatus similar to that employed at the transmitter is used, and the picture is produced first in black and white on a cathode-ray tube. In front of this is the colour disc similar to that used at the transmitter end and revolving exactly in step with it. This is achieved by controlling the motor driving the disc, from an impulse incorporated in the transmitted picture.

The black-and-white pictures, by passing through the colour discs, are coloured blue, green and red, and then projected on to the screen by means of a lens. On the screen they blend to give a television picture in colours. The screen is 2ft. 6in. by

2ft.—the largest screen ever produced for the home—and shows 600-line pictures, which is 50 per cent. increase in the lines used by the B.B.C. In addition to colour the new televisor will receive the B.B.C. black-and-white pictures on the same screen by merely pressing a button.

Four push-buttons are provided, and these bring into action an all-wave radio set, an automatic record changing radiogram, B.B.C. television, and colour television.

Previous Demonstration

COLOUR television was first shown in 1928, when Mr. Baird demonstrated television pictures in colour to the British Association. Ten years later he showed coloured television on a screen 12ft. by 8ft., at the Dominion Theatre in London, to an audience of 3,000 people, the transmission being by wireless from the Crystal Palace, nine miles away. In 1939 he again showed coloured television, this time with a cathode-ray receiver, but experimental apparatus was used in these demonstrations. To-day Mr. Baird has developed coloured television to the commercial stage.

The Reserved Age

MR. BEVIN, the Minister of Labour, is appealing for more skilled labour, and is conducting the experiment in the electrical trades of sharing out the skilled men available. The age of reservation of 17 grades of electrical workers will be raised to 30 on January 8th, and one grade will be raised to 35, but those released by this change in the age of reservation will not necessarily be taken into the services. The Minister is endeavouring to find out what each electrical worker is doing, and if it is proved that he is now doing a job of vital National importance he will remain where he is.

Editorial and Advertisement Offices:
"Practical Wireless," George Newnes, Ltd.,
Tower House, Southampton Street, Strand,
W.C.2. Phone: Temple Bar 4363.
Telegrams: Newnes, Rand, London.
Registered at the G.P.O. for transmission by
Canadian Magazine Post.

The Editor will be pleased to consider articles of a practical nature suitable for publication in PRACTICAL WIRELESS. Such articles should be written on one side of the paper only, and should contain the name and address of the sender. Whilst the Editor does not hold himself responsible for manuscripts, every effort will be made to return them if a stamped and addressed envelope is enclosed. All correspondence intended for the Editor should be addressed: The Editor, PRACTICAL WIRELESS, George Newnes, Ltd., Tower House, Southampton Street, Strand, W.C.2.

Owing to the rapid progress in the design of wireless apparatus and to our efforts to keep our readers in touch with the latest developments, we give no warranty that apparatus described in our columns is not the subject of letters patent.

Copyright in all drawings, photographs and articles published in PRACTICAL WIRELESS is specifically reserved throughout the countries signatory to the Berne Convention and the U.S.A. Reproductions or imitations of any of these are therefore expressly forbidden. PRACTICAL WIRELESS incorporates "Amateur Wireless."

The Perma-tuned Two

A Compact Receiver Designed for Immediate Use on a Pre-selected Wavelength, thus Eliminating All Tuning Adjustments

By L. O. SPARKS

THIS set was designed to satisfy the demand for a simple yet efficient receiver capable of receiving the Home Service or Forces programmes with the minimum of adjustment. It was intended for use in an air-raid shelter where it was possible to employ an external aerial of reasonable efficiency, and during the many months it has been in service it has proved very efficient, and economical as regards H.T. and L.T. consumption.

Circuit

The theoretical circuit is shown below. To obtain the utmost gain, a Cossor 210SPT is used as a leaky-grid detector, reaction being secured by the usual capacity controlled method. For the aerial-grid circuit, a Bulgin Type C.6 coil was selected, as tests revealed that it gave a satisfactory degree of selectivity, bearing in mind the single-tuned circuit, and the probable use of a short aerial. The L.F. output of the 210SPT is fed into an L.F. transformer, having a ratio of 3.5:1, by the parallel-feed method. This is indicated in the circuit

inductance to be obtained. In view of this, it is permissible to use a midget component, or one of a cheap type from the spares-box.

Across the secondary of the transformer is connected an Erie potentiometer, R.3, having a value of 0.25 megohms, the moving arm of which is connected directly to the grid of the output valve, a Cossor 220HPT. This is in the steep-slope economy pentode class, and gives ample output for loudspeaker work when the local transmission is being received. An external grid-bias battery has been eliminated by using an automatic grid-bias arrangement. The resistance R.4, connected between the H.T. and L.T. negatives, produces a D.C. voltage drop according to the values of the total current (H.T.)

consumed by the receiver and the resistance R.4. The condenser C.4, connected across R.4, is essential for by-passing purposes, and on no account should it be omitted.

If valves other than those specified are used, the value of R.4 must be adjusted to suit the new current conditions. The output of V.2 is taken direct to the speaker transformer, and in the original model this was a W.B. Junior, and no tone corrector was found necessary. As this may not apply in all instances, owing to possible variations in speakers and cabinet, a suitable tone corrector is shown by the condenser C.5 and fixed resistance R.5, the connections being indicated by the broken lines.

Construction

The layout and wiring of the components are shown opposite, the baseboard being

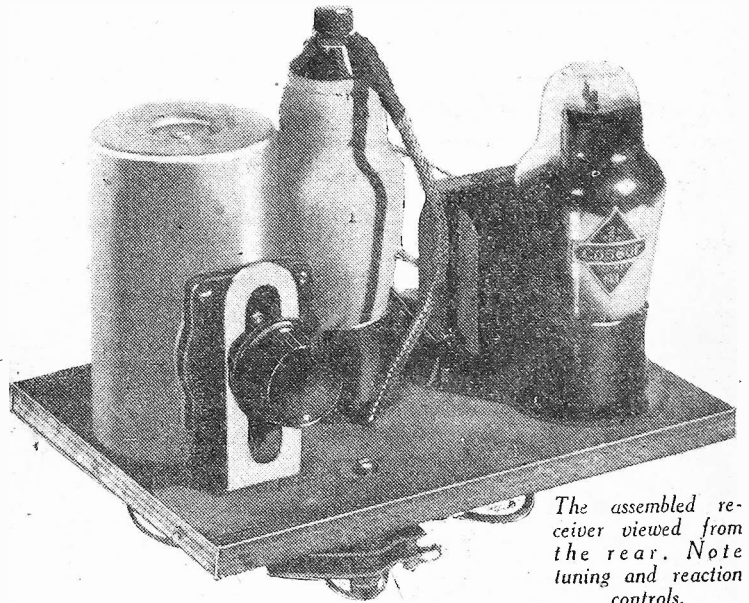

The assembled receiver viewed from the rear. Note tuning and reaction controls.

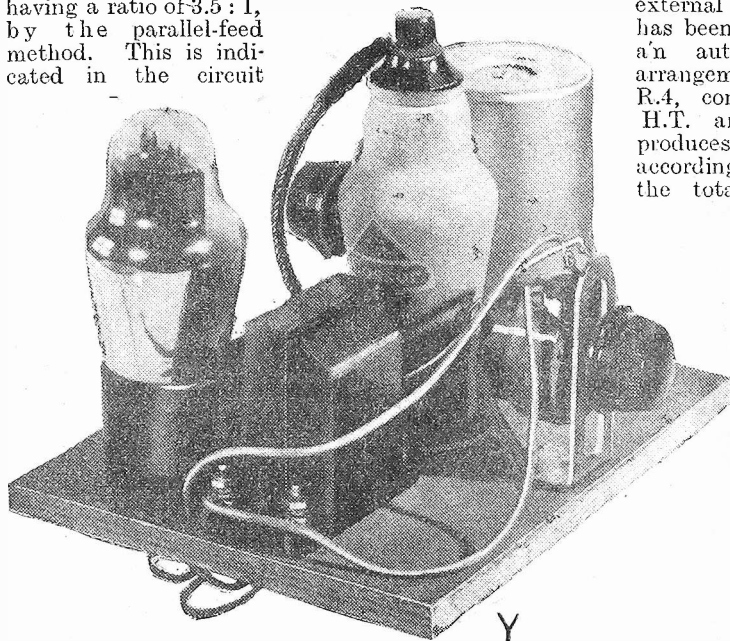

A front view, showing volume control and relative positions of coil, V.1 and transformer.

by the resistance R.2 and the fixed condenser C.3, the latter preventing any direct current from reaching the primary of the transformer, thus allowing its maximum

LIST OF COMPONENTS

Valves, Cossor 210SPT, 220HPT.
Tuning condenser, J.B. Dilecon, .0005 mfd.
Reaction condenser, J.B. Dilecon, .0005 mfd.
Valve-holders, Clix, two (one four-pin, one five-pin).
L.F. transformer, B.T.S., Varley, Bulgin.
Volume control, Erie, .25 megohm (with switch).
Coil, Bulgin, Type C.6.
Resistances: $\frac{1}{2}$ watt, one 2 megohm, one 100,000, one 750 ohms.
Condensers: Dubilier, one .0001 mfd., type 4601/S; one .05 mfd., type 4602/S; one .1 mfd., type 4603/S; one 2 mfd., 3016.
Component brackets, two.
Speaker, W.B. Junior.
Batteries, one 2 volt accumulator, one 120 volt H.T. Exide.

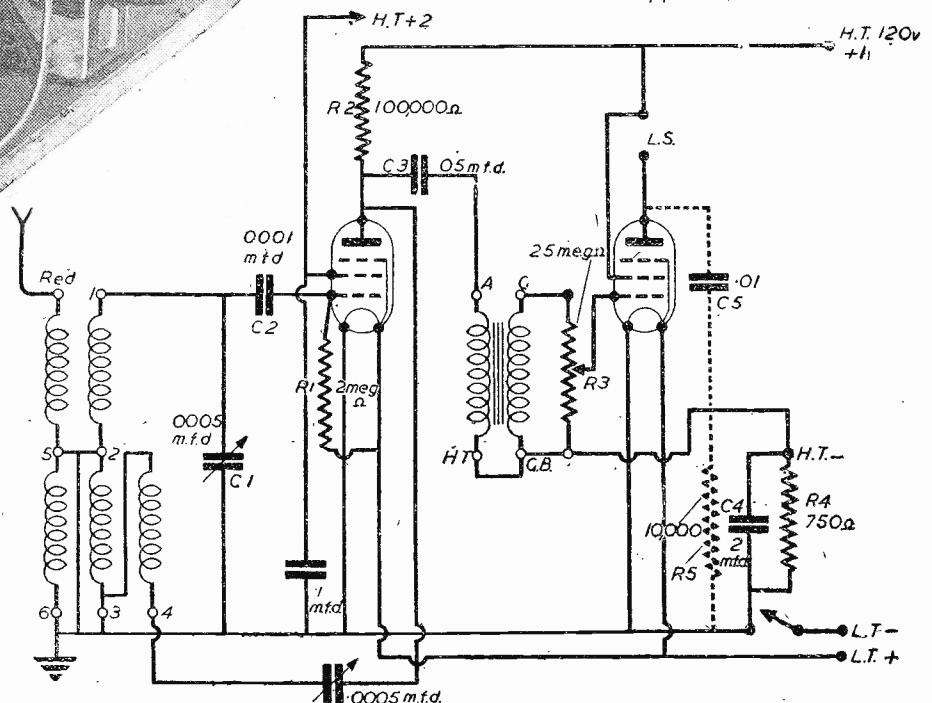

Theoretical circuit diagram of the Perma-tuned Two

cut from 5-ply to the size 6 $\frac{1}{2}$ in. by 5 $\frac{1}{2}$ in. On the top are mounted the coil, L.F. transformer, tuning condenser and the two valve-holders (one four-pin and one five-pin), the latter being for the output pentode. Two 1in. diameter holes have to be drilled for the valve-holders, and one 1 $\frac{1}{2}$ in. in diameter for the coil connecting

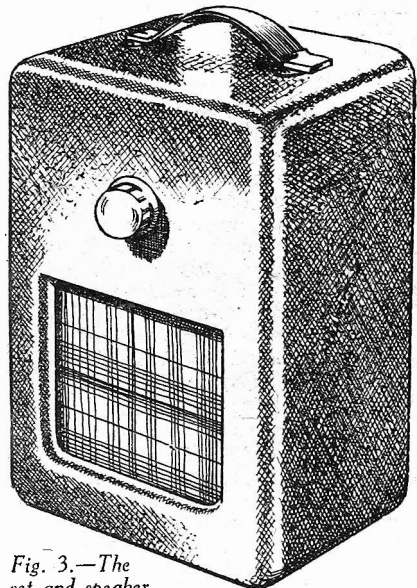

Fig. 3.—The set and speaker can be housed in a neat cabinet on similar lines to the one shown here.

tags. The two holders and transformer should be screwed into position first. This will allow much of the wiring to be completed before mounting the other components. The tuning condenser is held in position by an ordinary component mounting bracket, but for the reaction condenser it is necessary to bend a bracket into the shape shown, or make one from a strip of metal 2 $\frac{3}{8}$ in. by $\frac{3}{8}$ in. in width, the thickness being approximately $\frac{1}{16}$ in. The spindle of the reaction condenser passes up through the chassis, a suitable clearance hole, $\frac{3}{8}$ in. in diameter, having been previously drilled. As it is not possible to fit a knob to the spindle, a saw-cut, $\frac{3}{32}$ in. deep, should be made across the latter to allow adjustment to be made with a small screwdriver or trimming tool. It will be noted that no wave-change switch has been incorporated. This was omitted as the set was not intended for use on the long waves, therefore the coil tags Nos. 2, 3, 5, and 6 can be connected together before the coil is mounted in position, a length of wire, about 5in. in length, being left on for connection to the negative-earth side of the filaments. The red flexible lead from the coil is brought down through the centre hole in its base, instead of being left through the top of the screening-can.

The potentiometer is provided with an on-off switch, and this is wired in series with the L.T. negative supply so that the circuit is broken when the potentiometer is turned to its minimum position. Care should be taken to see that the metallised screening covering of the lead which goes to the top cap (anode) of the SPT is properly connected to the earth line, and that the ends are bound or protected from making contact with the internal conductor.

Housing the Set

A suggested design for a cabinet is given in Fig. 3, but, owing to the compactness of the set, it lends itself to many arrangements, according to individual requirements. When considering this part of the

constructional work, it must be appreciated that the back edge of the baseboard is that to which the two variable condensers are fitted. The potentiometer, i.e., L.F. volume control, is intended to be in the front, as it is the only control necessary once the set has been tuned to the desired station. The idea is clearly indicated in Fig. 3. The housing of the batteries depends on space available; the writer made a separate box to hold these.

Operation

The operation of the set follows normal procedure. After connecting batteries, aerial and earth and loudspeaker, the circuit is brought into operation by turning the volume control in a clockwise direction. Reaction should be set near its minimum; volume control at maximum,

and tuning then carried out by rotating the tuning condenser. When a signal has been received, strength can be increased by careful adjustment of the reaction condenser. Once the best settings have been found for the transmission concerned, the variable condensers need not be touched, as the set can be switched on and off, and the volume of the output controlled, by the single potentiometer control.

For best results, 120 volts H.T. is advisable at H.T. positive 1 and, approximately, 36 volts for H.T. positive 2, the latter is the screening-grid voltage. As this varies according to individual valves, the best value must be determined by experiment, but do not assume that higher voltages are always the best. When used as a detector, the SPT is invariably more efficient with a surprisingly low voltage.

Wiring Diagram of the Perma-tuned Two

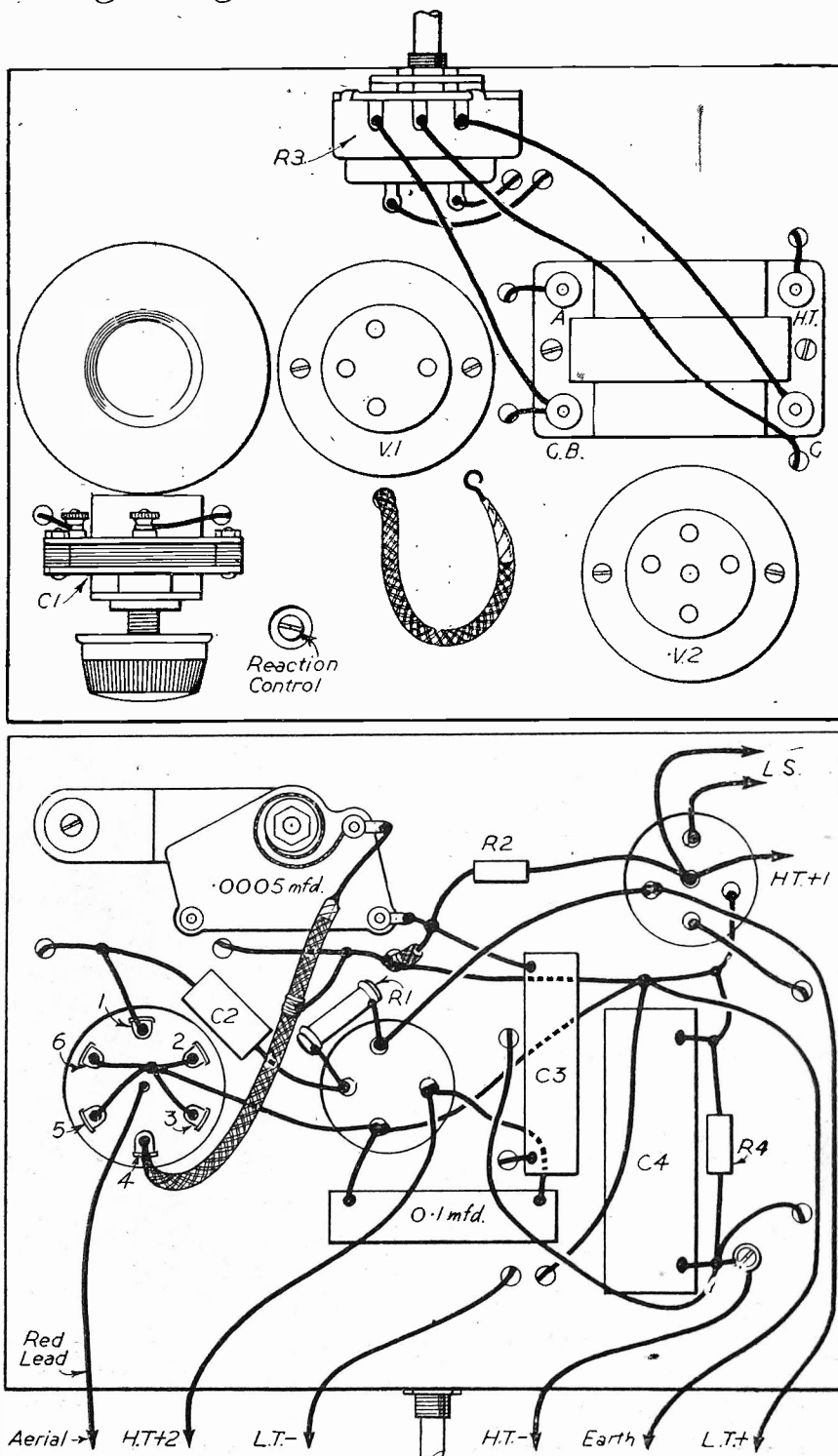

Problems of Amateur Receiver Design—6

The Choice and Use of Different Types of Coil

By FRANK PRESTON

BECAUSE of the great variety of coil types it is often difficult to decide which is most suitable for any particular circuit arrangement. In many cases it is possible to replace one coil by two or more other types without affecting results, but on the other hand it may be found that one pattern is better than all others when, for example, selectivity is the most important factor.

We can first discuss types of aerial coil used in a Det.-L.F. receiver. One very good type is that shown in Fig. 1, where it will be seen that the aerial lead-in is connected to a tapping on either M.W. or L.W. winding, according to the setting of the two-pole change-over wavechange switch. By making careful choice of the

If theappings are brought out to sockets, the aerial terminal can be connected, through the series condenser, to a flexible lead fitted with a wander plug. The plug can then be moved until the required degree of selectivity is obtained for any particular needs. The M.W.appings can be equally spaced from the "grid" end of the winding down to a point about one-third of the distance from the "earth" end of the winding.

The type of aerial coil with separate aperiodic (untuned) aerial winding is widely used, and one arrangement of windings is shown in Fig. 3. In this case, the aerial winding is coupled to the medium- and long-wave windings and is connected to a centre tap on the long-wave winding.

case there are two aperiodic aerial windings in series, the lower of which is short-circuited along with the long-wave tuning winding when the wavechange switch is moved to the medium-wave position. This type of coil is very satisfactory indeed, if well designed, since there is no compromise on either waveband. One little difficulty arises when the wavechange switch is not built in, however, due to the large number of terminals required. To keep the number down to seven, one end of the reaction winding is generally connected, inside the coil, to the earth terminal. Because of this, the reaction condenser must be on the "anode" side of the winding. Where an eighth terminal can easily be accommodated it is worth while to provide two separate terminals for the reaction winding.

H.F. Couplings

There are, of course, many other types of aerial coil, but those referred to are typical, and others are, in most cases, variants of them. When we come to consider coils suitable for coupling an H.F. valve to a detector or to a second H.F. valve, we find that most aerial coils can be used in this position. Fig. 5, for example, shows the connections for a coil of the type represented by Fig. 2. It is connected on the tuned-grid principle, and an additional grid tapping is shown. The latter is of considerable help in minimising grid-circuit damping and, hence, in improving selectivity. In practice, it would probably be found most convenient to use the first or second of the aerialappings.

Fig. 6 shows a modified form of the coil shown in Fig. 1 used in a tuned-anode circuit, whilst Fig. 7 shows a tuned-transformer arrangement where a coil of the general type, shown in Fig. 3 (but with completely separate primary winding), used in a tuned-transformer arrangement.

It is not possible to say that any one of the three circuits is better than either of the others, although tuned-grid coupling is most widely used. The choice is generally determined by the fact that aerial and inter-valve coils must be a matched pair if ganged tuning is to be satisfactory. And some makers may supply only one of the types shown.

Ensuring Stability

In the case of a two-H.F. "straight" circuit it is often found that stability can most easily be ensured by "mixing" the

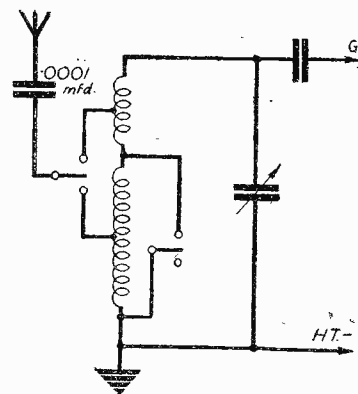

Fig. 1.—(Left) An excellent type of simple coil which is good on both wavebands.

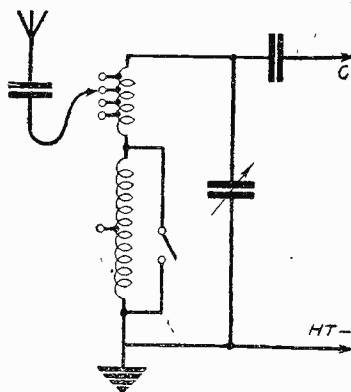

Fig. 2.—(Right) An experimental coil with several alternative aerialappings.

tapping points it is possible to obtain an approximately equal degree of selectivity on both wavebands. At the same time, a high degree of efficiency can be obtained. In the case of ready-made coils it can be taken for granted that the makers have found the most suitable tapping points; with home-made coils it is generally found best to tap the windings about two-fifths of the way down. It is, however, worth while to make a few tests to determine the best tapping points.

Multiple Aerialappings

Another type of coil which is excellent for an experimental type of receiver, or for DX use, is that represented diagrammatically in Fig. 2. It will be seen that in this case there are fourappings on the M.W. winding and one on the L.W. section.

By this means selectivity is slightly increased on long waves, and the aerial winding can be comparatively small so that the coupling between it and the grid winding is "loose." By using an aerial winding with about three-fifths of the number of turns used on the medium-wave winding it will be found that selectivity and efficiency are good.

In Fig. 3 the reaction winding is also shown, and the connections for it would be precisely the same in the coils represented by Figs. 1 and 2. It will be seen that the reaction condenser is included between one end of the winding and earth. Instead, it could be placed between the other end of the winding and the detector anode, but hand-capacity effects would probably be more noticeable in that case.

Aperiodic Aerial Windings

A modified form of the arrangement shown in Fig. 3 is given in Fig. 4. In this

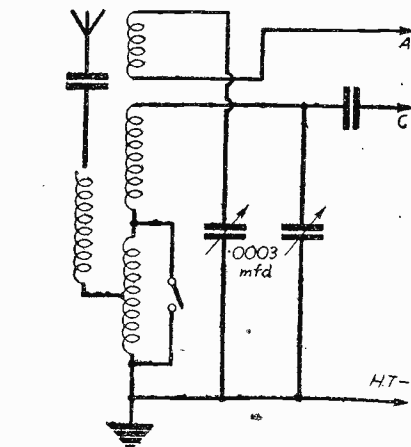

Fig. 3.—A type of aerial coil which is especially selective on long waves.

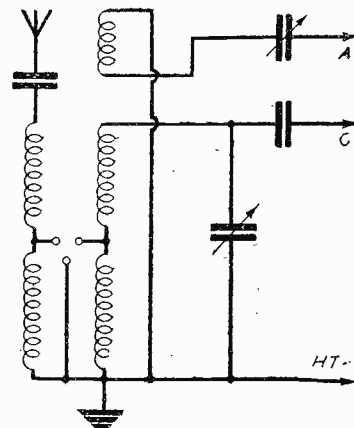
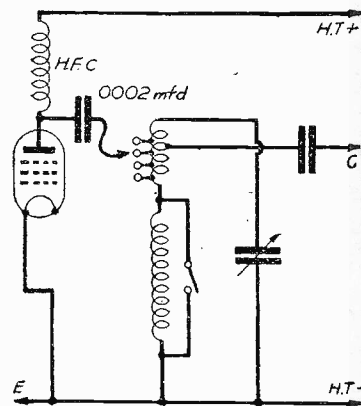

Fig. 4.—(Left) A coil with tapped aperiodic aerial winding. A three-point W/C switch acts on both windings at the same time.

Fig. 5.—(Right) Tuned-grid coupling, using a coil of the type shown in Fig. 2.



couplings; that is by, say, using tuned-anode coupling between the first and second valves, and tuned-grid between the second and third. It could be argued that if difficulty is found in obtaining stability without resorting to this method the design is bad. But the fact remains that the "mix-

ing" simplifies design, and the method can therefore be justified.

Band-pass Tuners

Band-pass tuning is less widely used to-day than it was a few years ago, largely because selectivity is better obtained by using a superhet. When considering a single-H.F. "straight" circuit, however, band-pass tuning is a definite advantage if a good degree of selectivity is required along with quality of reproduction. There are two schools of thought concerning the position of the band-pass filter: one prefers it between the aerial and the first valve; the other, between the H.F. and detector valves.

The advantage of the former position is that there is no danger of the tuning of the filter being "unbalanced" by reaction control—since reaction would be applied to the other tuning circuit. On the other hand, it does seem rather illogical to provide, say, a 9 kc/s band-width, and then to cut it by means of the single-circuit coil with reaction. For my own part, therefore, I prefer to place the filter between the H.F. and detector valves, and to take especial care with the reaction circuit. This consists of using the lowest capacity of reaction condenser with which oscillation can be obtained over the whole of both wavebands and, where convenient, using a differential reaction condenser. It also pays to take

care to apply the optimum H.T. voltage to the anode and (in the case of an H.F. pentode) to the screening grid, so that only a very small variation of reaction-condenser capacity is required with variations of tuning.

No mention has so far been made of the tuning and oscillator coils of a superhet, or with the I.F. transformers, but these questions can be dealt with in a later article.

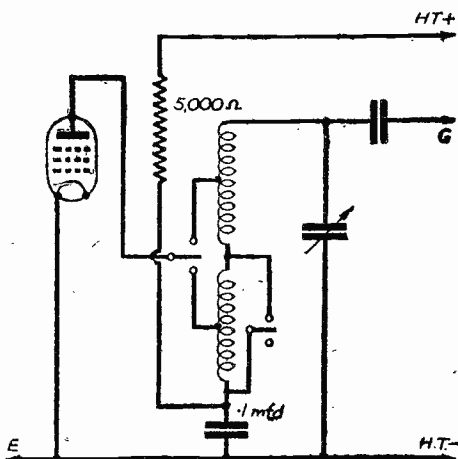

Fig. 6.—Tuned-anode coupling, with a simple type of coil which gives good selectivity. The reaction winding is omitted for simplicity, as it is from Figs. 5 and 7.

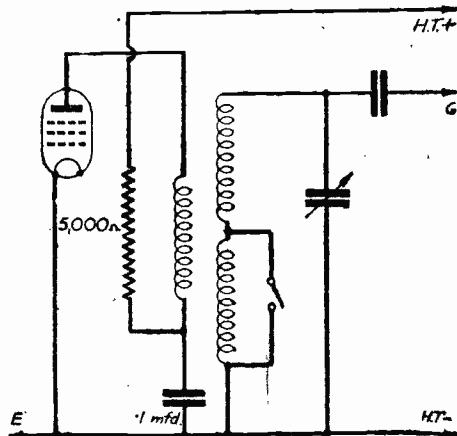

Fig. 7.—A tuned-transformer circuit, using a double-wound coil.

ITEMS OF INTEREST

Developments in B.B.C. European Service

NEW programmes for France and Luxembourg and an additional bulletin in Polish are included in recent developments made in the B.B.C.'s European Service. A Sunday programme for French listeners entitled, "Une demi-heure du Dimanche," which is now broadcast from 3.0 to 3.30 p.m. B.S.T., includes a review of the week's events and talks on general interest and religious subjects. It is transmitted on the wavelengths 49.59 metres and 25.29 metres.

The new programme for Luxembourg is broadcast on the last day of the month between 8.0 and 8.15 p.m. B.S.T. in the period entitled "Radio Belgique." The Grand Duchess of Luxembourg, it is hoped, will be among the distinguished representatives of the Duchy who will be heard from time to time. The wavelengths on which this transmission may be received are 285.7 metres, 261.1 metres, 49.59 metres and 30.96 metres.

A third News Bulletin in Polish was recently added to the B.B.C.'s broadcasts to Europe and can be heard from 4.15 to 4.30 p.m. B.S.T. each day on 49.59 metres and 25.29 metres.

New Appointment for Overseas Service

NEWLY arrived in this country from Australia is Mr. R. C. McCall, who has been appointed to the B.B.C. staff to organise the new Pacific transmission of the B.B.C.'s Overseas Service. This provides a further example of the close co-operation between Dominion broadcasting organisations and the B.B.C.—other similar examples have been the appointment of Mr. E. L. Bushnell, Controller of Programmes for the Canadian Broadcasting Corporation, to the position of North American Programme Organiser of the B.B.C. Overseas Service, and the work in

this country of the Canadian Broadcasting unit, which includes Mr. Bob Bowman, Mr. Gerry Wilmot and Mr. Rooney Pelletier.

Mr. McCall was for many years on the staff of the Australian Broadcasting Commission and has had wide experience of musical activity in Australia. He was Federal Programme Editor of the Broadcasting Commission at one time and later became Manager of the Commission's Victorian branch.

B.B.C. Diary for 1941

THE B.B.C. Diary for 1941 is now available. It contains 22 sections of interesting information about the B.B.C., including many details about the work of the B.B.C. under war conditions. The section, B.B.C. Personnel, containing biographies of some B.B.C. officials, has been brought up to date. Prices, including postage and purchase tax, range from 2s. 4½d. to 7s. 7d. The Diaries may be obtained direct from the B.B.C. Publications Department, Scarle Road, Wembley, Middlesex, or from any B.B.C. Regional Office.

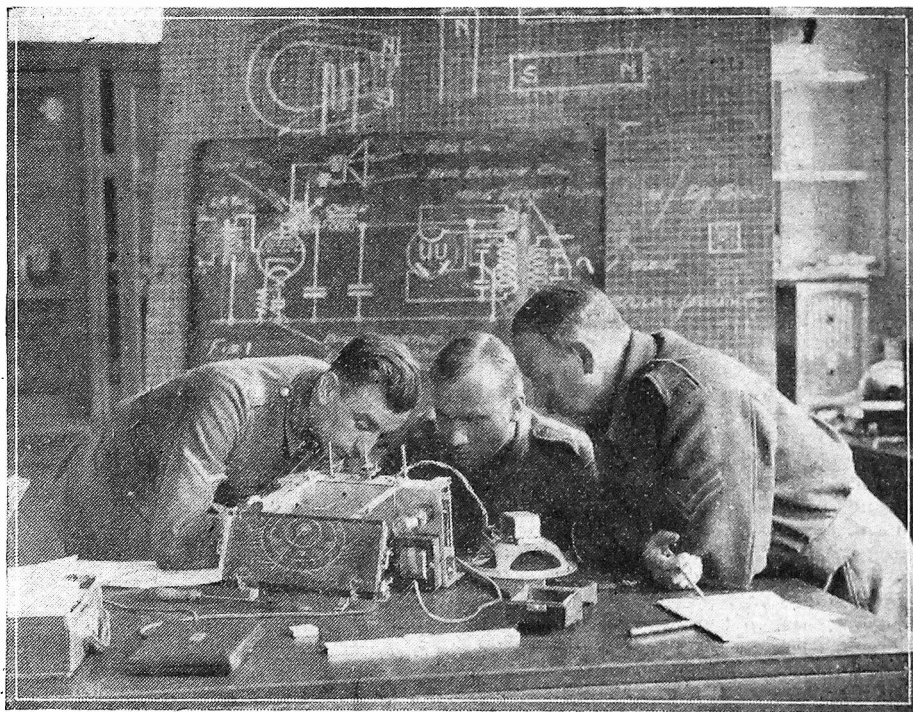

Troops are now being trained in a wide range of technical subjects, including many branches of engineering and wireless, at a London Technical Institute. In the illustration, three N.C.O.s are seen examining a wireless chassis.

Problems of Amateur Receiver Design—6

The Choice and Use of Different Types of Coil

By FRANK PRESTON

BECAUSE of the great variety of coil types it is often difficult to decide which is most suitable for any particular circuit arrangement. In many cases it is possible to replace one coil by two or more other types without affecting results, but on the other hand it may be found that one pattern is better than all others when, for example, selectivity is the most important factor.

We can first discuss types of aerial coil used in a Det.-L.F. receiver. One very good type is that shown in Fig. 1, where it will be seen that the aerial lead-in is connected to a tapping on either M.W. or L.W. winding, according to the setting of the two-pole change-over wavechange switch. By making careful choice of the

If theappings are brought out to sockets, the aerial terminal can be connected, through the series condenser, to a flexible lead fitted with a wander plug. The plug can then be moved until the required degree of selectivity is obtained for any particular needs. The M.W.appings can be equally spaced from the "grid" end of the winding down to a point about one-third of the distance from the "earth" end of the winding.

The type of aerial coil with separate aperiodic (untuned) aerial winding is widely used, and one arrangement of windings is shown in Fig. 3. In this case, the aerial winding is coupled to the medium- and long-wave windings and is connected to a centre tap on the long-wave winding.

case there are two aperiodic aerial windings in series, the lower of which is short-circuited along with the long-wave tuning winding when the wavechange switch is moved to the medium-wave position. This type of coil is very satisfactory indeed, if well designed, since there is no compromise on either waveband. One little difficulty arises when the wavechange switch is not built in, however, due to the large number of terminals required. To keep the number down to seven, one end of the reaction winding is generally connected, inside the coil, to the earth terminal. Because of this, the reaction condenser must be on the "anode" side of the winding. Where an eighth terminal can easily be accommodated it is worth while to provide two separate terminals for the reaction winding.

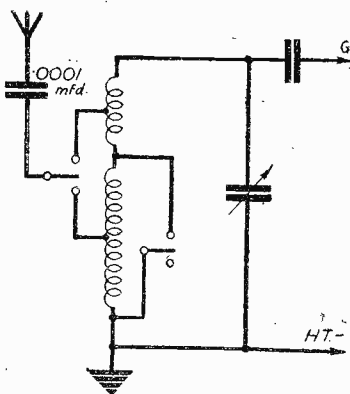

Fig. 1.—(Left) An excellent type of simple coil which is good on both wavebands.

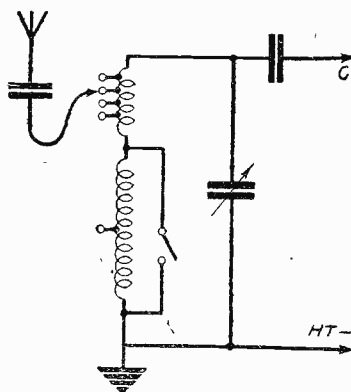

Fig. 2.—(Right) An experimental coil with several alternative aerial tappings.

tapping points it is possible to obtain an approximately equal degree of selectivity on both wavebands. At the same time, a high degree of efficiency can be obtained. In the case of ready-made coils it can be taken for granted that the makers have found the most suitable tapping points; with home-made coils it is generally found best to tap the windings about two-fifths of the way down. It is, however, worth while to make a few tests to determine the best tapping points.

Multiple Aerial Tappings

Another type of coil which is excellent for an experimental type of receiver, or for DX use, is that represented diagrammatically in Fig. 2. It will be seen that in this case there are four tappings on the M.W. winding and one on the L.W. section.

By this means selectivity is slightly increased on long waves, and the aerial winding can be comparatively small so that the coupling between it and the grid winding is "loose." By using an aerial winding with about three-fifths of the number of turns used on the medium-wave winding it will be found that selectivity and efficiency are good.

In Fig. 3 the reaction winding is also shown, and the connections for it would be precisely the same in the coils represented by Figs. 1 and 2. It will be seen that the reaction condenser is included between one end of the winding and earth. Instead, it could be placed between the other end of the winding and the detector anode, but hand-capacity effects would probably be more noticeable in that case.

H.F. Couplings

There are, of course, many other types of aerial coil, but those referred to are typical, and others are, in most cases, variants of them. When we come to consider coils suitable for coupling an H.F. valve to a detector or to a second H.F. valve, we find that most aerial coils can be used in this position. Fig. 5, for example, shows the connections for a coil of the type represented by Fig. 2. It is connected on the tuned-grid principle, and an additional grid tapping is shown. The latter is of considerable help in minimising grid-circuit damping and, hence, in improving selectivity. In practice, it would probably be found most convenient to use the first or second of the aerial tappings.

Fig. 6 shows a modified form of the coil shown in Fig. 1 used in a tuned-anode circuit, whilst Fig. 7 shows a tuned-transformer arrangement where a coil of the general type, shown in Fig. 3 (but with completely separate primary winding), used in a tuned-transformer arrangement.

It is not possible to say that any one of the three circuits is better than either of the others, although tuned-grid coupling is most widely used. The choice is generally determined by the fact that aerial and inter-valve coils must be a matched pair if ganged tuning is to be satisfactory. And some makers may supply only one of the types shown.

Ensuring Stability

In the case of a two-H.F. "straight" circuit it is often found that stability can most easily be ensured by "mixing" the

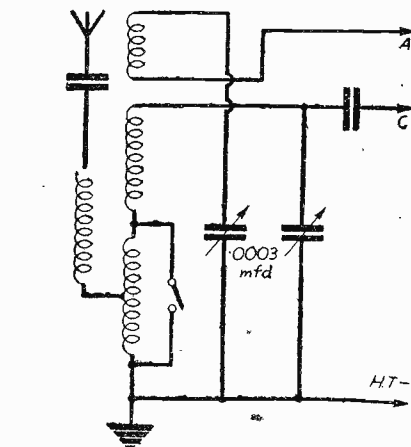

Fig. 3.—A type of aerial coil which is especially selective on long waves.

Aperiodic Aerial Windings

A modified form of the arrangement shown in Fig. 3 is given in Fig. 4. In this

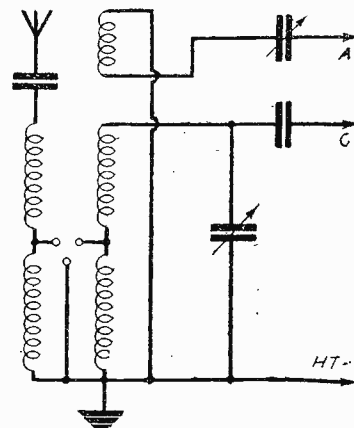
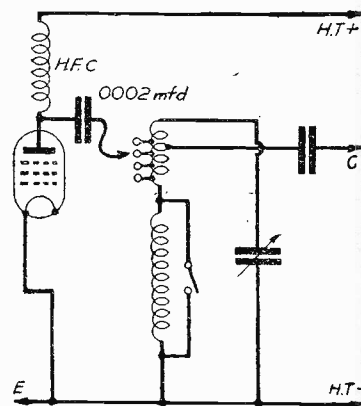

Fig. 4.—(Left) A coil with tapped aperiodic aerial winding. A three-point W/C switch acts on both windings at the same time.

Fig. 5.—(Right) Tuned-grid coupling, using a coil of the type shown in Fig. 2.



couplings; that is by, say, using tuned-anode coupling between the first and second valves, and tuned-grid between the second and third. It could be argued that if difficulty is found in obtaining stability without resorting to this method the design is bad. But the fact remains that the "mix-

ing" simplifies design, and the method can therefore be justified.

Band-pass Tuners

Band-pass tuning is less widely used to-day than it was a few years ago, largely because selectivity is better obtained by using a superhet. When considering a single-H.F. "straight" circuit, however, band-pass tuning is a definite advantage if a good degree of selectivity is required along with quality of reproduction. There are two schools of thought concerning the position of the band-pass filter: one prefers it between the aerial and the first valve; the other, between the H.F. and detector valves.

The advantage of the former position is that there is no danger of the tuning of the filter being "unbalanced" by reaction control—since reaction would be applied to the other tuning circuit. On the other hand, it does seem rather illogical to provide, say, a 9 kc/s band-width, and then to cut it by means of the single-circuit coil with reaction. For my own part, therefore, I prefer to place the filter between the H.F. and detector valves, and to take especial care with the reaction circuit. This consists of using the lowest capacity of reaction condenser with which oscillation can be obtained over the whole of both wavebands and, where convenient, using a differential reaction condenser. It also pays to take

care to apply the optimum H.T. voltage to the anode and (in the case of an H.F. pentode) to the screening grid, so that only a very small variation of reaction-condenser capacity is required with variations of tuning.

No mention has so far been made of the tuning and oscillator coils of a superhet, or with the I.F. transformers, but these questions can be dealt with in a later article.

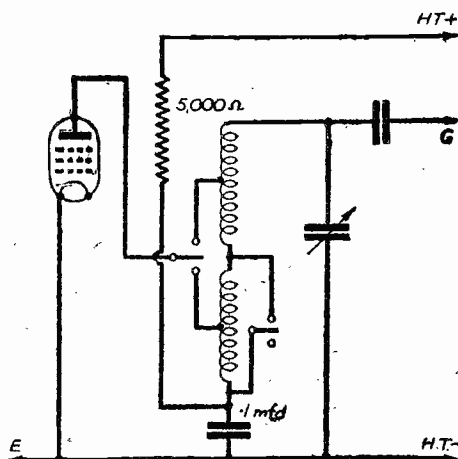

Fig. 6.—Tuned-anode coupling, with a simple type of coil which gives good selectivity. The reaction winding is omitted for simplicity, as it is from Figs. 5 and 7.

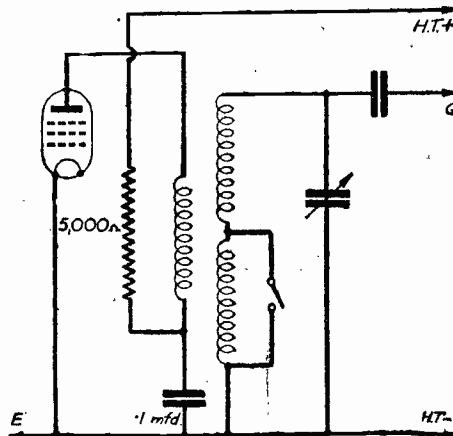

Fig. 7.—A tuned-transformer circuit, using a double-wound coil.

ITEMS OF INTEREST

Developments in B.B.C. European Service

NEW programmes for France and Luxembourg and an additional bulletin in Polish are included in recent developments made in the B.B.C.'s European Service. A Sunday programme for French listeners entitled, "Une demi-heure du Dimanche," which is now broadcast from 3.0 to 3.30 p.m. B.S.T., includes a review of the week's events and talks on general interest and religious subjects. It is transmitted on the wavelengths 49.59 metres and 25.29 metres.

The new programme for Luxembourg is broadcast on the last day of the month between 8.0 and 8.15 p.m. B.S.T. in the period entitled "Radio Belgique." The Grand Duchess of Luxembourg, it is hoped, will be among the distinguished representatives of the Duchy who will be heard from time to time. The wavelengths on which this transmission may be received are 285.7 metres, 261.1 metres, 49.59 metres and 30.96 metres.

A third News Bulletin in Polish was recently added to the B.B.C.'s broadcasts to Europe and can be heard from 4.15 to 4.30 p.m. B.S.T. each day on 49.59 metres and 25.29 metres.

New Appointment for Overseas Service

NEWLY arrived in this country from Australia is Mr. R. C. McCall, who has been appointed to the B.B.C. staff to organise the new Pacific transmission of the B.B.C.'s Overseas Service. This provides a further example of the close co-operation between Dominion broadcasting organisations and the B.B.C.—other similar examples have been the appointment of Mr. E. L. Bushnell, Controller of Programmes for the Canadian Broadcasting Corporation, to the position of North American Programme Organiser of the B.B.C. Overseas Service, and the work in

this country of the Canadian Broadcasting unit, which includes Mr. Bob Bowman, Mr. Gerry Wilmot and Mr. Rooney Pelletier.

Mr. McCall was for many years on the staff of the Australian Broadcasting Commission and has had wide experience of musical activity in Australia. He was Federal Programme Editor of the Broadcasting Commission at one time and later became Manager of the Commission's Victorian branch.

B.B.C. Diary for 1941

THE B.B.C. Diary for 1941 is now available. It contains 22 sections of interesting information about the B.B.C., including many details about the work of the B.B.C. under war conditions. The section, B.B.C. Personnel, containing biographies of some B.B.C. officials, has been brought up to date. Prices, including postage and purchase tax, range from 2s. 4½d. to 7s. 7d. The Diaries may be obtained direct from the B.B.C. Publications Department, Scarle Road, Wembley, Middlesex, or from any B.B.C. Regional Office.

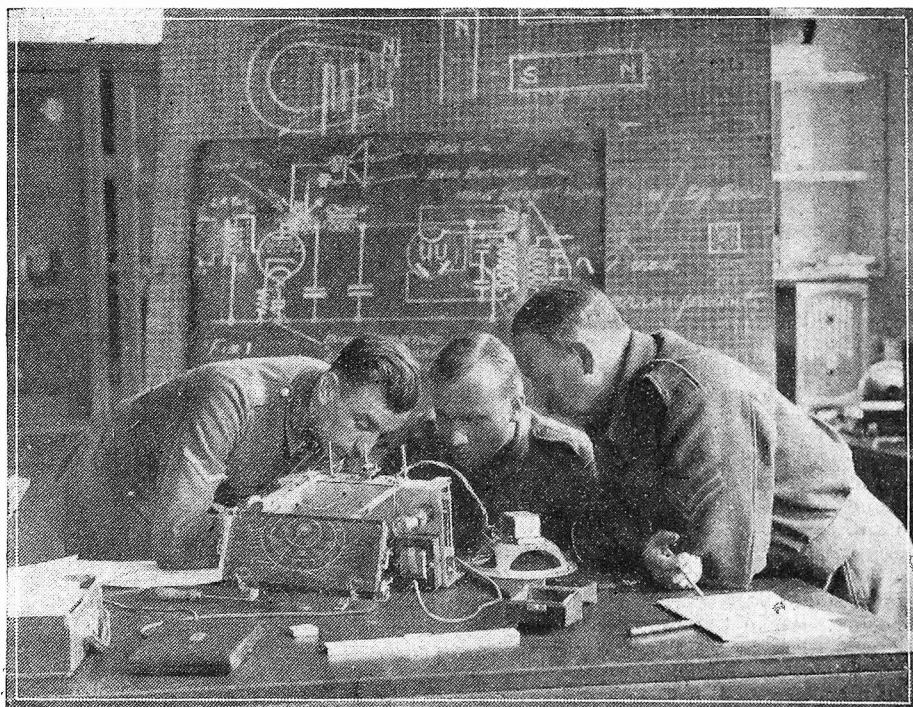

Troops are now being trained in a wide range of technical subjects, including many branches of engineering and wireless, at a London Technical Institute. In the illustration, three N.C.O.s are seen examining a wireless chassis.

New Ideas for the Constructor

Get Your Constructional Ideas Out of the Rut. Break Away from Stereotyped Designs and Develop Your Own

By THE TECHNICAL STAFF

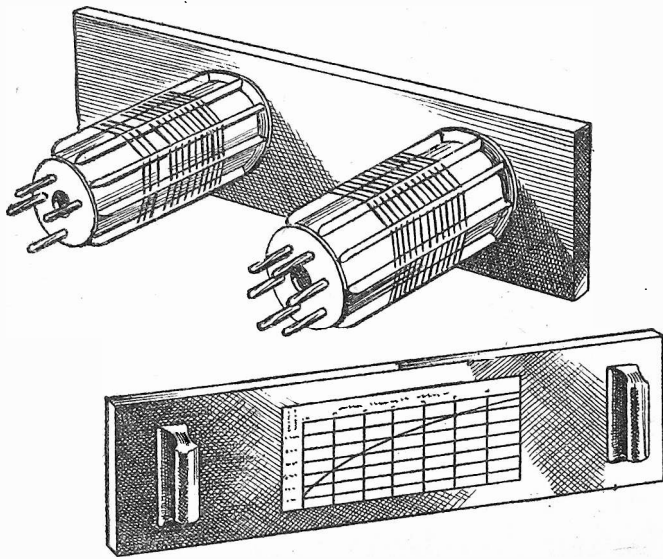

Fig. 2.—The basic idea for a simple two-coil unit. Actual construction will depend on individual requirements.

THE design of the simpler "straight" type of short-wave receivers has made very little progress. Circuits built around arrangements of two, three and four valves still hold the widest appeal, and the short-wave enthusiast is content to carry on with standardised equipment, components and circuits. This procedure is the wisest one for beginners to adopt, but with the more experienced amateur S.W.L., it tends to indicate lack of ideas. The recognised manufacturers of S.W. apparatus offered the constructor, before the war, an extensive range of components, but conditions now present an opportunity to the amateur to develop his own ideas and constructional abilities.

Circuits

Although an untuned H.F. stage can be useful, a tuned stage is likely to be better, and two tuned H.F. amplifiers will indicate how many transmissions are absent from the log book! Few amateurs use a 2-v-2 receiver; a number experiment with a single stage, but do not reach the second stage of H.F. amplification, fearing trouble due to instability and the consequent lack of signal strength. The adoption of the following suggestions will help to overcome the snags. Commence by getting a 1-v-1 receiver to work really well, the H.F. section being tuned and coupled to the detector by an efficient H.F. transformer. Stability in all stages is essential, and the H.F. stage must produce worth-while gain. When satisfied with the 1-v-1, the additional or pre-H.F. stage can be considered. The essentials are perfect screening, well-designed layout (see remarks in S.W. section last month), variable- μ valves of the metallised type and adequate anode decoupling. For screening purposes, it is advisable to use two separate screening boxes for the H.F. stages. Do not use one large box with a partition, for this does not provide complete isolation between the two stages. Pay particular attention to the construction of the boxes, and the earthing of all appropriate parts. All joints of the boxes must be tight and free from gaps, and there should be at least $\frac{1}{2}$ in. between the two boxes.

Variable- μ valves are necessary (if not in both stages, in the one preceding the detector), to allow all signal values to be handled and the utmost use made of the valve characteristics in other directions.

Be careful about the use of short-wave H.F. chokes. If more than one is used it is advisable to select different types

or makes, to avoid inter-circuit resonance. Ganged tank and/or band-spreaders should be such that it is possible to locate each section in its appropriate screening box. Trimming or balancing condensers, for individual coils, should be fitted (when such are needed) to the coil formers, although if sufficient adjustment of the inductances can be obtained by varying the spacing of the turns, that is preferable to the use of trimming condensers. All the constructional work must be rigid and careful consideration given to circuit details before use is made of metallised sleeving for screening individual conductors.

Single-signal and diversity receivers are two fields rich in experimental possibilities, whilst the incorporation of "R" strength indicators, noise limiter and L.F. limiter circuits, pre-H.F. amplifiers and regenerative I.F. stages in superhets all form valuable additions to a receiver.

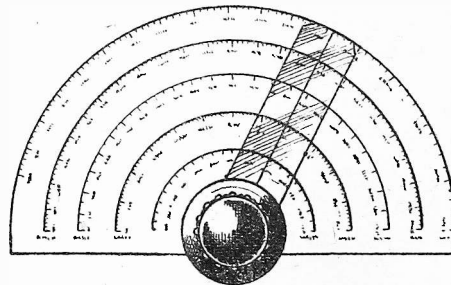

Scored line on Pointer filled with Enamel.

Fig. 1.—A suggested dial which provides a separate scale for each waveband.

Constructional Suggestions

An examination of catalogues of S.W. communication type receivers reveals many items not usually embodied in amateur-built sets. While it is not possible to incorporate all the ideas revealed in home-constructed sets, it is feasible to make use of many or devise an idea from the information contained in the specifications. For example, dials, coil units, panel layout, screening and switching arrangements are all items which provide scope for ingenuity.

Dials

A large-diameter dial, having clearly defined sections for different frequency bands, and giving a good length of pointer travel for each band, is desired by most S.W. operators. Such devices are not now cheap, nor easy to obtain, but as slow-

motion units do not suffer from the same restrictions, the construction of a satisfactory dial should not present difficulty. The slow-motion drives or mechanism can be purchased for from 2s. 9d. to 3s. 6d. from many of the advertisers in PRACTICAL WIRELESS, and they give a reasonable reduction ratio. In addition to these, various types of slow-motion drive can be made from three or four pulleys, a spring or two and a few odd pieces of metal. The dial can be marked out on Bristol board; a diameter of 6ins. to 8ins. will be generous, and after it is ruled off, horizontally, through its centre point, concentric lines can be drawn in and the sections marked off for the various frequency bands as shown in Fig. 1.

If a dial of this type is used for the band spreader control, it will be possible, provided that the tank control can be set to definite settings, like the Eddystone ten-position tank tuning-condenser, to utilise one of the semi-circular lines for the bandwidth covered by the complete movement of the b-s condenser for each setting of the tank condenser.

Coil Units

Most S.W. enthusiasts will be familiar with the well-made coil units which are included in certain

types of communication receiver. They add a professional appearance to the outfit, they eliminate plugging in individual coils and, as they are assembled as a rigid unit, they enable the inductance values to be adjusted to a remarkable degree to ensure perfect ganging. Simple types could be made for the simple 1-v-1 receivers, and with a little skill and ingenuity, the whole appearance and efficiency of the set improved. Ordinary commercially produced plug-in coils could form the basis of the construction on the lines suggested by Fig. 2. Other arrangements will suggest themselves, according to individual requirements; for example, locating the coils in a horizontal position and having wiping contacts; providing any necessary screening as part of the unit assembly and, finally, selecting the most suitable point for insertion of the unit, i.e., through the panel, the chassis or top side of cabinet.

ON YOUR WAVELENGTH

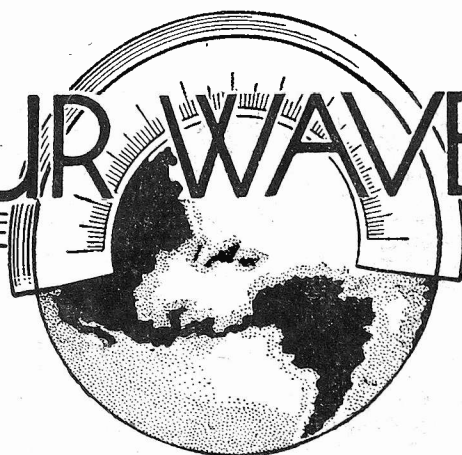

The Southern Accent

I READ that a schoolmaster recently informed the parents whose offspring were attending a Northern school that he intended to teach the Southern accent, because that was the accent adopted by the B.B.C. and represented the National accent. I am glad of this, because, quite frankly, I do not like the Northern accent, and the more northerly it is, the less I like it. I suppose that Northerners dislike the Southern accent just as much, and we must, therefore, fall back upon our lexicons to support the contention as to which is right, and which is wrong. The Northerner will retort that their accent is better than Cockney, but then the Cockney is a purely local dialect, and not general to the South. The Northern accent is, however, general to the district, and they cannot find support for it in any dictionary. We pronounce *book* as *buk*, but the Northerner pronounces it as *boook*, and similarly *look*. The Northern accent is, indeed, terribly bad and a grave reflection upon Northern school-teachers, who should be taught to pronounce the language they are supposed to teach. The Northern accent does, however, mildly represent the English language, whereas the [Scottish] accent is some sort of hybrid concoction of Gaelic, English, Erse, and Choctaw.

We must not forget, however, that our own B.B.C. is endeavouring to inculcate an accent of its own, e.g., *respit*, *cumbat*, etc., to which I have recently referred. Now they are endeavouring to use the word *gainfully*, which is a word much used in the North, but not in the South. It means "to work for profit, or lucratively," and I do not like the word, especially when the B.B.C. use it in the sense of "usefully." Another word I dislike intensely which is used in the North, and particularly in Lancashire, where the word was born. The Lancashire people like picturesque names, and the word *gradely* reeks of clogs, and it is really a piece of slang. Let us forget it.

Colour Television

MR. BAIRD recently gave a demonstration of colour television, to disprove statements that have appeared recently to the effect that Hitler's activities have stopped all television progress in this country. It was apparent from the demonstration that, as I have so often mentioned in these pages, experiments continue. The television industry will give broadcasting to thousands when television broadcasting recommences, at the critical period after the war. The reports which have appeared of colour television demonstrations in the U.S.A. deal with experiments only. Coloured lantern slides and coloured films only have been televised. The Americans have not yet overcome the difficulty of radiating studio scenes in colour. The pictures also are of comparatively low number of lines—343, and the system they use seems to be on the same principle as that demonstrated to the Press by Mr. Baird 18 months ago.

By Thermion

Those German Spies

SEVERAL readers have written to me asking for full details with wiring diagram of the transmitting outfit carried by the three German spies recently executed. We had, of course, immediately taken the matter up with the Authorities asking them to place one of the receivers at our disposal for purpose of description in this journal. However, such a receiver must make use of a standard circuit, and the only point of interest would rest in the compaction of the design. I do not know at the moment of going to press whether the Authorities will permit us to publish the details. We must remember that Neville Chamberlain, who was guilty of so many crassly ignorant mistakes, allowed 70,000 German refugees to enter this country when Hitler purged his country of the Jews. There can be no doubt Hitler saw in the hospitality which we extended to these refugees an easy method of giving spies and Fifth Columnists Jewish passports so that they could obtain easy entry into this country. As far as I have been able to trace there was not a thorough investigation into the bona fides of these refugees. The fact that some of them could carry portable transmitters which were not discovered until after they had landed is a somewhat disquieting factor. The present Cabinet are much more alert and alive to the possibilities, and it may be that they will refuse us permission to publish the details because it would put information in the hands of enemy agents in this country—technical information which would enable them to build their own transmitters. As amateur transmitting is illegal and all transmitters have been confiscated

in this country the publication of such information would not be of great interest. We do not wish to encourage our enemies to build transmitters. However, when the Authorities have transmitted the official point of view I will again refer to the subject.

Prizes Awarded

I HAVE awarded book prizes to the following in connection with the competition which was set for the best essays on "How the War Has Affected My Radio Hobby": W. Austin, 77, Sidney Street, Brightlingsea, Nr. Colchester, Essex; Lawrence McGee, 26n, Worra'l Road, Clifton, Bristol, 8; H. T. Bettèridge, 9, Eveson Road, Norton, Stourbridge, Worcs.; A. F. Light, Pemross, Pwllheli, N. Wales; Arthur McCaig, Main Street, Drymen, By Glasgow; C. R. Neville, 2, Sisters Cottages, Diamond Terrace, Greenwich, S.E.10; and G. N. Green, 13, Green Walk, Ruislip, Middx.

A selection of the essays will be published next month.

Readers on Active Service

I AM delighted to receive so many letters from readers on Active Service. Most of them are from readers who have corresponded with me for the past 10 years, and their letters take me back to the heyday of home construction when we were forgetting the last war and not anticipating the present one. Some of them saw Active Service in the last war and are now placing their valuable knowledge at the service of the country as instructors, operators, technicians, and servicemen. In spite of the difficulties of service life they still maintain their interest in radio. When peace returns we shall open up our columns to them so that they can record their experiences in greater detail than is possible under a censorship. Much of what they write I cannot refer to. One such reader, J. G. P., of Chatham, has just passed into the R.A.F. as a wireless mechanic. He was an amateur and all his knowledge, he says, was gained from this journal and our Handbook.

Delivering the Goods

TOO often in the past have I received letters from readers overseas complaining about the apparent indifference of the British radio manufacturers to their requirements, and the way in which more enterprising foreign firms were literally wiping up the markets. So many British firms adopted the ridiculous policy of supplying standard equipment, either through crass ignorance of the true conditions or the sublime attitude of "take it or leave it," with the result that other countries secured the orders. All that, thank goodness, is now altered, though why it could not have been done in peace-time I shall never understand. The latest figures of the export of electrical and radio apparatus from this country speak eloquently of the good work now being done. For September, 1940, the figures were £1,134,008 which show an increase of £567,490 over September, 1939.

Our Roll of Merit

Our Readers on Active Service—Eleventh List.

- C. E. Myers (Gnr., R.A.),
Durham.
- N. Shirley (Pte., R.A.O.C.),
Aldershot.
- J. G. Picot (Wireless Mechanic, R.A.F.),
Chatham.
- R. W. Lay (Pte., R.A.F.),
Fakenham.
- A. T. Caville (Lt., R.A.),
Oswestry.
- D. Dudding (Gnr., R.A.),
Leeds.
- C. Sloper (Cpl., R.A.F.),
Suffolk.

NEGATIVE FEEDBACK

Details of an Amplifier Embodying a Tapped Potentiometer and Making Use of Negative Feedback

MOST listeners have noticed that when the volume control of a receiver is adjusted so that the volume is below normal, the quality of the reproduced music is "thin" and lacking in depth. This effect has been explained satisfactorily by physiologists, and many attempts have been made to provide volume controls which compensate for this apparent distortion. In the usual type of compensated volume control a potentiometer is employed with a tapping near the middle, and a condenser and resistor in series are connected between the tapping and the earthed end of the potentiometer.

In the circuit diagram (Fig. 1), a two-stage audio-frequency amplifier which may be employed in a radio receiver or gramophone amplifier is shown, and comprises an audio-frequency signal input circuit 5, and an audio-frequency output circuit 6, between which is connected a first-stage amplifier valve 7, and a second- or output-stage amplifier 8, including an inter-stage coupling network 9 of the resistance-coupled type, and a suitable output transformer 10, the secondary 11 of which is connected to the output circuit 6, which includes the speech coil 12 of a loudspeaker 13.

Volume Control Potentiometer

The resistance of the input circuit 5 is indicated by the series-connected resistor 14, and this circuit is coupled through a suitable coupling condenser 15 to an attenuator or a volume control potentiometer resistor 16. In accordance with usual practice, a volume control contact 17 is movable over the resistor 16 to provide a variable signal voltage input connection for the control grid 18 of the first-stage amplifier valve 7.

One end of the volume control potentiometer 16 is connected to the high signal potential side of the input circuit, while the opposite end is connected to a chassis or earth 19, and to the low signal potential side of the input circuit, indicated by the earth connection 20.

The chassis connection for the potentiometer resistor permits the application to the control grid 18 of a suitable biasing potential derived from a self-bias resistor 21 in the cathode circuit of the valve 7. This may be by-passed, as indicated by the condenser 22, if it is desired to prevent audio-frequency degeneration in the cathode circuit.

Inverse Feedback

By properly polarising the connections with the output secondary 11 of the transformer 10, and earthing one terminal of the winding, as indicated at 23, inverse feedback potential may be derived from the amplifier output circuit 6, through an inverse feedback circuit, comprising the earth, and a lead 24, and may be applied to the input circuit of the first-stage amplifier 7 through a suitable variable attenuator network, including the volume control resistor of the potentiometer 16.

In the present example, the attenuator network includes the branch circuits 25 and 26, from the lead 24, each including a series condenser 27 and resistor 28, together constituting a frequency discriminating impedance element through which feedback voltage is applied at controlled and

differing values to the input circuit at predetermined volume levels.

The branch circuits are connected with separate spaced taps 29 and 30 on the volume control potentiometer 16, as shown, and the number of taps employed may correspond to the number of branch circuits in the attenuator network.

As is well known, distortion within an amplifier, and circuit noises, are reduced appreciably with inverse feedback. In the present amplifier, an inverse feedback voltage or potential is provided between the output circuit 6, and the input circuit 5, and is controlled by making the attenuator the variable element of the circuit. As a step further, the variable element is made part of the signal attenuator circuit, so that, by a single common impedance element 16-17 both feedback and input signal level may be controlled to provide the advantages already described.

From an inspection of the circuit shown, it is evident that the feedback voltage varies as the variable volume control contact 17 is moved along the resistor 16 past the taps supplying the feedback voltage. Furthermore, it is evident that the frequency characteristic of the feedback voltage varies at the same time. This in turn causes the frequency characteristic of the amplifier

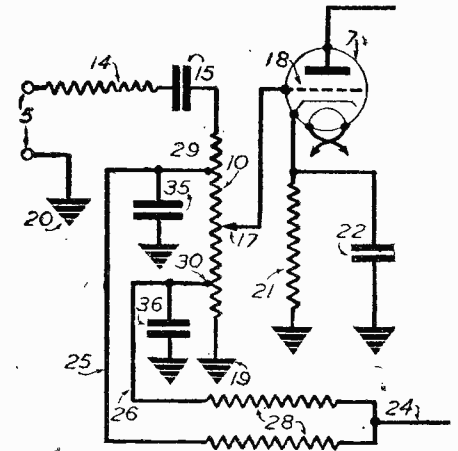

Fig. 2.—Modified circuit for low-frequency attenuation.

frequency attenuation is increased, because of the fact that inverse feedback is provided at the higher frequency end of the audio-frequency range, with a corresponding additional reduction in gain in the high-frequency ranges, while the feedback at the lower frequency end of the audio-frequency range is substantially prevented because of the relatively high impedance of the condensers 27 to low audio-frequencies.

If low-frequency attenuation is desired, the circuit may be modified or combined with the circuit of Fig. 1 in the manner indicated in Fig. 2.

Alternative Arrangement

In this circuit the feedback branch

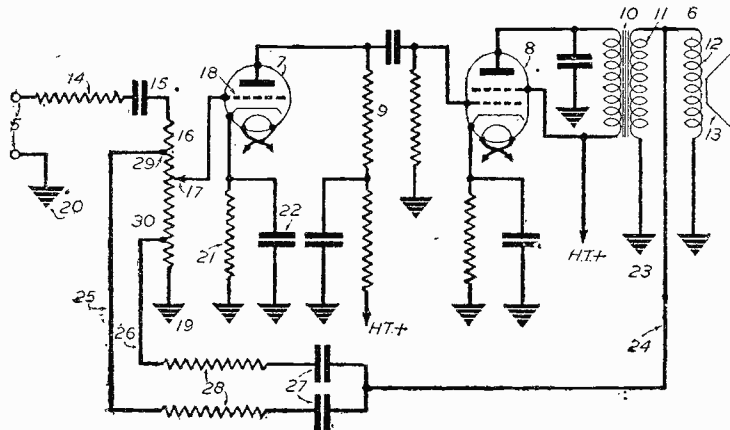

Fig. 1.—Theoretical circuit diagram of a two-stage audio-frequency amplifier incorporating negative feedback.

to vary with variations in the signal attenuation in a predetermined relationship.

L.F. Compensation

The size or capacity of the condensers 27 determines the amount of low frequency compensation which is provided at the several taps. For aural compensation, it is desirable to increase the low audio-frequency response of the system at low output levels by making the network one which gives more negative or inverse feedback at high frequencies than at low frequencies as the attenuation is increased; that is, as the volume control contact 17 is moved to reduce the input signal voltage applied to the first amplifier stage 7, the relative low-frequency response is increased. The range of high-frequency signals which are fed back to reduce the gain is determined by the impedance of the feedback circuit, that is, upon the controlling elements included in the lead 24, and such elements may include inductive or capacitive reactance elements, or both as required, together with suitable resistance means. Thus, in the circuit shown in Fig. 1, as the amplifier output or volume is reduced, the high-

circuits 25 and 26 include the resistors at 28 in series. However, the controlling reactance elements such as condensers 35 and 36 are connected in shunt to ground from each tap.

In this arrangement, feedback potentials in the higher audio-frequency ranges are attenuated by the by-pass effect of the condensers 35 and 36, tending to prevent a reduction in gain by reason of the inverse feedback in the high-frequency ranges, and thus increasing the high-frequency response of the amplifier, relative to the low-frequency response as the gain is reduced by movement of the contact 17 along the potentiometer 16 in the direction of increasing signal attenuation, in the same manner as described previously with regard to the circuit of Fig. 1. The system described was developed in the laboratories of the Radio Corporation of America.

**PRACTICAL WIRELESS
SERVICE MANUAL**

(/-, or 6/6 by post from George Newnes, Ltd.,
Tower House, Southampton St., Strand, W.C.2

Modern Factory Production Methods—5

Various Tests which Pre-production Models have to Undergo Before they are Approved for Full Production

By "SERVICE"

THE conclusion of the last article in this series dealt with the trial production of about 50 instruments of the new model after a few "hand-made" samples had been vetted by various representatives of the production, design, sales and service departments. The trial production is necessary in order to make sure that the operatives can carry out the process of wiring and assembly of a component on the test chassis, in the way arranged for by the process engineer who laid out the instructions. Despite his careful forethought it may be found that under fast working conditions a girl cannot effectively make a certain soldered joint, because the location of the joint is obscured by work carried out by the previous girl in the production line. Difficulties connected with the dressing of the wiring which affect sensitivity, instability, calibration, etc., must be examined and changes made if necessary.

It may be impossible to maintain the original high sensitivity of a chassis due to actual production troubles or to the fact that the valves arriving in quantities from the valve manufacturers may not all be up to the original sample with which the set was designed and first tried out. If the sensitivity cannot be maintained, then the test gears at the end of the production line must be altered to pass the chassis through at an agreed lower level.

Wiring of the Chassis

Another problem concerns the wiring of the chassis. Circuit wiring if incorrectly dressed may give rise to a large Co, thus causing trimmer condensers to be set at minimum, i.e., with very little interleaving of the fixed and moving plates in the case of air trimmers, and in the case of mica compression type, with hardly any tension upon the top plate. The very slightest alteration to the plates causes a very large percentage variation of their capacity, and they are thus extremely unstable. This will give rise to drift trouble, which means that the chassis when it is lined up on the assembly line will be rejected for sensitivity at the final test, due to trimmers having shifted and put the circuit out of alignment.

"Padding" Condensers

Sometimes it is found that it is impossible to alter this state of affairs during production, even by paying strict attention to the disposition of the wiring, and "padding" condensers have to be connected across the trimmers and the latter changed for ones of a lower value. These "padders," as they are familiarly termed, are small fixed condensers of about half the value of the trimmers, and their purpose is to enable the trimmers to be finally set at a point about half-way between maximum and minimum, at which position they are more likely to remain stable.

The reference above to Co refers to the capacity of the wiring in the circuit, which in its relative position to earth (or chassis) causes a capacity to be built up across the tuning coils, and may therefore be regarded as a condenser. In circuit diagrams condensers are generally referred to as C1, C2, etc., so that design engineers have acquired the habit of referring to the inter-capacity of wiring as Co.

When the 50 preliminary instruments have been made up they will be carefully scrutinised by the various engineers and departments mentioned previously. If any modifications have had to be made which affect sensitivity, quality, etc., the sales department will most certainly have something to say about it, and they may insist that the production is improved.

Test Specifications

The designs engineer, together with the service department, will see what type of fault is most commonly made upon production, and will arrange that special inspection is given to the processes which lead up to that fault. There will, of course, be inspectors at various stages all along the production line, and these men have definite

wiring is cut to the correct length, and component leads are shortened, when required, at a place away from the assembly line, so that there is no danger of extraneous matter getting into the chassis. Sometimes, however, it is necessary for wire trimming to be carried out on the chassis itself, and then the inspection mentioned above has to be instituted.

The matter of inspection, however, will be dealt with at length in a later article in this series, and we will revert now to our consideration of the 50 chassis which have been made up along production lines.

"Soak Test"

About 25 of these models will be put on what is termed a "soak test." During this test the sets will be run all day with the



A woman operator at a complicated coil-winding machine in a British radio factory which is working at full pressure producing radio sets for the export trade.

instructions as to the type of test that must be made and what constitutes a "reject." It must be appreciated that in a large factory organisation there can be no personal opinions as to what is right and wrong with a particular process, and the process layout engineer is responsible for issuing what are often called test specifications, which clearly lay down in black and white all the various stages, and the test to be applied at each one.

Some of these, of course, look rather ridiculous in printed form, but nevertheless they are very important. For example, at one stage in production it may be found necessary to have a girl whose job is nothing else than taking the chassis passed to her, lifting it upside down and giving it a good shaking. This may be necessary because despite previous precautions it had been found that short snips of wire remain hidden in remote parts of the chassis from which they would emerge under transit conditions to cause shorts, and intermittent operations. Wherever possible it is always arranged that

exception of a break at lunch time. It is essential to have a midday break for two reasons. The first is that it provides a definite time for the person responsible for the examination of the receivers to see that the receiver is functioning up to standard in all respects. Secondly, it provides the surges which may often break down a component.

When a set is switched on, high voltages are applied to various components, and the strain placed on the dielectrics is considerable, and often exceeds that at which the component will operate when the receiver is thoroughly warmed up and operating normally; similarly, when the set is switched off all these dielectrics suddenly revert to a condition of rest. Also, chokes and field coils develop a high voltage across themselves when the current flowing through them ceases suddenly. By arranging that the receiver is switched on and off periodically it is given a good test for the ability of the components to withstand the normal

(Continued on next page)

MODERN FACTORY PRODUCTION METHODS

(Continued from previous page)

surges, and if a breakdown occurs it is more quickly detected at a period of the day which leaves plenty of time for investigation.

When carrying out a "soak test" it is a good thing to arrange that the sets are operating at good volume, just as they would when in use by the public. In many cases this is not done, and the receiver is either operated with the volume control turned well back, or the loudspeaker is disconnected, and the output from the instrument is passed into a dummy load.

Faults that Develop

This is not entirely satisfactory because, although the loudspeaker is a separate component, and may have been given a long test, and the chassis also given a long run, it is often not until the two are brought together in one cabinet, with the back of the cabinet in position, that certain troubles develop. For example, microphony, rattling of scales and glass windows, speaker buzz, etc., would only become apparent when the receiver performance is extended to a fair degree. Just because the very early models had not these faults, it cannot be taken for granted that such faults will not develop under production conditions. A change of metal may have been made in the construction of the scale and wavelength pointer assembly, causing it to be more flexible and therefore more inclined to rattle on certain notes; the leads from the speech coil for the loudspeaker may not have been properly dressed by the operative assembling the loudspeaker unit so that they buzz under conditions in the receiver.

Drop Test

Another test which is essential at this stage of production is the drop test, although it can be made at an earlier stage if no drastic modifications to the weight or disposition of any of the receiver's components is likely to take place. This test is more than ever very essential, as due to war conditions transport is being carried out more and more by inexperienced personnel, and the difficulty of handling merchandise in a black-out has not abated. Instruments receive rough treatment, and must be built and packed to withstand dropping off the tailboard of the van, and being left standing upside down despite instructions to the contrary, which probably cannot be read owing to the darkness.

The drop test must be carried out with the instrument properly packed in the carton or case in which it is to be despatched. The normal drop is from a height of about three feet, and this test must be carried out on all sides of the instrument. By sides is meant the two ends, the top, bottom, back and front of the instrument, which makes six drops in all. The package must be suspended so that it is perfectly horizontal with the long side of the carton parallel with the floor in all respects. This is so that the carton meets the floor absolutely flat and the impact is far more effective than if the carton struck the floor on one edge or a corner.

After each drop the instrument is unpacked from its carton and thoroughly examined for all possible damage. One item which must not be overlooked is the effect of the drop on the loudspeaker. In the case of good quality battery receivers having a large permanent magnet speaker unit, the magnet assembly may be very heavy, and if the cone cradle which supports it is not quite strong enough for

the job it will become distorted so that the speech coil on the cone no longer moves parallel in the air gap, and distortion will occur when it fouls the loudspeaker during reproduction.

The fixing or anchorage points for all heavy components such as mains transformers, chokes, etc., must be examined, and, of course, the cabinet work around the joints and edges call for special inspection.

Radiograms

Obviously, large crated instruments, such as radiogramophones, cannot be expected to undergo such violent tests. In the majority of cases the receiver chassis employed in the radiogramophone is one which is used in a small cabinet as a table receiver, and as such will go through a drop test outlined above. Radiogramophones being so much heavier, generally receive more careful handling by the carriers as they cannot be thrown about like the smaller receivers. It is generally sufficient to send two of these radiogramophones on a fairly long journey to see how they fare.

Some manufacturers carry out a practical transit test by sending a number of instruments to a depot as far away as possible, perhaps it is a service depot or wholesaler, or perhaps a dealer who co-operates with the manufacturer. When the instruments arrive at the depot they are not opened, but are re-addressed back to the manufacturer. It can be well imagined what the receivers go through if the manufacturer is fortunate enough to have someone in the north of Scotland to assist him in this test.

Vibration Test

A vibration test is sometimes substituted for transit conditions which is not so drastic in appearance as the drop test, but which is often just as destructive to certain parts of the instrument. Under these conditions of continued shaking, knobs may come adrift, cord drives become deranged, bolts unscrew, and other such-like faults develop.

For this test the model is bolted to a small platform, which is supported by a coiled spring at each corner. Beneath the middle of the platform, and in contact with it, is an elliptical cam connected to an electric motor. When the latter is switched on the cam continually causes the platform to rise and fall, while the springs aggravate the movements so that the model is in a constant state of violent motion.

If breakages occur during any of the above tests decisions must be made as to whether an alteration in packing should be contemplated or a strengthening of the weak parts in the receiver. The least expensive way, usually, is to improve the packing.

Final Alterations

Some of the fifty pre-production models may be sent away to sales representatives, who will have their first inspection of the model which they will have to sell, and can criticise the instrument in the light of their knowledge as to the requirements in their particular area of the country. Naturally, any major alterations cannot be carried out at this late stage in the life of the model, but small details can be attended to if it is felt by the factory authorities that the criticisms are justified.

For example, perhaps in areas where the mains supply is very rough the hum level of the instrument may be high and, although in the vast majority of areas hum level is low and acceptable to the sales representative, the bad mains supply area may be a very thickly populated one in which there is a lot of competition from other makes of radio receivers. In these circumstances it will be worth while spending a little more on the smoothing circuits, or to introduce a screened lead in a vital grid circuit in order to eliminate the objectionable hum when the receiver is operated from the mains supply in that district.

Similar instances occur with reference to quality. The people in some areas of the country may like their radio reproduction with very little high-frequency response, and the sales representative may consider that the tone control does not sufficiently cut the high notes to produce the quality of reproduction which will be acceptable to the majority of his dealers and their public. As to meet this criticism may only mean the changing in value of a condenser in the tone control circuit, a modification in this respect can easily be effected.

When all the various criticisms and reports have been analysed and placed before the production committee, and they have approved any modifications felt to be necessary, the order for full production will be given. How this production is maintained, and the careful inspection necessary to ensure a completely satisfactory instrument, will be dealt with next month.

LATEST PATENT NEWS

Group Abridgments can be obtained from the Patent Office, 25, Southampton Buildings, London, W.C.2, either sheet by sheet as issued on payment of a subscription of 5s. per Group Volume or in bound volumes price 2s. each.

NEW PATENTS

These particulars of New Patents of interest to readers have been selected from the Official Journal of Patents and are published by permission of the Controller of H.M. Stationery Office. The Official Journal of Patents can be obtained from the Patent Office, 25, Southampton Buildings, London, W.C.2., price 1s. weekly (annual subscription, £2 10s.)

Latest Patent Applications

- 15654.—Standard Telephones & Cables, Ltd.—Systems and methods for television reception.—October 24th.
15672.—British Thomson-Houston Co., Ltd., and Moir, J.—Resistance-capacity coupled thermionic valve low-frequency amplifiers. October 25th.
15720.—Burgess Battery Co.—Manufacture of dry cells. October 25th.
15734.—Porter, N. J.—Wireless receivers. October 26th.

Specifications Published

- 528090.—General Electric Co., Ltd., and Jesty, L. C.—Apparatus for transmitting or receiving coloured television.
528179.—Percival, W. S.—Thermionic valve amplifiers.
528192.—Kolster-Brandes, Ltd., and Beatty, W. A.—Discriminating circuits for television and the like.
528198.—Jackson D., and Pye, Ltd.—Mounting of the chassis of radio and television apparatus or the like.
528424.—Radioakt.-Ges. D. S. Loewe.—Method of and apparatus for the televising of kinematograph films.

Printed copies of the full Published Specifications may be obtained from the Patent Office, 25, Southampton Buildings, London, W.C.2., at the uniform price of 1s. each.

Practical Hints

Converting 4-Pin Coils

HAVING recently erected a doublet, I decided to convert my 4-pin coils (2 windings) to three-winding coils without changing the formers. First, I roughly wound on the primary winding till I obtained a position and length which gave the required coupling, then I drilled the former and passed the ends of the winding

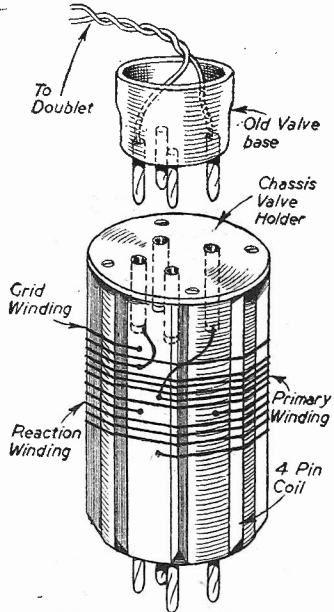

A simple method for converting 4-pin coils.

through the holes. These wires were soldered to two pins of a 4-pin chassis valveholder, which was then glued to the top of the former. The ends of the doublet feeder were connected to the two corresponding pins of an old valve-base. This method can also be used to connect an H.F. stage to a detector.

This method of conversion is certainly much cheaper than buying 6-pin formers, and the coil can still be used for ordinary purposes, if desired.—D. C. G. JOHNSON (Nottingham).

An All-purpose Desk Light

AS I am tired of balancing a pocket torch in precarious positions in my radio den, I constructed the small desk light as shown in the sketch. I first obtained a piece of wood measuring 4in. by 7½ins. and bevelled the edges. I made

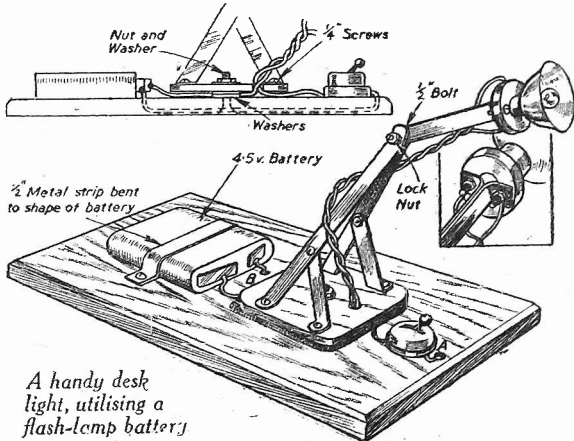

A handy desk light, utilising a flash-lamp battery

THAT DODGE OF YOURS!

Every Reader of "PRACTICAL WIRELESS" must have originated some little dodge which would interest other readers. Why not pass it on to us? We pay £1-10-0 for the best hint submitted, and for every other item published on this page we will pay half-a-guinea. Turn that idea of yours to account by sending it in to us addressed to the Editor, "PRACTICAL WIRELESS," George Newnes, Ltd., Tower House, Southampton Street, Strand, W.C.2. Put your name and address on every item. Please note that every notion sent in must be original. Mark envelopes "Practical Hints." DO NOT enclose Queries with your hints.

SPECIAL NOTICE

All hints must be accompanied by the coupon cut from page 168.

the turntable of ¾in. wood (measuring 2½ins. by 2½ins.) and rounded the corners. I assembled the turntable as follows: I recessed the middle hole in the baseboard and inserted a 1½in. bolt, slipping on to this two large diameter washers. Next the turntable was slipped on, then another washer, and finally the clamping nut. I next made the adjustable support of metal strips ¼in. wide, the construction of which is clear from the sketch. No measurements are given as these are left to individual requirements. The method of fixing the

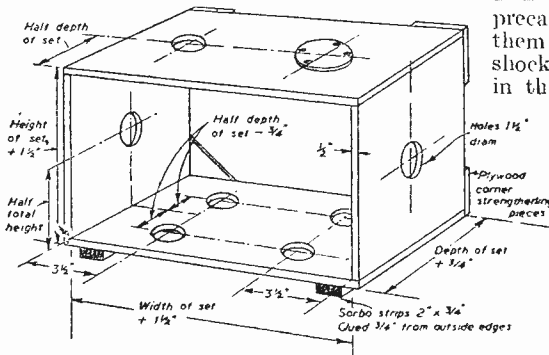
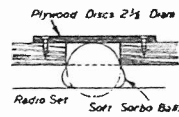
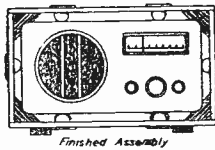

Details of a shock-proof mounting for radio receivers.

flat 4.5 v. battery with a ¼in. metal strip and the wiring connections will be clear from the sketch. The miniature toggle switch should be mounted well in front of the turntable to avoid fouling it. It will be noticed that one wire from the battery is taken through hole A along a groove made in the bottom of the baseboard, and up through hole B to the battery. The reflector is of the "screw" type, as shown, so that the flashlamp bulb can be screwed in, then into the bulbholder.—P. ROBINSON (Stratford-on-Avon).

A Slow-motion Drive

THE accompanying sketch shows a slow-motion drive which can be fitted to most condensers.

Two similar brackets (B) made from stout aluminium, have holes ¼in. in diameter drilled near the top for the condenser bushes.

The rubber tyred wheel F was taken from a mechanical toy, the bearing hole being enlarged to ¼in. diameter. The rubber tyre

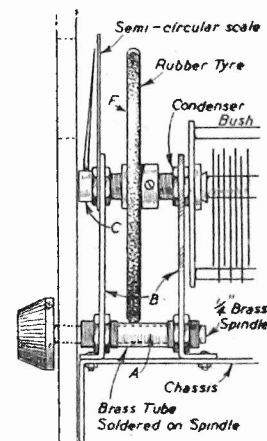

Side view of a home-made slow-motion drive.

is a friction fit against the brass tube A, which is soldered on the driving spindle. The scale held by bush C can be of any type, but I find an opaque protractor (or transparent one painted white at back) makes a good substitute.

The grub screw of the bush C was replaced by a long screw which when filed to a point forms the pointer. With a circular scale and double pointer it

is possible to mark S.W., L.W., M.W., degrees or stations, using parchment paper.

The action is smooth and free from backlash.—J. G. HARKNESS (Barry, Glam.).

Shock-proof Mounting for Radio Receivers

AS many radio receivers are now installed in shelters, it is advisable that some precautions should be taken to protect them from rough usage, or shock. The simple shock-proof mounting arrangement, shown in the illustration, is made as follows:

A simple frame is constructed from ¼in. thick wood and suitably strengthened in the corners with plywood, as indicated. Dimensions will vary according to the particular receiver to be housed.

Eight 1½in. diameter holes are then cut in the positions shown, and plywood discs 2½in. diameter cut to cover each hole. The bottom four are screwed in position and four soft 1½in. diameter rubber balls placed in the recesses now formed, after which the set is

placed in position, and the side and top balls put in place; the cover discs are then placed over same and screwed down. As an added precaution Sorbo strips can be glued to the underside of the framework as shown. In order to give a finish a coat of varnish or paint can be applied to the woodwork.—C. J. SANDERS (Maidenhead).

PRACTICAL WIRELESS ENCYCLOPAEDIA

By F. J. CAMM.

7/6 or 8/- by post from

George Newnes, Ltd., Tower House, Southampton Street, Strand, London, W.C.2

MAKING SIMPLE SUPERHETS

How an Efficient Superhet Receiver can be Made by Using Standard Components and a Number of Old-type Valves

DETAILS were given in a recent issue of a "Spares-Box Superhet," and they evoked a good deal of interest. There are no doubt many readers, however, who would like to build a receiver of rather more ambitious type than that described, but who are normally prevented from doing so because of the frequency-changer, H.F. pentode and double-diode valves required. It is to meet the requirements of this type of reader that we give on this page a circuit for a five-valve superhet. of fairly simple pattern, despite the number of valves, which can be built around existing valves of the screen-grid and small-triode types.

Five Standard Valves

The more critical reader will probably point out that the circuit is a "reversion" to an arrangement which was employed some years ago and which is now dead. We do not admit that, although it is granted that the general circuit layout does not differ very greatly from that employed in certain earlier receivers. But in drawing up the circuit—and we have recently used a set built round this circuit with satisfactory results—we have attempted to incorporate many of the best features of modern design with the best of earlier design. It might also be argued that the set has far too many valves; although only five are shown at least one L.F. or output valve would be needed to operate a speaker. Obviously, the number of valves is greater than that which has become usual in British receivers, but readers will probably remember that we have often expressed our preference for the system of using a greater number of valves, none of which is "stressed

to the limit." By following this arrangement there is far less trouble due to instability and difficulty of operation, and at the same time the overall efficiency obtained with the five valves shown is probably as high as that obtained by using three valves of more modern type—pentagrid, H.F. pentode and diode, for example.

It should be mentioned here that although screen-grid valves have been referred to,

by The Experimenters

and are suggested as suitable for first, second and fourth positions, H.F. pentodes or tetrodes could be used if they are on hand. Alternatively, there is no great objection to employing a combination of valve types so that use can be made of valves which are to be found in the spares box. Suitable types of valves, of comparatively old type, are indicated, and it will be observed that a small power valve is suggested for the oscillator stage and an L.F. or general-purpose valve for the second detector.

Tuning Arrangements

It will be seen that the sequence of stages is: preliminary H.F.; first detector; oscillator; I.F.; second detector. A simple arrangement of tuning circuits is shown, but the actual coils to be employed will depend upon what is available from the spares box. The aerial coil has an aperiodic aerial winding, whilst that used to couple together the H.F. and first-detector valves

is wired in a tuned-anode circuit. Since it will be desired to tune both of these by the same two-gang condenser, it will be clear that the coils should be similar and at least approximately matched. The oscillator coil may be of any ordinary broadcast type with reaction and separate aerial windings if a few turns are removed from the two tuning windings. Actually, it is not essential to modify the coil, although if this is not done the available waveband will be somewhat narrowed.

The number of turns to be removed will be dependent upon the intermediate frequency to be employed. That in turn will depend upon the I.F. transformers available. Since use is to be made of comparatively old components it is probable that the I.F. will be somewhere between 110 and 200 kc/s. In the case of our own experimental receiver we used a pair of I.F.s nominally rated as tuned to 165 kc/s (they were from an old commercial receiver), and an I.F. in this region proved very satisfactory. After completing the receiver a little experiment was carried out in connection with the optimum setting of the trimmers, and it was found eventually that in setting by trial and error, the I.F. was slightly above 170 kc/s.

The Oscillator Coil

With regard to the modification of a standard broadcast coil for use in the oscillator circuit, we found that the removal of about one-tenth of the total number of turns from the medium-wave winding, and about one-sixth from the long-wave winding, proved satisfactory. In addition, we inserted a .001-mfd. fixed condenser

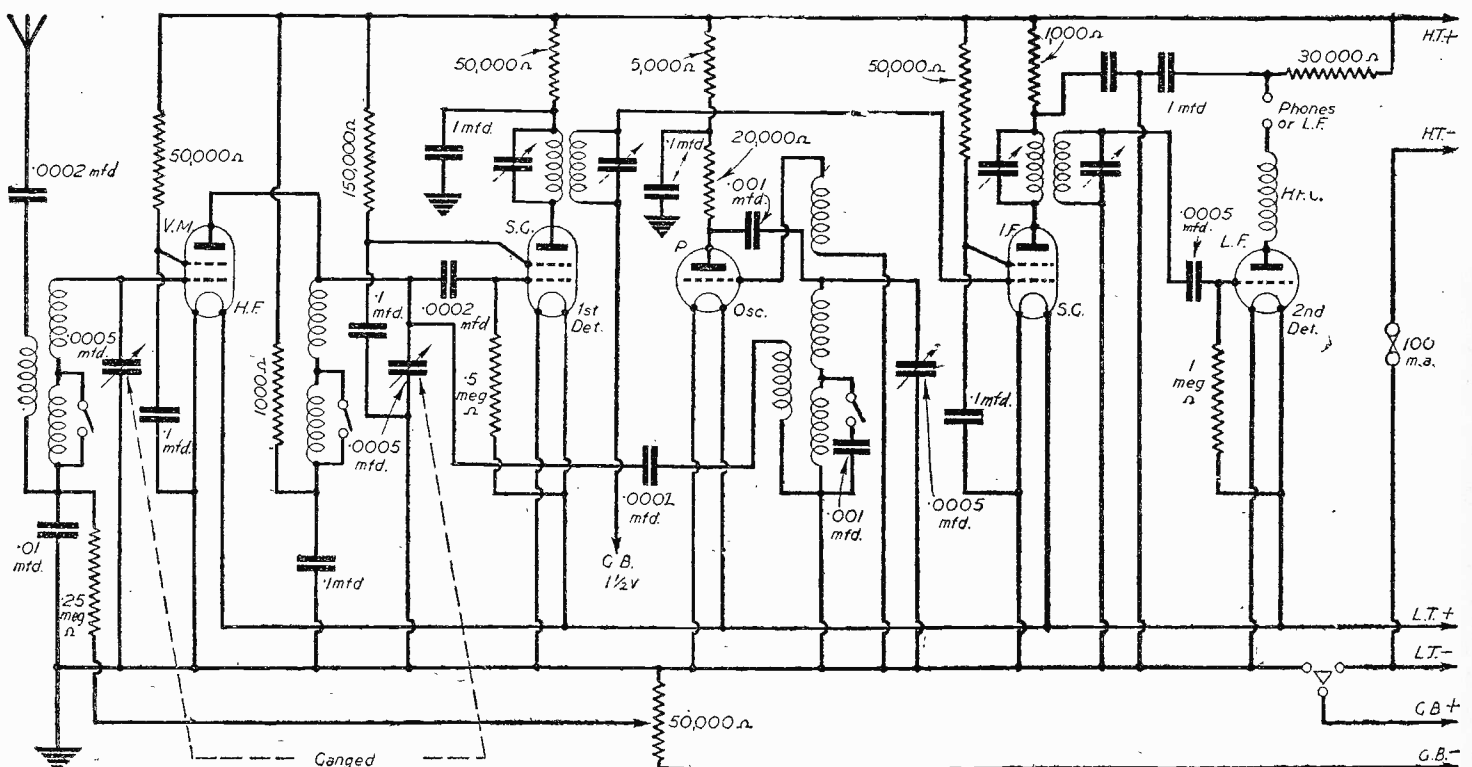

The circuit described. Suitable types of valve are indicated, and it should be noted that the tuned winding of the coil used for the oscillator is in the anode circuit.

in series with the long-wave winding in the position shown. It will be seen that the condenser was wired between the lower end of the winding and one terminal of the wave-changing and one terminal of the wave-cut. Since the switch was built into the coil assembly one lead to it was cut, the two ends being joined to the fixed condenser, which was wedged inside the coil base for neatness.

It is out of the question to consider the use of ganged tuning for the oscillator, as well as the H.F. and first-detector circuits, unless a set of superhet coils is used, and therefore we made use of a single .0005-mfd. condenser for tuning the oscillator circuit. The setting of this is generally fairly critical, so we looked out a condenser with dual-motion drive; that is, fitted with a dial which can be turned bodily (and moving the condenser spindle at the same rate), or which can be turned slowly by means of a built-in friction drive. The dial on the gang condenser was of the geared-down type, but the gearing was high so that the scale could be moved fairly quickly. Since tuning is not normally extremely critical on this condenser it was not found necessary to employ a very slow-motion drive.

In some instances it will be found that slow-motion drives, or two-speed drives, are not to be found. An alternative method is to have two plain direct drives and to fit a .00005 mfd. variable condenser as vernier in parallel with the oscillator tuning condenser. In some respects this method is preferable to the other, provided that the condensers are good ones with a rotor which can be turned smoothly and easily. The low-grade condensers having a rotor which is stiff at some points and which just "flops" round at others is practically useless in a set of this kind.

Method of Tuning

A little difficulty will be experienced at first in operating both tuning condensers at the same time, but after a few stations have been logged and notes made of the condenser settings, the difficulty should vanish. It will be found that both condensers follow a different "law." In other words, if the aerial condenser has to be turned through, say, 120 degrees to alter the tuning from 200 to 400 degrees, the oscillator condenser may have to be turned through only 90 degrees to cover the same waveband. These figures, incidentally, are purely arbitrary, and should not be taken as any real indication of the tuning positions to be expected.

But once this "law" has been established it will not prove very difficult to move both condenser knobs at the same time and to keep the tuning circuits fairly well "in step." The relative movements will be slightly different on the two wavelength ranges, but that should not be the cause of trouble.

Wavebands Covered

It has been taken for granted up to now that the receiver would be used for only medium and long waves. If other wavebands are required use can be made of multi-range tuners, modifying the medium- and long-range windings of that used for the oscillator; it will not be found necessary to make any alteration to the short-wave windings when using the comparatively low I.F. mentioned above. A much better method is to employ six-pin plug-in coils. When that is done it will usually be found that the next smaller coil to be used for the first two valves can be used in the oscillator circuit without any alteration being necessary. It is, preferably, that the coils should be screened, and this can be

arranged in one of many ways. Probably the best is to make use of ordinary coil screening cans taken from old coils. The base or "reversed lid" will be screwed to the receiver chassis and drilled, along with the chassis, to allow the coil-holder sockets to pass through. The coils must, of course, provide reasonable clearance to prevent any possibility of short-circuit.

If this method is not convenient, a rectangular screening box, divided into three equal sections, can be made from copper or aluminium (zinc is a moderate substitute if neither of the other metals can be obtained) and fitted with a lid. The coil-holder sockets will then be mounted in the bottom of each of the compartments. In the bottom of this arrangement, great care is necessary to ensure that all joints in the screening box are sound electrically; in most cases this is ensured by taking care to make them mechanically sound. If this point is overlooked the screening will be inefficient and the screens may actually serve to couple the coils together. The whole screen must, naturally, be well earthed to the chassis and to the earth terminal.

H.T. Supply

The question of H.T. current consumption cannot be overlooked in a receiver of this type, for if 120 volts H.T. is used the consumption of the five valves shown might easily amount to between 10 and 12 mA. And to that must be added the consumption of the L.F. amplifier used. From this it is evident that, for maximum efficiency, and when working on 120 volts, an eliminator, H.T. accumulator or Milnes-unit is desirable. The accumulator is to use a super-capacity H.T. battery, or two smaller batteries in parallel (not good practice) and to cut down H.T. to about 100 volts.

NOTES AND NEWS

Spies' Radio

A RADIO transmitter formed the communicating link between the three spies who were recently executed and their Nazi masters in Germany. The apparatus which was found in their possession consisted of a transmitter which fitted into a leather case measuring 8in. by 8in., and another case, 14in. by 6in., which housed the batteries. To outward appearances the two cases looked very much like those used for cameras, but when connected and used in conjunction with the special aerial, the power radiated was sufficient to make contact with the receiving station in Germany. It would appear that the circuit was intended for telegraphy, a compact Morse key forming part of the equipment, a good idea of which can be obtained from the accompanying illustration.

R.A.F. Selection Board and Secondary Schools

SO successful have been the visits of the Travelling Selection Board of the R.A.F. to the various public schools throughout the country that the scheme has now been extended to include the larger secondary schools.

Under the scheme, experienced personnel officers of the R.A.F. visit schools by arrangement with the schools' authorities, and interview senior boys who have an interest in the air. They give helpful advice on the methods of entry into the Royal Air Force, explain something of the different courses of training for pilots and

air crews, and discuss with the boys their prospects of gaining a commission.

Nearly 300 secondary schools have already asked to be included in the scheme, and the visiting officers will call personally on as many as possible of these during the current term.

During the first six weeks of the Michaelmas term, about 90 public schools have been visited, including many with famous

names. Over 250 senior boys have been recommended for entry at a later date as pilots, observers or wireless operator-air gunners, 160 as officers. Apart from the actual results achieved, the Selection Board scheme is enthusiastically received by many headmasters as being one of the best ways in which the boys about to leave school can get to know of the opportunities offered by the R.A.F.



The transmitting equipment which was found in the spies' possession.

The amplifier in its finished state. Neat, sturdy and pleasing in appearance.

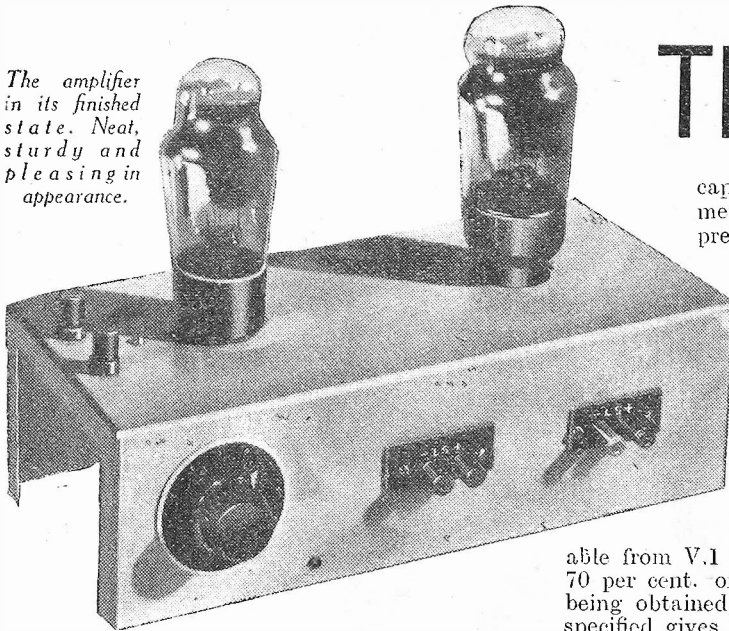

THE A.C. TWO

Constructional Details of the Amplifier for Record Reproduction and General Experimental Work

capacity coupling, this method being chosen, in preference to the use of an L.T. transformer, through considerations of space, layout, possible introduction of hum, cost and overall gain requirements. The anode load is provided by R.3, the value of which directly effects the amplification obtainable from V.1 and allowing for, say, 70 per cent. of the calculated gain being obtained, the resistance value specified gives reasonable tolerances.

as possible, provision has been made for headphones to be connected across the output of V.1. For this purpose a separate condenser C.5 is taken from the anode to one side of the two socket strips fitted to the centre of the front runner of the chassis. The other socket is connected to the common negative-earth line, i.e., chassis, thus completing the intermediate output circuit when the 'phones are in use. It will be appreciated that by using this method, no H.T. voltage (D.C.) is across the 'phone windings. Therefore there need be no fear of causing harm to them or the user.

OUR usual monthly analysis of readers' requests reveals that during the past month the outstanding demand is for a low-powered A.C.-operated amplifier, suitable for record reproduction and general experimental work. We have, therefore, produced the unit described in these pages, and although we have had to modify what might be termed the average specification submitted by those readers who wrote to us, we hope that the design will appeal not only to them, but to many others who are requiring an amplifier having good response characteristics.

It is difficult to combine in one unit an amplifying circuit capable of satisfying those who require a simple piece of apparatus to reproduce records faithfully, with the circuit and constructional modifications essential to make it ideal for general experimental work. The only alternative, and it is the one we have taken, is to compromise by producing an amplifier having good tonal qualities, and so constructed that its general utility value makes it an asset to the experimenter.

Circuit

We have assumed that the input will be provided by a modern type of electromagnetic pick-up, but allowances have been made so that satisfactory loading of the output valve will be obtained from smaller inputs. The input is isolated, so far as D.C. is concerned, from the grid of V.1 by means of the fixed condenser C.1, but the grid receives its bias via the potentiometer R.1, by virtue of the resistance R.2 in the cathode circuit. The proportion of the input signal arriving at the grid of V.1 is governed by the potentiometer which forms a smooth and effective volume control. The output from V.1 is fed to the grid of V.2 by means of a resistance-

Double-Anode Decoupling

It is essential, in circuits of the type under consideration, to take every precaution against hum being introduced by the H.T. line, especially in those stages giving appreciable amplification. For this reason, double-anode decoupling has been incorporated in the first stage; the use of two resistances and their associated bypassing condensers, R.4 and R.5 and C.2 and C.3, provide a much higher degree of decoupling than a single resistance having a larger value, without the disadvantage of causing a greater voltage drop.

The coupling condenser C.4 provides the link between the anode of V.1 and the grid of V.2, and, owing to the high conductance of the latter, grid and anode stoppers or stabilising resistances have been fitted, these being indicated by R.6 and R.7. It will be noted that a triode super-power valve has been selected for the output stage, thus ensuring most satisfactory tonal response, complete absence of pentode "pitch," and a wattage output in keeping with the purpose for which the amplifier is primarily designed. For monitoring purposes, "personal" listening, and to make the application of the unit as wide

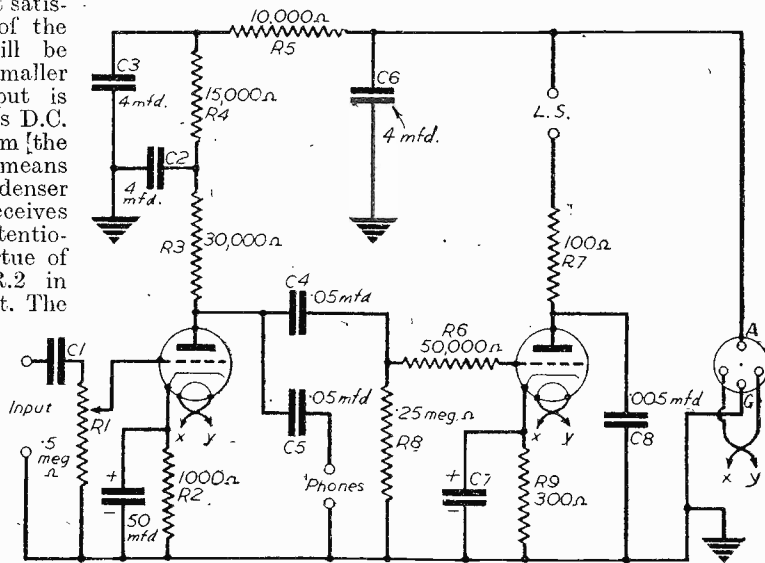
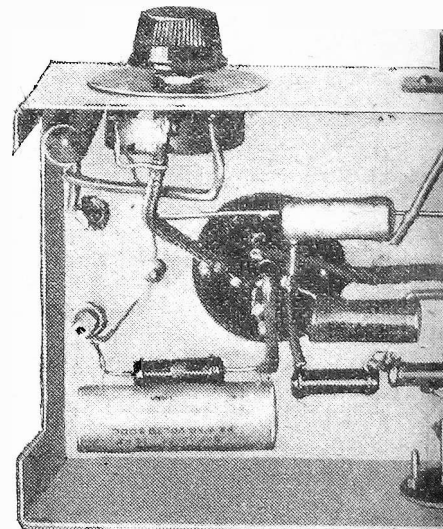

Fig. 1.—The simplicity of the circuit is shown by this theoretical diagram. Refer to it when reading the text.



This illustration of the original

The necessary H.T. and L.T. supplies are obtained from a separate unit, complete details of which are given farther on in this article. While there may be many who would have liked to see the amplifier and the mains equipment assembled as one complete unit, we decided to split the apparatus for various reasons. For example, many constructors already have by them a mains unit which could be used satisfactorily. Then there is also the question of space; many prefer to have a compact piece of apparatus which can be conveniently placed for operation, and that is not possible to the same extent if everything is incorporated in one assembly.

Construction

For those who wish to make the chassis out of sheet metal, a piece of 20-gauge sheet iron or 18-gauge aluminium, having

LIST OF COMPONENTS

- AMPLIFIER**
 Metal chassis. See text (Premier or Peto-Scott).
 Resistances: $\frac{1}{2}$ watt—one 15,000, one 10,000, one 30,000, one 50,000, one 100, one .25 megohm, one 1,000 ohms; 1 watt—one 300 ohms (Erie).
 Potentiometer, 0.5 megohm (Erie).
 Condensers (fixed), one, type 307; two .05 mfd., type 4602/S; one .005 mfd., type 4601/S; one 0.1 mfd., type 4603/S; one 50 mfd., type 3016; one 50 mfd., type 3004 (Dubilier).
 Valve-holders, one 4-pin, two 5-pin (Amphenol).

ROUND THE WORLD OF WIRELESS

Radio in Shelters

REPLYING to a question in the House of Commons recently, Mr. Herbert Morrison said that the use of wireless in shelters had the approval of the Government in principle, but no subsidy from Government funds was contemplated.

When it was suggested that the provision of wireless on the relay system would be inexpensive, Mr. Morrison replied that considering the number of persons who used the shelters, they should be able to get together and provide wireless receivers themselves.

Station WLWO, Cincinnati

LESS than a week after its formal dedication, station WLWO, Cincinnati, becomes the only international short-wave station in the United States authorised to operate on each of the six international wavelengths, with unlimited frequencies and with unlimited time.

The Federal Communications Commission has granted WLWO's application to operate on the 9, 11 and 15 megacycle bands, with exclusive frequencies.

The complete list of WLWO's frequencies in kilocycles now is as follows: 6,080, 9,590, 11,710, 15,250, 17,800 and 21,650.

A.R.P. Radio Link

IT is reported that an important step is being taken in a certain town to make it independent of the regional wireless station which, for two or three years, has been run by the neighbouring city police.

The basic idea of this installation is to be prepared for any grave contingency that might disorganise ordinary electrical communication.

The scheme is believed to be the first in the country. Two-way communication is provided for by means of a main 100 w. radio transmitter. All the police, fire, ambulance and A.R.P. services can be linked together for quick action when needed. The outlay will be several hundred pounds. The Watch Committee has just approved the project, and details have been sent to the Home Office for confirmation.

Automatic SOS

ANOTHER interesting "find" in one of the shot-down Nazi planes is a complete radio transmitter mounted in a waterproof metal container. The container holds a small transmitter, the necessary batteries and a motor which automatically "keys" the morse signal, S O S . S O S . . . when the transmitter is switched on.

The transmitter can be used in conjunction with a form of "umbrella" aerial fitted on a long, thin mast, or with a kite aerial, the line for which is carried on a reel inside the container.

It is presumed that this transmitter is intended for use in the rubber dinghy used by pilots who have had to leave their machines when over the sea. This transmitter does not appear to be a regular part of the equipment of the Nazi planes, but is probably carried only when an important Nazi official is being flown.

Radio Training Scholarships

FIFTEEN scholarships in radio training in the radio department of the Cincinnati College of Music were awarded recently by station WLW in co-operation

with the College. The scholarships, first of their type, are each valued at 100 dollars, and entitle the winners to a year's tuition in residence at the College. The courses offered include acting, announcing, production and sound effects.

Women Radio Operators for R.A.F.

BRITAIN'S air offensive, demanding more and more operational and training units of the R.A.F., is reflected in a new call for W.A.A.F. recruits. Young women, and those not so young, can join to do the sort of job they know, or to learn a new one. Clerks, cooks, telephonists, wireless operators, sick quarter attendants—there is a job for every woman from 18 to 43. Specially interesting is the work of

'plane say that it could also act as a robot bomber. It is estimated that the 'plane would cost between £250 and £300.

R.A.F. Require Radio Mechanics

BRIGHT young men now have a chance to learn the expert trade of radio mechanic—in the R.A.F. Formerly, entry into this trade was reserved for skilled men; now a special course of training will be given to the right sort of candidate. The age limits are 18-30, and the standard for entry is fairly high. A school-leaving certificate or its equivalent is desirable, and applicants must be physically fit and mentally alert. It is a chance for the young man who is perhaps just below the standard for air crew duty.



A Canadian wireless operator at work receiving instructions for the gun crews when Canadian soldiers of the artillery recently carried out practice shooting "somewhere in England."

women radio operators—"announcers," so to speak, of the R.A.F. For this post a high degree of intelligence is needed, and especially the capacity to keep cool and unruffled under any conditions. Younger women only are wanted—age 18-35.

Valves for German Aircraft Radio

AN interesting fact concerning the standard receiving equipment fitted to most of the German 'planes is that H.F. pentode valves are used exclusively; every valve in the set is interchangeable with any of the others. The valves have side contact bases and top cap; they are fitted in an inverted position and are held firmly in place. To withdraw them a small knob is screwed into a tapped hole in the plastic-material base. The valves are very small and bear some resemblance to "acorns," although being somewhat larger.

A Pilotless 'Plane

ACCORDING to an American inventor, Dr. Lee de Forest, a pilotless "television torpedo" 'plane may be completed within a year. He states that the 'plane could be made from inexpensive plastics and would require no armour, as it would be a robot machine. The flight could be directed by radio from a mother ship ten miles or more away.

Television cameras could be placed in the nose of the 'plane, and a television transmitter could send pictures of the terrain below to a ground base or to the mother ship, where operators would be able to manoeuvre the 'plane. The Army authorities who are at present testing the

Selectivity!

A CUSTOMER of a Kent trader, who has a lodger who insists on listening to German broadcasts, wrote in asking that her set should be fixed so that she could tune in to the B.B.C. wavelengths, but could not get German stations. The trader commented that it might be simpler to get rid of the lodger!

Mansfield's War Weapons Week

IT is gratifying to learn of the effort made by the little town of Mansfield in connection with their War Weapons Week. Aiming at a total of £200,000 the grand sum of £388,955 was finally received. The staff of Whiteley Electrical Radio Co., Ltd., contributed £666 5s. 6d.

An Important New Textbook

WATCHES: ADJUSTMENT AND REPAIR

By F. J. CAMM.

6/- or 6/6 by post

From GEORGE NEWNES, LTD., Tower House, Southampton Street, Strand, W.C.2.

Noise Suppression

The Requirements of Noise-suppressing Devices, including Scratch Filters, and Their Application to Radiograms

IN order to obtain satisfactory reproduction from gramophone records, it is necessary to provide means for controlling the frequency output from the pick-up. Just as it is essential to regulate the voltage output to compensate for the variations in the recording, so it is equally desirable to correct the frequency range to suit the amplifier and loudspeaker characteristics. The volume of sound will naturally be regulated by the usual control, which will be either incorporated on the base of the pick-up itself, on the motor-board, or even in the radiogram, where it may be doing double duty for both radio and gramophone reproduction.

On the majority of commercial sets no further provision is made for the pick-up, although, if the receiver includes a "tone control," this will sometimes act to restrict

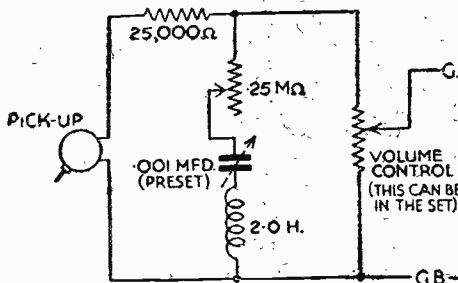

Fig. 1.—One method of controlling the output from the pick-up.

the higher audio-frequencies, which in the region of about 3,500 cycles coincide with the scratch noises. For a number of technical reasons later explained, such tone controls are apt to spoil reproduction rather than improve it. The main reason is that the "tone control" merely consists of a by-passing scheme for high notes, and in cutting off at any desired frequency within its scope it seriously attenuates all adjacent lower high notes, due to the broad tuning effect.

High-note Loss

Consequently, in attempting the suppression of scratch, the user, unless very careful in manipulating the control, is likely to rob the recording of its "brilliance" imparted to the reproduction by those frequencies immediately below 3,500 cycles. A tone-control transformer included as an L.F. coupling will offer somewhat greater scope, but even so, in attempting the suppression of scratch noises, the response curve will be tilted to the bass end, these latter frequencies then becoming more prominent.

Due to the limited bass notes on a modern electrical recording, this over-emphasis by the tone control is a good fault and will "level up" the output, provided, of course, the correction is not overdone. These remarks are tantamount to putting the cart before the horse, in that it is necessary to discover the causes of background noises in a pick-up before one is in a position to cure them.

Nearly all pick-ups operating on the electro-magnetic mechanical principle give rise to resonances at the upper end of the frequency response curve. Modern versions

possess substantially uniform characteristics, with a peak, due to the mechanical resonance of the armature, between 3,000 and 5,000 cycles, followed by a falling response up to about 7,000 cycles. Owing also to the movement of the needle point on the record, a further needle scratch noise is heard. From investigations made into these problems, the following interesting conclusions have been reached. (1) When needle scratch is superimposed on the resonance noise, the resultant background is loud because of the increase in amplification which is incident to the resonant circuit. (2) As the noise is thus at its loudest at the armature resonance point, reducing the amplification at the frequency of the armature will substantially reduce the background. (3) An asymmetrical condition of the pick-up armature—that is, when it does not affect both magnetic poles equally, due to being slightly out of mechanical centre or unequal magnetic pull—will result in the scratch varying in pitch with all pure high notes reproduced. (4) The surface noise of a gramophone record, due to it extending over a large range of frequencies, will quickly stimulate the pick-up armature into its natural resonance.

A Practical Scheme

It is obvious from the above that the removal of the natural resonance at the frequency of which it occurs offers the best solution to pick-up noises, rather than the entire removal of all frequencies on and above the resonant point, such as would occur with so-called tone-controls. The use of a scratch filter, therefore, imposes the limitation that it must only suppress at the resonant frequency, leaving frequencies above that point unattenuated. A scheme as shown in Fig. 1 or in Fig. 2 will be found to fulfil these conditions, as both circuits are fundamentally the same.

By careful adjustment of the variable controls provided on either device, it is possible to find the resonance point of the particular pick-up in use, as the action of the filter is to cause a trough in the frequency response by acting as a short-circuit to alternating currents of the

frequency to which it is tuned. This loss in the filter network can be made to cancel out the resonance gain, the nett result being a more level overall pick-up voltage output. Prospective users of these filters should note that the inclusion of the series resistance restricts the voltage output of the pick-up and, therefore, the amplifier must possess sufficient overall gain to load the output valve from a pick-up input about half that stated by the makers.

Surface Noise

The loss of output is unavoidable, as the filter circuit must of necessity include the series resistance to maintain a correct impedance ratio to the pick-up. On the other hand, the reduction of the resonance peak progresses at a greater rate than the loss of volume, and in most cases full correction will coincide with a loss not exceeding 40 per cent. When adjusting a scratch filter it is essential that the tone control (if used) be set to maximum brilliance, as this will allow the effect of the filter to be more easily observed. In any event, a low (mellow!) setting of the tone control is likely to mask settings of

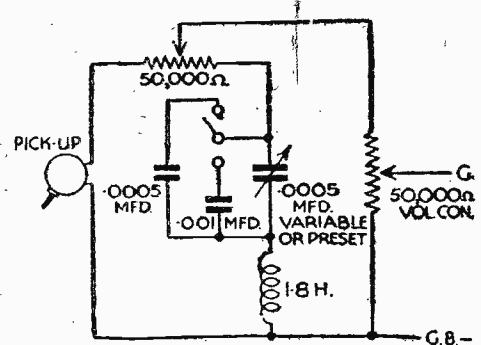

Fig. 2.—A more comprehensive pick-up control circuit.

the filter which may then appear to have no noticeable effect on the reproduction.

Noises due to the friction of the needle on the surface of the record are unlikely to be restricted by the use of these filters except at the point of resonance, and short of excluding all frequencies between the middle and top note register (which would naturally ruin reproduction completely) there does not appear to be any possibility of restricting them. A similar trouble was experienced with the sound-track on films during their early days, and it was not until a system of masking the silent part of the sound track came into being that the fault was overcome.

Radio Traffic Control in America

A NOVEL plan to bring traffic signals into cars in the form of distinctive tones corresponding to the "stop" and "go" lights, may in time make a car-radio a legal requirement on every car in America.

In its present form, this traffic-control system uses the existing car radio tuned to 550 kc., thus making the system immediately available for the 6,000,000 cars now equipped with auto-radios, though eventually a special small set would be employed with fixed tuning to the highway safety-signal frequency.

By the use of this system, the driver, instead of letting his attention wander from the roadway in his search for traffic signals in unfamiliar territory, would hear a pleasant low tone as long as the lights ahead were green. When "red" comes on, in all cars on that section of the roadway an interrupted high note would be heard, like a crossing signal.

Recorded Messages

The small highway transmitting unit, which may be mounted on a telephone pole or a traffic light stanchion, makes use of a magnetic tape sounding recording device by which continuous repetition of a traffic bulletin or a safety message may be broadcast. A distinctive sign placed on the street in advance of a given radio zone calls attention of motorists to the radio system which they are approaching and tells them the frequency to which to tune their set.

Preventing Traffic Jams

By means of this device, traffic can be re-routed to a secondary thoroughfare from crowded highways, preventing jams before cars have a chance to pile up; and drivers can be warned of speed limits or of emergency in case of fire or accident.

A Three-range Short-wave Coil

Constructional Details of a Triple-range Coil Unit for Experimental Receivers

IN the past a short-wave set has been looked upon by many as rather a special instrument intended only for the more advanced experimenter. As a result, sets of this type were made in somewhat "rakish" form and were fitted with numerous "gadgets" and controls which, in themselves, were sufficient to scare the average listener away from short waves. But these things have changed, and a short-wave receiver now had the appearance of an ordinary broadcast set. Partly as a result of this, and partly because there are many S.W. stations giving out important programmes, the ordinary constructor is giving more attention to short-wave work. This is all to the good and the change will lead to greater simplicity of design and operation. The use of plug-in coils is becoming a thing of the past just as it did in respect to broadcast receivers a few years ago.

12-70 Metres

The three-range tuner of which particulars are given in Fig. 1 will cover the wavelengths from approximately 12 to 70 metres when tuned by a .0002mfd. condenser. This range is a very wide one, of course, representing a frequency range of from 25,000 kilocycles to 4,250 kilocycles, and so it is divided into three portions which give approximately 12 to 20, 18 to 38, and 35 to 70 metres respectively. It will be seen that the bands overlap slightly and thus permit of an unbroken tuning range from the lowest to the highest wavelength.

The change-over from one wavelength to another is effected by means of two ordinary push-pull switches which each short-circuit a portion of the tuned winding. Reaction is provided, and by dividing the reaction winding into two parts, situated one at each end of the tuned winding, a more or less uniform degree of reaction coupling is obtained over the full tuning range.

Parts Required

The few materials required to make the tuner are:

- One 3 1/2 in. length of six-ribbed ebonite coil former, 1 1/2 in. diameter. (The di-

ameter is measured outside the ribs.)

- Six 6BA terminals.
- Six feet 18-gauge enamelled wire.
- Six feet 26-gauge enamelled wire.

Construction

First of all, drill six 3/16 in. holes around one end of the ebonite former and securely fix the terminals into them. Next make a pair of 1/16 in. holes about 1/2 in. away from the "terminal" end of the former, and anchor one end of the thinner wire in these, leaving a couple of inches of wire projecting inside the tube for later connections. The method of anchoring the wire is to pass the end through one hole, back through the other and back to the inside again through the first. Now wind on four turns, cut off the wire and secure the end by passing it through another pair of holes made in a suitable position.

Leave a space of about 3/16 in. and then make another pair of holes (about 1/2 in. this time) for securing the end of the thicker wire. Fix the end of the 18-gauge wire in these and wind on two turns before making a looped tapping as shown in detail on Fig. 1. Pass the loop through a 1/2 in. hole in the former and continue to wind on another three turns; make another loop and then put on the remaining seven turns. Terminate the winding by passing the wire through another pair of holes as at the beginning. It will be seen from Fig. 1 that all the turns of thicker wire are spaced by about the thickness of the wire; the spacing increases the tuner's efficiency by lowering its self capacity. To prevent the turns from slipping, a good tension should be kept on the wire whilst winding. Lastly, put on the other portion (seven turns) of the reaction winding, leaving a space of 1/16 in. between it and the lower end of the tuned winding. To fix the turns more securely in position they should be given a coat of shellac varnish.

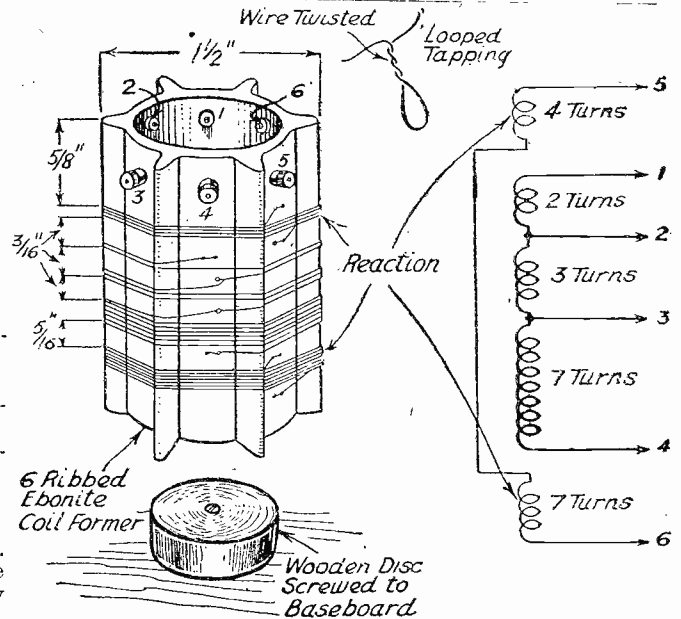

Fig. 1.—Constructional details of the short-wave tuning coil.

And now all the tappings must be soldered to their proper terminals. Before doing this cut them to such lengths that they will just reach the terminals, and scrape the ends bare. The proper terminal connections are shown diagrammatically in Fig. 1 and the relative positions of the terminals are clearly shown in Fig. 2. Notice that the two halves of the reaction winding are joined in series by soldering the end of the upper winding to the beginning of the lower one.

The simplest way to attach the tuner to the baseboard of the set is shown in Fig. 1; a wooden disc is made to fit tightly into the ebonite former and is secured to the baseboard by means of a screw.

Using the Tuner

The tuner is very suitable for use in the aerial circuit of any short-wave set, adaptor or converter, and in each case the connections will be shown in Fig. 2. Suitable values for the more important components are also shown in the latter figure, and these should be adhered to with fair accuracy. The .0001 mfd. pre-set series aerial condenser is a necessity and prevents damping of the tuned circuit by the aerial load. If it were omitted it would in most cases be impossible to obtain oscillation. Its optimum setting will depend to some extent upon the length and capacity of the aerial employed as well as the wavelength range in use.

Both wavechange switches are of the normal two-spring push-pull type, but it is important that good ones should be used because if the contacts are not perfect they will give rise to crackling sounds.

When both switch knobs are pushed in the highest wavelength range (35 to 70 metres) is obtained; by pulling out switch "B" the range is from 18 to 38 metres, tuner works on the very lowest range. The capacities of tuning and reaction condensers are shown to be .002 mfd. and .00015 mfd. respectively. These values are most suitable, but they might be increased to .0003 mfd. and .0002 mfd., or reduced to .00015 mfd. and .0001 mfd. without affecting efficiency to any marked extent. Both condensers should be good ones designed especially for short-wave work, and it is desirable (from the point of view of easy tuning) that the tuning condenser at least should be provided with a vernier control. The H.F. choke should, of course, be a special short-wave one and not of the ordinary type intended for a broadcast receiver.

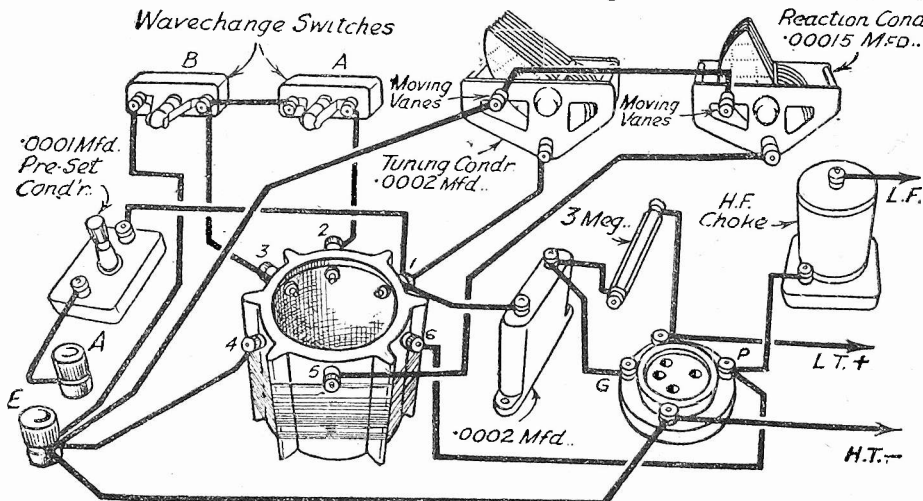

Fig. 2.—Pictorial diagram showing how the short-wave tuner should be connected up.

ORIENTATION OF AERIALS FOR SHORT-WAVE WORK

WHEN designing the aerial to receive a particular continent (say America) some amateurs simply consult a compass, and then proceed to the erection of the aerial—bearing in mind, of course, the dictum that for maximum signal strength the aerial should point away from the station it is desired to receive.

While this would be perfectly correct with a nearby medium-wave transmitter, it by no means follows that it is the best arrangement for receiving a short-wave station. In most cases the aerial will be horizontal, and although it may point away from the desired station, it may not be pointing away from the direction of the received waves. In fact, it may be necessary to point it to the planet Mars, or Jupiter, or some other heavenly body!

This is because the received waves in most cases come in at an angle, being reflected from the Heaviside or Appleton layer in the upper atmosphere. Thus you have to tilt your aerial in order to get the right orientation.

Since in most cases the waves are received at a steep angle, the vertical aerial will be found to give good results on the short waves, and this applies equally in all directions. In order to get the aerial pointing away from the direction of the received waves, however, it is necessary to take the lead-in from the top of the aerial, and those who have facilities for doing so will find it very advantageous.

Prize Problems

PROBLEM No. 416

YEOMAN designed and constructed an L.F. power amplifier having two indirectly-heated valves in a push-pull arrangement in the output stage. He took particular care with the smoothing and decoupling circuits and used condensers rated at the D.C. output of the rectifier. Results were most pleasing, but after a short time he experienced trouble due to the breaking down of the smoothing condensers. Twice did he make replacements, only to experience the same trouble. He then remembered about connecting condensers in series, to offer a greater safety factor, so in place of the single 3mf. condenser each side of the smoothing choke, he connected two of the same values in series, i.e., used four altogether. The breakdown trouble ended, but to Yeoman's dismay so did the dead-silent background. An appreciable hum was present. Why?

Three books will be awarded for the first three correct solutions opened. Entries must be addressed to The Editor, PRACTICAL WIRELESS, George Newnes, Ltd., Tower House, Southampton Street, Strand, London, W.C.2. Envelopes must be marked Problem No. 416 in the top left-hand corner and must be posted to reach this office not later than the first post on Monday, January 20th, 1941.

Solution to Problem No. 415

Thompson overlooked the fact, when making the connections for the mains aerial, that the two condensers he had joined in series across the primary, i.e., mains, with their junction taken to earth, offered a low impedance path to earth for H.F. current, thus virtually short-circuiting the aerial system.

The following three readers successfully solved Problem No. 414, and books have accordingly been forwarded to them: 959129 L.A.C. J. Collins, R.A.F., Scotland; 1176410 A.C.2 Breakspear, R.A.F., Wilts; W. D. White, 60, Croftend Avenue, Croftfoot, Glasgow, S.4.

COILS, CHOKES AND TRANSFORMERS, AND HOW TO MAKE THEM.

Edited by F. J. CAMM.

3/6, or 4/- by post from Geo. Newnes, Ltd., Tower House, Southampton Street, Strand, London, W.C.2.

NEW DETECTOR CIRCUIT

IN the conventional diode detector, a capacity is usually connected in shunt with the load resistance. The presence of this capacity frequently gives rise to difficulty because it may cause attenuation of the upper modulation frequencies, particularly if these frequencies approach the carrier frequency, as in television receivers.

This difficulty is largely overcome in a new detector circuit originated in the laboratories of the Radio Corporation of America. This circuit is shown in the accompanying diagram. The R.F. input is fed to the diode 15 via the transformer 11, 12, and the rectified current flows through the load resistance 14 in series with the diode. The usual by-pass resistance is, however, omitted, and the modulation voltages fed to the amplifier valve 17 are freed from carrier frequency components by means of the neutralising winding 16 which

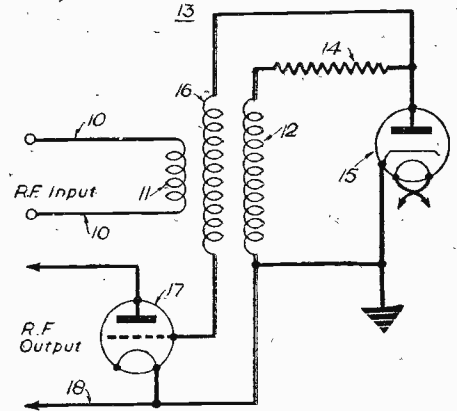

is coupled to the winding 11, and connected in series with the grid of the amplifier valve 17.

THIS YEAR WE CLIMB TO VICTORY

To achieve Victory we must be efficient—to be efficient we must be trained.

You can help your country and yourself at the same time if you do your best, but you are not doing your best if you waste time.

By becoming efficient in your vocation you can give the best service to your country and to yourself. The more you increase your earning power the better it is for the country and for yourself personally.

War or no war, earning power always brings its possessor to the front. It is no use waiting for better times. The ideal opportunity never arrives. We have to make the best of existing conditions.

Therefore, delay is useless; it is worse, it is harmful!

If it is your desire to make progress and establish yourself



LET ME BE YOUR FATHER

in a good career, write to us for free particulars on any subject which interests you, or if your career is undecided, write and tell us of your likes and dislikes, and we will give you practical advice as to the possibilities of a vocation and how to succeed in it. You will be under no obligation whatever. It is our pleasure to help. We never take students for courses unless we feel satisfied they are suitable. Do not forget that success is not the prerogative of the brilliant. Our experience of over thirty years proves that the will to succeed achieves more than outstanding brilliancy.

EARNING POWER IS A SOUND INVESTMENT!

DO ANY OF THESE SUBJECTS INTEREST YOU?

- | | | |
|---|--|-----------------------------------|
| Accountancy Examinations | Engineering. All branches, subjects and examinations | Pumps and Pumping Machinery |
| Advertising and Sales Management | General Education | Radio Communications |
| Agriculture | G.P.O. Eng. Dept. | Radio Service Engineering |
| A.M.I. Fire Ex. Exams. | Heating and Ventilating | Road Making and Maintenance |
| Applied Mechanics | Industrial Chemistry | Salesmanship, I.S.M.A. |
| Army Certificates | Institute of Housing | Sanitation |
| Auctioneers and Estate Agents | Insurance | School Attendance Officer |
| Aviation Engineering | Journalism | Secretarial Exams. |
| Aviation Wireless | Mathematics | Sheet Metal Work |
| Banking | Matriculation | Shorthand (Fittman's) |
| Blue Prints | Metalurgy | Short Story Writing |
| Boilers | Mining, all subjects | Speaking in Public |
| Book-keeping, Accountancy and Modern Business Methods | Mining, Electrical Engineering | Structural Engineering |
| B.Sc. (Eng.). | Motor Engineering | Surveying |
| Builders' Quantities | Motor Trade | Teachers of Handicrafts |
| Building, Architecture and Clerk of Works | Municipal and County Engineers | Telephony and Telegraphy |
| Cambridge Senior School Certificate | Naval Architecture | Television |
| Civil Engineering | Novel Writing | Transport Inst. Exams. |
| Civil Service | Pattern Making | Viewers, Gaugers, Inspectors |
| All Commercial Subjects | Play Writing | Weights and Measures Inspector |
| Commercial Art | Police, Special Course | Welding |
| Common Prelim. E.J.E.B. | Preceptors, College of | Wireless Telegraphy and Telephony |
| Concrete and Structural Engineering | Press Tool Work | Works Managers |
| Draughtsmanship. All branches | Production Engineering | |

If you do not see your requirements above, write to us on any subject. Full particulars free.

STUDY AT HOME IN YOUR SPARE TIME

JOURNALISM

Short Story, Novel and Play Writing

There is money and pleasure in Journalism and in Story Writing. No apprenticeship, no pupilage, no examinations, no outfit necessary. Writing for newspapers, novels or pictures, is not a gift; it is a science that can be acquired by diligent application and proper guidance. It is the most fascinating way of making pastime profitable. Trained ability only is required, we do the training by post. Let us tell you about it.

Department of Literature No. 104

IF YOU ATTEND TO THIS NOW IT MAY MAKE A WONDERFUL DIFFERENCE TO YOUR FUTURE

COUPON CUT THIS OUT

TO DEPT. 104, THE BENNETT COLLEGE, LTD., SHEFFIELD.

Please send me (free of charge) Particulars of (Cross out line which Your private advice about) does not apply.)

PLEASE WRITE IN BLOCK LETTERS

Name

Address

Open to Discussion

The Editor does not necessarily agree with the opinions expressed by his correspondents. All letters must be accompanied by the name and address of the sender (not necessarily for publication).

A Reader's Equipment

SIR,—The enclosed photographs of my gear may interest other readers.

In one photograph can be seen a three-valve (H.F. Pen.-v.-Pen) short-wave receiver; while to the right is a five-valve A.C. superhet. Under this there are two gas-mask box receivers. The switches on the wall control all of the receivers solely from the operating position. The output from either short-wave receiver can be switched over to the 'phones, which are left permanently connected to a terminal

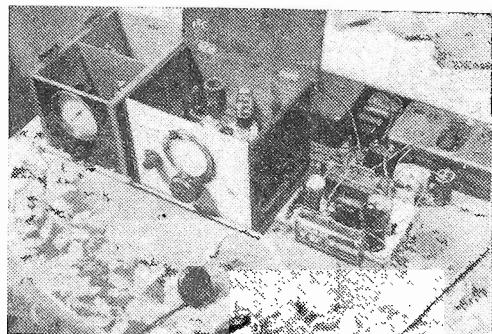

S. E. Janes' 0-v-0 receiver with its associated H.F. and L.F. amplifiers.

attained which is equal to that of the average commercial product. Without a definite system for tackling the job, one can go on altering the oscillator, tracker, and trimmers for days or even weeks. Taking the case of one particular station, one can get it at full strength by many different combinations of numbers of turns in the oscillator tuned coil and settings of the tracker, and in its proper place on the dial in each case, but, unfortunately, other stations will not be so obliging, and will be weak or not there at all. I soon found that a system would have

A corner of Mr. Janes' wireless den, showing the switches for controlling the receiver.

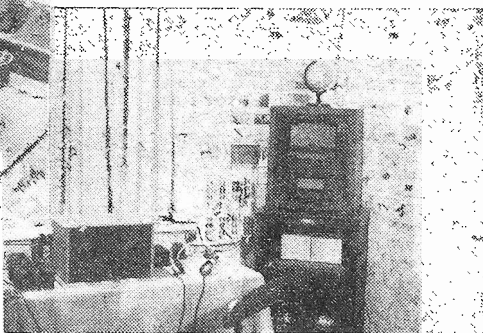

block. On the other hand, the receivers can be switched through to the P.U. sockets of the superhet if loudspeaker reception is desired. An audio oscillator can also be brought into operation for morse practice.

How do readers receive the Forces programme on the 40-metre band? I find that this station is badly "swamped" during the evening by some of the "local" Europeans.

I often visit Eastbourne, Sussex, in connection with my work, and spend a few days there each time. I should like to meet any readers in that town (during the evenings) who are interested in amateur radio. Perhaps they would drop me a line giving their QRA, etc.

On the other hand, any readers in this district (especially those in the Services) will find a welcome at this address. It would be as well, though, if intending visitors would let me know by some means when to expect them.—S. E. JANES (72, Kimberley Road, Croydon, Surrey).

Matching Coils

SIR,—The article on a Spares-box Superhet in the December, 1940, issue mentions the difficulty of matching coils in order to use a ganged condenser in a home-made frequency changer. But this is not impossible, even without special appliances.

Twelve months ago, having decided to convert my own mains H.F., Det., and L.F. receiver into a superhet, I determined from the beginning to use a ganged condenser in the frequency changer stage. I will not say that it is very easy for one who has not done it before, but it certainly can be done, and, with some care, accuracy of ganging

to be evolved, and this was done, with the result that I now have a three-wave-band superhet, satisfactory on each waveband, and as easily tuned as any manufacturer's product. It differs from the superhet described in that it is fitted with a single F.C. valve, but this does not affect the question of ganging.—A. O. GRIFFITHS (Wrexham).

[Bearing in mind that our remarks were intended for the average constructor, we think that A. O. G. proves that it is not an easy matter to obtain perfect ganging, or in other words, that it is practically impossible, for the man who would wish to build a set of the type under discussion, to secure satisfaction without some form of testing equipment. A. O. G. admits that he had to devise a system, and we feel sure that other readers would welcome more details of the procedure he found it necessary to adopt.]
—"THE EXPERIMENTERS."]

Tuning-up

SIR,—I was rather pleased to note the advice the writer of the article, "Tuning-up Your S.W. Receiver" in the January issue, gave concerning aerials. For a long time I have been using an indoor arrange-

ment and getting quite reasonable results, until about a month ago I decided to overhaul my installation and try a proper outside aerial. I put in quite a lot of time making and erecting it, and I paid particular attention to its insulation; in view of the amazing increase in range and sensitivity I am more than repaid for the work and cost involved. I would strongly advise all keen short-wave listeners who are still using indoor aerials to try and erect one outside, and take heed of the advice so often given in your pages. I am hoping to be able to try types other than the simple inverted "L" at a later date, just to see if I can get even better results. Before closing, I would like to thank the Editor and his staff for carrying on so that we might still get our much-appreciated copy of PRACTICAL WIRELESS each month.—S. RICHARDS (Pinner).

A Neat Wireless Den

SIR,—Like H. C., of Workington, I have not a photograph of my den, but I enclose a sketch of a corner of it, showing the receiving equipment. The receiver on the left is a five-valve superhet, and I am very proud of the results obtained with it. I have listened to WRUL, WGEA, and WPIT on most nights of the week. Good results are obtained on the other two wavelengths as well. The receiver on the extreme right is my pet four-valve short-wave receiver, with which I have logged VLR3, CR7BE, XGOY, VLQ7 (Sydney) (on 25.26 metres), Panama (HP5J), and most of the Ws. The rest of my equipment is made up of a wavemeter on the left of my short-wave set, and an Amplion speaker, through which quite a number of DX short-wave stations are heard. In the cupboards I keep my log books and weather books, noting carefully the position of the moon and other features. I still use the 75ft. inverted "L" type aerial.—RONALD ROSE (Birmingham).

Correspondents Wanted

J. R. JARDINE, 2, Spring Gardens, Glasgow, N.W., who is a beginner in radio, wishes to get in touch with someone in the Glasgow district who is interested in the same subject.

Ronald Rose, 212, Spies Lane, Quinton, Birmingham, would be pleased to correspond with anyone interested in short-wave work.

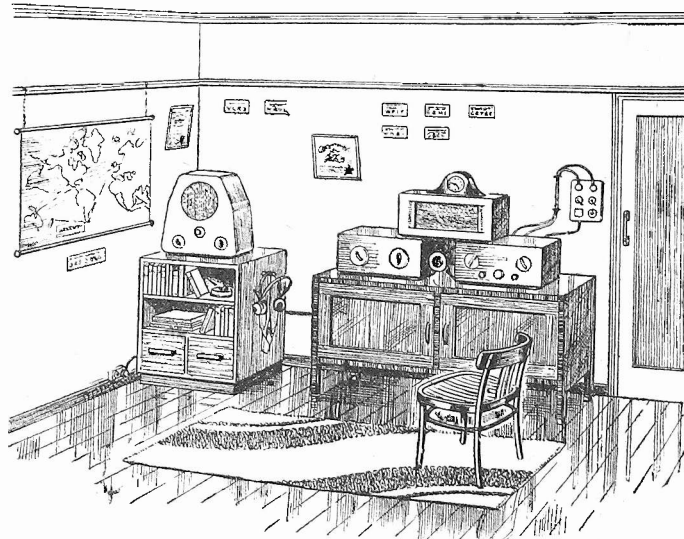

A corner of Ronald Rose's radio room, showing the well-arranged receiving equipment.

B.L.D.L.C. The British Long-Distance Listeners' Club

Get Busy

It is not possible to generalise, owing to the widely varying conditions in different parts of the country and in our occupations and hours of freedom, but all members should make every effort to act on the Hon. Sec.'s wise advice. Don't dilly dally, get right down to the work, and when you feel so disposed, write to us and let the details of your experiments and work be passed on to all other members. There are plenty of things to tackle, as an article on another page points out, so get busy and let it be recorded in these columns that B.L.D.L.C. members were the first to act on the suggestions put forward by the writers of the article, namely, my colleagues on the Technical Staff.

Station Lay-out

OUR very active member, No. 6,773, of Rotherham, certainly knows how to pull in the DX transmissions, make a decent station lay-out, and keep logs which are logs in the true sense. We reproduce below a plan sketch of his station, and we hope that it will prove of some guidance to others. He tells us that his aerial systems include a 40ft. high inverted "L," running due N.-S., another 50ft. high E.-W., and a directional beam (self-constructed) 40ft. high. Many thanks, 6,773, for the great interest shown. Can't you rope in a few more members in your area, and form a local section? Let's hear from you again.

Contact Required

A NEW young member (14½ years), living at 17, Runnymede Rd., Hall Green, Birmingham, wishes to contact someone about his own age.

0-V-0s

SOME very interesting remarks, concerning super 0-1-0 rigs, come from Wisbech, Cambs., in a letter from Member 6,320. After the usual greetings he opens up with: "I have been following with great interest the correspondence from other members re super one-valvers, and I should like to congratulate Member 6,032 on the fine results he has achieved with his 0-1-0. My own experiences with this type of

receiver date from early 1936, when I constructed one, and I must admit I was amazed at the DX capabilities of the 'toy' as I had thought. I had this receiver in use in its original form for about two years, and my log included all the more usual DX, some of the best cards I received being from K7FBE, K6NZQ, OQE, many VK'S, VR6AY, VS2AK, VS7RA, and 41 W states, all on telephony. All amateur bands from 10 to 160 metres were covered by means of plug-in coils of the four-pin

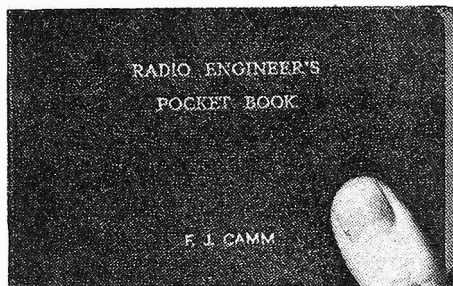

This illustration indicates the handy size of "The Radio Engineer's Vest Pocket Book," which costs 3/6, or 3/9 by post. It contains 160 pages of facts, figures and formulæ, and easily slips into the waistcoat or uniform pocket. Send postal orders to The Publisher, Book Department, George Newnes, Ltd., Tower House, Southampton Street, Strand, W.C.2.

type. The circuit lay-out was quite orthodox, being almost identical with that of Mr. Yeates, except that I had to use capacity coupling for the aerial because of the four-pin coils as compared with the six-pin used by him. The components were of good quality; ceramic insulated tuning condenser (.00025 mfd.) with Eddy-stone valve and coil-holders, and their

slow-motion reaction condenser. I used a 3 megohm leak, .0001 mfd. grid-condenser, 4,000 ohm phones (Ericsson), B.T.S. 100:1 airplane S.M. dial and their coils. Great care was taken to prevent losses in the tuned circuit; wiring was cut down to absolute minimum, and H.F. wires mounted well clear of the metal baseboard. I do agree with Mr. Yeates when he stresses the importance of 'how you listen.' I believe that almost any one-valver, which has been reasonably well put together, using good components, a suitable valve, and, also very important, efficient headphones, is capable of giving highly satisfactory DX results, provided that the operator is also up to his job. Reaction must be applied to a nicety, tuning must be carried out slowly and delicately, and one must be prepared to hang on like grim death to a certain frequency in order to extract a call-sign from some of the more elusive signals. In case I am making this sound more like work than pleasure, I can only say that I have found the keenest enjoyment in tracking down the faintest whispers from the other side of the world, and the thrill of achievement when a particularly difficult signal has been finally identified is something that has to be experienced to be appreciated.

"Finally, my own receiver has always given best results with a Mazda L.2 valve. I have found this to oscillate freely even on the higher frequencies around 30-40 mc/s."

New QRA

MEMBER 6,187, of Huyton, raises a point about which we hope to have more definite news later. He also tells us that he has changed his address; therefore, for the benefit of those who wish to make contact with him, we give his new QRA. It is "Laurel Bank," Tarbock Road, Huyton, Nr. Liverpool. He goes on to say: "My receiver is a home-made 0-V-2, and it is giving very satisfactory results; I have just received a card from VLQ2, and I shall soon be sending for an A.C.R. award. I should like to know if it is still possible to send reports to stations in the British Empire? I know it is impossible to send reports to foreign stations. I would like to establish contacts with a DX enthusiast about 15 years of age, anywhere in this district. Are A.C.R. awards still being issued?"

Yes, 6,187, the awards are still obtainable. We will let you know about the other matter as soon as possible.

A new member, No. 6,785, tells us "... experiments lately have included adding automatic grid bias to my 0-V-1 Rx, and making improvements in some home-made short-wave coils I have been testing. I have also made and tested a 'hotted-up' one-valver, and I am pleased to be able to report that results are most satisfactory. . . . My aerial is an 'inverted L,' 20ft. high and 50ft. in length, running N.-S. My super short-wave Rx is a circuit taken from one of the issues of PRACTICAL WIRELESS, and uses home-made coils and resistance-capacity coupling between detector and output pentode. I have received four of the five continents and I am still trying for Africa. I would like to express my keenest appreciation of the Editor continuing with the publication of PRACTICAL WIRELESS."

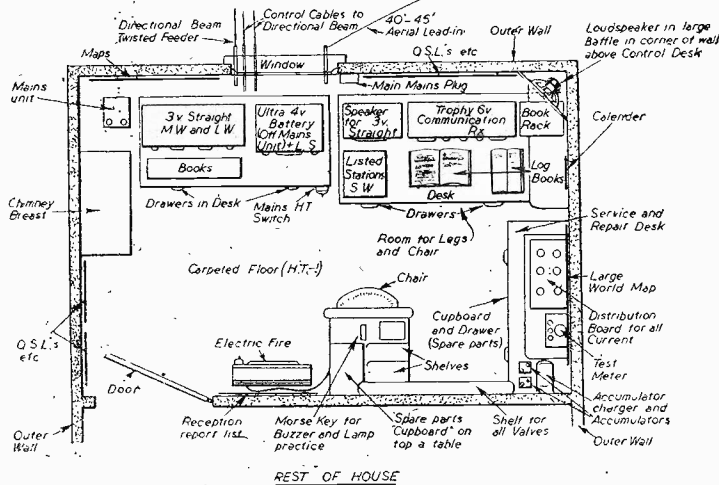

A rather unusual view of a den but, nevertheless, it shows that member 6,773 made good use of his extensive equipment.

LATHE-WORK for AMATEURS
 1/-, by post 1/2, from
 GEORGE NEWNES, LTD., Tower House,
 Southampton Street, - Strand, London, W.C.2.

Comment, Chat and Criticism

Outline of Musical History—16

Landmarks in the Development of Modern Music

By our Music Critic, MAURICE REEVE

BACH, Beethoven and Wagner, they are the three great landmarks in the history and development of modern music. It is around those three illustrious names that all others pivot. It is they who gave the cue as to what should be done; their laws and decrees have been almost immutable and, for better or worse, music to-day is as they fashioned it—that is, so far as the classic forms are concerned. Other great spirits there have been, of course, and the individuality of such masters as Mozart, Schubert, Liszt, Debussy and many others, are indisputable and unassailable. But the point I wish to drive home is this: that, with few exceptions, these incomparable masters didn't make music; they made their own dishes based on the recipes of the three great chefs named above.

Wagnerian Epoch

The death of Wagner, and of Brahms a few years later, marked the end of a truly memorable epoch. We can, perhaps, best realise the astounding progress and the amazing achievement, I think, when we realise that less than fifty years elapsed between the writing of the "Unfinished Symphony" and of "Tristan and Isolde." What an age that half century seems to cover! It seems, in fact, to cover more than a good half of all the music we know, and it certainly does when we include in it, as we are entitled to, all the later masterpieces of Beethoven himself.

Russian School

The Wagnerian epoch ended in the heyday of the great Russian school, composed of Tchaikowsky, Rimsky-Korsakov, Balakirew, Moussorgsky, Glinka, Borodin and several other lesser lights. They were, one might say, a transference eastward of the great romantic movement founded by Schumann, Liszt, Berlioz and the others. Marvellous were some of the things they accomplished, and works like Tchaikowsky's symphonies, Rimsky's "Scheherazade" and "Coq d'or," Moussorgsky's "Boris Godounov" and Glinka's "Une Vie pour le Czar," with many others, are among the most notable achievements of the century.

The music of these masters is like Wagner's, though born of entirely different motives, of a colour the vividness of which is frequently blinding, and of a passion the intensity of which is often overwhelming. It is music that goes right to the head, intoxicating and emotionally stimulating by turns. The craft displayed in its writing is astounding, and many new orchestral effects of the most bizarre character were founded.

Its most notable contribution was the founding of the great school of Russian opera, which has worthily taken its place beside those of Germany, France and Italy.

Side by side with this movement, Verdi was writing his operas in Italy—"Rigoletto," "Aida," "Otello," "Falstaff" and the rest. He was to be followed by his disciples Leoncavallo, Puccini, Mascagni, etc. In England there was no outstanding

musician to leave masterpieces to posterity or who could beat out new paths and new formulæ for music to flow down to future glories. But there was an excellent school of scholarly minds, and such men as Parry, Stainer, Sullivan, Cowan, Mackenzie, Bennett, and others, whose chief activities were in the field of church music. Sullivan, of course, was the founder of the English light opera school.

Edward Elgar

But, whilst these men were keeping the torch of music alight in England, a giant was girding on his armour and was starting on the creation of a series of master works which, apart from being incomparably the finest works in English music, stand worthily by the side of the myriads from the Continent. Edward Elgar, whose chief work is the fruit of the present century, wrote music in strict conformity with classical tradition, but his individuality and typically English outlook, coupled with a nobility and a sincerity, give his work a stature that few would care to deny or dispute. He was very like Brahms before him in that he followed hard in the footsteps of his great predecessors without striking many new paths for himself. But he was alone inasmuch as he had no native school of masters to follow, which fact is probably chief in accounting for his own peculiarly charming outlook on English life and character, which gives such an "Elgarian" originality to so many of his works.

The chief glories of Elgar's contribution to music are two glorious symphonies, the famous oratorio, "The Dream of Gerontius," symphonic poems like "Falstaff," "Froissart," "Cockaigne," "Polonia," etc.; a magnificent concerto for 'cello and orchestra, a quartet for strings, and a piano quintet. But I have left to the last my own personal favourite out of all the master's works, the incomparable set of variations on an original theme, styled "Enigma." Each variation is supposed to be a portrait, in tones, of one of his friends and each has the lucky person's initials at its head or some *nom de plume* such as Nimrod or Dorabella. The enigma is "Who are they?" The beauty of this composition and its marvellous scoring render it a landmark in English music. It was first performed at a Hallé Concert in Manchester under the great Elgar enthusiast, Arthur Nikitsch.

Debussy

The close of the century saw the rise of an eminent school in France with one outstanding genius, Claude Debussy, who was to achieve his principal work after 1900. Debussy was the Claude, or the Fragonard, of music, and the logical culmination of a line of tone impressionists dating back to Couperin and Rameau. The chief characteristic of his work was the use, in quantities and for effects hitherto undreamed of, of the whole tone scale. This scale, which eliminates the hitherto indispensable element of key, gives an element to a work of steely icy coldness and of a remoteness from the scenes and incidents around us which cause many to consider the music

of Debussy and his disciples strange, weird, and incomprehensible, etc., in much the same way that writing might appear when punctuation marks are eliminated. This is true up to a point, but when handled by a master hand like Debussy or Ravel, its effects can be entrancing and exciting in the extreme.

Debussy's "Après Midi d'une Faune," "Images," etc., and his many volumes of piano pieces, songs and chamber music, form a contribution to music which is treasured by all classes and schools of musicians. Looked at askance when he first made his appearance, Debussy is now recognised as one of the great musicians, and one of the most original and constructive thinkers in musical history. He died in 1915.

The modern Spanish school is a remarkable offshoot from the parent stem. Glittering, bizarre and intensely nationalistic, it has contributed a notable list of writers and works to the musical catalogues, particularly in the realm of ballet and piano solos. De Falla, Granados, Albeniz, Turina, Nin, are among the leaders.

Dvorak and Sibelius

We can only pass very rapidly over the scene, but in our brief glance the names of Grieg, Dvorak, Smetana, Sibelius, Scriabin, Fauré, Ravel and de Falla cannot fail of recognition. Dvorak and Sibelius are both in the direct line of succession of the great symphonists. And in our own day men like Prokofiev, Bartok, Berg, etc., are struggling to make music say something "new" and finding the effort very difficult. Berg's use of a quarter-tone scale is a development of which the less said here the better. The only remark I would care to make would be to offer up a prayer of thanks that the piano, and pianists, are spared the necessity of having to deal in them, at least until such a time as they are cursed with the invention of a piano with a keyboard that either goes right round the room or else stretches far down the corridor.

Bax

In England the rise of Elgar marked the evolution of a school of contemporaries which more than favourably compared with any on the Continent, but which was also as illustrious a band as any in our annals. Bax is a master of tone colour, and his palette has a variety of musical paints which are not only brilliant and daringly original, but which will unquestionably live and influence the future. Vaughan Williams, though sometimes extremely modern in his treatment of material, frequently turns to our collections of folk tunes for his inspiration. His "London" Symphony is a beautiful and moving picture of our now sadly harassed capital. There are also Holst, Ireland, Quilter, Walter, and many others.

What has music in store for us; what is its message? Has it said its say, or are there still more wonders to come, comparable to the St. Matthew Passion, the Seventh Symphony, and "Tristan and Isolde"? I shall hope to consider these questions in a future article.

Impressions on the Wax

A REVIEW OF THE LATEST GRAMOPHONE RECORDS

TUCKED away in the new Decca lists is a most unusual record. Unusual in that it contains a duet by two outstanding stars of light music. They are Mantovani and Sidney Torch. The recording took place at the State Cinema, Kilburn, where Torch is the resident organist. The record—Decca F 7563—contains the lovely "Intermezzo" from the film "Escape to Happiness," while on the other side is Eric Coates' "By the Sleepy Lagoon."

The two stars are also to be heard separately this month. Torch has a new swing medley—he calls it "Piping Hot"—on Decca F 7576; and Mantovani leads his famous orchestra through two tangos, "Jealousy" and "La Cumparsita" on Decca F 7571.

Songs of Hawaii

THIS month the Decca Company devote a whole album to genuine "Songs of Hawaii" played by a real native orchestra—Ray Kinney and His Hawaiians. The traditional native songs of the islands were inspired, strangely enough, by hymn tunes introduced by missionaries years ago. Not that we can hear a very close connection between any well-known hymn and the songs in this album. This new album contains ten ballads, love songs and hulas written by such popular musicians as Charles King, James Kapale, Matilda Kauwe, Johnny Almeida and Johnny Noble (The Jazz King of Hawaii). Ray Kinney, whose orchestra and singers are all natives of the islands, is himself a delightful singer and he is ably abetted by the high falsetto singing of George Kainafu and other vocal work by Henry Paul and Trio. This album is strongly recommended to all who want the real thing—but a word of warning, the titles in the original language are the most unpronounceable thing we know. (Decca Album No. 23: F 7373-7377).

Musicians in the R.A.F.

DANCERS and variety-goers who miss the old faces on the stand and on the stage will be glad to know that musicians who have joined the Services are still making records. Under the name of the R.A.F. Squadronaires a number of musical stars from such famous bands as those directed by Ambrose, Billy Cotton and Jack Payne have banded themselves together as a new dance band. This month, Decca releases their record of "By the Waters of Minnetonka" and "The Song is Ended"—Decca F 7572.

Two more records are added this month to Decca's documentary series covering the present World War. The first of the two, Decca K 934, tells in a dramatic way the story of the Finnish Campaign, 1939-40. The second—K 935—recounts the betrayal of Norway and Denmark. In the records the actual voices of Mr. Churchill, Mr. Attlee, a British sniper, a British soldier and a British officer are heard. This series of actuality recordings becomes more fascinating as each one is produced.

Victor Herbert Melodies

AMERICA is very fond of regarding Victor Herbert as the U.S.A. counterpart of our own Sir Arthur Sullivan, but the truth is that, like Sullivan, Herbert was an Irishman who became naturalised later. Born in Dublin, Herbert studied at Stuttgart and it was not until he was nearly

thirty that he went to America to take up the post of first 'cellist to the Metropolitan Orchestra of New York. Later he achieved a reputation as a solo 'cellist and wrote many serious works, including a concerto for his own instrument. Between times he amused himself by writing the lighter works on which his fame rests. Decca have engaged Harry Horlick and his Orchestra to record ten of the best-known Victor Herbert melodies to form their Album No. 22—Decca F 7247-7251.

Variety

NO subject is quite so fascinating as the study of current song titles. This month has produced a very good crop

that ranges from "Get Your Boots Laced Papa," which, played by Woody Herman and his orchestra, takes up two sides of Brunswick 03033, to "Little Curly Hair on a High Chair," by Jimmy Dorsey's Orchestra on Brunswick 03027. Between these two there is the odd title, "Honky Tonk Train Blues," by Milt Herth, on Brunswick 03025.

The Casa Loma Orchestra make four sides from the new Bing Crosby film "If I Had My Way." Best seller of the four should be "Pessimistic Character," on Brunswick 03030. Ambrose has a hit in "Carry On," on Decca F 7580, and Robert Ashley sings on the Jack Payne record of "I'll Be Waiting For You," on Decca F 7561.

Bing Crosby leads the new vocal records with the hits from his new film, "April Played the Fiddle" and "I Haven't Time to be a Millionaire," on Brunswick 03031,

(Continued on page 163)



Reg. U.S. Pat. Off.

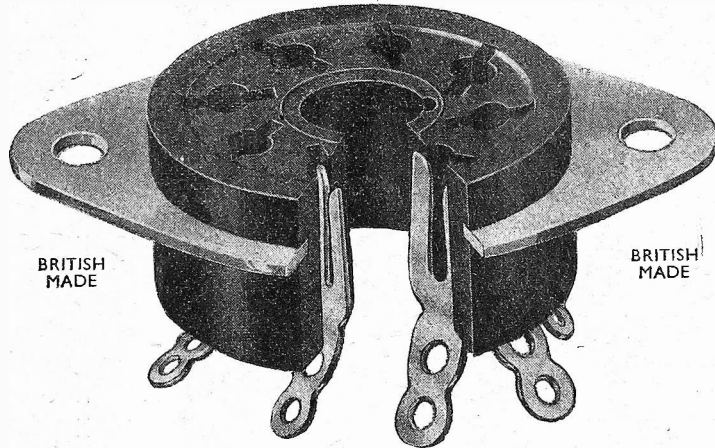

◆ CONSIDER THE FOLLOWING FACTS!

STRENGTH! EFFICIENCY!

- ◆ Exclusive Celestion-Amphenol Moulded-in Plates ensure maximum strength, rigidity and a high degree of efficiency.
- ◆ The sturdy plates keyed into the body cannot rattle loose.

UNIFORM CONTACT! INSULATION!

- ◆ Celestion-Amphenol Contacts pressed from specially treated phosphor bronze are engineered to ensure uniform contact on all prongs.
- ◆ There will be no "fatigue" even after constant use.
- ◆ Exceptional insulation is assured by the special properties of the moulding powder.

CELESTION-AMPHENOL VALVEHOLDERS

are specified for The A.C. Two-valve Amplifier described in this issue.
ALL STANDARD BRITISH AND AMERICAN TYPES IN STOCK.

CELESTION LIMITED

ENGINEERS,

KINGSTON-UPON-THAMES, SURREY

Telephone: KINGston 5656-7-8.

IMPRESSIONS ON THE WAX

(Continued from page 161)

and "Meet the Sun Half-Way" and "The Pessimistic Character," on Brunswick 03032. Bebe Daniels and Ben Lyon have also made a really fine record of "I Can't Love You Any More," on Decca F 7574.

Columbia

A NUMBER of band records feature in the Columbia list for this month. The Columbia Broadcasting Symphony Orchestra have recorded "Orpheus—Symphonic Tone Poem" (Parts 1-4) on Columbia DX 978-9, and Eric Coates and Symphony Orchestra play two of Coates's own compositions: "Calling all Workers" and "Sleepy Lagoon" on Columbia DB 1945. The London Theatre Orchestra revive an old favourite in "The Chocolate Soldier," selection parts 1-2 on Columbia DX 980, whilst H.M. Grenadier Guards Band play "Preciosa" Overture by Weber on Columbia DB 1946.

On the vocal side we have Nelson Eddy singing "The Magic of Your Love" and "Ride, Cossack, Ride" on Columbia DB 1911; Walter Midgley has recorded "My Song," which he couples with "So Deep is the Night" on Columbia DB 1934; and Turner Layton makes yet another record success with "We'll Go Smiling Along" and "Love Stay in My Heart" on Columbia FB 2486.

If you want to enjoy a good laugh then you should hear Stanley Holloway telling you all about "The Lion and Albert" and "Albert Comes Back" on Columbia FB 2482. Jack (Blue Pencil) Warner is also in cheerful vein with "Claude and His Sword" and "Alouette," a traditional Canadian song on Columbia FB 2484.

His Master's Voice

AN interesting set of records which have recently been released by the H.M.V. Company contain recorded speeches broadcast by the Prime Minister, the Right Hon. Winston Churchill, M.P., on the progress of the war. They cover a period from May to September, 1940. The four speeches occupy seven records, H.M.V. C3198-3204, and the proceeds from these records are being paid to charities nominated by the Prime Minister.

Among the famous vocalists who appear in this month's list are Webster Booth, singing "The Star of Bethlehem" and "The Holy City" on H.M.V. C3196; John McCormack, the Irish tenor, who also sings two religious songs—"Still Night, Holy Night" and "Legend—Christ in His Garden" on H.M.V. DA1755, and finally the well-known Australian baritone, Peter Dawson, revives two old Irish melodies—"The Mountains o' Mourne" and "Phil the Fluter's Ball" on H.M.V. B9114.

"Max Miller with the Forces," which are recordings of an actual performance, give us eighteen minutes of "The Cheeky Chappie" on three records—H.M.V. BDS83-5, which are sold complete in a portfolio for 6s. 6d.

Three records containing recordings of favourite scenes, songs and music from "Peter Pan" are also supplied in a delightfully decorated portfolio for 10s. 6d. The artists taking part are Jean Forbes-Robertson as Peter Pan, Dinah Sheridan as Wendy, and Gordon Harker as Captain Hook. Profits from these records—H.M.V. B9117-9—are being paid to the Hospital for Sick Children.

WINTER IS CREATING A BOOM IN EXTENSION SPEAKER LISTENING . . .

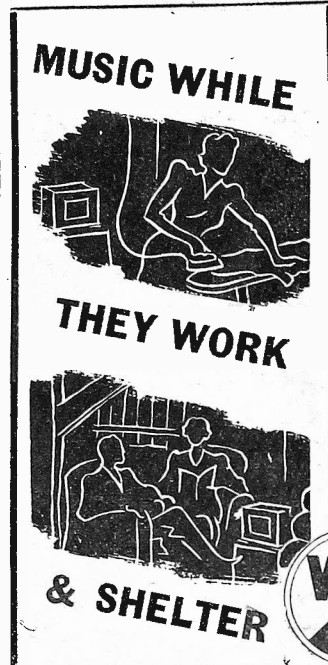
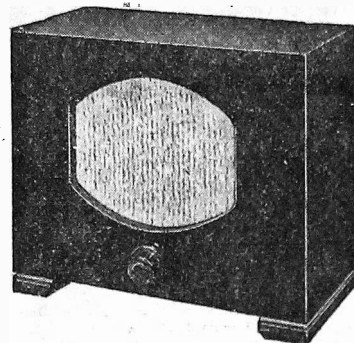

Thousands discovering the joy of a Stentorian . . .

This winter is introducing a rapidly increasing number of listeners to a new radio pleasure: "music where they want it"! Free from the restrictions of one-room radio, they are enjoying their favourite programmes in the Shelter, whilst working in the kitchen, or wherever it is convenient to listen; and all by the simple connection of a Stentorian Extension speaker to their existing radio. What's more, these handsome but moderately priced speakers offer an appreciable improvement in reproduction over most built-in speakers. Why not make full use of your radio this winter by installing a Stentorian? Cabinet models from 21s. 6d.

Illustrated literature on request.

Stentorian

THE PERFECT EXTRA SPEAKER FOR ANY SET

WHITELEY ELECTRICAL RADIO CO., LTD., MANSFIELD, NOTTS

PUBLIC APPOINTMENTS

MINISTRY OF AIRCRAFT PRODUCTION.
AERONAUTICAL INSPECTION DIRECTORATE.
VACANCIES EXIST FOR UNESTABLISHED APPOINTMENTS AS EXAMINERS IN THE GENERAL ENGINEERING, RADIO-ELECTRICAL AND INSTRUMENT BRANCHES.

QUALIFICATIONS
All candidates must have good general education, be able to read drawings, understand specifications, use micrometers and other measuring instruments.
(a) Applicants for the General Engineering Branch must have had practical experience in an engineering works. An elementary knowledge of materials testing is desirable.
(b) Applicants for the Instrument Branch must have knowledge of physics and training in light engineering or instrument making. Candidates with knowledge of optical instruments are also required.
(c) Applicants for the Radio-Electrical Branch should have good knowledge and experience of Radio or Electrical Engineering.
Normal age limits at entry 23 to 60.

PAY AND CONDITIONS.
Accepted candidates will be given a period of special training in inspection not exceeding three calendar months. The training courses comprise lectures and demonstrations by specialist instructors followed by practical works instruction.
During training candidates will be paid £3/10/0 weekly, plus Civil Service War Bonus (present rate of bonus 5s. weekly) and in addition subsistence allowance of £1/5/0 weekly is payable to married men whose normal residence is not in the training area.
On successful completion of training candidates will be appointed as Examiners at a fixed salary of £270 per annum, with a reduction of £12 per annum for each year of age under 24 on joining (payable monthly in arrears).
In addition payment for overtime is made when 40½ hours (net) or more have been worked in any one week, payment being made for all hours worked in excess of 40½ hours net.
Examiners are eligible for promotion to higher grades.
Candidates must be prepared to serve in any part of the United Kingdom.

APPLICATIONS.
Applications must be made on Form 786, copies of which can be obtained on application, by postcard only, to: Ministry of Labour and National Service, Box No. 171, Head Post Office, Small Street, Bristol. Candidates should indicate on their application forms the vacancy (a) (b) or (c) for which they wish to be considered.



FOR THE RADIO SERVICE MAN, DEALER AND OWNER

The man who enrolls for an I. C. S. Radio Course learns radio thoroughly, completely, practically. When he earns his diploma, he will KNOW radio. We are not content merely to teach the principles of radio, we want to show our students how to apply that training in practical, every-day, radio service work. We train them to be successful!

INTERNATIONAL CORRESPONDENCE SCHOOLS

Dept. 94A, International Buildings, Kingsway, London, W.C.2.

Please explain fully about your instruction in the subject marked X.

Complete Radio Engineering
Radio Service Engineers
Elementary Radio
Television

If you wish to pass a Radio examination, indicate it below.

Inst. of Wireless Technology
P.M.G. Certificate for Wireless Operators
Provisional Certificate in Radio Telephony and Telegraphy for Aircraft
City and Guilds Telecommunications

Name Age

Address

(Use penny stamp on unsealed envelope.)

New Circuits for Permeability Tuning

Variation of Core Permeability with Signal Current, and Some Applications

IN conventional tuned circuits of the type having inductances with ferro-magnetic or magnetic cores the change in permeability of the cores in operation is relatively small, and usually is not measurable because of the low flux density and relatively large volume of the cores ordinarily provided. It has been found, however, that with magnetite core tuning inductances, the permeability may be varied appreciably as the flux density in the core is increased to a relatively high value.

The flux density may be increased by the presence of strong signals, as in an I.F. amplifier, which increase the signal current flow through the inductance, or the core volume may be decreased to a relatively small percentage of a normal core volume. As a result of a relatively high flux density, it is possible to shift or vary the resonant frequency of a tuned circuit embodying such an inductance, over a relatively wide frequency range with a relatively narrow range of variation in the strength of the applied signal or signal voltage, because of the change in permeability, and that, for maximum change of flux density with relatively small voltage change, a low L.C. ratio in the tuning inductance is necessary.

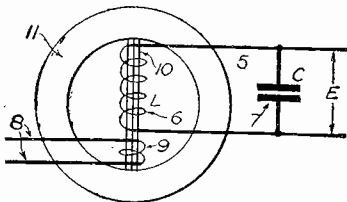

Fig. 1.—A tuned circuit incorporating a magnetite-core inductance.

By using this property it is possible to design a signal circuit of the magnetite core inductance tuned type which is responsive to variations in signal strength to cause a corresponding variation in permeability, and frequency response, so that the circuit is capable of being used in compensating circuits for high-frequency amplifiers, for example, as employed in the R.F. and I.F. circuits of a superheterodyne receiver, and also in connection with A.V.C. and A.F.C. circuits for radio receivers.

Tuned Radio Signal Circuit

In Fig. 1, a tuned radio signal circuit 5 is provided with a tuning inductance 6 and a shunt tuning capacitor 7 for said inductance. A signal input circuit 8 is coupled through a winding 9 with the inductance 6. This represents any suitable signal conveying circuit adapted to be tuned to resonance at a predetermined frequency. The inductance 6 is of the ferro-magnetic core type having a core 10 of magnetite of such volume or cross-section that the flux density therein is relatively high.

The magnetic circuit of the core 10 is preferably closed through a suitable path, provided by magnetic core material providing a relatively large volume or cross-sectional area. In the present example, the ends of the core 10 engage the inner

surfaces of a ring 11 of magnetic material having a large cross-sectional area with respect to that of the core 10.

By this arrangement, the core volume or cross-section under the winding is decreased. The signal intensity applied to the input circuit 8 and the voltage E in the tuned circuit 5 may be relatively high as in an intermediate-frequency amplifier, with the result that the flux density in the core 10 is increased to such a point that the permeability of the core is affected and, as previously pointed out, the effect is to increase the permeability with increase in the flux density so that it is possible to shift the resonant frequency of the tuned circuit 5 over an appreciable frequency range by variation in the signal intensity or voltage E across the tuned circuit.

Frequency Response Curve

As shown in Fig. 2 by the curve 12, it has been found to be possible to shift the resonant frequency of the tuned circuit 5 from 460 kc/s, for example, to 430 kc/s, with an R.F. voltage change of from zero to substantially 10 volts. This is with a low L.C. ratio in the tuned circuit 5. With a higher L.C. ratio, the response curve may be as indicated at 13 in Fig. 2, requiring a wider variation of voltage E across the tuned circuit to obtain the same shift of the resonance point.

The value of the capacitor 7 or the value of C in the circuit 5 was 400 mmfd for obtaining the curve 12, a capacity of 4,000 mmfd was employed across the tuning inductance. The lower L.C. ratio provides a higher current through and a lower voltage across the tuning inductance. With a higher value of tuning capacity, it is obvious that for the same frequency or frequency range the value of the inductance 6 and the number of turns on the winding must be lower. However, it has been found that with a lower number of turns, the flux through the core is increased appreciably because of the fact that the flux varies as the square of the current, and only as the first power of the inductance.

The ratio of the reactance of the induct-

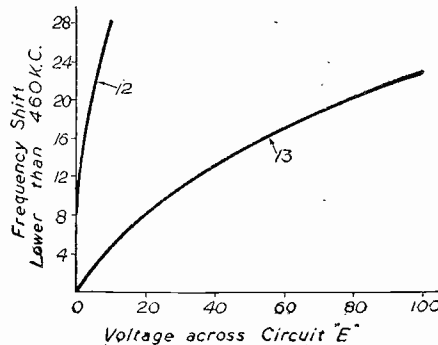

Fig. 2.—Frequency-response curve.

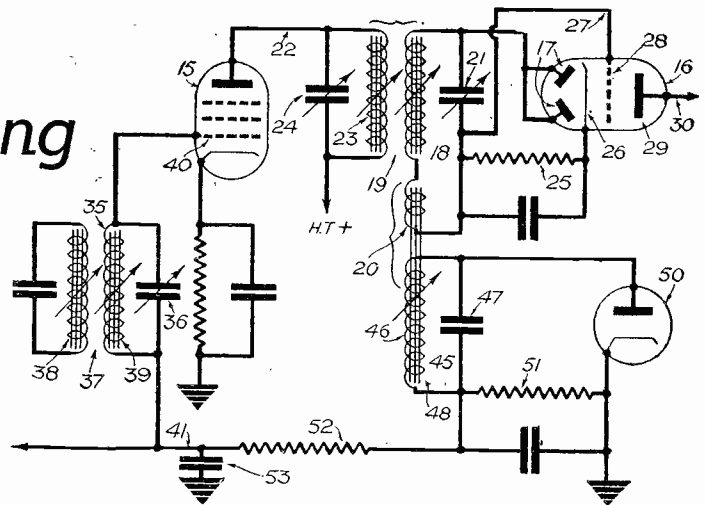

Fig. 3.—An intermediate-frequency amplifier circuit using permeability tuning.

ance 6 to its high-frequency resistance, or the Q of the coil, is reduced with increase in the strength of the signal applied through the circuit 8 to the circuit 5, because of the increase in the permeability, and this results in a decrease in the gain of any amplifier stage in which the circuit is connected, which is a desirable feature since it reduces the gain for strong signals, and permits increased gain automatically for weak signals.

As will be seen from the curves of Fig. 2, the voltage E required to change the resonant point or tuning of the circuit 5 through a relatively wide frequency range may be varied over a relatively wide range or a relatively narrow range, depending upon the L.C. ratio of the tuning elements in the circuit. This permits considerable latitude in the design of the circuit.

In any case, however, the range of frequency variation and the variation of the Q of the coil is relatively high only when the flux density is increased to a relatively high value, and this is accomplished not only by providing an inductance winding having a magnetite core of relatively low volume or cross-section whereby the flux density is high per unit volume of the core, but is also made possible at a lower input voltage E, by providing the tuned circuit with a low L.C. ratio.

In any tuned circuit, it is unnecessary to depart from the desirable features of magnetite core tuning to obtain a shifting of the resonant point or a frequency variation in the tuned circuit, since to obtain this characteristic, it is merely necessary to decrease the length and diameter of the coil and core assembly in such a manner that the flux density per unit of volume of the core is increased, and for a maximum change in frequency with low voltage change, a low L.C. ratio is used in the tuned circuit.

I.F. Amplifier Circuit

Referring now to Fig. 3, an intermediate-frequency amplifier circuit is shown in which a valve 15 is provided as the last intermediate-frequency amplifier stage preceding a second detector valve 16 in the signal channel of the receiver. The detector is of the diode rectifier type comprising a pair of diode electrodes 17, connected to the secondary 18 of I.F. coupling transformer 19, which is connected in series with a coupling coil 20, and is tuned by a shunt adjustable capacitor 21.

The output circuit 22 of the I.F. amplifier valve 15 is connected with the tuned

(Continued on next page.)

NEW CIRCUITS FOR PERMEABILITY TUNING

(Continued from previous page.)

primary winding 23 also provided with a shunt tuning capacitor 24, so that the two tuned circuits may respond to the same frequency, such as 460 kc/s, for example.

The secondary circuit 18-20-21 is connected at its low potential end through a diode output resistor 25 to the cathode 26. Audio-frequency signal output is derived from the resistor 25 through an output lead 27, connected in the present example to an amplifier grid 28 in the same envelope with the diode detector. Audio-frequency signals for further amplification and utilisation are derived from the output anode 29 associated with the grid 28, through the output circuit 30.

Tuned Input Circuit

The I.F. amplifier valve 15 is provided with a tuned input circuit comprising a tuning inductance 35, and a shunt tuning capacitor 36, thus forming the tuned secondary circuit of an I.F. transformer 37, the tuned primary of which is indicated at 38. The secondary 35 is tuned by the shunt capacitor 36 and also by a core 39 of magnetic material, such as magnetite, and being of such cross-sectional area or volume that, in response to normal signals supplied through the channel, the voltage across the circuit 35-36 causes the flux density in the core to be relatively high, thereby to decrease the permeability and the frequency of resonance of the input circuit by an amount at least sufficient to overcome the effect on the circuit of the input or control grid 40 of the amplifier which is connected thereto, and through the inductance 35 with a source of A.V.C. potential provided by the lead 41. As is well known, the increase in negative bias provided in response to increased signal strength in an A.V.C. system causes the capacity of the tuned circuit to be decreased, and the frequency response to be shifted towards a higher resonant frequency. This tendency is overcome by the present arrangement.

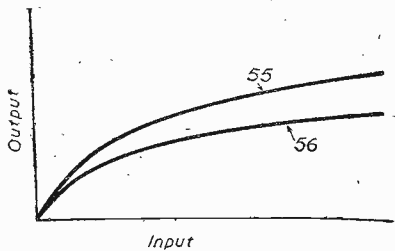

Fig. 4.—The improvement in A.V.C. characteristics is shown by these two curves.

To take advantage of the variable permeability in response to variations in signal strength to vary the tuning of a resonant circuit having inductance ferro-magnetic core tuning means, a tuned circuit 45, comprising a tuning inductance 46 and a shunt capacitor 47, is associated with the coupling winding 20 in such a manner that, as indicated in the drawing, the latter winding is coupled to the tuning inductance electro-magnetically for the transfer of energy to the circuit 45. The windings 20 and 46 are associated or coupled in much the same manner as indicated in Fig. 1 at 9 and 6, respectively, on a magnetite core 48 of low volume or cross-section to permit saturation or relatively high flux density at normal signal levels, thereby to change the permeability of the core, and the tuning of the circuit 45, the frequency being decreased with increased signal strength.

ELECTRADIX still leads in offers of real bargains: radio and electrical

DYNAMO BARGAIN. 100 volts 1 amp. D.C. shunt ballbearing "Croydon" 15lbs. 6in. x 6in. 12/6 post free.

A.C. MOTORS.—Start on full load 1.60 h.p. with pulley. Type 50. 1,500 revs. 12/6. 1.25 h.p. Type 36 G. 3,500 revs. 27/6. 1.4 h.p., 2,000 revs., 45/. Squirrel Cage 1/10 h.p. Motors, 2,500 revs., 35/-.
D.C. MOTORS.—1.40 h.p., 110 or 220 volts, series, Type K.B., 1,750 revs., 15/-. Type C, 1,35 h.p., 2,000 revs., 16/-. 1/12 h.p. Type C, 110 or 220 v. shunt, 1,700 revs., 30/-.
MOTOR GEN'S.—220 v. A.C. to 100 v. 1 amp. D.C. 60/-. Big stock all types.

LESIDX 2-AMP. SAFETY SWITCH
A Special Design in Auto-Switches with time-lag tripping on 2 to 3 amps. Safety thermo switch with quick-break auto overload trip, for back of panel with front indicating knob, compact, 4in. x 2in. x 1in. deep. Any voltage. Only 5/6.

OZONIZERS. For sweet air. For A.C. mains operation. One tube unit 10/6, or in white enamelled wall case with flex and plug, 12/6. Two-tube model 15/-. or supplied in walnut cabinet for 20/-.
TESTERS. Field A.C. or D.C. Vest Pocket Tester "Dix-Minanta" Bakelite case, 2in. by 3in. No projecting terminals. Universal versatile high grade moving-iron multi-range meter for service on A.C. or D.C. battery of mains. Three ranges of volts: 0-7.5 volts; 0-150 volts; 0-300 volts. Only 19/6.

3/9 MILLIAMMETERS.—New. Where the job calls for something simple without calibration for tuning or galvo for testing. Back of panel type, as illus., 8 m.a. full scale. Great Bargain at 3/9 post free.
MILLIAMMETERS.—Moving coil. 5, 10, 25, 50, 500 m.a., in various sizes, from 2 1/2 in. to 8in. dial. Switchboard Meters, 3 to 8in. dial, all ranges.
METER MOVEMENTS.—Full size, moving coil P.M. for home-made multi-range tester. Suits 3in. or 4in. dials. 5/- post 1/-.
CLEARANCE Speakers. moving coil, mains, cone damaged, 2/6. With speech transformer, 3/6. Postage on either 1/-.
F.L. and TRUVON P.A. Speaker Moving Coil Units for Large Horns. 6 volts, 12/6.

HIGH RESISTANCE AND RADIO PHONES. The finest always is the adjustable Browns A Reed Phone. Aluminium swivel headband, 4,000 ohms. 35/6. 1,500 ohms, 21/6. 120 ohms, 17/6. Cords, 1/9.
Various Makes. Second-hand Head-phones in good order. 2,000 ohms and 4,000 ohms. 8/6 and 7/6. with cords. Western Electric. 2,000 ohms, 4/6.

LEARNERS' MORSE PRACTICE SET. No. 3A Duplex with Key, Buzzer and Lamp for sound and visual, line plug on base, 7/-.
MORSE KEY. Key on moulded base; buzzer and lamp, 4/6.

MORSE KEYS. First class at low prices. A good small key on moulded base is the TX pivot arm, excellent for learners, 3/6. Full size, well finished key, all brass, solid pivot bar, adjustable tension, etc., 5/2. 7/6. Superior Type P.F. fully adjustable, nickel finish, 9/6. High Grade Type IV, plated fittings, polished wood base, a fine key, 10/6. Special Key on 3-switch box for buzzer and 2 lamps. C.A.V., 6/6.

BELLS. G.P.O. type trembler Circular Desk Bell, with movement in gong, 1/6. Wall Bells, trembler, 2/6. Ditto, large size, 7/6. Signal Bells, large metal, 12-volt single stroke Bells, 10/-.
ALARM BELLS. Small and large. Battery or mains D.C. or A.C., 10in. gong. Domestic Bells and Fire Bells, cheap. Please state wants. Single Bell Wire, 1/6 per 100 yds.

EDISON HIGH CAPACITY STEEL CELLS at half price for stand-by lighting, 120 a.h. to 300 a.h., 30/-. Makers' Price is 45. Ask for leaflet. **FULL PARTICULARS** gladly given as far as we are able to A.R.P. ENQUIRIES.

ACCUMULATORS. for stand-by H.T. at 6d. per volt. 3 amp. hours, in 24 volt unit crates, glass cells, 12/- each. Can be parallel charged off 12 volts.
230/230 VOLTS MAINS CONVERSION UNITS. For operating D.C. from A.C. mains, screened and filtered, 120 watts output, £2 10/-.
ROTARY CONVERTERS for radio, all sizes, large and small, single-phase and 3-phase. Special Crypto Constant Potential Charger, coupled to S.P. motor with D.C. output of 8 volts 50 amps, and 100 volts 1 amp. Fine set, worth £50, with switchboard, sale £30.

PETROL ELECTRIC SETS for Lighting and Charging 50 h.p. DIRECT COUPLED, 2-stroke water-cooled 1-cyl. Engine, magneto ignition. On headplate with dynamo, 1 h.p. 500 watts, 1 h.p. 50/70 volts, 10 amps. D.C. Dynamo magneto ignition, fuel and oil tank, £17/10/-.

A few unused 1 h.p. and 2 h.p. air-cooled engines on bed for direct drive, £7 and £10.

BARGAIN CINE PROJECTORS.—Powers No. 6, 35 mm. Dallmeyer lens and condenser motor drive, on stand with lantern and arc, £7, worth double. Sound head with head Amplifier and spool box for talkies, £8. **15-DAY TIME SWITCHES.**—Yenner 1 amp., 5 amps., 100 amps., 200 amps. From 17/6.
THERMOMETERS.—Panel 2 1/2 in. dial, 5ft. ether tube, for distant indicating reading 0 to 100 deg. Cent., 7/6. Cambridge, 10/6. **FOURNIER THERMOMETERS** by Cambridge Instrument Co. 4in. dial, 10-110 deg. Cent. Fitted adjustable electric contacts, 45/-.
FUSES.—Glass tube, 1 amp., 6d. With clips and base, 9d. A 2 m.a. **TABLE RELAY** for radio work. Compact vertical type, enclosed. Screened 3,000 ohm coils. Platinum contacts. Single pole change-over, 1 amp. contacts. Wood base. Metal case. Size 2 1/2 in. diam., 3 1/2 in. high. The G.P.O. glass top B. Relays are larger, twice the size and have massive platinum contacts, are 15/-. Some clipped, 10/-. A few without contacts, 5/-, 6d. postage.

5/- PARCEL of 10 lbs. of servicing components: resistances, tubulars, micas, variables, wire, sleeving, vol. controls, coils, magnets, chokes, switches, mouldings, terminals, etc., post free; 10 lbs., 5/-.
VARIABLE CONDENSERS.—0005 mfd. Tekade, 1/3; .00075 Polar Compax, 1/-; S/W. Formo, 2/-; J.B. Midget, .0001, 1/6; 2-gang variable, .0005, 2/6; 3-gang, 3/6.
SPECIAL CLEARANCE.—Parcels of experimental oddments, coils, magnets, wire, chokes, condensers, mikes, switches, terminals, etc. Post free, 10lb., 6/6. Very useful Bargain.

Over 1,000 other Bargains in our enlarged illustrated List "N." Stamped envelope, please.

ELECTRADIX RADIOS

218, UPPER THAMES STREET, LONDON, E.C.4
Telephone: Central 4611

As described above, the increase in permeability causes an increase in inductance of the windings 46, and tunes the circuit to a lower frequency, and to increase this effect, the magnetic circuit is preferably closed, as in the arrangement of Fig. 1, and, furthermore, the ratio of the inductance 46 to the capacity at 47, that is, the L.C. ratio, is made low. This provides a relatively high current and low inductance in the winding 46 for a given frequency.

With an intermediate-frequency circuit tuned to 460 kc/s, the circuit 45 may be tuned to 480 kc/s, for example, with weak signal input. As the applied signal strength is increased, the 480 kc/s circuit 45 will shift in resonant frequency to a lower frequency, approaching the intermediate frequency 460 kc/s as a limit, thus increasing the coupling to the secondary 18, and causing the output voltage from the tuned circuit 45 to increase at a higher rate than the signal.

A signal rectifier of the diode type indicated at 50 having a diode output resistor 51 may be connected across the tuned circuit 45 to provide controlling potentials for the A.V.C. circuit 41, the connection being made through a suitable filter comprising a series resistor 52, and a shunt filter capacitor 53. This causes a better

A.V.C. characteristic than is normally provided, as indicated in the curves of Fig. 4, in which the curve 55 is a response curve for a normal A.V.C. connection, whereas the curve 56 represents the A.V.C. control characteristic of the circuit of Fig. 3, clearly showing that the A.V.C. characteristic is much flatter in the present system.

This system was developed in the laboratories of The Radio Corporation of America.

WIRELESS TRANSMISSION FOR AMATEURS

Edited by F. J. CAMM

Explaining how to Learn the Morse Code: Applying for a Licence: Building and Operating a Transmitter. Illustrated by Many Practical Diagrams.

Price 3/6 or 4/- by post

From George Newnes, Ltd. (Book Dept.), Tower House, Southampton Street, Strand, W.C.2.

Replies to Queries

American Valve Details

"I am using a receiver which employs valves of the American types having 6.3 volt heaters. I have now been given a new valve marked 6N7, but as I am without any information concerning its characteristics, I am at a loss to know how to use it and whether I can embody it in my present set. Could you oblige by giving me the chief details?"—F. B. (Brighton).

WE cannot say whether you can use it in your receiver, as we are without any information of the circuit, therefore we hope that the details given below will enable you to determine this for yourself. According to the R.C.A. Manual, the 6N7 is a Class B twin triode. It is of the all-metal type and consists of two high mu triodes designed for Class B operation, contained in one casing. The triode units have separate external connections for all electrodes except the heaters and cathodes. Heater voltage is 6.3 volts at 8 amps. Maximum anode voltages 300 volts. Peak anode current, 125 mAs. Average anode dissipation, 10 watts. Typical operating conditions would be 250 volts per anode, Zero grid-voltage, anode to anode load of 8,000 ohms and a power output of approximately 8 watts. It is fitted with an octal base, the connections being 2 and 7 heaters; 8, cathode; 4, grid No. 2; 5, grid No. 1; 3, anode No. 2; and 6, anode No. 1. Pin No. 1 is blank.

Argon Charger

"I have been using this very efficient L.T. charger ever since you published its constructional details. Wishing to secure a spare rectifying valve, I found that the one specified is now no longer obtainable. Can you suggest an alternative which will not necessitate any modification of the wiring or assembly?"—T. P. (Chester).

AS the original valve is no longer being produced by the makers, it will be quite in order to use one made by Messrs. Philips, the type number being 1038. The price, before the Purchase Tax came into force, was 14s. 6d. The address of the firm is, Messrs. Philips Lamps, Ltd., Century House, Shaftesbury Avenue, London, W.C.2.

Meter Range

"I have become interested in making a multi-range test meter, but I notice that most of the designs use a meter having a scale range of 0-1 mA., and as I am unable to obtain one of these, I want to know if I can use a meter I have which has a maximum range of 0-1 amp. As resistances are used to increase the readings of the 0-1 mA. meter, cannot they be used in some other way to reduce the scale values of my meter?"—T. R. T. (Wimbledon).

THE scale reading of a meter can be increased, when it is used for measuring current, by connecting suitable resistances in parallel with it, and such resistances are known as shunts. When measuring voltages, however, resistances have to be connected in series, and in both cases the value of the resistances required depends on the number of times the original maximum scale reading is to be increased and the internal resistance of the meter. It is not possible to reverse the procedure; if one wishes to make, say, an 0-1 ammeter read lower values, then it becomes necessary

to modify the windings of the meter, and this is a process calling for great skill, and is usually considered to be well beyond the capabilities of the average amateur.

Starting in Business

"Being over military age and having a fairly sound knowledge of radio, including building and servicing receivers and amplifiers, etc., I am thinking about starting a small servicing business, as I understand that there is quite good scope in my area, but I am not too sure about the necessary procedure to adopt to obtain proper recognition by the various trade firms. Will it be necessary to have business premises, such as a shop, or will an office-cum-workshop suffice?"—A. E. C. (Leicester).

IT is very difficult to advise anyone about starting a business of their own, as so much depends on personal qualifications, finance, and the conditions prevailing in the particular district concerned. At the

RULES

We wish to draw the reader's attention to the fact that the Queries Service is intended only for the solution of problems or difficulties arising from the construction of receivers described in our pages, from articles appearing in our pages, or on general wireless matters. We regret that we cannot, for obvious reasons—

- (1) Supply circuit diagrams of complete multi-valve receivers.
- (2) Suggest alterations or modifications of receivers described in our contemporaries.
- (3) Suggest alterations or modifications to commercial receivers.
- (4) Answer queries over the telephone.
- (5) Grant interviews to querists.

A stamped addressed envelope must be enclosed for the reply. All sketches and drawings which are sent to us should bear the name and address of the sender.

Requests for Blueprints must not be enclosed with queries as they are dealt with by a separate department.

Send your queries to the Editor, PRACTICAL WIRELESS, George Newnes, Ltd., Tower House, Southampton Street, Strand, London, W.C.2. The Coupon must be enclosed with every query.

present time there is a shortage of skilled service engineers, and it would seem that now is the opportunity for anyone to enter this sphere of the radio industry, provided that they have a sound practical and theoretical knowledge and are familiar with modern commercial receivers. To make a success of a servicing business, it is essential for all work to be carried out quickly, efficiently and in a thorough manner, giving attention to all details. To obtain trade recognition, it will be necessary to occupy premises (shop, office, or workshop) on which must be displayed the name you adopt for trade purposes. The usual forms of business stationery should be used and it might be good policy to undertake a certain amount of local advertising. Advise the trade, through the trade papers, of your opening and the type of business you intend operating. Contact should also be made with the firms whose products you are likely to handle.

Accumulator Charging

"I recently secured an L.T. charger having an output of 2 amps., and I have been using it to charge my two 2-volt accumulators I use for my radio. I find that violent gassing takes place and that sediment is collecting in the bottom of the

case. Is the gassing in order and should the sediment be present, or am I doing something wrong in the charging?"—L. T., (Cafford).

WE would have liked more details about the charger and the number of hours you put the cells on charge: from the brief details provided, it would appear that you are over-charging. This can be as harmful as under-charging, therefore you must adjust the charging rate or the number of hours each cell is connected to the charger to suit the accumulator. Details of the correct charging current is usually given on the accumulator, and it is best to keep within the specified limits. The actual capacity of the cell, the number of hours it is in use and the total current taken from it will affect the re-charging. For example, if it has a capacity of 20 amp.-hours and your receiver consumes 0.4 amp. (say, 0.5 or $\frac{1}{2}$ an amp.), then it will last, approximately, 40 hours on one charge. Similarly, re-charging at the 2 amp. rate, the cell should become fully charged after 10 hours. Excessive gassing is bad for the plates. It is better to give a long, low charge than a short one at a higher rate.

Crystal Set Selectivity

"I am using a crystal set for headphone work and whilst I am more than satisfied with the strength and quality of its reproduction, its lack of selectivity allows very annoying interference to be experienced. Is it possible, without using valves, to make the circuit more selective and not lose any of its power?"—H. N. A. (Wembley).

IF you are prepared to experiment with simple coil making, we would suggest that you wind a coil on a 3in. former, according to the following instructions. For the coil former select a piece of dry cardboard tube, 6in. in length, having the diameter mentioned above. On this wind 60 turns of 20 S.W.G. tinned copper wire, spacing each turn the thickness of the wire. Connect one end (which we will call the top) to the fixed vanes of the tuning condenser. From the side of the crystal detector usually connected to the condenser, bring a flexible wire to the free end of which is fastened a crocodile clip. The earth terminal, the moving vanes of the tuning condenser, and the earth side of the headphones should also be connected to another similar length of flex complete with clip. A third clip must then be connected to the aerial terminal. To operate, clip the crystal connection to the 5th turn on the coil from the top. The aerial to the 15th and the earth circuit to the bottom of the coil. Tune in the normal manner and then experiment by varying the positions of the tapping clips.

REPLIES IN BRIEF

The following replies to queries are given in abbreviated form either because of non-compliance with our rules, or because the point raised is not of general interest.

H. Y. (Bolton). Apply current and voltage tests to each valve stage. We suspect high voltages or incorrect grid-bias. Are all the de-coupling condensers in order?

F. B. (Newbury). We have not published a blueprint design of a receiver having the specification you give. Our nearest is the P.B.4 (A.C. Model), blueprint number P.W.95.

L. R. (Balham). The PRACTICAL WIRELESS Service Manual, price 6s. 6d., post free, will help you in your work. It gives a great deal of information about the points you mention.

The coupon on page 168 must be attached to every query

OUTPUT WATTAGE

ESTIMATING the actual output of a power or pentode valve, especially when one attempts to do so by ear, is a matter which so often produces very inaccurate figures. Quite a number of constructors confuse the anode dissipation of a valve with its A.C. output. The first is obtained by multiplying the anode current by the anode high-tension voltage, i.e., direct-current wattage, but it must be appreciated that the figure thus obtained does not denote the wattage of the output so far as the loudspeaker and the signal is concerned. The efficiency of a valve is low, and it is quite feasible to assume that, say, only 25 to 30 per cent. of the anode dissipation wattage can be considered as being the amount delivered to the speaker. For example, supposing a power valve of the battery-operated type has an anode current of 10 mA's at a certain grid-bias. This current will be flowing the whole time the valve is in operation, and in view of its D.C. nature, will not produce variations in the speaker. A signal, however, on being applied to the grid, varies the grid potential above and below its standing value supplied by the G.B. battery. This effect, in turn, causes similar variations above and below the 10 mA's anode current, and it is these variations which cause the loudspeaker to operate in sympathy with the signal.

One has to be very experienced to estimate A.C. wattage output by ear. For instance, supposing the output from an amplifier was reduced or increased until the average person estimated that it was half or double as loud as the original, it would be found, and this fact has been proved by extensive tests, that the actual ratios of the power (the original to the

new) were in the neighbourhood of 6.3 : 1 or, in other words, an output of one watt would only sound half as loud as one rated at 6.3 watts. It is very difficult for a normal person to distinguish a variation in output of 50 per cent., but, as strange as this may seem, it is an actual fact, and only goes to prove how careful one has to be when attempting to judge the output by sound alone.

PERSONAL PARAGRAPHS

G. A. Marriott, manager of the Osram valve department of the G.E.C., has been elected as the new chairman of the British Radio Valve Manufacturers' Association.

Two brothers, E. G. Baker and H. C. Baker, who have served the G.E.C. for a period, between them, of 104 years, have just retired. The former has been associated with the wires and cables department, and the latter with the order department, both at Magnet House.

Wright and Weaire, Ltd., recently attained their majority, the firm having been engaged in the radio industry for 21 years. Both J. G. Wright and T. G. Weaire have been associated in the business during the whole of this period.

We regret to record the death, early in December, of Mr. Charles Oliver, founder of the firm bearing his name, at Woolwich, and one of the pioneers of the electrical industry.

It is now some forty-three years since Mr. Oliver started a small factory under the name of Oliver and Company to manufacture arc lamps. He was later joined by the late Mr. W. M. D. Pell, son of Mr. Pell, of Brockie-Pell fame, and Mr. Oliver then designed and produced in 1914 the longest burning magazine-frame arc lamp then

known, and these lamps, installed in the City of London as long ago as 1914, are still in service.

Among the designs and developments he fostered, his system of distant control of switchgear by mains ripples, the initiation and development of the Varley Magnet Coil-winding Company, now one of the largest in the country for this work, and the manufacture of Varley Wireless Sets and components well-known for their quality, stand out as pre-eminent. In recent years, the development of the Varley Dry Accumulator, and storage battery with no free acid, occupied much of his time, and now appears to hold excellent future prospects.

His close personal linking of technical and managerial problems in the business have, during his lifetime, resulted in the steady expansion of the original factory, until now, Oliver Pell Control Limited and its subsidiaries, employing some nine hundred men and women, will remain a monument to one of the old pioneers.

A FINE BOOK FOR THE BEGINNER!

EVERYMAN'S WIRELESS BOOK

By F. J. CAMM

5/- or 5/6 by post from George Newnes, Ltd., Tower House, Southampton Street, Strand, London, W.C.2.

Keep that happy expression



In good times or bad, wherever you are, keep to that happy expression "Player's Please." The cigarette which makes happy expressions everywhere.

Player's Please



PLAYER'S NAVY CUT CIGARETTES. MEDIUM OR MILD. PLAIN OR CORK TIPS.

NCC5208E

TRAINED MEN URGENTLY NEEDED

NEVER before has there been such an urgent demand for trained radio men. There's a job waiting for you; or you can earn good money in your spare time.

Are you liable for military service? The R.A.F. is appealing for radio men, and many of our students have already been accepted as Radio Mechanics, Operators and Instructors. They like the work and the pay is good.

You can study at home in your spare time and become a qualified Radio Engineer. Even if you know nothing about radio, we can train you.

Hundreds of our students who had no previous knowledge or experience of radio have secured well-paid employment or spare-time work as a result of our training.

Our Home-Study Courses are praised and recommended by leading Radio Authorities. Our fees are reasonable and can be paid by easy monthly instalments.

Wherever you live you can study at home without interfering with your ordinary occupation. Do not delay, but post coupon now for full details of our Courses.

We have moved from London and Ealing; our new address is :-

**T. & C. RADIO COLLEGE
29, Market Place, READING.**

(post in unsealed envelope, 1d. stamp)

Please send me free details of your Home-Study Radio Courses.

NAME

ADDRESS

P. 12.

Classified Advertisements

ADVERTISEMENTS are accepted for these columns at the rate of 2d. per word (minimum charge 2/- each paragraph). All advertisements must be prepaid. **EACH** paragraph will commence with the first word printed in bold face capitals. Additional words in bold face capitals are charged at 4d. per word. **ALL** communications should be addressed to the Advertisement Manager, "Practical Wireless," Tower House, Southampton Street, London, W.C.2.

CABINETS

A CABINET for every radio purpose. Surplus cabinets (undrilled) from noted makers. We have hundreds in stock (no catalogues). Send measurements of chassis, etc., and say what kind of cabinet required. Stamp for reply. Inspection invited.
H. L. SMITH AND CO., LTD., 289, Edgware Road, W.2. Tel.: Pad. 5891.

LITERATURE

AMATEUR Radio Handbook—Second Edition, now on sale, 328 pages, price 4s. 2d.—Radio Society of Great Britain, 16, Ashridge Gardens, London, N.13.

FIRST Edition. Revolutionary Detection theory; circuits; practical experiments. World-wide circulation. 2s. post free.—D'Arcy Ford, Gandy Street, Exeter.

LOUDSPEAKER REPAIRS

LOUDSPEAKER repairs, British, American, any make. 24-hour service, moderate prices.—Sinclair Speakers, Pulteney Terrace, Copenhagen Street, London, N.1.

MORSE EQUIPMENT

FULL range of Transmitting Keys, practice sets and other equipment for Morse training.—Webb's Radio, 14, Soho Street, London, W.1. Phone: GERRARD 2089.

MORSE TRAINING

FREE. "Book of Facts," tells you all about "The Candler System of Code training. Courses for Beginners and Operators.—Write: Candler System Co. (L.O), 121, Kingsway, London, W.C.2.

NEW LOUDSPEAKERS

3,000 Speakers, P.M. and energised 4in. to 14in. including several Epoch 18in.—Sinclair Speakers, Pulteney Terrace, Copenhagen Street, London, N.1.

PATENTS

THE owner of British Patent No. 469,498, relating to "Improvements in or relating to Phonographs" is desirous of entering into negotiations with one or more firms in Great Britain for the purpose of exploiting the invention either by the sale of the Patent Rights or by the grant of Licences on reasonable terms. Interested parties who desire further particulars should apply to Albert L. Mond and Thiemann, of 14 to 18, Holborn, London, E.C.1.

RADIO CHASSIS

ARMSTRONG CO. regret owing to the great difficulty in obtaining materials and skilled labour they have reluctantly been compelled to cancel many orders for various Armstrong chassis. A small number of the latest EXP48 chassis as advertised in the November issue of PRACTICAL WIRELESS are still available. Particulars gladly sent on request.—Armstrong Co., Warlters Road, Holloway, London, N.7.

RADIO MAP AND GLOBE

WEBB'S Radio Map of the World enables you to locate any station heard. Size 40" by 30" 2 colour heavy Art Paper, 4/6, post 6d. Limited supply on Linen, 10/6, post 6d. **WEBB'S** Radio Globe—superb 12" full-colour model. Radio prefixes, zones, etc. Heavy oxidised mount. Post Paid. 27/6.—Webb's Radio, 14, Soho Street, London, W.1. Phone: GERRARD 2089.

CHALLENGER RADIO CORPORATION

announce their New Wartime Policy, "One Super-Efficient Receiver a Year." Send 2/- stamp for handsomely illustrated brochure on this model. Also still available, valves at competitive prices, and P.A. Speakers. Challenger Radio Corporation, 31, Craven Terrace, London, W.2.

Miles in front!

A Candler trained operator now serving in the R.A.F. says:—

"... I should like to thank both yourself and the company for the great start which I obtained through taking your Junior Code Course. The experience which I gained from that, has kept me 'miles in front' of others who relied on obsolete means of learning code."

CANDLER CODE COURSE

There are Candler Code Courses for beginners and also for those who desire to increase their w.p.m. speeds.

There's no royal road to learning—but there IS a quick sure way to genuine CODE skill. Thousands of Candler Trained Operators, including many in the Services, have proved the value of this truly remarkable system of Code instruction.

In the "BOOK OF FACTS," which will be sent FREE on request, full information is given concerning the subjects covered by all Candler Courses.

Terms: cash or monthly payments.

COUPON

Please send me a Free Copy of Candler "Book of Facts."

NAME

ADDRESS

Post in 1d. unsealed envelope to London Manager.
CANDLER SYSTEM CO.
(S.L.O.), 121, Kingsway, London, W.C.2.
Candler System Co., Asheville, North Carolina, U.S.A.

241

TAYLOR METER

32 RANGE UNIVERSAL METER

Sensitivity 1,000 ohms per volt. A.C. and D.C.

The set testing functions of this precision instrument covers all ranges essential for carrying out accurate electrical measurements for Radio and General test work.

Model 90. PRICE

£9.9.0

(No purchase tax payable)

Complete with leads, test prods and comprehensive book of operating instructions. Delivery at present ex-stock.

STUDY THESE FEATURES!

METER. 4½" square type Taylor moving coil meter. Sensitivity of 900 microamps. **SCALES.** The large dial has 3 clearly engraved scales for measurements of Resistance, A.C. and D.C. volts, A.C. volts and amps. **RANGES.** The 32 ranges include:—(7) D.C. Volts 0-0.25 up to 1,000. (6) Output Volts 0-2.5 up to 1,000. (6) A.C. Volts 0-2.5 up to 1,000. (5) D.C. Current 0-1 mA. up to 2.5 amps. (4) Ohms from 1 to 10 megohms. (4) A.C. Current 0-1 mA. up to 2.5 amps. **SOCKETS.** There are 4 on the front panel, "Common," "Test," "1,000v" and "Output." **ACCURACY.** A high degree of accuracy is assured, as every instrument is carefully checked against our standard. **MODEL 95.** 17 Range D.C. Meter. £7 - 17 - 0

Technical brochures free on request.

BRITISH MADE. GUARANTEED 6 MONTHS.

TAYLOR

Electrical Instruments Ltd.
419-422, Montrose Avenue,
SLOUGH, Bucks.
Telephone: SLOUGH 20051.

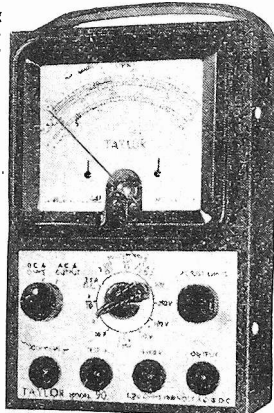

READERS' BARGAINS

TRANSFORMERS, Valves, Speakers, Condensers, etc. All in good condition. Many as new. Stamp for list.—Chadwick, 50, Woodstock Road, Manchester, 16.

EXCHANGE Mains Speaker, Four Mains Valves, Mains Transformer, Dual Range Coil, for Mandolin or Guitar.—A. Stevens, 10, Everett Close, Wells, Somerset.

RECEIVERS AND COMPONENTS

SOUTHERN Radio's Bargains.

ALL Guaranteed. Postage Extra.
5/- Parcel of useful Components, comprising Condensers, Resistances, Volume Controls, Wire, Circuits, etc. Value 25/- 5/- per parcel.

15/- Service Man's Component Kit. Electrolytic Condensers, Volume Controls, Resistances, Tubular, Mica, Paper Condensers, Valve Holders, etc. 120 articles contained in strong carrying case, 9" x 7" x 7", 15/- the Kit.

5/- 100 Wire-ended Resistances, assorted capacities, ½ and 1 watt, 5/- per 100.

ORMOND Loud-speaker Units, 2/6. Crystal Sets, 5/6; Westectors Type W2, 2/6; Crystal Detectors 2/-; Crystals, 6d.; "P.O." Microphones on Stand, for use with any receiver, 5/-; Telsen W349 Iron-core Midget D.R. Coils, 5/6; Morse Tapping Keys, 3/-; Buzzers, 1/6.

2/- Tool or Instrument Carrying cases, ex Government Stock. Wood 9" x 7" x 7", 2/-.

SOUTHERN Radio, 46, Lisle Street, London, W.C. GERRARD 6653.

THE OLD FIRM still going strong.

LONDON'S CENTRAL RADIO STORES,
23, Lisle St., W.C.2. Phone: Ger. 2069.

MAINS dropping resistors, .2 amp., tapped 200-215-230-245v., 4/- each.

MAINS Transformers, 200-250v. prim. 325-0-325, 6v. 3 amp., 5v. 2 amp., 9/6.

EX-G.P.O. Galvanometers by Sullivan, etc. Good condition, 8/6 each.

PLESSEY Motor-driven 2-gang .0005 condenser assembly with press-button control. New and perfect, 25/-.

CHROME-PLATED, super quality double button, carbon microphones, with transformer, 32/6.

SPARTAN 5-valve Press Button Radio. No manual tuning, 7 stations on press button. Walnut cabinet, provision for pick-up and extension speaker, 4 watts output with negative feed back, Multi-stage Superhet with A.V.C. for A.C. mains only, guaranteed reception. Price £4/5/0, carriage paid.

CRYSTAL SETS, Permanent Detector, suitable for A.R.P. shelters, few only, 7/6, post free. Oldhams ex-police used unsippable 2-volt 7 amp. Accumulators, suitable for lamps, portables, etc., 2/-.

B.I. CONDENSERS, 4 mfd., 450 v. working, resin oil filled, 3/- post free. .25 mfd. 1,000v. working, 2/3 each. .1 mfd. ditto, 2/3.

MORSE keys, 2/11 each. Microphone 80/1 Transformers, 1/9 each.

BALL-BEARING Bakelite Turntables, 6in. diameter, suitable for all purposes, 2/9 each. Universal Output Transformers for Push-Pull Class B. Pentode, etc., 4/9 each. High-note Morse Buzzers, 4½-6 volts, 2/6 each.

PERMANENT Crystal Detectors, complete with Bracket and Screws, 2/- each. New Mains Energised Speakers, best makes, 8in., 8/9 each. Hand Telephone Sets, 6/6, with cord, 7/-.

Dial Communication Telephones with hand set, 18/6 each. Step-up Transformers, 230-100 volts, or vice versa, 30-40 watts, 5/-.

POSITRON Dry Electrolytic Condensers, 8+8 mfd. 500 volt working 4-lead, 2/9 each. All goods post free.

LONDON CENTRAL RADIO, 23, Lisle Street, London, W.C.2. GERRARD 2069.

SURPLUS Components for sale. Condensers, Transformers, Mains and L.F., etc. Ideal for beginner. Stamp for list.—Pedley, 17, Vicarage Road, Coseley, Staffs.

VAUXHALL. Rola 8" P.M. speakers, with transformer, 14/9. Electrolytic condensers, 8 mfd., 500v., 2/3; 8+8 mfd. 500v. 3/6. 3-gang bandpass H.F. iron-cored tuning coils, 19/6.—Vauxhall Utilities, 163A, Strand, London, W.C.2. Postage extra under 3/-, 1d. stamp for list.

FREE ADVICE BUREAU

COUPON

This coupon is available until February 1st, 1941, and must accompany all Queries and Hints. PRACTICAL WIRELESS, February, 1941.

RECEIVERS AND COMPONENTS

GALPINS ELECTRICAL STORES

75, Lee High Road, Lewisham, London, S.E.13

Telephone: Lee Green 5240. Terms: Cash with Order

D.C. MOTOR BLOWERS, 2-in. inlet and outlet Aluminium body, laminated field, ideal for dug-out ventilation. 100 volt. 25/-.**CRYPTO SHUNT WOUND DYNAMO**, 12/13 volts, 8/10 amps., 2,200 r.p.m., in new condition, 37/6, carriage forward.**HIGH-VOLTAGE TRANSFORMERS**, useful for all test work, or television. Input 200/240 volts, output 5,000 and 7,000 volts, 6/6 each, post 1/-.**VOLTAGE CHANGING TRANSFORMERS** (Auto Wound), 100/110 to 200/240 volts or vice versa. Guaranteed 12 months; 500 watts, 32/6; 1,000 watts, 60/-.**DYNAMOS**, for charging or lighting, etc., all shunt wound and fully guaranteed. 100 volt 10 amp., 4-pole, 1,500 r.p.m., 90/-; 50/75 volt 15 amp., 1,750 r.p.m., 4-pole, 90/-; 25 volt 8 amp., 1,750 r.p.m., 2-pole, ball-bearing, 37/6; 50/75 volt 25 amp., 4-pole, 1,500 r.p.m., 110/-.**HIGH VOLTAGE CONDENSERS**. Infd. at 4,000 vol. working, 5/6 each, carriage paid.**REGULATORS, STARTERS AND LARGE DIMMER RESISTANCES**. Stud Switch-arm type. Please state requirements.**SWITCHBOARD VOLT AND AMPMETERS MOVING COIL AND MOVING IRON**. All first-class makers. Please state requirements.**"CRYPTO" SHUNT WOUND DYNAMO**, 30 volts 10 amps., 1,900 r.p.m., in good condition, 65/-, carriage forward.**D.C. ELECTRIC LIGHT CHECK METERS**, 200/250 volts 5 and 10 amps., 4/6 each, post 1/- (in new condition).**X-RAY TRANSFORMERS** by Watson & Philips. Input 200/250 volts, 50 cy., 1 ph., output 40,000 volts 2 kVA., 27/10/-, carriage forward. Another, 70,000 volts 3 kVA. output, 120 volt primary, 212/10/-, carriage forward.**A.C. ELECTRIC LIGHT Check Meters**, suitable for subletting, workshop, garage or any purpose where a separate check is required, for A.C. mains only, 200/250 volt, 50 cycle, single phase, in good condition and electrically guaranteed; 5-amp. type, 6/-; 10 amp. type, 7/-; carriage 1/- on any size.**DUGOUT LAMPS, EX R.A.F.**, as new, solid brass construction; any size bulb can be used; wall type, 3/- each, post 6d.; ditto, ring type, 2/6, post 6d.**DUGOUT LAMPS EX R.A.F.**, as new, porthole type; solid brass construction, 6-in. dia., 3 colour glass dome; white, red, or green, complete with bulb. Any size bulb can be used. Price 5/-, post 6d.**MANGIN LENSES**, convex 4 1/2 in. diam., 5/-.**EX R.A.F. AUTOMATIC CHARGING CUTOUTS AND VOLTAGE REGULATORS**, for 12 to 20 volt up to 20 amp. circuit (new) and complete in metal case, 3/6 each, post 6d.**EX R.A.F. GLASS ACCUMULATOR TANKS**, 5 x 5 x 5 in., new and unused, 3/6 each, post 1/-.**EX R.A.F. SWITCH PANEL**, with case (new), fitted 6 small knife switches, leads, cords and cleats, complete in wood case, 2/6 each, post 6d.**EX R.A.F. NEW NECO MOTOR BLOWER**, 100-volt motor, shunt wound 1,800 r.p.m., ball-bearing, fitted to Cyclone fan, 4 1/2 in. inlet, 5 in. outlet, massive aluminium casing 1 1/2 in. dia., new and unused, 55/- each, carriage 4/-.**1 KW. TRANSFORMER**, 100 volt, 100 cycles input, output 10,000 v., centre tapped, 30/- carriage forward.**AIR COMPRESSOR**—out of large "huggie"; twin cylinder, approx. 2 1/2 in. bore, complete with heavy baseplate, radiator and storage; in first class mechanical condition; suitable for high pressure. Price 24/10/-, carriage forward.**COULPHONE** Radio, New Longton, Preston. Prompt personal attention. Only Brand New goods supplied. Tuning valves. Guaranteed American valves, 5/9. Octal, 6/9. Airmaster 8-valve, 4 waveband chassis and speaker, 10 gns. Latest Goodmans 8" P.M. speaker, Universal transformer, 16/6. Erie and Dubilier 1 watt resistors. All standard values, 4/3 dozen. 8 mfd. block condensers, 2/6. 8x8 mfd., 4/3. Rola G12, 2,500 ohms with transformer, 57/6. 8" energised 2,000 ohm, with transformer, 13/6. Stamp for 1941 list.**BANKRUPT Bargains, GENUINE OFFER**. Brand new 1939-40 models, makers' sealed cartons, fully guaranteed, at 25 per cent. to 40 per cent. off present prices; also portable midgets. Send 1d. stamp lists. Radio Bargains, Dept. P.W., 261-3, Lichfield Road, Aston, Birmingham.**COIL KIT**. For superhet circuit. Including 2-gang straight condenser, aerial coil assembly, oscillator coil assembly and 2 465 k.c. I.F. transformers. With circuit diagram, 8/11 each.**PILOT LAMPS**, 6.3 3 amps., 6d. each.**PLESSEY** single gang .0005 variable condensers, 1/11 each.**T.C.C.** 8 mfd. tubulars electrolytics, 1/6 each, 150v.**B.I.** wire-end bias electrolytics. 50 mfd.—12v., 1/6 each. **TUBULARS**. Wire-end, non-inductive paper condensers. All sizes up .01 5d. each; .1 7d. each.

RADIO CLEARANCE, Ltd.

ALL-WAVE superhet chassis, 5-valve A.C. Latest Mullard Valves, TH-4.B., V.P.-A.B., T.D.D.-1, Pen.A.-1, L.W. 4/350v. Ranges: short-wave, 16-48 metres; medium-wave, 200-500 metres; long-wave 800-2,200 metres. Size of chassis, 14 1/2 in. long, 7 1/2 in. deep. Height overall, 8 1/2 in. Controls: Tuning ab side, volume on/off at side, wavechange, provision for pick-up. Complete with valves, 24/7/6 each.**SPECIAL OFFER**. Ready in 7 days, 200 only 5-valve A.C./D.C. sets, 3 wave-bands. Complete in attractive Cabinet, size 14 1/2 x 8 in. x 6 in., ready to plug in. List price, £8 8s. Our price, £4/19/6 each.**2V. OUTPUT PENTODE VALVES**, 5-pin, unboxed, 2/11 each.**LISSEN** P.T.2.A, 4/11 each.**LISSEN** rectifier valve U650, 2/11 each.**LOW-LOSS** Ceramic valve holders. Lissen III-Q Baseboard and chassis 7-pin 1/- each.**MANSBRIDGE** type condensers, Lissen Hi-Q, 250 D.C. working. Moulded cast with feet. 1 mfd. 6d. each.**LOW-LOSS** short-wave variable condensers. Ceramic insulation. Brass vanes. Lissen Hi-Q. Minimum capacity, 5 microfarads. Two types. Boxed, with knobs. 100 mfd. List 7/6 each. Our price, 3/- each. 20 mfd. List 5/6 each. Our price, 2/6 each.**ROTARY COIL UNITS**, Lissen Hi-Q, 4-band from 4.8-91 metres. Can be selected by turn of knob. With circuit. Boxed. List 15/6. Our price, 6/11 each.**PUSH-PULL** switches. Lissen 2-point, 4d. each. 3-point 6d. each.**YAXLEY** type switches. 4-pole, 3-way, 9d. each.**YAXLEY** type switches. 4-bank, 2-pole, 4-way, 2/6 each. 6-bank, 2-pole, 4-way, 3/- each. 9-bank, 2-pole, 4-way, 3/6 each.**AMERICAN LINE CORDS**, with fittings, 3/6 each. 3-way American Line Cords, 450 ohms resistance, 3/6 each.**ROLA** P.M. speakers. Latest model, 7 1/2 in. cone, with power and pentode transformer. Boxed, 15/- each.**MAGNAVOX** 10 in. energised speaker. Field resistance, 3,000 ohms, 12/6 each.**CLOCK-FACED DIALS**, 5 in. x 3 1/2 in. With printed scale. 3-way, 2/6 each.**STRAIGHT LINE** 3 waveband dials, 1/11 each.**MAINS TRANSFORMERS**. G.E.C. American windings. 350-0-350v., 63 m.a., 6.3v., 2.5 amps. Suitable for replacements in G.E.C. models, 6/6 each.**MAINS TRANSFORMERS. WEARITE** R.C.1. 250-0-250v., 80 m.a., 4v., 2.5 amps, 9/11 each.**R.C.2.** 350-0-350v., 120 m.a., 4v., 2.5 amps., 4v., 4 amps., 12/6 each. **R.C.3.** 350-0-350v., 150 m.a., 4v., 2.5 amps., 4v., 2 amps., 4v., 5 amps., 15/- each. **R.C.4.** 500-0-500v., 150 m.a., 4v., 2 amps., 4 v., 2 amps., 4v., 2.5 amps., 4v., 5.6 amps., 21/- each. **R.C.5.** 100-watt auto-transformer, 100-110v., 200-250v. Reversible, 12/6 each. All above transformers, 200-250v. tapped primaries. R.C.D. drop through type, capped. 350-0-350v., 100 m.a., 5v., 2 amps., 6.3v., 5 amps., 10/6 each.**CHASSIS** mounting valve holders. American 4-5-6-7-pin, 4d. each. Octals, 6d. each. Octal, 10d. each.**VALVEHOLDERS**, Celestion 5- and 7-pin chassis type, 4d. each. Baseboard type 5-pin, 2d. each.**VOLUME CONTROLS**. Centralab. Spindles length 2 1/2 in. With switch. 100,000, 250,000, 500,000 and 1 meg., 2/11 each. Centralab 1 meg. volume controls with switch, 1 1/2 in. spindle, 2/- each.**CENTRALAB** midget volume controls, 2,000, 5,000, 25,000, 50,000, 100,000, 500,000 ohms. Less switch, 2/9 each. 1,000, 25,000, 50,000. With switch, 3/6 each.**SPEAKER TRANSFORMERS**. Pentode output, 3/6 each.**PRESS BUTTON UNITS**. Size of unit, 6 in. x 6 in. x 2 in. Complete with 6 press buttons and capacitors, 4/11 each.**12-WAY PUSH-BUTTON SWITCHES**, 1/6 each. 11-way push-button switches, 1/6 each. 0-way push button switches, 1/- each.**SPEAKER CABINETS**. Suitable for 8 in. speaker. 4/6 each.**SET CABINETS**. Various sizes. Callers only. 4/- each.**DROPPING RESISTANCES**. For all purposes. Total resistance 535 ohms, 5 taps in step of 50 ohms. Standard for Pye, Lissen, Ever Ready, etc. 3/- each.**PUSH-BACK** Connecting wire. 1d. per yard. **10FT. COILS** connecting wire. Glazed. 4d. each.**DUAL CAPACITORS**. 300 x 600. 4d. each. **I.F. TRANSFORMERS**. 465 k.c. in 1 1/2 in. Cans. 2/6 each.**All orders must include SUFFICIENT POSTAGE TO COVER**. Hours of Business: Week-days, 9-4. Saturdays, 9-1 p.m.**PLEASE WRITE YOUR NAME IN BLOCK LETTERS**.**We cannot undertake to answer enquiries unless full postage included (21d.).****RADIO CLEARANCE, Ltd., 95, HIGH HOLBORN, LONDON, W.C.1.**

RECEIVERS AND COMPONENTS

FRED'S RADIO CABIN

75, Newington Butts, S.E.11. Phone: Rodney 2180

THE SPOT FOR KEEN BARGAINS

VOLUME CONTROLS. Last month's offer sold particularly well, many repeat orders for our parcel of 12 assorted volume controls, some with switches, various values. Ideal for servicing. Only a small quantity remain to be cleared. Buy now and keep a few spares before stock is exhausted. 3/- per doz.**EKCO** mains dropping resistances. Total resistance 700 ohms. 3 tappings: 500, 100, and 100 ohms. Only a few remain to be cleared, 3/6 each. Also a few "Truwind" mains dropping resistances. 2 tappings. 400 ohms. 2/6 each.**TUBULAR** servicing condensers, wire end in all values, assorted 1/6 doz. Another line, 0.1 mfd. 350 v. working 3d. each. Only a small parcel remains to be cleared from last month's offer.**RESISTANCES** wire end all values 12 assorted 1/6. A few to clear. First orders secure.**VALVE-HOLDERS**. 7-pin chassis type—the real thing—first quality contacts 3d. each. 2/9 doz.**H.F. FILTER** chokes, twin-mains for smoothing 2/3 each.**CRYSTAL** and cat's whisker in tin box. Bargain line to clear 7d. each. Very useful to experimenters.**T.C.C. CONDENSERS**. 25 mfd. 1,000 v. working at 9d. each, also T.C.C. 1 mfd. 1,000 v. working, 9d. each. State value required.**SLOW-MOTION** gears. The very thing for short-wave enthusiasts. Ratio 10-1. Well made in solid brass. Special price to clear small quantity, 1/3 each.**KNOBS** make all the difference to the appearance of your receiver. A good line of well-made polished brown bakelite knobs. Take standard spindle deep set locking screw. 3/6 doz. or 4d. each.**DX AERIAL FILTERS**. Cut out noise and interference and improve the quality of your reception. Easily fitted in a few seconds. 1/3 each. Also Lincoln Stewart Aerial Eliminator at 1/3 each.**METAL CHASSIS**. Has many uses, most suitable for power amplifiers, etc. 2 1/2 inches long, 1 1/2 inches wide, 3 inches deep. Made of heavy gauge galvanised iron. Some fitted with valve-holders. Actually they are ex-television receivers. Cheap price to clear, 2/8 each.**EKCO** Mains Chokes. Only a few in stock, 60 m.a., 350 ohms, 3/- each. Also "Haleyon" tapped I.F. chokes, 2,000 ohms, tapped at 600 ohms, 2/6 each.**PLUG** and adaptor. Well-made British line. This is remarkably good value and has sold well over the counter, cannot be repeated. 1/- each.**RESISTANCES AND CONDENSERS**. Strip containing 8 resistances and 4 condensers, all useful values. Ideal for servicing. 1/3 complete.**SWITCHES**. On-off toggle switches. Extremely good value at 6d. each. Double toggle switch at 1/- each.**EX-ROLA** speaker transformers for pentode output only 1/9 each.

Postage must be included with all orders.

Regret cannot accept C.O.D. orders.

FRED'S RADIO CABIN FOR BARGAINS

75, Newington Butts, S.E.11. Phone: Rodney 2180

TUITION

PRACTICAL Postal Courses, radio, television, test equipment design, trade-test coaching for R.A.F. posts, I.P.R.E. and I.W.T. exams; booklet free.—Secretary, I.P.R.E., Bush House, Walton Avenue, Henley-on-Thames.**YOUNG MEN** wanted to train as Radio Officers in Merchant Navy and R.A.F. Students of both sexes also prepared for appointments in Radio and Television. Boarders accepted. Low fees. College in ideal peaceful surroundings. Prospectus Free.—Wireless College, Colwyn Bay.

WANTED

WANTED.—Eddystone short-wave components: Recording Apparatus; Sky Buddy or similar; Valves; offers, stating price to: X2CYN, 24, Eaton Road, Chester.**WANTED** Sky Champion, reasonable, approval. Full details to C. Merrett, 26, Port Street, Evesham, Wores.**WANTED** 2v. Vibrator Supply Unit. Moving-coil 0-1 M.A. meter. S.T. A.C. 800.—Griffin, Coppice Hill Bps. Waltham, Southampton.**B.I.** 8 x 8 mfd. 440v. wkg. Cardboard electrolytics, 4/6 each. **B.I.** 4 mfd. tubulars, 1/9 each. **B.I.** 2 mfd. tubulars, 1/3 each. **B.I.** 8 mfd. cartons, 2/11 each.**CONDENSERS**. .0005 twin, 1/3 each, triple, 1/9 each.**LISSEN** mica condensers. Our assortment, 2/- dozen.**RAYTHEON VALVES, FIRST GRADE**. Largest stockists. All types stocked. Including Glass Series, Glass Octal Series, Metal Series, Bantam Series, Single-ended Metal Series and Resistance Tubes. All at most competitive prices. Send for lists.

FREE!

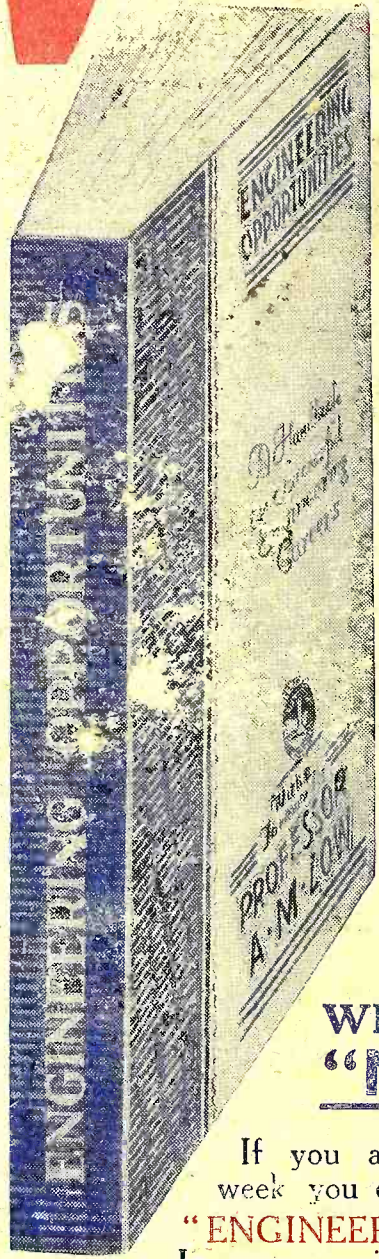

This IMPORTANT GUIDE to SUCCESSFUL ENGINEERING CAREERS

After months of intensive effort and research we are pleased to announce that the new edition of our handbook, "ENGINEERING OPPORTUNITIES," is now out of the publishers' hands and ready for free distribution. Containing 208 pages of practical guidance, this book is, beyond argument, the finest and most complete handbook on Successful Engineering Careers ever compiled. It is a book that should be on the bookshelf of every person interested in engineering whatever his age, position or experience.

The Handbook contains, among other intensely interesting matter, details of **B.Sc., A.M.I.C.E., A.M.I.Mech.E., A.M.I.E.E., A.M.I.A.E., A.M.I.W.T., A.M.I.R.E., A.M.I.P.E., CIVIL SERVICE,** and other important Engineering Examinations; outlines courses in all branches of **CIVIL, MECHANICAL, ELECTRICAL, AUTOMOBILE, RADIO, TELEVISION, AERONAUTICAL and PRODUCTION ENGINEERING, DRAUGHTSMANSHIP, TRACING, GOVERNMENT EMPLOYMENT, BUILDING** (the great after-war Career), **R.A.F. MATHS.,** etc. etc., and explains the unique advantages of our Employment Department.

**WE DEFINITELY GUARANTEE
"NO PASS-NO FEE"**

**R.A.F.
PILOTS
AIR-GUNNERS
NAVIGATORS**

Special rapid Home-study courses in the essential branches of Mathematics. For full details of this scheme apply or write

**B.I.E.T. (Dept. M409)
17, Stratford Place,
LONDON, W.1.**

If you are earning less than £10 per week you cannot afford to miss reading "ENGINEERING OPPORTUNITIES."

In your own interests, we advise you to write (or forward the coupon) for your copy of this enlightening guide to well-paid posts -NOW. There is no cost or obligation of any kind.

**BRITISH INSTITUTE OF
ENGINEERING TECHNOLOGY**

Principal: Professor A. M. Low

**409a, SHAKESPEARE HOUSE,
17, 18 & 19, STRATFORD PLACE, LONDON, W.1.**

TEAR OFF HERE
FREE COUPON

To B.I.E.T.,
409a, SHAKESPEARE HOUSE,
17, 18 & 19, STRATFORD PLACE,
LONDON, W.1.

Please forward, Free of cost or obligation of any kind, your 208-page Handbook, "ENGINEERING OPPORTUNITIES."

Name

Address

Published on the 7th of each month by GEORGE NEWNES, LIMITED, Tower House, Southampton Street, Strand, London, W.C.2. and printed in England by THE NEWNES & PEARSON PRINTING CO. LTD., Exmoor Street, London, W.10. Sole Agents for Australia and New Zealand: GORDON & GOTCH, LTD. South Africa: CENTRAL NEWS AGENCY, LTD. Subscription rates including postage: Inland 7s. 6d. per annum, 3s. 9d. for six months; Abroad 7s. per annum, 3s. 6d. for six months. Registered at the General Post Office for the Canadian Magazine Post.
CONDITIONS OF SALE AND SUPPLY.—This periodical is sold subject to the following conditions, namely, that it shall not, without the written consent of the publishers first given, be lent, resold, hired out or otherwise disposed of by way of Trade except at the full retail price of 6d.; and that it shall not be lent, resold, hired out or otherwise disposed of in a mutilated condition or in any unauthorised cover by way of Trade; or affixed to or as part of any publication or advertising, literary or pictorial matter whatsoever.