

*The*

# *Call Letter*

August 2016

Vol 43, #8



**Dick learning Dan is a grandfather**

# The Northwest Vintage Radio Society

Post Office Box 82379  
Portland, Oregon 97282-0379

The Northwest Vintage Radio Society is a non-profit historical society incorporated in the State of Oregon. Since 1974 the Society has been dedicated to the preservation and enjoyment of "Vintage Radio" and wireless equipment.

Membership in the Society is open to all who are actively interested in historic preservation. The dues are \$25.00 for domestic membership, due on January 1st of each year (prorated quarterly).

The Call Letter has been a monthly publication since 1974. It was originated with the founder, Bob Bilbie, and our first president, Harley Perkins. Through several editors and with the assistance of numerous society members, the Call Letter has continued to be a publication that informs members of the society's business and that supports the hobby of collecting, preserving, and restoring vintage radios.

Society meetings are held the second Saturday of each month at the Abernethy Grange Hall at 15745 S. Harley Ave. in Oregon City, Oregon. They convene at or about 9:30 AM for the purpose of displaying radios, conducting Society business, and exchanging information. Guests are welcome at all Society meetings and functions (except board meetings).

Other Society functions include guest speakers, auctions, radio shows, and radio sales which are advertised in the Call Letter and are held in and around Portland.

With each issue of the Call Letter, we remember Jim Mason, a charter member of the society who remained active until his death in 1999. A generous bequest from Jim's estate ensures the vitality of the Northwest Vintage Radio Society, and continued publication of the Call Letter.

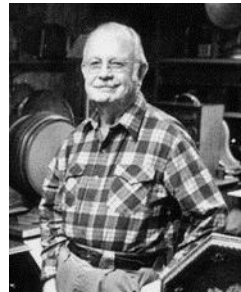

## Society Officers for 2016:

President	Mike McCrow (503)730-4639	<a href="mailto:tranny53@frontier.com">tranny53@frontier.com</a>
Vice-president	Brian Toon (503) 266-5527	
Treasurer	Ed Tompkins (360) 573-3895	<a href="mailto:edtomp@Q.com">edtomp@Q.com</a>
Recording Sec'y	Liles Garcia (503) 649-9288	<a href="mailto:landn2@frontier.com">landn2@frontier.com</a>
Corresponding Sec'y	Pat Kagi (503) 694-6149	<a href="mailto:kagi.pat@con-way.com">kagi.pat@con-way.com</a>
Board member at large	Mark Moore (503) 286-5224	<a href="mailto:mark@pdxhistory.com">mark@pdxhistory.com</a>
Librarian	Damon Vandehey (503) 459-1777	
Editor	Don Hanson	<a href="mailto:vanguard4@lycos.com">vanguard4@lycos.com</a>

## On the Cover

2016 Dick learning Dan is a grandfather  
Photography by Blake Dietze

---

## July Table of Contents

Announcements.....	1
July 2016 Meeting Minutes .....	2
Joe S. Naemura, M.D., W7CG, SK Obituary by Dick Howard ...	3
The Speed Feldshau Memorial Swap Meet by Dick Karman.....	4
Calendar of Events .....	5
May Monthly Feature – Members’ Choice .....	6
Hallock and Watson 1932 by Art Redman .....	9
Tips and Tangled Cords No. 3 by Blake Dietze .....	10
Speed Feldschau Picnic Flier by Charlie Kent .....	12

---

## Announcements

Our August 13 meeting will be the "Speed Feldschau Memorial Swap Meet and Picnic"

### August Meeting

The Picnic will be on August 13 and starts at 9:30 AM

**Editor’s Note** - Please have Call Letter Contributions in by **Aug 27**.

This month’s feature pics were taken by Blake Dietze. Thanks!!!

---

Visit our web site at:

[www.nwvrs.com](http://www.nwvrs.com)

Find us on Facebook:

[www.facebook.com/nwvrs](http://www.facebook.com/nwvrs)

---

# Meeting Minutes

NorthWest Vintage Radio Society Meeting -- July 9, 2016

President Mike McCrow called the meeting to order at 9:30 AM. Members pledged allegiance to the flag. The attendance today is 37 people. Mike mentioned that Dan Howard recently wrote an article on Forest Service radios. It is published in the current AWA Journal. Today is a business meeting due to the rainy weather. Our "Speed Feldschau Memorial Picnic and Swap Meet" normally held in July will occur at our August meeting. The Program Topic for our October meeting will be "Clock Radios". If it is raining for our August Picnic, then the Program Topic for our August meeting will be "Clock Radios".

The minutes of our June meeting were approved as published in the July Call Letter. Damon reminded the group to bring in any outstanding library books. Our Fall Swap Meet will be in September. The Program Topic for today is "Members' Choice". Members showed and discussed the radios that they brought. The meeting was adjourned.

Recorded by Liles Garcia, Secretary  
July 9, 2016

## Wireless Telephone, Sent to Old Flame, Might Reach Wifey

When a man puts his wife on a boat for a trip to Hawaii or any other place, for that matter—he had better not try to send a telephone wireless to an old sweetheart.

Word has just been received by the Northwestern Radio Manufacturing company in Portland from the Mutual Wireless company in Wailuku, Maui, Hawaii, that a message sent by the Portland radio telephone to Berkeley, Cal., was picked up by the island station.

From The Oregon  
Daily Journal  
(Portland, Oregon) ·  
Fri, Jan 6, 1922.

Thx to Dan Howard.  
(Please direct all  
comments to Dan...)

## **Joe S. Naemura, M.D., W7CG, SK**

*Obituary by Dick Howard*

Joe Naemura was born 4 January 1920 near Gresham, Oregon and died 12 July 2016 also in Gresham. He was the eldest of four children born to Sakaju and Seiki Naemura who several years earlier had emigrated from Japan.

Joe recounted that at about seven or eight years of age he built his first crystal set thus getting started in old radios when they were still new!

He obtained his first ham license, W7GXA, about the time he graduated from Gresham Union High School in 1938, when he also received his commercial radio telegraph license. By 1940 he had completed two years of electrical engineering at Reed College and Oregon State College. Money being still hard to come by because of the Depression, he applied for work as a ship radio operator. Although chief operator positions required two years of experience in addition to the commercial license, he was hired on a merchant vessel.

With the outbreak of World War II and the internment of Americans of Japanese descent, Joe and his brother, Roy, both volunteered for service in the U. S. Army. After the war he resumed his life as a maritime radio operator going to sea for several years. Once more he returned to pursue his engineering studies finally changing his career path to medicine, becoming an anesthesiologist at Providence Hospital for thirty years.

Coming from a time when real hams “rolled their own”, Joe preferred to build much of his own radio equipment, especially his transmitters, but he was very partial to National receivers, having twenty or more as well as the more prosaic Hallicrafters, Hammerlund and Collins equipment in addition to more modern imported transceivers.

His specialty in radio for much of his life was chasing DX, being on the DXCC Honor Roll for years and displaying a special plaque for being the number one DXer in the world in 1985. His early QSL cards were lost in the 1948 Vanport flood although a few of those cards were replaced by those DXers that he had worked. When the FCC made coveted two letter suffix callsigns available to Extra class amateurs in the 1970s, he traded his W7GXA call which is now held by his son, Joe for W7CG.

In 2003 he opted for a more convenient sized home in Gresham, giving up his tower and DX station, turning to collecting and restoring old radios. He was a member of NWVRS for a number of years and never ended the chase for radio goodies, his last swap-meet being the club swap in April 2016.

When Joe passed away in July of this year it brought a close to a fantastic seventy-eight year career in ham radio which actually commenced even ten years before with that first crystal set.

We'll all miss you, Joe. 73



---

## **The Speed Feldshau Memorial Swap Meet**

*By Dick Karman*

Speed Feldshau joined our society in the mid-1980s. He lived in Keiser, Oregon and made the trip up for meetings quite routinely. When the society met in the “Club House” in Oregon City the calendar made the July meeting a picnic in the Buena Vista Park. In about 1989 the membership had decided that they traveled and “garage saled” so much in the summer months that they didn’t need a meeting in July and August. So Speed opened his acreage in Keiser for a “back yard” swap meet and picnic. The first time was July in 1989. It would continue for several years with Speed firing up the barbeque and folks enjoying “Hot Swap under the Cool Trees” as Speed called it. Later it was referred as the Kool Keiser Swap meet. The last Keiser gathering was 1996. Speed Feldshau was elected president of the society for 1992 and 1993. The Society was going through some relocation conflicts during those years. In the late 1990s Speed became a silent key.

## Calendar of Events

August. Highline Amateur Radio Club SwapFest. DesMoines, WA. **CANCELED!**

August 20. Annual Clark County Amateur Radio Club (CCARC) Ham Fair, Vancouver, WA. *This is an ARRL sanctioned event.* [clarkcountyhamfair@w7aia.org](mailto:clarkcountyhamfair@w7aia.org) or [www.w7aia.org](http://www.w7aia.org) . [Flyer in PDF](#). (86K)

August 21. Antique Radio Swap Meet. Puget Sound Antique Radio Association. 9 AM to 1 PM. Shoreline Community College, 16101 Greenwood Avenue North, Shoreline, WA 98155. <http://www.pugetsoundantiqueradio.com/index> (Always the 3rd Sunday in August) [Flyer in PDF](#). (160K)

August 27. Seattle Fox Hunt, 2016. <http://n1qq.com/foxhunt/>

September 9-11. 20th Annual Northwest APRS/Digital Summer Gathering. Valley Camp, North Bend, WA. <http://valleycamp.org/> . Info list: <http://tinyletter.com/nwaprsg> , register at <https://goo.gl/YLfEUM> [2015 Photo Gallery](#)

**September 10. NWVRS Fall Swap Meet and Sale. See Ad Page 12.**

September 24. Washington State Convention (Spokane Hamfest) Spokane Valley, WA. *This is an ARRL sanctioned event.* [Flyer in PDF](#) (430K) <http://www.kbara.org/> Contact, Betsy, N7WRQ. [n7wrq@aol.com](mailto:n7wrq@aol.com) (509)448-5821

September 24. K7MVA tailgate Swap Meet, Twin Falls, Idaho. [Flyer in PDF](#). (1.3MB)

October 2 ComFest, Delta, BC. [http://rac.eton.ca/events/detail.php?event\\_ID=1823](http://rac.eton.ca/events/detail.php?event_ID=1823)

October 7th & 8th. 2016 PNWVHFS conference, Bend, OR Pacific Northwest VHF Society Conference. *This is an ARRL sanctioned event.* <http://www.pnwvhfs.org/conference/2016/announcement.htm>

## Monthly Feature

### Members' Choice

Photography by Blake Dietze



George Kirkwood – Superhet



Dan Howard - Insulators

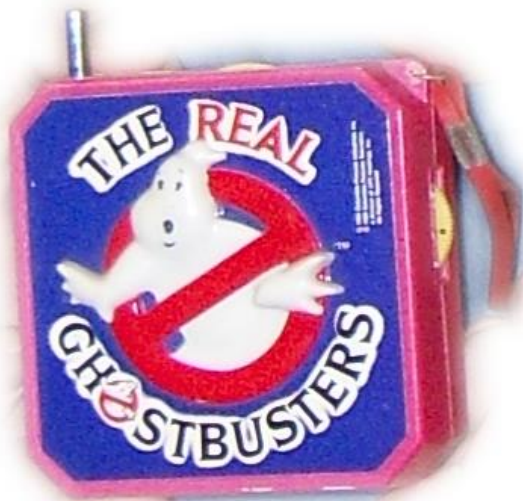

Charlie Kent –  
Ghost Busters





Brian Toon - Zenith TO Lookalike



Jerry Hertel Zenith L403



Dick Howard - Certificates and Licenses



Mike McCrow - Stewart Warner



Bill Weigel - Turntables



Sonny Clutter - Jewell\_533  
(Pics by Sonny – Ed)

Liles Garcia  
- Silvertone



# Hallock and Watson 1932

By Art Redman

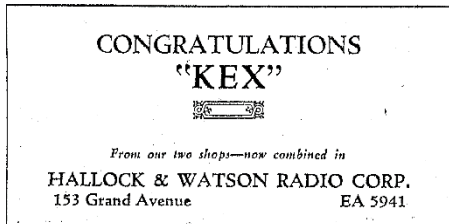

From the Oregonian April 9 1932

## 500-watt Police Transmitter

The big news for the firm of Hallock, Watson, and Yonge in 1932 besides building a radio transmitter for the Portland Police Department, was their merging of the west side and eastside stores in Portland into one location at 153 Grand Avenue, now 833 SE Grande according to the post -1933 address system. The announcement for the move came on April 9, 1932. The firm continued as official dealers for Brunswick, General Electric, and Rola brands and Gilfillan, which they sold since 1927, giving up Fada.

The west store located at 117 Park Street, the corner of SW Park and SW Salmon, for four years was closed. The firm continued its activities in building radio transmitters and special radio shop work. Manufacturing of the Port-a-Pac, their small radio inference locator continued under the supervision of Roy C. Yonge. The Port-a-Pac brand was also the name for their late 1920s superhet. Did Hallock and Watson sell their superhet or updated set as a radio direction finder?

Hallock, Watson, and Yonge bid and won a contract for constructing a 500-watt radio transmitter for the Portland Police: \$11,450 for the transmitter and \$1050 for eight monitor sets made by the Western Auto Supply Company on February 1, 1932. The other bidders were the Deforest Company, Graybar, Western Auto Supply, and Philco. Transmitter tests took place during June and the mayor and police chief dedicated station KGPP, (Government- Portland Police) on July 20, 1932.

Source: "Radio Stores Combined: East and West Side Braches Hallock & Watson Merge. The Oregonian, April 10, 1932, Section Two, page 2.

# Tips and Tangled Cords No. 3

By Blake Dietze

## *IF Transformers #1*

IF Transformers. When they work properly, they're fine. There are far too many failure cases to cover in just one column, so I'm going to divide them into multiple articles. In this installment I'm going to cover the IF coils found in Superhetrodyne radios from the 1930's and 1940's. These are typically in metal cans mounted topside on the chassis and usually have screw adjustments on top or on the side.



There are several common failure modes that can occur:

- Trim caps get dirty, corroded, or worse.
- Connection of coils can fail.
- One or more of the coils can be open.
- Breaks in the connecting wire insulation can short out to the chassis.

Dirty trimmers caps can short out if the dust is conductive. The conductive dust and debris can collect around the base of the trimmer (often out of site) shorting out the trimmer causing the resonant point of that side of the IF transformer to shift or short. You may be able to adjust the trimmer, but it may not peak properly. A thorough cleaning with a toothbrush and contact cleaner once disassembled usually corrects this problem. Use caution when brushing the trimmers, the mica wafers can easily be damaged by the toothbrush or even a blast of compressed air.

Measure the resistance of both sides of the coil to ensure the coils are not open, if they are, start with a good inspection of the IF transformer itself.

If the break is visible, and in a place where it can easily be addressed, fix it. If the break is not obvious and you have a suitable replacement, that may be your best bet.

If you don't have a replacement handy, or your unlucky enough to have a radio with an oddball IF frequency, there is still hope. A handy little trick is to replace the defective winding with a capacitor and resistor. If the primary is open, which is the most likely to fail since it's carrying high voltage to the plate of the previous tube, you can replace the open winding with a capacitor and resistor as shown in figure 1.

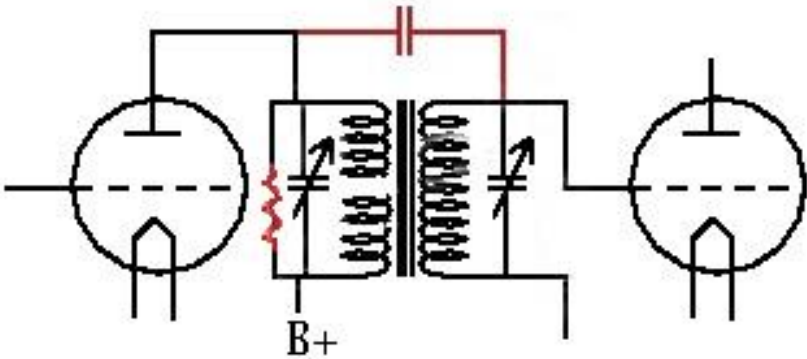

**Figure 1. Replacing an Open Winding**

By replacing the open winding on the primary (left side) with a capacitor around 150pF to 250pF (.00015uF to .00025uF) the signal can still pass to the grid of the next tube while allowing B+ to flow to the plate of the previous tube. You'll need a load resistor (shown in RED) of about 22 - 47KOhms (1 to 2 watts). You will only be able to peak one of the two trim caps and there will be some loss of signal strength, but this trick will work for most of the radios you'll encounter. The same trick can be used on audio transformers, but I'll save that for a later column.

In the next column, I'll cover the IF transformers of the fifties and sixties, their unique issues, and how to address them. We'll focus on the K-Tran and J-Tran Inductively tuned units. Unfortunately these IF transformers are more likely to fail and can't be modified in the same manner, they usually have to be disassembled and modified. That's it for this time; "happy hunting" and "keep 'em playing".

# *Northwest Vintage Radio Society*

presents

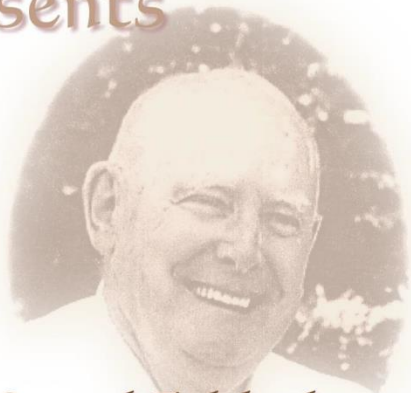

## 4th Annual Speed Feldschau Memorial Swap Meet and Picnic



**SATURDAY, August 13**

**8:am ~ Noon**

Tables Free (while they last). NWVRS will furnish Hot Dogs, Burgers & Drinks. Please bring a Pot Luck Dish. Many radios of all types will be for sale. INFO: Charlie Kent (503) 891-4615

*The music you love to listen to...*

Sunny1550AM33016



*America's best music*

33 rpm

45 rpm

QUARTZ



0%





NW Vintage Radio Society  
P.O. Box 82379  
Portland, Oregon 97282-0379

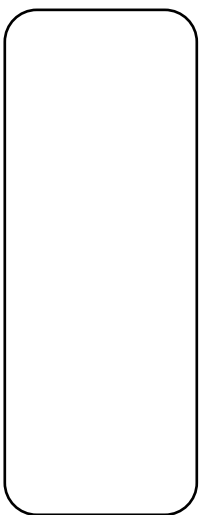
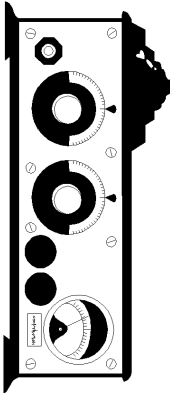

**FIRST CLASS MAIL**