

electronics

SPECIAL

Latest Trends in Microminiaturization —
new approaches, applications in systems,
design problems and research directions

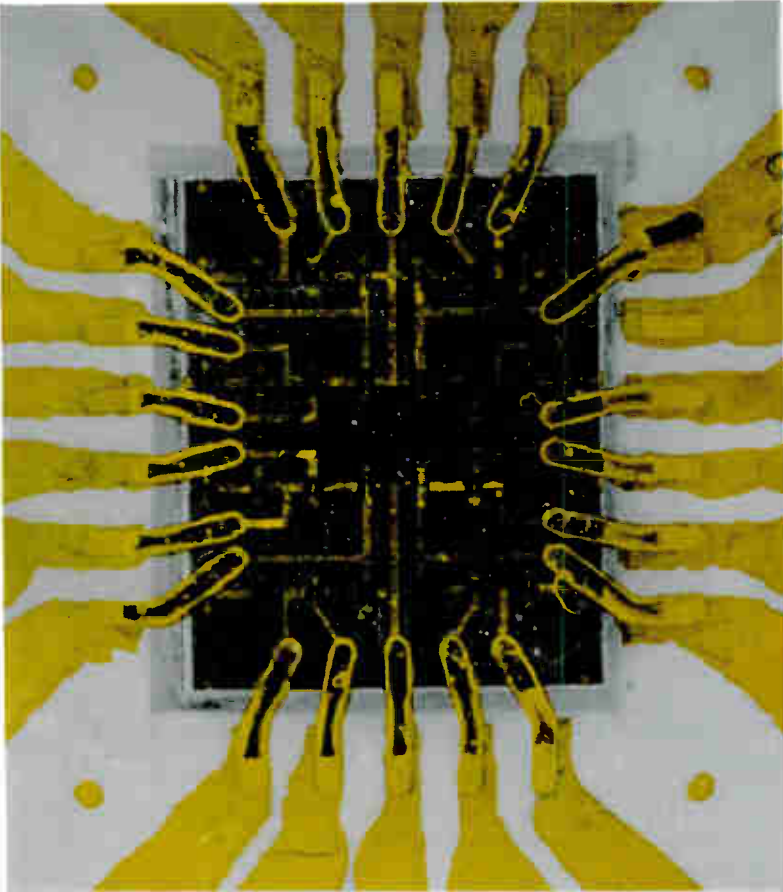

EIGHT-NEIGHBOR NOR gate (above); background shows flip-flop array using insulated-gate field-effect transistors

Dernage



The Counter with a Memory



now measures
to 500 Mc
with better than
10-mv sensitivity

General Radio's Universal Counter now measures to 500 Mc with its new Frequency Converter.

The Converter beats an unknown frequency against 10-Mc multiples of a 5-Mc standard frequency from the Counter, and applies the less-than-10-Mc difference frequency to the 1130-A Counter.

with the *NEW 1133-A Frequency Converter* you get:

- Two selectivity modes — narrow band for measuring low-level signals in noise; wide band for simplified high-level measurements.
- 10-mv sensitivity from 100 kc to 500 Mc.
- Linear mixing circuits to preserve the signal-to-noise ratio of the measured frequency; greatly extends the usefulness of the 1130-A Counter for low-level measurements.
- A unique dial arrangement which presents a large, easy-to-read digital display.
- Panel lights that eliminate guesswork — automatically indicate proper tuned-amplifier setting for narrow-band measurements.

The 1130-A 10-Mc Counter measures frequency, period, ten-period, time-interval, frequency ratios, pulse durations, and events without special plug-in units. A turn of a switch changes conventional intermittent display to continuous counting and display.

The 1130-A uses an inherently reliable decade code . . . does not require fussy, regulated power supplies . . . does not give erroneous readings without warning . . . operates properly under the worst combination of tolerances imposed by tubes, components, and voltages . . . performs properly even when its tubes approach the half-dead state.

Input trigger-level, slope, and attenuator controls permit triggering at any selected point on signal waveform, reducing the effects of noise.

Price of the new 1133-A Frequency Converter is \$1250. The 1130-A Digital Time and Frequency Meter costs between \$2585 and \$2950 depending on time-base stability desired. All prices are U.S. sales prices, f.o.b. Concord, Massachusetts. Write for complete information.

GENERAL RADIO COMPANY

WEST CONCORD, MASSACHUSETTS

in EUROPE
General Radio
Overseas
Zurich, Switzerland

NEW YORK, N. Y., 964-2722
Ridgefield, N. J., 943-3140

CHICAGO
(Oak Park) 948-9400

PHILADELPHIA, 424-7419
Abington, 887-8486

WASHINGTON, D. C.
(Rockville, Md.) 946-1600

SYRACUSE
454-9323

DALLAS
FL 7-4031

SAN FRANCISCO
(Los Altos) 948-8233

LOS ANGELES
469-6201

ORLANDO, FLA.
425-4671

IN CANADA
(Toronto) 217-2171

CIRCLE 900 ON READER SERVICE CARD

electronics

A McGraw-Hill Publication 75 Cents



W. W. MacDONALD, Editor

J. M. CARROLL, Managing Editor
 SENIOR EDITORS: Samuel Weber, George W. Sideris. SENIOR ASSOCIATE EDITORS: Michael F. Wolff, John F. Mason. ASSOCIATE EDITORS: Michael F. Tomaino, Sylvester P. Carter, William P. O'Brien, Sy Vogel, Leslie Solomon, George J. Flynn, Laurence D. Shergalis, George V. Novotny, Leon H. Dulberger. ASSISTANT EDITORS: Nilo Lindgren, Stanley Froud, Stephen B. Gray, Roy J. Bruun, Barry A. Briskman. REGIONAL EDITORS: Harold C. Hood (Pacific Coast, Los Angeles), Thomas Maguire (New England, Boston), Cletus M. Wiley (Midwest, Chicago). ART DIRECTOR: Howard R. Berry. ASSISTANT ART DIRECTOR: John C. Wright, Jr. EDITORIAL ASSISTANTS: Lorraine Rossi, Virginia T. Bastian, Lynn Emery, Ann Mella, Lorraine Werner, Alice M. O'Brien. FOREIGN NEWS BUREAU: Director, John Wilhelm; Alynne Elias, Betsy Wilson. LONDON—John Shinn, Derek Barlow, Nicholas Landon. BONN—Bruce Bendow, Richard Mikton, Silke McQueen. BRUSSELS—Peter Forbath. PARIS—Robert Farrell, Arthur Erikson. MILAN—Marc A. Messina. MEXICO CITY—Wesley Perry, Jr. RIO DE JANEIRO—Leslie Warren. MOSCOW—Stewart Ramsey. TOKYO—Richard Haloran, Charles Cohen, John Yamaguchi.

W. W. GAREY, Publisher

ARRAY OF insulated-gate field-effect transistor flip-flops will be diced into groups of 10 to become decks then interconnected as digital decade scalers in the frequency synthesizer of an ssb transmitter-receiver being built by RCA Labs. These transistors are also used in the eight-neighbor NOR gate shown in the inset; the flexible gold films are deposited between the silicon lands and ceramic package in one evaporation. *For more news on advances in microelectronics, see p 45*

COVER

UNDERSEA TRANSMITTERS Will Locate Missile Impacts. Acoustic signals will link hydrophone arrays to ships. *Atlantic Missile Range will use this system to cover target areas distant from land*

18

HYDROPHONES WILL TRACK SUBS. Here's another acoustic system, in experimental use for the Atlantic Undersea Test and Evaluation Center. *Transmission range is 10,000 yards*

19

INTEGRATED CIRCUITS Go Operational. The orders have gone out for 140,000 integrated circuits for Minuteman. *This wholesale use in ICBM's will put integrated circuits on the shelf for other uses*

26

SATELLITE INSPECTOR Gets Priority. Air Force hopes to put men into command and control space vehicles. *Other chores for manned spacecraft: satellite repair and inspection*

28

VTOL DEVELOPMENT Spurred by Limited-War Needs. Military plans to use vertical-take-off-and-landing planes in counter-insurgency operations. *Here's a rundown on the special electronics needed*

30

SYNCHRONOUS SATELLITES. First of these will be Syncom I, slated for launch this week. *NASA is also planning a synchronous weather satellite system*

32

SPECIAL—ADVANCES IN MICROMINIATURIZATION. This is the year to go micro, many manufacturers assert. A whole new technology has progressed from promise to practice in four short years. This report covers thin films, bulk semiconductor techniques, component-oriented approaches and combinations of all three. *Today the question is not when microminiaturization but how.*

By M. F. Wolff 45

ORBITING GEOPHYSICAL OBSERVATORY: A Look Inside. In a gross parody of Caesar's succinct war communique, the National Aeronautics and Space Administration now talks of "Ogo, Ego, Pogo." *Here's a look inside the complex satellite that will carry 50 different experiments aloft next summer.*

By P. F. Glaser and E. R. Spangler, Space Technology Labs 61

Contents Continued

Published weekly, with Electronics Buyers' Guide as part of the subscription, by McGraw-Hill Publishing Company, Inc. Founder: James H. McGraw (1860-1948).

Title © registered U.S. Patent Office, © copyright 1963 by McGraw-Hill Publishing Co., Inc. All rights reserved, including the right to reproduce the contents of this publication, in whole or in part.

Executive, editorial, circulation and advertising offices: McGraw-Hill Building, 330 West 42nd Street, New York 36, N. Y. Telephone Longacre 4-3000. Teletype TWX N.Y. 212-640-4646. Cable McGrawhill, N. Y. PRINTED IN ALBANY, N. Y.; second class postage paid at Albany, N. Y.

OFFICERS OF THE PUBLICATIONS DIVISION: Shelton Fisher, President; Vice Presidents: Joseph H. Allen, Operations; John R. Callahan, Editorial; Ervin E. DeGraff, Circulation; Donald C. McGraw, Jr., Advertising Sales; Angelo R. Venezian, Marketing.

OFFICERS OF THE CORPORATION: Donald C. McGraw, President; Hugh J. Kelly, Harry L. Waddell, Executive Vice Presidents; L. Keith Goodrich, Executive Vice President and Treasurer; John J. Cooke, Vice President and Secretary.

Subscriptions are solicited only from those actively engaged in the field of the publication. Position and company connection must be indicated on orders. Subscription rates: United States and Possessions, \$6.00 one year, \$9.00 two years, \$12.00 three years. Canada: \$10.00 one year. All other countries \$20.00 one year. Single copies, United States and Possessions and Canada 75c. Single copies all other countries \$1.50.

THE PUBLISHER, UPON WRITTEN REQUEST FROM ANY SUBSCRIBER TO OUR NEW YORK OFFICE AGREES TO REFUND THAT PART OF THE SUBSCRIPTION PRICE APPLYING TO COPIES NOT YET MAILED.

Subscribers: Please address change of address notices, subscription orders or complaints to Fulfillment Manager, Electronics, at above address. Change of address notices should provide old as well as new address, including postal zone number if any. If possible, attach address label from recent issue. Allow one month for change to become effective.

Postmaster: Please send Form 3579 to Fulfillment Manager, Electronics, 330 West 42nd Street, New York 36, New York.



Audited Paid Circulation

CONTENTS continued

TRANSISTOR THERMAL RESISTANCE: Practical Way to Measure It. Thermal resistance and thermal time constant are often specified by the military but procedures for making the required measurements can be confusing. *This article sets forth a simple procedure for thermal testing that satisfies MIL specs.*
By H. Bauman, Kearfott Div., General Precision 66

IMPROVING PULSE RISE TIME With Snap-Off Diodes. Rise times of a fraction of a nanosecond for sampling oscilloscope application can be achieved at recurrence rates of several hundred megacycles. *The secret is to cascade several charge-storage semiconductor diodes.*
By K. C. Hu, RCA Labs 68

NOVEL COINCIDENCE TECHNIQUE for Transistor Decade Counter. Decade counters that use four cascaded binary stages use forced triggering for advancing the count by six units during application of ten input triggers. *This new coincidence technique permits advancing the count one step or more at any stage and is as fast as the basic binary.*
By P. Malhotra and R. P. Parshad, National Physical Lab, New Delhi, India 71

DEPARTMENTS

Crosstalk. <i>Microminiaturization Coming of Age</i>	3
Comment. <i>Women Engineers</i>	4
Electronics Newsletter. <i>Russians Latching Onto Echo II Satellite</i>	7
Washington This Week. <i>Pentagon Preparing Long-Range Study of Contractors' Well-Being</i>	12
Meetings Ahead. <i>International Telemetry Conference</i>	38
Research and Development. <i>Raman Scattering Explains Liquids Lasers</i>	74
Components and Materials. <i>Will Tunnel Cathode Bring New Tubes?</i>	86
Production Techniques. <i>Honeycomb Enhances Cordwood Packaging</i>	94
New Products. <i>Integrated Circuit is Modified DTL</i>	106
Literature of the Week	121
People and Plants. <i>Electro-Optical Systems Expands</i>	124
Index to Advertisers	132

Microminiaturization Coming of Age



PERENNIAL OPTIMISTS and perennial pessimists can be equally detrimental to progress. This thought was brought home to us while gathering material for the special feature on microminiaturization beginning on p 45.

Recent progress in the design and application of integrated circuits, for example, is little short of amazing. Such circuits are now being incorporated into special-purpose digital computers and major military weapons systems (see p 26) despite early reactions resulting from too much ballyhoo on the one hand and too much cold water on the other.

As Harrell Noble, of the Electronics Technology Laboratory at Wright-Patterson AFB, said in our May 11, 1962, issue, when an Air Force team began a search for some new method of simply performing electronic functions back in 1953 they found two people in one laboratory who appeared to know what they wanted. And even these two said technology had not advanced far enough to permit solution of the problem. Others, at the same time, were painting glowing pictures for the future but offering little help.

Who is responsible for the solutions now rapidly being brought to bear? In our opinion just a few solid citizens in the military and industry who refused to be frightened off either by the early ballyhoo or by the imposing technical problems. They said, in effect, "this is what is needed, we have some keys to it, let's find more as fast as we intelligently can and then build it." And they did.

The over-optimistic and the over-pessimistic initially frightened off many good men in the middle who could have contributed greatly to

microminiaturization. This has happened before, and will happen again, in the exponentially-growing electronics industry.

We need more of these men in the middle, men who look ahead, but with good timing and good judgment.

SPACE WORKHORSE. A space vehicle to be launched this summer may turn out to be the DC 47 of orbital flight. Designated OGO (Orbiting Geophysical Observatory) for its initial flight, it is the first general purpose vehicle for space exploration. The basic design may remain frozen for several years.

The purpose of the vehicle (see p 61) is to provide a couple of cubic yards of orbiting laboratory. Instead of the satellite being wrapped around the experiments to be carried aloft, the experiment will be tailored to an off-the-shelf vehicle. The airborne laboratory comes with all modern conveniences including solar cells to supply power, attitude stabilizers and space-to-ground links.

NEW OLD WORLD. India is a country more famous for its metaphysical investigations than its physical research. Yet India has vigorous programs of scientific research on many fronts. Besides the industrial and university laboratories, there are government supported research establishments that investigate the same natural phenomena that scientists in the Western world have been probing.

Quite recently too, several American and European firms have set up subsidiaries there, and will build laboratories for fundamental research. Many Indian engineers and scientists obtain their graduate training in America and Europe, frequently returning to industrial posts in India with a broader technological background than many a home-grown American Ph.D.

As proof of the pudding this week, we are publishing an article (p 71) by staffers of the Indian National Physical Laboratory, in New Delhi—a laboratory that closely parallels our own National Bureau of Standards. The report is on a new method of speeding up a binary counter, using feedback.

VERY NARROW

10kc*

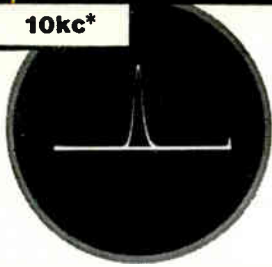

TO VERY WIDE

400mc**

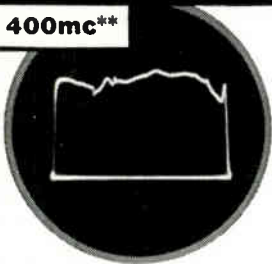

SWEEP WIDTHS
... all in one instrument

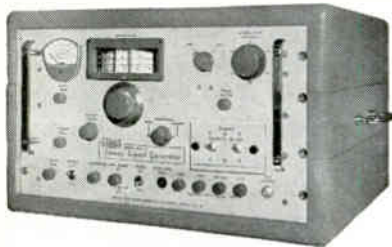

NEW JERROLD® 900B
SWEEP SIGNAL GENERATOR

The new Jerrold 900B is the last word in versatility and precision, the ultimate instrument for all your IF, VHF, and UHF sweep requirements. Bench space requirements and test set-up time are drastically cut because so much is already built in:

- Built-in crystal-controlled harmonic markers at 1, 10, and 100mc intervals.
- Built-in variable-gain dc or ac-coupled 'scope preamplifier with 200X maximum gain.
- Built-in precision attenuator from zero to 50db in 10db steps.

Generating sweeps with center frequencies ranging from 500kc to 1200mc, the 900B offers unusual stability with sweep widths as narrow as 10kc and as wide as 400mc. Write for complete technical data.

\$1,980.00 f.o.b. Philadelphia

*Typical communication receiver IF (selectivity approx. 6 kc).

**Frequency response of typical wide-band distributed amplifier (4-216 mc).

JERROLD ELECTRONICS CORPORATION
Industrial Products Div. • Philadelphia 32, Pa.



A subsidiary of THE JERROLD CORPORATION

COMMENT

Women Engineers

In response to the letter from Mrs. Coleman (Comment, p 4, Dec. 12, 1962):

Mrs. Coleman is perhaps not aware of the widespread efforts of the Society of Women Engineers to seek out engineering talent among women, and to encourage their development both as engineering professionals and as happy, fulfilled individuals.

I do not agree with Mrs. Coleman. There are women engineers. They earn excellent salaries. They are happy in their work—and they are lucky enough to be living the lives they chose to lead. There will be more and more of them as the years roll on. But in our highly-valued home- and family-oriented culture, women alone will never solve the engineering shortage. We must look to better utilization of all our trained engineering manpower—including both men and women—to do that.

But I will say this: If you know a girl with technical talent who really wants to be an engineer—by all means encourage her in her aspirations. For by so doing you will help her to do in life what she really wants to do—and that, after all, is the only sure road to her happiness and your freedom! What kind of an engineer she becomes is up to her; but whether she becomes one at all may well be up to you.

AILEEN CAVANAUGH

Society of Women Engineers
New York, New York

Flat-Plane vs End-Fire Antennas

Concerning your article entitled New Telemetry Antenna Adds Flexibility (p 48, Feb. 1), certain fundamental properties of end-fire arrays in general, and more recent work in particular, require further consideration. We have found the following:

Mechanical: A four-element array of about 8 ft square and 6 ft deep has the same gain as an approximately 12 ft square \times 2 ft deep conventional dipole mattress array. The end-fire array has a quasicubical shape with the center

of pedestal axes intersection at the center of gravity and close to the center of wind pressure from all aspects. This results in lower inertia, no overhung mass, much smaller swept volume and more flexibility since counterweights and wind sails are not required. Safe antenna stowage is thus achieved at any orientation.

Electrical: Boresight errors due to polarization and frequency are mainly caused by unbalance of the antenna radiators. A four-element end-fire array constitutes only a two-element interferometer; its element number n (advantage \sqrt{n}) has resulted in total combined measured boresight errors due to polarization and frequency of less than 0.05 deg, an order of magnitude less than figures quoted.

In addition, end-fires permit simultaneous multiple frequency band operation while mattress arrays are often considerably less flexible. In such other areas as polarization diversity, method of track, etc., both techniques can be equal.

Reliability: Since an end-fire antenna employs few active elements and makes up its gain by the parasitically excited end-fire directors, fewer transmission losses, radiator matching structures, and power divider components will be required. This reduces the number of failures that may occur at various interconnecting points and critical local areas.

JOHN PARRY

Technical Planning

Avien, Inc.
Woodside, N.Y.

Variable-Width Pulses

In reference to my article, How to Produce Variable Width Pulses (p 48, Dec. 21, 1962):

In Fig. 1, resistor R_3 should not be connected to the collector of transistor Q_2 , but to -24 volts. And diode D_2 should be a PS005.

In Fig. 2, resistor R_2 should go to $+18$ v.

IRVING SIMON

Monroe Calculating
Machine Co.
Orange, New Jersey

LAMBDA

LA SERIES

Convection Cooled Transistorized REGULATED POWER SUPPLIES

**IMMEDIATE
DELIVERY
FROM
STOCK**

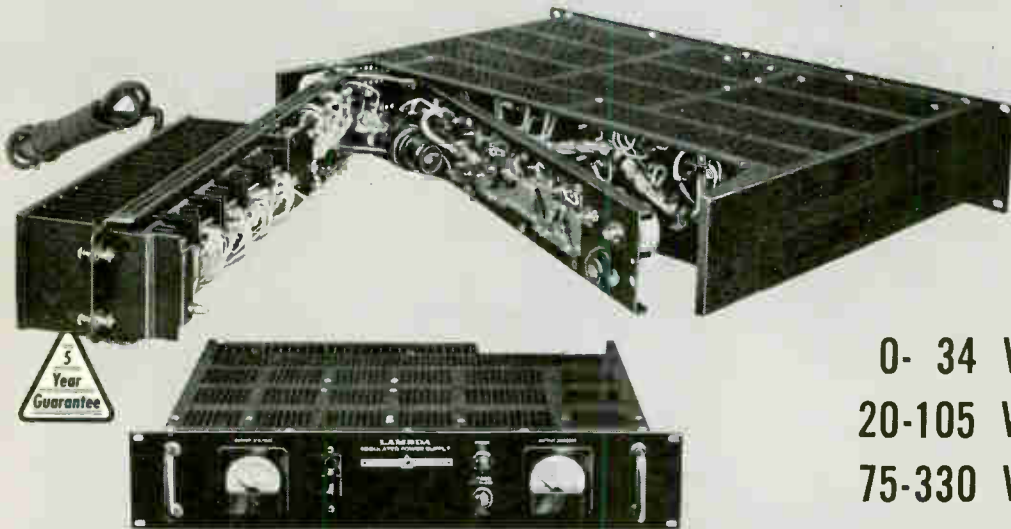

LA SERIES

0- 34 VDC 5, 10, 20 AMP
20-105 VDC 2, 4, 8 AMP
75-330 VDC 0.8, 1.5, 3 AMP

SPECIAL FEATURES

- Convection Cooled—No internal blowers or filters—maintenance free
- Ambient 50°C
- No Voltage Spikes or overshoot on "turn on, turn off," or power failure
- Guaranteed 5 years
- Remote programming over Vernier band
- Hermetically-sealed transformer designed to MIL-T-27A
- Easy Service Access
- Short Circuit Proof
- Constant Current Operation—Consult Factory

ALL MODELS 105-140 VAC INPUT

CONDENSED DATA—LA SERIES

DC OUTPUT (Regulated for line and load)

Model	Voltage Range ⁽¹⁾	Vernier Band ⁽²⁾	Current Range ⁽³⁾	Price ⁽⁴⁾
LA 50-03B	0- 34 VDC	4 V	0- 5 AMP	\$ 350
LA100-03B	0- 34 VDC	4 V	0-10 AMP	465
LA200-03B	0- 34 VDC	4 V	0-20 AMP	685
LA 20-05B	20-105 VDC	10 V	0- 2 AMP	350
LA 40-05B	20-105 VDC	10 V	0- 4 AMP	495
LA 80-05B	20-105 VDC	10 V	0- 8 AMP	780
LA 8-08B	75-330 VDC	30 V	0- 0.8 AMP	395
LA 15-08B	75-330 VDC	30 V	0- 1.5 AMP	560
LA 30-08B	75-330 VDC	30 V	0- 3 AMP	860

Regulation (line) Less than 0.05 per cent or 8 millivolts (whichever is greater). For input variations from 105-140 VAC.

Regulation (load) Less than 0.10 per cent or 15 millivolts (whichever is greater). For load variations from 0 to full load.

Ripple and Noise Less than 1 millivolt rms with either terminal grounded.

Temperature

Coefficient Less than 0.025%/°C.

(1) The DC output voltage for each model is completely covered by four selector switches plus vernier range.

(2) Center of vernier band may be set at any of 16 points throughout voltage range.

(3) Current rating applies over entire voltage range.

(4) Prices are for unmetred models. For metred models add the suffix "M" and add \$30.00 to the price.

AC INPUT

105-140 VAC, 60 ± 0.3 cycle⁽⁵⁾

(5) This frequency band amply covers standard commercial power line tolerances in the United States and Canada. For operation over wider frequency band, consult factory.

Size

LA 50-03B, LA20-05B, LA 8-08B 3½" H x 19" W x 14¾" D
LA100-03B, LA40-05B, LA15-08B 7" H x 19" W x 14¾" D
LA200-03B, LA80-05B, LA30-08B 10½" H x 19" W x 16½" D

SEND FOR COMPLETE LAMBDA CATALOG.



LAMBDA ELECTRONICS CORP.

515 BROAD HOLLOW ROAD • HUNTINGTON, L. I., NEW YORK • 516 MYRTLE 4-4200

Western Regional Office: 230 North Lake Avenue, Pasadena, California • Phone: Code 213, MUrray 1-2544

New England Regional Office: 275 Boston Post Road, Marlboro, Massachusetts • Phone: Code 617, HUNtley 5-7122

Middle Atlantic District Office: 515 Broad Hollow Road, Huntington, L. I., New York • Phone: Code 516, MYRtle 4-4200

Southeastern Region: W. A. Brown & Associates, Inc., Engineering Representatives

Orlando, Fla. • Fort Lauderdale, Fla. • Huntsville, Ala. • Alexandria, Va. • Winston-Salem, N. C.)

sensitivity: 200 microvolts/cm

bandwidth: 500 kilocycles

identical amplifiers

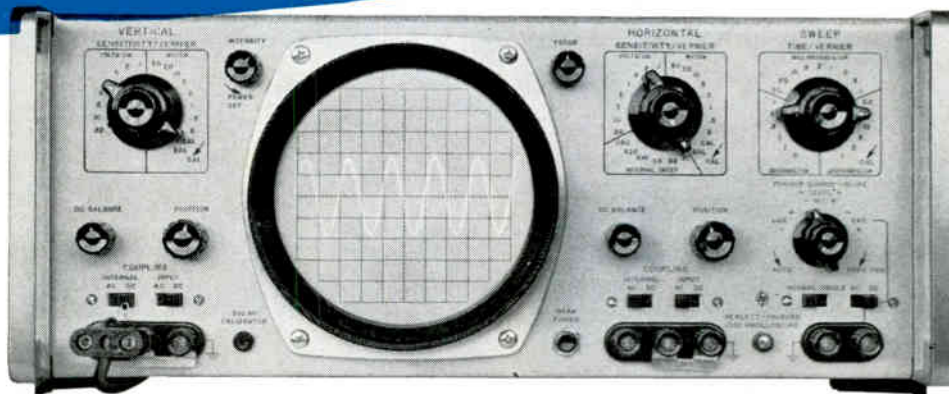

IN ONE SCOPE, hp 130C, \$695

The 130C Oscilloscope features identical amplifiers, 200 $\mu\text{v}/\text{cm}$ sensitivity, and a 500 kc bandwidth. Measures low-level signals directly without preamplification. Ideal for viewing output from transducers, strain gauges, small signals in solid state devices, detected rf, medical, physical phenomena and phase shift. In addition, a x2 to x50 magnifier expands waveforms for detailed measurements. Automatic triggering and beam finder simplifies operation while a no-parallax and no-glare CRT permits more accuracy.

The specifications tell the complete story. Look them over, then call your nearest Hewlett-Packard representative for a demonstration of this remarkable scope in your own lab.

SPECIFICATIONS

SWEEP GENERATOR

Internal Sweep: 21 ranges, 1 $\mu\text{sec}/\text{cm}$ to 5 sec/cm, accuracy within $\pm 3\%$; vernier provides continuous adjustment between ranges and extends slowest sweep to at least 12.5 sec/cm
Magnification: x2, x5, x10, x20, x50, accuracy within $\pm 5\%$ of sweep rates not exceeding a maximum rate of 0.2 $\mu\text{sec}/\text{cm}$

Automatic Triggering: Base line displayed in the absence of input signal; internal, 50 cps to 500 kc signal causing 0.5 cm or more vertical deflection, also from line voltage; external, 50 cps to 500 kc, 0.5 v p-p; trigger point, zero crossing, positive or negative slope

Amplitude Selection Triggering: Internal, 10 cps to 500 kc, 0.5 cm or more deflection; external, dc to 500 kc, 0.5 v p-p or more; trigger on any point on waveform, positive or negative slope.

Single Sweep: Front panel switch

VERTICAL & HORIZONTAL AMPLIFIERS

Bandwidth: DC Coupled: dc to 500 kc; ac coupled (at input): 10 cps to 500 kc; ac coupled (in amplifiers for trace stabilization): 25 cps to 500 kc at 0.2 mv/cm sensitivity; lower cut-off

is reduced proportional to sensitivity down to 20 mv/cm where it is 0.25 cps

Sensitivity: 0.2 mv/cm to 20 v/cm; 16 ranges in 1, 2, 5, 10 sequence; attenuator accuracy, $\pm 3\%$; vernier extends minimum sensitivity to 50 v/cm

Internal Calibrator: Approx. 350 cps square wave, 5 mv $\pm 3\%$
Input Impedance: 1 megohm shunted by 45 pf, constant on all sensitivity ranges

Balanced Input: Available on all sensitivity ranges

Phase Shift: Within $\pm 1^\circ$ relative phase shift to 100 kc

GENERAL

External Calibrator: Approximately 350 cps, 500 mv $\pm 2\%$, front panel input

Cathode Ray Tube: 10 x 10 cm internal graticule type, P31 phosphor standard, P-2, P-7 and P-11 available, same cost

Intensity Modulation: Terminals on rear; +20 volt pulse blanks CRT at normal intensity

Power: 115/230 volts $\pm 10\%$; 50 to 1000 cps approx. 90 watts

Size: 16 $\frac{3}{4}$ " wide, 7-5/16" high, 16 $\frac{3}{8}$ " deep; brackets furnished for quick conversion to 7" x 19" rack mount; 32 lbs.

Price: \$695

Price f. o. b. factory. Data subject to change without notice.

HEWLETT-PACKARD COMPANY

1501 Page Mill Road, Palo Alto, California, Area Code 415, DA 6-7000. Sales and service representatives in all principal areas; Europe, Hewlett-Packard S.A. 54 Route des Acacias, Geneva; Canada, Hewlett-Packard (Canada) Ltd., 8270 Mayrand Street, Montreal

8242

Soviets Latching Onto Echo II Satellite

U.S. AND SOVIET plans for cooperative experiments with the Echo II passive communications satellite balloon (p 7, Dec. 14, 1962) are firming up. Technical arrangements are expected to be ironed out when Hugh L. Dryden, NASA's deputy administrator, meets with his Soviet counterpart in Rome next month.

Facsimile, teletypewriter, telephone and radio signals may be bounced for about 15 minutes a week between the ground station at Andover, Me., and one in western Russia.

Construction of an American ground station in Alaska is reportedly being considered for communication with a Soviet station in Siberia. This could increase communications time considerably. The two stations would be in sight of Echo for much longer periods.

Meanwhile, the U.S. plans to use Echo II for tests of transmission medium characteristics, to study modulation and demodulation, and to analyze acquisition, tracking and orbital data. USAF will use a communications terminal at Floyd, N.Y., transmitter at Trinidad, and transportable station near Buffalo, N.Y.

Instead of inflating Echo with low-pressure gas, NASA may try dividing it into sections and filling each with high-pressure gas to eliminate the danger of rupture from sudden total inflation. Should NASA make the change, the launch date would be rescheduled. Launch is now planned for spring.

Duobinary Coding Speeds Up Data Flow

DUOBINARY CODING will speed up radio and telephone-line data transmission to 2,400 bits a second, or 3,200 words a minute, according to General Telephone & Electronics. System developed by Lenkurt should result in broader and more economical use of communications facilities, GT&E claims. The coding

technique is to convert binary 1's to either plus or minus pulses with a multivibrator according to the pattern of intervening binary 0's. The 0's remain unchanged. System can be used with any linear modulation method but f-m is most suitable.

Coherent Green-Light Source Is Achieved

INTENSE, coherent light in the green spectrum has been generated by Lear Siegler using an infrared laser and harmonic generating material. The company thinks it could pave the way for underwater laser communication and surveillance techniques. However, a true green laser, one generating coherent green light directly, has yet to be achieved. Many researchers are attempting to perfect a green laser.

So far, the device has put out

over 10 Kw of coherent radiation with a bandwidth of 2 angstroms centered on 5,300 angstroms. Peak powers of several megawatts may be obtained soon. An output beam from a neodymium-doped glass laser is projected into a nonlinear crystal (KDP or ADP) that generates a second harmonic with a wavelength of 0.53 microns. Beam width of the emitted green light is approximately 1 milliradian. The multiplier has a conversion efficiency of 1 to 3 percent. It was developed at LSI's Laser Systems Center, formerly Trion Instruments.

New Optical Diode and Transistor Are Planned

BOSTON—Solid-State device group at MIT Lincoln Laboratory is preparing experimental techniques for fabrication of high-speed photodiode and beam-of-light transistor,

Ring of Lasers Acts as Gyroscope

GYROSCOPE without moving parts may result from Sperry laser system (p 7, Feb. 8) that measures rate of rotation.

Four helium-neon lasers in series along a closed optical path emit identical coherent light beams, one clockwise and one counterclockwise. When the entire device is rotated, optical light path length in each direction effectively changes, since the speed of light is constant, and the frequencies of the two beams are altered in opposite directions. Beat note picked up in one corner is used for direct digital indication of rate of rotation and, when integrated, for total amount turned.

In a demonstration last week, laser beams of 2.61×10^{14} cps produced beat frequencies in the audio range, achieving a resolution of 2 degrees per minute. Resolution, said Sperry scientists, is limited

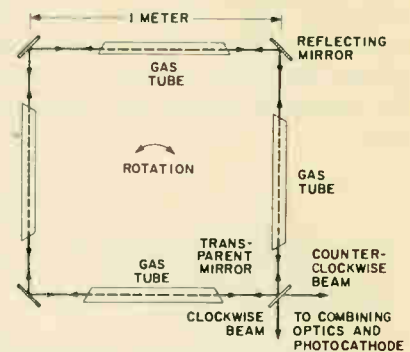

only by ability of detecting instruments to pick up and measure extremely low beat frequencies.

Sperry expects to develop a practical device under an Air Force contract. Ring laser devices will be insensitive to linear accelerations, gravity forces and vibrations, Sperry indicated. Absence of intricate mechanical parts machining would make production costs low

both device structures based on gallium-arsenide heterojunctions. Proposed diode would be high-speed photodetector for radiation emitted from either coherent or incoherent gallium arsenide diode infrared source. The new transistor would have infrared-emitting gallium-arsenide *p-n* junction as emitter and an *n*-gallium arsenide, *p*-germanium heterojunction as collector.

Among advantages of beam-of-light transistor predicted by Lincoln Lab design group is use of very low lifetime material, thus possibly opening transistor field to variety of low-lifetime semiconductor materials.

Ask Australia to Join British Satellite Plan

MELBOURNE — Australian government will be presented this week with a plan to join a \$450-million Commonwealth communications satellite scheme. Basil de Ferranti of Britain's Ferranti Ltd., partner in British Space Development Corp., says Australian share would be about one tenth of total cost and would provide 1,000 telephone channels to Britain and one tv channel. Australia now has 10 telephone channels to Britain. Project would reduce cost of telephone calls between the two countries by half, de Ferranti said. System would use twelve satellites orbiting 7,000 miles above the equator and could be operative within five years, he said.

New Satellite Series to Get Atomic Power Supply

WASHINGTON—AEC is negotiating a \$180,000 contract with Martin Marietta to develop a 20-watt Snap for NASA's satellite Imp (Interplanetary Monitoring Probe). The new Snap will probably be a scaled-down Snap 9-a, the 25-watt, plutonium-fueled device being developed by Martin for Navy's Transit navigation satellite.

Imp is designed to collect radiation and magnetic field data from around 110 miles to 150,000 miles from earth. Seven or more Imps

are now in the program. Part of their mission is to provide solar flare predictions for Apollo.

NASA wants to fly an Imp satellite powered by two Snaps in about 20 months. Weight limit for both Snaps is 45 lb. Meanwhile, at least two other Imps with solar power will be flown, starting this fall. The 130-lb satellite is being developed by Goddard Space Flight Center.

Two Computer Makers Will Exchange Patents

DETROIT—Burroughs and IBM have entered into a licensing agreement under which each makes its patent rights covering information handling systems available to the other. The agreement is retroactive, covering all existing patents, plus any that may be developed in the five years beginning February 7.

A Burroughs source stated that Burroughs does not feel it gained any immediate advantage, that the object was freedom to pursue research without worrying whether the two companies might be traveling a parallel path. There will be no exchange of prepatent information. Similar agreements have been made between IBM and RCA and Sperry Rand.

Radar Antenna Tilts Beam Electronically

LONDON—Radar height-finding antenna developed by Marconi's Wireless Telegraph Co. tilts the beam by frequency-sweeping, using a delay line. Full performance details are still classified but antenna sidelobes are 32 db down on the main beam and the vertical scanning are exceeds 70 degrees. Data acquisition is faster due to the inertialess tilting and the integration of the height finding and surveillance radars. An experimental 10-cm swept-frequency antenna has been successfully tested up to 3-Mw peak power.

Frequency sweeping technique uses a 12½-foot-long, helically wound waveguide as a delay line to illuminate a duraluminum cylindrical parabolic reflector. Another approach is to stack zigzag coaxial delay lines rectangular matrix.

In Brief . . .

AIR FORCE estimates each of the 1,000 Phantom aircraft it is buying (see p 12) will carry about \$250,000 in airborne electronics.

ARMY will buy \$20.2-million worth of AN/PRC-25 man-packed transistor radio sets in the year starting July 1.

ELECTRICAL wiring problems in the Atlas 130-D will delay Astronaut Leroy Cooper's Mercury orbital flight, which had been scheduled for April.

MAJOR JAPANESE set makers will bring out 16-inch color-tv sets with 90-degree-deflection picture tubes this spring. New size is being introduced in an attempt to make set acceptable to both domestic and export markets.

FAIRCHILD STRATOS will build a two-ton meteoroid detection satellite costing up to \$10 million, for NASA. Aluminum-Mylar skins of 96-foot-wide wings will act as huge capacitors, discharged upon each penetration by a meteoroid, providing signal pulse.

RCA OFFICIALLY announced this week its development of an insulated-gate field-effect transistor (see p 45).

ON FEBRUARY 25, small business firms will be sent invitations to bid, by Air Force Electronic Systems Division, Bedford, Mass., for programmed instruction techniques to train personnel in trouble-shooting at Sage sites.

MAGNAVOX has a \$4.8-million contract from Air Force for airborne uhf communications equipment. Gear will be shipped to Germany under NATO agreements.

ILS LOCALIZER antenna installed at London Airport by Standard Telephones and Cable, an ITT associate, is 160 feet wide, twice standard size. Beam is only 4 degrees wide. With its aid, the first completely automatic landing in fog has been made at the airport, ITT says.

New from Sprague!

2 x μ F

Get nearly twice the capacitance of older designs in Sprague's new high-gain etched-foil TANTALEX[®] Capacitors

IMPROVE FILTERING EFFICIENCY WITH NO SACRIFICE IN RELIABILITY, SIZE, OR WEIGHT!

HIGH CAPACITANCE Tubular Tantalex Capacitors with almost double the capacitance of standard etched-foil tantalum capacitors have been developed by the Sprague Electric Company to meet the needs of design engineers.

A new etching technique, the result of an intensive research program, gives considerably higher effective surface area to the capacitor electrodes *without sacrifice in reliability or in any of the electrical parameters* by which foil tantalum capacitors are usually judged.

Unlike other "high capacitance" foil tantalums, Sprague Tantalex Capacitors continue to maintain their rigid standards for shelf and service life under severe environmental conditions. Certain performance characteristics have actually been tightened. For example, allowable leakage current has now been halved, making the use of these capacitors possible in many new applications.

Etched-foil Tantalex Capacitors are available in two operating temperature ranges—polarized Type 112D and non-polarized Type 113D for -55°C to $+85^{\circ}\text{C}$ operation, as well as polarized Type 122D and non-polarized Type 123D for -55°C to $+125^{\circ}\text{C}$ operation.

The Foil-type Tantalex Capacitor Line also includes conventional low-gain etched-foil and plain-foil capacitors in both polarized and non-polarized construction, providing a foil tantalum capacitor for every application.



For complete technical data on 85 C capacitors, request Engineering Bulletin 3601B. For the full story on capacitors for 125 C operation, write for Engineering Bulletin 3602B. Address Technical Literature Section, Sprague Electric Company, 35 Marshall Street, North Adams, Massachusetts.

SPRAGUE COMPONENTS

CAPACITORS
TRANSISTORS
MAGNETIC COMPONENTS
RESISTORS
MICRO CIRCUITS

INTERFERENCE FILTERS
PULSE TRANSFORMERS
PIEZOELECTRIC CERAMICS
PULSE-FORMING NETWORKS
TOROIDAL INDUCTORS

HIGH TEMPERATURE MAGNET WIRE
CERAMIC-BASE PRINTED NETWORKS
PACKAGED COMPONENT ASSEMBLIES
FUNCTIONAL DIGITAL CIRCUITS
ELECTRIC WAVE FILTERS



*Sprague' and '®' are registered trademarks of the Sprague Electric Co.

IN NEW KODAK CAMERAS

... the Motomatic 35F and Automatic 35F ... power for operation of built-in flash units is supplied by Mallory Mn-9100 "N" size cells, which have exceptionally high energy in tiny size, and hold their capacity when left idle in the camera for long periods of time.

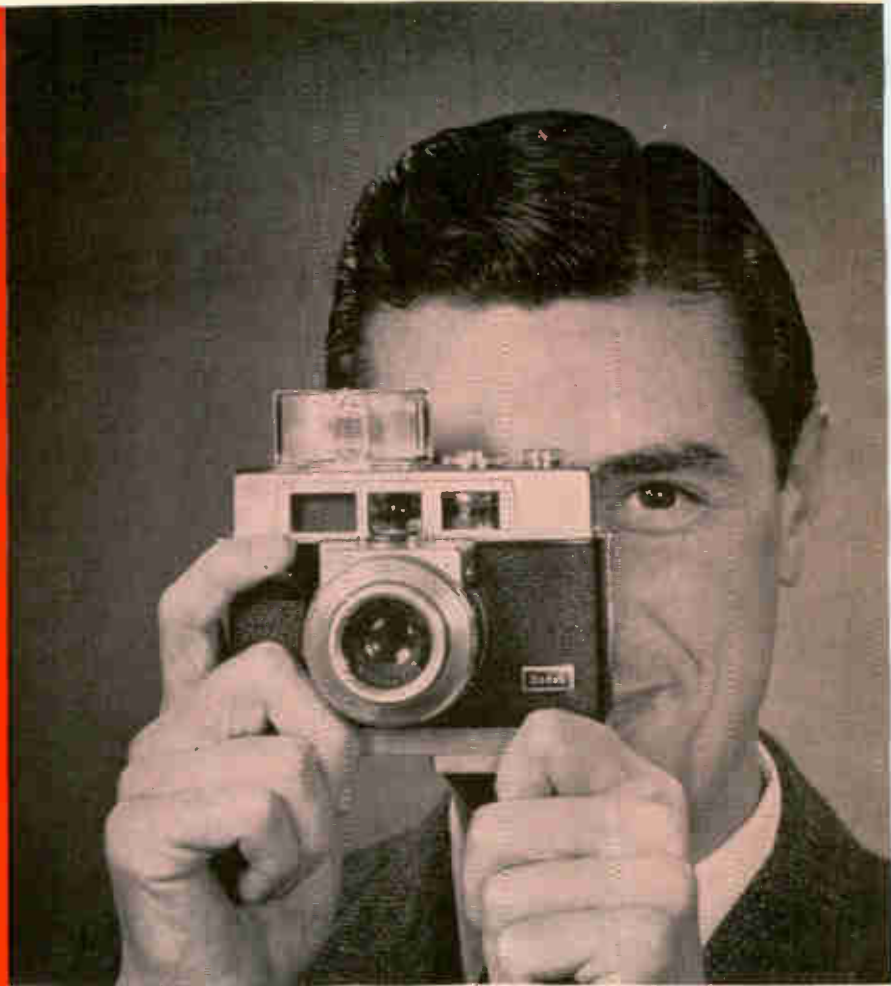

Design extra customer appeal into your products

PORTABLE RECORDER

made by Emcee Electronics, Inc., uses a Mallory Mercury RM-42R battery to deliver 0.2 mill amp continuous to the bridge circuit ... and a Mallory Mercury RM-12R battery as a precise reference voltage source for the standardizing circuit. Stable output of these batteries minimizes need for standardization of the circuit, helps assure accuracy of measurements. Expected life is a year or more.



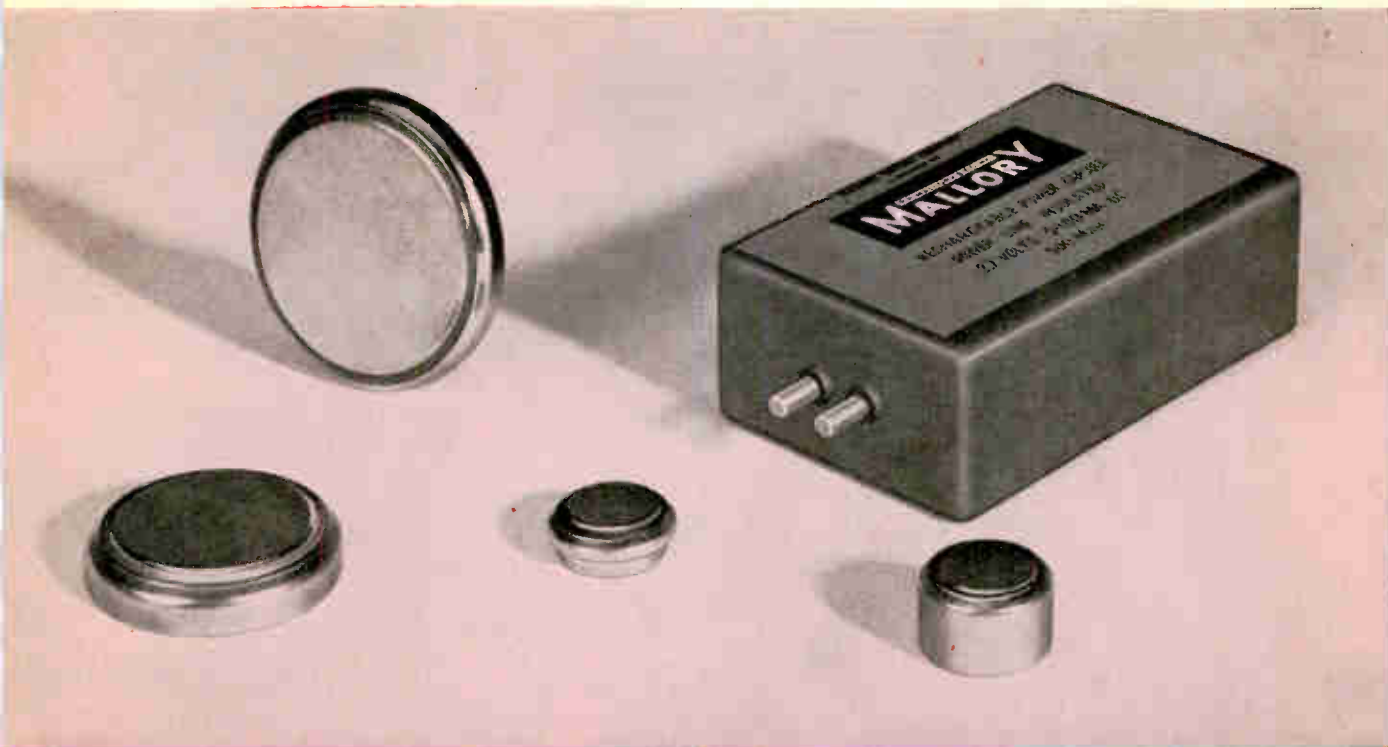

NEW RECHARGEABLE MERCURY BATTERIES

A different kind of sealed rechargeable battery... can hold its full charge for a year or more, has high primary capacity, and can be recharged for at least 100 cycles. Self-vented, non-leaking. Four cell sizes, with recharge capacities of 70, 120, 300 and 500 milliampere-hours,

rated for maximum drains of 10, 15, 50 and 250 milli-amperes. Nominal output is 1.2 volts per cell. Flat voltage-time discharge characteristic. Supplied with solid state self-regulating trickle charge circuit. Also available as complete, UL-approved power capsule for charging from 110-volt AC outlet.

with high-performance Mallory Batteries

Miniaturization . . . convenience . . . reliability . . . these are sales-boosting values that you can build into your new products, by using Mallory Batteries.

Leader in development and manufacture of high-performance batteries, Mallory has a broad range of battery systems that may help you generate new ideas in the use of packaged power:

Mallory Mercury Batteries . . . especially useful in low to moderate drain electronic circuits; 3 to 4 times more energy per unit volume and more milliampere-hour life than ordinary batteries; shelf life of 6 years or more. They're unique in their ability to deliver steady voltage throughout their long life. No-load output voltage is constant to $\pm 1/2\%$. In many sizes, including miniature types small as an aspirin tablet.

Mallory Manganese Batteries . . . new alkaline system

for medium and high drain service; dependability and shelf life comparable to Mallory Mercury Batteries; service life far greater than ordinary batteries in photographic, lighting, motor drive and similar applications. Many standard cell types.

Rechargeable Mercury Batteries . . . a new kind of renewable power source with exceptional performance.

Solidion® Solid State Batteries . . . high voltage in miniature size, extremely long storage life . . . for micro-ampere drains.

Mercury-Zinc Carbon Batteries . . . long-life system especially useful in cordless clocks and other low drain service.

Write today for technical data, and for a consultation on your requirements.

*Mallory Battery Company
North Tarrytown, N.Y.*

THE MALLORY CO. INC.
MALLORY

*Mallory Battery Company of Canada Limited, Clarkson, Ontario
Mallory Batteries, Ltd., Crawley, England*

WASHINGTON THIS WEEK

PENTAGON IS STUDYING ITS CONTRACTORS' WELL-BEING

PENTAGON is preparing a "comprehensive white paper" on the impact of government procurement policies on the defense and space industries. It will define fundamental issues to be ironed out by the Defense Department and industry over the next decade.

Among the key questions: How to preserve maximum private enterprise for companies essentially in a "captive" industry with one customer? What earnings level will sustain a healthy industrial base? How to absorb major changes in development and production programs resulting from technology, global politics, even disarmament?

Assistant Defense Secretary Thomas Morris, in charge of DOD logistics policy, plans to use the paper as a long-range agenda for Defense Industry Advisory Council meetings.

ASW DESTROYER MAJOR R&D TASK FOR NAVY

ANTISUBMARINE-WARFARE destroyer escort proposed by Navy would be designed from the keel up for ASW service—the first Navy ship so designed and the first new class of Navy vessels in many years. It would be crammed with electronic equipment. Navy plans to devote a significant part of its fiscal 1964 R&D effort to the ship. First prototype and the program are to be called *Sea Hawk*.

FCC ORGANIZES UHF BROADCAST ADVISORY PANEL

INDUSTRY ADVISORY GROUP will help FCC deal with problems in developing uhf broadcasting. To be organized at the National Association of Broadcasters' convention in Chicago next month, the group signifies FCC eagerness to avoid in uhf the painful experiences of early f-m broadcasting. The group, headed by Commissioner Robert E. Lee, will provide a "continuing forum," allowing FCC to take timely action on uhf problems. An early objective will be to encourage industry and the public to think of an "all-channel" tv system, instead of uhf and vhf.

Industry cooperation—led by EIA—on all-channel tv set questions pleased FCC. EIA is expected to play a key role again, but the new group will be broadly based, including NAB, the Association for Competitive Broadcasting, educational broadcasting associations, tv networks and "others who believe they could contribute." The organization has Justice Department approval on antitrust grounds, but must stick to general problems.

AIR FORCE BUYS 1,000 NAVY PLANES

AIR FORCE'S buy of McDonnell Aircraft's F4H Phantom II tactical fighter (F-110) will total more than 1,000 planes over a five-year period and cost some \$2 billion. Navy is also buying several hundred more.

Fire control equipment on the Air Force and Navy versions is expected to differ. One important mission, in the Air Force, will be supporting ground troops, putting stress on air-to-surface capabilities. Navy has "optimized" air-to-air fire control for interceptor missions.

Air Force selected the Navy-developed plane last year and has just received first deliveries. Electronic subcontractors include Texas Instruments, Bendix, Litton Industries, General Electric, Hydon Manufacturing and Electronic Specialty.

Signetics offers three ways to planar integrated circuits:

STANDARD

DTL
logic
circuits

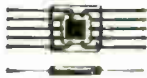

off-the-shelf

We can give you immediate delivery on any of our standard circuits. Our standard line includes: NAND/NOR Gate, Buffer, Multi-Purpose Flip-Flop, Diode Array, and Exclusive-OR Network. Each of these circuits provides a maximum noise rejection and the highest speed possible on low power consumption. And each is a product of the most refined degree of planar technology today. Your choice of TO-5 can or flat modular packaging. Write for complete details: 680 West Maude Avenue, Sunnyvale, California.

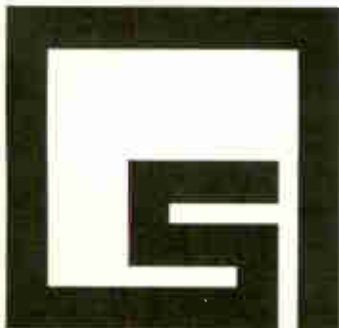

SIGNETICS INTEGRATED CIRCUITS

variFEBS®

customized
digital or
linear circuits



3 weeks

This is the quickest and most economical way to get integrated circuits made to meet your requirements. Here's how it works. Take any of our standard circuits. (They all have 500 MC transistors, 3 nsec diodes, 60 pf capacitors, and resistors up to 20 K.) And redesign the interconnection patterns. Then we'll integrate your interconnection patterns onto the silicon chip. Your choice of TO-5 can or flat modular packaging. Write for complete details: 680 West Maude Avenue, Sunnyvale, California.

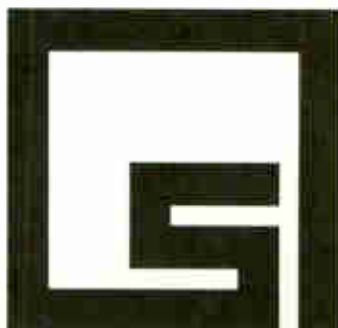

SIGNETICS INTEGRATED CIRCUITS

preFEBS®

custom digital
or linear
circuits



8 weeks

Here's the newest concept in integrated circuits. You design your own linear or digital circuit. Breadboard it with individually packaged transistors, resistors, diodes and capacitors from our stock. (These components have their associated parasitic capacitance and will duplicate the performance in the final integrated circuit.) Then return the circuit to us. And we'll integrate it. Your choice of TO-5 can or flat modular packaging. Write for complete details: 680 West Maude Avenue, Sunnyvale, California.

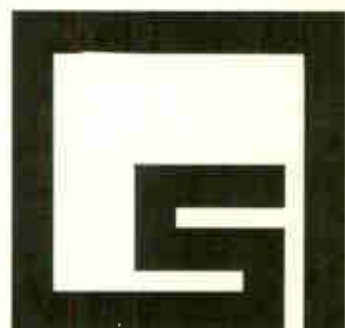

SIGNETICS INTEGRATED CIRCUITS

Kodak advertises:

how to look around in the tunnel . . . sweetness and light through capacitance . . .
what a good fighter's buttons are like

Cosmic film from France

The cobblestones seen in this electron micrograph are grains of silver halide sticking up out of a gelatin matrix. Very smart for extra-terrestrial use. Bear in mind the photographic conditions out there.

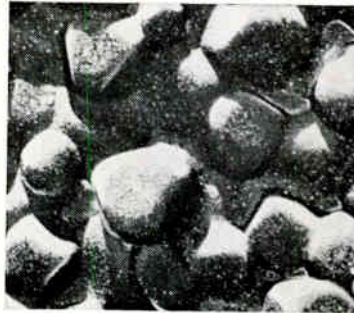

During the earthbound childhood of our race, we have been saying "ultra-violet" for radiation shorter in wavelength than what our particular natural-born sensing device happens to be tuned to. When at last we venture out from under the air blanket and note the ambience of the universe, we see what a special case is the life we have led. The color of the cosmos is not confined to an octave centered about the dominant hue of green cheese.

Even as we sing out in exultation, however, we must remind ourselves that all matter is opaque below about 2000Å and that the tunnel is long and dark all the way to x-rayland; for everything animal, vegetable, mineral, or gaseous is prone to electron transitions.

The light in your eyes, of course, goes out at around 3800Å, but any silver halide photographic material will get you down to 2500Å. The next 500Å is sticky: you spread a fluorescent oil over the emulsion to convert the energy to a wavelength long enough to penetrate the gelatin. Below 2000Å this stratagem poops out because even the oil robs you. At this point many years ago a spectroscopist named Victor Schumann had the bright idea of eroding gelatin away with H₂SO₄ to uncover the halide crystals. This worked fine. Schumann plates also proved useful for registering the focused ions in Aston's early mass spectrographs.

About 15 years ago we improved on Schumann plates by a technique that left only enough gelatin to keep the grains apart, as seen above. We call the product KODAK SWR Plates and still recommend it unless you need high sensitivity so desperately that neither granularity nor price can stand in your way. In that event we can arrange to import for you some 180mm x 35mm strips of film from Kodak-Pathé. Our clever French cousins have developed a very tricky centrifugal coating technique that permits them to paste down much larger halide crystals than the SWR kind, resulting in *le film TYPE SC5 (environ 10 fois la sensibilité du film S.W.R. vers 1200Å)*.

If \$108 for 24 such strips is not out of scale with the magnitude of your thinking, get in touch on this matter with Eastman Kodak Company, Special Sensitized Products Division, Rochester 4, N. Y. If you need nothing more special than a new free booklet entitled "Kodak Materials for Emission Spectrography," same address still applies.

Electric sugar, \$5 per lb.

A mighty industry breaks down the sugar molecule in the interests of conviviality. Use of the sugar molecule as a base for further building is little practiced, except by us. (We do it in the northeast corner of a state which respects the venerable craft that works the other way.)

And what is achieved thereby?

A high dielectric constant, a large increase in the capacitance of an electrical condenser compared with when there is nothing between the plates.

Obviously, the manufacturers of capacitors and of electro-luminescent panels have had to be notified. We find them interested and alert.

We divert a little sucrose from coffee breaks and react it

with acrylonitrile, forming a clear, viscous liquid designated *Cyanoethyl Sucrose* in which a statistical 7.3 of the 8 available hydroxyls are replaced by OC₂H₄CN groups. At 60 cycles this substance has a dielectric constant of 38 and competes with other cyanoethylated dielectrics at 11-19 and with chlorinated aromatic hydrocarbons at 4-6. (The dielectric constant of water runs around 80, but water is such watery stuff!)

Other invidious comparisons:

	Cyanoethyl Sucrose	other cyanoethylated dielectrics	chlorinated aromatics
cost per lb.	\$5 (development)	\$12-\$27	15c-25c
dissipation factor (25°C, 60 cycles)	0.010	0.17-2.7	< 0.1
volume resistivity (25°C, ohm-cm)	5 x 10 ¹¹	3-6 x 10 ⁹	> 5 x 10 ¹²

Request an 8-ounce sample of Cyanoethyl Sucrose and a data sheet from Eastman Chemical Products, Inc., Kingsport, Tenn. (Subsidiary of Eastman Kodak Company).

A more constant constant

*They shall beat their swords into plowshares and
their spears into pruning hooks. Nation shall not
lift up sword against nation. Neither shall they
learn war any more.*

— ISAIAH

Lockheed is very proud of its F-104 Starfighter. At a recent U. S. Air Force Fighter Weapons Meet at Nellis AFB, Nev., an F-104 (C model) outflow, outgunned, and outbombed all 13 of its competitors.

Lockheed has given us permission to disclose that the F-104 carries a 19.25mm hemisphere of KODAK ITRAN 2 Optical Material on the flat face of which we deposit by a unique method a 4mm x 4mm film of lead sulfide to which leads are attached. This kind of infrared sensor we call a KODAK EKTRON Detector, Type Q-5, Modified. The hemisphere has been made also out of another high-index infrared-transmitting material, strontium titanate. Replacement of this by ITRAN 2 material seems to make the time constant of the detector—which is about 250 μsec at 25°C—more stable over long periods with less effect from storage conditions. Also, the dark resistance stays put better. Therefore the s/n drifts less. Incidentally, signal and noise levels are both high, which lessens the demands on the associated circuitry. (NEP, however, is less than 6.7 x 10⁻¹¹ watts for 600°C radiation chopped at 2500 cycles/sec over a 1 cycle/sec bandwidth.)

We mention high index. We are rather pleased at having it in the record that some years ago we suggested to the brethren that the same principle that makes an oil-immersion microscope objective resolve more detail than the best dry objective could also be worked for another purpose in the infrared game. Putting the detector film on the high-index hemisphere flat boosts the signal by 3.4X.

Safe as the F-104 makes us feel as we sit before our hearths, we'd feel even safer if we had more sales outlets for these buttons than just one make of airplane. We sure would like it if it turned out, in line with the prophet's beautiful allusion to old iron, that an entirely different use were found in addition for Type Q-5 detectors. Eastman Kodak Company, Special Products Division, Rochester 4, N. Y. can help you think about that.

Prices subject to change without notice.

If you like, we can send you a pocket reference book that may help you and us achieve mutually beneficial contact through the bewildering variety of other products we make. Address Eastman Kodak Company, Dept. 8, Rochester 4, N. Y. It is a tiny bit out of date, but that can't be helped. (Everybody dies a little each day.)

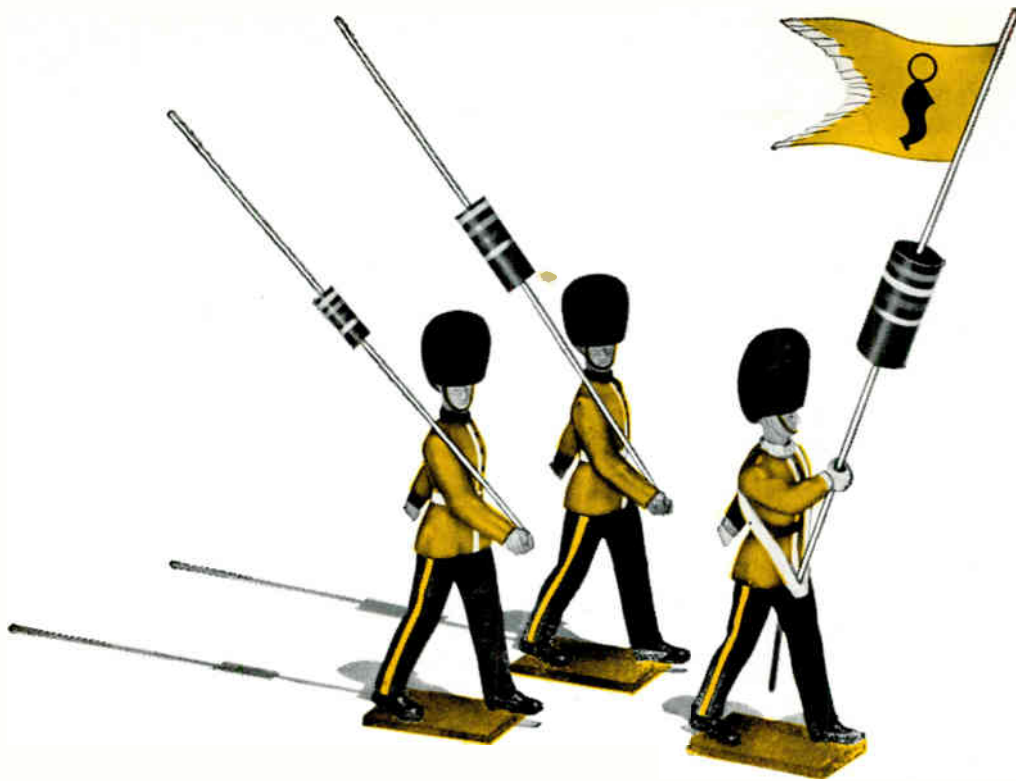

STACKPOLE—proved in service!

When it comes to stringent service requirements, Stackpole measures up! Designed to meet or exceed every MIL-R-11 requirement, Stackpole Coldite 70+ Fixed Composition Resistors bring in addition extra load life, and moisture and humidity resistance to a host of industrial applications.

For Extra Dependability, we mold Coldite 70+ resistance elements and outer insulating shells of similar materials. A completely new process then forms them into a solid, homogeneous structure that defies catastrophic failure or erratic resistance changes in severe environments.

Easiest of All to Solder by Dip or Iron, Coldite 70+ Resistors are unequaled for production line efficiency. They're the only resistors, whose leads are solder dipped — not once, but *twice* — besides the usual tin coating. That's why leads stay smooth and tarnish-free even after months in storage.

Today's Best-Looking Resistors, Coldite 70+ combine handsome, glossy finish and uniform, easily-read color codes. Their attractive appearance easily survives scrubbing with solvents. They're available in MIL-R-11 Type RC-20 (½ watt), Type RC-32 (1-watt), and Type RC-42 (2-watt) in all standard resistance values and at ordinary resistor prices.

Electronic Components Division
STACKPOLE CARBON COMPANY
 St. Marys, Penna.



CERAMAG® FERRITE CORES • VARIABLE COMPOSITION RESISTORS • SLIDE & SNAP SWITCHES • CERAMAGNET®
 CERAMIC MAGNETS • FIXED COMPOSITION CAPACITORS • BRUSHES FOR ALL ROTATING ELECTRICAL EQUIPMENT
 ELECTRICAL CONTACTS • GRAPHITE BEARINGS, SEAL RINGS, ANODES • HUNDREDS OF RELATED CARBON & GRAPHITE PRODUCTS.

MORE VERSATILE THAN EVER

"SPEEDIVAC"

MULTIPLE VAPOR SOURCE

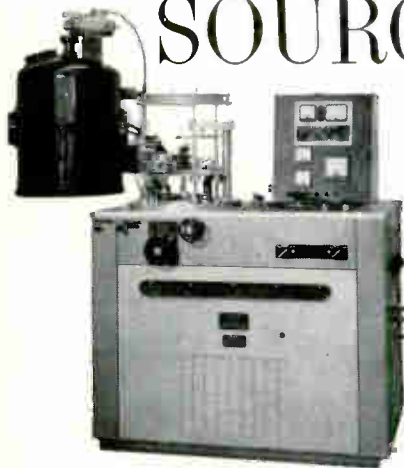

VACUUM COATING UNIT

Following are listed some of the special features supplied as standard fittings in the EDWARDS 19E6 evaporator.

Stainless Steel Bell Jar, Viton Gasketing, Six Position Vapor Source, Substrate Heater, Motor Driven Rotary Substrate Holder, Glow Discharge Cleaning, Ultimate Vacuum with LN^2 trap 2×10^{-7} Torr.

Fast reliable pump downs are, of course, a feature of all EDWARDS evaporators.

Write for your free technical reprints, written by members of our research staff on "Thin Films and Ultra High Vacuum Techniques."



MICRO-CIRCUIT JIG AND MASK CHANGER

The micro-circuit jig is complete with a six-position vapor source, enabling six 2" square substrates to be coated with six different materials using six different masks.

The jig is also provided with two substrate heaters, one to preheat the substrate to $150^\circ C$. and the second to raise the temperature of the substrate in the evaporation position to $300^\circ C$. Resistance monitor pick-up points are provided and separate resistance monitor and automatic source shutter can be provided.

Standard EDWARDS patented glow discharge cleaning rings are supplied with the jig, along with the rotating six-position vapor source.

The accuracy of registration of each successive mask in contact with a given substrate is within $\pm 0.001''$.

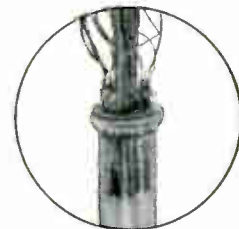
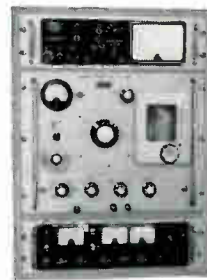

OMEGATRON-MASS SPECTROMETER

The "Speedivac" Omegatron Mass Spectrometer analyzer delivers quantitative and qualitative data of minute quantities of residual gases and vapors in vacuum systems. Its bakeable small volume head (80cc) is an integral part of the system and permits achievement of ultra high vacuum. In addition to platinum iridium electrodes which can be readily outgassed and arranged in stock structure for precise alignment, the unit provides the following characteristics: **High Sensitivity** • **Extended Range** • **Excellent Resolving Power** • **Rapid Response**, **Linear Scan** • **Pressure Measurement Independent of Gas Composition** • **High Sensitivity Leak Detection** • **Simple Construction**

GENERAL SPECIFICATIONS

Range	Mass 2-200
Resolution	Complete separation of adjacent peaks to mass 32 and very good separation to mass 60.
Sensitivity	The unit's high sensitivity enables the analysis of residual gases in the range 10^{-6} to 10^{-11} Torr.
Response Time	5 to 30 minutes depending on scanning system.

EDWARDS HIGH VACUUM INC. / 3279 GRAND ISLAND BLVD., GRAND ISLAND, N.Y.
MANUFACTURERS OF THE MOST COMPLETE LINE OF HIGH VACUUM COMPONENTS AND SYSTEMS

small
change



FOUR-LAYER INTEGRATED CIRCUIT AND LOGIC MODULE CARRIER

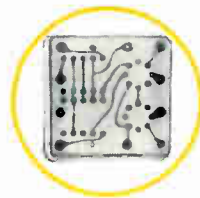

Small change? Yes—but it guarantees big performance. This little board is one sample of our leadership in the field of precision multilayer circuitry. It costs just about what you see here. Why not send us your requirements?

CINCH-GRAPHIK

DIVISION OF UNITED-CARR FASTENER CORPORATION



200 South Turnbull Canyon Road, City of Industry (Los Angeles), California • Phone (Area Code 213) 333-1201
Offices in 22 Principal Cities throughout United States, Canada, England and Australia listed under Cinch Mfg. Co.
or United-Carr Fastener Corporation • Cinch • Ucinite • Monadnock Mills • Howard B. Jones • Palnut

UNDERSEA TRANSMITTERS TO LOCATE MISSILE IMPACTS

Sound signals will link hydrophones to ship instrumentation

By JOHN W. WASIK
McGraw-Hill World News

CAPE CANAVERAL—A new self-contained missile-impact-location system, remotely controlled by an attending range vessel, will be tried on the Atlantic Missile Range.

Impact-sensing arrays, anchored to the sea floor, are to receive and transmit data acoustically, eliminating cable links to land stations.

Bendix-Pacific is developing the system, known as Star (for Ship Tended Acoustic Relay) under a \$1-million Air Force contract. Estimated operational date if the system works as expected is March 1964. Systems are being tested off the island of Eleuthera.

Once the Star system arrays are in position, AMR will be capable of covering vast expanses of ocean area, such as the South Atlantic and Indian Oceans, never covered before. Array locations will be determined by navigation methods.

Later, navigational satellites like Transit can give more precise locations.

NETWORKS—Two networks are planned for the Star system.

The Broad Ocean Area (BOA) net for large-area location of missile impacts will work with sound fixing and ranging (sofar) bombs carried aboard reentering nose cones or instrument packages. Ejected on impact, the bombs will explode about 3,000 feet deep.

The smaller array, known as a "splash net," can detect the splash and resulting sound propagation of an impact and does not need a sofar bomb. It will pinpoint impacts in preselected target areas.

Both nets will consist of about five units in arrays several miles in diameter. Units will have ship-positioning transponders as well as impact locaters. When interrogated by a range vessel, the transponders will emit an acoustic signal so the ship can orient itself to the array.

The range vessel will be able to turn each individual unit on and off, interrogate the ship positioning transponders and command a unit to surface by actuating an explo-

sive cutters that severs the cable.

BROAD AREA NET—Components of each BOA Net unit will be on a vertical cable, as illustrated.

The transponder, about 100 feet above bottom, will receive an acoustic signal from the vessel and respond acoustically on a different frequency. Time delay will indicate distance between ship and transponder. Interrogation of all units, each on a different frequency, will give ship position relative to the array, within an error of 500 feet at a range of 15 nautical miles.

SOFAR TRANSDUCER—The sofar transducer (hydrophone and amplifying equipment) will be positioned in the sound-channel axis of the ocean (an approximately horizontal plane usually at an average depth of 3,000 feet) permitting detection of a sofar bomb detonation several hundred miles away.

The acoustic signal received by the hydrophones is converted into an electrical signal by a piezoelectric device, amplified and sent about 9,000 feet down the cable to a projector. The projector reconverts the signal and emits it on a different acoustic frequency.

These signals and those from the ship-positioning transponders (also on different frequencies), are recorded with time signals aboard ship. Measurement of signal time delays and triangulation give impact location within miles.

The sofar transponders will also serve for ship-positioning.

The smaller Target Array net will have essentially the same equipment as the BOA net. However, the impact-location hydrophone will be only 300 feet from the projector. The hydrophones will detect the splash of impacts close to the net. Location accuracy will be within an error of 600 feet within 10 nautical miles of the array center.

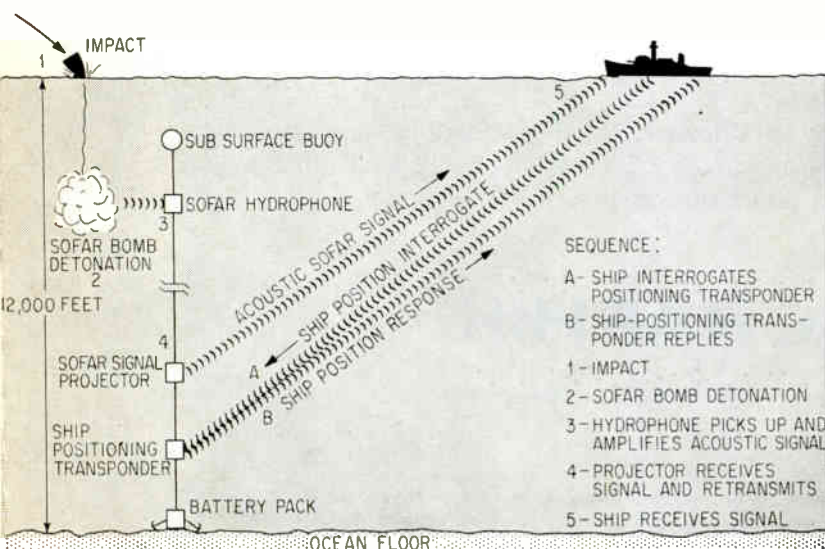

TWO ACOUSTIC SIGNAL paths are used. One gives ship's position relative to array and the other gives impact-location signals

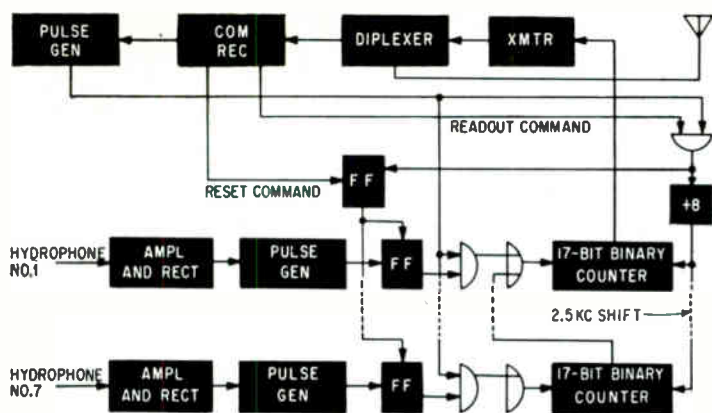

BUOY ELECTRONIC system operates on digital commands from the shipboard system. Binary counters (one for each hydrophone) provide a precise timing signal.

Hydrophones Will Track Subs

Experimental system will transmit to ship 10,000 yards away

LOS ANGELES—An experimental, deep-water, submarine detection and tracking system has been installed in an undersea canyon off the Atlantic Coast.

Called Taut Array, the system was built by Martin for the Navy to evaluate an underwater tracking system being considered for Project Autec, the Atlantic Undersea Test and Evaluation Center (ELECTRONICS, p 7, Jan. 4)

A report on the system, called Taut Array, was given here two weeks ago at the IRE military electronics conference, by I. G. Raudsep and W. C. Silbert, of Martin.

ARRAY STRUCTURE—The system consists of three vertical strings of hydrophones 2 to 5 miles apart, linked by electronic systems in surface buoys to a data-processing system aboard ship.

Each hydrophone is an anchored submarine cable into which six hydrophones are integrated at depths of about 225, 500, 1,000, 3,900, 4,200 and 4,650 feet. A main subsurface buoy 150 feet deep holds the array taut while an auxiliary buoy 50 feet down carries a seventh hydrophone.

The 7 hydrophones, each a transducer and a transistor preamplifier, have individual transmission lines to the surface.

DATA PROCESSING—The location of the ship is determined by measuring the travel time of an acoustic signal between a ship's projector and each hydrophone in vertical arrays. Maximum range from any array is 10,000 yards.

An r-f pulse transmitted at uhf from the shipboard system starts seven 17-bit binary counters in each buoy counting a precise timing signal transmitted from the ship.

On board, received data is modified for input to a multichannel tape recorder or digital computer. The basic data word is a 17-bit word received from each counter in the buoys.

Japan EIA Predicts 16.3% Production Rise

TOYKO—Japan Electronics Industry Association predicts Japan will produce \$1,834-million worth of electronics in fiscal 1963 (April, 1963, through March, 1964). This is 16.3 percent more than in fiscal 1962. JEIA said production of industrial electronics will increase 24.8 percent and consumer goods 12.7 percent. Entertainment electronics will total \$970 million including, \$533.3 million for tv sets, up 5 percent, and \$235 million for radios, an increase of 14.4 percent.

the Last Word in

HIGH SPEED printer systems

from



POTTER

the LP-1200 SYSTEM provides:

- **LOW COST BUFFER STORAGE...**
Computer proven Magnetostrictive Delay Lines are compatible with the fastest computer systems.
- **NEW DELAY LINE AMPLIFIER...**
Peak Detection circuit improves reliability at higher frequencies.
- **QUALITY HIGH SPEED PRINT-OUT**
Vacuum Paper control, coupled with high speed paper feed produces clean, sharp impressions.
- **HUMAN ENGINEERING provides...**
quick, front paper loading, ease of ribbon change, access to drum and hammers, convenient operating controls.
- **ADDITIONAL FEATURES...**
non-wearing Elastomeric torsion bearings assure long hammer life; low inertia drive belts minimize clutch and brake wear.
- **12 WEEK DELIVERY**

To learn how the Potter LP-1200 Printer System can reduce the cost of your computer time, write to the General Manager, Printer Division, today.



POTTER INSTRUMENT CO., INC.
PRINTER DIVISION
East Bethpage Road • Plainview, New York

MICRO DRILL PRESS

FOR VERY *SMALL* HOLES
DOWN TO
 $1/1000$ INCH
and *SMALLER*

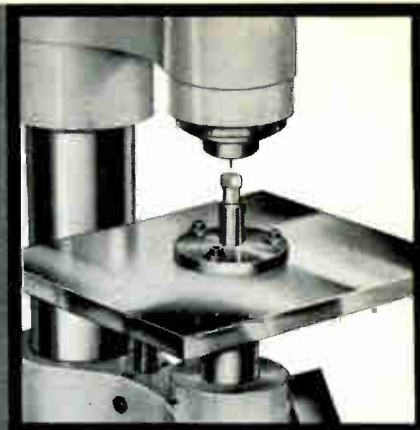

LEVIN® MICRO DRILL PRESSES are *sensitive* because there are no sliding quills and splines to cause drag. They are *accurate* because the precision preloaded ball bearing spindle is made to hold Levin WW Style Collets. For drilling holes from $1/8$ th inch down to $1/1000$ inch and smaller look to Levin for the finest in Micro-Drilling equipment.

Send for Drill Catalog Today

LOUIS LEVIN & SON, INC.

3573-1 Hayden Avenue • Culver City, California

CIRCLE 201 ON READER SERVICE CARD

WHAT
do you want
lacing cords and tapes
to do for you?

- Tie faster, easier, tighter!
- Knots that don't slip!
- Greater stability under high heat!

**HEMINWAY
& BARTLETT**

NYLON and DACRON CORDS and FLAT BRAIDED TAPES

give you all these advantages

In addition — they meet Govt. Spec. MIL T-713B.
Available in wax-coated, wax-free or "G. E." Finish.

Write for free samples

THE HEMINWAY & BARTLETT MFG. CO.

Electronics Division: 500 Fifth Avenue, New York 36, N.Y.

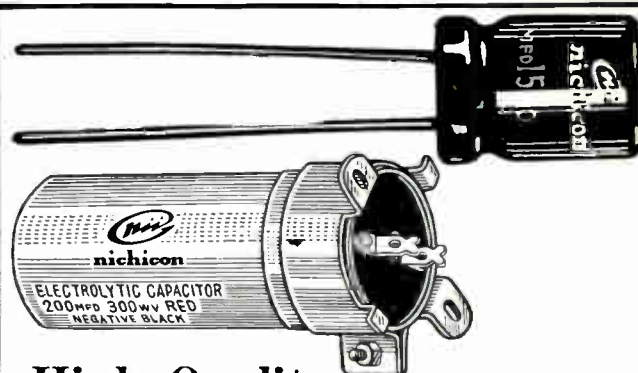

High Quality Nichicon Capacitors

for all electronic equipment

Nichicon research and experience assures remarkable strength and stability in all its capacitors. Nichicon produces a complete line of capacitors designed for every need.

nichicon MAIN PRODUCTS: Oil Paper Capacitor, Electrolytic Capacitor, Tantalum Capacitor, Metallized Paper Capacitor, Ceramic Capacitor, Mica Capacitor and Mylar Capacitor, etc.

Nichicon Capacitor Ltd.

HEAD OFFICE : Uehara Bldg., Oikedori, Karasumahigashi-iru
Nakagyo-ku, Kyoto, Japan
CABLE ADDRESS : CAPACITOR KYOTO

CIRCLE 202 ON READER SERVICE CARD
electronics

DECISIONS!



DECISIONS!

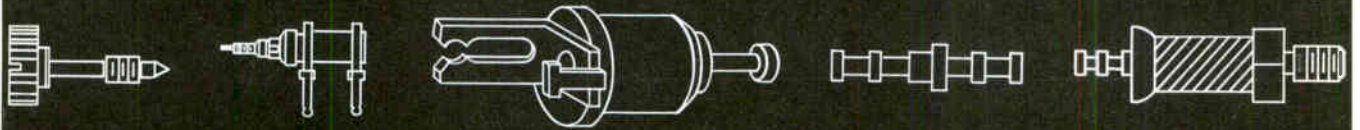

DECISIONS!

More easily made with Cambion®

There are more than 15,000 *standard* electronic components in the CAMBION line, including terminals, terminal boards, insulated terminals, coil forms, coils, capacitors, connectors, chokes, computer components and hardware. They are immediately available from stock and so reliable, they are unconditionally guaranteed in any quantity. When it's time to decide, choose CAMBION. You can't go wrong. *Write for our new full-line Catalog.* Cambridge Thermionic Corporation, 437 Concord Ave., Cambridge 38, Mass.

CAMBION

STANDARDIZE ON CAMBION...THE GUARANTEED ELECTRONIC COMPONENTS

FILTER DESIGNERS!

INDIANA GENERAL TEMPERATURE COMPENSATED CUP CORE ASSEMBLIES OFFER YOU ALL THESE ADVANTAGES:

- 1** Seven sizes (International Series) from stock .599" to 1.425" O.D.
- 2** Frequencies — 1 kc to 1.5 mc.
- 3** "Q" values to 800.
- 4** Standard Gapped Inductance Values 40 to 1,000 MH/1000 turns.
- 5** Unmatched temperature stability.
- 6** Available in complete assemblies with trimmer for minimum of 12% adjustment.
- 7** Complete test specifications and performance curves available.

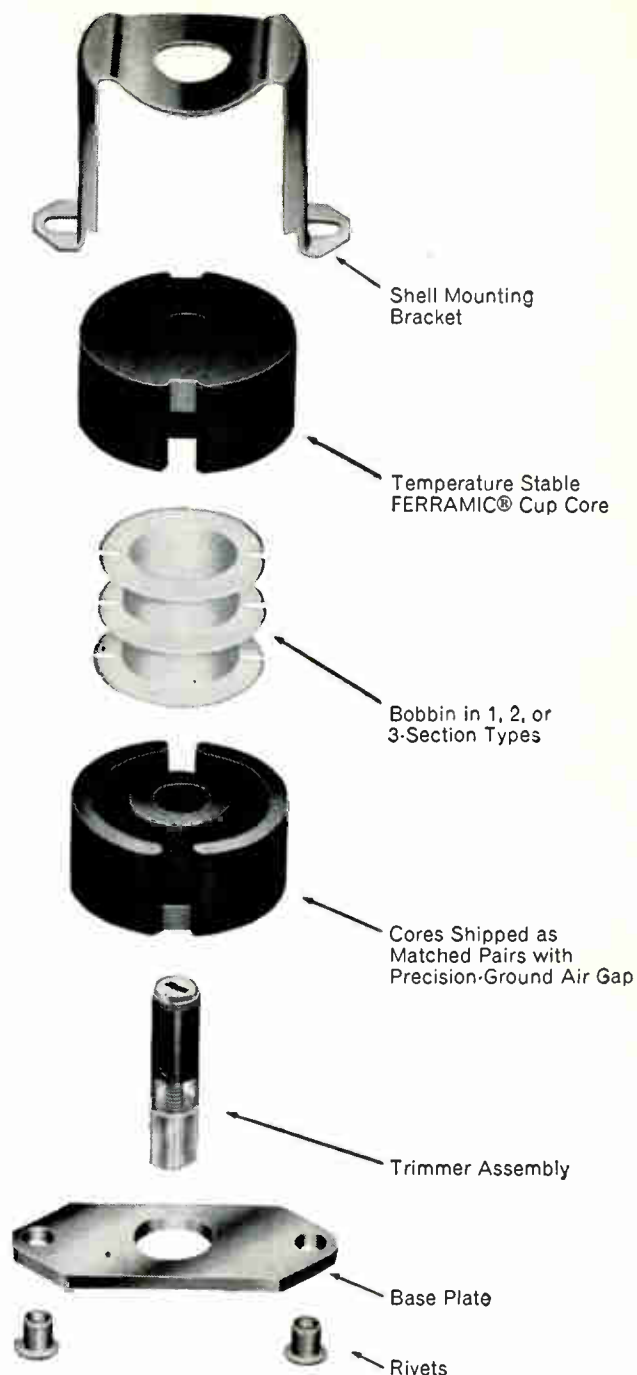

Specify Indiana General TC cup core assemblies next time you order. Wire or call for price and delivery information to Indiana General Corporation, Electronics Division, Keasbey, New Jersey, for complete performance curves and specifications. Request Bulletin 28

INDIANA GENERAL

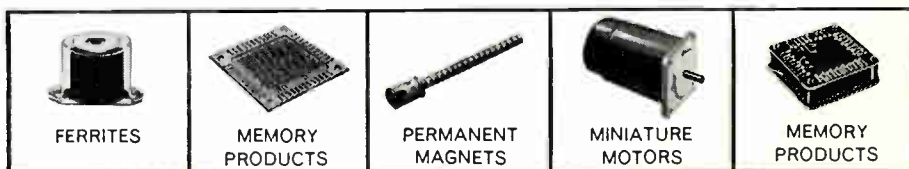

In **FIXED COMPOSITION RESISTORS**

if it's news, expect it first from IRC

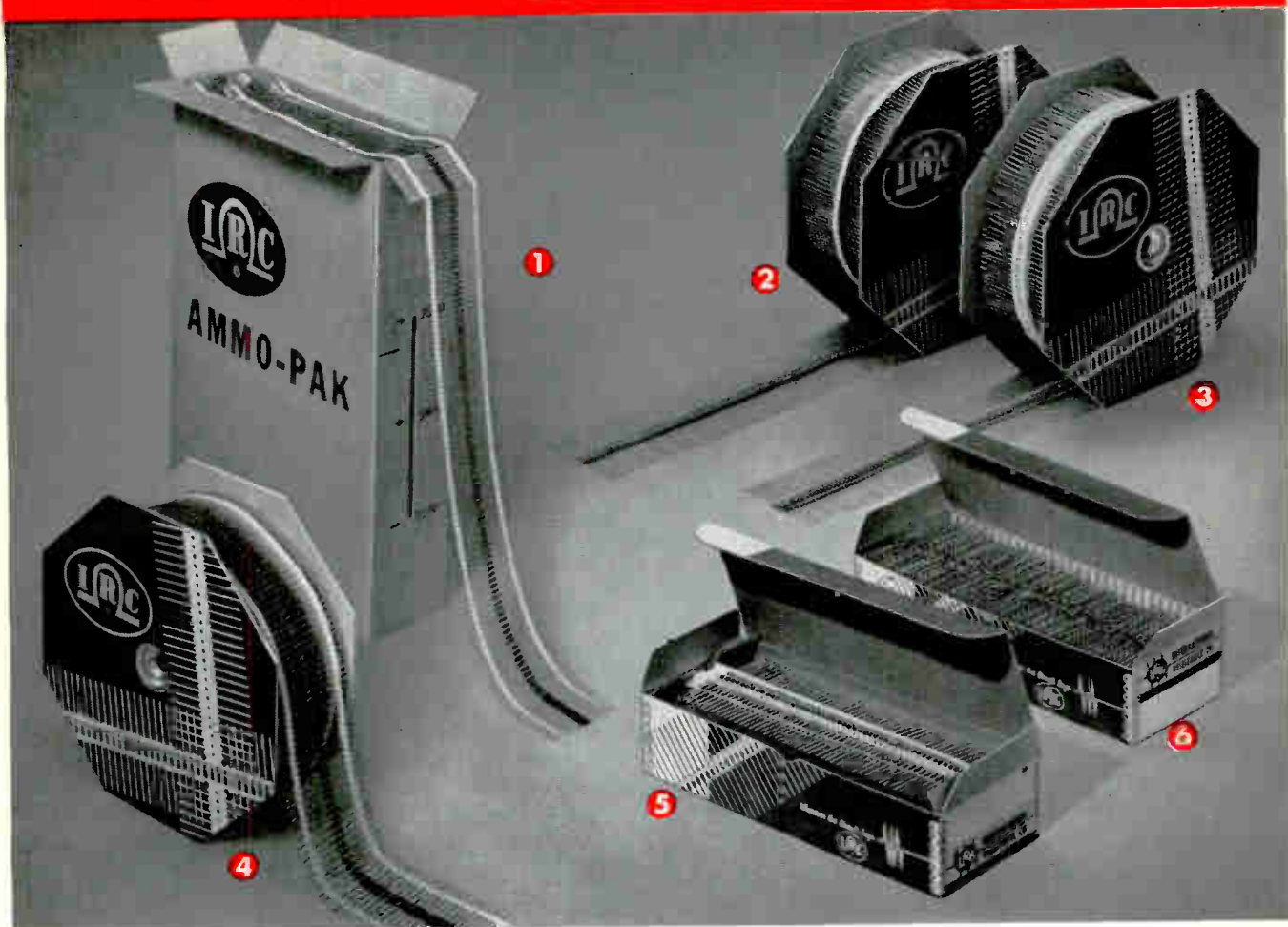

Only IRC Fixed Composition Resistors offer **6 WAYS TO CUT ASSEMBLY COSTS**

HERE'S WHY . . . IRC MIL-R-11 resistors are available in 6 forms of packaging. Whether you use high speed inserting machines or solder resistors individually, there is a packaging form to simplify your production procedure.

- ① **AMMO PAK.** 10,000 resistors on continuous lead tape.
- ② **BODY TAPE REEL.** Bodies held by pressure sensitive tape.
- ③ **GRIP REEL.** IRC exclusive; no adhesive, indexed for automation.
- ④ **LEAD TAPE REEL.** Leads held by pressure sensitive tape.
- ⑤ **GRIP STRIP®.** IRC exclusive; no adhesive, spill-proof, easy release.
- ⑥ **ORIENTED BULK.** Neatly oriented resistors with straight leads.

IRC Fixed Composition Resistors offer significant savings in counting, handling, stocking and assembling. Write for Packaging Bulletin. International Resistance Co., Philadelphia 8, Pa.

PERFORMANCE ADVANTAGES

IRC Type GBT's also provide

- Ranges to 100,000 megohms
- Superior high frequency characteristics
- Outstanding load life
- Better resistance-temperature characteristics
- Greater moisture protection
- Stronger termination
- Weldable leads



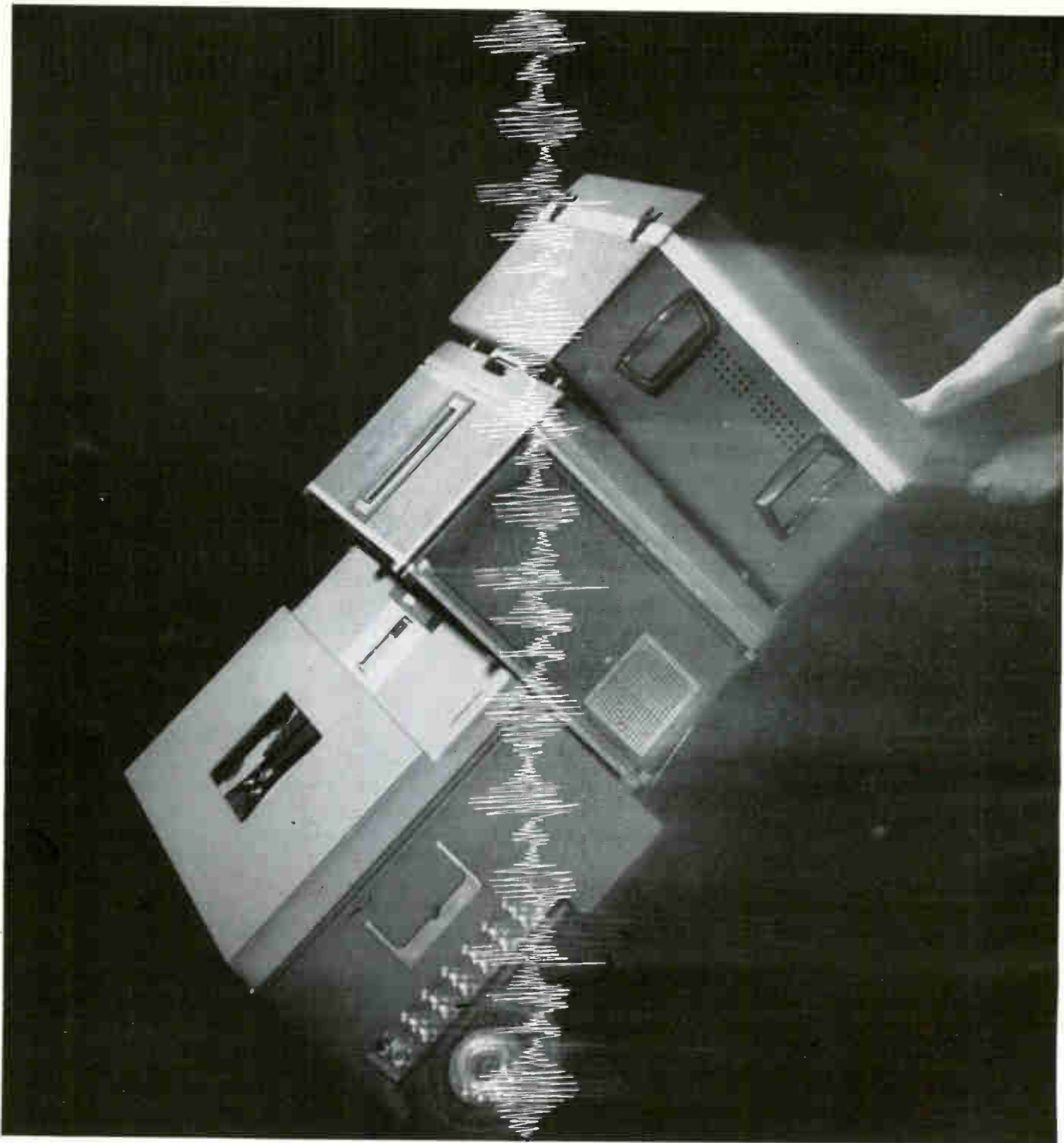

Who can deliver the most complete line of portable instrumentation recorders?

AMPEX

And what a line it is. There's a portable for medical, for industrial, for research applications, for rugged applications — for almost every data acquisition need. And there's a price to fit almost every budget. Behind each recorder stands the name of Ampex — to assure you true instrumentation performance all the time. On the top, above: the low-cost SP-300. It has four speeds, four tracks, push-button selection for FM or Direct recording, plus built-in attenuation, monitoring, calibration and erase. In the middle is the FR-1300. It offers 14 tracks, 300 cps to 300 KC capability on Direct, DC to 20 KC on FM and six speeds precisely controlled by a unique servo-driven capstan. On the



bottom: the rugged CP-100. It records Direct, FM-Carrier and PDM. Has a closed loop drive, six standard speeds, 14 tracks, a frequency response of up to 250 KC on Direct, down to DC on FM. And it operates on almost any source of power—including batteries. In other words, Ampex has a portable line so complete you can pick a recorder to fit your needs instead of having to modify your requirements to fit the recorder. For more information write the only company providing recorders, tapes and core memory devices for every application: Ampex Corp., 934 Charter St., Redwood City, Calif. Term financing and leasing available. Worldwide sales and service.



VACUUM-PACKAGING (10^{-10}) WITH COORS BeO

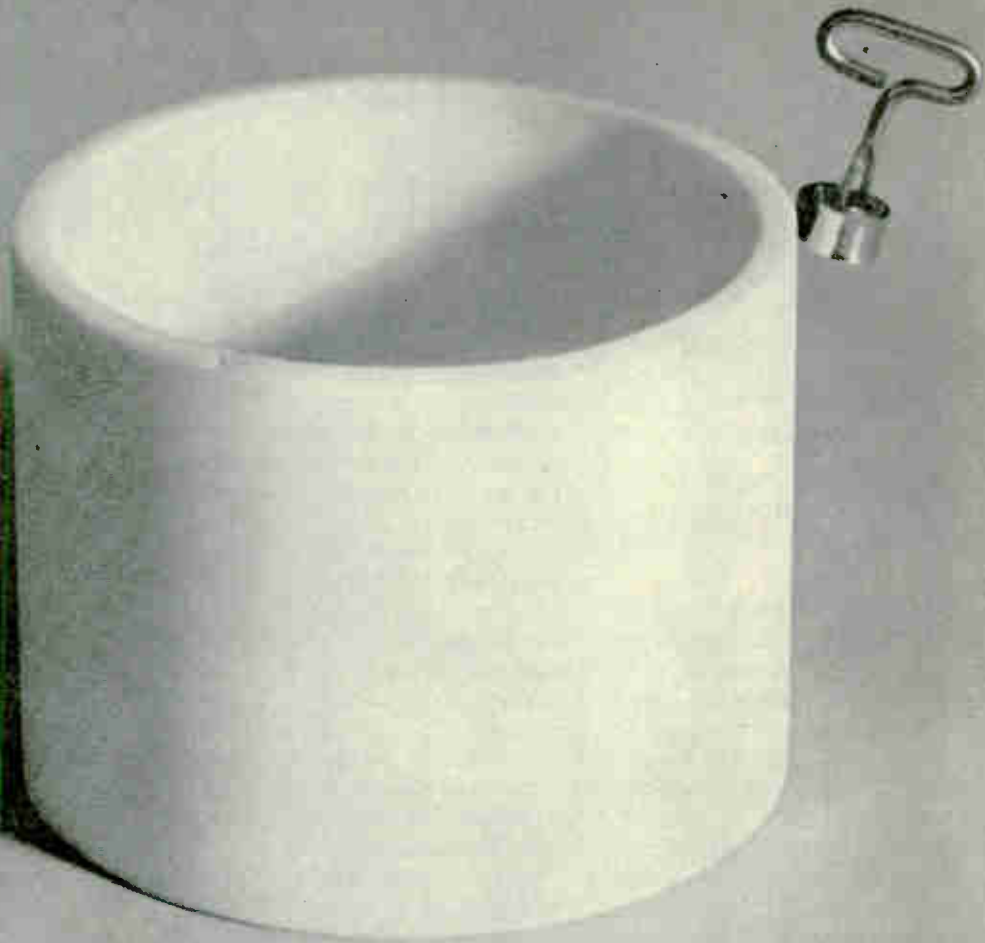

Design engineers are using Coors high-strength, *vacuum-tight* BeO ceramics as a new material for high-temperature, hermetic assemblies—envelopes and windows—as well as for heat sinks. Consistently vacuum-tight, 10^{-10} , Coors Beryllia is available in several compositions. They can be metalized and brazed using conventional techniques, making them readily adaptable to a wide range of ceramic-metal designs. High heat transfer properties of Coors Beryllia (better than yellow brass) give you new latitude for designing assemblies that are smaller and/or higher powered. Other physical properties equal or excel those of Coors high alumina ceramics. Write for data sheet 9501, send your drawings for quotations, or call your nearest Coors Regional Sales Manager: WEST COAST, William S. Smith, Jr., EM 6-8129, Redwood City, Calif.; MIDWEST, John E. Marozek, 528-2510, Roselle, Ill.; CENTRAL, Donald Dobbins, EL 4-9638, Canton, Ohio; EAST COAST, John J. McManus, MA 7-3996, Manhasset, N. Y.; NEW ENGLAND, Warren G. McDermott, FR 4-0663, Schenectady, N. Y.; SOUTHWEST, Kenneth R. Lundy, DA 7-5716, Dallas, Texas; SOUTHWEST, William H. Ramsey, UN 4-6369, Houston, Texas.

Coors

BERYLLIA CERAMICS

Coors Porcelain Co., Golden, Colo.

CIRCLE 25 ON READER SERVICE CARD

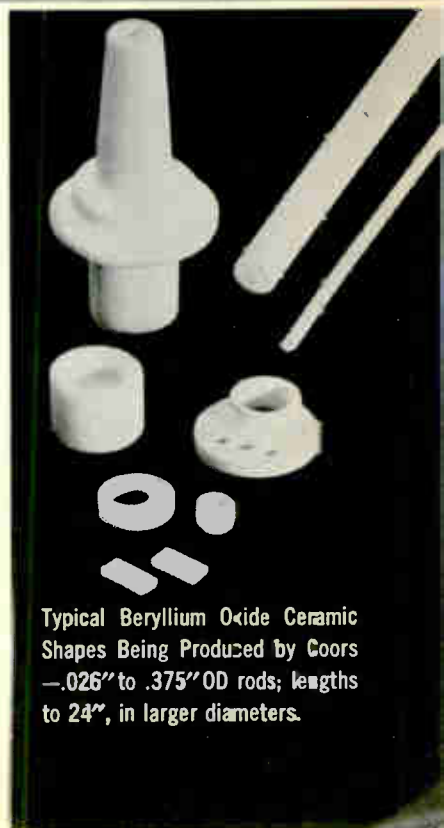

Typical Beryllium Oxide Ceramic Shapes Being Produced by Coors—.026" to .375" OD rods; lengths to 24", in larger diameters.

SIZE REDUCTION. Single board, on opposite page, carrying integrated circuits replaces five printed-circuit boards in present Minuteman computer shown here

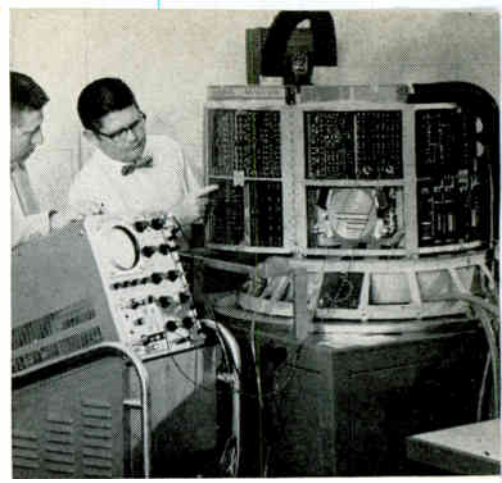

Integrated Circuits Go Operational

Wholesale use in ICBM will put them on the shelf for other uses

By **HAROLD C. HOOD**
Pacific Coast Editor

LOS ANGELES — Long-heralded swingover by important segments of the electronics industry to integrated circuits use (see p 45) seems assured with the commitment of major portions of the Air Force's improved Minuteman B missile to the new technology.

All electronics packages on the new missile, including guidance computer, flight control, and inertia measuring systems will be micro-miniature.

Benefits to the missile include a considerable increase in range over the 6,300 miles reported for the operational A model, larger warhead capability, vastly improved reliability and a tripling of target-hitting accuracy.

And, wholesale use of the latest semiconductor microcircuits in the program, long noted for its emphasis on reliability, should provide a powerful catalyst for designers on other projects to call out integrated circuits.

Production contracts for 140,000 integrated circuits have been let by Autonetics division of North American Aviation, associate prime contractor. Initial funding includes \$1.2 million to Texas Instruments, \$300,000 to Westinghouse, and \$300,000 to RCA. These, plus fol-

low-on contracts being drawn up, represent more dollars than all previous production orders combined.

Initial deliveries were last month. Systems are to be tested this year and first launch of a completed bird is expected during 1965.

CIRCUITS ORDERED — Approximately 20 different circuit types, mostly digital for the missile's guidance computer, are being made.

Texas Instruments will produce about 80,000 semiconductor networks including flip-flops, high-gain NAND gates, output drivers, gated write switches and demodulator choppers. Westinghouse will be a second source for many of these. Among RCA circuits will be a new power switch. Eventually, each supplier can supply the entire line.

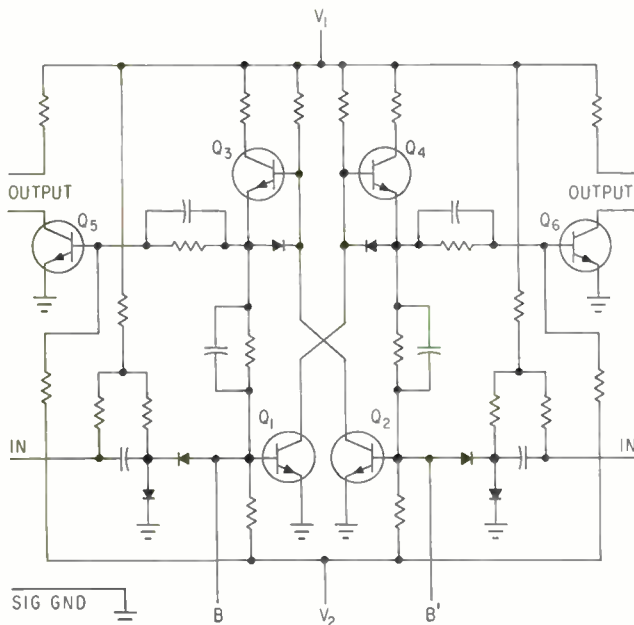

TYPICAL CIRCUIT for Minuteman computer is this flip-flop. Elements are formed in silicon by the passivated planar process. True state of the flip-flop is defined as Q_3 not conducting and Q_6 conducting

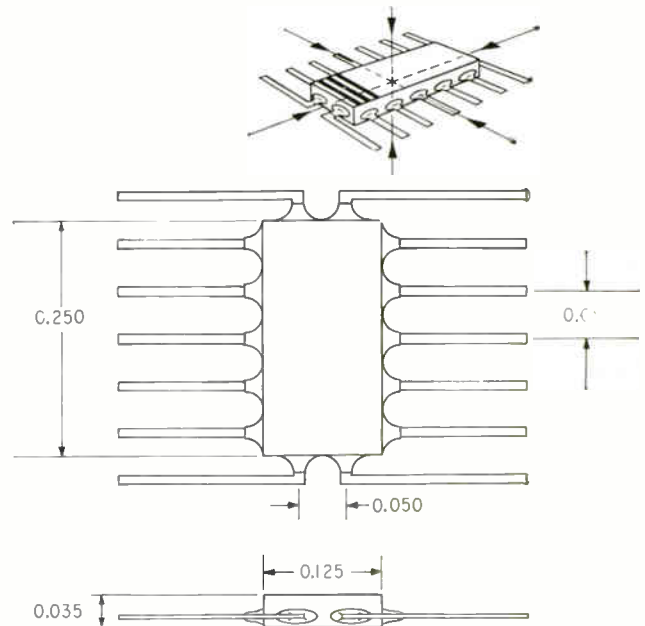

OUTSIDE DIMENSIONS of most of the integrated circuits are $\frac{1}{8}$ by $\frac{1}{8}$ inch. This may represent a size reduction as high as 20 to 30, compared to present Minuteman circuits composed of discrete components

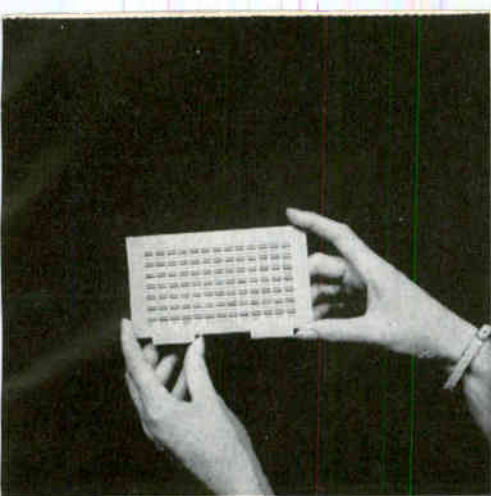

SOME THIN FILMS—Circuits not suited to integrated circuit techniques, primarily the more precise analog circuits and power supplies, will be ceramic-wafer printed circuits (CPC's) carrying thin-film passive elements, micropackaged active elements, or integrated circuit elements.

In some cases an integrated-circuit amplifier is mounted on a CPC with external discrete components and serves as an oscillator or trigger as well. Circuits requiring matched transistors are generally CPC.

C. P. Ballard, chief engineer of Autonetics' Minuteman division, says half as many integrated circuit elements as discrete components are used throughout the missile, and the average integrated circuit has the equivalent of 10 to 20 discrete components.

Guidance computer for the new bird weighs considerably less than its predecessor. Memory capacity is doubled to handle check-out chores previously relegated to ground support equipment and to upgrade operational capability.

About a tenth of the integrated circuits ordered will wind up in ground support equipment.

COST WILL DROP—One Autonetics official indicates that first circuit ordered will cost about twice that of its discrete component counterpart. Cost of the two should be about equal in follow-on contracts and should cost far less next year, he says.

A reliable source told ELECTRONICS that a typical first-batch integrated-circuit would cost \$100 to \$150, while the comparable discrete component circuit costs slightly over \$50.

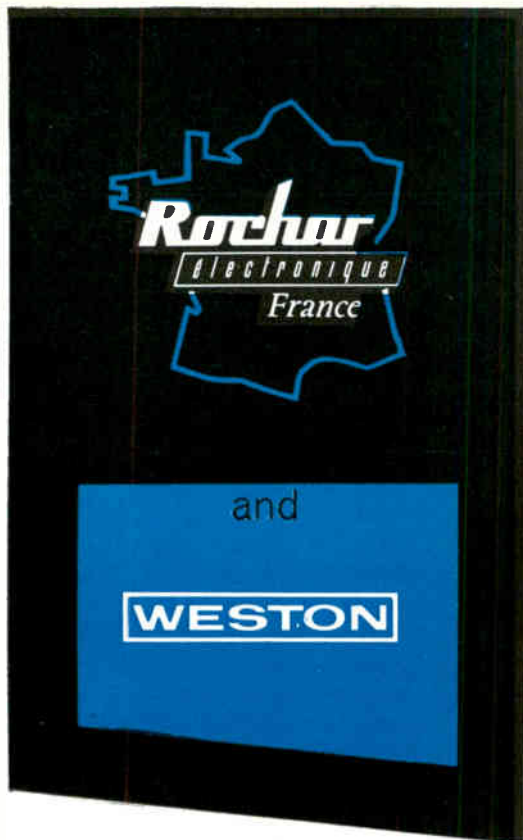

these are the **12**
main
reasons

why you will

choose **WESTON-ROCHAR** COUNTERS

- All solid state
 - High crystal stability
 - High input sensitivity
 - Maximum count capacity
 - Low consumption
 - AC or DC power supply
 - Cabinet or standard rack mounting
 - Direct reading on the counter
 - Direct recording from the counter
 - Wide temperature range
 - Shock and vibration tests
 - A great number of additional accessories (plug-in, transducers, ...) extending the range of applications of the instruments.
- even when connected to H.F. converters operating at any frequency.

For complete specifications, ask :

manufactured by **Rochar**
electronique

Distributed in U.S.A. and Canada by :
WESTON- Newark (N.J.)
for complete information on our line of products and address of our agency in your country please apply to
ROCHAR-ELECTRONIQUE, 51, rue Racine
MONTROUGE (Seine) FRANCE.

HOW ARE YOUR CON NEC TION S?

If they aren't what they should be, then you ought to be specifying Coaxial Connectors by

Automatic

METAL PRODUCTS CORPORATION
323 Berry St., B'klyn 11, N. Y. • EVergreen 8-6057

AIR FORCE GIVES PRIORITY TO

Satellite Inspector

Air Force hopes to put men into spacecraft for command and control

BROOKS AFB, TEXAS—Man will be needed in a number of military space missions, Maj. Gen. O. J. Ritland told industry representatives, scientists and physicians at the Aerospace Medical meeting here last week. Ritland is Deputy to the Commander, Air Force Systems Command, for Manned Space Flight.

Highest priority for a manned system, Ritland said, is Satellite Inspector (Saint), a vehicle that will rendezvous with hostile satellites, identify, inspect and, if necessary, destroy them. The unmanned version of this project was recently cut back by the Department of Defense (ELECTRONICS, p 18, Dec. 21, 1962) due to lack of funds, plus the decision to update

the system with new improved sensors.

Three other weapon systems in which man would be a valuable contributor, Ritland said, are: service capsules to repair complex unmanned satellites and to rescue stranded astronauts, a command and control and communications center located in space, and a system to control and defend sectors of space vital to national security.

Only practical step, to date, toward realizing these objectives is the recent NASA-DOD agreement to collaborate on the two-man Gemini program. Within a few days, the Air Force will submit plans for its participation to a board consisting of representatives from the DOD, NASA and USAF.

A space station, housing from two to four men, would be the basic vehicle needed for the command and control and communications center, and for the defense center. Ritland said such a space station is within the state of the art. All that's needed is DOD approval.

Voice of America's New Station

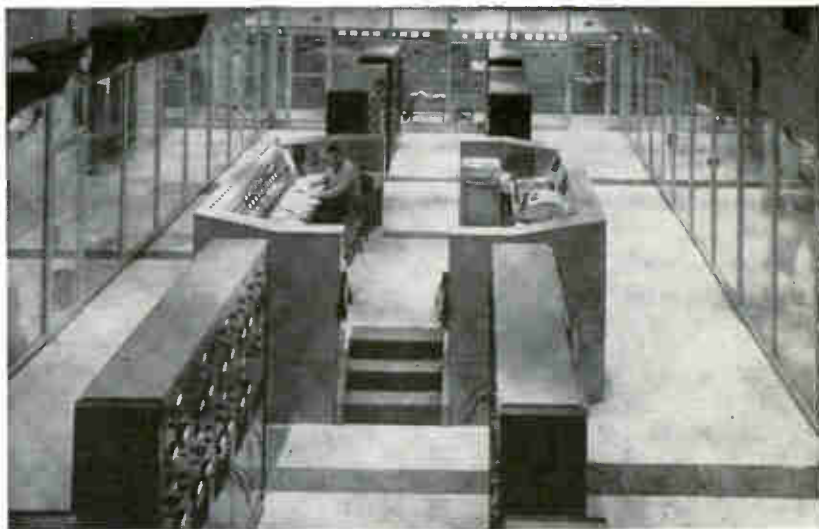

U. S. INFORMATION AGENCY last week formally inaugurated its short-wave transmitting complex at Greenville, N. C. Station control room (above) directs 22 transmitters with a total output of 4.8 Mw. Alpha Continental was prime contractor, Austin Co. and Smith Electronics were designers

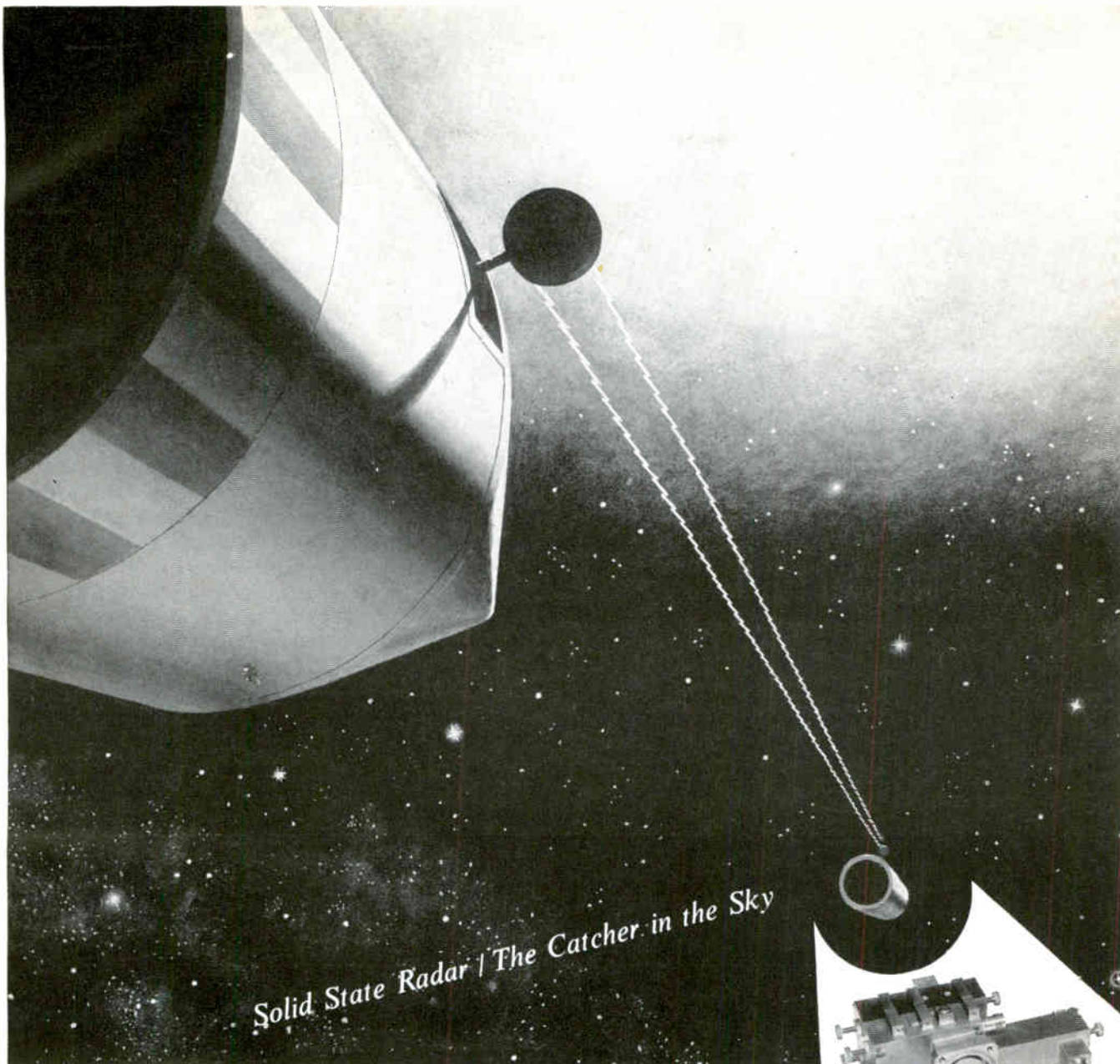

Solid State Radar | The Catcher in the Sky

A new solid state radar system built by STL engineers and scientists can send out and receive signals at X-band frequencies to help man rendezvous and dock vehicles in space. STELATRAC is its name. It is the first solid state system of its kind. The X-band transmitter is shown above. It has successfully passed temperature and vibration tests. STELATRAC can also be used as a command link between vehicles in flight. By altering its module design, the flexible radar system operates as an altimeter and doppler velocity sensor to guide spacecraft safely to the surface of the moon and planets. Today STL is busy on many such projects as STELATRAC. STL is also prime contractor for NASA's OGO and a new series of classified spacecraft for Air Force-ARPA. And STL continues Systems Management for the

Air Force's Atlas, Titan and Minuteman programs. These activities create immediate openings in Theoretical Physics • Systems Engineering • Radar Systems • Experimental Physics • Applied Mathematics • Space Communications • Antennas and Microwaves • Inertial Guidance • Analog Computers • Solid State Physics • Computer Design • Telecommunications • Space Physics • Digital Computers • Guidance & Navigation • Electromechanical Devices • Engineering Mechanics • Aerodynamics • Propulsion Systems. For Southern California or Cape Canaveral positions, write Dr. R. C. Potter, Department CG-2, One Space Park, Redondo Beach, California, or Box 4277, Patrick AFB, Florida. Your inquiry will receive a prompt reply. STL is an equal opportunity employer.



SPACE TECHNOLOGY LABORATORIES, INC.
a subsidiary of Thompson Ramo Wooldridge Inc.

Limited-War Needs Spur VTOL

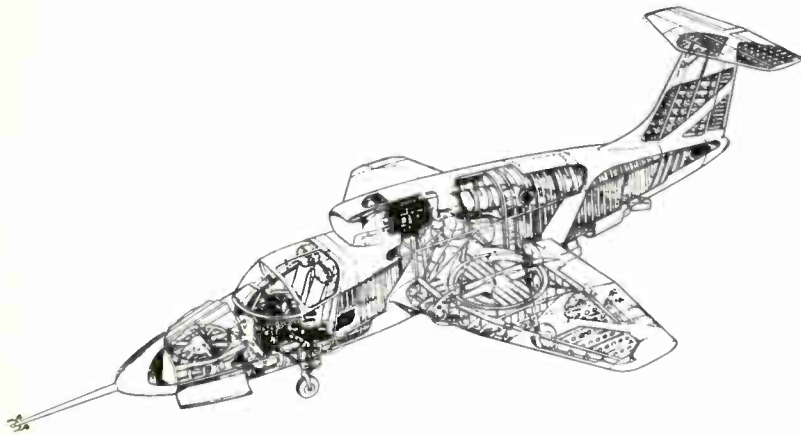

ARMY RESEARCH VTOL aircraft uses GE jet engines in Ryan-built airplane. Jet streams are diverted to turbine edges of lift fans in wings and nose for vertical take-off and landing



AUGMENTED JET aircraft, designed for VTOL operation is shown in conventional take-off. Lockheed Aircraft Corp. research vehicle is undergoing vertical-take-off tests this year

Vertical take-off planes require special radar and stabilization gear

By LEON H. DULBERGER
Associate Editor

THE DREAM of aeronautical designers—an aircraft with the vertical-flight ability of the helicopter and the high forward speeds of conventional craft—is near realization. Maximum usefulness of VTOL aircraft will be achieved through application of special electronics.

Development programs are now underway at a host of firms, under several military contracts, aimed at evolving operational vertical-take-off-and-landing (VTOL) aircraft.

The military is expected to inventory VTOL aircraft by 1967.

The need for VTOL airplanes has grown out of the tactical demands of modern warfare. Prime among these are counter-insurgency operations, where the ability to operate in rough terrain is mandatory and the relatively low speeds of the helicopter are prohibitive. VTOL aircraft tasks include reconnaissance, intelligence and supply. Higher-speed designs may be used to maintain air superiority.

ELECTRONIC SYSTEMS—VTOL aircraft will require extensive electronics, including conventional gear such as vhf and uhf communications, standard navigation equipment and iff equipment for identification.

Various military missions will demand specialized gear, including such surveillance equipment as side-looking radar, low-light-level television, infrared detection systems and electronically operated cameras.

The side-looking radar may employ synthetic aperture antennas, and computer signal processing techniques, for all weather mapping capability.

To assure all-weather operation of VTOL aircraft, and operation over rugged terrain, special obstacle avoidance radar display systems,

TILTING PROPELLER system is used in Curtiss-Wright VTOL aircraft. Full scale mock up shows two of the four props. Speed range planned is zero at hover, 460 mph in regular flight



VTOL TRANSPORT uses ducted propellers in artist's illustration of research aircraft built by Bell Aerosystems Co. Speeds to 350 mph in conventional flight are expected in this military craft



Development

high accuracy radar altimeters, and corner-reflector radar for landing may be required. In the latter system, reflectors tuned to the aircraft's radar frequency—thus providing a strong signal return—are laid out in a square to outline the landing area.

Direction-finding equipment is also a must for all-weather operation.

VTOL aircraft for search and recovery operations would employ doppler radar for target acquisition, and would also require specialized direction finding gear.

FLIGHT CONTROLS—Autopilot systems will be used in VTOL craft, as in most tactical aircraft. For certain missions, however, special stabilization systems may be used to provide extremely stable vertical flight. Manual override for the pilot would be provided. Such a stabilizer system might be designed along the lines of those used by helicopters for maintaining stable vertical flight in ASW hydrophone dunk operations.

Control of the transition from vertical to normal flight will be accomplished using hydraulic or electromechanical systems. However, electronic amplifiers may form part of the feedback control or indicator portion of such systems.

PROPULSION—Various methods of propulsion are under development. These include: fan-in-wing, ducted fan, augmented jet, tilt wing, and tilt propeller.

In addition to the U. S. military development contracts, and NASA research, there is international interest in developing a NATO aircraft through international manufacturing arrangements.

All VTOL aircraft now under study by the services are developmental in nature, and seek to prove the proper approaches for aircraft designed for different flight missions. When tactical conditions permit, most vertical-take-off designs may be used as short take-off aircraft, allowing larger payloads to be carried.

DVST

Machlett Direct View Storage Tubes

ML-8130
ML-8139



Brightness:

Over 2000 foot lamberts—ML-8130
Over 1500 foot lamberts—ML-8139

Writing Speed—at full brightness:

Over one half million inches per second—ML-8130
Over 150,000 inches per second—ML-8139

Storage: Uniform Storage Characteristics

Resolution: To 80 written lines per inch at optimum brightness

Focus:—both tubes: Electrostatic

**Deflection: ML-8130—Electrostatic
ML-8139—Magnetic**

USES

Airborne
Weather radar
Search Navigation
Terrain Avoidance

Ground
Slow-scan television
Storage, instrumentation

Shipboard
Sonar long-memory displays
Marine displays
Sonar devices displays

Write today for complete data on these new
Machlett Direct View Storage Tubes.



MACHLETT

An Affiliate of Raytheon Company

THE MACHLETT LABORATORIES, INC.

SPRINGDALE, CONNECTICUT

BIG PERFORMANCE

SUB
MINIATURE
DIMENSIONS

TERMINAL
BLOCKS



ACTUAL SIZE SIX STATION BLOCK

SUBMINIATURE
CB-S SERIES

Rated to 15 AMPS
#16 to #32 AWG wire

Camblock's patented* design utilizes a self-contained cylindrical cam. The wedging action of the cam, in conjunction with the busbar design, produces fast, positive locking with high vibration proof characteristics and extremely efficient conduction.

- No Lugging
- No Screws
- No Solder
- No Special Tools
- No Loose Parts

Making wire connections is amazingly simple: (A) strip wire, (B) insert into connector, (C) turn cam

- Wiring Labor Time is Sharply Reduced
- In-Field Service and Maintenance is Simplified
- Improved Quality Control With Less Dependence on Employee's Skill

Unbreakable, solid bottom body construction provides high dielectric strength and good protection against short circuiting and contamination. Terminal markings are molded on the housing.

* Patent No. 3,042,896
Write for technical data sheets

CAMBLOCK®
DIVISION



WALTHAM PRECISION INSTRUMENT
COMPANY, INC.

221 CRESCENT STREET

WALTHAM 54, MASSACHUSETTS

Tel: TWindbrook 3-4000 TWX: WALTH 1183-X



SYNCOM TESTS will be made by USNS Kingsport, off Nigeria, and station at Lakehurst, N.J. Photos show installation of 30-foot Triax antenna, by GE, and control room. Bendix headed team equipping the ship

Syncom to Have Cousin

NASA is now planning a synchronous weather satellite system, too

SYNCOM I, the communications satellite slated for launch this week (ELECTRONICS, p 7, Feb. 8), is the forerunner of synchronous-orbiting communications and weather satellites. Appearing stationary in a 24-hour orbit at an altitude of 22,300 miles, each of the satellites will provide continuous coverage of one-third the earth.

By summer, NASA expects to settle on design requirements for follow-on Syncoms with communications channel capabilities similar to Telstar and Relay. Syncom I, built by Hughes, will not be truly stationary—it will move in a figure-8 over the Atlantic—and can handle only one two-way telephone call or teletypewriter message.

By 1964, NASA hopes to orbit the first synchronous weather satellite. The agency has just given Republic Aviation a \$136,640 contract to determine the system's technical requirements.

Syncom I carries dual communications transponders. Either receiver may be used with either of the two twt transmitters. There are also two identical command receivers. Antennas include a slotted

array for communications transmission, a dipole for communications reception and a 4-whip turnstile for telemetry and command.

Frequencies are around 7,360 MC for communications transmission from ground, 1,815 Mc for satellite response, 1,820 Mc for the satellite's beacon signal, and 148 Mc for command. Satellite range and range rate are determined from two-way transmission time and doppler shift in the beacon signal.

SYNCOM'S fit in third-stage Delta launch rocket is checked by Douglas engineers



**OVERSHADOWED
IN SIZE... BUT
NOTHING ELSE**



COMPACT NEW **EH 410** SIGNAL GENERATOR

...WITH TRANSISTORIZED WIEN BRIDGE OSCILLATOR

Here's the advanced new signal generator with one-fourth the bulk of competitive instruments...and more capability. The E-H Model 410 is a stable, reliable instrument providing 6 decades of frequency coverage from 10 cps to 10 megacycles. You'll find the compact new 410 is easy to use for audio, ultrasonic and video measurements. And far less bulky on the bench!

SPECIFICATIONS

FREQUENCY RANGE: 10 cps to 10 MC, 6 Bands

OUTPUT: 3 volts into 600 ohms or 50 ohms; 1.5 volts into 600 ohms back matched

FREQUENCY RESPONSE: Flat within 1 db over the entire frequency range

DISTORTION: Less than 1% to 100 kc

OUTPUT ATTENUATOR: Up to 50 db, separate attenuators for 600 ohms and 50 ohms output

DIMENSIONS: 6 inches high, 12 inches wide, 9 inches deep. Weight—15 lbs.

PRICE: \$545. Rack mounted \$20 extra

WRITE, WIRE OR TELEPHONE TODAY FOR MORE INFORMATION... REPRESENTATIVES IN ALL MAJOR CITIES



E-H RESEARCH LABORATORIES, INC.

163 ADELIN STREET • TEMPLEBAR 4-3030 • OAKLAND 20, CALIFORNIA

TWX OA 396 U Cable EHLAB

Why so many?

We admit it.

Amphenol, more than any other connector manufacturer, accepts responsibility for confronting you with a seemingly endless selection of rack and panel connectors.

There's a good reason.

For some uses, a ten-contact connector the size of an Idaho potato will do just fine. In others, ten connections must be squeezed into a space no bigger than a jelly bean. Still other applications have unique requirements that relate to environment or mating force—even the technical skill of the operator.

WHY WE DO IT

We make a lot of different rack and panel connectors because it takes a lot to satisfy the wide range of applications.

For example: the Amphenol Blue Ribbon® rack and panel connector is widely used in "blind" mating applications. Part of Blue Ribbons' popularity is due to the fact that they mate with a smooth and gradual wedge-like force. Because they mate so smoothly, the "feeling" of correct alignment is unmistakable.

Another advantage of the Blue Ribbon design is the wiping action that occurs as connectors mate. Each time Blue Ribbons are mated, contact surfaces are wiped clean. Combine wiping action with high mated contact pressure, and the result is an extremely low-resistance connection.

THINKING SMALL?

As fine a connector as we know the Blue Ribbon is—it's just not right for the real tiny stuff. Thus, as miniaturized

electronic equipment became popular, Amphenol engineers developed the Micro Ribbon®—a rack and panel connector utilizing the ribbon contact principle, but in as little as one-half the space. Further development produced a circular Blue Ribbon connector which crammed 50 contacts into a diameter just under 3 inches.

Also, there's the question of terminating rack and panel connectors. Often, confined quarters or complex wired harnesses can tax the dexterity of even the most skilled worker

To solve this problem, Amphenol engineers developed rack and panel connectors with Poke-Home® contacts. Poke-Home contacts make it possible to terminate conductors independent of the connector. Contacts are crimped, soldered, or even welded to conductors, then inserted into the connector. Besides simplifying assembly, Poke-Home contacts can be easily removed *after* assembly should circuit changes or repairs later become necessary. Needless to say, Amphenol rack and panel connectors with Poke-Home contacts (Min-Rac 17®, 93 and 94 Series, for example) are popular items with engineers who are forced to think small, spacewise.

BEATING THE ELEMENTS

There's a need for environmentally resistant rack and panel connectors, too. High performance aircraft, missiles and space craft led to the development of Amphenol 126 and 217 Series environmentally sealed rack and panel connectors. (The 217 offers the added feature of Poke-Home contacts.) Other Amphenol rack and panel connectors

can accommodate coaxial connectors; many can be supplied with hermetically sealed contacts. There are rack-to-cable connectors available in every series. There are super-economy types and super-reliable types.

So, when you have a rack and panel connector problem, contact an Amphenol Sales Engineer (or an authorized Amphenol Industrial Distributor). With the broadest line of rack and panels in the industry—if he can't solve it, no one can. If you prefer, write directly to Dick Hall, Vice President, Marketing, Amphenol Connector Division, 1830 South 54th Avenue, Chicago 50, Illinois.

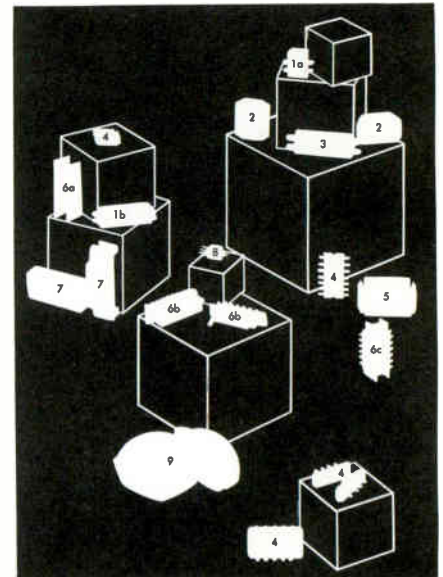

Amphenol connectors shown on the opposite page are: 1—Min-Rac 17 with (a) crimp-type contacts and (b) solder-type contacts 2—94 Series 3—Micro-Ribbon 4—126 Series Rectangular 5—93 Series 6—Blue Ribbon with (a) barrier polarization, (b) pin polarization and (c) keyed shell and barrier polarization 7—126 Series "CNI" 8—126 Series Hexagonal 9—Circular Blue Ribbon



Connector Division / Amphenol-Borg Electronics Corporation

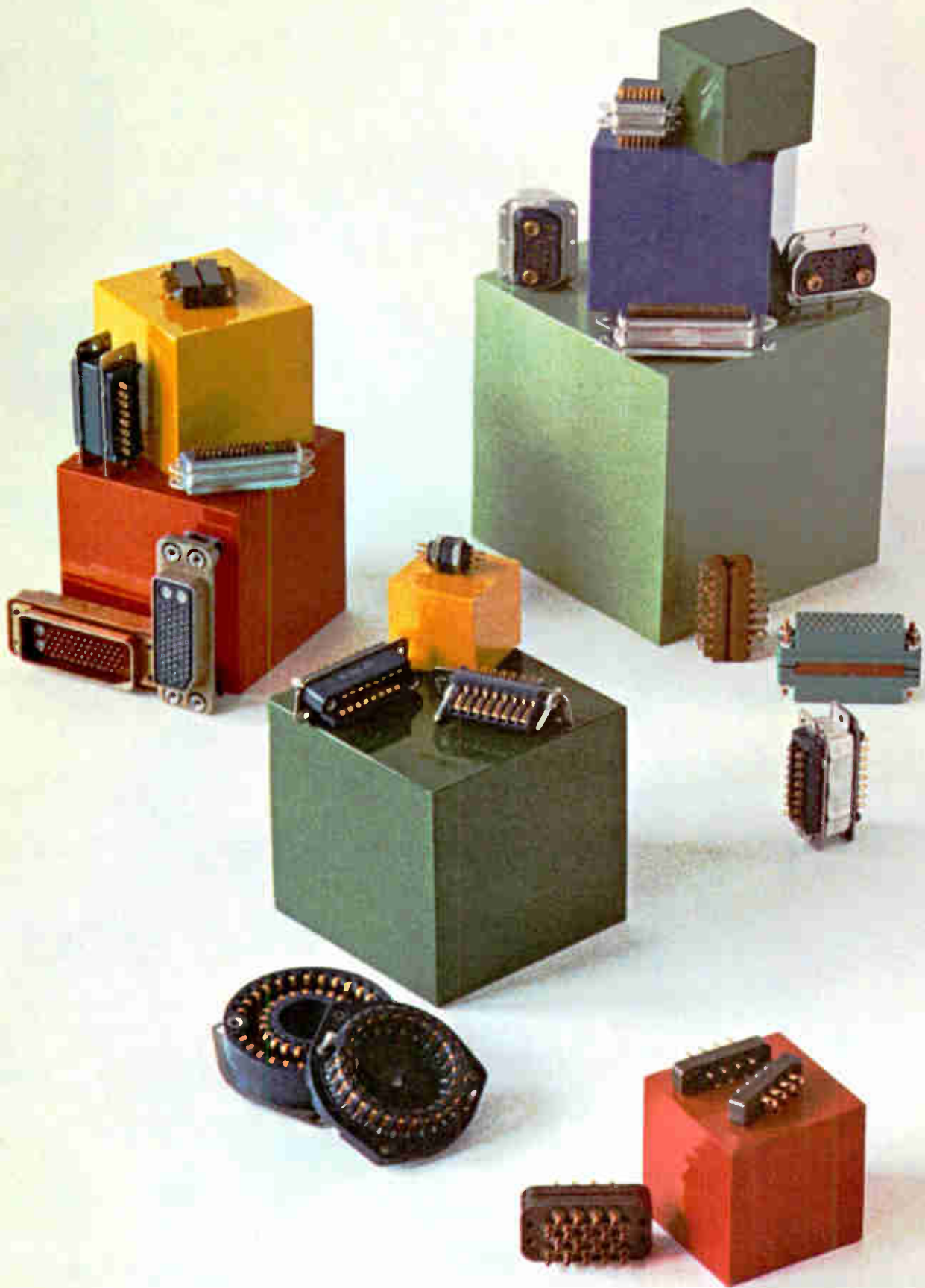

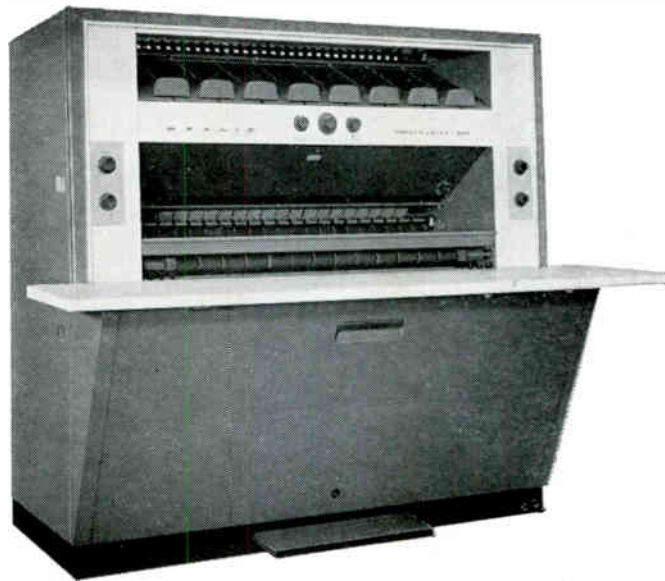

WHITEPRINTERS: WHAT TO LOOK FOR

Get new ease, economy and efficiency
with extras like these...
at no extra cost!

When looking for the ideal whiteprinter for volume production, it is important to evaluate work-saving features of the machine as well as the economics of day to day machine operation. Here are reasons the Ozalid Printmaster® 900 is your best buy.

Exclusive Ozalid Sleeveless Developer System eliminates sealing sleeve, perforated rollers, slip screen. Prints travel through heart of developer system, receive frictionless dual-sided development in one pass. Curl minimized. Protective sheets for film eliminated.

New Instant-start Variable Speed Control gives greater than ever operating reliability. Dependable silicon rectifiers replace expensive electron tubes, keep PM-900 costs low and performance high.

Variable Lamp Intensity Control adds flexibility to print exposure, allows slower machine speed where desired.

Double Action Reversing Pedal helps you correct alignment errors quickly, protects valuable drawings.

Automatic Safety Device acts instantly, positively to stop and reverse your Printmaster 900 should foreign objects trail into machine. Protects printing cylinder and other vital parts from damage.

Automatic Exhaust Timer keeps belts moving and blowers working up to 30 minutes after machine is switched off. Prolongs belt life. Prevents condensation.

Versatility. Printmaster 900 is specifically engineered to process efficiently the new Ozalid polyester films and other specialty intermediate materials.

For details on the Printmaster 900 write to: Ozalid, Dept. 101, Binghamton, N. Y.

OZALID
WE REPEAT
OZALID

General Aniline & Film Corporation
In Canada: Hughes-Owens Co., Ltd., Montreal.

Specifying discriminators? Do you know...

Which discriminator gives you the greatest reliability?



The GFD-3

(5000 hours MTBF...and we can prove it!)

Which discriminator is the most compact?

The GFD-5

(Seven occupy just 3½ inches of panel height)



Which discriminator works at the highest frequency?

The GFD-8

(Up to 5 Mc...high enough?)

Which switchable discriminator gives you phase-locked-loop operation?



The GSD-3

(23 channels; provision for remote control)

Who makes them?



A few more important facts about the complete family of DCS Discriminators: They're all solid state. They're all available on rapid delivery. And, there's a full line of accessories and mounting hardware. For more information, including data sheets containing complete specifications, write today to: Dept. E-11-2

Write for the name of your nearest representative. Address: Dept. E-11-2



DATA-CONTROL SYSTEMS, INC.
Instrumentation for Research

Los Angeles • Santa Clara • Wash., D. C. • Cape Canaveral

Home Office: E. Liberty St., Danbury, Conn. • Pioneer 3-9241

HOW TO LACE FOR

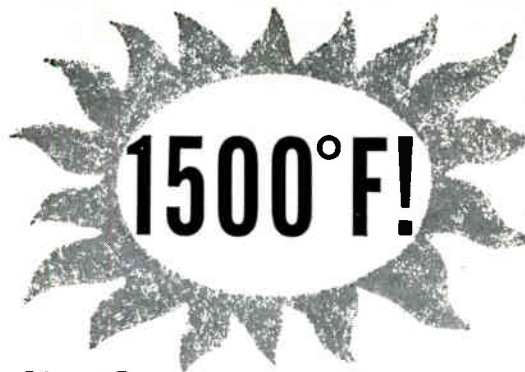

Why Gudebrod's Common Sense Approach to Lacing Problems Pays Dividends for Customers!

Recently a customer involved in the missile program came to us with a problem. He wanted a lacing tape that would be easy to use but must withstand extremely high temperatures . . . well above 1000°F!

We had to admit that we had no such tape. Our high temperature tapes such as GUDE-GLASS® have a maximum temperature range of 800°F. To solve this customer's problem, we developed GUDE-Q®, a revolutionary new lacing tape *that is essentially stable to temperatures in excess of 1500°F.*

GUDE-Q is a flat braid made from continuous length silica fibers that have been especially impregnated with a silicon finish to produce excellent handling and tying qualities. GUDE-Q lacing tape allows harnesses to be easily tied . . . knots don't slip, yet it withstands temperatures in excess of 1500°F.

Creating a new tape to meet high temperature requirements is but one of many ways in which we serve customers' needs. Whatever your lacing tape needs—civilian, military, fungus proofing, high temperature, color coding—Gudebrod's common sense approach to the problem will pay dividends for you because:

1. *Gudebrod lacing tape increases production!*
2. *Gudebrod lacing tape reduces labor costs!*
3. *Gudebrod lacing tape means minimal maintenance after installation!*
4. *Gudebrod is quality—our standards for lacing tape are more exacting than those required for compliance with MIL-T!*

Write today for our Technical Products Data Book which explains in detail the many advantages of Gudebrod lacing tape for both civilian and military use.

Address your inquiry and your lacing tape problems to:



GUDEBROD BROS. SILK CO., INC.

FOUNDED IN 1870

Electronics Division

12 SOUTH 12th STREET, PHILADELPHIA 7, PENNA.

MEETINGS AHEAD

QUANTUM ELECTRONICS INTERNATIONAL SYMPOSIUM, IRE, SFER, ONR; Unesco Building and Parc de Exposition, Paris, France, Feb. 11-15.

INFORMATION STORAGE AND RETRIEVAL SYMPOSIUM, American University; International Inn., Washington, D. C., Feb. 11-15.

ELECTRICAL & ELECTRONIC EQUIPMENT EXHIBIT, ERA, FRC; Denver Hilton Hotel, Denver, Colo., Feb. 18-19.

ELECTRICAL-ELECTRONIC TRADE SHOW, Electrical Representatives Club and Electronic Representatives Assn.; Hilton Hotel, Denver, Colo., Feb. 18-19.

SOLID STATE CIRCUITS INTERNATIONAL CONFERENCE, IRE-PGCT, AIEE, University of Pennsylvania; Sheraton Hotel and U. of P., Philadelphia, Pa., Feb. 20-22.

RESIDUAL GASES IN ELECTRON TUBES INTERNATIONAL SYMPOSIUM, Italian Society of Physics, et al; March 12-15.

PACIFIC COMPUTER CONFERENCE, AIEE; California Institute of Technology, Pasadena, Calif., March 15-16.

BIONICS SYMPOSIUM, United States Air Force; Biltmore Hotel, Dayton, Ohio, March 18-21.

IEEE INTERNATIONAL CONVENTION, Institute of Electrical and Electronics Engineers; Coliseum and Waldorf-Astoria Hotel, New York, N. Y. March 25-28.

ENGINEERING ASPECTS OF MAGNETO-HYDRODYNAMICS SYMPOSIUM, IRE-PGNS, AIEE, IAS, University of California; UCLA, Beverly, Calif., April 10-11.

OHIO VALLEY INSTRUMENT-AUTOMATION SYMPOSIUM, ISA, et al; Cincinnati Gardens, Cincinnati, Ohio, April 16-17.

CLEVELAND ELECTRONICS CONFERENCE, IRE, AIEE, Case Institute, Western Reserve University, ISA; Hotel Sheraton Cleveland, April 16-18.

INTERNATIONAL NONLINEAR MAGNETICS CONFERENCE, IRE-PGEC, PGIE, AIEE; Shoreham Hotel, Washington, D. C., April 17-19.

ADVANCE REPORT

INTERNATIONAL TELEMETERING CONFERENCE, IEEE, IEE, ISA, et al; Savoy Place, London, England. March 1 is the deadline for submitting papers in triplicate and not exceeding 4,000 words and one page of diagrams to: Lawrence L. Rauch, Instrumentation Engineering, University of Michigan, Ann Arbor, Michigan. Authors not living in North and South America and Japan should submit papers to: R. H. Barker, Institution of Electrical Engineers, Savoy Place, London W. C. 2, England. Of interest are theory, systems design and hardware techniques in any of the following areas: characteristics of information to be measured; transducers; signal conditioning (pre-transmission); transmitting systems (including coding); receiving and recording systems; signal recovery (demodulation); data reduction presentation and evaluation (computer mention should only be incidental).

Capture fast
signals
accurately,
in just 10
seconds,

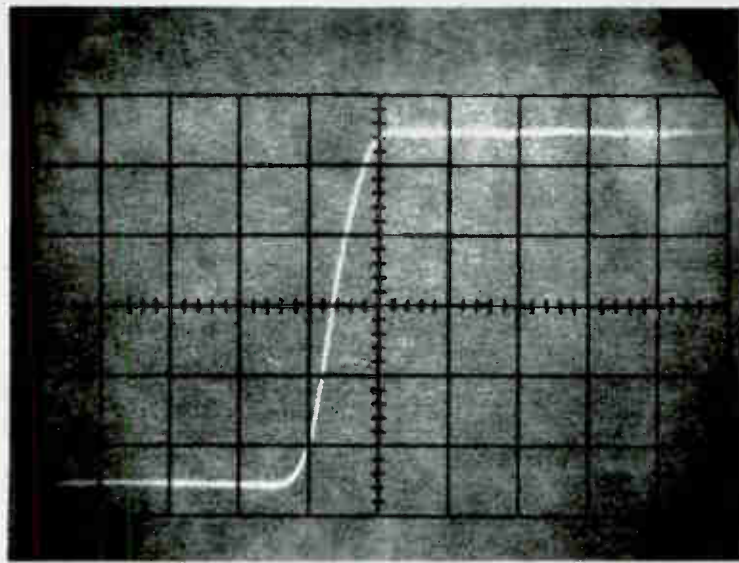
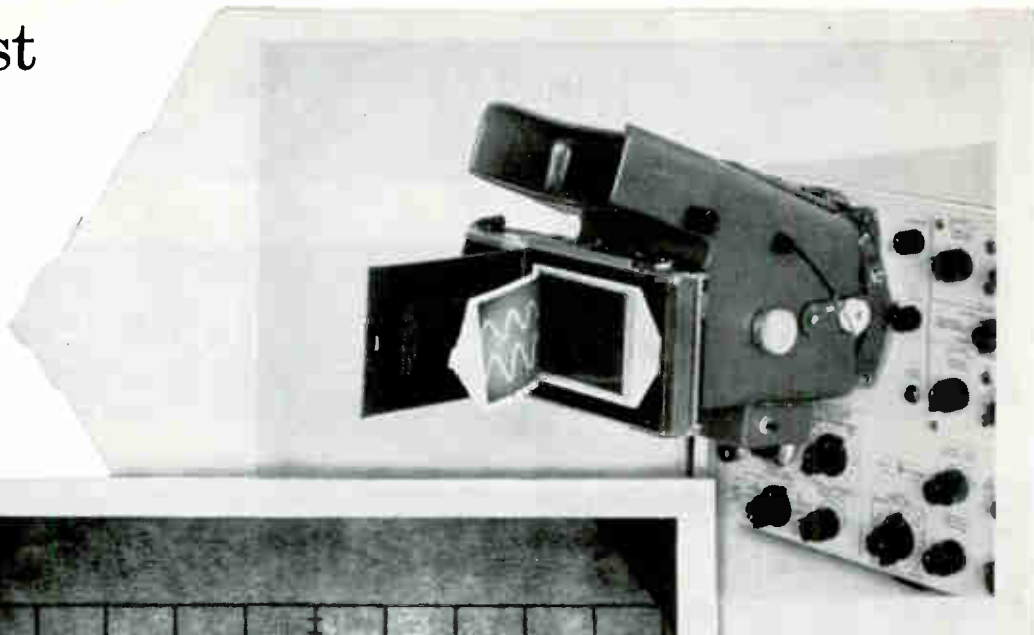



Single shot transient, 10 nsec/cm sweep speed

For a scope trace recording as precise and accurate as that shown here, you need three things:

1. new  no-parallax oscilloscope
2. new  196B oscilloscope camera
3. new Polaroid® PolaScope Land 10,000 speed film

This unique combination gives you sharp, scalable, easy to read (or reproduce) pictures completely developed in only 10 seconds — almost as fast as you can peel them from the back of the camera. The new, ultra-sensitive Type 410 Land film (10,000 ASA equivalent) captures even fastest transients with superior definition and picture quality. The single-shot transient shown, sweep speed 10 nsec/cm, is a typical example.

The 196B Camera features a built-in, low power black light. This near u-v illumination causes

the phosphor to glow, providing an intermediate grey background on the finished photo. This assures maximum contrast between the black graticule lines and white trace; photos are easier to read since ambiguity between graticule line and trace is eliminated. The black light also pre-sensitizes the film, increasing film speed. This light, standard on  196B, is available as a field modification for  196A Cameras. To completely avoid parallax error, new  cathode ray tubes have the graticule inside the tube in the same plane as the phosphor.

The lightweight  196B Camera is extremely simple to operate. It mounts in seconds, permits aperture and shutter speed adjustments after mounting. Two-eye direct viewing simplifies trace adjustments.

Camera specifications: Object/Image Ratio 1 to 0.9 (1-1 optional). Lens 3-inch (75 mm) f/1.9. Lens opening, f/1.9 to f/16. Shutter speeds, 1/100 to 1 second, Time and Bulb. Print size, 3¼" x 4¼". Image size, 2⅞" x 3-13/16". Film, Polaroid® Land film types 42, 44, 46, 46-L, 47, 410. Weight, 9 lbs. Price,  196B, \$490.00; 196A (same but without u-v light), \$440.00; u-v modification kit for 196A, \$50.00.

Data subject to change without notice. Prices f.o.b. factory.

**HEWLETT
PACKARD
COMPANY**



7754

1501 Page Mill Road, Palo Alto, California, Area Code 415, DA 6-7000. Sales and service representatives in all principal areas; Europe, Hewlett-Packard S.A., 54-54bis Route des Acacias, Geneva; Canada, Hewlett-Packard (Canada) Ltd., 8270 Mayrand Street, Montreal. Polaroid® by Polaroid Corporation

500 MAN HOURS

CUT TO 33½ HOURS IN

32,000 PRINTED CARD TESTS!

BETTER
MEASURING
FROM



Engineers of the Martin Company have developed an automatic card testing machine that electronically inspects printed circuit cards used in the firm's PERSHING, BULLPUP, GAM-83 missile systems as well as its air defense and communications systems. Key to the speed, simplicity and cost savings of the machine is the EI Digital Multimeter which displays test results of the tape program at the push of a button!

Each of the 1000 printed circuit cards produced daily by Martin can now be given 32 quality tests in less than 2 minutes — work which formerly took an experienced electronics technician and inspector 15 to 45 minutes per card!

As in the case of Martin, EI all solid state Digital Multimeters are your answer to greater speed, higher reliability, significant cost savings and a much lower investment.

Whether your interest lies in spacecraft, electronic components or industrial processes, we can demonstrate to you the advantages of EI digital instruments in measuring DC volts, AC volts, DC ratios, resistance, capacitance, inductance and impedance. Let EI all solid state Digital Multimeters provide you with swift, accurate, low cost solutions to your measurement and display problems.

For full details on EI's individual digital instruments, or our complete capabilities in the field of measurement, display and recording—write direct in care of Dept. MA-2.

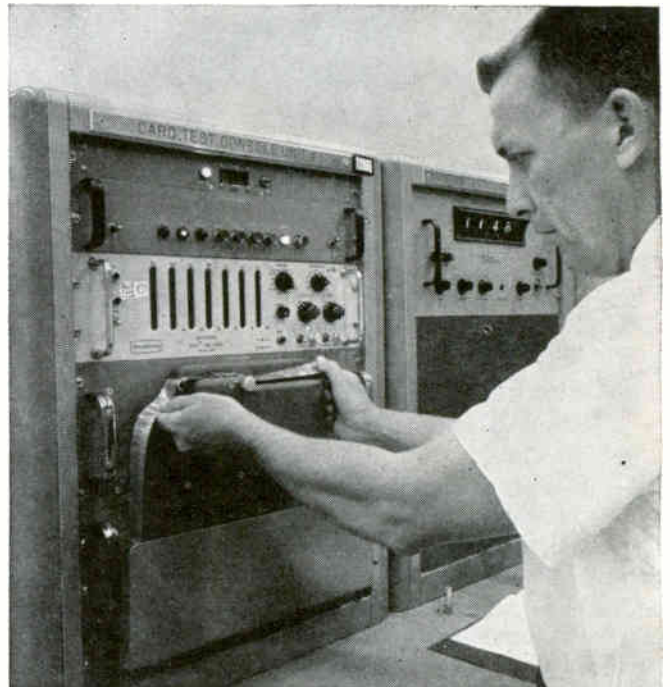

Carle W. Collins, production test engineer, Martin Company's Orlando (Fla.) Division, inserts coded Mylar tape into the reader unit of the Tape Programmed Automatic Tester which he designed.



Electro Instruments, Inc.
8611 Balboa Avenue, San Diego 12, California

KINNEY EVAPORATORS

**FROM
2" to 6"
SINGLE
OR
DOUBLE**

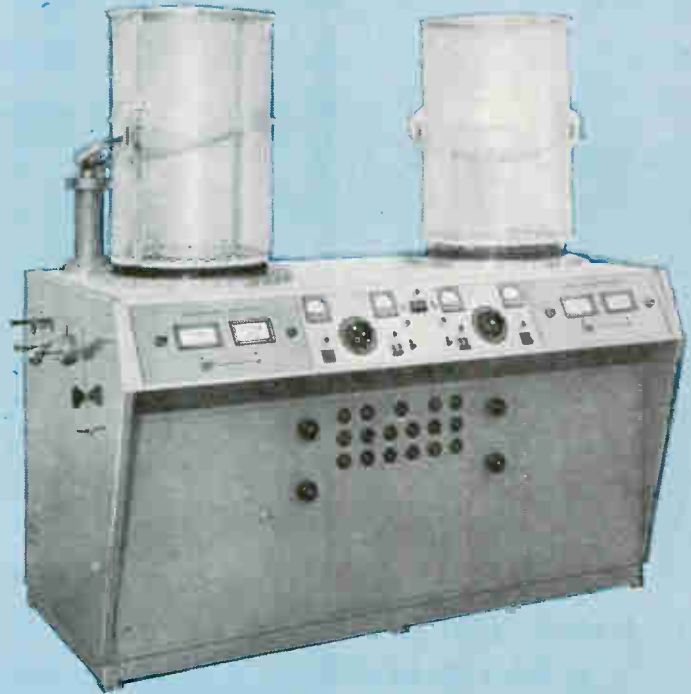

KINNEY . . .

EVERYTHING

IN VACUUM



**KINNEY
VACUUM**

DIVISION THE NEW YORK

AIR BRAKE COMPANY

3529 WASHINGTON STREET

BOSTON 30, MASS.

MEET ALL VACUUM REQUIREMENTS

Kinney Evaporators are designed for laboratory, pilot plant or production applications where versatility, dependability, and speed are required. These evaporators offer rapid evacuation and ultimate pressures as low as 5×10^{-7} torr when using liquid nitrogen. They are furnished complete with filament power supplies and vacuum gauges. Utilizing dependable Kinney components, each system is housed in a compact, functionally designed cabinet finished in hammertone grey enamel and topped with a durable formica work surface. All electrical controls and meters are grouped on a sloping console for optimum operator control and visibility. Its versatility is enhanced by a complete line of Kinney accessories. Kinney's standard models include 2" to 6", single and double evaporators; custom-designed systems can be built to your specifications.

**COMPACT,
LIGHTWEIGHT**

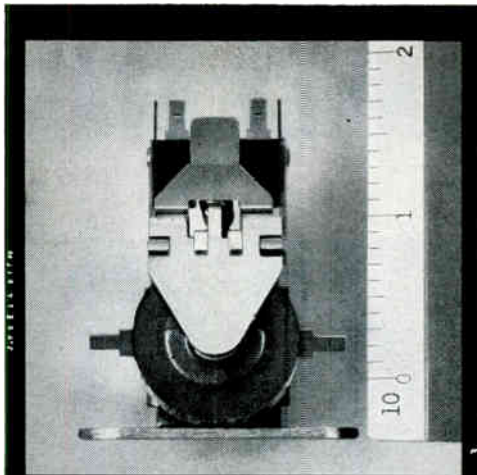

**CONTINUOUS-DUTY
COIL**

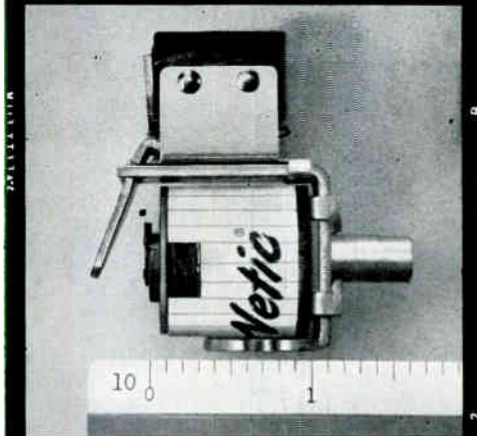

**5-AMP CONTACTS,
SPDT OR DPDT**

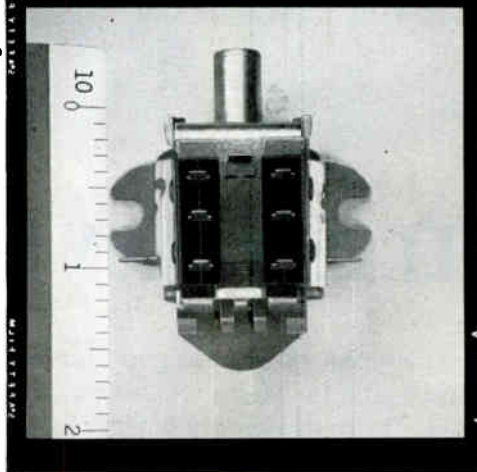

HEINEMANN TYPE B TIME-DELAY RELAY

Here's a bargain for you: a time-delay relay that can work as its own load relay. The Heinemann Type B.

The relay's continuous-duty coil does the trick. Makes it possible for the Type B to remain locked-in indefinitely after actuation. In most cases, this eliminates the need for a separate slave relay and associated circuitry.

The Type B Relay, happily, is quite moderate in price. It's also neatly compact. And it weighs only 3.5 ounces. You can have it in any of eighteen standard AC and DC operating voltages, and with any of sixteen standard timings, from a 1/4 second to a full two minutes. Contact capacity is generous for a relay of its size: 5 amps at 125 or 250V AC or 30V DC, resistive (3 amps, inductive load).

Our Bulletin 5005 will give you detailed information. Write for a copy.

HEINEMANN ELECTRIC COMPANY
2600 Brunswick Pike • Trenton 2, N. J.



The Choice of the Discriminating Communication Engineer . . . the Man who Never Settles for Anything Less than THE-VERY-BEST!

telrex "BEAMED-POWER" ANTENNAS and ANTENNA SYSTEMS

Provide optimum performance and reliability per element, per dollar. Antennas from 500 Kc to 1500 Mc. Free PL88 condensed data and pricing catalog, describes military and commercial antennas, systems, accessories, Towers, Masts, Rotators, "Baluns" and transmission line data.



Communication and TV Antennas

Asbury Park 41, New Jersey, U.S.A.
CIRCLE 204 ON READER SERVICE CARD



1 to 5 Reeds
.095 — .215 dia.
6 to 48 V.D.C.
Lead or Pin Term.
Also Available with Reeds.

Write for Bulletin and Prices

ELECTRICAL COIL WINDINGS

Wire sizes #6 to #56, Classes A, B, F and H. Complete engineering service available.

Coto-Coils COTO-COIL COMPANY INC.

65 Pavilion Avenue, Providence 5, R. I.

CIRCLE 205 ON READER SERVICE CARD
electronics

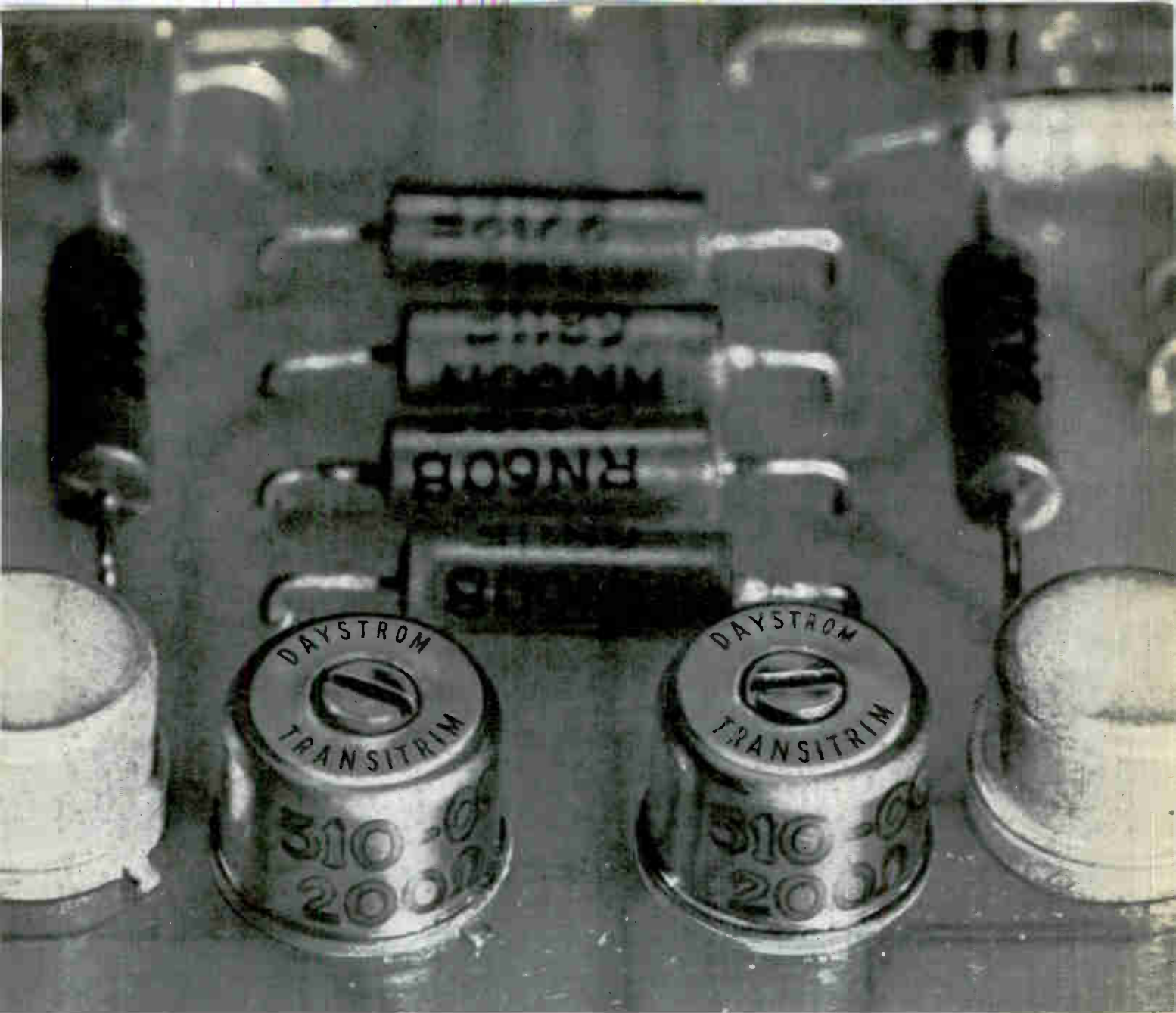

HEADED FOR AUTOMATION

...AND DESIGNED TO MEET ALL MIL SPECS. THAT'S THE STORY ON DAYSTROM TRANSITRIM.®

The Daystrom Transitrims potentiometer, in a TO-5 configuration, is designed to facilitate the automatic assembly of PC board circuitry. In addition, it is designed and manufactured to comply with the operational requirements of MIL-R-27208A. The Series 510 wire-wound Transitrims offers 1.25 watts dissipation in still air, resistance ranges from 10 ohms to 30 K, and an operating temperature range from -55°C to $+175^{\circ}\text{C}$.



ACTUAL SIZE

Some features of the Transitrims potentiometer include: a vacuum-tight glass-to-metal seal header with O-ring under compression on the adjustment screw; an all-metal housing free of plastic parts for greatest strength, durability, and heat dissipation; and $1\frac{1}{2}$ inch rigid bare wire leads for automatic assembly. The Transitrims is impervious to humidity, salt spray, sand and dust, etc. No other line offers so much... send for data!

DAYSTROM, INCORPORATED
 POTENTIOMETER DIVISION
 ARCHBALD, PENNSYLVANIA • LOS ANGELES, CALIFORNIA

CIRCLE 43 ON READER SERVICE CARD

The Siliconix 12 nsec 5 mw Dual NAND Gate

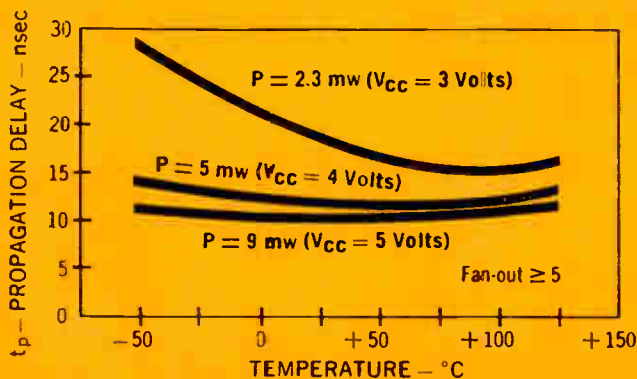
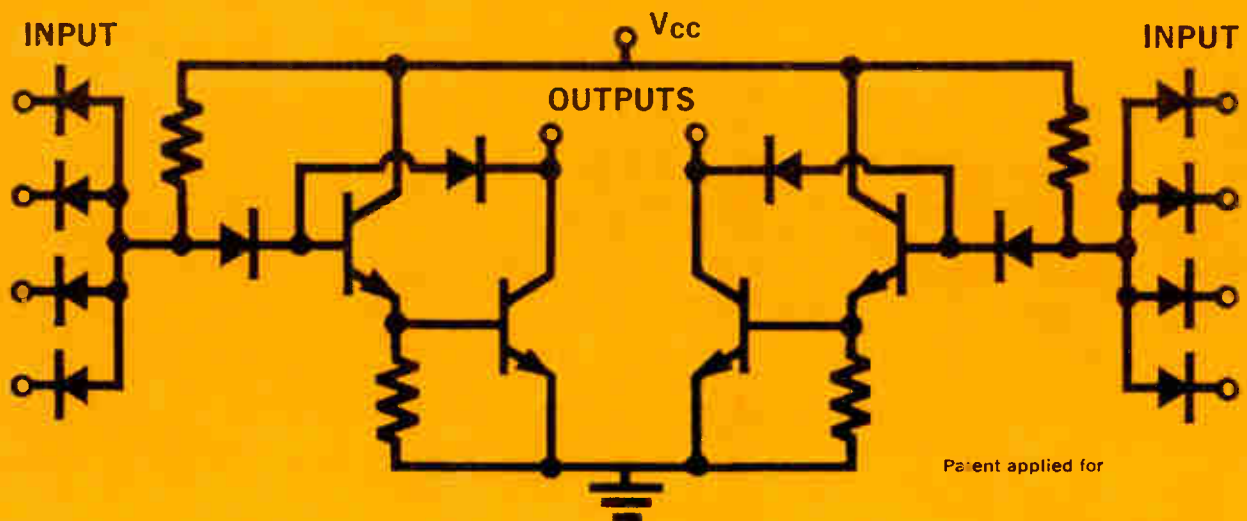

Average Propagation Delay vs. Temperature and Power Dissipation

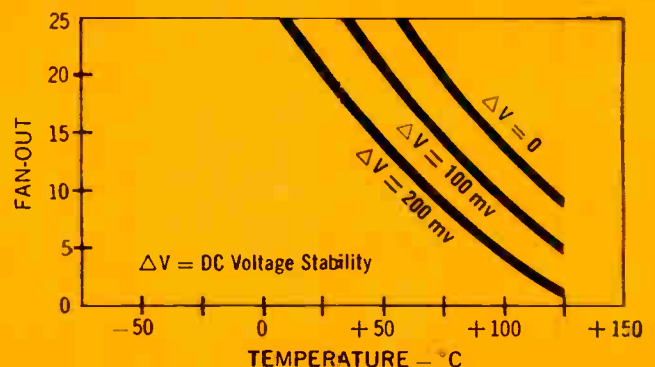

Fan-out as a Function of DC Stability and Temperature

THIS PLANAR SILICON INTEGRATED CIRCUIT HAS A LOWER POWER-SPEED PRODUCT (60 PICOWATT-SECONDS) AT HIGHER FAN-OUT THAN CONVENTIONAL DIODE-COUPLED NAND GATES BECAUSE OF:

- The unique emitter-follower diode-clamp circuit . . .
- Small geometry which minimizes capacitance . . .
- Epitaxially grown collectors.

PROPAGATION DELAY VARIES LESS THAN $\pm 7.5\%$ FROM -55°C TO $+125^{\circ}\text{C}$ WITH V_{CC} 4 TO 5 VOLTS. USE THIS GATE AS A NAND, NOT AND-OR, BISTABLE FLIP-FLOP, OR HALF ADDER. ANOTHER EXAMPLE OF THE WAY SILICONIX COMBINES CIRCUIT AND SEMICONDUCTOR TECHNOLOGIES INTO DIGITAL AND LINEAR INTEGRATED CIRCUITS AND COMPONENTS. WRITE FOR DETAILS.



Siliconix incorporated

1140 West Evelyn Ave. • Sunnyvale 33, California
Telephone 245-1000 • Area Code 408 • TWX 408-737-9948

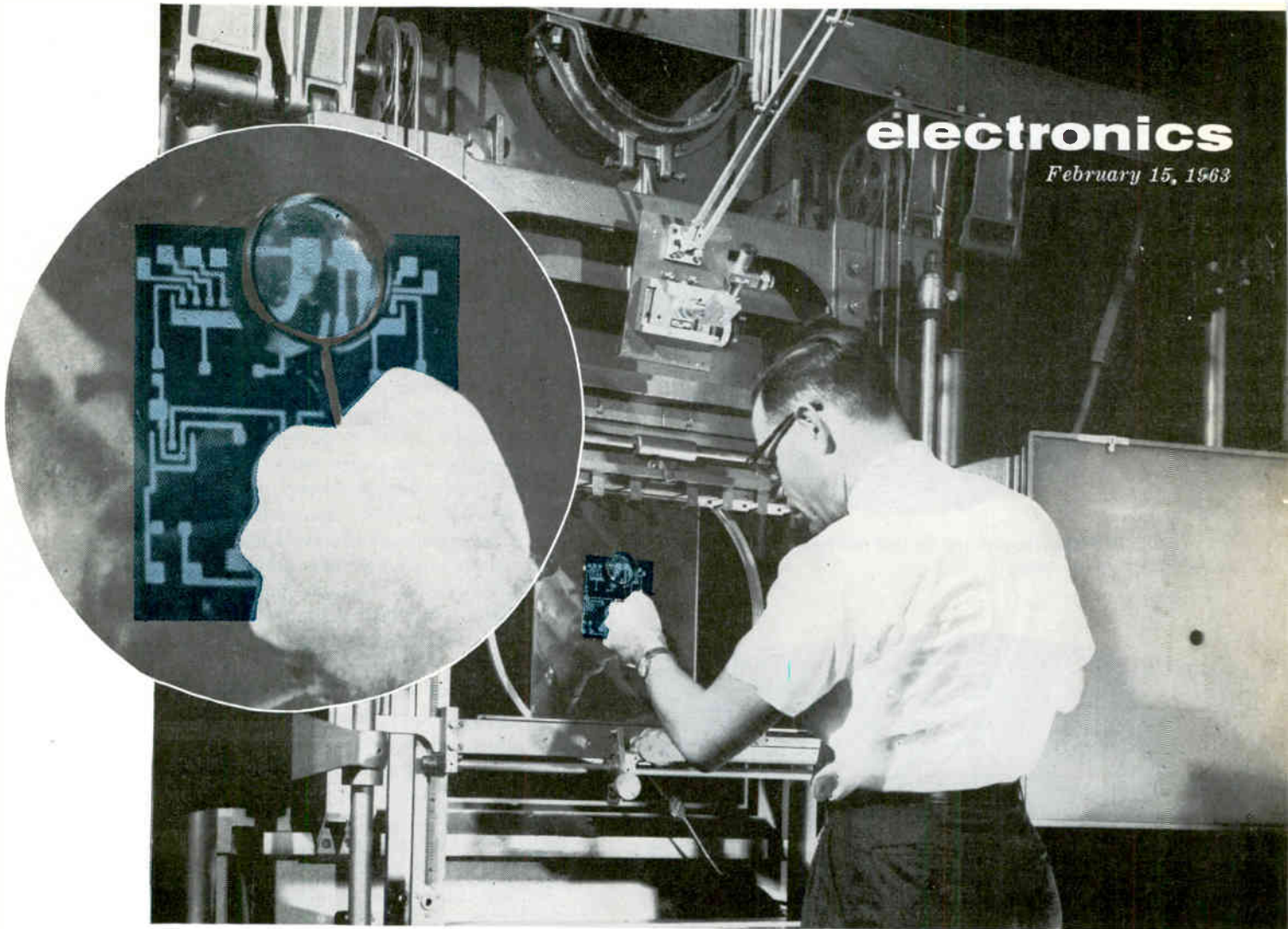

INSPECTING NEW metalizing mask for production of integrated circuits at Motorola Semiconductor Products division

ADVANCES IN MICROMINIATURIZATION

From promise to practice in just four years, a whole new technology for electronics heralds a change in the face of our industry. The question is no longer when and why microminiaturization, but how

By MICHAEL F. WOLFF, Senior Associate Editor

"WE'RE GOING MICRO." These words are being echoed throughout the industry in 1963—what was scoffed at in some quarters four years ago is now a reality.

Today production of microminiature equipment is underway for important military and space missions. Speculative talk about ultimate wonders, playing "the numbers game"—these are largely gone. Engineers are grappling with engineering problems: how best to fabricate, design, test, specify and demonstrate reliability. They emphasize that in microminiaturization they are not interested in size reduction for its own sake—rather engineers see a whole new technology of microelectronics that will bring low cost and high reliability as its most im-

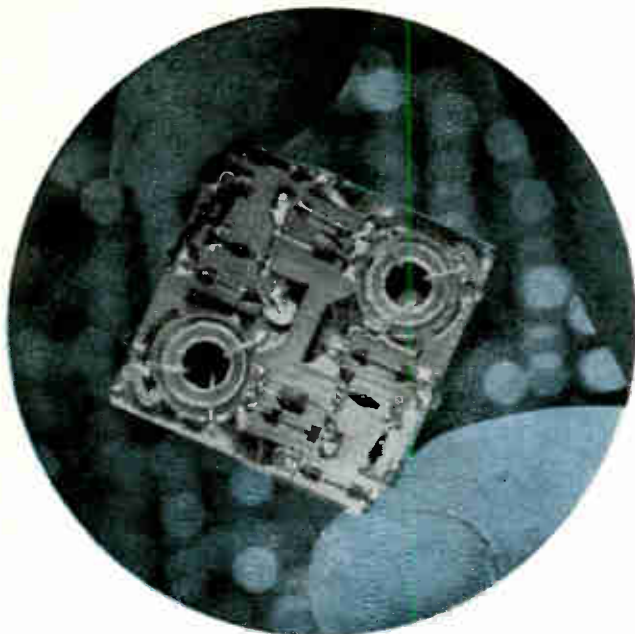

ONE OF FOUR standard wafers that comprise the logic in Arma's 20-lb space computer



(A)

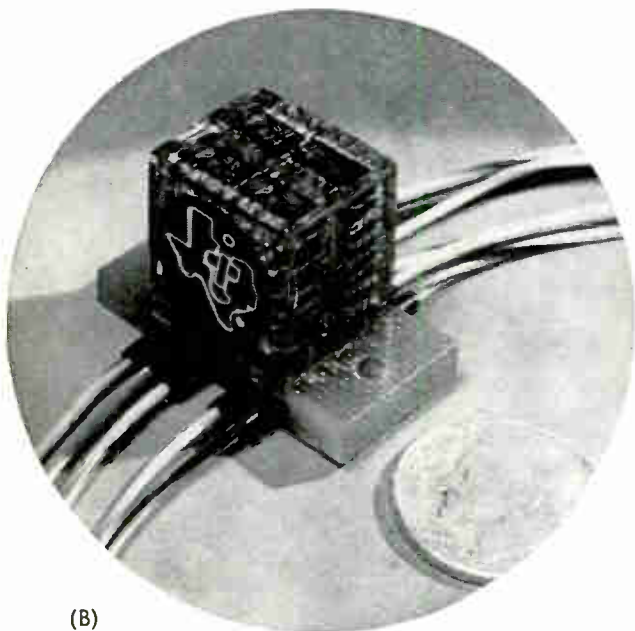

(B)

DIGITAL DATA signal conditioner for State University of Iowa experiment in first Orbiting Geophysical Observatory (A) uses 102 Texas Instruments semiconductor networks for all logic functions. Counter-scanner-programmer (B) uses 36 such networks, is undergoing laboratory evaluation for NASA

portant benefits. Now, at the start of microelectronics' first real production year, the major concern is with the practical problems of how best to realize these potentials.

APPROACHES

APPROACHES—Three approaches to microminiaturization still claim the major effort: component, thin-film and semiconductor integrated circuits.

Discrete microcomponents are widely used in soldered or welded modules. These will continue to be important where moderate size reduction is needed along with proven reliability and the design flexibility of choosing from a wide range of commercially available parts.

Smaller size with discrete components is obtained by attaching parts to "2-D" passive substrates or inserting parts in cavities in printed circuit boards. Arma's 20-lb guidance computer is an example of what can be done with the former. This 1-Mc computer is a serial, binary stored program computer designed to handle a variety of space navigation problems. It occupies 0.42 cubic foot and requires 50 w.¹ Second technique is also in production, has been used in several linear and nonlinear systems such as proximity fuzes and timers built for Army Ordnance under the Micram program.²

Standard component form factors have been derived for the micromodule program and pellet, or dot, concept. Micromodule production capabilities will be demonstrated this year as applications in Army communications and computer equipment are stepped up. In contrast to many other techniques, micromodules have an impressive amount of reliability data: RCA reports 3,493,940 element hours of life testing on 96 10-element communications modules has given an mtbf of 381,000 hours at 60 percent confidence, 16,568,650 element hours on 176 digital modules has given an mtbf of 528,000 hours.

By next year RCA estimates micromodule costs will drop below \$8 a logic circuit in quantities of 300,000. In some cases costs will be less this year than those of equivalent circuits with military-type components.

During the next few years new microelectronic techniques will also be incorporated in the micromodule package as they become feasible and are required. Experimental packages incorporating integrated circuits have been built. A new package is under development to give, in the same size, the additional interconnections these higher density techniques will need. Package would use electron-beam-welded ribbons on 25-mil centers.

Pellet approach is scheduled to be introduced into General Dynamics' manufacturing program this year. It is an interconnecting process that can use either discrete components or integrated circuits if they are packaged as pellets. Design survey indicates that 78 to 96 percent of the electronic circuits produced at General Dynamics' Astronautics can either be directly pelletized or pelletized with approximately 5 percent redesign, compared with 60 percent for thin films. Plans for a computer controlled automatic assembly system are underway.³

Thermionic integrated micromodules (TIMM's) could play an important role in high temperature and radiation environments. GE claims long-term, stable operation is possible from -65 to 500 deg C under total integrated flux of 10¹⁸ fast neutrons. Typical NOR circuit draws 3½ mw at 12-16 v. Nuclear power supplies in space, nuclear rockets and long-life (5 years or more) space communica-

nications systems are seen as possible applications.

INTEGRATED CIRCUITS—While component-oriented approaches will be around a long time, momentum seems to be toward thin-film and semiconductor integrated circuits where "circuit elements are inseparably associated on or within a continuous body to perform the function of a circuit." Feeling within the military and NASA is that these techniques will bring the reliability, maintainability and performance per dollar they consider necessary to perform their missions. Some spokesmen show little interest in discrete component approaches.

Feeling now is that semiconductor integrated circuits are satisfactory for most digital data processing functions, especially those requiring large volumes of standard circuits. Major limitation has been speed. Maximum clock rates are now generally limited to about 6 Mc but these will improve as design techniques to minimize parasitic coupling are applied and faster logic schemes introduced; 10 to 20 Mc is considered feasible on a production basis this year.

COST AND RELIABILITY—Cost has come down an order of magnitude in the last two years but yield is still considered too low. This will improve with better inspection and process control, packaging and interconnection techniques. Some observers say that yields and uniformity are good enough now that the cost of an individual transistor in a silicon integrated circuit is close to the cost of a discrete transistor. And while overall circuit costs are greater than those of comparable printed circuit boards with discrete components, the crossover point could come in the next year or two. Meanwhile introduction into commercially competitive systems will be slower than for military and space applications.

Practical limit in the complexity of a single integrated circuit that can be economically achieved is presently set by materials processing technology at around the shift-register level (about 15 transistors and 21 resistors) in the opinion of R. B. Seeds of Fairchild Semiconductor.

Increased understanding of the underlying silicon technology has led to widespread confidence in eventual high reliability of these circuits. Evidence coming in indicates this confidence may not be misplaced. Texas Instruments reported failure rate of 0.13 percent per 1,000 hours at 85 C in April 1962, estimates 0.04 percent for third quarter 1962 and predicts less than 0.01 percent by the end of this year.

Bureau of Naval Weapons feels semiconductor integrated circuits on the whole have demonstrated they are more reliable than average discrete components and expects 1-Mc devices to be available shortly with certified parameters and reasonable cost. In linear applications they feel 10 to 20 percent of present circuits can be realized with silicon integrated circuits but that here proof of reliability is not yet available.

APPLICATIONS—Semiconductor integrated circuits are already being introduced into several aerospace digital computers, but the significant boost to their application has come from the selection of Texas Instruments' semiconductor networks for the guidance and control electronics in the improved Minuteman. Observers say this program could run to ten's of millions of dollars, may eliminate the need to sell people on microelectronics.

MICROMINIATURIZATION 1963

Discrete components will always be important, but the tide is toward the circuit and function-oriented approaches. This means:

- Designers of systems, circuits and devices, will have to work closer together to generate the new circuit design and fabrication techniques that are needed. Each must know more about the other's problems than he does now
- Manufacturers will find the thin-film and semiconductor techniques complementary in their application—not competitive. But the key to the profits inherent in these technologies is careful attention to process control
- Users will find greater performance per dollar rather than small size and weight the rationale for microsystems. Eventually microminiaturization will allow attaining new levels of performance, such as duplicating biological systems

To realize fully the promise of microminiaturization, however, solving such problems as manufacturer-user cooperation, specification, testing and standardization will be just as important as solving the purely technical ones

Autonetics, associate prime contractor for Minuteman, also plans integrated circuits for inertial navigation systems under design and is evaluating them for a spacecraft radar with a 10,000-hour mtbf. Other programs planning semiconductor integrated circuits include: Apollo guidance computer, EGO and POGO satellite digital-data signal conditioners, an all-weather Naval avionics system for helicopters and VTOL aircraft, radar computer indicator for Navy's W2F-1 early-warning aircraft, and some Air Force pcm telemetry systems.

THIN FILMS—Considerable progress is being made in linear silicon circuits; however, at this time thin films appear more promising for complex and small-volume-production linear applications where high performance and relatively close tolerance components are needed. Diffused silicon resistors are generally limited to around 50,000 ohms and 20-percent tolerances, while thin-film resistors can be individually adjusted to less than 5 percent and go as high as 1 megohm. Practical-size silicon-dioxide capacitors are considered limited to around 1,000 pf, while 0.1 μ f is readily obtainable in metal films, especially tantalum where 1 μ f can be obtained at 5 v. Common film characteristics are tabulated on p 48.

Research group at Bendix Radio feels applications requiring reproducibility and rigidity will employ the early thin-film techniques. Examples are phased-array radar (because of the great number of identical receivers) and complex filter networks. Bendix wants stable circuits at uhf and above, is presently fabricating a 400-Mc i-f strip with a gain of 80 db and 100-Mc bandwidth. All resistors, capacitors and inductors will be thin film.

ITT Federal Laboratories expects to go into pilot production on tantalum film communications circuits this year. One application they are considering is a 70-Mc i-f

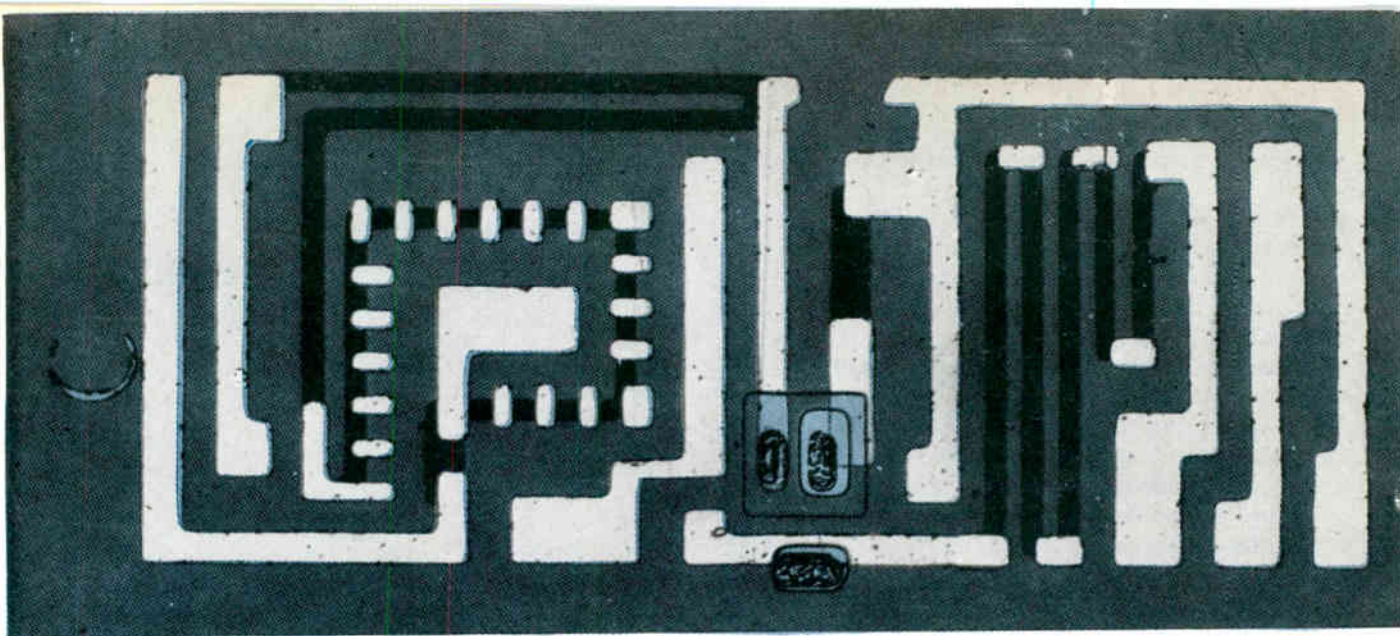

(A)

10 MILS

MICROCIRCUIT for a meteorological satellite differential amplifier (A) and NOR gate (B) built by CBS Labs. Hybrid construction employs

amplifier for parametric receivers, feeling tantalum film components can be used to about 100 Mc.

Kearfott is going into pilot production of a ¼-cubic-inch 5-watt servo amplifier that has a gain adjustable to around 1,000 at 400 cps. Some hearing aids now use films.

Battery-operated 15-Mc pulsed f-m receiver is under development at Johns Hopkins Applied Physics Laboratory for use by the National Institute of Mental Health in experiments on brain stimulation of animals. The thin-film receiver is on three 1 × 1-inch substrates, would be mounted on a monkey's head.

Thin films are also being used in specialized digital systems by those who claim the following advantages over semiconductors: design flexibility, faster fabrication of prototype systems, and higher speeds and pulse risetimes. GE is fabricating a 1,500-component digital decoder for a Navy missile; a 200-module digital computer built by Lear Siegler has been tested in a satellite. An 18-

lb airborne computer is scheduled for delivery by IBM this year under a Naval Avionics Facility contract.

Titanium metal technology is being pursued at Lockheed to meet space environmental requirements, particularly radiation. They report less than 5 percent change of resistor characteristics under 2×10^{10} neutrons per sq cm², have used titanium components in a sequencer subsystem for a space telemetry multiplexing system. The 0.894-cubic-inch unit draws 450 mw.

HYBRID APPROACHES—Major problem with thin-film circuits is the lack of compatible active components. At present, semiconductor diodes and transistors must be attached in what is considered a transitional hybrid that is generally larger, more expensive and less reliable than its equivalent in semiconductor integrated circuits. Real promise of the thin-film approach lies in its automation potential, but until deposited-film active components make this feasible, the trend is to use thin-film passive

TABLE—THIN-FILM RESISTORS AND CAPACITORS^a

RESISTORS	Ohms per sq	TCR (ppm/deg C)	Dissipation (w/in. ² of film @ rating)	Tolerance (%)	Stability (% @ 1,000 hr)	
Chromium ^b	500 — 30,000	50	25	±0.1	0.5	
Nickel-Chromium ^c	to 200	±50	12	±0.1	<0.1	
Tantalum ^c	to 100	±200	20	±0.01	1	
Tantalum Nitride ^c	to 200	-75 ±25	20	±0.01	<0.1	
Titanium ^d	500 — 2,000	+120 to -110	12.5 — 25	±1	0.8 — 1.5	
Tin Oxide ^e	Approx 500	±300	15 — 25	±2	1	
Cermets ^f	to 20,000	±250	to 20	±1	2	
Carbon Resin Ink ^g	10,000	500 — 1,000	1	±10	5 — 10	
Capacitors	Leakage Current (@ working voltage)	Working Voltage	TCC (ppm/deg C)	Dissipation Factor (%)	Tolerance (%)	Stability (% @ 1,000 hr)
Tantalum Oxide ^c	10 ⁻⁷ amp/μf	100V max	250	0.1 @ 50V	1	±3 ^h Approx 1 @ 85C
Titanium Dioxide ^d	2.5 x 10 ⁻⁷ amp/μf	50V	800	0.01	<1	±2 0.5
Silicon Monoxide ⁱ	<10 μ amp	6V	j	0.5	1	±10 j
Silicon Dioxide ^k	—	50V	<100	0.004	0.2	±10 j

(a) Representative manufacturable values variable with specific fabrication process (b) Xerox, on ceramic (c) Bell Labs (d) Lockheed (e) Corning Glass Works (f) International Resistance (g) Harry Diamond Labs (h) Without adjustment (i) IBM (j) Not available (k) General Instrument

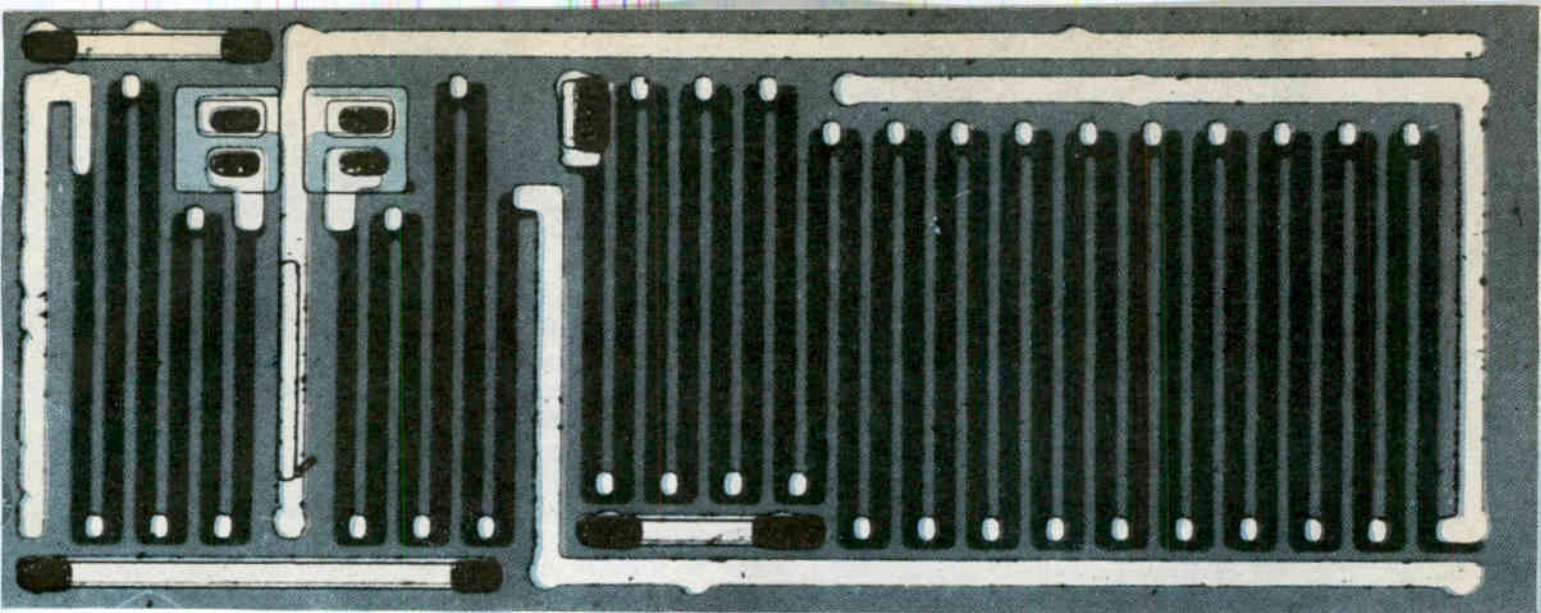

(B) 10 MILS

silicon transistors, nickel-chromium resistors on silicon oxide, and gold interconnections—Fig. 1

components with semiconductor integrated circuits in such a way as to get the most from both approaches.

Most aerospace companies are maintaining a balanced research effort. Some want an in-house thin-film assembly capability with purchased semiconductor integrated circuits for standard functions because they feel the complexity of the semiconductor technology and its inherent application to volume production preclude it as an in-house technology for the military and space electronic system assemblers.⁹

In addition to complementary usage of the two technologies there will be the actual hybrid integrated circuit consisting of semiconductor and thin film components. A promising hybrid technique is to deposit metal-film passive elements on a silicon-dioxide insulating region of a semiconductor block containing the active elements. Leads from passive to active components are then evaporated. This will be widely used wherever film passive components are required to perform a function that cannot be obtained in a silicon integrated circuit. It is seen especially attractive for 0-to-20-Kc servo control applications because there would be little problem with stray capacitance from the thin-film elements.

Figure 1A shows one of two identical patterns that make up a differential amplifier built this way for a 10-track digital tape recorder to be used in an advanced meteorological satellite. Circuit has three resistors adjustable to one percent and a transistor; amplifier can be placed inside the recorder next to the record-playback head for increased noise immunity.

Desire for greater flexibility with semiconductor integrated circuits is also leading to hybrid approaches here. These involve putting passive or active semiconductor components or both on top of an insulating substrate and interconnecting by metalization, wire bonding or both. Entire circuit is encapsulated in a single package.

While slightly more expensive than the single-block approach, this technique overcomes the problem of the inherent incompatibility of silicon transistors and resistors in the same block. Also, it minimizes capacitive coupling, permits easier testing, and is considered especially useful for small quantities of custom-made circuits where quick changes and modifications may be required. Some people

are going to this in any amplifier with more than three transistors where they need maximum speed. General Instrument is working on a technique to modify the mask so that resistors on a passive component chip can be selectively changed on the production line.

Bell Labs finds this hybrid approach reduces the number of leads made on the external circuit board by a factor of three in computer-type circuits. They are also using it in exploratory pcm circuits. In such circuits getting stable gain at 200-Mc bandwidths requires feedback. At these frequencies this feedback can best be accomplished in microelectronic circuits because otherwise the propagation time around the loop would be too great. (This points up an inherent functional advantage that many feel will give microelectronics an important role in nano-second circuits.)

Figure 2 shows an operational amplifier built this way, which because of parasitics could not have been built satisfactorily in a single silicon block. Comparison with the cordwood equivalent showed that in addition to getting much more stable closed-loop gain, open-loop performance began to degrade at 130 Mc compared to 50 Mc for the conventional. All components in the signal path are integrated except the precision feedback resistor.

DESIGN PROBLEMS

DESIGN PROBLEMS—Microelectronics will require changes in the designer's thinking. Circuit, equipment and systems engineers will have to work much more closely if an optimum microelectronic design is to result.

On the system level, decision to go micro will require a new look at solving the system transfer function. For example, digital integrated circuits might make it practical to switch to a digital command link and airborne data reduction.

Then there's the problem of devices that can't be miniaturized. In a typical airborne system mechanical components and electronic components with moving parts occupy half the volume and have a greater failure rate than pure electronic components. Arinc Research Corp. estimates that if only the latter are microminiaturized and their reliability assumed to be unity for the life of the

system, the system failure rate would only decrease by approximately 17 percent. They recommend microelectronics be used only in equipments that can be built almost entirely this way. Thus, designers will need to be alert to new ways of performing electromechanical functions more compatibly with microelectronics, such as solid-state relays, transducers and inertial components.

Active thin-film devices will not be replacements for transistors in thin-film circuits—they will have different characteristics and therefore require different approaches to circuit design. Similarly silicon integrated circuits differ from ordinary circuits in that transistors and diodes are cheaper than the passive components, and some components such as inductors are not even available. Also there will be advantages in linear circuits because of the ability to match components formed during the same diffusion and to have thermal tracking of parameters.

LOGIC—Integrated circuit logic is one of the most controversial subjects. With no microelectronic logic scheme yet applied extensively on a system basis, the user is often hard put to select the best for his needs.

Each logic scheme has advantages and disadvantages for both producer and user. From the user's standpoint no specific type is presently clearly superior to all others; in each case he should select to fit total system requirements, taking into account such factors as operating environment, cost, size, weight and power consumption. Moreover tradeoffs between power dissipation, switching speed, fan-in and fan-out, and component tolerance must be considered.

Several military and industrial groups are presently evaluating the different types of logic, indicated in Fig. 3. U.S. Naval Air Development Center has evaluated DTL, RCTL, DCTL, and ECTL. Of these they find DCTL the simplest for semiconductor integrated circuits. It is relatively easy to fabricate and can handle 1-Mc clock rates. Major disadvantage is current hogging where varying base to emitter characteristics of the load elements prevent even current distribution among the loads. Adding a resistor to the base of each transistor minimizes current hogging, but at the expense of operating speed.

DCTL is also sensitive to input noise which is injected directly into the base of the transistors. This is not the only noise mode that may affect microelectronic logic however, and the Center plans to investigate others.

Desire to eliminate current hogging and still maintain a relatively simple system led to ECTL (emitter-coupled transistor logic). This is a form of current-mode logic, which is presently gaining a lot of attention.

Present ECTL assemblies may use a few more parts than their DCTL equivalents but still contain only transistors and resistors. In ECTL the input base-to-emitter resistance is a function of the transistor β . Thus, the base current varies inversely with β , permitting higher fan-out. This advantage together with improved noise immunity is obtained with two power supplies compared to one in DCTL. GE claims a 2-Mc shift rate for shift registers.

Flip-flop clock rates of 20 Mc are claimed by Motorola for their current-mode logic. For a fan-out of 1, stage propagation delay, rise time and fall time are 4 nsec with a 20-pf shunt capacitance. Maximum fan-out is 26, noise

VIDEO AMPLIFIER consisting of six silicon planar resistors and two epitaxial transistors on ceramic substrate is fabricated at General Instrument, has been used in prototype navigational aids equipment. Typical values for a representative amplifier are on schematic

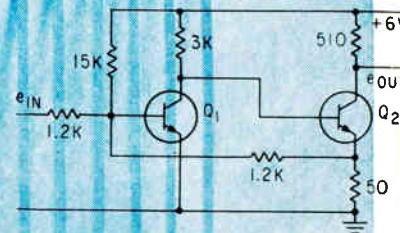
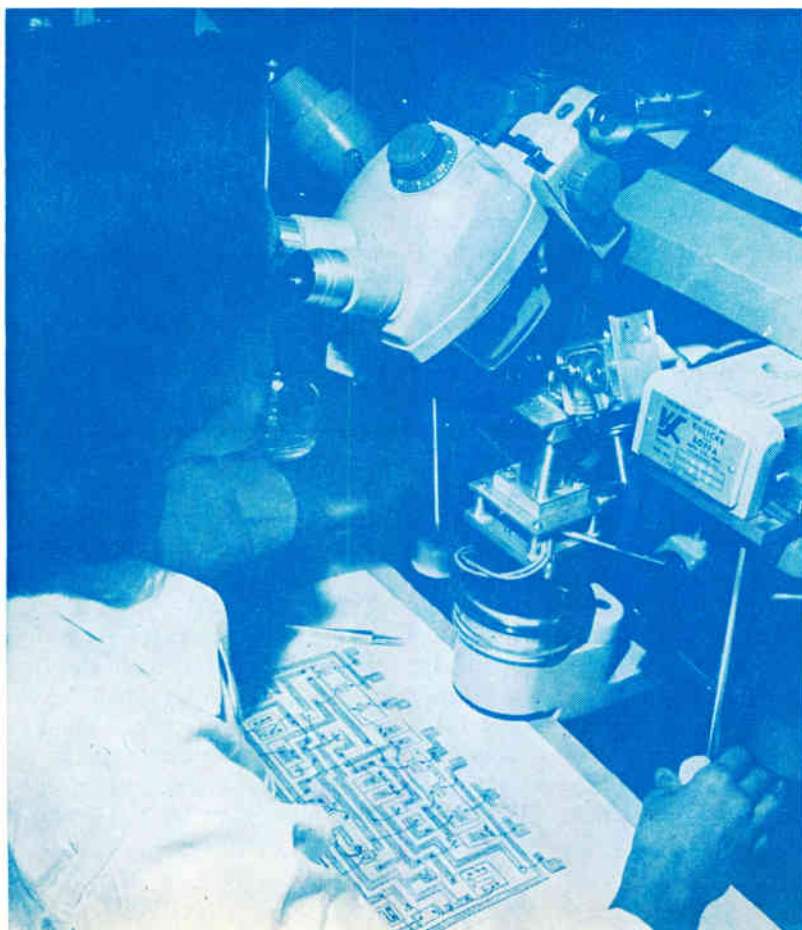

INPUT IMPEDANCE $\geq 1.2K$
 OUTPUT IMPEDANCE $\leq 500\Omega$
 VOLTAGE GAIN $\approx 200B$
 CURRENT GAIN $\approx 25DB$
 BANDWIDTH: 0-30MC
 OUTPUT SWING: 4.5V PEAK TO PEAK 25°C
 2V PEAK TO PEAK -55 - +125°C
 Q₁, Q₂ SIMILAR TO ZN744
 ALL RESISTORS TRIMMED TO $\pm 10\%$

voltage at the input can be half the input voltage before confusing the logic.

DTL is another relatively simple system to fabricate, is being used in many new semiconductor integrated circuits. It operates on relatively low voltage swings (4v) and is fast (3-6 Mc clock rates). Furthermore, immunity to noise can be 50 percent.

Most complex system now used is RCTL. The capacitors increase base current for fast collector current turn-on and minimize storage time by supplying a charge equal to the stored base charge. RCTL units have been quite insensitive to input noise and supply voltage variation but relatively slow (about 500 Kc), the Center finds.

Another type of logic becoming increasingly popular is TCL. This is similar to DTL and may be used with common bases and collectors (multiple emitter coupling). Claim is that TCL does not have the DCTL current hogging problem, has better noise rejection, and for constant power dissipation has about the same speed.⁷

Simplest logic is probably RTL. Because it needs resistors with ± 5 percent overall tolerance, however, it may be more suited to thin films. Also the resistors make it less efficient in terms of power dissipation.

LOGIC NETS—New concept of integrated logic nets is considered by RCA to offer the most economical way of meeting most digital requirements. Here arrays of 2,000 insulated-gate field-effect transistors (see Fig. 4) are fabricated on a 1-inch-square silicon substrate. These transistors are majority-carrier devices fabricated by diffusing heavily doped source and drain contacts into the silicon

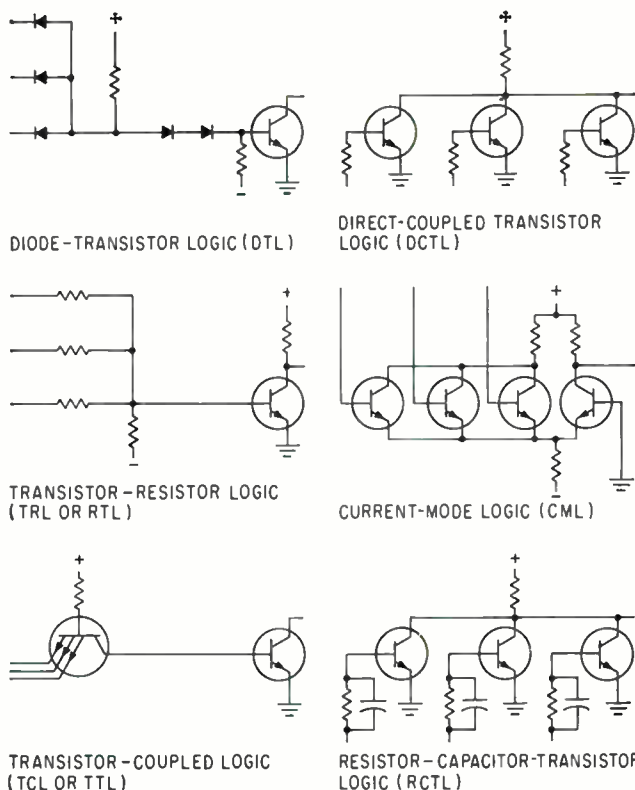

SIX FORMS of integrated circuit logic are illustrated for a fan-in of three—Fig. 3

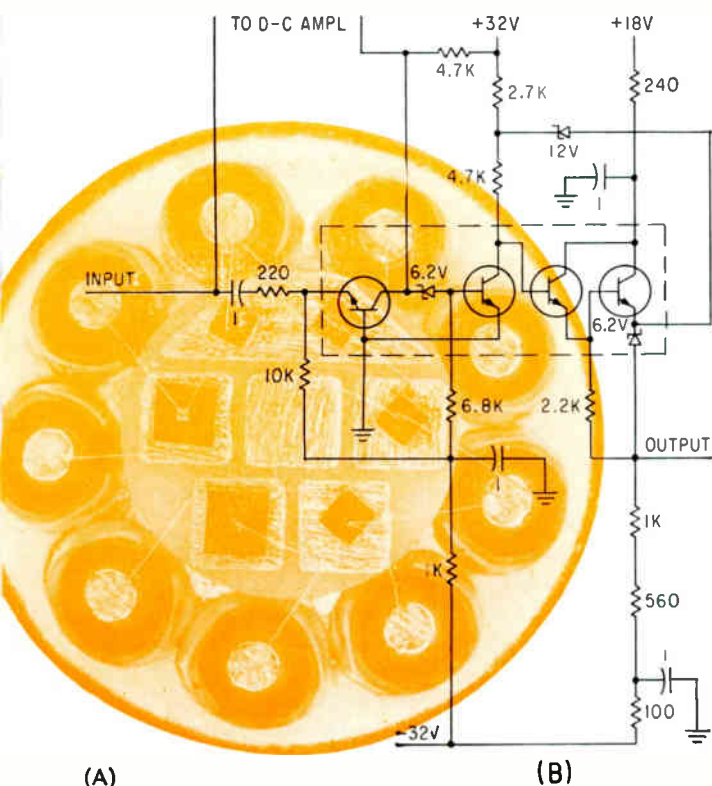

INTEGRATED CIRCUIT package (A) for Bell Labs high-frequency operational amplifier module (B) contains two experimental 2-Gc planar epitaxial transistors and two silicon zener diodes. External d-c stabilizing circuits and feedback loops are not shown—Fig. 2

SOME STRAIGHT TALK ON DESIGNING

Our rate of progress will be determined by the rate engineers can invent circuits that utilize the unexploited unique features of silicon rather than by simply avoiding the fundamental limitations of the silicon substrate says C. D. Simmons, director of Philco's microelectronics laboratory. For example, while the tolerance of individual diffused resistors is poor, new avenues of design are offered by the fact that differential tolerance can be reduced to 1 or 2 percent.

R. E. Lee, executive vice president of Siliconix, points out that some companies new to integrated circuits have been using the almost brute force method of trying to realize a circuit in a silicon block by part-for-part translation from what was a good optimum circuit in the discrete component domain. "This is not the ideal way to design an integrated circuit," he says, adding "integrated circuit design requires the combined experience of circuit-oriented people who can range over the entire scope of alternate designs to accomplish a given circuit function, joined with solid-state physics and device people who know what can and can't be done in a semiconductor block as far as device structures are concerned"

EXPERIMENTAL crystal controllable oscillator uses Sprague's thin-film ceramic-based microcircuits. Conventional two-electrode capacitor C_1 uses full ceramic substrate thickness as dielectric, C_2 and C_3 are multiple internal electrode capacitors, C_4 and C_5 are solid tantalum inlaid within cavities in the substrate

and then thermally growing a silicon dioxide layer between them. The contacts are then metalized and a metal gate put on top of the insulator.

Electrons flow between source and drain parallel to the surface only when the gate is biased positively. This allows direct coupling between successive stages in what can be regarded as voltage controlled relay logic. Equivalent of the DCTL load resistor can be obtained in a similar element by forming an n -type channel under the oxide between the source and drain. In addition the source is connected to the gate, giving a two-terminal nonlinear resistor that simulates a constant-current source with more rapid charging and better noise immunity than a linear resistor. Supply voltage is coupled through the nonlinear resistor to the drain, which is then connected to the next transistor gate.

Result is the ability to have series—parallel logic with unlimited fan-out and without shifting voltage levels between stages. With a 10,000-ohm load resistor, typical gate switching time is estimated at roughly 40 to 50 nsec and power dissipation at 40 mw. Computer clock rates of 10 Mc are seen with present devices. Scaling laws apply and clock rates of 20-200 Mc are predicted as device size comes down.

RCA claims laboratory yields exceed 90 percent, that the devices are highly uniform. They expect this technique to lead to an order of magnitude price reduction over other integrated circuit techniques. The transistor chains, nonlinear resistors, fingers and crossover insulation are made on a general array basis so that almost always only one layer of evaporated gold wiring is needed to complete the desired circuit.

Major failure mode reported so far is short-circuited gates. Major problem to be resolved is the long-term stability; however, researchers believe they will be able after a few months to show characteristics won't drift.

Technique may also lead to nanowatt computer memories. Here the transistors would be used with their hole-conduction equivalents in a flip-flop type memory (see Fig. 4D). Hole conduction occurs with n -type silicon and a $p+$ source and drain. (Logic circuits using similar complementary devices have been reported by Fairchild Semiconductor to consume less than 10 nw standby power per node and switch in less than 20 nsec.)

Presently two applications are under development (see the front cover). One is an eight-neighbor NOR gate for a 2-D data processing panel being built at Air Force Cambridge Research Laboratories. Panel will use a checkerboard array of the gates. Each nodal unit input is tied to eight neighbors; by changing the gate voltage it is possible to select which of the neighboring logic signals is to be OR-gated into the output.

Possibility of replacing the eight control leads with optical coupling is also being studied. This would be done by energizing the gate from a deposited photovoltaic cell, might eventually lead to adjustable computers that could change their logic functions by optical command.

Second application is a series of resettable decade ring counters that will divide by any of 28,000 integers in a 2-to-30-Mc ssb equipment under construction. There will

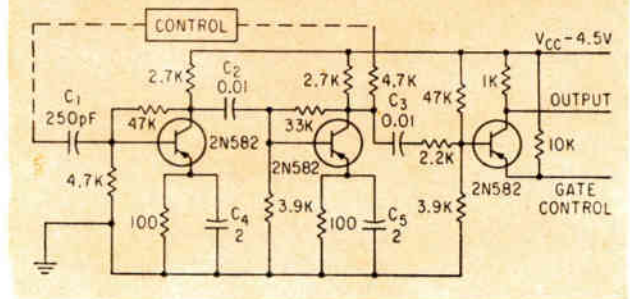
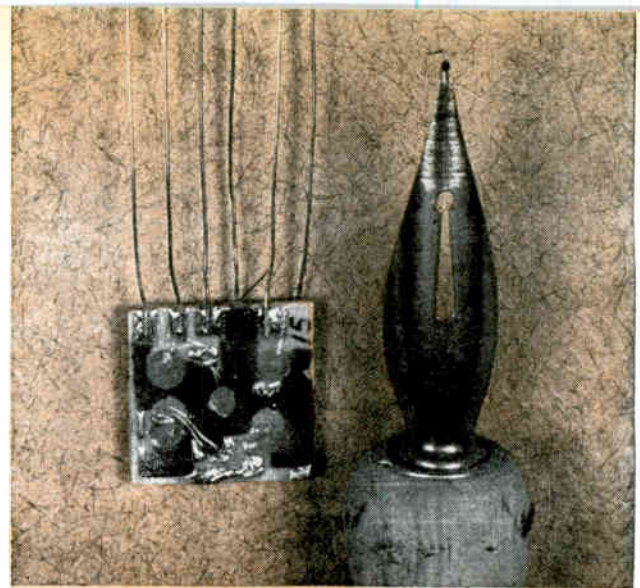

be five decks in a package expected to occupy 1 cubic inch and draw 2½ watts. Total number of interconnections is estimated at 105 compared with the 1,136 that would be required if the comparable circuit was fabricated with integrated circuits in 8-lead cans.

INDUCTORS—Fabrication of inductors still remains a major problem in designing integrated circuits. For within a limited volume, inductance can be raised only by increasing the number of turns and their cross-sectional area or improving the magnetic permeability of the surrounding medium.

Problem is to find the best compromise between inductance and Q for each application. Example of this is the diode-switched tuner shown in Fig. 5. Here the isolated resistors and capacitors are on the same substrate so that glass is used instead of ferrite. Since low permeability of glass requires more turns enclosing a larger area of pancake spiral coil, the conductor length of the larger coils is approximately 400 times the width. It was therefore necessary to make the film resistivity much lower than the usual thin-film conductor. By using thick high-conductivity silver films, the larger coils of this circuit have Q's near 100 and inductance of about 0.25 μ h.

The spiral inductors require a crossover to the center; a transformer can be made by interleaving two spirals or placing one on top of the other with an insulating layer between them.

Limitations of thin-film inductors prevent using them at audio frequencies. Above a few tenths of a microhenry or below 100 Mc you must replace deposited film inductors with discrete inductors or design around them by (1) attaching piezoelectric resonators, (2) using the simulated inductance in a forward-biased p - n junction together with negative resistance devices like tunnel diodes, or (3) designing notch filters and distributed R-C net-

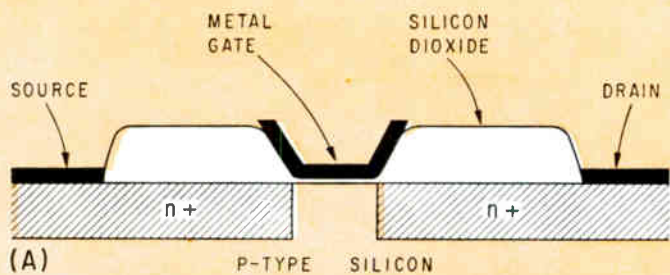

TYPICAL DEVICE SWITCHING CHARACTERISTICS

CAPACITANCE: 1 pF PER ELECTRODE
 "ON" RESISTANCE: 2 K
 CONTROL VOLTAGE: OFF $< 6 \pm 1/2$ V, ON > 14 V
 INTERNAL SWITCHING DELAY: 0.1 - 0.2 n SEC
 (SHORT CIRCUIT CONDITION)
 IMPEDANCE AT GATE: $10^{14} - 10^{15}$ OHMS
 CURRENT DRAWN: 1 MA AT 2 V
 TEMP RANGE: -80 TO +190 C



(B) DRAIN VOLTAGE 2V/DIV

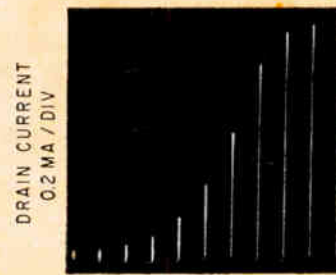

(C) GATE VOLTAGE 2V/DIV

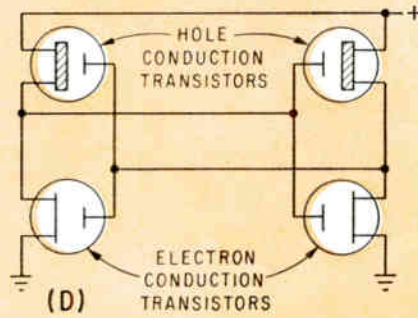

INSULATED-GATE field-effect transistor (A) has output characteristics of (B) and transfer characteristics of (C) when gate bias is varied in 2-v steps from 0 to 20 v. Load is 10,000 ohms and supply is 20 v. Complementary pairs of transistors could be used in the memory cell designed by P. K. Weimer of RCA Labs (D) whose two stable states would have essentially no dissipation—Fig. 4

works. Latter have been used in thin-film form to make band-pass amplifiers and phase shift oscillators; a frequency discriminator with a Q of 0.22 and an output linear over ± 17 percent has been designed.⁹

Obtaining selective frequency response without inductors is generally difficult, however, because it leads to instability. The higher the Q the more sensitive it is to element variations. For a standard twin-T null circuit components must maintain tolerances of about ± 0.1

percent over the entire range of operating conditions in order to attain a Q of 50 within ± 10 percent.¹⁰

DISCRETE INDUCTORS—Wound toroids are satisfactory up to 200 Mc; Q's of 50 to 100 can be obtained and the magnetic field is contained so there is little interaction with other circuits.

Shielded 1-mh solenoids 0.1 inch in diameter and 1/4 inch long with a Q of about 40 are being developed by Nytronics. Shielding is provided by a new magnetic powder molding process. Values to 100 mh in a year are projected. They are also working toward modular power transformers to fit micromodule wafers.

Equivalent performance of a resonant circuit in much smaller volumes and at lower cost is expected from materials such as lead-titanate-zirconate now being studied for use with metal members as thin-film piezoelectric filters.

Deposited resonators are needed in the 500-Mc region, where the required Q's of 1,000 are presently unobtainable except with various forms of lines. Engineers at Harry Diamond Laboratories feel the helical cavity resonator is best from the volume standpoint. They have built 0.01-cubic-inch units with unloaded Q's of approximately 230 at 500 Mc for the preselector of a command receiver. The receiver has screen-printed wafer circuits, occupies 0.75 cubic inch, and when completed is expected to have 60-db image rejection, approximately 3-db bandwidth at 5-6 Mc and 3-db insertion loss.

One possible solution to the inductance problem is to fabricate an integrated circuit out of piezoelectric material such as gallium arsenide. Junctions in gallium arsenide have high resistivity and theoretically could be used as resonators—but so far no one claims to know how. Furthermore, much more work is needed in alloying and diffusing so that other components could be made in gal-

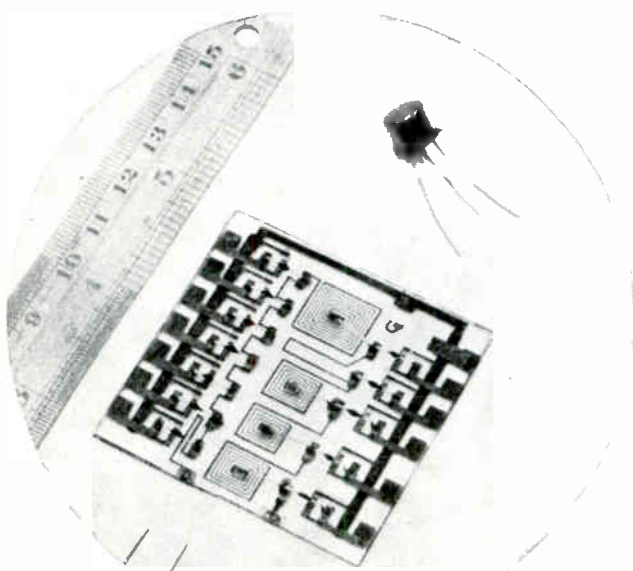

DIODE-SWITCHED tuner developed at General Instrument applied research laboratory covers range of 50 to 200 Mc—Fig. 5

lium arsenide, which is expected to allow higher frequency operation than silicon. However, it might be possible to grow a gallium arsenide junction heteroepitaxially in a certain spot on a silicon substrate.

FIELD-EFFECT DEVICES—Need to design around large resistors and capacitors is leading to field-effect transistors for raising impedance, thereby allowing smaller coupling and bypass capacitors.

Where large R-C time constants are required for coupling in low-frequency linear circuits, a field-effect transistor in series with a bipolar transistor can give high input impedance as well as high current gain. These devices can be diffused simultaneously into a silicon block to give input resistances over 1 megohm and, by cascading, g_m 's on the order of 1 mho.

Westinghouse Electric has fabricated an audio amplifier this way that uses a matched pair of unipolar transistors as a high-impedance input and nonlinear bias resistor for three Darlington-connected bipolar transistors. Typical amplifier gives 3 w out for $\frac{1}{2}$ v rms in at $2\frac{1}{2}$ percent distortion; frequency response is flat to nearly 1 Mc.¹¹

TEMPERATURE COMPENSATION—Semiconductor integrated circuits need built-in temperature compensation because diffused silicon resistors are not as stable as ordinary resistors. Negative feedback is widely used for this. Operating point is stabilized in a typical two-stage common-emitter amplifier because the ratio of emitter resistance to feedback resistance is maintained in spite of temperature variations since both resistors are made from the same piece of silicon and have the same TCR (temperature coefficient of resistance). Westinghouse engineers feel this technique allows designing practical linear circuits with good frequency response, low distortion, and stability comparable to that of ordinary circuits.

ISOLATION—Parasitic capacitance arising from use of reverse biased *p-n* junctions to isolate transistors and other regions in integrated circuits has been another important problem, particularly at high frequencies. Recent progress in alternately applying epitaxial growth and selective diffusion points to improved isolation, however. One technique considered useful up to 100 Mc is to diffuse *p*-type impurities through an *n*-type layer epitaxially grown on a lightly doped *p*-type substrate.¹²

NONELECTRICAL EFFECTS—Phenomena other than electrical should also be watched for in designing semiconductor integrated circuits. Figure 6 shows how thermal feedback can reduce the temperature variation of a Zener diode voltage reference. Resistors R_1 and R_2 establish a constant potential of approximately 0.4 v on the base of transistor Q_1 ; this is insufficient for conduction at room temperature. When the supply voltage is turned on, current through R_3 flows into the base of Q_2 , resulting in Q_2 dissipating enough power to raise the substrate temperature. As the temperature of Q_1 increases, the base-to-emitter voltage required for conduction decreases until Q_1 starts conducting. Current flowing into Q_1 then reduces the current at the base of Q_2 and the dissipation decreases until an equilibrium temperature is reached.¹³

There is also the possibility of exploiting the relation between frequency characteristics and distance for such devices as filters and oscillators. If a sinusoidally varying

heat source is attached to a uniform silicon bar, the propagation velocity of the resulting temperature wave is frequency dependent. Mathematical analysis indicates that varying the bar length and, hence, the transit time of the wave, will vary the oscillating frequency of a closed-loop system. Aeronautical Systems Division of Air Force Systems Command (ASD) is presently investigating thermal characteristics of silicon to see if this effect can be exploited for oscillators and band-pass filters.

MICROPOWER—You can expect increased emphasis on microwatt electronics, for progress in power reduction has not kept pace with other areas of microelectronics.

NASA ranks requirement for low power in space directly after reliability, has found silicon integrated circuits consume three times the power of standard circuits in applications like flip-flop memories and counters. This results largely from lack of large resistors and single-block complementary circuits. However, possibility of complementary insulated-gate field-effect transistors as well as recent demonstration that *pnp* and *nnp* transistors can be fabricated in the same block (see Fig. 7) now makes zero-watt logic look more realizable.

Several circuits that operate at microwatt supply power levels have been built at CBS Labs with the hybrid approach, which they feel offers the greatest versatility, least temperature sensitivity and highest speed for a given power level. These techniques are considered promising at 50-Kc clock rates, adequate for many satellite applications. The NOR gate in Fig. 1B consumes about 50 microwatts in a satellite 7-bit analog-to-digital converter.

For still lower power levels, researchers want nanowatt devices. Sperry Semiconductor has made transistors with common-emitter current gain of 20 at 1 namp and noise figures of about 1 db, feels they can be incorporated in a 1,000-transistor computer that would dissipate 5 mw.

While power gain has been obtained in nanowatt circuits, it is felt an order of magnitude size reduction is needed for significant speed through, perhaps, a filamentary transistor to cope with lead capacitance.¹⁴

Present logic schemes are being investigated at U.S. Army Electronics R & D Laboratory (USAERDL) to determine the tradeoffs that would occur at microwatt levels. James Meindl points out we can't assume relative merits and limitations at present milliwatt levels will be the same at microwatt. However, he cites the follow-

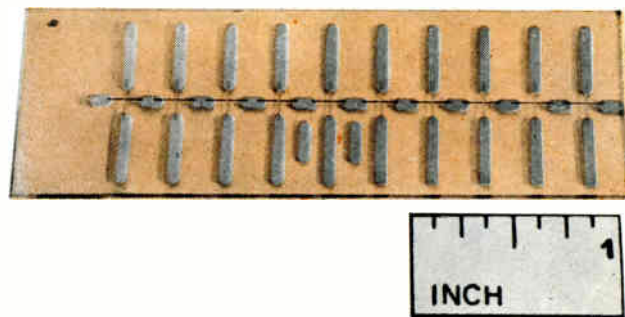

TUNNEL-EMISSION device fabrication program at Burroughs Laboratories has produced these diodes with 30-40-angstrom-thick oxide layers. Current density of 175 amp/cm² can be maintained and devices have worked with 35 ma d-c

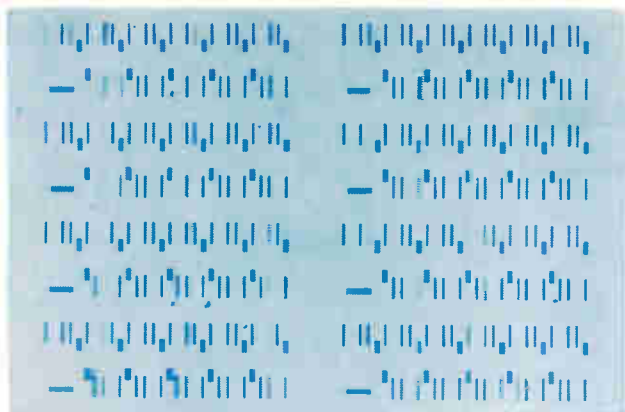

(1) Resistor Matrix of Cr-SiO

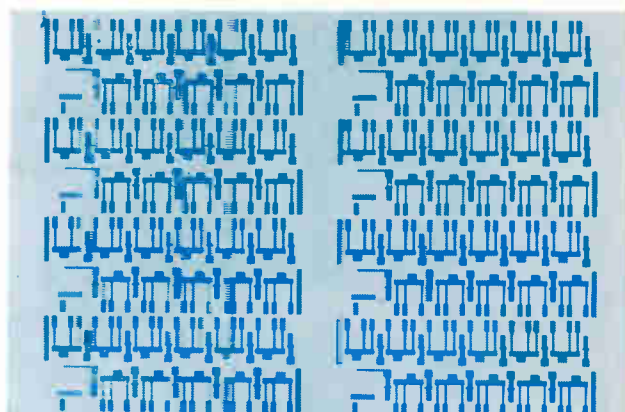

(2) Resistor Lands, Some Cu Interconnections

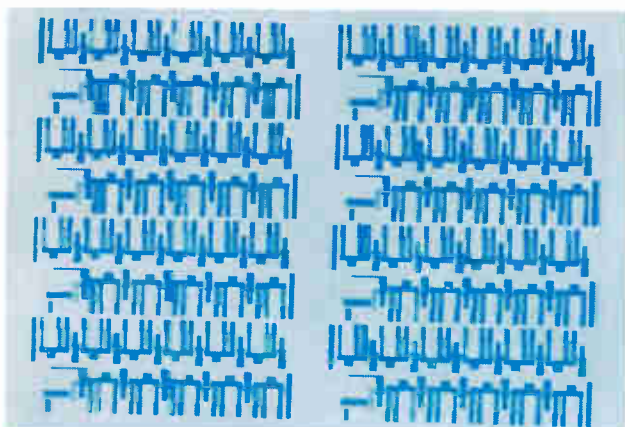

(3) SiO Capacitor Dielectric

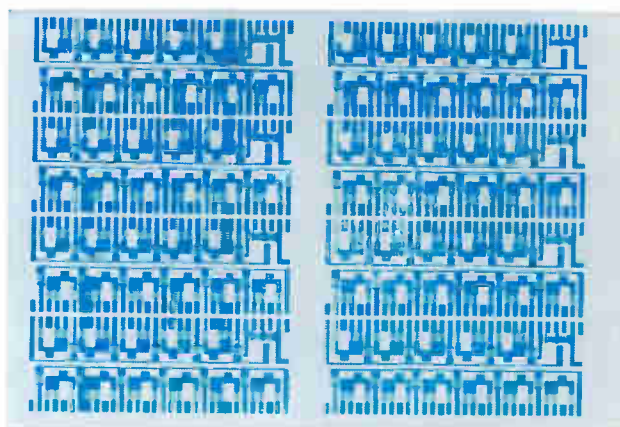

(4) Interconnections, Upper Capacitor Cu Plate

THIN-FILM PILOT production system built by IBM for Naval Avionics Facility at Indianapolis fabricates passive networks on SiO-coated $3\frac{3}{4} \times 5\text{-}3/16$ -inch substrates continuously in a four-stage deposition process. Equipment is first step toward what Navy hopes will eventually be a pilot production capability for complete thin-film circuits

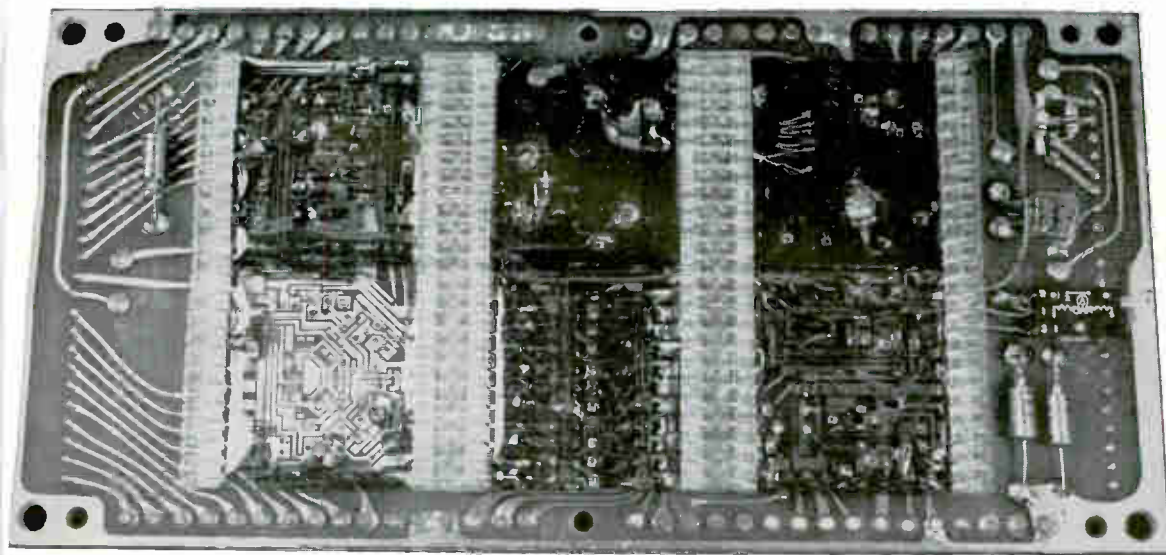

THIN-FILM COUNTER assembly occupies 9 cubic inches, was delivered to Army Ordnance, Frankford Arsenal, by Martin-Orlando in 16 weeks. Counter has maintained frequency stability in system of 0.05 percent over an operating temperature range of -45 to $+55$ C



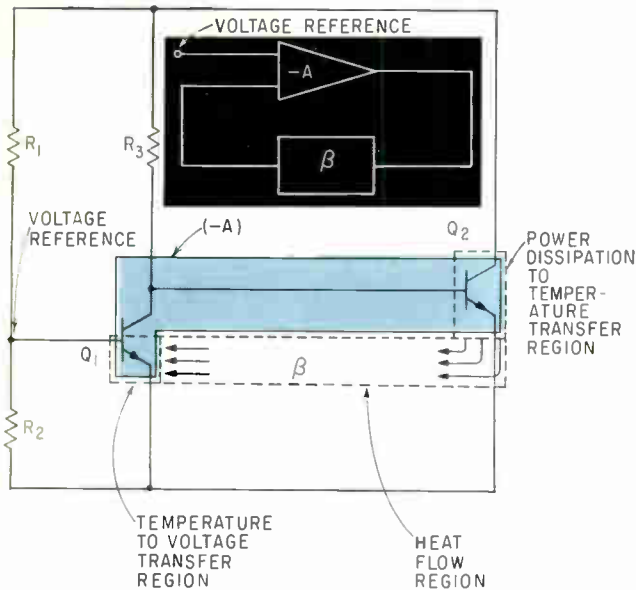

HOW THERMAL FEEDBACK reduces temperature variation of a voltage reference for analog-to-digital conversion in the telemetry encoder Texas Instruments is building for ASD—Fig. 6

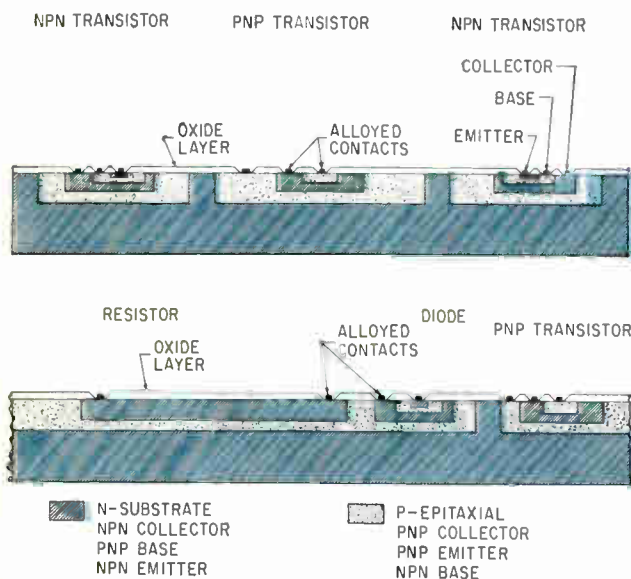

CROSS-SECTION of Texas Instruments' recently-announced series 52 linear amplifier illustrates how npn and pnp transistors can now be diffused into a single block of silicon—Fig. 7

ing problems microwatt logic designers will face regardless of the logic they select.

- Leakage currents with silicon transistors can be significant compared with operating current, I_{CBO} of 0.1 to 1 microampere is possible depending upon how high a temperature circuit is designed for. But germanium transistors will not be feasible.

- Current gain of ordinary micropower transistor will be more temperature sensitive than that of milliwatt transistors.

- Because microampere currents are obtained at essentially the same junction voltages as milliamper current

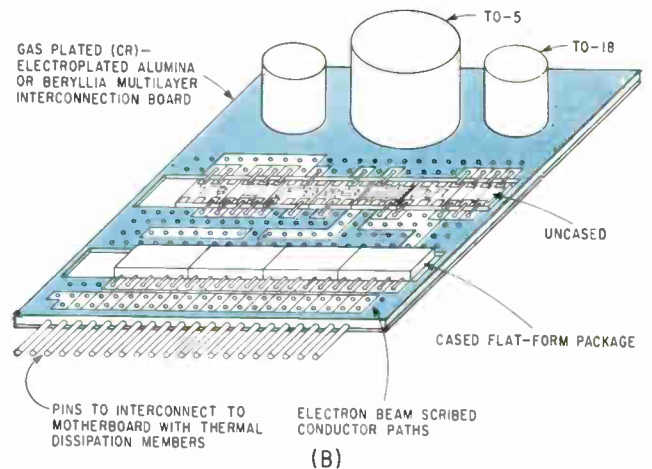
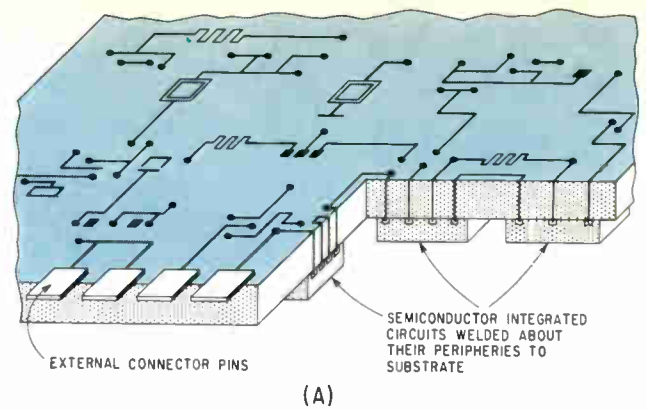

CONCEPTUAL illustration of unencapsulated hermetic header for intra-interconnection of semiconductor integrated circuits (A) and interconnection—packaging system for joining cased and uncased circuits and assembling systems (B) under study at Hamilton Standard div. of United Aircraft for ASD—Fig. 8

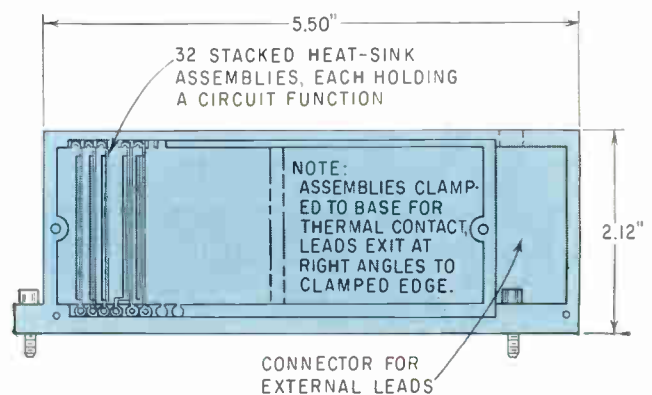

MODULE HOLDS 32 chips and occupies 13 cubic inches in this packaging technique by Autonetics—Fig. 9

rents, a high impedance circuit will result. This circuit will be slower in almost direct proportion to the current drop—if a 1-mw circuit operates at 1 Mc, then the 1-microwatt version will operate at approximately 1 Kc.

- In designing microwatt logic circuits it will be absolutely necessary to minimize stray and parasitic device capacitance. Also, maximum speed in the 1-100 microwatt range will require minimizing voltage swing to roughly 0.1 v to 0.4 v by tightening tolerances and controlling temperature.

INTERCONNECTION AND PACKAGING — Most

often cited as problem number one, size and power drain of interconnections still thwarts the goal of microelectronics and could be the determining factor in the practical success of a particular technique. However, thin-film technology may provide the answer.

Electron beam welding of semiconductor integrated circuits to a ceramic substrate is being studied by Hamilton Standard for ASD Electronic Technology Laboratory. Direct welds as well as bonds with intermediate materials such as chromium and titanium thin films will be used to hermetically seal all active surfaces while at the same time dissipating heat and providing for interconnections with minimum parasitic coupling (Fig. 8A).

Production processes are also being developed and an unbalanced production line set up for the ASD Manufacturing Technology Laboratory to interconnect present semiconductor integrated circuit systems. As shown in Fig. 8B, cased (or future uncased) circuits are attached to a grooved ceramic wafer of high thermal conductivity. A conductive matrix for interconnecting the packages, thin-film passive elements, and external circuits is fabricated by electron beam etching. Plated-through vertical feedthroughs permit crossovers, matrix design allows additional horizontal-vertical layers to be added to yield a multilayer matrix of horizontal networks.

Hughes feels its electroless copper plating process developed for pellet circuits will provide a mass interconnection technique as reliable as printed circuit wiring. No high temperatures are involved.

Near term will see greater use of flexible conductors, and also flat packets and stacked thin-film wafers. Packaging technique for semiconductor networks (which have flat form factor and leads) used by the Apparatus division of Texas Instruments on several equipment contracts is built around 1.5-inch-wide printed circuit boards with welded connections. On one contract, a computer unit has been delivered on which 49 boards are mounted in a package that weighs about 1½ lb, occupies about 22 cubic inches and meets environmental specifications for airborne operation per MIL-E-5400.

Figure 9 shows a packaging concept under study for Autonetics armament control circuits and systems.

Optical soldering techniques have been used to fabricate modules for flat packages as shown in Fig. 10.¹⁵ A system has been conceived and partially realized using this concept that will contain 35 circuits, dissipate 100 mw at 3.3 v, occupy 0.45 cubic inch, weigh 0.02 oz.

There is also considerable effort to eliminate thermo-compression bonds, particularly in high vibration environments like space. One technique under study is a ceramic sandwich where evaporated wiring on one wafer would be fused to circuit contacts on the other.

TESTING—Whole area of specification and testing faces change as we head toward microelectronics. With component junctions largely inaccessible, users want new measurements they can perform to check temperature stability and major device parameters. Failure rates which have largely been gathered on the component level are now needed on a circuit level. Manufacturers expect that if the circuit environment and application are known then worst case tests on terminal pins can be specified that will satisfy users. Some feel meaningful acceptance tests can be performed externally by evaluating characteristics that are the sum of internal parameters, rather than

evaluating the parameters themselves.¹⁶

A major problem for users according to Harry Knowles, general manager of Westinghouse Electric's molecular electronics division, is how to demonstrate reliability that may approach one failure per billion circuit hours in a few years. He sees the answer in giving users visibility into the process control and providing an analytical capability for overstressing devices. Then by determining the predominate failure modes in a run the user can extrapolate for his mission.

Advanced linear circuit design will also call for cooperation between device manufacturers and systems people in writing specs for such things as high-frequency properties, which can be measured only on the completed circuit. Inability to measure within the wafer may require more designing statistically for a class of devices.

Biggest day-to-day problem for designers could come from the high-frequency circuits that work only in the final encapsulation. Conventional breadboarding techniques fall down here and there is no possibility of trouble-shooting economically. Bell Labs engineers say designers will therefore have to operate more precisely than they have, possibly do more computer simulation or low-frequency analog work to be certain of their design.

THE FUTURE

THE FUTURE—By 1970 new forms of integrated circuits will undoubtedly arise that bear little resemblance to those presently under development. Key research areas to watch include: optoelectronics, new materials phenomena, active thin-film device research, homogeneous semiconductors, bionics, and advanced fabrication techniques like selective epitaxial growth.

Semiconductor integrated circuits are limited by present diffusion and epitaxial techniques to three or four layers. One approach that might lead to the next generation is in the early research stages at ASD. They envision fabricating a "three-dimensional" circuit by selective epitaxial growth, diffusion and vacuum deposition of both active and passive components. This would allow growing complex circuits of many layers and then depositing the metallic interconnections on the surface as the final step. Connections within the block could be by low-resistivity semiconducting material.

One way to fabricate a 3-D circuit might be to grow a number of epitaxial layers and isolate the active elements by high-resolution selective machining with molecular beams. Because the beam melts as it cuts, however, this would probably require later etching to remove shorts across junctions formed by subsequent refreezing.

Long-range goal at Norden division of United Aircraft is automatic synthesis and manufacture of optimized circuits or systems within a crystal. According to M. W. Aarons, chief of the applied physics branch at Norden, it is conceivable that in the future a description of the desired output in terms of the data supplied to the circuit will be typed into a computer. From this point on, manufacturing as well as business decisions would be computer-controlled.

One technical approach might be a laser beam servo-positioned over a substrate for controlled local heat. Various organometallic gases could then be synchronously valved to the growth chamber so as to epitaxially produce

devices with maximized characteristics, at their proper position upon the substrate. The substrate would have large anisotropic thermoconductivity so that heat could flow only normal to its plane. Such a technique would allow the selective growth of many presently incompatible devices of different materials and frequency characteristics over a broad conductivity range, Aarons says.

Optical techniques and devices will become increasingly important in microelectronics.

If a 3-D circuit could be fabricated out of a material with photoconductive properties, such as gallium arsenide, then connection within the block could be done optically. Such a scheme is shown in Fig. 11. Here the intrinsic and *n*-type material is transparent to the coupling light frequency and the *p*-type material is opaque. Thus, light conducting paths can be made by varying the doping.

At infrared wavelengths semiconductors such as indium antimonide, lead selenide, lead sulfide and silicon exhibit photoelectric, photovoltaic and photoconductive properties when exposed to the proper wavelength of light energy. Several of the photoconductive semiconductors can be fabricated into resistive areas that are variable when light is incident on the surface. Diffused resistors are also possible with these same materials and can be fabricated to a precision of ± 20 percent.

ACTIVE THIN-FILM DEVICES—Desire for a compatible technology that permits fabricating complete thin-film circuits with their interconnections in large volume and low cost is spurring widespread research on majority-carrier amplifiers and other active thin-film devices shown in Fig. 12.^{17, 18} Where there is to be competition between thin-film and semiconductor integrated circuits, it will come when these devices can be fabricated reproducibly—but few expect this before 1965. Here's a rundown of their status:

- Tunnel triodes—Absence of semiconductors has brought research support for this hot-electron tunneling device from such groups as Harry Diamond Labs, USAERDL and NASA who hope for high radiation resistance. Problems are formidable, however, and nobody has yet reported power gain. One must fabricate 20-to-50 angstrom oxide films to handle 10^7 volts per cm, and find

a collector material with the right barrier height and mobility that electrons can be collected with useful efficiency. Philco is trying to control barrier height by varying the ratio of cadmium to zinc in a layer of cadmium-zinc sulfide evaporated between base and collector.

Sylvania has formed contact rectifiers using titanium oxide as a semiconductor with current rectification ratios to 100 at 1 v.

- Metal base triode—Because of high input capacitance, presently conceived tunnel triodes are not expected to exceed the performance of a good high-frequency transistor. The metal base triode might, however. For a given emitter charging time it can operate at current densities two orders of magnitude lower than the tunnel triode, and its characteristically low base resistance gives the metal base triode a power gain-bandwidth product about two orders of magnitude better. With 10-micron layers, it should oscillate in the 100-Gc range.¹⁹

Although present structures use single-crystal semiconductors, the device may be evaporable. Even if it is not, however, it could be important in high-frequency hybrid circuits if a base metal is found that injected carriers can traverse without losing too much energy.

- Space-charge-limited triode—Although power gain or current transfer have yet to be reported, there is the possibility of 900-Mc operation. Difficult fabrication problems at the micron dimensions include properly placing the overlays to obtain isolated grid-base and grid-collector structures. GE Electronics Lab is studying evaporated cadmium sulfide devices containing an oxide-encased gold grid. In future experiments the cadmium sulfide may be replaced by zinc oxide to allow better control of trap density, which must be made very small.

- Field-effect triode—Most successful performance to date has been obtained with the cadmium sulfide thin-film transistor (TFT). This insulated-gate field-effect transistor operates in enhancement and depletion modes similarly to the silicon insulated-gate device. If performance can be improved and repeatable stable devices made, then the TFT would have the same potential for voltage controlled relay-type logic.

In the enhancement mode TFT's have had g_m 's greater than 10,000 micromhos and 12-Mc gain-bandwidth

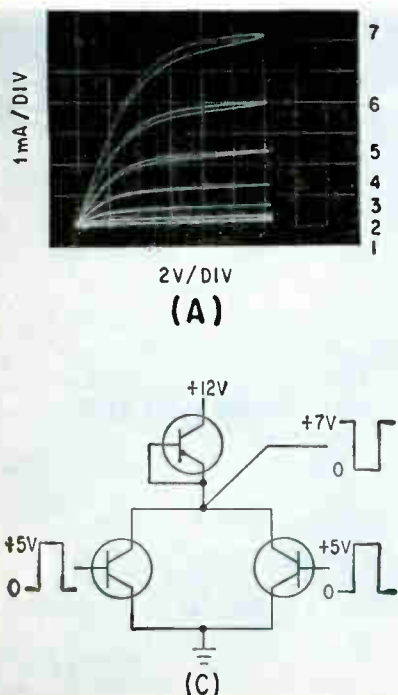

TWO RCA TFT's with typical characteristics as shown in (A) are used with a common load resistor in NOR gate (B); a 5-v pulse applied to input of either TFT gate (C) causes output to drop by 3 v (D). Two-stage audio amplifier (E) has circuit (F) which is not yet fully operative but has first stage waveform shown for 10-Kc input in (G)—Fig. 13

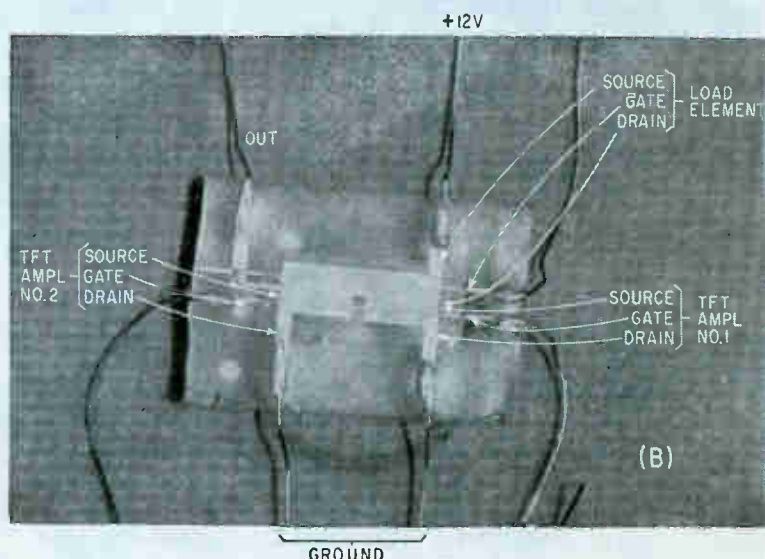

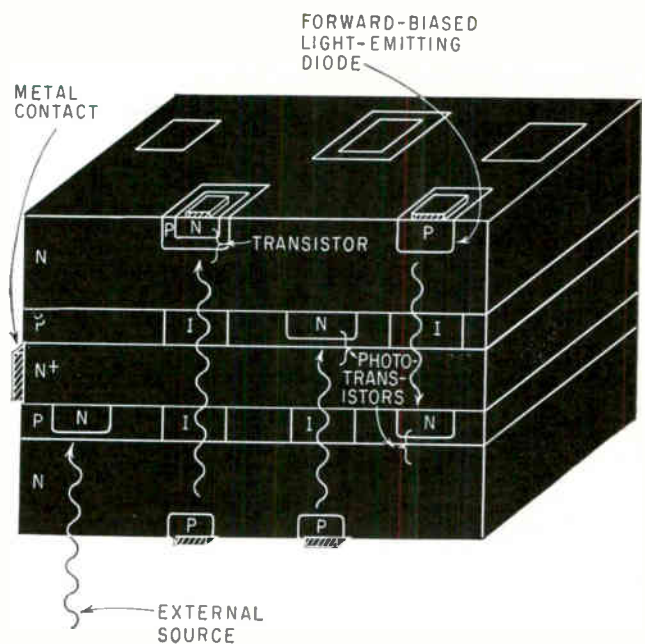
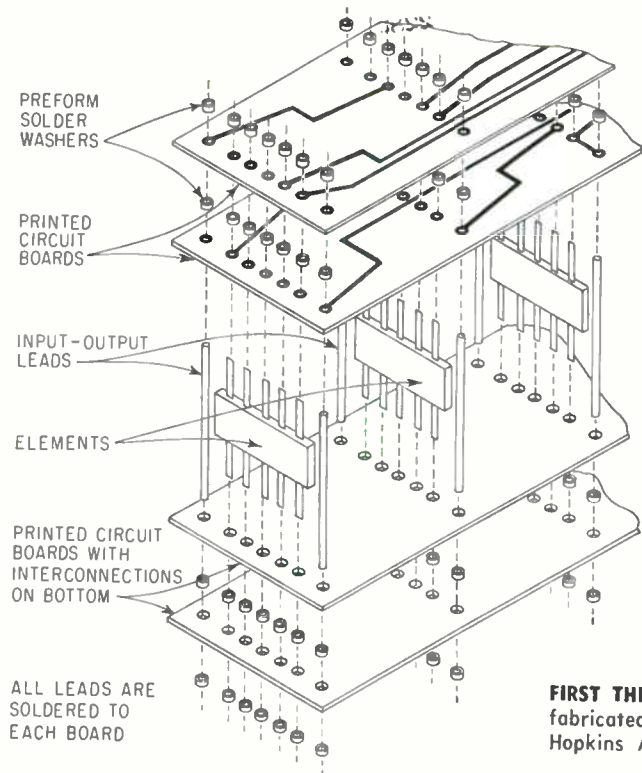

CONCEPT of 3-D integrated circuit under study at ASD—Fig. 11

FIRST THREE elements of a basic module for flat packages fabricated by optical soldering method developed at Johns Hopkins Applied Physics Laboratory—Fig. 10

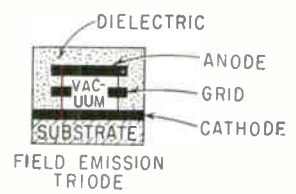
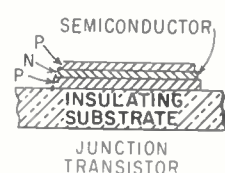
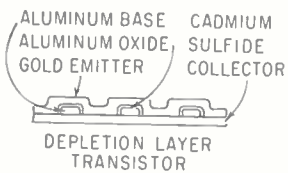
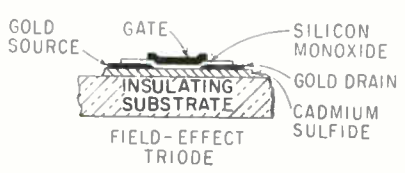
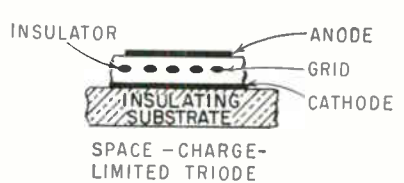
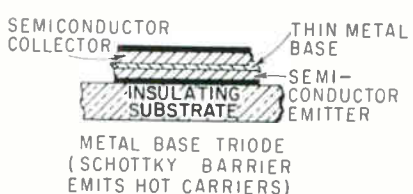
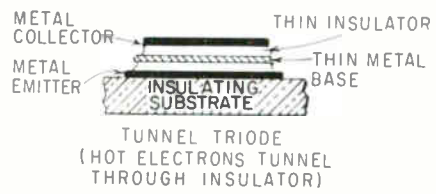

TRUE INTEGRATED thin-film circuits could result if research on these active thin-film devices is successful—Fig. 12

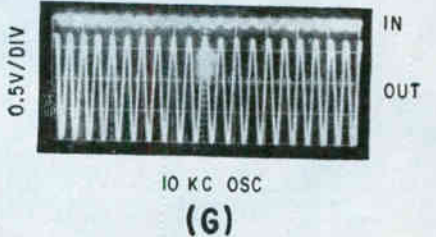
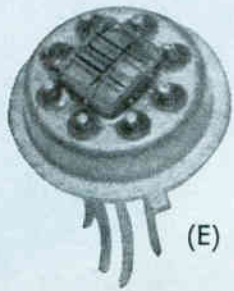
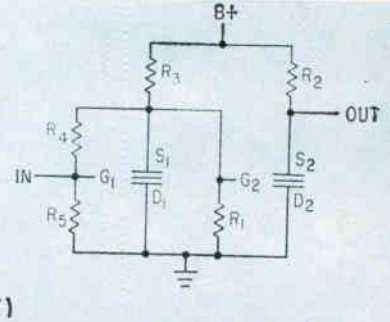
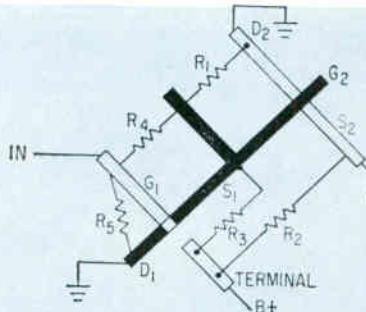
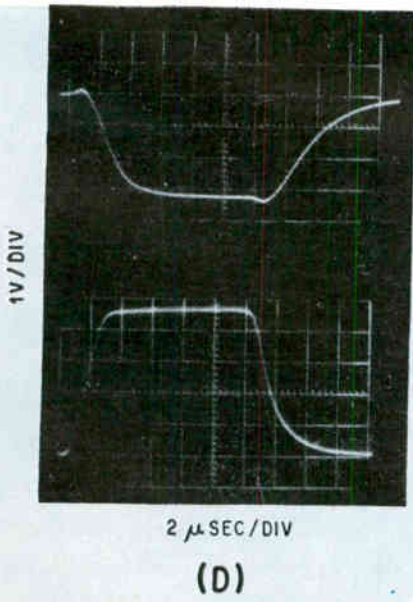

products.²⁰ Materials other than cadmium sulfide have been used, higher mobility of some 3-5 compounds may make these more promising. Typical TFT's (see Fig. 13A) have $g_m \approx 3,000$ micromhos/v, source resistance $\approx 15,000$ ohms and amplification factors of 30. They have recently been used under an ONR contract to fabricate complete circuits such as a NOR gate (Fig. 13B) and an audio amplifier with a gain of 20 db up to 70 Kc.

- Depletion layer transistor—Raytheon is studying a field-effect device analogous to the depletion layer transistor. Carriers are injected directly into the space charge region at the collector surface; by adjusting base potential it is believed feedback can be prevented and high frequency operation result.²¹

Philco has a similar device with single-crystal *n*-type germanium as the collector. Power gain of 10 db has been measured at 10 Mc and oscillation has been observed above 40 Mc.²²

- Some feel growing single-crystal semiconductors onto single-crystal or amorphous substrates will be more fruitful than trying to build majority-carrier amplifiers.

Sylvania is attempting to form thin-film silicon *p-n* junction devices on ceramic substrates by rheotaxial growth. They have deposited laboratory diodes and transistors, latter giving alphas of approximately 0.985 and betas of about 60 at $V_{cc} = 5$ v and $I_b = 0.1$ ma.²³

General Dynamics/Astronautics is researching deposition of single-crystal semiconductor films on amorphous substrates. They fabricate 500-angstrom-thick seed crystal films on a soluble substrate by direct epitaxy, then float the crystal onto an amorphous substrate and thicken by pyrolytic decomposition.

Melpar has deposited tunnel diodes pyrolytically on fused silica substrates. Martin is studying depositing germanium heteroepitaxially on sodium chloride and then separating the germanium film by sublimation.

- Vacuum thin-films—Most ambitious and original approach may well be the four-year-old program at Stanford Research Institute to build micron-size field-emission triodes and tetrodes.²⁴ Sponsored by USAERDL and ONR, aim is a one-cubic-inch data processing machine with 10^{11} amplifying, switching, storage and transducer elements. Devices would be fabricated from refractory metals by electron-beam-activated machining, are ex-

pected to withstand 900 C temperature, operate at less than 100 v and support (at micron size only) 10^7 to 10^8 w per square inch. While no devices have been built yet, simulation studies indicate the idea is feasible. Resolution of 300 angstroms has been obtained in the machining process, and a vacuum system built to reach 10^{-12} mm of mercury in two hours.

HOMOGENEOUS DEVICES—This class of junctionless devices may someday yield the true function-oriented approach to microelectronics, where discrete circuit elements are absent and the electronic function is performed by some bulk property of the material.

One that has attracted considerable attention is the cadmium sulfide ultrasonic amplifier, which uses the piezoelectric effect for electric-to-sonic coupling. Bell Labs is presently studying ways to suppress spontaneous oscillations so it can operate c-w, possibly at 100's of Mc.

Immediate plan is to use it as a booster in a broadband delay line. However, if better transducers can be devised it might be a high-frequency transistor substitute. This would require transducers with large conversion efficiencies at losses below 6-10 db. Diffusion-layer transducers, where copper forms a high resistivity layer in conductive cadmium sulfide, might be the answer here.

Other homogeneous devices include the cryosar, oscillator and helicon. Latter is under study at Ecole Normale Supérieure in Paris, works by a traveling-wave interaction in a semiconductor plasma. It is considered promising as a low frequency isolator, has operated at 50 Mc. Active geometries are also being sought.

Combinations of materials phenomena may also lead to new types of function-oriented devices. One presently under preliminary investigation by ASD is photoferroelectricity—the varying of ferroelectric characteristics of materials by incident light. Devices utilizing photopiczoelectricity are also anticipated.

Navy and others feel not enough work is being done in bioelectronics and self-organizing systems. Stepped-up effort in these areas could have an important influence on microelectronics, lead to capability for high component redundancy, self-diagnosis and healing through exploitation of such areas as electrochemical phenomena, organic semiconductors and artificial neurons.

REFERENCES

- (1) E. Keonjian and J. Marx, The Arma Micro Computer for Space Applications, Spaceborne Computer Conference, Anaheim, Calif., Oct. 1962.
- (2) A. Gross, Cleveland Metal Specialties, private comm., Nov. 6, 1962.
- (3) G. Mealey, General Dynamics/Astronautics, private comm., Dec. 1962.
- (4) EIA Microsystem Electronics Bulletin No. 1, Recommended Terminology in Microsystem Electronics, Dec. 1962 (definitions formulated by MCA-1 and 2 subcommittees).
- (5) W. D. Fuller, Lockheed Missiles and Space Co., private comm., Nov. 27, 1962.
- (6) W. D. Fuller, Production Techniques for Integrated Electronics, 6th National Conference on Product Engineering and Production, San Francisco, Nov. 1962.
- (7) W. W. Eckess, Pacific Semiconductors, private communication, Nov. 30, 1962.
- (8) F. M. Wanless and C. T. Sah, Nanowatt Logic Using Field-Effect Metal-Oxide Semiconductor Triodes, paper to be presented at 1963 International Solid-State Circuits Conference, Philadelphia.

- (9) P. S. Castro, A Thin-Film Frequency Discriminator, East Coast Conference on Aerospace and Navigational Electronics, Baltimore, Oct. 1962.
- (10) W. E. Newell, *Proc IRE*, p. 2, 517, Dec. 1962.
- (11) H. C. Lin, M. J. Geisler, and K. K. Yu, A New Unipolar-Bipolar Transistor Configuration for Integrated Audio Amplifiers, paper to be presented at 1963 International Solid-State Circuits Conference, Philadelphia.
- (12) D. S. King, G. R. Madland, and W. J. Carrigan, Methods of Isolation of Active Elements in Integrated Circuits, IRE PGED meeting, Wash., Oct. 1962.
- (13) A. D. Evans, Molecular Electronics Telemetry Encoder, Texas Instruments Interim Engineering Report 02-62-4 under contract No. AF 33(616)-8339, Jan. 1962.
- (14) W. W. Gaertner, Nanowatt Devices, IRE PGED meeting, Wash., Oct. 1962.
- (15) G. J. Veth, High Density Microelectronic System Realization, National Winter Convention on Military Electronics, Los Angeles, Jan. 1963.
- (16) R. H. Norman and R. C. Ander-

- son, Testing of Micrologic Elements, WJCC, Los Angeles, May 1961.
- (17) P. K. Weimer, Thin-Film Active Devices, East Coast Conference on Aerospace and Navigational Electronics, Baltimore, Oct. 1962.
- (18) W. Tantraporn, How Good Are Thin-Film Triodes, *ELECTRONICS* p 29, Dec. 28, 1962.
- (19) M. M. Atalla, The Hot Electron Triode with Semiconductor-Metal Emitter, Northeast Electronics Research and Engineering Meeting (NEREM), Boston, Nov. 1962.
- (20) H. Borkan and P. K. Weimer, Characteristics of the Insulated-Gate-Thin-Film Transistor, NEREM, Boston, Nov. 1962.
- (21) J. M. Lavine and A. A. Iannini, The Metal Interface Amplifier, NEREM, Boston, Nov. 1962.
- (22) R. F. Schwarz et al, A Tunnel Emission Triode, IRE PGED meeting, Washington, Oct. 1962.
- (23) E. Rasmanis, Thin Film Semiconductor PN Junction Devices, NEREM, Boston, Nov. 1962.
- (24) M. M. Perugini and N. Lindgren, Microminiaturization, *ELECTRONICS*, p 77, Nov. 25, 1960.

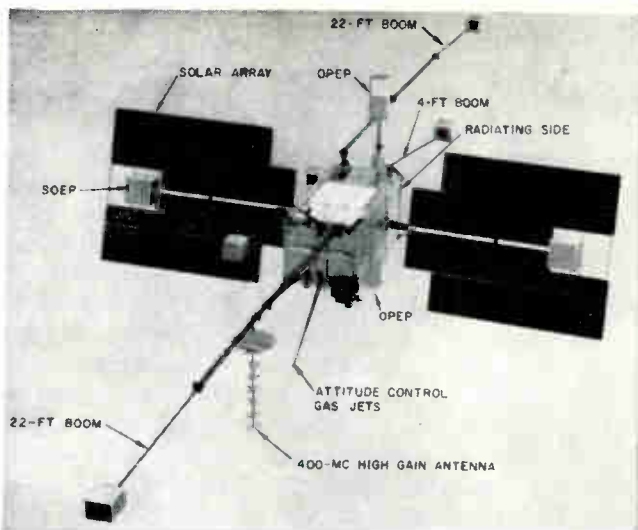
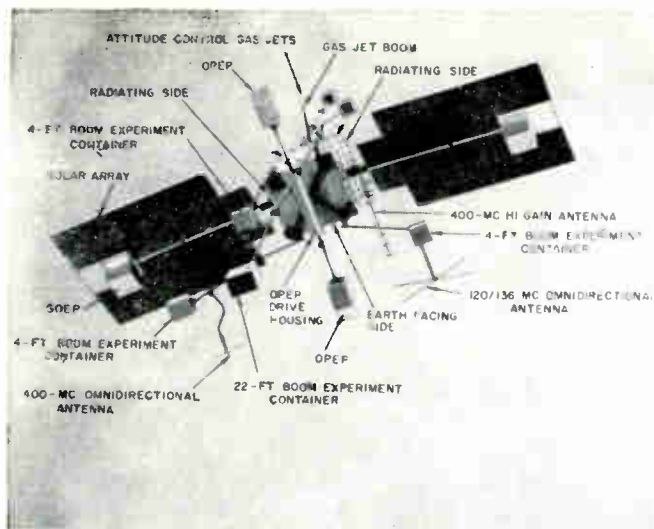

OGO can carry as many as 50 experiments in a variety of orbits. Gas jets keep vehicle in correct earth attitude

Inside the ORBITING GEOPHYSICAL OBSERVATORY

The orbital geophysical observatory (OGO), due for launch this summer will carry 50 diversified experiments in a wide variety of orbits and may become the space workhorse of the future

By P. F. GLASER and E. R. SPANGLER Space Technology Labs. Inc., Redondo Beach, California

FIRST PLANNED ORBIT of OGO (orbiting geophysical observatory) will be an inclined, highly elliptical one having an inclination of 31 degrees, a perigee of 150 nautical miles, and an apogee of 60,000 nautical miles. The name EGO (eccentric orbiting geophysical observatory) has been given to this specific mission to be launched in 1963. The second orbit, with an inclination of 90 degrees, is to have an apogee of 500 and a perigee of 140 nautical miles. This mission has been named POGO (polar orbiting geophysical observatory). The basic spacecraft for either mission will be the same, but the experiments will differ.

A model of OGO, unfolded as in orbit, is shown in the photographs.

The basic body is a parallelepiped approximately $6 \times 3 \times 3$ feet. Two doors on opposite sides of the length of the body contain those experiments that will face the earth

or precisely away from the earth. The remaining two long sides and one small side of the body contain thermal-radiating surfaces that are automatically exposed or covered

OGO, EGO, POGO

The tailworn craftsman that with earth-made implements laboriously conquers the earth—Carlyle, "Sartar Resartus"

OGO (orbiting geophysical observatory) is the basic spacecraft of EGO (eccentric orbit geophysical observatory) and POGO (polar orbiting geophysical observatory). It is extremely flexible and can carry a large number of experiments. Because of an internal patch panel, last-minute experiments can be included with minimum vehicle changes. EGO will probably be launched this summer followed by POGO next winter

by thermal louvers actuated by individual bimetal elements on each louver. In orbit, these three sides never see the sun and are used to radiate the heat away from the body of the spacecraft. The body, except for radiating areas, is completely insulated to contain internal heat and reject external heat.

Two long booms, designed for experiments such as magnetometers that require separation from masking effects of the rest of the spacecraft, are each 22 feet long. Four short booms four-feet long, contain experiments less sensitive to, but still undesirably affected by, proximity of other equipment. Antennas are also mounted on the short booms to take advantage of the improved antenna pattern possible by removal from the main spacecraft body. Two packages are mounted at the aft of the spacecraft for those experiments that require that they face either forward or backward in the orbital plane. These packages have been labeled orbit plane experiment packages (OPEP). The attitude control jet nozzles are also placed on booms on the forward end to increase the lever arm and thus reduce gas system weight. Two solar cell paddles are mounted on a shaft running through the spacecraft and can be rotated to allow the cells to remain normal to sunlight despite the constantly changing orientation of the body as one surface continuously faces the earth. Two solar oriented experi-

ment packages (SOEP), one on each array, are provided for experiments which must face directly toward, or away from the sun at all times.

Three features of OGO permit spacecraft flexibility basic to conception. Automatic charge regulation has been incorporated since the spacecraft must be capable of efficient operation in a relatively large spectrum of thermal and solar-power environments. The need for OGO to communicate effectively from a wide variety of orbits without redesign for each mission has required new features in this system. Since the requirement for the data-handling circuits to accommodate the needs of changing experiments is unique in spacecraft, these systems, for both digital and analog data, are unique.

CHARGE CONTROL — Battery charge control consists of two current regulators, each maintaining a preselected charge current to the battery pack connected to its output. A functional block diagram of the OGO power system, which includes the elements of the charge controller is shown in Fig. 1. Each regulator has two output power transistors with each transistor controlling one-third of the array. Thus, two-thirds of the solar array is controlled by each regulator.

The solar array is controlled by shunting current of one-half of the series solar cell modules associated

with each transistor. Turning power transistor Q_1 , or Q_2 full on effectively shorts one-half of the series cells being controlled, reducing the output voltage by one-half and the output current to zero. Except immediately after eclipse when the solar array is cold, this method controls solar array output from full on to off with less power dissipation than a series-type regulator. When the array is cold, control is lost and the battery voltage and load and battery currents set the array operating point. An advantage of this method of regulation is that power is required only when power is available. When the solar array is incapable of maintaining both the load and selected charge currents, the transistors are switched off.

During normal charging, after eclipse and before the batteries reach a preselected voltage or temperature level, charge current is regulated at a selected level adjusted by charge level set command switch S_1 . Four charge current levels can be selected by command ranging from trickle charge to full array capability. Resistors R_1 and R_2 define the trickle charge level and any shunt resistance causes this charge level to increase.

When the battery voltage increases to a preselected level as a result of charging, the voltage monitor switches the charge current from the selected level to the trickle charge level by shutting off

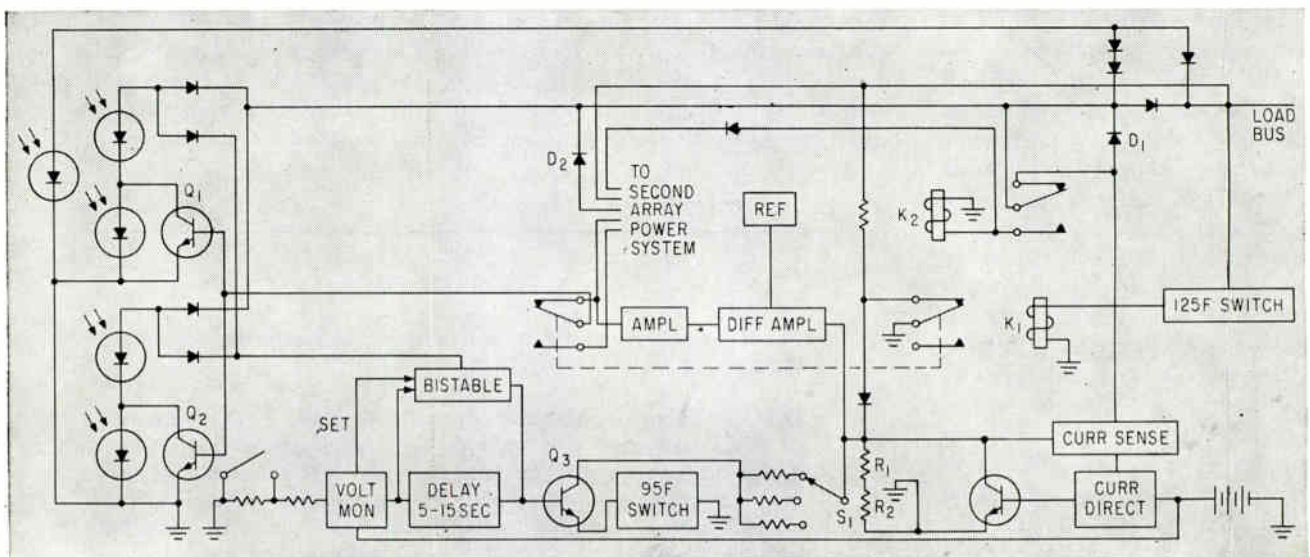

BATTERY charging system consists of two circuits like that shown above, one for each solar array. Battery charge is determined by temperature—Fig. 1

transistor Q_3 . The bistable flip-flop, with associated time delay, allows the trickle charge to occur for only 5 to 15 seconds, at which time the rate is reset to the selected rate. The cycle is continued each time the battery exceeds the preselected voltage level.

Should the battery reach a temperature greater than 95 F but less than 125 F, the 95 F normally closed switch opens, causing the array to drop to a trickle charge of the battery. This continues until the temperature of the battery is reduced to below 95 F.

A battery failure is indicated by a temperature greater than 125 F. When this temperature occurs, the 125 F normally-open switch closes and operates failure transfer relay K_1 . This relay opens the battery charging circuit (diode D_1 , reverse biased) and allows discharge of the malfunctioning battery only to the extent of its remaining capability during eclipse; connects the disconnected array buss and the array buss of the good battery by diode D_2 ; transfers control of the regulating transistors to the other regulator by relay K_2 ; and causes the charge rate of the remaining battery to be switched to full-on until overridden by a ground command.

Should both batteries fail, the regulating transistors are switched into saturation. The remaining unregulated two-thirds of the array will provide approximately 26 volts at nominal load current. Thus, even with both batteries failed, limited operation of the spacecraft when the solar array is illuminated is still possible.

COMMUNICATIONS—One of the major tasks in obtaining flexibility in the OGO design has been to provide a communications and data handling system to accommodate the separate missions while maximizing communication efficiency and minimizing weight.

The command and tracking functions of OGO use approximately 120 and 136 Mc respectively, making use of a single omnidirectional antenna with essentially 0-db gain. A combined diplexer-coupler allows transmission at 136 Mc and reception at 120 Mc simultaneously. The coupler allows two transmission ports and two receiver ports to be

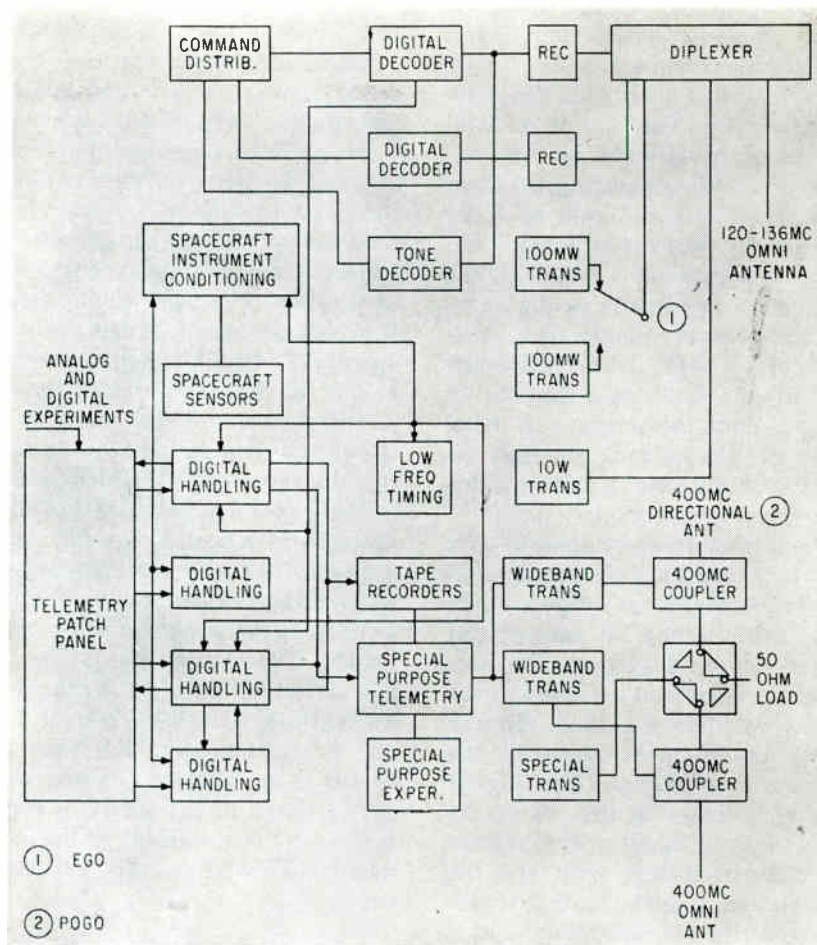

COMMUNICATION system of OGO uses three tracking transmitters and three wide-band transmitters for telemetry—Fig. 2

made available in a single unit as shown in Fig. 2.

For EGO, three transmitters are carried to provide an unmodulated signal to the ground tracking interferometer. A 100-mw transmitter at 136 Mc operates continuously. The redundant unit can be switched in by command. The 10-w tracking transmitter, used only on those missions with an apogee at an altitude greater than 6,000 nautical miles, is controlled by a timer which turns the transmitter off 45 seconds after it is commanded on. During the time the 10-w unit is operating, the 100-mw unit that had been operating is automatically turned off. When the 10-w unit goes off, the 100-mw unit is then turned back on.

Three telemetry transmitters operating at 400 Mc, two redundant 4-w units for wideband telemetry transmission and a half-watt special purpose transmitter are also carried. Normally wideband telemetry will be transmitted by a directional antenna providing 12-db gain. For low-altitude passes of EGO and

POGO, an omnidirectional antenna will be used and either transmitter can be used for either antenna. The special-purpose telemetry transmitter is provided for experiments which are not compatible with the time-sharing feature of the wide-band system or whose analog measurements need to be transmitted in an unprocessed form. All transmitters are solid state with the wide-band units having a strip-line filter and biphase modulation, with a possible modulation frequency of 1 to 200,000 bits per second. The special-purpose transmitter can use up to five subcarriers and operate from any experiment whose output is an f-m signal within system bandwidth of 0.3 to 100 Kc.

Two redundant a-m command receivers operating in phase diversity are fed from single elements of a crossed-dipole omnidirectional antenna. Each receiver contains two age loops, a signal-present relay and a squelch circuit.

The outputs of the two command receivers feed, in a parallel-redun-

dant fashion, two digital decoders and a single-tone decoder. Three separate parallel-output amplifiers in each receiver supply the decoders independently. The squelch or failure detection circuits in the receiver allow the operating receiver to increase its audio gain by 6 db if the other receiver is not operating. The additional 6 db of signal level allows the inputs to the various decoders to remain at a constant level. If both receivers operate, the 6-db gain feature is removed and the outputs of both receivers are added, so that in either case the level to the decoders is essentially constant.

The digital decoders operate on a frequency-shift keying signal amplitude modulated by a 128-cps sine wave, defining the bit rate of the digital command system. The output of the command receivers to the digital decoders contains the fsk signal, amplitude-modulated by the bit rate sync signal. The digital decoder operates on this waveform using the sync signal to synchronize the decoder system with the fsk information signal. Each decoder can be addressed separately, and it is possible to obtain an output from a single digital decoder to operate the command distribution unit. This unit consists of operating relays in a 16×16 matrix, providing 254 commands.

The command word contains 24 bits with the first 4 bits of the information signal to the digital decoder containing sync and address information. The first bit is always 1 for sync and the remaining 3 bits are used for address. It is required that a 1 be available in these 3 bits, thus the system has the capacity to address 7 decoders independently of each other. The next 2 bits define the mode in which the decoder is to operate. These 2 bits define whether or not the decoder provides signals to the command distribution or to the digital-data handling units. The two unused mode signals available in the 2 bits are provided for later spacecraft when a special programmer will be incorporated to allow change in telemetry operating mode without ground-station commands. The next 8 bits define the 254 commands within the command distribution unit. The 2 mode bits and 8 command bits are then repeated in an inverted position, as a parity check in the digital decoder before any of the relays in the command distribution unit are activated.

DIGITAL DATA HANDLING —

The wideband telemetry consists of two redundant digital telemetry systems which either operate in real time or feed two redundant recorders for delayed readout.

The basic data telemetry format includes 128 nine-bit words in the main frame. Three subcommutators, each 128 words long, are also provided. It is possible on command to operate one of the spacecraft commutators at the main frame rate and therefore provide high-data rates for spacecraft instrumentation purposes if so required. A flexible format is also provided in the digital telemetry system so that a limited amount of experiments can be combined to give 32 combinations of any 32 experiment inputs allowing data to be transmitted at higher rates than the main frame rate when desired.

The basic format and timing are implemented in the digital data handling unit. In addition, this unit contains all the necessary gates for digital experiments and provides inhibit and shift pulses to digital experiment shift registers. The digital data handling unit also provides timing and sequence signals to the analog data handling unit.

All experiments, either digital or analog, are fed directly to the telemetry patch panel. This panel defines the amount of cross-strapping between analog and digital experiments, and is used to define the basic word setup in all of the commutators. The panel contains approximately 2,000 terminals and contains all the interconnect points for both equipment group digital inhibits, digital gates and analog gates. The use of such a patch panel allows last minute changes in the telemetry format or makeup of an original format without affecting the equipment already acceptance tested in the spacecraft.

ANALOG DATA HANDLING —

The analog data handling assembly is shown in Fig. 3. Within this assembly are the analog gates for the main commutator, the experiment subcommutator and two spacecraft commutators and the analog flexible format gates. Although 128 words are provided in the main commutator and all subcommutators, only 96 analog gates have been provided in the main commutator, 112 in the experiment subcommutator and 88 in each of the spacecraft subcommutators.

Figure 4 shows the matrix gating used in the analog data handling assembly. The first-level gate stick

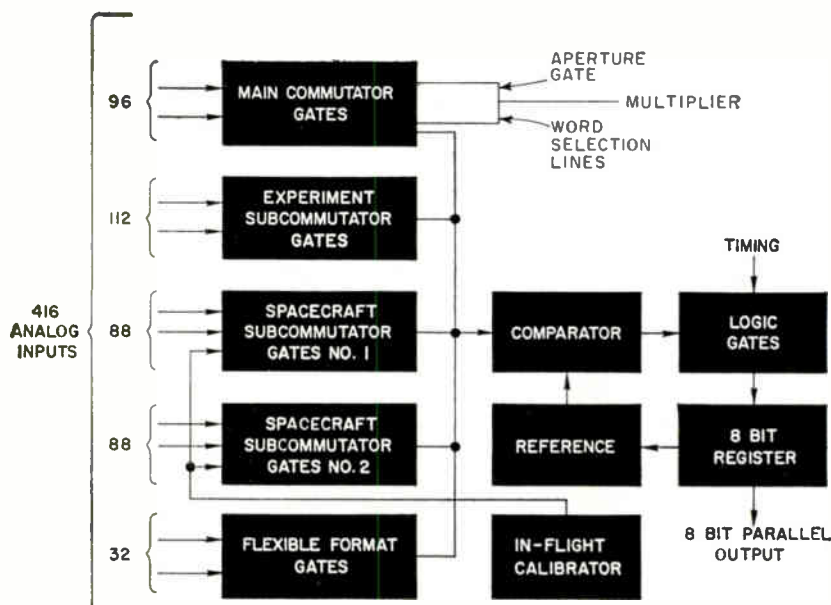

ANALOG data handling assembly contains gates for the main commutator, experimental subcommutator, two spacecraft commutators and an analog flexible format gate—Fig. 3

includes eight analog gates paralleled so that when a signal is available at a first-level driver and second-level gate, an output to the third-level gate occurs. The third-level gate allows an output signal to be directed to the analog-to-digital converter. All identification signals, aperture-gating signals and matrix for first- and second-level gate-drive signals are provided from the digital-data handling assemblies.

The analog-to-digital converter logic and truth table are shown in Fig. 5. The converter uses a successive approximation technique to achieve analog-to-digital conversions. Since the lowest quantization level is 0.2 v, 250 levels between zero and five volts provide an accuracy of 0.4 percent. The converter uses a compressed half-split sampling technique and accomplishes the conversion at a rate two times the highest input rate or 128 bits per second.

As shown in Fig. 5, the analog-to-digital converter contains a comparator, digital timing gate, a register (flip-flops a_1 through a_8) for storage, and a digital-to-analog converter (switches and ladder adder). The register flip-flops drive the a-d switches which in turn define accurate voltage levels by the ladder adder. The ladder adder is designed to apply binary weights to the register positions starting with a_1 as the most significant weight (2.5 v) through a_8 with the least significant weight (20 mv).

At time B_0 the register flip-flops are preset so that ladder-adder output is one-half of full scale (2.5 v) and this output, as reference, is applied to the a-d converter. As shown in the truth table, under logic timing B_0 the state of each flip-flop is shown as $a_1 = 1, a_2 = 0, \dots, a_8 = 0$. If the analog signal presented to the comparator is less than the reference voltage, a comparison is made. This condition allows timing pulse B_1 to reset the register flip-flop a_1 (B_1 AND gated with comparator output C). Pulse B_1 also sets a_2 . The binary weighted analog output of the d-a converter is then 1.25 v. Had the analog signal input to the comparator been greater than half of full scale (> 2.5 v), no comparison would have been made. Timing pulse B_1 would then have been blocked from resetting a_1 while setting a_2 . The

d-a converter reference output voltage would then be $2.5 + 1.25 = 3.75$ v.

Seven more successive comparisons are made on everdecreasing portions of full scale until the voltage of the input signal is known to within one quantization level. One quantization level is nominally 20 mv out of the full scale of 0 to 5 v. At the end of the sampling period (following time B_8) the register

flip-flops are left in states representing the binary equivalent of the analog signal voltage. If these eight states are interrogated at the readout bit rate, a serial string of binary bits representing the analog signal voltage are obtained. This interrogation is done by the digital data handling assembly where analog words are combined with other information to form the wideband telemetry format.

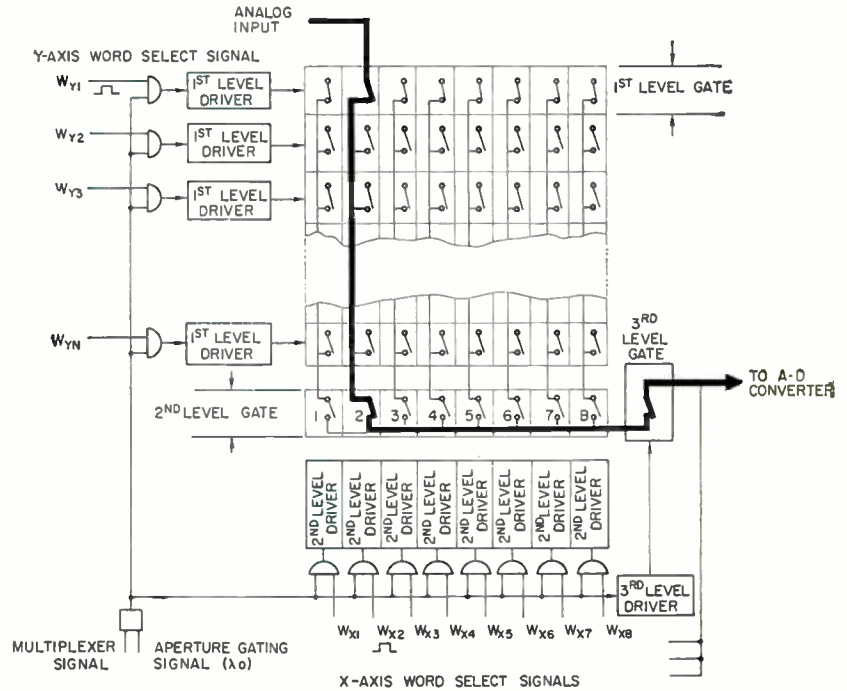

MATRIX gating accepts the analog signal and feeds it to the analog-to-digital converter—Fig. 4

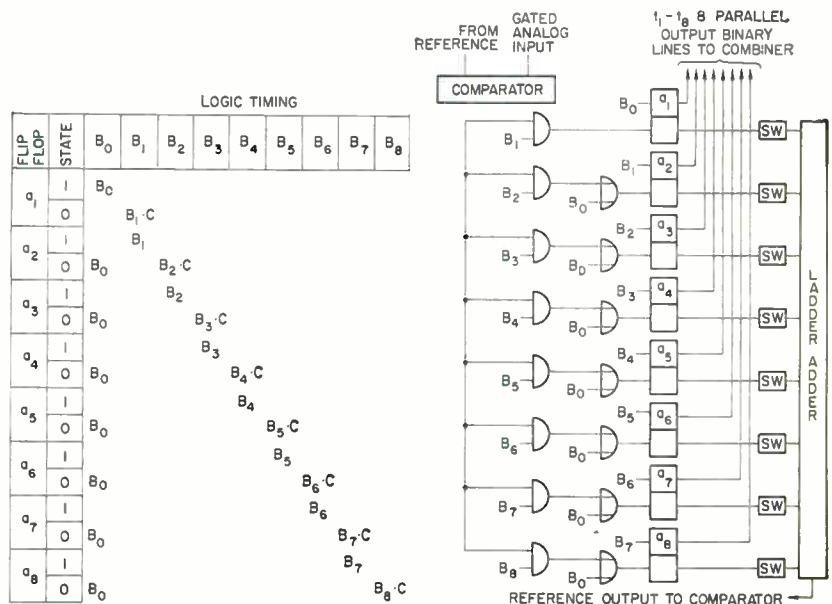

TRUTH TABLE (left) of analog-to-digital converter (right) uses successive approximation to achieve conversion—Fig. 5

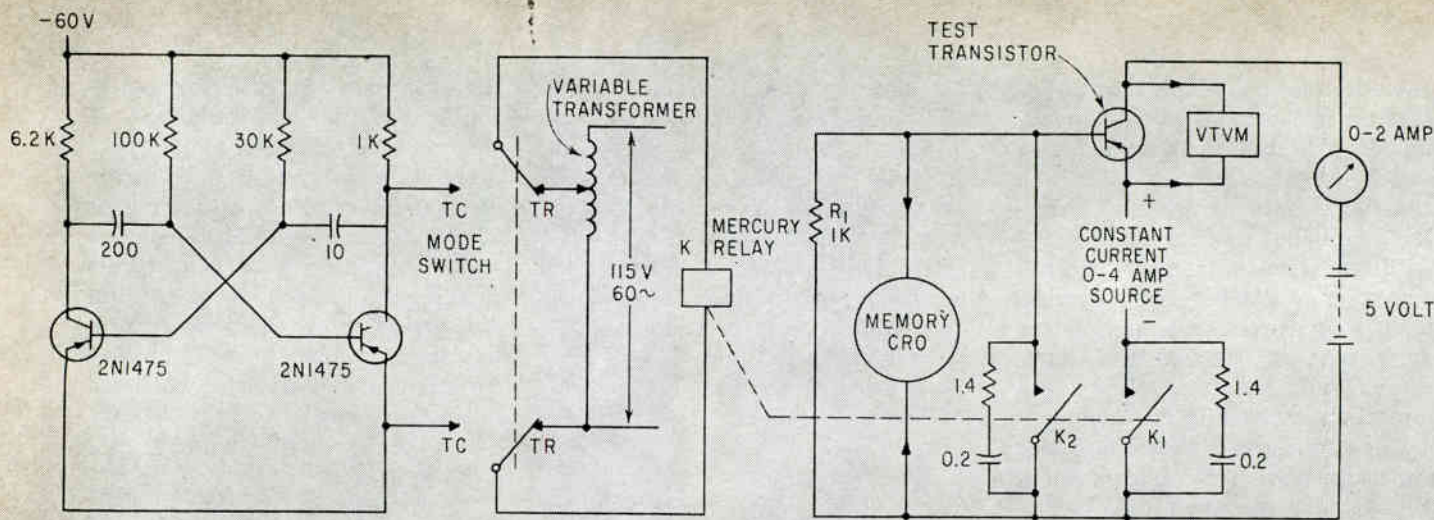

MULTIVIBRATOR pulses relay *K* during time-constant determination; 60-cycle supply drives relay for thermal resistance testing—Fig. 1

Practical Way to Measure Transistor

Test yields thermal resistance and thermal-time-constant data for transistors.

By HAROLD BAUMAN

Environmental Engineer,
Kearfott Division,
General Precision Inc.,
Little Falls, N. J.

THE TWO transistor parameters most often specified in MIL specs. are thermal resistance and thermal time constant. However, the procedures outlined in such specifications are somewhat confusing and difficult to carry out. This article sets down a simple and logical set of procedures for thermal testing.

Initially, the transistor is mounted in the circuit shown in Fig. 1, with provision for adequate heat dissipation during all phases of operation.

In this analysis, the collector-to-base leakage current is the temperature-sensitive parameter. An astable multivibrator controls a collector-to-base pulse I_{co} , which is generated for 0.3 second every 3 seconds. This produces a pulse, which can be monitored on a memory oscilloscope, across the 1,000-ohm re-

sistor R_1 . By varying the vertical control, the pulse pattern is shifted to a predetermined reference line. Constant power is then applied during the period between pulses, with power level near the transistor's normal operating steady-state value.

TIME CONSTANT—During the leakage pulse, I_{co} decreases exponentially to its value at room ambient conditions (Fig. 2A). The time taken by the trace to reach 63.2 percent of the leakage-decrease is the thermal time constant of the transistor. This technique also measures the thermal time constant of the temperature fall. Since the temperature rise is equal to unity minus the temperature fall ($1-\gamma_t$), it also measures the time constant

of temperature rise. The first step in performing the thermal resistance test is transistor calibration. Initially, an I_{co} reading (for example, 50 microamp) is taken at 25 C. The transistor is then placed in an oven and heated to, say, 60 C, at which temperature a second I_{co} reading, perhaps 250 microamp, is taken. These two points are then plotted as shown in Fig. 2B, enabling junction temperature T_j to be established for a given I_{co} .

The thermal resistance test is started by switching to the thermal resistance mode TR in the test circuit. Although the most reliable temperature-sensitive parameter in junction transistors is the forward drop (V_f) of the collector junction, the I_{co} parameter is used in this test since it is a required parameter

THERMAL TIME CONSTANT is measured by time taken for trace to reach 63.2 percent of the leakage decrease (A); calibration curve determines junction temperature for given I_{co} (B)—Fig. 2

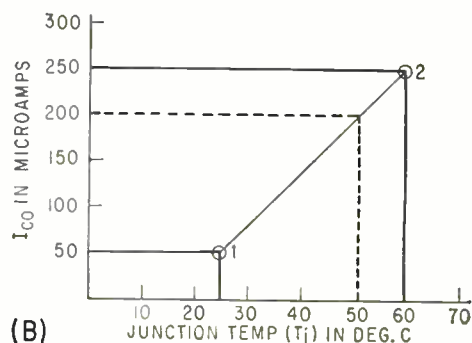
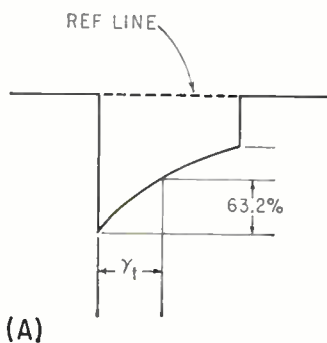

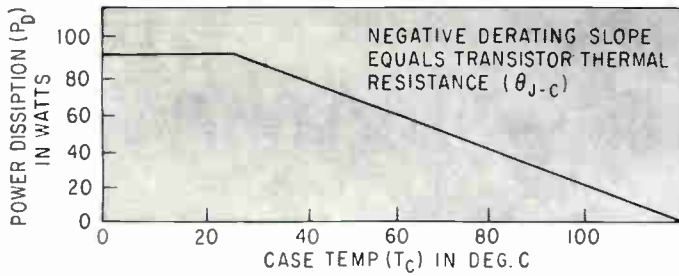

USING THE DATA

Transistor power dissipation is related to the junction temperature by a coefficient called thermal resistance. Since maximum power and junction temperature are tied together by this value, they lend themselves to determination of either case temperature (T_c) or power dissipation (P_d) by using thermal resistance and one of these variables (T_c or P_d). This is shown in power temperature derating curve, where the transistor becomes useless beyond about 120 deg C

THERMAL RESISTANCE

Method satisfies military specifications

in qualification testing of transistors. Both the I_{co} and V_i methods are subject to an error caused by the thermal response time of the transistor. However, this error has little effect on the outcome of the tests. In silicon transistors where I_{co} is small, differential-amplifier techniques are used in the detector circuit for precise measurements of the junction temperature.

HEAT MEASUREMENT—A thermocouple embedded in the heat sink near the transistor provides readings of temperature (T_c) when power is applied to the transistor. Relay (K) driver voltage is adjusted to a convenient value to drive the mercury relay in its chopper action. Collector voltage is set to about 5 volts, the exact value de-

pending upon the power rating of the unit.

Slowly increasing I_c produces a pattern on the scope indicating an I_{co} somewhere between the two previous calibration points (Fig. 3A). Both the thermocouple and I_{co} readings are allowed to stabilize, after which T_c and I_{co} are recorded.

Since the duty cycle of the relay will not allow readings of I_{co} , relay driver voltage is raised to hold relay contacts closed, permitting readings to be made more easily. Current (I_c) and voltage (V_{ce}) readings must then be taken quickly to prevent thermal drift.

The latest I_{co} readings are plotted on the calibration curves (Fig. 2B). Assuming a reading of 200 μ A (Fig. 3B), this gives a T_j reading of 50 C, thus determining junction

temperature for a particular case temperature.

USING THE DATA—By defining thermal resistance as the input power required to raise the junction temperature to some arbitrary higher temperature, thermal gradient can be calculated by

Thermal resistance (degrees C/Watt) =

$$\frac{\text{Case Temp } (T_c) - \text{Junction Temp } (T_j)}{\text{Collector Volts} \times \text{Collector Current } (I_c)}$$

Sample calculation

$T_c = 65\text{C}$ (taken directly after thermocouple stabilization)

$T_j = 50\text{ C}$ (taken from calibrated curve)

$V_{ce} = 5.5$ volts and $I_c = 1.8$ amp (taken after the mercury relay was closed)

Thus

$$\begin{aligned} \text{Thermal Resistance} &= \frac{65\text{ C} - 50\text{ C}}{5.5\text{ volts} \times 1.8\text{ amp}} \\ &= \frac{15\text{ C}}{9.8\text{ watts}} \\ &= 1.53\text{ C/watt} \end{aligned}$$

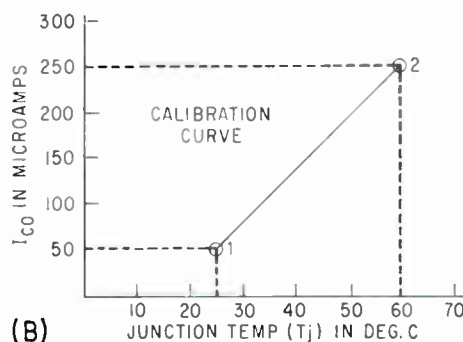
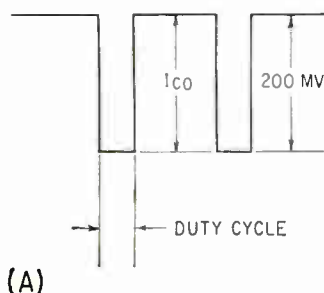

OSCILLOGRAM of relay controlled waveform across the test transistor's base resistor (A); I_{co} reading of 200 microamp corresponds to transistor junction temperature of 50 C (B)—Fig. 3

Improving Pulse Rise Time With

Tenfold improvement in pulse rise time is provided by cascading charge-storage diodes. Snap-off effect of the cascaded diodes is also used to generate ultrashort pulses that can be used for sampling oscilloscope

By K. C. HU, RCA Laboratories, Princeton, N. J.

CASCADED charge-storage diodes can improve rise time of a 30-volt pulse across 50 ohms from 5 to 0.5 nanosecond. Ultrashort pulses for oscilloscope sampling and other applications can also be provided by cascading these snap-off diodes. The recurrence rate of the snap-off action can be as high as several hundred megacycles.

Available pulse generators can supply pulses having a rise time of about 5 nanoseconds. These pulses of 500 milliamperes to 1 ampere can be supplied to a load of 50 to 100 ohms at recurrence rates of 1 Mc and higher. However, even with the best available components, such performance requires elaborate and careful circuit design, such as a negative power supply to enable d-c coupling. Several forward-biased charge-storage diodes in cascade across the output transmission line of the pulse generator can materially improve pulse rise time.

The extra loading on the generator output by the charge-storage diodes is more than compensated by the impressive improvement in rise

GETTING MORE OUT OF SNAP-OFF

If snap-off in one charge-storage diode can improve pulse rise time, two or three cascaded diodes should improve it even more. Here is how suitably biased charge-storage diodes provide a tenfold improvement in rise time and also enable generation of ultrashort pulses

time. Rise time is about 0.5 nanosecond for a typical 30-volt pulse across 50 ohms, which is a tenfold improvement.

SNAP-OFF—When a reverse voltage is applied to the charge-storage or snap-off diode after it has been conducting in the forward direction, it conducts in the reverse direction because of the charges stored near the junction.¹ The reverse current decreases during a period called the transition phase

until the charges have been removed. The transition period is short and is related to structure of the semiconductor device. When the diode is driven from a source with low internal impedance, the sudden stoppage of reverse current (snap-off) causes a sharp step change in voltage across the diode. The snap-off action has been used during the past few years, but its usefulness can be considerably extended by cascading several charge-storage diodes.

Three charge-storage diodes have been cascaded in Fig. 1. If the generator pulse were positive instead of negative, the diodes and their associated biases would be reversed. A coaxial cable of matched characteristic impedance is generally necessary to transmit the fast-rising pulses from the generator to the load. The coaxial transmission line is also convenient for mounting the diodes. The mechanical construction of the mounting is shown in Fig. 2. The r-f path is made as short as possible while preserving the continuity of the transmission line.

The instant that snap-off occurs

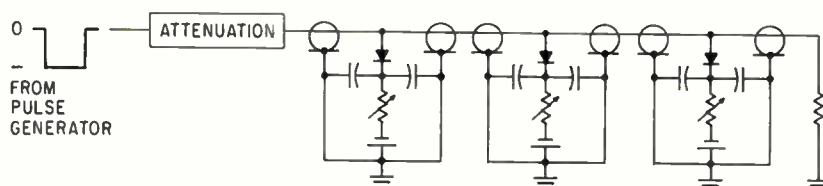

BIASES for cascaded charge-storage diodes are adjusted separately to control instant that snap-off occurs—Fig. 1

Snap-Off Diodes

for a given applied pulse depends on forward bias current. Therefore, forward bias current for each diode must be adjusted separately to increase steepness of the entire leading edge where this is desirable.

In some applications, only the step in a portion of the leading edge is of interest, such as when the diode is followed by a differentiator to generate short pulses. Although not yet fully investigated, the slope of the snap-off for a given diode depends on rise time of the applied reverse voltage. Thus, the resultant step is sharper if the snap-off step of a previous diode is used to drive the subsequent diode. The bias required is different from that needed for uniform steepness of the complete leading edge, and separate adjustment of the bias for each charge-storage diode is again necessary.

IMPROVING RISE TIME — A pulse is shown in Fig. 3A before and after the effects of three cascaded charge-storage diodes, and the leading edges of the pulse are shown in Fig. 3B. A Model 121 E-H Research Labs, Inc., pulse generator and three FD-100 charge-storage diodes were used in these experiments. A Tektronics type N sampling attachment and 543 oscilloscope were used to make these recordings. The sampling unit has a rise time limit of about 0.6 nanosecond.

The experimental results shown in Fig. 3C were obtained using a Lumatron 112A sampling oscilloscope adjusted for maximum bandwidth. The rise time limit of this oscilloscope is about 0.2 nsec. The biases used on the first, second and third charge-storage diodes were 100, 75 and 50 ma, respectively. In general, the first diode increases steepness of the last half of the

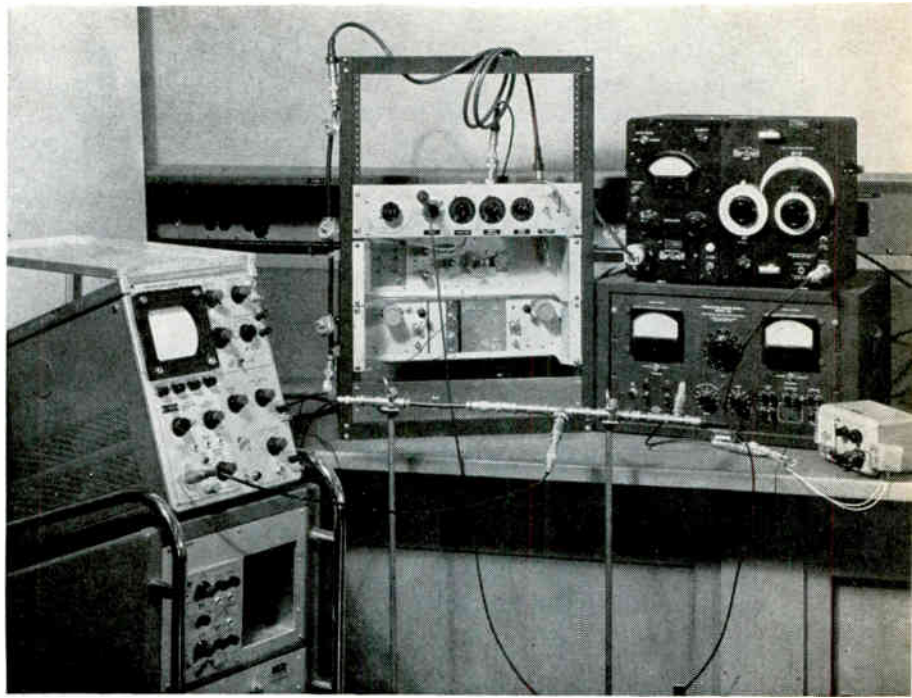

STROBOSCOPIC sampling oscilloscope was used to observe the effect of the three charge-storage diodes mounted on the coaxial cable at the left of the rack

leading edge; the third diode increases steepness of the initial portion of the leading edge; the second diode improves rise time of the remainder of the leading edge.

ULTRASHORT PULSES — Ultrashort pulses have been generated by differentiating the step voltage resulting from snap-off in charge-storage diodes. Differentiated pulses as short as 0.2 nsec have been measured at an amplitude of 0.5 volt across 50 ohms. Such pulses have been used in strobing sampling oscilloscopes by some instrument manufacturers.²

For a given voltage, the cascading of charge-storage diodes tends to generate pulses having shorter

rise times than those that have been reported using a single diode. The reason is again that a faster rising driving pulse is supplied to each successive diode by the snap-off action of the previous diode. Differentiation of the fast-rising waveform was achieved by placing an inductor (a piece of metal) between the center conductor and the shield of the transmission line at a position between the last diode and the load.

The pulses that resulted using one, two and three charge-storage diodes are shown in Fig. 4. Again, the Lumatron Model 112A sampling oscilloscope was used. Since the rise time limit of the oscilloscope is about 0.2 nsec, the difference between using two or three charge-storage diodes is not obvious. However, the difference can be seen when the resulting pulses are used for strobing in a specially built sampling oscilloscope. The waveform in Fig. 5 with the different strobe pulses shows the difference in signal rise time.

The oscilloscope was designed to display fast-rising waveforms having repetition rates up to several gigacycles. The signal in Fig. 4 was obtained from a tunnel diode monostable switching circuit with a 500-Mc sinusoidal input in addition to

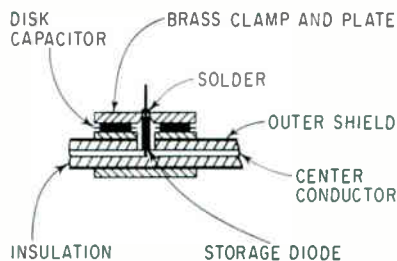

MOUNTING of charge-storage diode is provided by generator coaxial cable—Fig. 2

a d-c bias. Strobing rate is phase modulated around a center frequency of about 5 Mc, which is syn-

chronized with the signal.³ A GaAs sampling diode was used as a mixing gate.

As with other sampling oscilloscopes, rise time of a displayed waveform indicates maximum width of the strobing pulse. Thus, in Fig. 5C, maximum width of the top portion of the strobing pulse that opens the gate is 0.1 nanosecond. It could be much narrower, since switching time of this circuit as determined from calculations and by other methods is nearly 0.1 nsec. If bandwidth of the sampling diode is not a limiting factor, the performance limit of this sampling system using strobing pulses obtained herewith has not yet been determined.

Biases were 85, 45 and 80 ma for the first, second and third diodes, respectively. The initial 5-Mc driving pulses had a rise time of about 8 nsec and a peak amplitude of 30 volts across a 50-ohm load.

The experimental results indicate that charge-storage diodes can be used more widely either in fast-rise pulse generation or in short pulse generation for sampling or similar purposes. Some of the advantages of using charge-storage diodes are the relatively low cost and circuit simplicity. Also, the recurrence rate of the snap-off action can be as high as several hundred megacycles, and so far no generator can

provide pulses at these repetition rates and these amplitudes.

Some precautions should be taken in using this technique, such as loading from forward-biased diodes. Also, slowly rising pulses cannot be improved by this method. The slower the reverse driving pulses rise, the higher the forward bias must be. When pulses rise too slowly, either the diode is unable to carry the forward current or the generator is loaded too heavily. In general, the original pulse rise time should not be more than 10 nsec.

A minimum reverse driving voltage is also necessary to obtain proper snap-off action. For a 50-ohm load, about 10 volts is required.

When the diodes are conducting, the low impedance across the coaxial line causes reflections in the line between the diodes and the generator output. Attenuators must be properly placed between the generator output and the diodes to minimize the effects of the reflections.

This work was sponsored by the Bureau of Ships.

REFERENCES

- (1) J. L. Moll, S. Krakauer and R. Shen, P-N Junction Charge-Storage Diodes, *Proc IRE*, 50, p 43, January 1962.
- (2) W. M. Goodall and A. F. Dietrich, Solid State Generator for 2×10^{-10} Second Pulses, *Proc IRE*, 48, April 1960.
- (3) J. M. L. Jansen, An Experimental Stroboscopic Oscilloscope for Frequencies Up to About 50 Mc, *Philips Tech Rev*, 12, p 52, August 1950.

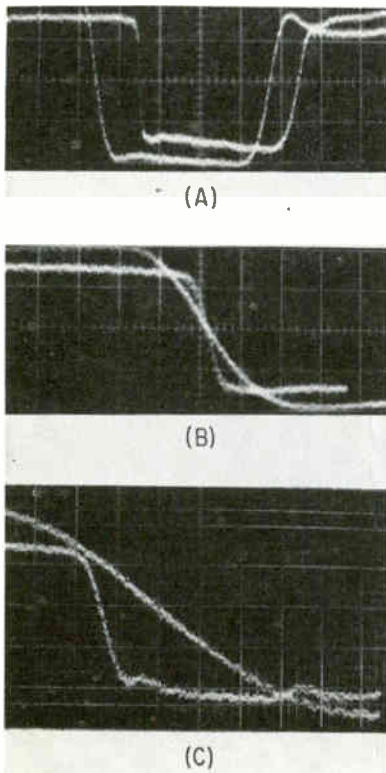

EFFECT of three charge-storage diodes on pulse leading edge is shown at 5 nsec (A), 1 nsec (B) and 0.5 nsec (C) per cm with vertical scale of 10 volts per cm—Fig. 3

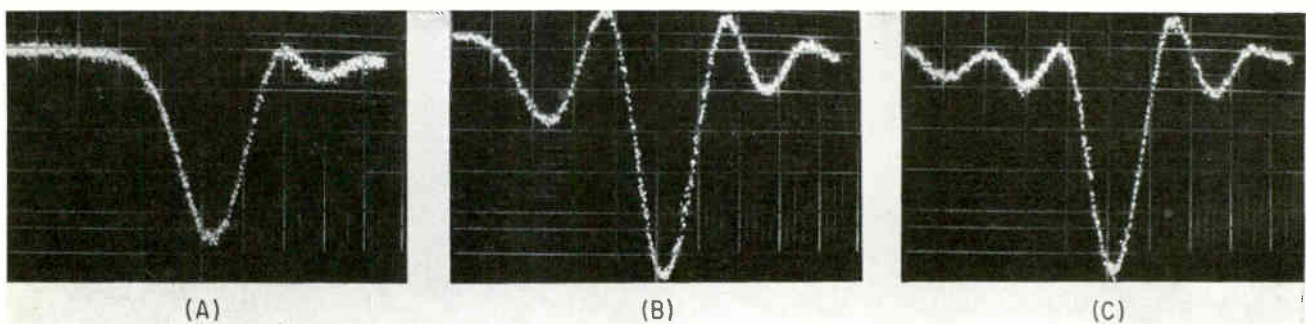

SAMPLING pulses using one (A), two (B) and three (C) charge-storage diodes are shown at 0.2 nsec per division and 0.32 volt per vertical division—Fig. 4

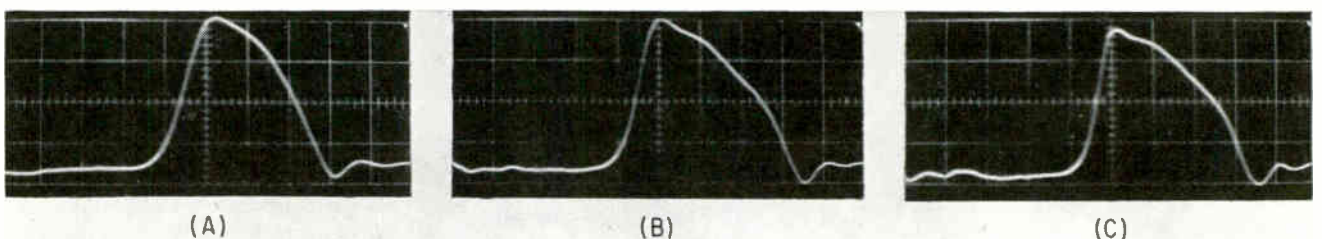

STROBE pulses using one (A), two (B) and three (C) charge-storage diodes are shown at 0.2 nsec per division—Fig. 5

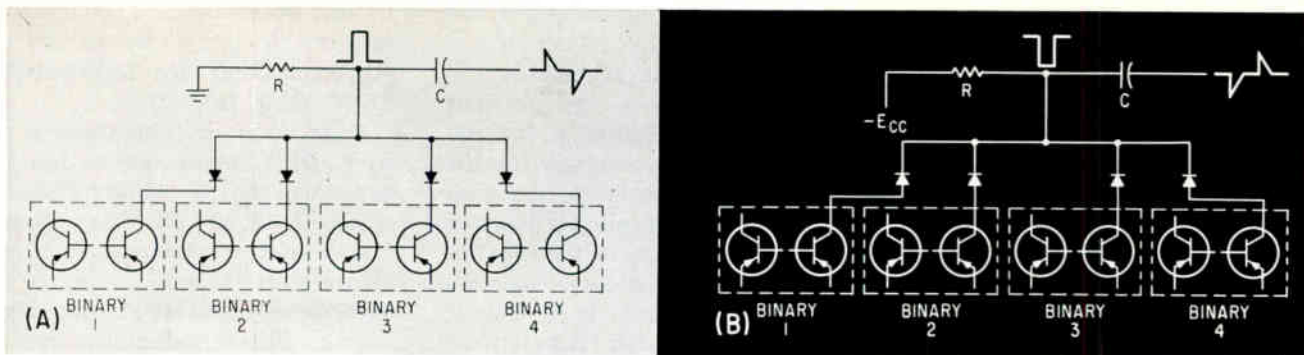

TWO EXPERIMENTAL ARRANGEMENTS (A and B) for coincidence technique in decade counter with pnp transistors—Fig. 1

NOVEL COINCIDENCE TECHNIQUE FOR TRANSISTOR DECADE COUNTER

This arrangement makes it possible to generate coincidence triggers for advancing count at any instant. The three decade schemes described are only a few of the many decade schemes made possible

By PAVAN K. MALHOTRA
RAM PARSHAD

National Physical Laboratory,
New Delhi, India

IN DECADE COUNTERS, that use four cascaded binary stages, forced triggering or feedback is employed during the application of ten input triggers for advancing the count by six units. A number of basic methods^{1, 2} have been developed to achieve decade counting by this advance of count.

A new coincidence technique for achieving decade counting in transistor circuits has two main characteristics: count can be advanced in one step or more, at any stage in application of input triggers, and the decade counter can be as fast as the unmodified binary.

NEW TECHNIQUE—Figure 1 (a) depicts the experimental arrangement for this technique using pnp transistors in decade counters. One collector of each of the four binary stages of the counter is connected to an assembly connected as an AND circuit. The anodes of the diodes are returned through a com-

mon resistor to ground (the collector supply being $-E_{cc}$).

At a particular count, the transistors whose collectors belong to the coincidence diode assembly all become conducting. Consequently, the diodes become nonconducting and the voltage at the common anode point rises to a maximum. For any other count, one or more of the diodes conduct and the voltage is at the lower level.

Thus by differentiating the voltage output at the common anode, a positive trigger is obtained at the start of the particular count and a negative trigger at the end of this count (and at the start of the succeeding one). These are called the leading coincidence trigger and the trailing coincidence trigger.

In the arrangement of Fig. 1B the diodes are reversed and the common cathode point is returned through a resistor to the negative collector supply ($-E_{cc}$).

Here the coincidence pulse would be negative-going, obtained when all the transistors whose collectors are in the coincidence diode assembly become nonconducting. By differentiation of the voltage at the common cathode, leading negative and trailing positive triggers are obtained that can advance the count.

NPN TRANSISTORS—Adaptation of the circuits in Fig. 1A and 1B for npn transistors is straightforward. In Fig. 1A the common anode point is returned to a positive collector supply $+E_{cc}$ instead of to

A BETTER WAY TO COUNT

This new decade counting technique makes it possible to obtain a great many more decade schemes than by existing feedback techniques, because triggers can be generated for advance of count at any configuration of the counter. Also, this technique makes it possible to obtain any kind of interpolation and not to lose speed of counting over that of the unmodified binary

ground; in Fig. 1B the common cathode point is returned to ground.

To obtain the positive-going coincidence pulse in Fig. 1A, the transistors would have to be all non-conducting (instead of conducting as for the *pnp* transistors); to obtain the negative-going coincidence pulse in Fig. 1B, they would have to be conducting.

Potter² showed that a stage of the counter could be prevented from being normally triggered by the previous stage, by applying to the former stage a blocking trigger synchronously with the firing trigger from it. The combined use of coincidence and blocking triggers increases the number of decade schemes available for achieving a ten-light system of interpolation.

In general, only trailing coincidence triggers should be used in combination with blocking triggers.

DECADE SCHEMES—In Fig. 2 (dotted-line scheme, at left, connecting to basic stages), counting proceeds in binary fashion till the eighth input count. At the ninth count, a positive leading coincidence trigger is obtained from the coincidence assembly comprising binary stages I and IV. This trigger is applied to stages II and III for changing their states from ZERO to ONE. Thus at the ninth input count, the counter has all its stages in the ONE state (reading the binary interpolation number 15). The next

(tenth) input trigger clears the whole counter to its ZERO state.

Another decade scheme is obtained simply from the previous scheme by interchanging one collector of the fourth stage for the other in its connection to the coincidence diode assembly. Starting from the zero stage of the counter, at the first input trigger, the leading positive coincidence trigger triggers stages II and III to the ONE state, the counter thus reading the binary number, seven. From then on, the operation is binary.

An advantage of these two schemes is that feedback is not necessary. In schemes using feedback, there is always the possibility of undesirable triggers passing through, thus sacrificing stability of operation. Various earlier attempts have been made to eliminate feedback.³⁻⁵

In still another scheme (Fig. 2, dashed lines), the advance of count of six units is made at the instant of the fourth input trigger. At the fourth count, a trailing negative coincidence trigger is obtained from the coincidence assembly comprising stages I, II and IV. This trigger puts stage IV to the ONE state; in so doing a negative trigger is obtained from this stage, which blocks stage II from being reset to ZERO as a result of resetting of the first stage to ZERO. Thus the counter has the following configurations: at the end of the 3rd count, stages I, II, III,

IV are ONE, ONE, ZERO, ZERO respectively, and at the end of the 4th count, they are ZERO, ONE, ZERO, ONE respectively.

From then on, operation is binary. This decade scheme has the advantage that the binary states of stages II, III and IV of the counter can be split in combinations of two binary states, which are unique for each number pair of the input counts. This number pair can be resolved by associating each unique set with the two binary states of the first stage. Grosdoff¹ has shown how this kind of combination of binary states can possibly yield a ten-light system of interpolation, one separate neon lamp lighting for each separate applied input count. The method has straightforward application to vacuum-tube circuits where sufficiently high voltages are available for lighting neon lamps. With high-voltage transistors, this method of interpolation should become useful in transistor counters.

An additional advantage of the coincidence technique is that there is no loss of counting speed over that of the unmodified binary.

REFERENCES

- (1) I. E. Grosdoff, *Electronic Counters*, RCA Rev. 7, p 428, 1946.
- (2) J. T. Potter, *A Four Tube Counter*, *ELECTRONICS*, p 110, June 1944.
- (3) Elmore and Sands, "Electronics Experimental Techniques", p 211, McGraw-Hill, New York.
- (4) E. L. Kemp, *Gated Decade Counter Requires No Feedback*, *ELECTRONICS*, p 145, Feb. 1953.
- (5) P. Krenitsky, *Decade Counter Employs Silicon Transistors*, *ELECTRONICS*, p 112, Aug. 1955.

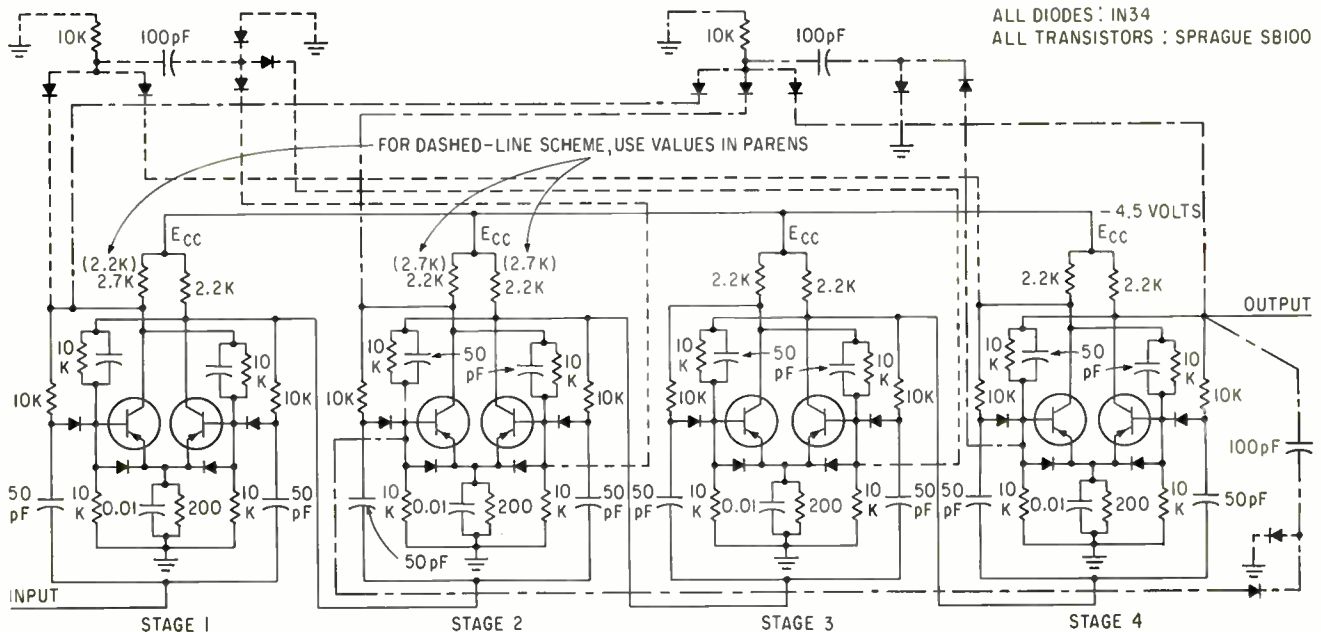

TWO DECADE SCHEMES are shown here, one in dotted lines, the other in dashed lines—Fig. 2



Cool indifference—up to 310°C.

That's the big difference with AMPLIMICA* Capacitors!

This stacked foil capacitor goes right on giving dependable performance in control systems, high voltage power supplies, pulse forming networks, and atomic reactors under temperature ratings up to 310°C. And the big reason for this is our new dielectric—a processed mica which takes all the advantages of raw mica and makes them more readily controllable for today's miniaturization and operational requirements.

In addition to being effectively resistant to high temperatures, our new AMPLIMICA Capacitors are also

resistant to radiation . . . even high dosage rates cause no appreciable capacitance loss.

If your requirements call for a capacitor that assures reliable, stable performance under temperatures ranging up to 310°C., we offer AMPLIMICA Capacitors in a complete range of sizes and configurations . . . ready to do the job. Send for complete information today.

*Trademark of AMP INCORPORATED

AMP | **CAPITRON**
INCORPORATED | **DIVISION**
 155 PARK STREET, ELIZABETHTOWN, PA.

AMP products and engineering assistance available through subsidiary companies in: Australia • Canada • England • France • Holland • Italy • Japan • Mexico • West Germany

Raman Scattering Explains Liquid Lasers

Stimulated scattering of photons by laser offers clues to material structure

APPLICATION of very-high-power pulsed lasers to the study of properties of matter has resulted in some new techniques for observing the effects of interaction of light with matter. Work on laser-stimulated Raman scattering of light, one of the directions of research in this area, has been conducted at the Hughes Research Laboratories, and has been reported on in a series of conference papers including one by R. W. Hellwarth at the Stanford Meeting of the American Physical Society in December, 1962.

The Hughes team has observed stimulated Raman scattering in a

number of organic liquids, mostly ring compounds with five or more C-H or C-D bonds.

Q-SPOILING USED—The stimulated Raman scattering is analogous to laser action, and is brought about by releasing giant pulses from a solid-state laser in

the same enclosure as the liquid under study.

A giant pulse is produced by first pumping up a large population excess, while laser action is quenched by preventing regeneration (Q-spoiling), and then by suddenly applying high regeneration (Q-switching), so that the large material gain that accompanies high population excess causes a sudden conversion of the energy stored in the laser material into coherent light. The amount of energy that can be converted is $\frac{1}{2}nh\nu$ where n is the pumped population excess, h Planck's constant, and ν the laser frequency. Duration of the pulse is at least as long as the natural cavity decay time present during light emission. As an example, in a strong pumping operation with the R_1 transition in pink ruby crystal, the pulse energy is typically $\frac{1}{2}$ joule per c.c. of active ruby, and pulse duration of the order of 3 to 30 nanoseconds; resulting peak powers reach tens of megawatts per c.c. of active ruby.

Hellwarth said that although the gross details of giant pulses are understood fairly well, the specific nature of the spectrum and deviations from a regular pulse shape that occur under various conditions of pumping and Q-switching are not understood at all. It was reported by Hughes at the Electrochemical Society in spring 1962 that the pulse spectrum from ruby was as broad as several angstroms, and

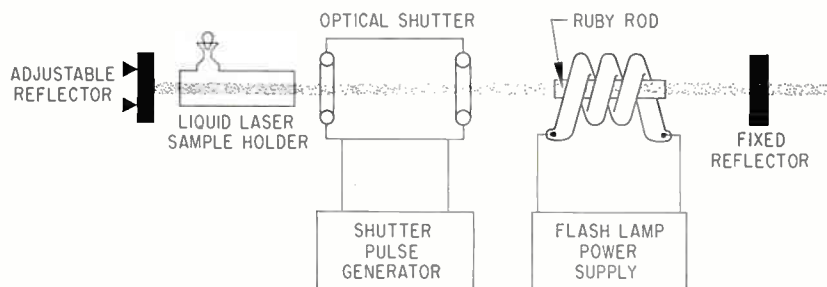

LIQUID LASER diagram shows physical arrangement of liquid sample holder, optical shutter, and ruby laser used for triggering the liquid lasing action

Maser Uses Superconducting Magnet

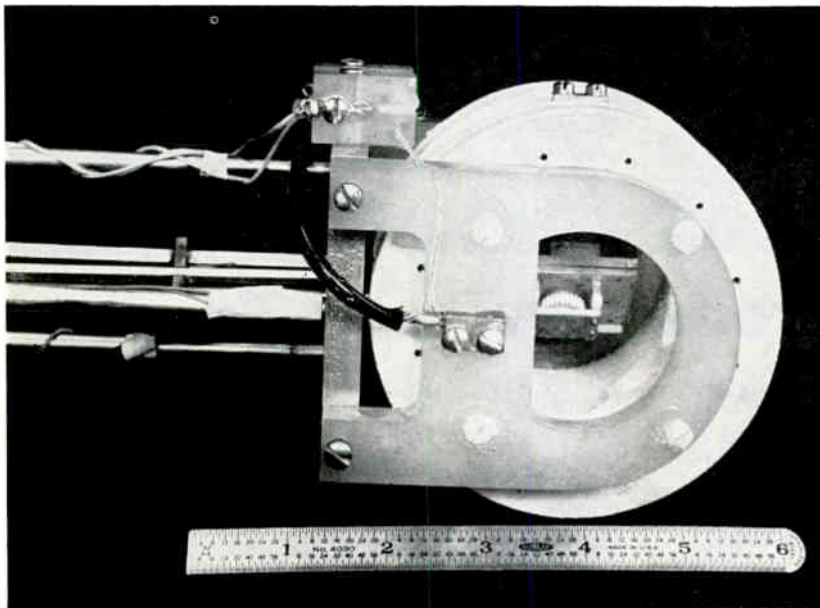

HIGH FIELD UNIFORMITY, important to maser gain and bandwidth, is provided by niobium-zirconium superconducting magnet's 8,000-gauss field with homogeneity of two parts in 10,000, with a $\frac{1}{2}$ -inch spherical volume. The five-pound magnet is part of a 96-Gc wave maser, having a pump frequency of 65 Gc, developed by Westinghouse. Gains of over ten db have been achieved at noise levels near two db by new low-frequency pumping technique, which incorporates five paramagnetic-spin energy levels to obtain inversion. The iron-doped titanium oxide (rutile) maser operates at 4.2 degrees K for low noise

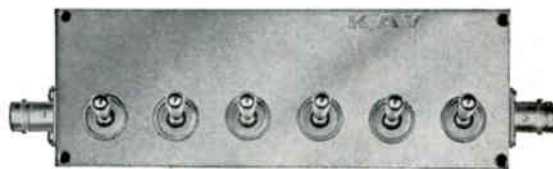

PRECISION, HIGH FREQUENCY ATTENUATORS

DC TO 500 MEGACYCLES

- 50, 70, or 90 ohm impedance
- High-Frequency, Precision Teflon & Silver Switches
- 1% Carbon Film Resistors
- Fully Shielded Units
- Up to 101 db
- Fixed 0 or 10 db insertion loss
- SWR: 1.2:1 max up to 250 mc
1.4:1 max 250 to 500 mc
- Min. Insertion*: 0.1 db at 250 mc; 0.2 db at 500 mc
- Accuracy: At full Attenuation: 0.5 db at 250 mc, 1.2 db from 250 to 500 mc
- Price: (Model 20) \$79. f.o.b. factory. \$87. f.a.s. N. Y.

*Zero insertion loss (Model 20-0) \$75. f.o.b. factory

REMOTE CONTROL
FOR ALL UNITS
(Electrically Operated)
Price: \$350.

NEW
DC TO 1000 MC
SWITCHED ATTENUATOR PADS

Model 10-10A
Frequency Range: DC to 1000 MC
VSWR: Less than 1.15:1
Insertion Loss: Less than 0.1 db
Accuracy: 0.25 db
Price: \$39.
Model 42-0 (Rotary): \$250.

Write for Catalog

KAY ELECTRIC COMPANY

DEPT. E-2 MAPLE AVENUE • PINE BROOK, MORRIS COUNTY, N. J. Capital 6-4000



**DEUTSCH
CONNECTORS**

**24 Hour
Delivery**

COAST-TO-COAST

- **DM Series** — push-pull, meets Mil-C-26482
- **DS Series** — push-pull, insertable, removable, crimp contacts
- **DTK Series** — bayonet lock, meets or exceeds applicable requirements of Mil-C-0026482A
- **DRS Series** — rectangular rack and panel, advanced application performance
- **DC Series** — push-pull, environmental, crimp-type RF connector
- **DM and DH Hermetics** — glass to metal seals, leak proof glass to metal seals
- **DR Series** — rigid insert connector with snap-in crimp contacts

DISTRIBUTED BY:

ARCO
electronics inc.

CONNECTOR DIVISION

COMMUNITY DRIVE, GREAT NECK, N. Y. • HUNTER 7-0500

TWX: GREAT NECK, NY 639

LOS ANGELES
ARCO CAPACITORS, INC.
1548 So. Robertson Blvd.
Los Angeles 35, Calif.
Crestview 1-1151
TWX: BV 7012

DALLAS
ARCO ELECTRONICS, INC.
1339 Crampton St.
Dallas 7, Texas
Melrose 1-0270
TWX: DL 526

RAMAN SCATTERING

This is a technique commonly used to identify and study different materials. It is based on the Raman spectrum of scattered light, produced when incoming photons not in resonance with a transition in the matter are deflected to a new angle and frequency, while the reflecting material undergoes a transition to a new state such that over-all energy is conserved. The scattered photons therefore appear only at or near frequencies shifted from the incoming photon frequency by amounts corresponding to the frequencies of Raman-active vibrations in the matter; these spectra serve to identify different materials. Even though the total Raman scattering cross-sections for a given line are very small (about 10^{-29} cm²) for a typical Raman active molecule, many materials exhibit a non-linear increase of the order of thousands or millions of the scattering cross-section when very high intensity light is scattered from matter in thermal equilibrium. This is because gain appears for the scattered light waves, just like the gain occurring in normal maser materials when the populations are inverted, and the scattered photons are amplified by inducing more scattering from the incoming beam

somewhat shifted from normal laser operation; this was apparently due mainly to stimulated Raman scattering from the nitrobenzene in the Kerr cell used in the switching apparatus. When a KDP Pockel's cell was substituted for the nitrobenzene Kerr cell, the spectrum observed was at least as narrow as that of the normal ruby laser output, and was centered at the same frequency. It is expected that a high-resolution study of the output from a KDP switched laser will show some deviation from the normal laser spectrum, reflecting cross-relaxation processes in the *R₁* line, which are apparently much faster than was at first supposed. The apparently high rate of cross-relaxation makes the existence of after-pulses, or subsidiary light pulses which often follow the main pulse, more difficult to understand because they are delayed by times orders of magnitude longer than the giant pulse duration, Hellwarth said. However, despite these and other unsolved problems in light pulse emission from ruby, the now known spectral purity of the pulses, exceeding 0.3 angstroms, enhances their usefulness in studying the stimulated Raman scattering.

QUANTUM EXPLANATION —

Stimulated Raman scattering can be easily explained on the basis of the quantum theory; given the mode and frequency of the oncoming pho-

tons, the average rate of change of the number of photons in the scattered state can be easily calculated. If the number of incident photons exceeds a certain amount, as happens in stimulated scattering, a net gain results and there is an effect very similar to laser action.

These experiments have already brought about new knowledge about the structure of liquid nitrobenzene; new energy levels previously unobserved have been found in the material because of their effect on the spectrum of the output light frequency. The technique is expected to bring about a better understanding of the molecular structure of organic materials.

The strongest laser emitters have been C₆H₆ and C₆D₆. On the other hand, two strongly Raman active liquids—carbon tetrachloride and sulphuric acid—have failed to produce laser action, as have water, acetone and o-dichlorobenzene. Photometric evidence for induced emission was found by the Hughes researchers in trichlorethylene, heptane and methyl alcohol.

Hughes scientists expect that a large number of liquids, and also solids, can be induced to lase by the stimulated Raman scattering technique. This opens up possibilities for laser applications.

NEW LASER WAVELENGTHS—

The large number of possible laser materials means that a very large

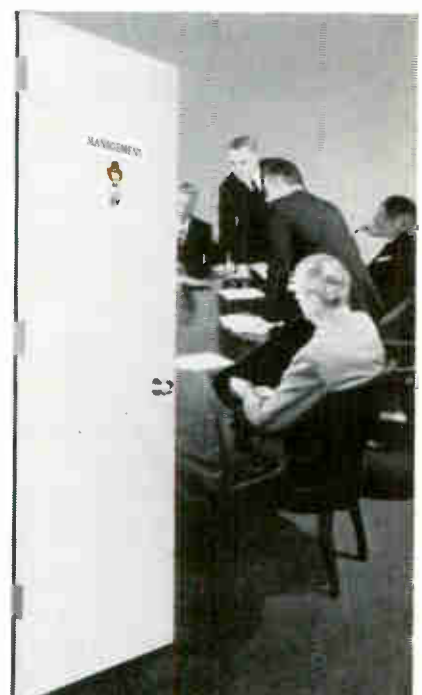
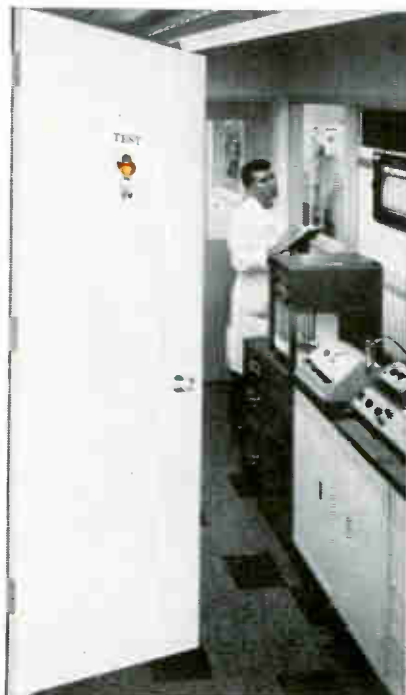
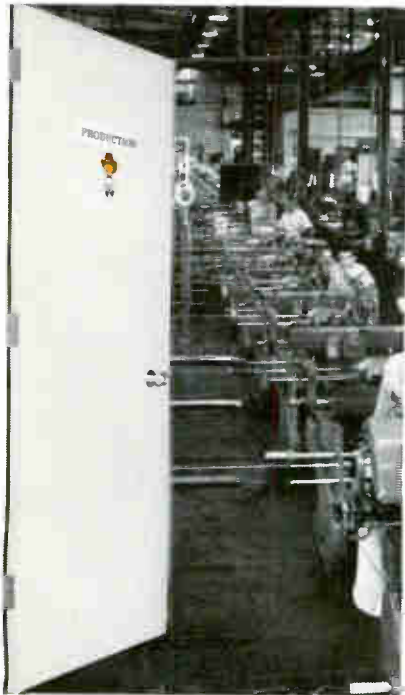
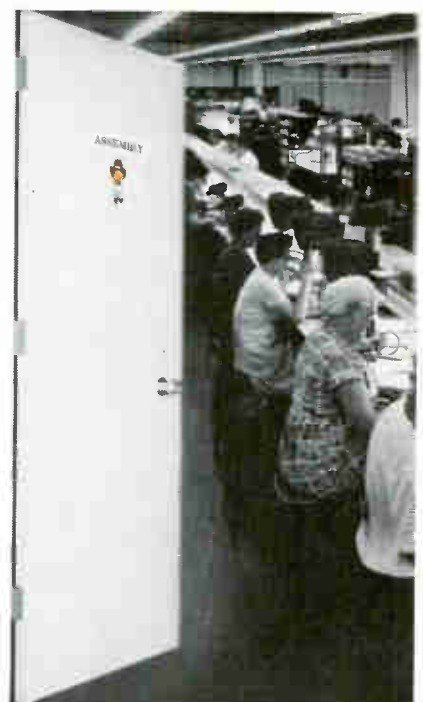
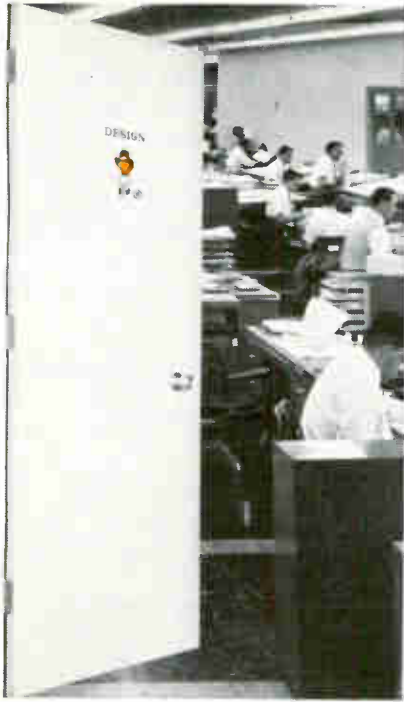

Where Is Our Quality Assurance Department?

Actually, product quality at Deutsch doesn't begin and end in our hard-working QA department...it is a function of everyone in the plant. First of all, management sees to it that quality is designed into each product...not just determined by final inspection. Then experienced personnel follow countless quality control procedures all the way from raw materials to finished parts inventory. And finally reliability engineers verify that quality is consistently reproduced to the toughest user specifications. This then is the basic

philosophy behind our almost unreasoning concentration on product reliability...from design to delivery. If you would like a full rundown on the plant-wide QA program that always means performance beyond specifications, contact your

local Deutschman today or write for Data File K-2. Deutsch Electronic Components Division, Municipal Airport, Banning, Calif.



DEUTSCH
Advance Specification Electronic Components

**Tom
Lunschen
can
show
you...**



Sales Engineer, Tech-Ser, Inc.

how to measure ac ratios to one part per million... at a sensible price

In fact, any of North Atlantic's field engineering representatives can quickly demonstrate how the Models RB-503 and -504 Ratio Boxes will meet all your requirements for high accuracy at lowest cost.

Designed for either bench or rack mounting, both models provide rated accuracy over their full ratio range, with six-digit, in-line window readout for best readability. Both incorporate heavy duty switches with transient suppression, fold-away legs, easily removeable end plates and voltage dividing transformers to MIL-T-27A. Abridged specifications are given below:

	RB-503	RB-504
Ratio Range	0.000000 to 1.111110	-0.111110 to +1.111110
Accuracy Of Ratio For All Ratios (at 400 cps)	$\pm \left[0.001 + \frac{0.0001}{(\text{Ratio})} \right] \%$	$\pm \left[0.0001 + \frac{0.000025}{(\text{Ratio})} \right] \%$
Frequency Range (Useful)	50 to 10,000 cps	50 to 10,000 cps
Nominal Input Impedance (at 400 cps)	50K-60K	> 250K
Max. Input Voltage	0.5f, Volts, (f in cps) (not to exceed 350 V.)	1.0f, Volts, (f in cps) (not to exceed 350 V.)
Max. Effective Series Resistance	3.5 ohms	8 ohms
Resolution	5 decades plus 1 turn potentiometer	5 decades plus 1 turn potentiometer
Size	13½" h. x 19" w. x 8" d.	3½" h. x 19" w. x 8" d.
Price	\$295.00	\$450.00

Also from North Atlantic: Model RB-510 for high precision at 10 kc and RB-520 for MIL Spec applications.

If you're up against critical jobs of ac ratio measurement — in the laboratory, on the production line, or in the field — it will pay you to talk to the North Atlantic man in your area. For his name, call or write today. Or request Bulletin RB 503-504 for complete data.



NORTH ATLANTIC industries, inc.
TERMINAL DRIVE, PLAINVIEW, L. I., NEW YORK • OVERbrook 1-8600

number of different discrete laser frequencies are possible; in communication applications this means a large number of non-interfering channels. A laser apparatus could be tuned to these different frequencies by simply inserting cells of the stimulated-Raman-scattering materials.

Electromechanical Timer For Lab Applications

By FRED W. KEAR
Lytle Corporation,
Albuquerque, N. M.

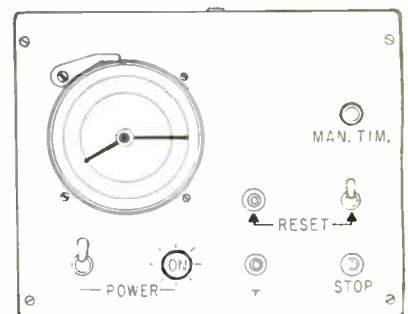

FRONT PANEL of timer installed in portable cabinet—Fig. 1

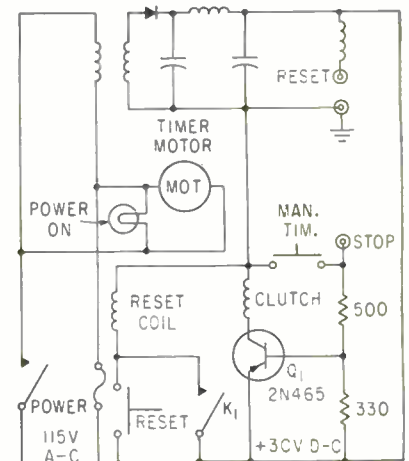

CIRCUIT DIAGRAM using transistor for timer triggering—Fig. 2

LABORATORY timing requirements can often be met more easily and cheaply with standard timing motors than with digital timers. Standard timers compare favorably in accuracy, reliability and simplicity, requiring only a minimum of maintenance of the mechanical and electromechanical portions.

The timer shown in Fig. 1 and 2

QUITE A SET!

Seven crystal filters altogether . . . one of them with 35 db of built-in notch . . . four of them packed into 1/3-cubic-inch cases.

There was something for everybody in the set of seven crystal filters Collins designed for an air defense missile's ground tracking system. □ Stand-out in the set was a 5 mc center frequency clutter filter which picks out a doppler-shifted radar signal and rejects signals from standing targets with unheard of accuracy. Frequency response curve of the filter shows an unusual pattern made up of two steep-skirted passbands separated by a 35 db rejection notch. Selectivity specs require the curve to pass through 12 precise frequency points at attenuation ranging from 2 to 50 db; passband ripple is held to ± 1 db. □ The clutter filter incorporates a number of design and manufacturing innovations, including Collins ability to hold frequency tolerances of the crystal discs within .001 per cent over a 0-65° C range. □ Other elements in the set were velocity filters and four of them, with similar characteristics, were paired off and packaged in cases of less than 1/3 cubic inch volume, about half the space normally required for this type filter. □ With prototypes developed and accepted, the filter sets went into initial production. To date, more than 300 sets (2100 filters) have been delivered and the preliminary phase of the missile development and testing program is well underway. □ With more than 100 components engineers, and separate engineering departments for crystal, mechanical and LC filters, Collins offers you the widest selection of standard designs and the broadest capability for special designs. Call Collins today or write for Data File 203. COLLINS RADIO COMPANY • Components Division • 19700 San Joaquin Road • Newport Beach, California • Phone: Kimberly 9-2911 • International Division, Dallas, Texas

See Collins display at the New York IEEE Show March 25-28.

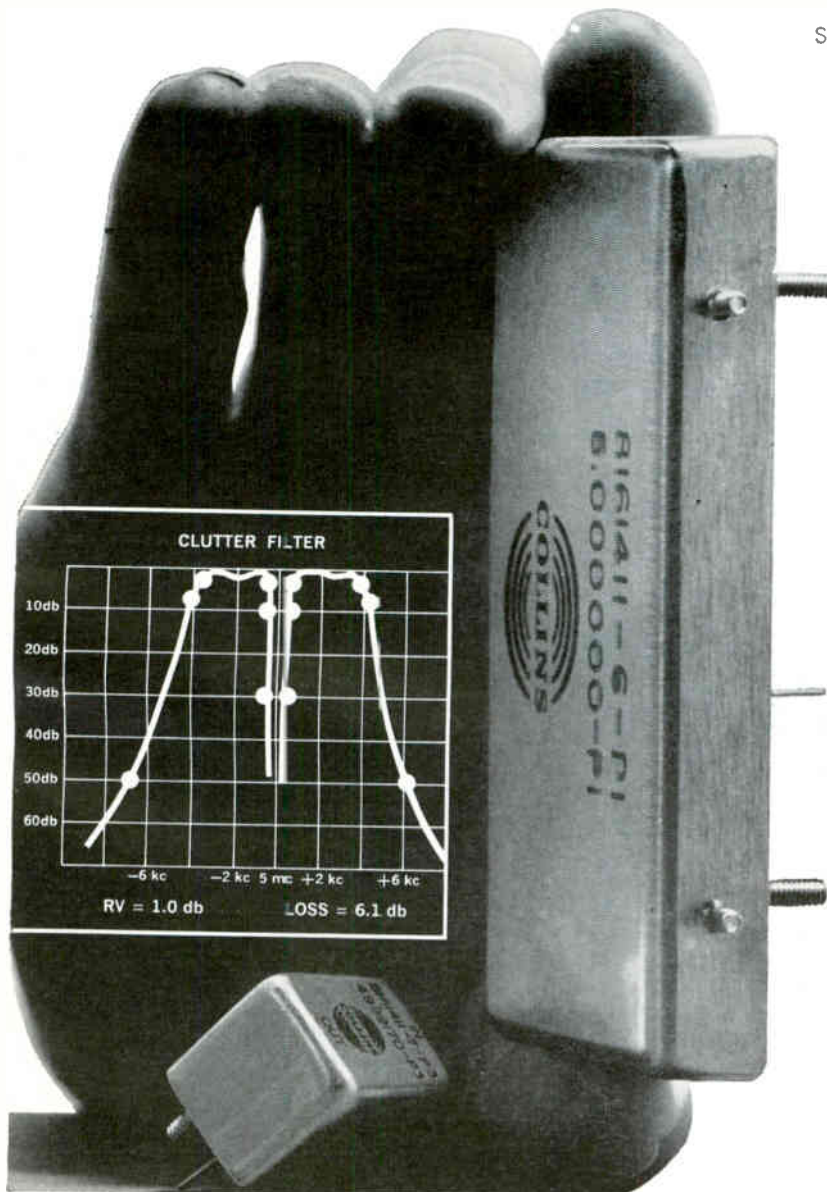

...up to 160
channels in a
5 $\frac{1}{4}$ " panel!

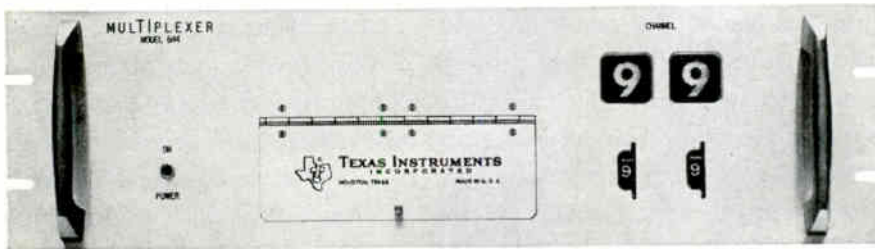
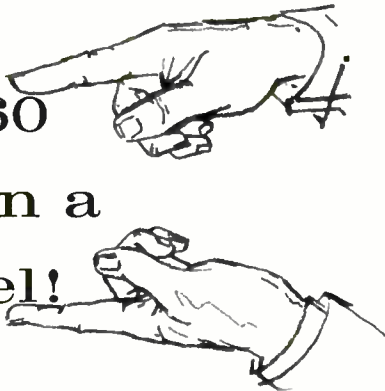

**versatile
addressable or sequential**
Multiplexers

- features**
- Sampling rate to 50,000 channels/sec
 - Variable frame length
 - Accuracy $\pm 0.02\%$ full scale
 - Input levels to ± 10 V

Texas Instruments Multiplexers are all solid state units providing accurate, high-speed bipolar operation with low dynamic crossfeed, fast settling time, and variable strobe. Manual channel select switches facilitate system set-up and check-out. Frame length is selectable from front panel. Expandable to 160 channels by means of plug-in printed circuit cards. Case size 5 $\frac{1}{4}$ by 19 by 18 inches for standard relay rack mounting.

TI's high speed
Model 834 Analog-Digital
Converter, ideal
companion instrument to
the TI Multiplexer.

High speed: 1.5 μ sec per bit
Built-in sample and hold

Accuracy: $\pm 0.05\%$ full scale
Automatic zero stabilization

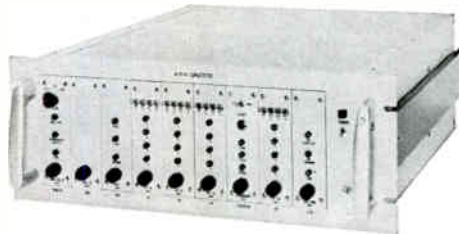

Ask a TI Application Engineer for further information on digital data handling equipment for your specific needs.

INDUSTRIAL PRODUCTS GROUP
STRIP CHART RECORDERS
TEST EQUIPMENT
DATA SYSTEMS
TRANSDUCERS



TEXAS INSTRUMENTS
INCORPORATED
3609 BUFFALO SPEEDWAY
P. O. BOX 66027 HOUSTON 6, TEXAS

558

is suitable for a large number of timing applications. Figure 1 shows the front panel of the timer mounted in a small portable cabinet. A panel-mounting timer mechanism is used. A ground jack is provided for reference voltage to operate transistor circuits in the instrument. A jack is provided to insert a start and stop signal; another to reset the timer from an external signal source. A manual timing push button causes the timer to run as long as it is depressed; a reset switch will reset the timer when in the down position; a power switch and a power "on" pilot light complete the controls. The timer may also be reset by a lever at the upper left corner of the timer mechanism.

TIMER CIRCUIT—Figure 2 illustrates the timer circuit. It operates from a 115-v a-c source; the timer motor runs directly from the power source, controlled by the power switch. A conventional 30-v d-c power supply operates the reset coil and timer clutch. A binding post terminal at the negative side of the power supply provides ground reference for control signals.

The reset coil may be energized through the reset pushbutton, when automatic timing is not required, or through the contacts of relay *K*, when a ground pulse is supplied to the reset test jack. Most timers need about one ampere of current for reset.

With the timer motor running, the clutch must be energized for the hands to move and timing to begin. Transistor *Q*₁ energizes the clutch; very little current is drawn by the coil, so *Q*₁ need not have high heat dissipation. In automatic timing, the start and stop signal reaches the base of *Q*₁ through the stop jack. Normally, *Q*₁ is back biased through 330 ohms; a negative signal at the stop jack is required to forward-bias *Q*₁. The manual timing push button provides a zero volt signal at the stop jack for manually starting the timer. The manual timing stops when the push button is released, allowing the transistor to become back-biased.

The fast switching time of the transistor enhances considerably the instrument's accuracy. Most

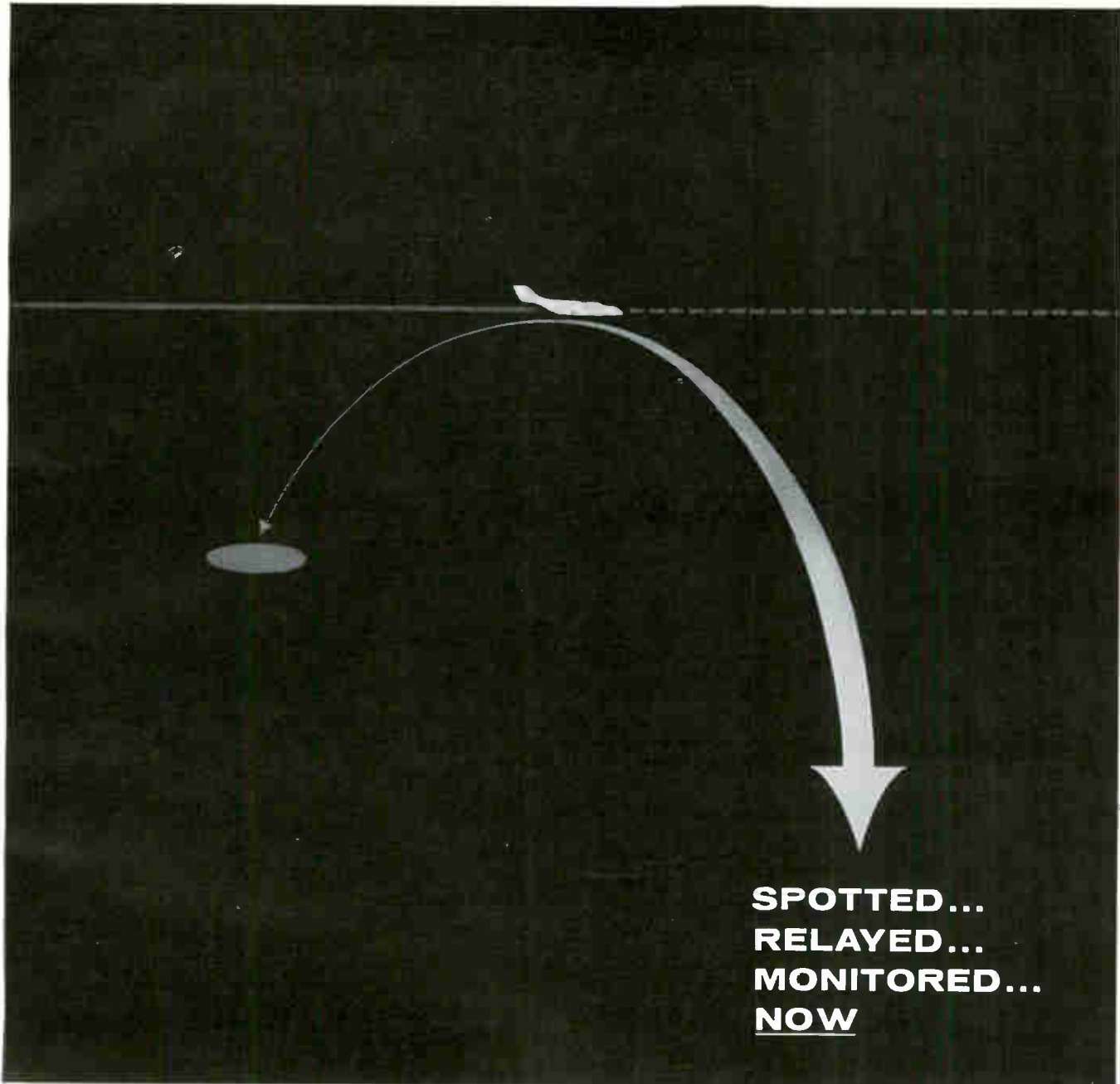

**SPOTTED...
RELAYED...
MONITORED...
NOW**

Fairchild Stratos now makes it possible for remote military commanders to watch enemy activities in "real time" as they are being observed by airborne sensors. How? Through hardware-proven wide-band data link which closes the critical time gap between picture-taking and interpretation. The Fairchild Stratos approach provides for transmission of large amounts of information from a variety of sensors to

distant ground stations. Auxiliary data, including precise geographic location is displayed in easily read alpha-numeric format. High-powered, wide-band data link is but one outgrowth of the years of experience that have made Fairchild Stratos the leading supplier of equipment for reconnaissance and surveillance needs. For more information, contact our Director of Customer Relations.

When there's a need to know: Fairchild Stratos-Electronic Systems Division capabilities are best reflected in an integrated approach to data requirements. Extensive experience in acquisition, processing, transmission and display has given FS-ESD engineers a particularly sensitive awareness of both final information needs and the many subsystems required to answer them. • For knowledgeable engineers interested in career opportunities in advanced data techniques, may we

suggest a note to our Director of Industrial Relations for the brochure "Grow Your Own Future". FS-ESD, an equal opportunity employer.

FAIRCHILD STRATOS
ELECTRONIC SYSTEMS DIVISION
WYANDANCH, LONG ISLAND, NEW YORK

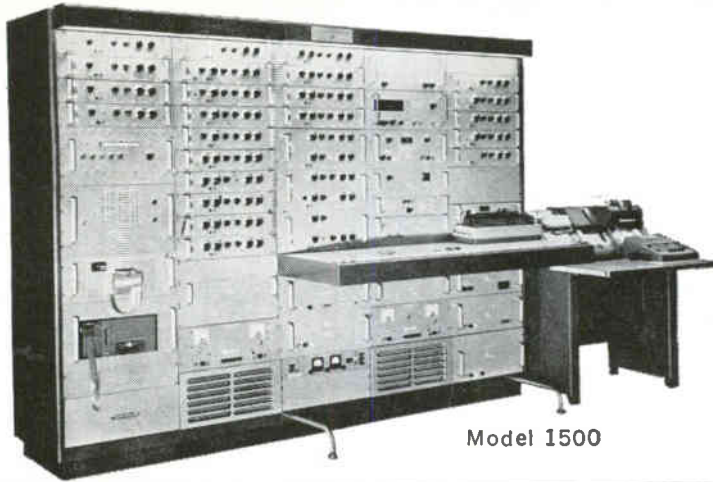

Model 1500



TEST MODULES

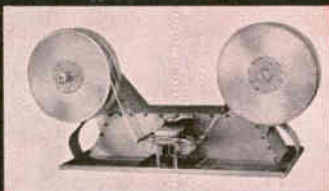

AXIAL LEAD HANDLER



TURRET ADVANCE



TAPE PROGRAM MODULE

IC80 20 v	IE80 5 v	IC60 10 v	IC200 1C ua	ICV80 10 ua	ICV60 600ua
172	496	401	0x1	548	275
257	115	031	513	383	252
238	305	020	247	621	287
305	197	067	643	548	167
232	154	042	632	664	207
185	107	023	586	466	291
205	126	050	386	457	160
607	218	071	383	479	124
178	145	050	623	654	303

LOGGED-DATA



Automatic semiconductor tester provides **MODULAR ANSWERS** to parameter testing problems

For incoming inspection . . . production testing . . . reliability testing . . . engineering studies . . . component sorting . . . the multi-parameter Model 1500 Testing Station has fast become recognized by leading transistor/diode producers and users as the most versatile and accurate instrument in its field.

Programming: Automatic and direct reading manual program modes are available. Punched Tape provides an unlimited number of sequential tests to be performed on any device. Self-Instruction permits new programs to be prepared directly from the precision dials and panel selector switches on the test modules. Test type, bias conditions, hi-lo limits and delays are all included in the program.

Measurements: All DC, small signal (grounded base and emitter), pulse, and diode tests are available. The TEST MODULE concept permits complete measurement flexibility. Over 30 standard test modules are available. Field installation of new modules is easily accomplished.

Ranges: Currents 0.1 nanoampere to 10 amperes
Voltages 1 millivolt to 1000 volts
AC or DC Ratios (gain transfer ratios) 0.1 to 1000.

Accuracies: 1% on DC tests; 3% on AC and Pulse tests.

Readouts: GO, NO-GO; digital indication; print-out; summary punch; classification and automatic bin selection.

Input Devices: Scanners; Axial Component Handlers; Conveyor Systems.

OPTIMIZED DEVICES INC.

PLEASANTVILLE, NEW YORK
R O g e r s 9 - 6 1 0 0

timer mechanisms read on their outer scale down to 1/100 second; in checks against digital timers it has been found that instruments of this type can be read to within 0.005 millisecond consistently. The inner scale of these timers is usually calibrated in seconds, up to sixty seconds.

Silicon Junction Is Laser Detector

LONDON—A silicon *p-n* junction developed by the Government Signals Research and Development Establishment is operating as a square law detector mixing light from adjacent axial standing-wave modes of a ruby laser.

Light from the laser is focused onto the junction which is reverse biased at 108 volts. Output from the diode located in the center conductor of the coaxial line is at 1,635 Mc, corresponding to the difference between neighboring axial modes of the two-inch ruby rod. Output at the higher harmonic, 3,270 Mc, of the next nearest adjacent modes is also detected.

Detection mechanism is through the generation of electron-holes at a rate proportional to the incident radiation intensity. Carriers generated in the depletion layer are swept out by the high field in a short time compared with the laser beat-frequency period.

Advantage of the system is that its high-frequency performance is limited by the carrier transit time instead of by the minority carrier lifetime as in other mixers.

Hungarian Instruments Measure Plasma Changes

VIENNA—Instruments for plasma research and spectroscopy were developed by Prof. Bartocz at Precision-Optics Instruments of the Hungarian Academy of Sciences. Hungaropress, a state news agency, says the instruments will be brought to the U.S. later this year by their designer on a lecture tour.

The new instruments permit registration of changes occurring in plasma as a result of temperature

SEE US AT BOOTH 3036 AT N. Y.—IEEE

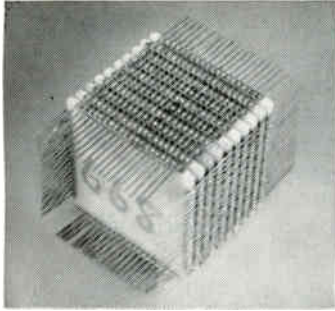

Micro assemblies of 0.030-inch thick alumina wafers with riser wire interconnections welded by a new Hamilton Standard electron beam technique.

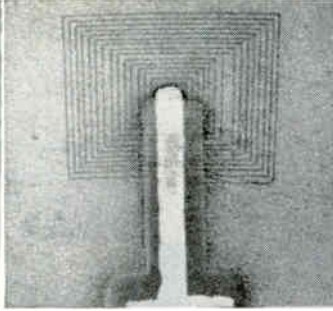

Thin film inductor, consisting of titanium film on an aluminum oxide wafer, scribed by high-power density Hamilton-Zeiss cutting equipment.

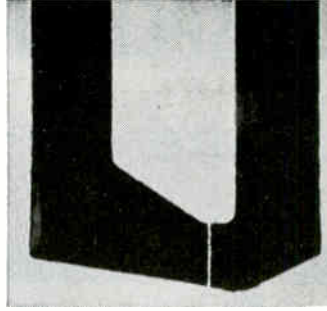

Ferrite memory core, 0.005-inch thick, with slots cut by electron beam. Slot widths: 0.0005- to 0.001-inch.



Grid screen of .003" diameter holes on .010" centers drilled in .020" stainless steel sheet.

NOW — THE FIRST COMPLETE MICROMINIATURE PRODUCTION TOOL

The new Hamilton-Zeiss Electron Beam CW-1 Cuts, Welds, Drills, Scribes

The new Model CW-1 Electron Beam Cutter-Welder is the most advanced machine yet developed for work in microminiaturization. With CW-1 equipment, you can fabricate complete microminiature assemblies, cut, scribe and drill thin film and solid state components. You can also weld necessary leads without distorting the workpiece. And the vacuum chamber provides a contamination-free environment with a bonus in "free" vacuum for hermetic encapsulation operations. Almost all metallic elements and many nonmetallics including aluminum oxide, quartz, and ceramics, can be processed by the CW-1.

The new CW-1 can cut and drill shapes of practically unlimited geometries for fabrication of micro-storage devices. All materials that are chemically and metallurgically compatible may be welded without distortion or contamination, and heat-affected zone is for all practical purposes eliminated. For the first time, you can fabricate thin film resistors and capacitors to extreme accuracies by "in-process" monitoring and corrective feed-back, thus eliminating high reject rates and selective assembly techniques.

Heart of the CW-1 is a highly developed electron gun and electron optical system providing a focused spot diameter of .0005" or less. The system operates at a maximum accelerating voltage of 150 KV and provides currents to 15 Ma during pulsed operation

providing nearly 10,000 megawatts per square inch at the workpiece. Such extremely high power densities permit the cutting of any material known today.

UNIQUE FEATURES OF THE MODEL CW-1

- A *Zoom Type Binocular Optical Viewing System* (14X to 40X) provides stereo-effect microscopic examination of the workpiece at all times permitting precise positioning and eliminating the need for removal of the workpiece for inspection. Fabrication and inspection can be combined in one operation.
- A *Precision Beam Deflection System* permits programming of the beam (workpiece stationary) over the workpiece in any pre-selected pattern using electronic programming* and simple external control knob adjustments.
- A *Precision Work Table* with all backlash eliminated provides positioning accuracies of .001" or better.
- *Polished Stainless Steel* is utilized on the inside of the work chamber and on all apparatus exposed to the work chamber, thus providing an extremely clean workpiece environment free from corrosion, outgassing and extraneous contamination.
- *Tape Controlled Programming.** Operation of the CW-1 can be fully automated. Beam deflection and table position can be programmed on tape using conventional industrial numerical controls.

*With optional equipment at extra cost.



For complete information on the Model CW-1, contact: Sales Manager, Electron Beam Machines, Hamilton Standard, Windsor Locks, Conn.

Hamilton Standard DIVISION OF UNITED AIRCRAFT CORPORATION



BRISTOL HIGH-SPEED RELAYS

■ fast ■ accurate ■ reliable



Bristol Syncroverter* high-speed relays are used in the finest and most accurate multiplex systems and analog computers.

Their fast, accurate, uniformly consistent transfer characteristics help cut system errors and build system reliability.

Nearly 100 different models available to meet the stringent demands of diverse applications. Write for detailed specifications.

The Bristol Company, Aircraft Equipment Division, 152 Bristol Road, Waterbury 20, Conn.

A Subsidiary of American Chain & Cable Company, Inc. 1-20

ACCO



*T.M. Reg. U.S. Pat. Off.

BRISTOL ... engineers for precision, builds for reliability

variations. Plasma is created by electric discharges or sparks. Material placed in the path of the discharge or spark undergoes enormous temperature changes; attempts to photograph changes occurring in their spectrum as a result of this had so far been unsuccessful.

TIME RESOLUTION—Prof. Bartocz succeeded in resolving the time phase of the spark into appropriate minute proportions, using electronic control which ensures synchronized operation. The operator can register on a single picture all the spectra, which illustrate, step by step one underneath the other, the phenomena occurring in the material during a single scintillation cycle under vast temperature differences.

These instruments allow taking of photographs at intervals of a tenth of a millionth of a second, thus showing changes happening during the brief life of a spark, including the plasma state.

Lasers May Check Out Speed of Light

WASHINGTON—Lasers can be used for long-distance light measurements, it was established by metrologists at the National Bureau of Standards. Laser techniques will probably be used for calibration of highly accurate surveying tapes, and later as possible replacement for such tapes. Also foreseen is a more accurate measurement of the speed of light, which depends on highly accurate measurements of distance.

Scientists at NBS have achieved length-measuring interference fringes over a 100-meter optical path, using a helium-neon continuous gas laser, pumped by a r-f generator, and splitting the light beam with a Koester prism. Earlier distance measurements, using the recently adopted international standard of length—the krypton 86 wavelength—were limited by the krypton beam to an optical path of about $\frac{1}{4}$ meter.

Laser distance measurements, NBS reports, will be possible over long distances with an accuracy better than one part in 200 million.

Eisler

A NAME TO REMEMBER IN MACHINERY FOR ELECTRONICS

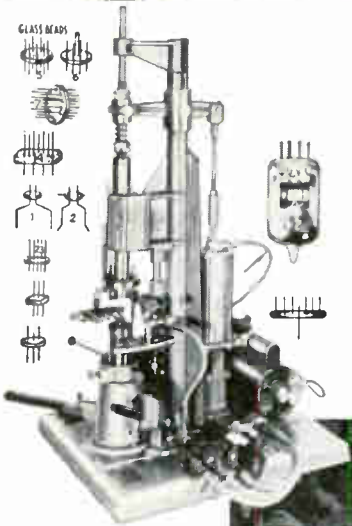
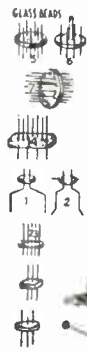

At left: No. 105-BST1 Single position Button Stem and Wafer making machine—Fully automatic. Designed for small production runs on special tube parts or for laboratory use. Produces button stems up to 1 1/4" diameter. Machine can be supplied with up to 24 positions.

Illustrated below: An Eisler precision Vertical Spot Welder designed exclusively for welding of electronic components. Available in sizes from 1/2 to 7 1/2 KVA.



Write us today for full particulars!

EISLER ENGINEERING CO., INC.

Charles Eisler Jr., President

751 So. 13th St., Newark 3, N.J.

CIRCLE 206 ON READER SERVICE CARD



Around the world it's **KEW**



MODEL F-98

MODEL EW-16

MODEL P-22

MODEL VR-2P

MODEL VO-38

MODEL TK-20A

MODEL FL-202

MODEL PV-200

MODEL TR-A

SWR & RF WATTMETER

KYORITSU ELECTRICAL INST. WORKS, LTD.

No. 120, Nakane-cho, Meguro-ku, Tokyo, Japan

Cable Address: "KYORITSUKEIKI TOKYO"

Tel: (717) 0131 ~ 5 • 0151 ~ 3

CIRCLE 207 ON READER SERVICE CARD
February 15, 1963

Microcircuit of the Month

Over the past year a considerable number of circuits have been designed and custom fabricated to reduce large portions of existing electronics systems into compatible microcircuit form with the inherent advantages of direct replacement, reduction in size and weight, with improved reliability and maintenance.

BLOCKING OSCILLATOR

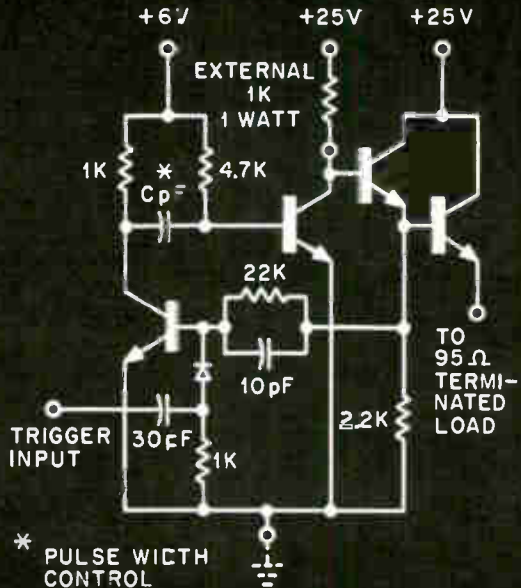

* PULSE WIDTH CONTROL

OUTPUT PULSE CHARACTERISTICS

RISE TIME: 30 nsec (typ cal)
FALL TIME: 40 nsec (typical)
DUTY CYCLE: 10%
TEMP. RANGE: -55°C to +125°C.

This circuit designed to replace transformer type Blocking Oscillators; reduces such undesirable effects as overshoot, ringing, and pulse droop. The pulse width is easily changed in manufacture and various versions can be readily supplied. It is well suited for coaxial cable driving, resetting of large registers and system clock generators.

If you are considering the use of microcircuits for redesign of present systems—or for future designs, we at General Instrument respectfully request the opportunity to assist you. Call 516-OV 1-8000 or write Nanocircuits, General Instrument Semiconductor Division, 600 West John Street, Hicksville, Long Island, New York.

GENERAL INSTRUMENT SEMICONDUCTOR DIVISION
General Instrument Corporation

CIRCLE 85 ON READER SERVICE CARD 85

Will Tunnel Cathode Bring New Tubes?

Emission principle holds promise for new family of improved vacuum tubes

NEW TYPE of vacuum tube which has no heater to light up, and could operate at room temperature, is under study at General Electric.

Involving use of what is called a tunnel cathode, such a tube would be likely to have higher tolerance to ionizing radiation than would thin film or other microminiature active devices based on semiconducting materials. Thus the tunnel cathode holds high significance in improving the reliability of space electronics.

New tube concept will be investigated under a proposal supported in part by the National Aeronautics and Space Administration by a contract granted to GE through the Harry Diamond Laboratories, Department of Defense, Washington, D. C.

TUNNELING—Conventional vacuum tubes employ a metal cathode which must be heated before electrons will flow through the vacuum under the influence of a different potential. Tunneling emission is basically a phenomena wherein electrons flow from a cool substrate metal layer through an insulator which may be only a few tens of atoms thick to a thin counter

electrode which is maintained at a few volts positive potential with respect to the substrate.

If this second layer is electronically thin enough, some of the tunneling electrons will pass through and away from it, having not lost energy by collisions with other electrons. Such electrons are emitted, and thus the device becomes a cathode.

This type of tube could give designers new freedom in tube construction. Tunnel cathode could yield smaller tubes, with lower capacitances. Absence of heater temperature may permit unusual electrode arrangements to yield new and different characteristics.

Such improvements in turn could give electronic circuit and equipment designers a new set of tools—amplifiers that are cooler, more reliable, and more tolerant to severe environments.

Tunnel cathode can feature high tunneling current density, said C. E. Horton, advanced development consulting engineer in charge of the project. He pointed out that tunnel diodes usually operate at 1,000 amperes per sq cm and frequently ten times this level.

In applying tunneling to vacuum tubes, it is hoped that emission current densities can reach from 10 to 100 amperes per sq cm. So far, the fraction of tunneling that has appeared as emission into the vacuum has been only about 2 percent. But he added that 10 percent or better is not an unreasonable figure to hope for, and that higher ratios cannot be called impossible.

MATERIALS—Of prime importance in the present tube study will be attaining information about suitable materials for the insulating layers and the substrates. Schedule initially calls for the optimizing of tunnel cathodes using anodized aluminum insulating layers. This will include refinement of related metal film techniques, test

Monitor Controls Thin Films



RESISTOR and capacitor values for thin-film circuits are continuously monitored by specially-designed deposition programmer, designed and built by General Electric's new Light Military Electronics Department, Utica, N. Y. Deposition stops automatically when desired component value has been reached. Monitor also controls thickness of dielectric material by measuring frequency of an oscillating quartz crystal exposed to silicon-monoxide vapor. Nickel-chromium is used for resistors, aluminum and silicon monoxide is used for capacitors, and evaporated aluminum or copper form conductor paths

CAPACITORS OF MYLAR®

THE PRICE RANGE

AS PAPER

BUT WITH EXTRA RELIABILITY

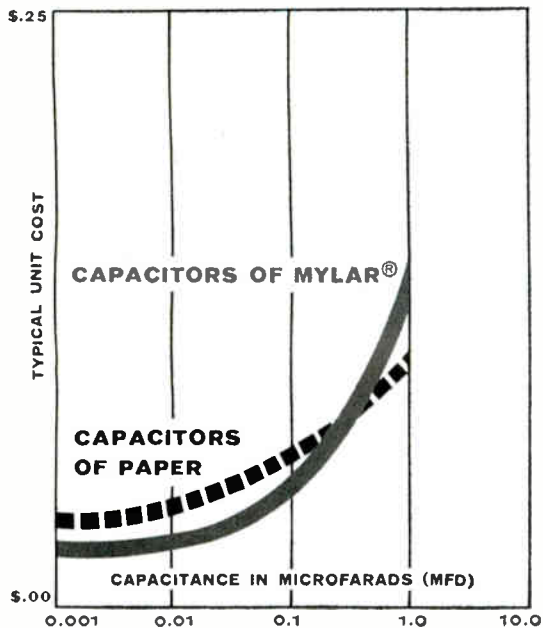

You may not realize it, but you can benefit from the higher dielectric strength, moisture resistance and reduced size of capacitors of "Mylar"® polyester film without paying a premium price. An industry study of manufacturer prices shows THAT OVER A RANGE OF SIMILAR CAPACITANCES AND RATINGS, UNITS OF "MYLAR" COMPARE CLOSELY IN COST WITH THOSE OF PAPER.

According to a recent survey, few engineers are aware of this close price comparison... although they recognize the outstanding properties of "Mylar". Look into it yourself. Before specifying capacitors for your design, get this free booklet study with performance facts and price charts. Write: Du Pont Co., Film Dept., Wilmington 98, Delaware.

*Du Pont's registered trademark for its polyester film.



REG. U.S. PAT. OFF.

BETTER THINGS FOR BETTER LIVING ... THROUGH CHEMISTRY



WE'RE THE ONLY ONES WHO POT MODULES IN *TIMONIUM*

EMC

**ELECTRONIC
MODULES
CORPORATION**

1949 GREENSPRING DRIVE • TIMONIUM, MD.
Clearbrook 2-2900

DIGITAL LOGIC MODULES • DIGITAL
EQUIPMENT AND CUSTOM PACKAGING

methods, and handling procedures. A broad evaluation of a variety of materials will be made to find those most suitable for practical emitters.

Other materials under construction include tantalum, titanium, zirconium, and niobium, because all have been successfully anodized to produce suitable insulating layers. Oxide film experimentation will also encompass several other materials.

Compatibility of materials, effects of film structure, and substrate materials all will be considered before a concentrated effort is made to refine the specific materials and configurations that appear most promising as tunnel cathodes.

Irradiation Forms Heat-Shrinkable Sleeve

FIBERGLASS fabric, sandwiched between two layers of modified polyolefins, is subjected to high-voltage electron bombardment. Irradiation process, developed by Raychem, results in a molecular cross-linking that has been described as comparable to tying tough elastic bands between the fibers of a rope. The elastic bands stretch at a given temperature, allowing the fibers to be stretched or twisted.

When the material is cooled, the structure will "freeze" in this position. When the material is reheated, the "elastic bands" immediately snap back into their original or remembered position. Because the cross-linking is accomplished by a high-voltage electron bombardment, there is no residual radioactivity in the end product.

Irradiation technique is used in the manufacture of harnesses and cables, and for encapsulating components and subsystems. A line of heat-shrinkable tubings will be marketed by Bentley-Harris Manufacturing Co., a subsidiary of Raychem.

The use of the sleeving is as simple as slipping it over the component to be encased, and applying 275 F heat until shrinking has been completed. Time varies from three seconds to a maximum of one minute for sleeving of two-inch ir-

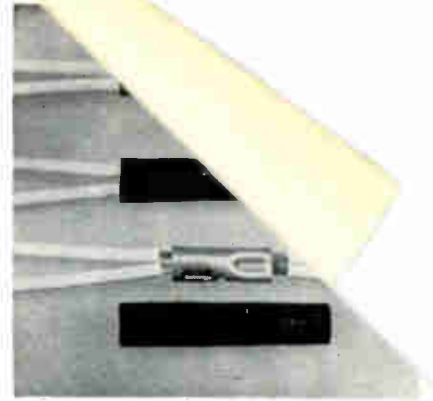

IRRADIATED sleeving slips over cable and connector. Sleeving shrinks under exposure to heat, offering a snug fit of fiberglass-reinforced insulation

radiated diameter. Sleeving size selection is not critical. Sleeving is presently being manufactured in sizes ranging from $\frac{1}{8}$ in. to 2 inches.

Sleeving may be used at temperatures up to 130 C continuously. It also withstands corrosive and difficult chemical environments. Minimum individual short time dielectric breakdown value of 12 Kv has been established with typical averages values found at 22 Kv. Low temperature flexibility extends to below -80 C. Low loss values recommend investigation for electronic circuits.

W. H. Bentley, president of Bentley-Harris, says that Fiberfit will command a slightly higher cost to the manufacturer than most presently impregnated fabric sleeveings, and more than most heat-shrinkable single film sleeveings, except those that employ fluorocarbon compounds.

Exploring Phenomena Basic to Materials

MATERIALS scientists working in three areas: metallurgy, ceramics and plastics, compared notes last week and found that their fundamental understanding of materials was the same, even though their terminology was different.

Purpose of the meeting, according to L. J. Bonis, president of Ilikon Corp., of Natick, Mass., sponsor to the symposium, "was not just to familiarize scientists with



**New Sylvania NAND gate micro-circuit...
faster because it's epitaxial planar**

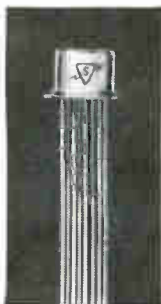

Less than 10-nanosecond propagation delay is typical of the single-chip micro-circuit shown above. An achievement of Sylvania's advanced epitaxial and photolithography techniques, the silicon chip is only .025" square, or no bigger than a typical transistor chip! This means your design can have both: the performance benefits resulting from Sylvania's pre-eminence in epitaxial techniques, plus the reliability and miniaturization of planar integrated circuitry.

The epitaxial planar NAND gate consists of a 3-input AND gate followed by an inverting stage. With a fan-out

of 5 over a temperature range of -55°C to $+125^{\circ}\text{C}$, it effectively replaces 4 diodes, a transistor and a resistor. The package is a modified TO-5, but other configurations are available.

A true "building block" circuit, the Sylvania NAND gate has variations, capabilities and applications too numerous to list here. And this is only the first of a series of circuits. Let us know what you want to accomplish with integrated circuitry. Write directly to Semiconductor Division, Sylvania Electric Products Inc., 1100 Main Street, Buffalo 9, New York.

SYLVANIA

SUBSIDIARY OF

GENERAL TELEPHONE & ELECTRONICS



Hyperion STANDARD

POWER SUPPLIES

Years of "custom engineered" experience, in designing and manufacturing power supplies to MIL Specs, are incorporated into Hyperion's line of Standard Power Supplies. This includes such features as: constant current or constant voltage regulation, adjustable current limiting, parallel or series operation, remote programming, remote voltage sensing, short circuit proof and isolated output.



W1 Series

Input: 105-125 VAC, 50-440 cps.
Regulation: 0.05% or 5 MV
Response Time: 50 μ sec.
Temp: continuous full load at 50° C.
Size: 4 $\frac{3}{4}$ " x 8 $\frac{1}{2}$ " x 6 $\frac{1}{2}$ "

Z1 Series

Input: 105-125 VAC, 60 cps.
Regulation: 0.05% or 5 MV
Response Time: 50 μ sec.
Temp: continuous full load at 50° C.
Size: 6 $\frac{5}{8}$ " x 8 $\frac{1}{2}$ " x 10 $\frac{7}{8}$ "



Model	Voltage Range	Current	Ripple RMS	Price*
HY-W1-16-1.0	0-16 VDC	1 amp	1 MV	\$139.00
HY-W1-30-0.6	0-30 VDC	0.6 amp	1 MV	\$129.00
HY-W1-60-0.3	0-60 VDC	0.3 amp	1 MV	\$149.00
HY-Z1-16-1.5	0-16 VDC	0-1.5 amps	1 MV	\$179.00
HY-Z1-16-4.5	0-16 VDC	0-4.5 amps	1 MV	\$219.00
HY-Z1-16-7.5	0-16 VDC	0-7.5 amps	2 MV	\$279.00
HY-Z1-32-1.0	0-32 VDC	0-1 amp	1 MV	\$189.00
HY-Z1-32-2.5	0-32 VDC	0-2.5 amps	1 MV	\$229.00
HY-Z1-32-5.0	0-32 VDC	0-5 amps	2 MV	\$289.00
HY-Z1-60-0.5	0-60 VDC	0-0.5 amp	1 MV	\$199.00
HY-Z1-60-1.0	0-60 VDC	0-1 amp	1 MV	\$239.00
HY-Z1-60-2.0	0-60 VDC	0-2 amps	2 MV	\$299.00

*Prices are F.O.B. Watertown, Massachusetts

Write or call Hyperion for your Standard or Custom MIL Spec Power Supply requirements.

Hyperion INDUSTRIES, INC.

• POWER EQUIPMENT DIVISION

127 COOLIDGE HILL ROAD, WATERTOWN, MASSACHUSETTS
TWXN: WTWN MASS 860 TEL: WA 6-0140

one another's fields, but to gain information from one field that is applicable to another."

At the conference two phenomena, basic to the materials sciences were discussed. These were sintering—the formation of a solid from powders, and plastic deformation—the changes in shape that solids undergo. F. V. Lenel, of Rensselaer Polytechnic Institute, discussed the basics of sintering from the metallurgists point of view, while R. Coble of MIT discussed the same subject from standpoint of the ceramicist. Then J. F. Lontz of DuPont spoke on forming polymers, the complex molecular chains that make up plastics.

STRUCTURE—The common denominator was found to be that each was concerned with the same problems, such as atomic structure and surface effects. Although the materials were different in their applications, the polymer chemist, metallurgist and ceramicist agreed they were using the same tools to understand the behavior of materials.

The second session on plastic deformation included discussions by Rensselaer's G. S. Ansell on metals, Brown University's J. Gilman on ceramics, and Rensselaer's S. S. Sternstein on polymers. Speakers demonstrated that materials can change shape only within the framework of their atomic arrangements. Through the understanding of atomic structures, it is possible to predict how materials deform under stress.

Sternstein pointed out that workers in diverse fields were already wiping out many of the linguistic and semantic differences among the various sciences. "Because of the complexity of materials applications, at one time or another a chemist is bound to deal with many types of materials. He must, therefore, know what characteristics these have in common so as to create successful combinations," Sternstein said.

Widespread feeling among scientists that a broader exchange of information among various disciplines is desirable and necessary for increased development in basic sciences created wide interest in this interdisciplinary materials meeting. A similar meeting was

planned for next year to delve deeper into materials phenomena.

Panel guests included such well known scientists as N. J. Grant of MIT, H. H. Hausner of Brooklyn Polytechnic Institute, and R. Davis of the Arthur D. Little Company.

Over 150 scientists participated in the symposium, a nonprofit effort sponsored by Ilikon Corp., advanced research and development company.

Shields Devices From Nuclear Effects

CERAMIC that provides a wide spectrum of radiation shielding is claimed to afford excellent gamma and neutron shielding properties, as well as x-ray and nuclear particle shielding.

Manufactured as a dry solid in granular or powdered form, material can be molded or formed in thermal or cold-setting materials.

Utilizing short half-life materials (the degree to which materials remain radioactive), the Polyshield ceramic permits construction of reactor shields and high-energy particle shields incapable of being permanently radioactive. This is said to be a major technological achievement in atomic energy protection.

Test data and technical information on Polyshield are available from American Brands Corporation, Los Angeles.

New Photoresist Coat Extends Applications

ORGANIC materials that harden upon exposure to light to form an acid-resistant coating that controls plating or etching is claimed to work faster than compounds previously available, according to Eastman Kodak spokesmen. The new Kodak Ortho Resist, KOR, is said to be 8 to 16 times faster than regular Kodak photoresist for arc-light exposures, and 20 to 40 times faster for tungsten illumination.

One application of the new resist material might be in the assembly-line manufacture of printed circuits, according to Kodak's D. R. Spear. The resist-coated circuit board could be moved along the line

and exposed to light projected through the circuit negative. In some cases a slide projector provides enough light for contact printing small areas. Previously, the negative had to be brought into contact with the coated board and exposed to arc lights.

High viscosity and solids content of the new resist permits its use full strength or diluted for various coating thicknesses.

Use of resists is rapidly increasing in the manufacture of miniature electronic components used in satellites and computers, as well as in commercial radio and television equipment.

Since the new photoresist is sensitive to tungsten light, it can be exposed through glass lens systems. This makes possible many resist applications previously considered impractical.

How to Apply Pellet Resistors

By CLINTON W. HARTMAN
CTS of Berne, Inc.
Elkhart, Indiana

RESISTORS in pellet form can be produced in any size and shape, although attempts have been made to standardize. Main area of interest for these units are in miniaturized circuits. Hard pellet resistors are stable at temperatures up to 500 C. Pellets are not affected by moisture exposure or other environmental conditions normally encountered in resistor military specifications.

Although military specifications have not been issued to cover resistor pellets, such as the CTS Ceradot, these units are presently being tested to MIL-R-10509D, characteristic B for type RN60, modified to reflect the smaller mass (0.375 in. long by 0.125 in. diam) of this resistor.

Ends of the pellet can be terminated in a number of ways, depending on the subsequent termination into the circuit by the user. Fired on platinum-gold, with or without tinning, can be provided when soldering to the pellet. Eutectic tin-lead solder with 3 percent silver added can be used for low-temperature applications. Fired-on gold is used when termination by conduc-

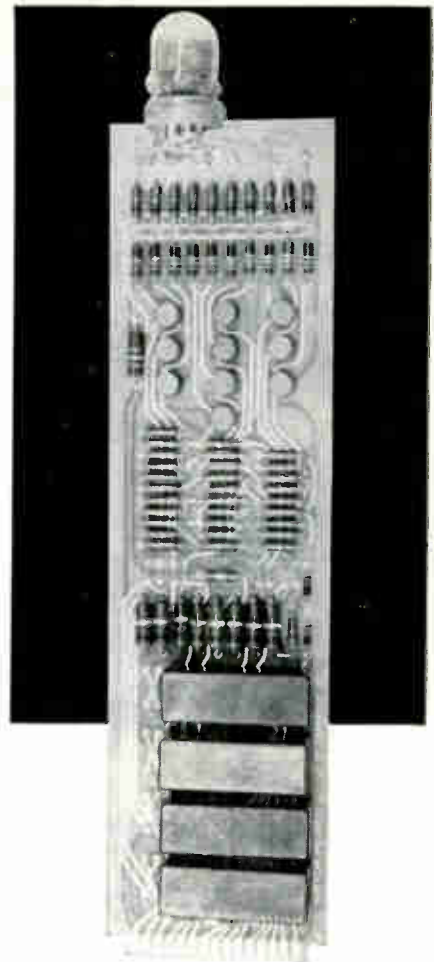

TYPE

DC-1 Module SOLID STATE 4 BIT CONVERTER

Only the Hyperion DC-1 Module provides storage and decimal display and can be used as a:

1. 4-bit parallel to decimal display converter*
2. Variable Radix counting unit (1 through 9)*
3. 4-bit serial shift register*

Changing from one mode of operation to another is accomplished by simply changing the input jumper connections.

Rack (3½" Panel Height) mounted assemblies are available with power supply for housing up to 9 DC-1 Modules. DC-1 Module can be provided for activating filamentary type readout.

Write for Technical Bulletin 550.

*Units can be cascaded to increase digital function.

Hyperion

INDUSTRIES, INC.

• DIGITAL PRODUCTS DIVISION

127 COOLIDGE HILL ROAD, WATERTOWN, MASSACHUSETTS
TWX: WTNW MASS 860 TEL: WA 6-0140

at Western Electric *Allentown Works*



bonding is easier

This operator uses a B&L StereoZoom® Microscope to bond germanium wafers smaller than a pinhead to the transistor header. Big, vivid 3-D views speed her work and keep it within critical tolerances.

inspection is surer

Every completed transistor header assembly must be checked prior to encapsulation. Here the unique zoom feature lets the operator dial any needed magnification, from 3.5X to 120X. No flaw gets by her eye.



with StereoZoom Microscopes

Never before has any microscope, at any price, provided so many advantages: instant selection of any magnification within the full range—all-day viewing without eye fatigue—up to 7" of unobstructed working distance—sharp views and flat fields in natural 3-D—and, of course, Bausch & Lomb dependable quality and lifetime service. Mail the coupon today—find out how StereoZoom Microscopes can help you.

BAUSCH & LOMB



**BAUSCH & LOMB
INCORPORATED**
61438 Bausch Street
Rochester 2, N. Y.

- Schedule a demonstration at my convenience.
 Send StereoZoom Catalog D-15

Name

Company

Address

City Zone State

tive epoxy is to be made. Some users are thermal-compression-bonding leads to the pellets. Fired on platinum is found best for this application.

For special conditions, flat or round nickel leads, plain or gold plated, can be attached to the Ceradot. Leads are attached with low-temperature or high-temperature solder, or with conductive epoxy. This results in a resistor which is smaller than those now on the market, but with properties comparable, and in some cases, exceeding those of present standard type resistors. Leaded pellets can be encapsulated with epoxy for further environmental protection, and for insulation, if desired. In several instances pellet resistors permit packaging normally not possible with standard resistors presently available.

The pellet resistor is a micro-powder mixture of noble metals and their oxides bonded with a high-melting organic flux. Automatic handling insures low production costs in large quantities. A pellet resistor 0.50 in. diam by 0.30 in. high has a resistance range of 50 ohms to 100,000 ohms. This size is rated at 1/10 watt at an ambient of 125 C. Ratings increase or decrease from this as the volume varies and depends to a large degree on the heat-dissipation features available in the mounting system which is used.

Solder-Joints Unreliable?

TYPICAL missile guidance system has 50,000 solder joints, according to Autonetics' George V. Browning. "A reliability goal permitting not more than one failed solder joint out of several million for every 1,000 hours of operation is not uncommon," he said. "Considering such reliability needs, it became apparent to Autonetics that extensive test work was required to select a combination of soldering process parameters to meet this requirement."

Flux-less, hydrogen-flame soldering technique employed to solder-coat ceramic printed circuits for internal guidance and control systems have accumulated more than 12 billion solder-joint-hours with no failures reported.

CORRELATE FREQUENCY ANYWHERE ON EARTH TO 0.000000003%

WITH NEW SOLID STATE VLF FREQUENCY CORRELATOR SETS

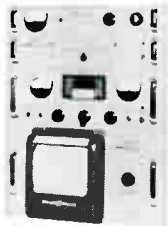

The new Interstate VLF Receiver/Correlator receives worldwide VLF transmissions and electronically compares the precise transmitted frequency and phase to a local oscillator for calibration. Calibration to 3 parts in 10 billion is easy to attain over a few hours with this reliable, solid state set. A variety of recording and readout options are available for broad versatility of application. Write for technical brochure.

WRITE TO: **Interstate** ELECTRONICS CORPORATION

707 East Vermont Ave. • Anaheim, California • Phone 714-772-2222
(A subsidiary of Interstate Engineering Corporation)
NATIONWIDE REPRESENTATIVES

ANOTHER **Interstate** SOLID-*state* INSTRUMENT
CIRCLE 208 ON READER SERVICE CARD

Typical performance at 22,500 rpm

VAX-1.5 BLOWER

400 or 800 cycles a.c.

This compact high-performance spot cooling package weighs only 4.0 ounces, yet puts out up to 16 cfm of air at 1.5" H₂O back pressure! Housing and blade are precision cast aluminum, black anodized. Units are designed to meet stiff MIL environmental specs. Minimum life is 1000 hours at 125° C. Globe's new VAX-1.5-AC mounts in a 1 5/8" diameter hole using standard servo clamps. Request Bulletin VX-15 from Globe Industries, Inc., 1784 Stanley Avenue, Dayton 4, Ohio. Telephone Area Code 513 222-3741.

GLOBE INDUSTRIES, INC.

CIRCLE 209 ON READER SERVICE CARD

IN ELECTRONIC CIRCUITS

NEW GLASS CAPPED MICROFUSES
Pigtail or plug in.
1/500 through
5 amps @ 125V.

AND MICROFUSE HOLDERS

Front panel. Indicating type.

IT'S LITTELFUSE FIRST

DES PLAINES, ILLINOIS

CIRCLE 93 ON READER SERVICE CARD

PIGEON-HOLING COMPONENTS

Conventional cordwood packaging techniques stack components parallel to each other as closely as their form-factors will allow. Honeycomb technique has high packaging density, but provides components with the equivalent of individual metal cases, making heat-conducting encapsulations unnecessary and providing electrical isolation. Repairs are easier, too, because potting with gel is practical



ALUMINUM cell material in honeycomb matrix is flexible enough to permit insertion of various sized components

Honeycomb Enhances Cordwood Packaging

Provides economic, flexible package with a minimum of esoteric design

By PAUL HELLER

Airborne Instruments Laboratory
A Division of Cutler-Hammer, Inc.
Deer Park, New York

ALUMINUM HONEYCOMB matrices commercially available in all widths, cell sizes and weights, provides the basis for a new and more practical cordwood packaging tech-

nique. Components are placed in the honeycomb channels that can be easily distorted to take various sized parts. The aluminum honeycomb material provides adequate heat removal to a lightweight supporting frame of formed or extruded metal that could contain fins for additional external cooling. This eliminates the need for potting with heat-conducting epoxies.

Other advantages include:

- High packaging density
- Superior electrical isolation properties

- Inexpensive to develop and fabricate
- Easier and more practical assembling
- Easy drafting layout of prototype assemblies
- Practical breadboard
- Flexible design
- Lends itself to standardization or commercial product use.

ASSEMBLY—The aluminum honeycomb matrix is cemented or dip-brazed to the metal frame.

In assembling a module, the parts are simply pushed into individual honeycomb cells. The cells hold them sufficiently tight for additional assembly operation. Cell size is normally selected so as to provide a push fit for a $\frac{1}{2}$ -watt resistor. In inserting larger components, cells are distorted (with a pencil or proper-size mandrel). The honeycomb material easily accepts all sizes of components. Very small parts such as diodes are tacked in place with cement.

WIRING—After all components are inserted a clear punched plastic

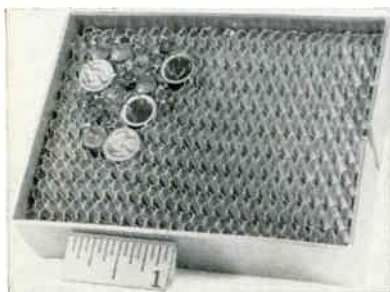

CLOSE-UP shows aluminum honeycomb matrix enclosed within lightweight metal frame that could include fins for additional cooling



END-CONNECTION terminals and test points are brought out of the wired module to be soldered, wire-wrapped or welded

RACK'EM UP!

EFFICIENTLY & INEXPENSIVELY

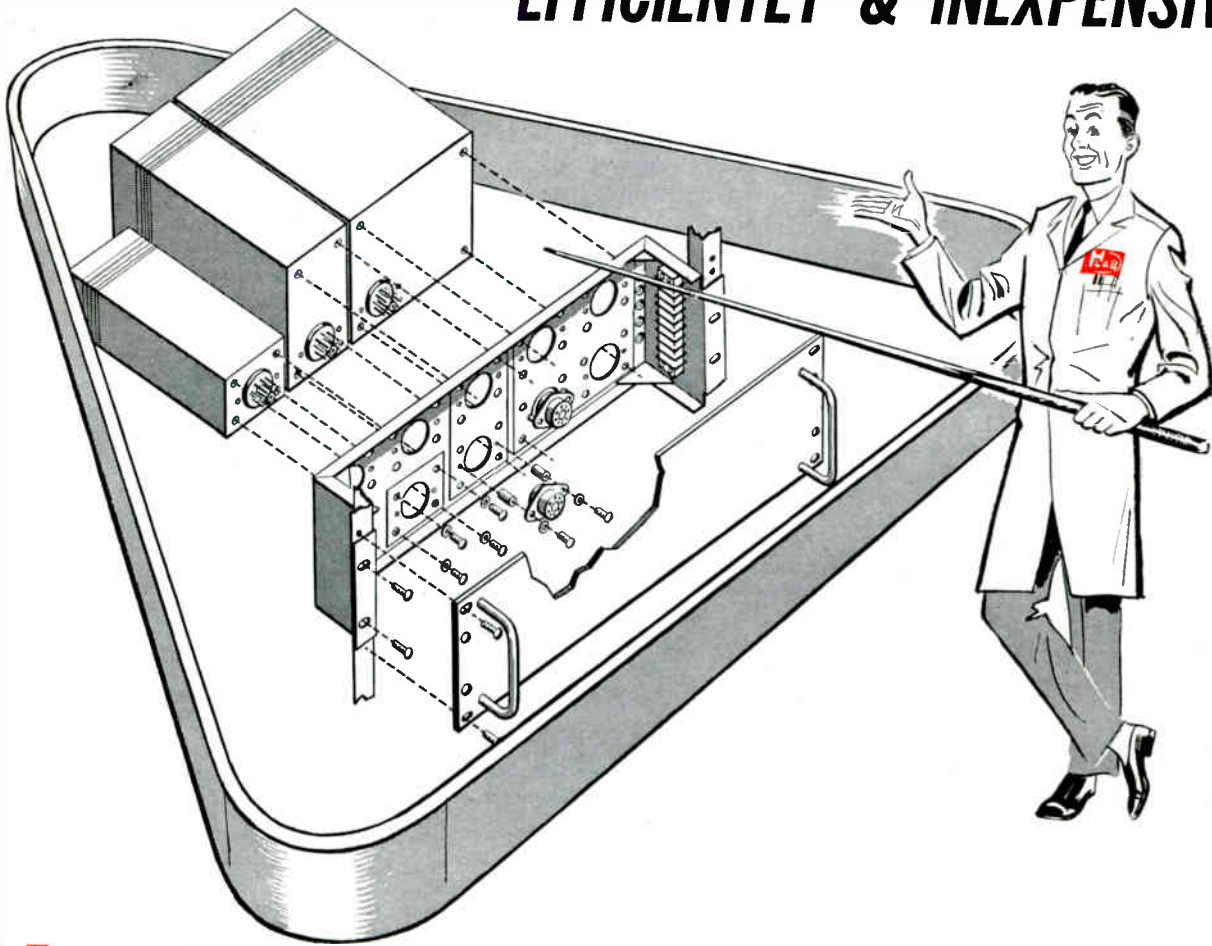

6340 SERIES MODULAR POWER SUPPLIES

CHALK UP H-LABS' NEW MODULAR POWER SUPPLY CONCEPT AS A MUST FOR YOUR SYSTEMS REQUIREMENTS.

Systems requirements for several DC power supplies at different voltages and currents can now be satisfied in a minimum amount of space using H-Labs' new plug-in modular concept. Each of the three modular sizes requires a mounting area exactly twice that of the next smaller module. All input and output power connections plus output voltage control are accomplished through the plug-in terminal connections. These sup-

plies feature the traditionally low H-Lab regulation and ripple figures as well as remote programming, remote sensing, adjustable current limiting and short-circuit-proof operation.

SPECIFICATIONS

MODEL NO.	SIZE	OUTPUT RATING	WEIGHT	PRICE
6343A	A	0-18V @ 0-300 milliamps	5 lb.	\$120.00
6344A	B	0-18V @ 0-1 amp	15 lb.	\$165.00
6345A	C	0-18V @ 0-2.5 amps	25 lb.	\$225.00
6346A	A	0-36V @ 0-150 milliamps	5 lb.	\$120.00
6347A	B	0-36V @ 0-500 milliamps	15 lb.	\$165.00
6348A	C	0-36V @ 0-1.5 amps	25 lb.	\$225.00

SIZE
 A 3"L x 2 1/2"W x 8"D
 B 5"L x 3" W x 9"D
 C 6 1/4"L x 5"W x 9"D
INPUT: 105-125 VAC

LOAD REGULATION: Less than 3 mv or 0.02%
LINE REGULATION: Less than 3 mv or 0.02%
 RIPPLE AND NOISE: Less than 1 mv rms
OPERATING TEMPERATURE RANGE: 0°C to 50°C

Contact your local sales rep or write directly to factory for complete specifications on any of H-Lab's complete line of regulated power supplies.

Write for new catalog describing the complete H-Lab line.

HARRISON LABORATORIES

A DIVISION OF
 HEWLETT-PACKARD 

45 INDUSTRIAL ROAD • BERKELEY HEIGHTS, NEW JERSEY

464-1234 • Area Code 201 • TWX-201-464-2117

See us at the New York IEEE Show Booth Nos. 3405 & 3407



LASER EQUIPMENT

10 LASER PULSES PER SECOND

Model 325 Power Supply with associated capacitor banks ■ Up to 10 Laser pulses per second.

- Higher average powers.
- Greater average Laser output.
- Fast cycling for tracking purposes and product research.
- Up to 20,000 joules of energy storage.
- Individual capacitor fusing, safety interlocks and automatic discharge.



100,000 JOULE POWER SUPPLY

Model 350 Power Supply available for:

- 100,000 joules of energy storage ■ Choice of operating voltages: 5,000, 10,000 or 20,000 ■ Average powers to 5KW ■ Forced air circulation ■ Maximum safety: individually fused capacitors, safety interlocks and automatic discharge.

OTHER MODELS FOR ALMOST EVERY NEED

Standard models provide almost any combination of volts, watts and joules, with continuously variable voltages from 0 to 5,000, 10,000 or 20,000.

From the earliest beginnings of Laser research, Electro Powerpacs has pioneered in the development of Laser power supplies, capacitor banks, light pumps, special devices and accessories which are in use in most leading industrial and government research laboratories.

Accessories include: ■ Solid State Laser Mounts — air cooled or liquid nitrogen cooled — for rods of all sizes ■ "Q" Spoiler ■ Arc Quench ■ Peak Power Meter ■ Optical Bench.

For further information, write ...



ELECTRO POWERPACS, INC.
MANUFACTURERS OF POWER SUPPLIES,
LASER MOUNTS AND ACCESSORIES

A SUBSIDIARY OF HYDRA-POWER CORPORATION

16 HADLEY ST., CAMBRIDGE 40, MASS.
TELEPHONE: 617-876-9220

film is placed over their leads. This film is marked with required interconnections to simplify wiring of the components. Either welding ribbon or bus wire for hand soldering can be used. End connection terminals and test points are brought out of the wired module. These terminals can be adapted for standard soldering, wire wrap or welding.

After wiring, plastic film end sheets are dissolved chemically, leaving an operating electrical assembly in the honeycomb matrix.

CLEAR-GEL POTTING — After testing, the assembly is potted with a semirigid clear gel (for example, Dow 182 Sylgard). This gel protects the assembly, and permits easy inspection and repair. This makes large modules a practicality without danger that a single failure after potting would necessitate scrapping of entire assembly. After encapsulation, metal covers are mounted to provide protection for the gel and complete the heat sink around the unit.

POSSIBILITIES—With standard off-the-shelf modules, a breadboard prototype can be fabricated directly from the schematic by a technician. Since the honeycomb is manufactured in a regular geometric grid pattern, the drafting layout problem is substantially simplified.

Completed modules may be joined in any number of ways depending on the overall package design. For example, individual units may be stacked flush side by side in "buckets" and interconnected. Alternately, long bolts may pass through successive modules anchoring them to a heat conductive structural wall, etc. All connections are made to the exposed terminals by soldered wires, welded matrices or printed flexible wiring.

PRECAUTIONS—While the parts are stacked almost as close as in conventional cordwood techniques, the aluminum cell surrounding each component adequately removes heat to the frame. Since the cells are electrically grounded, each part is substantially better isolated from its neighbor than in simple cordwood design. However, as in conventional cordwood design, atten-

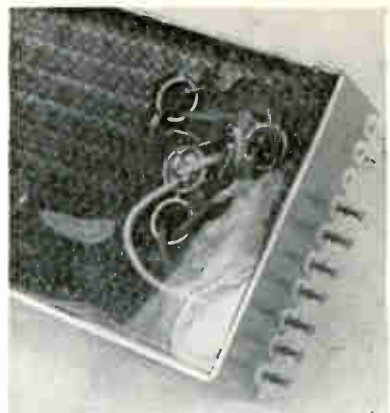

CLEAR semi-rigid gel encapsulating module permits easy inspection and repair



HEAT SINK for module is completed with mounting of metal covers, which also protect encapsulating gel

tion must be paid to the capacitance problem where high-speed circuitry is involved. It is possible to anodize the honeycomb materials so that possibility of shorts or "hot" transistor cases is minimized.

Hydrogen Retort Furnace Eliminates Mech Feeder

HYDROGEN re-circulation through an external heat exchanger at the completion of brazing cycles rapidly cools a GE-designed hydrogen retort furnace. This facilitates manual placement of parts to be brazed in the retort, so that a mechanical feeder system is not used. This, says GE, eliminates possible movement of parts which can cause an imperfect braze.

Designed and built by GE's Power Tube Department to eliminate solder runoff and leakage and to prevent braze erosion during manufacture of klystrons and hydrogen thyatrons, the furnace reportedly provides quality control

CRYSTAL CASE TIMERS
microminiature solid state
timers feature ruggedized design

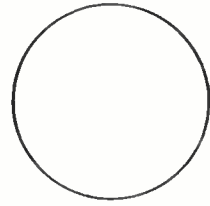
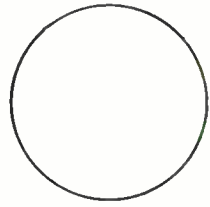
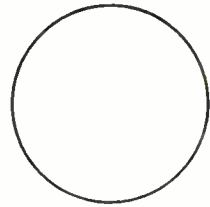
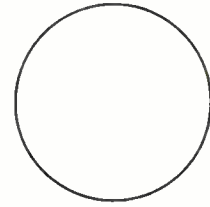
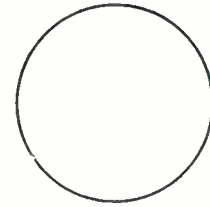
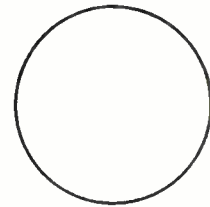

These advanced precision timers provide, in a microminiature package, fixed or adjustable time delays up to 60 seconds previously available only in larger size or less versatile units. They are designed for use wherever reduced weight and volume together with high accuracy and a maximum degree of reliability are important considerations, including such critical applications as missiles, satellites, and space vehicles. The complete hermetically-sealed timer package weighs only 0.8 ounces and measures 1.0" x 0.8" x 0.4".

TEMPO INSTRUMENT INCORPORATED

Plainview, L. I., New York

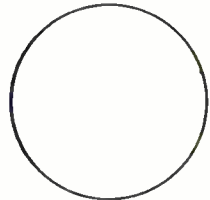

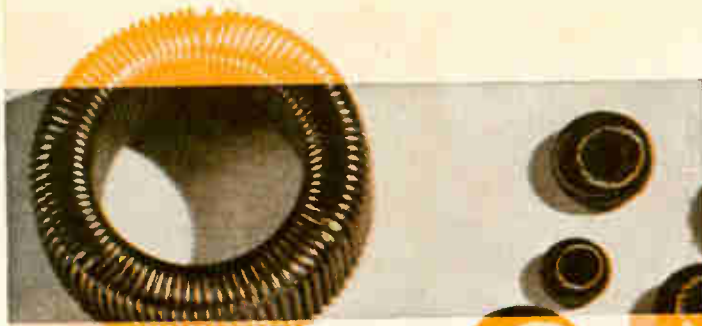

A NEW CONCEPT IN TOROIDAL WINDING MACHINES

OBJECTIVE OF THE T 100 CONCEPT: TO ENABLE TOROID MANUFACTURERS TO INCREASE PRODUCTION, LOWER COSTS, MAINTAIN UNIFORM PRODUCT QUALITY . . . WITH GREATER FACILITY AND FLEXIBILITY TO MEET CHANGING REQUIREMENTS.

The T 100 Series of Boesch Toroidal Winding Machines affords toroid manufacturers an opportunity to select an "optimum" machine for their specific needs — the appropriate combination of versatility and sophistication with price and operating economy. A basic design providing production durability, methods efficiency, and precise winding performance is the core of each machine ranging from models with manually operated core rotation to those having a full complement of automatic and predeterminable controls.

Quick change interchangeable shuttle heads permit fast and flexible changes in set-up for winding a wide range of coils from sub-miniature sizes (.035" I.D.) to large sizes — in a wide latitude of wire sizes of virtually every type. Attachments and accessories have been designed to extend the capabilities of the machines to meet changing requirements.

The flexibility and precision of the T 100 machines make them eminently suitable for development and prototype work; Boesch durability and high maintenance-free productivity are designed in for stringent production requirements. The ability to use the same machine for both prototype and production will eliminate many of the difficulties encountered in the transition from development to production and will assure product uniformity.

By the most exacting standards . . . Boesch T 100 machines deliver value . . . whether the measure be productivity or cost reduction, uniformity or quality of product, range of application, price or economic life. And there is a model in the T 100 series that should meet virtually any price and performance requirement.



TUBE ASSEMBLY is removed from furnace making metal-ceramic seals

not provided by commercially-available furnaces. It is claimed that since hydrogen is continuously flowing in and out of the retort, possibility of residual contamination from one production cycle to another is eliminated.

Circuits Die-Stamped Reliably at Low Cost

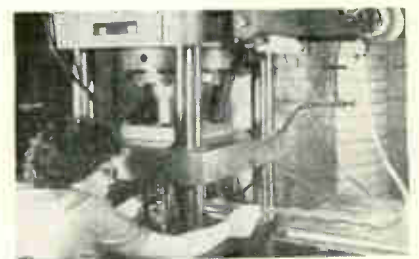

CIRCUIT CONFIGURATIONS are stamped out of copper ribbon by heated die in low-cost, mass-production process

FRANKLIN PROCESS patented by the Resources and Facilities Corporation is claimed to be a low-cost technique for mass producing high-quality printed circuits. A ribbon of copper coated on one side with a thermosetting adhesive is passed under a heated die bearing circuit configuration. Die shears configurations from copper ribbon. Die's continuing stroke then affixes configurations to an insulator panel. Advantages claimed for the process include: base-material electrical properties unimpaired since no chemical solutions are used and no adhesive remains on the insulating



BOESCH MANUFACTURING DIVISION

WALTHAM PRECISION INSTRUMENT COMPANY, INC.
DANBURY, CONNECTICUT / Telephone: Pioneer 3-3886 / Teletype: OANB 468

the finest precision
coaxial connectors*

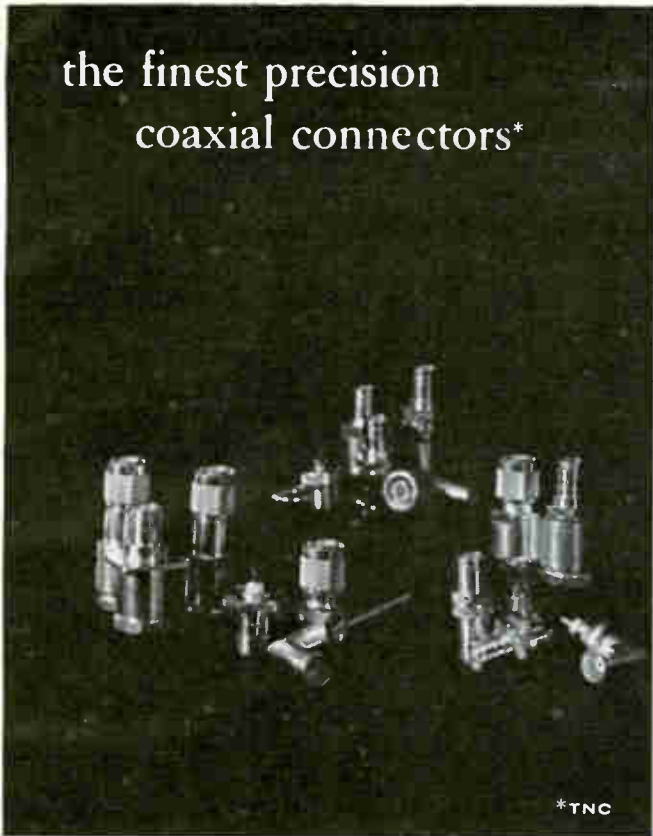

*TNC

General RF Fittings, Inc.

702 BEACON STREET, BOSTON 15, MASSACHUSETTS
Telephone: 617 267-5120

CIRCLE 210 ON READER SERVICE CARD

Laboratory Ovens

FOR MORE
RELIABLE
DATA

500°-650°-850°
1000° MODELS

For

- DRYING
- CURING
- AGING
- STERILIZING
- ANNEALING
- TEMPERING



DESPATCH
BUILT

Versatile, rugged, accurate Despatch laboratory ovens will fit your particular needs. Available in standard models of various dimensions, each Despatch Oven guarantees automatic temperature control $\pm \frac{1}{2}^{\circ}$ C. Standard units up to 1000° F. max.; special models to 1350° F. Forced convection assures even wiping of ambient air and fast warm-up time. Gas or electricity may be used for heating. *Despatch has been serving American industry for 60 years.*

WRITE TODAY for free bulletin 203-4F Laboratory ovens.

DESPATCH

OVEN
CO.

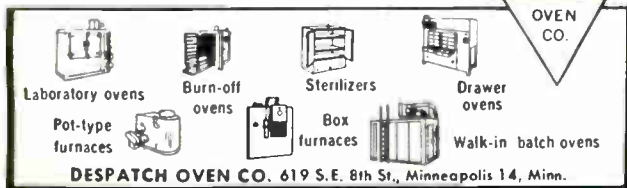

DESPATCH OVEN CO. 619 S.E. 8th St., Minneapolis 14, Minn.

CIRCLE 211 ON READER SERVICE CARD

February 15, 1963

PRODUCT
NEWS from EPL

... nothing high but performance, quality

0-55 VDC continuously variable to 10 A
with only 0.5% ripple



Model
PS-5R \$275

Model
PS-5 \$250

NEW POWER SUPPLIES OPERATE 55 VDC EQUIPMENT

— including new high voltage aircraft equipment

Up to 550 watts of filtered power . . . Heavy current output, good load regulation and low ripple assure continuous top performance for powering 48-volt amplifiers; testing transistor circuits, DC motors, relays and other electronic equipment 24 hours a day.

Only 45¢/watt of output . . . At these prices, units deliver more reliable current at lower cost than obtainable elsewhere.

13% regulation . . . Why pay two or three times more for regulation you don't need when 13% is more than ample for most jobs.

Guaranteed 1 year . . . Your best assurance of superior quality and many years of satisfactory performance.

Special Features . . . found only in costlier supplies
• Fast-acting circuit breaker • Smooth continuously variable DC output • Special chokes, condensers, Pi-type filters • Silicon rectifiers for higher efficiency • 2% accuracy D'Arsonval movement meters.

Available Now at Your Electronic Distributor

17 OTHERS FROM 6 TO 125 VDC

Write for Complete Line Catalog PS-562



2214

ELECTRO PRODUCTS LABORATORIES

6125-F Howard, Chicago 48 (Niles), Ill.
Phone: 647-6125

Canada: Atlas Radio Ltd., Toronto

Since 1936 . . . Pioneers in Low Voltage DC Power Supplies

CIRCLE 99 ON READER SERVICE CARD 99

NEW DIMENSIONS IN RELIABILITY

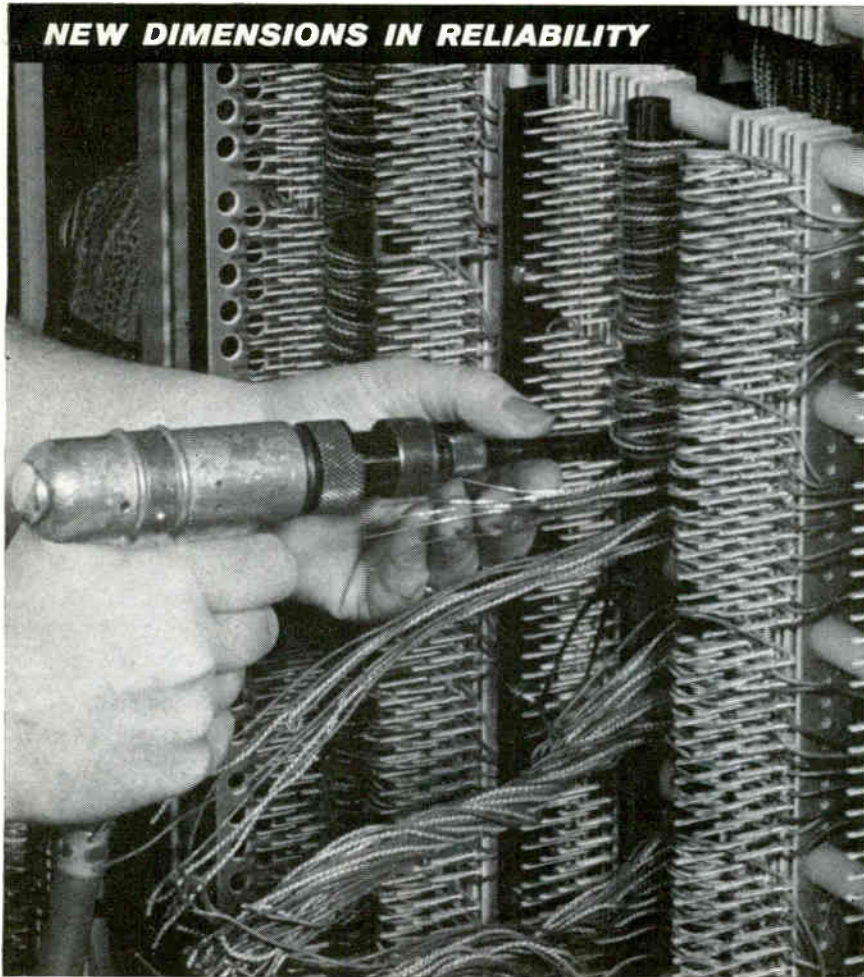

SCRAP COPPER is easily peeled from stamped phenolic strips

areas; unique base materials such as compressed paper and wood products can be used; circuit configuration uniformity maintained indefinitely—not dependent on human skills or process consistency with respect to chemical solutions, etc.; no line breaks or undercutting; large volume of conductor metals can accommodate current flow in excess of 40 amperes.

Immersion Gold Solution Used in Electroplating

By PAUL PETRACK
Columbus Electronics Corp.
Yonkers, N. Y.

ELECTROPLATING PROCESS using an immersion gold solution resulted in the production of silicon rectifiers with more uniform standards of performance and maximum power-rectification efficiency. Aided greatly has been manufacture of high voltage silicon rectifiers having a wide range of output current capabilities.

Previously, we performed gold plating using regular electroless plating methods and a high-quality immersion gold plating solution: Atomex manufactured by Engelhard Industries. Silicon rectifiers so produced did meet all standard requirements.

However, in trying to produce rectifiers with reduced power losses, we discovered that greater mechanical reliability in making electrical connection to the rectifying junction was called-for. This required better adherence of gold plating to single crystal-silicon slices in producing clean and stable junctions. This in turn, forced development of the new process:

The same immersion solution is contained in a glass beaker equipped with a mesh-loop anode made of stainless steel that com-

Permanent, solderless connections in ONLY THREE SECONDS

... that's the solderless wrapping method—proved superior by leaders in communications and electronics. What's the proof? Over a billion connections without reported failure.

And the best way to make these connections is with Gardner-Denver "Wire-Wrap"® tools. Every bit is individually tested and inspected—every bit is individually packaged in a plastic tube. And only Gardner-Denver makes a complete line of this type equipment.

Write for Bulletin 14-1.

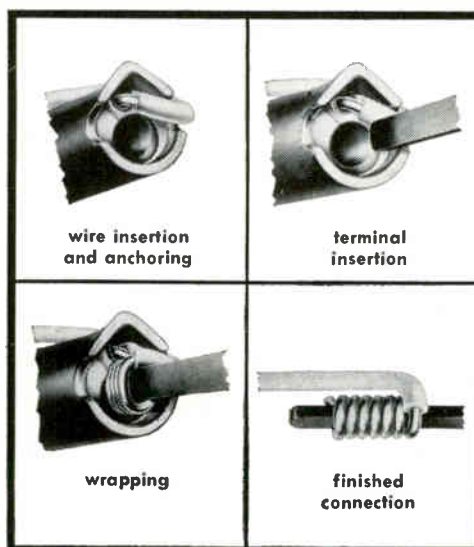

EQUIPMENT TODAY FOR THE CHALLENGE OF TOMORROW

GARDNER - DENVER

Gardner-Denver Company, Gardner Expressway, Quincy, Illinois

In Canada: Gardner-Denver Company (Canada) Ltd., 14 Curity Ave., Toronto 16, Ontario

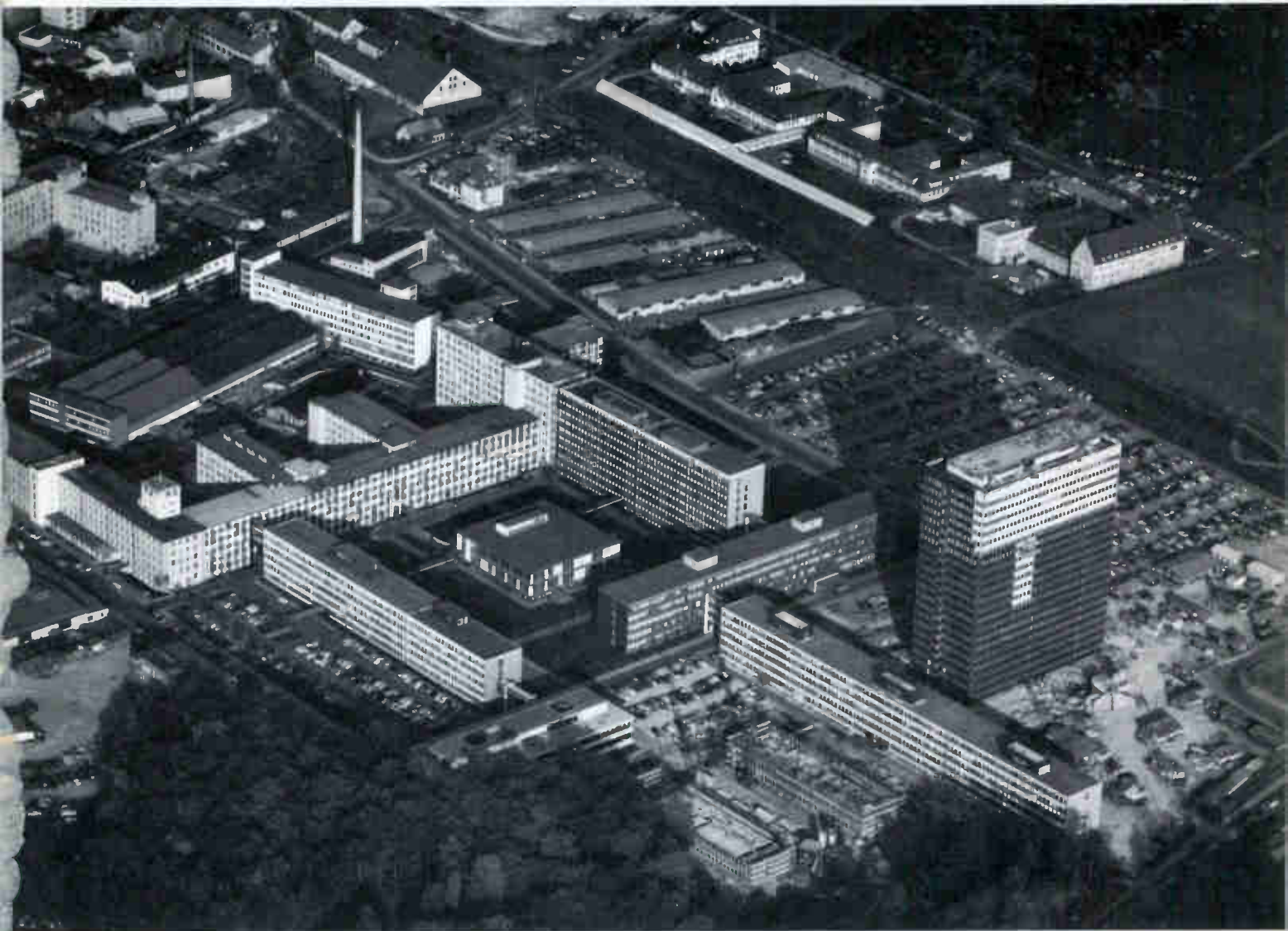

General view of the Telecommunication Research Center in Munich.

This is Siemens

Siemens (pronounced zee-men-z) was founded 115 years ago; it is the largest private employer in Germany and one of the largest business enterprises in the world. It employs 240,000 persons in factories and offices in 79 countries.

Siemens manufactures practically every type of electrical equipment from micro-miniature components to complete power stations—for reproducing and transmitting sound, sight, data and power.

Siemens products are found in homes, stores, factories, laboratories, trains, planes, ships, theatres... wherever men work, live and play.

For general information on Siemens, circle 268 on Reader Service Card.

SIEMENS & HALSKE AG - GERMANY

Subsidiary in the U.S.A.:

SIEMENS AMERICA INCORPORATED

350 Fifth Avenue, New York 1, N.Y.

In Canada:

SIEMENS HALSKE SIEMENS SCHUCKERT (CANADA) LTD.

407 McGill Street, Montreal 1, P.Q.



SIEMENS

Polystyrene ("Styroflex") capacitors "Mica" properties at "paper" prices

Styroflex capacitors offer reliability against voltage breakdown and stability against change in operating characteristics...at prices unusually low for these properties.

These and other *Styroflex* properties result from the unique properties of polystyrene and the method of manufacture developed by Siemens: The polystyrene film is stretched, and stabilized in the stretched condition, before winding. After winding, special heat treatment shrinks the film, forming a hard, stable body. The heat also fuses the polystyrene layers at the ends to form a solid plastic seal.

Reliability against voltage break-through is assured by the extra thickness of the film as well as the standard Siemens test on each unit at 3.3 times rated voltage. For filter applications, reliability in the microvolt range is assured by positive *welded* contacts between foil and leads.

The reliability of *Styroflex* capacitors is proved by their long, successful use in computers.

Low dissipation factor (usually even lower than for mica capacitors) is provided by *Styroflex* capacitors...making them specially suitable for filter circuits.

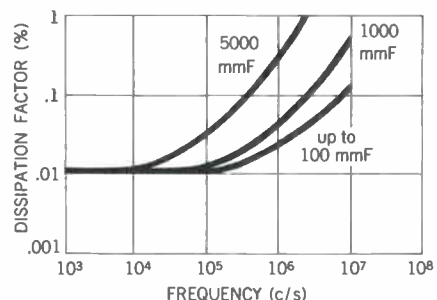

Stability against change in capacitance over long periods of time is one result of the solidity and hardness of the capacitors...produced by the shrinkage during manufacture.

Low self-inductance is a result of a special contact design and is particularly important in very high frequency applications. Self-inductance values are as low as for extended-foil construction.

Complete shielding. The outer layer of foil completely encloses and shields the inner foil. (The terminal for the outside foil is indicated by the voltage band.)

Highest insulation resistance (higher than for any other type of dielectric) is a result of the well-known properties of polystyrene.

High resistance to humidity. Polystyrene has the lowest water absorption coefficient of all capacitor dielectric materials. As a result, *Styroflex* capacitors show very low capacitance change due to changes in relative humidity.

Small size. *Styroflex* capacitors in the lower capacitance ranges are even smaller than mica capacitors.

Long life. *Styroflex* capacitors have a record of long and successful use in telecommunication equipment carrying guarantees of 15 years or more. In addition, their extremely long life is proved by hundreds of thousands of capacitors tested under all types of climate and voltage conditions.

Close to a billion *Styroflex* capacitors have been made by Siemens. Hundreds of millions of these are in use in European radio and TV sets as well as in industrial equipment.

SPECIFICATIONS

Operating temperatures: -40° to +85°C.

Stability: Less than 0.2% +0.4 mmF variation in capacitance in 2 years at 40°C and 75% relative humidity. (Capacitance changes due to humidity changes are small and are reversible.)

Insulation resistance: 500,000 megohms at 20°C after 1 minute tested with 100 volts DC.

Temperature coefficient: -150 ±50 ppm/°C.

Capacitance tolerances: ±20, ±10, ±5 and ±2½% of rated capacitance.

Dimensions (inches)

Capacitance Values (mmF)	Nominal Voltage			
	125V ⁽¹⁾		500V	
	Length	Diam. (max.)	Length	Diam. (max.)
2-300	0.40 ⁽²⁾	0.17"	0.60"	0.26"
305-1000	0.40 ⁽²⁾	0.22	0.80	0.27
1,050-2,000	0.60	0.25	0.80	0.34
2,050-5,000	0.80	0.32	0.80	0.50
5,050-10,000	1.20	0.31	1.20	0.49
10,050-25,000	1.20	0.45	—	—

(1) Smaller capacitors, for 30V and 50V, also available. (2) Capacitances from 2 to 620 mmF are also available in .315" length.

In stock for shipment from White Plains, N.Y.

The following capacitance values in mmF and the same values multiplied by 10, 100 or 1000 (up to 24,000 mmF for 125V and up to 10,000 mmF for 500V) are available in 125V and 500V ratings and with capacitance tolerance of ±2½% for immediate shipment from White Plains, New York:

10 ⁽¹⁾	16	27	43	62	100
11 ⁽²⁾	18	30	47	68	110
12	20	33	50	75	120
13	22	36	51	82	etc.
15	24	39	56	91	etc.

(1) Also 100, 1000, 10,000 mmF. (2) Also 110, 1100, 11,000 mmF, etc.

Other values, voltages and tolerances are available on factory order. Also tape mounting for automatic assembly.

Detailed engineering data and service are available on request.

Styroflex capacitors are distributed by William Brand Electronic Components, Inc., and are available through leading sales representatives throughout the U.S.

CIRCLE 269 ON READER SERVICE CARD

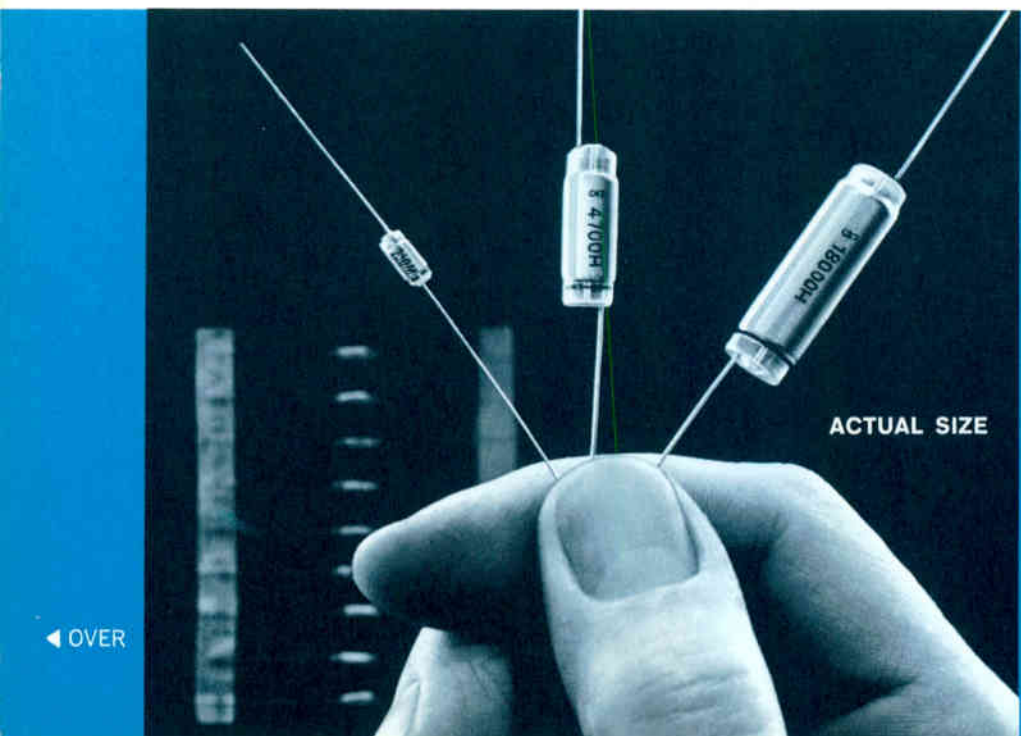

ACTUAL SIZE

Siemens components available: Ferrite pot cores and transfluxors; capacitors (electrolytic, polystyrene, metallized plastic, metallized paper, tantalum); deposited-film resistors. Distributor for these electronic components:

WILLIAM BRAND

Electronic Components, Inc.
220 Ferris Ave., White Plains, N.Y.
Telephone: 914 WH 8-3434

In Canada:
SIEMENS HALSKE SIEMENS SCHUCKERT
(CANADA) LTD.
407 McGill Street, Montreal 1, P.Q.

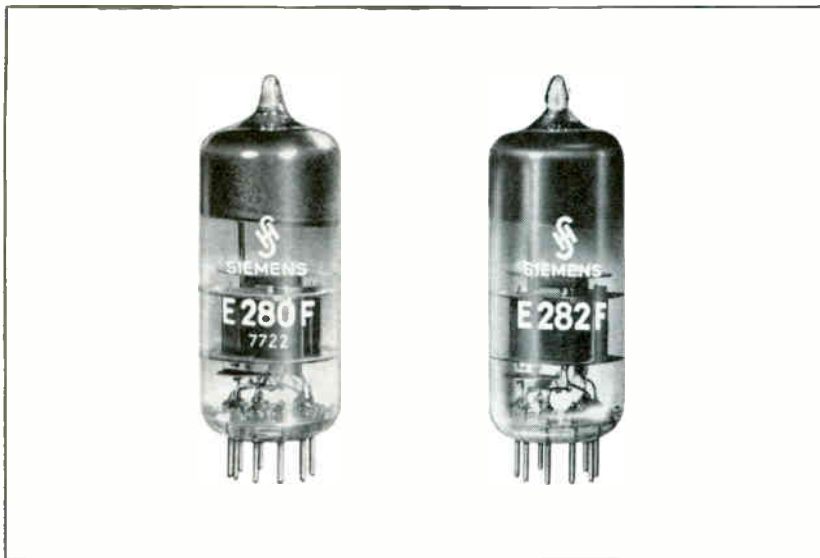

Electron Tubes

Special quality tubes

Frame grid construction with high transconductance to plate current ratio for use in critical industrial and military applications, in which service reliability is of primary importance.

Pentodes for broadband RF amplifiers

Type	Characteristics				Maximum ratings		
	Plate supply voltage V	Plate current mA	Transconductance μ mhos	Gain band width product Mc/s	Plate voltage V	Plate dissipation Watts	Cathode current mA
E 280 F/7722	190	20	26000	180	220	4	30
E 282 F	125	35	26000	175	200	4.2	50
7721	190	22	35000	230	220	4.2	30

For further information and application engineering assistance regarding these electron tubes manufactured by Siemens & Halske AG • Germany, please write to their distributor in the U.S.A.

SIEMENS AMERICA INCORPORATED

350 Fifth Avenue, New York 1, N.Y. • Tel: LOngacre 4-7674. Telex 01-2070, Cable: siemens

In Canada:

SIEMENS HALSKE SIEMENS SCHUCKERT (CANADA) LTD.

407, Mc Gill Street, Montreal 1, P. Q. • Tel: 849-5783. Telex 012800, Cable: siemenscan

CIRCLE 103 ON READER SERVICE CARD

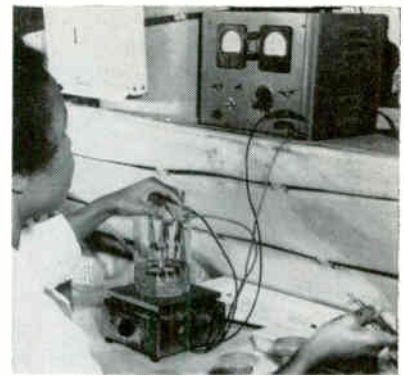

FOUR microinches of 24-karat gold coating is deposited in less than one minute in plating silicon disks



PROCESS has minimized rejects of disks subjected to microscopic inspection for flaking porosity and adherence

pletely surrounds pieces to be plated. Plating current is obtained from a power supply current-regulated to 70 milliamperes d-c at 2 volts. Heat for the beaker and solution is provided by a regular laboratory hot plate.

After silicon slices have been diffused to form a rectifying junction and nickel plated they are sent to one of the gold-plating work tables. At each table, an operator picks up six slices with a pair of stainless steel tweezers after rinsing the work load. The six slices are completely immersed in the gold solution ($\frac{1}{2}$ oz. of Atomex gold concentrate in a gallon of water at 160 degrees F).

Gold-plating thickness deposited depends on device manufactured and ranges from 3 to 5 microinches. Plating rate is 5 microinches per minute so that an extremely dense coating is quickly and uniformly deposited.

With this process, control of plating process parameters is easier, lending it to large-volume produc-



FRONTIER FREQUENCY / TIME STANDARDS are the best across-the-board

Here are space-tested System Frequency/Time Standards that meet your most exacting requirements for commercial, industrial or military applications. The same engineering capability that supplies Frequency/Time control to major space projects places in your hands advanced crystal control that fulfills any precision timing assignment. ■ Frontier's line features a wide range of frequencies (30 cps to 100 megacycles), stabilities for every need (1×10^{-8} , 20×10^{-6} or whatever you require), solid-state circuitry and oven control (no noise-generating thermostats!). The line has unitized modular construction for best shock and vibration resistance — fast start-up and low power consumption — choice of sizes and mountings — *individual test documentation shipped with each unit* — mounts in any position. Write or call today for complete technical information:

Visit us at the I.E.E.E. Show Booth 3017
March 23 to 28 The Coliseum, New York

Commercial / Military
Systems Capability



FRONTIER ELECTRONICS DIVISION
INTERNATIONAL RESISTANCE COMPANY
4600 Memphis Avenue • Cleveland 9, Ohio • Phone: 216 749-1570

tion. Although using an immersion-gold solution for electroplating may appear contradictory to usual electroplating principles (gold is relatively inert), our results have proved process superior in producing quality silicon rectifiers with a minimum of rejects.

Two-Hour Pump Down Achieved with Trap

HIGH PUMPING speed achieves a 5×10^{-7} vacuum in less than 2 hours with a vacuum laboratory evaporator produced by General Vacuum Corporation of Medford, Mass. It is based on an in-use ultra-high vacuum trap the company developed for space simulation systems. The high conductance liquid nitrogen trap has 100-percent anti-migration characteristics and a full-opening 12-inch diameter air-operated poppet valve. The polished stainless steel evaporation chamber is front-mounted to give access to top and bottom feed-throughs, manipulators, electron-beam heating guns and other accessories. Vision and access into chamber is provided by a 14-inch diameter hinged sight port mounted in the front.

Clean Rooms Keep Humidity at 38 Percent



GYROS and accelerators are assembled in these super-clean rooms at Litton Systems (Canada). Dust and bacteria are removed from the air with an efficiency of 99.97 percent at 0.3 micron

SUPER-CLEAN rooms are used in the precision assembly of gyro and accelerator components at Litton Systems (Canada), Ltd. Humidity is maintained at 38 percent ± 3 percent, temperature at 72 degrees F ± 2 degrees. Seven pressure zones ensure that no "uncontrolled" air enters the room.



NEW ROTARY SWITCH "IRM" SERIES

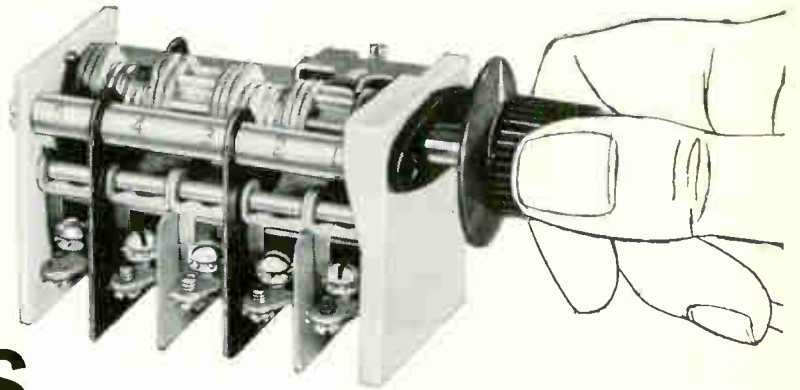

CAMSHAFT INSURES ACCURATE SEQUENCING—A camshaft operating mechanism in the "IRM" series eliminates the need for complicated "jumper" wiring connections to provide desired switching sequence.

HIGH-CAPACITY MULTI-POLE DOUBLE-THROW—Up to 8-pole circuitry provides "on-off", "on-on" and "off-on" action. Silver contacts are UL listed for 15 amps. 125-250 vac. Gold alloys available for low energy uses.

MANY ROTARY DESIGNS are available from MICRO SWITCH. Examples (see below): "20AS" can be provided with up to 20 poles and 12 operating positions, "28AS" has "cock-and-fire" positive actuating mechanism, "25AS" is smallest environment-proof series available, "17AS4200" and "17AS300" are decimal-to-binary rotary input switches. Hermetically-sealed (metal-to-metal, glass-to-metal fusion) subminiature switches are in "29AS" rotary assembly.

ENCLOSED CONTACTS—In addition to shaft and panel seals, the contacts are enclosed in phenolic cases. Design options include a choice of solder, screw, or quick-connect terminals, and from two to eight operating positions.

MORE INFORMATION ON ROTARY SWITCH ASSEMBLIES? Contact any one of our 35 branch offices in principal cities—or send for Data Sheets.



MICRO SWITCH

FREEPORT, ILLINOIS

A DIVISION OF HONEYWELL

IN CANADA: HONEYWELL CONTROLS LIMITED, TORONTO 17, ONTARIO

HONEYWELL INTERNATIONAL SALES AND SERVICE OFFICES IN ALL PRINCIPAL CITIES OF THE WORLD. MANUFACTURING IN UNITED STATES, UNITED KINGDOM, CANADA, NETHERLANDS, GERMANY, FRANCE, JAPAN.

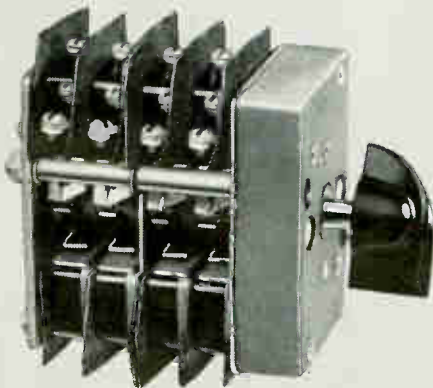

"20AS"



"28AS"



"25AS"



"17AS4200"

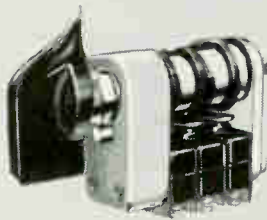

"17AS300"



"29AS"

Integrated Circuit is Modified DTL

Contained in one silicon chip, the device has a low power-speed product

ANNOUNCED by Siliconix Inc., 1140 West Evelyn Ave., Sunnyvale, California, the integrated dual NAND/NOR logic circuit combines small geometry, an epitaxial layer for transistor collector regions and a unique emitter-follower diode clamp circuit to produce a logic gate with high speed and low-power dissipation without sacrificing d-c stability, fan out or high-temperature performance. Both gates are contained on a single silicon chip. The power-speed product is used to compare integrated logic circuits and using typically 12 ns at 5 mw, this nand/nor gate offers 60-picowatt second performance with a fan out of 5. With a 3-v supply, this drops below 40-pws over limited temperature range. The device operates from -55 to +125 C with fan out of at least 5 for supply voltages from 3 to 5 v. Worst-case d-c sta-

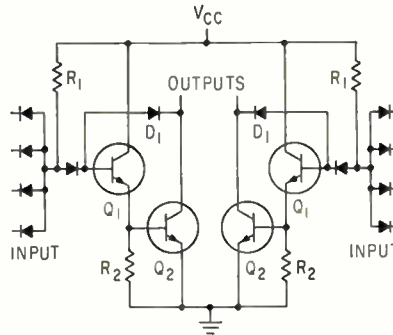

bility is 100 mv at +125 C and fan out of 5 with V_{CC} of 4 v. Dotted portion of above graph shows fan out versus temperature for this voltage. Propagation delay at various temperatures and voltages are shown as solid lines. These were made using a five-stage ring oscillator. At +125 C, 4-v supply, threshold input for 40 μ a output is 0.77 v, maximum input current is 1.5 ma, maximum output voltage at 7.5 ma output and -200 μ a input is 0.67 v, maximum diode leakage is 2.5 μ a and maximum output current in off condition is 40 μ a. The gate is a modified form of DTL logic as shown in the sketch. The circuit is load compensated by emitter-follower Q_2 , so when

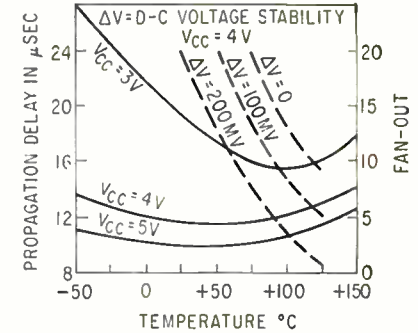

each input is turned off, inverter Q_2 is kept ON over a wide range of collector currents. Fan out is then principally limited by stability requirements. The additional gain allows selecting R_2 to optimize power-speed product without concern for gain requirements, and need for a second power supply is eliminated. Clamping diode D_1 restricts voltage swings and reduces effect of line capacitance on switching speed and allows excess drive current from R_1 to bypass the amplifiers preventing overdrive at low fan out. The dual gate is packaged in a 12-lead TO-5 header and a single-gate version comes in an 8-lead TO-5 package.

CIRCLE 301 READER SERVICE CARD

Counting and Timing 100-Mc Pulses

RECENTLY announced by Eldorado Electronics, 1832 Second

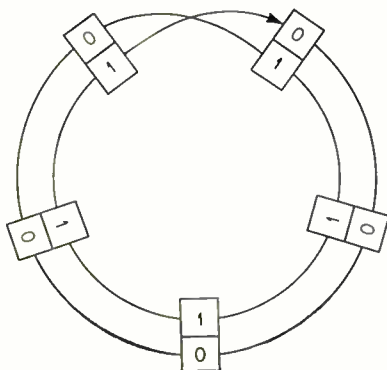

St., Berkeley 10, California are the series 780 solid-state 100 Mc, 10 ns counters and timers. Although available in separate packages, model 786B combines both in a single package. The 10 ns time interval counter counts 100 Mc pulses from either internal or external 1 Mc standards. Any number of counters can be synchronized. The unit features two input (start-stop) measurements. Input is 2 to 10 v and levels up to 40 v will not damage the circuit. An optional 8-4-2-1 output can be provided. Timing gate start-stop channels are

level sensitive and not affected by waveshape or slope except where low-frequency response of polarity-inverting transformers falls off at a slope of less than 1 v per 100 ns. Ambiguity of start-stop times increases as signal slope decreases but high trigger level stability minimizes this. Short term trigger level stability is less than 10 mv and long term trigger stability is less than 100 mv. Timing gate cycles on to off in less than 10 ns. A lockout circuit prevents gate from starting after a stop pulse. The in-line visual readout is provided with

take the headache out of
your packaged circuitry
design with new

U.S. PATENT NO. 3,192,883 CANADIAN PATENT NO. 864,814

JFD MINIATURE TANK CIRCUITS

Now—two conventional components in an unconventional high density format help cut production time and costs.

New JFD miniature tank circuits employ a precisely wound air core coil across a miniature trimmer piston capacitor. Result: an unusual combination of variable capacitance and fixed inductance that delivers more circuitry and reliability per dollar.

Compactness

More capacitance and inductance in less cubic volume—ideal for high density formats.

Economy

Both a trimmer and an inductor at slightly more than the cost of the trimmer capacitor alone.

Assembly Speed

You mount only one unit instead of the two that would otherwise be necessary...save time and labor...eliminate production breakage.

Reliability

Exceptionally high ruggedness and dependability under extreme environmental conditions.

JFD Tank Circuits are available in standard or special models with toroids or ferrite cores, shielded or unshielded, in series or parallel coil design, with any JFD standard panel mount, miniature, MAX-C[®] or Sealcap[®] capacitor.



model	self-resonant frequency range, MC		nominal Q (80-220 mc.)
	min.	max.	
LC371	475 mc.	1000 mc.	230
LC372	290 mc.	850 mc.	230
LC373	230 mc.	650 mc.	230
LC374	190 mc.	525 mc.	230
LC375	165 mc.	425 mc.	230

Call your JFD franchised distributor for quantities up to 299 units, or your nearest JFD sales engineer or representative for further details or specialized assistance.

Components Division

15th Avenue at 62nd Street, Brooklyn 19, N. Y. • Phone 212 DE 1-1000 • TWX212-833-7001 Cable-JEFDEE N. Y.
 JFD WESTERN • 9 Morlan Place • Arcadia, Calif. • Phone: Hillcrest 6-0312
 JFD MIDWESTERN • 6330 Hermione St. • Chicago 46, Ill. • Phone: 775-5424
 JFD MIDWESTERN-OHIO • P. O. Box 36090 • Cincinnati 36, Ohio • Phone: 421-1166
 JFD NORTHEASTERN • Ruth Drive, P. O. Box 22B • Marlboro, Mass. • Phone: Huntley 5-7311
 JFD CANADA • 51 McCormack Street • Toronto, Ontario, Canada • Phone ROger 2-7571
 JFD ELECTRONICS (ISRAEL) LTD • Industrial area B, Building 23 • Azur, Israel • Cable Address: JFD AZUR, ISRAEL
 LCC STEAFIX • 12B Rue de Paris • Montreuil, Seine, France
 STANDARD TELEPHONE & CABLES LTD. • Footscray, Sidcup, Kent, U. K.
 DUNCAN CONDENSER PTY. LTD. • Villawood, N.S.W., Australia

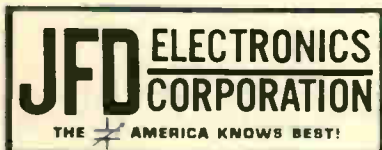

Variable Trimmer Piston Capacitors • Fixed Metallized Inductors • LC Tuners • Filters • Diplexers Fixed and Variable Distributed and Lumped Constant Delay Lines • Pulse Forming Networks

See what's new at JFD IEEE Booth 1226

**20 MICROSECOND TO
10 MILLISECOND DELAY**

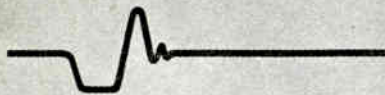

**DECREASED DELAY DRIFT
DUE TO
TEMPERATURE CHANGES**



**MAGNETIC AND
HUMIDITY SHIELDING**

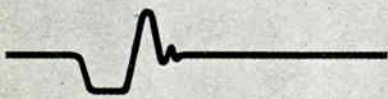

COMPACT



**5 MILLISECOND DELAY
TO 1 MC/S
WITH RETURN-TO-ZERO**



Now, consider magnetostrictive delay lines as precise quantitative storage elements. Deltime, Inc., pioneer in Magnetostrictive Delay Lines offers models capable of operations at 1 MC/S with return-to-zero. Advanced developments of Deltime make possible stability under temperature changes, protection against humidity and stray magnetic fields, assuring you precision to the most rigid requirements.

WRITE FOR COMPLETE TECHNICAL CATALOG

deltime

A subsidiary of Seaelectro Corporation
608 FAYETTE AVE., MAMARONECK, N.Y.

an overflow lamp. Trigger level stability is ± 0.1 v and circuit operates with pulse slope ratio as high as 25 ns per volt. The gated pulse counter is an externally-gated counter that can count pulses from 0 to 100 Mc and sine waves at 100 ± 10 Mc. The counters use twisted-ring logic shown in sketch (p 106). The twisted-ring 100 Mc decade is a five binary ring counter in which the binaries are triggered in succession to one state and then in succession back to the original state. In this system, each binary is required to operate at only one-fifth the input frequency.

CIRCLE 302 READER SERVICE CARD

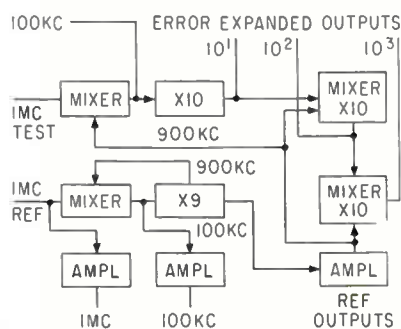

Rapidly Comparing Two Frequency Standards

INTRODUCED by Motorola Communications and Electronics Inc., 4501 Augusta Blvd., Chicago 51, Illinois, the frequency error expander multiplies an input frequency by 10^1 , 10^2 or 10^3 to reduce time required to make accurate frequency comparisons. For example: on a 1-second count, measuring resolution is parts in 10^9 while on a 10-second count, resolution is parts in 10^{10} . Reference input signal is 1 Mc, 0.3 to 2-v rms with input impedance of 3,000 ohms, while test signal input is 1 Mc or 100 Kc, 0.3 to 2-v rms with input impedance of 3,000 ohms for the 1 Mc and 1,000 ohms for the 100 Kc. Jitter is less than $\pm 1 \times 10^{-9}$ for a 1-second count and less than $\pm 2 \times 10^{-10}$ for a 10-second count. Outputs are 1 Mc expanded 10, 100 and 1,000 times, 1 Mc and 100 Kc reference for a counter. Output level is 1 v for expanded and 1.5 v for reference. As shown in the sketch, the 1 Mc test signal is mixed with 900 Kc synthesized from the 1-Mc reference to provide 100-Kc output. The 100 Kc is multiplied up to give a 10 times error

expanded signal at 1 Mc. The same process is repeated giving error expanded outputs up to 1,000 times always at 1 Mc. If the test signal is 100 Kc, input bypasses the first mixer and goes directly to $\times 10$ multiplier. (303)

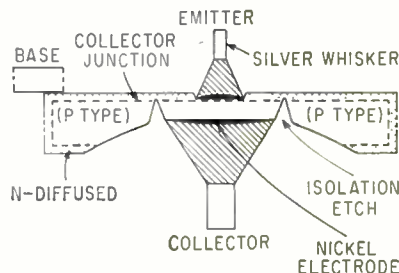

New Transistor Uses Micro-Alloy Diffused Electrode

ANNOUNCED by Philco Corporation, Tioga and C Streets, Philadelphia 34, Pennsylvania, the 2N2699 MADE (micro-alloy diffused electrode) transistor combines the micro-alloy emitter junction of the MADT type with the diffused collector junction of the MESA type. Used for ultra-high speed, low-level logic, the device is an avalanche-resistant transistor with 4-v emitter breakdown and 8-v open base collector-to-emitter breakdown rating. It also features collector output capacitance of 3.5 pF maximum at 10 v collector voltage and a specified base input voltage spread of 150 mv at 10 ma collector current and 1 ma base current. The unit uses a diffused collector junction (electrode) formed by an n-dopant into p-type germanium. This forms a pn junction within the dice whose junction area is restricted by an isolation etch. This results in an isolating moat around the nickel collector electrode extending into the n-type base region. The result is a thick mechanical basewidth providing high-power dissipation and narrow electrical basewidth allowing high-speed performance. (304)

Thermal Voltmeter Allows A-C Measurements to 50 Kc

MANUFACTURED by Weston Instruments and Electronics Div., Daystrom Inc., 614 Frelinghuysen Ave., Newark, N. J., the model 1573

What a Team!

... by MIDLAND

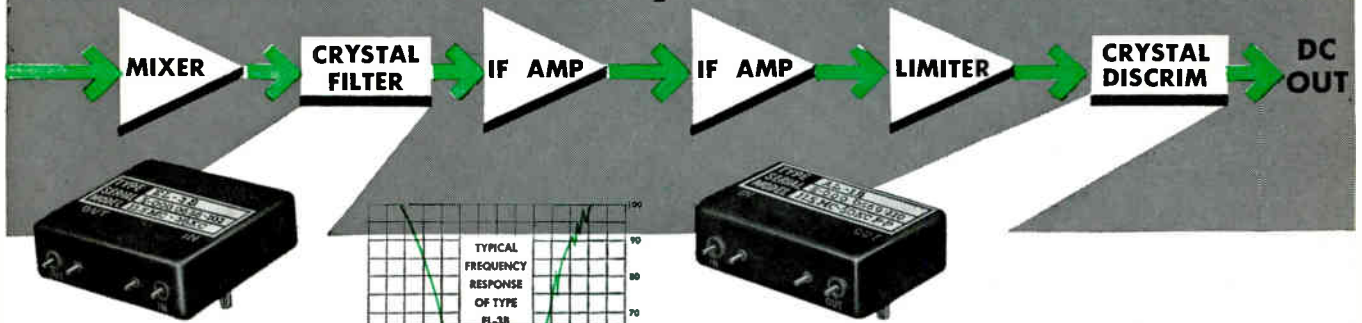

SPECIFICATIONS EL-3B

CENTER FREQUENCY: 11.5 MC \pm 1 KC
 3DB BANDWIDTH: 36 KC \pm 1 KC Min.
 60DB BANDWIDTH: 100 KC Max.
 ULT. REJ.: 90 db — 8 MC to 14 MC
 INSERTION LOSS: Less than 3 db
 INBAND RIPPLE: 0.5 db nom./1.0 db Max.
 OPERATING TEMPERATURE: -55°C to $+90^{\circ}\text{C}$
 Z_{in}/Z_{out} REQ.: 50 ohms \pm 5% resistive
 MAX. INPUT LEVEL: \pm 10 dbm
 SHOCK: 200 g's
 VIBRATION: 15 g's to 2 KC
 APPROX. SIZE: 1 1/4" L x 1 1/4" W x 1/2" H

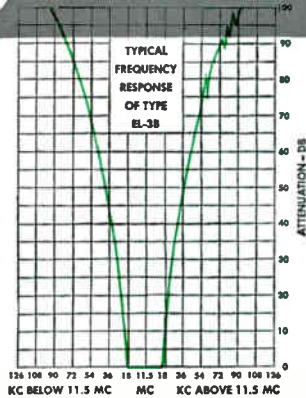

SPECIFICATIONS AL-1B

CENTER FREQUENCY: 11.5 MC \pm 2 KC
 BANDWIDTH PEAK/PEAK: \pm 25 KC Min.
 HARMONIC DIST.: Less than 2% @ \pm 6 KC dev.
 ZERO ADJUST.: \pm 1 KC
 INPUT LEVEL: 400 mv to 6 volts RMS
 OPERATING TEMPERATURE: -55°C to $+90^{\circ}\text{C}$
 Z INPUT: 300 ohms \pm 5% resistive
 Z OUTPUT: Greater than 100K ohms
 SHOCK: 200 g's
 VIBRATION: 15 g's to 2 KC
 APPROX. SIZE: 1 1/4" L x 1 1/4" W x 1/2" H

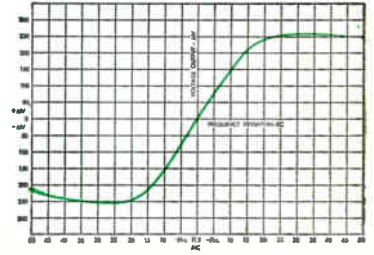

WRITE FOR ENGINEERING BULLETIN NBS-106

WRITE FOR ENGINEERING BULLETIN CDS-107

Midland MANUFACTURING COMPANY • KANSAS CITY 15, KANSAS
 WORLD'S LARGEST PRODUCER OF QUARTZ CRYSTALS AND CRYSTAL FILTERS • DIVISION PACIFIC INDUSTRIES, INCORPORATED

CIRCLE 212 ON READER SERVICE CARD

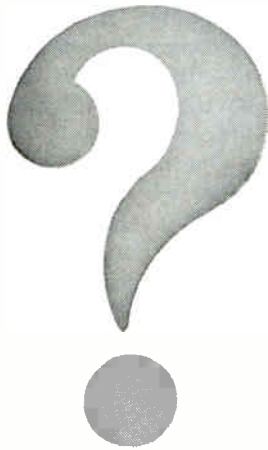

Are you selling the whole buying team

Tough competition demands that the electronics man be reached and sold wherever you find him: *Research, Design, Production, and Management.* Only advertising in electronics reaches all four... the same men your salesmen call on. Put your advertising where it works *hardest*....

in **electronics**

February 15, 1963

NEW

12-PAGE CERMET CATALOG

Complete Line—Cermet (ceramic-metal) high-temp variable and micro-miniature fixed resistors have excellent stability and high reliability. The Cermet element is processed at over 600°C. These resistors have proved successful on Apollo, Tiros, Minute Man and Talos, and similar projects where extreme environmental conditions are common.

CATALOG DESCRIBES

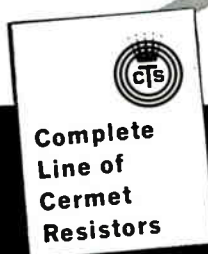

The new Cermet Catalog includes the environmental performance specifications, the electrical and mechanical specifications and ordering information as well as photographs of the entire standard Cermet line. Products listed in the catalog: 1. CERAFER (Module Cermet Fixed Resistor Wafers); 2. CERADOT (Cermet Pellet Resistors); 3. CeraTrolS (Cermet Variable Resistors); 4. CERATRIM (Cermet Trimmers).

Write for your **FREE** Cermet Catalog.

CTS of Berne, Inc., Berne, Indiana

Subsidiary of CTS Corporation, Elkhart, Indiana • West Coast: Chicago Telephone of California, Inc., 1010 Sycamore Avenue, South Pasadena, California • Canada: CTS of Canada, Ltd., Streetsville, Ontario, Canada



CIRCLE 109 ON READER SERVICE CARD

109

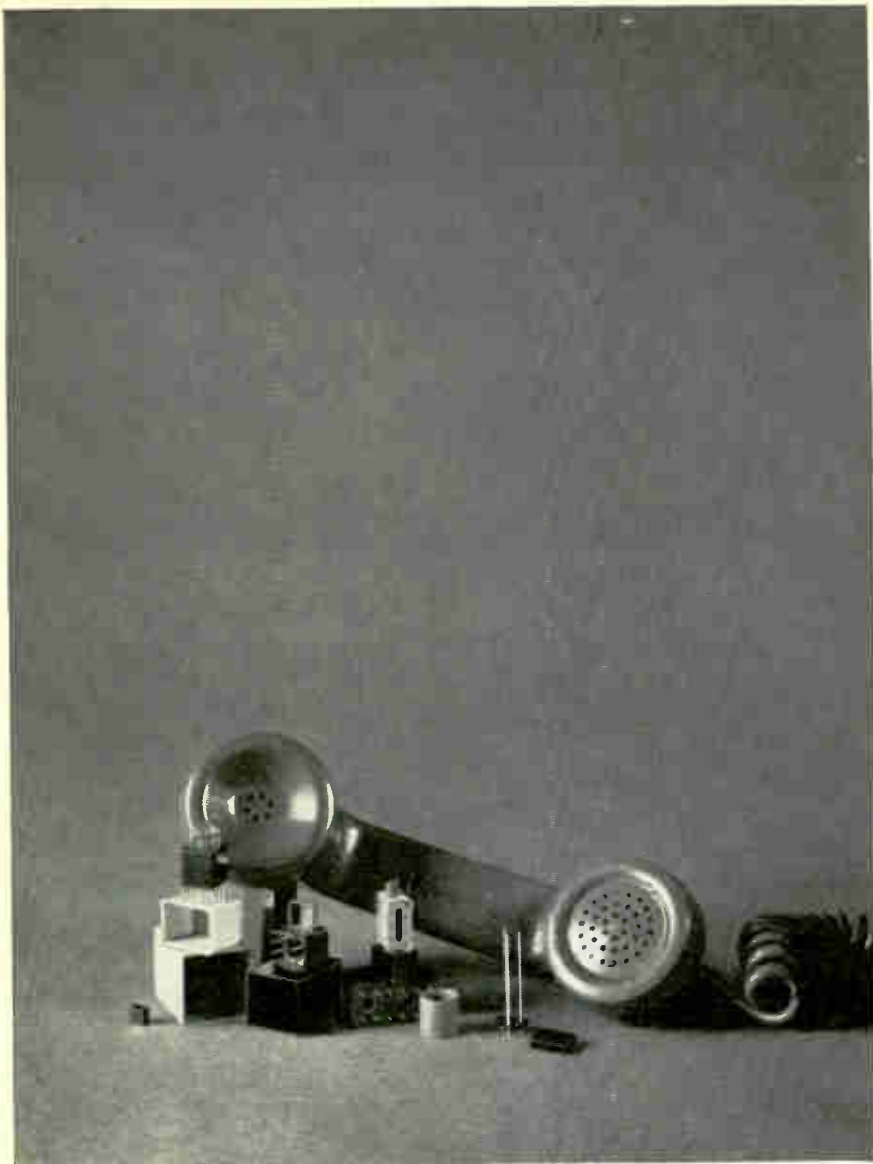

Precision-molded shells and headers for microcircuit encapsulation... call Milton Ross

Milton Ross precision-formed shells and headers are the simple solution to high-volume microcircuit and miniature component encapsulation. They provide a low-cost protective package that is consistently uniform and attractive, unit to unit and batch to batch. And they're available off the shelf, in a wide range of sizes, shapes, styles, and Mil-Spec materials.

Standard rectilinear and cylindrical shapes can be supplied in dimensions on any side from $\frac{3}{16}$ " to $2\frac{1}{2}$ ". Headers can be furnished with or without molded-in pins, in a number of pin styles and configurations. (We even have them with mounting

centers as close as 0.100".) Shells and headers are available in fifteen different colors (more, if need be), and they can be had in diallyl phthalate, alkyd, or epoxy. Quality? Judge for yourself; we mold any size and shape to a dimensional tolerance of ± 0.005 " or closer.

If one of the Milton Ross off-the-shelf items doesn't meet your spec's right down the line, we'll be happy to make a special shell and header for you—at no additional cost for tooling on orders of 2,000 units or more. And with a delivery time of only three or four weeks. Call or write for samples and dimension drawings.

thermo voltmeter has direct reading capabilities on both d-c and a-c to 50 Kc. Voltages from 1 to 1,000 v can be directly measured by a six-dial precision resistor forming an in-line digital readout. Sensitivity is 10 ma. Accuracy at 23 C as a direct-reading voltmeter is 0.015 percent on d-c, 0.025 percent between 50 cps and 10 Kc, 0.05 percent between 10 and 20 Kc and

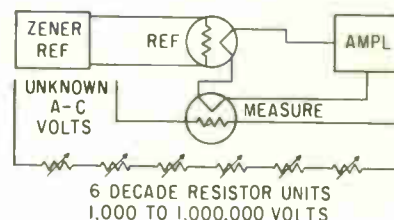

0.25 percent between 20 and 50 Kc. As a transfer standard between 40 cps and 1 Kc, accuracy is 0.005 percent and between 1 and 10 Kc, accuracy is 0.015 percent. As a d-c reference for digital voltmeter calibration between 0.1 and 10 v, accuracy is 0.005 percent + 2 μ v. As shown in the sketch, the basic a-c circuit uses special thermoelements having a reversal error 0.002 percent or less in a differential connection. The a-c measuring circuit is adjusted to exactly 100 ohms at 10 ma supplied by a regulated, well-filtered zener reference source having a stability of 0.003 percent for a minimum of three months. Output is balanced for null with 10 ma in the measuring circuit heaters. D-c measurement above 1 v is made by direct comparison with the zener reference in series with the null detector across a 100-ohm precision resistor. Unknown voltage is applied across the same resistor and decade adjusted for null.

CIRCLE 305 READER SERVICE CARD



Piston Trimmers Offer High Capacitance

ROANWELL CORP., Elcom Department, 180 Varick St., New York 14, N. Y. Series of precision piston trimmer capacitors features simple



THE MILTON ROSS COMPANY

513 SECOND STREET PIKE • SOUTHAMPTON, PA. • (215) EL 5-0200

SA 2762

construction and high capacitance values from 1 to 40 $\mu\mu\text{f}$ up to 1 to 90 $\mu\mu\text{f}$. They have no capacitance reversal and have a Q factor of 500 minimum at 1 Mc. Operating temperature is -55 to $+125$ C. Tuning torque is 1 to 5 in.-oz. Length (behind panel) for 90 $\mu\mu\text{f}$ capacitance is 2 in. Units feature solid metal electrode bands which permit the user to solder directly to the electrode at any point. (306)

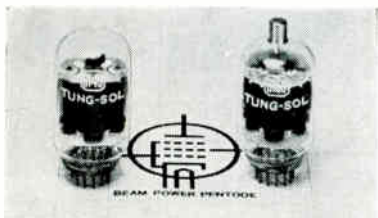

Beam Power Pentodes Operate at 40 W

TUNG-SOL ELECTRIC, INC., One Summer Ave., Newark 4, N. J., offers two beam power pentodes intended for use as r-f power amplifiers and oscillators at frequencies up to 175 Mc. Type 8149 is a single ended T-12 compactron design and the 8150 is a double ended T-12 compactron design. Both feature a center tapped heater so that they may be operated from either a 3-cell or 6-cell storage battery system. Both have 12 pin button bases and have cathodes coated unipotential. (307)

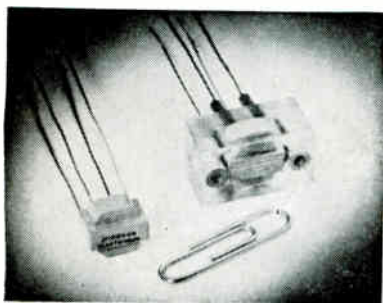

Audio Transformers for Transistor Circuits

JOHNSON ELECTRONICS, INC., P. O. Box 7, Casselberry, Fla., announces a line of subminiature transistor transformers that operate over frequency range of from 100 cycles to 100 Kc. With a power rating of 50 mw at 300 cycles, the units have a frequency response of 3 db down at 150 cycles. Response is flat from 400 cycles to 30 Kc. Primary d-c

No. 3 of a Series—What's behind the superior reliability of Atohm Trimmer Potentiometers

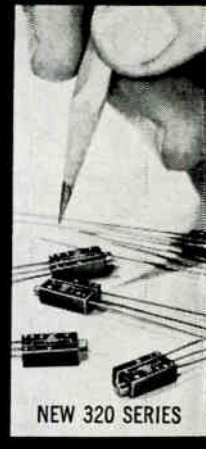
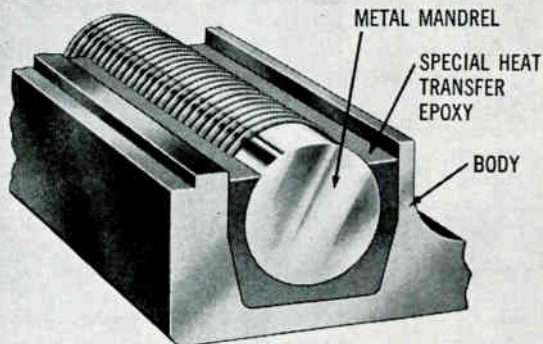

Atohm's metal mandrel eliminates hot pots

All Atohm trimmer potentiometers use *metal* mandrels imbedded in a special heat-transfer epoxy. This combination provides far better heat dissipation than techniques and materials used in competitive instruments. Atohm pots operate cooler, and are, therefore, more reliable. Write for catalog.

Don't rely on "Pot Luck"—ask for
ATOHM ELECTRONICS INC.
7648 San Fernando Road, Sun Valley, California



CIRCLE 222 ON READER SERVICE CARD

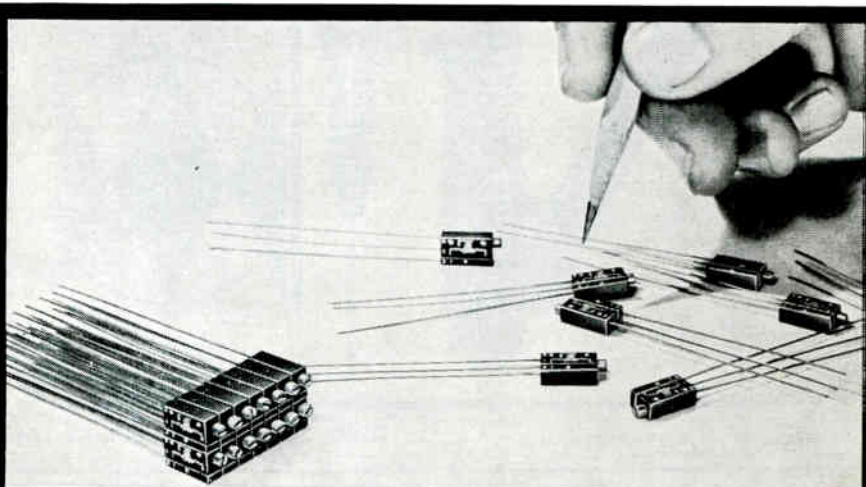

52 linear, wirewound pots in 1 cubic inch!

You may never use 52 pots in such a small space, but you could with the new Atohm Series 320. It's a precision, trimmer pot measuring only .250" x .435" x .150", but providing resistances from 5 ohms to 50K ohms. Its simple, linear mechanism provides a more uniform winding, more ohms per linear length, and better mechanical distribution of the resistant material. Unique, clip-type mounting. Write for complete data.

ATOHM ELECTRONICS
7648 San Fernando Road, Sun Valley, California



CIRCLE 111 ON READER SERVICE CARD

111

LOOKING FOR A
MINIATURE
METAL NIBBLER?

OR A GOLD-PLATED
MICRO-PROBE?

OR A SELECTION
OF OTHER
MICROSCOPIC
HAND TOOLS?



STOP LOOKING

Now you can get any miniaturized precision tool you need from one reliable source . . . Micronics Corporation of America. Any micro-electronic tool? Take a look for yourself. More than 850 cost-cutting tools are illustrated in the new Micronics Corp. catalog. Including assembly bench tools, epoxy systems, optical production tools, highly specialized precision tools, ultrasonic systems and white room equipment • Why waste time—and money—shopping around for micro-tools when you can get everything you need from Micronics? Without paying a nickel more than competitive industry list prices! • Write for a copy of the industry's first complete catalog of microscopic hand tools . . . or ask your Purchasing Agent to contact your local Micronics distributor.

MICRONICS
CORPORATION
OF AMERICA



Department M201
8116 Old York Road • Phila. 17, Pa.

CIRCLE 112 ON READER SERVICE CARD



Your electronics BUYERS' GUIDE should be kept in your office at all times—as accessible as your telephone book.

current is 0.5 ma with primary impedance from 10,000 ohms to 20,000 ohms depending on part number.

CIRCLE 308 READER SERVICE CARD

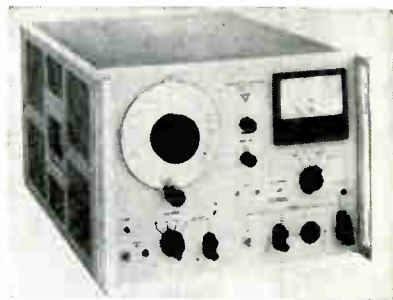

Frequency Changer Provides Up to 260V

HEWLETT-PACKARD CO., 1501 Page Mill Road, Palo Alto, Calif. The frequency changer, model 4301A, is essentially an r-c oscillator feeding a sine wave into a low distortion power amplifier. The oscillator covers 40 to 2,000 cps with an accuracy of ± 1 percent and a stability of ± 1 percent. Harmonic distortion is less than 1.5 percent for resistive loads, and is less than 5 percent of reactive loads with power factors up to 0.7. The output voltage is continuously adjustable from 0 to 130 v at 2 amp max output current, or from 0 to 260 v at 1 amp max. (309)

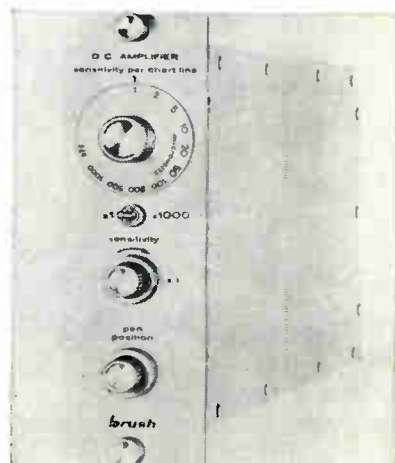

Modular Preamplifier Features Low Noise

BRUSH INSTRUMENTS, Division of Cleveland Corp., 37th and Perkins, Cleveland 14, O., offers a low-noise, high-impedance, modular preamplifier that extends the sensitivity of medium gain recording systems to levels as

low as 1 μ v. Designated model RD4215 60, the compact, solid-state unit assures clear, high-resolution recordings from such low level sources as thermocouples, EEG electrodes, and photocells when used in combination with Brush Mark 200 or any standard Brush medium gain direct writing system. (310)

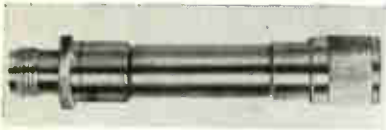

Coaxial Filters Cover 100 Mc to 10 Gc

RLC ELECTRONICS, INC., 25 Martin Place, Port Chester, N. Y., offers a line of precision low pass coaxial filters. Model F-30 covers a frequency range of 100 Mc to 10 Gc in 13 standard units. Each unit has a power rating of 100 w average. Each has a minimum 60 db stop band rejection of 1.35 to 5.0 cutoff frequency. Units range in length from 14½ in. to 4½ in. These coaxial filter assemblies provide a minimum vswr, 1.3 max, over the pass band. Insertion loss over the pass band is 0.2 db max. Price is from \$30 to \$55 depending on frequency. (311)

Toroids

SATURN ELECTRONIC CORP., 126-03 18th Ave., College Point, N. Y. Precision 360 deg resistive toroids and magnetic toroids are fabricated on Saturn's own proprietary winding machines that are capable of winding extremely small diameter (0.0006 in.) wires. (312)



Static Power Supply Offers Dual Output

VICTORY ELECTRONICS, INC., 145 Michael Drive, Syosset, L. I., N. Y. Model AD100-50-2C a-c to d-c static



CUT COSTLY CUSTOM ENCLOSURE
DESIGN TIME TO A MINIMUM

SPECIFY EMCOR®

STANDARD ENCLOSURES

Fulfill your enclosure requirements with the simplicity of EMCOR Enclosure catalog ordering. Make literally thousands of control center assemblies, equipment banks, or console arrangements from hundreds of enclosure widths, depths and heights in a variety of configurations. Broad range of colors. Investigate these and many more EMCOR Enclosure features for reducing your costly custom enclosure design time to a minimum. Get full details today.

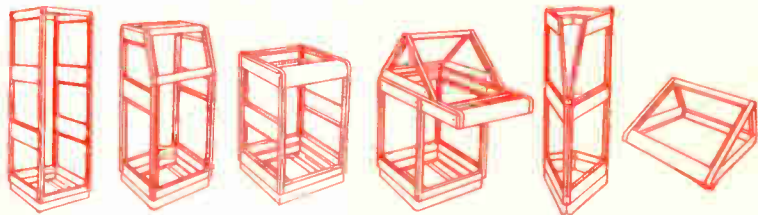

REQUEST DESIGN MANUAL 107



BORG-WARNER

EMCOR—The Original Modular Enclosure System by

INGERSOLL PRODUCTS

Division of Borg-Warner Corporation
1000 W. 120th ST. • DEPT. 1242 • CHICAGO 43, ILL.

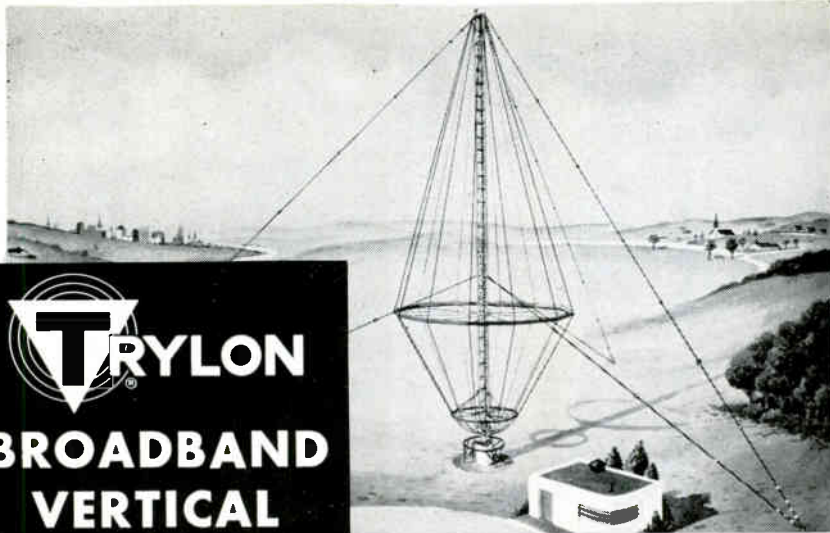

TRYLON BROADBAND VERTICAL RADIATORS

for frequency ranges from 2 to 6 mc.
4.5 to 13.5 mc.—11 to 33 mc.—or similar ranges

A multi-frequency service radiator requiring no matching equipment

ADVANTAGES

- Extremely constant input impedance over a wide frequency range.
- Power handling capacity to 150 kw. or more.
- Radiation performance equal to, or better than a conventional radiator without the need of impedance matching equipment.

WIND TURBINE COMPANY ELVERSON, PA.

Phone: WHitney 2-2981
(Area 215)

TRYLON TOWER AND ANTENNA SYSTEMS

- RESEARCH
- MANUFACTURE
- DEVELOPMENT
- INSTALLATION

Write, wire or phone for information or application to your requirements.

CIRCLE 213 ON READER SERVICE CARD

For Production

Line Testing...



EICO SCOPES

give you:

- professional performance
- reliability
- ruggedness
- versatility

... at moderate cost

EICO's high quality standards and low initial cost add up to true economy: EICO units outperform scopes selling for two or three times EICO's prices.

With kits, the initial cost is even lower. And the experience each operator gains in building his own, increases his efficiency, and enables him to keep his scope in better condition, with less "down" time.

	prices		freq. resp. (sinusoidal)		sensitivity (rms)	
	kit	wired	vert.	horiz.	vert.	horiz.
5" Push-Pull Scope #427	\$69.95	\$109.95	DC-500 KC/FLAT	2 CPS TO 450 KC/FLAT	10mv P-P/cm	0.5V P-P/cm
5" DC-4.5 MC Scope #460	79.95	129.95	DC-4.5 mc/flat	1 cps to 400 kc flat	25 mv/in	0.6 V/in



See the 41 additional EICO test instruments helpful for your lab and production work. Write for free Catalog & name of neighborhood Distributor.

3300 NORTHERN BOULEVARD, Dept. E-2B, L. I. C., 1, N. Y.

See us at I.E.E.E. Booth 3101

power supply is designed to operate from 108 to 122 v 380 to 420 cps. Unit operates at 80 percent efficiency. Two completely separate outputs provide 2 amp each, one at 50 v d-c, the other at 100 v d-c. Regulation for line and load for each output is ± 0.5 percent, ripple is 0.05 percent rms. Output voltage is variable for 5 percent minimum.

CIRCLE 313 READER SERVICE CARD

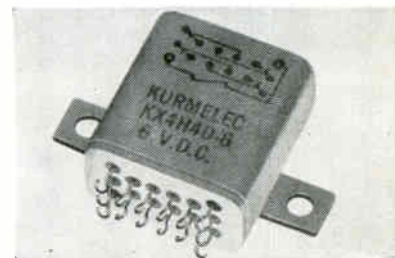

Microminiature Relay Meets MIL R-5757D

KURMAN ELECTRIC CO., 191 Newel St., Brooklyn 22, N. Y. Model KX4H4D Astrolrelay, a 4pdt micro-miniature unit, is available for immediate, off-the-shelf delivery. It weighs $\frac{1}{2}$ oz and can be specified in three stock voltages—6, 12, 24 v d-c (35, 150, and 600 ohms). It withstands 100 g shock and 40 g vibration up to 2,000 cycles. Operating temp is -65 C to 125 C. (314)

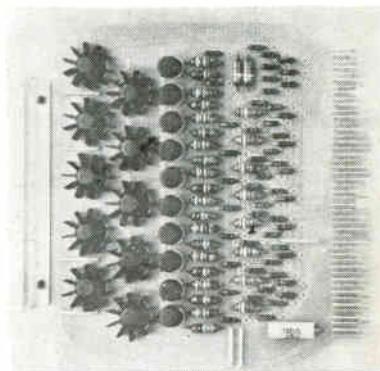

Display Driver Modules Operate From 0-100 C

SCIENTIFIC DATA SYSTEMS, 1542 15th St., Santa Monica, Calif. Two silicon modules are available for driving either an incandescent display or a Nixie display. Both operate at temperatures from 0-100 C and permit direct decoding of any of the following codes: (8, 4, 2, 1), (2, 4, 2, 1), (5, 4, 2, 1), (4, 2, 2, 1), (Excess 3) or (Gray). Output is

add 5% in the West

10 lines while input uses standard silicon module voltage levels of zero and +8 v. (315)



Socket Made to Fit Transistor-Size Relay

BRANSON CORP., 41 S. Jefferson Road, Whippany, N. J. Current rating for this microminiature relay socket is 2 amp. Dielectric strength at sea level is 1,000 v rms between terminals and between terminals and ground. At 70,000 ft the comparable dielectric strength is 350 v rms. Operating temperature range is -65 C to +125 C. The unit has five pin, solder lug terminals. (316)

Ferrite Memory Core

ELECTRONIC MEMORIES, INC., 8430 Bellanca Ave., Los Angeles 45, Calif. A new Isodrive ferrite memory core in the 30 mil size for use in coincident current memories can be operated over a temperature range of -65 C to +100 C without compensation. (317)



Tape Recorder Amplifier Has Adjustable Gain

ASTRODATA INC., 240 S. Palais Road, Anaheim, Calif. Modular instruments tape recorder amplifier provides amplification between 1 and 100 to signals which range from d-c to 200 Kc. The all-transistorized, adjustable-gain model TPA-141 is especially designed for use in coupling medium-level signal sources to tape recorders, f-m subcarrier oscillators, strip chart recorders and other instrumentation. Eleven

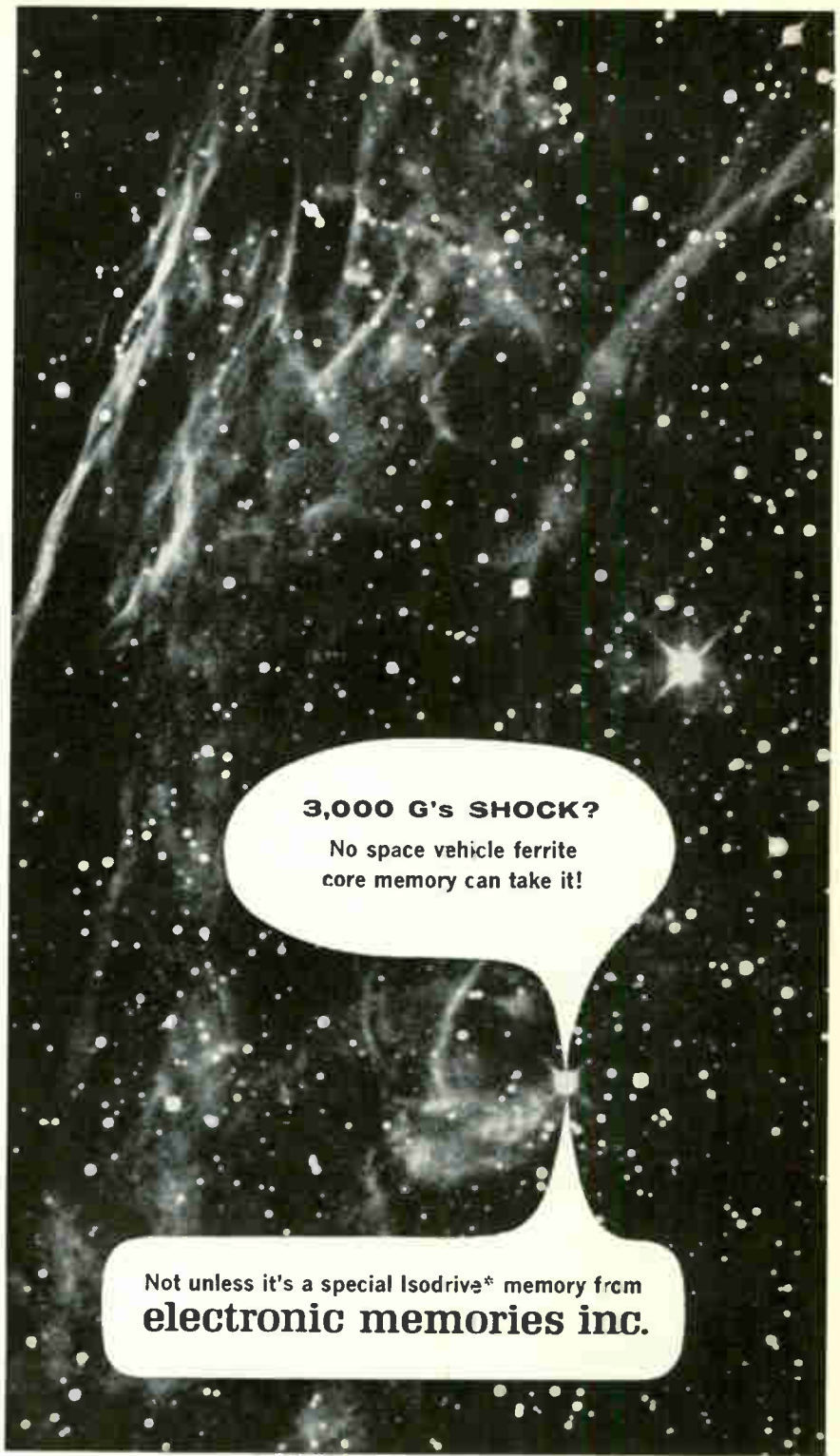

3,000 G's SHOCK?

No space vehicle ferrite core memory can take it!

Not unless it's a special Isodrive* memory from **electronic memories inc.**

Take a 1440-bit memory. Accelerate it at 180 mph into a balsa structure. As it hits, decelerating 3,000 G's in 3 milliseconds, feed it information. Then see what it remembers. ■ That's what Ford's Aeronutronic Division did to one of our SE1440Z1A Isodrive* memories. Results? Perfect! The memory was still intact. So was the data. Likewise our claim that a 1.2-pound, 2" x 3" x 5" core memory with a 50,000-bit/second read/write cycle could do it. And



that's not to mention a calculated mean-time-to-failure of 50,000 hours while exposed to ambient temperatures from -20°C. to +60°C. ■ At Electronic Memories, Inc., conquering shock is only part of the story. Across the board, our capabilities in MIL-Spec ferrite cores and memories are extensive. It's all spelled out in our capabilities brochure. Shouldn't you have one? Write Dept. C, 9430 Bellanca Ave., Los Angeles 45, Calif.

© Electronic Memories, Inc.

OVER 400 STANDARD MODELS OF REGULATED POWER SUPPLIES

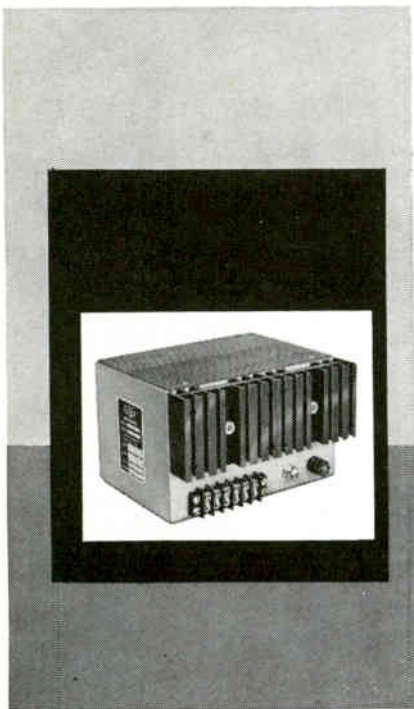

IF NONE OF THE 400 STANDARD MODELS MEET YOUR REQUIREMENTS, ELASCO WILL MODIFY STANDARD DESIGNS OR DESIGN TO YOUR SPECIFICATIONS

WRITE NOW FOR COMPLETE 12 PAGE CATALOG . . . AND BETTER STILL, SEND YOUR POWER SUPPLY REQUIREMENTS FOR QUOTATION



ELASCO, INC.
FIVE PRESCOTT ST.
ROXBURY 19, MASS.

Highlands 2-1600

gain steps may be selected by front panel switch. Gain accuracy is ± 1 percent at d-c; gain stability, ± 0.1 percent for three months.

CIRCLE 318 READER SERVICE CARD

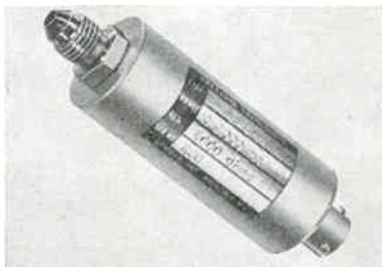

Pressure Transducers Are Rugged, Accurate

PRECISION SENSORS, INC., 1133 Main St., Paterson, N. J. The HPT-35 subminiature pressure transducer features a construction which combines pressure sensor and mechanism assembly for maximum stability, ruggedness and accuracy. A precision wire wound potentiometer element provides excellent output characteristics. The instrument is designed for pressure ranges of 0-500 to 0-20,000 psi. Units insure outstanding service in industry, laboratory research and advanced missile applications. Price is \$294. (319)

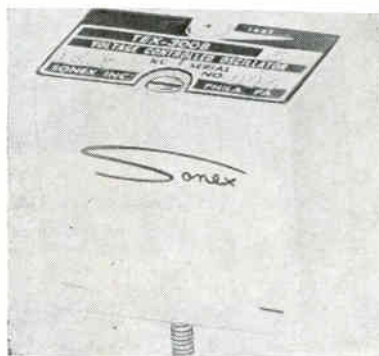

Telemetry Oscillator With No Adjustments

SONEX, INC., 20 East Herman St., Philadelphia 44, Pa. The TEX-3008 is a 1.1 cu in. all solid-state high environmental subcarrier oscillator. Its stable characteristics are emphasized by the absence of adjustment potentiometers; this feature eliminating failures due to human error in the field. Units are available in all standard IRIG frequencies from channel 4 through 18 and

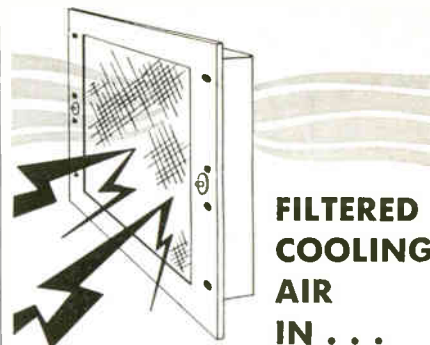

**FILTERED
COOLING
AIR
IN . . .**

RFI OUT!

WITH NEW
McLEAN
RFI
SHIELDED
BLOWERS
and Filter-Grille Assemblies

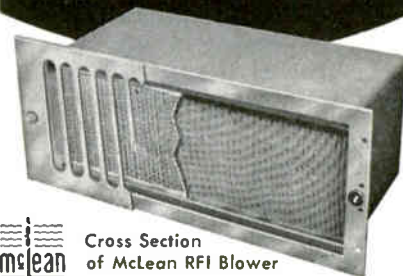

McLean Cross Section
of McLean RFI Blower

Now you can pressurize radio-shielded electronic cabinets with cool, filtered air without opening the "envelope" to RF interference.

McLean RFI-shielded blowers and filter-grille assemblies have been designed and built for RFI performance in accordance with MIL-1-6181D — meeting or exceeding all requirements including susceptibility, generation and shieldability. WRITE TODAY for details.

SEND FOR
NEW 44-PAGE
CATALOG



**McLEAN ENGINEERING
LABORATORIES**

World Leader in Packaged Cooling
P.O. Box 228, Princeton, New Jersey
Phone Area Code 609 WALnut 4-4440

TWX 609-799-0245

See us at The New York IEEE Show Booth #1624
CIRCLE 214 ON READER SERVICE CARD

electronics

channels A through E. Linearity of ± 0.25 percent from best straight line and a high input impedance of 750,000 ohms are maintained for -20 C to $+85\text{ C}$. (320)

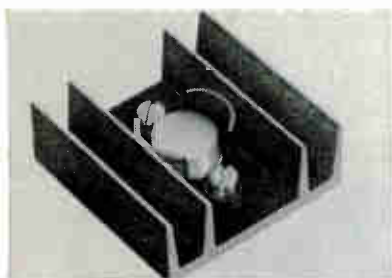

Heat Dissipators For Semiconductors

AUGAT INC., 33 Perry Ave., Attleboro, Mass. Series 9021 heat dissipators are designed for TO-8 or stud mounted semiconductors. Employing an extruded parallel fin design, they give maximum efficiency in either a vertical or horizontal position. The units are small (1.590 by 1.590 by 0.625 in.) but dissipate heat at the rate of 6 deg C/w. (321)

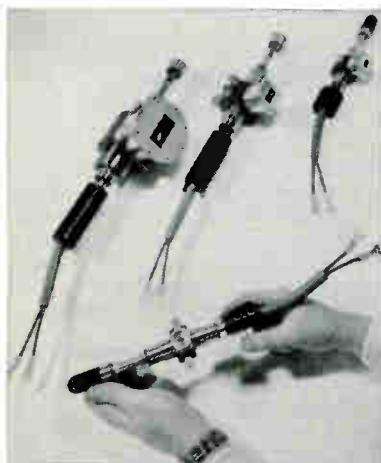

High Power Magnetrons Come in 4 Models

FERRANTI, LTD., Ferry Road, Edinburgh 5, Scotland, introduces a new range of 4 high power magnetrons ranging in peak power from 2 Mw at about 5,000-6,000 Mc to 100 Kw at 35,000 Mc all with very high mean power ratings. This is largely due to the company's development of the bombardment type high temperature thoriated tungsten cathode previously exploited only at X-band in their VF10 and VF11. Heating by means of an electron

PAKTRON TAKES THE HAND WORK OUT OF MICROMODULE PRODUCTION

The Micromodule Assembler is only one of the units designed and made by PAKTRON to eliminate hand operation.

With "controlled mechanization", reliability is constant as production is increased.

Ten years' experience in electronic circuit packaging, metalization, ceramics, automatic assembly and test devices are reasons why PAKTRON is one of the prime suppliers in this new technology.

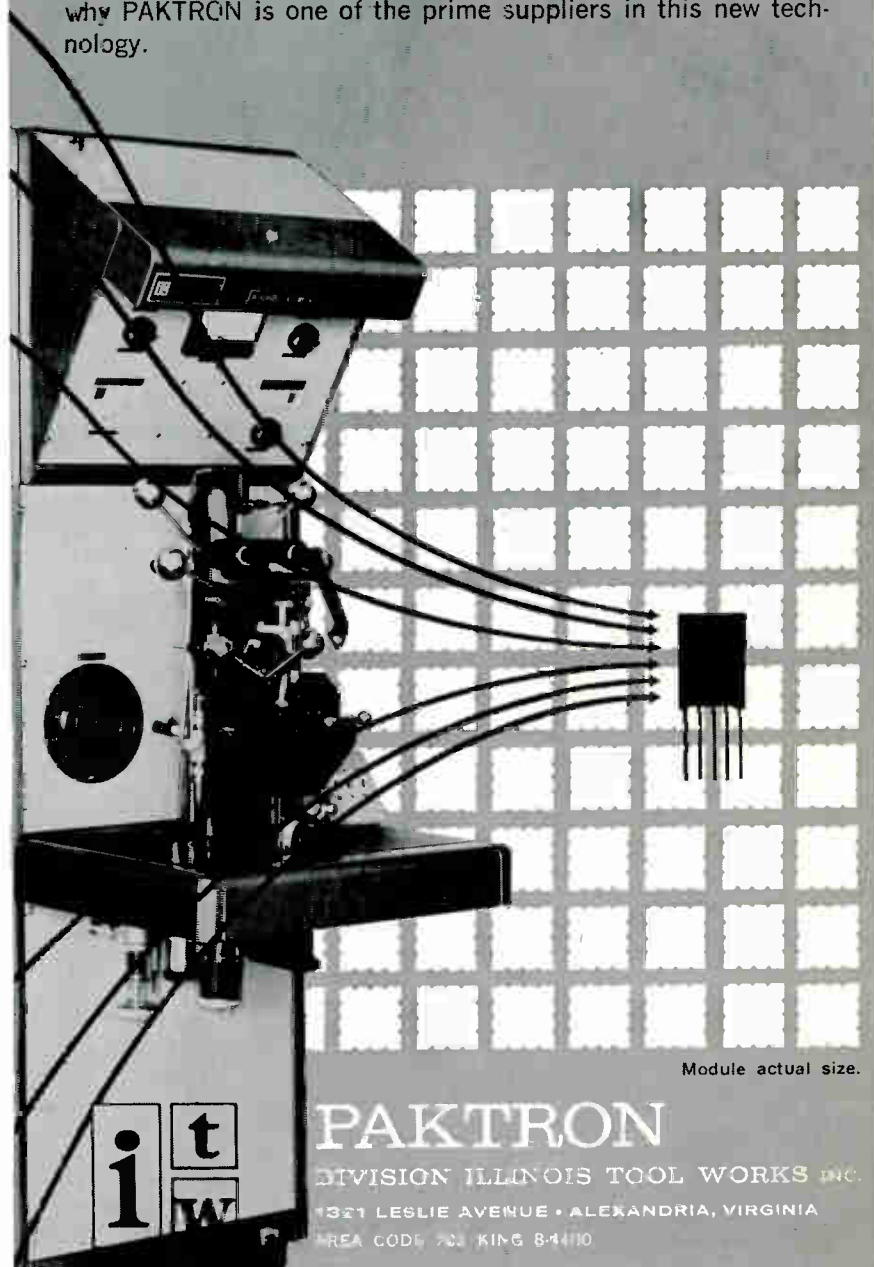

Module actual size.



PAKTRON

DIVISION ILLINOIS TOOL WORKS INC.

1321 LESLIE AVENUE • ALEXANDRIA, VIRGINIA

AREA CODE 703 KING 8-4410



Now . . . a low-cost Planar Passivated Silicon Transistor for the entertainment market

New 2N2711 series now available in quantity for hi-fi, TV, and portable radio applications

Now . . . for the first time in the entertainment market . . . a highly reliable *silicon* transistor at *germanium* prices.

The 2N2711 series silicon planar passivated transistor represents a new concept in transistor manufacturing. It is not a "fallout" of an existing product type. It is designed, manufactured and marketed strictly for entertainment applications . . . and it features high power gain, low noise, low *I_{CO}*, high mechanical strength, and small size (fits TO-18 outline, except 250 mil height, for smallest portables).

27 MC Crystal Controlled Superheterodyne

MINIMUM DISCERNIBLE SIGNAL
= 0.5 μV ACROSS 50 Ω

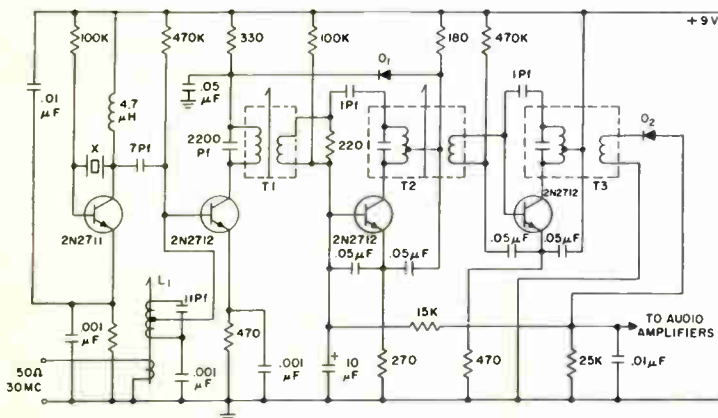

X - 27 MC XTAL
T₁ - RADIO INDUSTRIES 13964-R,
T₂-T₃ - RADIO INDUSTRIES 13964
D₁ - GERMANIUM DIODE

L₁ - 15T #30 WIRE TAPPED 5T
FROM GRD END - ON CTC LS6
FORM WHITE DOT CORE.
D₂ - SILICON DIODE

One million transistor hours of life test back up the reliability of the New 2N2711 series Planar Passivated Silicon Transistors.

Everything is optimized for amplifier service! No high-cost glass-to-metal seals. A unique, new solid-epoxy housing on a planar passivated surface makes possible exceptionally high levels of performance at exceptionally low cost . . . with the reliability inherent in a planar passivated silicon transistor. For complete technical data ask for Application Note 90.8. Write: Section 16B146, Semiconductor Products Department, General Electric Company, Syracuse, New York. In Canada: Canadian General Electric, 189 Dufferin St., Toronto, Ont. Export: International General Electric, 159 Madison Ave., New York 16, New York.

Performance Data

High Power Gain . 42-45 db.
Neutralized at 455 kc.
Low Noise S/N in typical RF circuit, 22 db.; 10 Kc Noise Figure of 2.8 db.
Betas Two ranges: 30 to 90, 75 to 225
Low *I_{CO}* 0.5 μA max.

Available through your G-E semiconductor distributor

gun allows a far higher cathode temperature to be used without involving a short heater life.

CIRCLE 322 READER SERVICE CARD



Ultrasonic Cleaner Has Large Capacity

L&R MFG. CO., 577 Elm St., Kearny, N.J., has developed a 22-quart ultrasonic cleaner in portable console form. The Ultra-Clean 760 GT is a completely self-contained, one-piece console on casters which can be moved easily to any location where ultrasonic cleaning is required. The entire console is controlled by a single knob, making it practical for use by production line personnel and others who might be unfamiliar with the complexities of tuning, dialing, etc. Overall size, 33 by 13 by 21 in. (323)

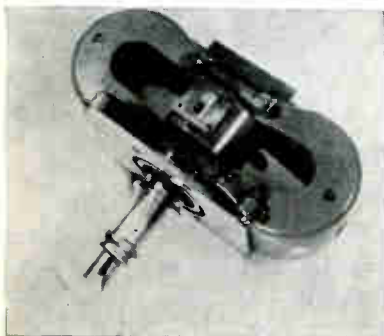

X-Band Magnetron Delivers 1.5 Mw

S-F-D LABORATORIES, Union, N. J. The SFD-303A CEM coaxial magnetron generates 1.5 Mw peak and



aluminum foil for electronics

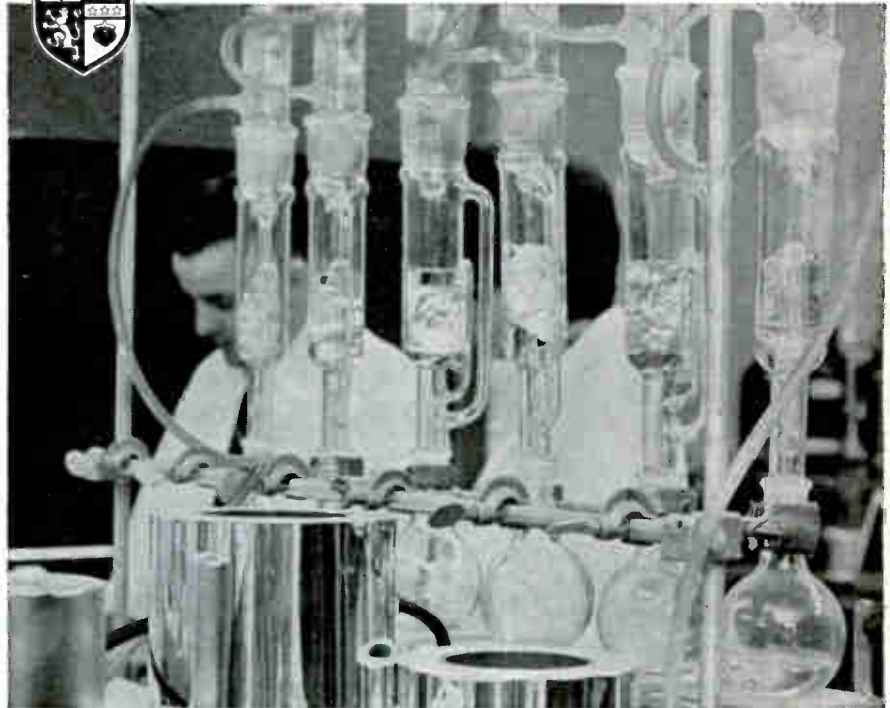

"Quality Leadership"

Extracting organic residues from specimens of each run of capacitor foil enables Republic to maintain strict control over the foil surface . . . vital to the manufacture of electronic components such as condensers. Continual monitoring of surface condition is but one of the advanced test methods that is a direct result of Republic's recognition of the critical requirements of the electronics industry. Republic's **Electro-Dry®** Foil is the highest quality foil for condensers and capacitors (surface residues are controlled by Republic's proved extraction test like the one pictured above) assuring maximum performance. This is why Republic Foil continues to maintain . . . **Quality Leadership.**

Whether your requirements are for plain aluminum foil for paper or film wound capacitors, or for etched aluminum foil for the manufacture of high reliability electrolytic capacitors, Republic Foil consistently meets the most critical specifications.

THE LEADING MANUFACTURER OF A COMPLETE LINE OF CAPACITOR FOIL

- LIGHT GAGE FOIL for paper and film wound capacitors of all types,
- ETCHED ANODE & CATHODE FOIL
- PLAIN FOIL FOR ETCHING
- PLAIN FOIL for electrolytic capacitors, coil winding, and other uses,
- FULL TECHNICAL SERVICE

write for brochure describing Republic's full foil line



REPUBLIC FOIL INC.

GENERAL OFFICES • DANBURY, CONNECTICUT

ROLLING MILL DIVISION — Danbury, Connecticut

ELECTROCHEMICAL DIVISION — Salisbury, North Carolina

BRANCH SALES OFFICES — 5306 West Lawrence Ave., Chicago 30, Illinois
Van D. Clothier, Inc., 165 South Mission Road, Los Angeles 33, California



NOW! HIGH FREQUENCY PERFORMANCE
UP TO 100 Mc.

WITH MECHATROL'S
NON-WIREWOUND **MECHATRIMS**[®]

1/2" SQUARE TRIMMER POTENTIOMETERS

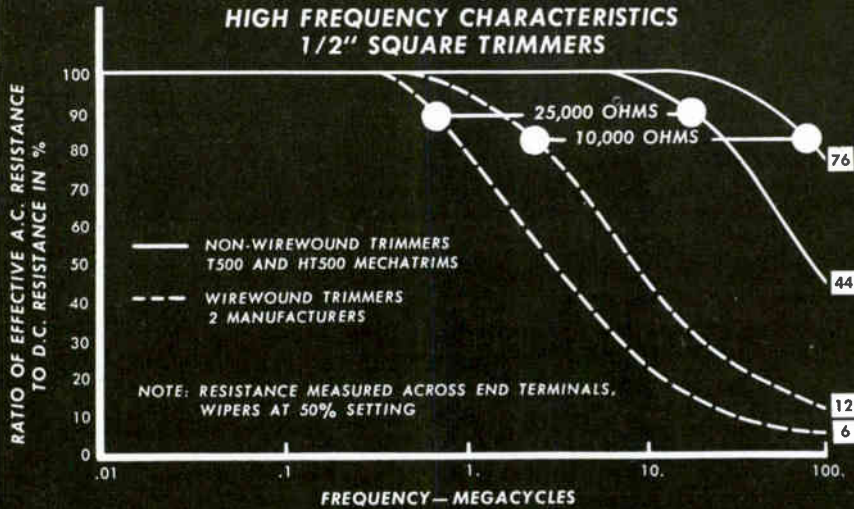

SERVOMECHANISMS/INC.
MECHATROL DIVISION

WESTBURY, LONG ISLAND, NEW YORK

EL SEGUNDO, CALIFORNIA

CIRCLE 215 ON READER SERVICE CARD

1 Kw average power at 9.375 Gc. Power is coupled in RG/51U waveguide through a ceramic output window. The 43 lb packaged tube operates at 55 percent efficiency. The inherent stability of the magnetron is displayed by the 3.5 Mc typical pulling figure. Unit is liquid cooled and operates over a wide range of pulse conditions, to more than 2 μ sec.

CIRCLE 324, READER SERVICE CARD

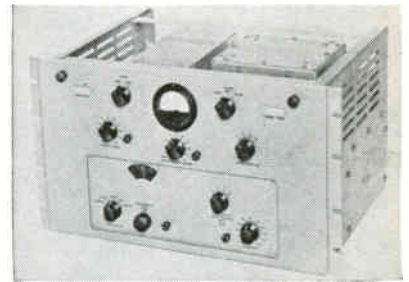

Keyer Calibrates Frequency Shift

MARS ELECTRONICS, Syosset, L. I., N. Y., announces a frequency shift keyer which provides 10 crystal oven-controlled channels and meets MIL specifications. Model FS-303 provides a means for modulating an r-f carrier signal with FSK transmissions. It has a frequency range of 2 to 4 Mc with 10 separate channels provided. Frequency shift is calibrated from 0 to ± 1000 cycles. Power output is approximately 2 w into 50 ohms. (325)

SLIT MASKING TAPE INTO EXTRA THIN STRIPS—FAST WITH DISPENS-O-SLIT[®]



4 EASY STEPS

1. Apply tape to female groove block
2. Run cutting block across tape
3. Raise ends of slit tape with the lift block
4. Lift slit pieces of tape with tweezers

FEATURES

- Can slit tape ranging in size from 1/4" to 4" wide into slits 1/16" to 3/8" wide.
- Eliminates large stocks of pre-slit tape.
- Can get 8 rolls of 1/8" tape from one roll 1" tape—substantial savings.
- Blades press fit for easy adjustment of widths.
- Portable—can be placed at any working area.

Write for complete descriptive literature on Dispens-O-Slit and other Mask-O-Matic products.

mask-o-matic inc. 
WHEN MASKING... REMEMBER MASK-O-MATIC.

55 Belmont Ave. • Paterson 2, N. J.
Area Code 201 Phone 684-5600

NIMS

NATIONWIDE IMPROVED
MAIL SERVICE PROGRAM

For Better Service
Your Post Office
Suggests

That You Mail Early
In The Day!



Component Ovens in Over 100 Designs

MONITOR PRODUCTS CO., 815 Fremont Ave., South Pasadena, Calif., offers a line of ovens used to control the temperature of crystals, oscillators, and other temperature sensitive components. Over 100 designs are available from miniature airborne crystal ovens to rack mounted laboratory units. Stabilities to ± 0.003 C can be met. (326)

Literature of the Week

EPOXY ADHESIVE Gulton Industries, Inc., 212 Durham Ave., Metuchen, N. J. Bulletin covers an epoxy adhesive offering the optimum combination of tenacious bond strength and high conductivity at a low price. (327)

ANTENNA PEDESTAL Temec, Inc., 7833 Haskell Ave., Van Nuys, Calif., has catalog sheet on model 12 servo-position antenna pedestal. (328)

SILICON PLANAR TRANSISTORS Sperry Semiconductor, Norwalk, Conn. Technical bulletin SS-500 describes the new silicon planar transistors which combine high breakdown voltage with high beta in a single transistor. (329)

D-C TRANSDUCER/AMPLIFIER Taber Instrument Corp., 107 Goundry St., North Tonawanda, N. Y. Bulletin introduces a 0-50 psia, 5 v d-c transducer/amplifier. (330)

NOISE SOURCE TUBE Warnecke Electron Tubes, Inc., 175 West Oakton St., Des Plaines, Ill. Catalog RW-100 describes a 50 Kc to 200 Mc high-powered permanent magnet focus noise source tube. (331)

CALIBRATION PRESSURE CONTROLLER Consolidated Electrodynamics Corp., 360 Sierra Madre Villa, Pasadena, Calif. Operation of type 6-003 calibration pressure controller is described in a bulletin. (332)

PROGRAMMING PACKAGES General Electric Co., Phoenix, Ariz., has available five "software" brochures on latest programming packages for the GE-225 computer. (333)

RECORD ACCESSORIES Texas Instruments Incorporated, 3609 Buffalo Speedway, Houston 6, Texas. Bulletin R-504 describes series 300 accessories for the "recti/riter" galvanometric recorders. (334)

MULTIPLE-COMPUTER SYSTEM Burroughs Corp., Detroit 32, Mich. Technical information bulletin contains an illustrated paper on the D825—a multiple-computer system for command and control. (335)

INSERTION LOSS TEST SET Weinschel Engineering, P. O. Box 577, Gaithersburg, Md. *Application Note* No. 4 describes a dual channel insertion loss test set. (336)

TIME-MARK GENERATORS Accutronics, Inc., 12 South Island, Batavia, Ill. Single sheet brochure covers a line of portable, battery powered time-mark generators. (337)

SHAFT ENCODER Theta Instrument Corp., 520 Victor St., Saddle Brook, N. J. Engineering bulletin describes the Decitrak, direct-decimal shaft encoder. (338)

COMPONENT CLIPS Braun Tool and Instrument Co. Inc., 140 Fifth Ave.,



OFFERS THE WIDEST RANGE OF RESISTANCE VALUES

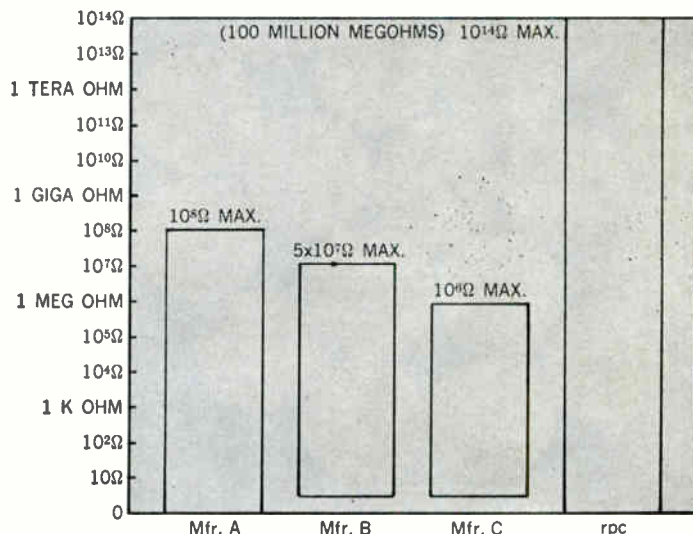

Manufacturers' ohmic ranges based on highest and lowest ohm single resistor.



WIREWOUND RESISTORS DRIFT ONLY 25 PPM IN 3 YEARS

(If applicable to your needs)

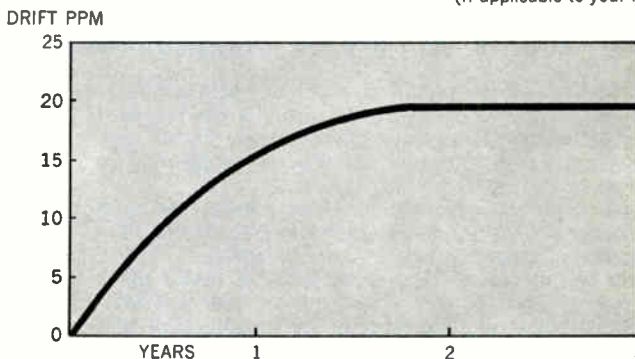

Drift in PPM. Resistors stored and measured at room temperature without the use of controlled atmosphere.

In addition to brilliant performance and outstanding reliability, RPC offers you a wide choice of quality resistors and a highly competent engineering department that can help you solve sticky problems involving resistance.

- PRECISION WIRE WOUND
- PRECISION METAL FILM
- CARBON FILM
- RESISTANCE NETWORKS



Resistance Products Co.

914 S. 13th Street, Harrisburg, Pa.

100% RELIABILITY

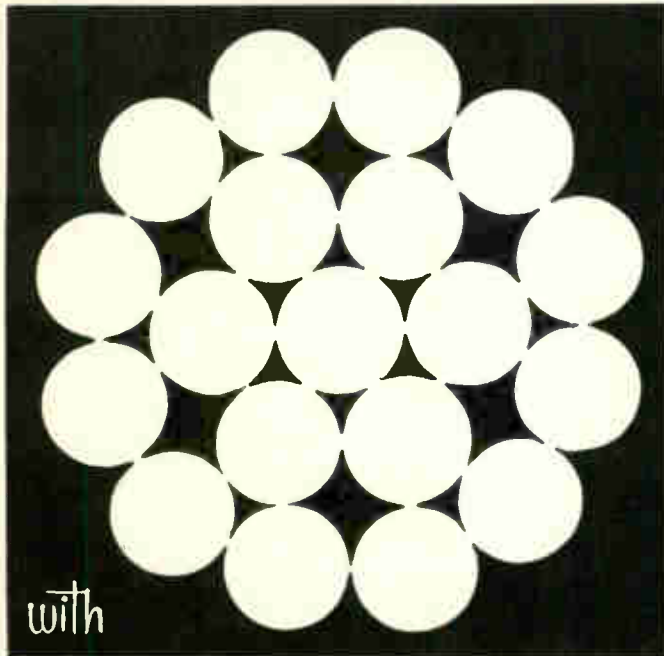

with

TRUE CONCENTRIC STRANDED WIRE CONSTRUCTION

For The TEFLON® Industry

Don't Settle For Substitute Constructions Where Quality Cannot Be Compromised

International Wire produces precision wire products for an industry where 100% reliability is the standard of performance. Time and experience has proved that only true concentric wire construction measures up to this level.

If you engineer a product into which reliability must be designed, specify quality in the insulated wire components . . . specify true concentric strand. Don't permit second class substitutes to find a place in your designs. To insure performance that will withstand the test of time, specify the construction that has already withstood the test of time . . . true concentric strand.

Write for

FREE, FACTUAL
SURVEY REPORT

"TRUE CONCENTRIC
VS.
UNILAY STRANDED WIRE"

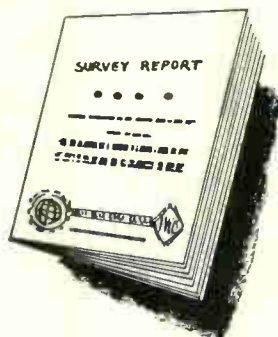

**INTERNATIONAL
WIRE PRODUCTS CORPORATION**

300 Greenwood Ave., Midland Park, New Jersey
Gilbert 4-2151

CYLINDRICAL OR FLAT

VK ultra precision components

TOLERANCES TO .000,005"
SURFACE FINISHES TO .5
FLATNESS TO .000,002"

Eliminate rejection problems! Special skills developed at VK over a period of nearly 50 years enable us to produce, *economically*, Precision Pivots (including carbide), Precision Valve Parts, Precision Pistons, Precision Spacers, Precision Pins and other components having *gage characteristics*.

Our special production techniques can be applied to your miniature parts . . . to assure utmost reliability. We can assist you in manufacture, finish-operations, or inspection.

Send us a print, a part, or specs. Better still, phone us, collect, at WA 6-1450 (Area Code 617).

PRECISION PARTS DIVISION

THE VAN KEUREN CO.

171 Waltham Street
WATERTOWN 72, MASS.

CIRCLE 216 ON READER SERVICE CARD



**Are you a
COMPLETELY
INFORMED
electronics
engineer?**

Today you may be working in microwaves. But on what project will you be working tomorrow? You *could* have read electronics this past year and kept abreast of, say, microwave technology. *There were 96 individual microwave articles between July, 1961 and June, 1962!*

But suppose tomorrow you work in some area of standard electronic components, in semiconductors, in systems? Would you be up-to-date in these technologies? Did you read the more than 3,000 editorial pages that electronics' 28-man editorial staff prepared last year?

electronics is edited to keep you current *wherever* you work in the industry, *whatever* your job function(s). If you do not have your own copy of electronics, subscribe today via the Reader Service Card in this issue. Only 7½ cents a copy at the 3 year rate.

electronics

electronics

CONDUCTIVE PRECIOUS METALS

SILVER • GOLD • PLATINUM

Superior Quality-Controlled
IN READY-TO-USE FORM
LIQUID OR PASTE

Offer
Designers
And
Engineers
BETTER

Adhesion
Conductivity
Solderability
Abrasion
Resistance
Application Ease

MAY BE

BRUSHED — SPRAYED

DIPPED — SCREEN PRINTED ON
PORCELAIN • CERAMICS • PLASTICS
GLASS • WOOD • QUARTZ • MICA

Let Our Specialists Solve
Your Unusual Metallizing Problems

BROCHURE ON REQUEST
FROM OUR UNITED STATES REPRESENTATIVES

**MATERIALS for
ELECTRONICS CO.**

Bldg. 17, N. Y. Int'l Airport
Jamaica 30, New York



DEGUSSA

Ceramic Colors Department
FRANKFURT/M., W. GERMANY

CIRCLE 217 ON READER SERVICE CARD

AM-FM Tuner Unit



AM SEC. CAPACITY: MAX. 377FF
MIN. 12PF
TUBE: 6AQ8, 12DT8, 17EW8

PLASTIC
VARIABLE CONDENSER

Square Size
15 mm., 17 mm.,
20 mm., 21 mm.,
Single band
2 band, 3 band
and for FM only.

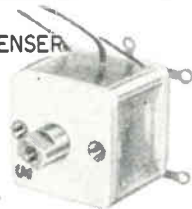

SANKAISHA CO., LTD.

Cable address: SANESVARICON TOKYO
1425, 4-chome, Higashinakanobu,
Shinagawa-ku, Tokyo, Japan.

CIRCLE 218 ON READER SERVICE CARD

February 15, 1963

Hawthorne, N. J., has released
bulletin No. 362 on six new beryl-
limum copper component clips. (339)

ALUMINUM-CAPPED KNOBS Raytheon
Co., 55 Chapel St., Newton 58, Mass.
Brochure MC-113 describes the com-
plete Designer series of aluminum-
capped knobs. (340)

EDUCATIONAL TV SYSTEMS Adler Elec-
tronics Inc., One LeFevre Lane,
New Rochelle, N. Y. An illustrated
brochure describes various methods
available for expanding educational
horizons through use of tv tech-
niques. (341)

DATA ACQUISITION SYSTEMS Systron-
Donner Corp., 888 Galindo St., Con-
cord, Calif., has published a 4-page
brochure entitled "Systrac Sys-
tems." (342)

SAWTOOTH GENERATOR Waddell Dy-
namics, Inc., 5841 Mission Gorge
Road, San Diego 20, Calif., offers a
bulletin describing models L3SG-
L3SG1 time linear sawtooth gener-
ator. (343)

MAGNETIC COMPONENTS Relcoil Prod-
ucts Corp., a division of Hi-G, Inc.,
Bradley Field, Windsor Locks, Conn.
Brochure contains technical data on
high performance r-f and i-f mag-
netic components. (344)

DIGITAL PRINTERS Franklin Electronics,
Inc., Bridgeport, Pa. Bulletin 2030A
describes a new generation of digi-
tal printers—decimal as well as
alpha-numeric. (345)

MAGNETOSTRICTIVE DELAY LINES Com-
puter Control Co., Inc., Old Con-
necticut Path, Framingham, Mass.,
offers a comprehensive data package
on 3C Soniline magnetostrictive de-
lay lines. (346)

TWO WAY ANTENNAS Andrew Corp.,
P. O. Box 807, Chicago 42, Ill., has
released a catalog on fixed station
antennas for the mobile radio
services. (347)

BALANCED MODULATORS Spectran Elec-
tronics Corp., 146 Main St., May-
nard, Mass., announced an *Appli-
cation Note* containing application
information on suppressed carrier
modulators for use in ssb systems
and in spectrum analyzers. (348)

FLAME RETARDING RESINS Isochem
Resins Co., 221 Oak St., Providence
9, R. I. Technical data bulletin
covers Isochemrez 470FR series
which offers an excellent base for
self-extinguishing p-c boards. (349)

SOUND LEVEL METER Rohde & Schwarz,
111 Lexington Ave., Passaic, N. J.
Bulletin includes specifications and
descriptions of operation and use
of the type ELZT self-contained
sound level meter. (350)

SCR SERVO AMPLIFIERS The Diehl Mfg.
Co., Somerville, N. J., has published
application bulletin 607B on its line
of scr servo amplifiers. (351)

WIDE BAND AMPLIFIER Community Engi-
neering Corp., 234 E. College Ave.,
State College, Pa. Data sheet de-
scribes model 1019F solid state wide
band amplifier. (352)

LET US HELP YOU CUT COSTS!

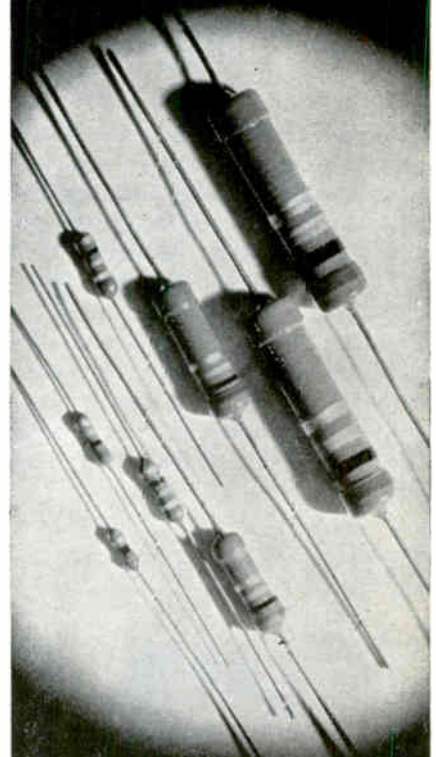

CARBON FILM RESISTOR

Rohm

**TOYO
ELECTRONICS
INDUSTRY
CORPORATION**

P. O. BOX 103 CENTRAL
KYOTO JAPAN

CIRCLE 123 ON READER SERVICE CARD

123



Electro-Optical Systems Expands

COMPLETION of a new \$2 million corporate headquarters and research, development, and systems laboratory in Pasadena, Calif., has been announced by Electro-Optical Systems, Inc. It expands total physical facilities of the company to over 200,000 square feet and consolidates corporate operations into three principal locations.

Constructed on an 8-acre site, the 3-story 135,000-square-foot

structure will house many of the country's most advanced programs in energy storage and conversion, advanced power systems, microelectronics, laser research and optical systems, and space instrumentation, according to company officials.

Designed especially to meet the critical needs of military and space systems while providing for supporting research facilities as well,

the building contains 65 laboratories, extensive environmental test equipment, prototype assembly areas, machine shops, and uniquely designed, atmospherically controlled research and assembly laboratories. It also includes over 200 scientific and administrative offices, a complete technical library, and a 200-seat auditorium for scientific seminars.

In addition to its new facility, EOS will continue to expand its ion and plasma physics R&D activities, and will also retain a space structures and prototype manufacturing unit, both in Pasadena.

Since its founding in Pasadena in 1956, Electro-Optical Systems, Inc., has been one of the city's fast-growing companies. From sales during the first year of \$80,000 the organization last year grew to a volume of approximately \$10 million. The company is listed among the top 100 research and development defense contractors in the United States.

As a research and systems development oriented company, EOS carries on no commercial manufacturing activities itself. However, items evolving from research programs that are of commercial or industrial use are manufactured and marketed by subsidiary companies.

One such subsidiary is Micro Systems, Inc., of San Gabriel, which is engaged in producing semiconductor instrumentation devices in the transducer and strain gage fields for applications in industrial, military, space and bio-medical devices.

TI Officers Elected to Board



Mark Shepherd, Jr.



S. T. Harris

J. E. JONSSON, board chairman of Texas Instruments Incorporated, has announced the election to the TI board of directors of Mark Shepherd, Jr., executive vice president, and S. T. Harris, senior vice

president. This increases board membership to ten.

Shepherd joined Texas Instruments in 1948 as a project engineer, and Harris came with the company in 1949 as a sales engineer.

Tucker Appointed Research Director

INTERNATIONAL BUSINESS MACHINES CORP. has announced the promotion of Gardiner L. Tucker to IBM director of research. Formerly director of development engineering for the IBM World Trade Corp., he will be responsible for the company's research activities at its Yorktown, N. Y., New York City, San Jose, Calif.; and Zurich, Switzerland,

Microwave, semiconductor and fast switching circuits with high density packaging, that heretofore have been thought impractical or impossible to build because of their bulk or complexity, are successfully produced in TRI-PLATE Strip Transmission Line. □ In breadboarding, packaging and quantity production, what the concept of strip transmission promised, TRI-PLATE

techniques deliver — they've made the concept a practical reality! □ For example, Sanders developed a beam-forming matrix — with both azimuth and elevation capabilities — which makes possible simultaneous, multiple-beam transmission and reception. It not only simplifies the design of electronically scanned antennas, it also drastically reduces both their overall

size and the number of components required. □ Shown below is a 16-element, beam-forming matrix and antenna array which operates at S-band over a 30 per cent bandwidth. It measures just $10\frac{1}{4}'' \times 10\frac{1}{4}''$ and requires only 32 hybrid devices as compared to 192 three-port power dividers needed in a conventional design. Similarly, a 64 x 64 array capable of forming 4,096

**Breakthrough
designs
achieved
with Tri-Plate®
techniques**

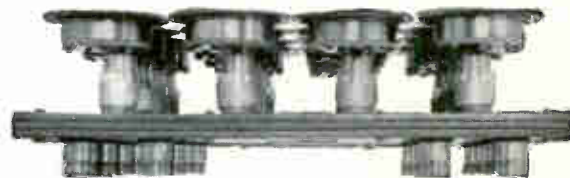
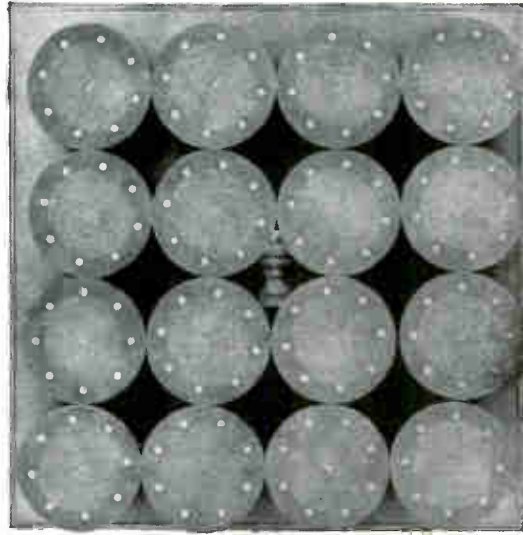

RF BEAM-FORMING MATRIX

pencil beams would require only 24,576 hybrids — in contrast to nearly one-half million power dividers. In addition to radar applications, this beam-forming matrix developed by Sanders can be used wherever simultaneous transmission and reception of data is desirable — including space communications. This is just one example of how TRI-PLATE engineering techniques might be applied to solve your design problem. □ To help you speed the time from design to breadboard to prototype to pro-

duction with known characteristics, there are more than 600 TRI-PLATE Modules — including over 150 TRI-PLATE Mounts for semiconductor devices — available from Sanders. They let you test new circuit ideas — no matter how different or daring — quickly, easily and economically. You can go from paper schematics to functioning circuits in just minutes to evaluate new design concepts. □ And

microwave systems designed in TRI-PLATE Modules can be produced in quantity as integrated TRI-PLATE Packages, with performance equal to or better than modular prototypes, and with great savings in size and weight. For further information about TRI-PLATE Products, including specifications and prices, write to Sanders Associates, Inc., Microwave Products Dept., Nashua, New Hampshire.

® REG. T.M.; EXTENSIVE PATENT COVERAGE. SANDERS ASSOCIATES, INC.

CREATING NEW DIRECTIONS IN ELECTRONICS
SANDERS TRI-PLATE® STRIP TRANSMISSION LINE



DISENCHANTED WITH FUSES?
CONSIDER—

MICROELECTRON CURRENT LIMITERS



*Here's
proven performance
characteristics you
can rely on:*

- 1
Total Vibration Resistance
- 2
Impervious to Environmental
Conditions
- 3
Married to Semi-Conductor
Characteristics
- 4
300% to 400% faster acting
than any fuse

In service on some of the nations most advanced aero-space projects, these current limiters deliver precise protection to the most delicate circuits. Temperature coefficient is plus .2% per degree C. At elevated temperatures this has the effect of increasing sensitivity to overloads. Semiconductors exhibit a similar coefficient. Therefore these current limiters are ideal for protection of transistors and diodes. Amperage ratings from 1/32 to 3 amps; also to 5 amps in S100 and S125 units. For complete details on price and delivery contact your nearest Microelectron representative or write to Microelectron at 1547 18th Street, Santa Monica, California.



Bulletin P-200 gives full facts on Microelectron Current Limiters. Request your copy.

MICROELECTRON

laboratories. He will report to Emanuel R. Piore, IBM vice president for research and engineering.

Tucker succeeds Gilbert W. King who has resigned to become vice president and director of research for the Itek Corp., Lexington, Mass.

Zenith Executives Take New Posts

ZENITH RADIO CORPORATION, Chicago, Ill., has announced that Robert Adler has been appointed vice president-director of research, a post held since 1949 by Alexander Ellett, who has been named to the new position of vice president, special scientific projects.

Adler, elected vice president in 1959, has been associate director of research since November, 1952.

Ellett joined Zenith in 1945. During World War II, as chief of Division 4 of the National Defense Research Committee, he directed development of the V-T proximity fuze.

In addition to the appointments listed above, the company also announced that Erwin M. Roschke is promoted to assistant director and administrative manager of research, and Bertrand Miller to assistant research director.



Benzing Accepts Vice Presidency

APPOINTMENT of Louis H. Benzing, formerly director of operations of the Lockheed Electronics Co., as vice president and general manager of the G. C. Dewey Corp. has been announced. He has assumed complete responsibility for the direction of the company's data systems, electronics and test support divisions,

MIDGET TAP SWITCH has giant range



\$3.00 List
(Without Handle)

TYPE 3A

MOLDED FROM DIALLYL PHTHALATE

Only 1" in diameter . . . weighs 30 grams . . . as many as 8 decks and up to 12 positions per deck. These are among the features of Tech Labs' new all-molded miniature Type 3A tap switch.

Designed for a wide range of military and commercial applications, this single-hole mounted switch has adjustable stops if fewer than 12 positions, single pole, or 6 positions, double pole, are required.

"Shorting" and "non-shorting" types are available and the switch can be furnished solenoid-operated and hermetically sealed.

SPECIFICATIONS

Size: 1" diameter, 1 1/4" with terminals. First deck, 1-1/16" long. Each additional deck, 1/2" long.

Weight: First deck, 30 grams. 10 grams for each additional deck.

Rating: 1200 volts rms, 2000 VDC, 5 amps (carrying) 115V.

Insulating resistance: 100 megohms minimum at 500 volts DC.

Life: 1.5 — 2 million revolutions.

Contact resistance:

(standard) 6-10 milliohms.

(silver) 3-5 milliohms.

Temperature range: -65°C to 100°C.

Mounting: Single-hole.

Meets MIL-S-3786A



Write for details
and prices.

PALISADES PARK, NEW JERSEY

and will also supervise the engineering and manufacturing operations as well as the marketing requirements of the Pitometer Log Corp., the firm's wholly-owned subsidiary.

In 1955 Benzing joined Stavid Engineering, Inc., subsequently acquired by Lockheed, where, after successive promotions he became director of operations responsible for all material and manufacturing functions and supervised the activities of 525 people.



Western Electric Elects Clow

ARTHUR P. CLOW, a Chesapeake & Potomac Telephone Co. executive, has been elected vice president and member of the board of directors of Western Electric Co.

In his new post, Clow will head the Defense Activities division which is responsible for bringing together Bell System resources to accomplish national defense and space communications projects.



American Electronics Promotes Echolds

PROMOTION of E. Frank Echolds to vice president-operations of American Electronics, Inc., Fullerton, Calif., has been announced. He will be responsible for engineering, for

THINNER THAN EVER!



is the thermo module newly developed by Sanyo Electric Co. The technique evolved by Sanyo eliminates high cost and brittle nature of the bismuth telluride alloys used in production of thermoelements. Our ex-

haustive study reveals possibilities of still reducing its thinness, resulting in wider and more

economical applications to scientific and electronic equipment.

SPECIFICATIONS

Type	Thermo couple	Optimum Current (amp.)	Optimum Voltage (Volt)	(1) ΔT (°C)	Insulation Voltage(2) (Volt)	Dimensions mm (Inch)
STM-1025	10	25	0.9	55	50	57×43×10.5 (2.24×1.69×0.413)
STM-1021	10	21	0.9	55	50	57×43×10.5 (2.24×1.69×0.413)
STM-1016	10	16	0.9	55	50	57×43×10.0 (2.24×1.69×0.393)
STM-1012	10	12	0.9	55	50	41×32.3×9.5 (1.62×1.28×0.374)
STM-1006	10	6	0.9	55	50	41×29×9.5 (1.62×1.28×0.374)

Subject to change without notice.
Note: (1) No heat loads; T_h is 27°C.
(2) Voltage applied between circuit and hot or cold plate.



Thermo-electric Refrigerator



Thermo Electric Jar



Power Unit



Power Units



Thermo Poc



Thermo Processing Tray

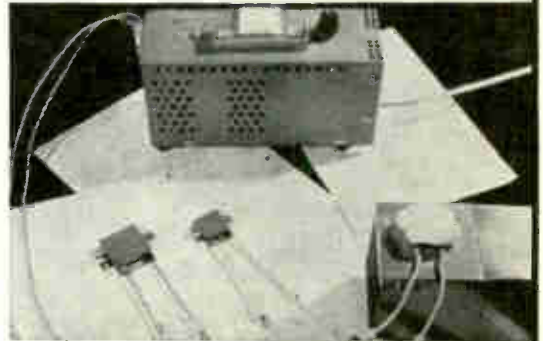

Apply for further details to:

SANYO

SANYO ELECTRIC INC., ELLENVILLE, N.Y.

SUBSIDIARY OF SANYO ELECTRIC CO., LTD. OSAKA, JAPAN
MAKERS OF RADIO, TV, STEREOPHONOGRAPH, ROOM AIR CONDITIONER,
REFRIGERATOR, WASHING MACHINE, SEMICONDUCTOR, THERMOELEMENT.

CIRCLE 127 ON READER SERVICE CARD

**HELP YOUR POST OFFICE
TO SERVE YOU BETTER
BY
MAILING EARLY IN THE DAY
NATIONWIDE IMPROVED MAIL SERVICE
PROGRAM**

reliability
...based on
experience

POLYCON
SEC
MYCON

ultra-high precision capacitors

Southern Electronics high-precision capacitors are demonstrating their proven reliability today in twelve different missiles, analog computers, and many radar and communications applications.

SEC high-precision capacitors utilize polystyrene, providing .01% tolerances, and mylar and teflon to meet .5% requirements. They show excellent stability characteristics over an extended temperature range, and tolerances are unaffected even at extreme high altitudes.

The unusual accuracy, stability and reliability of SEC capacitors are the result of engineering experience concentrated on the design and manufacture of precision capacitors only, plus rigid quality control standards subjecting each capacitor to seven inspections during manufacture, plus final inspection.

Our engineering experience enables us to meet your size requirements, while holding to exact capacitance and tolerance specifications.

SEC capacitors are manufactured in a wide range of capacitance to meet your needs from 100 mmfd. to any higher value, and meet or exceed the most rigid MIL-SPECS.

Write today for detailed technical data and general catalog.



SOUTHERN ELECTRONICS Corporation

150 WEST CYPRESS AVENUE
BURBANK, CALIFORNIA

all manufacturing operations, and for quality control at the Fullerton facilities.

American Electronics produces electronic systems and components for the aerospace industry.

MCL Moves to New Plant

AFTER 13 months of operation, Microwave Cavity Laboratories, Inc., has moved to a new plant in LaGrange, Ill.

The 10,000-square foot building which is three times larger than the original plant, completely houses the general offices, engineering and manufacturing. The new facilities include provision for further expansion up to 30,000 square feet.



William Wells Joins Perkin-Elmer

WILLIAM F. WELLS has joined the Perkin-Elmer Corp., Norwalk, Conn., as general manager of its Electro-Optical division west coast operations.

Wells was executive vice president and general manager of Midwestern Instruments, Tulsa, Okla., before accepting the new position. Previously he was with General Electric Co. for 16 years in a variety of engineering, manufacturing and managerial positions.

Servonic Instruments Building Addition

SERVONIC INSTRUMENTS, INC., Costa Mesa, Calif., has under construction a 10,000 square foot facility. This addition will house research and development, prototype produc-

TRANSISTOR ...

small signal "h" parameters



Model 1803A

Write for information about industry's most complete line of standard and custom designed instruments for semiconductor testing.

DYNATRAN

electronics corporation

178 HERRICKS ROAD
MINEOLA, NEW YORK

Pioneer 1-4141

CIRCLE 220 ON READER SERVICE CARD

- SCAN CONVERSION
- FLICKERLESS DISPLAY STORE
- VIDEO STORAGE

RECORDING STORAGE TUBE SYSTEMS

Single-gun, dual-gun, multi-tube systems to convert scan for radar, sonar, television, and to perform analog processing, data analysis, contract or expand time scale, auto correlation.

- SLOWED TELEVISION TRANSMISSION

by telephone line or other narrow-band systems.

- IMAGE ENGINEERING

OPTICAL CHART READERS, FLYING SPOT SCANNERS, LOW-LIGHT-LEVEL CAMERAS, and IMAGE RECTIFICATION. Automatic inspection and recognition of size, shape, color, and texture.



Write or call for complete information:

INSTRUMENTS, Inc.

2300 Washington Street
Newton 62, Massachusetts
617 WOODWARD 9-8440

FREE TO COMPANY OFFICIALS LOOKING FOR A NEW PLANT SITE

WE WILL PREPARE FOR YOU A
CONFIDENTIAL SURVEY
OF SELECTED LOCATIONS
FOR YOUR NEW PLANT IN
NEW YORK STATE

TABLE OF CONTENTS

SUBJECT	PAGES
Introduction	1
Growth Trends	2-3
Climate	4-6
Public Utilities	7-22
Financial	23
Government Services	24-44
Taxes	
Protective Services	
Water Supply & Sewerage	
Community Facilities	45-73
Housing	
Education	
Recreation & Culture	
Industrial History	74-79
Labor	80-92
Natural Resources	93-94
Transportation & Markets	95-104
Sites	105-133

TAILOR-MADE. This confidential report is not taken off the shelf. It will be prepared specifically for you, based on the requirements for your new plant as you give them to us. Send these requirements on your business letterhead to Commissioner Keith S. McHugh, N.Y. State Dept. of Commerce, Room 232K, 112 State St., Albany 7, N.Y.

Keith S. McHugh

Keith S. McHugh, Commissioner
New York State Department of Commerce

tion and the environmental test laboratory. Scheduled for completion on or about March 1, it will bring the total company plant area to over 35,000 square feet.

According to Patrick S. Chase, president of Servonic, this addition plus its equipment will represent an investment of almost \$250,000.

Primary products of Servonic Instruments, Inc., are pressure transducers, pressure switches and rectilinear potentiometers.

PEOPLE IN BRIEF

Lendon E. Flener, previously with Frank Industries, named director of mfg. for Tracerlab div. of Laboratory For Electronics, Inc. Ashley A. Farrar, v-p and g-m of Pickard & Burns, Inc., elected to board of directors. Ben Trivelli leaves Airtron to become mgr. of engineering at Microtech, Inc. Don Cinalia promoted to mgr. of the Industrial Products div. of Jerrold Electronics Corp. Sumner S. Averett and Victor Brociner advanced to mgr. of engineering and mgr. of research, respectively, at University Loudspeakers, div. of Ling-Temco-Vought, Inc. Robert B. Yeaton moves up to supervisor of the electronic laboratory at Superior Tube Co. Sperry Rand ups Robert W. Jagoe to mgr. of its new Infrared/Optics/Laser Group. Harold Treece elevated to div. mgr. of the Electro-Ceramics div. of Automation Industries, Inc. Robert N. Palmer, from Sylvania to Varian Associates as a senior engineering mgr. Ralph A. Galbraith, exec v-p of the Syracuse University Research Corp., elected to the board of directors of the Crouse-Hinds Co. Jack Wilkeyson, ex-Western Electric, named mgr. of the high reliability crystal group at Monitor Products Co. Andrew J. Unetic, v-p and g-m of Bourns Instrument div., elected to the board of directors of Kinetics Corp. George V. Woodrow, Jr., advances to director, research and engineering for LFE Electronics. C. Gunnar Svala moves up to the new post of technical director, North Electric Co.

SPECIFY HANDSETS

by
Stromberg-Carlson



... for mobile radio, dictating systems, carrier, microwave and other applications.

Illustrated are lightweight models No. 33 and No. 35. Both incorporate push-to-talk switches and high-gain receivers and transmitters. These Stromberg-Carlson handsets meet a great variety of needs in a broad range of industrial applications.

No. 33 lightweight handset is furnished with a rocker bar switch.

No. 35 comes with a button switch, or with both the button and rocker bar switches.

Get technical data on these and other handsets from our Industrial Sales Department.

STROMBERG-CARLSON
A DIVISION OF GENERAL DYNAMICS
114 CARLSON ROAD • ROCHESTER 3, N. Y.

electronics

WEEKLY QUALIFICATION FORM FOR POSITIONS AVAILABLE

ATTENTION: ENGINEERS, SCIENTISTS, PHYSICISTS

This Qualification Form is designed to help you advance in the electronics industry. It is unique and compact. Designed with the assistance of professional personnel management, it isolates specific experience in electronics and deals only in essential background information.

The advertisers listed here are seeking professional experience. Fill in the Qualification Form below.

STRICTLY CONFIDENTIAL

Your Qualification form will be handled as "Strictly Confidential" by ELECTRONICS. Our processing system is such that your form will be forwarded within 24 hours to the proper executives in the companies you select. You will be contacted at your home by the interested companies.

WHAT TO DO

1. Review the positions in the advertisements.
2. Select those for which you qualify.
3. Notice the key numbers.
4. Circle the corresponding key number below the Qualification Form.
5. Fill out the form completely. Please print clearly.
6. Mail to: Classified Advertising Div., ELECTRONICS, Box 12, New York 36, N. Y. (No charge, of course).

COMPANY	SEE PAGE	KEY #
ACF INDUSTRIES INC Albuquerque Division Albuquerque, New Mexico	131	1
ATOMIC PERSONNEL INC., Philadelphia, Penna.	126*	2
BELL AEROSYSTEMS CO., Div. of Bell Aerospace Corporation A Textron Company Buffalo, N. Y.	126*	3
FMA, INC., El Segundo, Calif.	131	4
GENERAL DYNAMICS/ELECTRONICS Rochester, N. Y.	124*	5
GENERAL ELECTRIC COMPANY TV Receiver Department Syracuse, N. Y.	124*	6
HONEYWELL St. Petersburg, Fla.	114*	7
INTERNATIONAL BUSINESS MACHINES CORP. New York, N. Y.	125*	8
LOCKHEED CALIFORNIA COMPANY Burbank, California	103*	9
LOCKHEED MISSILES & SPACE CO., Div. of Aircraft Corp. Sunnyvale, California	92*	10
MOTOROLA INC., Semiconductor Products Div., Phoenix, Arizona	127*	11
NORTHROP CORPORATION Beverly Hills, California	119*	12
PERSPECTIVE Needham, Mass.	131	13

(Continued on opposite page)

(cut here)

electronics WEEKLY QUALIFICATION FORM FOR POSITIONS AVAILABLE

(cut here)

(Please type or print clearly. Necessary for reproduction.)

Personal Background

NAME

HOME ADDRESS

CITY ZONE STATE

HOME TELEPHONE

Education

PROFESSIONAL DEGREE(S)

MAJOR(S)

UNIVERSITY

DATE(S)

FIELDS OF EXPERIENCE (Please Check)

21563

- | | | |
|--|--|---------------------------------------|
| <input type="checkbox"/> Aerospace | <input type="checkbox"/> Fire Control | <input type="checkbox"/> Radar |
| <input type="checkbox"/> Antennas | <input type="checkbox"/> Human Factors | <input type="checkbox"/> Radio-TV |
| <input type="checkbox"/> ASW | <input type="checkbox"/> Infrared | <input type="checkbox"/> Simulators |
| <input type="checkbox"/> Circuits | <input type="checkbox"/> Instrumentation | <input type="checkbox"/> Solid State |
| <input type="checkbox"/> Communications | <input type="checkbox"/> Medicine | <input type="checkbox"/> Telemetry |
| <input type="checkbox"/> Components | <input type="checkbox"/> Microwave | <input type="checkbox"/> Transformers |
| <input type="checkbox"/> Computers | <input type="checkbox"/> Navigation | <input type="checkbox"/> Other |
| <input type="checkbox"/> ECM | <input type="checkbox"/> Operations Research | <input type="checkbox"/> |
| <input type="checkbox"/> Electron Tubes | <input type="checkbox"/> Optics | <input type="checkbox"/> |
| <input type="checkbox"/> Engineering Writing | <input type="checkbox"/> Packaging | <input type="checkbox"/> |

CATEGORY OF SPECIALIZATION

Please indicate number of months experience on proper lines.

	Technical Experience (Months)	Supervisory Experience (Months)
RESEARCH (pure, fundamental, basic)
RESEARCH (Applied)
SYSTEMS (New Concepts)
DEVELOPMENT (Model)
DESIGN (Product)
MANUFACTURING (Product)
FIELD (Service)
SALES (Proposals & Products)

CIRCLE KEY NUMBERS OF ABOVE COMPANIES' POSITIONS THAT INTEREST YOU

1 2 3 4 5 6 7 8 9 10 11 12 13 14 15 16 17 18 19 20 21 22 23 24 25

SUPERVISORY POSITIONS

in the Southwest with Albuquerque Division

ACF INDUSTRIES, INC.

A prime contractor for the Atomic Energy Commission

SENIOR ELECTRONICS ENGINEER

To be responsible for maintenance of all electronic equipment in the plant, which includes electronic tape controlled machine tool equipment, gaging equipment, and production processing equipment. BSEE with five years experience required.

ELECTRONICS ENGINEER

To supervise hourly electronic technicians engaged in maintenance of above mentioned equipment. BSEE with two years experience required.

Salary will be commensurate with training and experience. Relocation costs paid. U. S. citizenship required.

Mail resume to:

General Supervisor, Professional Recruiting
Albuquerque Division, ACF Industries, Inc.
P. O. Box 1666, Albuquerque, New Mexico
"ACF IS AN EQUAL OPPORTUNITY EMPLOYER"

FREE TRIP IEEE (IRE) SHOW NEW YORK CITY MARCH 25-28TH

Scientists and Engineers you can have an all expense paid trip and confirmed selected interviews with national electronic companies if you qualify. Requirements: BS, MS, or PhD and one year experience. Opportunities available in: Research—Design—Development—Sales—Marketing—Applications.
Air Mail Resume in Complete Confidence—No Obligation
Write or Call Collect Dept. E for Full Details Boston (617) 444-7113

Alan Glou—Technical/Scientific
Sid Hopper—Sales/Marketing

PERSPECTIVE

A PROFESSIONAL PLACEMENT ORGANIZATION SERVING SCIENTISTS & ENGINEERS
TEN KEARNEY ROAD, NEEDHAM, MASS.
Highland Ave., Exit #56W Off Rte. 12B—Marr Bldg.

electronics

WEEKLY QUALIFICATIONS FORM FOR POSITIONS AVAILABLE

(Continued from opposite page)

PHILCO WESTERN DEVELOPMENT LABS., Palo Alto, California	72*	14
POTTER INSTRUMENT CO., INC. Plainview, N. Y.	122*	15
SCOPE PROFESSIONAL PLACEMENT CENTER Waltham, Mass.	126*	16
SPACE TECHNOLOGY LABORATORIES, INC. Sub. of Thompson Ramo Wooldridge Inc. Redondo Beach, California	29	17

* These advertisements appeared in the Feb. 8th issue.

this spells op·por·tu·ni·ty

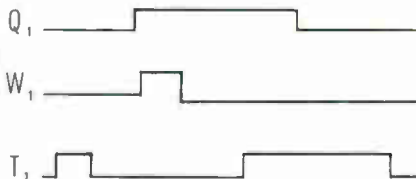
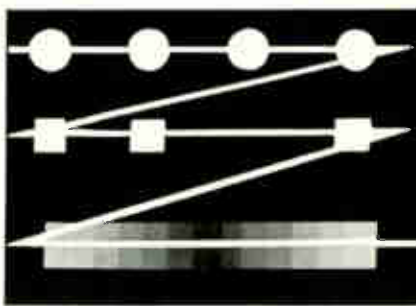

for an imaginative electronic engineer

At FMA we use advanced electro-optical scanning techniques to read information recorded on film. Sometimes the information is spelled out in machine-readable code; sometimes the information is a photograph.

Using a special purpose computer to control the scanning system, we read the information optically, then feed the results back into the computer for processing, achieving, in effect, a sampled data system. With these techniques we can do many technically interesting things—such as enhancing photography, recognizing patterns, or automatically retrieving information.

We're looking for an electronic engineer with hardware and systems experience who can put these and related techniques to imaginative use in advanced electro-optical equipment. It's an opportunity for you to play an important role in a company which is growing rapidly because of its significant technical accomplishments.

Because of our continuing requirements, your résumé will always receive prompt and confidential attention.

Write to: Mr. C. J. Blades
FMA, Inc. 142 Nevada Street
El Segundo, California

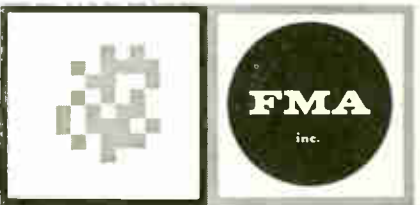

AN EQUAL OPPORTUNITY EMPLOYER

When you think of inForMation think of FMA

SELLING OPPORTUNITY AVAILABLE

Representatives wanted; calling on Original Equipment Manufacturers, edge lighted panels (Mil-P-7788A) pioneers in white lighting. Exclusive territory, New England, Middle Atlantic, South East, Mid West. RW-1554, Electronics, Classified Adv. Div., PO Box 12, New York 36, N. Y.

SEARCHLIGHT SECTION

(Classified Advertising)

BUSINESS OPPORTUNITIES

EQUIPMENT - USED or RESALE

DISPLAYED RATE

The advertising rate is \$27.75 per inch for all advertising appearing on other than a contract basis. Contract rates quoted on request. An ADVERTISING INCH is measured 1/4 inch vertically on one column, 3 columns—30 inches—to a page. EQUIPMENT WANTED or FOR SALE ADVERTISEMENTS acceptable only in Displayed Style.

UNDISPLAYED RATE

\$2.70 a line, minimum 3 lines. To figure advance payment count 5 average words as a line. BOX NUMBERS count as one line additional in undisplayed ads.

want
to sell
electronic
equipment
FAST?
(at low cost)



Try an experienced, marketing-minded advertising agency; try an advertising agency that knows how to get at the heart of a problem quickly and without fumbling.

We offer tangible, traceable results. It might very well pay you to try

HAROLD MARSHALL ADVERTISING Co., Inc. 171 Madison Avenue, N. Y. 16 • MU 6-5652

CIRCLE 950 ON READER SERVICE CARD

PUBLICITY for INDUSTRIAL COMPONENTS, ELECTRICAL & ELECTRONIC PRODUCTS

Sales-stimulating inquiries provided quickly at reasonable cost. Individual projects or continuing basis. Inquiries invited.

ENGINEERING INFORMATION SERVICES
P. O. Box 654 Mamaroneck, N. Y.

CIRCLE 951 ON READER SERVICE CARD

FOR RESEARCH — DEVELOPMENT & EXPERIMENTAL WORK

Over 10,000 different electronic parts: waveguide, radar components and parts, test sets, pulzers, antennas, pulse xmtrs, magnetrons, IF and pulse amplifiers, dynamotors, 400 cycle xmtrs, 584 ant. pedestals, etc.

PRICES AT A FRACTION OF ORIGINAL COST!
COMMUNICATIONS EQUIP CO.
313 CANAL ST., N. Y. 13, WQ 6.4045
CHAS. ROSEN (Formerly at 131 Liberty St.)

CIRCLE 952 ON READER SERVICE CARD

Antique TELEPHONES

As is complete, decorative purpose \$12.00. Working order, Inter-comm. \$15.00. Ext. on dial \$17.50; talking circuit only. Write for complete list. All shipments FOB, Simpson, Pa.
TELEPHONE ENGINEERING CO.
Dept. E-2153, Simpson, Pa.



CIRCLE 953 ON READER SERVICE CARD

RADIO RESEARCH INSTRUMENT CO.

AUTO-TRACK & TELEMETRY ANTENNA PEDESTALS 3 & 10 CM. SCR. 584 AUTOTRACK RADARS. AN/TPS-1D SEARCH. AN/TPS-10 HT. FINDERS. AN/FPN-32CCA. AN/APS-10 NAVIG. & WEATHER. AN/APS-15B PRECISION. AN/APQ-35B PRECISION. AN/APS-61A SEARCH. DOZENS MORE. 3-12 MEGAWATT HIGH POWER PULSERS.

RADIO RESEARCH INSTRUMENT CO.
550 Fifth Ave., New York, N. Y. 10017
Judson 6-4691

RADAR SYSTEMS & COMPONENTS/ IMMEDIATE DELIVERY

CIRCLE 954 ON READER SERVICE CARD

Book Notes

TUNNEL-DIODE AND SEMICONDUCTOR CIRCUITS

Just Out. Practical treatment of the theory and application of semiconductor devices other than conventional transistors and diodes. Gives thorough, eight-chapter coverage of tunnel diodes. Other important subjects are semiconductor circuits applied to microminiaturization of electronic equipment, parametric amplifiers and voltage-variable capacitors, four-layer diodes, silicon-controlled rectifiers, and unijunction transistors. Practical circuits are given, with component values. **By J. M. Carroll, Electronics.** 384 pp., 8 3/4 x 11, illus., \$9.75

DIGITAL COMPUTER PRINCIPLES

Just Out. Bridges the gap between highly specialized treatments and over-simplified approaches, giving detailed coverage of all aspects of digital computers—logic and language, pulse techniques, circuitry, and organization. Actual circuits now in use are described in detail at the technical level. Shows how the basic computer elements are grouped to form the computer's functional units; describes data flow between units; discusses programming techniques; and lays the technical groundwork for a solid understanding of more advanced computer systems. **By Burroughs Corp. Staff.** 507 pp., 332 illus., \$10.95

INTEGRALS OF BESSEL FUNCTIONS

Just Out. Provides research workers, mathematicians, and scientists with information on the evaluation of definite and indefinite integrals involving Bessel functions. Gives full treatment to generalized hypergeometric functions, then many useful representations of Bessel functions and their integrals, by specialization of parameters. **By Y. L. Luke, Midwest Res. Inst.** 409 pp., \$12.50

NEW

Ideal for staff distribution

HOW ANYONE WHO SUPERVISES

can be helped to do a better job

Practical guide for managers, supervisors, and foremen. Gives how-to pointers used successfully by hundreds of companies. Covers many front-line problems in training and handling people and union relations. **Front-line Management** by J. M. Black & G. B. Ford. 292 pp., \$6.95

• For wholesale prices on quantities for your key personnel, write or phone John Stockwell, McGraw-Hill Book Co. 212-LO4-3000

10 DAYS' FREE EXAMINATION DIRECT FROM PUBLISHER

McGraw-Hill Book Co., Dept. L-2-15
327 W. 41st St., New York 36, N. Y.

Send me book(s) checked below for 10 days' examination on approval. In 10 days I will remit for book(s) I keep, plus few cents for delivery costs, and return unwanted book(s) postpaid. (We pay delivery costs if you remit with this coupon—same return privilege.)

- Carroll—Tunnel-diode & Semicond. Circs., \$9.75
- Burroughs—Digital Computer Prin., \$10.95
- Luke—Integrals of Bessel Func., \$12.50
- Black & Ford—Front-line Mgt., \$6.95
- Send me information on wholesale prices for...copies of Black & Ford—Front-line Mgt.

Name
Address
City Zone State
Company
Position

For price and terms outside U.S., write McGraw-Hill Int'l., N.Y.C. L-2-15

INDEX TO ADVERTISERS



Audited Paid Circulation

AMP Incorporated Capitron Div.	73	Electronic Memories Inc.	115
Ampex Corporation	24	Electronic Modules Corp.	88
• Amphenol-Borg Electronics Corp. Connector Division	34, 35	Fairchild Stratos	81
• Arco Electronics Inc.	76	• Frontier Electronics Div. International Resistance Co.	104
Atohm Electronics	111	Gardner-Denver Company	100
• Automatic Metal Products Corp.	28	• General RF Fittings, Inc.	99
Bausch & Lomb, Inc.	92	General Electric Co. Semiconductor Products Dept.	118
Boesch Mfg. Div. Waltham Precision Instrument Co. Inc.	98	General Instrument Corp. Semiconductor Div.	85
Bristol Company, The	84	General Radio Co.	2nd Cover
• Brush Instruments, Div. of Clevite Corp.	3rd Cover	Globe Industries Inc.	93
CTS of Berne Sub. of CTS Corp.	109	Gudebrod Bros. Silk Co., Inc.	38
Camblock Div. Waltham Precision Instrument Co. Inc.	32	Hamilton Standard, Div. of United Aircraft Corp.	83
Cambridge Thermionic Corp.	21	• Harrison Laboratories Div. of Hewlett Packard	95
Cinch-Graphik Div. of United-Carr Corp.	17	Heinemann Electric Co.	42
Collins Radio Co.	79	Heminway & Bartlett Mfg. Co., The ..	20
Coors Porcelain, Co.	25	• Hewlett-Packard Company	6, 39
• Coto-Coil Co., Inc.	42	Hyperion Industries Inc.	90, 91
Data-Control Systems, Inc.	37	• Image Instruments, Inc.	128
• Daystrom Incorporated Potentiometer Div.	43	• Indiana General Corp.	22
Dell-Dine Sub. of Sealectro Corp.	108	• Ingersoll Products, Division of Borg-Warner Corp.	113
Despatch Oven Co.	99	International Resistance Co.	23
Deutsch Electronic Components.	77	International Wire Products Corp.	122
duPont de Nemours & Co., Inc. E. I.	87	Interstate Electronics Corp.	93
Dynatran Electronics Corp.	128	• J F D Electronics Corp.	107
Eastman Kodak Co.	14	• Japan Piezo Electric Co., Ltd.	134
Edwards High Vacuum Inc.	16	Jerrold Electronics Corp.	4
E-H Research Laboratories Inc.	33	• Kay Electric Co.	75
• Eisler Engineering Co., Inc.	85	Kinney Vacuum Div. of New York Air Brake Co.	41
Elasco, Inc.	116	• Kyoritsu Electrical Instruments Works, Ltd.	85
Electro Instruments Inc.	40		
Electro Powerpacs, Inc.	96		
Electro Products Laboratories.	99		
• Electronic Instrument Co., Inc. (EICO)	114		

• Lambda Electronics Corp.	5	• Tempo Instrument, Inc.	97
Levin and Son, Inc., Louis.	20	Texas Instruments Incorporated Industrial Products Group.	80
Littelfuse	93	Thermal American Fused Quartz Co., Inc.	133
		• Toyo Electronics Ind. Corp.	123
Machlett Laboratories Inc., The.	31		
Mallory and Co., Inc., P. R.	10, 11	Van Keuren Co., The.	122
Mask-O-Matic Inc.	120		
Materials for Electronics Co.	123	• Wind Turbine Company.	114
McGraw-Hill Book Co.	132		
• McLean Engineering Laboratories.	116		
Microelectron	126		
Micronics Corp. of America.	112		
• Micro Switch Division of Honeywell	105		
Midland Mfg. Co.	109		
New York State Dept. of Commerce. .	129		
• Nichicon Capacitor Ltd.	20		
• North Atlantic Industries, Inc.	78		
Optimized Devices Inc.	82		
Ozalid A Div. of General Aniline & Film Corp.	36		
Partron Div. of Illinois Tool Works Inc.	117		
• Potter Instrument Co., Inc.	19		
• Radio Corporation of America. 4th Cover			
• Republic Foil Inc.	119		
• Resistance Products Co.	121		
• Rochar Electronique	27		
Ross Co., Milton	110		
Sanders Associates, Inc.	125		
Sankaisha Co., Ltd.	123		
• Sanyo Electric Inc.	127		
Servomechanisms Inc. Mechatrol Div.	120		
Siemens America Inc.	101, 102, 103		
Signetics Corp.	13		
Siliconix Inc.	44		
• Southern Electronics Corp.	128		
Space Technology Laboratories, Inc. .	29		
Sprague Electric Co.	9		
Stackpole Carbon Co.	15		
Stromberg-Carlson Div. of General Dynamics.	129		
Sylvania Electric Products, Inc. Semiconductor Div.	89		
• Tech Laboratories, Inc.	126		
Telrex Laboratories	42		

CLASSIFIED ADVERTISING

F. J. Eberle, Business Mgr.

EMPLOYMENT OPPORTUNITIES. 131

SPECIAL SERVICES 131

EQUIPMENT

(Used or Surplus New)

For Sale 131

INDEX TO CLASSIFIED ADVERTISERS

- ACF Industries Inc. 131
- Communications Equipment Co. 131
- Engineering Information Services. 131
- FMA, Inc. 131
- Marshall Adv. Co., Inc., Harold. 131
- Perspective 131
- Radio Research Instrument Co. 131
- Telephone Engineering Co. 131

• See advertisement in the July 25, 1962 issue of *Electronics Buyers' Guide* for complete line of products or services.

This Index and our Reader Service Numbers are published as a service. Every precaution is taken to make them accurate, but **electronics** assumes no responsibilities for errors or omissions.

and
now ...
**MASER
TUBES**
in
VITREOSIL[®]
**PURE
FUSED
QUARTZ**

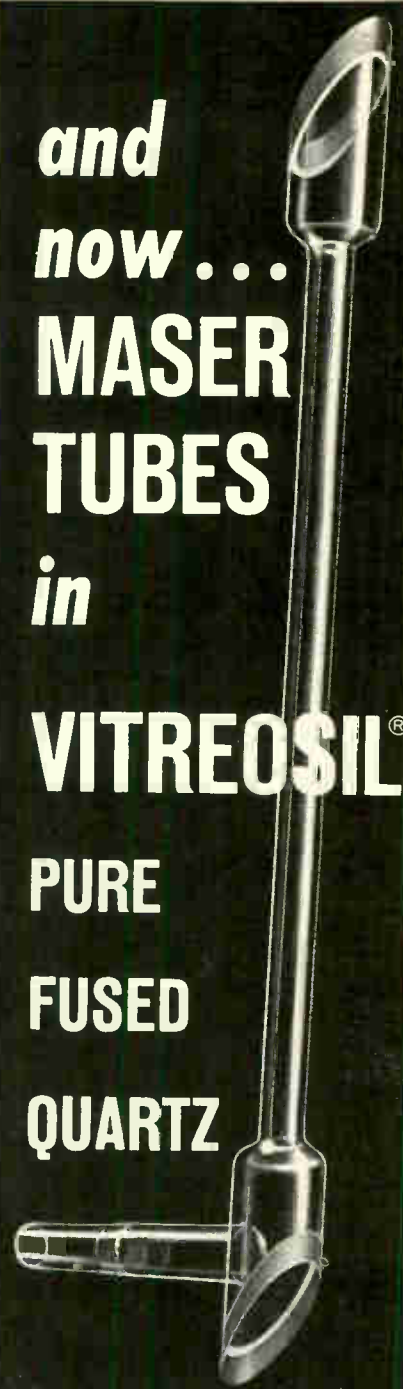

For experimental gaseous optical maser (laser) applications. Precision bore stock size tubes are ready for filling complete with graded seals to Pyrex or Kovar and quartz windows in half, quarter and tenth wave flatness — transmission from U.V. through I.R. Vitreosil permits high bake-out temperatures, does not contaminate gases and maintains dimensional stability over a wide temperature range. Write for details.



THERMAL AMERICAN
FUSED QUARTZ CO.
RT. 202 & CHANGE BRIDGE RD.
MONTVILLE, NEW JERSEY

Acoustical Components of Superior Quality

JAPAN PIEZO supplies 80% of Japan's crystal product requirements.

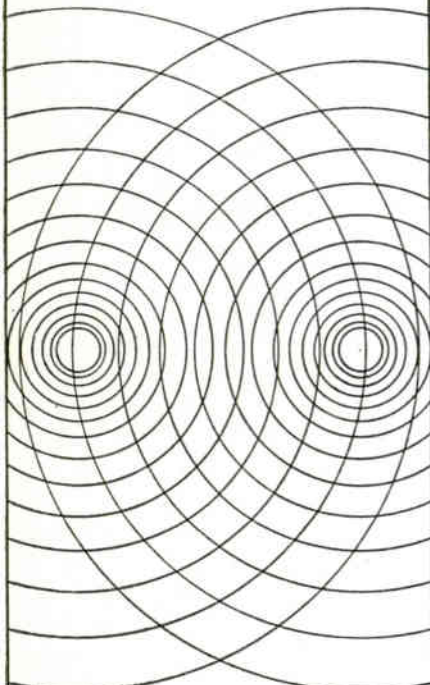

STEREO CARTRIDGE Crystal — "PIEZO" Y-130 X'TAL STEREO CARTRIDGE

At 20°C, response: 50 to 10,000 c/s with a separation of 16.5 db. 0.6 V output at 50 mm/sec. Tracking force: 6 ± 1 gm. Compliance: 1.5×10^{-6} cm/dyne. Termination: $1M\Omega + 150$ pF.

Write for detailed catalog on our complete line of acoustical products including pickups, microphones, record players, phonograph motors and many associated products.



JAPAN PIEZO ELECTRIC CO., LTD.

Kami-renjaku, Mitaka, Tokyo, Japan

electronics



Audit Bureau
of Circulations



Associated Business
Publications

Audited Paid Circulation

JAMES T. HAUPTLI

Advertising Sales Manager

R. S. QUINT:
Assistant Publisher Buyers'
Guide and Business Manager
DAVID CUNIFF:
Promotion Manager
B. ANELLO:
Market Services Manager

RICHARD J. TOMLINSON:
Production Manager
GEORGE E. POMEROY:
Classified Manager
HUGH J. QUINN:
Circulation Manager

ADVERTISING REPRESENTATIVES

ATLANTA (9):
Michael H. Miller, Robert C. Johnson
1375 Peachtree St. N.E., Trinity 5-0523
(area code 404)

BOSTON (16):
William S. Hodgkinson, Donald R. Furth
McGraw-Hill Building, Copley Square,
Congress 2-1160 (area code 617)

CHICAGO (11):
Harvey W. Wernecke, Robert M. Denmead
645 North Michigan Avenue, Mahawk 4-5800
(area code 312)

CLEVELAND (13):
Paul T. Fegley
55 Public Square, Superior 1-7000
(area code 216)

DALLAS (1):
Frank Le Beau
The Vaughn Bldg., 1712 Commerce St.
Riverside 7-9721 (area code 214)

DENVER (2):
J. W. Patten
Tower Bldg., 1700 Broadway,
Alpine 5-2981 (area code 303)

HOUSTON (25):
Joseph C. Page, Jr.
Prudential Bldg., Halcombe Blvd.,
Riverside 8-1280 (area code 713)

LOS ANGELES (17):
Peter S. Carberry, Ashley P. Hartman,
W. C. Gries
1125 W. 6th St., Huntley 2-5450
(area code 213)

NEW YORK (36):
Donald H. Miller, Henry M. Shaw,
George F. Werner
500 Fifth Avenue, LO-4-3000
(area code 212)

PHILADELPHIA (3):
Warren H. Gardner, William J. Boyle
6 Penn Center Plaza, LOcust 8-4330
(area code 215)

SAN FRANCISCO (11):
R. C. Alcorn
255 California Street, Douglas 2-4600
(area code 415)

LONDON W1:
Edwin S. Murphy Jr.
34 Dover St.

FRANKFURT/Main:
Matthée Herfurth
85 Westendstrasse

GENEVA:
Michael R. Zeynel
2 Place du Port

"Headquarters for Business Information"

McGraw-Hill Technical and Business Publications

American Machinist/Metal-
working Manufacturing
Aviation Week and Space
Technology
Business Week
Chemical Engineering
Chemical Week
Coal Age
Construction Methods and
Equipment
Construction Daily
Control Engineering
Electrical Construction
and Maintenance
Electrical Merchandising Week
Electrical Newsletter
Electrical West

Electrical Wholesaling
Electrical World
Electronics
Engineering Digest
Engineering and Mining Journal
E & M Metal and Mineral
Markets
Engineering News-Record
Factory
Fleet Owner
Industrial Distribution
National Petroleum News
Nucleonics
Nucleonics Week
Platt's Oilgram News
Platt's Oilgram Price Service
Power

Product Engineering
Purchasing Week
Science Week
Textile World

Overseas only:
Automobile International
(English, Spanish)
Ingenieria Internacional
Construccion (Spanish)
International Management
(English, Spanish
Portuguese editions)
Metalworking Production
(Great Britain)

Available by subscription only — to qualified persons actively engaged in the field of the publication. For subscription rates and information describing the editorial coverage of any of the above publications, write to: Subscription Manager, Circulation Department, McGraw-Hill Publishing Company, 330 West 42nd Street, New York 36, N. Y.

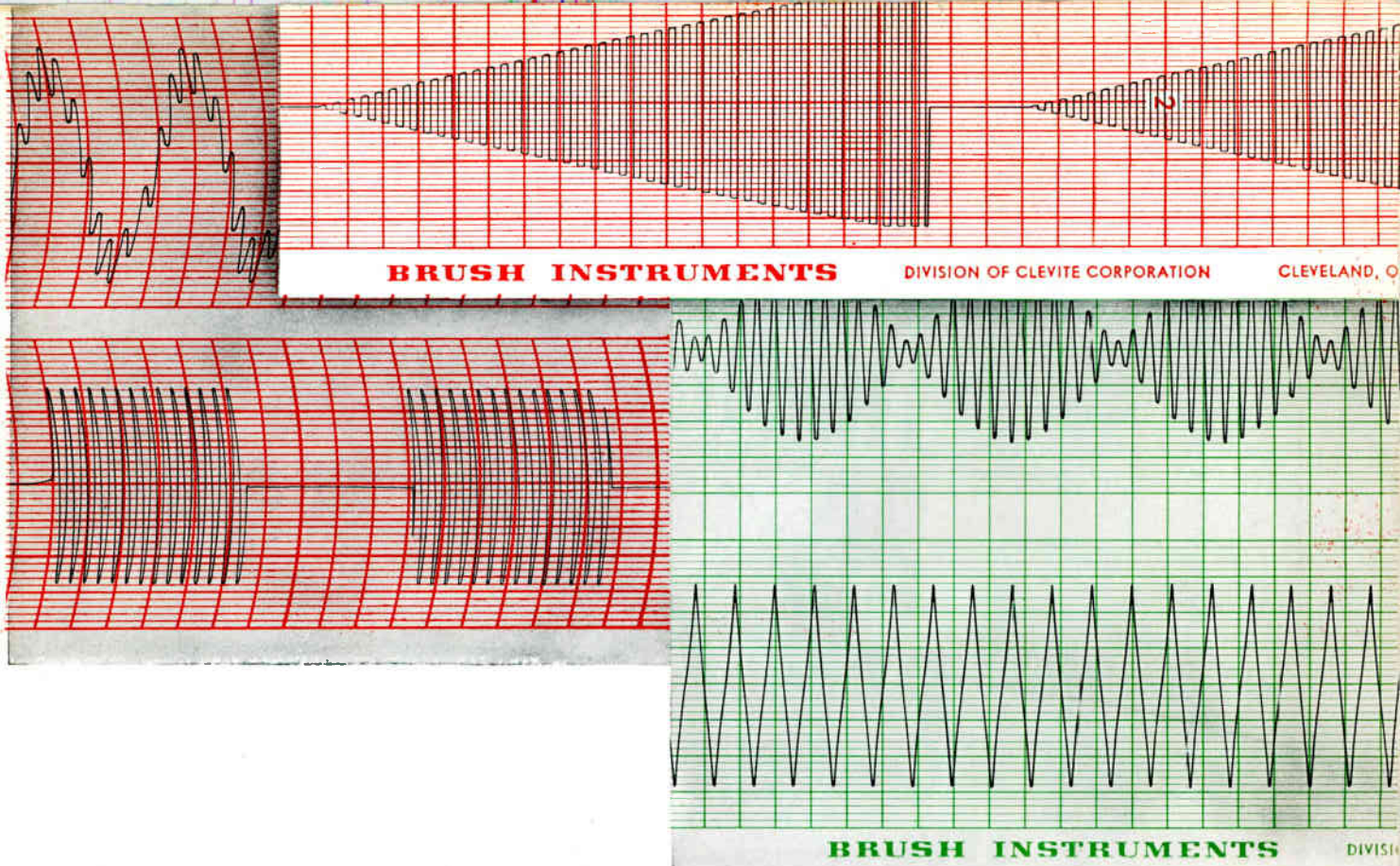

it pays
to use
Engineered
chart paper

Engineered details make the difference in chart paper. And only Brush chart paper is engineered as an integral part of the rigid specifications for today's Recording Systems. Imitation papers cannot match the special processing of paper surface to minimize pen friction; the unusual dimensional stability and tensile strength; the perfect alignment attained by winding and then rewinding the rolls; the carefully controlled printing conditions. Eliminate chance—specify *Brush* and you'll know your records will be accurate, permanent, easily read and reproduced. Stocks available from branches and sales representatives throughout the U. S. and Canada. Write for samples of actual tracings on Brush Chart Paper. Ask for "Brush Engineered Recording Supplies".



brush INSTRUMENTS
DIVISION OF **CLEVITE** 37TH AND PERKINS, CLEVELAND 14, OHIO

CIRCLE 901 ON READER SERVICE CARD

EXTRA NEW "UNIVERSAL" TRANSISTOR RCA UP TO SILICON TRANSISTORS NOW ON THE MARKET



HERE NOW IN QUANTITY!

HIGH-PERFORMANCE, RELIABILITY-PROVED, TRIPLE DIFFUSED SILICON
2N2102 AND 2N2270 NOW AVAILABLE AT ECONOMY PRICES

RCA now announces new economy prices on the 2N2102, the "universal" triple-diffused planar silicon transistor designed for widest possible application in military and industrial equipment. It can replace up to 40% of all silicon transistors now on the market and will cover a vast majority of your Small-Signal and Medium-Power Applications.

The RCA 2N2102 features high switching speed, high pulsed beta (h_{FE}) at $I_C = 1$ amp, and controlled beta from $I_C = 10\mu$ a to 1 ampere. It has high breakdown-voltage ratings, high dissipation ratings, low saturation voltages and low output capacitances.

RCA 2N2270, economy version of the RCA 2N2102, offers many of the features of the 2N2102 at substantial savings.

Call your RCA Representative today or write RCA Semiconductor and Materials Division, Commercial Engineering, Section IN2-3, Somerville, N.J.

For Application information on RCA 2N2102, write for Application Note SMA-14, "The Design of Low-Level and RF Circuits Utilizing the RCA 2N2102".

For Reliability data on RCA 2N2102, call your local RCA Semiconductor Field Office. Your RCA Representative will discuss the latest reliability information with you.

AVAILABLE THROUGH
YOUR RCA DISTRIBUTOR



THE MOST TRUSTED NAME IN ELECTRONICS

CIRCLE 902 ON READER SERVICE CARD