

Testing microwave systems in use 87
Charting major European meetings 97
Bell gears for Picturephone production 131

\$1.00 A McGraw-Hill Publication

January 19, 1970

Electronics®

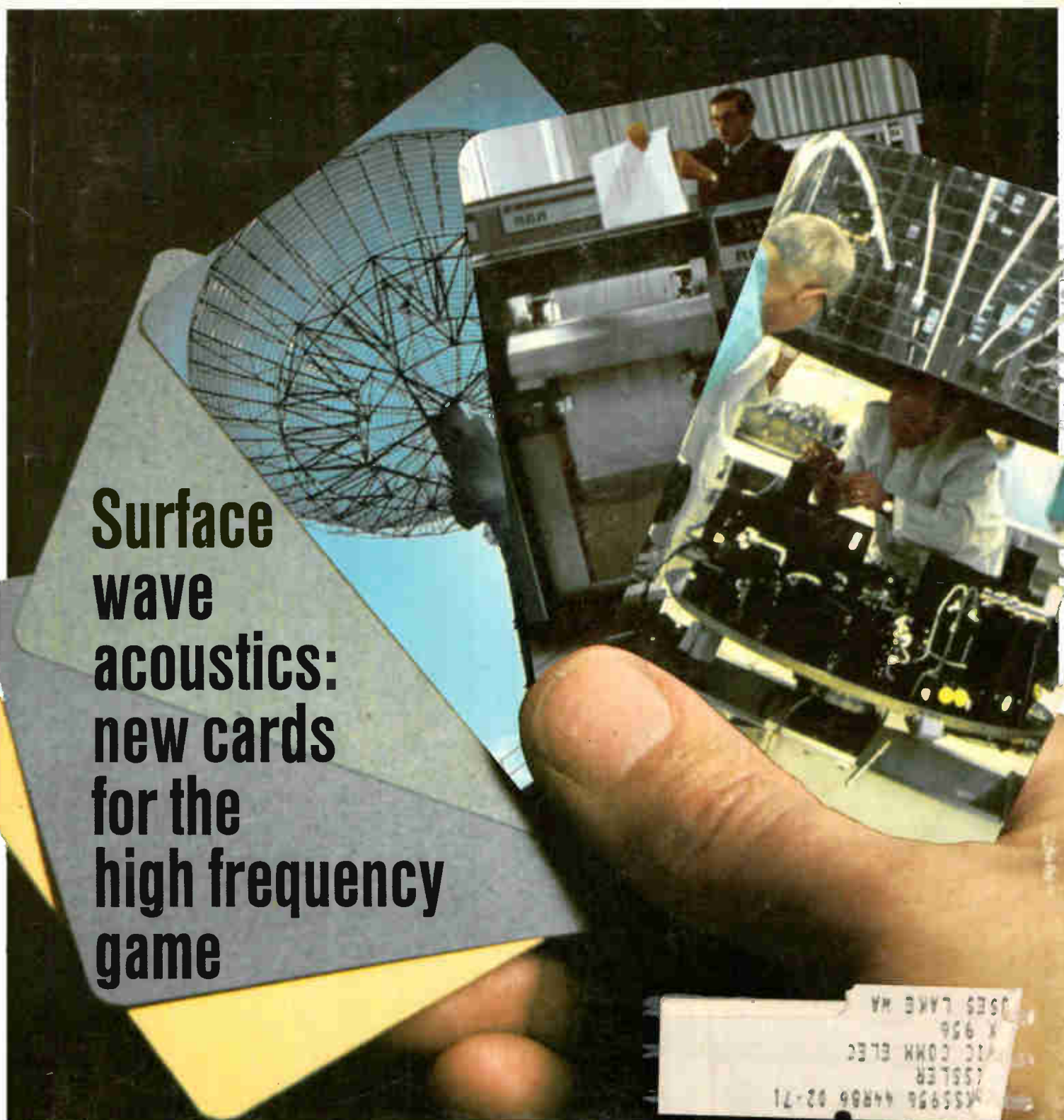

**Surface
wave
acoustics:
new cards
for the
high frequency
game**

4455956 44866 02-71
L55LER
837557
IC COM ELEC
956 X
355 LAKE WA



Help exterminate the QUADRADECAPEDE!

West Concord, Mass. - Doctors here announced a cure for the virus streptocircuitus integratus, transmitted by the fourteen-legged logic bug and prime cause of inflamed logic and many chronic output diseases.

A statement released by the group said in part, "By using the new General Radio 1790 Logic-Circuit Analyzer, with all its active ingredients, we are now in a position to perform 100% functional testing — on even the most complex modules. The computer-controlled 1790 can test devices with as many as 96 inputs and 144 outputs, checking from a simple functional GO/NO-GO test to a detailed step-by-step analysis for the debugging of defective units, and the optional programmable logic levels permit marginal testing!

"For only \$32,500 we can't see why any user of printed-circuit boards or integrated arrays would be without one — especially since extensive programming knowledge isn't

required. The results have been overwhelming! In several thousand test cases we've been able to eliminate defective IC's and modules early in the game, thereby producing harmony, well-being, and great cost savings in production."

Help increase the yield and longevity of logic circuits! Write or phone for more information from General Radio Company, West Concord, Massachusetts 01781; telephone (617) 369-4400. In Europe write Postfach 124, CH 8034 Zurich 34, Switzerland. Price applies in U.S.A.

GENERAL RADIO

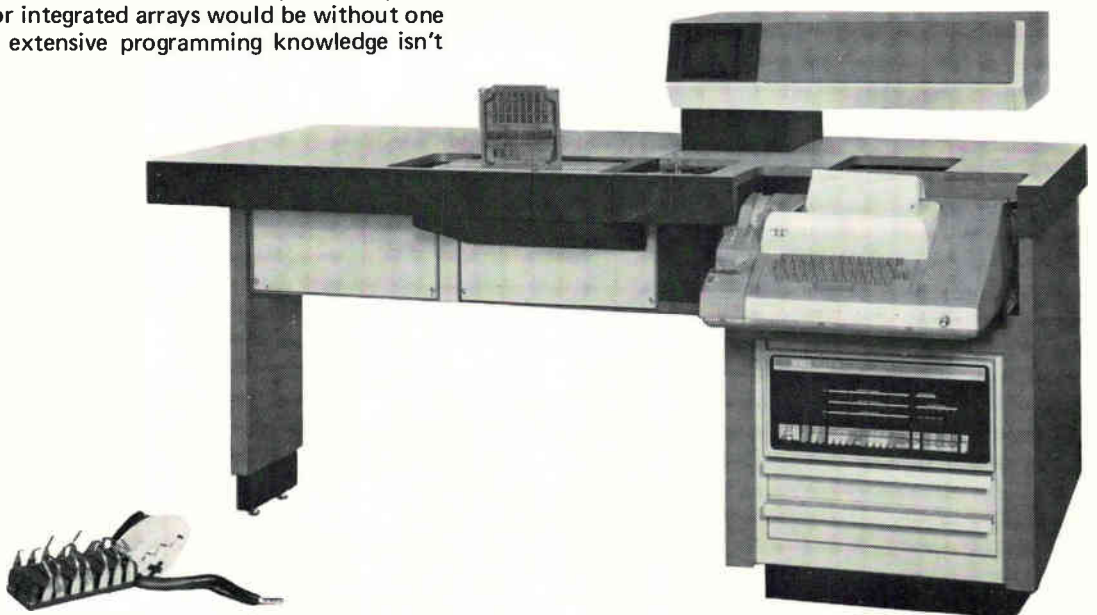

Circle 900 on reader service card

News Features

Probing the News

- 131 **Solid state:** Mass production of silicon vidicons holds key to Picturephone future
- 137 **Electronics abroad:** Is Russian market ready to boom for computers, peripheral equipment?

U.S. Reports

- 39 **Government:** NASA to make choice of ERC projects; closing foreshadows NASA moves
- 41 **Solid state:** Thermocouple with 30-nsec response time for i-r laser
- 42 **Space electronics:** Co₂ laser for ATS-F satellite
- 44 **Contracts:** Push for uniform Pentagon accounting methods
- 46 **Communications:** Problems with Mars Mariner '71's tape recorder
- 48 **For the record**

Electronics International

- 65 **Japan:** Plated-wire memory handles telephone switching
- 66 **Japan:** Quartz controls for wristwatches
- 66 **Great Britain:** Cooperative program for mask making
- 67 **Great Britain:** Argus-eyed computer
- 68 **Central America:** Five nations link up by microwave

New Products

- 141 **In the spotlight**
- 141 Word generator has 48 outputs
- 145 **Instruments review**
- 145 Sweeper covers 25 khz to 3 Ghz
- 149 **Subassemblies review**
- 149 Cassette deck for data storage
- 155 **Data handling review**
- 155 Coupler compensates for line woes
- 158 Memory has 650-nsec cycle time
- 161 **Microwave review**
- 161 Detector becomes Impatt oscillator
- 165 **Semiconductor review**
- 165 TTL MSI offers attractive tradeoff
- 168 IC amplifier needs little help
- 172 **New materials**

Technical Articles

- Instrumentation** 82 **Computer-controlled testing can be fast, reliable, and economical without extensive operator training**
Simple language, versatile functions reduce costs while helping to design, test and troubleshoot circuits
Matthew Fichtenbaum,
General Radio Co.
- Microwave** 87 **Avalanche diodes permit in-service measurements of critical parameters in microwave equipment**
Solid state noise sources can be built into microwave gear to insure reliable performance
Norman Chasek,
International Microwave Corp.
- Circuit design** 92 **Designer's casebook**
- Diodes eliminate crossover distortion in video amplifier
 - Shift register simplifies design of phase comparator
 - IC line receiver converts pulses to logic levels
- Calendar** 97 **Highlighting major European meetings**
- Memories** 102 **Post-and-film memory delivers NDRO capability, low noise, high speed, but avoids problem of creep**
Robert F. Vieth and Charles P. Womack,
Litton Systems
- 107 **Simple electroplating process allows high-storage waffle-iron memory to be built easily, inexpensively**
Peter Langlois, Nye Howells, and Alan Cooper,
Standard Telecommunications Laboratories
- Advanced technology** 110 **Surface-wave delay lines promise filters for radar, flat tubes for television, and faster computers**
Advances in technology can open up a broad spectrum of new applications
J.H. Collins and P.J. Hagon,
Autonetics

Departments

- | | | | |
|----|--------------------------|-----|--------------------------|
| 4 | Editorial Comment | 33 | Electronics Newsletter |
| 5 | Readers Comment | 63 | International Newsletter |
| 9 | Who's Who in this issue | 71 | Washington Newsletter |
| 14 | Who's Who in electronics | 175 | New Books |
| 22 | Meetings | 179 | Technical Abstracts |
| | | 182 | New Literature |

Electronics

Editor-in-Chief: Donald Christiansen

Senior staff editors

Technical: Stephen E. Scrupski

News: Robert Henkel

International: Arthur Erikson

Art director: Gerald Ferguson

Assistant managing editors: H. Thomas

Maguire, Howard Wolff, William Bucci,

Richard Gundlach, Frederick Corey

Special projects editor: Roger Kenneth Field

Senior staff writer: John Johnsrud

Reader communications manager: John

Drummond

Department editors

Senior associate editors: Joseph Mittleman, Harry R. Karp; Advanced technology: Laurence Altman; Communications: Leon M. Magill; Computers: Wallace B. Riley, George Weiss; Design theory: Joseph Mittleman; Industrial electronics: Harry R. Karp; Instrumentation: Owen Doyle; Military/Aerospace: Alfred Rosenblatt; New products: William P. O'Brien; Solid state: George Watson, Stephen Wm. Fields

Copy editors: Edward Flinn, William S. Weiss

Assistant art director: Charles Ciatto

Production editors: Susan Hurlburt, Arthur C. Miller; Editorial research: Virginia Mundt; Editorial secretaries: Lorraine Longo, Claire Goodlin, Bernice Pawlak, Barbara Razulis, Vickie Green.

Field bureaus

Boston: James Brinton, manager, Gail Farrell; Los Angeles: Lawrence Curran, manager, Ralph Selph; New York: Peter Schuyten; San Francisco: Stephen Wm. Fields; Washington: Ray Connolly, manager; Robert Westgate, Lois Vermillion; Frankfurt: John Gosch; London: Michael Payne; Paris: Arthur Erikson; Tokyo: Charles Cohen

Reprints: Virginia Mundt; Circulation: Isaaca Siegel

Publisher: Gordon Jones

Associate publisher: Dan McMillan

Assistant to the publisher: Wallace C. Carmichael

January 19, 1970

NASA's closing of ERC—why now?

● As any bureaucrat can tell you, Government centers are easy to create, but agonizingly difficult to phase out. Just how painful will be the death of NASA's Electronics Research Center in Cambridge, Mass., remains to be seen, but ERC didn't even have an easy birth. Seldom has a Government agency had to battle so hard through so many hearings and rehearings as NASA did to convince Congress that ERC was essential to the space program, and that the MIT-Harvard neighborhood was the place for it. Politics was a factor, of course, but probably no more so than in the choice of Houston for the Manned Space Flight Center.

So it is eminently relevant to ask: What makes ERC so expendable all of a sudden? It's hard—doubly so for this publication—to take seriously NASA Administrator Thomas O. Paine's comment about a general de-emphasis of electronics in space plans. Also unpersuasive is the "economy" explanation. The center spent only 1% of the NASA budget, and wasn't in operation long enough to prove either a waste or a good investment.

The center's programs were evolving, of course. But basically, ERC was chartered to advance the state of the art in electronic technologies for both space exploration and aviation—along a broader front than what could be done by centers involved in specific NASA missions.

Few ERC programs can be "de-emphasized" if the nation remains committed to space exploration and aviation improvements. Some of those that could be endangered include:

▶ Component development, tailored to the space environment.

▶ Semiconductor reliability, with recent emphasis on proc-

ess control for improved IC's and LSI circuitry, on computer-aided testing, and on specifications for a semiconductor data bank.

▶ Sensor technology, primarily for the earth resources program, focusing on ultraviolet and microwave techniques. These are areas where there are few experts.

▶ Bioinstrumentation, originally conceived to develop advanced sensors for space telemetry, and broadened to the point where the group became a bridge between the Boston-area medical and engineering communities.

▶ Power processing. The goal was to apply the same level of control to onboard space and aircraft power-generation as in signal- or data-processing.

▶ V/STOL avionics program, principally to develop a digitally based navigation and landing system.

▶ CTOL avionics, including an automatic landing system for conventional jet aircraft.

▶ A pilot warning indicator—a simple collision-avoidance technique using diode detectors to spot nearby aircraft.

▶ L-band navigation satellites.

And as of November 1969, ERC had awarded about 250 R&D contracts to industry and universities for work on spaceborne computers, microelectronic interconnections, application of computer-aided design to space hardware, strap-down guidance systems, detection of clear-air turbulence, and a dozen other technological advances that will prove valuable in the future.

All of these programs are not going to die with ERC. Some work, like the V/STOL program, is shared with other centers and agencies. And some programs will be transferred,

Published every other Monday by McGraw-Hill, Inc. Founder: James H. McGraw 1860-1948. Publication office 99 North Broadway, Albany, N. Y. 12202; second class postage paid at Albany, N. Y. and additional mailing offices.

Executive, editorial, circulation and advertising addresses: Electronics, McGraw-Hill Building, 330 W. 42nd Street, New York, N. Y. 10036. Telephone (212) 971-3333. Teletype TWX N. Y. 710-581-4235. Cable address: MCGRAWHILLN.Y.

Subscriptions solicited only from those professionally engaged in electronics technology. Subscription rates: qualified subscribers in the United States and possessions and Canada, \$8.00 one year, \$12.00 two years, \$16.00 three years; all other countries \$25.00 one year. Non-qualified subscribers in the U.S. and possessions and Canada, \$25.00 one year; all other countries \$50.00. Air freight service to Japan \$50.00 one year. Single copies: United States and possessions and Canada, \$1.00; all other countries, \$1.75.

Officers of McGraw-Hill Publications Company: Joseph H. Allen, President; John R. Emery, J. Elton Tuohig, Senior Vice Presidents; Gordon L. Jones Jr., Group Vice President; Vice Presidents: John R. Callahan, Editorial; John W. Holden, Marketing; David G. Jensen, Manufacturing; Jerome O. Luntz, Planning & Development; Robert F. Marshall, Administration; Robert M. Wilhelm, Finance; Director of Circulation: Ralph Blackburn.

Officers of the Corporation: Shelton Fisher, President and Chief Executive Officer; John L. McGraw, Chairman; Robert E. Slaughter, Executive Vice President; Daniel F. Crowley, Donald C. McGraw, Jr., Bayard E. Sawyer, Senior Vice Presidents; John J. Cooke, Vice President & Secretary; Gordon W. McKinley, Vice President & Treasurer.

Title © registered in U.S. Patent Office; © Copyright 1970 by McGraw-Hill, Inc. All rights reserved. The contents of this publication may not be reproduced either in whole or in part without the consent of copyright owner.

Subscribers: The publisher, upon written request to our New York office from any subscriber, agrees to refund that part of the subscription price applying to copies not yet mailed. Please send change of address notices or complaints to Fulfillment Manager; subscription orders to Circulation Manager. Electronics at address below. Change of address notices should provide old as well as new address, including postal zip code number, if possible, attach address label from recent issue. Allow one month for change to become effective.

Postmaster: Please send form 3579 to Fulfillment Manager, Electronics, P.O. Box 430, Hightstown, New Jersey 08520.

If price and performance are important— here's a 7 MHz value

This is a lab-quality, all-solid-state scope—at a price you'd ordinarily expect to pay for older vacuum-tube models.

Value—DC to 7 MHz bandwidth. This frequency range covers audio, video and most control circuit applications.

Value—5 mV to 20 V per division deflection factor. Here is sufficient capability to pick up most electronic or electro-mechanical system outputs without distortion or need for additional amplifiers.

Value—Rock solid triggering with capabilities ordinarily found only in more expensive lab type oscilloscopes . . . triggered or recurrent sweep, single-sweep, and automatic triggering.

Value—Low drift, long-term stability. Field effect transistors virtually eliminate drift from temperature changes, shock or vibration. Long-term stability means less frequent calibration.

Value—Easy to use. Logical arrangements of controls, beam finder, auto-triggering make operation easy. Interlocking controls on sweep time and magnifier prevent readout errors.

Value—Easy-to-see display. Internal graticule, 8 x 10 cm CRT for measurement accuracy. Bright, small spot-size trace increases visibility and resolution.

Value—Available in single channel cabinet or rack versions (1215A or 1215B), or in dual-channel cabinet or rack versions (1217A or 1217B). Electrical characteristics are identical. Rack version is only 5¼" high. Panel on the cabinet version is about the size of this page.

Value—Price, 1215A/B, \$950; 1217A/B, \$1175. Add up the features, then divide by price and you'll find this is the greatest performance/dollar value ever offered.

080/8

These 7 MHz oscilloscopes are new members of HP's growing family of low- and mid-frequency oscilloscopes. In addition to these new mid-range scopes you have 500 kHz scopes in 14 models with your choice of: Single or dual trace, 100 μ V/cm or 5 mV/cm deflection factors, conventional display or variable persistence and storage, all in cabinet or rack versions.

If you're looking for accurate mid-frequency measurements, ease of use, reliability—all at a low cost—here's a real 7 MHz value!

Call your local HP field engineer. Or, write to Hewlett-Packard, Palo Alto, California 94304. Europe: 1217 Meyrin-Geneva, Switzerland.

HEWLETT  **PACKARD**
OSCILLOSCOPE SYSTEMS



When you buy a low-cost electronic counter from us, you get a unique bonus. Us.

With 55 service offices in the United States and Canada and 86 offices worldwide, we're always close by if you need help. And we give the same complete, dependable back-up to customers who spend a few hundred dollars for a counter as we do to those who spend a few thousand. That's a good thing to keep in mind when you're looking for an inexpensive way to solve your counting problems. And when you add the price and service to the performance you can expect from these counters, you know you're onto a real bargain.

For instance the Hewlett-Packard

5321A counts frequencies up to 10 MHz, has a 100 mV sensitivity and 1 M Ω /30 pF input impedance, 4-digit readout with display storage, zero blanking for easier, faster reading. All this is \$425.

The more versatile and more accurate Hewlett-Packard 5321B gives you BCD recorder output, 5-digit readout, frequency ratio and pulse duration measurement, additional gate times and a quartz crystal time base. Yet the price is just \$775.

The Hewlett-Packard 5221A/B Counters are the same in everything but shape. They're higher, narrower and not as long as the 5321A/B.

If you need greater capability, the Hewlett-Packard 5216A will provide it for \$985. This counter will totalize, measure

frequency, period, multiple pages, ratio, multiple ratios and duration. It has a 7-digit readout times of 0.01 to 10 seconds, 10 millivolt sensitivity, BCD recorder output, and a maximum count rate of 12.5 MHz.

So when you need a low-cost counter, talk to the people who can deliver the goods *and* whatever service you need, whenever you need it. Call your local Hewlett-Packard field engineer for all the details. Or write to Hewlett-Packard, Palo Alto, California 94304; Europe: 1217 Meyrin-Geneva, Switzerland.

HEWLETT  PACKARD
ELECTRONIC COUNTERS

02912

Circle 2 on reader service card

Count on us for as little as \$425.

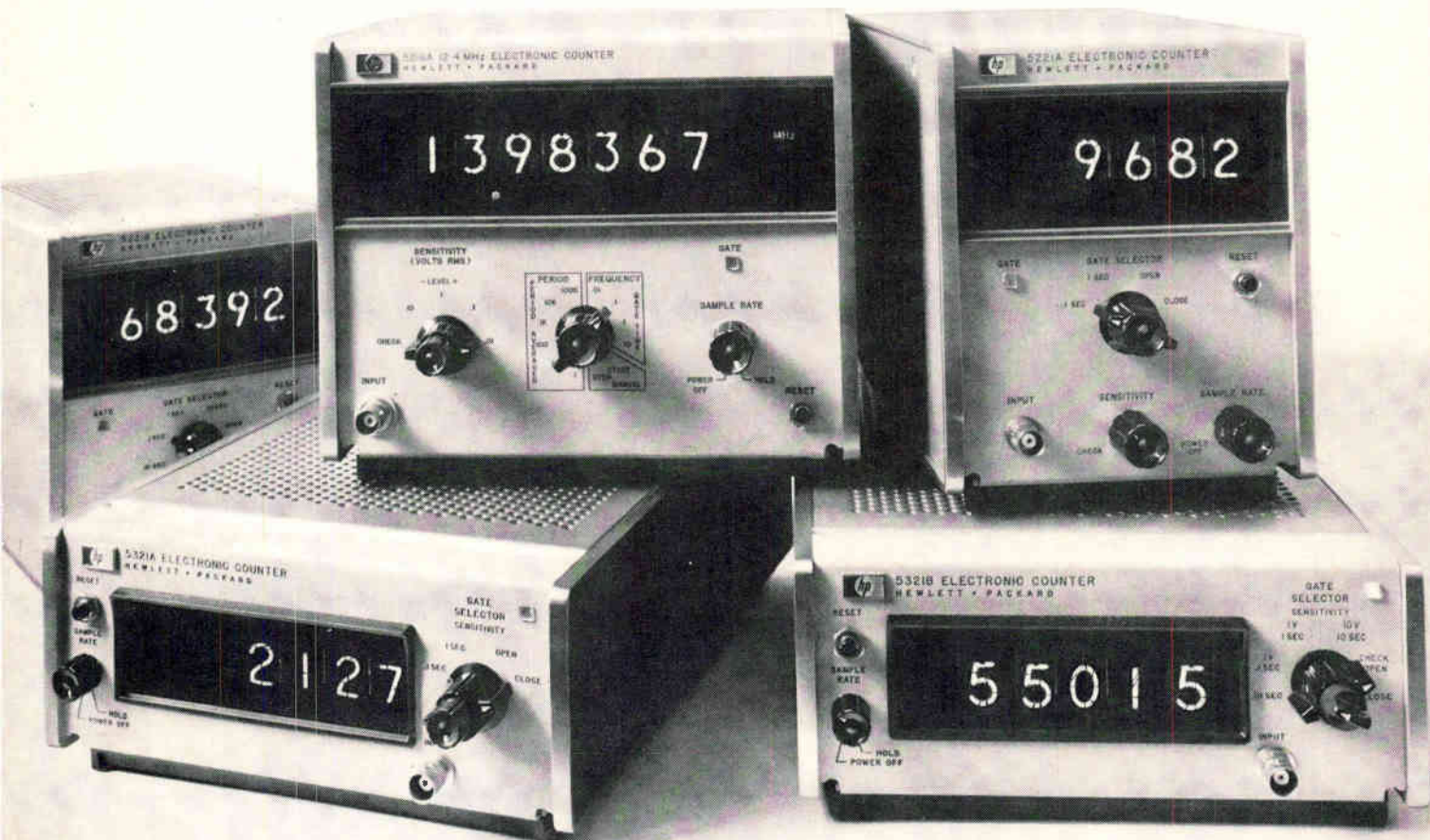



fairly intact, to surviving centers.

But it is unrealistic to assume that the space effort won't be hurt at all. One of the most important achievements of the center was the organization of teams—scientists, engineers, and administrators—for in-house research and for monitoring contracts to industry. People usually don't relocate in teams, and Civil Service bureaucracy regulations may not permit team transfers. For example, the ERC work on power systems for future spacecraft and airplanes logically might be transferred to the Lewis Research Center. But to preserve momentum, Lewis would have to absorb the personnel who were involved, no mean feat for a Federal center caught in a budget squeeze.

One of the most serious dislocations will be the multifaceted NASA microelectronics reliability program, which has carried the ERC stamp from the beginning. The program's administration can be relocated, but it probably will be impossible to move the technical team intact.

Even more puzzling than Administrator Paine's "de-emphasis of electronics" comment is his reported assertion that ERC's work can be performed as well or better by contracting out research to industry.

In fact, most of the center's work already was contracted out to industry; ERC was the monitor, supervisor, sometimes initiator, and guardian of NASA's and the government's interests. But Paine's remark brings into sharp focus the illogic of the ERC shutdown: if its work can be performed better by private industry, why was it created, and allowed to continue in operation so long? And why, suddenly, did ERC become so expendable?—H.T.M. ●

McGraw-Hill News Service

Director: Arthur L. Moore; Atlanta: Fran Ridgway; Chicago: Robert E. Lee; Cleveland: Arthur Zimmerman; Dallas: Marvin Reid; Detroit: James Wargo; Houston: Barbara LaRoux; Los Angeles: Michael Murphy; San Francisco: Margaret Drossel, Tyler Marshall; Seattle: Ray Bloomberg; Washington: Charles Gardner, James Canan, Herbert W. Cheshire, Seth Payne, Warren Burkett, William D. Hickman; Bonn: Robert F. Ingersoll; Brussels: James Smith; Hong Kong: Kate Mattock; London: John Shinn; Mexico City: Gerald Parkinson; Milan: Jack Star; Moscow: Jack Winkler; Paris: Robert E. Farrell, Stewart Toy; Tokyo: Marvin Petal

To the Editor:

In regard to the recent announcement of the intended closing of NASA-ERC [see Editorial Comment, facing page; *Electronics*, Jan. 5, p. 33], I must admit this news left me astounded, to say the least.

It seems incredible that the U.S. Government is unable to plan effectively for a span of no more than half a decade. After making an investment of over \$36 million to implement the center, the Administration now apparently believes that the benefits from ERC do not justify funding operational monies to maintain it. This type of decision-making is responsible for the worst in Government inefficiency.

In my opinion the product of ERC—electronics research and development—has great value to the country as a whole, particularly in the areas of collision-avoidance systems and other aircraft-related work badly needed at this time.

Basic research and electronic product development have broad value only when the results of such development are well communicated. ERC has done an outstanding job of communicating to industry and other Government agencies in this regard. As a result, concepts developed for a space application may well find additional applications in air and water pollution, or in relieving airway congestion.

The concept of Government-sponsored R&D has been one of the cornerstones of recent economic growth in this country. The closing of ERC represents a significant and dangerous step backward in the progress of this country.

Howard B. Foster

Parametric Industries
Winchester, Mass.

A blue note

To the Editor:

The information in your special report on communications [Nov. 24, 1969, p. 73] relating to electronic music and the Moog Synthesizer is consistently wrong. The Vocoder and the synthesizer bear no relationship to one another. The Moog isn't essentially a keyboard instrument (a keyboard is only one of many possible accessories). And except for a couple of custom units, no synthesizer has 12 oscillators. Walter Carlos, a New York recording engineer, not George Harrison, made "Switched-on Bach." The Moog Synthesizer does not make synthetic sounds. The Moog Synthesizer makes real, synthesized sounds as do all other electronic

(continued on p. 6)

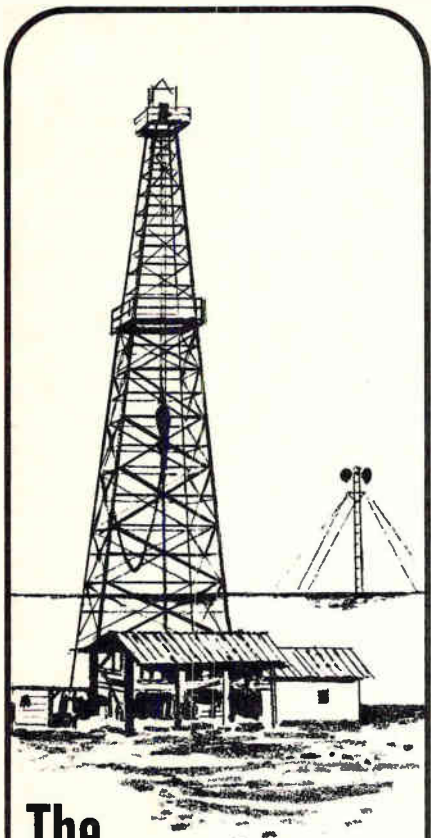

The Coastal States Gas Producing Co. of Texas

uses Farinon microwave systems for reliable communications

So do three oil companies in Africa, four more in Venezuela, nine major US oil producers, 43 major US telephone companies, 16 US government agencies, and five railroads . . . among 223 others.

They appreciate Farinon's skill at combining high performance and reliability with economy.

Write for our catalog of radio, microwave and multiplex equipment, accessories and services.

Farinon

Farinon Electric, 925 Washington St., San Carlos, Cal. 94070

Readers Comment

music synthesizers.

As for your statement that "synthetic refrains" don't have the power associated with high recording levels, this is meaningless both musically and technically. And what video tape recorder fitted out with up to 32 tracks do you have in mind? I know the recording industry fairly well, but I never heard of a 32-track recorder.

R.A. Moog

President,
R.A. Moog Inc.
Trumansburg, N.Y.

▪ The relationship between the Vocoder and the synthesizer was mentioned merely to illustrate that music, as well as speech, could be synthesized electronically. The Moog Synthesizer, as Mr. Moog points out, may not be a keyboard instrument. But by his company's own count, upwards of 99% of all Moog Synthesizers are sold with keyboards. And as for Mr. Moog's contention that, barring custom units, no synthesizer has 12 oscillators, the synthesizer examined by *Electronics*' Roger Field did indeed have 12 such voltage-controlled devices. This unit was a custom synthesizer, as are all synthesizers.

These oscillators produce various frequencies, one at a time, as voltages corresponding to desired musical notes are supplied by either the fingered keyboard or some other sequencing device, such as a computer. The oscillators, unfortunately, are not without drawbacks. According to some synthesizer users, the oscillators are

temperature sensitive, drift off pitch, and need frequent tuning.

With regard to synthetic music's apparent lack of power, there is both a musical and technical explanation. An orchestrator reckons musical power in terms of projection, fullness of sound, sharpness of attack, tuning and cleanliness of the musical sound, and, of course, sheer volume. Intonation, or pitch, can be used to create the effect of power.

Perceived acoustical power can be increased electronically by boosting audio power levels, especially in the middle ranges of the audio spectrum to which the human ear is most sensitive. The Moog Synthesizer's apparent lack of power relates to the relative purity of the generated sound—enharmonic oscillations in the upper-middle and the upper portions of the audio spectrum are lacking, and the signal strength at both extremes of the spectrum can be excessive.

Unquestionably, 24-track audio heads on 2-inch video-tape decks have become commonplace. And some studios reportedly are working with 32-track machines.

Electronics goofed on one point. Mr. Carlos did indeed make the "Switched-on Bach" recording. The Beatles' George Harrison composed the music for another synthesized recording, "Electronic Sound." Also, Mr. Moog's semantic point regarding synthetic vs. synthesized sounds is provocative. One might also argue that synthetic music is real music.

SUBSCRIPTION SERVICE

Please include an *Electronics Magazine* address label to insure prompt service whenever you write us about your subscription.

Mail to: Fulfillment Manager
Electronics
P.O. Box 430
Hightstown, N.J. 08520

To subscribe mail this form with your payment and check new subscription renew my present subscription

Subscription rates: qualified subscribers in the U.S.: 1 year \$8; two years, \$12; three years, \$16. Non-qualified: 1 year \$25. Subscription rates for foreign countries available on request.

CHANGE OF ADDRESS

ATTACH LABEL HERE

If you are moving, please let us know five weeks before changing your address. Place magazine address label here, print your new address below.

name

address

city

state

zip code

D/A CONVERTERS

10-BIT D/A

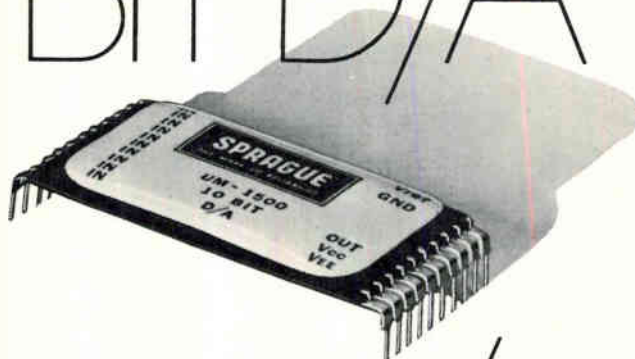

5 BUCKS / BIT

A HYBRID CIRCUIT
PRICE/PERFORMANCE
BREAKTHROUGH.

Check these specs:

- $\pm 1/2$ LSB accuracy
- 100 kHz bit rate
- 25 k Ω output impedance
- 5 ppm/ $^{\circ}$ C T_c max.
- 0 to +70 $^{\circ}$ C operating temperature

Now you can get a complete thin-film 10-bit D/A converter—buffer amp, ladder switch, and tantalum nitride ladder network—all in a single package with DIP compatible pinning. And for \$5.00 per bit.

We've also got a 4-bit D/A, a 4-bit expander module to get 8 bits, and a three package kit to get 12 bits.

Find out about all of them.

SAMPLES? PRICE? DELIVERY? LOCAL DISTRIBUTORS? TECHNICAL LITERATURE?
GET THE ANSWERS AT ANY OF THE NUMBERS LISTED BELOW.

ALA. Huntsville, no charge call operator, WX4000 ARI. Phoenix (602) 279-5435 CALIF. Burlingame (415) 347-8217 Los Angeles, Bell Tel., (213) 870-0161, Gen. Tel., (213) 391-0611 San Diego (714) 278-7640 COLO. Denver (303) 756-3611 CONN. Trumbull (203) 261-2551 DC. Washington (202) 244-6006 FLA. Orlando (305) 831-3636 ILL. Schiller Park (312) 678-2262 IND. Indianapolis (317) 546-4911 MASS. Newton (617) 969-7640 North Adams (413) 664-4411 MICH. Ann Arbor (313) 761-4080 Detroit, no charge call operator, Enterprise 7498 MINN. Minneapolis (612) 335-7734 MO. St. Ann (314) 291-2500 NJ. Cherry Hill (609) 667-4444/(215) 467-5252 Wayne (201) 696-8200 NY. Melville (516) 293-6710 Upstate call (413) 664-4411 NC. Winston-Salem (919) 722-5151 OHIO Chagrin Falls (216) 247-6488 Dayton (513) 223-9187 Cincinnati, no charge call operator, Enterprise 3-8805 TEX. Richardson (214) 235-1256 WASH. Seattle (206) 632-7761.



more functions in less space

radiation hardened magnetic Flat Pak modulators, analog multipliers, demodulators mount directly on IC cards.

- Flat Pak design only 0.1" thick.
- Zero Hysteresis.

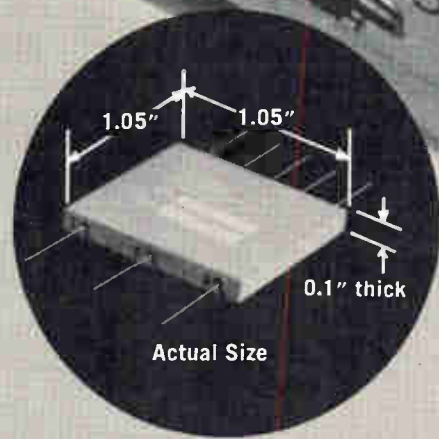

Accuracy 1% absolute or 2 MV whichever is greater

- Hybrid assemblies mount directly on IC cards.
- Space saver design . . . typical dimensions 0.1" thick x 0.5" x 0.75".
- Rugged design, extreme reliability. MTBF design goal 0.25 per million hours.
- Extremely low drift over -55° to $+125^{\circ}\text{C}$ range.
- Not affected by high intensity nuclear radiation.
- Capable of operating on carrier frequencies as high as five Mhz.
- One or more isolated or floating input signals may be used for modulating, multiplying, dividing, squaring or extracting a root.
- No external nulling or offset adjustments.
- No additional components or compensation required.
- No external operational amplifiers required.
- Standard ± 15 V DC power supplier unless otherwise specified.

As an Analog Multiplier of a Bipolar DC signal times an AC signal, the output **product accuracy** is 1% of point, or 2 MV, whichever is greater over a dynamic range of 10,000:1 in each quadrant.

Over the temperature range of -55°C to $+125^{\circ}\text{C}$, the following parameters hold:

- 1) Zero Point Drift: ... Less than 2 MV of in phase component
- 2) Gain Slope Stability: Less than 2% change
- 3) Dynamic range and output wave quality independent of temperature variations

Typical input/output parameters:

- X Signal: 0 to ± 5 V
- Y Signal: 0 to ± 5 V
- Output: 0 to 5V RMS across 5K or greater load impedance

MAGNETIC MULTIPLIERS

Dynamic Product Range

80 db

Magnetic Modulators

Dynamic Range:

60 db

Magnetic DC x DC Multiplier

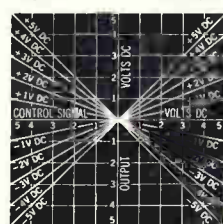

Squaring

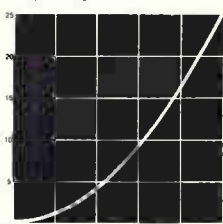

Square Root

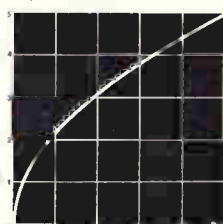

Division

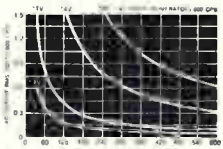

Amplitude Modulation

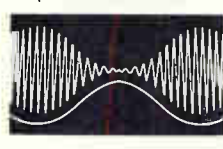

Balanced Modulator

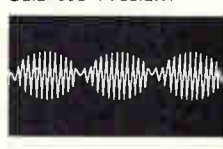

There is No Substitute for Reliability
GENERAL MAGNETICS, INC.
 135 Bloomfield Avenue,
 Bloomfield, New Jersey 07003

Who's Who in this issue



Chasek

Involved in designing microwave systems and components for 19 years, Norman Chasek, author of the article starting on page 87, is one engineer who certainly appreciates the importance of making sure a system actually is operating the way it's supposed to. Chasek is president of the International Microwave Corp. of Cos Cob, Conn., a company he founded in 1961. It's one of a few companies that produce the tiny noise diodes described in the article. One of the first products put out by the fledgling company was a tunnel diode amplifier which, Chasek admits, he never thought would prove practical. But Chasek now estimates his firm is the world's leading supplier of tunnel diode amplifiers, producing about 2,000 a year. Prior to organizing International Microwave, Chasek was employed for five years by Bell Labs' radio research department in Holmdel, N.J., and spent four years at the Air Force's Rome Air Development Center, designing jamming systems. He has a master's degree in electrical engineering from Polytechnic Institute of Brooklyn.

Authors of the article beginning on page 107, Peter Langlois and Nye Howells worked on the waffle-iron memory from 1964 until early 1969. Langlois headed digital storage space development in the magnetic materials division of Standard Telephones and Cables before joining the Standard Telecommunications Laboratories in 1968. Howells was an STC computer specialist. He moved to STL five years ago, and has been working on theoretical studies of telephone networks and signaling systems. Alan Cooper has worked on the waffle-iron store since 1965. Previously, he specialized in digital circuits for telephone exchanges.

Materials research and development manager at Litton Systems' Guidance and Control division. Robert Vieth, author of the article beginning on page 102, directed the studies of the projected post-and-film memory, and of the ferrite and film materials, following which his group produced a prototype nondestructive readout stack. Then co-author Charles Womack's memory systems development group took over at Litton's Data Systems division. Vieth has a Ph.D. from Michigan State, and has been working at Litton since 1963. Womack has a Ph.D. from the University of Kansas, and worked at Collins Radio before joining Litton.



Vieth

In his undergraduate days, New-York-born Matthew Fichtenbaum, author of the article that begins on page 82, spent one semester working at General Radio and two semesters studying at MIT. After going on to earn an advanced degree in electrical engineering from MIT, Fichtenbaum returned to General Radio as a development engineer. When General Radio made the decision to build a computer-controlled test system, Fichtenbaum was called upon to perform the programming chores. At present, he notes, "I do a fair amount of work both with programming and hardware systems design in digital processing."

Concluding the series on acoustic surface-wave technology in this issue, J.H. Collins and P.J. Hagon of Autonetics, in their article starting on page 110, examining the important new and developing applications for surface waves—from analog filters to video displays. The first article discussed the theory of the technology, amplification, materials, transducers, delay lines, and waveguides. The second of the three articles concentrated on surface waveguides and acousto-electric amplifiers.



Fichtenbaum



23 months ago, this was American Data Systems. Today, it's 200 strong.

TI Supply supplied the supplies.

Here, behind company president Arthur Wilkes, is where American Data Systems got its start.

Not too impressive, perhaps, but the products that came out were. Demand for the company's data transmission terminals has been so great that the staff has grown from 6 to 200 employees in less than two years. And American Data Systems is moving into a modern 100,000 sq. ft. plant.

TI Supply—a new breed of industrial distributor—played a key role in this meteoric growth

...with engineering assistance in matching electronic components to a product that's pushing the state of the art.

...with balanced inventories and scheduled deliveries to keep production lines running without ADS tying up a large amount of money.

...with overnight delivery of special TTL integrated circuit orders from far-away stocks.

We've supplied American Data Sys-

tems with connectors, resistors, capacitors, integrated circuits, wire, and cable.

Plus lots of personalized service.

But these aren't the only ways we serve our customers.

You might want to use our assembly and custom-marking services, tailoring products to your specific requirements.

Or our testing service to screen devices to specific electrical parameters.

Many of our customers needing high-reliability semiconductors couldn't do without our "burn-in" services.

But above all, we are dedicated to helping your business grow. We have thirty-nine world-wide locations, any one of which is ready to serve you now.

Maybe your problems are not the same as those of American Data Systems, but if they involve electronic components, industrial supplies or services, there's a good chance we can come up with right solutions.

Give us a call.

Make the correct connector connection:

Among the supplies American Data Systems required were connectors. And they got connectors perfectly matched to the application. Because TI Supply maintains in-depth inventories of a wide choice of connectors: Amphenol, Burndy, Cinch, Kings, Sealectro, TI, U.S. Components. (Not to mention IC sockets.) So, like ADS, you're assured of always getting the *correct* connector.

But TI Supply goes further. We'll assemble your connectors, quickly and economically. And we'll put a connector specialist to work on your particularly knotty connector problems.

Make the correct connector connection—call your local TI Supply branch office or write TI Supply Co., P. O. Box 35486, Dallas, Texas 75235.



TI SUPPLY.. the problem solvers.

EAST
Boston (Canton), Mass (617) 828-5020
Clark, New Jersey (201) 382-6400
New York, New York (212) 895-0803
or (516) 488-3300
Philadelphia (215) 664-1132

MIDWEST
Kansas City, Missouri (816) 753-4750
Minneapolis (Edina), Minn (612) 941-5020
Chicago (Rosemont), Ill (312) 296-7187
Wichita (Derby), Kansas (316) 788-1714

SOUTHWEST
Austin, Texas (512) 454-2531
Dallas, Texas (214) 357-6121
Fort Worth, Texas (817) 332-9361
Houston, Texas (713) 785-4800
Tulsa, Oklahoma (918) 437-4555

WEST
Los Angeles, California (213) 776-4490
Denver, Colorado (303) 757-7671
San Francisco (Sunnyvale), Calif (408) 732-5555
CANADA
Montreal (St. Laurent), P. O. (514) 332-3550
Toronto (Richmond Hill), P. O. (416) 889-0844
Ottawa, P. O. (613) 825-3716

How to get the world's first monolithic dual FET.

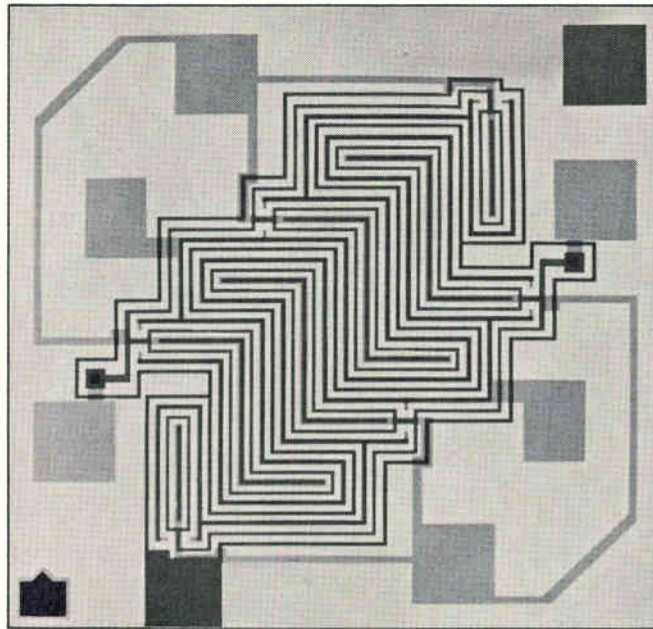

By design.

By tomorrow.

There's never been an N-channel dual FET remotely like it. We should know. With FETs by the millions under our belts, this little 2-in-1 device is something else again.

It's monolithic. It's matchless. It's National's FM3954. Wipes out the sticky problem of matching two separate FETs for identical specs. This revolutionary new dual eliminates the entire costly, time-consuming process. By designing both FETs on a single chip, the match is built in to stay.

Our monolithic marvel's a unique performer too. Even the best discrete matched duals can't touch its track record; offset voltage (5mV max.), temperature drift ($5\mu\text{V}/^\circ\text{C}$ max.), from $50\mu\text{A}$ to $500\mu\text{A}$.

Not to mention its flexibility of use or the reliability advantage because it's monolithic. And because it's National.

Available now. No maybe's about it. We've got monolithic dual FETs packed on the shelves, ready to ship without delay. Priced from \$2.40 to \$15.00 in hundred lots.

Write or call for complete spec data. We'll throw in a brief listing of our hundred or so other discrete FETs. National Semiconductor, 2900 Semiconductor Drive, Santa Clara, California 95051 (408) 732-5000 TWX: 910-339-9240
Cable: NATSEMICON

National/FET

RCL

miniature rotary switches



Actual
Size

U.S. Pat. #3352979

INDUSTRY'S MOST COMPLETE SELECTION

- Shorting AND non-shortng poles may be grouped on one deck in any combination.
- Up to 12 positions per deck shorting or non-shortng.
- As many as 6 poles per deck.
- All individual deck parts are self-contained, and are permanently molded into place.
- Life expectancy 200,000 mechanical operations.
- Meets MIL-S-3786B

"Off-the-Shelf" Shipments

Write for complete
engineering information

RCL

General Sales Office
RCL ELECTRONICS, INC.
700 South 21st Street
Irvington, New Jersey 07111

Who's Who in electronics



Robert Mammano

New semiconductor companies seem to pop up every week, but it's often years before they make any market impact, or even deliver their first products. Based on its early performance, Silicon General Inc., founded last March in Westminster, Calif., bears watching as a comer in the linear integrated circuit business. One of the reasons for Silicon General's fast start is the strong influence on product choice exercised by Robert Mammano, engineering vice president.

The 34-year-old Mammano was formerly manager of the Electronic Technology group at the Arinc Research Corp. in Santa Ana, Calif. He was responsible for circuit design and analysis and development of computer programs for automated IC design.

Gently. "We won't try to press the state of the art," says Mammano. "You can't until you become established. We'll stay with known processes, principally monolithic bipolar technology, and move into other areas when it makes sense."

Silicon General already has six linear IC's in production, and made its first shipment in November—just 5 months after firing up its diffusion furnaces. The firm was able to get going fast because roughly 80% of its present production equipment was bought from Westinghouse when the Molecular Electronics division got out of the

commercial market.

Four of Silicon General's initial products are second-source items: Fairchild's μ A 710 and 711 voltage comparators, plus two versions of a Texas Instruments high-speed sense amplifier. The other two are Silicon General designs: a wide-band video amplifier and a variable-gain amplifier/multiplier. But there are six more second-source products designed and ready to go, including the 741 operational amplifier and National Semiconductor's LM101A op amp. And there are at least two more proprietary products designed.

At your service. Silicon General has its sights set on sales of \$20 million by 1975, and officials expect to ship "well in excess of 1 million devices" in 1970. How will they do it? "Through service," says Mammano. "That's what a small company [35 to 40 employees now] has to offer. There's a tremendous demand for products to meet given requirements. The big houses may not want to be bothered with small orders, or they may charge heavily for custom design." That's the opportunity Silicon General hopes to seize.

A new man is at the controls of Weston Instruments. Early in December the Newark, N.J., firm promoted Roger Swanson from director of marketing to president, replacing Charles Kirkland, who moved to the New York headquarters of Weston's parent company, Schlumberger Ltd.

The new president, who came to Weston in 1968 from Sylvania's Semiconductor division, has set three goals: "I want to increase profits, restore or regain our leadership in instrument sales and technology, and expand our operation here in Newark."

Because Swanson is satisfied with the facilities he has in Newark, expansion will take the form of hiring. "We have been adding to our engineering staff and we have a substantial increase in num-

YOU ARE NOW ENTERING
**THE
MULTILAYER CIRCUIT
CENTER
OF THE U.S.A.**

CINCH-GRAPHIK
POP. 740

Cinch-Graphik is a volume producer of all types of printed circuits, but multilayer boards are our specialty. We produce them with the newest and most advanced automated equipment.

For information on Cinch-Graphik, write for our new Capabilities Brochure . . . available from any Cinch Electronic Group District office or by writing Cinch-Graphik, 200 South Turnbull Canyon Drive, City of Industry, California. 91744, Phone (213) 333-1201.

CG-7001

CINCH-GRAPHIK

DIVISION OF UNITED-CARR



CINCH MANUFACTURING, CINCH-GRAPHIK, CINCH-MONADNOCK AND CINCH-NULINE DIVISIONS OF UNITED-CARR INC., A SUBSIDIARY OF TRW INC



First Fiddles

ROTARY ATTENUATORS

tuned into the needs of OEM and Systems firms, and into the full state-of-the-art capabilities of today's electronic instrumentation, Texscan's RA-50 and RA-51 are rugged, dependable top performers. Both easily withstand aerospace or shipboard environments... feature precision film resistive elements, lightweight irridited aluminum housing... are available in either 50 or 75 ohms impedance and all types of connector configurations... are designed for a service life exceeding 100,000 operations.

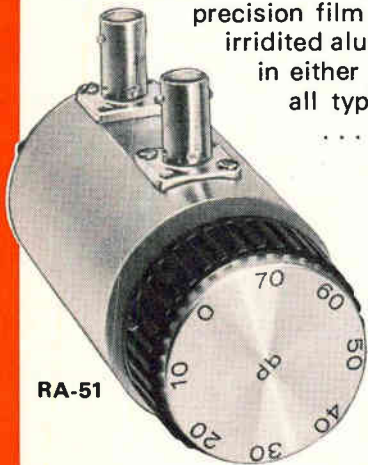

RA-51

**Unequaled
in Delivery.**

10 pieces or fewer from stock; consult factory for larger quantities.



RA-50

Unsurpassed Performance.

KEY SPECIFICATIONS

| | RA-50 | RA-51 |
|-----------------|-----------------------|---------------------|
| Frequency Range | DC to 2000 MHz | DC to 2000 MHz |
| Attenuation | 0-10 db in 1 db steps | 0-70 in 10 db steps |
| Accuracy | ±0.5 at 1500 MHz | ±2 db at 1700 MHz |



Texscan
CORPORATION

2446 N. Shadeland Ave., Indianapolis, Indiana 46219
Phone: 317/357-8781 / TWX: 810/341-3184

Who's Who in electronics



Roger Swanson

bers budgeted for this year," he says.

Competition, according to Swanson, has cut into Weston's former dominance of the market. "Looking at panel meters and portable instruments," he says, "it isn't that we've dropped in image or our volume; more and more competitors are all taking a small share of the market, which has decreased our total percentage."

Has a plan. The drive to boost profits will center around a three-year plan Swanson has submitted to Schlumberger. Refusing to give details, Swanson claims that Weston's growth in 1969 "was substantially ahead of the industry."

Swanson does say that Weston won't fuel its growth by acquiring or by adding different types of products to its line, which comprises panel meters, portable voltmeters and multimeters, relays, and tachometers.

Swanson also wants to boost overseas sales. "One of our weaknesses," he says, "is that we haven't done a very good job in the international area. I plan to put some greater effort into international sales. We just haven't made the effort in giving them [overseas customers] the service and putting the manpower and so forth into this area." Swanson says overseas sales account for "under 10%" of Weston's total; he wants to reach 20% to 25%.

The new Fluke 893A will retire lots of good old Fluke voltmeters.

They won't be the only ones to go!

All kinds of differential voltmeters are likely to find quick retirement when you check out the new solid state Fluke Model 893A AC/DC Differential Voltmeter. Here's a low cost differential voltmeter with infinite resistance at null to 1100 volts, dc accuracy of 0.01%, ac accuracy of 0.05%, and integral battery pack operation.

Available in both half and full rack models, price is \$995 for either. Battery operation can be added at any time for only \$100. Grounded recorder output is available for \$50 more.

Ranges are 1, 10, 100, and 1000 volts ac and dc with 10% overranging. Resolution is 1 ppm of range. Reference regulation is the best available. Reference stability is 15 ppm/hr.

Using the instrument in the battery mode assures portability and complete isolation from the effects of power line interference. In the ac mode, the useful frequency range is 5 Hz to 100 KHz with a 1 mv accuracy. In the TVM mode, input resistance is 100 megohms, so you get the same advantages of low source loading as with older vacuum tube differentials.

Other user features include large, in-line readout with 360° rotation of voltage dials, virtual immunity to damage by accidental overload, and automatic decimal switching with range.

Ready to make the change?

We'd like to help. Your friendly Fluke sales engineer (listed in EEM and EBG) has all the facts as well as demo equipment. Call him or contact us directly if it's more convenient.



Fluke, Box 7428, Seattle, Washington 98133. Phone: (206) 774-2211.
TWX: 910-449-2850.

In Europe, address Fluke Nederland (N.V.), P.O. Box 5053, Tilburg, Holland.
Telex: 884-50237. In the U.K., address Fluke International Corp., Garnett Close,
Watford, WD2 4TT, England. Phone: Watford 27769. Telex: 934583.



It's a great week to order

M

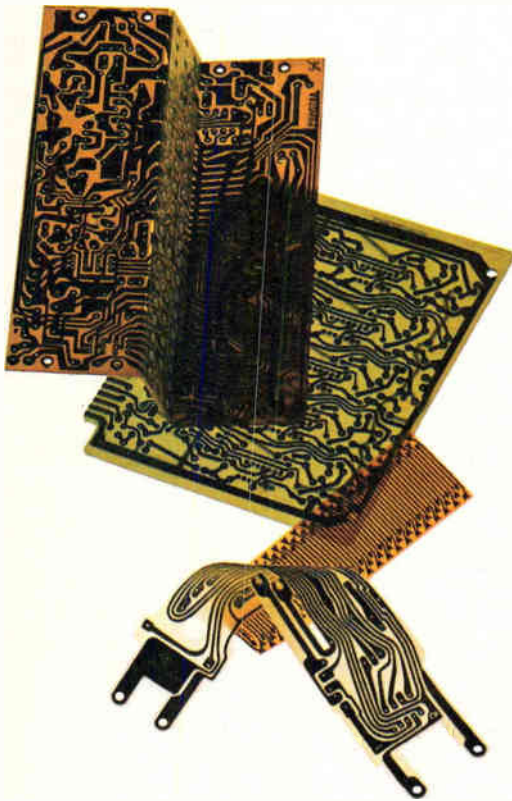

Metal-clad circuit materials

We supply metal-clad laminates in flexible, rigid board, and ultra-thin. Our lineup includes the widest selection of flexible materials, including Kapton and Mylar types. We offer highest quality glass-epoxy laminates of all grades, to military, NEMA, and IPC specs.

T



Laminated plastics

We manufacture laminated sheets, rods, and tubes in an unmatched variety of materials, dimensions, and shapes to suit the most exacting requirements. In sheets, for example, we offer more than 50 base grades with reinforcements of paper, glass, fabric, asbestos, and other materials.

W



Molded plastic parts

Molding thermosetting plastic parts calls for experience and equipment—and we have both. We offer molding capability that produces parts of unusual shapes that require little or no finishing, and with strength comparable to laminated plastics. Our know-how results in economical molded parts.

our materials and parts.

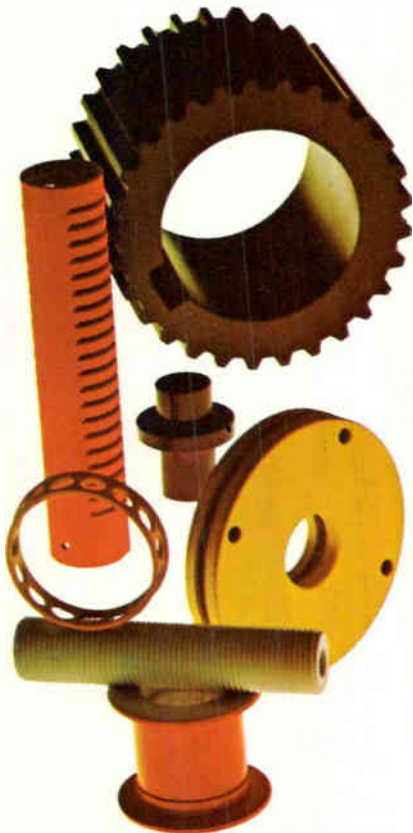

Fabricated plastic parts

Specialized equipment, experience, rigid quality control, and application engineering are four big advantages of Synthane-Taylor plastics fabrication. We can handle every step, from raw materials selection to tooling and production. We produce any size, in any quantity.



Vulcanized fibre

We furnish vulcanized fibre in sheets, rolls, coils—and fabricate it, too. It has excellent electrical and mechanical properties: resistance to arcing, flame, abrasion, impact, wear, chemicals. It is strong, flexible, formable.

Synthane-Taylor has the capability to meet your every need every day of the week. There are three plants, local warehouses, and a nationwide staff of sales engineers to serve you.

Today's the day to find out more. Send the coupon for full information.

Synthane-Taylor Corporation
Valley Forge, Penna. 19481

Please send _____ information
and/or _____ samples on:

- Metal-clad circuit materials
- Laminated plastics
- Molded plastic parts
- Fabricated plastic parts
- Vulcanized fibre
- Have a sales engineer contact me

My application is _____

Name _____

Title _____

Firm _____

Street _____

City _____ State _____ Zip _____



synthane-taylor

Circle 19 on reader service card



KBSR1 keyboard switch for logic encoding.

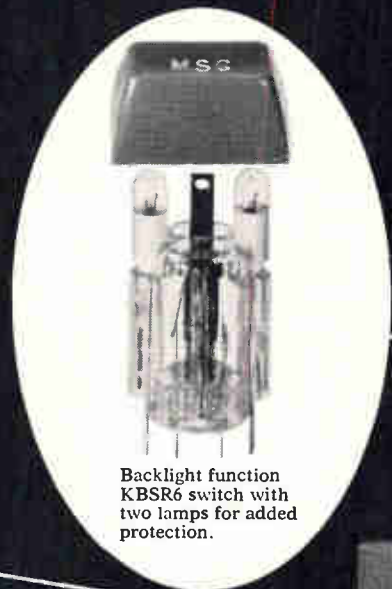

Backlight function KBSR6 switch with two lamps for added protection.



Two-level KBSR2 with double detent action for dual-circuit applications.

RAYTHEON KEYBOARD SWITCHES:

high-reliability, low-cost reed types— now available from stock.

Designed for switching at logic levels, these handsome Raytheon keyboard reed switches have a featherlight touch that is precise and reliable. Just a 2½-oz. touch activates the switch. Bounce is less than 250 microseconds. Operation is smooth and quiet in both directions.

Wide range of special electrical configurations are available on special order to meet keyboard needs for data entry devices, calculators, data retrieval systems, and many other applications. Unique backlighted switches and function lights, with two 25,000-hour lamps and matching cap designs, are also available.

Two configurations of key caps—regular square caps, white with black characters, and a truncated design with 2-color molded characters—are available. Standard colors are grey or black with white characters, and white with black characters. All alphanumeric characters are available from stock. Caps with custom-engraving are available on special order.

Long life expectancy*. In terms of on-off operations, mean operation to failure is 800,000,000 operations. At a usage rate of one per minute, the indicated MTBF is 19,000,000 hours. At worst case usage rate of one per second, MTBF is 300,000 hours.

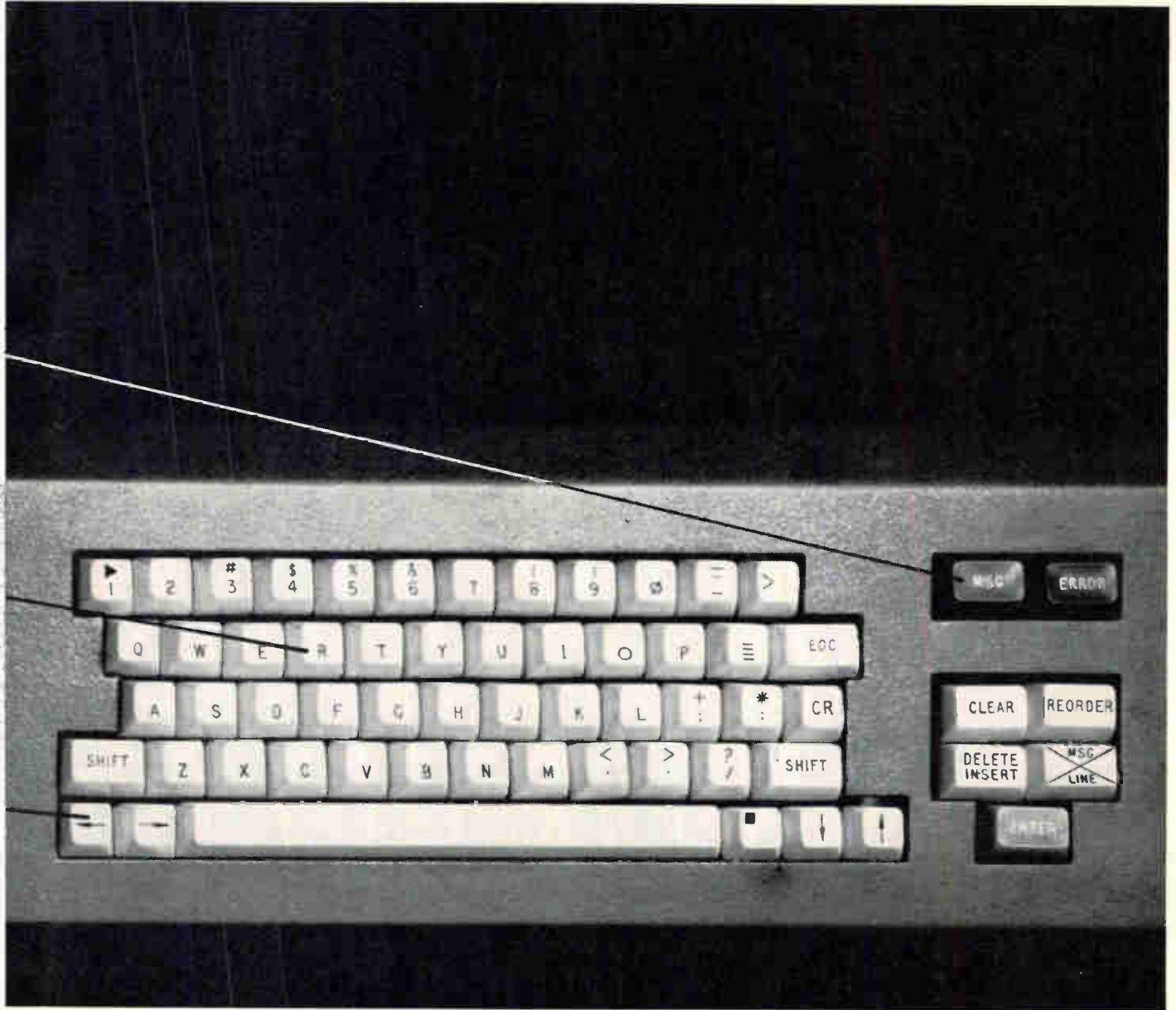

Highest quality materials used throughout: stain-resistant caps, polycarbonate see-through cases; stainless steel springs and beryllium copper contact supports. Reed contact material is rhodium-plated for low contact resistance and long life.

Unique low-cost mounting. Switches are designed to be plugged into printed circuit boards 1/16" to 1/8" thick. Contact pins snap in and firmly lock in place for flow solder, dip solder, or hand soldering. No wiring or mounting hard-

ware is required. This unique, low-cost mounting significantly reduces installation time and costs.

All switches are available with flat bases or slanted bases with 10° slope.

Send reader service card for complete information. For free sample, write on your letterhead—describing your application—to *Raytheon Company, Industrial Components Operation, 465 Centre Street, Quincy, Massachusetts 02169.* *Established in government-qualified testing laboratory.

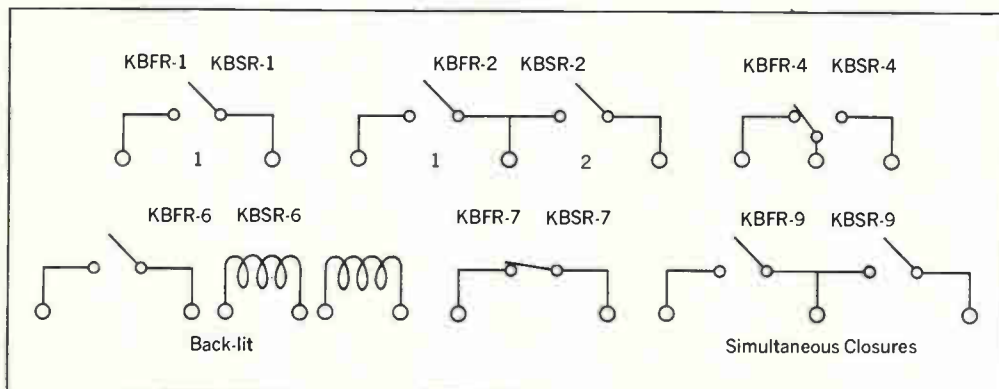



SOLVING
electro-optical
problems
is OPTRON'S
ONLY business....
SO, WE HAVE
TO BE GOOD!

You can count on Optron for high interest and undivided attention to your most exacting optoelectronic device requirements. And, you'll get product design, development and manufacturing benefits that only Optron experience can offer.

For example, through continuous process monitoring made possible by the use of diffusion lot traceability, Optron maintains the highest possible reliability. Still other special Optron manufacturing techniques make possible optimum device performance in variable light and temperature conditions. You get sensors with a lens/device relationship previously thought impossible.

Versatile OP 600 Series NPN planar silicon light sensors eliminate cross-talk and are ideally suited for high density arrays. In addition, these small, rugged devices will satisfy virtually any application requirement in optical character recognition. But, if your application isn't standard, you'll especially like Optron's fast reaction to your custom programs, too.

Write today for
Optron product
technical data
and the name
of your nearest
sales
representative.

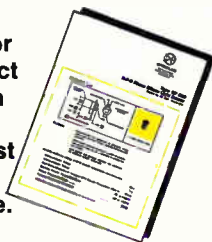

OPTRON, INC.

1201 Tappan Circle
Carrollton, Texas 75006
214/242-6571

Meetings

EE's and MD's to talk it up.

More talking and less listening awaits engineers and physicians at the Second National Conference on Electronics in Medicine, set for Feb. 12 to 14 in San Francisco. Moving away from last year's stress on prepared papers, conference chairman Samuel Weber is devoting almost half the meeting to six simultaneous "work sessions" covering on-line computer applications, automated laboratories, multiphasic screening, patient-monitoring, the problems faced by a physician without access to a large hospital, and purchasing and maintaining electronic equipment. At each session panel members will talk for a few minutes, and then the moderator will ask the audience for questions, views, and gripes.

IBM's Dr. G. Eric Marler will lead the discussion of how computers can help care for a patient and diagnose his ills. Until now the computer's medical role has been largely confined to record-keeping.

Patient monitoring systems, the fastest-selling items in the medical electronics catalogue, will be examined by a panel made up of Duane Sutfin from Honeywell and three physicians experienced in using these systems.

Multiphasic screening at its most primitive is a computer, armed with a decision tree, taking a patient's history; but many physicians say that multiphasic screening promises an economical method of giving physicals on a large scale. A panel chaired by Stanford Research Institute's Alexander Sarros will discuss when, if ever, that promise will be kept.

Just listen. The conference's prepared papers will be given in three morning sessions. Following the keynoter, Dr. George Burch of Tulane University, will be Robert Allison from the Scott and White Clinic in Texas and Dr. Arnold Pratt from the National Institutes of Health, talking about what's right and wrong with electronic instruments and with the computers used in medical work. Then the

Government's top physician, Roger Egberg, assistant secretary for health and scientific affairs, will speak at the first day's luncheon.

On the second day, Johns Hopkins University's George Webb and the University of Missouri's Dr. Donald Lindberg will look at the problems faced by an engineer working in medicine. Staff members from Oakland's Samuel Merritt Hospital will take over on the third morning, explaining how they evaluate electronic equipment.

For further information contact Samuel Weber, Second National Conference and Exposition on Electronics in Medicine, 330 W. 42nd St., New York, N.Y. 10036

It's a bird . . .

With two lunar landings already history, the Institute of Navigation will appraise recent U.S. space efforts, then explore navigational theory and practice in the post-Apollo era at its 1970 National Space Meeting. The conference, from Feb. 17 to 19, will be hosted by NASA Ames, Moffett Field, Calif.

The meeting will be divided into four sessions—the first two will look at lunar navigation retrospectively and in the near future. Highlights include an appraisal of lunar orbiter spacecraft guidance and control by James E. Montgomery of Boeing, and a paper from the Marshall Space Flight Center on its experimental program for surface navigation equipment.

Getting around. At the third session, devoted to space transportation, Robert L. Eshbaugh of TRW Systems in Redondo Beach, Calif., will present a paper on guidance system cost vs. reliability. Space shuttle automatic landing systems and the application of aircraft systems technology will be the topic of a paper by Walter Maas of Lockheed and Harold N. Tobie of Boeing.

The final session will focus on planetary missions, emphasizing

(Continued on p. 24)

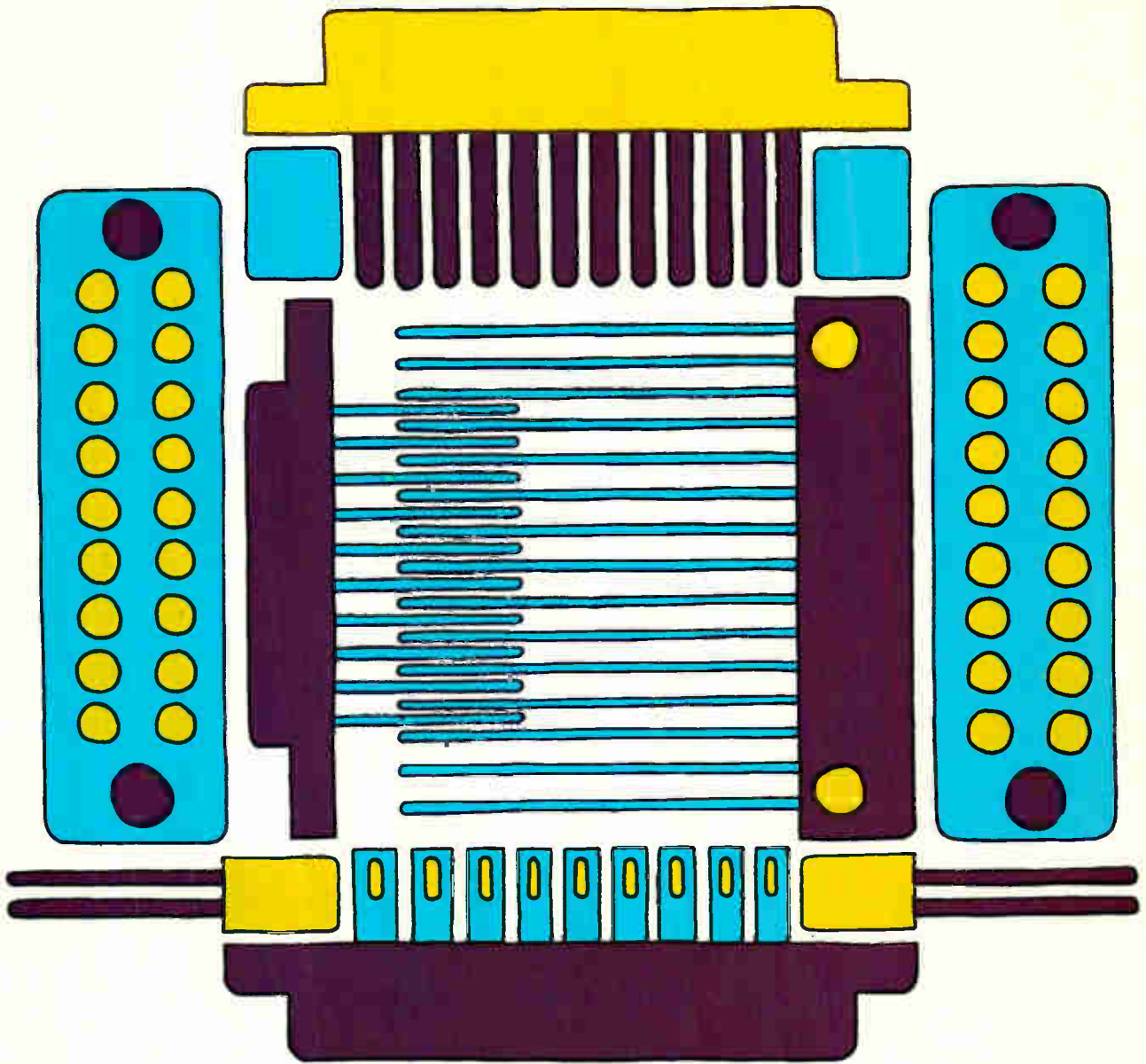

Winchester Electronics

where in-stock printed circuit connectors are closing today's communications gap.

Typical of Winchester Electronics' capabilities in printed circuit connectors are our lines of card edge and board joiners pin and socket connector. And for even more exacting applications, our military approved HB/HBD series.

Available in single and double row terminations, these connectors not only meet

MIL-C-21097 requirements but exceed them in quality and reliability at an economical price.

So, before you go to the expense of ordering a special printed circuit connector, look into the in-stock selection at Winchester Electronics. Just write Winchester Electronics, Main Street and Hillside Ave., Oakville, Conn. 06779.



**WINCHESTER
ELECTRONICS**

DIVISION OF LITTON INDUSTRIES





**Champagne
quality
RFI/EMC
filters
at beer prices**

A toast! May you and your products benefit from finer, lower-cost filters from Captor Corporation. Captor combines knowledgeable application engineering with a quality assurance program that extends through every manufacturing step from order entry to final packaging. Costs are closely controlled because production is geared to a specific electronic components family: miniature RFI/EMC filters, communications and security filters, and custom designed filters and assemblies. Captor's new environmentally conditioned plant is designed expressly for fast, efficient manufacture of this integrated product line. Write for our capabilities brochure today and drink in the whole story.

 **CAPTOR**
CORPORATION
Electronics Division

5040 Dixie Highway, Tipp City, Ohio 45371, Phone: (513) 667-8484

Meetings

(Continued from p. 22)

the exploration of Mars. Thomas C. Duxbury of the Jet Propulsion Laboratory will take a look at navigation data already received via the Mariner Mars tv pictures in 1969. Instrument requirements for outer-planet fly-by missions will be the subject of a paper from MIT.

For further information, contact the Executive Director, Institute of Navigation, 711 14th St., N.W., Suite 912, Washington, D.C. 20005.

Calendar

Winter Power Meeting, IEEE; Statler Hilton Hotel, New York; Jan. 25-30, 1970.

Annual Symposium on Reliability, Group on Reliability of the IEEE, American Society for Quality Control, American Society for Nondestructive Testing, and the Institute of Environmental Sciences; Biltmore Hotel, Los Angeles; Feb. 3-5, 1970.

International Solid State Circuits Conference, IEEE, University of Pennsylvania; Sheraton Hotel and University of Pennsylvania, Philadelphia, Feb. 18-20, 1970.

Second National Conference and Exposition on Electronics in Medicine, Electronics/Management Center, Electronics, Medical World News, Modern Hospital, Postgraduate Medicine; Fairmont Hotel, San Francisco, Feb. 12-14, 1970.

Symposium on Management and Economics in the Electronics Industry, IEE; University of Edinburgh, Scotland, March 17-20, 1970.

International Convention, IEEE; New York Hilton Hotel and the New York Coliseum, March 23-26, 1970.

Meeting of the Association for the Advancement of Medical Instrumentation, Statler Hilton Hotel, Boston, Mar. 23-25, 1970.

Symposium on Submillimeter Waves, IEEE, Polytechnic Institute, Brooklyn, New York, March 31-April 2, 1970.

Communications Satellite Systems Conference, American Institute of Aeronautics and Astronautics; International Hotel, Los Angeles, April 6-8, 1970.

(Continued on p. 26)

Switching Diodes

9 from the pines

You may get weary. Bleary-eyed. And a mite confused.

With the thicket of 1,637 switching diodes to choose from.*

But stout heart!

TI's nine meet the majority of switching diode applications.

We make them by the millions. High quality. Double-plug construction. Keenly competitive prices. With ultra fast delivery from TI factory or distributor stocks.

All are part of TI's preferred semiconductor line. Selected after

months of computer demand analysis. To save you time and money in specifying discrete components.

So turn to TI switching diodes first. For computers. Calculators. Memories. Peripherals. Or any diode application that calls for low capacitance and fast switching speed.

If one of the nine doesn't fill your specific needs, TI makes dozens more switching diodes. Also logic and core drivers for computers and high-voltage diodes for TV.

* 1969 Worldwide figure from D.A.T.A., Inc., publishers of *Electronic Data*.



TI's Preferred Switching Diodes

| | |
|--------|--------|
| 1N251 | 1N4148 |
| 1N661 | 1N4154 |
| 1N914 | 1N4448 |
| 1N914B | 1N4454 |
| 1N3070 | |

Write for your copy of TI's new *1970 Preferred Semiconductors and Components* catalog: Texas Instruments, PO Box 5012, MS 308, Dallas, Texas 75222.

Or just circle reader service card number 168.



TEXAS INSTRUMENTS
INCORPORATED

THE
Now
 GENERATION
SCR

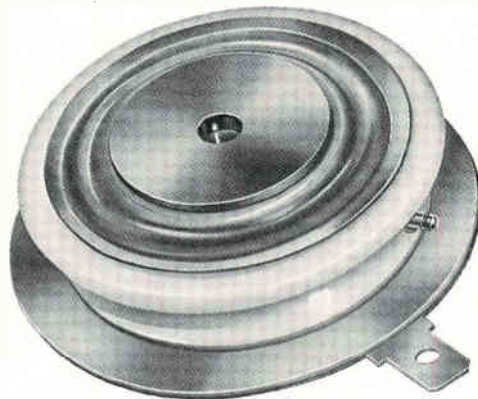

**DISC PACKAGED
 REGENERATIVE GATE
 SCR's**

Operation to 20 KHz with low switching losses
 ⊕ di/dt capability to 800 A/μsec. ⊕ low power
 gate drive ⊕ dv/dt capability to 500 V/μsec.
 ⊕ 175 and 370 amperes RMS ⊕ turn-off time
 capability to 10 μsec. ⊕ also available
 in stud type package to 470 amperes RMS.

For additional information and application assistance,
 write or call National Electronics, Inc.,
 a varian subsidiary, Geneva, Ill. 60134,
 phone (312) 232-4300.

NATIONAL ELECTRONICS, INC.
 a varian subsidiary

*1969 COMPETITION WINNER
 Cited by Industrial Research Inc.
 as one of the 100 most
 significant technical products of the year.*



A NATIONAL® exclusive,
 Patent Pending.

Meetings

(Continued from p. 24)

Reliability Physics Symposium, IEEE;
 Stardust Hotel and Country Club,
 Las Vegas, Nevada, April 7-9, 1970.

Meeting and Technical Conference,
 Numerical Control Society; Statler
 Hilton, Boston, April 8-10, 1970.

**Computer Graphics International
 Symposium, IEE;** Uxbridge, Middlesex,
 England, April 13-16, 1970.

**International Geoscience Electronics
 Symposium, IEEE;** Marriott Twin Bridges
 Motor Hotel, Washington, April 14-17,
 1970.

American Power Conference, IEEE;
 Sherman House, Chicago, April 21-23,
 1970.

**International Magnetics Conference
 (INTERMAG), IEEE;** Statler Hilton Hotel,
 Washington, April 21-24, 1970.

Annual Frequency Control Symposium,
 U.S. Army Electronics Command;
 Shelburne Hotel, Atlantic City, N.J.,
 April 27-29, 1970.

Short courses

**Safe-Life Design Practices: Practical
 Applications of Fracture Mechanics,**
 Engineering 879.4; Boelter Hall, Room
 4442, University of California, Los
 Angeles, March 16-20, \$285 fee.

Aerospace and Marine Corrosion,
 Engineering 868.9; Boelter Hall, Room
 4442, University of California, Los
 Angeles, April 20-24. \$285 fee.

**Laser Fundamentals and
 Communications;** Rice University,
 Houston, Texas, May 4-6. \$300 fee.

Call for papers

**International Conference on Engineering
 in the Ocean Environment, IEEE**
 Panama City Section of Region III, IEEE
 Oceanography Coordinating Committee;
 Panama City, Fla., September 21-24.
**March 3 is deadline for submitting
 abstracts and summaries to C.B. Koesy,**
 Code P750, Naval Ship Research and
 Development Laboratory, Panama City,
 Fla. 32401.

**Systems Science and Cybernetics
 Conference, IEEE Systems Science and
 Cybernetics Group;** Pittsburgh, Pa.,
 Oct. 14-16. **April 15 is deadline for
 submitting abstracts to Prof. A. Lavi,**
 Carnegie-Mellon University, Pittsburgh,
 Pa. 15213.

NEW



*New Allen-Bradley
hot-molded Type GD
dual variable resistor
shown actual size*

**TWO
IN
ONE**

Allen-Bradley hot-molded dual variable resistor

Here's the most compact two section variable resistor currently available—the new Allen-Bradley dual Type GD. It's one-half inch in diameter and only a fraction of an inch longer than the popular single section type G control. The case is dust-tight as well as watertight. ■ Both resistance tracks in the dual Type GD are solid, hot-molded elements, which provide long operating life. As with the single Type G, the noise level is low initially and actually decreases with normal use. Adjustment is smooth at all times with virtually infinite resolution. And low inductance permits operation at frequencies far beyond the usable range of wirewound controls. ■ In addition to standard application, these new dual Type GD controls are ideally suited for use in compact attenuators. ■ Dual Type GD controls are available with nominal resistance values from 100 ohms to 5.0 megohms. You can get immediate delivery at factory prices from your authorized A-B industrial electronics distributor. Or write: Marketing Dept., Electronics Div., Allen-Bradley Co., 1201 S. Second St., Milwaukee, Wis. 53204. Export Office: 1293 Broad St., Bloomfield, N.J., U.S.A. 07003. In Canada: Allen-Bradley Canada Limited.



ALLEN-BRADLEY
QUALITY ELECTRONIC COMPONENTS

microtopics

1024-bit static ROM

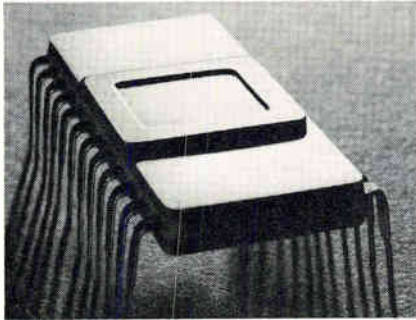

The Philco® MOS 1024-bit read-only memory has a static output data level. It remains valid as long as an address is present.

That means you can address it as slowly as necessary to be compatible with your output device, and the extra expense of clock generators and drivers is eliminated.

Bit pattern, 128 8-bit words; access time, typically 2 μ s; cost in 100-piece lots, less than 4 cents per bit.

The pMS1024C static ROM is packaged in a 24-lead hermetic DIP. Samples available now in character generator form.

And for high-speed applications, try our *dynamic* ROM . . . comparable costs and access times less than 1.0 μ s.

CIRCLE 512 ON READER SERVICE CARD

COMING SOON FROM PHILCO-FORD

- MSI 9300 Series
- New MOS memory products
 - 256-bit RAM
 - 2048-bit static ROM
 - 2240-bit static character generator ROM
- PL7751 Differential wide-band memory sense amplifier
- Schottky-barrier diodes in new packages

Our InSb multi-element IR detectors are all ours.

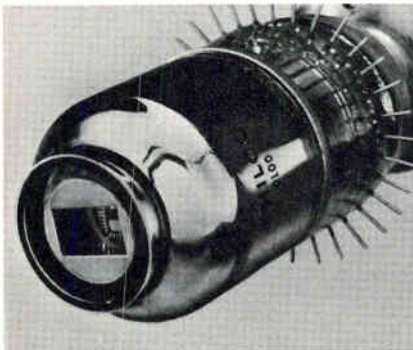

Because Philco® detectors are made entirely in-house. The whole assembly . . . detector array, liquid nitrogen- or cryostat-cooled dewar with cooled filter, and matching current-mode preamp.

What does this mean to you? Your interface problems are eliminated. You also gain from the start-to-finish quality control. By growing our own InSb, for example, we control impurity levels for maximum sensitivity and low noise performance.

And we've been doing these things for over 10 years . . . long enough to have more InSb photovoltaic detectors in the field than anyone else.

Take a look at some of the specs . . . elements as small as .05 mm x .05 mm with element spacing .025 mm for high resolution, detectivity approaching theoretical limits, linear arrays of more than 100 elements, and detector impedance of 10 megohms or more.

CIRCLE 513 ON READER SERVICE CARD

UHF to Ku band. How's that for broadband switching?

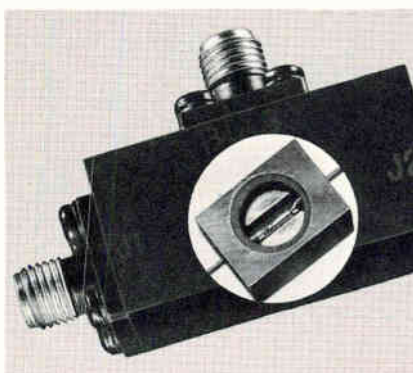

That's what you get with our new Philco® P9800 Series coax switch assemblies.

And switching performance over any part of that range is better than just about any narrow-band switch assembly you can find.

The secret? The P9800 Series employs our new L8370/L8380 Series integrated switch modules. These hermetically sealed modules eliminate the package parasitics which limit the broadband performance of conventional semiconductor diode switches.

These new modules, which are also available separately, permit switching ratios in the order of 50 db over the specified operating frequency range with switching speeds down to 10 nanoseconds.

You can get the new P9800 Series switch assemblies with integral hybrid drivers to solve your control circuit interface problems. In addition, units designed to exhibit linear attenuation or other special characteristics can be supplied as required.

CIRCLE 514 ON READER SERVICE CARD

The better idea people in microelectronics.

PHILCO



PHILCO-FORD CORPORATION • MICROELECTRONICS DIVISION • BLUE BELL, PA. 19422

Three new low-drain linear IC's make up a complete IF-audio system.

A Philco® IF amplifier-audio system suitable for future-generation FM radio receivers is here today... the CP 1057 input amp and limiter, CP 1058 output limiter and quadrature detector, and CP 1059 audio amp. Designed for narrow-band systems, these bipolar IC's operate in the range of 9 to 12 MHz—on a low 70 to 90 milliwatts of power each. Audio output of the system is in excess of 50 milliwatts.

The CP 1057 includes an amp with 50 ohms input impedance and a 50-db limiter. Internal voltage regulators minimize the number of external connections. Other specs: power consumption, 70 mw; input amplifier voltage gain, 32 db; combined gain, 82 db.

The CP 1058 consists of a limiter amp, quadrature detector, and audio buffer amp. One simple detector coil makes for easy tuning, during manufacture or in the field. Two matched diodes are included for optional demodulator connection. Other specs: power consumption, 70 mw; limiter gain, 23 db.

The CP 1059—which can be used alone to feed any balanced transformer-coupled audio amp—comprises a buffer amplifier, phase splitter amp, power amp, and a Class B push-pull power output stage. Other specs: power consumption, approximately 90 mw; gain, 45 db; distortion, 4%.

Each IC is available in a 14-lead flatpack, and all operate over the full MIL temperature range of -55° to $+125^{\circ}\text{C}$. Engineering units are available for evaluation. Write to Bipolar Products Marketing.

CIRCLE 515 ON READER SERVICE CARD

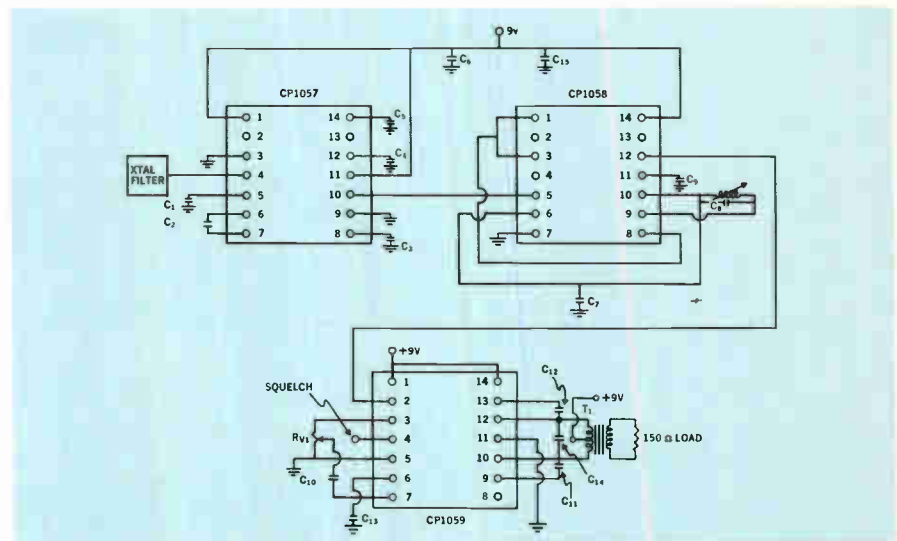

Need analog MSI? Call a Philco Hybrid Hunter.



Want to microminaturize a circuit now designed for discrete components? Need more voltage, current, or power capability than you can get from monolithic integrated circuits?

Then you need an AMSI by Philco. Here's an example of an AMSI hybrid circuit now in volume production at our Spring City hybrid facility. It's a triple detector circuit, contained in a 1 x 1-inch all-hermetic flatpack made by Philco-Ford. Look what's inside:

- 13 thick-film resistors, in values from 3.9K to 182K ohms. All resistors are 1% tolerance, low TCR.

- 6 capacitors, in values from .033 to .33 μfd . All capacitors 1% tracking with temperature.

- 19 active PNP and NPN devices, with V_{be} and V_{ce} matching ± 5 millivolts.

When you need AMSI, call a Philco Hybrid Hunter. Just show us your circuits... and give us a month. We'll have prototype hybrid circuits on your desk. They will be ready for production in one of the most experienced hybrid facilities in the country. And they will be priced competitively.

CIRCLE 516 ON READER SERVICE CARD

Nobody-
but nobody
offers as many
T²L functions
as Motorola.

- where the priceless ingredient is care!



113 functions you can count on — 657 ways to go! Motorola's five families of T²L provide "no compromise" solutions to your design requirements. The choice is yours, whether your need be military or commercial, ceramic or plastic dual in-line, or flat packages, our T²L versatility will work for you. Optimize your system design by flexible selection from the industry's most popular T²L families.

MTTL I MC500/400 Series . . . Medium speed logic circuits with typical gate propagation delay of 10 ns. Electrically interchangeable with SUHL I.

MTTL II MC2100 2000 Series . . . High speed logic circuits with typical gate propagation delay of 6.0 ns. Electrically interchangeable with SUHL II.

MTTL III MC3100/3000 Series . . . Advanced

design high speed logic circuits with typical gate propagation delay of 6.0 ns. Compatible with MDTL and SN54H/SN74H Series devices.

MC4000 MSI Series . . . Complex function circuits offering state-of-art increases in logic per function and significant reduction in package count. Compatible with all MTTL and MDTL lines.

MC5400/7400, MC5400L/7400L, MC7400P Series . . . Electrically interchangeable with Series SN5400J/SN7400J, SN7400N types.

MC5400F/7400F Series . . . Electrically interchangeable with Series SN54F/SN74F types. **MC5400/7400 Series Complex Functions** . . . MSI circuits designed for compatibility with MC5400/7400 Series gates and flip-flops.

The option is yours — exercise it. You'll see that... **Nobody** — but **nobody** offers as many T²L functions as Motorola.

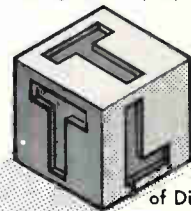

Building Block of Digital Circuitry

MTTL, MDTL Trademarks of Motorola Inc. SUHL I, SUHL II Trademarks of Sylvania Electric Products, Inc.

MOTOROLA Integrated Circuits

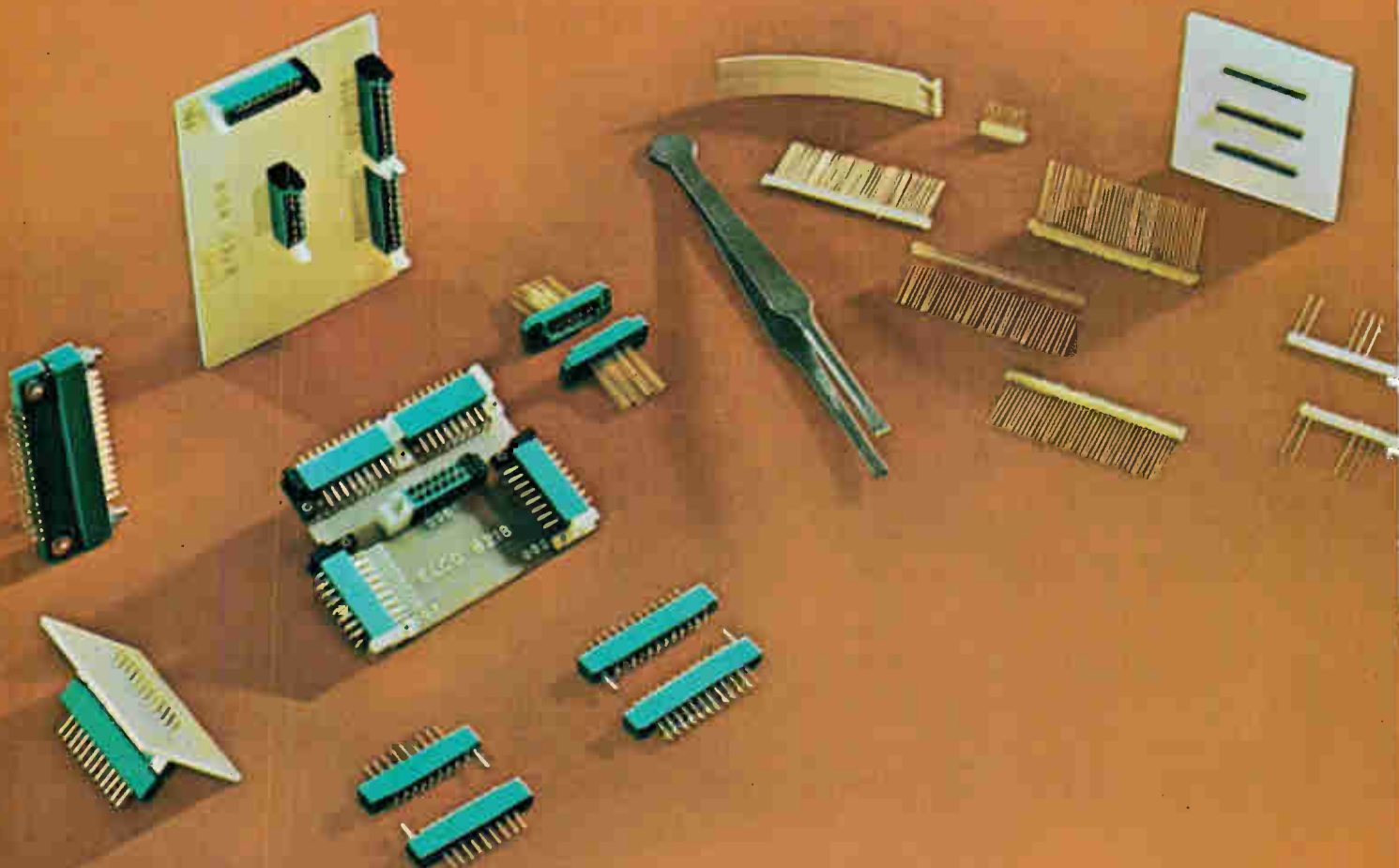

Miniature, subminiature connectors, yes.

Miniature, subminiature contacts, no.

Microelectronics can give you a pain in the tweezers. You have to be perfect. And you have to be perfect in places so small that a flea would have trouble scratching his back.

Actually, the electronics part isn't too hard, what with piezoelectric this's and thin-film that's to work with.

But, inevitably, there comes the day when all the this's and that's have to be put together. It's a problem. Mechanically. Electrically.

You don't want to put a big fat plug on a skinny little mini-circuit.

So you need miniature or subminiature connectors. Those we have. By the catalogfull.

But you sure don't need undernourished contacts. You need all the strength you can get, all the contact area you can get, all the hang-togetherness you can get.

Those we give you. Every miniature in our catalog is made with our patented Varicon™ contacts (you probably already know about them). Our newer sub-miniatures are made with Bi/Con™ contacts (which

is sketched at the left).

See the four mating surfaces?

Four mating surfaces, coined so that they're exceptionally hard and smooth.

Four mating surfaces, held together snugly by the spring-like action of the design. And by the innate characteristics of the phosphor-bronze.

Four mating surfaces, strengthened by a reinforcing web.

Four mating surfaces, on a contact that floats in its insulator to make sure that the four mating surfaces mate.

No comparably sized contact can match the Bi/Con's dimensional, electrical, and mechanical characteristics.

And no subminiature contact can match the Bi/Con's incredibly low price, either.

For more information, write, wire, call or TWX us for our Microelectronics catalog.

Elco Corporation, Willow Grove, Pa. 19090.

(215) 659-7000. TWX 510-665-5573.

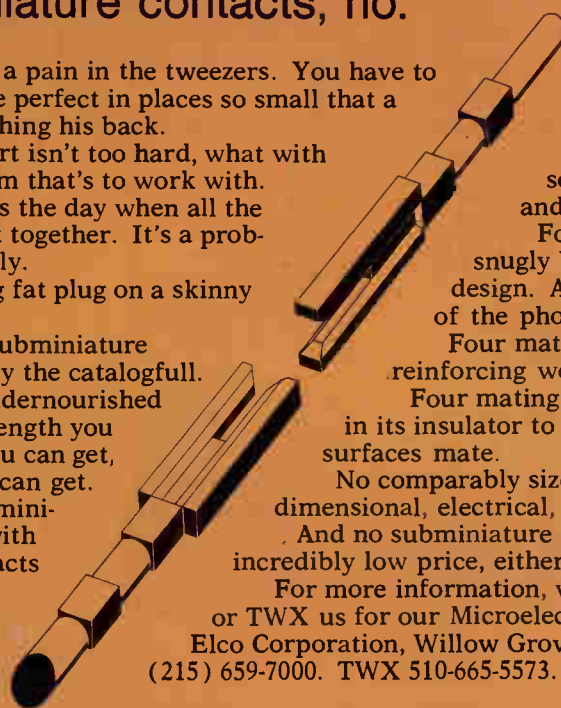

ELCO Varicon® miniatures
Bi/Con® subminiatures

Circle 32 on reader service card

See us at Nepcon West 1970. Booth #509.

Electronics Newsletter

January 19, 1970

Phillips quits at Autonetics . . .

Autonetics, known as a maker of integrated circuits for military systems, is suffering some hard knocks in its effort to crack the commercial IC market. First there was trouble with its initial commercial contract—a two-year, \$30-million deal with the Sharp Corp. of Japan (formerly Hayakawa Electric Co.) calling for MOS LSI circuits to go into a desktop calculator [*Electronics*, Oct. 13, 1969, p. 54]. Now, Alvin Phillips, who was named general manager of the Autonetics Products division just last November, has resigned suddenly.

The departure of Phillips, who was brought in because of his background in commercial IC production and marketing, caused industry rumors about the Sharp difficulties to fly once again. Last summer, Phillips said the problem, caused by a change from 1.5-inch-diameter to 2-inch wafers, was under control. As for the renewed rumors triggered by his resignation, Phillips denied there is further difficulty in meeting the Sharp contract.

The word from Japan backs him up. Sharp apparently is getting large quantities of MOS LSI kits after Autonetics made changes in circuit patterns and processing. The best indication that the array kits are rolling in comes from increased work schedules at Sharp.

. . . because he felt 'like an apple among oranges'

Alvin Phillips, while denying he left Autonetics because of the Sharp contract, offered some insight into what can happen to the commercial semiconductor man who moves into a military-aerospace operation. It's also interesting to note that Phillips won't be replaced—the job has been eliminated.

Phillips says he resigned "because of philosophical differences about handling a commercial semiconductor business in an aerospace environment." He adds: "I felt like one big commercial apple in a basket of aerospace oranges." Although he stresses that he resigned under amicable terms, in effect his resignation, turned in Jan. 8, was to take place immediately.

Phillips came to Autonetics in April 1968 from Sylvania as assistant for microelectronics planning to S.F. Eyestone, president. Before being named general manager last November, he had been operations manager of the infant Autonetics Products division. The general manager duties will be resumed by Robert S. "Sam" Carlson, an aerospace man who had been vice president and general manager before relinquishing the latter responsibility to Phillips.

Raytheon may have display woes licked

Raytheon "has made very significant progress" in solving design problems in its planned view display consoles for the en-route portion of the advanced National Airspace System and "may be out of the woods." That's the view of the Federal Aviation Agency, which promised three months ago that if the problems weren't solved by December, the agency would look for a backup source [*Electronics*, Oct. 27, 1969, p. 54].

A decision will be made the week of Jan. 19 following an extensive technical audit. If the company's equipment division in Wayland, Mass., has not been able to eliminate display brightness and line width difficulties, Sanders Associates of Nashua, N.H.—originally an unsuccessful bidder—may be tapped to supply a new version of its Model 990

Electronics Newsletter

advanced data display system now being used for telemetering. The Mitre Corp., the FAA's systems engineering contractor, informed the agency that Sanders was the only company that could supply equipment not requiring important design changes.

EM&M bows out of plated-wire picture

Electronic Memories and Magnetics is the latest firm to drop plated-wire memories as a viable venture. It follows the decision by the Librascope group of Singer-General Precision to abandon its woven-wire operation [*Electronics*, Nov. 10, 1969, p. 33] EM&M, formerly Electronic Memories Inc., had begun manufacturing plated-wire memories (though not woven) and sample products made with it before acquisition of Indiana General, which was a little further along in plated wire.

The old EMI plated-wire operation in Hawthorne, Calif., has ceased operating, although some military work continues at what used to be Indiana General's Electronics division in Kearny, N.J. A company spokesman says EM&M "continues to assess its position in plated wire," but he wouldn't predict whether the activity would be discontinued.

FCC's new row: Johnson vs. Burch

More 1970 headlines involving the Federal Communications Commission are being predicted in Washington after round one of a slugfest between maverick Commissioner Nicholas Johnson and his new chairman, Dean Burch. In a year of multiple decisions on public communications policies ranging from domestic satellites to how much profit AT&T should be permitted, Johnson is becoming even more outspoken in criticizing the new FCC chairman than he was with the former chairman, Rosel Hyde.

The first Johnson-Burch clash came after the FCC denied a petition by the National Association of Regulatory Utility Commissioners—including AT&T's competitors—to reject AT&T's long-distance telephone rate reductions. NARUC objected, asserting that the reductions would aggravate "intolerable" disparities between intrastate and interstate rates, would create revenue hardships for the 1,850 independent telephone companies, and would add to "the existing grave telephone service situation."

In a curt exchange, Johnson charged the commission with being "solicitous of AT&T" and attacked Burch's "apparent pride" in the \$150 million rate reduction, when "we are left with the fact that AT&T grossed over \$14 billion last year." Burch, defending the majority action, expressed "personal distaste for broadside attacks upon the intelligence and integrity" of the FCC and its staff. The Nixon appointee says Johnson's "broad generalities [are] devoid of any reference to fact" and should result in "embarrassment" to Johnson.

Honeywell opens unit at ERC building

With discussions going on between ERC officials and representatives of both industry and other Government agencies aimed at keeping intact at least part of the Electronic Research Center's capabilities and staff [see p. 39], Honeywell jumped into the act by leasing space for a new operating unit in a Cambridge building that also houses ERC. The new Information Sciences Center's mission will be basic, not applied, research. While the group will number only six to eight men at the outset, insiders wonder if the "other computer company" has its eye on ERC's computer research cadre.

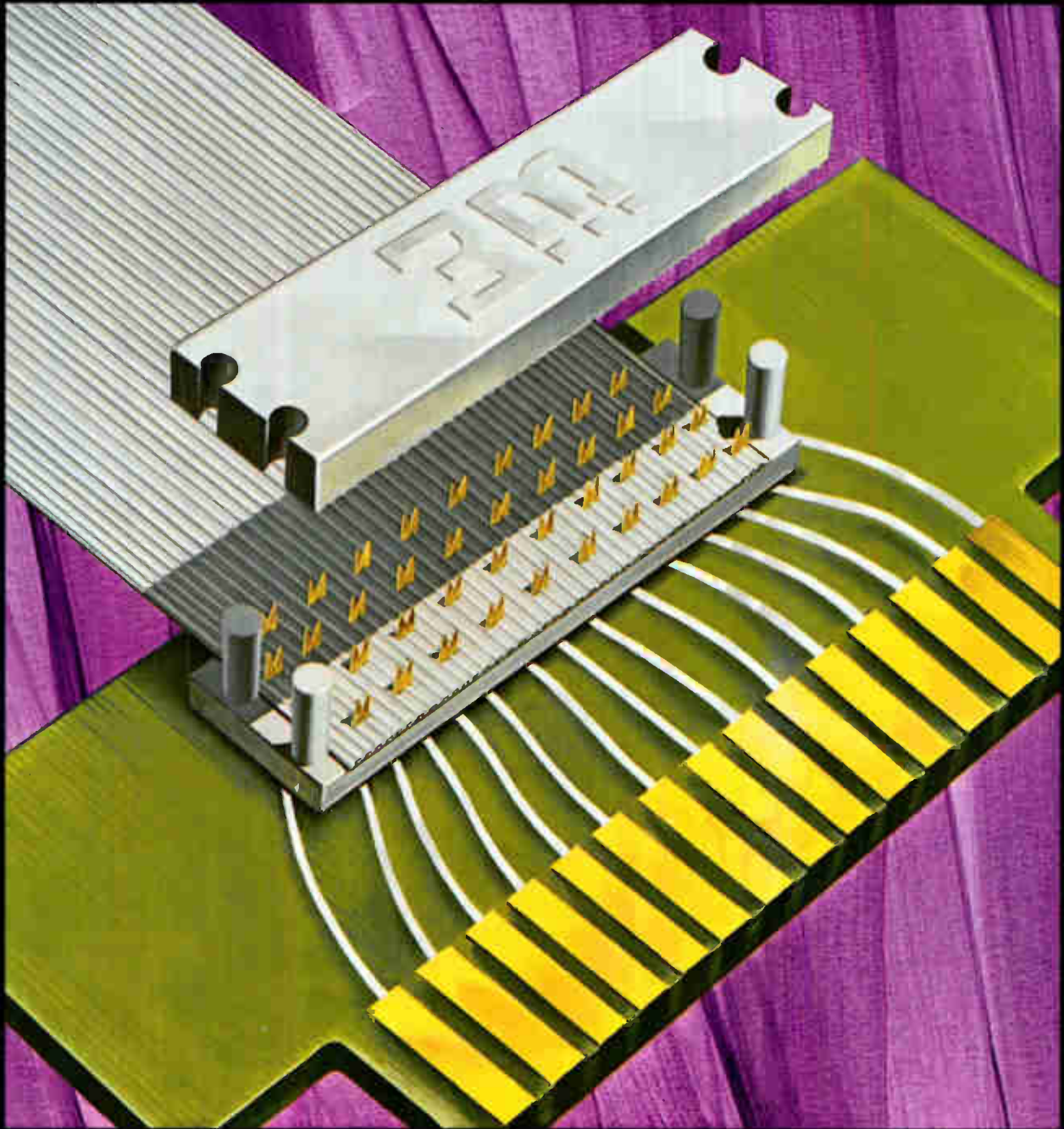

3M's Flat Cable and Connectors... your systems approach to circuitry.

Speed and dependability are yours for your circuitry system assemblies. 3M has the answer with new "Scotchflex" Flat Cable and Connector Systems. They provide fast simultaneous connections of circuitry... help reduce equipment packaging costs.

"Scotchflex" Flat Cable and Connector Systems win on every count (no stripping or soldering) • Reduce wiring errors • Permit easy trouble-shooting • Provide predictable electrical characteristics • Speed production. [Connecting Systems?](#) *Think 3M!*

“Scotchflex”[®] Brand Flat Cable and Connectors provide the perfect transition.

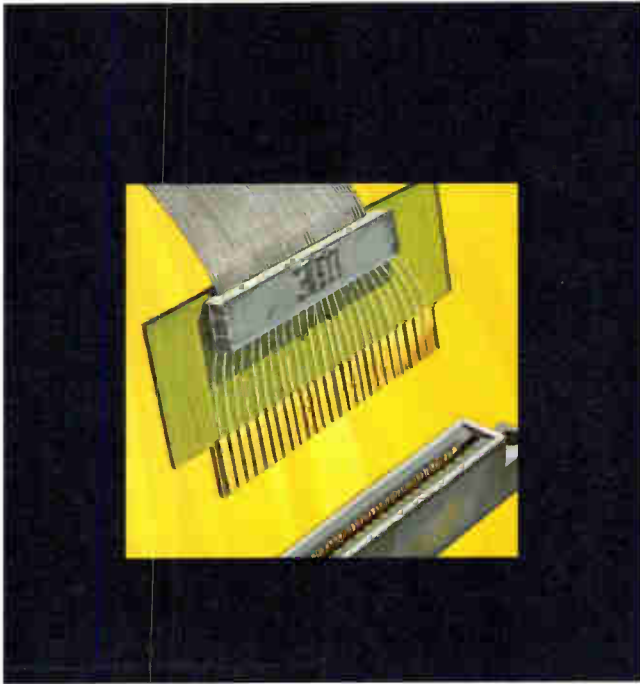

Printed Circuit Board Transitions. Transition flat cable to printed circuit boards simply and reliably. Up to 64 conductors on .050" centers can be terminated simultaneously with 3M's unique "U" contact principle.

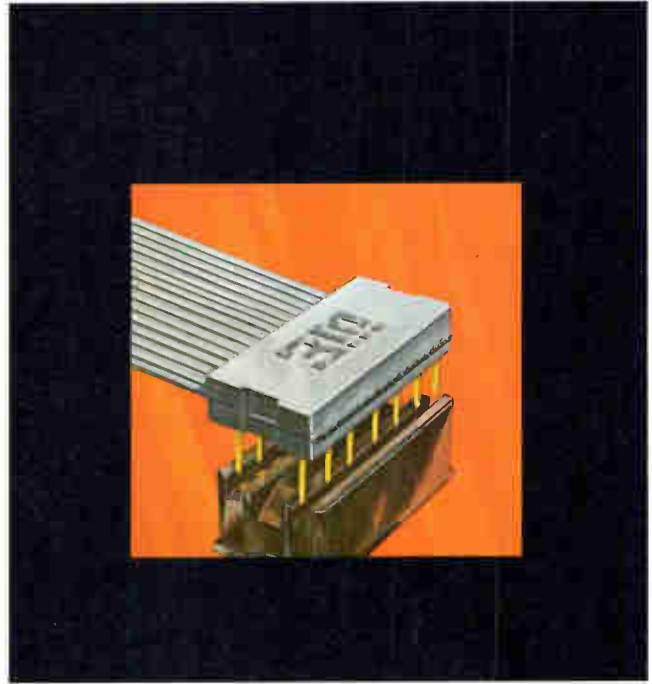

Dual In-Line plug Transitions. 14 and 16 position DIP plugs transition between round conductor flat cable on .050" centers to I.C. Socket patterns. Pins are located on .100" x .300" grid.

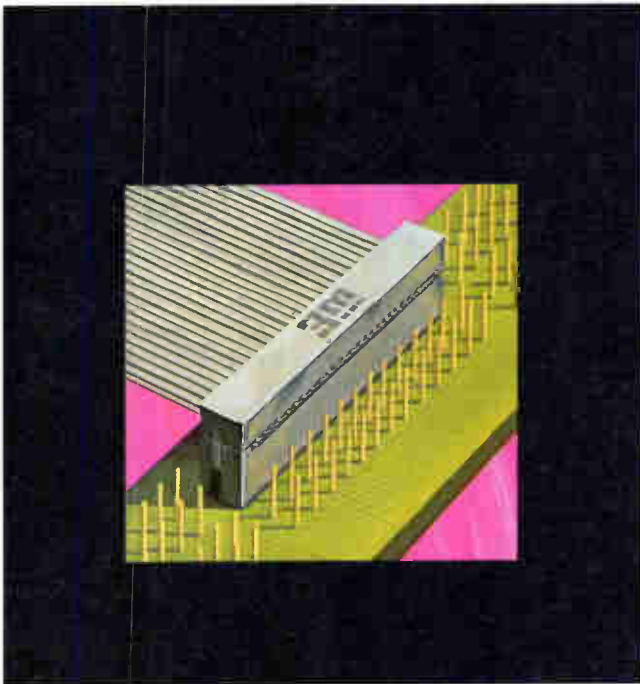

Wire wrap post socket Transitions. Self-stripping 26, 34 and 40 position wire wrap post sockets interface directly to .025" square posts on .100" x .100" grid. Completes your transition dependably.

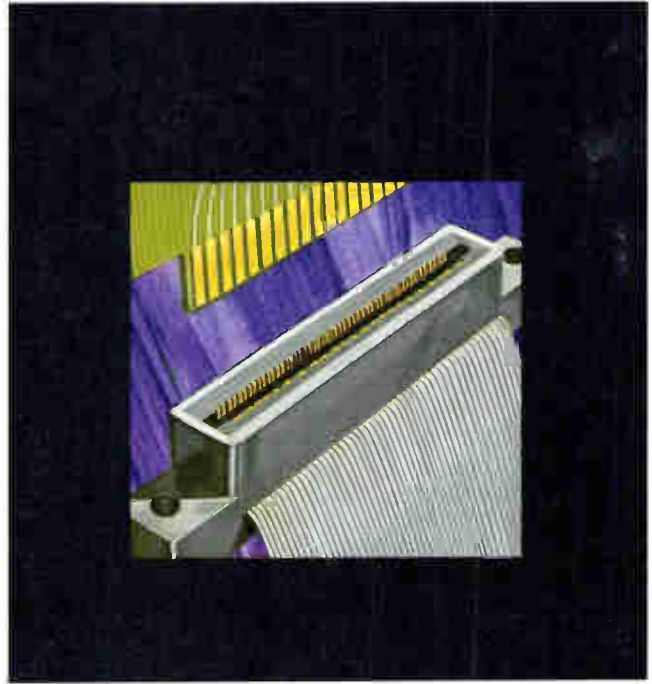

PCB Edge Card Transition. A double sided printed circuit board on .100" centers can be transitioned to flat cable on .050" centers with the 50 position edge card transition quickly and easily.

For complete technical information on "Scotchflex" Flat Cable and Connector Systems, write: Dept. EAH-1, 3M Company, 3M Center, St. Paul, Minn. 55101



The Following Performance Is Brought To You By The Only Manufacturer Of 50 A, Hot Carrier Rectifiers

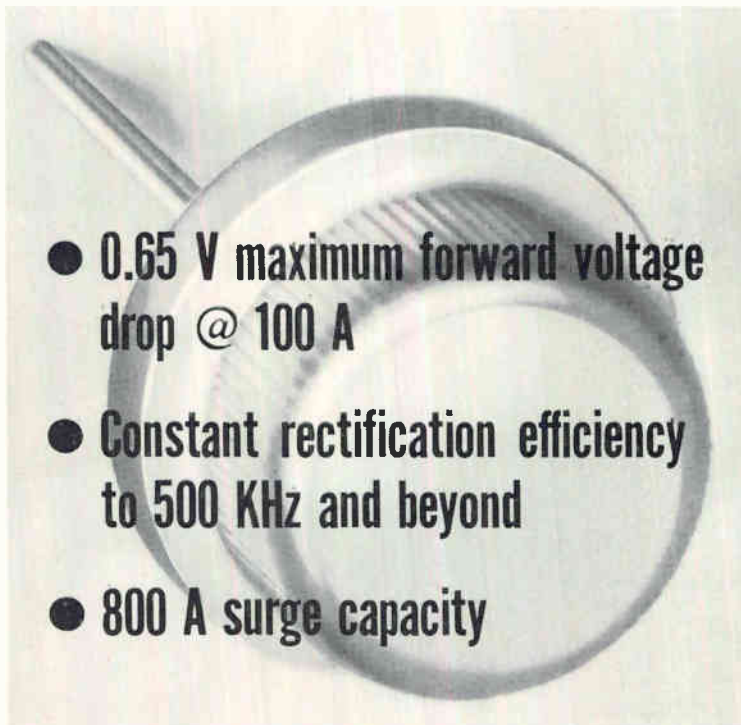

- 0.65 V maximum forward voltage drop @ 100 A
- Constant rectification efficiency to 500 KHz and beyond
- 800 A surge capacity

50% less power loss than conventional alloy or diffused devices!

That's the advantage in efficiency behind the new MBD5500, 50 A (I_o) hot carrier silicon rectifier. And, not only does this unique high-current device cut your power losses through unmatched low forward voltage drop but it trims time and money outlay for required heat sinking through one of the most efficient, low-cost package designs available – the pressfit (DO-21 outline).

Employing Schottky barrier, low resistivity, metal-over-oxide junction techniques in a large area chip, the 20 V ($VRM_{(rep)}$) MBD5500 is perfect for use in low voltage power supplies in computers and other applications where power loss and/or high frequency rectification are prime design considerations.

Its "majority carrier" operation makes it inherently suitable for applications where extremely low stored charge is required or where commutation transients are a problem.

Combine these advantages with top rectification efficiency, excellent surge-handling, low thermal resistance and passivated junctions and you've virtually got the "ideal" diode . . . the MBD5500 – available now for evaluation from your franchised Motorola distributor.

Turn one loose in your circuit design and watch it go – *efficiently!* Write Box 20912, Phoenix 85036 for more data.

— where the priceless ingredient is care!



MOTOROLA
RECTIFIERS

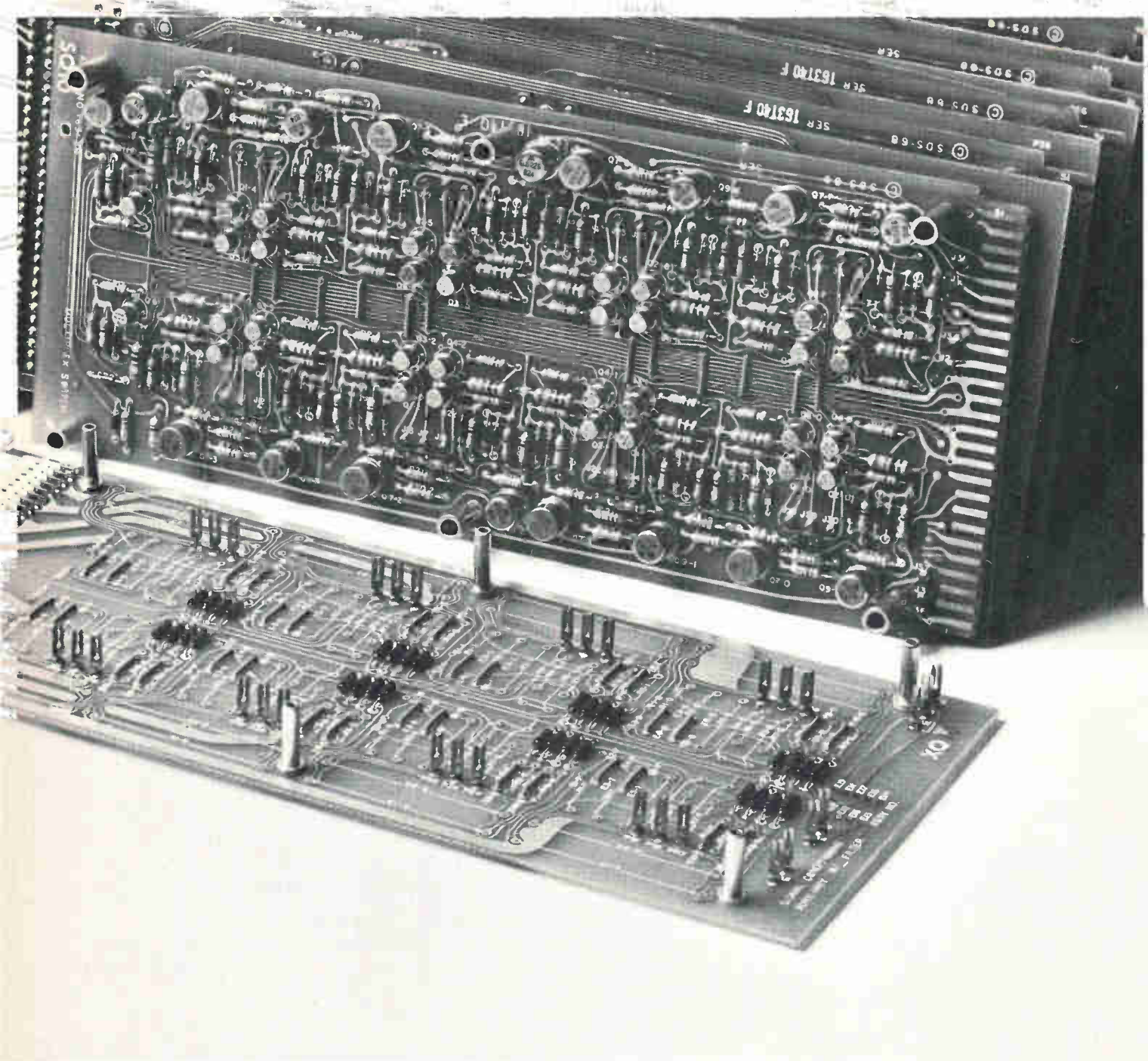

Look into our new low level multiplexer. It's good for your system.

Our DM40 solid-state differential multiplexer makes a great front-end, with amplifier per channel performance. It accepts analog signals from thermocouples, strain-gauges, resistance bridges, transducers, amplifiers and the like. It has very low noise and you don't have to worry about acquisition errors due to previous channel overload. The DM40 takes 128 input lines and you can hook eight units together for a total of 1024 inputs. It multiplexes and amplifies each signal and transmits it to your digitizer at a rate up to 10KHz. When you use it with one of our controller-digitizers you can get 13 different gain ranges.

In fact, the DM40 is even better when you get all your system components from us. This way you can be sure they'll work as a system. No interface problems to solve, no missing hardware to engineer. Our components are made to get along together.

After all, they come from a good family.

Circle 38 on reader service card

DM40 Minispecs:

| | |
|------------------------|--|
| Input signals: | From 2.5 millivolts full scale to 10 Volts full scale. |
| Gain Accuracy: | 0.02% between steps. |
| Linearity: | 0.005% |
| Zero Stability: | 1 microvolt rti +20 microvolts rto/°C. |
| Crosstalk: | 120db |
| Common Mode Rejection: | 120db, DC; 100db, 60Hz. |
| Noise: | 10 microvolts peak rti +100 microvolts peak rto. |

Write for complete specifications.

XDS
Xerox Data Systems
El Segundo, California

NASA prepares for ERC surgery

Better known efforts probably will be shifted elsewhere, but future of semiconductor reliability, bioinstrumentation work is bleak

"I guess we'll spend the next five months getting ready to pass our files to whoever eventually gets our projects," says a branch chief at NASA's Electronics Research Center. But he doesn't know for sure; nobody at ERC knows for sure about the future of the projects, and no one knows when he'll find out.

When the closure of the center was announced, so was the creation of a committee at NASA headquarters to help the people of the center find new jobs within NASA or the Government; apparently the same committee system is going to be applied to the selection of the

projects and programs to be retained by NASA.

Apparently, ongoing work will be summarized before the end of the fiscal year and given a priority ranking by the ERC staff, and the reports passed along to NASA headquarters. "We'll propose, they'll dispose," says a spokesman. "HQ will decide what survives and who gets which bloody chunk."

Finally, spokesmen can't even be sure of having a full five months to wind things up. Spending on current contracts and on those yet to be funded is being held up pending a headquarters go-ahead. Thus, some projects that might have been

brought to a neat, if abrupt, completion may be stopped dead in their tracks with an even more chaotic result.

Survivors. ERC's more visible projects probably will survive in some form. The V/STOL (vertical/short takeoff and landing) avionics program is one example. A joint effort with the Langley Research Center, it would have resulted in development of a set of in-depth tradeoff studies of a combined navigational, stability augmentation, flight control, and landing system for helicopters and less conventional V/STOL aircraft. ERC was supplying the digital computer sys-

Ripples spread in the Bay State

"The back of the hand" is a universal cliché. It also is what Massachusetts seems to be getting from the Federal Government. The closure of ERC marks only the latest in a series of Federal spending cuts aimed at Massachusetts, and it's rumored there will be at least one more, also with an effect on technology.

Bay state political spokesmen point to the shutdown during the summer of 1969 of operations at Westover Air Force Base, note that the Boston Navy Yard is about to be moved and cut in size, and add that the city of Boston has just lost \$63 million in urban renewal funds.

Also, the rumor that the Air Force's Electronic Systems Division at Hanscom Field will be closed has resurfaced. As rumors go, this one is a gray-beard, and it has been categorically denied by the Air Force.

Signs. But Rep. Alexander Pirnie's (R., N.Y.) sole share of the pork barrel is the Rome Air Development Center at Rome, N.Y., and as RADC is his district's largest source of income, recent spending cuts have hurt his voter image. The Administration tried to help out by giving Pirnie a role in the draft lottery ceremony; Pirnie's quiet spreading of the word in his home district that ESD would be moved to Rome is more interesting to observers. It's noted, however, that a more logical merger would be Rome into ESD.

Nobody at ESD will confirm the rumor, though they acknowledge that the idea has been breezed around repeatedly. Nor will spokesmen estimate the effect ESD's movement would have on the Air Force Cambridge Research Labs—also at Hanscom Field. However, with Massachusetts now a politically weak state, rumors are more likely to grow into fact than they were when, say, John F. Kennedy was President.

Massachusetts has no force in the capital. Only former Governor, now Secretary of Transportation, John A. Volpe and Sen. Edward W. Brooke have access to Republican councils. And Volpe is said to be weak, while Brooke lacks seniority and connections—Brooke was pooh-poohing the ERC closure the week before the ax fell.

Wrong pick. Massachusetts also gave the Democrats a large plurality in the 1968 Federal election. It has a governor with little following within the state and less in Washington, even though he is a Republican. And Senator Edward M. Kennedy's influence, which might have saved ERC, has declined mightily since the summer's incident at Chappaquiddick Island.

There are rumors that several firms are interested in the ERC shop, and that the Department of Transportation wants to take over ERC for the FAA—but not until the fiscal 1971 budget is settled. However, such a move is unlikely because of general Federal economy moves.

U.S. Reports

tem and inertial platform references, and had in the works several advanced strapdown and laser gyro developments. If the center's closure is final, says Robert W. Wedan, director of the technical programs, the V/STOL avionics work probably will move to Langley, although that facility is analog-processor oriented and won't have openings for ERC's V/STOL project personnel.

The FAA may pick up a parallel program aimed at providing an advanced automatic landing system for conventional jets. Wedan says the joint ERC-FAA flights will be finished well before the end of the fiscal year, but regrets that a second phase that would have extended the aircraft control into hold zones and approach areas will be delayed and perhaps forgotten.

The L-band navigational satellite work being performed by ERC may have been severely damaged by the closure and by its timing. Ironically, just before the ERC closure announcement, the International Civil Aviation Organization made public its request to NASA headquarters that a back-up satellite carrying Navsat experiments be launched as quickly as possible. But Leo M. Keane, head of ERC's satellite programs branch, fears that any L-band work will be delayed, even if (as Keane now anticipates) the Goddard Research Center gets Navsat research responsibility; "While the men at Goddard are good, they don't have the four to five years' experience with Navsat problem analysis we do. And like everyone else, I'm not too optimistic about finding slots down there for me and my men."

If NASA hadn't closed ERC, the L-band back-up satellite might have been the center's first hardware-oriented major project. Now, in the confusion, a decision on the proposed satellite is sure to be delayed. And the deployment of an operational North Atlantic Navsat System will also be postponed—some say by as much as three to five years, or even into the 1980's.

Also. . . Other programs aren't as public as these three, and it is felt that they will probably suffer



Vital. James C. Elms, ERC director, says bioinstrumentation group shouldn't be broken up.

even more. ERC's advanced technology directorate has long been working to boost semiconductor reliability in a multitude of programs. Over the past four to five years, ERC has funded investigations of failure mechanisms in discrete and integrated semiconductors, investigated diffusion and interconnection techniques, developed what amounts to a Duncan Hines rating system for IC production lines, and developed with industry's cooperation a visual inspection specification for semiconductors. Most recently, it has worked hard to develop the production controls necessary for high yields of large-scale IC's.

Many of the contracts in this broad area were small, and many were brainchildren of individuals in the center. Thus, while ERC would have gone on to investigate computerized testing of LSI and similarly advanced areas, it now may find most of its reliability work at a dead end unless spots can be found for key personnel.

The bioinstrumentation group may be one of the most fragile of ERC's components. Like the satel-

lite programs office, it warrants special concern because the chief loss will be the skilled personnel dispersed after the time taken to bring them together.

Center Director James C. Elms cites it as an example of what must not be lost in the closure of ERC. The group expanded upon its charter for development of space medical sensors to develop so-called diagnostic chairs, capable of measuring pulse, respiration, blood pressure, and other parameters without the patient's knowledge. Blood pressure sensors capable of being implanted in the bloodstream also came out of its labs. But just as important, says Elms, is the bridge built by the group between the engineering and scientific community and the medical profession. Much of this involves personal relationships, and so in this case, it would be almost impossible to divorce people from projects, according to Eugene G. Manella, advanced technology director. Just moving the paper work won't save the projects.

Budget punch . . .

When NASA Administrator Thomas Paine flew to Boston on December 29 to tell 850 electronics research center staffers the center will be closed this year, he did more than confirm the first published report eight days earlier [*Electronics*, Dec. 22, 1969, p. 62]. Paine also indirectly acknowledged the clout being wielded in Washington by Budget Bureau Director Robert Mayo. And, it's a fiscal fist that is sure to affect 1970 plans of other Federal agencies as well.

Hurting NASA just as much as Paine's formal announcement of the center's coming shutdown is the unannounced fact that there are no billets at any of the other space agency centers to accommodate any of the 850 persons who will lose their jobs at Cambridge.

A high NASA official notes that the agency had asked the Budget Bureau for at least 300 billets so that some of the more important program people at ERC could be

transferred to other centers, but Mayo refused to budge from his position. "Now we'd take almost anything," moans the NASA man.

A few options. However, personnel at these centers would simply have to take on a heavier work load if the research were to be continued. ERC people would have to move to other agencies, join private electronics or aerospace firms, or start collecting unemployment insurance. However, under Civil Service rules, some veteran personnel may be able to "bump" newer NASA employees with less seniority.

... and follow-through

At least a pair of other centers—the Michoud Assembly Facility in New Orleans, and the Mississippi Test Facility in Bay St. Louis, Miss.—may be next to receive the ax in the continued slash of NASA's budgets, both the one already approved for fiscal year 1970 and the yet-to-be approved one for the fiscal 1971 year.

And because of the cancellation of Apollo 20, and the NASA ground rule that all lunar orbital experiments must be flown at least twice, two new experiments planned for Apollo 17 and six for Apollo 19 may be placed aboard earlier launches or dropped.

For AAP. The Saturn 5 launch vehicle "saved" by NASA from the canceled Apollo 20 is now scheduled to be used to get the first Apollo Applications Program (AAP) workshop off the ground in July 1972. The first space station will be moved ahead to 1977 or 1978, and a second workshop or the first space shuttles will be flown after Apollo 19 in 1974 and before the space station in 1978.

"We'll know where we stand after President Nixon presents the budget to Congress and after the spring hearings," a spokesman explains. At present the President is expected to request \$3.6 billion for the agency—the lowest NASA budget since fiscal 1963. The decision on whether to advance the first shuttle launch or to put up a sec-

ond workshop may be made at that time.

AAP's workshop program probably is one of the safest NASA programs—if any project can be called safe in these jittery budget-juggling days. If the Administration decides that the space station will be part of the nation's space efforts, the workshop must fly too. It will contain about 50 experiments to assess, experiment with, and increase man's capabilities in space for longer and longer periods.

In addition, the capability and reliability of experienced manned space flight personnel—both at the agency and at shuttle contractors—must be maintained.

"We can justify keeping people for a year between launches," one NASA official explains, "but it will be damn tough to justify keeping them for two years without a launch, and almost impossible for three years."

Semiannual. As now planned, future Apollo shots will be spaced about six months apart to give scientists more time to analyze and evaluate returned data. Apollo 16 and 17 will fly 18 to 20 months apart, during which time the three workshop missions will be flown. However, contractors will be expected to hold to the original delivery schedules, NASA said.

If a second workshop is okayed, it would be launched in late 1974 or early 1975 and would have missions lasting three to four months—no longer. While a second workshop will be delivered with the first by McDonnell Douglas, there is no backup launch vehicle authorized or planned for construction as yet. The launch of one or more flights of the space shuttle could take up the remaining years before the station's estimated lift off in 1978.

The Coast Guard and the Departments of Transportation and Housing and Urban Development have been discussing sharing the use of the Mississippi facility with NASA. The Coast Guard reportedly wants to set up headquarters there for its ocean data buoy project. Transportation is thinking of using the facility to test high-speed trains for its urban mass-transit program.

Solid state

Sensitivity training

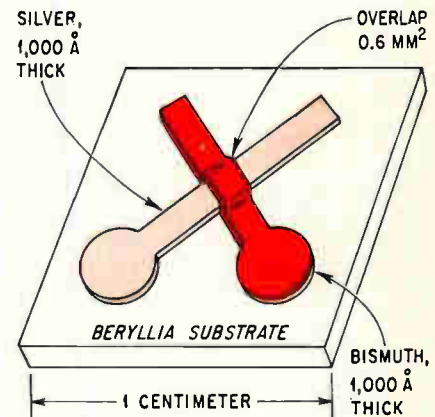

Slim. Bismuth-on-silver-on-beryllia thermocouple has 30 nsec response time for measuring fast-pulsed infrared laser.

Thermocouples provide a great way to measure infrared radiation—they're simple, inexpensive, and easy to use. Unfortunately, however, thermocouples respond slowly to the i-r stimulus. The typical response time of several milliseconds is just too slow to measure a fast-pulsed i-r laser, so laser researchers have had to resort to inconvenient cryogenic devices—usually germanium photoconductors cooled to 77°K—to make their measurements.

But relief is on the way. Oscar L. Gaddy and his coworkers in the department of electrical engineering and nuclear engineering at the University of Illinois, reasoning that the relatively large mass of the conventional thermocouple is what causes its sluggish response, are building thin-film thermocouples. By vacuum-depositing a thin film of bismuth on a thin film of silver on a beryllia substrate, the Illinois researchers have achieved response times of 30 nanoseconds with Q-switched carbon dioxide lasers. The films are 1,000 angstroms thick and they overlap in a 0.6-millimeter-square area of the thermocouple.

Heat's off. Bismuth is used for the topmost film because of its high absorption of infrared and its high thermoelectric coefficient, characteristics that contribute to

TUBULAR,
BULKHEAD
MOUNTING TYPE

RFI/EMI FILTERS

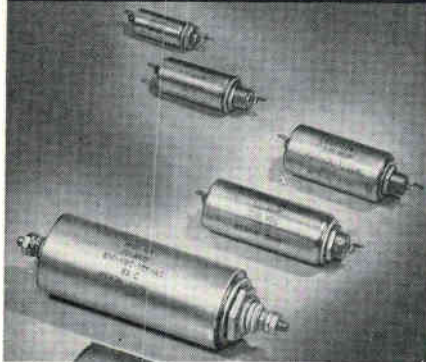

Rtron

Cylindrical Style Interference Filters

that reduce or eliminate unwanted noise or signals. Small size, light weight, maximum attenuation. Voltage current or insertion loss characteristics required, determine physical size. Maximum isolation of terminals and high frequency performance are assured by threaded neck design for bulkhead mounting. Feed-thru capacitor circuitry conservatively rated for both military and commercial applications.

Rtron corporation

P.O. Box 743 Skokie, Illinois 60076
312 • 327-4020

- Send catalog and prices.
- Have Representative call.
- Specifications enclosed on Multi-circuit or custom design filters. Send estimate.

Name _____

Firm _____

Address _____

City _____

State _____ Zip _____

U.S. Reports

the sensitivity of the device. Silver is used for its conductivity, and beryllia for its heat-dissipation properties.

The thin-film thermocouple has withstood 10-kilowatt peak-power laser pulses for several minutes without burning out. This corresponds to a repetitive transient-temperature increase of about 1,000°C. The device has ample tolerance of high-energy beams, the researchers say.

Cost of the thin-film thermocouple will be no more than a dollar, Gaddy predicts. He points out that the thermocouple output must be preamplified before it can be applied to a measuring instrument; an integrated circuit costing \$10 to \$15 is used for this. Regardless of this requirement, the thin-film device is less expensive than cryogenic devices, and it's certainly easier to use.

The major difficulty in developing the device has been sensitivity—getting an adequate number of output volts per watt of input power from the laser. The problem is that sensitivity is proportional to the film thickness, whereas response time is proportional to the square of the thickness. Designing for fast response necessarily means a trade-off with sensitivity, the Illinois researcher points out.

Developing. Gaddy reports that sensitivity is now adequate for many laboratory measurements. Nevertheless, he still calls the devices experimental. The reason is that calculations show there's still much room for improvement: response time could be reduced even further, to less than a nanosecond. The significance of this prediction lies not so much in the response time—it's already fast enough—but in the possibility it opens for improving sensitivity. According to the prediction, sensitivity should be 100 times what it is now at the present 30-nsec response time, and the job now is to get it to that higher level.

Meanwhile, other materials aren't being neglected. The Illinois group is looking at low-conductivity glass substrates and at thin metal film and bulk semiconductor thermoelectric junctions.

Space electronics

Lased words

There were some raised eyebrows when NASA passed over Hughes, General Electric, Sylvania, Honeywell, and Philco-Ford to award Aerojet-General a \$5 million contract for a CO₂ laser communications system to be placed aboard the ATS-F applications technology satellite. The explanation, says Al Belikow of Aerojet's Electronics division, is simple. "Some people wondered why we got the contract, but we probably have the best and most complete optical testing facilities in the world, although they have mainly been used for highly classified work." The work he refers to is the Air Force's spy satellite.

While the communication system will be just one of 18 experiments aboard the sixth ATS when it's launched into a 22,000-mile synchronous orbit in the spring of 1972, both NASA and Aerojet are hopeful that eventually it will be usable for commonplace communications between points in space as well as for satellite-to-ground systems.

The feasibility experiments will seek to establish communications between the Goldstone tracking station in Mojave, Calif., and the satellite. "The CO₂ laser was selected because there is a nice window in the earth's atmosphere at 10.6 microns, and that wavelength also brings the size of the optics down to an acceptable level," says Belikow. "It also yields savings in weight and space, and a reduction in complexity, all of which are important in terms of erecting an antenna in space."

Prime coming. The final package configuration awaits award of the prime ATS-F contract, expected shortly, to either Fairchild-Hiller or GE, Belikow says. However, its size will be about 17 by 15 by 22 inches, and weight will be 45 to 50 pounds. Aerojet will produce five systems, three for preflight tests, one flight model, and a backup. The laser subsystem is being subcontracted to RCA, and the receiver Airborne Instrument Laboratories.

Thirty watts of input power are

You Can't Get This Kind of Performance From Any Other Op Amp:

for **\$17.85***

RA-2600

Input Bias Current = 2nA

Input Impedance = 200 M Ω

Voltage Gain = 200,000 V/V

Slew Rate = ± 7 V/ μ s ($A_v=1$)

Input Offset Voltage = 2mV

Fully Compensated

Short Circuit Protected

for **\$27.25***

RA-2520

Slew Rate = ± 120 V/ μ s ($A_v=2$)

Input Offset Voltage = 4mV

Voltage Gain = 15,000 V/V

Large Signal Bandwidth = 200 kHz

Input Impedance = 100 M Ω

Our RA-2510 has a slew rate of ± 60 V/ μ s and our RA-2500 has a slew rate of ± 30 V/ μ s with similar characteristics and equally low prices.

*100 unit price

We're calling our linear line the no-compromise op amps because you don't have to compromise your design to stay within budget. In fact, with performance characteristics such as we offer, your design job is easier, and you end up with a more reliable circuit, too.

Get off-the-shelf delivery of these monolithic op amps that exceed hybrid performance. We build them to full military temperature range and to comply with MIL-STD-883. (If you don't need military temperature range, our commercial version, 0°C to +75°C, devices are available at even greater savings.)

Ask your nearest Radiation sales engineer about our no-compromise linear line. He'll help you *pick the best IC for the job.*

Lexington, Massachusetts (617) 862-1055
Norwalk, Connecticut (203) 853-3646
Frederick, Maryland (301) 662-5400
Oaklawn, Illinois (312) 423-6010
Dallas, Texas (214) 231-9031
Albuquerque, New Mexico (505) 268-3549
Palo Alto, California (415) 321-2280
Long Beach, California (213) 426-7687
P. O. Box 37, Melbourne, Florida 32901 (305) 727-5430

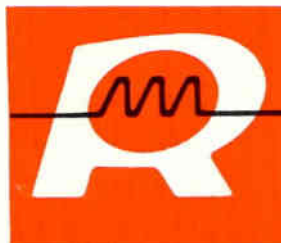

RADIATION
INCORPORATED
SUBSIDIARY OF HARRIS INTERTYPE CORPORATION
MICROELECTRONICS DIVISION



"Black Magic" FROM Plastic Capacitors

NEW "LQ" Series
OIL-FILLED
CAPACITORS
FOR MEDIUM AND HIGH VOLTAGE
APPLICATIONS



- Voltage range, 1000 to 10,000 volts DC
- Power Factor, 0.5% at 60 and 1000 Hz.
- Peak to Peak Ripple Voltage, 20% of DC Voltage Rating
- Designed for continuous operation of 10,000 hours at 65°C
- Black phenolic shell, epoxy end fill
- Axial wire lead terminations
- Excellent corona characteristics

Here's new "Black Magic" from PC, delivering more power and reliability at extremely low cost. Compact size and stability increase their versatility. Quality construction assures peak performance. Intensive testing to insure field performance applications unlimited.

Write for free samples and complete engineering data today!



Plastic Capacitors
INC.

2620 N. Clybourn • Chicago 14, Ill.
DI 8-3735

U.S. Reports

used for the f-m system, with a transmitter output of 547 milliwatts and a maximum signal bandwidth of 5 megahertz, adequate for color tv. The transmitted beam width is 14 arc-seconds, half-power, and received beam width is 32 arc-seconds, half-power. The antenna, or course pointing mirror looking toward earth, is a polished beryllia ellipse with a 7-inch minor axis. The primary telescope mirror is similar, except that it is circular. Heterodyning techniques are employed on the received signal; signal-to-noise ratio at the receiver is 23 decibels.

Three CO₂ laser tubes are used, including a transmitter laser 29 centimeters long with an 8-millimeter internal diameter, and a local oscillator 16 cm long with an 8-mm internal diameter. A backup local oscillator provides redundancy if the tube fails. It also can act as an unmodulated carrier-wave transmitter for other experiments, such as testing atmospheric effects on the laser beam and far-field intensity of the beam.

A gallium arsenide modulator with a crystal length of 5 cm is in the transmitter laser cavity. A single mercury-cadmium-telluride detector measuring 10 by 10 mils is used. The detector acts as a mixer, beating the local oscillator frequency against the received frequency. The detector is cooled to 100°K or lower with black body-metal radiators, consisting of stacked disks made of a proprietary material. The radiators can dissipate a heat load of 27 mw; remaining heat is transferred through a base-plate heat sink in the package. A conical shield over the radiators keeps out sunlight. The ground station at Goldstone will use a liquid nitrogen refrigeration system for cooling.

Broader beam. For signal acquisition, the receiving station beam is widened to 32 arc-seconds and scans. To facilitate the search, nine designated areas, or squares, of space are scanned, in turn, by the beam. A computer-controlled search is made in each of the nine squares. Acquisition time is 100 seconds maximum, according to Aerojet. Changes in the satellite's attitude

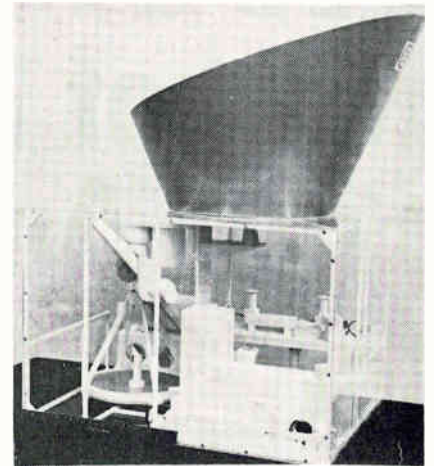

Mockup. Aerojet General's CO₂ laser communication system for the ATS-F satellite. Cone shields heat radiators from direct or indirect sunlight.

up to 0.2° can be handled by image-motion compensation in the system. Mean time for critical failure is estimated at 2,000 hours of operation over a two-year orbiting period.

At least in the ATS-F launch, the laser system will use a 30-foot S-band microwave antenna on the satellite to provide telemetry for checking laser operation. Officials at Aerojet claim, however, that once their system is proven, the bulky S-band antenna may no longer be necessary.

Looking ahead to the ATS-G in 1973, Belikow says a bandwidth up to 100 Mhz may be employed.

Contracts

Accounting for it

An amendment to the Defense Production Act of 1950, offered by Sen. William Proxmire (D., Wis.) and which he asserts will save \$1 billion over present accounting methods, would change the Defense Department's armed services procurement regulation (ASPR) to include uniform cost accounting for contracts that amount to over \$100,000.

Slated to come before the Senate Banking and Currency Committee early in the new session, the

Breach the current barrier

Fast-switching
RCA SCR's
have high di/dt
capability

| SCR families | Volts | Current (rms) | Typical Applications |
|--------------|-------------------|---------------|---|
| TA7395 | 600 400 200 | 40A | modulators/inverters, small radars, sonars, high frequency inverters, pulse modulators |
| 40555 | 600 400 200 | 5A | |
| 40216 | 600 | 35A | |
| 2N4101 | 600 400 200 | 5A | |



Stick most SCR's with a 400 A/ μ s pulse and they're destroyed—they can't turn off fast enough. Slam the developmental RCA-TA7395 with the same kind of pulse, and it keeps working... and working... and working. (It literally breaches the current barrier!) That's because RCA SCR's turn off in 10 μ s and spread forward current faster—so switching losses are low—and less heat is dissipated internally.

In addition to fast turn-off times, the TA7395 and other RCA SCR families have high dv/dt characteristics, and may be used at frequencies up to 25 kHz.

Engineers take notice: RCA SCR's are subjected to the most stringent quality assurance tests in the industry. With case temperatures held at 120°C, the SCR's are pulsed by 100 A/ μ s and 250 V/ μ s (up to rated voltage) signals to check turn-on switching losses and turn-off times.

For further details, see your local RCA Representative or your RCA Distributor. Or write RCA Electronic Components, Commercial Engineering, Section N1-2/UR5, Harrison, N.J. 07029. In Europe: RCA International Marketing S.A., 2-4 rue du Lièvre, 1227 Geneva, Switzerland.

RCA

TRYGON power supplies are... a New systems grouping providing the utmost in flexibility and economy

OEM Modules; ¼ racks; ½ racks; full racks
—all compatible with ruggedly constructed
rack adapters for up to 161 VDC and 70 amps.

- Complete Systems Reliability
- Unattended Continuous Operation



TPS
Super Trypack Series
Slot range system module
from \$56.



LVW-LVS
Liberator Sub-Rack Series
Slot and wide range modules,
from \$89.



LQS
Liberator Sub-Rack Series
¼ rack slot range,
optional metering
from \$135.



LHS
Liberator Sub-Rack Series
½ rack slot range,
optional metering
from \$219.



L3R/L5R Liberator Series full rack systems
power supply from \$450.

Unregulated units available for
NIXIE and relay applications.

TRYGON MEANS POWER!

Write now for complete data and pricing
of this new systems grouping.

TRYGON POWER SUPPLIES

111 Pleasant Avenue, Roosevelt, New York 11575
Tel: 516-378-2800 TWX: 510-225-3664
Trygon GmbH 8 Munchen 60, Haidelweg 20, Germany
Prices slightly higher in Europe.

U.S. Reports

amendment, if passed, would require the General Accounting Office to "promulgate uniform cost accounting standards within 18 months of enactment of the legislation," says Proxmire. The 1950 act simply mandated study of feasibility of uniform cost accounting standards.

A report by the GAO on noncompetitive contracts over \$100,000—awarded on the basis of contractors' catalog prices—led to the Proxmire amendment. The GAO charges that the Pentagon's rules in awarding such contracts are too vague, and that it generally fails to verify contractors' commercial sales data used to substantiate a contractor's claim of a reasonable catalog price.

Same rules. In accepting a catalog price as the basis for a contract, the Defense Department does not require submission of cost or pricing data, and doesn't specify how much of an item procured must be sold in the commercial market, only that commercial sales be "substantial." The GAO says ASPR regulations should be more in line with the Renegotiation Board's requirement of 55% commercial sales of an item before it can be defined as a "standard commercial item," or as one the Renegotiation Board feels can be accepted for a contract on the basis of catalog price. A single set of rules is needed, says the GAO.

In examining the noncompetitive awards, which are made on a firm, fixed-price basis, and about a third of which are for electronic equipment, the GAO finds that many of them "should not have been accepted on a catalog-priced basis," since contractors' commercial sales data in most cases was either not obtained or not verified by the Pentagon. In some instances, subcontractors selling items to prime government contractors record these sales as commercial.

The GAO also found instances where a company sells an item to a commercial customer "at a lower price than that paid by the Government on purchases of greater quantities."

To iron out these discrepancies in noncompetitive contracts, the

GAO suggests that Congress change ASPR to require contractors and subcontractors to use a standard form in claiming exemption from the requirement of submitting cost or pricing data. It's likely that this recommendation led Proxmire to seek uniform accounting on a grander scale. The GAO would further require contractors to open their books for verification of claims by the Defense Department. Up until now, contractors have resisted this request. A leader of the resistance before he became Deputy Secretary of Defense was David Packard, who took the Hewlett-Packard Co.'s case right to the top of the Federal court system—and lost.

Communications

Sticky business

Launch time for two orbiting Mariner Mars 1971 spacecraft still is more than a year away, but Jet Propulsion Laboratory engineers already have a sticky problem on their hands. Dan Schneiderman, Mariner '71 project manager, says his group is trying to prevent magnetic tape in the on-board reel-to-reel recorder from sticking to the playback heads and stalling the motor. "We don't know yet how it can be corrected," he says, "but a similar problem has been encountered in the Nimbus weather satellites."

[Harry Press, manager of the Nimbus project at Goddard Space Flight Center, says that the problem is a classic one. To get around it on Nimbus 3, which went up last April, considerable testing was involved. Also, the tape and the heads were matched carefully. But on Nimbus 2, all the tapes were lost six months after launch.]

Apart from such mundane difficulties as sticky tapes, Schneiderman says operation of the two craft in orbit around Mars for 90 days "will be hellishly complicated" because of the vast quantity of data to be returned and the time lag between Mars and Earth.

However, most of the scien-

Xtal Filters.

Damon shapes up fast!

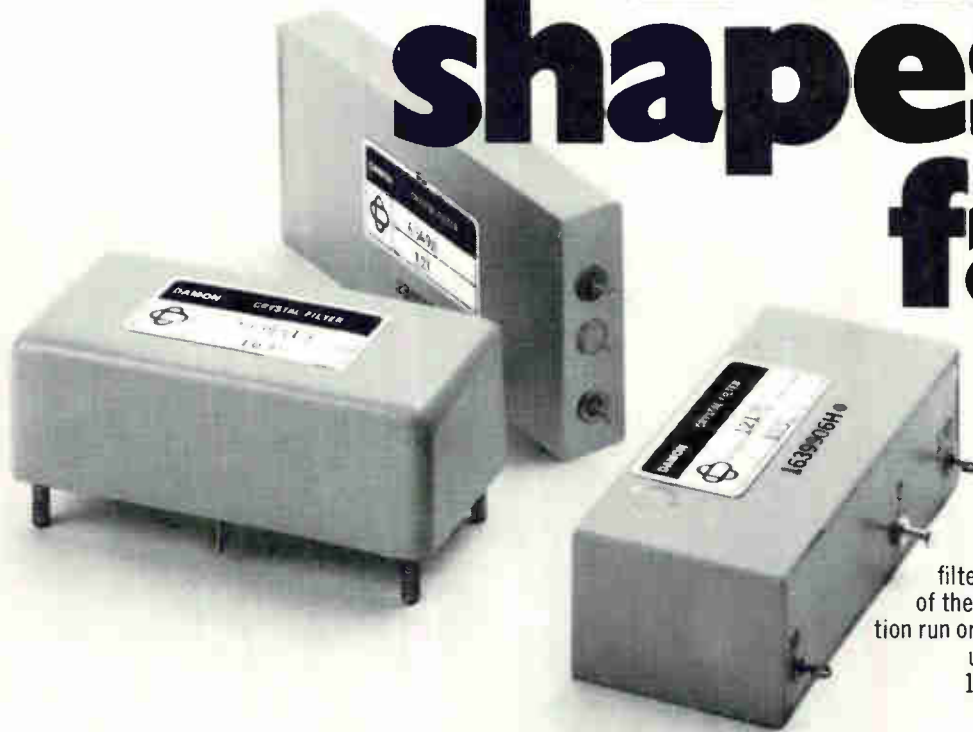

Whether your signal shaping need is a sharp rejection notch, a band-pass or a single side-band filter – call Damon. Choose from dozens of computer-assisted standard designs including Butterworth, Chebyshev, Gaussian or Bessel. Or let Damon create a custom filter to your specs. Either way, you're sure of the exact crystal filter you need. A production run or a prototype, Damon meets your schedule. Try us. Damon/Electronics Division, 115 Fourth Ave., Needham, Mass. 02194. Phone: (617) 449-0800.

Band-Pass Filters

| PARAMETER | RANGE |
|--------------------------------|-----------------|
| Center Frequency | 10 Khz-75 Mhz |
| Bandwidth | .01%-3% of C.F. |
| Phase Linearity | <±5% |
| Transient Overshoot | >40 db |
| Shape Factor | <1.25:1 |
| Differential Phase Shift | <±2° |
| Group Delay Uniformity | <±5% |

Band-Reject Filters

| PARAMETER | RANGE |
|------------------------|---------------------|
| Center Frequency | 10 Khz-35 Mhz |
| Reject Bandwidth | .01% to .5% of C.F. |
| Pass Bandwidth | Up to 100% of C.F. |
| Shape Factor | <1.8:1 |
| Notch Rejection | >80 db |
| Insertion Loss | <0.5 db |
| Ripple | <0.25 db |

Single Side-Band Filters

| PARAMETER | RANGE |
|-----------------------------------|--------------------|
| Center Frequency | 10 Khz-35 Mhz |
| Pass Bandwidth | .01% to 2% of C.F. |
| Carrier Rejection | >40 db |
| Shape Factor Carrier Side | <1.15:1 |
| Shape Factor Side-Band Side | <1.25:1 |
| Insertion Loss | <3 db |
| Ripple | <1 db |



the im-possible ALCOSWITCH

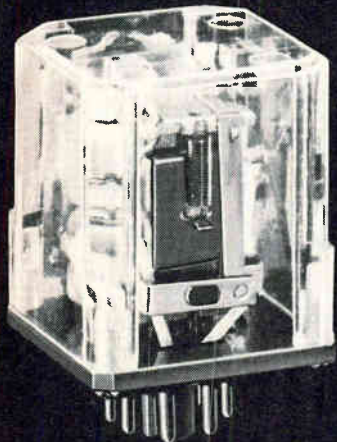

Since when does ALCOSWITCH make relays? Since we learned how to make the impossible switch. All we've done is to combine a step-down transformer and a relay in a single core, all in miniature.

If your product operates on 115 VAC and has possibilities of remote operation chances are you could use this ALCOSWITCH-RELAY!

Refer to the figure below: by simply shorting the remote control leads "xx" the flux path changes thereby closing the relay armature.



The only product in the world of this type that allows you to control up to 600 watts remotely, safely, and economically.

Whether you manufacture hi-fi amplifiers, electric fans, vacuum cleaners, projectors, thermostat controls, consumer appliances or industrial equipment, you may have a need for this revolutionary switching product.

If you are seeking a marketing advantage for your products, we will be happy to assist you by suggesting one of our ALCOSWITCH-RELAYS.

ALCO

ELECTRONIC PRODUCTS, INC.

Lawrence, Massachusetts 01843

Circle 48 on reader service card

U.S. Reports

tific instruments, including wide- and narrow-angle television cameras, infrared radiometers, and ultraviolet spectrometers, will be basically the same as those proven in Mariner '69. One exception: the infrared spectrometer, which has been replaced with an infrared interferometer using a pyroelectric detector, and operating in the 6- to 22-micron spectral range. The interferometer is a modified version of one developed for the Goddard Space Flight Center and used on Nimbus.

Schneiderman says the change was made to obtain a higher-resolution spectrum and because cryogenic cooling of the detector, necessary with the previous i-r spectrometer, isn't feasible for the longer Mariner '71 mission. Some data was lost during the 1969 mission when a failure in the cryogenic cooling system caused the loss of one channel in the i-r spectrometer.

Faster shutter. Optics in the narrow- and wide-angle television cameras will be the same as in Mariner '69, but faster—down to 3 milliseconds—shutter speeds will be used in both cameras, and the wide-angle unit will have a commandable filter wheel, permitting random selection of red, green, or blue filters. In the earlier mission, the filter wheel was sequenced automatically.

Another change is in the data stream, which will be totally digital. In Mariner '69, the most significant bits were digitally recorded and transmitted; the least significant were sent in analog form.

"Going all-digital will increase our ability to reduce the pictures because we won't have to match the digital and analog data streams, and it will result in a cleaner system with less noise," says Schneiderman. And the reel-to-reel configuration contrasts with Mariner '69's lubricated, continuous-loop tape. Since the tape deck will be in constant use during the mission, Schneiderman explains, "we want to avoid the crud that accumulates on the heads over a period of time when a loop with lubricated tape is used."

Another innovation will be all-digital data storage and handling in the spacecraft. In Mariner '69, two tape recorders were used; a digital recorder for scientific data plus the most significant video information, and an analog recorder for the remainder of the video data. Mariner '71 requires only one machine.

Data rates will be variable down to 1.012 kilobits per second. The variable rate is necessary because of the constantly changing communications link characteristics caused by the spacecraft's orbit, Schneiderman says. Data rates below 2 kilobits per second will be handled by 85-foot antennas in the ground station network at Goldstone.

The project manager says the line arrangement in the video system has been changed from the 704 lines by 945 elements per line used in 1969 to 700 lines with 832 elements per line. Each element, or spot, is converted to a 9-bit word, compared to 8 bits in last year's mission.

"The systems will provide an accuracy of one part in 512, and give more resolution in terms of light intensity than we had in 1969," he says. "We are seeking albedo [brightness] information rather than object discrimination in this mission," he adds. During 90 days in orbit, the two Mariner '71 spacecraft are expected to send back 7,400 pictures, compared with about 200 relayed to earth by Mariner '69.

Memory in the spacecraft's computer/processor has been increased to 512 words with 22 bits per word to provide more command and sequencing flexibility than was possible with Mariner '69's 128-word memory.

For the record

Deflation. Monsanto, which is set to introduce a new type of solid state readout, has cut prices on its MAN-1 solid state numerics by more than 60%. This, says the company, makes them more competitive with Burroughs' Nixie

Circle 49 on reader service card →



When you can't afford a "wrong number"...

Symbolic representation of the TV, voice, ranging data and biomedical telemetry signals from the moon. Photograph courtesy of NASA.

bring ERIE in early.

Where are they? How are they? What do they see... and say? NASA and the world want to know. And, the only way to find out is over the special Motorola S-band equipment on both the Command and Lunar Modules. Once the Apollo Astronauts are over 30,000 miles out, it's their *only* communications link with Earth. It simply can't fail. That's why Motorola called on ERIE TECHNOLOGICAL to develop the EMI filters and Monobloc capacitors that would help this equipment perform flawlessly on every Apollo mission since Motorola has been involved. Proof, once again, that it pays to bring ERIE in early.

ERIE TECHNOLOGICAL PRODUCTS, INC.
644 West 12th Street, Erie, Pennsylvania 16512
(814) 456-8592



THAT'S OUR BAG.

The Post Office is an \$8-billion-a-year business. And we're in it. Working with specialists from the Department, we're designing a prototype post office from the ground up. How come they asked us? Because we've done some unusual things in computer analytical techniques and dynamic modeling. The postal people aren't looking for the tried and true, and we don't intend to give it to them. So it's fresh ideas, bright ideas, that count. The kind that carry the mail speedily through snow, and rain, and sleet, and hail, and gloom...

*Martin Marietta Aerospace Group. Headquarters:
Friendship International Airport, Maryland.*

MARTIN MARIETTA

U.S. Reports

tubes. The price of Monsanto's seven-segment readout has been trimmed to \$11 in quantities of 1,000, from \$25. A comparable Nixie costs \$4. The new Monsanto type will be made monolithically, so the diodes can be deposited on the substrate during processing, instead of being bonded manually. The saving in time and labor could bring Monsanto's price down to that of Burroughs.

Thud. A super-secret effort to combine biochemistry and electronics in an automated blood-analysis instrument has been dropped by the Medical Diagnostic operation of the Xerox Corp., leaving about 300 persons jobless. The move may portend discontinuation of the MDO as a separate Xerox entity, although the work on "xeroradiography" continues. Xeroradiography produces an X-ray-like image for medical analysis, and has been used initially to detect breast cancer in women. An MDO spokesman says cancellation of the blood-analysis instrumentation project does not mean the xeroradiography effort will be deemphasized; in fact, the aim is to get experimental units into the field for clinical tests "in the next few months," said the spokesman.

Loser's spoils. North American Rockwell Corp.'s Aerospace and Systems group has been downgraded and its top management reshuffled after the company lost out in the Air Force F-15 fighter production contract competition. The group has been redesignated the aerospace and systems office. John R. Moore, who had been the group's president, is now a corporate vice president assigned to the general offices staff.

Migration. Charles Stark Draper, the U.S. father of inertial navigation, has a new post: president of the newly established research center bearing his name at the Florida Institute of Technology at Melbourne. Draper will continue as vice director of MIT's instrumentation Laboratory, now renamed the Draper Laboratory.

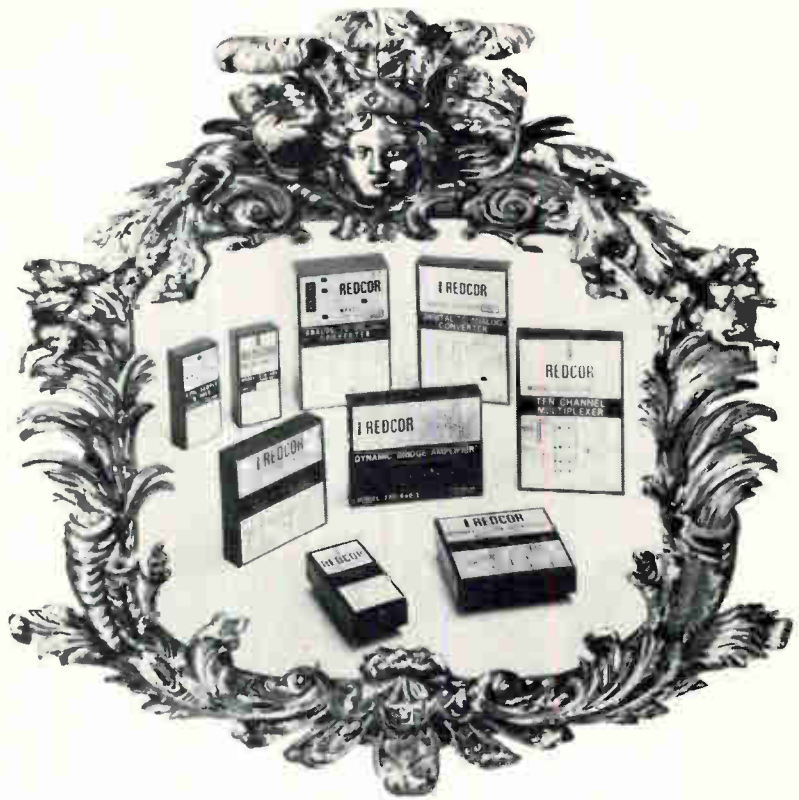

The Family Portrait

REDCOR Closed Loop Analog Modules

The REDCOR Module line has "guaranteed performance" for easy use by the system and instrument designer. The nine modules shown above are only part of the growing family. Meet some of the relatives:

- BUF-FET Amplifier/770-406
- Dynamic Bridge Instrumentation Amplifier/770-440
- 1MV High Speed Comparators/770-724
- 0.1% Sample and Hold/770-708
- 0.01% Sample and Hold/770-715
- 10 Channel Multiplexer/770-730
- 12-Bit Digital to Analog Converter/770-712
- REDIREF® $\pm 10V$ Reference Supply/770-501
- 12-Bit Analog to Digital Converter/770-750

The relatives can be combined in a variety of ways to solve your individual analog problem. They are all compatible, to each other, and the "outside world." If you would like to learn more about the members of our family, write or call:

REDCOR
CORPORATION

Complete Systems Capability / 7800 Deering Avenue, P.O. Box 1031,
Canoga Park, California 91304—(213) 348-5892



Cinch originated *all* these back plane connector features?

You deserve a pat on the back!



First with removable bus bars and contacts?

OK wise guy, take out this one.



You can apply a separate voltage or ground to any contact in the assembly? And easily remove them too?

Whose idea was that? Hmm. I might have guessed.



Were you really first to use a monoblock insulator?

It saved how much money?



You keep telling engineers they'll need less gold with Cinch selective plating.

How about telling my dentist!



Cinch used special coordinate testing to maintain .010" contact radius tolerance over the entire panel.

Well, they sure look straight enough to me!

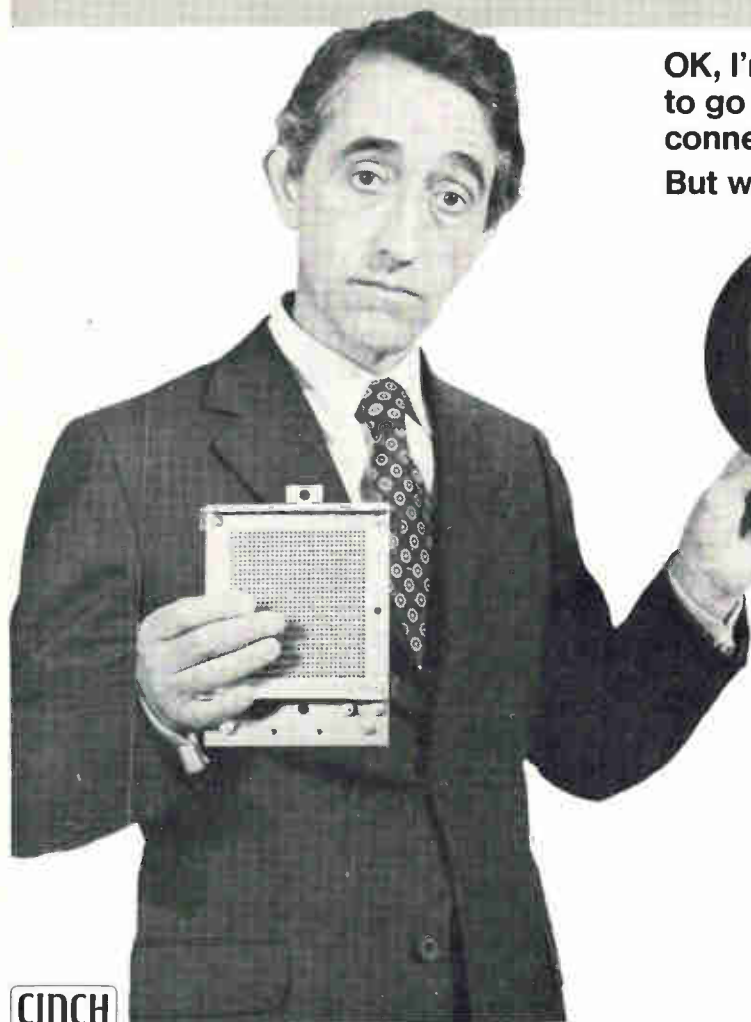

OK, I'm convinced! Cinch is the place to go for innovations in back plane connector designs!

But will you make me famous?

Cinch *pioneered* the back plane assembly features that have become industry standards. More important, we will apply the same creative engineering to your connector requirements. For further information on Cinch back plane connectors—or any connector problem contact your nearest Cinch Electronics Group sales office or Cinch Manufacturing Company, 1501 Morse Avenue, Elk Grove Village, Illinois 60007.



A DIVISION OF TRW INC.



DIVISIONS OF TRW INC.: CINCH MANUFACTURING, CINCH-GRAFIK, CINCH-MONADNOCK AND CINCH-NULINE



TRW
Metallized
Mylar Capacitors

are different

The little things set them apart.

Things like superior electrical properties. Better environmental properties, too.

Things like variety. Tape-wrap, epoxy or hermetically sealed. Axial or radial leads. Voltages from 50 volts to 600 volts. Values from .001 mfd. to 10.0 mfd. And

tolerances to 1%.

And not so little things like unequalled experience in metallized mylar*. And the technical know-how to meet special requirements. They all add up to a big difference!

Contact any TRW distributor, or TRW Capacitors, Box 1000

Ogallala, Nebraska. Phone (308) 284-3611. TWX 910-620-0321. TRW Capacitors is a Division of TRW INC. *DU PONT REGISTERED TRADEMARK

TRW

If your product has to be cleaned completely, safely, efficiently, you should be using FREON[®] cleaning agents.

Here's why...

- 1.** **Low boiling point (under 120° F)** for low-temperature vapor degreasing. Eliminates cooling time for post-cleaning processes... no damage to heat-sensitive parts. Minimal heat passed into work environment.
- 2.** **High density combined with low surface tension** evacuates soil from pores, crevices and cracks—floats away contaminants.
- 3.** **Clean without damage.** Compatible with widely used materials of construction. Clean completed assemblies instead of individual parts.
- 4.** **Chemically pure and stable.** No acid acceptance and scratch tests necessary. No inhibitors needed. Parts dry residue-free.
- 5.** **Safe to people,** as well as to material—nonflammable, nonexplosive, low order of toxicity.
- 6.** **Lower overall cleaning costs possible.** FREON solvents are recoverable for reuse indefinitely. Very low power requirements in vapor degreasing because of a low heat of vaporization. Better cleaning results in fewer production rejects.

Du Pont FREON cleaning agents have been used to solve critical cleaning problems in the electronics and aerospace industries for many years. If you have a critical cleaning problem, or are looking for a better cleaning system, write today to Du Pont Company, Room 8703, Wilmington, Delaware 19898.



Buy a whole ADAC...

or a choice cut

This new, computer-controlled Astrodata Data Acquisition and Control system is a low-cost, expandable unit based on over ten years of Astrodata experience in data systems. A basic ADAC system will accept up to 10 low-level signals (expandable to 500), amplify, filter, condition, multiplex, convert, compute, control and record them, for less than \$30,000.

What's also convenient about the ADAC concept is that you buy only as much system as you need now, with low-cost plug-in expandability for future functions. Or perhaps your requirements are for ADAC components only. Look at the selection:



ASTRODATA

1. "Front-end" Equipment



Astrodata 889 Low-level amplifiers; wide band, differential, high gain and compact. Astrodata 889-900 Filters, low pass 3-pole devices with 3dB cutoff

points at 9 frequencies plus wide band.

Astrodata 889-600 Signal Conditioners which include isolated power supplies and bridge completion networks for transducer excitation and signal conditioning.

2. Low-Level Multiplexing



With the ADAC, you have a choice of Astrodata's Model 960 Low-Level Multiplexer which can accept 10 to 100 inputs (using 10-channel

cards), has 5 gain ranges from ± 5 to ± 100 mv, with speeds up to 10 kHz, OR Astrodata's new Model 990 featuring wider dynamic range and speeds to 40 kHz. Either can be provided with programmable offset voltage.

3. Analog to Digital Conversion



The ADC in this system is an ASTROVERTER data converter—and does it perform! Throughput rate is 100 kHz with an accuracy of

$\pm 0.06\%$ full scale $\pm \frac{1}{2}$ least significant digit. Output is eleven binary bits plus sign. But the ASTROVERTER is much more than an ADC. By merely replacing a few cards, the ASTROVERTER becomes a DAC, or a 128-channel high-speed multiplexer, or a simultaneous sample-and-hold device. It can also be used as the total interface between analog and digital signals. Its great flexibility, high speed (5 μ sec digitizing) and low cost provide a panacea for the system designer.

4. Computation

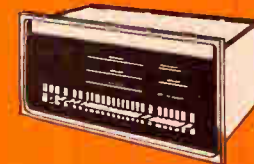

The selection of a computer allows the ADAC system to be fitted more precisely to the application. By having more than 40 computing devices from

which to select, Astrodata engineers can supply exactly what's required, allowing for future expansion, and reducing overall system cost. If you already have a computer at your installation, so much the better, interfacing is our middle name.

5. Software

With a staff of nearly 100, Astrodata's software group can develop any, yes any, type of program your application may require, from simple data acquisition to a highly involved control complex.

That's ADAC—its parts and its entity, all products of Astrodata, its people and its resources. Call us now if you want more data, write for the ADAC brochure, or request information on specific system components.

15 nano-second memory...

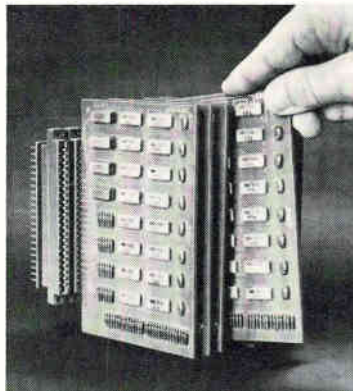

there's a lot behind it

For one year we have been quietly mobilizing the industry's most capable semiconductor memory team. Personnel from all disciplines to design, assemble, test and volume produce the fastest, most reliable memory systems.

Here are the results:

1. Our memories are the world's fastest —15 nsec. access and 10 nsec. cycle times.
2. Our designs are pre-evaluated and optimized by computer simulation.
3. Our chips are individually packaged in proven, low-cost, ceramic Dual-In-Line packages and mounted on standard P/C cards.

4. Our cards are fully functional and incorporate our own logic support circuits to enhance system performance and minimize overhead circuit requirements.
5. Our quality is verified every step of the way by computerized testing that performs up to 5000 tests/sec. on the chip, the packaged devices, and the modular assemblies.
6. We are now in production.

We design our memories to be modularly expandable and we supply them in ECL and TTL compatible configurations. Our products reflect total capability...The kind of capability that puts a lot behind us, including the competition.

Our first series of modular cards is now available. To order:

| | Price: (1 to 9) | ECL Compatible | TTL Compatible* |
|--------|-----------------|----------------|-----------------|
| 32 x 8 | \$768.00 | AMS 0328E | AMS 0328T |
| 32 x 9 | \$845.00 | AMS 0329E | AMS 0329T |

*Delivery on TTL—one month.

AMS

ADVANCED MEMORY SYSTEMS, INC., 1276 HAMMERWOOD AVENUE, SUNNYVALE, CALIFORNIA 94086, TEL. (408) 734-4330

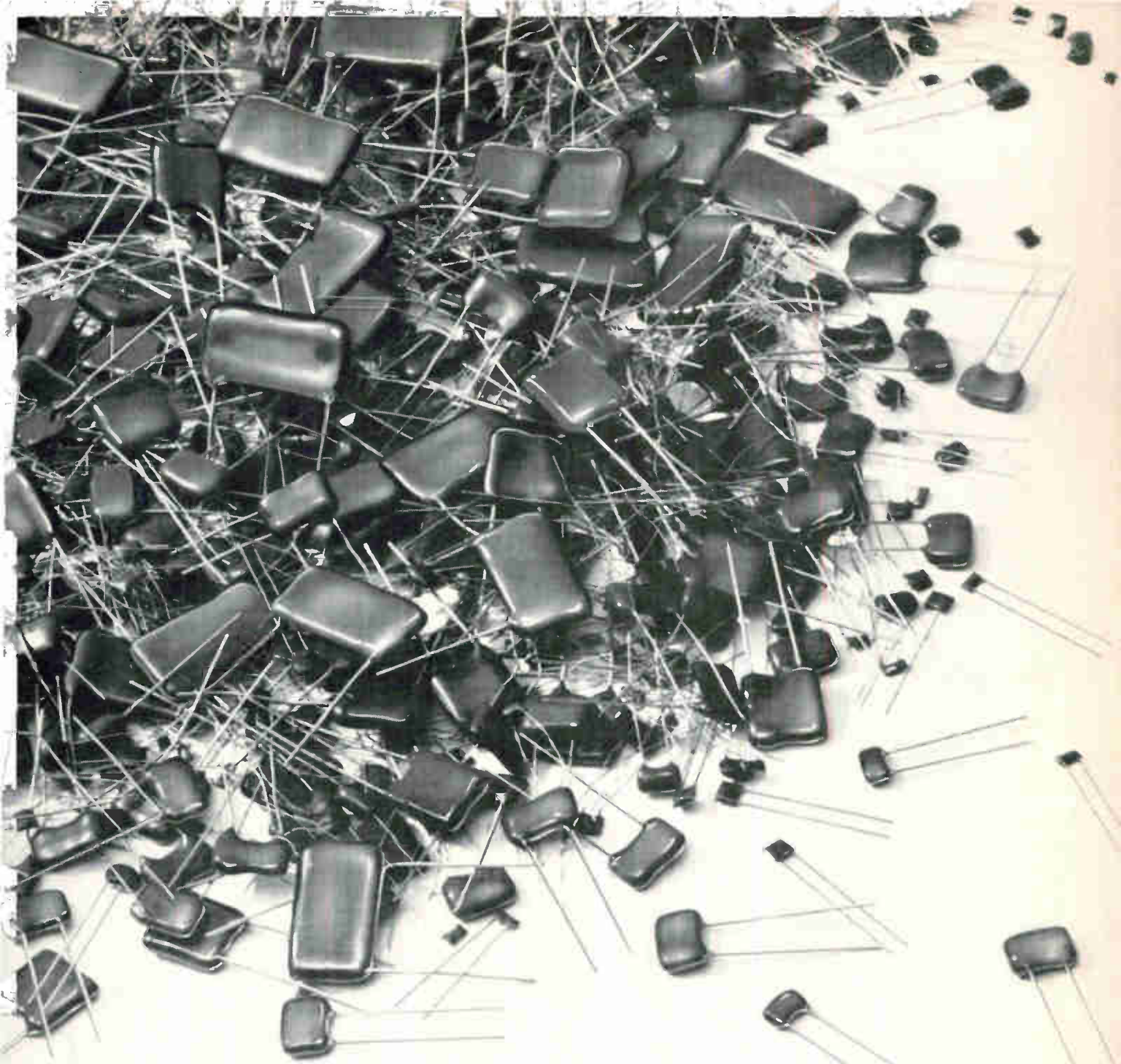

Dipped Mica by the Millions!

The greatest selection of Dipped Mica Capacitors available—from the exclusive CD6 (the smallest dipped mica in existence) through the entire range of standard mica ratings.

From the inventor of the Mica Capacitor. **CDE** CORNELL-DUBILIER



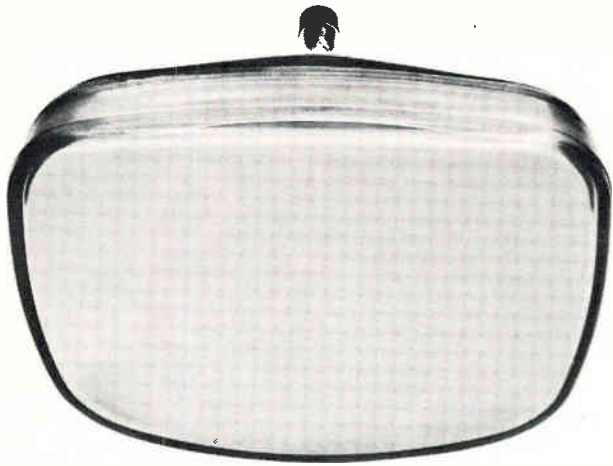

CRT Tubes—buy the components and build the display system you need.

Minimum



CRT Terminals—buy the full-scale system and get more than you need.

Maximum

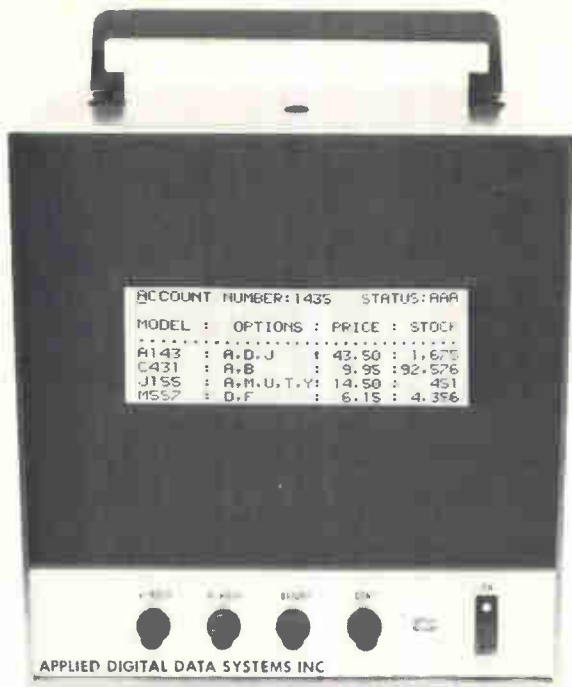

New CRT Readout—buy exactly what you need and pay less to get it.

Optimum

Announcing the MRD-200—a new, low-cost way to display alphanumeric data using TV monitors.

Now there's a practical way to read out alphanumeric data from computers, keyboards, magnetic tapes or any other sequential source.

The MRD-200 accepts ASCII data, stores it in its own memory, converts it to a composite video signal and displays it on any 525-line TV monitor. In from 32



to 1024 character positions in 1, 2, 4, 8, or 16 lines with either 32 or 64 characters per line. Data may be

displayed on any number of monitors at any number of locations with just a single coaxial cable.

Cost for an MRD-200, not including monitors, starts at \$1250.

Control features let you advance to any line or character position, blink any character or combination of characters on and off, use a cursor symbol for tracking the location of the next character, and erase all or part of the screen.

The MRD is also available in other configurations. The MRD-500, for example, can read as well as write, and has random access capability. Thus, it's ideal for custom-designed display systems.

So if you have an alphanumeric display problem in process control, test equipment, data acquisition, computer consoles or data transcriber displays, you no longer have to go to extremes.

Now there's a happy medium.

From the company that specializes in innovative data communications systems.

ADDS
Applied Digital Data Systems, Inc.

Mr. Richard Kaufman, Dept. 18
Applied Digital Data Systems, Inc.
89 Marcus Boulevard
Hauppauge, New York 11787

Please send more information about the MRD-200.

Name _____
Title _____
Company _____
Address _____
City _____
State _____ Zip _____

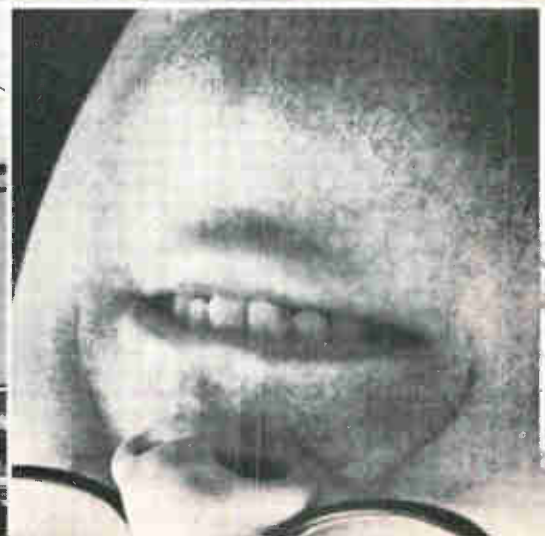
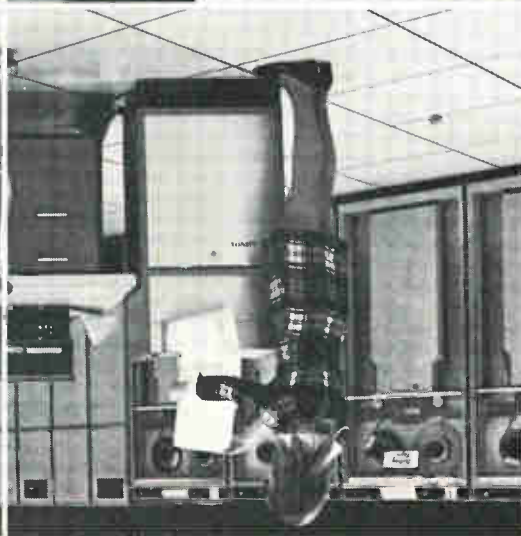
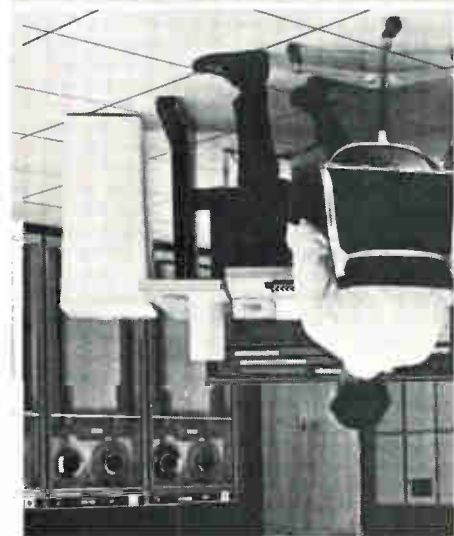
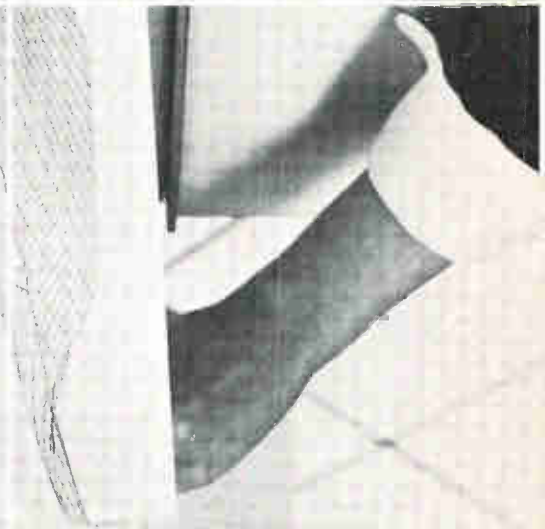
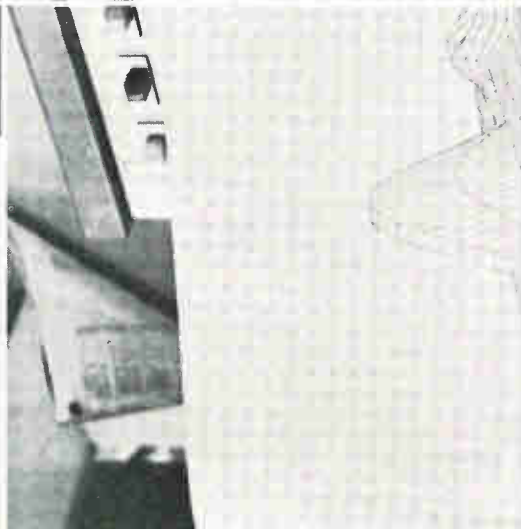
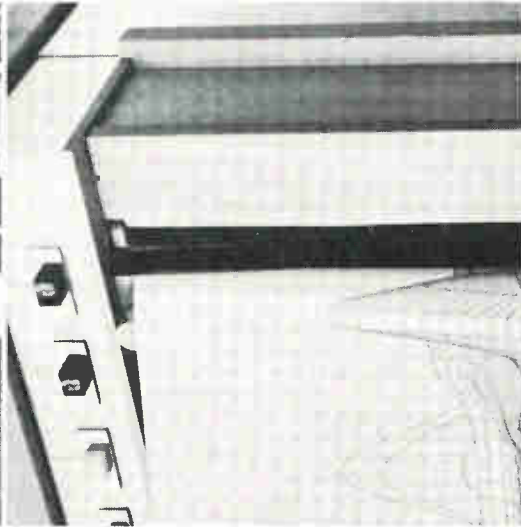
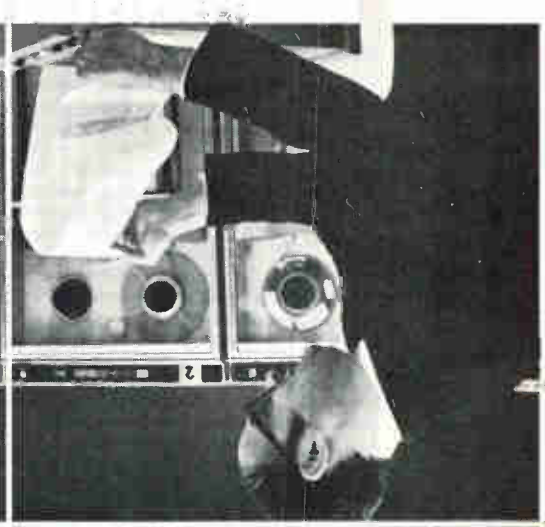
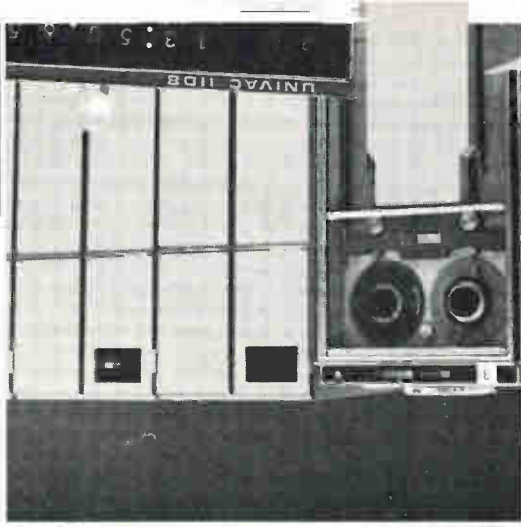

"The Clevite electrostatic printer increases our printout capability anywhere from eight to two hundred times."

That's how Mr. Stanley Y. Curry, President of Chi Corporation sums up their experience with the Clevite 4800 hardcopy printer.

A Cleveland-based computer service firm founded by Case Western Reserve University, Chi wanted a fast, versatile printer to complement its third generation Univac 1108. Chi uses its Clevite 4800 printer to perform a wide variety of highly sophisticated scientific and engineering computations, for both the university and over 100 customers currently using the firm's many services.

Here are some more of Mr. Curry's observations . . .

"We use the Clevite 4800 in three principle areas . . . text editing; intermixing text and pictures; circuit diagrams, plotting and perspective drawings. Currently, we're experimenting with applying it to our billing procedures and are exploring its use for high-speed label printing. It looks as if the printer is useful for just about any output.

"Take text, for example. The 4800 is ideal because of the speed with which it provides copies. Change, delete, add, then program the computer accordingly. Almost instantly the electrostatic printer provides a clean copy of the edited material.

"Our experience with core dump has been quite impressive. Here is an area where the printer's diagnostic

ability really comes to play. Our computer stores some four million binary bits of information, and core dumping used to take around twenty minutes. With the Clevite Printer, we're now completing a core dump in just two minutes," Mr. Curry concludes.

MORE FACTS ON THE CLEVITE 4800

Clevite 4800 reproduces signals from any source of digital input or data transmission by telemetry, radio microwave, and/or land line. It produces accurate printouts of both alphanumerics and graphics almost as fast as the computer supplies them.

A productivity rate of 412,000 characters per minute means fast-acting computers are no longer hampered by mechanical equipment, noisily hammering out a few hundred lines per minute.

No other printer gets as much out of your computer as fast as Clevite 4800. And no other printer is so economical. The Clevite 4800 reduces capital investment, because conventional equipment costs more per unit. Also, there are few moving parts, reducing the need for constant maintenance and servicing. Clevite 4800. It's faster, more versatile, quieter, and more dependable than anything else you can buy.

Drop us a line to find out how it fits into your computer room. Graphics Division, Gould Inc., 3631 Perkins Ave., Cleveland, Ohio 44114.

GOULD CLEVITE

Clevite 4800. The next generation of high-speed printers.

HELIAX ELLIPTICAL WAVEGUIDE

twelve
ways
to
beat
the
clock...

by eliminating planning and installation complications of rigid waveguide . . .

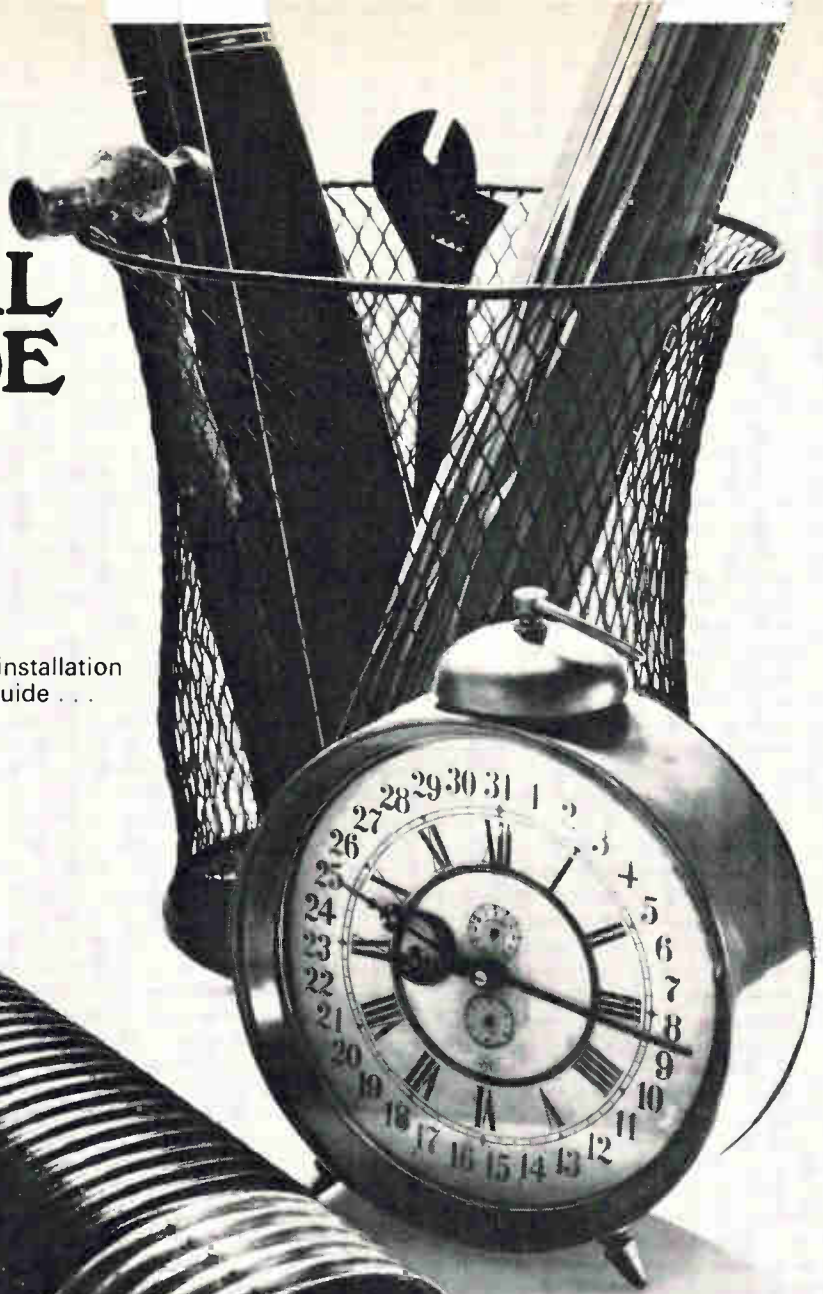

Yes, we have twelve sizes of HELIAX® elliptical waveguide for the microwave spectrum: 10 in stock, 2 more soon. Coverage from 1.7 to 15.2 GHz. Andrew's unique corrugated construction makes the difference. Makes HELIAX copper waveguide stronger, more flexible. Long continuous lengths are easily fitted to your layout. You save time and money all down the line. Wouldn't you like to know more? Communicate with Andrew.

10-68

 **ANDREW**

CONTACT THE NEAREST ANDREW OFFICE OR ANDREW CORPORATION, 10500 W. 153rd STREET, ORLAND PARK, ILLINOIS 60462
Circle 62 on reader service card

International Newsletter

January 19, 1970

Singapore lands GE assembly plant

General Electric is about to take the first step in what Singapore officials hope will become a major investment program there. The company is reported ready to open next month an electronics assembly plant employing 300 to 400 workers. First products: modules for GE radios, using both U.S. and Japanese components. All of the modules are expected to be shipped back to the U.S.

GE began gearing up for its Singapore operations few months ago when a subsidiary, General Electric (USA) Consumer Electronics (Private) Ltd., was registered, and a factory was rented from the government. Local sources expect GE to rent another plant by the end of the year for manufacturing small electric motors for appliances.

Other investments may be in the works, too, judging by the number of company executives visiting Singapore in recent months. One possibility hinges on Singapore's hopes to establish an aerospace industry on the site of the Royal Air Force bases, which will be turned over to the local government in December 1971. Lockheed already is planning a maintenance and repair depot, and the bases may become an important center for avionics and other military electronic activities.

British tv makers underestimated surge in color-set sales

Demand for color television in Britain is outpacing all expectations. When color broadcasts were extended from 35 to 100 hours per week in November, everybody expected sales to take off, but not nearly as fast as they have. Color set sales, which averaged only 7,500 monthly from January to August last year, leaped to 17,000 in September and averaged nearly 26,000 monthly during the last quarter of 1969. Current production capacity is likely to keep deliveries at this level through the next few months; waiting time for popular sets averages three months.

The boom is causing many makers to revise their plans upward. Thorn Colour Tubes Ltd., which splits the color tube market with Mullard Ltd., will build a new plant, doubling present capacity to 300,000 tubes a year. Thorn is owned by Thorn Electrical Industries, a major British tv set maker, and RCA. The new plant, costing \$25 million and incorporating RCA's latest production-line techniques, follows closely Thorn's plans for a third receiver assembly plant, devoted exclusively to color sets, which the company decided to build in December—after the boom began.

Siemens to expand computer activity

Siemens AG, after a decade of trying, is now West Germany's No. 2 computer maker—and shows every sign of hanging in as IBM's chief competitor in that nation. After several lean years following its 1959 entry into the computer business, Siemens is chalking up big sales both at home and abroad. It has in 10 years installed or received orders for about 800 systems worth nearly \$410 million. What's more, at least one out of every four computer orders placed by first-time users in Germany this year will be for a Siemens machine.

Although much of its success in the last few years is due to a five-year-old agreement with RCA—under which Siemens is building its 4004 series using Spectra 70 technology—fully 10 of the 16 computers Siemens offers are based on in-house development work. In a move to

International Newsletter

further strengthen its position, Siemens is planning a huge data processing center on the outskirts of Munich. The installation, which reportedly will cost \$140 million, will consolidate sales and service, research and development, and other related activities in data processing. The center, to be started this summer, initially will employ 8,000 people and about 15,000 eventually.

French atomic lab develops low-drift MOS-bipolar preamp

France's Atomic Energy Commission, faced with the need to measure currents as weak as 10^{-14} amps in nuclear reactors, has developed a differential MOS preamplifier with a temperature drift of less than 40 microvolts/ $^{\circ}$ C. Using MOS technology in weak-current measurement presents an impedance problem, which designers solved by combining the IC's seven MOS transistors with two bipolar transistors. The circuit thus has an input impedance of more than 10^{18} ohms and an output impedance of 700 ohms.

More than 400 prototypes have been ordered by various laboratories of the 30,000-man organization. Its Grenoble Laboratory will sell prototypes to all comers at about \$25. There are no serial manufacturing plans at present, but the laboratory hopes to eventually license production to a private company. The circuit also shows promise in analog memories, say its developers, because the high input impedance permits charging an input capacitance, which gives analog storage of the input charge.

British compatible pushbutton phones start to sell

It's still a year before the British Post Office will decide which way to go on pushbutton telephones. It is looking at both integrated circuit-equipped subassemblies that are functional equivalents of a regular telephone dial and at voice-frequency circuits that require changes in central office equipment, but offer extra capabilities.

One company—the Telephone Manufacturing Co.—has decided not to wait for the government to make up its mind. Instead it started volume production of its pushbutton phone system, gambling that early production would give a big jump on the competition and open new markets. The gamble has paid off. TMC, a Philips subsidiary, has just landed a contract for \$380,000 from the Hong Kong Telephone Co., which ordered several thousand units.

TMC's phone uses an integrated circuit as a functional equivalent to the conventional circular dial. General Instrument-built MOS chips generate 10 or 20 pulses per second. Although that is slow, it means the phones are directly compatible with existing switching office gear; as far as the switching office can tell, dial and pushbutton phones give the same signals.

Yamaha to make Philco-Ford IC's

Philco-Ford, which lays claim to manufacturing one-third of the IC's imported by Japan, is making further inroads into the Japanese market. It is reported in Japan that U.S. firm has concluded a \$5 million licensing deal with the Nippon Gakki Co., better known as Yamaha. In addition to providing Yamaha with MOS licenses, Philco-Ford is giving technical assistance to help the Japanese company set up production. Initially, Philco-Ford will supply Yamaha with circuits, which it will use in its line of electronic organs.

Plated-wire memory tapped for Japanese telephone system

Costs kept down to 2.5 cents per bit by five layers of plating, ribbons of plated wires and economical use of peripheral circuits

An electrically alterable semipermanent memory for telephone electronic switching systems has been developed at the Nippon Telegraph and Telephone Public Corp. Instead of metal punched cards or magnetically encoded cards to alter infrequently changed information, such as subscriber addresses or phone numbers, the new memory needs only an electric signal.

Although the unit resembles other plated wire memories, the company's development team—headed by Sachinobu Shimizu—had to keep costs down to levels competitive with other telephone memory systems. By using five layers of plating on the digit wires, ribbons of plated wires, sharing of sense amplifiers and limited peripheral equipment, a total memory cost of 2.5 cents per bit is possible even if only 20 million bits per year are made. Of this, only about 0.3 cents is the cost of the actual memory, the remainder being the cost of the peripheral circuits. Higher volume resulting from using the memories for other applications might bring the total price down to 1.4 cents per bit.

Nippon Telegraph and Telephone will use the new memories in the upcoming DEX-21 electronic exchanges, which is an improved version of the DEX-2 and will be the first type to be installed for commercial use in Japan.

Layered. Combination digit and sense lines in this memory consist of 0.1 millimeter diameter beryllium-copper wires plated with five layers of magnetic material. The first, third and fifth layers are permalloy with a thickness of 2,500

angstrom units. The second and fourth layers are nickel-cobalt with a thickness of 600 angstrom units. The low-coercivity permalloy is a soft magnetic material, while the nickel-cobalt layer is hard. The effect of a strong magnetic field during plating is an easy magnetic axis around the wire, and a hard magnetic axis along the wire.

The plated digit lines are attached to the plane perpendicularly to the word lines. To facilitate fabrication of the planes the digit lines are sandwiched between a layer of polyester tape and a layer of polyethylene tape and compressed under heat to form a laminated cable. Each word has 33 bits; but, since some spares are required—there is no way to repair a completed assembly—each laminated

cable contains 72 parallel pairs of plated wire. There are two cables side-by-side on each plane, so that 288 bits are under one word line.

Eight of these planes form one module. The laminated cable digit lines are continuous for all eight planes and greatly simplify fabrication by eliminating interconnections. In the eight-plane module there are a total of 270,000 memory bits, not counting spares. Four of these modules are enclosed in one standard telephone rack to give a memory capacity of 1,080,000 bits, or about 33,000 words 33 bits long. The remainder of the rack is taken up by peripheral and power supply circuits.

Although a telephone exchange might have a number of these memory racks, a single rack for writing

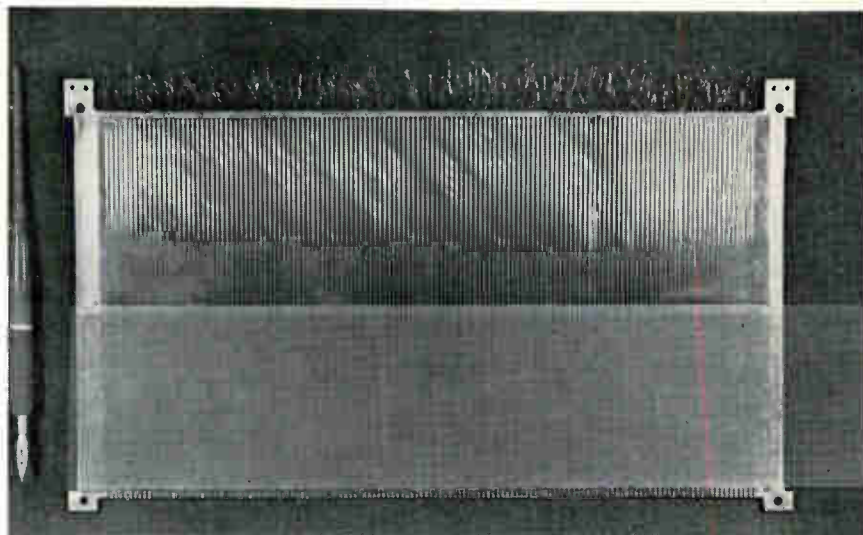

Beribboned. Plated wires laminated in plastic run across five-turn word lines. When several planes are clamped together, ribbon is held rigidly between planes, keeping magnetostrictive effects low. Loops of ribbon linking different planes serve as simple interconnection wires.

would be sufficient because writing is needed only intermittently, and thus circuits could be shared. Writing is one word at a time; but, if necessary, all million bits in a rack can be rewritten in less than four seconds, one word at a time. Although contents of this memory are sensitive to electrical changes, tests show that stored information can be read more than 10^{11} times without deterioration. Life tests of the memory planes show that at 40°C expected physical life of memory plane components is 100 years.

Makes sense. Readout cycle time of the memory is 1.4 microseconds. Access time is just 0.7 microseconds. During readout a 270-milliampere current with a rise time of 160 nanoseconds is impressed on the selected word line. To reduce the word drive current to this convenient value, a five-turn word line is used. A one-turn ribbon word line with drive current in excess of 1 ampere has also been tested, but makes for more expensive peripheral circuits. The word drive current induces a voltage of about 11 millivolts into the digit lines. This is more than is needed, and it is possible to simplify the memory by sacrificing some of this voltage.

Rather than providing sense am-

plifiers for each of the four memory modules, only 33 sense amplifiers are provided in each rack. Digit lines on two modules are connected together in pairs. Selection between words in a given pair is by word drive, and the desired pair is connected to sense amplifiers by low-level selectors. When two modules are paired, half the output voltage is wasted in the unselected module in parallel with the selected one. Thus, the available output voltage is only 5.5 millivolts. Tests have shown that even for worst-case variations in current during writing and reading, operation at temperature extremes, worst-case strobe timing for sense amplifiers, and degradation from 20 years' use, the output voltage for even the poorest crosspoints will exceed 2 millivolts.

Great Britain

Camp followers

As more and more devices are squeezed on to an integrated circuit chip, more and more holes have to be cut in the master masks. The holes are basically simple shapes and sometimes a high pro-

portion are repeated many times, but cutting has to be done very precisely. A minor error in one of the later holes can write off a week's work.

Consequently, most mask cutting is now done with tape-controlled cutters, which eliminate human error from the cutting if not from preparation of the tape. What's more, computer operation is a lot quicker so devices get to the customer faster.

To get faster turn-around, three British-owned IC makers—Marconi-Elliott Microelectronics Ltd., Plessey Co., and Ferranti Ltd.—are using computer methods to make the cutting tape itself.

Though each has its own particular techniques, all use a language and compiler program developed at the Royal Radar Establishment for digitizing mask dimensions and processing them in a computer to produce a tape that can be fed straight into a cutter. RRE's system is known as CAMP, for computer-aided mask production. It's been two years in development, was first tried out a year ago, and is now pretty well bug-free, says John Wood, its main developer.

Four points. CAMP exploits four redundancy characteristics of mask patterns. First, all hole shapes are really straight lines and circles, which can be easily defined. Second, most holes have slides parallel to the x and y axes. Third, many masks, particularly MOS, have hole patterns repeated many times, sometimes with the same perspective, sometimes rotated or reflected. These shapes need be detailed only once, after which they can be called up by giving them a name, and adding a repeat, rotate or reflect instruction. Fourth, whole circuit sections are often repeated, and can be treated as repeated shapes. This principle can be extended, so that commonly repeating shapes and circuit sections—such as a standard transistor geometry—can be stored in a library and called up as required.

When CAMP was first tried out, the circuit designer transformed his completed multiple mask layout drawing into CAMP language manually. That is, he divided his

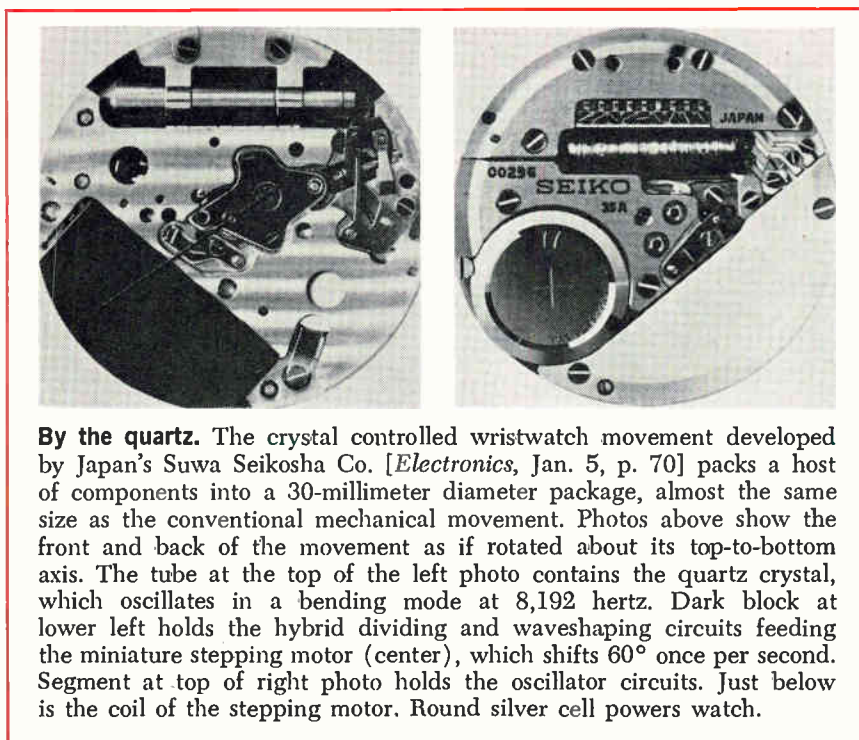

By the quartz. The crystal controlled wristwatch movement developed by Japan's Suwa Seikoshi Co. [*Electronics*, Jan. 5, p. 70] packs a host of components into a 30-millimeter diameter package, almost the same size as the conventional mechanical movement. Photos above show the front and back of the movement as if rotated about its top-to-bottom axis. The tube at the top of the left photo contains the quartz crystal, which oscillates in a bending mode at 8,192 hertz. Dark block at lower left holds the hybrid dividing and waveshaping circuits feeding the miniature stepping motor (center), which shifts 60° once per second. Segment at top of right photo holds the oscillator circuits. Just below is the coil of the stepping motor. Round silver cell powers watch.

layout into polygons, rectangles, circles, and part-circles and noted which shapes and groups of shapes were identical so that they could be partially lumped together in the instruction list, and he punched out his list in CAMP on a teletypewriter.

For a polygon he would punch in "poly," followed by a number in brackets to indicate which mask the polygon was on, followed by the letter "s" if all sides were parallel to the axes, and then the absolute coordinates of one corner followed by the length of each side with or without a minus sign to indicate direction. Rectangles, which are common, had an abbreviated code.

Thereafter, wherever a shape was repeated, he had only to punch in the identifying letter of the polygon and enter the locating coordinates, with a code indicator for any variation, such as "rotate through 90°." Similar action handled groups of shapes, and patterns held in the library. The tape would then be run through the computer with the CAMP compiler to produce the cutter tape.

Labor saver. But every coordinate still had to be read off the grid paper and punched in by hand, so the companies have inserted coordinate digitizers between the layout drawing and the computer. According to Plessey, cutting tape for a big mask that might take two weeks to prepare without CAMP can be prepared in two days.

In the computer, the tape is read, checked for errors, and stored on temporary file. When it's required, the layout description is transferred to the core store, the library group definitions are read in at the proper places and the categorized shapes read in fully. The resulting data structure is then compiled into a list of coordinates of corners, and transferred to a disk store.

Post-processors turn the disk contents into a tape that can be run through two types of automatic drafting machines, a microfilm plotter and a crt display, so that the tape can be checked and modified if necessary. The Contraves drafting machine tape used in the system is also suitable for automatic cutting, because the Contraves cut-

ter, the one RRE has, is in effect a drafting machine modified to take a cutting head instead of a pen. Plessey, Ferranti, and Marconi-Elliott use either RRE's cutter or service bureau cutters, but all will soon have their own.

Because CAMP is a joint project—the Philips subsidiary Mullard Ltd. and the ITT subsidiary STC Semiconductors Ltd. have also contributed to it, though presently they don't use it, preferring to develop their own systems—nearly all the program is written in machine-independent Algol and is easily translatable from RRE's Elliott computer to other computers. RRE has translations to ICL 1900 and Burroughs 5500 computers. CAMP will cope with up to 23 masks at a time, and needs 32-K of memory to cope with current complex masks, though 24-K will do for simpler IC's.

Argus-eyed

A Briton in the market for a small, cheap computer can now "Buy British"—and have a choice. Until now, U.S.-owned companies have had a virtual monopoly of the British market for computers costing, say, \$5,000 dollars with 1K of memory or \$10,000 with 4K. Small independent companies have been formed to promote native designs, but so far only one of these newcomers has actually delivered a computer [*Electronics*, Oct. 13, 1969, p. 205].

Now Ferranti Ltd., one of the three big British computer makers and oldest established in process control, has jumped in with a new machine, the Argus 600. Using 1K memory blocks expandable to a maximum of 8K, it features TTL processor logic and an 8-bit word. A slim instruction code of 17 functions and restricted arithmetic—9.2 microseconds add time—and subroutine capabilities mean that it's essentially a controller and data gatherer, not a data processor.

In its simplest configuration—processor and 1K of store for building into a larger system—price is just over \$4,000. With monitor panel and teletypewriter drive, it

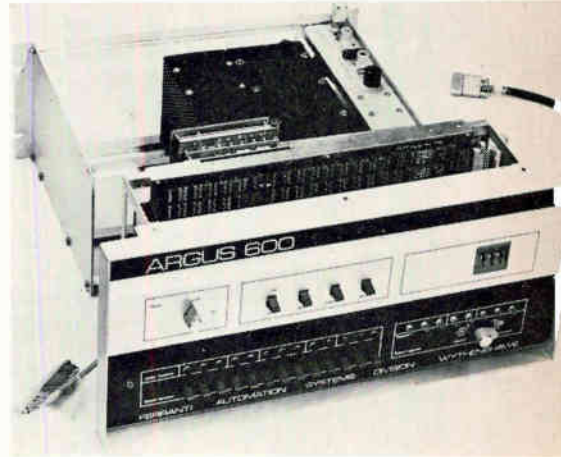

Watchful. Aimed at data gathering and control, computer starts at \$4,000.

meets the opposition's price—\$5,540—but has the advantage of big company backing.

Sales target. Ferranti is aiming mostly at industrial process system builders who need an on-line small-scale controller or a time-sharing data gatherer serving a large remote data processing computer. Because the company is well-established in industrial computer control, volume production will help it supply off-the-shelf units for data loggers, sequence controllers, and direct digital controllers, replacing equipment currently custom built. In the data gathering field the company will be entering new territory, but has sold one already—to a bank—for time-sharing the telephone link between a big central computer and branch peripherals, where speed is not a prime essential.

The way Ferranti looks at it, the present need is for a small machine that can be very simply programmed. Hence the limited instruction code. This means that programming tends to be longwinded but it can be done, claims the company, by a complete novice. "We designed the code so that a normally intelligent graduate engineer can sit down with the programming instruction manual, and within a week start to write his own programs," says Mike Eyre, design engineer with Ferranti's Automation Systems division. "Basically, the code's not unlike a simplified PDP-8 code," he says.

To strike a balance between cost

and speed, the company designed a machine that could gather data with three 1200-bits-per-second data lines, or monitor 32 three-term control loops once per second.

Ferranti uses Mullard-built core-store modules with 4-microsecond cycle time, and 14- and 16-lead TTL logic packs, MSI where possible. All the logic is mounted on a single board, which fits the monitor panel, controls, interface, and power supplies into a 19-inch rack. The input/output interface logic is DTL for compatibility with the company's larger Argus computers and established peripherals. If only 1K of memory is used, the module attaches to the rear of the frame. If more is used, a separate rack is required.

Central America

Missing link

Five Central American countries, whose only direct communication with each other is by telephone, will have an all-purpose microwave network in operation by mid-1971.

The five countries—Costa Rica, Nicaragua, Honduras, El Salvador and Guatemala—currently only have direct telephone communications via vhf. Telegrams, teletype messages, and other communications have to be sent by radio to New York, then relayed back to the receiving country.

The wide band, 960-channel network will transmit telephone, telegraph, teleprinter, tv and computer data signals directly, and allow direct dialing of telephone numbers throughout the zone.

A contract for \$8.5 million was recently signed with Japan's Nippon Electric Co. to install 31 repeater stations, equipment, buildings, and roads. Still to be let is a contract for five switching centers, one for each capital. Bids will be asked for sometime in the next two months. As in the case of the microwave network, the contract will probably go to one company so as to make the equipment uniform throughout the zone. Total

cost of the system, including the microwave network, will be around \$15 million.

The five countries make up the Central American Common Market, an organization designed to stimulate trade and industry through free intrazonal trade and other measures. The market's Central American Bank of Economic Integration is financing the communications project.

The project is being directed by the Comisión Técnica Regional de Telecomunicaciones, a zonal organization created by a special treaty in 1966. Coordinator for the project is Antonio F. Cañas, an electronics engineer and submanager of the Instituto Costarricense de Electricidad, Costa Rica's state-owned communications company and electrical utility.

Net value. All microwave equipment will be solid state and will have a 1-watt output at 4 gigahertz, with an input of 45 watts. Power will come from local power lines, when available. In the absence of powerlines, the mountain-top repeaters will be equipped with three 8-kilowatt generators one for daytime use, one for night and one standby unit.

The generators' a-c output will

be rectified to d-c and fed to batteries, which will provide the operating power of 48 volt d c. If all three generators fail, the batteries will keep a station operating for up to 24 hours so that repairs may be made.

In addition to providing direct communications between the five countries, the system will also give Central America a direct link with the U.S. via Mexico's microwave network. It will also allow direct lines with Europe and South America by Satellite, through an existing ground station in Panama, which is not a member of Comtelca.

Comtelca had planned to build its own ground station for satellite communications in Honduras, approximately in the center of the zone. However, last summer's war between El Salvador and Honduras has stopped this project for the foreseeable future. The war also set back the microwave project a few months, as it was originally scheduled to go into operation at the beginning of 1971.

"This system should give a big boost to our common market," says Cañas. "Not only will we offer services which are not now available, but we will be able to lower tariffs on existing services."



Hot line. Directly dialed telephone calls, as well as tv signals and data communications, will course down Central American microwave net.



25 years in the thick of it



Centralab introduced thick film technology in 1945.

The result — microcircuits with superior design and performance today.

No one offered thick film microcircuitry as a serious answer to reliability and miniaturization requirements 25 years ago. But Centralab got right into the thick of it. And it's difficult to catch someone with a 25 year head start. In numbers alone our lead is commanding. We've produced more than 500,000,000 units, with some 5,000 custom designs. No one can approach this production record. In material selection our experience again gives us a sharp edge. Ceramics, metallizing compounds, resistor inks, glaze and sealing materials have all been

specially developed by Centralab's Material Sciences Group to our specifications for durability in processing and application. The Semiconductor Division is a ready source for a wide variety of chips. We even manufacture our own ceramic substrates through an exclusive thin sheet process that is superior to any other method in the industry. And our computer-aided analysis service provides prompt, practical answers to circuit design problems. We don't mean that thick film chip hybrids are the answer to every problem in microcircuitry.

But you'll be surprised at how many solutions these low-cost custom units provide. For more information on how you can get into the thick of it with Centralab, turn the page.

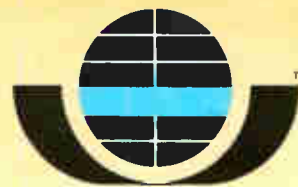

CENTRALAB

Electronics Division
GLOBE-UNION INC.

5757 NORTH GREEN BAY AVENUE
MILWAUKEE, WISCONSIN 53201

1945-1970

A quarter century of technology on your side



First use of Centralab's thick film microcircuit

Centralab pioneered thick film microcircuitry in 1945 when we developed a miniature oscillator-amplifier circuit for a mortar shell proximity fuse. This first-of-a-kind unit, admittedly crude by today's standards, consolidated carbon composition resistors, silver-ceramic capacitors and silver circuit paths screened onto a ceramic substrate, which met tough shock requirements. The completely sealed unit was about 3 inches in diameter and 4 inches long.

carbon composition resistors, silver-ceramic capacitors and silver circuit paths screened onto a ceramic substrate, which met tough shock requirements. The completely sealed unit was about 3 inches in diameter and 4 inches long.



100,000,000th microcircuit

This assembly, which became known as a Packaged Electronic Circuit (PEC), opened the door to an entirely new technology. By 1959, we had produced our 100,000,000th unit. A plaque commemorating this historic production is on permanent display at the Smithsonian Institute, a milestone in the electronic industry.

PECs are still being used extensively for industrial, military and consumer applications. But continued technological developments have brought a new degree of sophistication to the art of thick film microcircuitry. So we've developed our new thick film chip hybrid microcircuits. Chip active devices — diodes, transistors, and ICs — are combined with fired on resistors, wiring and capacitors to provide a reliable circuit module. These are smaller, harder working, more sophisticated devices that are custom designed for specific applications.

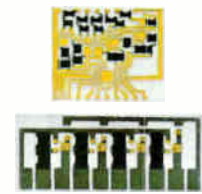

Centralab's new thick film chip hybrid

We're uniquely qualified to provide thick films because our 25 years of experience have given us an intimate knowledge of materials, technology, design, production and service. Following, in more specific terms, is what we mean:

Materials to service: The Centralab capability

Basic to the ultimate performance of thick film chip hybrid microcircuits is the evaluation, selection and development of materials that will withstand sophisticated manufacturing processes as well as demanding applications. The Centralab Material Sciences Group of specialized technical personnel determines what materials will best support the special requirements of our design and production facilities.



Materials developed specifically by Centralab

One example of the work of this group is the ceramic substrate used in our thick film circuits. To meet design parameters for maximum thermal conductivity and mechanical strength, as specified by our engineers, an exclusive thin sheet ceramic production process was developed that produces substrates of unexcelled surface finish and reliability. These are so superior to others available, that Centralab is a leading supplier to other microcircuit manufacturers. Our ceramic capability has also provided high performance hermetic packages.



Centralab substrates and packages

Another joint effort of our materials and engineering development personnel resulted in a monolithic chip capacitor (Mono-Kap) that has virtually eliminated pin holes that destroy capacitor reliability and long life.

Micrographs of Mono-Kaps and competitive units

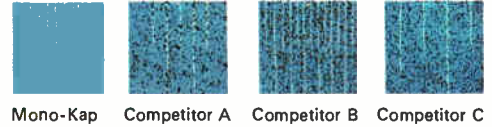

Mono-Kap Competitor A Competitor B Competitor C

We've also produced molybdenum/gold substrates with amazingly complex pattern geometry. These substrates, and our proprietary process (patent applied for) for producing them, permit thicker gold deposits and are ideally suited to ultrasonic and thermocompression bonding methods.



Molybdenum/gold substrates

Our computer-aided design and circuit analysis services can provide optimum design to minimize failures, enhance performance, and reduce cost. Our comprehensive thick film background gives us another head start in being able to program our computer so that improved design is assured at the most reasonable cost.

All of our experience and technological skills are reflected in the design and production of Navy Standard Hardware Modules. These plug-in modules combine circuit functions to constitute a complete electronic system that is reliable, flexible and economical.

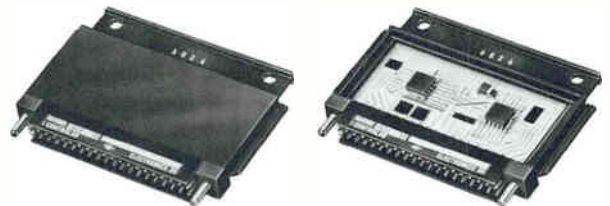

Navy Standard Module

One more thing. With all our capabilities, we realize that speed is often the most important criteria for judging a thick film microcircuit manufacturer. That's why we are geared to provide production samples to your specifications in as little as three weeks; production quantities eight weeks after prototype approval.

It all adds up to one fact: No other manufacturer is better qualified to help you find the most efficient use of thick film chip hybrids in your circuit design. And if you'd like to find out precisely how we can help you, send your requirements or circuit design to Centralab Application Engineering. There's no better way to get into the thick of it.



CENTRALAB

Electronics Division
GLOBE-UNION INC.

5757 NORTH GREEN BAY AVENUE
MILWAUKEE, WISCONSIN 53201

Washington Newsletter

January 19, 1970

DOD's Laird demands bigger economies . . .

Although the first Nixon budget does not go to Capitol Hill until Jan. 27, firm intelligence is developing on fiscal 1971 spending plans and priorities. Defense Secretary Laird, for example, has tipped the press that the Pentagon request will be cut substantially more than another percentage point of the Gross National Product. That would bring it from 9% to less than 8%, with the goal 7% [Electronics, Nov. 24, 1969, p. 63].

Though this could bring the Pentagon's total obligational authority down to somewhere between \$70 billion and \$72 billion, it would put new obligational authority—the figure industry reads to get a handle on where new funds will be committed—to about \$63 billion.

The driving force behind much of the reduction in the spending level is Deputy Defense Secretary David Packard, who takes a hard-nosed approach on weapons hardware, demanding that the military subordinate enthusiasm for blue sky technology in favor of systems that can be rapidly deployed and easily maintained with service personnel.

. . . but wants more for Safeguard ABM

A forthcoming recommendation by Secretary Laird and Deputy Secretary Packard to accelerate development of the highly controversial Safeguard antiballistic missile system, coupled with the threat to go forward with other strategic systems—the B-1A bomber and Navy's Undersea-Launched Missile System—at first appears inconsistent with the Defense Department's planned economies. Too, the recommendations—especially Safeguard—are sure to generate much heat in Congress. But, excepting Safeguard, Washington insiders categorize Laird's proposals as political talk rather than 1970 engineering realities. The B-1A and ULMS systems are viewed as vulnerable to strategic arms negotiations with the Soviet Union, and likely to be kept in a holding pattern unless such talks prove fruitless.

But Army's Advanced Ballistic Missile Defense Agency at Huntsville, Ala., is already proceeding with a study on a Safeguard variation called Coastal Antisubmarine-Missile System, which it hopes to contract within two months. Where does the Defense Department expect to find new funds for Safeguard and other strategic programs? It looks for about \$6 billion in savings from Vietnam as costs there drop from more than \$23 billion to about \$17 billion in fiscal year 1971, plus a few hundred million dollars from cuts in domestic civilian and military manpower.

People problem grows at Defense Dept., too

More evidence that the Administration means business when it says it will balance the fiscal 1971 budget is reflected in memoranda being sent by Washington electronics industry representatives to corporate offices. Under the gun to compete for a diminishing number of new contracts and thus limit layoffs, an official of one major company wrote home that "Washington's got a people problem, too." The Defense Department is expected to drop about 73,000 civilians this year; the first 10,000-man cut already has been disclosed. The total could rise to 150,000 by July 1971—about half the number of defense industry job losses projected for the same time frame. Government reductions in civilian staff are over and above an anticipated military manpower cut of a quarter-million people.

Washington Newsletter

Will Hickel handle pollution control?

Consolidation of widely disbursed government activities in pollution and environmental problems under one Federal authority is under consideration by the Nixon Administration, with the most likely choice an expansion of Secretary Walter Hickel's Interior Department into a Department of Natural Resources.

President Nixon is preparing to make a "substantive commitment" to pollution R&D in his first State of the Union address this month [*Electronics*, Dec. 22, p. 61] and undoubtedly would like to see environmental activities consolidated under a single management. In return for HEW's air pollution and solid waste disposal activities, Interior would turn over its Bureau of Indian Affairs to HEW.

NASA to push second Workshop

Look for NASA to put forth some strong arguments for flying a second Workshop in 1974, now that Philip E. Culbertson has been named director of the Advanced Manned Missions Program. The Workshop, basically an experimental space station, has received most of Culbertson's attention since May 1967, while he was director of project integration for the Apollo Applications Program. He joined the agency in 1965 as director of Manned Lunar Missions from General Dynamics/Convair where he had held key aerospace positions for 11 years. Culbertson, 44, now will direct the long-range planning for manned space flight.

And if the budget-balancing Administration doesn't okay another Saturn 5 rocket to launch the second Workshop, expect a second Apollo landing to be scrubbed—as was Apollo 20, to use its launch vehicle for the first Workshop.

Safety group to list fire-prone color tv's

Listings by maker and model of fire-prone color television receivers are set for publication Jan. 26 by the National Commission on Product Safety. The action is scheduled to come after some tough face-to-face discussions with manufacturers a week ago to discuss Government studies of which sets are potential fire hazards. Industry and the NCPS are upgrading standards which a Tracor Inc. study contends are not good enough. As for tv receiver emission of X-radiation, manufacturers began on Jan. 15 to label sets meeting maximum allowable Federal emission standards [*Electronics*, Jan. 5, p. 34].

IBM plugs, unplugs a '4th generation'

An IBM computer package dubbed FS-4 within the company's Federal Systems division at Gaithersburg, Md., was scheduled to get its first reading at the IEEE computer group conference that opens in Washington June 16. But no longer. Asked about the paper, IBM officials said it has been withdrawn, called its inclusion in a preliminary program schedule "premature," and asked, "Are you calling it 'fourth generation'?" Sources suggest the FS-4 may be a modification of the IBM 4 Pi airborne system, which never really flew.

AF due to cut off F-111 production

Cancellation of the remaining Air Force buy of General Dynamics Corp.'s controversial F-111 swept-wing fighter is expected soon. After Sen. McClellan (D., Ark.) announced another round of hearings this session on the trouble-ridden aircraft, Secretary Laird disclosed that internal USAF reviews might lead to the program's cancellation.

In a world that offers a million different connectors, who needs 7 more?

We don't want to complicate your life.
We want to make it easier for you.

And we think these 7 printed circuit
connectors are just the ones that can do it.

Each one started as a special order for a
customer like Univac, Automatic Electric,
or Mohawk. Each had so many possibilities
that we got permission to make them for
everybody.

So here's the biggest little line of connec-
tors in the business. Utterly unique, not
available as standard items anywhere else.

216-pin, 8-position

196-pin, 2-position

44-pin, 1-position

27-pin, 1-position

220-pin, 5-position

All connectors are made with our famous
welded gold-dot contact design that puts
gold only where it's needed, yet holds
contact resistance below 5mV drop
at 5A.

Until recently, you couldn't
buy off-the-shelf connectors
like these for love or money.

You still can't buy them
for love. Sylvania Metals &
Chemicals, Parts Division,
Warren, Pennsylvania 16365.

98-pin,
1-position

40-pin, male-connecting module

SYLVANIA
GENERAL TELEPHONE & ELECTRONICS

we're not only first in hybrid ICs... we're also second...

| | | | | |
|--------------|----------------------|------------------------|-----------------|----------------------|
| | } | power buffer | NH0002 ≡ NC0002 | |
| | | NH0002C ≡ NC0002C | | |
| NSC | | MOS clock driver | NH0007 ≡ NC0007 | |
| | | NH0007C ≡ NC0007C | | |
| | | two phase clock driver | NH0009 ≡ NC0009 | |
| | | NH0009C ≡ NC0009C | | |
| FSC | | lamp relay driver | SH2001 ≡ NC2001 | } GENERAL INSTRUMENT |
| | | SH2001C ≡ NC2001C | | |
| Westinghouse | | voltage regulator | WC109T ≡ NC109T | |
| | | | | |
| Amelco | JFET analog switches | 2126BG ≡ NC2126 | | |
| | 2137BF ≡ NC2137 | | | |
| | 2114BF ≡ NC2114 | | | |
| | | | | |

General Instrument was the first to manufacture hybrid microcircuits. Since that time, some ten years ago, while others have entered the field, General Instrument has maintained its no. 1 position by providing not only the broadest, but the most advanced line of hybrid ICs available.

As a second source too, General Instrument is no. 1, in making available exact pin-for-pin replacements for some of the more popular hybrids being produced by other manufacturers in the field . . . such as those listed.

The above General Instrument hybrid ICs are immediately available from your authorized General Instrument Distributor.

For full information write, General Instrument Corporation, Dept. H, 600 West John Street, Hicksville, L.I., N.Y. 11802. (In Europe, write to General Instrument Europe S.P.A., Piazza Amendola 9, 20149 Milano, Italy; in the U.K., to General Instrument U.K., LTD., Stonefield Way, Victoria Rd., South Ruislip, Middlesex, England.)



our products
have been to
the moon
too!



EAGLE FOLLOWS YOU THE WORLD AROUND

World-wide . . . that's Eagle. Specify Eagle machine and process controls for your equipment and you can be assured of on-the-spot service and replacement units whenever you need them, wherever your equipment goes! A stock of more than \$1 million in Eagle time/count controls, control relays and precision potentiometers is waiting to serve you now . . . including the U.S.A., Canada, South America, the United Kingdom, Europe and Australia.

Insist on Eagle . . . Where the state of the art
is the standard of the industry



Eagle Signal

a systems division of
GULF + WESTERN INDUSTRIES, INC.
736 Federal/Davenport, Iowa 52803

Three **new** reasons to specify

D I G I E C



Model 262

Digital Multimeter

(AC, DC, Ohms)

A .1% Multimeter for everyday usage. A necessity for design and development, production, quality control, or anywhere that DC volts and current, AC volts, and ohms are measured. Battery pack available.

\$375



Model 311

Precision Calibrator

(Voltage & current source)

A .01% precision voltage and current Calibrator that serves as a working standard. In addition, the high current capability may be used as a lab source for developing those critical circuits so essential in electronics today.

\$650

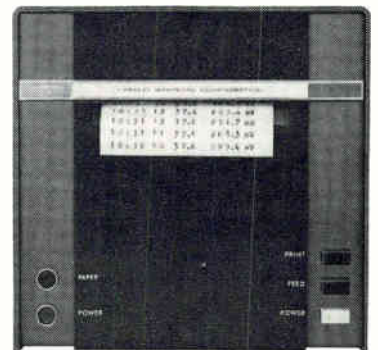

Model 691

21 Column Printer

(3 lines per second)

A Drum Printer which is expandable from 4 to 21 columns to satisfy your specific requirements. This versatile printer accepts all standard BCD inputs and provides 38 symbols along with "floating" decimal point.

starting at **\$770**

D I G I  E C

by **UNITED SYSTEMS CORPORATION**

918 Woodley Road • Dayton, Ohio 45403 • (513) 254-6251
Representatives Throughout the world

For complete specifications
request new catalog D69A



Solid state displays

The MAN 1 is a seven-segment light-emitting all-semiconductor alpha-numeric readout.

Put the attention-demanding red light from electrically excited GaAsP to work in your digital displays for industry, computer peripherals, or avionic/marine instrumentation. Our MAN 1 is shock-resistant and long-lived. Offers styling advantages because it's flat, parallax-free and visible within 150°. Reads out all numbers plus A, C, E, F, H, J, O, P and U. Available now. Any quantity.

Brightness: 200 ft-lamberts @ $I_f = 20$ ma, 3.4V, per segment

Compatibility: directly interfaces with off-the-shelf IC decoder/drivers

Price: ~~1-9, \$48; 1,000 or more, \$25~~

contact distributors for new prices!

GaAsLITE Update

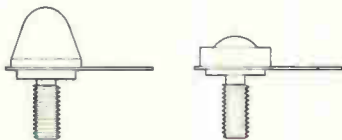

12 mW @ 1A IR emitters

New high power low cost 9000 Å GaAsLITEs give you extra mW for your \$.

Design these powerful infrared sources into your next card or tape readers, intrusion alarms, or calibration units. Anything that uses silicon detectors wants our ME 2 and ME 5 GaAs infrared emitters. They give you a 2500-mil² emitting area with either lambertian (ME 2) or collimated (ME 5) radiation patterns. Guaranteed minimum output: 10 milliwatts at 1 amp. (Less expensive ME 2A and 5A versions radiate 7.5 mW.)

Peak forward current: (1μs pulse width, 300 pps) 25 amps

Forward voltage: 1.3 V typ ($I_f = 1.0$ A)

Rise time: 10 nanoseconds

Prices: ME 2, 5: 1-9, \$30; 1,000, \$12.50
ME 2A, 5A: 1-9, \$14.75; 1,000, \$8.00



GaAsLITEs by the millions

Bright red solid state lights are here. And affordable!

Want high performance and low price? Immediately? Order our new MV 50:

750 ft-lamberts @ 20ma; thousands ready to be shipped from your Monsanto distributor at \$1.50 each.

Finally, a price that lets you justify GaAsLITEs for high volume applications. MV 50s can replace miniature and sub-miniature lamps down to the T3/4 size. Their solid-state reliability makes them ideal for indicator lights in computer systems, data processing equipment, communications systems, and as diagnostic lights on pc boards. And just think what you could do with them in large arrays and in optical logic systems....

Size: 0.10" diameter

Output: 750 ft-lamberts (6500 Å) @ 1.6V, 20 ma

Switching time: 1 nanosecond

Price: 1-9, \$2.30; 1,000, \$1.50

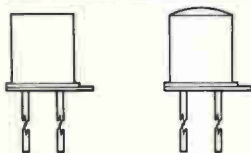

The superfast detector

Our 500-picosecond silicon PIN photodiodes, MD 1 and MD 2, complement our light-emitting diodes.

High speed optical switching has all kinds of sexy uses today: Laser detecting, for instance, and optical encoding. Even simple burglar alarms can use it.

Their half-a-nanosecond response cycle makes them perfect mates for Monsanto GaAsLITEs. And they work with other sources, too. Packaged in standard transistor cans, they're easy to handle and mount. Available with either flat lens or built-in optics.

Rise time: .5 nanoseconds ($V_R = 20V$; $R_L = 50\Omega$)

Breakdown voltage: 50V ($I_R = 10\mu A$)

Sensitivity: MD 1 1.5 μA/mW/cm² (min) (.9 microns, $V_R = 20$ volts)

MD 2 3.0 μA/mW cm² (min) (.9 microns, $V_R = 20$ volts)

Price: 1-9, \$6.25; 1,000, \$3.40

Monsanto

All available through Schweber, Semiconductor Specialists, Kierulff or K-tronics. For additional technical information and world-wide distributor list, write Monsanto Electronic Special Products, 10131 Bubb Road, Cupertino, California 95014. (408) 257-2140

OVERSPEED CONTROL UNDERSPEED

**COMPACT, LOW COST WAY TO
PREVENT MACHINE DAMAGE
AND COSTLY DOWNTIME**

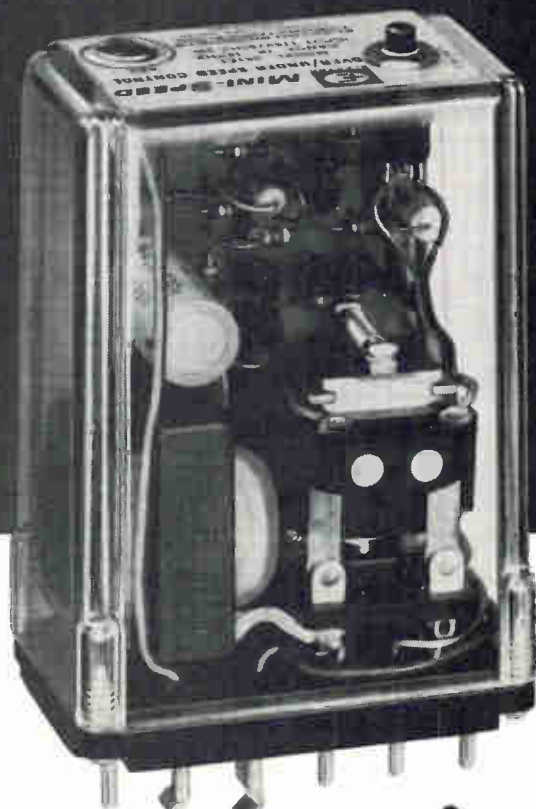

MINI-SPEED

MODULAR PLUG-IN CONTROL

These new compact plug-in units offer the ultimate in solid state reliability, and operate equally well on the output signal of magnetic pickups, proximity switches or your existing circuitry. They are temperature stable in ambients of -30°F to $+160^{\circ}\text{F}$.

FIVE MODELS COVER ALL PRACTICAL RPM RANGES

Typical case: From 0.1 to 15,000 RPM using 60 tooth gear

Each model provides a choice of two control functions: over or under speed with either function operable in latch or non-latch mode. Both mode and function can be determined by the user at the time of installation. In all models, the input signal triggers on a pulse amplitude as low as 1 volt peak at 0.1 MA.

Write for Bulletin MS-769 for complete information on the five models available.

**NOW
\$89⁵⁰**

F.O.B. Factory
SOCKET EXTRA



ELECTRO

ELECTRO PRODUCTS LABORATORIES, INC.
6125 West Howard St., Chicago, Ill. 60648 • 312/647-8744

CAN OPENERS

PHOTOCOPIERS

ADDING MACHINES

WASHING MACHINES

AIR CONDITIONERS

VENDING MACHINES

AUTOMATIC TYPEWRITERS

COMPUTERS

FILM PROJECTORS

CLOTHES DRYERS

want to start something?

COLLATORS

AUTO TURN SIGNALS

VACUUM CLEANERS

TAPE RECORDERS

RADIOS

BLENDERS

PRINTING PRESSES

COFFEEMAKERS

PHONOGRAPHS

TELEVISION SETS

specify Cherry long-life switches.

This year, 17 million products will start with Cherry switches. Product designers like Cherry's long-life coil-spring mechanism. Production people find high-overtravel Cherry switches install much easier. If you are looking to start something and need operating forces as low as 1¼ grams or electrical ratings as high as 25 amps, check CHERRY.

Just off the press! Send for complete new 44-page Cherry Switch Catalog.



CHERRY



CHERRY ELECTRICAL PRODUCTS CORP. • 1656 Old Deerfield Road • Highland Park, Illinois 60035

TESTING EQUIPMENT

GARAGE DOOR OPENERS

POWER TOOLS

DISHWASHERS

CALCULATORS

DEHUMIDIFIERS



Circle 79 on reader service card

Helipot slashes
voltage regulator prices
to

5.82

Now Models 809 and 859 Voltage Regulators are available
at \$5.82 each (1000 quantity) or \$8.95 (1-9) from local stock.

Beckman

INSTRUMENTS, INC.
HELIPOT DIVISION
Fullerton, California 92634

INTERNATIONAL SUBSIDIARIES: AMSTERDAM; CAPE TOWN; GENEVA; GLENROTHES,
SCOTLAND; LONDON; MEXICO CITY; MUNICH; PARIS; STOCKHOLM; TOKYO; VIENNA

Circle 80 on reader service card

January 19, 1970 | Highlights of this issue

Technical Articles

**Computerized testing:
fast and economical
page 82**

General Radio used to check out each of its digital subassemblies with its own specially designed fixture. But as the subassemblies became more complex, General Radio found it was spending too much time and money on the fixtures. The company made its own computer-controlled tester, and reports that this system not only tests faster and more reliably, but also is less expensive over the long run.

**Noise diodes allow
in-service testing
page 87**

Avalanche diode noise sources are the basic components in systems that monitor in-service performance of radar, communications, and electronic countermeasures systems. Immediate action then can be taken when a degradation in system operation occurs, rather than relying on bench checks. The diodes, small, inexpensive, and with long lifetime, allow checking of such parameters as front-end noise, amplifier gain, and tracking of gain and phase.

**Memories:
Post and thin film
page 102
Waffle iron
page 107**

Batch fabrication has been a memory designer's goal for years; though ferrite-core arrays have been the standard, problems with stringing up to four wires through thousands of the tiny rings have challenged inventive people to devise a better way. One approach is the post-and-film method; a similar British approach is called a waffle-iron memory. Following these discussions is a report on similar techniques around the world.

**The many applications
of surface wave technology
page 110**



Signal processing with acoustic surface waves already is under way, with pulse-expanders and compressors, analog matched filters, and multiplexers being developed rapidly. But radar, communications, and navigation represent only a small portion of the potential applications for this important new technology. For example, computer logic, video filters, readout displays, and even flat tv tubes are just some of the areas where surface waves show great potential. This concluding article of the series explores the expanding horizon for new applications.

Coming

**New process points way
to monolithic MIC's**

Generally, IC's for intermediate and microwave frequencies must use hybrid components. The old screen-printing technology yields high-loss components unsuitable for most applications. But a new thick-film process, arc-plasma spray, could eliminate the hybrids, leading to a truly monolithic microwave circuit technology.

Computer-controlled testing can be fast and reliable and economical without extensive operator training

Simple language, versatile functions reduce costs while helping to design, test and troubleshoot circuits; *Matthew Fichtenbaum* of General Radio explains how his firm made the move to a programmed system pay off

● One of the most important decisions facing engineers is whether to turn to computer-controlled systems to solve test problems. The automatic rigs are faster and more reliable, and they do a better job of keeping records. But it was felt that the high cost of systems and the time and expense of training people to program them offset these advantages. Well, they're not expensive, and it isn't tough to train operators. Since computer-controlled systems can be modified to test different subassemblies by changing no more than a program, there's no need to go out and buy new voltmeters, counters and other gear just because you've stopped testing some control circuits and are starting to test shift registers. Therefore in the long run the systems are much less expensive. And training programmers is a simple procedure if the system uses an uncomplicated language.

Typical of the systems being built is the one General Radio engineers use to test digital circuit boards and other subassemblies. The system poses none of the problems General Radio had been encountering in its former test methods. The old approach was to build a hard-wired test fixture for each subassembly tested. This was fine as long as the subassemblies were simple, but digital circuits are getting more and more complex and using a specific fixture for each presents problems.

Designing and building these fixtures requires considerable time and effort. The simplest takes a week

to design and fabricate, while putting together a more complex one can take a month. And these fixtures often demand special mechanical design effort, custom-etched printed-circuit boards, and specialized instrumentation. Furthermore, all this time and trouble must be multiplied by the number of subassemblies in an instrument.

It's also difficult to design a fixture that thoroughly tests a subassembly without making the fixture itself a fairly sophisticated piece of equipment. And fixtures, as a rule, just test; they give very little indication of the cause of a failure. With subassembly complexity increasing, engineers need test systems that do troubleshooting and repairing. GR's computer-controlled system, on the other hand, has cut diagnosis-and-repair time to one-eighth of what it had been. Finally, storing fixtures takes up space; besides, "good" subassemblies must be built and then stored with those fixtures that are basically comparators.

The arguments most heard against computer-controlled systems are that they are costly and require long development times. True, it is costly and time-consuming to design and build one, but since a good system tests many subassemblies, the time and money eventually would be dwarfed by the time and money spent building a multitude of special fixtures. And it's not necessary to buy special instruments for each subassembly to be tested—the software is what changes, not the hardware.



1: SET ALL SWITCHES ON TEST FIXTURE TO NORMAL POSITIONS.

2: PUSH ONE READOUT BUTTON TO SETUP TEST SEQUENCE FOR 5, 6, OR 7 DIGIT BOARD.

3: DO NOT TEST BOARD WITHOUT READOUT TUBES.

4: CHECK BOARD FOR PROPER JUMPERS.

5: PLACE BOARD ON FIXTURE-LOCK IN PLACE-INSTALL ETCHED CIRCUIT PLUG.

PRESS CONTINUE BUTTON.
 DE NO. 001

Check out. When the user puts the test program into the memory, plugs a subassembly into its adaptor, and hits the START button, the system runs a complete set of functional tests, displaying or printing instructions for the user when necessary. Typically tests run in a minute or less.

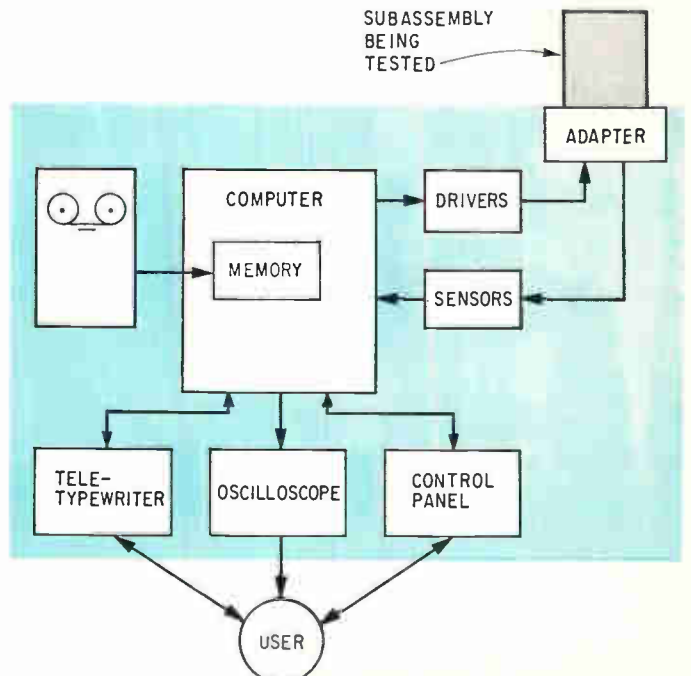
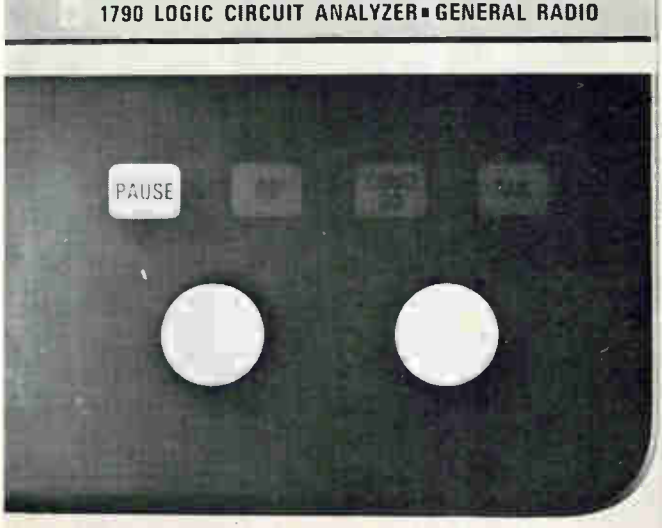
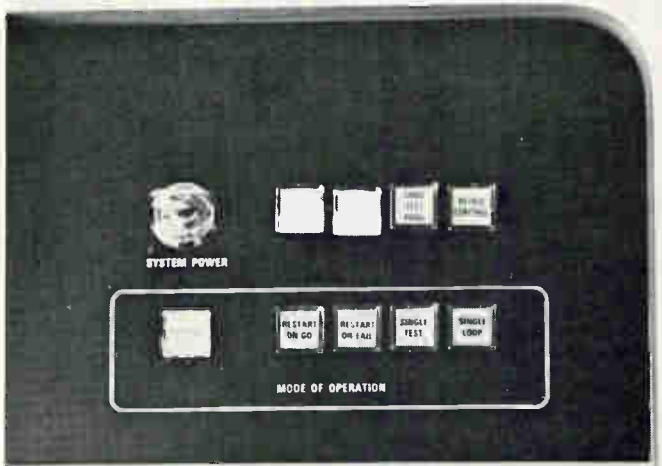

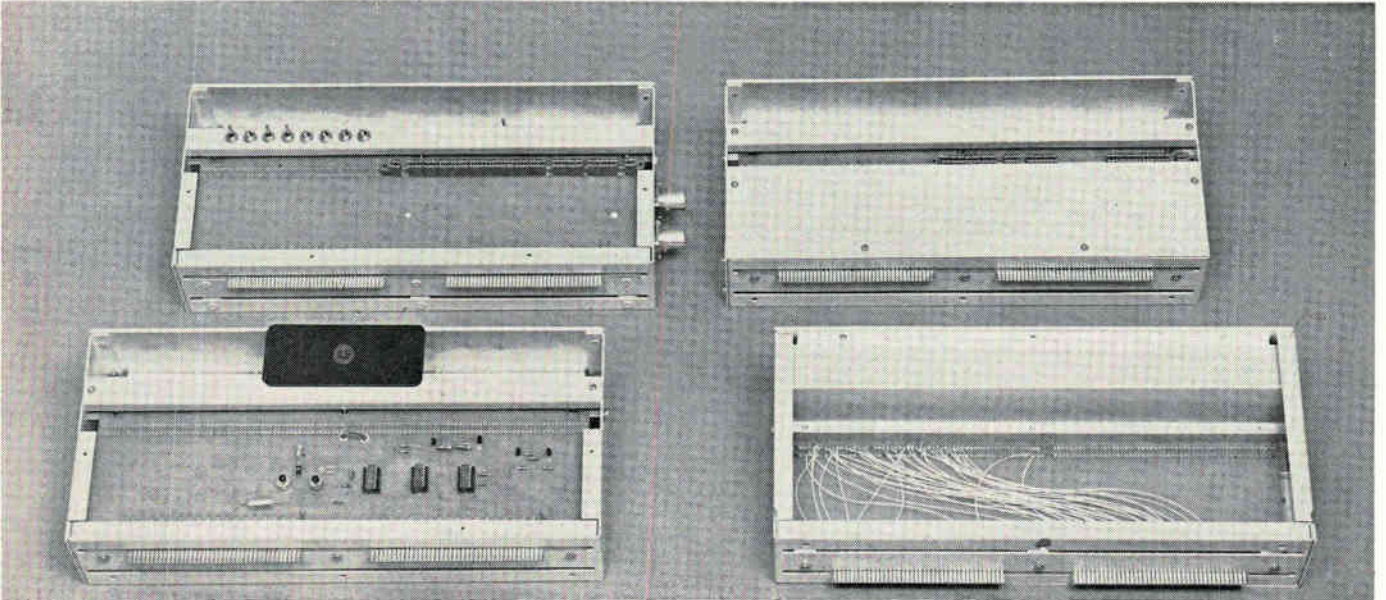
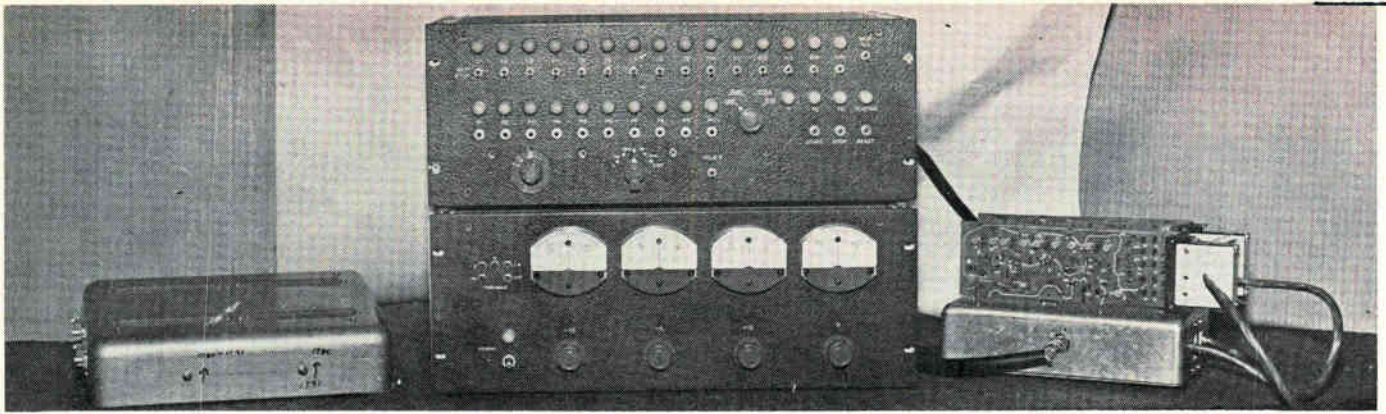

Typical Program

- (1) /BOARD NUMBER 1790-4140
- (2) /USE ADAPTOR 4
- (3) /PROGRAM REVISION 1
- (4) *I (1, 2, 14, 15, 17)
- (5) *O (20, 21, 22, 23, 30)
- (6) 1; IH(2) OH (22, 23)
- (7) 2; IL (14, 2)
- (8) PRINT MOVE S1 TO POSITION 5
- (9) AND PRESS CONTINUE
- (10) PAUSE 1
- (11) DO 5, 30
- (12) 3; IH (2) IL (17) \$
- (13) 4; IL (1) OH (30)
- (14) 5; IH (1) IL (2) OL (30)
- (15) DELAY 100
- (16) IGNORE (21, 22)
- (17) 6; OL (20)
- (18) IF (23) 7
- (19) PRINT PROBE TEST POINT 1 AND IF HIGH,
THEN IC8 IS BAD
OTHERWISE CHECK IC6 !
PAUSE 2

*The numbers
and Greek letter
in the left-hand column
aren't part
of the program.*

.....
.....

(Ω) END

The computer, reading the slash before each of them, ignores (1), (2), and (3), which are annotations put there for the system user. (4) names as inputs terminals 1, 2, 14, 15, and 17 of the subassembly being tested, and (5) names as outputs 20, 21, 22, 23, and 30.

(6) is test 1. After setting all inputs high, the computer checks whether outputs 22 and 23 are high. (7) tells the computer to set 14 and 2 low (all other terminals are left at the same state they were in during the previous test), and check whether the states of outputs change.

(8) and (9) order the computer to display instructions for the operator, after which (10) tells it to wait until the instructions are followed.

(11) puts the system into a do loop in which tests 3, 4, and 5 run 30 times. The dollar sign in test 3 signals the computer to ignore the output's states during that test.

After stopping for 10 milliseconds (100 x 0.1 msec) the computer reads (16), which tells it to stop checking 21 and 22 until further notice.

After test 6 comes an IF statement, which sends the computer on to test 7 (not shown) if 23 is high and 20 and 30 are low. (19) lists troubleshooting steps taken if test 7 comes up bad.

Old and new. General Radio engineers built this rig to test circuit boards put into an automatic capacitance bridge. In the fixture on the right are mounted two boards, the one tested and the "good" one used for comparison. The bottom photo shows four adaptors for the computer-controlled system. Little more than metal boxes with some interconnecting wires, an adaptor can be built in a few hours. The one on the bottom left is for MOS shift registers; the others for circuit boards used in a real-time analyzer.

In a typical system, GR's digital-circuit tester, the computer is a Digital Equipment Corp. PDP-8/L. The test program, read into the component's memory on a tape reader, controls the computer. Also connected to the computer are a control panel, a teletypewriter and a display oscilloscope.

Each type of subassembly tested plugs into its own adaptor, connecting the subassembly to the system's input and output terminals and power supplies. Specific adaptors for different subassemblies allows flexibility in handling subassemblies of different sizes and shapes.

What's the difference between an adaptor and test fixture? Plenty. An adaptor is built from commonly available parts and usually contains no circuitry other than interconnecting wires. In no way does it control or determine test sequences. And since an adaptor's jobs are simple and well defined, designing them is a straightforward task, usually taking no more than two to four hours.

The GR system performs only functional tests; at each test-sequence step the computer reads an input pattern of logical "1"'s and "0"'s from the test program; sends this pattern to the subassembly being tested; reads the subassembly's outputs—again "1"'s and "0"'s—and compares them with predetermined correct responses stored in the computer's memory. If the computer determines a failure it prints out an error message through the teletypewriter and displays the message on the oscilloscope.

If one or more steps in the test sequence requires action by the operator, the computer prints and displays instructions when these steps come up.

The input pattern, correct output pattern, and test sequence are controlled by the specific test program. These programs normally are stored on paper tape and are loaded into the computer memory through the photoelectric reader. Only the program tape and the corresponding device adaptor are required to set up for a particular test.

Using the system's controls the operator can read a test sequence from a tape into the memory, start a test sequence, continue a sequence from an error or programmed pause, and switch the system into one of several diagnostic operating modes.

This particular system wasn't designed to measure dynamic parameters, such as pulse duration and rise time, because the equipment required would be expensive, and measurement time per test is as much as 100 times greater for dynamic testing. Also, since the subassemblies to be tested are made with integrated circuits that have been dynamically tested by the manufacturer, failures tend to be functional in nature.

A major objective in the system's design was to eliminate the need for the operator to directly program the computer. This, of course, demands that programming be simple, without restricting the system's capabilities. To achieve this goal, the system was designed so that it can be programmed with a higher-level language than the computer itself uses. Special programs in the computer's memory convert a system program to the lower-level language of the computer. Written in the language developed for this system, a typical test program is simply a step-by-step statement of the test inputs and outputs to and from the subassembly.

Training people to use such a simple language is no problem. Of the 10 technicians and test engineers at GR now able to write programs, only one had prior computer programming experience. They had no formal instruction on the language; instead they learned from a written set of programming rules. On average, these men were writing test programs within two days. To write a complete program takes at most a few days. For example, one of the more complex subassemblies that the system has tested is a p-c board (from the GR 1921 Real-Time Analyzer) that contains 40 integrated circuits, and 76 discrete components. It took two days' time to write and debug the test program for this board, and less than half a day to build the device adaptor. The program has 650 tests and runs in 150 milliseconds.

Writing programs for other subassemblies has taken from 30 minutes to 12 hours, and these programs run in times ranging from a few milliseconds to a few seconds. For most-subassemblies, test time is limited mainly by the time it takes to remove one subassembly from the adaptor and insert another.

The test system also has been helpful to designers, who find that writing a test program and building an adaptor is the easiest way to verify the performance of a prototype or model board. When the board reaches the manufacturing stage, the same program and adaptor can be used for production testing.

A program consists of a number of test steps, each representing an application of 1's and 0's to the subassembly, and the comparison of the outputs with the

correct pattern. Four types of statements are needed. These set inputs and outputs to 1 or to 0; only those inputs or outputs that have changed since the previous test need be specified.

If desired, only the subassembly's inputs need be programmed. The outputs may be read from a subassembly known to be good, and stored on tape.

Besides input-output instructions, the language has additional statements which don't directly control the subassembly. For example, the DO statement allows a predetermined repetition of a test or group of tests; PRINT orders the display of commands or diagnostic information.

But testing isn't the system's only strong point: it also is good at troubleshooting. The system can help locate and repair a fault in 15 to 30 minutes; previously, it took hours. With the test program sufficiently detailed, information on the cause of a subassembly failure can be found by determining only the test number at which the failure occurred.

To test very complex subassemblies, diagnostic decision trees can be included within the program. With the conditional-branch instruction IF, the program compares the subassembly's outputs with a specified pattern and changes the program flow in line with the result. The comparison may trigger a transfer to a program section that finds out what caused a failure.

A clip-on IC probe wired to the adaptor provides an additional group of outputs. When the test program detects a fault, it instructs the system operator to attach the probe to a particular IC. Based on the outputs from the probe, the program makes further decisions including whether to probe other packages.

The system has several operating modes which help in troubleshooting a bad subassembly. Besides the normal test mode, the operator has such options as:

- ▶ Single-test. The system pauses after each test, and displays the test number and the states of the inputs and outputs.
- ▶ Single-loop. This is like single test, except programmed DO loops are executed without intermediate stops.
- ▶ Restart on fail. The system, upon encountering an error, restarts the test sequence, allowing oscilloscope observation of error occurrences.
- ▶ Restart on go. The system continually cycles through the test program until an error occurs. A sus-

pected subassembly may be subjected to voltage or temperature variations or stress while being tested.

▶ Trigger on specified test. The system generates an externally-available trigger pulse concurrent with a specified test.

▶ Stop on specified test. This augments the single-test mode by allowing the system to step through long portions of a program at normal speed.

The extent to which the computer-controlled system has helped General Radio can be measured by looking at the case of the GR 1192, a small, inexpensive counter made in large volume. It has only three circuit boards, and one contains all the digital circuitry—counting decades, read-out drivers and tubes, and clock circuitry. It's a very complex board, more difficult than the average board to troubleshoot and repair. However, because of its high component count it's more economical to repair than to scrap. Therefore any test setup designed for the board must have troubleshooting ability.

The system completely checks this board in three minutes. When a fault occurs, it's usually found and remedied within 30 minutes. The test program for the board took only one week to write and debug, and the adaptor, also of greater-than-average complexity, took a week to design and build. If the system had not been around, the counter could not have been built to sell for anywhere near its present price. ●

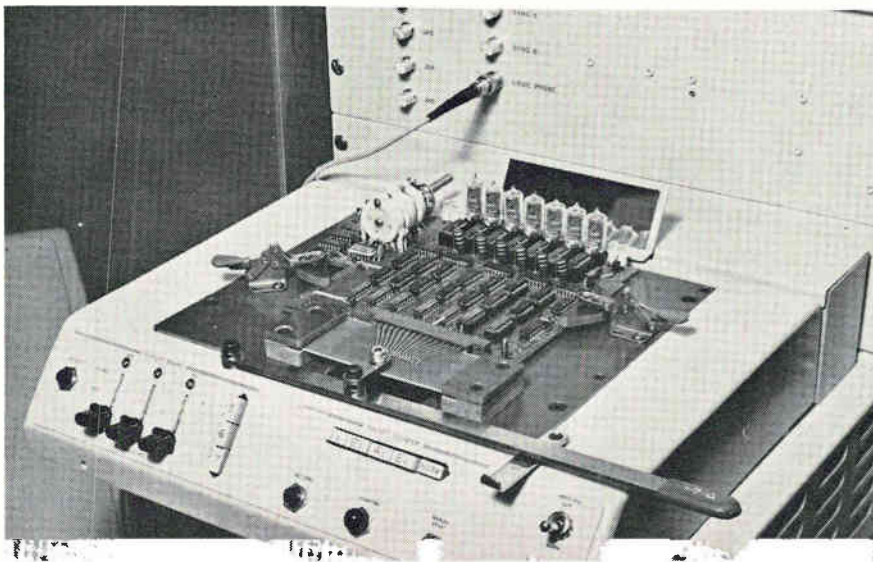

Counter clearance. Mounted in its adaptor is the main circuit board from a frequency counter. Even though the board contains a particularly complex array of circuitry, its test program took but a week to write. It runs in three minutes.

Avalanche diodes permit in-service measurements of critical parameters in microwave equipment

Bench testing often doesn't turn up defects that could occur in operation; *Norman Chasek* of Int'l Microwave Corp. shows how solid state noise sources can be built into microwave gear to insure reliable performance

● Checking out performance of microwave equipment under bench-test conditions is fine—for bench operation. But what about in-service monitoring? If important parameters could be measured while a radar or long-distance relay station actually was operating, time, money, and perhaps even lives could be saved. Now, tiny solid state microwave sources of white noise—avalanche diodes—in combination with some additional components, are set to do a big job when built into equipment.

Until now, most in-service monitoring has been done on a go or no-go basis. For example, meters are provided to indicate whether voltage is turned on, or currents are up to a certain value. Little effort is expended to monitor parameters that may be gradually deteriorating. Such monitoring equipment, often using argon-gas noise sources, for example, would be too bulky and expensive, and is itself unreliable. But the avalanche diodes, which can be easily built into equipment, are inexpensive, small—less than a quarter cubic inch—and require little power—only five to 10 milliamps at 10 volts.

They make it possible to measure not only receiver front-end noise but also system distortion and gain, and gain-and-phase tracking, while the system operates with hardly any interference. Rapid measurements also can be made on swept receivers, such as those used in electronic countermeasures and frequency agile radars.

The diodes' output power—ranging over bands from 0.1 to 20 Gigahertz—is supplied for long periods at a high level, typically 30 to 35 decibels above kT , the Boltzmann's constant room temperature reference. This is high enough so that the noise can be coupled into a system through standard 20-db couplers and thus minimize interference to the system. The level is constant to within a half-decibel over wide temperature ranges. The noise, coupled into the system like a test signal, is easily gated at microsecond rates, a must for the test techniques employed. And because the test noise and receiver front-end noise have similar spectral characteristics, measurements are independent of the receiver's bandwidth, band shape, and gain.

Noise figure measurements usually are made by comparing noise, generated externally at a standard level and injected into the system, with the system's own internal noise.

New measurement techniques using white noise—which represents an infinite number of incoherent sine waves of constant amplitude uniformly spread over the diode's frequency band—require that the noise be gated into the system, not injected continuously. After it passes through the system, the gated test noise, which now also contains system noise, is fed into a square law detector. The detector transforms the incoherent test noise into a coherent signal at the gate frequency.

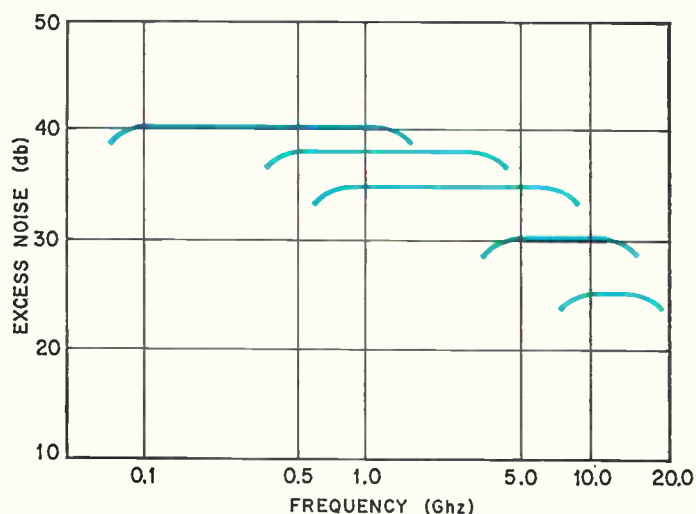

Noise choices. Typical solid-state avalanche diode noise sources have bandwidths that range from about 0.1 Gigahertz up to 20 Ghz.

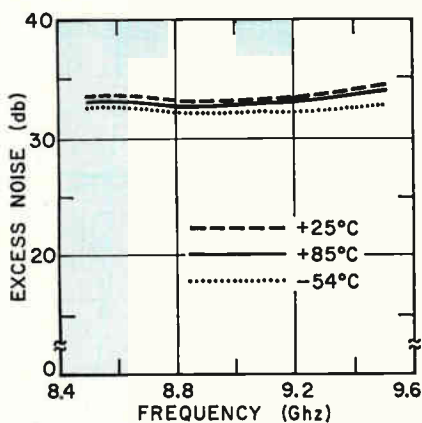

Steady as she goes. Noise output of avalanche diode is fairly constant over a wide temperature range.

The amplitude of this coherent signal now serves as a reference level since it is mathematically proportional to the injected test noise. In effect, the square-law detector has taken some fraction of the power distributed through the test noise band and translated it to power at the gate frequency.

The summing process that occurs as a result of the square-law detection makes it possible to use a low level of test noise that's considerably below the system-noise level, so that measurements can be performed while the system is in operation with little adverse effect.

Following square-law detection the coherent signal is filtered out of the remaining noise with a narrow-band filter whose center frequency coincides with the gate frequency. The narrower the filter, the lower the test noise can be and the more it can be submerged in the system noise.

To measure the system noise figure, an operator first would switch in the gated test noise, and the output from the narrowband filter would be used to deflect a voltmeter. The test noise then would be turned off so that the unmodulated system noise alone comes through the square-law detector and the narrow-band filter deflects the meter. The system noise figure depends upon the two meter readings as follows:

$$\frac{[\text{system noise} + \text{gated test noise reading}]}{(\text{system noise}) \text{ reading}} \propto \text{noise figure}$$

The constant that relates the noise figure and the two measurements is ascertained by calibrating the system.

But it isn't always necessary to insert noise in this fashion. A time domain test is possible; it's especially useful for radar systems.

To test a search or surveillance radar, for example, a narrow noise pulse, synchronized to the pulse rate of the radar transmitter, is injected at the time corresponding to a specific range—generally the radar's maximum. The noise, introduced through a 20-db coupler, as shown on p. 89, causes a ring or circle to appear at the maximum-range position on the radar's plan position indicator (PPI) scope. In effect, the noise acts as a target surrounding the radar. As long as the ring appears clearly before the radar operator, the entire receiving system is operating properly. But as the receiver's front-end noise increases, the noise ring gets wider and more diffuse. In effect, the noise ring meshes into the background noise on the scope.

An actual target also would fade into the background but would not be as apparent as the fading noise ring—the radar operator knows the noise ring should be there; he's not so sure about the target. Thus, as the ring fades into the background noise the operator can judge when the radar's performance has been degraded to the point where repairs are required.

It's very convenient to use such a calibrating noise ring. The operator can check on the radar's performance while he's doing his job. And as long as the ring is visible, the radar's gain levels are set to give small targets maximum visibility among large targets.

If the entire radar including the antenna's rotary joint must be monitored, the noise injection system can be placed on the rotating antenna pedestal and powered from the 110 volts a-c usually available there. Isolators in series with the noise source will protect against damage from transmitter power. Such a system monitors the rotary joint, waveguide feed, transmit/receive tubes, microwave receiver, and the video and display system.

The performance—noise figure, gain- and phase-tracking—of a tracking radar, with its dual receivers, can be monitored using the manual switching arrangement shown on p. 89. The noise source is connected through equal lengths of line, to identical directional couplers leading to each receiver input. The intermediate-frequency outputs from the two receivers are coupled off into a hybrid, again through equal-length lines. The output of the hybrid is fed into a narrow-band amplifier tuned to the modulation rate.

The noise figure of each channel is measured by switching the modulated noise into one receiver at a time. As with the search and surveillance radars, the ratio of receiver noise levels when the noise source is on and off yields the noise figure.

Gain tracking is monitored by alternately switching, at a slow repetition rate, the test noise into one receiver and then into the other. If the output of the narrow-band amplifier is rectified and passed through a filter tuned to this slow repetition rate, the amplitude of this alternating component is proportional to gain track. Zero output, which corresponds to the same output from the narrowband amplifier for each switch position, indicates perfect gain track.

Phase track can be determined by feeding test noise to both receivers simultaneously. If the output of the

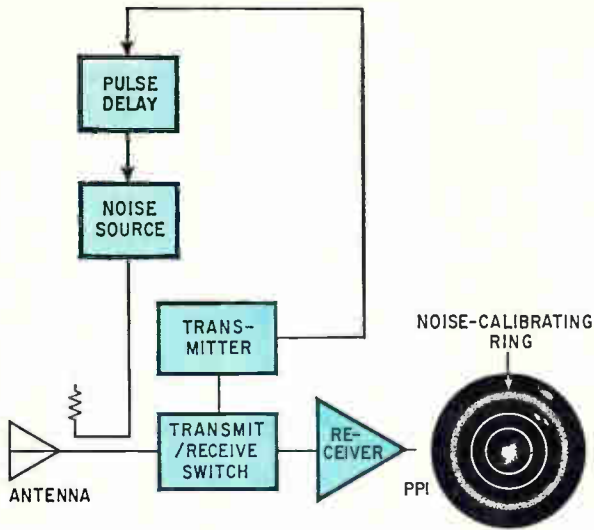

Ring of bright noise. Noise burst, synchronized to the pulse of a radar's transmitter, produces a ring on the radar's PPI scope that can be used to monitor system noise. When the ring is clearly visible, noise in the receiver system is low. If the ring fades into the background on the scope, system noise level has risen and maintenance may be needed.

hybrid is zero, there is perfect phase-tracking across the entire transmission band of the receiver. Any phase-tracking error is proportional to an output signal from the hybrid. Broadband noise for phase-track testing instantaneously checks the receiver's entire transmission band. Also, phase track is continuously monitored as the receiver is tuned over any radio-frequency band.

In weather radars, receiver gain as well as its noise figure, should be monitored. When the gain is known it's possible to calibrate cloud return and determine more accurately their density.

Noise at a known level and gated at a high repetition rate is injected into the radar during the dead period before the transmit pulse. It's then picked up at the receiver output by a narrow-band amplifier, whose output is proportional to the receiver's gain. Variations in output are caused by gain changes within the system. Automatic or manual adjustment then can be made in the i-f amplifier to maintain the receiver's gain level.

For a microwave communications system, monitoring the noise performance of each of the repeater stations is most desirable. This can be readily done for a remodulating type of repeater which demodulates the f-m carrier and converts it into a baseband signal that then is used to remodulate the transmitter. The test noise is introduced into the receiver front end and the noise figure is monitored at the baseband output.

But it isn't possible to do this with a heterodyne repeater system. Here, the carrier signal and the information it contains are translated only to intermediate frequencies, amplified and then translated back up to microwave. A monitor system for such a repeater would have to tap a demodulator into the i-f line to bring the signal down to the needed baseband range, a very expensive proposition.

However, heterodyne communications systems have stations which drop and add channels. The information channels at these stations are translated down to baseband frequencies so that the noise techniques for the remodulating repeaters can be used there.

Actually, the test measures the over-all noise figure—the sigma noise figure—of the communications system at the repeater station. This is similar to receiver noise figure except that the sigma figure lumps together noise that's been accumulated earlier in the system and noise generated at the repeater being monitored. The sigma noise in a multichannel communications system, then, is the sum of intermodulation and transmitter noise generated earlier in the system, and receiver front-end noise at the repeater being monitored.

The sigma noise figure measurement can be made on a microwave repeater with the arrangement shown on p. 90. The modulated noise source test signal is introduced into each channel, either selected by an operator

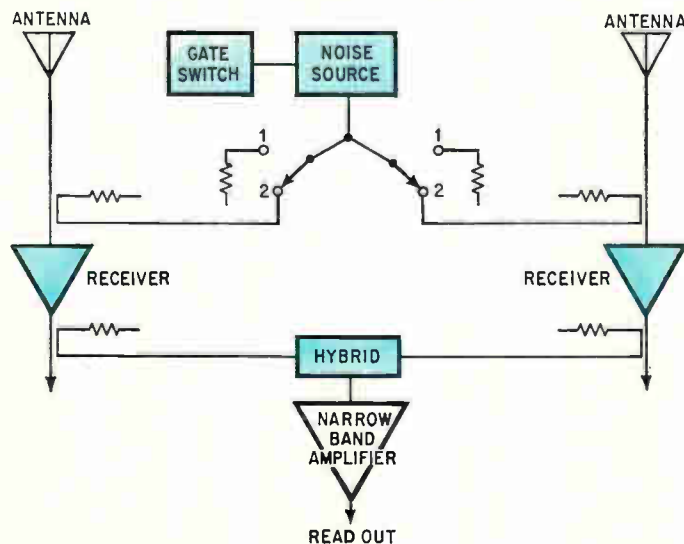

On the right tracks. Depending on the switch positions, the modulated noise source can be used to monitor noise figure, gain-tracking, and phase-tracking of a tracking radar. If receivers are tracking properly, and noise is coupled to both receivers, the output of the hybrid should be zero. Hybrid output increases as channels get out of track.

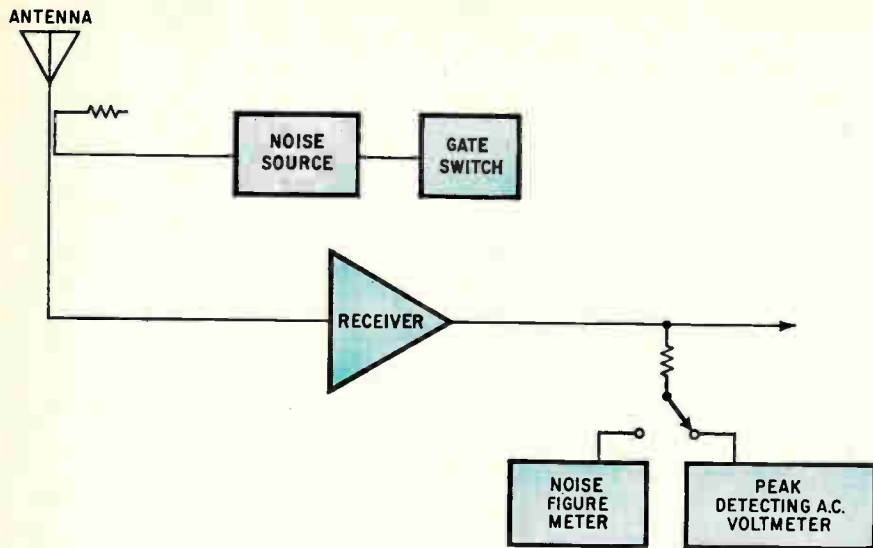

Countermeasures monitor. Modulated noise, coupled to the input of a swept electronic countermeasures receiver, is used to monitor average noise figure across the receiver band. Peak noise points within the band are presented on the peak-detecting voltmeter.

or automatically through a standard 20-db coupler. However, the frequency gating the noise is higher than the highest baseband channel frequency, so that any traffic—and the system should be monitored during peak traffic hours—can be readily filtered out and not affect measurement.

The output of each channel is passed through a band-pass filter, whose center frequency is the gating frequency on the noise source. The filter bandwidth should be wide enough to yield an adequate sample of the output, but narrow enough to exclude any baseband signals. One megahertz is a typical value for bandwidth.

The filter output is square-law detected, providing a coherent component which then is filtered out, using an extremely narrow (100 hz) bandpass filter. The filtered output then is amplified and measured.

Often, system distortion must be monitored as a separate parameter by adding gated noise from the diode source on top of the normal signal traffic. If there is any system nonlinearity, the superimposed gated noise will mix with the traffic to produce out-of-band signals. These signals, with components at the same frequency as the noise's gating rate, can be separated out by a filter tuned above the baseband, square-law detected, and then passed through a second filter tuned to the gating frequency.

The amplitude of this final signal is a measure of the

system's nonlinearity. It can be measured in one of three ways: as an absolute measurement made with a voltmeter; as a ratio to a reference level of noise injected into the receiver; or as a ratio of levels generated by any two consecutive repeaters that are tested alternately.

In electronic-countermeasures and intelligence-gathering equipment a crystal video receiver is often used, preceded by an r-f filter and low noise preamplification. Such receivers also can be multiplexed with each continuously surveying a small portion of the spectrum. Three parameters can be monitored to assess performance: noise level, gain, and gain tracking.

Usually, the noise performance of these receivers is checked by increasing its tangential sensitivity using pulse techniques and an oscilloscope.

But noise figure can be measured automatically through switching a diode noise source from channel to channel. Here the noise source is modulated at a repetition rate anywhere within the transmission band of the video amplifier—generally between 0.1 and 2 Mhz. The modulation is square-law detected and filtered, and the noise ratio is taken for the conditions when test noise is on and off. The receiver's gain is simply monitored by checking the level of the noise test signal at the output and comparing it with the noise input.

Since the noise input is known and constant, output levels changes are due to gain changes.

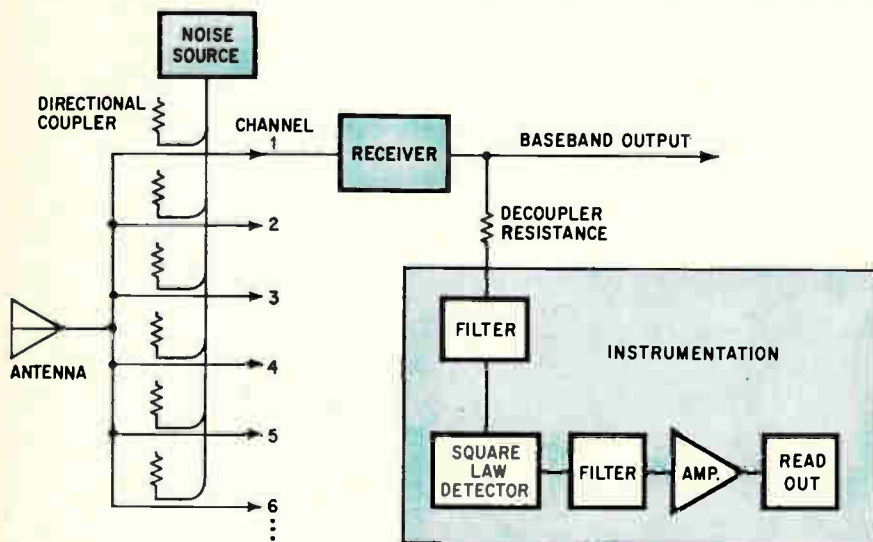

Noise on the line. Modulated noise source is coupled to the repeater channels of this microwave communications system to check on noise levels. The first filter only passes signals above the system passband so that traffic does not affect the noise reading. Second filter zeros in on the coherent signal, produced by the square-law detector, that is proportional to the system noise.

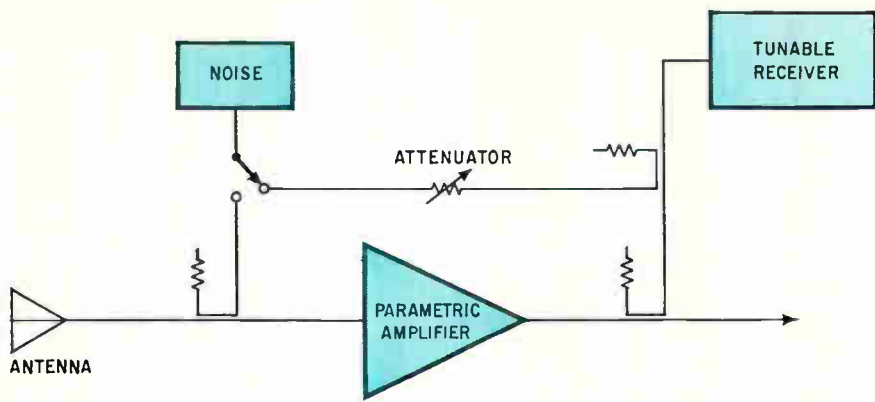

Flatness check. Gain variations across the transmission band of the preamplifier in a satellite ground station also can be monitored. Switched at a slow rate between the preamp's input and output, the noise produces a tone in the tunable receiver whose amplitude depends on the preamplifier's gain.

In direction finding systems, gain tracking between the receivers associated with each antenna is required. In this case, separate noise sources permanently attached to each channel, or one source switched between channels, will monitor the receiver over the complete r-f band. The basic method is similar to that used for the tracking radar, with the noise source gated at a rate somewhat lower than the video bandwidth.

First one noise source and then the other is switched into each channel at a slow rate. The output of each channel then is coupled off and combined. The signal is filtered, detected, and then filtered again at the switching rate. Average gain tracking over the complete r-f spectrum of the system is proportional to the amplitude of the output signal—if gain tracking were perfect the signal amplitude would be zero.

Swept receivers, used for countermeasures and surveillance, also can be tested through the noise sources. In this receiver the local oscillator sweeps over the r-f band at a relatively slow rate—once every hundredth of a second, for example. It's possible for receiver sensitivity to fluctuate over the band because of bad spots in the local oscillator, mixer, or preselector filters. Or the average noise figure can be low because of a noisy i-f amplifier or bad mixer diodes. Receiver performance can be determined by monitoring either the average noise figure over the swept band or peak fluctuations in the r-f

transmission loss in the receiver's front end.

Test noise is inserted every other sweep of the local oscillator. The ratio of the two noise levels provides the average noise figure. R-f loss fluctuations are determined from the output with a peak detecting voltmeter.

The performance of pulse-code modulation systems can deteriorate severely after a threshold level of noise is reached. When this happens, output noise increases very rapidly, although there are only small increases in noise at the input.

Again, the injected reference noise is keyed on and off and compared with the noise in the system. In phase shift keying or in bipolar pcm a simple full-wave rectifier will convert the pcm into a full-wave-rectified sine wave, leaving most of the lower end of the video band devoid of signal.

Satellite ground terminals use threshold extension systems that tolerate only a very few decibels of noise to make the difference between a perfectly working system and failure. Thus, it's wise to monitor both the noise figure of the receiving system and the gain of the system's parametric amplifier. The solid state noise sources inject noise across the operating band of the system through 40-db directional couplers. This attenuation is sufficiently high so that the coupler does not load the system. All working channels can be monitored for noise figure as well as net channel gain.

With the noise sources, it's also possible to check on the gain and transmission flatness of the low-noise parametric amplifiers in the satellite ground station's microwave receiver. A noise source and a receiver tunable across the amplifier's band are used as shown above. The test noise is alternately switched into the input and the output of the parametric amplifier, with the attenuator adjusted to yield equal signal-to-noise test ratios in each switch condition.

The testing is based on the fact that if the gain of the parametric amplifier varies across its frequency band, there'll be a change in the output level of the second detector that's in the tunable receiver. If switching, for example, occurs at a 100 hz rate, the noise levels at the input and output are balanced until there is no 100 hz tone after the second detector. The receiver then is tuned across the parametric amplifier band to detect the gain variations. Because the gain is referenced against passive components—the directional couplers and attenuator—its variations are independent of the tunable receiver or noise-source characteristics. And by adding a narrow 100 hz filter after the second detector, measurements will be unaffected by signal traffic. ●

Designer's casebook

Designer's casebook is a regular feature in Electronics. Readers are invited to submit novel circuit ideas and unusual solutions to design problems. Descriptions should be clear. We'll pay \$50 for each item published.

Diodes eliminate crossover distortion in video amplifier

By Roland J. Turner

General Atronics, Philadelphia, Pa.

A video amplifier with a dual Darlington transistor configuration operates in a true class B manner because silicon diodes bias the transistors into immediate conduction. Unlike most resistor-biasing used in other amplifiers, crossover distortion is completely eliminated over a wide temperature range because the forward drop of the diodes tracks the forward drop of the transistors with changing temperature.

During positive signal swings Q_1 and Q_2 conduct; during negative swings Q_3 and Q_4 conduct.

The result is a low output impedance for both positive and negative signal swings. Diodes D_1 and D_2 are forward-biased to provide a 1-volt d-c bias to transistors Q_1 and Q_2 . This overcomes the initial forward blocking voltage across the base-emitter junctions in each transistor so that the complete positive cycle of the input signal can be transmitted. Since the same applies to the biasing of transistors Q_3 and Q_4 , the full negative swing is transmitted.

The output impedance of the driver is 12 ohms at up to 2 megahertz. And 50- to 100-ohm transmission cables can have up to 100-picofarad loads and still be driven efficiently.

The video amplifier delivers 270-milliamperere signal swings into a 30-ohm load at 1 Mhz. The 3-decibel cutoff frequency for the amplifier is 13 Mhz.

If the 10-ohm resistors in the emitter circuits of the output transistors are eliminated, then the output impedance of the amplifier will be 2 ohms at up to 2 Mhz with a small tradeoff in linearity.

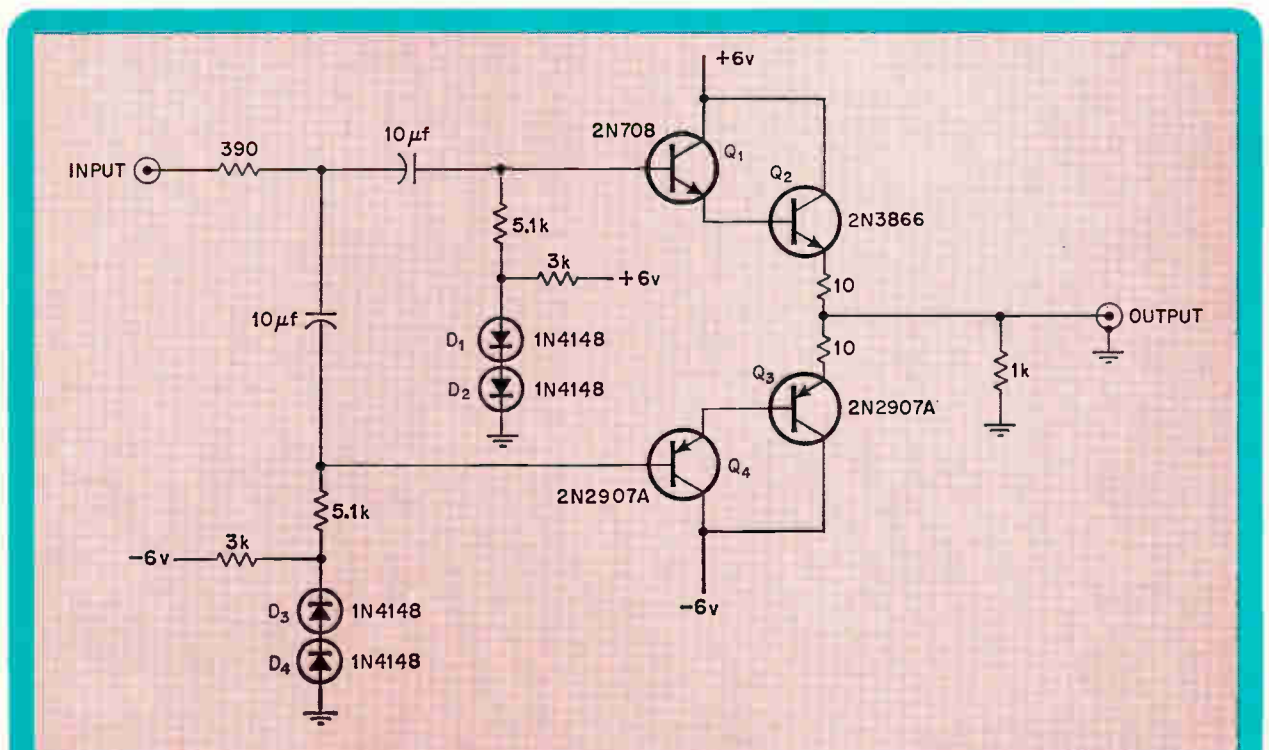

Class B. True class B operation is obtained from the dual Darlington configuration by biasing the transistors with silicon diodes. Forward drop of the diodes temperature-track the forward drop the transistors, eliminating crossover distortion in the amplifier over a wide temperature range.

Shift register simplifies design of phase comparator

By Ivars Breikss

Honeywell Test Instruments Division, Denver, Colo.

A bidirectional shift register and one other integrated circuit are all that's required to build a phase comparator for pulse trains of varying frequencies. The register produces an output pulse pattern with a duty cycle proportional to the relative phase of the two input signals, but in contrast to other comparators, it produces no outputs if other frequency ratios are present. The relative phase between the two signals may vary over a 360° range.

The shift register contains four bits, of which three are used. The bits in the register are shifted when the positive edge of a pulse arrives at the clock input to the register. The shift is to the right when the parallel enable input, PE, is at logical 0, and to the left when PE is a logical 1.

The shift direction is determined by the state of the flip-flop G₁ and G₂. The input signals, f₁ and f₂,

trigger the flip-flop, whose output is a 1 when a pulse from f₁ occurs and is 0 with a pulse from f₂. Thus f₁ drives PE to a 1 and shifts the register 1 bit to the right, while f₂ drives PE to 0 and shifts the contents 1 bit to the left.

A 0 is continuously entered into the first bit position of the register and a 1 in the third bit position; the fourth bit is not used. A pulse from f₁ shifts the 0 to the second bit position of the register and the output Q₁ is a 0.

As long as pulses on the f₁ input arrive, or a preponderance of f₁ pulses occur, the logic state of Q₁ will remain at 0. If the f₂ pulses begin to predominate, the 1 applied at the third bit position P₂, will be shifted to the left and the output will be a constant logic 1. If the pulses at f₁ and f₂ arrive alternately, then the 0 and 1 applied at P₀ and P₂ will be alternately shifted into bit position P₁, resulting in an output containing an alternating pulse pattern of 1's and 0's. The duty cycle of the pulse pattern will indicate the relative phase—or equivalent delay—between the two input trains of the same frequency.

Appropriate filtering at the output provides a d-c level proportional to the phase difference between f₁ and f₂ when the two frequencies are equal. A maximum or minimum voltage indicates one of the other modes of operation.

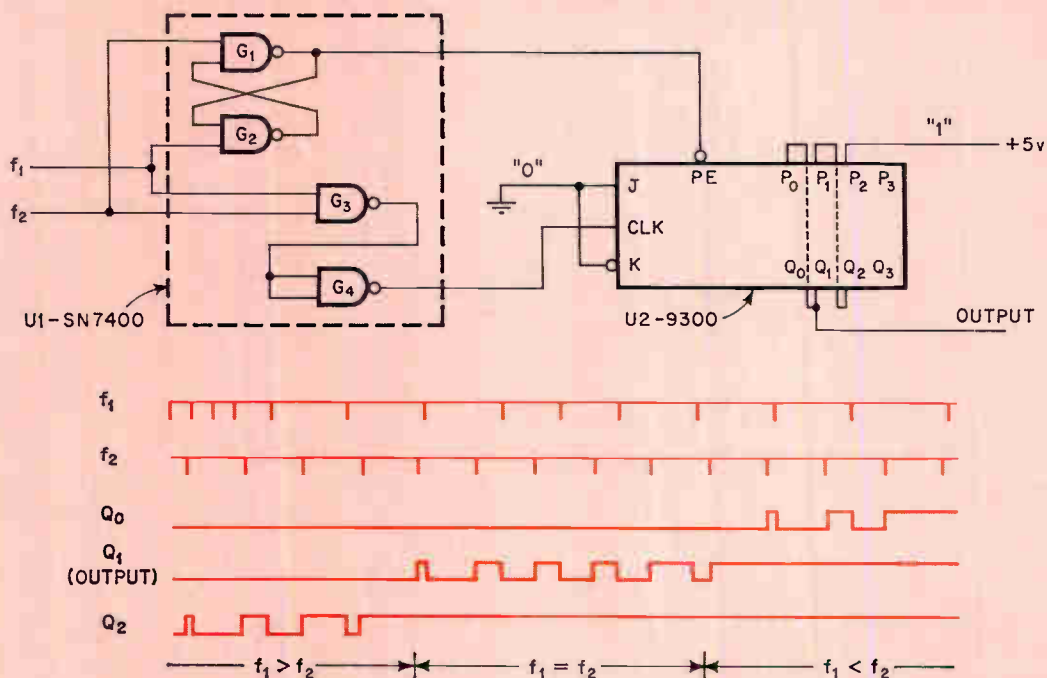

Right shift. The middle-bit position, P₁, of the shift register will alternate between logical 1's and 0's when the two input signals, f₁ and f₂, are equal in frequency. The duty cycle will be proportional to the phase difference between the incoming pulses.

IC line-receiver converts pulses to logic levels

By Ken Erickson

Interstate Electronics Corp., Anaheim, Calif.

When digital data is transmitted over long distances, use of transformer coupling is desirable for maintaining isolated signal grounds at opposite ends of the transmission line. But because the data is in true-and-false, constant-voltage, logic levels, the pulse transformers cannot handle this data format. Thus the data must be transmitted by short pulses accompanied by clock pulses. Because of differences in transmission line and driver delays, timing problems often ensue. However, a digital data line receiver using integrated circuits can convert the data and clock pulses back to the original data format of logic levels, while allowing a generous tolerance on the skew deviation between pulses.

The receiver is equipped for four input data channels and one clock channel, but can be expanded to handle more data channels. One 9300

register would be required for each additional four bits added. Each data channel contains an IC line receiver and a latch made with a pair of NAND gates that temporarily store the incoming data. Before a clock pulse arrives, all the latches are held in the reset mode by one of the complementary outputs of the 1-microsecond, one-shot multivibrator. The reset signal is removed when the one-shot is triggered. A latch is set whenever a data pulse is received on one of the input channels; otherwise the latch remains reset.

The 9300 register is clocked on the trailing edge of the 1- μ sec pulse from the one-shot, transferring the data stored in the latches to the register.

The two other one-shots in the circuit generate a 150-nanosecond output clock which is delayed by 800 nsec with respect to a change in the output data. The delay eliminates any race conditions between the clock and data outputs wherever the two signals are used.

The circuit receives four channels of data at a rate of 600 kilohertz with a nominal pulse amplitude of 5 volts and a pulse width of 300 nsec. The resistor R should have a value that matches the characteristic impedance of the coax or twisted-pair transmission line. The input threshold voltage is about 1.4 volts and is obtained by forward-biasing two 1N914 diodes.

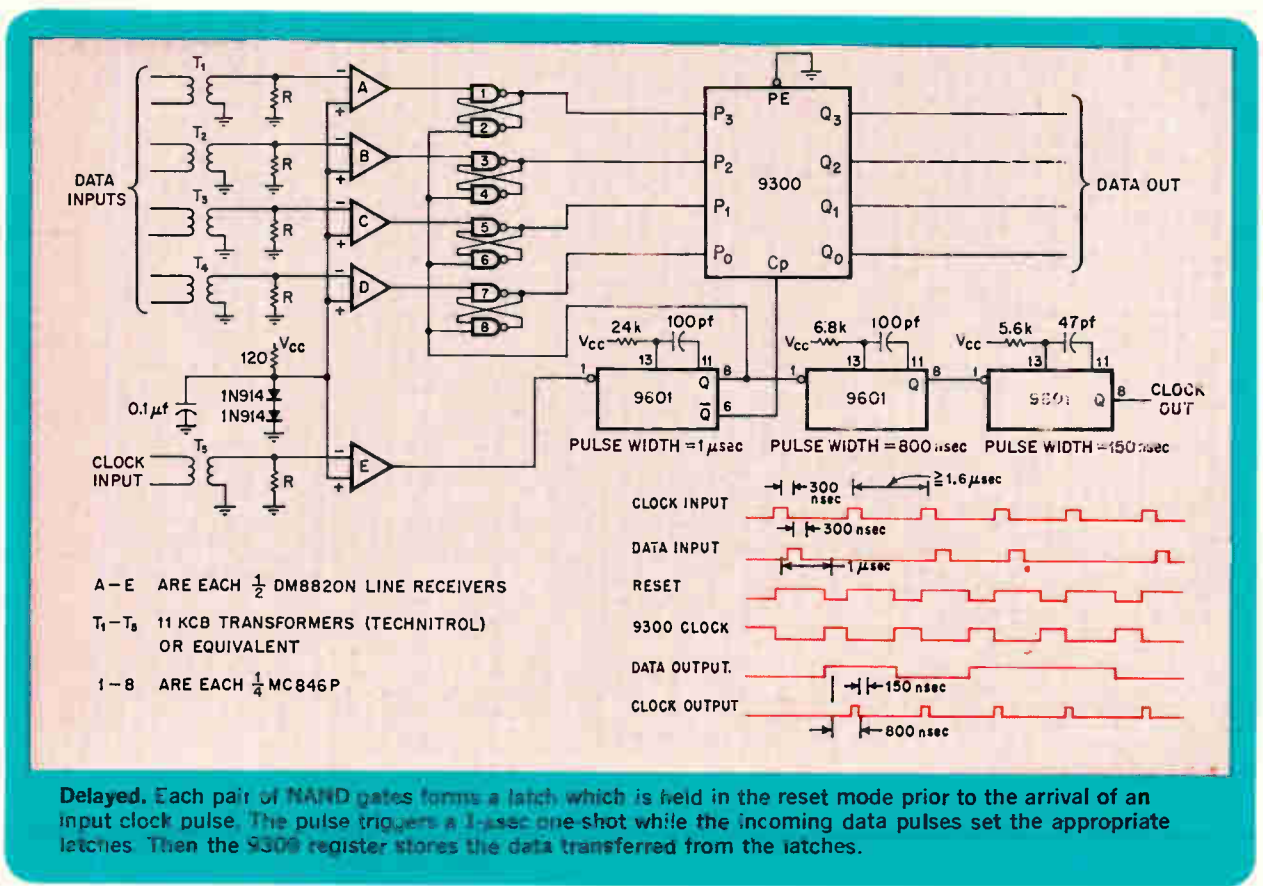

**NO
OPERATORS
WANTED**

Model 364 does it all

Place the PC board on any conveyor at your component inserting station... then hands off. "Fingers" on adjustable conveyor rails gently pick up any PC board or chip from 2" to as much as 24" wide, depending on model, and carry it through programmed foam fluxing, flux-drying, pre-heating, soldering and cleaning stations to deliver a perfect product every time.

Additional controls, instrumentation or modules can be applied readily to customize Model 364 to your exact requirements.

Model 364 is the ultimate in wavesoldering automation, truly representative of the engineering skill, ingenuity and craftsmanship that goes into every piece of Electrovert equipment. Yet, the simplicity of design reduces maintenance to an absolute minimum and virtually eliminates downtime.

Incidentally, if your operation does not require adjustable conveyor rails, Electrovert Model 346 will achieve the same automated precision at considerably less cost. Write for detailed specifications.

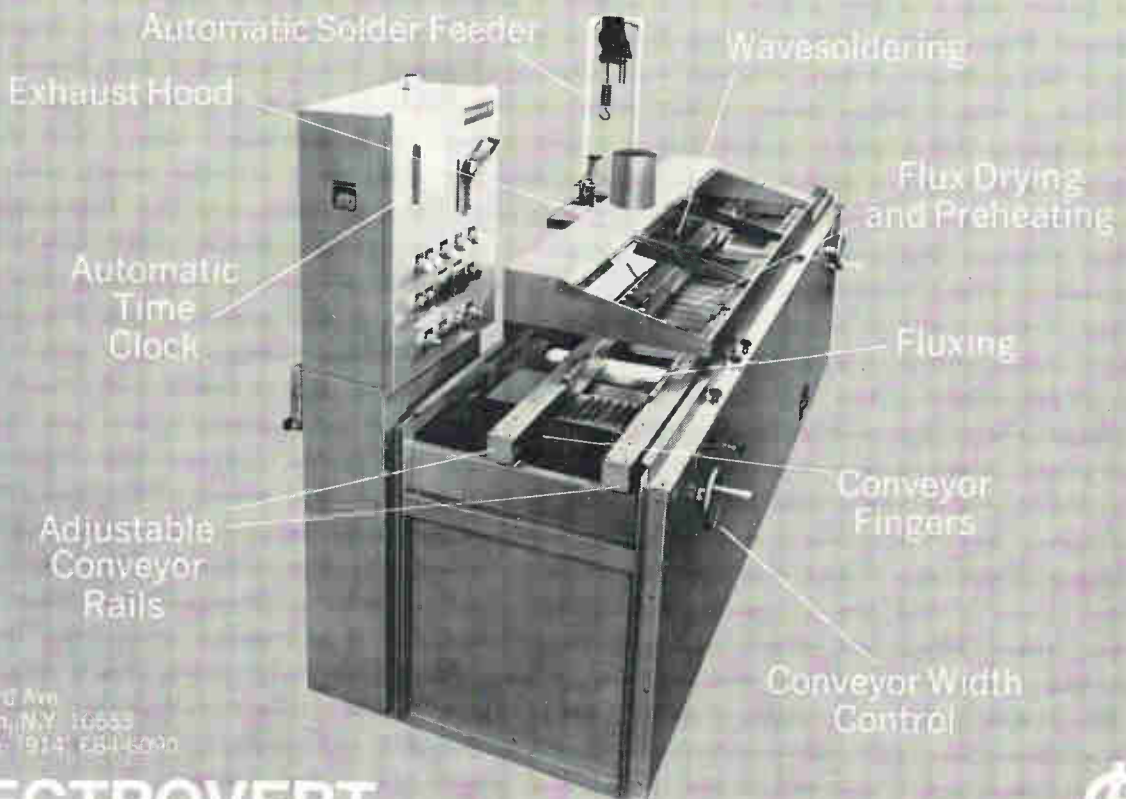

88 Hallford Ave.
Mt. Vernon, N.Y. 10553
Telephone: 914/684-6090

ELECTROVERT INC.



"See our exhibit at NEPCON WEST"

Seeing things in Paris

A half-dozen French groups involved in audio-visual aids — either as users or equipment makers — have banded together to mount an international salon that will have its premiere this year. There'll be a series of conferences on audio-visual aids plus an exposition of equipment: language laboratories, video recorders and closed-circuit tv, teaching machines, kits, and the like.

By the numbers in Zurich

There'll be special emphasis on computer applications at the Zurich digital-processing seminar. General papers presented at morning sessions will summarize the state-of-the-art; afternoon sessions will concentrate on reports of recent research in the use of digital computers and software to operate on analog signals.

Links to Rome

Telecommunications will be the prime topic at this year's electronics congress in Rome. There'll be four main themes: data transmission, switching networks, broadcasting, and land mobile telephone services. Most likely topics for the most lively debates are tv transmission by satellite—direct or indirect—and community antenna systems as general networks.

A round of Scotch

Lord Polwarth, who as head of the Scottish Council sparked a campaign that brought a thriving electronics industry to Scotland, will lead the Edinburgh symposium on electronics management and economics. There are six keynote themes: management of innovation, marketing, economics of production, management services, personnel and training, and the role of governments.

In the clouds at Cranfield

There'll be a look at aerospace instrumentation from both sides of the Atlantic at the Cranfield conference. In a session on American flight test data systems, W. J. Irwin of the Boeing Co. will talk about the hardware for the 747 jumbo jet. In a session devoted to European instrumentation, there's a paper on the Anglo-French Concorde, by T. T. Waters of the British Aircraft Corp. Other aircraft whose test hardware will get an airing during the eight sessions include the Dutch Fokker F-28, the Canadian CF5A, and the Franco-British Jaguar.

April in Paris

There'll be a three-ring circus as well as chestnuts in blossom for electronickers in Paris during the first fortnight of April. Ring 1 features an MSI/LSI seminar, sponsored by *Electronics*. It will put designers through three days of presentations and work sessions that will leave them equipped to handle MSI and LSI circuits as basic subsystems. In the center ring, there's the Salon des Composants, biggest of Europe's components shows. Third attraction is a four-day colloque that will cover advanced IC's, complex microelectronics systems, and computer-aided design.

Drawn to Uxbridge

Brunel University's 1968 symposium on computer graphics drew such enthusiastic crowds that its sponsors have increased the size and scope of both the technical sessions and the accompanying exposition. There'll be some 60 papers presented (compared to 17 last time), with special emphasis on industrial applications of displays. The number of firms exhibiting should double: 30 are expected.

Reading up on defects

In order to delve deeply into the subject, the physics department of Reading University plans to limit its seminar on defects in semiconductors to some 50 participants. The chosen few will learn about both point and complex defects, their interactions, their causes, and their effects.

London show

For British electronics, the Instruments, Electronics and Automation Exhibition is the greatest show on earth. The last IEA (1968) drew wares from 900 firms, which were scrutinized by 110,000 visitors. There'll be more of both this time around, plus private showings in hotels around Olympia Hall. They are held by companies—many of the American—that feel there's too much visiting and too little buying at the main show.

Signal conference

A wide review of processing methods for radio telephony transmission is on tap at this May London meeting. Among the topics: bandwidth reduction, power conservation, matching transmission to propagation path characteristics, digitizing and speech quality assessment.

Flying high in Toulouse

Space electronics experts from 10 countries will present papers at the International Federation of Automatic Control's third symposium, held this year in Toulouse. There'll be 25 Russian papers and 24 American ones. The 15 sessions will cover about everything that happens in a space mission after a vehicle goes into orbit. Some of the main topics: man-machine problems, docking, planetary exploration, attitude control, guidance and navigation, and reentry.

Electronics' guide

Major European shows and meetings January-June 1970

Full measure

There'll be considerable shuttling between the huge dome of the CNIT on the outskirts of Paris and the Versailles meetings hall during late May and early June. At Imeko V there'll be eight main subjects and they'll be covered by 176 papers by authors from 21 countries. Half the subjects are particularly electronic. They are: data-acquisition systems, new instrumentation components like lasers, environmental problems with instruments, and industrial applications of vhf measurements. Meanwhile, back at CNIT, there'll be a display of test instruments, data-handling equipment, automation equipment, and measuring instruments put on by some 1,400 firms. About 100,000 visitors are expected. Anyone bothered by the traffic jams around the CNIT can head to Versailles and possibly learn how they'll be unjammed. From June 1 to June 5 there's a symposium on traffic control — on roads, rails, air lanes, and waterways.

Major European shows and meetings January-June 1970

January

**Seventh Annual Solid State
Physics Conference**
January 6-8
Manchester University, England

February

**International Audio-visual
Aids Salon**
February 6-11
Parc des Expositions, Paris

March

Leipzig Spring Fair
March 1-10
Fairgrounds, Leipzig
East Germany

**Third IFAC Symposium—
Automatic Control in Space**
March 2-6
Palais des Congrès, Toulouse

**Seminar on Digital Processing
of Analog Signals**
March 11-13
Swiss Federal Institute
of Technology, Zurich

**17th International Scientific
Congress on Electronics**
March 16-19
Palazzo dei Congressi, Rome

**Management and Economics
in the Electronics Industry**
March 17-20
University of Edinburgh, Scotland

**Field-Effect Transistors
Conference**
March 17-19
University of Freiburg,
Freiburg/Breisgau, Germany

**6th International Aerospace
Instrumentation Symposium**
March 23-26
College of Aeronautics,
Cranfield, Berkshire, England

April

**MSI/LSI Circuits Seminar for
Equipment & Systems Designers**
April 1-3
Hotel Hilton, Paris

International Components Salon
April 3-8
Parc des Expositions, Paris

**International Colloquium
on Advanced Microelectronics**
April 6-10
Unesco, Paris

4th Thin Films Conference
April 6-8
Reading University, England

**Seminar on Defects
in Semiconductors**
April 13-17
Reading University, England

Computer Graphics
April 14-16
Brunel University, Uxbridge,
Middlesex, England

**Hanover Fair and
German Air Show**
April 25-May 3
Fair Grounds and Langenhagen
Airport, Hanover

May

**International Instruments,
Electronics & Automation
Exhibition (IEA)**
May 11-16
Olympia Hall, London

**Signal Processing Methods
for Radio Telephony**
May 19-21
IEE, Savoy-Place, London

Fifth Imeko Congress
May 25-30
Palais des Congrès,
Versailles, France

**Mesucora—Measure, Control
and Regulation**
May 27-June 4
CNIT, Puteaux (Paris)

June

**International Aeronautics
And Space Salon**
June 5-14
Torino Esposizione, Turin

Details on other side

Announcing two new standards of power supply engineering for laboratory, test bench and production



DC Power Supply Tester Model 1006

- DC and variable frequency floating electronic loads
- Tests transient response, regulation, ripple and impedance
- Loads from 0 to 10 A at 0 to 120 volts in 4 ranges
- Triangular and square wave current loading continuously variable from 100 seconds to 100 microseconds
- External modulation
- Meter monitors output voltage and load in all modes
- Scope output with selectable 50X and 1000X gain, 10 Hz to 1 KHz or 100 KHz bandwidth
- Scope sync pulse at either low-high or high-low transition
- Overvoltage and overcurrent protection with overvoltage signal lamp
- Size 8" wide by 5" high by 12" deep
- Price \$650



DC Power Supply Model 1004

- DC output 0 to 20, 0 to 50 and 0 to 100 volts at 0 to 4, 0 to 2 and 0 to 0.5 amperes
- Constant current or constant voltage operation in all ranges
- Digital indication of voltage settings
- Vernier output control to 0.5 mv resolution
- Overvoltage protection, with crowbar, continuously adjustable from 5 to 105 volts
- Temperature coefficient: constant voltage 20 PPM/°C; constant current 100 PPM/°C
- Ripple and noise: constant voltage 50 microvolts rms; constant current 75 microamperes rms
- Regulation, line and load, better than 50 PPM
- Size 8" wide by 5" high by 12" deep
- Price \$425

blp

B. L. PACKER CO.

5-05 BURNS AVENUE, HICKSVILLE, N. Y. 11801 ■ (516) 433-4470



Post-and-film memory delivers NDRO capability, low noise, high speed, but avoids problem of creep

Fixing one or two continuous films on a grooved ferrite wafer forms a batch-producible memory with paths for flux closure; *Robert F. Vieth* and *Charles P. Womack* of Litton Systems discuss the process in detail

● A hybrid technology has been devised that combines anisotropic thin-film and ferrite-core memory technologies. It grants a designer the advantages that thin films have over ferrite cores, such as batch fabrication, high speed, wide temperature range, capability for nondestructive readout, and low noise; but at the same time it overcomes thin films' disadvantages, such as close tolerances on drive currents and tendency to creep.

The memory produced by this technology, called the post-and-film memory, comprises either one or two continuous films atop a ferrite wafer that has two sets of closely-spaced grooves cut into it at right angles, thus creating an array of square posts that provide a path for flux closure, thereby preventing creep. Word wires are in the grooves parallel to the film's easy axis of magnetization; digit wires are in the orthogonal grooves. The one-film memory, shown below, reads data destructively, so that data read out must be regenerated for later use; the two-film version, on the opposite page, permits non-destructive readout (NDRO).

This design offers high reliability and wide operating tolerances, as well as manufacturing costs as low as 2¢ per bit. These memories also dissipate very little power, so that their drive and sense circuits can be built with monolithic integrated circuits. Their speed—250 nanoseconds in the current model—is limited more by their associated circuits and connecting transmission lines than

by an intrinsic characteristic of the memory elements.

Each ferrite wafer is one inch square and contains 64 grooves in each direction. The film stores one bit above each pair of groove intersections in the basic design; this density can be doubled by using one intersection per bit—straight digit lines instead of the U-shaped ones shown below—but the electronics costs more. Shortly, the designers expect a further increase in density; they plan to decrease the groove spacing and to use 2¼-inch square film substrates to achieve a 50,000-bit capacity per substrate.

Simple thin-film technology has significant advantages that are retained in the post-and-film approach:

▶ The array can be batch-fabricated. Other batch-fabricated memory forms have turned out either to have severe problems in development, or to be difficult or impossible to manufacture in quantity, or to pose operating or packaging problems due to magnetostriction.

▶ Like simple thin films, the post-and-film structure is potentially capable of 100-nanosecond cycle times.

▶ It is potentially capable of producing large output signals, which are possible for two reasons: first, the film's permeability is much higher than that of ferrite; and second, the volume of each film element is less than that of a core. Thus, the total magnetization is about the same order of magnitude.

▶ It can operate satisfactorily over a wide tempera-

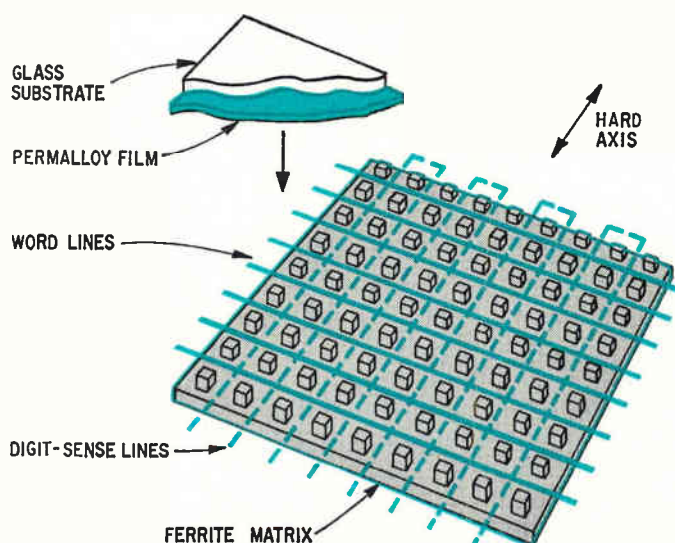

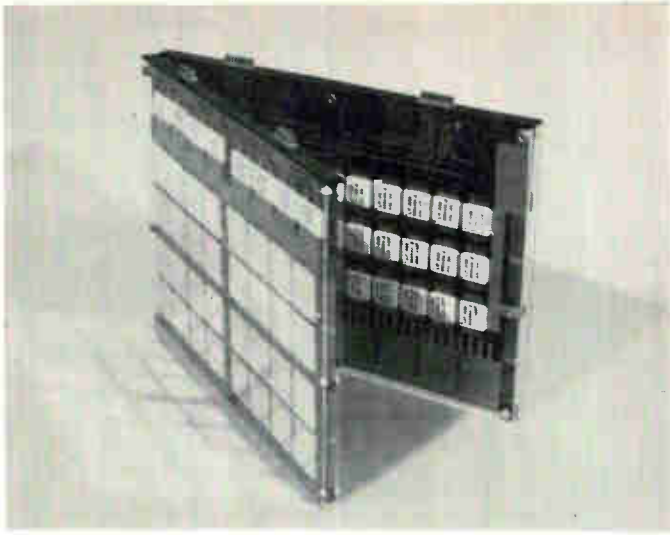

Open book. Current model of post-and-film memory has memory elements mounted on one side of base plate, electronics on opposite side; two plates, hinged together, close up for compactness, or open for maintenance.

ture range, because the film is made of materials that have high Curie temperatures and which therefore, retain their magnetic properties.

► It is capable of nondestructive readout, without maintaining tight tolerances on the drive current, as long as the film's magnetic hard axis remains unsaturated.

► The signal is inherently less noisy than that from a ferrite-core memory.

This noiseless operation is a critical factor in a memory's speed. In the presence of noise, the output signal has to be much larger or of a significantly different character from the noise in order to be distinguished from it, which tends to lengthen the cycle; and the noise generated during a given memory cycle must be allowed to die away before a new cycle can begin, otherwise the new output signal will be contaminated not only by its own noise but also by noise left over from a preceding cycle.

There are three reasons, or three and a half, for this nearly noiseless operation in thin films: first, a core, being much bulkier than a film element, necessarily has part of its magnetic material considerably more distant than other parts from the wire carrying the drive current. The more distant parts are subjected to weaker fields than the nearer parts, so that the core switches more or less gradually. This gradual switching generates noise.

Second, when the magnetization vector in a core switches, it does so all the way from a positive maximum

to a negative maximum relative to a particular reference, whereas a film switches from the positive maximum to zero as the vector rotates through a right angle.

Third, core arrays are usually wired with the cores at an angle to the wires, so that only a fraction of the applied field acts to switch the cores. The remaining component is parallel to the core's axis and therefore has no effect on switching.

The half-reason is related to this angular wiring; it's the fact that the sense wire is usually parallel to the drive wire, permitting a high degree of coupling from one to the other. In thin films the conductors are necessarily orthogonal to the storage elements and to each other, for maximum coupling to the elements and minimum coupling to each other.

These advantages in simple thin films are accompanied by a number of disadvantages, which have been overcome in the post-and-film technique:

► Unlike simple thin films, the post-and-film's NDRO capability resides in its structure—the two films set against the ferrite wafer—rather than in the control of its drive currents. Therefore, the tolerances on these currents can be much looser in post-and-film than in simple thin films. The latter require such tight tolerances that, in fact, they are rarely designed for NDRO.

► In the post-and-film technology the flux paths from the film, which stores the data, close in the ferrite posts,

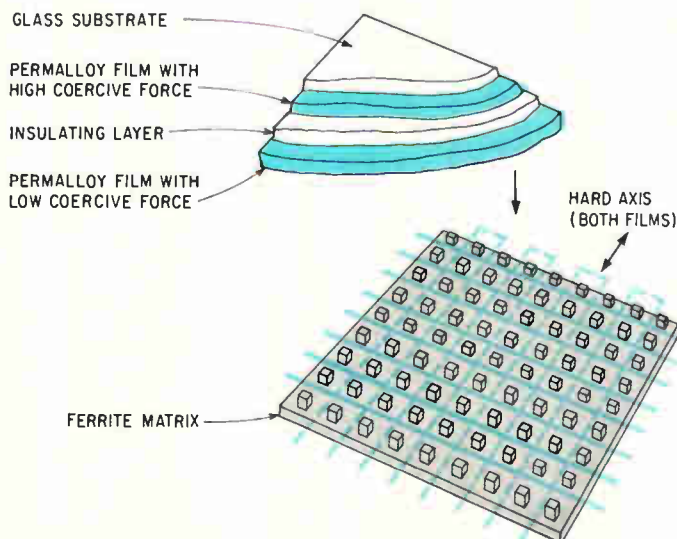

Two versions. In the one-film version of the post-and-film memory (far left), data is stored in film, read and written with the aid of wires laid in the grooves between the posts. In the two-film model, flux from hard film restores data in soft film after reading, thus permitting nondestructive readout.

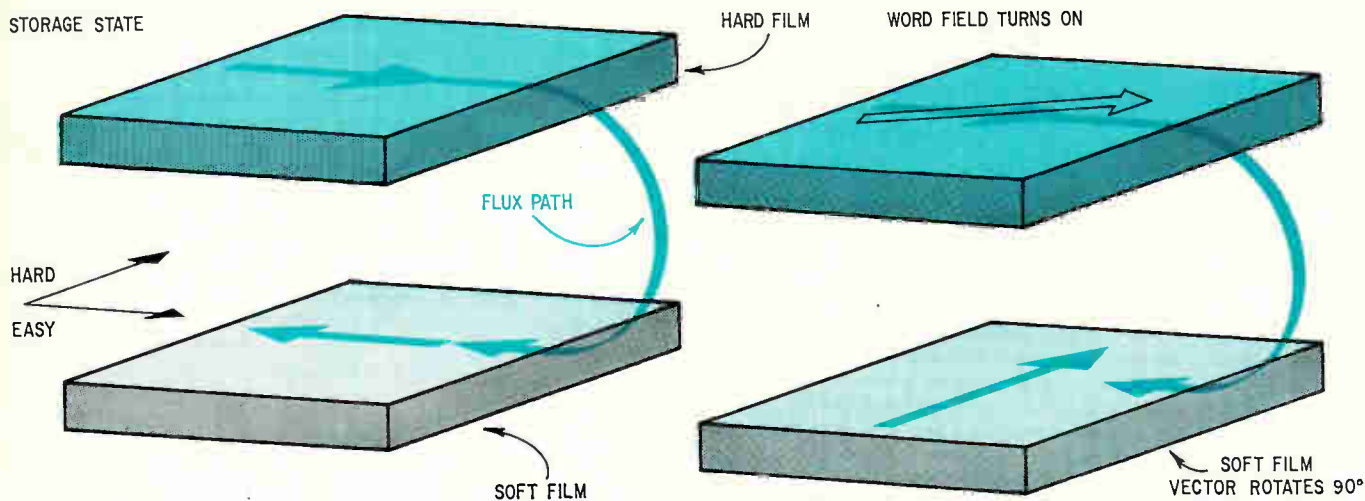

as shown below. This control of the flux also enhances the output signal. In simple planar thin films, the flux paths close in air, so that the magnetic patterns representing stored data are subject to creep, a phenomenon caused by repeated reading and writing at one location, which tends to affect the data stored in nearby locations.

Various artifices have been employed to avoid this difficulty. One strategy uses a coupled-film design, in which two film spots on separate substrates are placed face to face to provide a flux path entirely within magnetic material except for a small air gap separating the two films; this gap is established by the drive lines passing between the films. Another approach would be to use a keeper, which is a slab of ferrite or other magnetic material placed over an array of film spots or a continuous film. It specifically provides a closed flux path. In a way, the post-and-film memory is an extension of the keeper concept. Almost all planar thin film designs utilize one of these or a similar strategy.

►The films in the post-and-film structure are plated in an electron-beam evaporation process, in which only three parameters must be controlled: the substrate temperature, the melt composition from which the evaporation takes place, and the thickness of the evaporated film. Many ordinary thin films are electroplated. This process is difficult to control because it involves many variables: the temperatures of the various solutions, the plating

current, the substrate's surface roughness, the magnetic field in which the plating takes place, and many others. There is no one-to-one correspondence between variations in any of these parameters and variations in some specific quality of the plated film.

Development of the post-and-film memory was initiated at Litton as an in-house research project, and is being continued for the Naval Air Development Center under contract N62269-69-CO239.

The single-film version of the post-and-film memory operates in much the same way as simple thin films. When a saturating field is applied at right angles to the single film's anisotropic easy axis, the magnetization vector rotates to align itself with the field. Removing this word field permits the vector to rotate back to the easy axis. It may rotate back in either direction; a small digit field parallel to the easy axis "tips" it back toward the proper direction before the word field turns off.

A current in a word wire parallel to the easy axis generates the word field; a digit wire at right angles to the word first carries a readout pulse generated by the magnetization vector's rotation, and then carries a current to generate the digit field. This is the method used to write new data in thin film and regenerate old data following a destructive readout.

All simple thin-film memories operate this way. Without the small restoring field following readout, the vec-

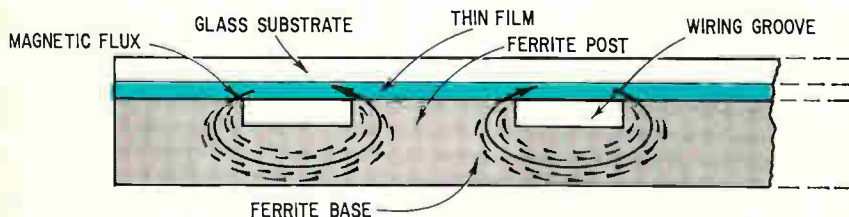

Closed path. Flux lines from magnetic storage elements close in ferrite posts, for high reliability at low cost.

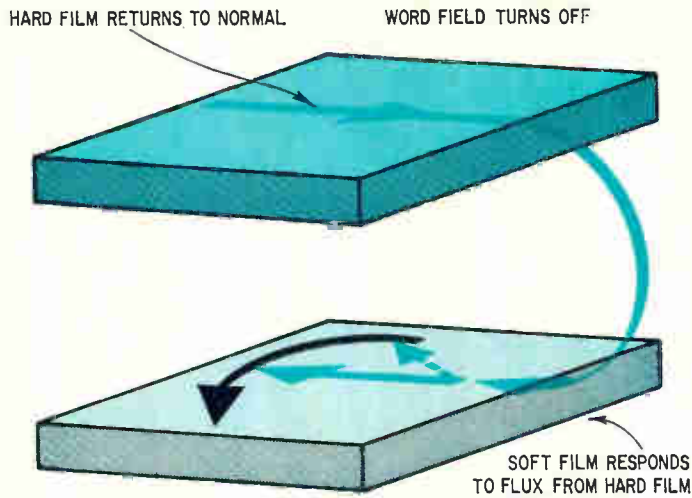

Turn vs. twitch. Flux lines of data stored in two magnetic thin films close within the films (left). But a word field large enough to saturate the soft film in its hard direction (center) has hardly any effect on the hard film. As a result, the hard film restores the magnetization in the soft film (right) for nondestructive readout.

tor would drop back to the easy axis in either of two directions, at random, and the stored data would have been destroyed; in this case, readout would be destructive. For NDRO, the vector would have to rotate far enough to generate an adequate output signal, but not so far that its dropping back to its original orientation can't be guaranteed; this requires impractically precise word currents.

The principal advantage of the post-and-film memory over simple thin films is its flux closure in ferrite rather than in air.

In the double-film version, one of the films is "hard"—that is, it has a much higher coercive force than the other, so that it requires a much stronger external field to significantly affect its magnetization. A small read pulse in the word wire rotates the magnetization in the "soft" film to read out the data, while having only a very small effect on the magnetization of the hard film. When the read pulse turns off, the magnetization in the hard film drags that of the soft film back to its previous orientation, without the need for an external digit field, as shown above. To write new data in the double-film memory, a much stronger word current rotates both the hard and soft magnetizations.

This description ignores the effect of the ferrite posts on the flux paths. Because they provide low-reluctance paths for the flux, the posts bend the magnetization away

from true alignment with the easy axis, as shown below, but the memory operates essentially as described.

Currents for the post-and-film memory are only 40 and 250 milliamperes in the digit and word lines respectively—as against 125 and 800 ma for plated wire or 300 and 800 ma for ferrite cores. A memory of 8,192 words of 16 bits each dissipates only 22 watts, compared to 70 for cores.

Three different batch fabrication techniques are applied in manufacturing the post-and-film memory. These are the film evaporation process, the ferrite base preparation, and the wiring of the array.

The film evaporation apparatus, shown on page 106, is basically similar to that used in the semiconductor industry and elsewhere; it contains an electron gun that shoots a beam of electrons down onto a water-cooled copper block serving as the anode. But sitting on the block in the path of the beam is a container holding a small quantity of permalloy, which melts at about 1,500°C under the electron beam's bombardment. Because the apparatus is evacuated, a significant vapor pressure quickly builds up, and metallic permalloy precipitates on the relatively cool substrates, which are mounted around the block but out of the beam's path.

The substrates to be coated with film are mounted in holders that have two pole faces and two field coils. These apply a magnetic field across the substrate while

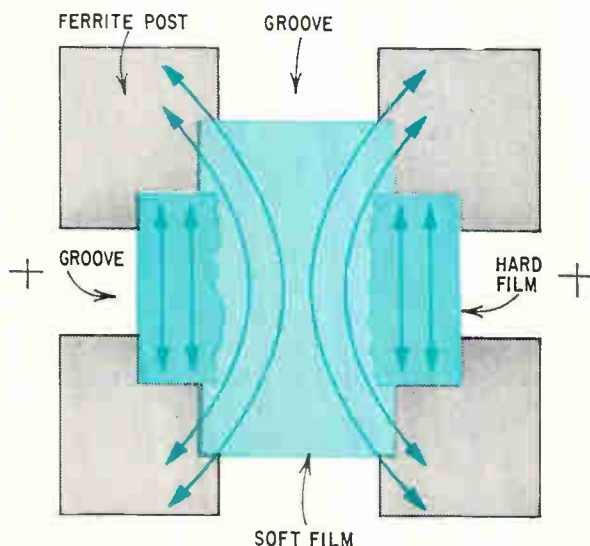

Curved axis. Ferrite posts, having much lower reluctance than air, distort the magnetic vector in the soft film, but without destroying its basic anisotropic character.

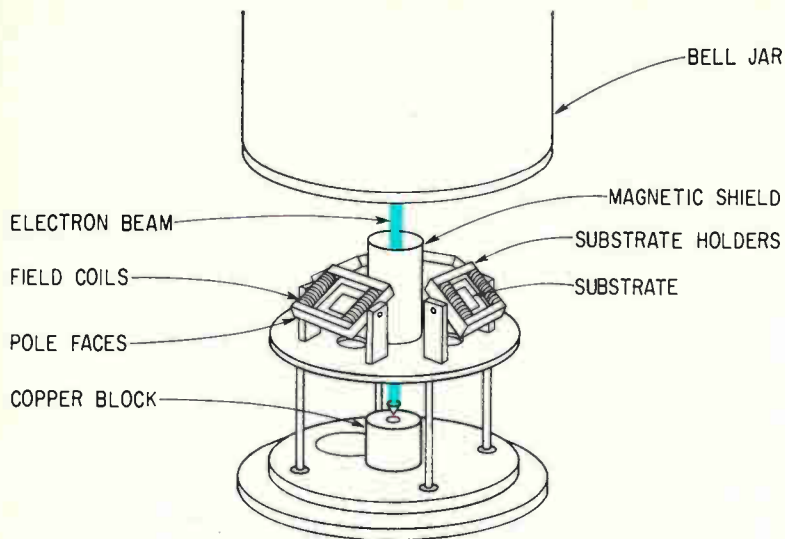

Evaporator. Electron beam (color) melts piece of permalloy on hearth; permalloy evaporates in vacuum, and vapor precipitates on relatively cool substrates.

the film is being deposited, to establish the direction of the film's easy axis. They are maintained at a temperature of about 400°C.

In the process currently in use at Litton Systems, four large substrates are coated in a single operation; each is 2¼ by 2¼ inches, thus containing enough surface to hold four of the inch-square ferrite wafers. Thus enough thin film is prepared with each evacuation of the evaporator, assuming 100% yield, to make 16 post-and-film memory arrays of over 2,000 bits each. The substrates are cut apart later to the smaller size.

Only two tests are required on the film. The films are not etched, nor do they age or deteriorate in any way as a result of mechanical or thermal stresses. As a result, their yield is indeed very nearly the 100% assumed in the preceding paragraph.

The ferrite bases are stamped out from powder in the same way as other ferrite components, and the grooves are cut in them using the same standard techniques as for dicing semiconductor wafers. There are two ways to do this: one method relies on a small circular saw with diamond teeth, and the other uses an oscillating wire and a slurry of abrasive material. Both techniques use several of these cutters ganged together, so that a whole ferrite wafer is grooved in only two operations, one for each orthogonal set of grooves.

The wires that thread the posts are preformed and drop

quickly in place. Although details of the preforming process are proprietary, in general, the conductor pattern is etched from a piece of copper-clad epoxy board, new layers of copper and insulation are then built up, and the epoxy is removed. This leaves a preformed structure that resembles a small piece of fine screen, and that fits over the ferrite wafer.

After the wires are in place, the ferrite wafers are attached to printed-circuit boards to which the wires are connected. Then the films, on glass substrates, are placed on the wafers, film side down; alignment isn't critical because the films are continuous. However, the film's easy axes must be closely aligned with the direction of the word wires; to achieve this the substrates are slightly rotated by hand until the output of a sampling of bits is a maximum. Because some of the thin-film elements may have easy axes with a certain angle of skew relative to the nominal easy axis, the substrates' final position may appear to be rather carelessly out of line with the wafers.

Finally, the substrates are thermally laminated to the ferrite wafers and the assemblies given a final test.

Repairs can be made at each of these stages, if necessary. For example, individual preformed wires can be cut out and replaced if faults are detected before the films are put in place. Even after the laminating step, the ferrite wafer with the film in place can be removed and replaced, if necessary. ●



Simple electroplating process allows high-density waffle-iron memory to be built easily, inexpensively

A thick-film layer atop a grooved ferrite block produces a memory whose performance approaches that for plated wires, say *Peter Langlois, Nye Howells, and Alan Cooper* of Standard Telecommunications Laboratories

● Another batch-fabricated memory superficially similar to the post-and-film memory [page 102] is the waffle-iron memory. Although it uses square wafers of ferrite, grooved to make an array of posts, it uses a one-layer film about 10,000 angstroms thick—perhaps two orders of magnitude thicker than Litton's film—that is magnetically anisotropic.

In the waffle-iron memory, shown below, each wafer has 5-mil grooves spaced 15 mils apart. The word and digit lines define a storage element at every pair of groove intersections—two intersections per bit. The storage density is thus very high; but even so, improved mechanical techniques, such as for grooving the ferrite wafers, could double the density.

One set of grooves contains the digit lines, which are U-shaped—they go “out” and “back” in adjacent grooves. The other set, at right angles to the first, contains the word lines, which are straight. Simultaneous word and digit currents magnetize the film over their two intersections diagonally from left to right, as shown on page 109, for either direction of digit current. In general, the digit current magnitude is smaller than that of the word current, so it doesn't destroy data in cells where no word current is present.

A reverse current in the word line, in the absence of a digit current, destroys this diagonal pattern and switches the flux to directly adjacent ferrite blocks, from

right to left. This switching generates readout pulses in the digit line; the readout is destructive. Nondestructive readout techniques are being developed, but are still experimental.

Design characteristics of a typical waffle-iron memory appear in the table on page 109, compared with a typical plated-wire design. The waffle-iron is easier to build, and therefore costs less, and its performance competes with the plated wire.

Fabrication of the waffle-iron memory occurs in three main steps; the ferrite preparation, the film and substrate, and the mating of the two parts.

Plates of ferrite are lapped flat to within 6,000 angstroms, or approximately one wavelength of visible light. Then they are grooved with a multiple blade cutter, polished to make a good mating surface, and cut into ¼-inch squares.

The storage film is electroplated on a metal substrate an inch square. Because the film is thick and isotropic, the plating process doesn't require the stringent physical controls used in most thin-film memories, the electroplating yield is very high.

These substrates have 16 times the area of the ferrite wafers. This is done to permit the wafers to be interchanged more readily; one-inch square wafers could be made just as easily as the ¼-inch square ones, and at about the same cost.

Continued on page 109

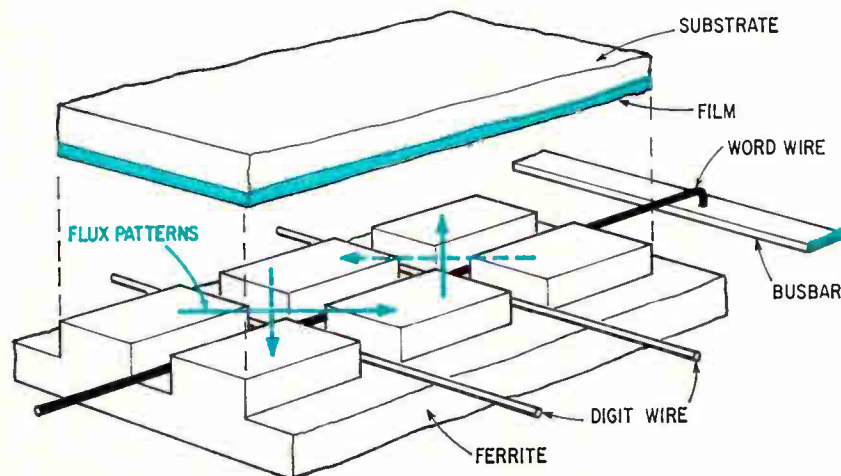

Groovy. Ferrite wafer has 5-mil grooves spaced 15 mils apart, to hold word and digit wires. Thick magnetic film on substrate laid over the grooves stores data, is switched by currents in the wires.

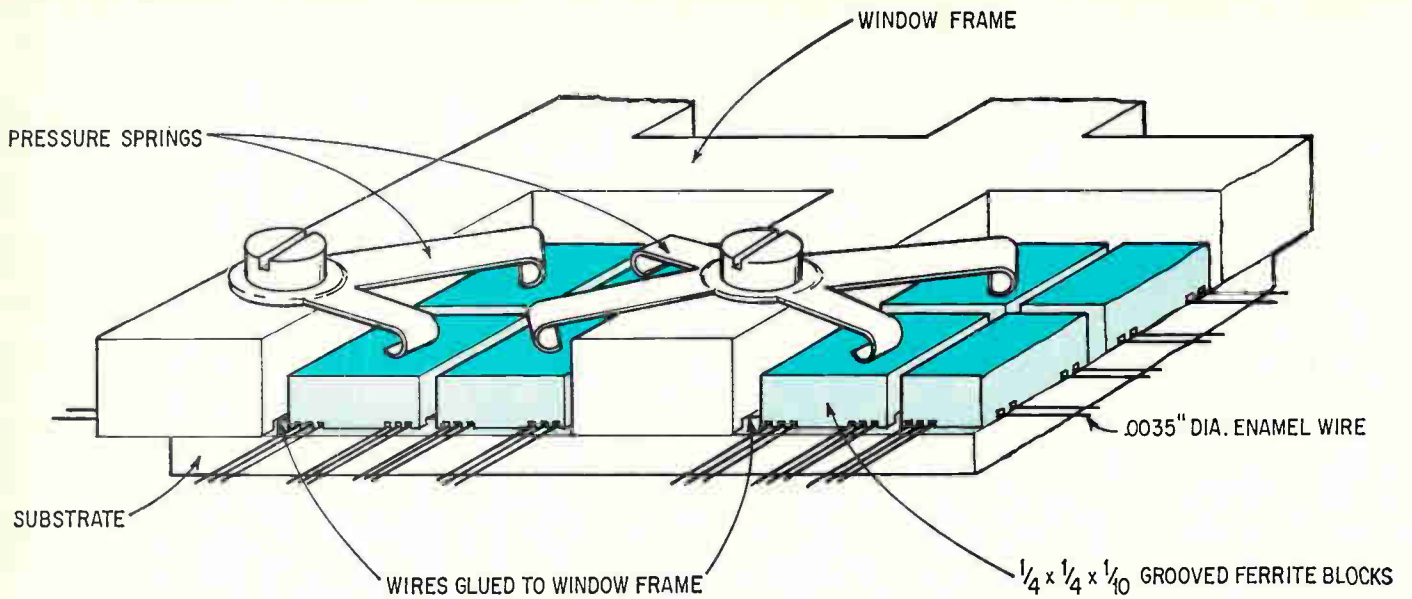

X-shaped clamp. Eight of the ferrite wafers are held in place in a frame containing word and digit wires by X-shaped spring clamps that permit individual wafers to be removed for maintenance and repair.

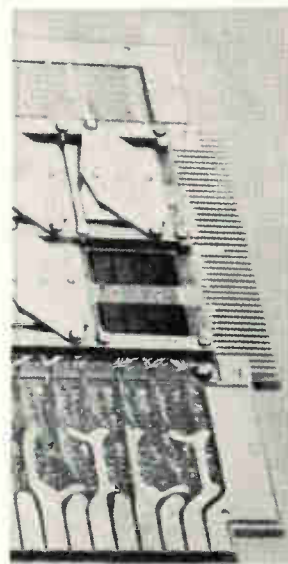
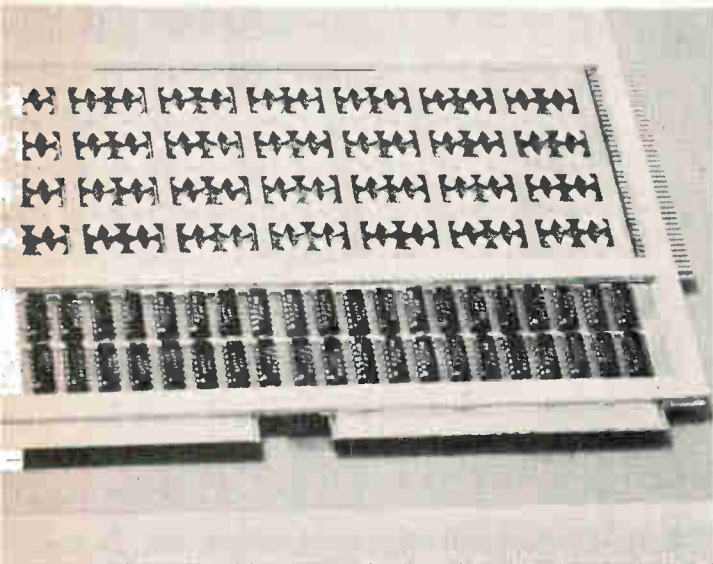

Working models. At far left is waffle-iron array storing 512 words of 64 bits each, showing spring clamps, and IC diode packages, 12 per chip. With hole-storage diodes, only one per word is needed, not two. Small photo shows reverse side of same array; diamond-shaped plates (one removed) hold film substrates. Below left is closeup of different array showing wires and ferrite wafers.

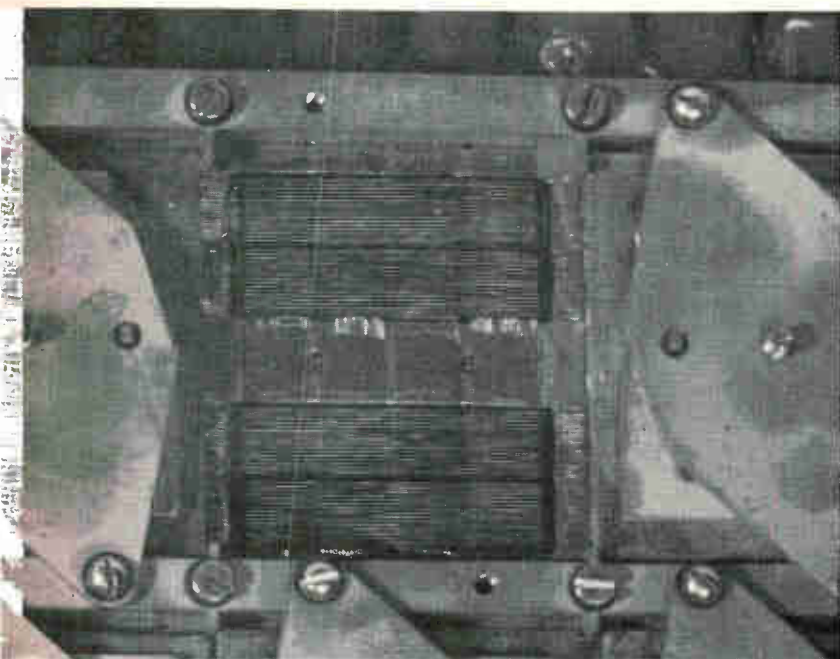

Different recipes for waffles

Besides the versions at Standard Telecommunication Laboratories and at Litton Industries, waffle-iron-shaped memories are also being worked on at a number of other places.

In Japan, at the government-owned Electrotechnical Laboratory, researchers are working on a version of the waffle-iron that uses plated-wire as the sense-digit line instead of plain wire [Electronics, Dec. 22, 1969, p. 167]. They do not use the overlaid thin film on top of the ferrite plate. And lukewarm efforts are said to have been made at a number of private laboratories, including those of Tohoku Metal Industries Ltd.

Performance comparison

| | Waffle Iron | Plated Wire |
|---------------------|-------------|-------------|
| Bits per sq. inch | 2,000 | 200-300 |
| Switching time | 25 nsec | 15-25 nsec |
| Word current, read | +500 ma | +500 ma |
| Word current, write | -180 ma | +500 ma |
| Digit current | ±80 ma | ±50 ma |
| Output | ±20-25 mv | ±8-10 mv |
| Capacitive coupling | 0.05 pf | 0.3-0.5 pf |

Continued from page 107

Word and digit wires are stretched over a 1-by-1/2-inch aperture in a frame, and bonded to the frame's sides. Into this window eight of the 1/4-inch ferrite squares are placed, so that the wires fit into the grooves. They are held in place by a simple spring clamp, as shown at left. The film on its substrate is secured on the underside of this assembly, against the ferrite and covering the grooves.

If necessary, for repairs or inspection, either the film or the ferrite can be easily removed. A single 1/4-inch square can be removed and replaced without disturbing its neighbors; the wires are kept in place by the other squares and the frame.

Skeleton models of memories as large as half a million bits—4,096 words of 128 bits—have been built; they achieved cycle times of less than 250 nanoseconds. A smaller memory of 256 by 128 bits has been completely assembled and is in satisfactory operation, and one of 1,024 by 64 bits is being tested. ●

This is the 15th installment, and the 35th and 36th articles, in *Electronics'* continuing series on memory technology, which began in the Oct. 28, 1968, issue.

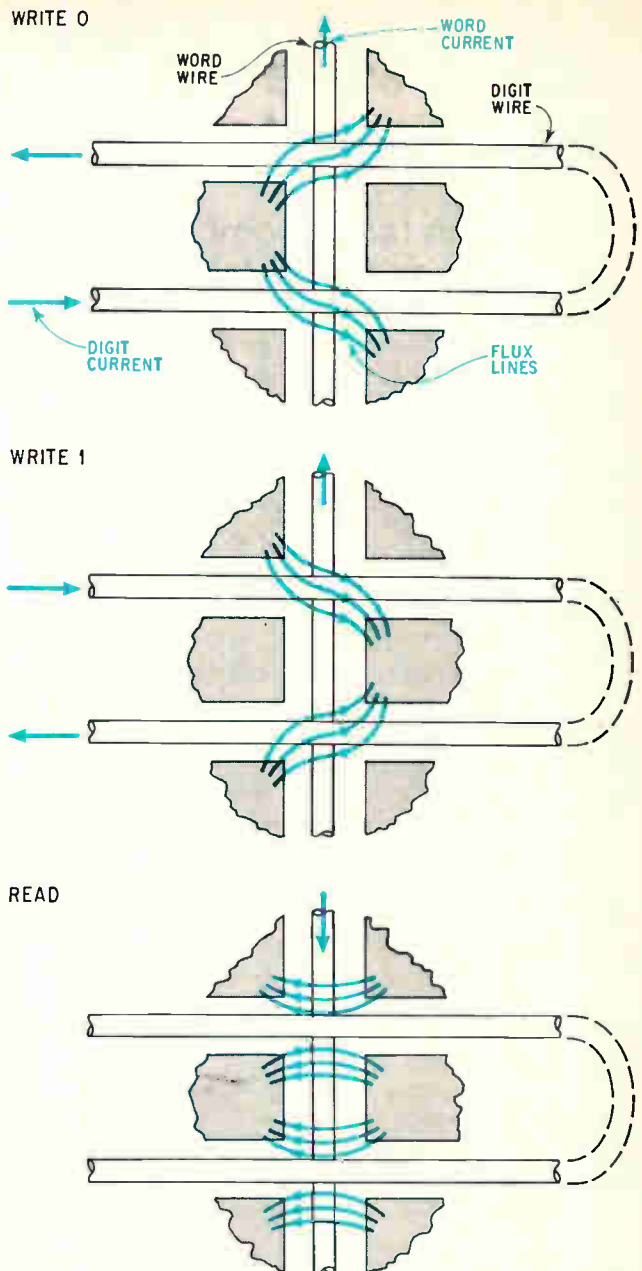

Catercorner. Flux paths in the thick film lie diagonally over the intersections of two grooves; two intersections store one bit.

At Thomson-CSF in France, two versions have been developed. One of these resembles Litton's two-layer post-and-film memory; the company is shooting for a 72,000-bit production prototype sometime this winter, with a 100-nanosecond cycle time.

The other is a read-only memory in which squares are etched out of the film wherever a binary 0 is stored; the memory can hold microprograms, mathematical tables, a cathode-ray tube character generator, and so on. A 16,000-bit prototype has been built, with an access time of 55 nsec.

At Iowa State University, in Ames, Iowa, researchers under the direction of A.V. Pohm are working on a similar idea using, instead of the waffle-iron

plate, a fabricated keeper formed by pouring a slurry over an array of wires and letting it dry. The wires are either plated wires—cylindrical thin films—or the drive and sense wires for a planar thin film. The slurry is made of powdered magnetic material of low permeability dispersed in an organic solvent, which dries by evaporation.

At AC Electronics, a division of the General Motors Corp., some work was done a few years back on what its designers called a waffle-iron memory, but it was different from the waffle-iron memories which used film structures. It was a read-only memory comprising a grooved ferrite plate, drive and sense lines in the grooves, and iron slugs on a printed-circuit card

to complete the flux paths across the intersections of the grooves. The slugs lay in either of two diagonal directions, thus coupling from the drive line to the sense line in either of two polarities, corresponding to 1's and 0's.

Bell Telephone Laboratories did most of the original work on waffle-iron memories in the United States. But it got the idea from a Philips Gloeilampenfabrieken patent on a method for batch-fabricating core arrays. Philips used a flat ferrite slab across the top of the ferrite waffle-iron to complete the flux paths around wires in the waffle-iron grooves. Bell Labs discontinued its waffle-iron work to begin plated-wire investigations—which it has now also discontinued.

Surface wave delay lines promise filters for radar, flat tubes for television, and faster computers

Advances in technology can open up broad spectrum of new applications; *J. H. Collins* and *P. J. Hagon* of Autonetics tell how surface waves decode signals, compress and expand waveforms, and modulate beams of electrons

● Still a brand-new technology, surface acoustic waves have progressed from simple delay lines to sophisticated signal processing functions. As the technology developed, so did methods of manipulating signals during the delay. For the first time acoustic resonators, couplers, and signal routing guides became feasible for signal processing on the same substrate.

Yet the more difficult but more useful processing functions, such as tapped delay lines leading to analog matched filters, and pulse expansion and compression for chirp radars, had to wait for a more advanced acoustic technology—new methods of acoustic transduction and acoustoelectric amplification, and new materials with greater electromagnetic acoustic coupling and lower transmission losses. This work has now reached the point where surface acoustic wave technology is ready for advanced applications.

The most important property of surface acoustic waves for tapped delay lines leading to analog matched filters is accessibility to tapping at any point between input and output transducers. Since a signal can be stored in the line for a time equal to the total delay, this tapping capability allows signal-sampling at many points at the same time. Once the signal is tapped and sampled it can be compared to other signals from different parts of the system, or it can be instantaneously compared with different sections of the same signal.

And since coded incoming signals must be compared either to a standard decoding program or to another signal stored in the system, signal manipulation becomes essential in extracting information from, or decoding, incoming signals.

Analog matched filters are important in the decoding process, especially when the system must handle the complex signals used in today's radar, communication, and navigation systems. Specifically, these filters are required to pass only the signal bearing the information and reject all others. This task, however, is quite difficult.

Usually the received information, impressed on a carrier by phase, amplitude, or frequency modulation, always is corrupted by random fluctuations in phase and amplitude from the transmission medium—either cable or atmosphere—and further deteriorated by noise in the initial stages of the receiver. Furthermore, operational military systems may have to contend with jamming signals.

Just how complicated the decoding process can be may be seen from the waveform shown in the figure below, which is a typical output of a receiver after undergoing the initial stages of mixing and i-f amplification. Clearly for this type of transmission the signal must be differentiated from the noise. For radar this means determining which is the return echo; for communications, which information bit is present.

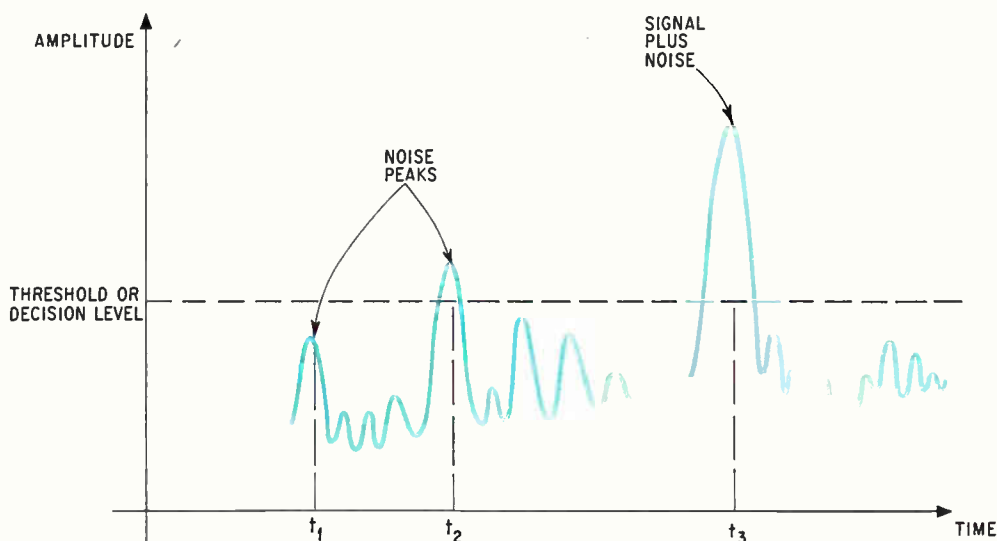

Coded waveform. A matched filter extracts the desired information from this sketched portion of a radar waveform by giving a signal at information point t_3 only, and rejecting noise signals at points t_1 and t_2 . Setting the threshold level high enough to eliminate all noise peaks introduces the chance of losing an information point.

Many low-level noise pulses could be removed simply by setting a threshold or decision-level device to give an output when a pulse amplitude rises above threshold, and to ignore lower amplitudes. But often a noise pulse as well as an echo pulse rises above threshold, resulting in a false output. Raising the threshold level to eliminate all false outputs undoubtedly will cause some true signals to fall below the threshold and be lost.

This problem is common to all radar and communications systems operating at maximum range or where strong interference—random or jamming—is present. The solution is a matched filter, which is matched to the expected input signal so that useful signals aren't lost and no false alarms are sounded. In effect, the filter must maximize the signal-to-noise ratio.

But the matching must be done in a very special way. Analysis of white noise present in these types of signals shows that proper matching will occur when the impulse response of the filter is the time-reversal of the received signal. And since a variety of signals are used in different systems, the structure of surface-wave matched filters can vary considerably. A matched filter for a biphas-coded continuous waveform—that is, a waveform that changes its phase by 180 degrees at a specific time—could be a tapped delay-line structure with, say, 50 constant-period taps. On the other hands for the linear f-m waveform of a chirp-radar system, the

matched filter would consist of two transducers with a graded periodicity.

Matched filters for biphas coded c-w signals can be built using tapped delay lines consisting of an input-output interdigital-transducer pair and intermediate-placed single finger-pair taps separated by a distance corresponding to a particular surface wave delay. When a coded waveform enters this delay line from the input transducer, it proceeds through the series of intermediate taps, shown in the figure below along with the input transducer. Waveforms of the first and second bits of the code are shown at a particular time in relation to the position of taps 1 and 2.

In this code, both bits, and every subsequent bit, consist of four cycles of the carrier frequency with a duration or bit time equal to the time between taps. As the signal proceeds, the output at tap 1 is $(A + N)$, where A is the information part of the signal, and N is the noise. Further, because of the tap spacing, the signal appearing at tap 2 is $-(A + N)$. The polarity of this signal, however, can be inverted by reversing the tap connection, and its contribution is $-[-(A + N)]$ or $+(A + N)$, the same as from tap 1. When both contributions are added from tap 1 and 2, because the information-bearing parts of the signal are exactly in phase, they will add coherently, increasing by a factor of 2, while the noise contributions, being random, add in-

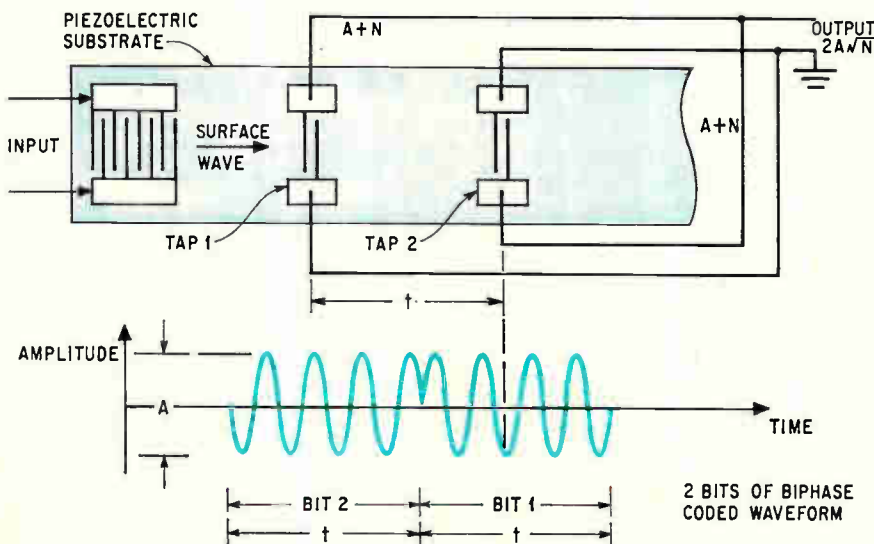

Enhancement. Because the information amplitudes, A , are coherent and add in phase at each tap (two are shown along with a portion of a coded signal) while the random noise, N , adds as the square root, signal to noise enhancement is obtained at the end of the line. Errors in tap spacing—spacing is critical and equals the bit distance—lead to errors in phase which degrade the summed signal.

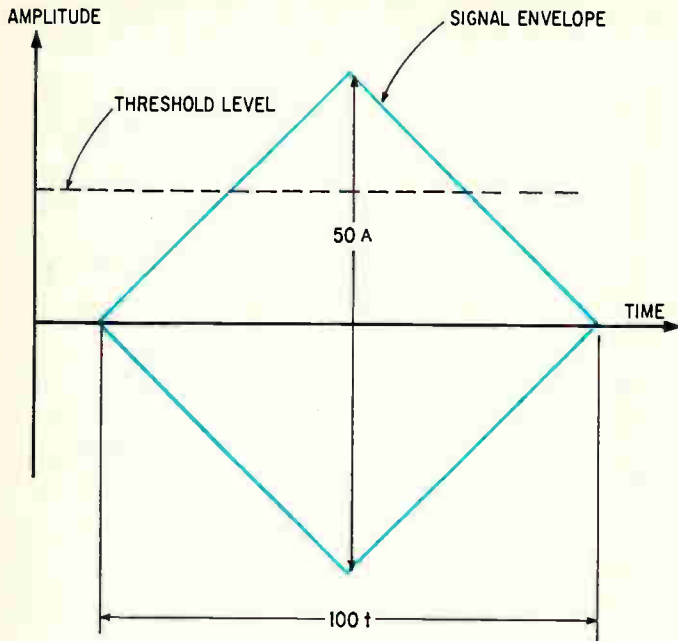

coherently, increasing only by a factor of $\sqrt{2}$. In short, the addition from both taps is $2A + N\sqrt{2}$. The result is that the signal-to-noise amplitude ratio from two added taps is $\sqrt{2}$ times the signal-to-noise amplitude ratio from a single tap. And most important, for a 50-tap line, the added signal at the end of the line is $50A + N\sqrt{50}$, an output signal-to-noise power ratio improvement or "processing gain" of 50:1 over a single tap. All 50 taps add in phase at each bit time, so as a 50-bit signal passes through the line the summed output will increase by A at each bit time, and after a time $50t$, bit 1 will coincide with the 50th tap. At this point the summed signal amplitude will be $50A$. The signal then will drop to zero after a further time $50t$ as the coded waveform exits.

Although the signal-to-noise ratio is vastly improved by a 50-tap matched filter, the envelope of the output signal will be spread out, that is, some uncertainty will exist in the actual time the output crosses the threshold. To overcome this problem, a code must be used that allows positive and negative phase signals from taps to cancel each other at all points except when the 50 signal bits are opposite the 50 taps. Then the peak, still occurring at $50t$, will rise from 0 to $50A$ in one bit time, giving much higher time accuracy. This allows for accurate synchronization of the receiver for efficient decoding of following signals. By choosing a code such as the Barker code, used where high data solution is required, the time sidelobes can be reduced to amplitudes appreciably less than the $50A$ of the main peak. Thus the tapped delay line provides both signal-to-noise ratio improvement and decoding functions.

The delay line can also produce codes. If for example, a single 4-cycle bit of duration t is applied simultaneously to all 50 taps connected together in a specific polarity or biphase code, a 50-bit code of duration of $50t$ will emerge from the input transducer. Thus with this line a single bit can be encoded into a 50-bit biphase coded waveform and then be transmitted. A receiver with an identical tapped delay line can decode this signal, retrieving the original information bit with high accuracy. Comparable accuracy can be obtained by transmitting the information bit at 50 times the power level needed for the coded waveform. Thus the coded waveform technique allows peakpower to be much lower within a given

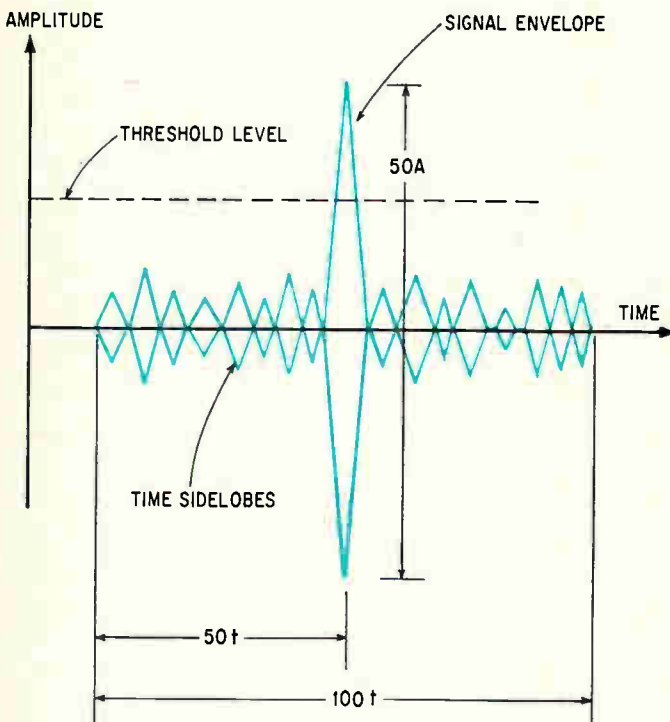

Reducing code. Although enhanced in amplitude (top) a summed filter output has a broad envelope equal to the total time in the line. To overcome the resulting uncertainty, a code is used that cancels the signal at all times except when bits coincide with taps, thus reducing the rise time (bottom) to one bit time.

Communicating

There are many codes used in radar. A common one is the Barker code, frequently used where accurate, unambiguous time synchronization is required. A biphasemodulated c-w system, it consists of coded pulse sequences impressed at fixed intervals on amplitude, frequency, and phase of a coherent c-w carrier.

Consider a seven-bit Barker code with four cycles per bit. The coded waveform, representing a single information word which contains seven bits, requires a matched filter that can give a single, unambiguous output when the waveform passes through it. This output, which is the initial decoding stage, is an information bit ready for subsequent process. Therefore, a seven-bit Barker code can be used to encode a single information bit into a seven-bit biphasemodulated signal, which can be transmitted, received

and passed through a matched filter to retrieve the original information bit with high certainty.

Under the decoding arrangement, a matched filter is designed for the seven-bit code by depositing seven interdigital transducers on a surface acoustic-wave delay line between the input and output transducers. The spacing between successive transducers must be four times the carrier surface acoustic wavelength to achieve coherent addition of tap outputs.

Phase reversals at specific taps also are necessary for coherent signal summation. These reversals are chosen for the first, third and fourth taps, because at these points the signals are 180° out of phase with signals from the second, fifth, sixth, and seventh taps. Further flexibility in phase reversals can be attained by reversing tap connections.

The output of the delay line, as the coded waveform enters and passes through, consists of a series of six signals—one signal per bit period—with amplitude alternating between 0 and $-A$, where A is the amplitude from one tap. When bit 1 arrives at tap 7—the tap closest to the input transducer—a signal of $-A$ is obtained from the summed output. One bit-time later, bit 1 is at tap 6, giving an output of $-A$; simultaneously, bit 2 is at tap 7 giving an output of $+A$. This cancels the $-A$ to give a net output of zero. Adding and cancelling continues until, during the seventh bit period, the amplitude is 7 times A , obtained when the output of all seven taps are adding in phase. This is followed by six further bit periods with amplitude of 0 or $-A$; thus one distinct output corresponding to the information bit is obtained.

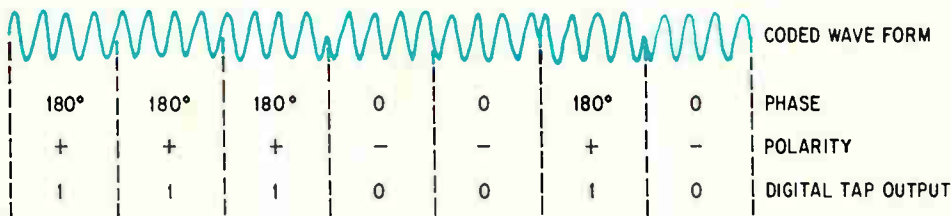

Good timing. This 7-bit Barker-coded biphasemodulated carrier with four carrier cycles per bit is used in radar systems where accurate time synchronization is required.

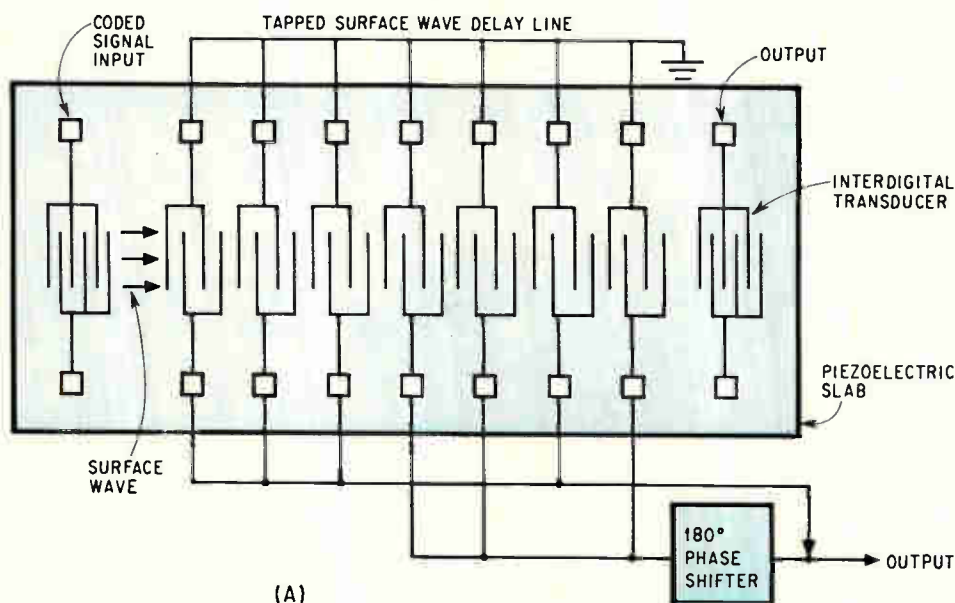

Bit by bit. This schematic of the 7-tapped surface wave delay line will decode the above 7-bit waveform by the method of biphasemodulated correlation. The output waveform shows the desired information extracted in the 7th bit.



Tapped for Radar

Long radar codes need multiple-tap, matched-filter delay lines in which the number of taps equals the bit capacity. One example is an YX quartz, 11-tap line designed for a 150-megahertz carrier frequency. Tap spacing is 0.125 inch, corresponding to a 1-microsecond time interval, or 151 wavelengths. This matched filter can handle 11 bits at 1-Mhz bit rates. It has a -3 decibel bandwidth of 6 Mhz, which results from the 24-finger-pair input interdigital transducer.

High-capacity delay lines require longer delays. To this end, a 50-tap line, the largest to date, has been fabricated on quartz. It's designed for future multiple access communication systems that require accurate and unambiguous synchronization of data streams. In this line the center frequency is 120 Mhz with a -3 db

bandwidth of 5 Mhz, determined by the 24-finger-pair input interdigital transducer. Tap spacing is 25 mils, corresponding to 200 nanoseconds or 24 wavelengths of the 120-Mhz carrier. This represents a 5-Mhz rate. The 3-finger-pair taps have a 40-Mhz bandwidth, each extracting 1/32,000 of the total acoustic power from the surface-wave beam as launched by the input transducer.

This acoustic-wave delay line was built into a flat package measuring $1\frac{3}{4}$ by $1\frac{1}{8}$ inches. Each tap was connected by wire bonds to one of the two sum lines (0° - 180°) deposited on a thin-film substrate.

Performance was tested with a 63-bit biphase code obtained by feeding a digital drive signal (1st trace) into the modulation port of a double-balanced mixer. A 120-Mhz c-w signal

also is fed into the mixer, resulting in a biphas-modulated c-w code with the phase, 0° or 180° , determined by the corresponding digital signal 0 or 1.

The 2nd trace, showing the summed output, is attained with the desired sharp correlation peak every 63rd bit when all 50-tap output add in phase. The summed-output correlation peak shown in the last trace has been expanded, indicating a 200-nsec rise time. Insertion loss from input to output correlation peak is approximately 16 db. Furthermore, the 75 khz 3-db bandwidth of the correlation peak is inversely proportional to the total delay time between the first and last taps. This means that doppler information is readily transmitted, because doppler frequency shifts in most radar system applications are significantly less than 37.5 khz.

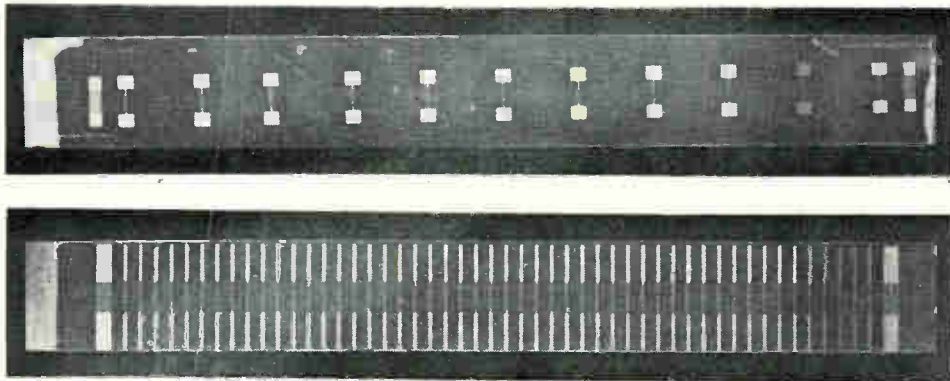

Long codes. These laboratory-fabricated matched filters can handle the complex codes of today's radar. Top, an 11-tap line designed for a 150-Mhz carrier with a bit rate of 1 Mhz. Bottom, the largest capacity to date, a 50-tap, 120-Mhz filter with a 5-Mhz bit rate.

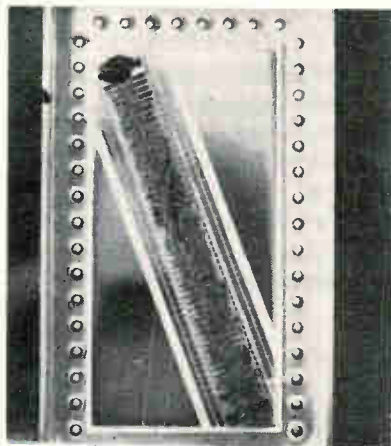

Tight fit. Fabricated in the lab, this new 50-tap filter makes a package of only $1\frac{3}{4}$ x $1\frac{1}{8}$ inches.

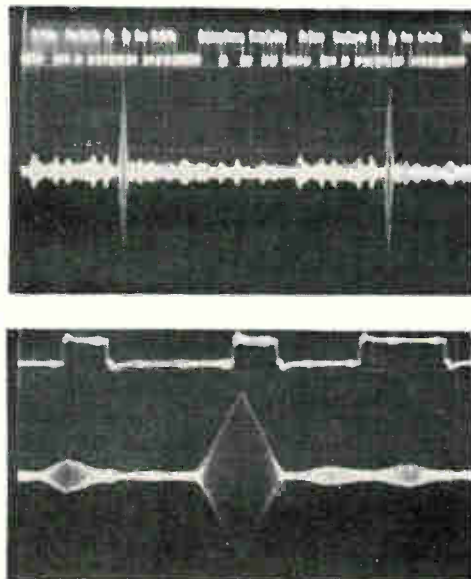

50-tap performance. First trace, the digital drive for the biphase modulator. The filter output with its sharp correlation peak is shown in the second trace after all 50 taps add in phase. Expanded in the last trace, this peak has a 200 nsec rise time.

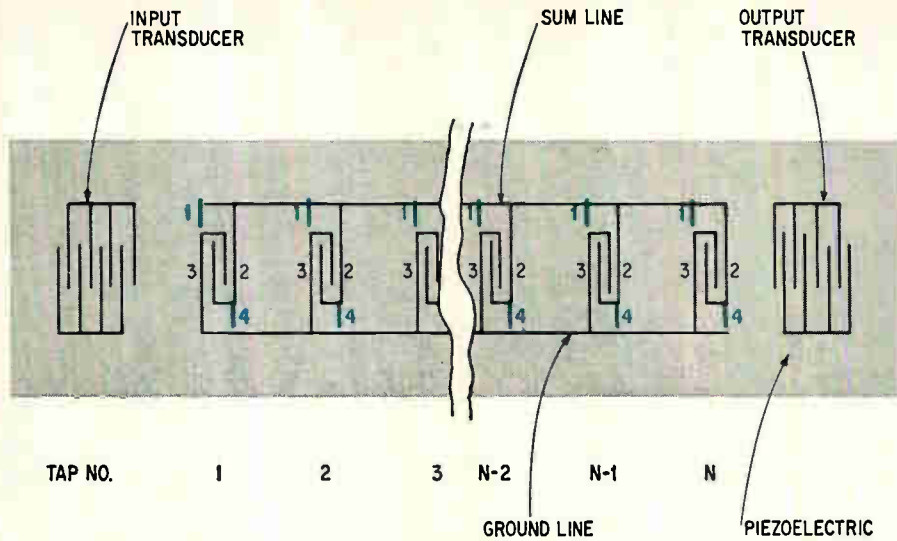

Burn program. Encoding an analog matched filter with N-taps so that each tap has a 0° or 180° phase to match its coded waveform can be accomplished by burning out lines 1 and 4, or 2 and 3, with a programed laser beam.

range, or a greater range for a given transmitter peak power, or a higher immunity to jamming for a given transmitter.

Tapped surface acoustic-wave delay lines have key properties that make them valuable for analog matched filtering. For one thing, they are ideal for processing biphasic coded c-w waveforms in the 50-500 megahertz range, which is well-suited for acoustic surface wave devices. For another they're linear processing systems with wide dynamic range. Data taken from an existing delay line using an interdigital transducer with 30 finger-pairs deposited on a Y-cut X-oriented quartz substrate at 100 Mhz show an insertion loss of only 10 decibels maintained over a range of inputs from 10 microvolts to 5 volts—a dynamic range greater than 100 db.

Further, these small, light, passive delay lines have high reliability and low projected costs, and the sum of these virtues adds up to an extremely attractive package for analog matched filter applications.

However, to accomplish the decoding with a minimum of error the delay line must be designed to meet certain critical line processes. For example, the input transducer impulse response must be matched to the bit period so that it will act as an efficient bandpass filter, passing all the useful signals while rejecting all unwanted signals and extraneous noise outside the band. Also, the time delay between taps must equal exactly

both the bit period and an integral multiple of the carrier period. When this is done all tap outputs sum coherently and signal-to-signal ratio is maximized.

Clearly the performance of these multi-tap delay lines depends critically on the accuracy of the tap placement. In fact, tap placement accuracy within ± 1 micron of required position, which corresponds to less than $\pm 14^\circ$ phase error, is needed for a line operating at 120 Mhz. Larger phase errors will cause partial cancellation between signals from different taps, resulting in consequent degradation of summed signal peaks and signal-to-noise ratio. However, standard photolithographic mask fabrication techniques common in microelectronic technology can insure this level of accuracy.

Temperature can present problems in these lines. For a quartz line operating at 120-Mhz carrier frequency, with a total delay of 10 microseconds at 3-db correlation bandwidth of 75 kilohertz, the frequency of the correlation peak increases at a rate of 28-parts-per-million per degree centigrade, representing a 3-db loss in peak amplitude for a 15°C temperature change. This problem can be eased by using a closely temperature-controlled ($\pm 1^\circ\text{C}$) enclosure of the crystal-oven type. It can be further reduced by using Z-propagating lithium niobate as the substrate material. This has one-sixth the linear thermal expansion coefficient of X-propagating quartz, and will not adversely effect acoustic propagation. With Z-propagation lithium niobate a control of less than $\pm 6^\circ\text{C}$ is required.

Multi-tap delay lines also require a large number of lead bonds, a potential cause of system failure. But there's a method to eliminate all but four of the bonds, that is 98 of the 102 leads required for, say, a 50-tap line. This involves running two parallel lines, each connecting all taps on a side, and each requiring only two lead bonds. One line serves as the sum line, the other the ground line. A programed laser-beam burn-out technique can then be used to give each tap connected with either the 0° or 180° phase required to match the system's coded waveform.

Multiple-tapped delay lines offer techniques for handling fixed codes; however, many applications require matched filters which can be rapidly set to different codes, and these will require microelectronic circuitry, such as low capacitance diode switches, to switch the tap coding of a fixed multiple-tap surface wave delay line

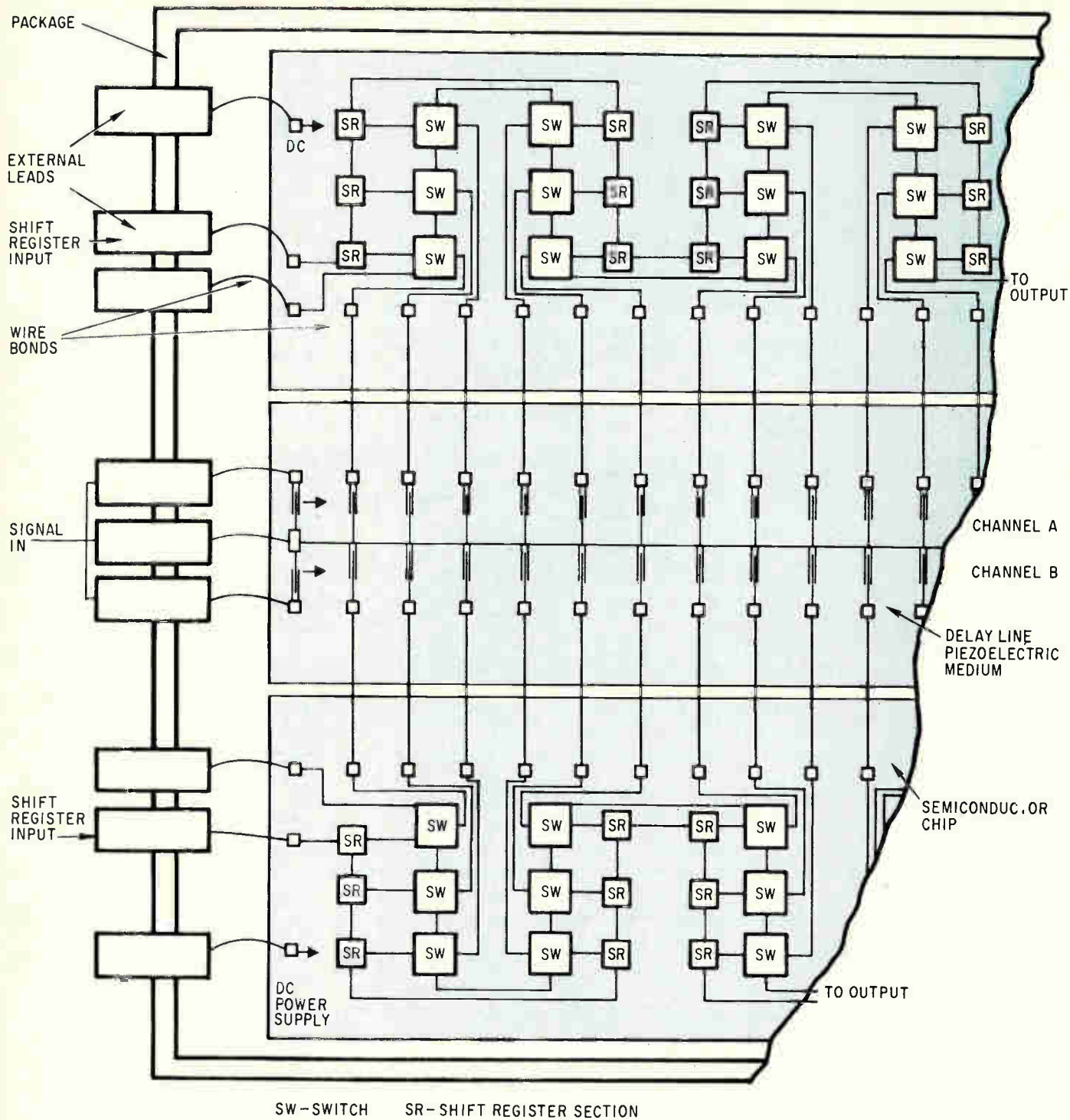

Variable codes. This schematic of an analog matched filter handles variable codes by using a pair of tapped surface acoustic wave delay lines in combination with microelectronic shift registers and switches. Capable of handling 50-bit or longer codes, this filter is switched between channels by a series of slave switches, SW, controlled by the shift register, SR, memory cells. With this set-up, it is possible to change the tap coding rapidly to match the filter to any received code.

Graded for radar

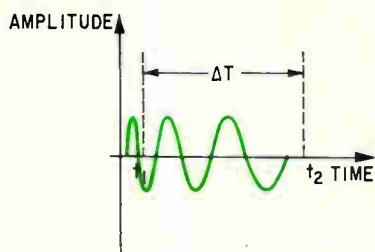

TRANSMITTED WAVEFORM

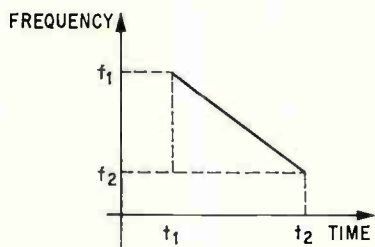

FREQUENCY OF TRANSMISSION

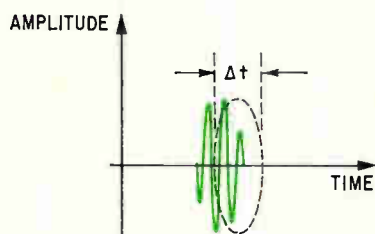

REFLECTED SIGNAL RECEIVED AND COMPRESSED

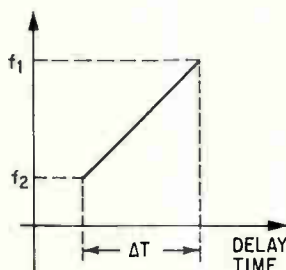

FREQUENCY CHARACTERISTIC OF COMPRESSION FILTER

One important application for pulse expansion and compression filters with graded transducers is in Chirp radar. In this system, the Chirp transmitter, linearly swept across a fixed frequency band for a set time period (ΔT), produces a relatively long rectangular pulse. The filter compresses the pulse returning to the receiver into a higher-amplitude, but shorter, time period, Δt . The filter has a linear time delay-frequency characteristic which matches that of the transmitted pulse. The filter's pulse compression ratio is $\Delta T/\Delta t$.

Surface-wave pulse-compression filters use two transducers with graded fingers widths and spacings. To obtain the linear time delay-frequency characteristic, the transducers must be mirror images of each other about a common reference plane. In operation, one end of the input transducer responds only to high-frequency (f_1) signals, sending them through the transducer pair, where after a time T_2 they are picked up by the high-frequency side of the output transducer. Likewise, the other ends of the transducers only respond to the low-frequency signals (f_2) and delays them by a time T_1 .

The differential time delay between the high and low frequencies is $T_2 - T_1$ and the transducers are designed so that $T_2 - T_1 = \Delta T$. For a bandwidth $B = f_2 - f_1$, with interdigital transducers containing M fingers ($M/2$ finger pairs) on a piezoelectric with surface

wave velocity v , the transducer design equations are

$$y_1 = v \left(\frac{\Delta T}{2B} \right) f_2 - \frac{v}{4f_2}$$

$$y_m^2 = y_1^2 + (m-1) v^2 \left(\frac{\Delta T}{2B} \right)^2$$

$$m = 1, 2, \dots, M$$

$$M = 1 + 2 \left(\frac{B}{\Delta T} \right)$$

$$\left\{ \left[\left(\frac{\Delta T}{B} \right) \frac{f_1}{2} - \frac{1}{4f_1} \right]^2 - \left[\left(\frac{\Delta T}{B} \right) \frac{f_2}{2} - \frac{1}{4f_2} \right]^2 \right\}$$

To increase resolution of pulse-compression systems, time sidelobe reduction must be accomplished. This is particularly important for radar using complex codes with high bit rates. Time sidelobe reduction can be effected either by changing the transducer-finger over-lap distance (amplitude weighting), or the finger position (phase weighting). Computer-aided designs to determine the optimum parameters are currently under investigation.

SURFACE WAVE PULSE COMPRESSION FILTER-TRANSDUCER PAIR

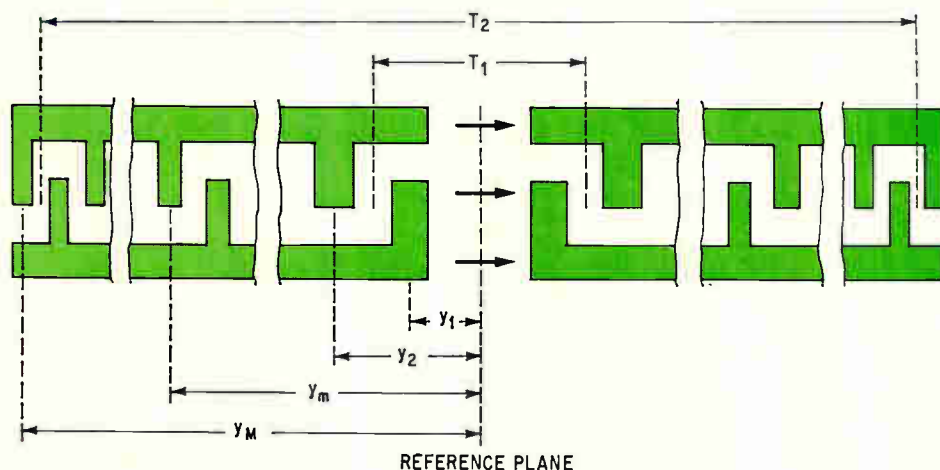

Identical twins. This transducers pair, with graded finger width and spacing, are mirror images of each other about the reference plane. The arrangement, used in surface wave pulse compression filters, is needed to give the required frequency characteristics.

Monopulse Radar

Monopulse radar, another system that uses pulse compression, can achieve high range resolution as well as high angular sensitivity by employing three receiver channels.

Monopulse radar uses a short time-duration energy burst generated periodically by a pulse generator at the pulse repetition frequency. This burst, of constant amplitude, is fed into the expansion filter which shows a frequency dependent delay over a bandwidth centered at the i-f frequency. The filter both expands the burst in time and limits its bandwidth to that of the filter. The signal then is up-converted into the microwave-frequency region, amplified, and radiated from the antenna.

The reception mode relies on antenna apertures and associated micro-

wave circuits to produce the desired information. The receiver produces three signals: a sum signal (Σ), its error signal for azimuth information, Δ_{az} , and its error signal for elevation, Δ_{el} . Each requires an identical processing channel. Each signal undergoes frequency down-conversion to i-f and amplified before passing through the pulse compression filter. Undesired time sidelobes from both the pulse expansion and compression filters are removed with an amplitude-weighting network, yielding a signal with a time length of about 1.4 its original time length. Low-level spurious energy that follows each main signal still remains, caused both by reflections arising during transmission and reception and by small nonlinearities in certain components. It is time separated from the

main signal and can be removed by a transversal equalizer, essentially a tapped delay line whose taps are at the necessary time separations and phase inversion. Spurious energy can be reduced to 40 db below the main signal. The clean signal then can be detected and used as a video output to the radar-display subsystem.

This system requires one pulse expansion filter and three compression devices. Typical parameters are 5- μ sec radiated pulses which can be frequency modulated over 20 megahertz with an i-f frequency of 60 Mhz. Filters with these performance characteristics can be fabricated by optomask and etching techniques on a single-piezoelectric chip, assuring identical characteristics and automatic temperature compensation.

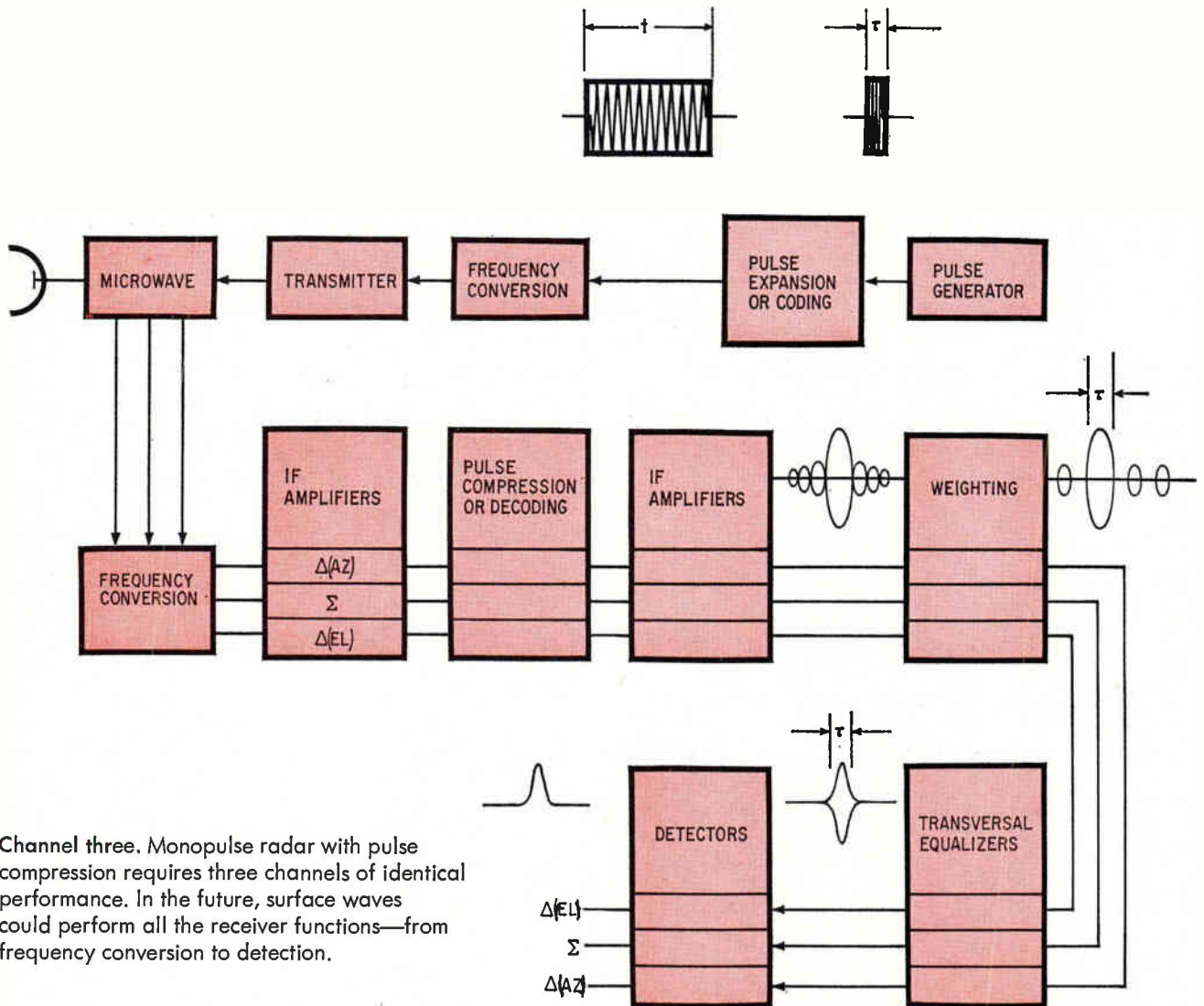

Channel three. Monopulse radar with pulse compression requires three channels of identical performance. In the future, surface waves could perform all the receiver functions—from frequency conversion to detection.

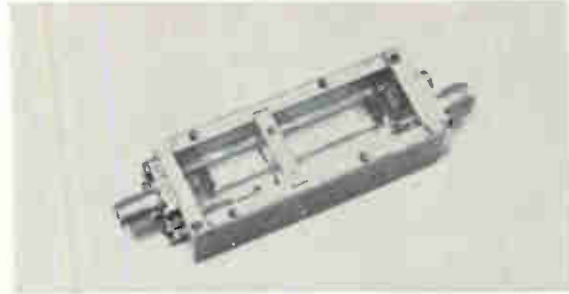
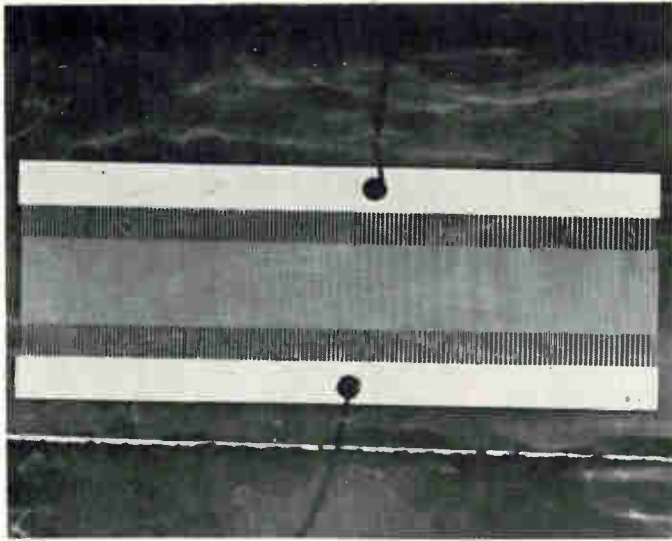

Graded. Used in pulse expansion and compression filters, this graded-periodicity interdigital transducer (left) has a center frequency of 60 mhz, contains 143 periods, and operates over a bandwidth of 20 Mhz. The pulse compression filter package (above) includes matching networks.

called for in the code program.

This switching can be effected through two adjacent acoustic channels and a series of slave switches, each controlled by the content of one memory cell of the shift register to which it is connected. For a 50-bit code, a shift register capable of holding 50 bits for an extended period of time is employed to control a series of these slave switches. Each bit stored in the shift register can order a corresponding slave switch to either turn itself on and pass the tap signal to a sum line or cut off the signal. The taps can be coded by feeding a binary code serially into the shift register until it is full and then holding for any required period. The delay-line tap coding is set because the shift-register bits have set the slave switches, which in turn control the tap outputs. Code changing can be effected in approximately 50-shift register clock times by feeding a new code serially into the shift register, 50 bits being fed into the shift register to change the coding of 50 taps. Now it is possible to change the tap coding rapidly to match the filter to any required received code. This approach removes the restriction of the fixed-tap placement and connection which yields a line matched to one code only.

Radar signal-processors require another specific type of matched filtering—pulse expansion and compression filters. With these devices radar systems can operate at long range with high resolution and can overcome an

inherent disadvantage of present transmitters—they become peak-power limited before becoming average-power limited.

These expansion/compression filters employ highly controllable time delays both monotonically increasing and decreasing with frequency, in such a manner that each is the frequency conjugate of the other. This requirement is necessary to ensure that energy at all frequencies receives the same total delay after traversing both filters. With this condition satisfied, a short pulse that is fed into the expansion filter will be reconstituted approximately as the same short pulse after traversing the compression filter. This is a must for high-range resolution.

Controllable dispersive networks not only are the key to pulse expansion and compression which can produce this conjugation, but they can provide time delays which are linear functions of frequency. To accomplish controlled dispersion, the inherently nondispersive surface acoustic wave must be converted into a controlled dispersive one. There are two ways of doing this: coded transducers, or slower acoustic material overlaid on the delay line substrate.

Coded transducers that offer the required dispersion are designed with graded periodicity throughout their length. This is done by grading the distance between adjacent interdigital fingers. An acoustic wave passing through the finger pairs will be synchronous at different frequencies depending on local periodicity. Expressed analytically, each frequency component, f , generated at the plane within the transducer, corresponds to the condition $v = f p$, where p is the local periodicity and v the Rayleigh wave velocity. Since v is a constant—fixed and unique for the cut and orientation of the piezoelectric material employed—frequency is an inverse function of the periodicity alone. High frequencies are generated and detected where the interdigital periodicity is small; conversely low frequencies are generated where the interdigital periodicity is large.

Laboratory transducer models with graded periodicity have been built with 143 finger pairs deposited on a quartz substrate yielding 143 different periods. The distances between fingers are tapered so that one end corresponds to high frequencies, the other to low frequencies, yielding a frequency range of say 20 Mhz.

By collinearly spacing two of these graded transducers

The Other Road

There's another way to build microwave delay line for signal processing—with magnetic surface waves, using yttrium iron garnet (yig) films on a new substrate material, non-magnetic gadolinium gallium garnet, G^3 . In these delay lines transduction is done through a periodic array of current bars, shorted at their ends, or through a meander line providing spatially periodic r-f magnetic fields which couple to the magnetic waves. Although the magnetic waves are sensed in a manner similar to that used in surface acoustic waves, the magnetic yig delay lines offer higher frequency of operation—up to 5 gigahertz or higher. This high frequency is achievable because above 500 megahertz, magnetic wave propagation losses increase linearly with frequency, instead of as the square of the frequency, as is the case with acoustic surface waves.

But up to now, the flux-grown single-crystal yig, the method commonly used to grow the crystals, presented problems. This is because fabrication of geometries with fairly uniform internal d-c magnetic fields had proved possible only in the undesirable sphere geometry. Slab geometries convenient for magnetic wave propagation exhibit dispersion properties that vary from point to point in the yig crystal, thus limiting their usefulness in delay lines.

The advent of epitaxial films of yig grown on the G^3 substrate using chemical vapor deposition techniques opens up a new magnetic-wave delay-line technology. Now highly uniform fields are readily attained, making the magnetic propagation spatially independent along the substrate. Further, the wave is readily tapped, with the dispersion properties invariant to tap position. Also, pure magnetic waves don't radiate into the substrate, which is important because radiation into bulk waves in the substrate is an ever-

present danger in surface acoustic wave technology.

Further, with this epitaxial growth technique, ferromagnetic resonance linewidths at 9 Ghz already are down to 0.6 oersteds, meaning that losses are comparable at this high frequency to surface acoustic wave losses at much lower frequencies. And magnetic waves in films are inherently dispersive, so that pulse compression and expansion are easily attained. Further, if dispersion is not wanted in a particular application such as in many radar decoding systems, graded periodicity transducers, similar to acoustic transducers for pulse compression, can be employed to remove dispersion over specified frequency ranges.

The two basic types of magnetic waves in yig films are surface and volume. With surface waves the bias magnetic field is applied orthogonally to the direction of propagation, while with volume waves the field is applied in a parallel direction.

The r-f magnetization of which a surface wave is composed has polarization properties very similar to particle displacement for the acoustic Rayleigh wave; similarly, coupling to the outside world is made through the associated r-f magnetic field. Since the wave is dispersive, it has an inherent advantage: wavelength can be kept invariant of frequency merely by adjusting the bias field thus avoiding the use of scanning electron microscopy for transducer fabrication. The surface nature of the wave is such that, for propagation in one direction, energy clings to the upper surface, whereas for propagation in the opposite direction energy clings to the lower surface. This inherent traffic control property could lead to two way transmission on the same substrate at the same time. And signifi-

cantly, this surface mode is nonreciprocal, opening up applications in isolators.

Because arbitrary two-dimensional shapes can be readily etched, epitaxial yig films have an important degree of flexibility. Already over 50 yig discs of 0.020-inch diameter and 2.8 microns thick have been etched out of a single G^3 substrate, allowing precision investigation of sample-to-sample ferromagnetic linewidth variations. This arrangement makes possible topographical magnetic waveguides with cross-sectional areas of approximately one square wavelength, non-radiating into the G^3 substrate. Thus, magnetic waveguides and directional couplers analogous to their surface acoustic wave counterparts should be realizable.

This yig research is paying off in devices. Spatially-periodic transducers have been fabricated and their characteristics determined, both at fixed frequency with variable bias field and at fixed bias field with variable frequency. A series of spatially-parallel L-band microwave pulse-compression filters with identical characteristics suitable for the monopulse radar application are operational on a single substrate. Further, the anisotropy of the wave vector for magnetic surface waves has been utilized to realize a d-c current-controlled steerable delay line configuration [Electronics, Dec. 22, 1969, p. 37] in which energy can be switched between an array of input and output transducers.

As a possibility of using a combination of technologies in the same system, surface magnetic waves and surface acoustic waves may be made to interface. Here, the magnetic transducer periodicity is set equal to the appropriate acoustic wavelengths at the operating frequency to produce magneto-acoustic waves.

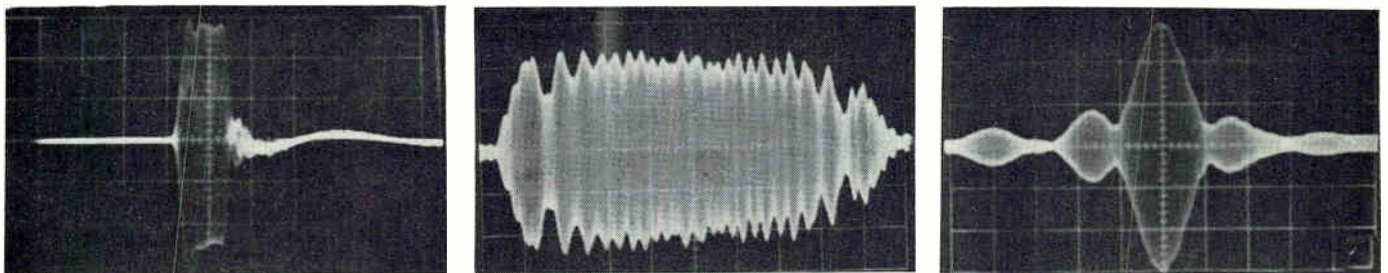

Round trip. The input of a 60 Mhz expansion/compression filter (left) is a nominal 50 nanosecond pulse. The expanded output (center) has a 4.6 microsecond duration, determined by the physical lengths of the transducers. The Fresnel ripples on this pulse, arising from the finite aperture of the radiating antenna, have little effect on further signal manipulation. After passing through the compression filter, the compressed pulse (right) has a lobe width of 50 nanoseconds, thus recovering the original input pulse.

so that the high frequency ends are closest to each other and the low frequency ends are furthest apart, the high-frequency waves travel a shorter distance and thus experience less delay than the low-frequency waves. This differential time delay produces the required pulse expansion or compression for the correct input signal.

Conjugate networks can be formed readily with these graded-periodicity transducers by flipping the input and output transducers. The low-frequency waves experience the shortest delay and high-frequency waves the longest delay. And by fabricating two parallel delay lines on a single piezoelectric substrate, it is possible to design an expansion/compression network using one line as an expansion filter and the other, with flipped transducers, as the compression filter. Here, acoustical cross-coupling between filters can be kept below 40 db by spacing the filters at greater than two acoustic beamwidths. Further, this arrangement can provide for the important function, automatic temperature compensation.

Extended to monopulse radar, expansion/compression filters will yield simultaneous high-range resolution and high-angular sensitivity. One expansion filter and three identical pulse-compression filters are required. And current state-of-the-art methods can allow the necessary four parallel delay lines to be fabricated on a single substrate.

Also, with these filters it is no longer essential to op-

erate under linear delay changes with frequency. With the coded form of interdigital transducer, matching of expansion and compression characteristics is easy; radar systems can be designed for almost arbitrary waveforms. This means that the system can operate with a number of matched-filter characteristics simply by switching in sequence from pulse to pulse between pairs of delay lines. This flexibility offers different range resolutions. Furthermore, jamming is easier to circumvent. And since the wide range of center frequencies can be accommodated with the coded transducer, the technique offers a broader range than is commonly available with other pulse-compression filters. In fact, designs for center frequency in the 10-to-800 Mhz range with operating fractional bandwidths of at least 0.35 are possible now. Further, the maximum differential-time delay is limited primarily by optomask techniques, which are improving steadily. Currently, for 60-Mhz operation, 15 μ sec is the limit.

On the other hand, one of the problems plaguing these high-performance filters is mechanical loading of the surface acoustic wave due to the metal electrodes required in the transducers. This loading causes additional dispersion and may necessitate precision phase-compensation techniques.

Guessing time scales on the future state-of-the-art of surface acoustic-wave technology is virtually impossible. But the fact is, in under two years the technology has evolved from the theoretical to the practical in high-performance functional signal-processing components. If this is an indication, the movement in the next two years should be even greater. And applications seem abundant in the many parallel fields, such as matched filters for radar communications and sonar, i-f filters for color television, and acoustic logic for computers.

But the technology may have certain fundamental system limitations. For example, pulse compression filters with integrated weighting networks may be difficult to obtain with sidelobe suppression better than 30 db, a requirement for some radars. Also, MOS large-scale arrays offer serious competition because they can perform the matched filtering function digitally. Here the trade-offs must be analyzed, but it is likely that the inherent planer nature of surface acoustic wave technology will be a decisive choice factor. But more progress must be made on digital operation and its implementation in active tapped delay lines, and on electronically-variable phase shifters. All are important for data processing, doppler processing, and spectrum analysis.

An application of surface acoustic waves destined to have a profound effect on display technology is the control of electronic emission utilizing the electric fields associated with Rayleigh waves on a piezoelectric. This phenomenon, demonstrated by Blackledge and Kaufman of Arizona State University, promises to be valuable in flat television-display tubes.

The basic principle is that the "voltage" between crests of a Rayleigh wave can correspond to energies of 1 electron-volt for acoustic powers of only 100 milliwatts per centimeter of acoustic beamwidth. And one electron-volt is just the energy level required to control the electron emission from solid-state photocathodes.

Use of this surface wave "voltage" requires a photo-emissive material to be deposited on a piezoelectric material. This can be done by heteroepitaxial-growth tech-

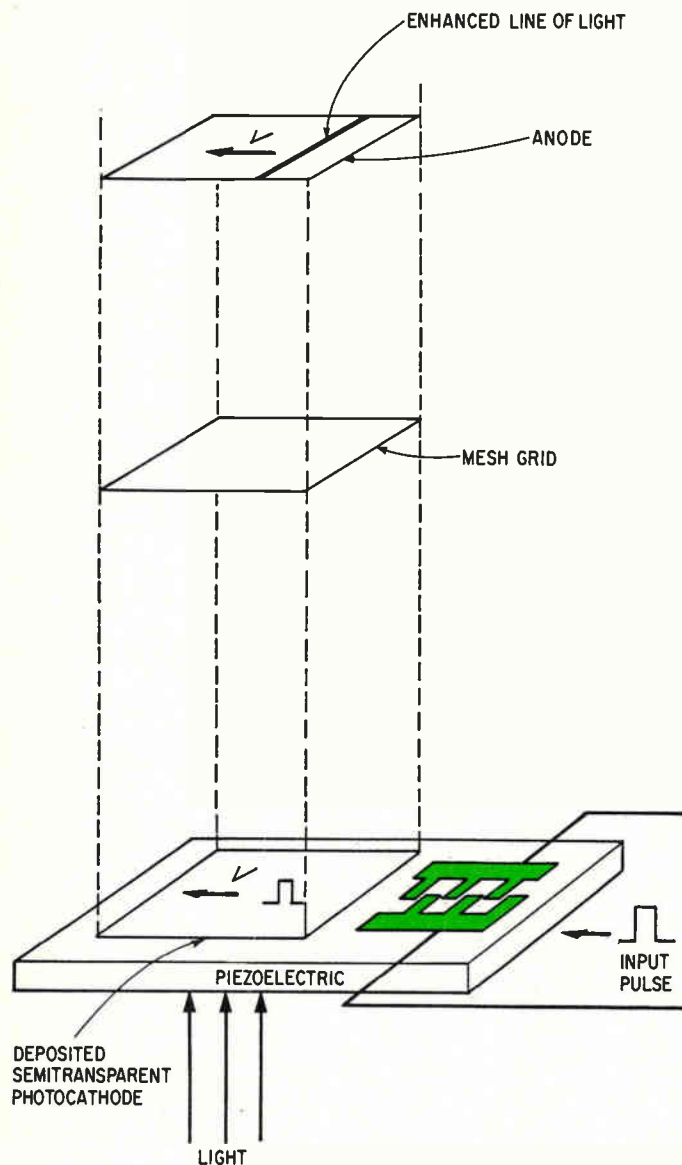

Good picture. Promising for flat tv, surface waves achieve video action when an acoustic beam passes over the illuminated photocathode grown on the substrate. The anode—aluminized phosphor illuminated by photocathode action—serves as the video output by receiving the enhanced line of light which is controlled by the voltage between surface wave crests.

niques. Suitably illuminated, this sheet emits electrons which are visible when accelerated by 10 kilovolts against an aluminized-phosphor screen. Therefore, an acoustic pulse can make a transverse line of light on the screen; moving at the Rayleigh velocity, it provides horizontal scan. Vertical scan can be obtained through a spacially-orthogonal acoustic beam applied simultaneously to the substrate.

Certain radar-processor requirements represent another ideal application for surface waves. Experiments at IIT Research Institute have used an electron beam to sense the propagation of the surface wave on the piezoelectric substrate. Read-outs are obtained from secondary emission much the same way as in the ultrasonic image converter tube and scanning electron microscope. The ultimate bandwidth limitation here is that the wavelength of the information impressed on the acoustic signal must be comparable to the width of the electron beam. Operation well into the microwave region therefore is predicted.

Surface acoustic waves also have potential in computer applications for high-speed data processing—bit rates in excess of 100 Mhz. Digital-logic bits are converted to pulses with the required phase by an input gate circuit, then passed through an arrangement of surface-wave transducers which perform the logical operations by providing outputs of either zero, or pulses of high amplitude. These outputs are converted back into digital outputs or into pulsed r-f waveforms for further processing by an output gate circuit. With this system, using 5 cycles of 500 Mhz signals as a single bit gives a bit rate of 100 Mhz, illustrating the system's capability for high speed. Further, "Logical inverter," "NAND", and "OR" gates have been operated at 120 Mhz with a 5-Mhz bit rate; also operation through two stages of logic has been demonstrated without the need for amplification.

Yet another important application of surface acoustic waves is to displays associated with high-resolution radar systems. Normal radar displays usually have bandwidths of less than 10 Mhz, but high-resolution radar systems require much larger bandwidths—500 Mhz. The operating radar bandwidth therefore must be reduced to display bandwidth. Wideband surface acoustic-wave delay lines can be used to buffer the radar to the display. Stored and recirculated, the signals may be sampled and displayed at a lower frequency. The next generation of avionics-system radars likely will employ either surface or bulk acoustic-wave delay lines for this purpose. Further, surface acoustic wave technology may reverse the trend toward digital techniques embodying MOS devices. ●

Bibliography

- The following papers appear in IEEE Transactions on Microwave Theory and Techniques, MTT-17, Special issue on Microwave Acoustics, Nov. 1969.
- W.R. Smith, H.M. Gerard, J.H. Collins, T.M. Reeder, and H.J. Shaw, "Analysis of Interdigital Surface Wave Transducers by Use of an Equivalent Circuit Model," and "Design of Surface Wave Delay Line with Interdigital Transducers."
- P.H. Carr, "The Generation and Propagation of Acoustic Surface Waves at Microwave Frequencies."
- K.M. Lakin and H.J. Shaw, "Surface Wave Delay Line Amplifiers."
- E.A. Ash, R.M. DeLaRue, and R.F. Humphreys, "Microsound Surface Waveguides."
- E. Stern, "Microsound Components, Circuits and Applications."
- W.D. Squire, H.J. Whitehouse, and J.M. Alsop, "Linear Signal Processing and Ultrasonic Transversal Filters."

Draw your own conclusion

if you want to find out which company is such a far-and-away leader in TTL that an ever-increasing number of IC manufacturers are starting to second-source its 8000 series!

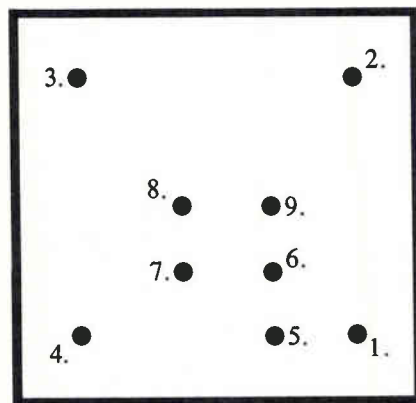

(P.S. Once you've connected the dots, connect with us—by writing for our DCL handbooks. They show why we're the leader in TTL—including the most-wanted MSI like Adders, Multiplexers, Shift Registers, Counters. Our address: Signetics, 811 East Arques Avenue, Sunnyvale, California 94086.)

A SUBSIDIARY OF CORNING GLASS WORKS

Only ITT has BOTH

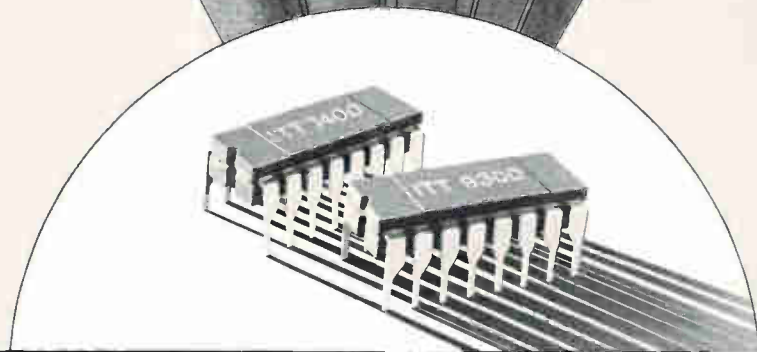

Get mixed pricing on 7400 and 9300 series TTL MSI circuits

Only ITT offers both 7400 series and 9300 series TTL MSI circuits. Therefore, only ITT gives you the advantages of mixed pricing on large quantities of these popular types.

Available Now: the 7475, 7490, 7491A, 9300, 9301, 9304 and 9309. All are ceramic packages, all with input diode clamps to prevent ringing, and all completely interchangeable with MSI devices offered by leading suppliers.

Coming Soon: all the other devices that leave series 7400 and series 9300 almost without competition in the MSI field.

Start now to simplify and economize your MSI procurements. Make ITT your single source by contacting your field sales representative or stocking distributor. ITT Semiconductors is a Division of International Telephone and Telegraph Corporation, 3301 Electronics Way, West Palm Beach, Florida 33407, telephone 305/842-2411.

semiconductors **ITT**

FACTORIES IN FLORIDA • MASSACHUSETTS • ENGLAND • FRANCE • GERMANY • PORTUGAL • AUSTRALIA

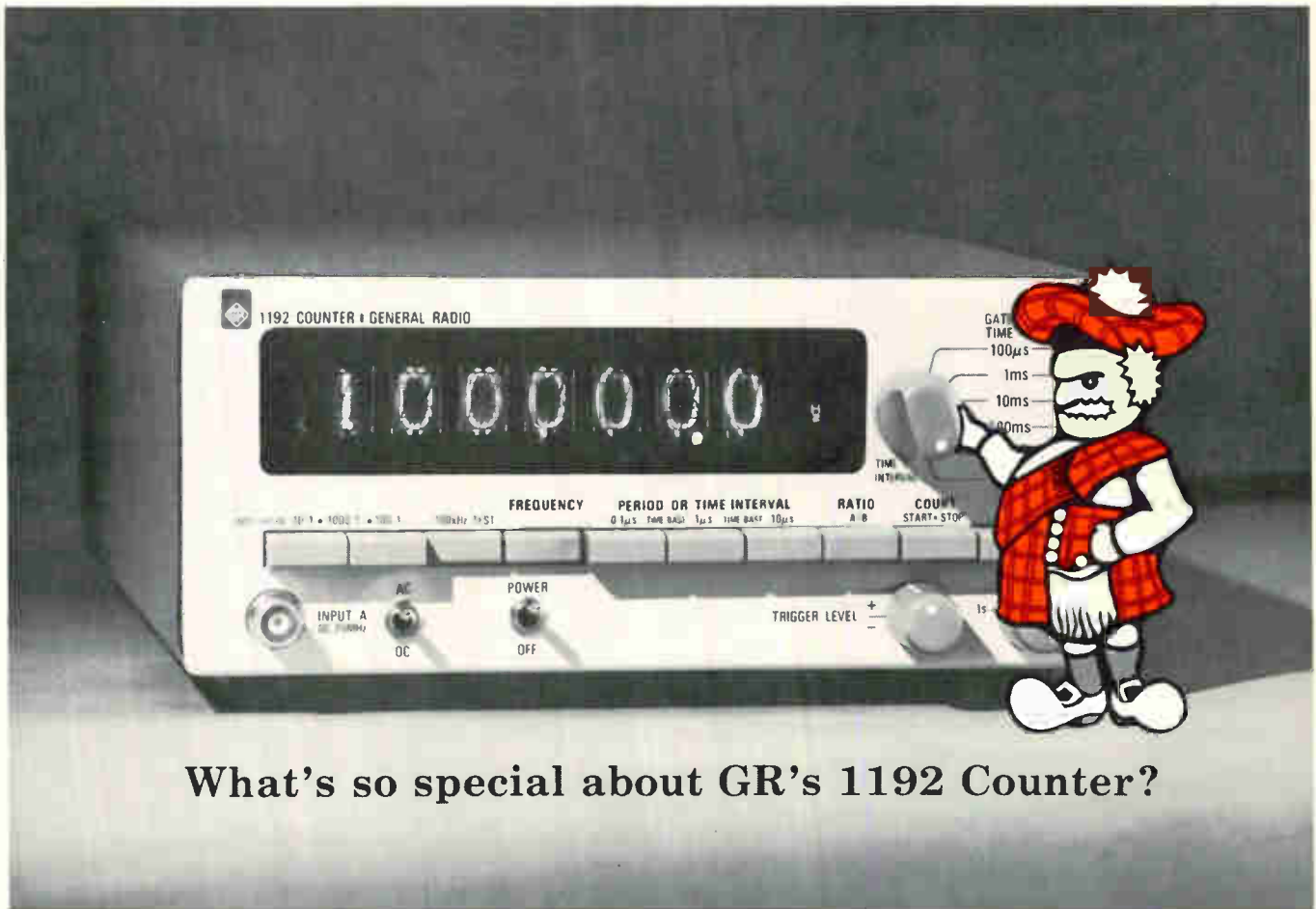

What's so special about GR's 1192 Counter?

The answer has to be VALUE.

Where else could you get a \$575, 5-digit counter that measures frequency (dc to 32 MHz), period (single or multiple), frequency ratio, and time interval? Or 10-mV input sensitivity up to 20 MHz, a 10-MHz crystal time-base with a stability better than $\pm 2 \times 10^{-6}$ per month, or manual attenuation up to 60 dB?

You say you want more for your money? How about automatic units-of-measurement and decimal point displays, and SPILL and COUNT indicators?

For a few more dollars we can really make it worthwhile! Get a 6-digit counter for \$675, or 7 digits for \$775; add a BCD data output for \$50 and a rack mounting for \$20. And if you have higher frequencies to look at, tack on our 500-MHz scaler for \$850.

Now that you're interested, why not get all the details from the General Radio Company, West Concord, Mass. 01781; telephone (617) 369-4400? In Europe write Postfach 124, CH 8034 Zurich, Switzerland. To sweeten the deal, we'll tell you about our quantity discounts and Annual Purchase Agreement.

Prices apply in USA.

GENERAL RADIO



Colorado's New Front Range of Science and Technology is one of the places the expanding universe is expanding.

In fact, it's one of the fastest-growing places in America.

The new Front Range of Science and Technology is a 150-mile span on the high plains immediately before the Rocky Mountains. Metro Denver is the heart.

It's growth country for the growth companies . . . because it's an environment for profit.

Some of the companies who moved here are Eastman Kodak (2,853-acre site and a manufacturing complex that will cost "tens of millions of dollars," to quote Kodak President Dr. Louis K. Eilers), IBM in operation with over 4,000 employees in more than 1 million square feet of space, Western Electric now building a \$15 million complex for 3,000 employees, Bell Telephone Laboratories with 250 scientists, Gulf & Western with a \$15 million complex.

And Honeywell, Hewlett-Packard, Kaman Nuclear, Ampex, Ferroxcube, Sundstrand Corporation, Ball Corp., Amphenol, Beech Aircraft, Litton, Dahlstrom, Dow Chemical, Martin Marietta, Monsanto Electronics.

Those who started here are expanding, too. Samsonite is putting finishing touches to an \$18.5 million luggage manufacturing complex. Gates Rubber has a new \$25 million tire plant underway. Millar's Coffee a new \$1 million plant.

Other Denver-headquartered leaders include Great Western United, Ideal Basic Industries, Coors, C. A. Norgren, CF&I Steel, Frontier Airlines.

denver

All the economic indicators—construction starts, population growth, bank footings, retail sales, etc.—are at record levels.

The thrust behind this expanding economy is magnificent recreation and a dry, sunny climate, fast and economical transportation coupled to geographic centrality, business-oriented community attitudes, abundant power and water, and educational excellence that results in skilled, productive, and highly stable manpower.

WRITE TODAY—If you're interested in a new plant site, research facility, administrative headquarters or distribution center, ask for our new 68-page brochure which gives a broad review of Metro Denver and Colorado's Front Range of Science and Technology. All inquiries confidential. Write Manager, Forward Metro Denver, Dept. 262, 1301 Weltaan Street, Denver, Colorado 80204. Telephone (303) 534-3211



- ▲ Private firms available for research and development contracts.
- Proprietary research and development.
- Universities available for research and development contracts.
- ◆ Government agencies doing research and development.



**Model 630-A
Laboratory V-O-M**

1. $\pm 1\frac{1}{2}\%$ DC, $\pm 3\%$ accuracy.
2. One selector switch minimizes chance of incorrect settings and burnouts.
3. Rugged $5\frac{1}{2}$ " suspension meter movement with $4\frac{1}{2}$ " mirrored scale. Suggested USA user net price \$75.



**Model 630-APL
Laboratory V-O-M**

1. $\pm 1\frac{1}{2}\%$ DC, $\pm 3\%$ accuracy.
2. One selector switch minimizes chance of incorrect settings and burnouts. Polarity reversing for DC.
3. Suspension meter movement diode protected against instantaneous overloads. Suggested USA user net price \$75.



**General Purpose V-O-M
Model 630-PL**

1. One selector switch minimizes chance of incorrect settings and burnouts. Polarity reversing for DC.
2. 4.4 Ohms center scale, 0.1 ohm to 100 megohms resistance.
3. Meter movement diode protected against instantaneous overloads. Suggested USA user net price \$64.



**General Purpose V-O-M
Model 630**

1. One selector switch minimizes chance of incorrect settings and burnouts.
2. 4.4 Ohm center scale, reads from 0.1 ohm up to 100 megohms resistance in 4 ranges.
3. 20,000 ohms per volt DC sensitivity; 5,000 AC. Suggested USA user net price \$64.

Laboratory or General Purpose Triplet meets the need precisely

Products of Triplet's long experience in the design and manufacture of high-quality, high-performance V-O-Ms, these representatives of the great Model 630 series offer the most-wanted features combined as perfectly as the skills of dedicated craftsmen can guarantee.

See your Triplet representative or distributor for a free demonstration of any or all of these versatile instruments.



TRIPLETT
CORPORATION

BLUFFTON, OHIO 45817

MANUFACTURERS OF THE WORLD'S MOST COMPLETE LINE OF V-O-Ms

The magnificent seven.

Our seven basic AT toggle switch assemblies are made up of precision snap-action basics under a single toggle actuator.

They offer hundreds of design options. All right off the shelf.

Like multiple circuits. Get up to eight or more SPDT precision switches under a single toggle. Or take your pick from a wide selection of circuit combinations.

Get them with two and three position toggles, maintained and momentary lever positions, or pull-to-unlock levers.

There are also sealed switches and "electric memory" switches. And a choice of high capacity or dry circuit capabilities.

As we said, literally hundreds of design options. And MICRO SWITCH can supply them all. For more information, call your Branch Office or Authorized Distributor (in the Yellow Pages under "Switches, Electric").

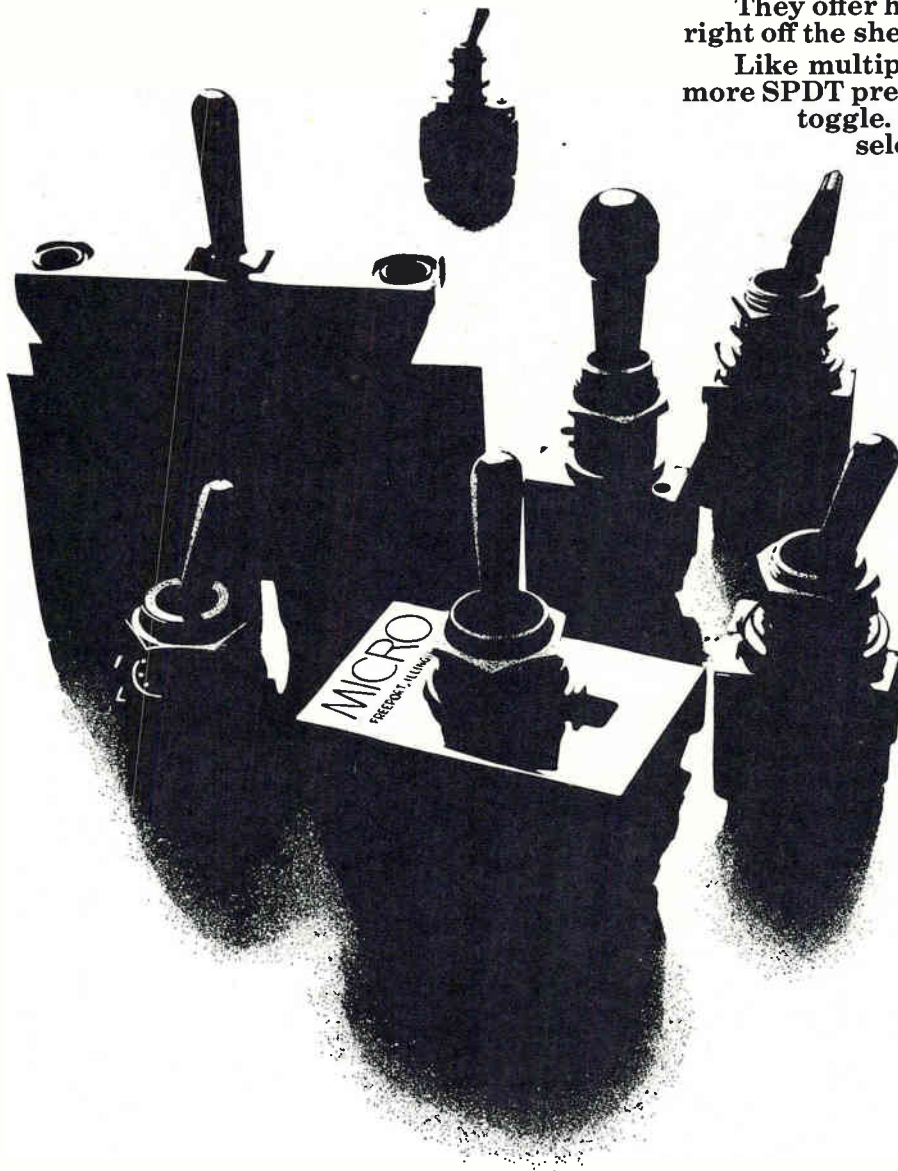

MICRO SWITCH

FREEPORT, ILLINOIS 61032

A DIVISION OF HONEYWELL

HONEYWELL INTERNATIONAL: Sales and service offices in all principal cities of the world.

128 Circle 128 on reader service card

Circle 128 on reader service card →

Our center of attraction.

We're the only ones with .050 centers in our flat conductor cable connectors. We're the only ones with a metal shell to protect that fragile connector. And the only one whose connector will mate with any existing version. (No matter what type of wire is used.) Interchangeable. Intermountable. You can use them with any of your retrofit projects. And should repair be necessary, modular construction makes them easily repairable in the field. They can even be potted for environmental sealing. It's the newest idea yet in flat cable connectors. One more thing. We're trying to come up with a name for this connector. Something Better than Flat Conductor Cable Connector. If you can think of a name we can use, it's worth a case of booze. And even if you don't win the booze, we'll be happy to send a genuine certificate recognizing your idea.

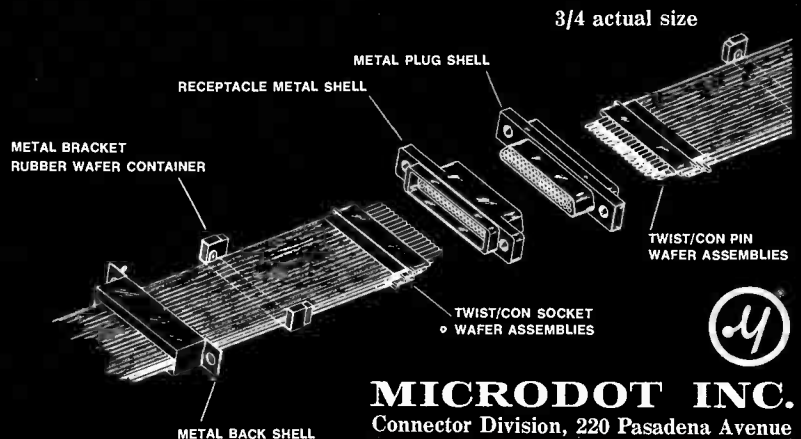

MICRODOT INC.
Connector Division, 220 Pasadena Avenue
South Pasadena, California 91030

STORAGE / PLUG-IN

CONVENIENCE / MEASUREMENT FLEXIBILITY

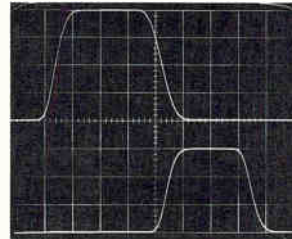

multi-trace

Make dual-trace measurements from DC-to-10 MHz with 35-ns rise-time capabilities and a 10 mV/div to 10 V/div deflection factor.

Type 3A6 Plug-in \$550

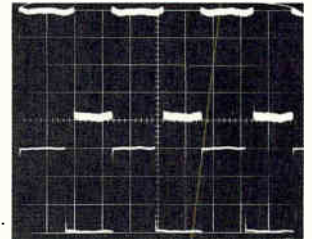

differential

Measure from DC-to-500 kHz with a 100 μ V/div deflection factor, dual-trace and a 50,000:1 common-mode rejection ratio.

Type 3A3 Plug-in \$950

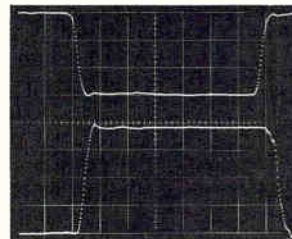

sampling

Extend your measurement capabilities to 14 GHz with 25-ps rise-time, internal triggering, dual-trace and sweep rates to 20 ps/div.

Type 3T2 Time-Base \$1100
Type 3S2 Amplifier \$ 950

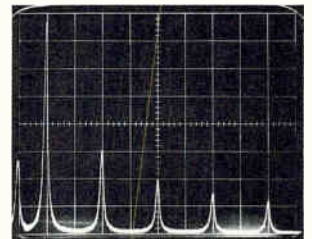

spectrum analysis

Analyze the frequency spectrum from 50 Hz to 1 MHz with calibrated dispersion and calibrated deflection factors.

Type 3L5 Plug-in \$1125

Split-screen bistable storage, automatic erasure and plug-in measurement flexibility . . . all are features of the Tektronix Type 564B MOD 121N.

STORAGE

The contrast ratio and brightness of stored displays produced by this instrument are constant and independent of viewing time, sweep speeds, or signal rates — a special feature of Tektronix "bistable storage". The auto-erasure mode is an operator convenience feature and may be used to view very slow changing waveform phenomenon by employing a continuous sequence of storing, viewing, and erasure of the upper half, lower half, or the entire screen. Variable viewing time allows observation of the stored display for up to 12 seconds before erasure. A "SAVE" mode retains the stored image up to 1 hour.

MEASUREMENT FLEXIBILITY

More than 25 plug-in units are available for the Type 564B MOD 121N, covering single channel, multi-trace, differential, sampling, spectrum analysis and other special purpose applications. Adapting your measurement capability to meet your changing measurement needs is assured.

Your local Tektronix Field Engineer will show you how storage lets you concentrate on the results of the measurement, rather than making it. Please call him. For detailed specifications, consult your current Tektronix catalog, or write: Tektronix, Inc., P. O. Box 500, Beaverton, Oregon 97005.

Type 564B MOD 121N Oscilloscope \$1250
Type 3B3 Time-Base Plug-in \$ 680

U.S. Sales Prices FOB Beaverton, Oregon



Mass production of silicon vidicons holds key to Picturephone's future

Industry will benefit from Western Electric's pioneering effort to get extraordinarily complex silicon-target camera tube out of the laboratory and onto the assembly line

By Leon M. Magill

Electronics staff

Facing a goal of 1 million Picturephones in use by 1980, the Bell System is having a difficult time ironing out formidable production problems. With only 500 to 1,000 Picturephones expected to be in operation by the end of 1970, assembly is virtually a handmade operation—any sort of volume production of the highly complex instrument is at least a year away. Bell has been promoting Picturephone service heavily in the past year or two, but delivery to customers will be highly selective when the actual installation begins in July.

The major problem in building Picturephone is the silicon-target camera tube, which some industry spokesmen say is an order of magnitude more difficult to build than any previous electronic device. One

manufacturer of silicon-target camera tubes likens the technology to large-scale integration on an even greater scale. In fact, the number of components per wafer—5,000 for LSI and about 750,000 for the silicon target—indicates the complexity of constructing the camera-tube target. And if lead attachment were necessary, as in LSI, the silicon targets simply could not be built, says one of Western Electric's production engineers.

Pilot production of the camera tubes is taking place at Western Electric's Reading, Pa., plant in what amounts to a model shop atmosphere. However, creation of a production facility is under way, and Western Electric hopes to be ready to start volume production in mid-1971.

What the Bell System learns in setting up volume production of the new silicon vidicons would provide an example for other companies that will have to face up to the same problems in the near future. Last month, Bell System officials met with more than a dozen licensees, exchanging information relating to this new technology. In fact, this exchange included proprietary information.

Using present technology, Western Electric can produce a target in a week to 10 days using two eight-hour shifts. Presently, the company is making more targets than vidicons—about 20% more—with the yield ranging between 33% and 66%. When the Picturephone goes into service, Bell is hopeful of a vidicon life expectancy

Face to face—on a small scale

Proclaimed by the Bell System as the advent of face-to-face communications, Picturephone will put only a few faces in contact during the initial offering in July. The new service will be offered in New York City, south of 59th Street in Manhattan, and in Pittsburgh's Golden Triangle section. If previous trials are any indication, a lot of prospective users will be banging on Ma Bell's doors in the scramble for those first 500 to 1,000 units.

The videophone, developed by Bell Labs, received its first public exposure in 1964 at the New York

World's Fair, where randomly selected visitors tried the service for 10 minutes. Initial public reaction was very good. In 1965, the first commercial trial was between the Union Carbide Corp.'s offices in New York and Chicago. Union Carbide was so pleased with the results that it chose to keep its 12 instruments and use them as interoffice videophones. They are still in use today. In 1967, the trial was expanded to cover three Bell Labs locations. And Bell Labs has since explored additional uses of Picturephone, such as an inter-

face between man and computer.

The most recent test was conducted in 1969 between the Westinghouse Electric Corp.'s offices in New York and Pittsburgh—the route of the July offering. The trial was hailed by both Westinghouse and the Bell System as a success.

The experiment, consisting of 29 Picturephones in Pittsburgh and 11 in New York, allowed Westinghouse executives the choice of face-to-face communication or graphic-data retrieval. Information was hand-fed into the computer every half-hour.

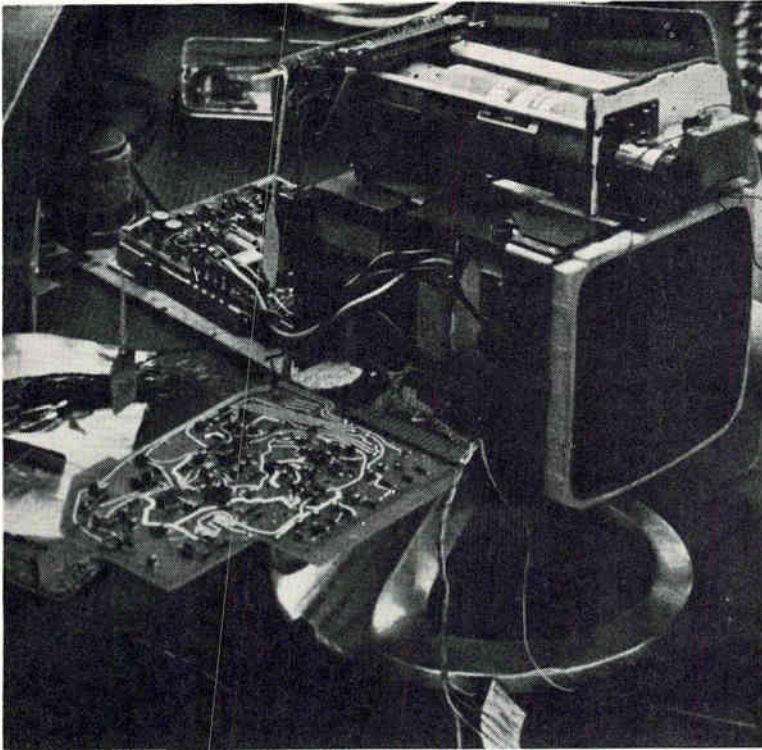

Inside look. This partially assembled Picturephone is one of the units going into service later this year. The silicon-target camera tube is mounted above the display tube.

exceeding 10,000 hours. This would be five times the life expectancy of present silicon camera tubes. Contributing to the vidicon's longer life, while the heater is in the always-on condition, is a new cathode made of nickel-coated carbon-ite. Western Electric engineers feel that advances in the state of the art will allow them to produce 100,000 camera tubes a year by 1975 and 250,000 by 1979, and thus enable them to meet the 1980 goal of 1 million Picturephones. For the time being, there are no plans afoot for Bell to second-source the tube, but the company doesn't rule out such an eventuality.

The silicon-target camera tube was chosen over the conventional vidicon whose glass target was covered with antimony trisulfide. The new tube has a better ability to prevent burnout and an improved response to low light levels. The new silicon vidicon used by Bell in Picturephone can be used where light levels range from 2 foot-lamberts to 500 foot-lamberts, and it's automatically adjustable, too. The tube is so rugged that it can be pointed directly at the sun for long periods, say an hour, without any physical damage.

The target itself consists of a planar array of reverse-biased silicon photodiodes which are accessed by a low-energy scanning beam similar to that used in conventional vidicons. The planar array is made up of 840,000 diodes, 750,000 of which are partitioned for use on the 1/2-inch-square wafer. Of prime concern to Bell engineers is diode failure. Dark-current leakage, wherein a diode approaches a short-circuit condition, yields a white spot on the screen; a missing or open-circuited diode causes a dark spot. Of the two types of failure, the open-circuited type is far more tolerable—black spots are less-easily perceived on the screen.

Preventing shorts. To prevent excess charge from building up between diodes and then leaking out through them, a vacuum evaporation of a resistive film is used over the entire target. The technique, developed by Bell Laboratories, involves the evaporation of either gallium arsenide or antimony trisulfide onto the target to form a resistive sea. This layer prevents the charge from building up in the regions between the p-type silicon islands in the sea. The required resistivity is high and one of the big

problems faced by Bell Laboratories in obtaining a suitable resistive-sea structure has been reproducibility. The proper resistive film allows vacuum baking of the vidicon, thereby contributing to a cathode's lifespan.

Unquestionably, cleanliness is the foremost problem facing Western Electric engineers in their quest for high-yield production. Cleanliness of the air, water, paper, and other materials is paramount if highly reliable targets are to be produced.

Dust particles several microns large can ruin a silicon target if contact is made during fabrication. In fact, increased activity during production generates more dust and dirt, thereby lowering the target yield. "The environmental control of silicon targets must be at least an order of magnitude better than present cleanliness in semiconductor and IC fabrication," says Tom Mendel, department chief of Picturephone engineering at Western Electric's Reading plant. To provide stringent environmental control, Western Electric is constructing a 10,000-square-foot class 100 clean room at a cost of more than \$1 million.

Cleanliness extends to everything in the presence of the silicon wafers. Teletypewriter terminals are being placed inside and outside of the clean rooms to relay information and data. Special paper will be used to assure the required degree of cleanliness.

Environmental control of water in the manufacture of silicon targets is far more stringent than in IC technology. Triple distillation is not satisfactory, and during the rainy season, soluble silica, which can't be removed from solution, becomes a problem. Western Electric is working on a deflocculation method, adding chemicals to the water so that the silicon particles coagulate in little clumps and can then be filtered out. Present manufacture of targets uses processed water for rinsing steps at the rate of 5 gallons per minute with a filter at the point of use.

Toothbrush. The importance of the cleanliness of the silicon wafers is borne out by the 13 cleaning steps required—two acid baths, two alkali baths, two special solvent baths, five water rinses, one ultra-

sonic cleaning, and one mechanical scrubbing prior to oxidation. Originally, an operator scrubbed each wafer with an electric toothbrush. Now, 14 silicon wafers in a tray are placed into a special cleaning tank. The tray rotates when the cover is closed and a counter-rotating brush emerges and scrubs the wafers; water and detergent are applied from the cover using the Venturi effect.

Western Electric is using new and different techniques to process more wafers in a shorter time. One such method diffuses five times as



On target. A silicon-target vidicon is handled with care in one of its final assembly stages.

many wafers as in the past. A groove is placed in the quartz furnace tube to allow passage of larger trays with more silicon wafers. Before the grooves were used, the targets would score the tubes, causing the quartz to flake and deposit on the wafers in the oven.

High-speed production also is being held back by the vacuum required for electron-beam scanning of targets. "If we could utilize a



Pfizer Research advances the science of sound and image recording.

The phenomenon of magnetism, which occurs naturally in some minerals, was known to the Greeks six centuries before Christ. Yet it remains perhaps the least understood of all forces.

For example, how *can* a thin coating of special iron oxides—on any of many base materials—reproduce with high fidelity almost the entire range of sound and visual communications?

Pfizer probably knows as much about this mystery as anyone, since we've pioneered in magnetic recording for over 20 years. Not in making tapes, drums, and discs except for test purposes . . . but rather in the iron oxides they require. Oxides possessing exceptional performance characteristics.

Pfizer has learned a lot about the subject, and is continuing to learn more, from our extensive research, development, and pilot plant manufacturing. If you make any of the products concerned, for consumer sales or industrial use, our advanced knowledge may help you.

Your technical inquiries will receive immediate attention.

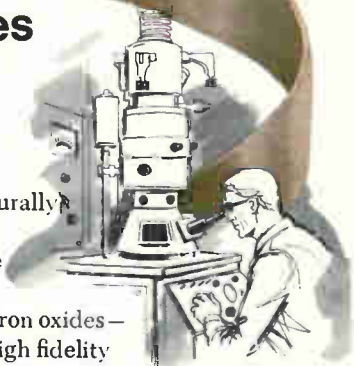

Photo Caption:

GOETHITE— $\text{Fe}_2\text{O}_3 \cdot \text{H}_2\text{O}$, hydrated ferric oxide. Named after poet J. W. von Goethe. Specimen from Gömör, Hungary and reproduced in scale of 4.3:1 reduction. High purity grades of synthetic Goethite are among the major sources of Pfizer's wide range of oxides for magnetic recording purposes.

Pfizer

**MINERALS
PIGMENTS
& METALS
DIVISION**

Dept., 9E3 235 East 42nd Street
New York, New York 10017



The things we do to stay in front!



Because we're No. 1 in control knobs . . .



and because we're Rogan

Our reputation means a lot to us. So much in fact that the knobs we make are quality knobs . . . knobs that are "out in front" with "real design appeal" —yet priced right to fit your budget. Write today for free New color catalog or see us in Sweets or Thomas Micro catalogs.

Rogan
BROTHERS, INC.
8031 N. MONTICELLO AVE.
SKOKIE, ILLINOIS 60076
PHONE: (312) 675-1234

Circle 194 on reader service card

OPTICAL SCANNING ?

Convert Your TV Camera (or ours) into a highly Versatile computer input device with the CVI model 321 Video Analyser!

Sampling bandwidth compression allows convenient low rate digitization of wide band video signals with line or raster scanning, X-Y-Z point analysis, noise reduction, and other significant operations.



cv**i** COLORADO VIDEO, INCORPORATED

P O BOX 928 • BOULDER, COLO. 80302 • PHONE (303) 444-3972

Video Data Acquisition — Processing — Display — Transmission

134 Circle 134 on reader service card

continuous vacuum, we could test a target every two minutes," says Mendel. The continuous target approach was developed for tantalum circuit-sputtering, and Western Electric hopes to use it in its new production facility. The targets are set in a horizontal cylinder and passed through an orifice where the fit is less than .001 inch. Then, using new high-speed pumps working against the leakage, the inside of the cylinder is at a 10^{-7} torr vacuum while the outside stays at room pressure. This in-line vacuum system will provide Western Electric with continuous access to the targets under test; present testing

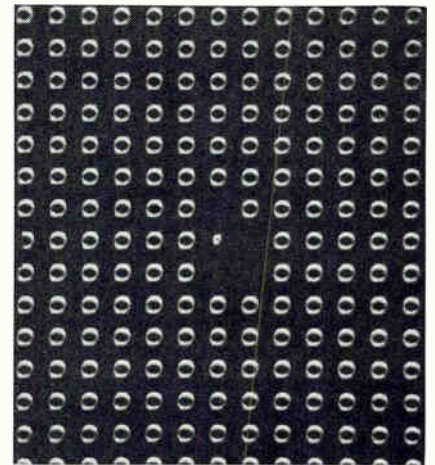

Target reject. One undersized and four missing diodes cause a dark spot on the video display; diodes are 8 microns in diameter.

requires 20 targets to be brought down to vacuum in $3\frac{1}{2}$ hours with testing taking an additional $1\frac{1}{2}$ hours. When the continuous vacuum is developed and put into service, Western Electric expects to test 30 targets an hour. Mendel indicates he could test more targets in a shorter time, but the extra time required to pump them down to vacuum would nullify any gain.

An electron beam scans the target and displays the output on a video monitor. The operator then takes Polaroid photographs of the display of any marginal targets for evaluation. Two pictures are taken, using different illuminations, to assure that the fault lies in the target and not in the photographic film. In fact, Mendel likens the present testing method to grading lumber —it relies solely on the operator's

Electronics | January 19, 1970

... evaluating silicon vidicon targets at present is much like grading lumber ...

judgment and experience. While this method is accurate, Western Electric isn't satisfied with it for production and is looking at methods that utilize automatic defect counters linked to a computer.

The photolithography techniques used to set the diode pattern are constantly being developed. Projection masking, using positive photoresist, has the inside track at the present time. However, Bell has not abandoned contact masking using negative photoresist. Projection masking can provide infinite mask life—but only if dust and dirt are kept from the masking surface. This is the technique that Western Electric probably will bring into its new clean room.

Getting operators. Personnel training is very difficult, according to R.M. LeLacheur, development and manufacturing engineering manager at Western Electric's Reading plant. The company's pilot training program started last September and has just begun to produce qualified operators who can work without engineering supervi-

sion. Western Electric's new production facility will occupy 10,000 square feet, complementing the clean room of the same size, and will speed up production. The work has been going on for more than a year, and funding has been allocated for procurement and installation of new equipment. On completion in 1971, the facility will be the largest of its kind.

Camera-tube production utilizes a 10-joule ruby laser to drill .002-inch holes in the beam-focusing electrode. The laser emits a 5-millisecond pulse to drill the hole in a single shot. Although the laser drill is still used on an experimental basis, it is drilling several thousand electrodes a year. The camera tube is a completely brazed structure and uses a .002-inch-aperture, beam-straightening mesh that is smaller than most commercial meshes and allows 45% beam transmission. However, Western Electric is in the process of developing a finer mesh, which, the company hopes, will boost beam transmission to 60%.

It's more than just a tube

The display tube and beam-lead integrated circuits used in the Picturephone don't require the extraordinary production controls needed in silicon-target fabrication. However, Picturephone's high reliability standards do necessitate special manufacturing techniques for its components.

"Western Electric has taken special care with the Picturephone display tube," says R.M. LeLacheur, manager of development and manufacturing engineering. "Rim bonding has been used to attach a special tempered glass cover to the picture tube for safety," he asserts, noting that the glass plate is tinted to reject reflection.

The display tube has a 5-by-5½ inch screen and is prefitted with deflection coils and yoke, and then covered with polyurethane foam. The final package needs no preadjustment prior to installation. All that's required is the connection of the flying leads. And since ac-

celeration voltage is only 14,000 volts, the tube has no harmful X-ray emission.

There are about a dozen beam-lead IC's used in Picturephone, but Western Electric plans to more than double that number in the near future. "The cost factor hasn't shrunk yet but the promise of IC's is there and this is certainly the way to go," says LeLacheur.

Western Electric's Reading plant is setting up a pilot program to produce 90% of the IC's required for Picturephone. Manufacturing at the Reading plant is in a laboratory environment; all pieces are hand-carried from one station to the next. The pilot line is shared on an equal basis by Western Electric and Bell Labs, with the latter involved in developmental work. However, Bell Labs' involvement will be cut to 25% this year, allowing more production time for Western Electric.



or...you can
use
platinum

and avoid the headaches

Specify products made of platinum for those tough jobs other materials can't do. Platinum products—sheet, tape, foil, wire, tubing, gauze, discs, cathodes, electrodes, crucibles, others—offer properties unobtainable elsewhere. They withstand temperatures to 3200° F, will not erode or corrode, are catalytically active, and chemically inert. And, platinum can be recovered and reused, time and again. For details, contact . . .

MBI

MATTHEY BISHOP, INC.

MECHANICAL DIVISION

Platinum Mechanical Department

MALVERN, PENNSYLVANIA 19355

A Johnson Matthey Affiliate

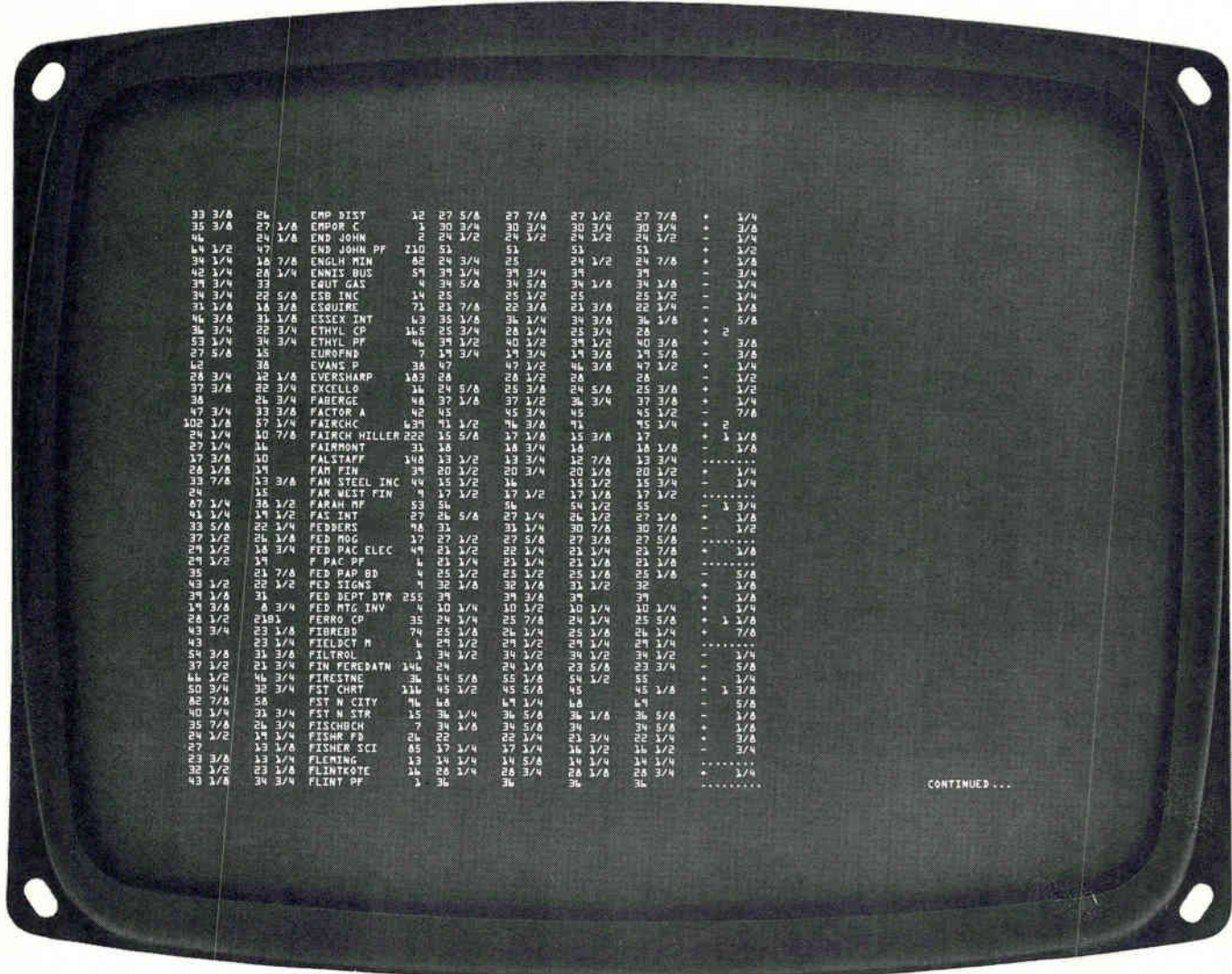

| | | | | | | | | | |
|---------|--------|---------------|-----|--------|--------|--------|--------|-------|-------|
| 33 3/8 | 24 | EMP DIST | 12 | 27 5/8 | 27 7/8 | 27 1/2 | 27 7/8 | + | 1/4 |
| 35 3/8 | 27 1/8 | EMPOR C | 1 | 30 3/4 | 30 3/4 | 30 3/4 | 30 3/4 | + | 3/8 |
| 46 | 24 1/8 | END JOHN | 2 | 24 1/2 | 24 1/2 | 24 1/2 | 24 1/2 | - | 1/4 |
| 44 1/2 | 47 | END JOHN PF | 110 | 51 | 51 | 51 | 51 | + | 1/2 |
| 24 3/4 | 18 7/8 | ENGLISH MIN | 82 | 24 3/4 | 25 | 24 1/2 | 24 7/8 | + | 1/8 |
| 42 1/4 | 28 1/4 | ENNIS BUS | 57 | 34 1/4 | 34 3/4 | 34 | 34 | - | 1/4 |
| 37 3/4 | 33 | EQUOT GAS | 4 | 34 5/8 | 34 5/8 | 34 1/8 | 34 1/8 | - | 1/4 |
| 34 3/4 | 22 5/8 | ESB INC | 14 | 25 | 25 1/2 | 25 | 25 1/2 | - | 1/4 |
| 31 3/8 | 18 3/8 | ESQUIRE | 73 | 21 7/8 | 22 3/8 | 21 3/8 | 22 1/4 | - | 1/8 |
| 46 3/8 | 31 1/8 | ESSEX INT | 13 | 25 1/8 | 24 1/4 | 24 3/8 | 24 1/8 | + | 5/8 |
| 36 3/4 | 22 3/4 | ETHYL CP | 165 | 25 3/4 | 28 1/4 | 25 3/4 | 28 | + | 2 |
| 53 1/4 | 34 3/4 | ETHYL PF | 46 | 34 1/2 | 40 1/2 | 34 1/2 | 40 3/8 | + | 3/8 |
| 27 5/8 | 15 | EUROFND | 7 | 14 3/4 | 14 3/4 | 14 3/8 | 14 5/8 | - | 3/8 |
| 46 | 38 | EVANS P | 38 | 47 | 47 1/2 | 46 3/8 | 47 1/2 | + | 1/4 |
| 28 3/4 | 12 1/8 | EVERSHARP | 183 | 28 | 24 1/2 | 28 | 28 | - | 1/2 |
| 37 3/8 | 22 3/4 | EXCELLO | 11 | 24 5/8 | 25 3/8 | 24 5/8 | 25 3/8 | + | 1/2 |
| 36 | 26 3/4 | FABERGE | 48 | 37 1/8 | 37 1/2 | 36 3/4 | 37 3/8 | + | 1/4 |
| 47 3/4 | 33 3/8 | FACTOR A | 42 | 45 | 45 3/4 | 45 | 45 1/2 | - | 7/8 |
| 102 1/8 | 57 1/4 | FAIRCHC | 639 | 41 1/2 | 46 3/8 | 41 | 45 1/4 | + | 2 |
| 24 1/4 | 10 7/8 | FAIRCH HILLER | 222 | 15 5/8 | 17 1/8 | 15 3/8 | 17 | + | 1 1/8 |
| 27 1/4 | 11 | FAIRMONT | 31 | 18 | 18 3/4 | 18 | 18 1/8 | - | 1/8 |
| 17 3/8 | 10 | FALSTAFF | 148 | 13 1/2 | 13 3/4 | 12 7/8 | 13 3/4 | | |
| 26 1/8 | 14 | FAM FIN | 34 | 20 1/2 | 20 3/4 | 20 1/8 | 20 1/2 | + | 1/4 |
| 33 7/8 | 12 3/8 | FAM STEEL INC | 44 | 15 1/2 | 16 | 15 1/2 | 15 3/4 | - | 1/4 |
| 24 | 15 | FAR WEST FIN | 4 | 17 1/2 | 17 1/2 | 17 1/8 | 17 1/2 | | |
| 47 1/4 | 38 1/2 | FARAH RF | 53 | 56 | 56 | 54 1/2 | 55 | + | 1 3/4 |
| 41 1/4 | 14 1/2 | FAC INT | 27 | 26 5/8 | 27 1/4 | 26 1/2 | 27 1/8 | + | 1/8 |
| 33 5/8 | 22 1/4 | FEDDERS | 46 | 31 | 31 1/4 | 30 7/8 | 30 7/8 | - | 1/2 |
| 37 1/2 | 26 1/8 | FED HOG | 17 | 27 1/2 | 27 5/8 | 27 3/8 | 27 5/8 | | |
| 29 1/2 | 18 3/4 | FED PAC ELEC | 49 | 21 1/2 | 22 1/4 | 21 3/4 | 22 7/8 | + | 3/8 |
| 24 1/2 | 14 | F PAC PF | 4 | 21 1/4 | 21 1/4 | 21 1/8 | 21 1/8 | | |
| 35 | 21 7/8 | FED PAP BD | 4 | 25 1/2 | 25 1/2 | 25 1/8 | 25 1/8 | - | 5/8 |
| 43 1/2 | 22 1/2 | FED SIGNS | 4 | 32 1/8 | 32 1/8 | 31 1/2 | 32 | + | 1/8 |
| 34 1/8 | 31 | FED DEPT DTR | 255 | 34 | 34 3/8 | 34 | 34 | + | 1/8 |
| 14 3/8 | 8 3/4 | FED RTC INV | 4 | 10 1/4 | 10 1/2 | 10 1/4 | 10 1/4 | + | 1/4 |
| 28 1/2 | 21 1/2 | FERRO CP | 35 | 24 1/4 | 25 7/8 | 24 1/4 | 25 5/8 | + | 1 1/8 |
| 43 3/4 | 23 1/8 | FIBREDD | 74 | 25 1/8 | 26 1/4 | 25 1/8 | 26 1/4 | + | 7/8 |
| 43 | 23 1/4 | FIELDCT M | 6 | 24 1/2 | 24 1/2 | 24 1/4 | 24 1/4 | | |
| 54 3/8 | 31 3/8 | FILTROL | 1 | 34 1/2 | 34 1/2 | 34 1/2 | 34 1/2 | - | 1/4 |
| 37 1/2 | 21 3/4 | FIN PEREBATM | 146 | 24 | 24 1/8 | 23 5/8 | 23 3/4 | - | 5/8 |
| 46 1/2 | 46 3/4 | FIRESTNE | 36 | 54 5/8 | 55 1/8 | 54 1/2 | 55 | + | 1/4 |
| 50 3/4 | 32 3/4 | FST CRT | 111 | 45 1/2 | 45 5/8 | 45 | 45 1/8 | - | 1 3/8 |
| 82 7/8 | 58 | FST N CITY | 46 | 68 | 64 1/4 | 68 | 64 | - | 5/8 |
| 40 1/4 | 34 3/4 | FST N STR | 15 | 36 1/4 | 36 5/8 | 36 1/8 | 36 5/8 | - | 1/8 |
| 35 7/8 | 24 3/4 | FITCHRCH | 7 | 34 1/8 | 34 5/8 | 34 | 34 5/8 | + | 1/8 |
| 24 1/2 | 14 1/4 | FISHR FB | 24 | 22 | 22 1/4 | 21 3/4 | 22 1/4 | + | 5/8 |
| 27 | 13 1/8 | FISHER SCI | 85 | 17 1/4 | 17 1/4 | 16 1/2 | 16 1/2 | - | 3/4 |
| 23 3/8 | 13 1/4 | FLEMING | 13 | 14 1/4 | 14 5/8 | 14 1/4 | 14 1/4 | | |
| 32 1/2 | 21 1/8 | FLINTKOTE | 14 | 26 1/4 | 26 3/4 | 26 1/8 | 26 3/4 | + | 1/4 |
| 43 1/8 | 34 3/4 | FLINTY PF | 1 | 36 | 36 | 36 | 36 | | |

CONTINUED ...

You meet more characters in this business.

When you do business with Fairchild-DuMont, your display tube hang-ups dissolve, your horizon widens. You can think of computer readouts with 1000, 2000, even 4000 characters. You can think of tubes that are smaller than an inch across — or nearly three feet. You can choose magnetic or electrostatic deflection — or both. Most of all, you can think of Fairchild-DuMont — the prime source for *precisely* any display tube you need. Chances are the design is in stock. If not, we design it for you.

Every size and shape . . . the optics, resolution and phosphor type to suit your specific kind of alphanumeric or graphic display . . . and the parameters you need built into the *tube* rather than solved in the circuit . . . that's the kind of business we're in.

Fairchild-DuMont tackles your problem from all standpoints — glass, gun, phosphor and operating requirements. We've designed more guns, coated and modified more glass, and met tougher specs than anybody in the information display tube field.

But there's a way to find out for yourself. Discuss with us the CRT you need. We can usually have a sample on your desk in *ten days* . . . plus a quote . . . plus the fastest delivery of production tubes anywhere. Anything less would be out of character for us. Try us. And see. Call Computer Tube Sales at (201) 773-2000 for technical sales assistance.

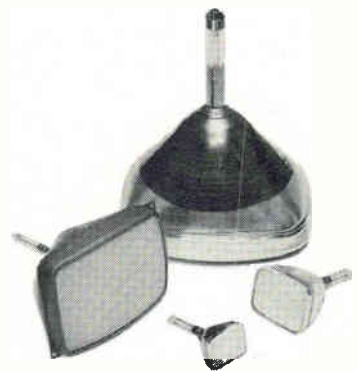

FAIRCHILD

DU MONT ELECTRON TUBES

A DIVISION OF FAIRCHILD CAMERA AND INSTRUMENT CORPORATION
750 BLOOMFIELD AVENUE, CLIFTON, N. J. 07015

Is Russian market ready to boom for computers, peripheral equipment?

Over 40 U.S. firms are now represented in Moscow; best tools for sales researchers are a feel for Soviet politics and a sixth sense about prospects

By Jack Winkler

Moscow news bureau

"Wait until the Americans get interested in this market," West European businessmen in Moscow have been saying for years, "then the competition is going to heat up." That interest would burgeon, the guessers reckoned, as soon as the Vietnam war ended.

They miscalculated. The year 1969 can be marked as the year when, electronically speaking, the Yanks landed in the Soviet Union. In the past 12 months more than 40 U.S. electronics firms have been actively trying to sell the Russian market, mostly through European subsidiaries. And their names, with a few conspicuous exceptions, read like a register of American big business: General Electric, Westinghouse, Philco-Ford, Honeywell, National Cash Register, 3M, Hewlett-Packard, Bendix, Litton Industries, Control Data, Burroughs, Clarkson Industries, Varian Associates, and others. There are even rumors in Moscow that IBM is negotiating to sell software.

Arcane art. Predicting the Russian import market for electronics is something of a black art. The 1968 guess was \$15 million to \$100 million [*Electronics*, Dec. 9, 1968, p. 126]. Because Soviet officials don't even understand the concept of market research and treat it as something of a treasure hunt—"The clever man will be able to find out," says one senior aide with a wink—businessmen in Moscow must sample the political winds as a rough indicator of what the USSR will be buying. And lately, political indicators of importance to the electronics industry have been very strong.



The feeling now is that the Soviet electronics imports are about to take off. The main areas will be automation and process-control equipment. Such machinery was the subject of an exhibit last spring, and since then there has been considerable public complaint about inadequate automation of the Soviet economy. Moreover, a decree has been issued supporting major advances in automation, a boost in industry's technical level, and the introduction of new equipment.

There also should be increased interest in office electronics—desktop calculators, accounting equipment, and small computers—because they, too, have been the subject of a decree and the USSR does virtually nothing in the field. One U.S. manufacturer trying to sell such equipment last spring (before the decree) met vast interest but made no sales. Things should be different in the next 12 months. Raznoimport, one of the foreign-

trade organizations, has just set up a display room, occupying an entire floor, filled entirely with Western office equipment.

Also facing a bull market is peripherals, another area in which the USSR admits its weakness. It's believed that Britain's International Computers Ltd., the biggest electronics exporter to Russia, considers the peripheral market its best bet.

Big computer roadblock

Completing the list is big computers. The Russians have been trying for some time to get their hands on such machines, but find U.S. controls blocking the way. Control Data found this out the hard way. The sale of one CDC 6600 to the Nuclear Research Institute in Yerevan has been held up by export control regulations and has become the central issue in a projected exchange of nuclear physicists between the U.S. and

NEW INEXPENSIVE FET INPUT HYBRID OP AMP

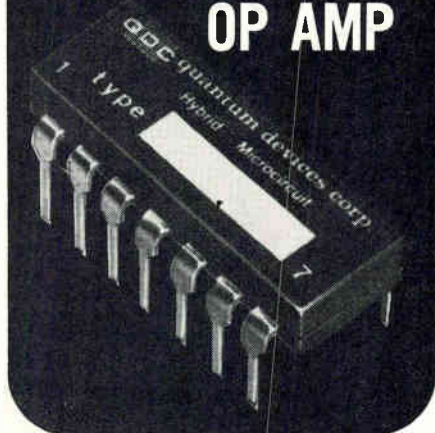

Available in an epoxy dual in-line package, the Quantum FET input op amp is produced using the latest thin film microtechnology, and computer selected components. Its low price combines with its advanced design to make it ideal for inclusion in the most sophisticated of instruments and equipment.

Send for more details on our custom hybrid capabilities.

Voltage offset
Initial @ 25°C ± 5 mv max.
Trimable to zero
with 10K pot

Voltage offset vs. temp.
(-25°C to +85°C)
OA-109 Typical 65 μ v/°C
Max. 100 μ v/°C

Open loop gain 150,000 typical
CMRR 65dB min.

Input bias current 75 pa max.

Voltage swing
($R_L = 2k V_s = \pm 15V$) ± 10 v min.

Price (100 lot) \$15.50

QDC

QUANTUM DEVICES CORP.

15 West Main Street,
Bergenfield, N.J. 07621
(201) 385-9600

Russia. The Russians want the Americans to bring the computer along if they do experimental work at the giant Serpukhov accelerator, and so far this hasn't been allowed. And Guri Marchuk, one of the USSR's leading cyberneticians, says his country can use four or five times the current annual computer production.

Factions. It's in the computer area that a businessman can find the most clearly defined interaction of Russian politics, technology, and business. Of much greater significance in the long run than any trade developments is the sudden revival in the last months of 1969 of the cybernetics faction among Soviet economists, planners, and politicians. The computer has become a political symbol in the Soviet Union. It stands for a rational technocratic control of the economy and, ultimately, Soviet society. As such it presents a threat to the long traditions of political control and discipline by the party and has become the focus of a crucial, though largely behind the scenes, battle.

The computer advocates are the continuation, both in logic and personnel, of a faction of dissidents that has existed throughout the years of Soviet power, stretching back through the economic reformists, anti-Stalinists, anti-collectivists, the new economic policy men, and, ultimately, to the Mensheviks. They are the soft-liners and are usually called progressives in the West. In earlier Soviet debates, fought solely on policy grounds, they usually came out the losers. But the computer offered them a technical advantage: they could do something in the party that hard-liners could not. With the economic reform of 1965, they seemed to come into the ascendancy. They remained there until early 1968 when the conservatives began a counter-attack, pointing out correctly that the computer hadn't produced an immediate economic improvement. This was immediately followed by the Czech crisis showing, to the hard-line point of view, the political dangers of economic reform. The computer faction seemed to be losing.

Then in late September and October came the five Soviet government decrees designed to raise

labor productivity. They specifically advocated greater use of computers, automation, and even the firing of workers where necessary, thereby killing a 50-year-old sacred cow that had reached enormous proportions. The new measures were quite clearly sponsored by the controversial and conspicuous reform economist Aleksandr Birman. The computer faction appears to have vaulted back into the saddle again.

Role debated

The practical significance of all this political intrigue is that the electronics industry, and computers in particular, appear to be in for major expansion. The crunch of the political debate was the scope of the role to be given to computers in the economy. The hard-liners wanted to restrict computer applications to process control and information gathering, leaving decision making to the party. The computer faction, however, has held out the vision of a whole planned economy being run by a vast network of computers all over the country. If the cyberneticians have won their fight for a big role for computers, as it appears they have, the consequences for the industry could be enormous.

It would almost certainly mean a massive increase in domestic production of both computers and software, and a reorganization of the industry's structure. At the least, this would mean bringing the five ministries now engaged in production under one roof. Then, there would be increased imports of all sorts. In the USSR, command over foreign exchange and hence imports is a function of political weight. If the computer men have indeed won they will start buying abroad.

Progress on the state network of computing centers might also result. The intention was to have 800 of these operating as time-sharing centers by 1975. The system became stalled by the political debate, with the conservatives apparently trying to subordinate it to the central statistical board as a mere information-gathering network. In the latest report, the system, planned for at least five years now, was still "on the threshold." At least the major political hurdle may

Trade winds

U.S. policy on trade with Communist nations is undergoing a mid-winter thaw. Congress has passed a liberalized export-control law that requires the Commerce Department to review its list of restricted products and technologies. The object: free items that do not make significant contributions to the military potential of the Communist bloc and thus pave the way for freer trade.

Under the new law, Commerce will have to explain why a license is required for an item even when it is available elsewhere, and if a license is refused, why it was.

have been surmounted.

Finally, major automation of industry could be in the cards. The decree on machinery has given a start to the work. The Lvov and Barnayul experiments in completely automated factories should soon be finished with, the computer men hope, a viable system resulting.

But whatever happens, the Americans won't have the Soviet market to themselves. Britain's ICL, long a front-runner in Eastern Europe, is now installing a computer-distribution system for Soviet steel and has just been allowed to open a permanent office in Moscow, the only electronics firm so privileged by the Soviet government.

Here they come. Neither will trade be all one way. For the first time, the USSR displayed its micro-circuitry at this year's Paris International Electronic Components Show. More than 200 types, both hybrids and monolithic, were shown and some at least were internationally competitive. Licensintorg, the Soviet license trading monopoly, has been building up an electronics section and now offers 10 items, eight of them already patented in the U.S. and Western Europe, including multistable circuitry [*Electronics*, April 28, 1969, p. 157].

After Paris, the Russians put their circuits on display in London and Scandinavia. Initial reaction seems to indicate that Scandinavia has the most potential, but it's still too early to say. ■

RMC

TEMPERATURE COMPENSATING SOLDER-INS

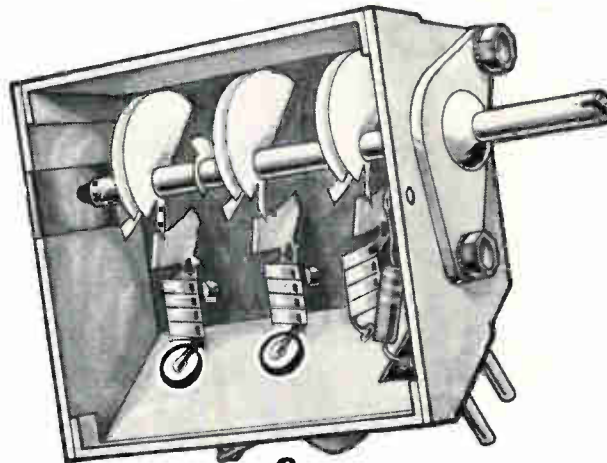

for UHF APPLICATIONS

SPECIFICATIONS

CAPACITANCE: Within tolerance @ 1 MC and 25°C

CAPACITANCE TOLERANCES: $\pm 5\%$, $\pm 10\%$ or $\pm 20\%$ (but not less than $\pm .25$ pf)

WORKING VOLTAGE: 500 VDC

INSULATION RESISTANCE: Greater than 7500 Megohms @ 500 VDC

FLASH TEST: 1000 VDC for 1 second

ELECTRODE: Pretinned for assured solderability

These new solder-in capacitors are designed for use in UHF applications requiring the absolute minimum in lead inductance effects. Solder-ins are available in a wide range of temperature coefficients in capacities from 1.5 to 105 pfd.

If your application requires special physical or electrical characteristics, contact RMC's Engineering Department.

Write today on your company letterhead for your copy of the RMC Catalog.

DISCAP
CERAMIC
CAPACITORS

RMC

RADIO MATERIALS COMPANY

A DIVISION OF P. R. MALLORY & CO., INC.

GENERAL OFFICE: 4242 W. Bryn Mawr Ave., Chicago 46, Ill.

Two RMC Plants Devoted Exclusively to Ceramic Capacitors

FACTORIES AT CHICAGO, ILL. AND ATTICA, IND.

Our 1¼ oz. alarm will blast you with 80db of the most irritating noise in the world.

Nothing can drown out or cover up the persuasively piercing sound of the Mallory Sonalert® electronic audible signal. It's made to be heard.

The light, compact Sonalert is of solid state design for maximum efficiency and reliability and requires as little as 3 milliamps current. No arcing. No mechanical wear.

You can use Sonalert in hundreds of places—autos, trucks, boats, planes, laboratory, home and industry—anywhere a warning signal is required. Its penetrating audible signal scares burglars, warns of dangerous conditions and is an adjunct to many types of visual signals. It produces no RF noise, making it ideal for low-volt-



age circuits in computers, medical electronics, instrumentation and communications equipment.

Sound intensity range is 68db @ 6VDC to 80db @ 28VDC. Sound frequency levels are 2900 ± 500 Hz and 4500 ± 500 Hz, depending on model. Warbling, pulsing and AC models also are available. You can get Sonalert from your local Mallory distributor.

For a free 48-page idea booklet of applications, #9-406 "How to Use Sonalert," write to Mallory Capacitor Company, a division of P. R. Mallory & Co. Inc., Indianapolis, Indiana 46206.

Sonalert® — Registered trademark, P. R. Mallory & Co. Inc.

MALLORY

MALLORY CAPACITOR COMPANY

a division of P. R. MALLORY & CO. INC.

3029 E. Washington St., Indianapolis, Indiana 46206; Telephone: 317-636-5353

Electrical and Electronic Components • Sequence Timers • Metallurgical Products • Batteries

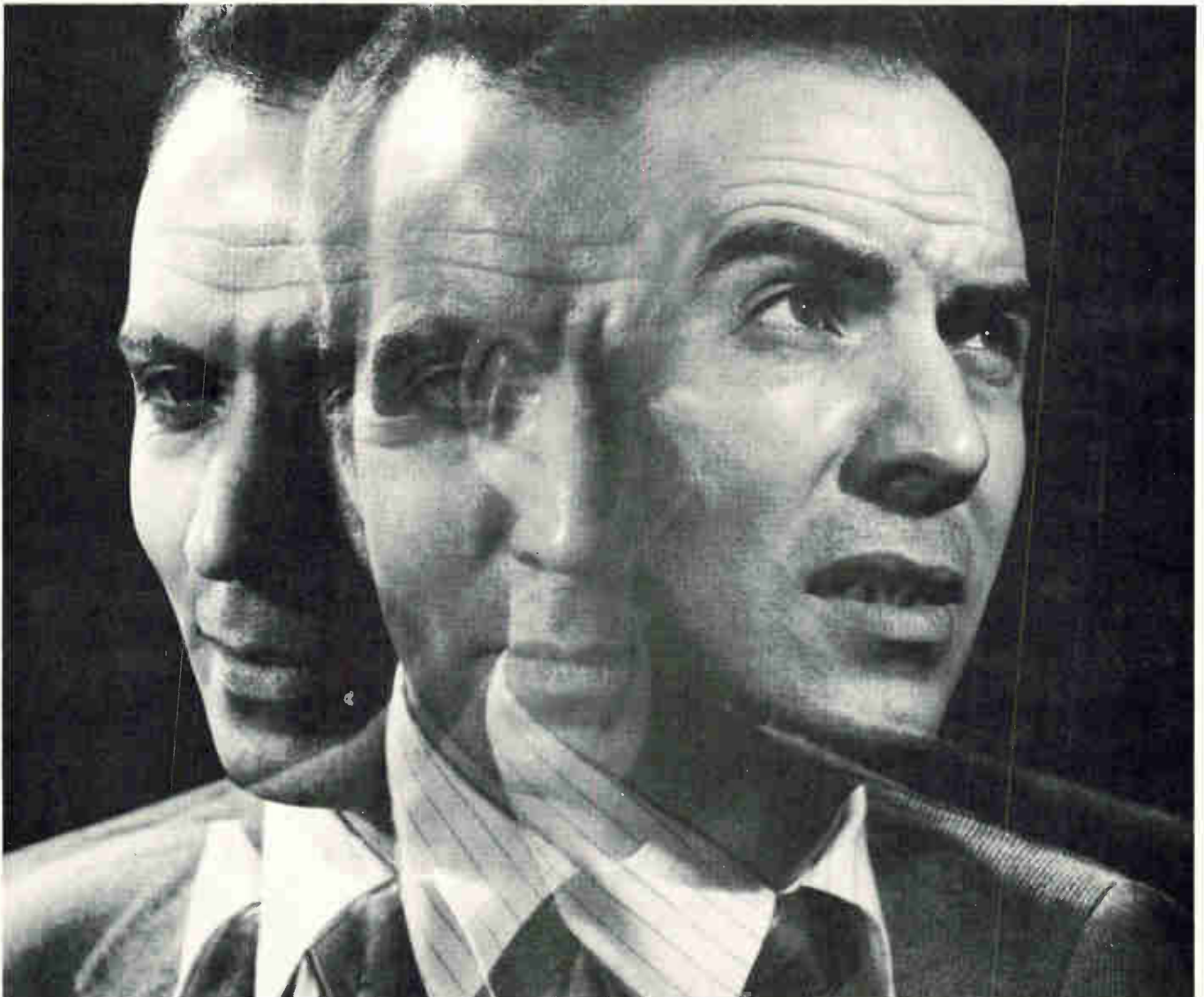

Word generator has 48 outputs

Unit built for testing the larger LSI arrays expected soon; outputs are adjustable from 10-bit to 4,000-bit lengths

By Owen Doyle

Electronics staff

Engineers at the Educational Computer Corp. feel at times as though they are bucking the tide. First, while all the other companies bent on making large-scale-integration array testers are turning out computer-controlled systems, ECC has been offering a manual unit that takes up to an hour to set up.

Now ECC is going against the current again. The company is preparing—for introduction at the IEEE Show in March—a 48-output word generator, something that ECC feels array makers will be demanding very shortly. However, ECC is bucking a trend in the way it makes the generator. The key part of any word generator is its memory. With the speed of LSI circuits increasing, it would be expected that a generator's memory would be made of semiconductor arrays, or at least of shift registers. But ECC is using a core memory.

The vice president and chief engineer, Alfred Homann, feels that his company is moving in a profitable direction. In the case of the tester, Homann points out that his company's unit is at most one-fifth the price of computer-controlled systems. "Our tester goes for around \$40,000" he says. "Texas Instruments is quoting \$358,000 for its 561, and Autonetics is asking \$250,000 for the 310."

And Homann finds many reasons to justify using the core memory in the new generator. When the decision had to be made about the memory, the question that had to be answered, says Homann, was: "Is this (cores) the way to go, or should we use semiconductor arrays? This is tough to answer be-

cause array makers are talking about speeds of 10, 20 or 30 nanoseconds—which means you could have a word generator that runs at 10 or 20 megahertz.

"My answer," recalls Homann, "was to go to the cores because they're proven, reliable, and available. If semiconductor memories become available at the right price, we've made the generator so that we'll be able to use them."

ECC ruled out shift-register memories. "The testers I know of made by other companies—TI and Fairchild and so forth—rely on shift registers for memories, either static or dynamic" says Homann. "If they're static, the tester can go down to d-c but it's pretty limited in the kinds of testing it can do.

If they're dynamic, they're limited to at least 100-hertz minimum frequency, and 1 kilohertz if you want to make sure they don't drop any bits. It sure seems to me that shift registers have a notorious habit of dropping bits."

Another reason for going to the core memory was the price. ECC buys the memories from California's Core Memories Inc., paying \$10,000 each. Homann estimates that the cost for a shift-register or semiconductor memory would be several times that.

The new generator has a repetition rate of d-c to 1.5 Mhz, and the length of its 48 output words is adjustable between 10 bits and 4,000 bits. And the outputs are compatible with transistor-transis-

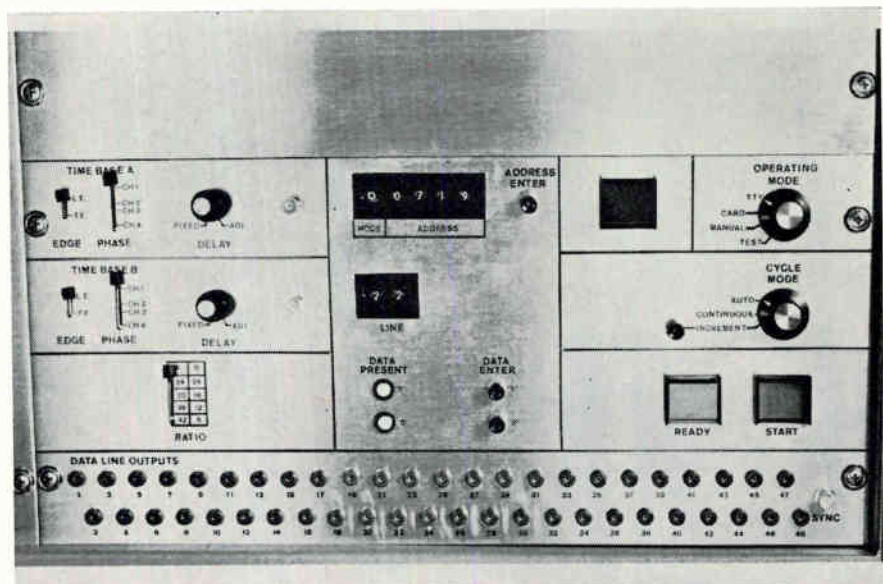

Words to test by. Switch at the lower left hand of word generator's control panel determines how much of the total data comes out at any one interval. Buttons at right of center section are used to correct mistakes detected during data input operation.

Opportunities for

RADAR SYSTEMS ENGINEERS

Expanding activity on long-range programs and advanced projects has created stimulating assignments for Radar Systems Engineers qualified in the following areas:

ANALYSIS & FUNCTIONAL DESIGN

These openings involve generation of system design requirements and specifications, analysis of system performance and technical design coordination. Experience is required in doppler, monopulse or high-resolution radar systems; background in signal processing or clutter analysis is desirable.

TEST & EVALUATION

Immediate assignments are available involving performance of radar systems, integration and evaluation tests, analysis of test data and recommendation of appropriate design action. Radar systems test and evaluation experience is very desirable; hardware design, flight test or field engineering experience will also be considered.

CIRCUIT & PRODUCT DESIGN

These positions involve the circuit or product design and development of advanced radar hardware components, including antennas, transmitters, receivers, signal and data processors, range/velocity/angle trackers, compression circuits and power supplies. Experience with digital/analog micromin circuits is desirable.

For immediate consideration, please airmail your resume to:

MR. ROBERT A. MARTIN
Head of Employment
Hughes Aerospace Divisions
Dept. 42
11940 W. Jefferson Blvd.
Culver City, Calif. 90230

HUGHES

HUGHES AIRCRAFT COMPANY
AEROSPACE DIVISIONS

An equal opportunity employer—M & F

U.S. citizenship is required.

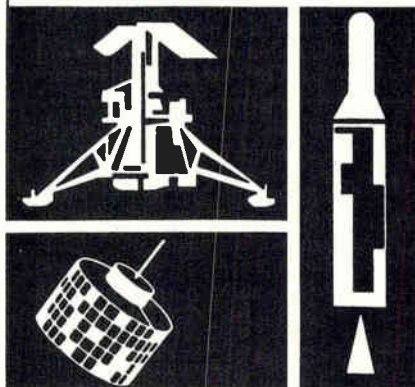

... in later models, commands will be stored in the memory, allowing the generator to make a choice among several test programs ...

tor-logic circuits.

The memory has 48 planes, one for each word, and each plane is 64 by 64 bits.

Ins and outs. In any digital-circuit tester, the word generator puts out a variety of signals which go to the inputs of the circuit being checked. The tester compares the resulting outputs from the circuit against what it knows to be the correct responses. Thus, there are two steps involved in using a word generator: storing the test signals in the memory, and then reading these signals out.

In the ECC generator, the test sequences can be read in by teletypewriter, punched cards, or by hand, although a card reader does by far the fastest job.

Regardless of the input means, the signals come in serially, the address first and then the word to be stored. Since the address is part of the input, the memory is a random-access unit and no special care need be taken about the order in which the data comes in.

The input signals first pass through a mode detector, which determines whether the signals are test sequences or commands. Initial models of the generator will only accept test sequences, but ECC engineers want eventually to store commands in memory. When this is done, the generator will be able to do such things as store more than one test program, Homann points out.

When the time comes to use the data, it comes out of the memory into a bank of JK flip-flops. Then it passes into a second bank of flip-flops, which are strobed. ECC uses two sets of flip-flops because while all the data leaves the memory at once, some of the outputs can come out of the second bank of flip-flops at one time, and the rest of the outputs an interval later.

On the generator's front panel is a switch that controls the strobing. With it, the user can have all the data come out at once, or have 24 words come at one time and 24 an interval later, 30 words and then

18, 36 words and then 12, or 42 words and then 6.

Also on the front panel is a set of thumbwheel switches with which the user can dial any address in the memory. A button on the panel allows the user to change the data at that address without changing his punched cards.

At the bottom of the panel are the 48 jacks for the generator's outputs.

The generator is 19 by 17 by 19 inches, weighs 50 pounds, and plugs right into ECC's present tester. The word generator now used by the tester puts out 40 words of 100 bits at rates up to 2.5 Mhz. But Homann points out: "You can just see the way arrays are going in physical size, and they're starting to put a couple of arrays into one package. If we didn't come up with a bigger generator, we'd be out of the market within a year."

The generator by itself will sell for \$39,000. The LSI tester with the new generator will cost \$64,000. Deliveries are scheduled to start in May. At first, says Homann, ECC will be able to ship one unit a month, because that's as fast as ECC can get the memories. However Homann expects the production rate to go up by year's end.

ECC expects its customers will include companies wanting the complete tester, and those building their own test systems but unwilling to spend a lot of time designing the generator.

Says Homann: "The demand would be greater if LSI existed, or—rather—existed in quantity at a price you could afford. The people building equipment around LSI now design the smallest, lightest, and probably best equipment around. But it's a real sticky situation they can get themselves into if they're not careful. If they can't get the circuits, they're in trouble. And I think it's safe to say that all the leading producers of LSI arrays have disappointed people in the past on deliveries."

Educational Computer Cor., Sicklerville, N.J. [338]

The cable that won't hold you back

To move ahead in today's complex technology, the wire and cable you specify must be as sophisticated as the equipment it connects. Being unable to repair themselves, connections have to be more dependable than the humans they replace.

The wire and cable you put in today should have the most contemporary construction and electronic capabilities available . . . to minimize rewiring as you expand.

It should be equal to the unfamiliar equipment and interfacing systems that you're going to be living with soon.

This is the kind of wire and cable that Brand-Rex can bring you because we've been in on the development of these systems for years.

Are you the push-forward type? Send for our "all-products brochure". It covers contemporary wire and cable for telephone/communications . . . computer/peripheral . . . commercial/appliance . . . municipal . . . industrial/utility . . . and military applications. Tubing and sleeving, too. Brand-Rex Division, American Enka Corp., Willimantic, Conn. 06226. Phone 203 423-7771.

**Connect for tomorrow
BRAND-REX**



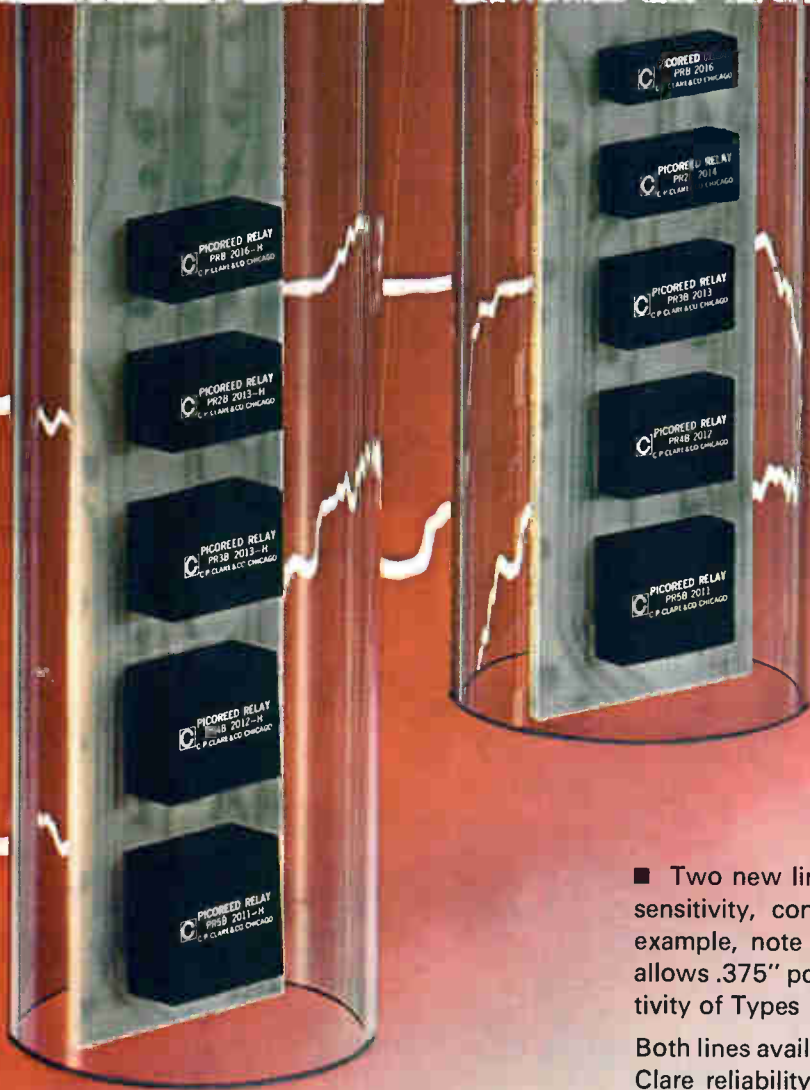

■ Two new lines of Picoreed® relays give you a wider choice in sensitivity, contact configurations and space-saving size. For example, note the new low profile of Types PRA and PRB—allows .375" pcb mounting centers. And note the new high sensitivity of Types PRAH and PRBH.

Both lines available in one to five Form A contacts with traditional Clare reliability. 100,000,000 operations at signal levels. 5 volt (must-operate 3.75v), compatible with standard 5 v DTL and TTL logic families. 6, 12 and 24 volt standard relays also available.

For information, circle Reader Service number, or write for Data Sheet 971A. C. P. Clare & Co., Chicago, Illinois 60645...and worldwide.

NEW
 ...from CLARESEARCH
 ...Ultraminiature
 reed relays

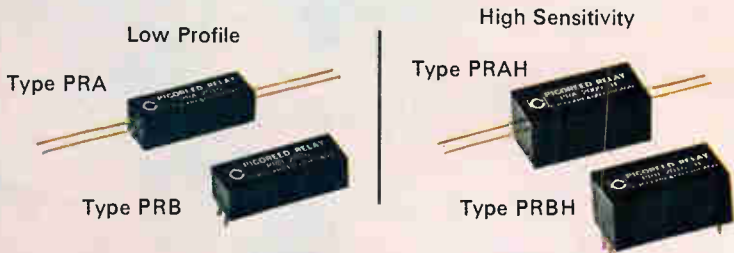

| <i>Electrical and Dimensional Characteristics</i> | Types PRA/PRB—Low Profile | | Types PRAH/PRBH—High Sensitivity | |
|---|---------------------------|-------------|----------------------------------|-------------|
| | Form 1A | Form 5A | Form 1A | Form 5A |
| Operate time, including bounce | 500 μ s | 600 μ s | 600 μ s | 900 μ s |
| Average nominal power for 5 volt units | 65 mw | 250 mw | 46 mw | 140 mw |
| Pcb mounting centers | .375" | .375" | .500" | .500" |
| Length | .781 | .800 | .800 | .800 |
| Width* | .250 | .675 | .400 | .800 |
| Height | .187 | .225 | .350 | .350 |

*Widths vary according to number of switches. One through 5 available.



a GENERAL INSTRUMENT company

Circle 144 on reader service card

Sweeper tries to plug into wide market

Available with video, vhf and uhf generators, unit delivers output that is flat to within 0.05 db

Priced in the \$2,000-and-above range, sweep generators are too expensive to supply to each man in a laboratory. As a result they remain pass-around instruments. Marconi Instruments Ltd.'s new sweeper can't be called dirt-cheap, but at least, because of its wide frequency range, it can be passed around to a lot of people. Using plug-ins, the instrument covers the range from

25 kilohertz to around 3 gigahertz.

A mainframe, called the TF 2361, and one of three plug-ins make up the sweeper. The TM 9692 video plug-in's range is 25 khz to 30 megahertz; the TM 9693 very-high-frequency unit goes from 1 Mhz to 30 Mhz; and the third plug-in, scheduled for April release, will cover the ultra-high-frequency band (300 Mhz to 3 Ghz).

Marconi's U.S. office has yet to set prices for the sweeper. Tentative figures are \$2,800 for the mainframe and video plug-in, and \$3,300 for the mainframe, vhf plug-in and an attenuator. A Marconi spokesman in the U.S. calls these "the maximum possible prices". No prices have been set for the uhf plug-in.

Besides wide range, the sweep-

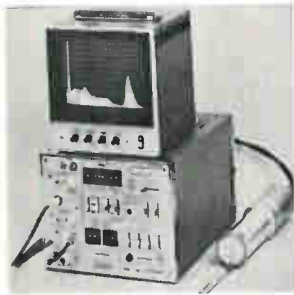

Multichannel analyzer called Spectrazoom can be used either as a conventional pulse-height analyzer or as a multiscaler. It has an 8 Mhz analog-to-digital converter combined with a memory cycle time of less than 8 μ sec. Featured are: display on standard tv monitor, and two floating-point, 100-address memories. Packard Instrument Co., 2200 Warrenville Rd., Downers Grove, Ill. [361]

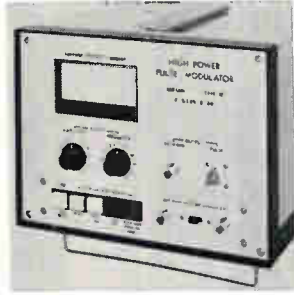

Pulse modulators are computer-controllable for automated testing. Type 101 provides up to 10 kw of regulated and continuously variable peak power output in a compact design. Standard units are available with peak outputs of 3.5 kv at 3 amps, 5 kv at 2 amps, and 100 v at 100 amps. Price is \$985; delivery, 2 weeks. Bertan Associates Inc., 15 Newtown Rd., Plainview, N.Y. [362]

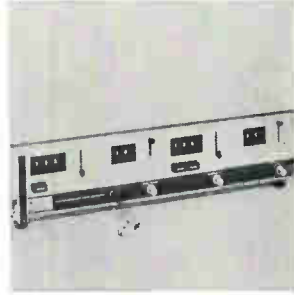

Dual programmable pulse generator model 1210 is a general purpose unit for use in manual or computer-controlled applications. Both generators are fully programmable in pulse repetition interval from 200 nsec to 9.99 msec (100 hz to 5 Mhz), and pulse widths from 100 nsec to 0.99 msec. Price is \$995; delivery, 60 days. Antekna Inc., 4015 Fabian Way, Palo Alto, Calif. 94303 [363]



Pulse generator model 448 is used to simulate the output of semiconductor detectors for the calibration of high-resolution spectrometry systems. It can be set with an accuracy of 10 ppm. Stability is typically ± 10 ppm, with a long term drift of no more than 15 ppm for a 24-hr period with temperature and voltage constant. Ortec Inc., 224-L Midland Rd., Oak Ridge, Tenn. 37830 [364]



Autoranging digital dbm/khz test set 1101A is for telecommunications circuits. It combines the capability for both frequency and transmission level measurements. It provides direct digital readout for signals between -50 dbm and +10 dbm; 10 readings per sec at a resolution of 1hz. Price is \$1,185. Telecommunications Technology Inc., 920 Commercial St., Palo Alto, Calif. [365]

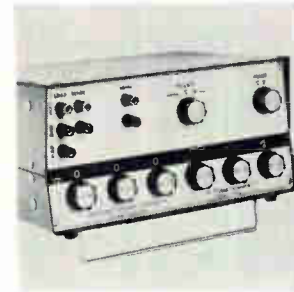

Precision d-c voltage calibrator model 472A features $\pm 0.0025\%$ accuracy of setting. It is adaptable, with two ranges—9 to 11 v and 0 to 110 mv output. An input current of 20 ma can be drawn on the 11-v range; a 100 to 1 divider provides simultaneous output of 0 to 100 μ v at 10 ohm output resistance. Precision Standards Corp., 1701 Reynolds, Santa Ana, Calif. 92705 [366]



Digital relay testers measure and digitally display the time of all moving electromechanical relay functions. The series DRT units feature all solid state modular construction and Nixie tube readouts. Models are available with a 100 khz or a 1 Mhz clock rate. Relays can be accommodated from 6 v to 28 v d-c. Holland Electronics Inc., 842 E. 94th St., Brooklyn, N.Y. 11236 [367]



X-Y calibrator model 132, for oscilloscopes and volt ohmmeters, provides accurate d-c or square wave output up to 1 Mhz and from 0.10 through 10 v. Precision time base calibration with 0.005% accuracy is provided by crystal oscillator and IC dividers. It measures 3 x 11 x 6 in. Price is \$99.50 in kit form or \$198.50 assembled and tested. Paramatron Corp., Rochester, N.Y. [368]

SAN-E

**MSP-4 full four track stereo
R/P head for auto-reverse
cassette system**



**MSP-4 ¼ track full 4 heads R/P
head for phillips cassette tape
PE-M AC bias eraser for MSP-4
head**

**Other product
8 track (MS-8) stereo head
for home & car stereo
* write immediately
for further details**

SAN-E DENKI COMPANY, LIMITED.

110-1 Minami-Kawahori-cho, Tennoji-ku,
Osaka, Japan
phones: 779-1591
cable: SANMAGNETICS

Circle 195 on reader service card

TYPE FRC

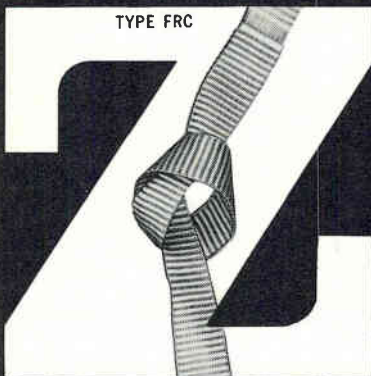

**ZIPPERTUBING®
FAB-RI-CABLE**

Spirals, folds, knots, tucks without change in characteristics! Custom woven to your specifications.

FRC, a flat tightly woven yet flexible ribbon cable does the job of heavy, bulky cables, yet fits in tight spaces or along edges. Breakouts do not disturb insulation of adjacent conductors.

Specify 4 to 100 conductors with any type insulation in any combination of colors, breakouts or conductor sizes.

Available woven in synthetic fibers such as Kapton, Teflon, Nylon, Nomex, as well as cotton or linen.

For full information on specialized high-performance Fab-Ri-Cable and ZT Jacketing, contact:

THE ZIPPERTUBING® CO.

CORPORATE HEADQUARTERS
13000 S. BROADWAY
LOS ANGELES, CALIF. 90061
Los Angeles Phone: (213) 321-3901
New Jersey Phone: (201) 256-4980



BALTIMORE • BOSTON • CHICAGO • CLEVELAND • DALLAS
NEW YORK • ORLANDO • PHOENIX • SAN FRANCISCO • WEST GERMANY

... sweeper will become nucleus of complete checkout systems ...

er's chief virtue is the flatness of its output. The 9692 delivers a signal with an amplitude constant to within ± 0.1 decibel over the full 25-khz-to-30-Mhz range. Working with feedback from a remote detector, the sweeper does even better—an output flat to within ± 0.05 db. Even without a detector, spurious and harmonic signals both are better than 40 db down.

The vhf output is almost as clean; harmonic and spurious signals are down 35 db and 40 db respectively. With a detector, the TM 9693 sends out a signal flat to within ± 0.25 db.

Lock up. Each plug-in has a calibrated knob for setting sweep width and a tuning dial for picking the center frequency. Interlocks for these two controls make impossible settings impossible. For example, the user can't choose a 10-khz that generates the horizontal-26 khz (the plug-in's minimum frequency is 25 khz).

For both plug-ins 2% is the linearity value, which Marconi engineers define as "the deviation of any marker from the expected position with respect to the full sweep width."

The sweeper operates in a standard fashion. Inside the mainframe is a voltage-controlled oscillator that generates the horizontal-sweep signal, over a range of 0.1 hertz to 100 hz. Besides going to a front-panel terminal, the oscillator's output goes to the plug-in. There it drives a varactor, which is connected to another oscillator. Since a varactor is a voltage-sensitive capacitor, as the voltage com-

ing from the mainframe changes, the frequency of the varactor's oscillator, and of the plug-in, also changes.

There are many ways to control the sweep speed besides setting it with a front-panel switch. On the front panel is a function control. When it's set to the MAINS position the sweep rate is the frequency, usually 60 hz, of the line power. MAINS is picked when the system under test has a parameter, such as tv frame rate, that is synchronized to the line frequency. Also, locking an oscilloscope and a sweeper to the same frequency, such as line frequency, often is convenient.

TV LOCK, which locks the sweep rate to tv frame rate, is useful in testing tv systems in which the frame rate isn't synched to the line frequency.

EXTERNAL DRIVE disconnects the sweep oscillator, allowing an external signal of any shape at any frequency up to 20 khz to set the sweep speed.

The CW position cancels the sweeping, allowing the unit to work as a signal generator. MANUAL allows the user looking for spikes to sweep a selected range of frequencies by hand.

Marconi has plans for the sweeper that go beyond normal applications. In the works are complete test systems. First to be introduced will be a tv transmission-station checkout setup. But that's about a year away. Marconi will start delivering the sweeper to U.S. customers in April.

Marconi Instruments Division, 111 Cedar Lane, Englewood, N.J. [369]

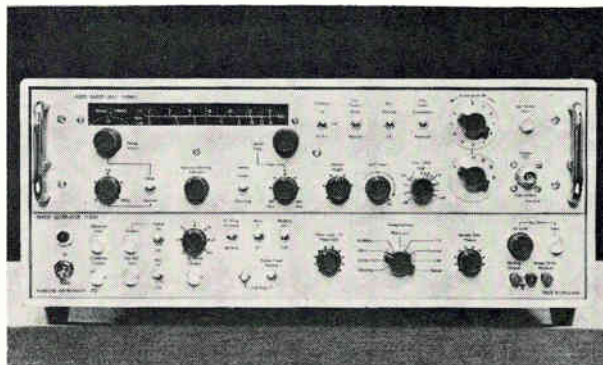

Set a speed. A voltage-controlled oscillator drives sweep at variable speeds. Function switch allows external control or synchronization with line frequency.



an unfair comparison...

The new Cyclohm Fan from Howard vs. "the other fan"

The new Howard tubeaxial fan delivers a larger volume of air over a wider range, runs up to 10 years without service or lubrication, has a rugged cast aluminum frame, yet costs about the same as "the other fan" you're now using. (See why we call the comparison "unfair"?)

In all fairness, we admit the new Howard Cyclohm fan is exactly the same size as "the other fan." They're interchangeable.

But then we come to comparisons like Howard Cyclohm's six-blade impeller (vs. three) which is computer-mated to the famous Howard Unit Bearing Motor with a 5-year warranty based on an engineered lifespan of 10 years (vs. a traditional bearing motor). Then, too, there's 115 CFM air delivery (vs. 100). And cost: The new Howard Cyclohm never costs more than "the other fan" . . . and Howard delivery is overnight!

Be fair to yourself: Send for all the unfair facts.



HOWARD

HOWARD INDUSTRIES
A DIVISION OF MSL INDUSTRIES, INC.
2420 18th STREET, RACINE, WISCONSIN 53403
414-632-2731 TWX 910-271-2387

Integrated Circuits



The ABCs of MIL-STD-883: MACH IV

TI is ready now to deliver integrated circuits "in accordance to MIL-STD-883." We're committed to the task. Money, manpower and facilities.

What's more, we're ready to tell you exactly how we'll do it.

In detail.

You'll find most of the answers in TI's 40-page MACH IV procurement specification covering 883—supplemented by 100 pages of detailed product specifications.

It is the most comprehensive book of its kind. By far.

If you need more answers, you'll get them from the men pictured above. They're members of a special HI-REL Task Force organized for TTL ICs (we have Task Forces for DTL and linear, too).

These men are managers from

the areas of reliability engineering, process engineering, product planning, military marketing, product sales, product engineering, quality control, manufacturing, and HI-REL assembly.

They'll help you determine the specific procedures and reliability levels you'll need to meet 883.

Then they'll see your order through. Successfully. Even if they have to cross departmental boundaries and step on a few toes to break bottlenecks.

They'll focus TI's experience and abilities on your job. You see, we've been delivering 100% tested ICs for years. Millions of them for Minuteman, Sprint, Poseidon, F-111 and other programs.

And some of these had even tighter requirements than 883.

Another thing. You'll have the industry's best facilities going for you at TI. From more than 50,000 burn-in sockets to environmental shake, rattle and roll labs, to IR scanners, microprobes, Radiflo and variable data loggers.

With our commitment, experience and facilities, we're doing our best to make MIL-STD-883 as simple as ABC.

Write for "MACH IV High Reliability Procurement Specification MIL-STD-883" on your company letterhead. Texas Instruments Incorporated, PO Box 5012, MS 308, Dallas, Texas 75222. Or call your local TI Sales Office.



TEXAS INSTRUMENTS
INCORPORATED

Cassette deck tailored to data storage

Unit aimed at minicomputer and peripheral equipment market designed for tight control of speed, high packing density

Cassette recording could have the effect on data storage that it has had on the entertainment industry. In the minicomputer market, the cassette offers cost and size advantages that other storage formats can't touch.

Unfortunately, most cassette recorders now use tape drives designed for audio, not edp use. And the result is poor regulation of tape

speed, tape bounce causing dropouts both on record and playback, and other faults, most of them caused by poor mechanical design features.

Compucord Inc. has developed what it calls the first industrial-grade deck for cassette data storage and retrieval. The firm plans to use it in its own Compudette 1200 and 1400 recorders, and to sell

the deck to equipment makers as the Compudette 1100.

Like other firms, Compucord plans to cash in on the hoped-for boom in peripherals and small computers—in the early seventies. Robert Crawford, president, and Robert Shay, vice president, picked data recording, and specifically the cassette deck, as the product area with the best combination of po-



I-f amplifier 4051A has a flat frequency response from 10-20 Mhz. A gain control system allows 50 db change with less than $\pm 2^\circ$ phase shift. This eliminates the need for phase matching in applications such as monopulse, interferometer and multichannel phase-lock receivers. Noise figure is 3.5 db; gain, 80 db. Electrac Inc., 1614 Orangethorpe Way, Anaheim, Calif. 92801 [381]

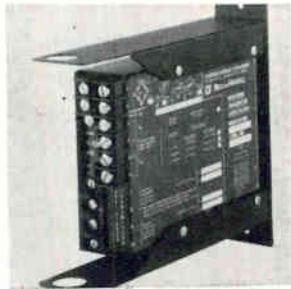

Resistance transmitter 18-112A receives signals from a resistance temperature detector, variable resistor, strain gage transducer or other resistance source and provides d-c voltage or current output signals. Input/output linearity is adjustable to $\pm 0.05\%$ with high resolution span and zero trimmers. Price is \$180. Bell & Howell Co., 706 Bostwick Ave., Bridgeport, Conn. [382]



Video limit indicator model 122 is used with cctv systems to provide a graphic display of 30 separate vertical white bars, each of which may be individually positioned to any location on the tv screen. Fifteen bars indicate high limits; and 15, low limits. An automatic alarm may be given when predetermined limits are exceeded. Colorado Video Inc., Box 928, Boulder, Colo. [383]



Wideband filter 262 performs frequency analysis of complex noise, pulse, video and transient signals. It is switch selectable in 5 modes: high-pass, low-pass, by-pass, band-pass, and band-stop. It has continuously adjustable cut-off frequencies from 10 hz to 10 Mhz and a pass-band from 5 hz to 15 Mhz. Systems Research Laboratories Inc., 7001 Indian Ripple Rd., Dayton, Ohio [384]

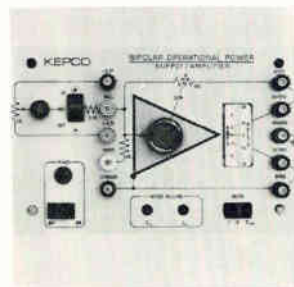

Bipolar operational power supply/amplifier is rated ± 36 v at ± 1.5 amps. It can respond to programming commands in either direction from zero. Low distortion (less than 0.5%) and lack of zero crossover discontinuity result from use of a d-c coupled npn/pnp complementary-symmetry output stage. Bandwidth is 20 khz full output. Kepco Inc., 131-38 Sanford Ave., Flushing, N.Y. [385]

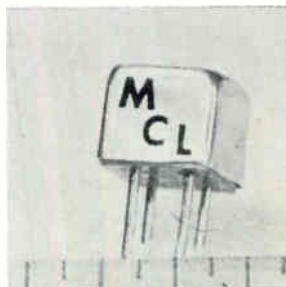

Microminiature double-balanced mixer ASK-2 covers 25 khz to 500 Mhz, occupies 0.05 cu in. Ruggedness and durability are built-in features. Internal components include precision miniature p-c boards, hot carrier diodes, and newly developed transmission line transformers. Price in quantity is under \$45. Mini-Circuits Laboratory, 2913 Quentin Rd., Brooklyn, N.Y. 11229 [386]



Annunciators have miniature, solid state relay modules mounted directly on small pilot lights. The audible signal is operated by a solid state amplifier. One solid state power supply can handle up to 10 annunciator points. The 3 units may be mounted and wired together into a light box annunciator unit if desired. Rundel Components Inc., 740 B'way, Redwood City, Calif. [387]



Magnetic head tester 101C is a dynamic testing unit for measuring performance of computer recording heads. It provides special circuits for simulating conditions the head undergoes when placed on a tape transport in a computer environment. Automated and manual switching is provided for studying all recording parameters. Magnetic Head Corp., Marcus Blvd., Hauppauge, N.Y. [388]

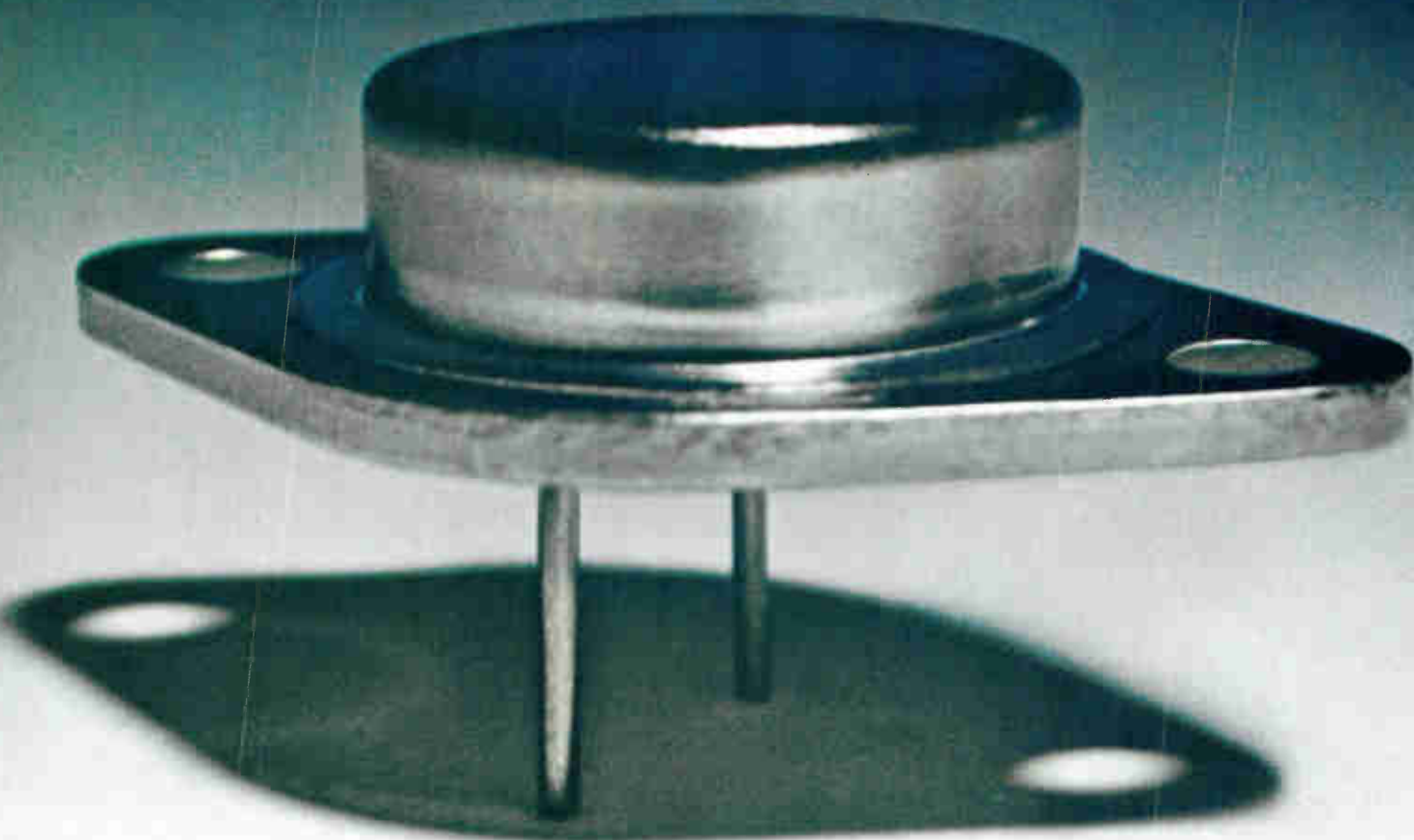

We're available—immediately

**Get up to 10,000 units
of 2N3773 transistors
immediately from
Westinghouse**

What's more, we'll also give you fast service on larger orders. As many as it takes to fill your total requirements.

Our 2N3773, 2, 1, (TO3) is a family of 30-amp diffused transistors for high power switching and amplifying applications. They offer a wide selection of

voltage and gain.

For complete data — and a large ready supply—of any and all these transistors, contact your local Westinghouse Distributor (see adjacent listing) or Westinghouse Semiconductor Division, Youngwood, Pa. 15697.

You can be sure ... if it's Westinghouse



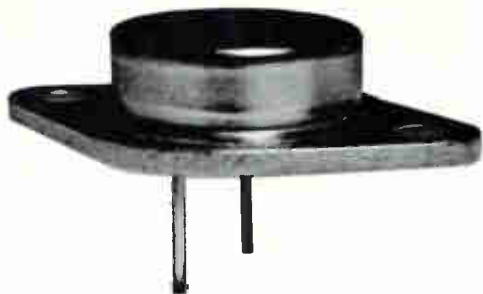

Westinghouse Industrial Semiconductor Distributors

Alabama
ACK Semiconductors, Inc.
Birmingham Phone: 205 322-0588
Electronic Wholesalers, Inc.
Huntsville Phone: 205 534-5722

Arizona
Hamilton Electro of Arizona
Phoenix Phone: 602 272-2601
Kierulff Electronics Corp.
Phoenix Phone: 602 273-7331

California
Newark Electronics
Inglewood Phone: 213 674-8440
Hamilton Electro Sales
Los Angeles Phone: 213 870-7171
K-Tronics
Los Angeles Phone: 213 685-5888
Elmar Electronics, Inc.
Mountain View
Phone: 415 961-3611
Hamilton Electro Sales—North
Mountain View
Phone: 415 961-7000
Hamilton Electro of San Diego
San Diego Phone: 714 279-2421

Colorado
Electronic Parts Co.
Denver Phone: 303 266-3755
Hamilton Denver
Denver Phone: 303 934-5508

Connecticut
Cramer Electronics, Inc.
North Haven Phone: 203 239-5641

Florida
Cramer Electronics, Inc.
Fort Lauderdale
Phone: 305 566-7511
Electronic Wholesalers, Inc.
Orlando Phone: 305 841-1550

Georgia
Specialty Distributing
Atlanta Phone: 404-873-2521

Illinois
Semiconductor Specialists, Inc.
Chicago Phone: 312 279-1000
Pace/Avnet Electronics
Schiller Park Phone: 312 678-6310

Indiana
Fort Wayne Electronics Supply, Inc.
Fort Wayne Phone: 210 742-4346
Ra-Dis-Co.
Indianapolis Phone: 317 637-5571
Radio Distributing Co.
South Bend Phone: 210 287-2911

Maryland
Pyttronic Inc.
Baltimore Phone: 301 727-5100
Hamilton Electro Sales
Baltimore Phone: 301 668-4900
Cramer Electronics, Inc.
Rockville Phone: 301 424-2700

Massachusetts
Cramer Electronics, Inc.
Newton Centre
Phone: 617 969-7700
Schweber Electronics
Waltham Phone: 617 891-8484

Michigan
Semiconductor Specialists, Inc.
Detroit Phone: 313 255-0300

Minnesota
Semiconductor Specialists, Inc.
Minneapolis Phone: 612 866-3434
Stark Electronic Supply
Minneapolis Phone: 612 332-1325

Missouri
Electronic Components for
Industry Co.
Kansas City Phone: 816 421-8400

Electronic Components for
Industry Co.
St. Louis Phone: 314 647-5505
Hall-Mark Electronics Corp.
St. Louis Phone: 314 521-3800

New Jersey
General Radio Supply Co., Inc.
Camden Phone: 609 964-8560
Angus, Inc.
Moorestown Phone: 609 235-1900
Sterling Electronics, Inc.
Perth Amboy Phone: 201-HI 2-8000

New Mexico
Kierulff Electronics Corp.
Albuquerque Phone: 505 247-1055

New York
Stack Industrial Electronics
Binghamton Phone: 607 723-6326
Summit Distributors
Buffalo Phone: 716 884-3450
Cramer/Eastern
East Syracuse Phone: 315 437-5671
Schweber Electronics
Long Island Phone: 516 334-7474
Milgray Electronics, Inc.
New York Phone: 212 989-1600

Ohio
Sheridan Sales
Cincinnati Phone: 513 761-5432
Sheridan Sales
Cleveland Phone: 216 524-8120
Hughes-Peters, Inc.
Columbus Phone: 614 294-5351
Mentronics, Inc.
Mentor Phone: 216 946-3058

Oklahoma
Hall-Mark Electronics Corp.
Tulsa Phone: 918 835-8458

Pennsylvania
Cameradio Company
Pittsburgh Phone: 412 391-4000

South Carolina
Sawyer Electronics Corp.
Greenville Phone: 803 235-0438

Texas
Hall-Mark Electronics Corp.
Dallas Phone: 214 231-6111
Midland Specialty Co.
El Paso Phone: 512 533-9555
Hall-Mark Electronics Corp.
Houston Phone: 713 781-6100
Lenert Company
Houston Phone: 713 225-1465
The Altair Co.
Richardson Phone: 214 231-5166

Washington
Hamilton Electro Sales of the
Pacific Northwest
Seattle Phone: 206 624-5930
Kierulff Electronics Corp.
Seattle Phone: 206 725-1550

West Virginia
Charleston Electrical Supply
Company
Charleston Phone: 304 346-0321

Wisconsin
Taylor Electric Company
Milwaukee Phone: 414 964-4321

Canada
Canadian Westinghouse
Hamilton, Ontario
Phone: 416 528-8811

European Headquarters
Westinghouse Electric
International, S.A.
London, S.W. 1
Phone: Whitehall 2704

Westinghouse Semiconductor Division
Youngwood, Pennsylvania 15697

tentials in the computer industry.

Decks in other cassette equipment largely are made in either Japan or Europe, they found, and have both specification and reliability problems. Tape speed variations reach 12% easily, and the decks take their time with tape movement—start and stop times often range from 120 to 200 milliseconds. While these drawbacks could be overcome to a degree by spending more on electronics, the engineers at CompuCORD figured that a better cassette drive would lead to a more cost-effective recording scheme.

In the end, they came up with a deck which shows far less than 2% speed variation, which has a start/stop time of less than 20 milliseconds (8 milliseconds without solenoid reaction time), and which with its accompanying electronics at-



Data store. Cassette format offers size and cost benefits in edp.

tains error rates as good as one lost bit in 10^8 . "Actually, we're somewhere between one in 10^8 and one in 10^9 ," says Crawford, "with tape speed at 5 inches per second and packing density at 500 bits per inch." Formerly a cassette deck with one error in 10^5 bits was top grade.

He adds that packing densities are going up as research proves the steady tape control of the deck more of an asset to designers of associated electronics. Already a packing density of 1,000 bits per inch is offered as an option, and CompuCORD has experimented with 3,000 bits per inch, though this capability isn't on the commercial calendar yet.

Crawford says the unusual de-

An Off-the-Shelf, Custom-Designed RECEIVING SYSTEM

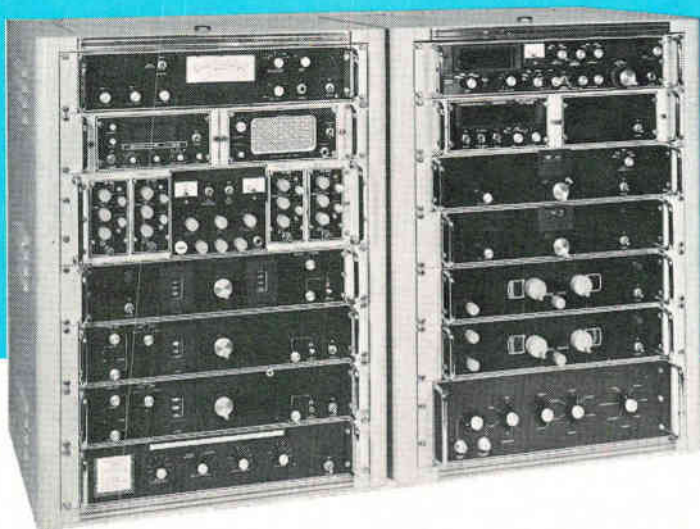

The modular design of W-J's RS-125 Receiving System makes it possible. W-J has supplied many variations of the RS-125—each for a specific application. Yet, in most cases, components have been standard versions, right out of stock.

A wide selection of tuners, demodulators, bandwidths and ancillary devices is readily available. So you can order only those components required for the monitoring job at hand. You eliminate obsolescence by adding units as the needs arise.

The RS-125 processes received signals through a demodulator utilizing plug-in modules available in 10 standard bandwidths ranging from 5 kHz to 8 MHz. This highly versatile arrangement of equipments provides AM, FM, CW and pulse reception over a frequency range as wide as 500 kHz to 12 GHz utilizing W-J tuners.

A system covering the range of 10 MHz and above could include tuners with internal motor drives which feature sector scan, enabling the operator to adjust the upper and lower frequency limits of the sector in which he is interested.

It also could include a frequency extender-counter combination which would provide a direct six-digit readout of the tuned frequency, plus Digital Automatic Frequency Control (DAFC).

Two basic types of the RS-125 are offered: The "B" system for applications requiring low VSWR, and the "C" system for applications requiring maximum sensitivity.

**World's Largest Selection of Receiving Equipment for
Surveillance, Direction-Finding and Countermeasures**

CEI DIVISION



WATKINS-JOHNSON

8006 EXECUTIVE BOULEVARD, ROCKVILLE, MARYLAND 20852 • (301) 881-3300

sign features that enable such performance are these: First, in contrast to audio decks, the 1100 deck uses a hysteresis synchronous capstan motor (some audio decks don't even have capstans, much less hysteresis motors). A shaded four-pole motor is used to drive the reels, and flywheels are used to smooth any speed variations that remain. All motors are dynamometer-tested. The sum of this care results in speed control with only 1% variation, versus the conservative 2% specification.

The reels are driven through instrumentation-type flat belts, not the O-rings usually found on audio decks. CompuCORD claims that there's no need for special tension-controlling mechanisms, and that a coating on the belts prevents slippage and thus cuts wear. On the other hand, O-rings gradually lose tension, and their drive characteristics change along with tape speed. They also wear quickly at high accelerations.

Tape reversal is accomplished in about 120 milliseconds with the motors turning all the time; a cup drive arrangement is used to change the direction of motion without adding the lag time for starting the motor. Even during this operation, speed control is tight with variation within 10 milliseconds reaching 5%—including the 2% normal variation.

The drive has adjustments built in to compensate for whatever wear does occur anyway, and the company claims five to six years of life. "We are quoting around 10,000 hours lifetime," says Shay, "and motor life is the rating factor rather than deck mechanics."

CompuCORD thinks its end- and start-of-tape sensor also will outlast those of competitors. Two optically ground rods, one of which doubles as a tape guide, transmit light to one another, and a photo-resistor is triggered by passage of a clear section of tape. Others either stop when the tape is jerked against its reel or use light reflected from a foil coating on the tape, and CompuCORD feels the foil is vulnerable to wrinkling or damage.

The 1100 is priced at \$300 each, and—in volume orders—the price goes as low as \$125.

CompuCORD Inc., 225 Crescent St., Waltham, Mass. 02154 [389]

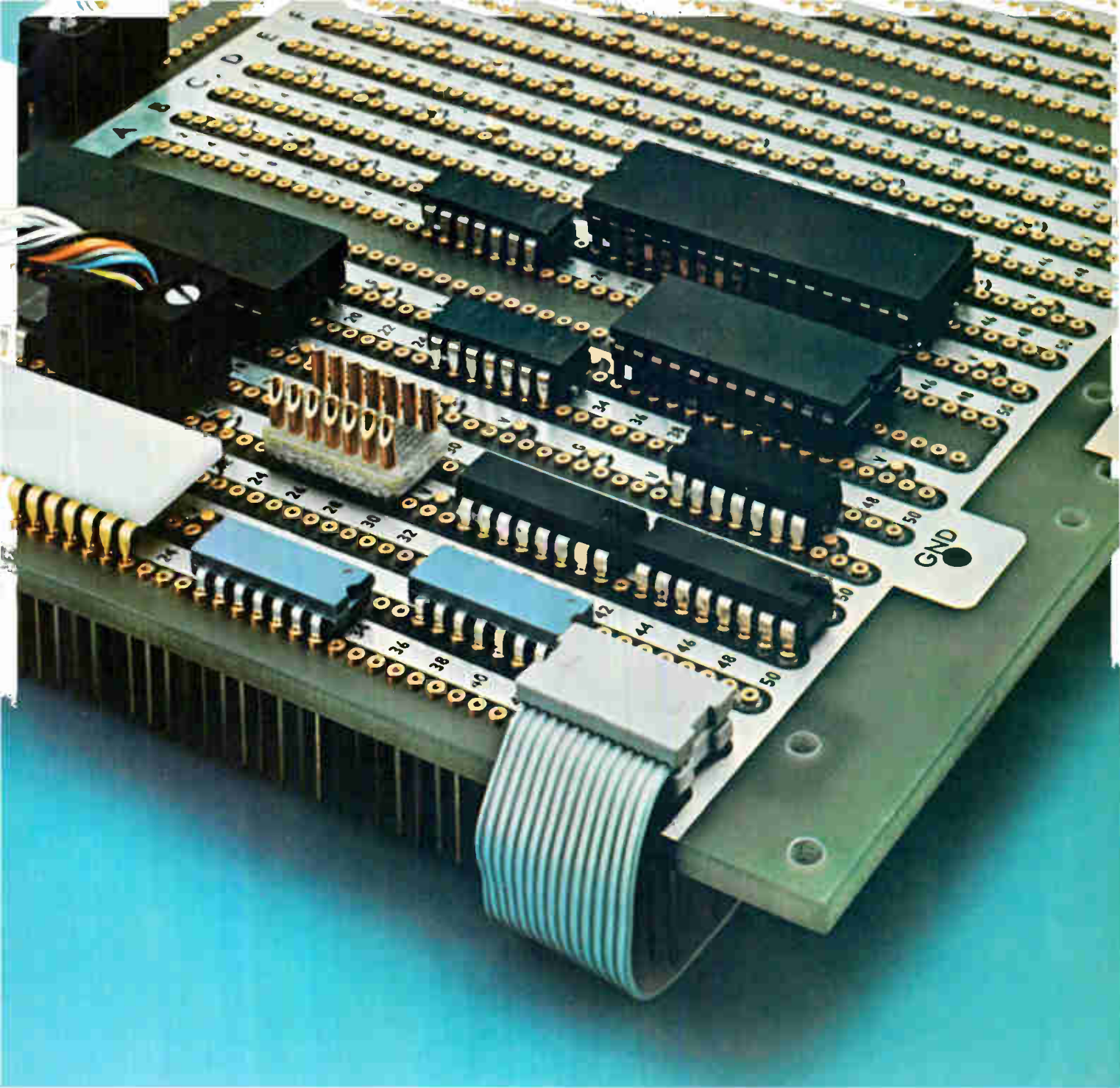

Plug in anything

Let Augat's new universal board provide complete flexibility in IC packaging and prototyping.

You can plug in any dual-in-line IC including popular 14, 16, 24 or 36 packages. The rows of contacts also accommodate our adaptor plugs for interposing discrete components and plugs for I-O connections and interfacing. Board also accepts Augat's new 14-pin, flat cable plug with unique patented design permitting fast assembly without stripping the wire. Plugs directly into IC socket pattern.

Universal board is available in modules of 9 rows with 50 contacts to a row up to 6 modules. Additional pins

are tied in to power and ground planes are strategically located . . . easily accessible. No interference with IC patterns. Like all Augat panels, board is available automatically wrapped to your specifications.

Why be restricted in your packaging and prototyping? Let Augat open the door to greater flexibility.

Call us, (617) 222-2202, or write for our complete IC folder. Augat Inc.
30 Perry Ave. Attleboro, Mass. 02703.

AUGAT INC.

Circle 153 on reader service card

Would the engineer who asked us to design a marking system to color band electronic peanuts, please call (603) 352-1130.

It's ready.

If for some strange reason you're not making electronic peanuts, how about your transistors, IC's, SCR's, diodes, thyristors or whatever. We can handle those, too.

We've got the systems, typefaces, inks, supplies and services to mark whatever you make, and mark it right.

Our problem-solver booklet will tell you more about us.

Write for it now.

(before you go nuts)

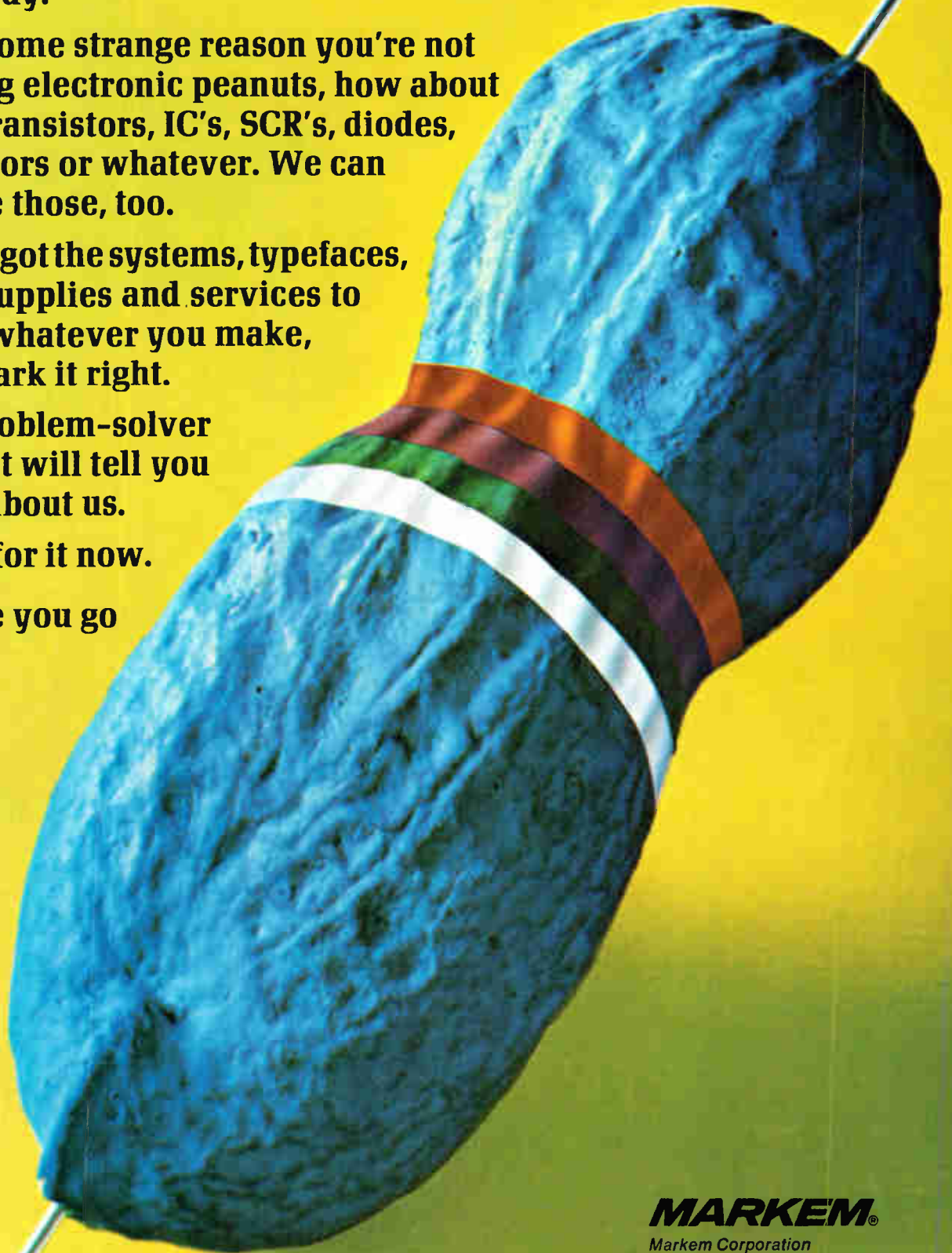

MARKEM®

Markem Corporation
305 Congress Street
Keene, N. H. 03431

International Offices: Markem Europa N.V. Schiphol Oost, Holland; Markem U.K. Ltd. Rugby, Warwickshire, England

Circle 154 on reader service card

Coupler runs on line that is 31 db down

Third-harmonic injection eliminates second-harmonic distortion, permitting 10-db improvement over most acoustic units

Until recently, the best performance one could hope for in an acoustic coupler was limited to signals not more than 21 decibels below the transmitted signal level. Applied Digital Data Systems of Hauppauge, N.Y., has developed an acoustic coupler that can handle signals on a line where attenuation is 31 db, a 10-db improvement over existing devices. The secret: the

second-harmonic distortion is eliminated by third-harmonic injection.

"What we've done is compensate for line problems right in the coupler, rather than simply blame the telephone company for weak, noisy, or fading lines," says Reuven Meidan, developer of the new unit. The causes of second-harmonic distortion are nonlinear characteristics of the telephone microphones and

cross-coupling between microphone and receiver. The second harmonics of the transmitted signal are generated by the microphone and are in the same frequency band as the received signal. These unwanted harmonics place limitations on the transmitted power level and restrict acceptable received signals to those of relatively high levels.

The new 300-baud coupler, called



Graphic remote integrated display GRID 240 is for use in on-line computer interaction where output can be displayed in graphic form. Input to the system is by means of the light pen, alphanumeric keyboard or function keyboard which are provided as part of the system. System has its own processor with a 4K, 12-bit memory. Control Data Corp., 34th Ave. So., Minneapolis. [421]



Versatile magnetic tape encoder model 75 has automatic features of operation and correction that can increase data processing production by 25%. It can be used with any computer system and virtually eliminates need for expensive, hard-to-use key punch encoders. Featured is a video monitor positioned above the keyboard. Data Input Devices, 5333 Northfield Rd., Cleveland [422]



Acoustic data coupler Design 79 offers a method of communicating with a time-shared computer or with another remote data terminal via an ordinary telephone. The telephone handset is simply placed on the data coupler, the coupler attached to a teletypewriter or other data terminal, and the computer number dialed. Design Elements Inc., 2074 Arlington Ave., Columbus, Ohio [423]



Computer controlled data system series C07100 is a medium-speed, multiple-channel digitizer of analog signals for recording on magnetic tape in computer format. It includes a stored program controller with 4,096 words of memory, and a 12-bit analog to digital converter. Unit is priced at \$17,500. Computer Operations Inc., 10774 Tucker St., Beltsville, Md. 20705 [424]



Small-to-medium capacity ferrite core memory model CE-50 has an access time of 250 nsec and a 500 nsec cycle time. It is available in capacities of 4, 8 and 16 K words of 10 to 60 bits. Multiple-module capabilities permit expansion to larger capacities and word lengths. Standard interface is TTL compatible. Lockheed Electronics Co., 6201 E. Randolph St., Los Angeles 90022 [425]



System-oriented computer model A includes 4,096 16-bit words of core memory, 32,768 words of disk memory, a memory access controller, a central processor, an input/output bus, and a teletypewriter with paper tape reader and punch. The 32,768-word disk is field expandable to 65,536 or 131,072 words. Price is \$14,995. Multidata, 15142 Goldenwest Circle, Westminster, Calif. [426]



Field expandable system links man directly to the central computer and provides computer-generated real time voice response. It permits personnel in various business activities, anywhere in the world within the telephone network, to simultaneously query the computer and receive immediate voice answers to questions and verification of input. Voice Response Systems Inc., Elmsford, N.Y. [427]

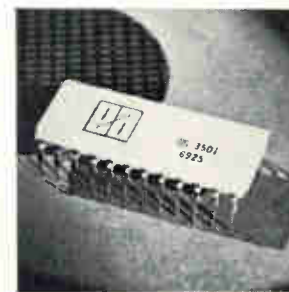

Read only memory EA3501 generates the 64 basic ASCII characters in horizontal scan crt uses. It is an MOS unit containing 512 words, 5 bits each. The monolithic silicon chip, housed in a 24 pin metal-ceramic hermetically sealed dual-in-line package, contains approximately 3,000 transistors in an area 0.065 x 0.094 in. Electronic Arrays Inc., 501 Ellis St., Mtn. View, Calif. [428]



Victoreen's rare specimen!

Our MOX-1125. A rare specimen made only by Victoreen. With rare qualities in the 1-10,000 Megohm range. Rated at 1.00W @70°C. 5,000 volts maximum. Yet it's just .130" in diameter by 1.175" long.

It's one of Victoreen's Mastermox metal oxide glaze resistors. About one-half the size of competitive resistors of similar power handling capacity.

All Mastermox resistors are rare performers. Excellent stability: As little as 1% drift under full load in 2000 hours — with more than 40 watts power dissipation per cubic inch. $\pm 0.5\%$ tolerance. 10K ohms to 10,000 Megohms resistance range. Voltage and temperature cycling leaves no permanent effect. And Mastermox stays potent on the shelf — less than 0.1% drift per year.

Get Mastermox. Rare resistor performance.

| Model | Resistance Range | Power Rating @ 70°C | *Max. Oper. Volts | Length Inches | Diameter Inches |
|----------|------------------|---------------------|-------------------|---------------|-----------------|
| MOX-400 | 1 - 2500 megs | .25W | 1,000V | .420 ± .050 | .130 ± .010 |
| MOX-750 | 1 - 5000 megs | .50W | 2,000V | .790 ± .050 | .130 ± .010 |
| MOX-1125 | 1 - 10000 megs | 1.00W | 5,000V | 1.175 ± .060 | .130 ± .010 |
| MOX-1 | 10K - 500 megs | 2.50W | 7,500V | 1.062 ± .060 | .284 ± .010 |
| MOX-2 | 20K - 1000 megs | 5.00W | 15,000V | 2.062 ± .060 | .284 ± .010 |
| MOX-3 | 30K - 1500 megs | 7.50W | 22,500V | 3.062 ± .060 | .284 ± .010 |
| MOX-4 | 40K - 2000 megs | 10.00W | 30,000V | 4.062 ± .060 | .284 ± .010 |
| MOX-5 | 50K - 2500 megs | 12.50W | 37,500V | 5.062 ± .060 | .284 ± .010 |

*Applicable above critical resistance. Maximum operating temperature, 220°C. Encapsulation: Si Conformal. Additional technical data in folder form available upon request. Or telephone: (216) 795-8200.

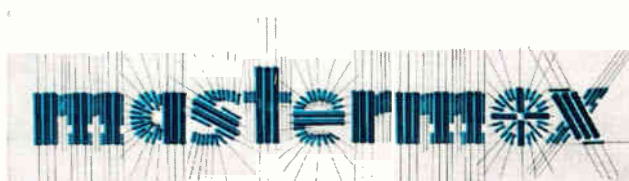

DMA 532

VICTOREEN INSTRUMENT DIVISION
 10101 WOODLAND AVENUE • CLEVELAND, OHIO 44104
 EUROPE: ARNDAL HOUSE, THE PRECINCT, EGHAM, SURREY, ENGLAND • TEL: EGHAM 4887



the ADDS series COM 100, has the same sensitivity as the Bell System's 103 modem, 31 db, and therefore is not limited by it. However, one may encounter lines of up to 49-db attenuation in the telephone network, which may necessitate re-dialing the call. The present gap is due to the specifications set by the Bell System and affects all data sets, including Bell's 103.

ADDS has added several other design features to the COM 100 series; an enclosed handset chamber provides acoustic shielding and an optimum handset cradle position, a 45° angle position with the membrane and mouthpiece face up, which adds more stability to the output signal. The net result: the ADDS coupler can transmit at 3 times higher power and receive 10 times weaker signals than other couplers.

There are two options available with this new line of couplers. The remote-echo option permits the coupler to echo received data back to the computer for verification. Under direct computer control, any error is printed out. The second option allows parallel data interfacing between the coupler and the user's equipment.

The COM 100 series equipment is available in three models; the COM 110 is for acoustic coupling only, the COM 120 is for direct connection to a telephone line via a data access arrangement, and the COM 130 is for both. All are compatible with the Bell 103.

The coupler is 4½ inches high, 11 inches deep, and 9 inches wide, with the heaviest unit weighing 10 pounds. ADDS plans to incorporate the COM 110 coupler in a portable crt terminal fitted in an attache case. This is scheduled for introduction in March.

Prices start at approximately \$500 for the COM 100 series; delivery time is 120 days.

Applied Digital Data Systems, 89 Marcus Blvd., Hauppauge, N.Y. 11787 [429]

If the communications system
doesn't track after the big move,
you know who's going to hear about it.

You might receive a few communications that would be banned in Boston (or anywhere else) if the sensitive electronic components go on the blink.

So maybe you'd better communicate with a highly-professional mover who knows how to do the job—Allied Van Lines.

Our Electronic Vans are just as good as our personnel. They have a special bracing that keeps your equipment from slipping . . . an air suspension system that soaks up jolts and bumps along the way.

Call the highly-trained Allied Agent in your area.



We make the kind of moves
you never hear about

WE'VE GOT A BETTER WAY TO MAKE PRINTED CIRCUITS!

Here's some Industrial History you should know!

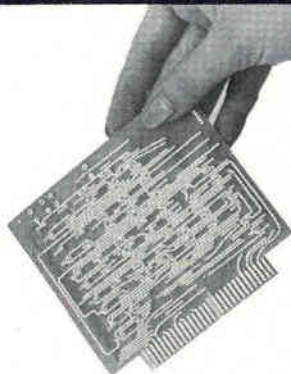

F-104

Developed new technique to produce circuit boards with more reliable plated-through holes.

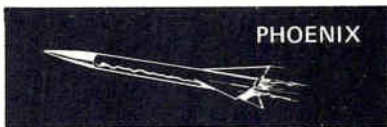

PHOENIX

Required new techniques for manufacturing heat sinks and insulation by chemical milling.



F-111

New industry technique was used to produce multilayer circuit boards with an internal heat sink.



POSEIDON

Developed new technology for sequential laminating multilayer circuit boards with aluminum backbone.



707

Reliable circuit boards in high volume at low cost were produced for this project.



MERCURY

Our company used a unique etch-back method for plated-through holes in large quantities.



C5

We introduced circuit boards that had the highest density circuitry ever used before on a production basis.



GEMINI

Again, top reliability was required and delivery on-time was made to the customer.

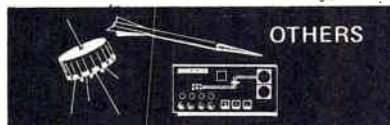

OTHERS

Hundreds of projects use our circuit boards in all phases of civilian and military equipment. We've got a better way to make printed circuitry.



APOLLO

Our circuit boards were on Apollo, LEM, and seis. experiment. Sequential laminating, extra-fine line width and spacing, plated slots and edges.



This design & production experience can give you a BIG JUMP on your next project. CALL US NOW!

CONTROL DATA
CORPORATION

CONTROL DATA CORPORATION

PRINTED CIRCUITS OPERATION
7800 COMPUTER AVENUE
MINNEAPOLIS, MINN. 55435
PHONE: (612) 920-8600

Data handling

Memory cycles in 650 nsec

Ferrite core system for computer mainframes sells for 3-5 cents a bit

Drive circuitry is the key to speed, high bit density, and performance of a ferrite core memory system developed for computer mainframe applications.

Designated the Nanomemory 3650, the unit has a cycle time of 650 nanoseconds and is available in capacities that range from 16,000 to 128,000 words and 8 to 76 bits per word. Up to 8 million bits, with power supplies, can be accommodated in a five-foot rack.

The company says the minimum mean-time-between-failures of the Nanomemory 3650 is 2,000 hours. It will sell for between 3 and 5 cents per bit, and deliveries will begin this quarter.

The drive circuitry for the system provides rise and fall times of about 50 nanoseconds, and current margins in the range of 10 to 15%, and it keeps power consumption in a 32K-by-38 system to 250 watts. The efficiency of the drive system is a major contributor to the high MTBF, says general manager Thomas J. Gilligan. The same drive circuitry lowers power dissipation and reduces component count, providing a compact memory for OEM applications. The lower power dissipation also permits a tighter package with improved electrical performance, because shorter connections are less susceptible to noise, require less drive, and generate lower back-voltages.

All stacks and electronics are on plug-in cards. Diodes are directly accessible from the outside of the stack and are easily replaced. The electronics is bit- and byte-organized to facilitate maintenance. When errors occur in a specific byte, that assembly can be unplugged. When errors are traced to a bit, the card for that bit can be replaced.

Electronics Memories Inc., 12621 Chadron Ave., Hawthorne, Calif. 90250 [430]

Any chips off the new IC?

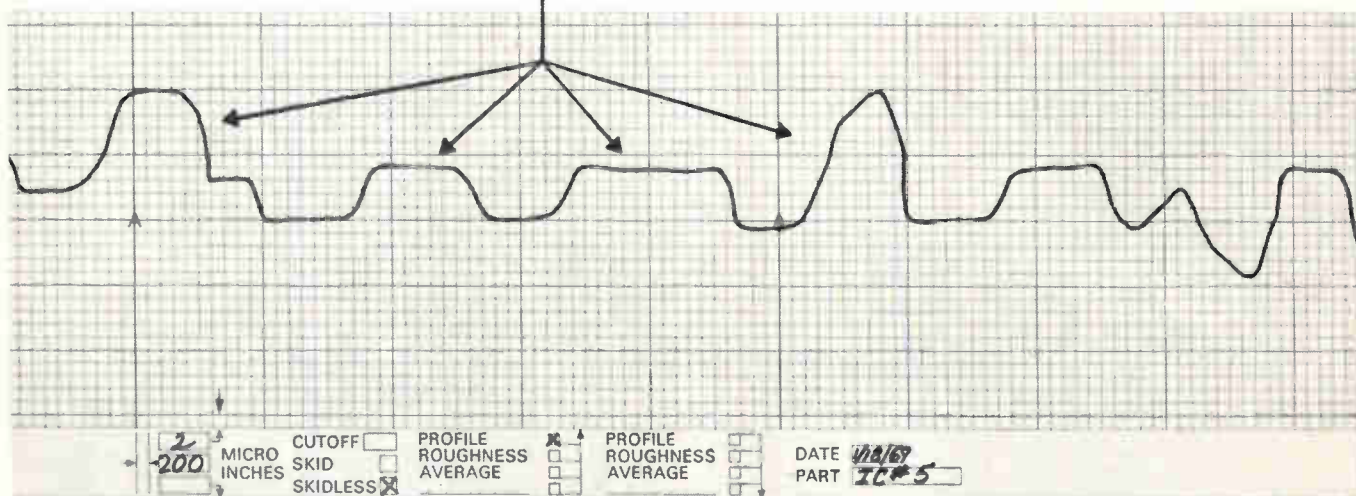
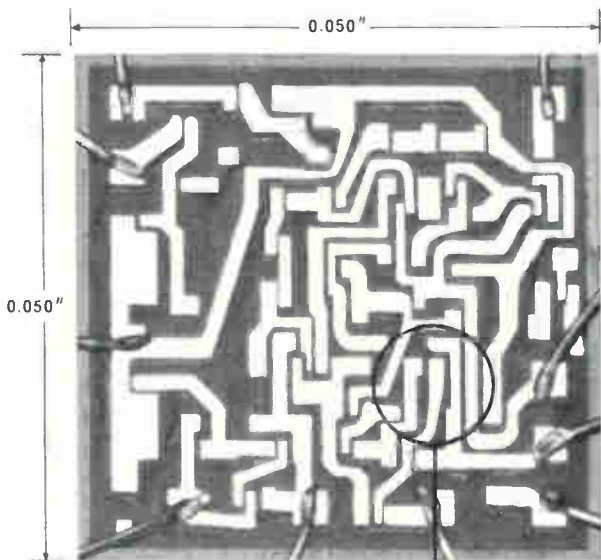

Non-destructive Clevite Surfanalyzer tells you for sure. Shows deposit thickness, steps and true surface profile of a 0.050" diameter IC on a chart 3 feet long! And we haven't scratched the surface!

Never will either.

The stylus of the Surfanalyzer adds the required light touch to surface measurement—glides across delicate circuit deposits at just 0.05 grams. Picks up the slightest imperfection . . . provides an undistorted view of the IC surface.

Note the extra-wide rectilinear channel. And the engineered chart paper that allows actual dimensional measurement of deposit on substrate. And the razor-sharp smudge-

proof trace. It's all part of our plan to provide IC manufacturers and suppliers with the most accurate, easy-to-read, easy-to-use surface recording system.

Have we done it? You be the judge. Write for complete details and the name of your nearest distributor. There's one close by waiting to demonstrate this extraordinary test equipment. Gaging and Control Division, Gould Inc., 4601 N. Arden Drive, El Monte, California 91731. Tel. (213) 442-7755.

Clevite Surfanalyzer 150 Surface Measurement System

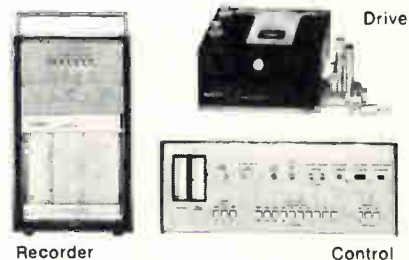

GOULD CLEVITE

'The Dirty Fighter'

(Our New Ultra-Pure Cleaning System.)



Boy, does it fight dirty. With cascading rinses of ultra-pure hot water pouring over just about any miniaturized component you can name, impurities just don't have a chance. Not even the tiniest ones, down to 0.45 micron, escape the dirty fighter.

Available with or without a laminar flow hood, and in two models with flow rates to 50 gph. The dirty fighter is clean-cut, however; steel cabinetry, recessed controls, sliding access doors, and a plastic-coated working surface.

Sure, our cleaning system fights dirty. You wouldn't want it any other way. Write or call for more information. Barnstead Company, 225 Rivermoor Street, Boston, Mass 02132, (617) 327-1600.

 **BARNSTEAD**

Adapter turns detector into Impatt oscillator

Built-in matching makes diode a replacement for crystal unit; converted detector tunable over 8.2-12.4 Ghz, puts out 50 mw

Most microwave engineers would like to experiment with Impatt diodes, but the high cost often puts them off. A few of the more inventive have tried to save money by adapting the crystal detector mounts found in almost all laboratories, but this, too, can cost money in terms of the man hours required to machine new step transitions and to change waveguide height.

It also ruins the mount for later use as a detector.

Now Parametric Industries Inc. is offering a drop-in-replacement for the detector mount's IN23 crystal detector; called the PG1201, the packaged Impatt looks nearly identical to the diode it replaces, but turns the mount into an X-band oscillator. And since it offsets the need for mechanical modifications

to the mount, the mount can be retained for its original purpose.

Tunable over an 8.2-to-12.4 gigahertz bandwidth, the converted detector delivers a minimum of 50 milliwatts. But, according to sales manager Howard Foster, output typically runs to 65 to 75 mw, with about 10% of the conversion devices attaining 100 mw.

The broad mechanical tunability



Sweep generator series 101 generates swept frequency signals from 0.1 to 24 Ghz without external plug-in units. Range is divided into 5 bands, selected by a front panel control: 0.1 to 4.2 Ghz, 4.2 to 8.2 Ghz, 8.2 to 12.4 Ghz, 12.4 to 16.4 Ghz and 16.4 to 24 Ghz. Continuous sweep is up to 4100 Mhz including 100 Mhz to 4200 Mhz range. Space Kom Inc., Box 10, Goleta, Calif. [401]

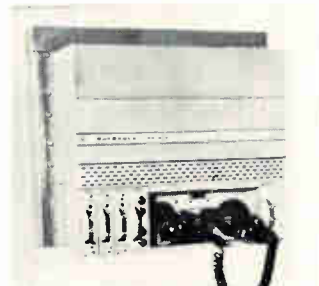

Microwave equipment MR-200, operating in the 2 Ghz band, is for transmission of up to 300 high quality voice channels over systems extending for hundreds of miles. It has built-in expansion capability for voice, data, or facsimile channels and is designed so that remodulating repeaters are practical on long-haul systems. Motorola Inc., Schaumburg, Ill. [402]

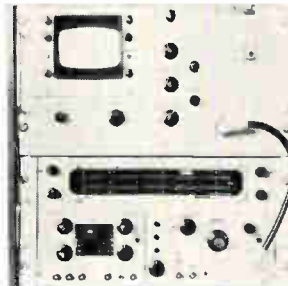

Frequency-domain oscilloscope features YIG preselection. Using a tunable preselector filter to eliminate spurious input signals, the scope is designed to check out frequency modulation and stability of an r-f oscillator and to measure the pulse and bandwidth of the r-f oscillator pulse. Frequency range is 1 to 10 Ghz. Spedcor Electronics Inc., Morganville, N.J. 07751 [403]

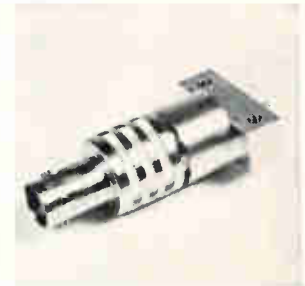

Stripline diode holders are designed especially for right angle (series 34613) or end mounting (series 35613). They have an untuned mount and compensated transition requiring external d-c return. Frequency range covers 100 Mhz to 12 Ghz. Units feature an output filter to suppress r-f and pass audio. ESCA Div., Solitron/Microwave, Cove Rd., Port Salerno, Fla. 33492 [404]

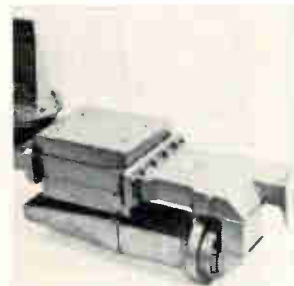

High-power differential phase-shift circulator model CSH63 is designed for radar applications. Unit includes loads at ports 3 and 4. It operates in a frequency range of 3,135-3,465 Mhz, with an average power capability of 6 kw and a peak of 1.2 mw. Minimum isolation is 20 db and maximum insertion loss is 0.4 db. Raytheon Co., 130 Second Ave., Waltham, Mass. 02154 [405]

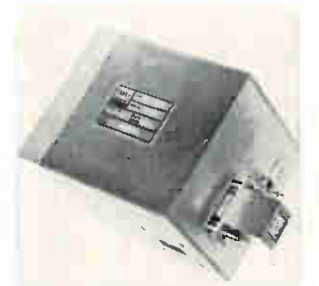

Solid state Ku-band source model 5025-9201 operates from 15.50 to 15.80 Ghz with a minimum power output of 100 mw. Typical power output is 150 mw. Capable of being crystal-controlled with plug-in crystal oscillators or swept with an external source, the only power required is ± 38 v d-c at 600 ma maximum. Trak Microwave Corp., 4726 Eisenhower Blvd., Tampa, Fla. [406]

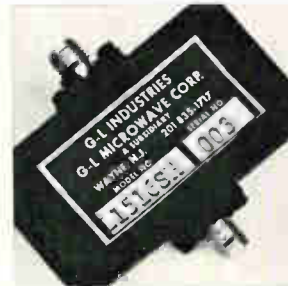

High power diode limiter for sensitive receiver protection can withstand 5 kw of peak power, with pulse lengths up to 250 μ sec. It operates in the 1,400 to 2,300 Mhz band. Insertion loss is 0.25 db maximum; spike leakage, less than 0.12 erg; flat leakage, 40 mw. Recovery time is less than 1 μ sec, and vswr is 1.20 max. G-L Microwave Corp., Wayne, N.J. 07470 [407]

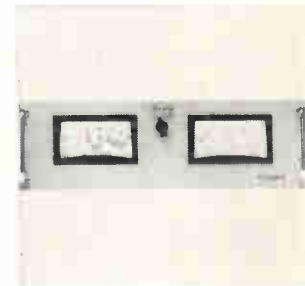

Precision vswr meter of a new series is combined with a Thru-line r-f wattmeter. The unit has two expanded scales, one for $2.5/1 \pm 0.2$ and the other for $1.3/1 \pm 0.06$ vswr full scale. The forward power meter is designed for 6 full scale ranges from 25 w to 1,000 w and 3 frequency ranges from 100 to 1,000 Mhz. Bird Electronic Corp., Cleveland, Ohio 44139 [408]

Crisp Bacon in 90 Seconds

with INTERNATIONAL'S
MICROWAVE OVEN



The culinary wonder of space age cooking moves to your kitchen with this new International countertop oven that cooks with radar-spawned microwave power.

People on the go will welcome an oven that makes cooking chores a pleasure. Imagine a "piping hot" TV dinner (frozen) in 3½ minutes* instead of 20 to 50 minutes. Bake a potato in 5 minutes instead of 60 minutes. Warm a chilled baby bottle in 60 seconds. Fry crisp bacon in 90 seconds on a paper plate. Great for those leftovers.

International Microwave Oven is truly remarkable. No more waiting for the oven to reach cooking temperature.

Countertop designed for the home, mobile home, or the galley on your boat. No special wiring required. Works on 115 vac house circuit. **\$695.00**

Available direct from International or through your local appliance dealer.

**Times listed are approximate and vary with size of item.*

Write for folder



CRYSTAL MFG. CO., INC.
10 NO. LEE • OKLA. CITY, OKLA. 73102

... detector designed
to fit common mounts ...

of the detector mount is achieved at the cost of some efficiency. Since the Q of the detector mount is relatively low, the power of the diode is dispersed over a spectrum of about 300 kilohertz (at 6-decibel points) about any given center frequency in a Gaussian distribution. Because Q isn't high enough to cram all the power under the curve into a single sharp spike, efficiency reaches only about 2% versus efficiencies of 10% for other Impatts in special mounts.

But this tradeoff has its good side: power output holds up well out to the extremes of the waveguide band, being about 1 db below maximum at 8.2 and 12.4 Ghz.

Foster says that the matching built into the 1N23 type package consists mostly of a specially de-

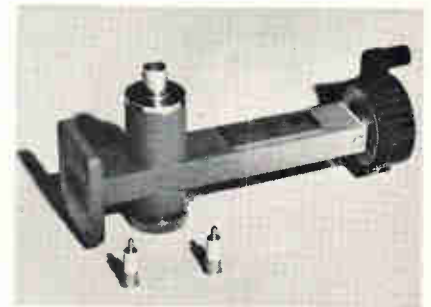

For experiments. Impatts are in front of detector mount.

signed loop to emulate the whisker inductance of the crystal, and other corrective circuitry to allow for the difference in the die sizes between crystal and Impatt. Also, there's heat-sinking built into the Impatt package that allows efficient heat transfer to the mounts's waveguide body.

The PG1201 is designed to fit common mounts like the H-P 485B or Narda model 510—among others—and is priced, as well as designed, for the experimenter. In lots of 1-9, the PG1201 costs \$75.

Power required is about 80 volts d-c at about 40 milliamperes. Parametric recommends a crowbar-protected, current-regulated supply.

Parametric Industries Inc., 742 Main St., Winchester, Mass. 01890 [409]

Instant Changes.

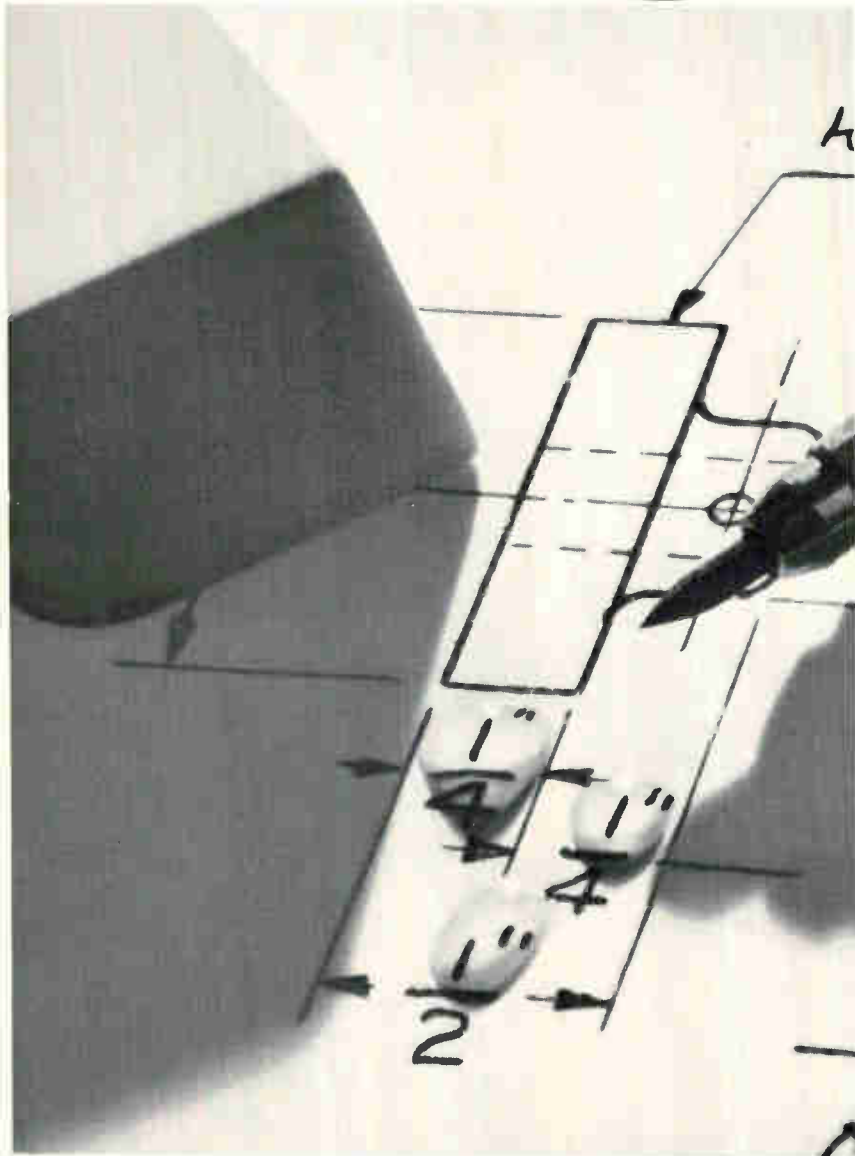

Revisions are easier with KODAGRAPH Wash-Off Films.

Here's a real bonus for draftsmen.

You don't need to retrace an entire drawing that needs only revision. A beautiful reproduction on KODAGRAPH Wash-Off Film can be made that includes only the unchanged areas. You merely draw the new details.

The improved drafting surface on these ESTAR Base Films takes pencil or pen nicely—holds up under repeated erasures. Photographic lines are wet erasable. Resulting diazo prints will be sharp and clean.

Ask your local Kodak Technical Service Representative to show you all the drafting shortcuts possible with Kodak Photo Drawing Systems. Or write Eastman Kodak Company, Business Systems Markets Division, Rochester, New York 14650.

DRAWING REPRODUCTION SYSTEMS BY KODAK

Kodak

Even if your data goes from  to  you can see it all on one display.



Some of your data will barely twitch an indicator.

Some of it goes right off the scale.

No problem. The HP 7563A Voltmeter/Amplifier logarithmically compresses data with a dynamic range of 110 dB—110 dB!—and gives you a single output that includes both high and low amplitude data with constant resolution and accuracy. The 7563A accepts positive or negative signals from vibration tests, geophysical measurements, pulse height analyzers, computers and similar sources, compresses the amplitudes logarithmically and feeds the results directly to a recorder or oscilloscope. The front-panel meter gives an instant visual display in dB. And when it's not performing that job, the 7563A will double as a voltmeter (calibrated from 0.3 mV to 100 V) for

system or bench use. How's that for a voltmeter/amplifier with the modest price of \$695 and one of the widest dynamic ranges you can buy?

To add AC log conversion and voltmeter applications to DC, use the 7562A with its 80 dB dynamic range. It's the only converter on the market that can measure the true rms value of an AC voltage. Turn it loose on vibration studies, biochemical data, seismographic

studies, audio research or similar data with large asymmetrical wave forms and it will give you the most accurate log conversion you can get in AC. Or use it as an AC/DC voltmeter, calibrated directly in volts. Price is \$995.

For more information, call your local Hewlett-Packard field engineer or write Hewlett-Packard, Palo Alto, California 94304; Europe: 1217 Meyrin-Geneva, Switzerland.

HEWLETT  PACKARD

TTL MSI offers attractive tradeoff

Speed is reduced by a third to get low power dissipation, but devices are still faster than other low-power families

Two methods for supplying power for portable equipment had been the only routes open to a designer. He could either use standard transistor-transistor-logic MSI circuits with a hefty power supply, or rely on low-power circuits operating at a maximum frequency of about 1 megahertz. But now Fairchild Semiconductor offers a third choice — its 9200 series of low-power

medium-scale-integration circuits. The initial introduction comprises six complex functions: a 9200 4-bit shift register; a 9208 dual 4-bit latch; a 9209 dual 4-input multiplexer; a 9211 1-of-16 decoder; a 9212 8-input multiplexer; and a 9228 dual 8-bit shift register. All are available in both the industrial and the military temperature ranges, and in both ceramic flat

packs and ceramic dual in-line packages.

According to Bob Wickham, marketing manager for advanced digital bipolar circuits at Fairchild, "The low-power MSI circuits previously available were limited to clock rates of about 1 Mhz. And although the power dissipation was down around 1 milliwatt per gate, the speed-power tradeoff was a

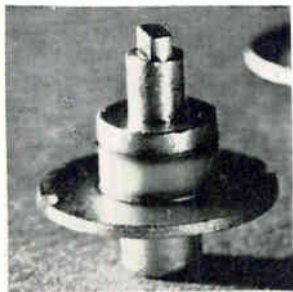

R-f power transistor TA7205 features 5 w minimum output with 70 db gain at 2 Ghz and a typical 10 w output with over 10 db gain at 1 Ghz. The advantages of coaxial packaging and overlay construction result in very low case inductance and low input Q. It is applicable to coaxial, stripline and lumped constant circuits. RCA Electronic Components, 415 S. 5th St., Harrison, N.J. [436]

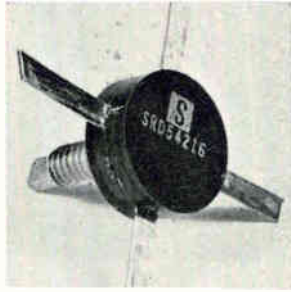

R-f silicon transistors in the SRD-54216 line are for the mobile communications market. Output is 40 w at 175 Mhz. They provide reliable single ended output and will withstand infinite vswr at any phase angle. Units are packaged in TO-128 stripline opposed emitter cases and suitable for rugged use. Solitron Devices Inc., 1177 Blue Heron Blvd., Riviera Beach, Fla. [437]

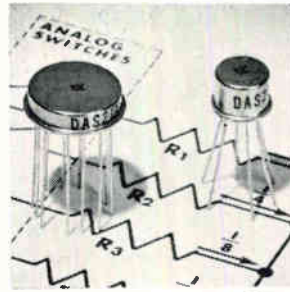

Hybrid IC analog gates series DAS2107, DAS2110 (spst) and DAS2126 (spdt) are directly applicable for use in A/D and D/A converters, sample and hold functions, and various multiplexing applications. Features include switching speeds as fast as 300 nsec, "on" resistance as low as 30 ohms and zero offset voltage. Dickson Electronics Corp., P.O. Box 1390, Scottsdale, Ariz. [438]



Hybrid IC FET input operational amplifier 20-248 is hermetically sealed at a cost comparable to plastic cased units. It is packaged in a TO-8 case and is operable over the full military temperature range. Maximum input bias current is 5 pa. Unit is available for immediate delivery and price is \$30. Bell & Howell, Control Products Div., 706 Bostwick Ave., Bridgeport, Conn. [439]

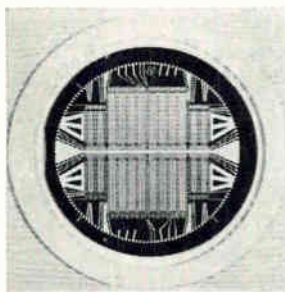

Three long bit lengths are offered in LSI shift registers. Standard units include a dual 253, a dual 349, and a dual 501-bit shift registers using standard TTL circuitry with TI's exclusive discretionary routing technology to interconnect individual shift register cells on a single monolithic 1 1/2 in. diameter slice of silicon. Texas Instruments, Box 5012, Dallas. [440]



High-frequency, step recovery silicon diodes designed for X and Ku bands feature very low transition times. The GC-2500 series diodes offer all order multiplication from X2 through X20. Output power efficiencies range from 1/N to 2/N. Maximum snap time is 70 to 100 psec with maximum series resistance of 0.6 to 0.9 ohm. GHZ Devices Inc., Kennedy Dr., N. Chelmsford, Mass. [441]



Plastic encased silicon rectifiers series 2AF have a d-c rating of 2 amps, resistive or inductive load, at 25° C and are available in 6 different piv ratings from 100 to 1,000 v d-c. Maximum rms input voltages range from 70 to 700 v d-c. All are designed to sustain peak 1 cycle surge currents of up to 60 amps. Sarkes Tarzian Inc., 415 N. College Ave., Bloomington, Ind. [442]

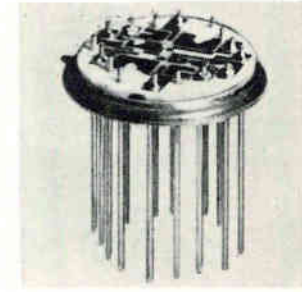

Precision DTL to MOS level shifter is for use in high speed digital systems and to assure dependable long-life operation under hostile environmental conditions. With a typical switching speed of 200 nsec, the new IC will convert logic levels from DTL-TTL levels to MOS levels and is compatible with all RTL, DTL, and TTL logic families. Mepco Inc., Morristown, N.J. [443]

WANG 700



Calculator or computer?

It's compact enough to be a calculator, thanks to the most advanced integrated circuit technology. But who ever heard of a calculator with 960 step programming capability? Or one with an 8192-bit magnetic core memory organized as 120 data registers, each of which can add, subtract, multiply and divide like 120 individual calculators? The 700 is very computer-like in its ability to loop, branch, do subroutines and make decisions. But unlike most computers, you don't have to wait to get on-line and you don't have to know a special language to use it. You'll get calculator-like convenience from its instantaneous dual NIXIE® display for both X and Y registers and computer-

like efficiency from an optional automatic typewriter. You can use the 700 to conquer large and small numbers from 10^{+98} to 10^{-100} , to invert a 10×10 matrix, or to perform special functions like bond yields, life expectancy, nuclear half-life, or process formulas. It will execute + and - functions in 300 μ sec, \times and \div in 3 to 5 msec. Log_e^x and e^x in 17 to 35 msec and trig functions in 250 msec. The 700 can give you the right answer to a complex statistical, financial, or scientific problem before an ordinary calculator understands it or a full-scale computer is even aware of it. To simplify matters we're calling the 700 an electronic calculator, because who ever heard of a computer for \$4900? *



Dept. IH, 836 North St., Tewksbury, Massachusetts 01876 • Tel. 617. 851-7311

| Call today! | | | | | | |
|----------------|----------------|----------------|----------------|----------------|----------------|--|
| (201) 272-7160 | (303) 364-7361 | (412) 243-3642 | (515) 288-5991 | (615) 266-5055 | (717) 675-3879 | |
| (203) 288-8481 | (305) 563-8458 | (413) 734-2230 | (516) 437-2500 | (616) 458-6595 | (801) 487-2551 | |
| (205) 881-5360 | (309) 673-6620 | (414) 442-0160 | (518) 785-3234 | (616) 454-4212 | (802) 223-6398 | |
| (206) 525-2000 | (312) 297-4323 | (415) 692-0584 | (601) 875-5588 | (617) 542-7160 | (805) 962-6112 | |
| (212) 736-0084 | (313) 352-7112 | (501) 666-7115 | (602) 274-2110 | (702) 322-4692 | (808) 536-5359 | |
| (213) 776-2985 | (314) 997-5866 | (502) 897-5143 | (603) 669-0404 | (703) 595-6777 | (813) 872-7347 | |
| (214) 361-7156 | (315) 463-9770 | (503) 297-2501 | (608) 255-4411 | (703) 359-6320 | (816) 444-8388 | |
| (214) 958-1810 | (316) 262-1388 | (504) 729-6858 | (612) 884-7328 | (704) 372-9660 | (915) 565-9927 | |
| (215) 642-4321 | (401) 421-0710 | (505) 255-5775 | (614) 488-9753 | (713) 666-2451 | (915) 683-3304 | |
| (301) 588-3711 | (404) 633-6327 | (512) 454-4324 | (614) 268-3511 | (714) 276-8464 | (918) 743-2571 | |
| (301) 821-8212 | (405) 524-4489 | (513) 531-2729 | (615) 524-8648 | (716) 328-2510 | (918) 747-0018 | |
| | | (513) 771-3445 | (615) 889-1408 | (717) 236-4782 | (919) 272-5683 | |

*Price in 48 contiguous states and District of Columbia.

bad one because equipment clock rates were more than 1 Mhz. In the 9200 family, we're offering speeds on the order of 5 Mhz, with a power dissipation of 2 mw per gate." Standard TTL MSI circuits such as Fairchild's 9300 series have speeds of from 15 to 20 Mhz, and dissipation is 10 mw per gate.

Instrument makers, because of speed limitations, couldn't use low-power MSI before, says Wickham, but now they can. And because the 9200 series is compatible with the standard 9300 series, the devices can be mixed. As an example, Wickham points out that "in the adder circuit in a counter, you want the carry term to get to the next stage before the sum is generated, so you could use the lower-speed 9200 circuits for the sum term and the higher-speed 9300 circuits for the carry term."

Digital trend. Another advantage involves the size of an instrument. "The trend in small portable instruments," says Wickham, "is towards digital readouts. And especially in panel meters, space is at a premium—in many cases the size is determined by how much heat has to be dissipated. The low-power circuits will not only allow smaller power supplies, but also closer packing of the IC's." Wickham adds that large instruments can also benefit. "In some units, a smaller power transformer can be used, and the cooling fan can be eliminated."

But instruments are not the only products that can benefit from the reduced power requirements. The advantage in military equipment is obvious—the goal is to reduce power consumption and shrink size. In aerial reconnaissance, for example, "By reducing power requirements," says Wickham, "you can get more processing on-board." Computer peripheral equipment is another area, adds Wickham, where small size is important. "And when you're interfacing with humans, you don't need very high speed circuits—5 Mhz is enough."

"What we're trying to do," says Wickham, "is offer the user the widest choice of circuits. The six we are introducing were the hardest to implement in a low-power design; now we'll do the easy ones." Eventually all of the devices in the 9300 series will have low-power

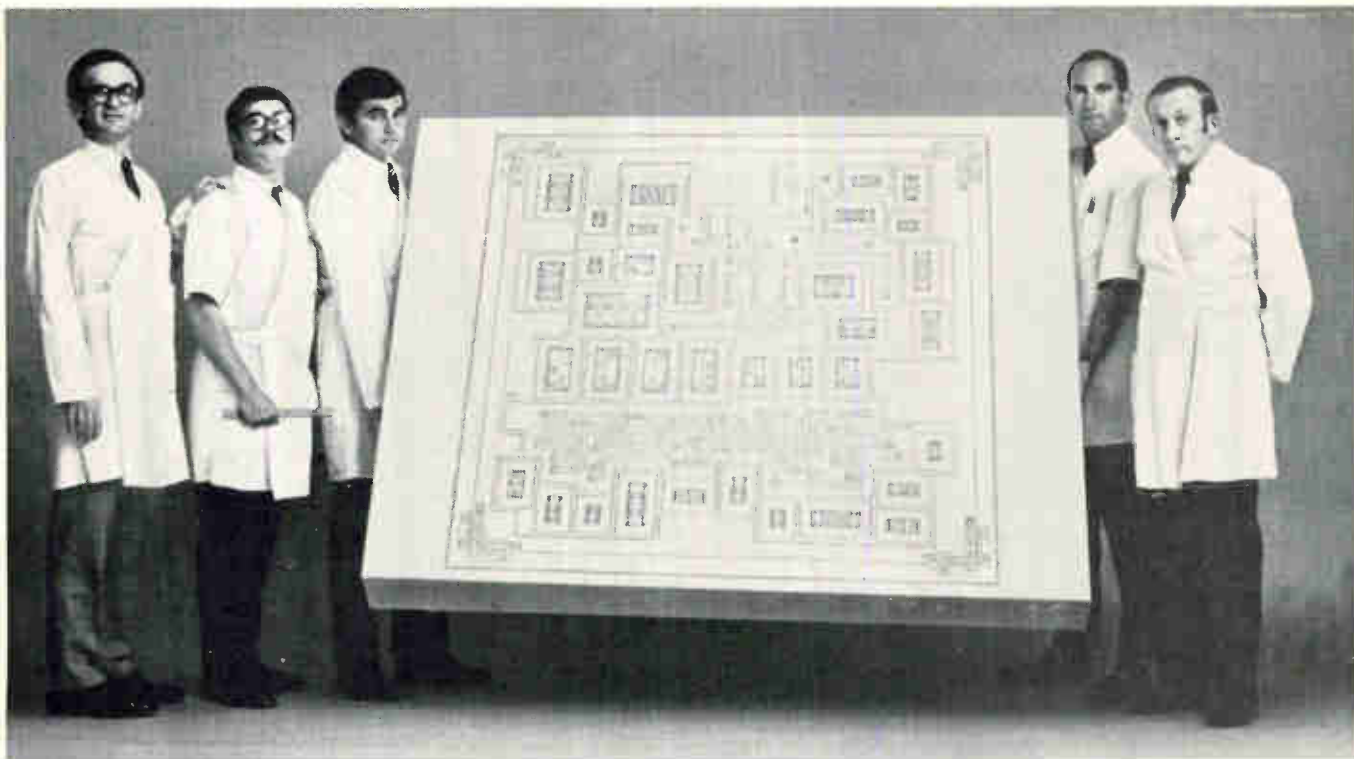

CalComp presents the 6 foot microchip.

Before you can make IC chips, you must first make IC masks.

And the fact is, if you want to make masks, nobody can help you more than CalComp.

Today CalComp offers a complete hardware and software package for IC mask cutting:

Our giant CalComp 718 flat-bed plotter.

And our unique MASKGEN program.

With a resolution of .001 of an inch, the CalComp 718 quickly plots and verifies IC designs as large as 4.5 by 6 feet.

And with its strippable film

cutter, it automatically cuts them, too.

You provide the basic cell and interconnect pattern data. And let CalComp's MASKGEN program do all the work.

The CalComp 718 is the plotter preferred by industry leaders.

And with MASKGEN, you're in business right away.

So if you want instant IC capacity or would like help with your present system, get on the phone to your nearest CalComp man today. (CalComp has offices in 34 cities.)

He won't just look at your problem.

He'll really chip away at it.

CALCOMP

TEACH YOUR COMPUTER TO DRAW.
California Computer Products, Inc.
305 No. Muller Avenue, Dept. X-1
Anaheim, California 92803



How fast is GE's new helium leak detector?



Let your fastest operator show you

Manufacturers of electronic components asked us to help cut down leak test time.

So General Electric engineers designed a new leak detector to do the job.

It's the LC-40 Mass Spectrometer Helium Leak Detector, which offers unmatched testing speed in a general purpose leak detector. The LC-40 achieves this by combining the highest net pumping speed of any leak detector on the market (for equivalent sensitivities), with fast recovery from leaks. This combination pays off in a time-to-test of only seconds.

Complementing this test-time capability is a new simplified control system, which permits the operator to complete a test merely by loading the test piece and flipping a single switch. Results are instantly displayed on a meter.

But the LC-40 detector isn't just fast. It includes such performance-proven features as all-solid-state circuitry for dependable service; burnout-resistant thoriated iridium filament, exclusive with GE; all-welded stainless steel high vacuum system; high sensitivity (5×10^{-11} atmo. cc/sec He), a new source design to eliminate background signals, and many other significant advances.

Although ideally suited for high-speed production testing, the unit also can be used for general purpose applications. If you would like to learn more about General Electric's new LC-40 Mass Spectrometer Leak Detector, write General Electric Company, Analytical Measurement Business Section, 4MX, 25 Federal Street, West Lynn, Mass., 01905

268-41

GENERAL  ELECTRIC

counterparts. In a few months, Fairchild plans to announce a low-power line of gates and binaries—the 9400 series—which will complement the existing 9000 series of TTL gates. In addition, the 4600 series of micromatrix large-scale-integrated circuits will also have a low-power complement—the 4400 series.

Prices for the initial six devices will range from \$6.60 for both the 9202 and the 9212, and up to \$15 for the 9228. These figures refer to industrial DIP devices in quantities of 100.

Fairchild Semiconductor Corp., 313 Fairchild Dr., Mountain View, Calif. [444]

New semiconductors

IC amplifier is a loner

Variable-gain unit
needs minimum of
external componentry

Designers of linear IC variable-gain amplifiers haven't exploited monolithic technology for a variety of reasons. One of them is that the circuits have been conceived as parts with broad applications, and have needed specialized external circuitry to make them fit a specific task. But engineers at Silicon General Inc. have designed a versatile variable-gain amplifier/multiplier that requires a minimum of external componentry to make it work as a wideband amplifier, multiplier, modulator/demodulator, or a phase switch.

Silicon General, a new company, feels no desire at present to press the state of the art in the linear world—the initial niche the firm has carved out for itself. But Robert Mammano, Silicon General's vice president for engineering, says the new circuit, the SG1402, incorporates his design philosophy.

"Our biggest concern," he says, "is to make all our products as easy to use as possible." Drawing on his

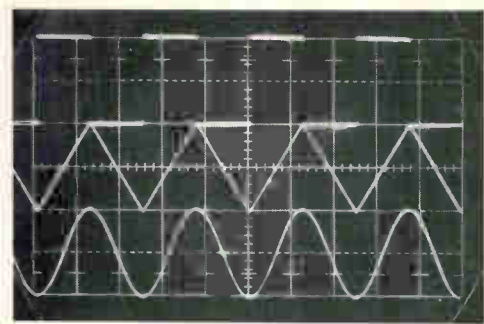

Sine, square & triangle

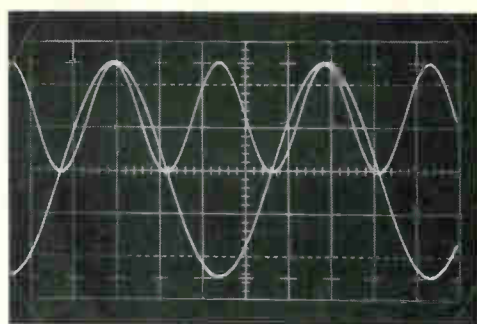

Sine squared

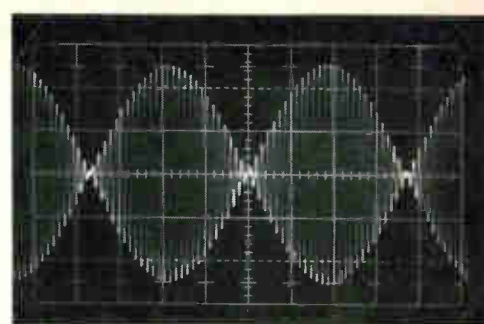

Suppressed carrier modulation

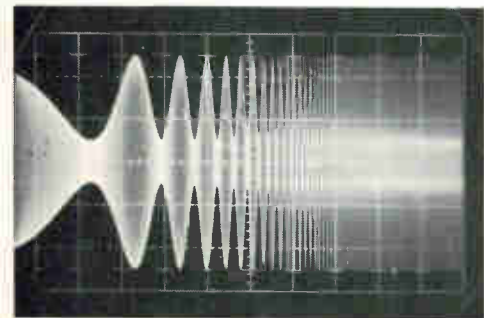

AM log swept envelope

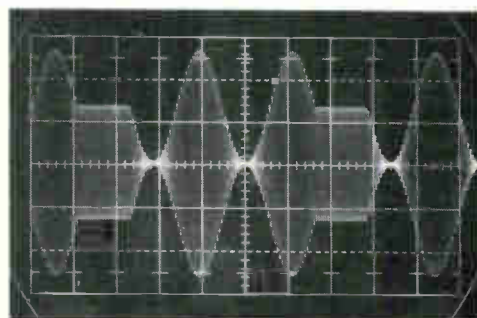

Tone burst AM

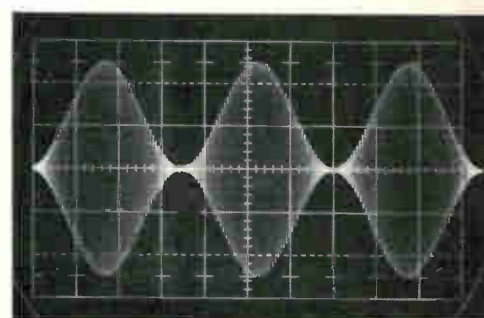

Sine wave amplitude modulation

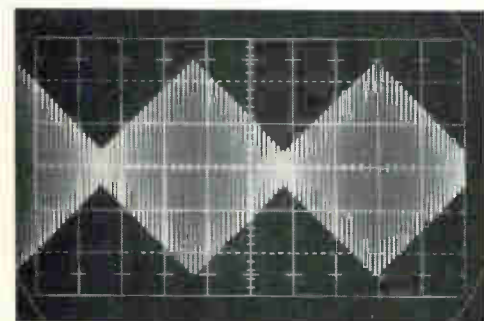

Triangle amplitude modulation

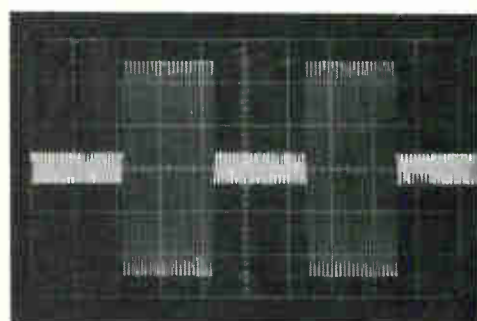

Square amplitude modulation

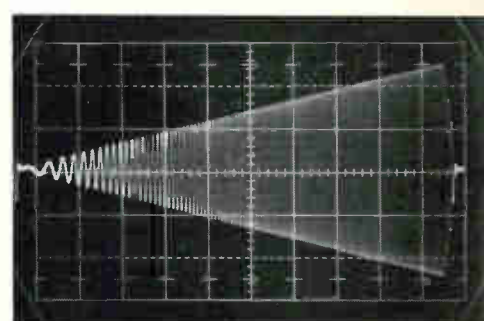

Swept AM - FM

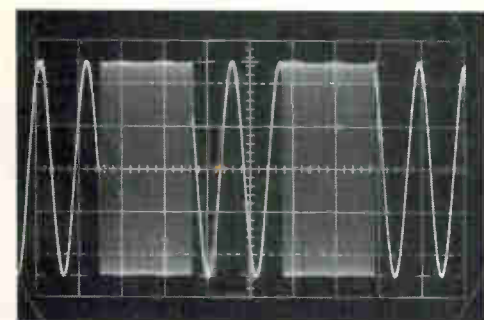

Frequency shift keying

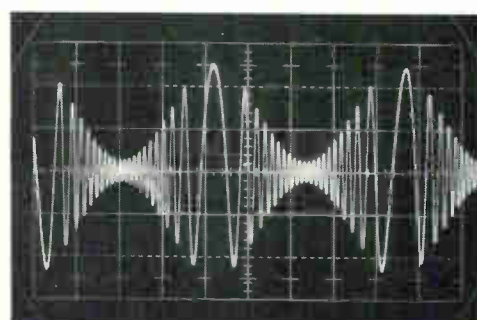

Linear AM - FM (sine wave)

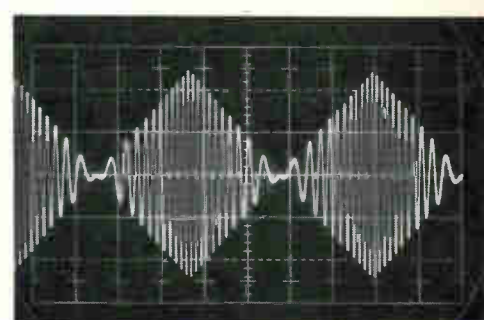

Linear AM - FM (triangle)

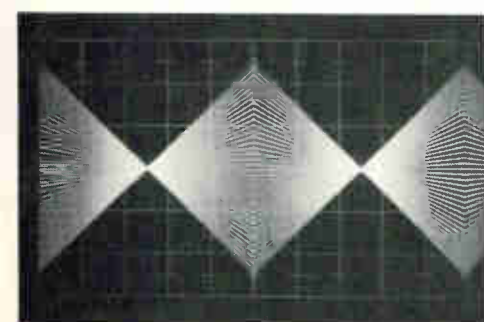

Ultra low frequency AM



Model 135 LIN/LOG Sweep Generator



Model 136 VCG/VCA Generator

How do these waveforms grab you, generator fans?

WAVETEK®
 9045 Balboa Ave., San Diego, Calif. 92123; Tel. 279-2200
 P.O. Box 651, San Diego, Calif. 92112; TWX 910-335-2007

NOW...

Hamilton precision metals has added facilities...and is in the Photoformed® Parts business...



BIG!

Hamilton has added a new plant—just to produce precision, Photoformed® parts!

This new facility is equipped with the most modern photo-etching machinery on the market. The new equipment will produce precision parts in large quantities to the highest standard of dimensional accuracy.

Now, you can get from the Precision Metals Division, finished parts to the same degree of precision as world wide metal users have come to expect in Hamilton's strip and foil.

Hamilton offers the Total Capabilities of a completely integrated facility controlling every step from melt to finished strip or foil—and now to finished parts. This means that you get the same adherence to metallurgical standards and dimensional accuracy that has become the hallmark of Hamilton.

For the complete story on the capabilities of Precision Metals Division and what it can do for you, write for your copy of the new Photoforming brochure. It's yours for the asking—write today!

PRECISION METALS DIVISION
HAMILTON
WATCH COMPANY • LANCASTER, PA. 17604
• PHONE (717) 394-7161

systems background and IC design and analysis experience, Mammano designed the SG1402 to include cross-coupled base connections and all direct-current biasing circuitry on the monolithic chip. This feature, plus the fact that the circuit operates from a single power supply of +10 volts, will make it attractive to designers of carrier control systems and communications networks.

The SG1402 was conceived as a variable-gain amplifier that would eliminate d-c offset and transients when changing gain. This has been a problem with this kind of circuit, contributing to system noise, Mammano says. In achieving these goals, Mammano points out, the circuit also is easily applicable in a pulse modulator, in which it can go from no output to full output with no d-c offset or transient.

The maximum supply level is +18 volts; +10 volts is typical. At 10 volts, typical gain is 25 decibels, and power consumption is just 50 milliwatts. With a given output, the circuit can be controlled so that the gain goes from 25 db at zero phase shift down through -24 db and back up to +25 db through a phase shift of 180°.

The SG1402 needs only coupling capacitors external to the monolithic chip, and the number depends on the application. "It can be as few as an input and output coupling capacitor," Mammano explains, "but in most applications you'd also need bypass capacitors for good high-frequency response." The device's typical frequency response is 50 megahertz.

Silicon General is offering three versions of the circuit. The SG1402 is a tight-tolerance device housed only in a metal TO-100 can, and operates over the full military temperature range of -55°C to +125°C. Price for 100 to 249 pieces is \$4.95 each. The SG2402 has the same electrical characteristics as the 1402, but operates from 0°C to +70°C. It comes in both the TO-100 and in a 13-pin plastic dual in-line package, and costs \$3.45 each for 100 to 249 pieces. The SG3402 has slightly relaxed tolerances and comes in both packages. It's intended for the limited temperature range, and sells for \$2.10.

Silicon General Inc., 7382 Bolsa Ave., Westminster, Calif. 92683 [445]



The CHAMP'S profile

Meet the all-points winner.

Bausch & Lomb's StereoZoom 7 Microscope.

Overwhelming choice for cost reduction, increased production in microelectronics, quality control/assurance, manufacture and assembly.

- Greatest range of 100% USABLE magnification, from 2.5X through 280X.
- Infinitely variable zoom and accessory lenses let you select the power best for you and your work.
- Large field of view, optimum for visual scanning.
- All the working distance you need for widely diversified applications.
- Convenient photomicrography with integral and interchangeable cameras.
- Highest eyepoint eyepieces, comfortable for eyeglass wearers.
- Power pods interchangeable with any models from 1959 to 1970, and 180° reversible.

That's the world's Champ.

Bausch & Lomb's StereoZoom 7 Microscope.

There's a new catalog that tells all about The Champ.

Write today for No. 31-15 and our free demonstration plan.

StereoZoom, Reg. T.M. Bausch & Lomb.

BAUSCH & LOMB 
SCIENTIFIC INSTRUMENT DIVISION

61425 Bausch Street, Rochester, New York 14602

What happened when doctors and engineers got together:

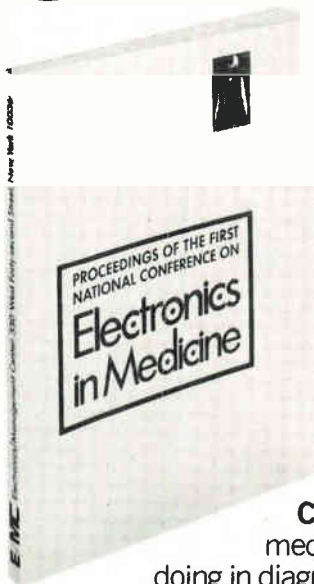

Doctors told engineers how they were using electronics and revealed their most urgent needs. Engineers described and demonstrated their newest equipment for diagnosis, treatment, and prevention. And hinted at things to come.

Their complete dialogue, with illustrations, makes pretty informative reading on a vital and growing market.

Here are some of the things it contains:

Computers: How they're joining the medical team. What computers are doing in diagnosis. In communications. The small computer as a paramedical aid.

Instrumentation: What's needed. What's available. Patient management. Protection. Standards and safety.

Electronics in the Hospital: The surgeon, the hospital, the instruments. What the administrator wants. Prescription for large-scale health care. The surgery department.

Electronics/Management Center
330 West 42nd Street, New York, N.Y. 10036

Enclosed is \$12 for a copy of the Proceedings of the First National Conference on Electronics in Medicine.

Send the Proceedings and bill me later. P.O. # _____

Name _____

Company _____

Address _____

City _____ State _____ Zip _____

New materials

Substrate smooth to 2 microinches

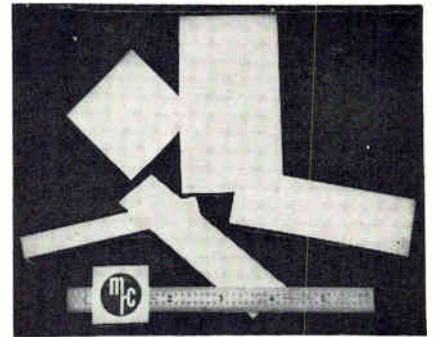

Ceramic substrates for the electronics industry are prepared under ultraclean conditions by a special process to yield an as-fired-defect-free surface characterized by a 2-3 microinch surface smoothness. No glaze is required to achieve such a surface. Film adhesion to the material is said to be superior to that achieved with polished sapphire or polished alumina substrates having equivalent degrees of surface smoothness. Substrates are suited for microwave IC and hybrid LSI circuit manufacture. Materials Research Corp., Orangeburg, N.Y. 10962 [491]

E-Gas has been prepared for etching silicon prior to epitaxial deposition in semiconductor manufacture. It is colorless, odorless, nontoxic, and noncorrosive. Matheson Gas Products, P.O. Box 85, East Rutherford, N.J. 07073 [492]

Resistive cermet pastes series CC200 are being supplied in the very low ranges with temperature coefficients much less than 100 ppm. This series, combined with the series CC100, can offer a complete thick-film system with a stable, reproducible temperature coefficient that will meet all MIL spec requirements. The line of pastes fires at 565° to 610° C and offers in-process range and temperature coefficient adjustments. Both series are priced competitively at \$50 to \$90 a troy ounce in small quantities. Conshohocken Chemicals Inc., P.O. Box 224, Flourtown, Pa. 19031 [493]

Unilloy 326 is a magnetic, high-strength, low-nickel stainless steel of special interest to the fastener industry. It is available in all cold heading wire sizes. Universal-Cyclops Specialty Steel Division, Cyclops Corp., 650 Washington Rd., Pittsburgh, Pa. 15228 [494]

Chemical etchants for thin-film etching of metalized substrates are supplied in a 1-qt. polyvinyl bottle. All chemicals are shipped with applicable etching instructions. Prices range from \$5.50 to \$9.50/qt., and delivery is from stock. Tek-Wave Inc., P.O. Box 420, Princeton, N.J. 08540 [495]

Signal Innovator



SG-1000 Uniqueness in Signal Generation

Singer has advanced the state-of-the-art with a signal generator so New it almost requires a new name.

The Model SG-1000 obsoletes every other signal generator within its frequency range . . . singly or in combination. Its performance is so superior that no other instrument available can equal or even approach it.

That's why we call it the Innovator.

Here's why you'll call it unbelievable . . .

- Digital readout of frequency.
- Broadband frequency coverage from 61kHz to 512MHz (to 1024MHz with a simple passive doubler) in a small 5¼" high package.
- Exceptional frequency accuracy and resolution . . . typically 0.005% . . . and no human readout errors.
- Full modulation capability AM FM Pulse Video Internal 1,000Hz modulation . . . and combinations of the above.
- Output levels from +20dBm to -146dBm.
- An automatically leveled output . . . within ± 0.5 dB over the entire frequency range.
- Use it as a 2MHz counter for counting modulating signals or rep rates directly.
- A spectrally pure output signal approaching that of a crystal . . . extremely low residual and incidental FM.
- Total elimination of dial tracking errors.
- The availability of BCD frequency output and a

programmable attenuator to assure system integration.

This is only part of the SG-1000 story. A more complete technical description is available in Singer Application/Data Bulletin SG-10 upon request.

For additional information contact your local Singer Representative, or write or call —

The Singer Company
Instrumentation Division
915 Pembroke Street
Bridgeport, Conn. 06608.
203-366-3201.

In Europe contact: Singer
Sewing Machine Company,
Instrumentation Division, P.O.
Box 301, 8034 Zurich, Switzerland,
Telephone: (051) 47 25 10
TWX 710-453-3483

SINGER
INSTRUMENTATION

MICO

NEW MODEL 885 SEVEN RATIO WIDE-RANGE ENGRAVER

NO. 885

FOR LONG AND
MULTI-LINE WORK

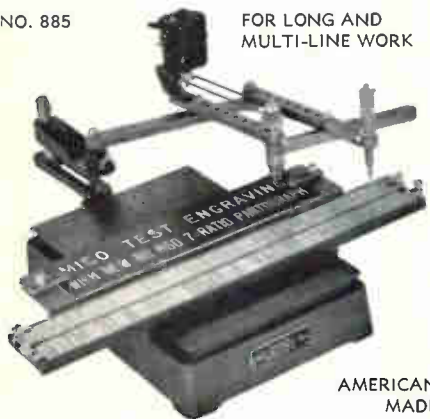

AMERICAN
MADE

- A time-saver for large plate work
- Engravers letters 1/32" to 3" high using standard masters.
- Seven pantograph ratios—from 1:5:1 to 6:1.
- Choice of 3-ball-bearing spindle assemblies for 1/8", 3/16" or taper-shank cutters.
- HSS, COBALT and Solid Carbide Cutters.
- Single and multi-line copy carriers for holding blanks 3/4" to 3 1/2" high.
- Accommodates Mico standard accessories.

Send for bulletins and prices

MICO INSTRUMENT CO.

77 Trowbridge St. Cambridge, Mass. 02138
Circle 220 on reader service card

P/C Reed Relays

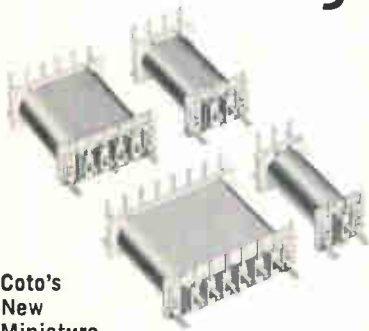

Coto's New Miniature Series 1000

- Especially designed for P/C board applications
- Pin spacing 1" x .150" centers
- Stock voltages 6, 12, 24, 32 and 48 volts
- Form C contacts, 4 poles, ratings 3 watts
- Form A mercury-wetted, 6 poles, ratings 28 watts
- Electrostatic and/or magnetic shields

Special voltages and resistances available, with multiple windings for flip-flop, memory and crosspoint selection applications.



COTO-COIL COMPANY, INC.
61 Pavilion Avenue, Providence, R. I. 02905
Tel: (401) 941-3355

Circle 221 on reader service card

New Books

Communication bible

Communication Systems Engineering
Theory
Erling D. Sunde
John Wiley & Sons Inc.
512 pp., \$19.95

The communications explosion predicted for the 1970's is almost upon us and a new book dealing with system theory has arrived not a moment too soon. The book, backed by the author's two decades of experience at Bell Labs, provides excellent additional material to current communication texts dealing with basic principles of communications theory and mathematics.

The first three chapters—basic transmission concepts and relations, basic modulation concepts and objectives, and statistical properties of Gaussian random variables—provide a review of fundamental concepts. These ideas are used throughout the remainder of the book in the development of more advanced theories and concepts.

The "meat" of the book begins with chapter four; the author derives the optimum shapes of transmit and receive filters in the presence of additive Gaussian random noise. He considers both analog and digital baseband and carrier modulation and concludes that optimum matched filters only when the noise power spectrum is flat and the transmission medium attenuation is constant across the entire transmission band. Only single-band transmission is considered except for comparison with multi-digital transmission over baseband channels.

Chapter five covers various baseband and carrier modulation and detection methods for digital-pulse transmission. Extraction from the received signals of a carrier-demodulating wave is but one of the methods covered. Transmission limitations by Gaussian noise, phase- and binary-modulation techniques, and sub-binary transmission are among the topics given comprehensive treatment in this chapter providing the reader with an up-to-date analysis of digital techniques.

Circle 175 on reader service card →

think one plane



MG
19

MINIATURE NEON ELFIN®

ELFIN® — the new single plane, segmented neon readout indicator provides brighter displays, uniform clarity, wider viewing and easy readability. 0.41" diameter allows four digits in a 2" space. Numerals are .413" high.

The MG-19 ELFIN® forms numerals 0-9, + and -, some alpha symbols and decimal point.

The MG-17 ELFIN® displays numerals 0 to 9, and has two decimal points.

\$2.99 each in 1000 lots.

MS-250A



MS-4000B

MINIATURE INCANDESCENT

ALCO's low cost metal encased readouts have reliable T-1, 5-volt MIL GRADE lamps. Large, easy-to-read figures on a single plane provide a bright display that is clearly read under ambient light conditions. Numeric and symbol readouts are available. Character height .46" (MS-250A), and .62" (MS-4000B).

These low-voltage readouts are designed to be used with ALCO 7-Segment Decoder-Drivers and can be mounted with stock mounts and bezel kit assemblies.

Send for detailed catalog.



ALCO

ELECTRONIC PRODUCTS, INC.
Lawrence, Massachusetts 01843

Perfect Your CCTV System with COSMICAR® lenses



Focal length 15~145mm Aperture f/2.5

A new member to the superb COSMICAR lens family!!

The most efficient **10 : 1 zoom** lens, unmatched for its optimum performance, both optically and mechanically, with impeccable definition and resolution throughout its entire zoom range.

Also available are scores of other lenses, ranging from 8.5mm to 1,000mm telephoto, zoom and those motordriven among them, for immediate delivery, after being tailored to your specifications.



COSMICAR OPTICAL CO., LTD.

568, Shimoochiai, 2-chome, Shinjuku-ku, Tokyo

Cable Address: "MOVIEKINO TOKYO"

Circle 198 on reader service card

TWO NEW BELL RINGERS FROM DELTA

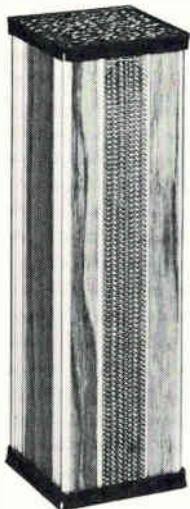

DELTALERT... Your night watchman for pennies a month!

Delta introduces its all new ultrasonic silent sentry, the total motion detection, intrusion and monitoring alert system. The system plugs into any wall outlet. It also features variable sensitivity control and adjustable timing which provides the most advanced sentry system on the market.

SPECIFICATIONS:

Ultrasonic Frequency: 35 KHZ Δ
Area Coverage: 15-30 feet (depending on shape of area) Δ Controls: On-Off Switch; Built in Timer; Variable Sensitivity Control Δ Output:

110-130V at 1 Amp. Δ Power Requirements: 110-130V, 60 HzAC Δ Dimensions: 10 $\frac{3}{8}$ "W x 3 $\frac{1}{4}$ "H x 3 $\frac{1}{4}$ "D Δ Complete with 110-130V Drop Cord Δ Walnut designer finish.

For Complete Unit, Ready to UseONLY \$59⁹⁵_{ppd}



HIGH VOLT ANALYST Tune your car like a pro.

Delta's new concept in automotive tune-up. The High Volt Analyst, is a unique and complete auto analyzer which provides all the primary advantages of a scope and is completely portable.

SPECIFICATIONS:

Accuracy — Tachometer \pm 2% of full scale (all ranges) • Dwell Meter \pm 1% (both ranges) • OHMS Scale \pm 5% • Low Voltage \pm 2% of full scale • High Voltage \pm 5% of full scale Δ
General — Fully protected meter circuit* • Size: 6 $\frac{1}{2}$ "W x 8"H x 3 $\frac{1}{2}$ "D • Weight: 3 $\frac{1}{4}$ lbs. Δ Ranges — DC Volts 0-15V, 15KV and 45KV • OHMS: 0-1 Meg. (10K center scale) • Dwell: 4, 6 and 8 cylinders • Tachometer: 0-1500 RPM, 6000 RPM

*Batteries (8 Type AA cells) included. Comes complete with standard lead set, a special probe, and high tension lead.

\$79⁹⁵_{ppd} / \$59⁹⁵_{ppd}
Assembled Kit Form

DELTA: Please send me literature immediately.

I am enclosing \$ _____ for items checked.

- DELTALERT
 High Volt Analyst, Assembled
 High Volt Analyst, Kit form

Please ship immediately.

Name _____

Address _____

City/State _____ Zip _____

E 9-11



DELTA PRODUCTS, INC.

P.O. BOX 1147 • GRAND JUNCTION, COLORADO 81501
PHONE: (303) 242-9000

CLASSIFIED ADVERTISING

SEARCHLIGHT SECTION

BUSINESS OPPORTUNITIES
USED OR SURPLUS EQUIPMENT



RADAR SYSTEMS GROUND AND AIRBORNE AUTOMATIC TRACKING ANTENNA SYSTEMS. NIKE AJAX, NIKE HERCULES, M-33, M50-1A, MPS-19, MPS-9, SCR 584, TPS-1D, TPS-2B, FAA-ASR-2, AIRBORNE SYSTEMS, APN-84, APN-102, APS-2D, APS-27, APS-45, DPN-19, DIGITAL COMPUTERS, IBM 450, IBM 704.

LARGEST INVENTORY OF RADAR AND MICROWAVE EQUIPMENT IN THE WORLD.
RADIO RESEARCH INSTRUMENT CO.
45 WEST 45TH ST. N. Y. 10036 212-JU 4-4691

CIRCLE 967 ON READER SERVICE CARD

Ideas to Cash WANTED

Prototype Toys

Write to: P. Brief

RAI RESEARCH CORP.

36-40 37 St., L.I.C., N. Y. 11101

CIRCLE 968 ON READER SERVICE CARD

EMPLOYMENT SERVICES

Resume Guide — Authentic writing instructions, clear, examples: \$2. Executive Resumes, Box 246EL, Montclair, N.J. 07042.

Don't forget the

BOX NUMBER

When answering the classified advertisements in this magazine don't forget to put the box number on your envelope. It's our only means of identifying the advertisements you are answering.

FASTENERS FROM



DIE CAST
ZINC ALLOY



MOLDED
NYLON &
DELRI



NYLON SCREWS AND NUTS

also available in Delrin

MACHINE SCREWS from miniature #0 thru 1/4" in wide range of lengths and head types.

Also SET SCREWS, NUTS from #2 thru 5/16".

GRC's exclusive methods—die casting zinc alloy or molding Nylon and Delrin fasteners in one high speed automatic operation—assure high quality at lowest possible cost.

Write, wire, phone TODAY for SAMPLES, prices, your copy of GRC's NEW INDUSTRIAL FASTENER CATALOG



GRIES REPRODUCER CO.

Division of Coats & Clark Inc.

World's Foremost Producer of Small Die Castings
151 Beechwood Ave, New Rochelle, N.Y. • (914) 633-8600
Plants in: New Rochelle, N.Y.; Warren, R.I.; Toccoa, Ga.

Circle 230 on reader service card

New Books

The chapter also reviews the more frequently used types of digital systems, together with their more significant characteristics and basic principles. Power spectra, timing wave deviations, error probabilities arising from additive Gaussian noise, and transmission capacity as limited by Gaussian noise for linear time-invariant channels are among the theoretical relations presented. Reference is made to the latest literature.

The beginning of chapter six is the breakpoint in the conceptual arrangement of the text. The first five chapters presented a realistic transmission- and modulation-theory approach that permitted transmission impairments by random noise in both analog and digital systems as well as optimum designs to minimize these distortions. The remainder of the book deals with an explanation of analytical methods for determining other transmission impairments.

The subject of attenuation and phase distortion in analog systems is handled by examining the statistical properties of Gaussian noise to determine the intermodulation distortion of digital systems is evaluated as a result of phase deviations and attenuation in the channel band. The intermodulation distortion is determined as a result of nonlinear amplification. Relations are presented for intermodulation distortion as a result of amplitude to phase modulation, commonly encountered in microwave transmitters and multicarrier f-m satellite systems.

By examining troposcatter paths, the statistical properties of the transmissions of time-varying multipath channels are determined intermodulation distortion in f-m troposcatter systems is also evaluated and comparisons are made with experimental data. The text also examines the error probability of digital transmission at many rates and over random multipath or troposcatter channels; additive random noise and frequency selective fading are considered. In addition, intersystem interference for all types of modulation is treated.

Circle 177 on reader service card →

designer's keyboard

SB-033 — INTERLOCK
SB-034 — MOMENTARY



28.50 User Net

The ALCO modular idea is a simple concept for the design engineer to create his own custom push button layouts from "stock" switch modules and assemblies.

The basic modules allow use of up to twelve (shown at right) switches per section. A designer may stack any number of these switch sections in a group by themselves or in conjunction with the ALCO mating 12-segment keyboard assemblies (shown above).

Highly efficient, single pole "normally open" reed switches are used throughout, thus assuring reliability and extremely long life expectancy.

For design-service assistance and price quotations, call (Area 617) 686-3887.

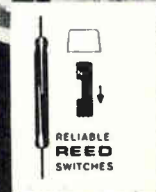

Available as
Momentary
and Interlock

ALCO

ELECTRONIC PRODUCTS, INC.

Lawrence, Massachusetts 01843

Power Structure!

These modular power supplies can be quickly structured to meet the power needs of micro-electronic systems. Litton's reputation for reliability and performance is unsurpassed in the electronic industry.

Compact, lightweight, with power outputs to 300 watts in single packages from 108 to as small as 8 cubic inches weighing from 7 to as low as .75 pounds. Manufactured to MIL Specs or commercial standards.

To help you build Litton power supply reliability and performance into your engineering design, let us send... FREE... a set of actual size replicas, specifications and additional information. To receive yours, use the inquiry card provided in this magazine.



SPECIAL PRODUCTS
Data Systems Division • Litton Industries
9001 Fullbright Ave., Chatsworth, Calif. 91311



Circle 199 on reader service card

THUMBWHEEL SWITCHES

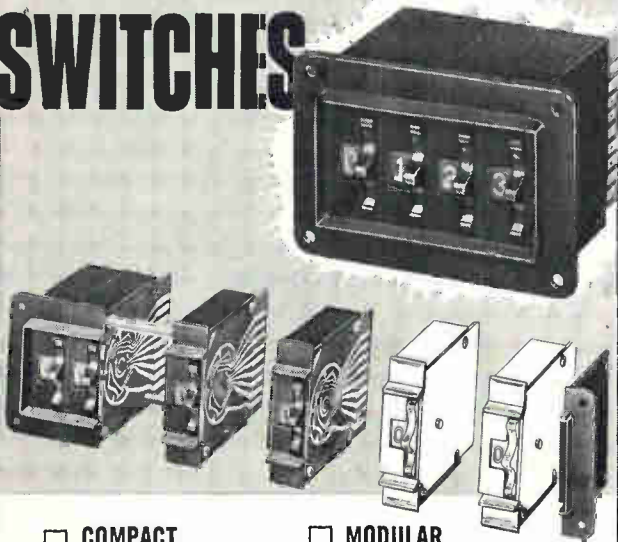

- | | |
|---|--|
| <input type="checkbox"/> COMPACT | <input type="checkbox"/> MODULAR |
| <input type="checkbox"/> POSITIVE OPERATION | <input type="checkbox"/> WIDE RANGE OUTPUT |
| <input type="checkbox"/> SIMPLE, CLEAN INSTALLATION | <input type="checkbox"/> EDGE LIGHTING AVAILABLE |
| <input type="checkbox"/> ECONOMICAL | |

Send for further information

TECH LABORATORIES, INC.

Palisades Park, New Jersey
Phone: 201 — 944-2221 • TWX: 201 — 947-4730

Make your own break.

You can take a lot of the chance out of your future by including yourself in the Electronics Manpower Register.

When you do, your experience and talents become part of a nationwide computerized placement service.

Our computer is programmed to give every registrant the same look for every opening. With your prior approval, you'll be considered for every opportunity that matches your resume.

All you have to do is send one to:

Electronics Manpower Register

Electronics
330 West 42nd Street
New York, N.Y. 10036

Technical Abstracts

Tuning in with varactors

Investigation of microstrip applications for varactor-tuned uhf tuners

Darrell W. Whitten
Texas Instruments
Dallas, Texas

Using microstrip with varactor diodes in a uhf tv tuner is a departure from the norm. Microstrip mainly is used for broadband circuits with a fixed center frequency, while the uhf tuner employs fractional bandwidths less than 5% over an octave variation of center frequency. Although practical limitations inherent in the devices, such as circuit Q, circuit loss, and varactor Q, are keeping such a tuner off the market, when higher Q devices become available, the tuner could become practical.

The basic tuned circuit consists of a shorted section of microstrip that acts like an inductance and resonates with the capacitance of a varactor diode. The device must be tuned from 473 to 887 megahertz; if a fixed inductance is used, the useful capacitance ratio must be 3.52. However, the transmission line elements complicate matters because the effective inductance is a non-linear function of frequency.

The result is that the required ratio of tuning capacitance is a strong function of the choice of electrical length of the microstrip resonator. Although it is implied that the choice of resonator length sets the tuning capacitance ratio, the electrical length of the resonator will be dictated by the capability of the varactor diode. Similarly, the choice of resonator characteristic impedance will be determined by the magnitude of the available capacitance.

A resonator of constant electrical length 45° ($\lambda/8$) would resonate with 6.74 picofarads, 4.92 pf, and 3.6 pf at 473 Mhz, 650 Mhz, and 887 Mhz, respectively. The electrical length, however, is not constant with frequency. The line chosen to be 45° at 650 Mhz would be 33° at 473 Mhz and 62° at 887 Mhz, requiring capacitances of 10.45 pf at 473 Mhz, 4.92 pf at 650 Mhz, and 1.92 pf at 887 Mhz. These

values, based on a 50-ohm system, would be halved for a 100-ohm system, and doubled in a 25-ohm system.

Although higher values of capacitance help swamp out parasitic capacitances, they also degrade the varactor Q; the lower capacitance reduces the tank circuit losses but makes the parasitics significant.

The Q available in practical microstrip is relatively low and adjusting the substrate thickness and characteristic impedance provides the most sensitive control of resonator Q. But to compare with Q's of several thousand presently achieved in commercial uhf tuners using plated stubs tuned with air-dielectric capacitors, the Q's of microstrip will have to increase at least tenfold.

Minimal requirements for quality factors were determined using a double-tuned circuit to represent the preselection function. A minimum unloaded Q of 344 of the varactor and microstrip line at the lowest frequency and a cutoff frequency of 155 gigahertz is necessary. Since the lines are not lossless, the unloaded Q and the cutoff frequency of the varactor must be even higher. And based on presently available varactors and microstrip circuits, a circuit Q of 63.5 at 473 Mhz is attainable.

Presented at NEC, Chicago, Dec. 8-10.

Microwave IC's move up

Microwave integrated circuits (fabrication, design, performance, and applications)

Gordon R. Harrison and Kurt Gsteiger
Sperry Microwave Electronics Division
Clearwater, Fla.

At first glance, integrated-circuit technology didn't impress microwave equipment makers. All they envisioned were low volumes and high costs. But the recent success of IC's in cutting costs of lower-frequency circuits has occasioned another look, resulting in the building of many microwave devices as IC's. In some cases development costs were higher than they would have been had the devices been made in an old fashioned way; but

Test Power Transistors



FAST · ACCURATE · AUTOMATIC

The Lorlin Automatic Transistor Tester Model TB is programmable over a range of 0.1 nanoamps to 10 amps and 10 mV to 600 V. All types of transistors from small signal to high power can be tested for breakdown voltages, leakage, gain and saturation voltages with 1% accuracy.

A complete test sequence can be programmed by the operator in minutes. Since a standard test takes just 16 milliseconds, high daily thruput is possible.

Models are available with up to 24 test positions and 18 sorting classifications. Remote test stations with the same range and accuracy are available to permit several operators to share one tester. All Lorlin testers will interface with automatic probing, handling and classifying equipment.

Lorlin testers are designed for maximum reliability, ease of service, convenience of programming, and simplicity of operation. Their speed, accuracy and reasonable price provide users a substantial return on their capital investment. Write or call for more information and a demonstration in your plant.

 **LORLIN**
industries inc.

Precision Road, Danbury, Connecticut 06810
Tel: 203-744-0096

For Literature circle 510
For Demonstration circle 511



DYNAMIC CIRCUIT BREADBOARD

Take the mess out of breadboarding with the ELite 1

This unique instrument takes all of the scavenging and soldering out of design, yet will accommodate any combination of IC's and Discrete Components

BUILT-IN FEATURES ARE:

- Precision pulse generator
- Variable frequency, ampl. and width
- Variable lower supply
- Neon lamp display with drivers
- No special tools, plugs or patch cords are required
- Size is only 4½" high, 15" wide, 11" deep

WITH THESE ADVANTAGES:

- Total breadboarding without soldering
- Complete bread inter-connection with solid #22 wire
- Convenient desk-top operation

Use the ELite 1 for all designing, testing and burn-in thereby reducing your breadboarding to inserting components, inter-connected with #22 wire and monitoring circuit responses via the built-in neon display

Write or phone for complete specifications and catalog



EL Instruments Incorporated
61 First Street, Derby, Conn. 06418 • Phone 203/735-8774

Circle 201 on reader service card

Looking for a memory system with low cost per bit, but fast cycle time/access time, and high reliability in one compact package?

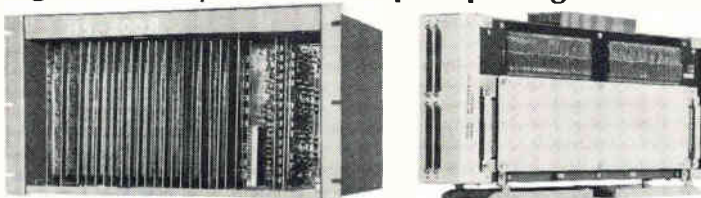

Look no further. TOKO's new, improved Woven-Plated Wire Memory System HS-500R is now available.

TOKO's HS-500 memory system has won praise and popularity for its low-cost, high-performance characteristics. Now ready to be marketed is improved Model HS-500R with the following features:

Compact size: 10"(H) x 19"(W) x 13-1/3"(D)

Access time: 250ns

Memory capacity: 8K bytes—32K bytes (4096 words—16384 words)

Flexible operation: Linear selection organization for multi-word operation; 8 bytes are simultaneously written and read in one word; required bits or bytes are then selected at the interface; thus a variety of memory capacities is made possible.

Low cost Model HS-500R also shares with its predecessor such outstanding features as fast cycle time of 500ns; wide operating temperature range without any current compensation: 0°C to 50°C; and low power dissipation of 100W.

TOKO can also undertake the manufacture of custom-made systems according to your specifications. Complete technical details from our New York office.



TOKO, INC.

Head Office: 1-17, 2-chome Higashi-Yukigaya, Ohta-ku, Tokyo, Japan
TOKO N.Y., INC. 350 Fifth Avenue, New York, New York 10001

the long-range savings in production costs, not to mention savings in weight and size, should far outweigh the initial outlay.

These new products, such as circulators, oscillators, and mixers, signal the emergence of a definite microwave-IC technology. Most new microwave IC's are built with the microstrip approach, in which a high-dielectric-constant material is the substrate with conductors put on one side and a ground plane on the other. This technique permits low-cost fabrication methods. Now an engineer can photoetch a complete r-f circuit quickly onto a ½-inch substrate. For example, making a receiver or transmitter requires only one or two etchings.

Fabrication of a microwave IC begins by picking the right substrate. Fused silica, beryllium oxide, microwave ferrite, silicon and microwave garnet all are popular.

After lapping the substrate to a smoothness of within 5 to 10 microns, the IC maker puts a metalization layer onto the substrate. He vacuum deposits 0.02 to 0.04 micron of chrome, followed by 0.25 micron of gold. The last layer is 5 microns of electrodeposited gold. After completing the metalization layer, the maker puts down a coat of photoresist and begins etching his circuit, keeping conductor thickness equal to four or five times the skin depth.

The devices commonly made as ferrimagnetic IC's are circulators, phase shifters, and filters. A typical ferrimagnetic circulator has a 0.5 decibel insertion loss and 20-db isolation over 10% bandwidths from L through Ku band.

Semiconductor - substrate IC's made now are signal generators, mixers, converters, switching circuits and detectors.

The IC-maker's goal is to build families of circuits in order to put together microwave assemblies, such as radar test sets, with just a few chips. When they are successful the biggest impacts will be felt in doppler navigation systems, space communications, man-pack radars, and expendable reconnaissance equipment.

Presented at NEC, Chicago, Dec. 8-10.

Technology Consultants, Inc. has the **TALENT** for helping your company profit!

Profitable growth to a position of industry leadership is often the result of ideas developed to maximum usefulness. But finding the skilled resources or time to move ideas into the money market could be a problem. TCI can help.

TCI provides a team of electronic specialists from a vast talent pool to extend your technical capability. They can help you solve critical technical problems when in-house resources may be limited. Or, guide your existing capabilities into new directions for growth. They assume overall job responsibility. And they relieve the financial burden of carrying a full-time technical staff on your payroll.

A TCI team of experts... with appropriate analytical and technical talent... and with direct support of all Electronics/Management Center resources is ready to help you by participating in:

- Systems design & analysis
- Search for new products
- Research & development
- Technical proposals
- Seminars for up-dating technical staffs
- Product feasibility studies
- Literature searches

supplying the electronics industry with extended capability for research, technical assistance, product development, and growth.

Ask for our brochure or call direct and arrange for a preliminary meeting now.



Technology Consultants, Inc.

An Exclusive Technical Affiliate of

E/MC

Electronics/Management Center
330 West 42nd Street
New York, N.Y. 10036
(212) 971-3485

The newest, fastest and easiest way to specify indicator lights, push button switches and readouts.

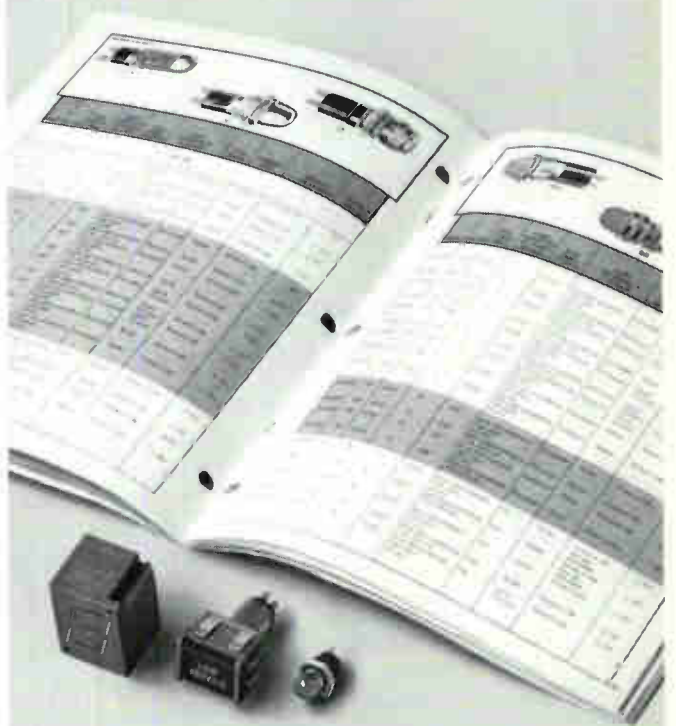

Dialco's new 56-page product selector guide helps you select from over 1,500,000 visual indicators

This book is the result of an all-out effort to provide you with fingertip data on all Dialight components and to make it very easy for you to locate the detailed specs and information you desire. Designers and engineers will find the "Product Selector Guide" invaluable in their work. Send for your copy today. Dialight Corp. 60 Stewart Ave., Brooklyn, N.Y. 11237.

DIALCO

DIALIGHT

A North American Phillips Company

New Literature

Passive repeaters. Microwave Systems Co., 15860 W. 5th Ave., Golden, Colo. 80401, has issued catalog SM-300, an illustrated engineering manual on passive repeater systems. Circle 446 on reader service card.

Dumet wire. General Electric Co., 21800 Tungsten Rd., Cleveland 44117. An eight-page folder on the care and handling of Dumet wire describes Dumet, which is a glass sealing wire used in radio tubes, semiconductors, and other hermetically sealed products. [447]

DIP sockets. Barnes Corp., Lansdowne, Pa. 19050. Technical bulletin 539 covers the 121-2002 series of production mounting sockets for dual-in-line IC devices. [448]

Electronic thermostat. Kimco Laboratories Inc., 5721-23 18th Ave., Brooklyn, N.Y. 11204, has published a four-color brochure describing its portable, wireless electronic thermostat. [449]

Magnetic pickup. Electro Products Laboratories Inc., 6125 W. Howard St., Chicago 60648. Bulletin DM-769 contains complete specifications, performance graphs, and suggested applications for Di-Mag, a digital pulse output magnetic sensor. [450]

Memory system applications. Ferro-cube Corp., Saugerties, N.Y. 12477. A 28-page booklet, "How to Use Digital Magnetic Core Memories" explains in detail memory system applications including interface. [451]

Data transmission system. Lenkurt Electric Co., 1105 County Rd., San Carlos, Calif. 94070. A 12-page brochure describes the 25B data transmission system, which provides speeds from 75 to 600 bits per sec on a standard voice-grade telephone circuit. [452]

Analog recorders. Beckman Instruments Inc., 3900 River Rd., Schiller Park, Ill. 60176. Types R and RC Dynograph analog recorders are featured in bulletin 660A. [453]

Data monitor. Theta Instrument Corp., Fairfield, N.J. 07006. Technical bulletin 67-12A describes the model DM-1 data monitor for readout/printout/computer interfacing. [454]

Resistor network. CTS of Berne Inc., Berne, Ind. 46711. Data sheet 3760B pictures and describes the series 760 cermet resistor network which increases packaging flexibility with a 16-lead dual-in-line package. [455]

Test system. TeleSciences Inc., 351 New Albany Rd., Moorestown, N.J. 08057. A 12-page, four-color brochure

NO ONE CAN COMPLETELY DESTROY A JOSELYN PROTECTOR AND YOUR ELECTRONICS WILL STILL WORK

For over 20 years, Joselyn has never had a surge protector fail to perform its surge protection function. It has been tested repeatedly with simulated lightning current strikes, over-illumination, and other conditions that would normally blow up and blow apart . . . but the electronics continued to work.

Call today for full information and delivery of our proven surge protection equipment. We can solve your particular problem. Full line information available on request.



ELECTRONICS
Barbara Research
Box 817
California 92011
(619) 968-3501

explains Omnitester, an automatic high speed test system for low-cost production checkout and maintenance of electronic equipment. [456]

Heat sinks. Astrodyne Inc., 207 Cambridge St., Burlington, Mass. 01803, has released a catalog describing Hockey-Puck heat sinks for use with high-power, compression-mounted rectifiers. [457]

Portable strip printer. Dataline Inc., 181 S. Boro Line Rd., King of Prussia, Pa. 19406. Technical bulletin 100 deals with the model 5064 portable strip printer, a digital impact unit that provides hard copy readout when incorporated with a receiver into a data communications system. [458]

Digital data system. Howell Instruments Inc., 3479 W. Vickery Blvd., Fort Worth, Texas 76107, has available a 24-page brochure on the H4200 digital data system, which monitors and measures temperature, pressure, load, thrust, voltage and resistance directly in engineering units. [459]

Rfi filters. San Fernando Electric Mfg. Co., 1501 First St., San Fernando, Calif. 91341. Specifications of rfi filters designed to attenuate fluorescent lamp-generated noise in computer centers, instrumented test and research laboratories, clean rooms and other installations are highlighted in a data sheet. [460]

Broadband products. Narda Microwave Corp., Plainview, N.Y. 11803. The 1970, 152-page catalog No. 17 features new state-of-the-art broadband products, and contains a complete technical reference data section. [461]

Electrolytic transducer. Hamlin Inc., Lake & Grove Sts., Lake Mills, Wis. 53551. Data sheet B-8002 describes the EP-10-750 gravity sensing electrolytic transducer. [462]

Zero-voltage switch. RCA Electronic Components, Harrison, N.J. 07029. Application of the CA3059 zero-voltage switch in thyristor circuits is the subject of 12-page application note ICAN-4158. [463]

Sine-cosine converter. Transmagnetics Inc., 134-25 Northern Blvd., Flushing, N.Y. 11354, has issued a single-sheet catalog bulletin on the series 655 three-wire synchro to d-c sine-cosine converter. [464]

Power supplies. GPS Instrument Co., 14 Burr St., Framingham, Mass. 01701. A two-page brochure describes four new dual-tracking, low profile, miniaturized power supplies that are priced as low as \$38. [465]

Filters. Barnes Engineering Co., 30 Commerce Rd., Stamford, Conn. 06904, has available bulletin 100 describing standard lines of visible and near infrared filters. [466]

Does
H_(BEEP)P_(BEEP)
really lose
sleep
over us?

They would
if they knew
about the
1028.



Our new 1028 is the world's lowest priced frequency synthesizer. For \$1990, it does virtually everything their \$8000 model does. Frequency and amplitude are fully programmable. Sine wave and square wave output may be used simultaneously. Five digit frequency resolution

is constant over the 1 Hz to 12.9 MHz range. The price is guaranteed to give you know-who insomnia. For specs on the 1028 Frequency Synthesizer, write Pacific Measurements Inc., 940 Industrial Avenue, Palo Alto, California 94303. We gotta be better.



PACIFIC
MEASUREMENTS

EIMAC's new family of outstanding power tetrodes offers 13 impressive features:-



- (1) High linearity. 3d order products —40 dB or better.
- (2) Low input capacitance. Typically, 45 pF.
- (3) Over 600 watts measured output at 865 MHz.
- (4) Very high gain-bandwidth product. Over 125 MHz
- (5) Low grid interception in linear amplifier service.
- (6) Low drive. Typically 40 volts for class AB-1 service. Easily driven at 150 MHz with 5 watt solid state device.
- (7) Plate dissipation up to 800 watts. Both air and liquid cooling available.
- (8) Coaxial base adapter available.
- (9) Shock-resistant design for rugged service.
- (10) 20 kW pulse output at 430 MHz.
- (11) Very low cathode lead inductance.
- (12) 5-pin base adapted for heat-sink cooling.
- (13) High grid and screen dissipation ratings.

The unique 4CX600 family is an exciting result of EIMAC's CAD (computer-aided-design) program for ceramic/metal tetrodes. Closely controlled parameters permit intermodulation distortion limits to be included as a defining tube characteristic, establishing new criteria of performance.

EIMAC's advanced segmented cathode and electron focussing combine with an unusually high figure of merit in this family, providing you with tubes useful in widely diversified services: linear amplification, high reliability aircraft-to-ground communication, wideband

distributed amplifier service in airborne ECM gear, and r-f pulse application.

Another example of EIMAC's ability to provide tomorrow's tube today! Here are the numbers to prove it:

| TUBE TYPE | FIL. VOLTS | RATED TO: (MHz) | BASE | COOLING | MAX. RATINGS | | TYPICAL POWER OUTPUT (150 MHz) | USEFUL FOR: |
|--------------|------------|-----------------|-------------|---------|--------------|---------------|--------------------------------|----------------------------|
| | | | | | Plate Volts | Plate Amperes | | |
| 4CX600B | 6.0 | 890 | 5-PIN SPEC. | Air | 3000 | 0.6 | 750W | WIDEBAND AMPLIFIER SERVICE |
| 4CX600F | 26.5 | | | | | | | |
| 4CW800B | 6.0 | 890 | 5-PIN SPEC. | Liquid | 3000 | 0.6 | 750W | WIDEBAND AMPLIFIER SERVICE |
| 4CW800F | 26.5 | | | | | | | |
| 4CX600J 8809 | 6.0 | 150 | OCTAL SPEC. | Air | 3000 | 0.6 | 750W | CLASS AB-1 LINEAR SERVICE |

More? Our Application Engineering Department's ability to design tube into circuit means less engineering time for you. For all-around capability, talk to EIMAC. For circuit and application information on these new power tetrodes, write to EIMAC for our new, free application bulletin #14, *Using the 4CX600 Family Tetrodes*. Or contact your nearest Varian/Eimac Electron Tube and Device Group Office. They are located in:

| | | |
|--------------------|------------------------|----------------------|
| Albuquerque, N. M. | Dayton, Ohio | Santa Monica, Calif. |
| Alexandria, Va. | Los Altos, Calif. | Scottsdale, Ariz. |
| Atlanta, Ga. | Melville, L. I., N. Y. | Springfield, N. J. |
| Cherry Hill, N. J. | Park Ridge, Ill. | Syracuse, N. Y. |
| Clearwater, Fla. | Richardson, Texas | Waltham, Mass |

International Sales Offices are located in:

| | |
|-----------|--------------------|
| Australia | Italy |
| Benelux | Japan |
| Brazil | Scandinavia |
| Canada | Switzerland |
| France | United Kingdom and |
| Germany | Ireland |



Electronics advertisers

January 19, 1970

| | | | | | |
|---|---------------|--|----------------|--|----------|
| Advanced Memory Systems Fleig and LeBoeuf Adv., Inc. | 56 | General Radio Co. | 2nd Cover, 125 | □ Rohde & Schwarz | 19E |
| Alco Electronics Products, Inc. | 48, 175, 177 | Horton, Church and Goff, Inc. | | San-E Denki Co., Ltd. | 146 |
| Marketronics Advertising | | Gould, Inc., Gaging & Control Div. | 159 | Sanko Sha Adv. Agcy. Co., Ltd. | 3E |
| Allen-Bradley Co. | 27 | Carr Liggett Adv., Inc. | 60, 61 | □ Sfernice | |
| Hoffman-York, Inc. | | Gould, Inc./Graphics | | Publisher | |
| Allied Van Lines, Inc. | 157 | Carr Liggett Adv., Inc. | | Signetics Corp., | |
| Young & Rubicam, Inc. | | Gries Reproducer Co. | 177 | Sub. Corning Glass Works | 123 |
| □ Ancrona Corp. | 14E | Harold Marshall Advertising | | Cunningham & Walsh, Inc. | |
| Wilhelm Bacher Werbung | | Hamilton Watch Co. | 170 | Singer Co., The, | |
| □ AMP Europe | 5E, 6E | Beaumont, Heller & Sperling, Inc. | | Instrumentation Div. | 173 |
| Allardyce Palmer Ltd. | | ■ Hewlett Packard, H.P. Associates | 188 | Technical, Industrial and | |
| Andrew Corp. | 62 | Lennen & Newell, Inc. | | Scientific Marketing, Inc. | |
| Fensholt Adv., Inc. | | ■ Hewlett Packard, Colorado Springs Div. | 1 | □ Souriau & Cie | 10E |
| □ A O I P | 4E | Tallant/Yates Adv., Inc. | | Ariane Publicite | |
| Dumesnil Publicite | | ■ Hewlett Packard, San Diego Div. | 164, 174 | □ S.P. Elettronica | 11E |
| Applied Digital Data Systems, Inc. | 58, 59 | Lennen & Newell, Inc. | | Studio Sergio Rosata | |
| Shaw Elliott, Inc. | | ■ Hewlett Packard, Santa Clara Div. | 2 | Sprague Electric Co., The | 7 |
| Astrodata, Inc. | 55 | Lennen & Newell, Inc. | | Harry P. Bridge Co. | |
| Jensen Assoc., Inc. | | ■ Howard Industries, Inc. | 147 | Standard Condenser Corp. (Rtron Corp.) | 42 |
| ■ Augat, Inc. | 153 | K & A, Inc. Adv. | | R. N. Johnson Advertising | |
| Horton Church & Goff, Inc. | | ■ Hughes Aircraft Co. | 142 | ■ Sylvania Electric Products, Inc., | |
| ■ Barnstead Co., | | Footo, Cone & Belding | | Parts Div. | 73 |
| Div. of Sybron Corp. | 160 | ■ International Crystal Mfg. Co. | 162 | Doyle Dane Bernbach, Inc. | |
| Creamer, Trowbridge, Case & | | Robert V. Freeland & Associates | | Synthane-Taylor Corp. | 18, 19 |
| Basford, Inc. | | ITT Semiconductor Div. | 124 | Gray & Rogers, Inc. | |
| Bausch & Lomb, Inc. | 171 | Neals & Hickok, Inc. | | ■ Tech Laboratories, Inc. | 178 |
| Wolff Assoc., Inc. | | Joslyn, Inc. | 182 | Lewis Adv. Agcy. | |
| ■ Beckman Instruments, Inc., | | Chace Co., Adv., Inc. | | ■ Tektronix, Inc. | 130 |
| Helipot Div. | 80 | Lambda Electronics Corp. 3rd Cover, 191, 192 | | Dawson, Inc. | |
| N. W. Ayer/Jorgensen/MacDonald, Inc. | 143 | Michel Cather, Inc. | | Texas Instruments Incorporated, | |
| Brand-Rex | | Litton Ind., Inc., Data Systems | 178 | Components Group | 25, 148 |
| Creamer, Trowbridge, Case & Basford, Inc. | | Lorlin | 179 | Albert Frank-Guenther Law, Inc. | |
| California Computer Products | 167 | Marketing Assistance, Inc. | | ■ Texcan Corp. | 16 |
| Carson/Roberts, Inc. | | □ LTT | 16E, 17E | TI Supply Company | 10, 11 |
| ■ Captor Corp. | 24 | Promotion Vente Publicite | | Albert Frank-Guenther Law, Inc. | |
| Weber, Geiger & Kalat, Inc. | | ■ Mallory and Co., P.R., Mfg. Div. | 140 | Toko, Inc. | 180 |
| ■ Centralab Div. of | | Aitkin-Kynett Co. | 154 | Hakuhodo, Inc. | |
| Globe Union, Inc. | 69, 70 | Markem Corp. | | Triplett Electrical Instrument Co. | 127 |
| The Brady Company | | Creamer Trowbridge Case and | | Byer and Bowman Advertising | |
| ■ Cherry Electrical Products Corp. | 79 | Basford, Inc. | | TRW Electronics, Capacitors Div. | 53 |
| Kolb/Tookey and Assoc., Inc. | | Martin Marietta Corp. | 50 | Fuller & Smith & Ross, Inc. | |
| Cinch Graphik, Div. of | | Redmond Marcus & Shure | | Trygon Electronics, Inc. | 46 |
| United Carr Fastener Co. | 15 | Matthey Bishop, Inc. | 135 | Technical, Industrial & Scientific | |
| Stral Adv. Co., Inc. | | Richardson, Thomas & Bushman, Inc. | | Marketing, Inc. | |
| ■ Cinch Manufacturing Co. | 52 | Micro Instrument Co. | 175 | United Systems Corp. | 76 |
| Stral Adv. Co., Inc. | | Microdot, Inc. | 129 | Advertising & Merchandising, Inc. | |
| Clare & Co., C.P. | 144 | Gumpertz, Bentley and Dolan Adv. | | □ U.S. Trade | 9E |
| Reincke, Meyer & Finn Adv., Inc. | | ■ Micro Switch, Div. of Honeywell | 128 | Ruder & Finn France S.A. | |
| Colorado Video, Inc. | 134 | N. W. Ayer and Son, Inc. | | Varian Associates—Eimac Div. | 184 |
| Wolf & Weir | | 3M-Electro-Products Div. | 35, 36 | Botsford, Constantine and McCarthy, Inc. | |
| Control Data Corp., | | Batten, Barton, Durstine and Osborn, Inc. | 77 | Victoreen Instrument Div. | 156 |
| Printed Circuits Operation | 158 | Monsanto Co. | | Dix and Easton, Inc. | |
| Midwest Adv. Services, Inc. | | Michel Cather, Inc. | | Wang Laboratories | 166 |
| Cornell-Dubilier Electronics | 57 | Motorola Semiconductor | | Impact Adv., Inc. | |
| Daniel & Charles, Inc. | | Products, Inc. | 30, 31, 37 | □ Watkins-Johnson Co. | 7E |
| ■ Cosmicar Optical Co., Ltd. | 176 | Lane & Wampler Adv., Inc. | | William C. Estler Adv. | |
| Matsushita, Inc. | | □ Multicore Solders, Ltd. | 15E | Watkins-Johnson Co., (CEI) | 152 |
| Coto Coll Co., Inc. | 175 | Jefferies Harper & Partners, Ltd. | | William C. Estler Adv. | |
| The Williams Co. | | ■ National Electronics, Inc., | | Wavetek | 169 |
| Damon Corp. | 47 | Subsidiary Varian Associates | 26 | Chapman Michetti Adv. | |
| Ingalls Assoc., Inc. | | Connor-Sager Associates, Inc. | | Westinghouse Semiconductor Div. | 150, 151 |
| Delta Products, Inc. | 176 | National Semiconductor Corp. | 12, 13 | Ketchum, MacLeod and Grove, Inc. | |
| The William Loughran Co. | | Hall Butler Blatherwick, Inc. | | Winchester Electronics, | |
| Dialight Corp. | 181 | Optron, Inc. | 22 | Div. of Litton Industries | 23 |
| Michel Cather, Inc. | | Dean & Bain Adv., Inc. | | Wilson, Haight & Welch, Inc. | |
| DuPont de Nemours & Co., Freon Div. | 54 | Pacific Measurements, Inc. | 183 | Wiremold Company, The | 186 |
| N. W. Ayer & Son, Inc. | | Jack Herrick Adv., Inc. | | Charles Brunelle Co. | |
| ■ Eagle Signal Div. of | | Packer Co., Inc., B.L. | 101 | Xerox Data Systems | 38 |
| Gulf & Western Co. | 75 | Murray Heyert Associates | | Doyle, Dane, Bernbach, Inc. | |
| Feeley & Wheeler Div. of Geyer, | | Pfizer & Company, Chas. MPM Div. | 133 | Zippertubing Co. | 146 |
| Oswald, Inc. | | Newmark, Posner & Mitchell, Inc. | | Edward S. Kellog, Co. | |
| Eastman Kodak Co., | | Philco Ford Co., | | | |
| Business Systems Markets Div. | 163 | Microelectronics Div. | 28, 29 | | |
| J. Walter Thompson Co. | | The Aitkin-Kynett Co., Inc. | | | |
| ■ Elco Corp. | 32 | Philco Ford Corp. | | | |
| Schaefer Adv., Inc. | | Surra Electronics Operation | 187 | | |
| Electro Products Laboratories, Inc., | | Hal Lawrence Inc. | | | |
| Transducer Div. | 78 | Philips Electronics Instruments | 95 | | |
| Grant Wright & Baker, Inc. | | Marsteller, Inc. | | | |
| Electrovert, Inc. | 96 | □ Philips N. V. Pit/Tmi Div. | 2E | | |
| The Stanley Schwartz Co., Inc. | | Marsteller International S.A. | | | |
| EL Instruments, Inc. | 180 | Plastic Capacitors, Inc. | 44 | | |
| Froehlich Advertising Services | | Sander Rodkin Adv. Agcy., Ltd. | | | |
| E/MC Electronics/Management | | Pomona Electronics Co. | 186 | | |
| Center | 172, 174, 181 | Buxton Adv. Agcy. | | | |
| Ries Cappiello Colwell, Inc. | | Power Mate Corp. | 174 | | |
| Erie Technological Products Co., Inc. | 49 | Caroe Marketing, Inc. | | | |
| Walker, Schmidt & Mackall, Inc. | | Quantum Devices Corp. | 138 | | |
| Fairchild-Dumont | 136 | Tek-Mark, Inc. | | | |
| Josephson, Cuffari and Co. | | Radiation, Inc. | 43 | | |
| Farinon Electric | 6 | W. M. Zemp and Associates, Inc. | | | |
| Jack Herrick Adv., Inc. | | Radio Corporation | | | |
| □ Ferisol | 12E | of America | 4th Cover, 45 | | |
| Agence Domenach | | Al Paul Lefton Co. | | | |
| ■ Fluke Manufacturing Co., John | 17 | Radio Materials Co., | | | |
| Bonfield Associates | | P.R. Mallory and Company | 139 | | |
| Forward Metro Denver | 126 | M.M. Fisher Assoc., Inc. | | | |
| Broyles, Allebaugh & Davis, Inc. | | Raytheon Co., Components Div. | 20, 21 | | |
| General Electric Co., (Analytical | | Fuller & Smith & Ross, Inc. | | | |
| Measurement Business School) | 168 | ■ RCL Electronics, Inc. | 14 | | |
| Robert S. Cragin, Inc. | | Morvay Adv. Agcy. | | | |
| General Instrument Corp., | | Redcor Corp. | 51 | | |
| Semiconductor Products Div. | 74 | Management Communication | | | |
| Norman Allen Associates | | Consultants, Inc. | | | |
| □ General Instrument Europe S.P.A. | 8E | ■ Rogan Brothers | 134 | | |
| Studio Cigiemme | | Christopher Advertising, Inc. | | | |
| General Magnetics | 8 | | | | |
| McCarthy/Sciba/DeBiasi Adv. Agcy., Inc. | | | | | |

Classified & Employment Advertising

F.J. Eberle, Manager
212-971-2557

EGUIPMENT (Used or Surplus New) For Sale

Radio Research Instrument Co. 177
RAI Research Corp. 177

■ For more information on complete product line see advertisement in the latest Electronics Buyer's Guide

□ Advertisers in Electronics International

Electronics Buyers' Guide

George F. Werner, Associate Publisher
[212] 971-2310
Robert M. Denmead,
Midwest Regional Manager
[312] MO 4-5800
Cliff Montgomery,
New York District Manager
[212] 971-3793
Regina Hera, Directory Manager
[212] 971-2544
Thomas M. Egan, Production Manager
[212] 971-3140
Carol Gallagher,
Assistant Production Manager [212] 971-2045
Circulation Department
Isaaca Siegel, Manager [212] 971-6057
Research Department
David Strassler, Manager [212] 971-6058

STATE-OF-THE-ART in electrical convenience

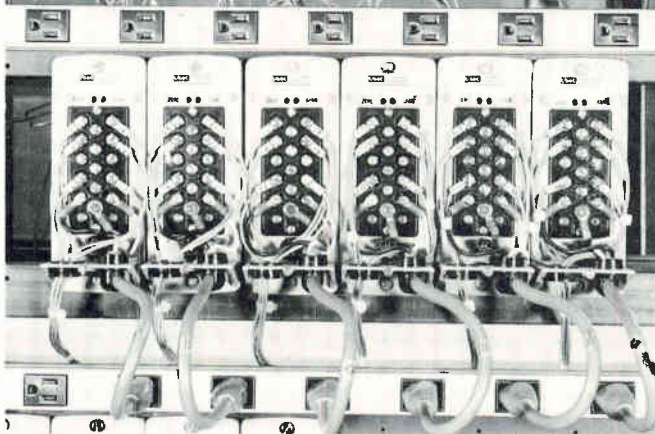

Look at the outlets! Here's proven, simplified power wiring for complex instrumentation behind or inside cabinets, panels, consoles. Easy-to-mount Plugmold 2000 Multioutlet Systems — the last word in compact, plug-in convenience.

Wiremold® and Plugmold® systems help put "tomorrow" in today's wiring for makers, users, and testers of electronic equipment. Write for helpful, problem-solving literature.



THE WIREMOLD COMPANY / HARTFORD, CONNECTICUT 06110

Circle 203 on reader service card

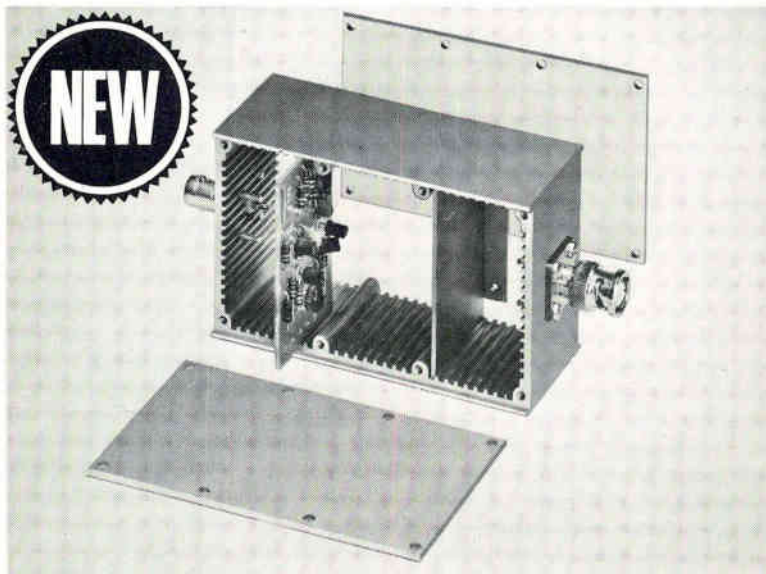

SHIELDED BOXES with CARD GUIDES

Rugged die-cast aluminum boxes, slotted to accept $\frac{1}{8}$ " circuit boards and shielding dividers. Excellent for packaging electronic circuitry. Boxes have removable top and bottom covers. Useable inside space: 4"x2"x1 $\frac{1}{2}$ ". Several models with various connectors.

Write for 1969 Catalog



POMONA ELECTRONICS CO., INC.
1500 E. Ninth Street, Pomona, California 91766

Advertising Sales Staff

Dan McMillan III [212] 971-3468
Associate Publisher

Wallis Clarke [212] 971-2187
Advertising Sales Service Manager

Tomlinson Howland [212] 971-6792
Promotion Manager

Warren H. Gardner [215] 971-3139
Eastern Advertising Sales Manager

Atlanta, Ga. 30309: **Michael H. Miller**, 1375
Peachtree St., N.E.
[404] 892-2868

Boston, Mass. 02116: **William S. Hodgkinson**
McGraw-Hill Building, Copley Square
[617] CO 2-1160

Cleveland, Ohio 44113: **William J. Boyle**, 55
Public Square, [216] SU 1-7000

New York, N.Y. 10036

500 Fifth Avenue

James R. Pierce [212] 971-3615

John A. Garland [212] 971-3617

Michael J. Stoller [212] 971-3616

Philadelphia, Pa. 19103:

Jeffrey M. Preston

6 Penn Center Plaza,

[215] LO 8-6161

Pittsburgh, Pa. 15222: **Jeffrey M. Preston**,

4 Gateway Center, [412] 391-1314

Rochester, N.Y. 14534: **William J. Boyle**,

9 Greylock Ridge, Pittsford, N.Y.

[716] 586-5040

Donald R. Furth [312] MO 4-5800

Midwest Advertising Sales Manager

Chicago, Ill. 60611: **Kenneth E. Nicklas**

Ralph Hanning 645 North Michigan Avenue,

[312] MO 4-5800

Dallas, Texas 75201: **Richard P. Poole**, 1800

Republic National Bank Tower,

[214] RI 7-9721

Houston, Texas 77002: **Robert Wallin**,

2270 Humble Bldg. [713] CA 4-8381

Detroit, Michigan 48226: **Ralph Hanning**,

856 Penobscot Building

[313] 962-1793

Minneapolis, Minn. 55402: 1104 Northstar

Center [612] 332-7425

St. Louis, Mo. 63105: **Kenneth E. Nicklas**,

The Clayton Tower, 7751 Carondelet Ave.

[314] PA 5-7285

James T. Hauptli [415] DO 2-4600

Western Advertising Sales Manager

Denver, Colo. 80202: **David M. Watson**,

Richard W. Carpenter

Tower Bldg., 1700 Broadway

[303] 266-3863

Los Angeles, Calif. 90017: **Ian C. Hill**,

Bradley K. Jones, 1125 W. 6th St.,

[213] HU 2-5450

Portland, Ore. 97204: **James T. Hauptli**,

Don Farris, 218 Mohawk Building,

222 S.W. Morrison Street,

Phone [503] 223-5118

San Francisco, Calif. 94111: **James T. Hauptli**,

Don Farris, 255 California Street,

[415] DO 2-4600

Pierre Braude Tel: 727 73 01: **Paris**

International Director

Paris: **Denis Jacob**

17 Rue-Jeorges Bizet, 75 Paris 16, France

Tel 727 33 42, 727 33 60

United Kingdom and Scandinavia

London: **Oliver Ball**, Tel: Hyde Park 1451

34 Dover Street, London W1

Milan: **Robert Saidel**, **Roberto Laureri Jr.**

1 via Baracchini Phone 86-90-656

Brussels: **Denis Jacob**

27 Rue Ducale Tel: 136503

Frankfurt/Main: **Hans Haller**

Elsa-Brandstroem Str. 2

Phone 72 01 81

Geneva: **Denis Jacob**

1 rue du Temple Phone: 31 95 60

Tokyo: McGraw-Hill

Publications Overseas Corporation,

Kasumigaseki Building 2-5, 3-chome,

Kasumigaseki, Chiyoda-Ku, Tokyo, Japan

[581] 9811

Osaka: **Akihiko Kamesaka**, McGraw-Hill

Publications Overseas Corporation, Kondo

Bldg., 1-63, Umegae-cho Kita-ku [362] 8771

Australasia: **Warren E. Ball**, IPO Box 5106,

Tokyo, Japan

Business Department

Stephen R. Weiss, Manager

[212] 971-2044

Thomas M. Egan,

Production Manager [212] 971-3140

Maury D'Gongora,

Assistant Production Manager [212] 971-2045

Dorothy Carmasin, Contracts and Billings

[212] 971-2908

Frances Vallone, Reader Service Manager

[212] 971-2865

Introducing: A better way to measure load-handling capacity of multichannel systems

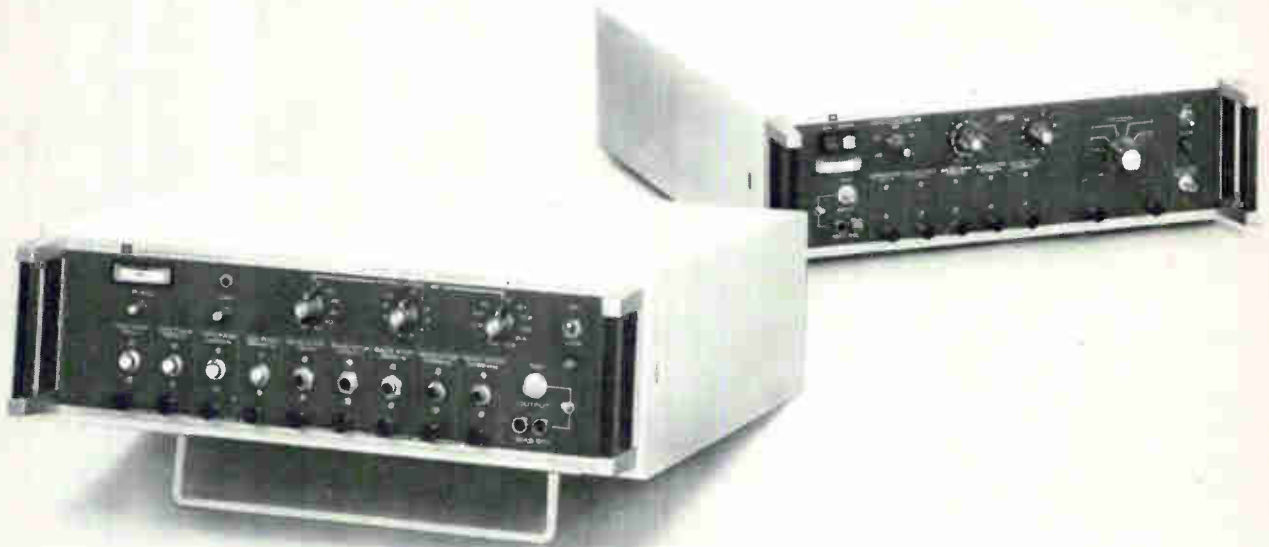

Today is the day of data. The world is going digital. And the ultimate test of a sophisticated system is its ability to bear the heavier loads imposed by digital data.

That's where our Model 330A can help you. You'll be able to pinpoint the critical load point of multichannel microwave systems by measuring intermodulation noise performance along selected transmission paths. Armed with data uncovered by our 330A, you can tell what the optimum capabilities of your system are, and avoid degrading its performance.

The White Noise Generator half of our test set (Model 330A-G) generates noise over a frequency range of 12 kHz to 13 MHz. Front panel plug-in receptacles accept up to four band-limiting and five band-stop filters, each with a push button control. You can rapidly press filters of different bandwidths into and out of service for quick serial testing of two or more noise slots. Regulation of power in true rms keeps output constant with any combination of band-stop filters in the network, automatically compensating for different band-stop frequencies. You no longer need to adjust the level each time you switch in different filters.

The White Noise Receiver half of our test set (Model 330A-R) accepts up to five narrow bandpass filters, each controlled by a Frequency Selector switch. Simply by setting the switch to the appropriate bandpass filter, you tune the receiver to the desired band-stop frequency. The frequency selection circuit contains five crystal-controlled local oscillators, each matched in frequency to its respective narrow-bandpass filter to assure drift-free performance. Input attenuators are scaled for direct reading in Noise Power Ratio (NPR) from 0 to 80 dB.

Performance range of the Model 330A system covers baseband frequencies of standard multiplex systems with capacities from 12 to 2700 channels. Sets can be packaged for rack mounting or in ruggedized carrying cases.

There are many more advantages. Full details are in Product File 569. For yours, write Product Sales Manager at Philco-Ford Corporation, Sierra Electronic Operation, 3885 Bohannon Drive, Menlo Park, California 94025. Or phone (415) 322-7222, ext. 231.

PHILCO 

The Better Idea People in Telecommunications Measurement

Circle 187 on reader service card

You get many extras when you buy a Hewlett-Packard solid state display

HP builds in the decoder driver so you don't have to add it yourself. It's an IC-compatible, long-life compact display that can stand up to tough environments. It gives you sharp, parallax-free readings even from extreme angles. And saves you space and time and money.

HEWLETT  PACKARD
SOLID STATE DEVICES

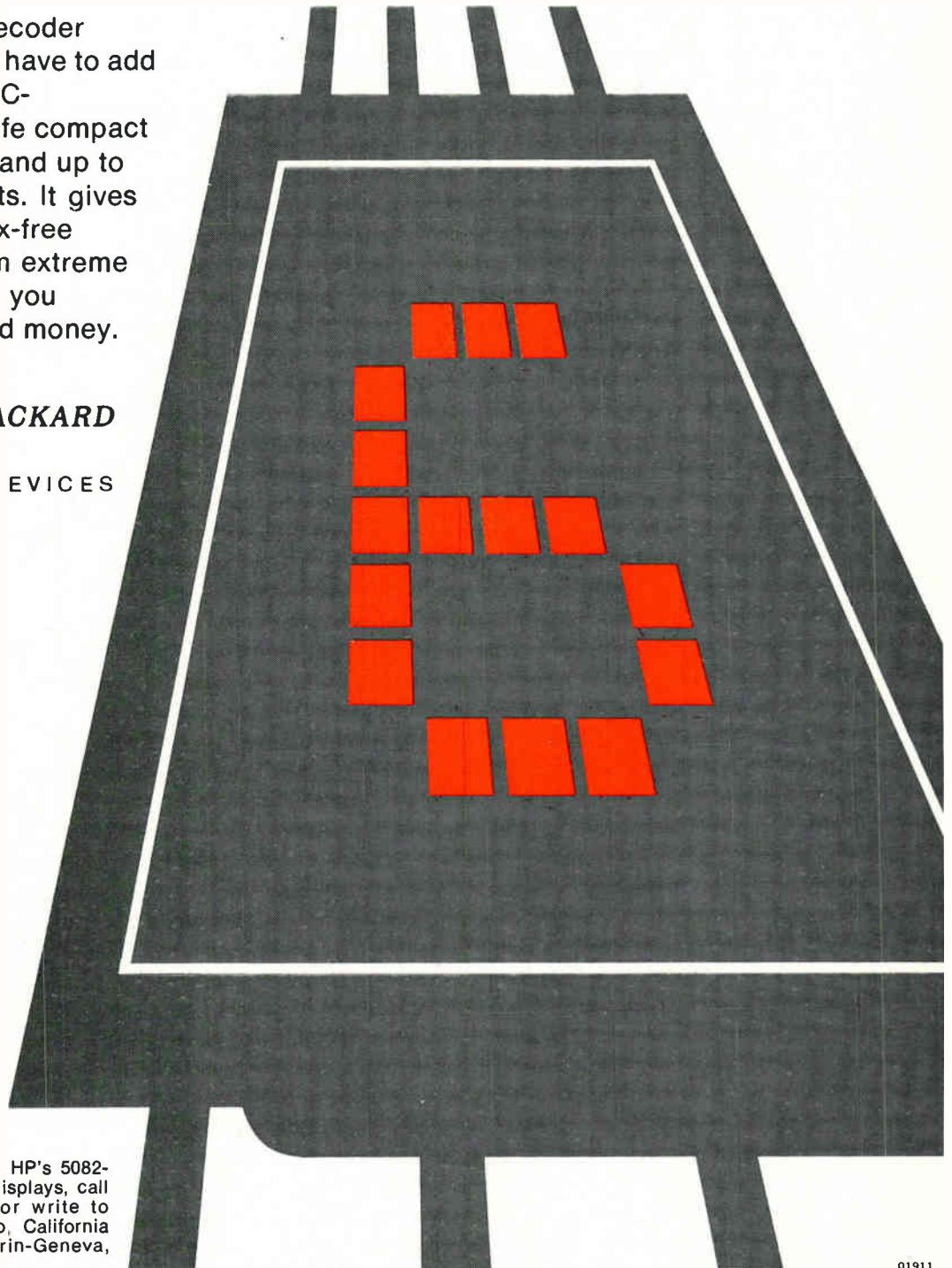

For the glowing details on HP's 5082-7000 solid state numeric displays, call your HP field engineer or write to Hewlett-Packard, Palo Alto, California 94304; Europe: 1217 Meyrin-Geneva, Switzerland.

01911

Electronics reader service

Use these handy post cards for more detailed information on: products advertised, new products, new literature.

Circle the number on the Reader Service post card that corresponds to the number at the bottom of the advertisement, new product item, or new literature in which you are interested.

Please print clearly. All written information must be legible to be efficiently processed.

If someone has beaten you to the post cards, you may obtain the needed information by writing directly to the manufacturer, or by sending your name and address, plus the Reader Service number, to Electronics Reader Service department.

All inquiries from outside the U.S. that cannot reach Electronics before the expiration dates noted on the Reader Service post card, must be mailed directly to the manufacturer. The manufacturer assumes all responsibilities for responding to inquiries. Electronics merely provides and clears requests for information from inquirer to manufacturer.

Correct amount of postage must be affixed for all mailings from outside the U.S.

To subscribe to or to renew Electronics

Fill in the "For Subscriptions" area on the card if you desire to subscribe to or renew your present subscription to Electronics. Send no money. Electronics will bill you at the address indicated on the Reader Service post card.

Multi-product advertisements

For information on specific items in multi-product advertisements which do not have a specific Reader Service number indicated write directly to manufacturer for information on precise product in which you are interested.

Warning: The Post Office now requires your ZIP CODE on all mail. Please include your ZIP CODE number when filling out your reply card.

2 *For employment inquiries fill in home address. January 19, 1970 Card Expires March 19, 1970 14

Name _____ title _____

Company* _____

Address _____

City _____ State _____ Zip Code _____

| | | | | | | | | | | | | | | | | | | | | | | | | | | | | |
|----|----|----|----|----|-----|-----|-----|-----|-----|-----|-----|-----|-----|-----|-----|-----|-----|-----|-----|-----|-----|-----|-----|-----|-----|-----|-----|-----|
| 1 | 20 | 39 | 58 | 77 | 96 | 115 | 134 | 153 | 172 | 191 | 210 | 229 | 248 | 267 | 286 | 305 | 324 | 343 | 362 | 381 | 400 | 419 | 438 | 457 | 476 | 495 | 514 | 962 |
| 2 | 21 | 40 | 59 | 78 | 97 | 116 | 135 | 154 | 173 | 192 | 211 | 230 | 249 | 268 | 287 | 306 | 325 | 344 | 363 | 382 | 401 | 420 | 439 | 458 | 477 | 496 | 515 | 963 |
| 3 | 22 | 41 | 60 | 79 | 98 | 117 | 136 | 155 | 174 | 193 | 212 | 231 | 250 | 269 | 288 | 307 | 326 | 345 | 364 | 383 | 402 | 421 | 440 | 459 | 478 | 497 | 516 | 964 |
| 4 | 23 | 42 | 61 | 80 | 99 | 118 | 137 | 156 | 175 | 194 | 213 | 232 | 251 | 270 | 289 | 308 | 327 | 346 | 365 | 384 | 403 | 422 | 441 | 460 | 479 | 498 | 517 | 965 |
| 5 | 24 | 43 | 62 | 81 | 100 | 119 | 138 | 157 | 176 | 195 | 214 | 233 | 252 | 271 | 290 | 309 | 328 | 347 | 366 | 385 | 404 | 423 | 442 | 461 | 480 | 499 | 518 | 966 |
| 6 | 25 | 44 | 63 | 82 | 101 | 120 | 139 | 158 | 177 | 196 | 215 | 234 | 253 | 272 | 291 | 310 | 329 | 348 | 367 | 386 | 405 | 424 | 443 | 462 | 481 | 500 | 900 | 967 |
| 7 | 26 | 45 | 64 | 83 | 102 | 121 | 140 | 159 | 178 | 197 | 216 | 235 | 254 | 273 | 292 | 311 | 330 | 349 | 368 | 387 | 406 | 425 | 444 | 463 | 482 | 501 | 901 | 968 |
| 8 | 27 | 46 | 65 | 84 | 103 | 122 | 141 | 160 | 179 | 198 | 217 | 236 | 255 | 274 | 293 | 312 | 331 | 350 | 369 | 388 | 407 | 426 | 445 | 464 | 483 | 502 | 902 | 969 |
| 9 | 28 | 47 | 66 | 85 | 104 | 123 | 142 | 161 | 180 | 199 | 218 | 237 | 256 | 275 | 294 | 313 | 332 | 351 | 370 | 389 | 408 | 427 | 446 | 465 | 484 | 503 | 951 | 970 |
| 10 | 29 | 48 | 67 | 86 | 105 | 124 | 143 | 162 | 181 | 200 | 219 | 238 | 257 | 276 | 295 | 314 | 333 | 352 | 371 | 390 | 409 | 428 | 447 | 466 | 485 | 504 | 952 | 971 |
| 11 | 30 | 49 | 68 | 87 | 106 | 125 | 144 | 163 | 182 | 201 | 220 | 239 | 258 | 277 | 296 | 315 | 334 | 353 | 372 | 391 | 410 | 429 | 448 | 467 | 486 | 505 | 953 | 972 |
| 12 | 31 | 50 | 69 | 88 | 107 | 126 | 145 | 164 | 183 | 202 | 221 | 240 | 259 | 278 | 297 | 316 | 335 | 354 | 373 | 392 | 411 | 430 | 449 | 468 | 487 | 506 | 954 | 973 |
| 13 | 32 | 51 | 70 | 89 | 108 | 127 | 146 | 165 | 184 | 203 | 222 | 241 | 260 | 279 | 298 | 317 | 336 | 355 | 374 | 393 | 412 | 431 | 450 | 469 | 488 | 507 | 955 | 974 |
| 14 | 33 | 52 | 71 | 90 | 109 | 128 | 147 | 166 | 185 | 204 | 223 | 242 | 261 | 280 | 299 | 318 | 337 | 356 | 375 | 394 | 413 | 432 | 451 | 470 | 489 | 508 | 956 | 975 |
| 15 | 34 | 53 | 72 | 91 | 110 | 129 | 148 | 167 | 186 | 205 | 224 | 243 | 262 | 281 | 300 | 319 | 338 | 357 | 376 | 395 | 414 | 433 | 452 | 471 | 490 | 509 | 957 | 976 |
| 16 | 35 | 54 | 73 | 92 | 111 | 130 | 149 | 168 | 187 | 206 | 225 | 244 | 263 | 282 | 301 | 320 | 339 | 358 | 377 | 396 | 415 | 434 | 453 | 472 | 491 | 510 | 958 | 977 |
| 17 | 36 | 55 | 74 | 93 | 112 | 131 | 150 | 169 | 188 | 207 | 226 | 245 | 264 | 283 | 302 | 321 | 340 | 359 | 378 | 397 | 416 | 435 | 454 | 473 | 492 | 511 | 959 | 978 |
| 18 | 37 | 56 | 75 | 94 | 113 | 132 | 151 | 170 | 189 | 208 | 227 | 246 | 265 | 284 | 303 | 322 | 341 | 360 | 379 | 398 | 417 | 436 | 455 | 474 | 493 | 512 | 960 | 979 |
| 19 | 38 | 57 | 76 | 95 | 114 | 133 | 152 | 171 | 190 | 209 | 228 | 247 | 266 | 285 | 304 | 323 | 342 | 361 | 380 | 399 | 418 | 437 | 456 | 475 | 494 | 513 | 961 | 980 |

First class
Permit no. 42
Hightstown, N. J.

Business reply mail
No postage stamp necessary if mailed in the United States

Postage will be paid by

Electronics
Reader service department
Box 444
Hightstown, N.J. 08520

2 *For employment inquiries fill in home address. January 19, 1970 Card Expires March 19, 1970 14

Name _____ title _____

Company* _____

Address _____

City _____ State _____ Zip Code _____

| | | | | | | | | | | | | | | | | | | | | | | | | | | | | |
|----|----|----|----|----|-----|-----|-----|-----|-----|-----|-----|-----|-----|-----|-----|-----|-----|-----|-----|-----|-----|-----|-----|-----|-----|-----|-----|-----|
| 1 | 20 | 39 | 58 | 77 | 96 | 115 | 134 | 153 | 172 | 191 | 210 | 229 | 248 | 267 | 286 | 305 | 324 | 343 | 362 | 381 | 400 | 419 | 438 | 457 | 476 | 495 | 514 | 962 |
| 2 | 21 | 40 | 59 | 78 | 97 | 116 | 135 | 154 | 173 | 192 | 211 | 230 | 249 | 268 | 287 | 306 | 325 | 344 | 363 | 382 | 401 | 420 | 439 | 458 | 477 | 496 | 515 | 963 |
| 3 | 22 | 41 | 60 | 79 | 98 | 117 | 136 | 155 | 174 | 193 | 212 | 231 | 250 | 269 | 288 | 307 | 326 | 345 | 364 | 383 | 402 | 421 | 440 | 459 | 478 | 497 | 516 | 964 |
| 4 | 23 | 42 | 61 | 80 | 99 | 118 | 137 | 156 | 175 | 194 | 213 | 232 | 251 | 270 | 289 | 308 | 327 | 346 | 365 | 384 | 403 | 422 | 441 | 460 | 479 | 498 | 517 | 965 |
| 5 | 24 | 43 | 62 | 81 | 100 | 119 | 138 | 157 | 176 | 195 | 214 | 233 | 252 | 271 | 290 | 309 | 328 | 347 | 366 | 385 | 404 | 423 | 442 | 461 | 480 | 499 | 518 | 966 |
| 6 | 25 | 44 | 63 | 82 | 101 | 120 | 139 | 158 | 177 | 196 | 215 | 234 | 253 | 272 | 291 | 310 | 329 | 348 | 367 | 386 | 405 | 424 | 443 | 462 | 481 | 500 | 900 | 967 |
| 7 | 26 | 45 | 64 | 83 | 102 | 121 | 140 | 159 | 178 | 197 | 216 | 235 | 254 | 273 | 292 | 311 | 330 | 349 | 368 | 387 | 406 | 425 | 444 | 463 | 482 | 501 | 901 | 968 |
| 8 | 27 | 46 | 65 | 84 | 103 | 122 | 141 | 160 | 179 | 198 | 217 | 236 | 255 | 274 | 293 | 312 | 331 | 350 | 369 | 388 | 407 | 426 | 445 | 464 | 483 | 502 | 902 | 969 |
| 9 | 28 | 47 | 66 | 85 | 104 | 123 | 142 | 161 | 180 | 199 | 218 | 237 | 256 | 275 | 294 | 313 | 332 | 351 | 370 | 389 | 408 | 427 | 446 | 465 | 484 | 503 | 951 | 970 |
| 10 | 29 | 48 | 67 | 86 | 105 | 124 | 143 | 162 | 181 | 200 | 219 | 238 | 257 | 276 | 295 | 314 | 333 | 352 | 371 | 390 | 409 | 428 | 447 | 466 | 485 | 504 | 952 | 971 |
| 11 | 30 | 49 | 68 | 87 | 106 | 125 | 144 | 163 | 182 | 201 | 220 | 239 | 258 | 277 | 296 | 315 | 334 | 353 | 372 | 391 | 410 | 429 | 448 | 467 | 486 | 505 | 953 | 972 |
| 12 | 31 | 50 | 69 | 88 | 107 | 126 | 145 | 164 | 183 | 202 | 221 | 240 | 259 | 278 | 297 | 316 | 335 | 354 | 373 | 392 | 411 | 430 | 449 | 468 | 487 | 506 | 954 | 973 |
| 13 | 32 | 51 | 70 | 89 | 108 | 127 | 146 | 165 | 184 | 203 | 222 | 241 | 260 | 279 | 298 | 317 | 336 | 355 | 374 | 393 | 412 | 431 | 450 | 469 | 488 | 507 | 955 | 974 |
| 14 | 33 | 52 | 71 | 90 | 109 | 128 | 147 | 166 | 185 | 204 | 223 | 242 | 261 | 280 | 299 | 318 | 337 | 356 | 375 | 394 | 413 | 432 | 451 | 470 | 489 | 508 | 956 | 975 |
| 15 | 34 | 53 | 72 | 91 | 110 | 129 | 148 | 167 | 186 | 205 | 224 | 243 | 262 | 281 | 300 | 319 | 338 | 357 | 376 | 395 | 414 | 433 | 452 | 471 | 490 | 509 | 957 | 976 |
| 16 | 35 | 54 | 73 | 92 | 111 | 130 | 149 | 168 | 187 | 206 | 225 | 244 | 263 | 282 | 301 | 320 | 339 | 358 | 377 | 396 | 415 | 434 | 453 | 472 | 491 | 510 | 958 | 977 |
| 17 | 36 | 55 | 74 | 93 | 112 | 131 | 150 | 169 | 188 | 207 | 226 | 245 | 264 | 283 | 302 | 321 | 340 | 359 | 378 | 397 | 416 | 435 | 454 | 473 | 492 | 511 | 959 | 978 |
| 18 | 37 | 56 | 75 | 94 | 113 | 132 | 151 | 170 | 189 | 208 | 227 | 246 | 265 | 284 | 303 | 322 | 341 | 360 | 379 | 398 | 417 | 436 | 455 | 474 | 493 | 512 | 960 | 979 |
| 19 | 38 | 57 | 76 | 95 | 114 | 133 | 152 | 171 | 190 | 209 | 228 | 247 | 266 | 285 | 304 | 323 | 342 | 361 | 380 | 399 | 418 | 437 | 456 | 475 | 494 | 513 | 961 | 980 |

Reprint service

All Electronics editorial matter available in reprint form:

For reprints of special reports and feature articles see list on right side of this page. Send your order to Electronics Reprint Department at the address indicated. To expedite mailing of your order for single reprints please send cash, check or money order with your order. Allow 3-4 weeks for delivery.

Bulk reprints of editorial matter can be ordered from current or past issues. The minimum quantity is 100 copies. Price quoted on request: call 212-971-2274, or write to address below.

Warning: The Post Office now requires your ZIP CODE on all mail. Please include your ZIP CODE number when filling out your reply card.

3

Business reply mail

No postage stamp necessary if mailed in the United States

Postage will be paid by

Electronics
Reader service department
Box 444
Hightstown, N. J. 08520

First class
 Permit no. 42
 Hightstown, N. J.

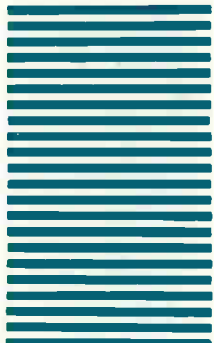

2 Please Print Clearly January 19, 1970 Card Expires March 19, 1970 14

Name _____ title _____ For Subscriptions
 Company _____ new renewal
 Address _____ 3 years \$16.00
 1 year \$8.00

| | | | | | | | | | | | | | | | | | | | | | | | | | | | | |
|----|----|----|----|----|-----|-----|-----|-----|-----|-----|-----|-----|-----|-----|-----|-----|-----|-----|-----|-----|-----|-----|-----|-----|-----|-----|-----|-----|
| 1 | 20 | 39 | 58 | 77 | 96 | 115 | 134 | 153 | 172 | 191 | 210 | 229 | 248 | 267 | 286 | 305 | 324 | 343 | 362 | 381 | 400 | 419 | 438 | 457 | 476 | 495 | 514 | 533 |
| 2 | 21 | 40 | 59 | 78 | 97 | 116 | 135 | 154 | 173 | 192 | 211 | 230 | 249 | 268 | 287 | 306 | 325 | 344 | 363 | 382 | 401 | 420 | 439 | 458 | 477 | 496 | 515 | 534 |
| 3 | 22 | 41 | 60 | 79 | 98 | 117 | 136 | 155 | 174 | 193 | 212 | 231 | 250 | 269 | 288 | 307 | 326 | 345 | 364 | 383 | 402 | 421 | 440 | 459 | 478 | 497 | 516 | 535 |
| 4 | 23 | 42 | 61 | 80 | 99 | 118 | 137 | 156 | 175 | 194 | 213 | 232 | 251 | 270 | 289 | 308 | 327 | 346 | 365 | 384 | 403 | 422 | 441 | 460 | 479 | 498 | 517 | 536 |
| 5 | 24 | 43 | 62 | 81 | 100 | 119 | 138 | 157 | 176 | 195 | 214 | 233 | 252 | 271 | 290 | 309 | 328 | 347 | 366 | 385 | 404 | 423 | 442 | 461 | 480 | 499 | 518 | 537 |
| 6 | 25 | 44 | 63 | 82 | 101 | 120 | 139 | 158 | 177 | 196 | 215 | 234 | 253 | 272 | 291 | 310 | 329 | 348 | 367 | 386 | 405 | 424 | 443 | 462 | 481 | 500 | 519 | 538 |
| 7 | 26 | 45 | 64 | 83 | 102 | 121 | 140 | 159 | 178 | 197 | 216 | 235 | 254 | 273 | 292 | 311 | 330 | 349 | 368 | 387 | 406 | 425 | 444 | 463 | 482 | 501 | 520 | 539 |
| 8 | 27 | 46 | 65 | 84 | 103 | 122 | 141 | 160 | 179 | 198 | 217 | 236 | 255 | 274 | 293 | 312 | 331 | 350 | 369 | 388 | 407 | 426 | 445 | 464 | 483 | 502 | 521 | 540 |
| 9 | 28 | 47 | 66 | 85 | 104 | 123 | 142 | 161 | 180 | 199 | 218 | 237 | 256 | 275 | 294 | 313 | 332 | 351 | 370 | 389 | 408 | 427 | 446 | 465 | 484 | 503 | 522 | 541 |
| 10 | 29 | 48 | 67 | 86 | 105 | 124 | 143 | 162 | 181 | 200 | 219 | 238 | 257 | 276 | 295 | 314 | 333 | 352 | 371 | 390 | 409 | 428 | 447 | 466 | 485 | 504 | 523 | 542 |
| 11 | 30 | 49 | 68 | 87 | 106 | 125 | 144 | 163 | 182 | 201 | 220 | 239 | 258 | 277 | 296 | 315 | 334 | 353 | 372 | 391 | 410 | 429 | 448 | 467 | 486 | 505 | 524 | 543 |
| 12 | 31 | 50 | 69 | 88 | 107 | 126 | 145 | 164 | 183 | 202 | 221 | 240 | 259 | 278 | 297 | 316 | 335 | 354 | 373 | 392 | 411 | 430 | 449 | 468 | 487 | 506 | 525 | 544 |
| 13 | 32 | 51 | 70 | 89 | 108 | 127 | 146 | 165 | 184 | 203 | 222 | 241 | 260 | 279 | 298 | 317 | 336 | 355 | 374 | 393 | 412 | 431 | 450 | 469 | 488 | 507 | 526 | 545 |
| 14 | 33 | 52 | 71 | 90 | 109 | 128 | 147 | 166 | 185 | 204 | 223 | 242 | 261 | 280 | 299 | 318 | 337 | 356 | 375 | 394 | 413 | 432 | 451 | 470 | 489 | 508 | 527 | 546 |
| 15 | 34 | 53 | 72 | 91 | 110 | 129 | 148 | 167 | 186 | 205 | 224 | 243 | 262 | 281 | 300 | 319 | 338 | 357 | 376 | 395 | 414 | 433 | 452 | 471 | 490 | 509 | 528 | 547 |
| 16 | 35 | 54 | 73 | 92 | 111 | 130 | 149 | 168 | 187 | 206 | 225 | 244 | 263 | 282 | 301 | 320 | 339 | 358 | 377 | 396 | 415 | 434 | 453 | 472 | 491 | 510 | 529 | 548 |
| 17 | 36 | 55 | 74 | 93 | 112 | 131 | 150 | 169 | 188 | 207 | 226 | 245 | 264 | 283 | 302 | 321 | 340 | 359 | 378 | 397 | 416 | 435 | 454 | 473 | 492 | 511 | 530 | 549 |
| 18 | 37 | 56 | 75 | 94 | 113 | 132 | 151 | 170 | 189 | 208 | 227 | 246 | 265 | 284 | 303 | 322 | 341 | 360 | 379 | 398 | 417 | 436 | 455 | 474 | 493 | 512 | 531 | 550 |
| 19 | 38 | 57 | 76 | 95 | 114 | 133 | 152 | 171 | 190 | 209 | 228 | 247 | 266 | 285 | 304 | 323 | 342 | 361 | 380 | 399 | 418 | 437 | 456 | 475 | 494 | 513 | 532 | 551 |

1

Business reply mail

No postage stamp necessary if mailed in the United States

Postage will be paid by

Electronics
Reader service department
Box 444
Hightstown, N.J. 08520

First class
 Permit no. 42
 Hightstown, N. J.



To order reprints or for further information, please write to: Electronics Reprint Department, 330 West 42nd Street, New York, N.Y. 10036.

To expedite mailing of your order for single reprints please enclose payment with your order.

You may order any of the below listed reprints by key number. Discounts on quantities over 10.

- Key no. R-01 Computer-aided Design: Part The Man-machine Merger. 1 pages. \$1.25.
- Key no. R-04 Multilayer Circuit Board: Sharpening An Imperfect Art 7 pages. 50¢.
- Key no. R-06 Report on Japanese Technology: Sony. 20 pages. 50¢.
- Key no. R-010 Special Report on Large Scale Integration. 54 pages. \$1.50
- Key no. R-011 Medical Electronics (1967). 1 part series, 44 pages. \$1.25.
- Key no. R-012 Special Report on Gallium Arsenide 17 parts. 32 pages. \$2.00
- Key no. R-016 Special Report on The Transistor: Two Decades of Progress 48 pages. \$1.50.
- Key no. R-017 Special Report on Ferrites. 16 pages. \$1.00.
- Key no. R-021 Infrared Detector Characteristics. 23 x 11 inch fold-out chart. 50¢
- Key no. R-022 Active Filters: Part II, Varying the Approach. 8 pages \$1.00
- Key no. R-023 Special Report: Tomorrow's Communications. 32 pages \$1.75
- Key no. R-024 1969 Electronics Index to Technical Articles and Authors. Free
- Key no. R-025 Combined reprint of 1970 European and U.S. Markets Reports with two foldout charts. 62 pages \$1.75
- Key no. R-79 MOS Integrated Circuits. 12 pages. 50¢.
- Key no. R-78 The Overlay Transistor. 15 pages. 50¢.
- Key no. R-64 Field Effect Transistors. Parts I, II, and III. 64 pages. \$1.00.

If Lambda's LC series listed in Underwriters' Laboratories Recognized Component Index doesn't excite you...

All-silicon DC power supply using integrated circuits to provide regulation system

except for input and output capacitors, rectifiers and series regulation transistors

Increased reliability

through use of integrated circuit which replaces 32 discrete components from conventional designs

Convection cooled

no external heat sinking required

Regulation

line or load $\pm 0.01\% + 1\text{mv}$

Ripple and noise

250 μv rms; 1mv p-to-p

Wide input voltage and frequency range

105-132 vac, 57-63Hz

Wide temperature range

-20°C to $+71^\circ\text{C}$

Temperature coefficient

$\pm 0.01\% + 300\mu\text{v}/^\circ\text{C}$ external programming resistor

$\pm 0.015\% + 300\mu\text{v}/^\circ\text{C}$ internal programming resistor

Lightweight

Overvoltage protection

available as accessory up to 70 vdc

Multi-current-rated

Complete serviceability

all components replaceable

Remote sensing

No overshoot

on turn-on, turn-off or power failure

More current per cubic inch

Remote programming

1000 ohm/v nominal or volt/volt

Series/parallel operation

with similar single or dual units

Completely protected

automatic current limiting

Features of dual output models

Independent operation

Independent remote sensing

Independent remote programming

Series/parallel operation

(master/slave)

Each supply electrically isolated

and floating with respect to ground

Lambda power supplies

LCD-A



LCS-4, LCD-4



LCS-2, LCD-2



LCS-3, LCD-3



LCS-1



Maybe our 1-day delivery and 5 year

LCS-1 SINGLE OUTPUT MODELS



3 $\frac{5}{32}$ " x 3 $\frac{3}{32}$ " x 1 $\frac{21}{32}$ "

| Model | ADJ. VOLT RANGE VDC | MAX. MA. AT AMBIENT OF: ¹ | | | | | | | | Price ⁽²⁾ |
|-----------|---------------------|--------------------------------------|-------|------|-------|------|-------|------|------|----------------------|
| | | 40°C | 50°C | 60°C | 71°C | 40°C | 50°C | 60°C | 71°C | |
| LCS-1-01A | 0-7 | 275 | (250) | 220 | (180) | 165 | (120) | 110 | (75) | \$70 |
| LCS-1-02A | 0-18 | 130 | (115) | 130 | (115) | 100 | (80) | 85 | (40) | 70 |
| LCS-1-03A | 0-32 | 90 | (80) | 90 | (80) | 90 | (50) | 50 | (25) | 70 |
| LCS-1-04A | 0-60 | 50 | (45) | 50 | (45) | 50 | (35) | 30 | (15) | 80 |
| LCS-1-05A | 0-120 | 18 | (15) | 18 | (15) | 18 | (15) | 18 | (10) | 85 |

*Bracketed ratings are for 47-53Hz operation.

UNREGULATED POWER SUPPLY



3 $\frac{5}{32}$ " x 3 $\frac{3}{32}$ " x 1 $\frac{21}{32}$ "

| | | | |
|----------|---------|---|------|
| LUS-1-06 | 180 VDC | 25 ma up to 71°C at nominal line voltage for use with up to 7 Nixie® tubes. | \$35 |
|----------|---------|---|------|

LCS-2 SINGLE OUTPUT MODELS



3 $\frac{5}{32}$ " x 3 $\frac{3}{32}$ " x 3 $\frac{3}{32}$ "

| Model | ADJ. VOLT. RANGE VDC | MAX. MA. AT AMBIENT OF: ¹ | | | | Price ⁽²⁾ |
|----------|----------------------|--------------------------------------|------|------|------|----------------------|
| | | 40°C | 50°C | 60°C | 71°C | |
| LCS-2-01 | 0-7 | 550 | 455 | 350 | 240 | \$80 |
| LCS-2-02 | 0-18 | 330 | 275 | 210 | 140 | 80 |
| LCS-2-03 | 0-32 | 240 | 205 | 155 | 95 | 80 |
| LCS-2-04 | 0-60 | 145 | 115 | 87 | 57 | 90 |
| LCS-2-05 | 0-120 | 50 | 50 | 45 | 30 | 90 |

LCS-3 SINGLE OUTPUT MODELS



3 $\frac{3}{16}$ " x 3 $\frac{3}{4}$ " x 5"

| Model | ADJ. VOLT. RANGE VDC | MAX. MA. AT AMBIENT OF: ¹ | | | | Price ⁽²⁾ |
|----------|----------------------|--------------------------------------|------|------|------|----------------------|
| | | 40°C | 50°C | 60°C | 71°C | |
| LCS-3-01 | 0-7 | 1200 | 1000 | 750 | 500 | \$90 |
| LCS-3-02 | 0-18 | 750 | 620 | 480 | 320 | 90 |
| LCS-3-03 | 0-32 | 400 | 350 | 265 | 170 | 90 |
| LCS-3-04 | 0-60 | 240 | 190 | 140 | 85 | 99 |

(Nixie is trademark of Burroughs Corp.)

Circle 192 on reader service card

LCS-4 SINGLE OUTPUT MODELS (Fixed Voltage)



4 $\frac{29}{32}$ " x 4 $\frac{29}{32}$ " x 5"

| Model | FIXED VOLT. RANGE VDC | MAX. AMPS. AT AMBIENT OF: ¹ | | | | Price ⁽²⁾ |
|-----------|-----------------------|--|------|------|------|----------------------|
| | | 40°C | 50°C | 60°C | 71°C | |
| LCS-4-3 | 3±5% | 4.5 | 3.9 | 3.1 | 2.0 | \$130 |
| LCS-4-3P6 | 3.6±5% | 4.5 | 3.9 | 3.1 | 2.0 | 130 |
| LCS-4-4 | 4±5% | 4.5 | 3.9 | 3.1 | 2.0 | 130 |
| LCS-4-4P5 | 4.5±5% | 4.4 | 3.7 | 2.9 | 1.8 | 130 |
| LCS-4-5 | 5±5% | 4.4 | 3.7 | 2.9 | 1.8 | 130 |
| LCS-4-6 | 6±5% | 4.0 | 3.4 | 2.6 | 1.5 | 130 |
| LCS-4-8 | 8±5% | 4.0 | 3.4 | 2.6 | 1.5 | 130 |
| LCS-4-10 | 10±5% | 3.2 | 2.8 | 2.2 | 1.3 | 130 |
| LCS-4-12 | 12±5% | 3.1 | 2.8 | 2.2 | 1.3 | 130 |
| LCS-4-15 | 15±5% | 2.8 | 2.6 | 2.1 | 1.3 | 130 |
| LCS-4-18 | 18±5% | 2.6 | 2.4 | 2.0 | 1.2 | 130 |
| LCS-4-20 | 20±5% | 2.4 | 2.2 | 1.9 | 1.1 | 130 |
| LCS-4-24 | 24±5% | 2.2 | 1.8 | 1.5 | 0.95 | 130 |
| LCS-4-28 | 28±5% | 2.0 | 1.6 | 1.4 | 0.85 | 130 |
| LCS-4-36 | 36±5% | 1.8 | 1.5 | 1.3 | 0.85 | 140 |
| LCS-4-48 | 48±5% | 1.2 | 1.1 | 0.9 | 0.75 | 140 |
| LCS-4-100 | 100±5% | 0.46 | 0.46 | 0.46 | 0.34 | 140 |
| LCS-4-120 | 120±5% | 0.40 | 0.40 | 0.40 | 0.30 | 140 |
| LCS-4-150 | 150±5% | 0.32 | 0.32 | 0.32 | 0.25 | 180 |

LCS-4 SINGLE OUTPUT MODELS (Wide Range)



4 $\frac{29}{32}$ " x 4 $\frac{29}{32}$ " x 5"

| Model | ADJ. VOLT. RANGE VDC | MAX. AMPS. AT AMBIENT OF: ¹ | | | | Price ⁽²⁾ |
|----------|----------------------|--|------|------|------|----------------------|
| | | 40°C | 50°C | 60°C | 71°C | |
| LCS-4-01 | 0-7 | 3.3 | 3.0 | 2.3 | 1.5 | \$130 |
| LCS-4-02 | 0-18 | 1.8 | 1.6 | 1.2 | 0.8 | 130 |
| LCS-4-03 | 0-32 | 1.0 | 0.9 | 0.7 | 0.5 | 130 |
| LCS-4-04 | 0-60 | 0.55 | 0.5 | 0.43 | 0.3 | 140 |
| LCS-4-05 | 0-120 | 0.25 | 0.25 | 0.22 | 0.16 | 140 |

LCD-2 DUAL OUTPUT MODELS



3 $\frac{3}{16}$ " x 3 $\frac{3}{4}$ " x 5"

| Model | ADJ. VOLT. RANGE VDC (EACH SIDE) | MAX. MA. AT AMBIENT OF: ¹ | | | | Price ⁽²⁾ |
|----------|----------------------------------|--------------------------------------|------------|------------|------------|----------------------|
| | | 40°C | 50°C | 60°C | 71°C | |
| LCD-2-11 | 0-7 0-7 | 300 300 | 240 240 | 175 175 | 115 115 | \$125 |
| LCD-2-12 | 0-18 0-7 | 160 300 | 130 240 | 100 175 | 65 115 | 125 |
| LCD-2-13 | 0-32 0-7 | 120 300 | 95 240 | 70 175 | 45 115 | 125 |
| LCD-2-22 | 0-18 0-18 | 160 160 | 130 130 | 100 100 | 65 65 | 125 |
| LCD-2-23 | 0-32 0-18 | 120 160 | 95 130 | 70 100 | 45 65 | 125 |

guarantee on parts and labor will.

LCD-2 DUAL OUTPUT MODELS Continued

| Model | ADJ. VOLT. RANGE VDC (EACH SIDE) | MAX. MA. AT AMBIENT OF: ¹ | | | | Price ⁽²⁾ |
|----------|----------------------------------|--------------------------------------|------|------|------|----------------------|
| | | 40°C | 50°C | 60°C | 71°C | |
| LCD-2-33 | 0-32 | 120 | 95 | 70 | 45 | \$125 |
| | 0-32 | 120 | 95 | 70 | 45 | |
| LCD-2-44 | 0-60 | 65 | 52 | 37 | 23 | 170 |
| | 0-60 | 65 | 52 | 37 | 23 | |
| LCD-2-55 | 0-120 | 30 | 30 | 22 | 14 | 170 |
| | 0-120 | 30 | 30 | 22 | 14 | |

LCD-3 DUAL OUTPUT MODELS

3³/₁₆" x 3³/₄" x 5"



| Model | ADJ. VOLT. RANGE VDC | MAX. MA. AT AMBIENT OF: ¹ | | | | Price ⁽²⁾ |
|----------|----------------------|--------------------------------------|------|------|------|----------------------|
| | | 40°C | 50°C | 60°C | 71°C | |
| LCD-3-11 | 0-7 | 700 | 590 | 480 | 340 | \$150 |
| | 0-7 | 700 | 590 | 480 | 340 | |
| LCD-3-12 | 0-7 | 700 | 590 | 480 | 340 | 150 |
| | 0-18 | 400 | 350 | 300 | 210 | |
| LCD-3-13 | 0-7 | 700 | 590 | 480 | 340 | 150 |
| | 0-32 | 225 | 190 | 160 | 120 | |
| LCD-3-22 | 0-18 | 400 | 350 | 300 | 210 | 150 |
| | 0-18 | 400 | 350 | 300 | 210 | |
| LCD-3-23 | 0-18 | 400 | 350 | 300 | 210 | 150 |
| | 0-32 | 225 | 190 | 160 | 120 | |
| LCD-3-33 | 0-32 | 225 | 190 | 160 | 120 | 150 |
| | 0-32 | 225 | 190 | 160 | 120 | |
| LCD-3-44 | 0-60 | 130 | 100 | 70 | 45 | 175 |
| | 0-60 | 130 | 100 | 70 | 45 | |

LCD-A DUAL OUTPUT MODELS

3³/₁₆" x 3³/₄" x 6¹/₂"



| Model | ADJ. VOLT. RANGE VDC | MAX. AMPS. AT AMBIENT OF: ¹ | | | | Price ⁽²⁾ |
|----------|----------------------|--|-------|------|-------|----------------------|
| | | 40°C | 50°C | 60°C | 71°C | |
| LCD-A-11 | 0-7 | 1.0 | 0.9 | 0.7 | 0.5 | \$155 |
| | 0-7 | 1.0 | 0.9 | 0.7 | 0.5 | |
| LCD-A-12 | 0-18 | 0.5 | 0.45 | 0.4 | 0.3 | 155 |
| | 0-7 | 1.0 | 0.9 | 0.7 | 0.5 | |
| LCD-A-13 | 0-32 | 0.35 | 0.3 | 0.25 | 0.2 | 155 |
| | 0-7 | 1.0 | 0.9 | 0.7 | 0.5 | |
| LCD-A-22 | 0-18 | 0.5 | 0.45 | 0.4 | 0.3 | 155 |
| | 0-18 | 0.5 | 0.45 | 0.4 | 0.3 | |
| LCD-A-23 | 0-32 | 0.35 | 0.3 | 0.25 | 0.2 | 155 |
| | 0-18 | 0.5 | 0.45 | 0.4 | 0.3 | |
| LCD-A-33 | 0-32 | 0.35 | 0.3 | 0.25 | 0.2 | 155 |
| | 0-32 | 0.35 | 0.3 | 0.25 | 0.2 | |
| LCD-A-44 | 0-60 | 0.2 | 0.18 | 0.14 | 0.12 | 180 |
| | 0-60 | 0.2 | 0.18 | 0.14 | 0.12 | |
| LCD-A-55 | 0-120 | 75 ma | 75 ma | 75ma | 60 ma | 200 |
| | 0-120 | 75 ma | 75 ma | 75ma | 60 ma | |

Write, wire or call for new 72-page catalog



LCD-4 DUAL OUTPUT MODELS

4²/₃₂" x 4²/₃₂" x 5"



| Model | ADJ. VOLT. RANGE VDC | MAX. AMPS. AT AMBIENT OF: ¹ | | | | Price ⁽²⁾ |
|-----------------|----------------------|--|------|------|-------|----------------------|
| | | 40°C | 50°C | 60°C | 71°C | |
| LCD-4-11 | 0-7 | 1.8 | 1.5 | 1.2 | 0.7 | \$190 |
| | 0-7 | 1.8 | 1.5 | 1.2 | 0.7 | |
| LCD-4-12 | 0-18 | 1.0 | 0.8 | 0.65 | 0.4 | 190 |
| | 0-7 | 1.8 | 1.5 | 1.2 | 0.7 | |
| LCD-4-13 | 0-32 | 0.6 | 0.53 | 0.4 | 0.24 | 190 |
| | 0-7 | 1.8 | 1.5 | 1.2 | 0.7 | |
| LCD-4-22 | 0-18 | 1.0 | 0.8 | 0.65 | 0.4 | 190 |
| | 0-18 | 1.0 | 0.8 | 0.65 | 0.4 | |
| LCD-4-23 | 0-32 | 0.6 | 0.53 | 0.4 | 0.24 | 190 |
| | 0-18 | 1.0 | 0.8 | 0.65 | 0.4 | |
| LCD-4-33 | 0-32 | 0.6 | 0.53 | 0.4 | 0.24 | 190 |
| | 0-32 | 0.6 | 0.53 | 0.4 | 0.24 | |
| LCD-4-44 | 0-60 | 0.33 | 0.3 | 0.24 | 0.15 | 240 |
| | 0-60 | 0.33 | 0.3 | 0.24 | 0.15 | |
| LCD-4-55 | 0-120 | 0.12 | 0.12 | 0.12 | 0.075 | 240 |
| | 0-120 | 0.12 | 0.12 | 0.12 | 0.075 | |
| LCD-4-152 Fixed | 15±5% | 1.5 | 1.3 | 1.0 | 0.6 | 220 |
| | 15±5% | 1.5 | 1.3 | 1.0 | 0.6 | |

OVERVOLTAGE PROTECTORS (ACCESSORIES)

(Separate OV required for each output)



| Model | ADJ. VOLT. RANGE VDC | FOR USE WITH | Price ⁽²⁾ |
|----------|----------------------|-----------------------------------|----------------------|
| LC-OV-10 | 3-24 | LCS-1, LCS-2, LCD-2, LCS-3, LCD-3 | \$20 |
| LC-OV-11 | 3-47 | | 20 |
| LC-OV-12 | 3-70 | | 25 |
| LM-OV- 1 | 3- 8 | Fixed Voltage | 30 |
| LM-OV- 2 | 6-20 | LCS-4, LCD-4 | 30 |
| LM-OV- 3 | 18-70 | | 30 |
| LH-OV- 4 | 3-24 | LCD-A & wide range LCD-4, LCS-4 | 35 |
| LH-OV- 5 | 3-47 | | 35 |
| LH-OV- 6 | 3-70 | | 35 |

NOTES: (1) For operation at other than 57-63 Hz, consult factory for ratings and specifications.
(2) All prices FOB Melville, N. Y. All prices and specifications subject to change without notice.

One day delivery—90% of all models

Guaranteed for five years material and labor

These are new reduced prices effective November 1, 1969.

LAMBDA
ELECTRONICS CORP.
A Veeco Company

Where do you go if you are looking for high-performance, high-reliability solid-state power sources, traveling-wave tubes, and triode cavity devices? Sure, you don't need them for any one microwave system. But can you get them from a single microwave source?

Call RCA. For more than two decades, RCA has devoted itself to design and development of product that could easily be integrated into a microwave system. A superior product line has resulted. It includes:

□ Packaged solid-state "black-boxes" such as Transferred Electron Oscillators, Microwave Integrated Circuits and Fer-

rite devices for a variety of applications which include phased array radar, navigation and communications.

□ Ceramic-metal TWT's that represent significant break-throughs in size, weight, and performance for ECM applications.

□ Pulsed triode cavities with improved efficiencies, longer life, and stable performance for airborne automatic traffic control and altimeter systems.

Designed into dozens of systems, from ground support equipment to satellite communications, any of these components are examples of advances made possible only through years of involvement with

system designers' problems. They could endow your system with advanced reliability and performance.

For more information, consult your local RCA Representative. For technical data, write: RCA Electronic Components, Section A-19-2 /ZM6, Commercial Engineering, Harrison, N. J. 07029. In Europe: RCA International Marketing S.A., 2-4 rue du Lièvre, 1227 Geneva, Switzerland.

RCA

In Microwaves, the hot line is RCA

