

electronics

A McGRAW-HILL PUBLICATION

JANUARY 8, 1960

PRICE SEVENTY-FIVE CENTS

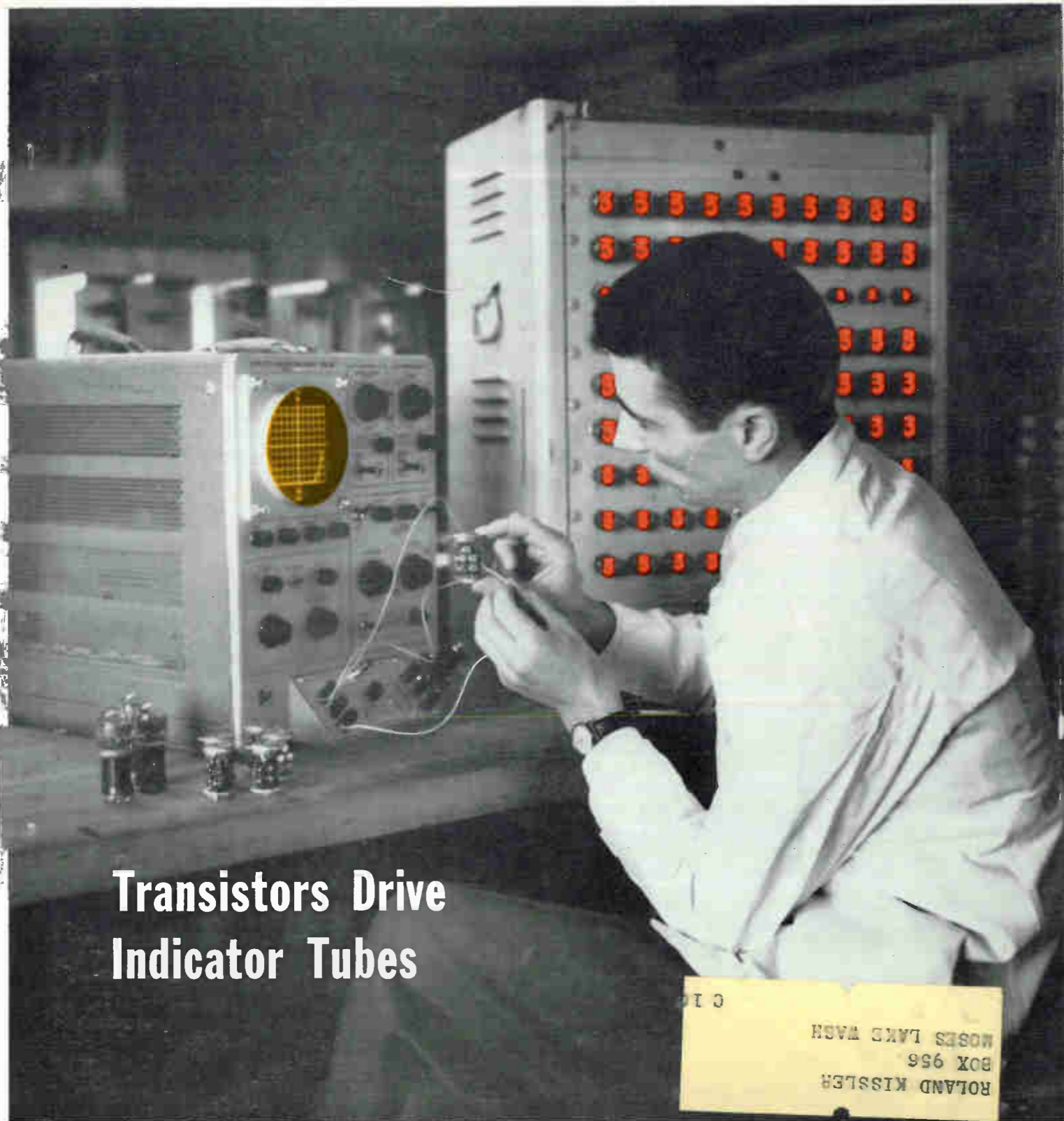

Transistors Drive Indicator Tubes

ROLAND KISSLER
 BOX 956
 MOSES LAKE WASH

This new-concept hp 500 MC oscilloscope

can help you now...and here's how!

- Analyze millimicrosecond pulses
- Measure transistor response time
- Make fractional millimicrosecond time comparisons
- Measure diode switching time
- Determine pulse jitter
- Make permanent X-Y plots
- Measure memory-unit switching
- Measure uhf voltage amplitude

... here, now, is the convenience
 of conventional pulse measurement in the
 millimicrosecond region

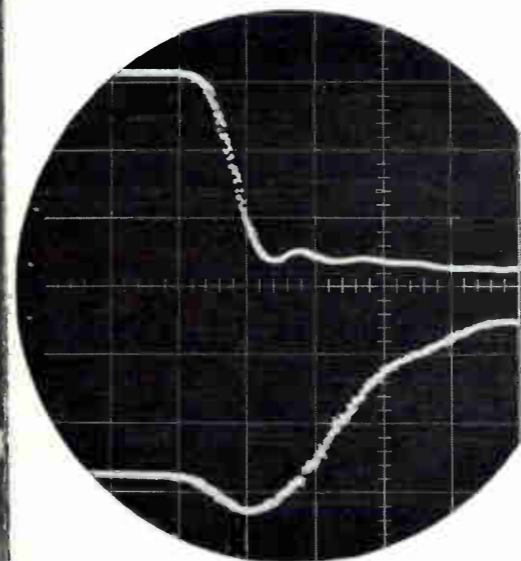

Dual pulse presentation on hp 185A. Top trace shows pulse from mercury pulser applied to 2N1385 mesa transistor. Bottom trace shows responding turn-on of transistor. Dip in bottom trace at start of turn-on results from capacitance. Scope sweep speed 1 millimicrosecond/cm.

The hp 185A 500 MC Oscilloscope is a completely new instrument that is virtually as simple, convenient and easy to read as conventional broadband oscilloscopes, yet provides a wealth of fast-circuit information never before available. In such fields as computer and radar research and design, and semiconductor research, the Model 185A is the first practical, available answer to the pressing need for measuring and viewing millimicrosecond phenomena.

It should be emphasized that the 185A is an existing instrument—ready for you now, with bright, clear 5" scope traces that are totally comparable in information, clarity and usefulness with presentations you associate with much lower frequencies.



SAMPLING OSCILLOSCOPE

Ⓢ 185A is a sampling oscilloscope, whereas most previous oscilloscopes have been broadband instruments.

The sampling technique avoids several inherent limitations of the broadband approach which arise in the millimicrosecond region. One of these is the intrinsic sensitivity-bandwidth-display-size limitation of cathode ray tubes; another is the characteristic gain-bandwidth limitation of associated amplifiers.

A third critical problem with the broadband approach in the 500 MC band pass area is that, frequently, fast pulses or occurrences happen at low repetition rates. This means that the writing rate is not sufficient to provide a bright trace on the cathode ray tube.

Ⓢ 185A adroitly sidesteps all these roadblocks by immediately translating the input signal to a much lower frequency, through the sampling technique, then proceeding with more conventional signal processing to provide standard oscilloscope operating ease and bright, clear, large-screen presentation.

"Sampling" in this application is analogous to stroboscopic light methodology in that both techniques simulate slowing down the "motion" for better visual study—and both depend on repetition to build a faithful image.

OPERATION DESCRIBED

In the case of the Ⓢ 185A, the sampling approach is applied in the following manner.

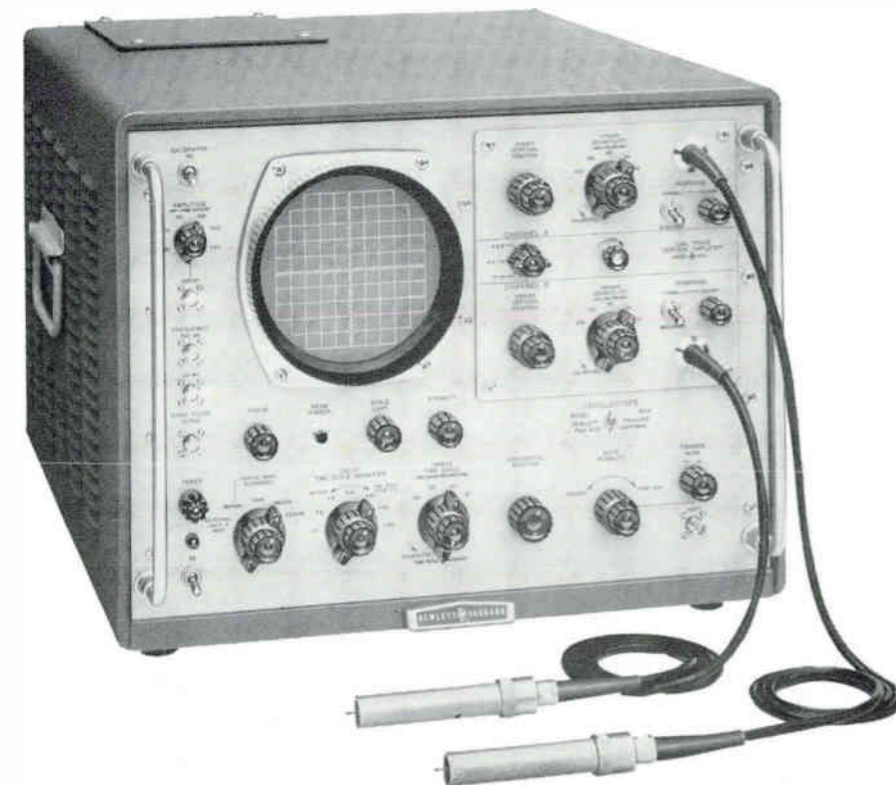

The first step in building the 185A's cathode ray tube picture is to apply a staircase voltage to step the beam across the CRT face. (Figure 1).

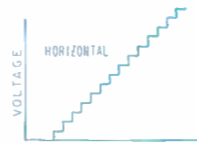

Figure 1

Next, input voltage samples, each taken from a differing point on the waveform, are fed through the vertical amplifier to the scope face.



Figure 2

Now, between the staircase steps, the beam is blanked so that the signal becomes a series of dots. In operation, many dots are present, and the pattern appears continuous. (Figure 2).

A basic element of the sampling technique as here applied is the incremental delay of each sampling pulse—such delay insuring that a different or successive portion of the wave is examined each time.

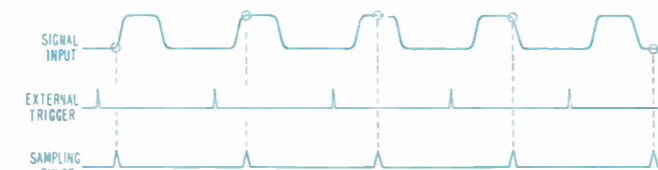

Figure 3

Figure 3 illustrates this delay process. Electrically speaking, it operates as follows. A gate is opened for a very brief time and a capacitor charged to a voltage proportional to the instantaneous amplitude of the test signal. The voltage on the capacitor remains after the gate is closed, and is amplified to provide vertical cathode ray tube deflection.

So that the entire signal under examination is scanned, each succeeding sample is gated at a slightly later point along the waveform. Each time such a sample is taken the "spot" on the CRT is moved horizontally along the waveform. Thus, a complete picture of a repetitive high speed signal is synthesized by a build-up of image-retaining "dots" on the conventional 5AQP 5" scope face. (As in Figure 2).

UNIQUE ADVANTAGES

The result is a compact, practical instrument of conventional oscilloscope configuration and operating ease which offers you these truly unique features:

- **bright, clear presentation of repetitive short pulses requiring a bandwidth up to 500 MC and beyond**
- **bright, steady traces even at repetition rates down to 50 cps**
- **at least 0.7 millimicrosecond rise time, permitting brilliant viewing of millimicrosecond pulses**
- **dual channel input for waveform comparisons**
- **simultaneous sampling of both channels allows accurate time comparison**
- **times-100 sweep expansion increasing sweep speed to 0.1 millimicrosecond/cm for extreme resolving capability**
- **1.0% time calibrator for accurate rise time measurements and time comparisons**
- **high sensitivity for viewing small signals; wide dynamic range for viewing small voltages on higher voltage plateaus**
- **differential input for studying signal differences**
- **high resistance 100,000 ohm probe to minimize disturbance to circuits under test**
- **X-Y recorder output—plot input vs. time or one input against another**
- **time, amplitude calibrators; beam finder, panel similar to conventional scope controls**
- **unique feedback circuit stabilizes vertical sensitivity; 5 calibrated ranges**
- **balanced sampling circuit minimizes feedback of sampling pulses to circuit under test**

SPECIAL, EASY-TO-USE PROBES

An outstanding feature of the Ⓢ 185A is the pair of compact, new-concept probes arranged for easy application to the circuit under test. The probes provide a high 100,000 ohm input resistance shunted by 3 μ f to virtually eliminate loading to the circuit under test. For maximum versatility, the probes may be used with Type N, BNC or other conventional fittings.

Calibrated vertical sensitivity controls permit the instrument to measure a wide range of input levels from 10 to 200 mv/cm. A vernier between steps further increases sensitivity to 3 mv/cm.

To assure maximum usefulness, the 185A has a variable time delay and a four-range time scale with a six-step scale magnifier. These features permit study of fast pulses in extreme detail and under varied trigger conditions.

Model 185A syncs with external triggers up to 50 MC, and also provides a front panel delayed sync pulse which may be used to trigger the circuit under test. In situations where the circuit will respond to this trigger, a delay line is unnecessary.

Front panel controls are few in number and grouped in familiar oscilloscope array. One unusual control is a front panel scanning control governing the number of samples contained in a single trace. Density of these samples may be adjusted from 50 samples (a series of spaced dots) to 1,000 samples (where the presentation appears as a continuous trace).

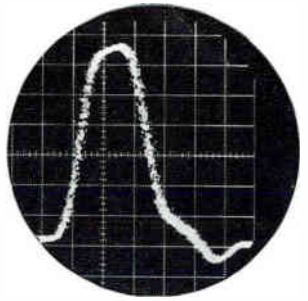

2 millimicrosecond pulse on 5" CRT of Ⓢ 185A.

A particularly helpful feature of the Ⓢ 185A is its X-Y recorder output. The Manual Scan control can be used to further slow the input signal, permitting X-Y plotting for permanent records, reports, etc., with such instruments as the Moseley Model 2D Autograf Recorder.

DUAL OR DIFFERENTIAL INPUT

Ⓢ 187A Dual Trace Amplifier is a plug-in unit for use with Ⓢ 185A. It permits observation and comparison of two high speed signals simultaneously, or comparisons of time, duration and spacing. The amplifier has a wide dynamic range of 3 mv to 2 volts peak; each channel has an independent sensitivity control calibrated to $\pm 5\%$.

SPECIFICATIONS



Ⓢ 185A with Ⓢ 187A Dual Trace Amplifier

VERTICAL (Dual Channel)	
Bandwidth:	Greater than 500 MC at 3 db; less than 0.7 μ sec rise time
Sensitivity:	Calib. ranges 10 to 200 mv/cm, $\pm 5\%$ accuracy Vernier sens. increase to 3 mv/cm
Voltage Calibrator:	10 to 500 mv, $\pm 3\%$ accuracy
Input Impedance:	100,000 ohms, 3 μ f shunt
HORIZONTAL	
Sweep Speeds:	0.1 μ sec/cm to 100 μ sec/cm, 5% full sweep, 1 μ sec/cm to 100 μ sec/cm except on x100 scale and first 30 μ sec of 100 μ sec/cm scale. 10, 20, 50, 100 μ sec/cm, vernier
Time Scale:	
Time Scale Magnifier:	x2, x5, x10, x20, x50, x100
Jitter:	Less than 0.05 μ sec peak-peak
Time Calibrator:	500 and 50 MC damped sine waves
Minimum Delay:	120 millimicroseconds
Variable Delay Range:	10 times TIME SCALE less display time
External Trigger:	± 50 mv, 20 μ sec; ± 0.5 v, 1 μ sec
Sampling Rep Rate:	100 KC maximum
Trigger Rate:	50 cps to 50 MC
SYNC PULSE OUTPUT:	
Amplitude:	Negative 3 v into 50 ohms
Rise Time:	Approx 2 millimicroseconds
Timing:	Approx 20 μ sec after undelayed trace start
Accessories Furnished:	Ⓢ 187A-76A BNC Adaptors (2); Ⓢ 185A-21A Sync Probe
Accessories Available:	Ⓢ 187A-76B type N Adaptor, \$8.00; Ⓢ 187A-76C 10:1 Divider, \$12.50; Ⓢ 187A-76D Blocking Capacitor, \$3.50; Ⓢ 187A-76E 50 ohm T Connector, \$15.00
PRICES:	Ⓢ 185A Oscilloscope, \$2,000.00 Ⓢ 187A Dual Trace Amplifier, \$1,000.00

HEWLETT-PACKARD COMPANY

1021A Page Mill Road, Palo Alto, California, U.S.A.
Cable "HEWPACK"
Hewlett-Packard S.A., Rue du Vieux Billard No. 1, Geneva, Switzerland
Cable "HEWPACKSA" DAVENPORT 5-4451
Tel. No. (022) 26.43.36

NOW! IN EUROPE!

Recently Hewlett-Packard S.A. was established in Geneva, with a branch in Frankfurt am Main, offering technical sales and engineering help and information. Previously established relationships with representatives in other parts of Europe, of course, continue. In addition, there is a new  warehouse in Basel stocking instruments and parts, and an  factory near Stuttgart is producing  instruments for customers throughout Europe.

A McGRAW-HILL PUBLICATION
Vol. 33 No. 2

JAMES GIRDWOOD, *Publisher*

W. W. MacDONALD, *Editor*

JOHN M. CARROLL, *Managing Editor*

Senior Associate Editors: Samuel Weber, Roland J. Charest

Associate Editors: Frank Leary, Michael F. Tomaino, Howard K. Janis, Sylvester P. Carter, William P. O'Brien, John F. Mason, William E. Bushor, Thomas Emma, Sy Vogel, Leslie Solomon, M. M. Perugini, George J. Flynn

Assistant Editors: Michael F. Wolff, Nilo Lindgren, Harold M. McKean

Regional Editors: Harold C. Hood (Pacific Coast, Los Angeles), Harold Harris (Midwestern, Chicago), Thomas Maguire (New England, Boston)

Market Research Editor: Edward DeJongh

Buyers' Guide Editor: George Sideris

Art Director: Harry Phillips

Production Editor: John C. Wright, Jr.

Editorial Assistants: Glaria J. Filippone, Arlene Schilp, Bernice Duffy, Patricia Landers, Carol Weaver, Marian L. Freed, Dolores A. Fornaro, Lorraine Ressi, Dorothy Smith, Virginia T. Bastian

BRUCE A. WINNER, *Advertising Sales Manager*. R. S. Quint, *Assistant Advertising Sales Manager and Buyers' Guide Manager*. Fred Stewart, *Promotion Manager*. Richard J. Tomlinson, *Production Manager*. George E. Pomeray, *Classified Manager*. Hugh J. Quinn, *Circulation Manager*

New York: Donald H. Miller, Henry M. Shaw, George F. Werner.
Boston: Wm. S. Hodgkinson.
Pittsburgh: David M. Watson.
Philadelphia: Warren H. Gardner, William J. Boyle.
Chicago: Harvey W. Wernecke, Martin J. Gallay.
Cleveland: P. T. Fegley.
San Francisco: T. H. Carmady, R. C. Alcorn.
Los Angeles: Carl W. Dysinger, D. A. McMillan, Marshall Freeman.
Denver: J. Patten.
Atlanta: M. Miller.
Dallas: Gardan L. Jones, Robert T. Wood.
London: E. E. Schirmer, Norman Strick.
Frankfurt: Stanley M. Kimes

Issue at a Glance

Business

Missile Interference: Cause and Cure. New range unit operates.....	24
Citizens Radio Crackdown Looms. Sales continue to advance.....	28
Wage Fix Due for Device Makers. Ruling due soon.....	31
Computermen Active in Europe. Common market spurs business....	34
Unit Measures High Altitudes. Uses coincidence circuit.....	37
Shoptalk	4
Electronics Newsletter	11
Washington Outlook	14
Financial Roundup	21
25 Most Active Stocks.....	21
Market Research	22
Current Figures	22
Meetings Ahead	38

Engineering

Back-biasing of base-emitter junction raises collector-emitter breakdown level. See p 48.....	COVER
High-Speed Plotting of Telemetry Data. Magnetic-tape input plotter is described.....	By R. L. Sapirstein 41
More Bandwidth for Magnetic Recorders. Recorder bandwidth is expanded to cover 250 cps to 250 kc.....	By D. R. Steele 44
Transistor Bias Method Raises Breakdown Point. Reverse biasing lets transistors operate with voltages higher than collector rating.....	By A. Somlyody 48
Microwave Terminations. Four major types of terminations tabulated	By G. Bostick 50
Designing High-Power Transistor Oscillators. Step-by-step design for high-frequency transistors.....	By W. E. Roach 52
Reflex Klystrons as Receiver Amplifiers. Microwave-receiver sensitivity improved 42 db.....	By K. Ishii 56
Pulse-Height-to-Digital Converter. Speeds pulse-height data reduction..	By W. Grannemann, C. Longerot, R. Jones, D. Endsley, T. Summers, T. Lommasson, A. Pope and D. Smith 58
Audio Volume Compressor. Transistorized unit improves tape recordings.....	By E. C. Miller 62

Departments

Research and Development. Range Will Aid Antenna Research....	64
Components and Materials. Demand in Europe for Silicon.....	68
Production Techniques. Squeezer Unkinks Transistor Leads.....	72
On the Market.....	78
New Books	86
Literature of the Week.....	90
Plants and People.....	92
News of Reps.....	95
Comment	96

Index to Advertisers.....107



Select from the Line with **ADVANCED DESIGN**

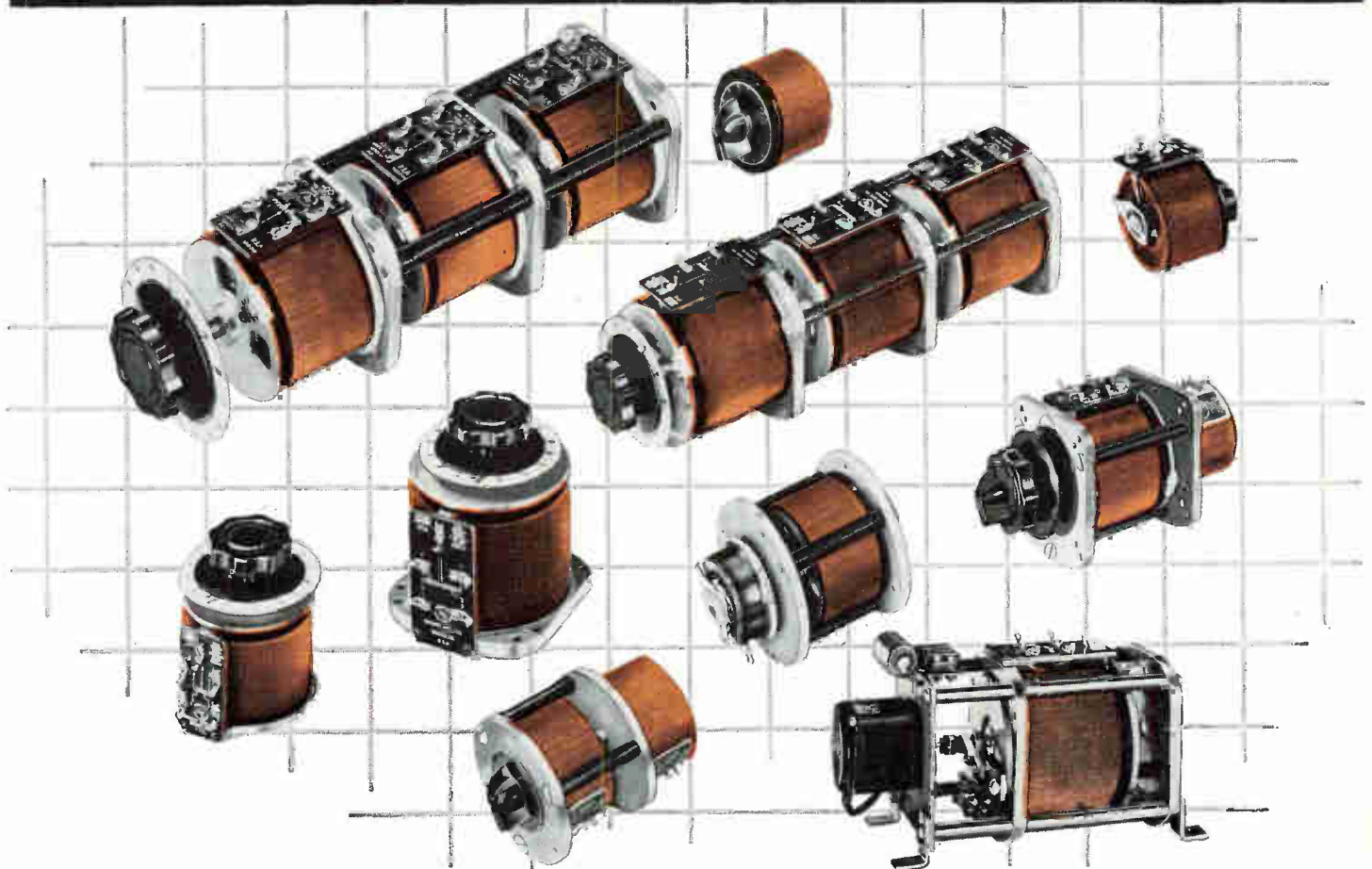

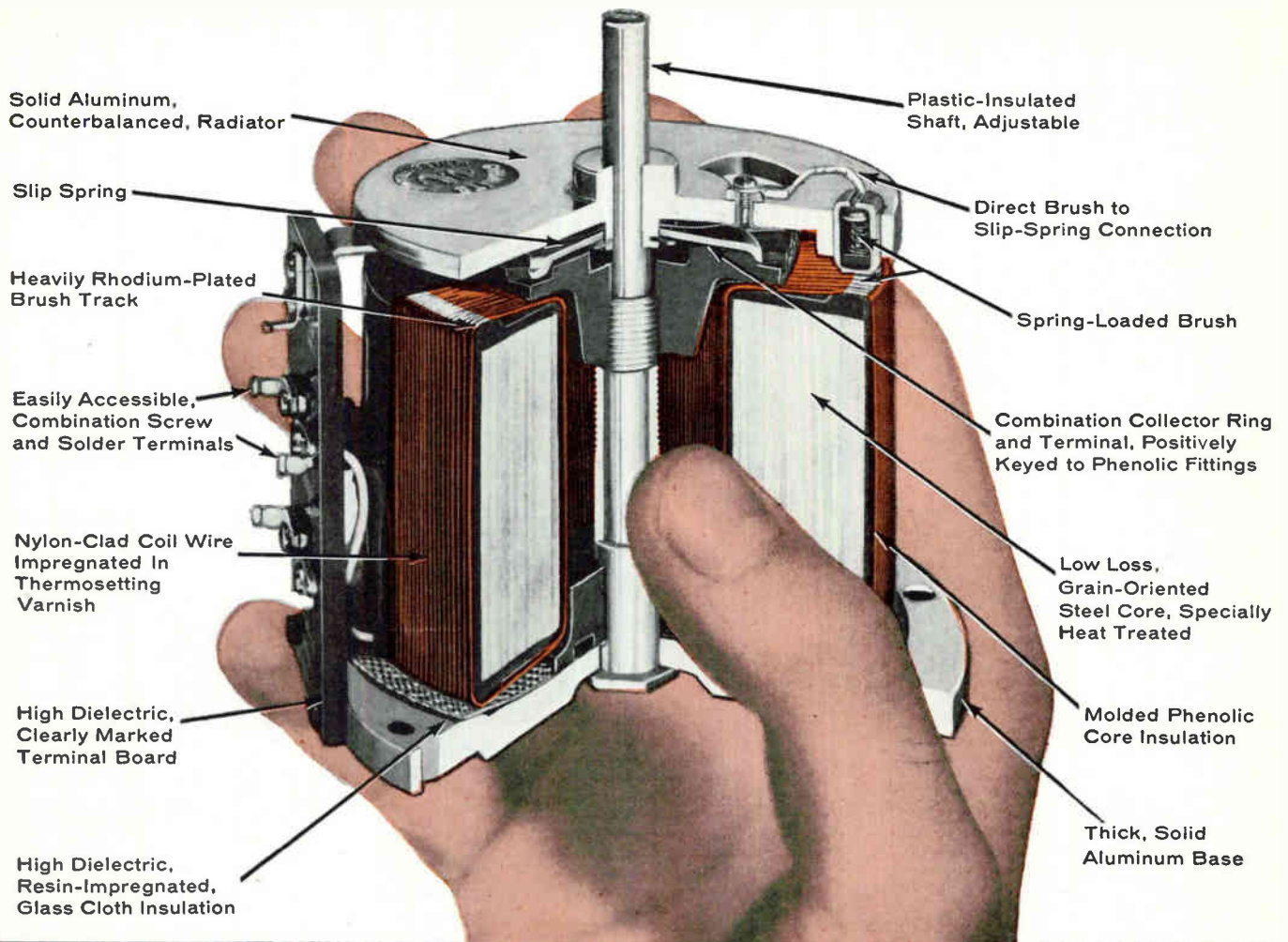

OHMITE® "v.t." VARIABLE TRANSFORMERS

By combining a fresh approach in design with traditional Ohmite quality, "v.t." variable transformers offer convenience features and performance not found elsewhere. They offer top efficiency and high output for their size. Through Ohmite's engineering design, a sizeable bonus in output is available in the "no-overflow" types where voltages above line voltage are not required. These units deliver rated output current at *any* brush setting . . . freedom from wave-form distortion . . . excellent regulation at any point within the rated load . . . unusually long life . . . smooth, maintenance-free operation. They are interchangeable with other makes. Adjustable shafts permit ready conversion to

table or panel mounting. Offered in a diversified choice of cased models.

Moreover, you can get fast delivery from stock on 35 different models covering ratings up to 10 amps. Or, if you desire, select your special requirements from the many modifications possible. Among these are special windings, custom enclosures (including "explosion-proof"), motor-driven assemblies, auxiliary switches, numerous shaft styles, special tandem units, and combination assemblies with other components.

On your next order for variable transformers, try the line with *advanced design*—Ohmite.

Be Right with



OHMITE MANUFACTURING COMPANY

3610 Howard Street, Skokie, Illinois

RHEOSTATS • RESISTORS • RELAYS • TAP SWITCHES

R.F. CHOKES • VARIABLE TRANSFORMERS

TANTALUM CAPACITORS • GERMANIUM DIODES

SHOPTALK . . . editorial

electronics

January 8, 1960 Vol. 33, No. 2

Published weekly, including the ELECTRONICS BUYERS' GUIDE and REFERENCE Issue in mid-June as part of the subscription, by McGraw-Hill Publishing Company, Inc., James H. McGraw (1860-1948) Founder.

Executive, Editorial, Circulation and Advertising Offices: McGraw-Hill Building, 330 W. 42 St., New York 36, N. Y. Longacre 4-3000. Publication Office: 99-129 North Broadway, Albany 1, N. Y.

See panel below for directions regarding subscriptions or change of address. Donald C. McGraw, President; Joseph A. Gerardi, Executive Vice President; L. Keith Goodrich, Vice President and Treasurer; John J. Cooke, Secretary; Nelson L. Bond, President, Publications Division; Shelton Fisher, Senior Vice President; John R. Callahan, Vice President and Editorial Director; Joseph H. Allen, Vice President and Director of Advertising Sales; A. R. Venezian, Vice President and Circulation Coordinator.

Single copies in the United States, U. S. possessions & Canada 75¢; \$1.50 for all other foreign countries. Buyers' Guide in the United States, U. S. possessions & Canada \$3.00; all other foreign \$10.00. Subscription rates—United States and possessions, \$6.00 a year; \$9.00 for two years; \$12.00 for three years. Canada, \$10.00 a year; \$16.00 for two years; \$20.00 for three years. All other countries, \$20.00 a year; \$30.00 for two years; \$40.00 for three years. Second class postage paid at Albany, N. Y. Printed in U.S.A. Copyright 1960 by McGraw-Hill Publishing Co., Inc.—All Rights Reserved. Title registered in U. S. Patent Office. BRANCH OFFICES: 520 North Michigan Avenue, Chicago 11; 68 Post Street, San Francisco 4; McGraw-Hill House, London E. C. 4; 85, Westendstrasse, Frankfurt/Main; National Press Bldg., Washington 4, D. C.; Six Penn Center Plaza, Philadelphia 3; 1111 Henry W. Oliver Bldg., Pittsburgh 22; 55 Public Square, Cleveland 13; 856 Penobscot Bldg., Detroit 26; 3615 Olive St., St. Louis 8; 350 Park Square Bldg., Boston 16; 1301 Rhodes-Haverty Bldg., Atlanta 3; 1125 West Sixth St., Los Angeles 17; 1740 Broadway, Denver 2; 901 Vaughn Bldg., Dallas 1. ELECTRONICS is indexed regularly in The Engineering Index.

Subscription: Address correspondence to: Fulfillment Manager, Electronics, 330 W. 42nd St., New York 36, N. Y. Allow one month for change of address, stating old as well as new address, including postal zone if any. Subscriptions are solicited only from persons engaged in theory, research, design, production, management, maintenance and use of electronics and industrial control components, parts and products. POSITION and COMPANY CONNECTION must be indicated on subscription orders.

Postmaster: please send form 3579 to Electronics, 330 W. 42nd St., New York 36, N. Y.



Member ABP and ABC

AS A NOTE in our Washington Outlook warned last week, there are legislators in Congress who would like to place automation under control of the federal government. These senators and congressmen have the wellbeing of the nation at heart, and they want to remove one of the major gripes of some of the industrial unions. But they're attacking the wrong thing.

Automatic machinery may temporarily displace some workers. However, within another decade this nation will need all the automatic machinery it can produce, as well as every possible worker. It would not be good for government to interfere with the development of automatic industrial systems merely because some unions and some industries seem at this time unable to come to grips with their problems.

Our industry has a large stake in the future of automatic industrial control equipment. When the Senate Labor Subcommittee opens hearings on the steel strike this month, we had better do all we can to make sure that the voice of reason is heard in the committee rooms.

Coming In Our January 15 Issue . . .

NEREM HIGHLIGHTS. As brought out in a recent ELECTRONICS report (p 49, Jan. 1), research and development is one of the fastest growing areas of our industry. This was impressed on New England Editor Maguire and Associate Editor Vogel when they attended the Northeast Electronics Research and Engineering Meeting in Boston recently. At NEREM, they found advanced R&D to be the theme of an extensive technical program.

Next week's conference roundup spotlights several significant design and R&D programs. Leading off a summary of technical papers is the revelation of an impending breakthrough in microwave-tube power. Greater power is anticipated as a result of a new tube design that permits a tenfold increase in tube input and output without a large increase in size or cost. Application of the design is expected to yield average r-f power outputs of 400 kw.

Among other significant developments unveiled at the three-day meeting and described in our next issue are a new crossed-field microwave amplifier, a fresh approach to the problem of stabilizing maser gain and a new semiconductor switch.

FILTER FOR TELEMETERING. Because of the limited number of higher response channels available in missileborne telemetering equipment, it is frequently necessary to commutate signals that have frequency components greater than one-half the sampling rate. To prevent the multiplexer from superimposing interfering sidebands on the signal, it is necessary that a low-pass filter be inserted between the signal source and the multiplexer.

In our next issue, R. C. Onstad of Convair Astronautics describes the design of a transistorized low-pass filter for subaudio frequencies. The filter has a flat response from d-c to 1 cps and an insertion loss of less than 1 db.

FURTHERMORE—A variety of other interesting material coming next week includes: new electron-tube-oscillator mixers for tv and f-m tuners, by E. H. Hugenholtz of Rogers Electronic Tubes & Components; a tabulation of magnetic shift register elements, by J. Porter of Portronics, Inc.; conversion circuits for earth satellites, by D. N. Carson of Bell Labs and S. K. Dhawan of Columbia U.; computer diodes as microwave switches, by M. Bloom of Sylvania, and a multiple-range sweep generator, by H. P. Brockman of Westinghouse.



Get much more information in the ...



new electronics BUYERS' GUIDE

When designs call for products in the field of electronics, the Guide solves problems *in advance*.

There's a 64-page reference section with up-to-the-minute data on markets, materials, components and applications to make product selection easier.

You'll find detailed facts about the products of nearly 700 advertisers — that's 42% more than you'll find in

any other similar guide.

Also local sales offices of manufacturers . . . the names, addresses, and phone numbers of representatives . . . complete lists of manufacturers . . . registered trade names . . . and, of course, the most complete list of electronic and related products. Tells you what you need to know *when you are ready to buy*.



A McGraw-Hill Publication • 330 West 42nd Street, New York 36, New York

New from Superior Tube . . .

ALL-PURPOSE CATHODE ALLOY

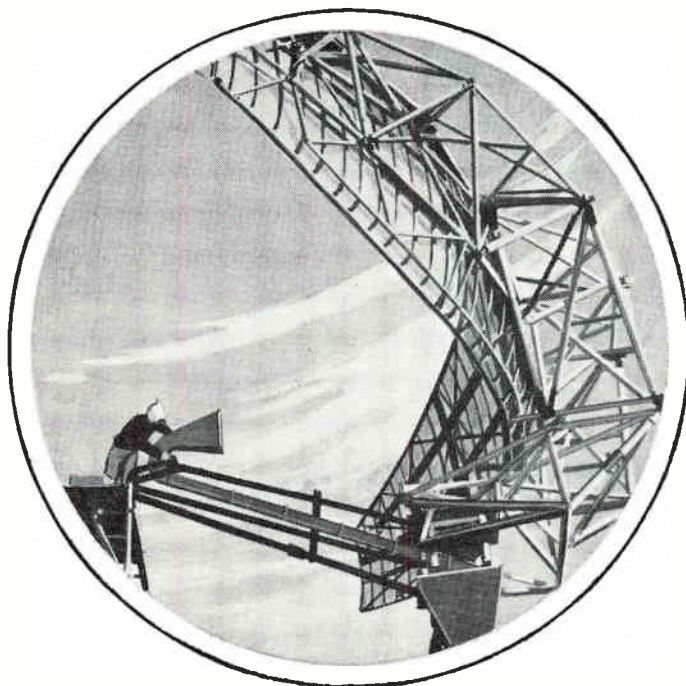

... for pulse application 

... or continuous signal 



THIS IS X-3012* . . . first cathode alloy to do every job well. Use it where you want a passive alloy. It has greater emission capacity. Use it where you want an active alloy. It gives longer life. And look at these other characteristics:

1. Both sublimation and interface impedance reduced practically to the vanishing point
2. Has twice the hot strength of ordinary nickel alloys
3. Longer sustained life even under high current conditions and with overvoltage abuse
4. Good cathode coating adherence
5. Cathodes available from both air-melted and vacuum-melted material

Alloy X-3012 was developed in the electronic laboratories of Superior Tube. It is a combination of nickel, tungsten and zirconium . . . selected from a wide range of different heats as having the most effective proportions of these three metals. Available now in lockseam, lapseam, and Seamless/Weldrawn® cathodes. Write for a detailed technical report. Superior Tube Company, 2500 Germantown Ave., Norristown, Pa. * U.S. Patent No. 2, 833, 647 (Superior Tube Co.)

Superior Tube

The big name in small tubing
NORRISTOWN, PA.

Johnson & Hoffman Mfg. Corp., Mineola, N.Y.—an affiliated company making precision metal stampings and deep-drawn parts

Instruments that Stay Accurate

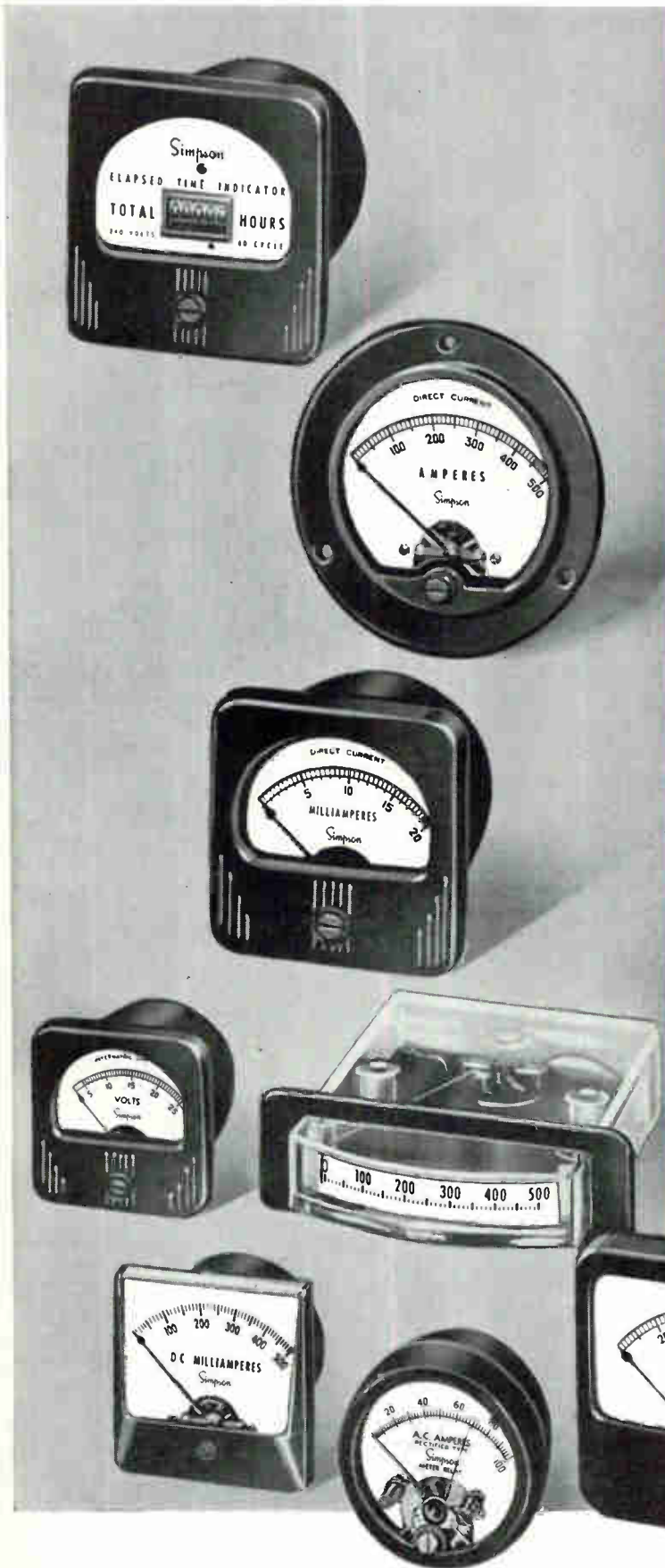

After More Than 600 Separate Inspections — One Panel Instrument

Sounds like a lot of inspecting, but it's one of the things that makes possible Simpson's fine panel instruments.

Take pivots, for example, which support the rotating armature of a meter movement. Because Simpson quality standards are so high, Simpson makes its own pivots which require more than 60 separate inspections during manufacture. Among these are 100% inspection under a 100X microscope and sampling inspection under a 400X microscope to check radius, cone angle, finish and other characteristics. One result is pivot points with a radius tolerance maintained to within .000010". Moreover, Simpson inspects each and every group of pivots for correct hardness so they won't deform under rough use.

Through such meticulous care as this, Simpson is able to offer you panel instruments with accuracy limits that are 100% guaranteed . . . instruments with conservative ratings on which you can rely . . . instruments that *stay* accurate . . . instruments you can specify with confidence.

Write for Catalog 2059A.

Simpson

ELECTRIC COMPANY

5203 West Kinzie Street • Chicago 44, Illinois
Phone: EStebrook 9-1121

In Canada: Bach-Simpson Ltd., London, Ont.



CLARE

NEW...

Clare printed circuit relays,
custom built to **your** design,
offer sensational savings
in space, weight, and cost
for modern data processing
and other high speed
switching devices

Relay mounted on **your** circuit board

This outstanding relay assembly permits single or multiple installation of CLARE mercury-wetted contact relays in the small space of a printed circuit board. It plugs into a console in the same manner as the logic circuit it serves.

It brings to designers of data processing and data logging equipment all the proved advantages of CLARE mercury-wetted contact relays in the smallest possible space. Individual switch capsules and coils are affixed to the printed circuit board and sealed from dust, moisture and tampering by "Skin-Pack," a tough vinyl coating.

Let us show you how we would adapt your board to include either the standard HG relay or the ultra-high speed HGS... as well as other selected components.



CLARE mercury-wetted contact switch hermetically sealed in high-pressure hydrogen atmosphere. Life expectancy over a billion operations.



Each capsule is surrounded by individual coil which is custom-wound to suit the operating characteristics of the customer's application. For full information on CLARE HG printed-circuit relays send for Bulletin CPC-4.

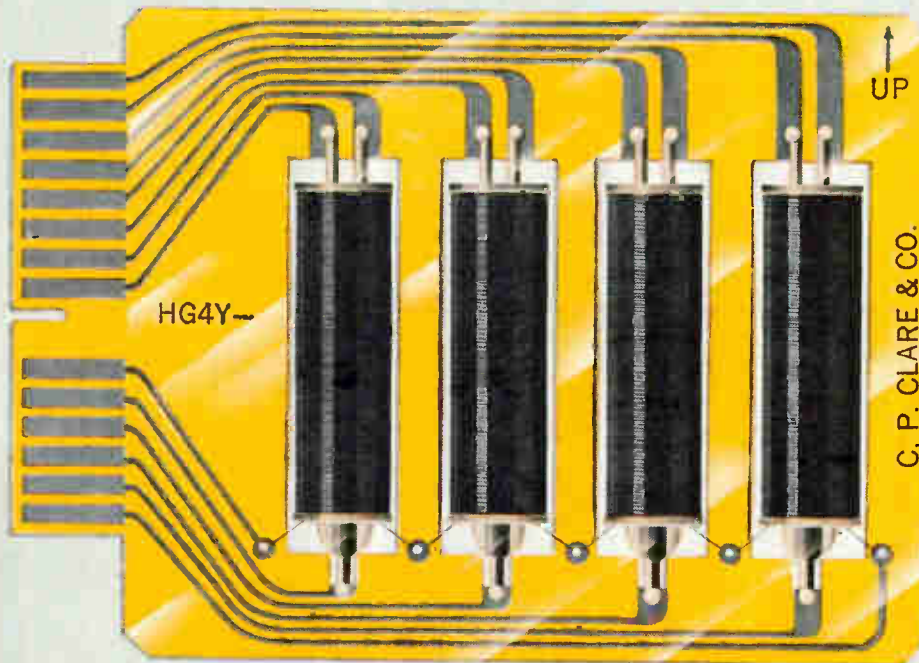

Typical assembly

Send us your printed circuit board

Discover how you can save time, space and money... enhance the performance of your high-speed equipment... with CLARE printed circuit relays. Contact your nearby CLARE Representative, or address: C. P. Clare & Co., 3101 Pratt Blvd., Chicago 45, Illinois. In Canada: C. P. Clare Canada Ltd., P. O. Box 134, Downsview, Ontario.

CLARE RELAYS

FIRST in the industrial field



IN DEFENSE
ELECTRONICS



HOW A 6-YEAR-OLD RADAR STAYS YOUNG

A six-year operational veteran, the FPS-6 is still the principal height-finder for air defense. Fundamentally sound design and built-in capacity for improvement enable General Electric to keep this radar "young."

Contrasted with earlier versions, today's FPS-6 features height line display as a full-time trace. Indicator calibration, sector scan, performance monitoring and azimuth blanking are automatic. The nod angle, formerly fixed, has been made variable to attain more hits per target. A new ferrite isolator increases magnetron life and stability. Noise figure has been improved by nearly 1.5 db.

The sustained effectiveness of this radar at operational sites during six years of a rapidly changing air defense environment is truly an achievement in defense electronics. 227-4

Progress Is Our Most Important Product

GENERAL  ELECTRIC

DEFENSE ELECTRONICS DIVISION
HEAVY MILITARY ELECTRONICS DEPARTMENT

ELECTRONICS NEWSLETTER

TRANSISTORIZED TELEVISION SET will be marketed by Sony Corp., Tokyo, during 1960. Sony will demonstrate the set beginning next week in Japan. New development uses 23 transistors and 14 diodes with an 8-in. picture tube and a built-in folding antenna. Set operates on 100 v 60-cycle a-c or on a self-contained rechargeable 12-v battery, uses 15 w of power. Battery is a 3 amp-hr unit, lasts about 2½ hours. Set weighs 11 lb without the battery (13 lb with), measures 6¼ by 8 by 8¾ inches, will sell for about \$200 in Japan. Sony president Masaru Ibuka names March as launch date for marketing program, hopes to beat his own schedule because "the quickest way to perfection is . . . fair judgment of the public." Plans call for production of 1,000 to 1,500 sets monthly at first, rising to 10,000 sets monthly by yearend. Widely divergent broadcast frequencies and sweep and raster systems in European, Asian and American markets will put a brake on world market exploitation, but Ibuka is confident that the set will ultimately be exported.

Tunnel diode development is pushing to higher frequency of oscillation all the time. This week it was learned that IBM, which had reported reaching 4,020 mc (ELECTRONICS, p 11, p 70, Oct. 30, '59) has attained even higher frequency figures. Researcher R. F. Rutz and his colleagues have attained 5,300 mc at about 1 microvolt, observed a second harmonic at 10,600 mc at a power of about 1 nano watt (1 millimicrowatt) and found indications of a third harmonic at 15,900 mc but have no power measurements.

GALACTIC NOISE MEASUREMENT was one mission of the 4-stage sounding rocket launched from Wallops Island, Va., to a height of 560 miles late last month. First three stages were an Honest John and two Nikes; fourth stage was the X248 rocket engine which will be the third stage of NASA's Delta launch vehicle. The 48-lb payload contained a 3-mc radio receiver to listen in on the galactic noise and telemetry systems to relay noise measurements and performance data on the X248 to earth.

GROUND-VELOCITY INDICATOR which permits sustained automatic hovering and accurate all-weather navigation for helicopters has been demonstrated by Ryan Electronics. New AN/APN-130 is a c-w doppler system designed primarily for aircraft with hovering and negative-speed capabilities—'copters and lighter-than-air ships. Heading, drift and vertical speeds are automatically and continuously measured, according to Ryan, without aid of ground stations, wind estimates or true-air-speed data. Set can handle ground speeds from zero to plus or minus 150 knots.

DIGITAL COMPUTER for industrial control functions will be built and marketed by Westinghouse Electric. Company plans a rugged modular system whose speed, in-out capacity and memory can be

matched to specific industrial needs by addition of functional modules. Westinghouse figures it can crack the industrial market by making a generalized central unit with specialized peripheral gear and by making the system rugged enough to withstand the severe environments of chemical, paper, petroleum and steel industries. As planned, system will accept analog or digital data, operate either continuously variable or on-off controls.

TECHNICAL AID IN CIVIL AVIATION is being provided to the United Arab Republic by Federal Aviation Agency. Project, sponsored by State Department's International Cooperation Administration, aims to help UAR install and operate air-traffic controls, communications systems and civil navigation aids for jets. Program will take two to four years to complete, will cost \$3 million to \$5 million, will include radar approach control (RAPCON), instrument-landing and approach-light systems, vhf omnirange and various types of communications gear.

Patent protection in the Soviet Union can only be achieved by applying for Soviet patents. Gordon Grant, British Comptroller-General of Patents, says. "There is nothing to stop the copying of foreign inventions in the Soviet Union unless they are patented there." Grant recently led a UK delegation to Russia, determined that a new patent law of April, 1959—which gives 15 years of protection contingent on payment of annual renewal fees—is more in line with general world practice than former USSR practice.

INTERNATIONAL COOPERATION in geophysics and related sciences has been placed on a permanent basis. New International Geophysical Committee (CIG, for Comite International de Geophysique) has been set up by the International Council of Scientific Unions to succeed the Committee on the International Geophysical Year and to pursue the IGY pattern of worldwide cooperation. CIG has already mapped plans for the next few years, will keep open three world-data centers now operating, will continue studies of earth sciences, atmosphere and upper atmosphere phenomena. One big project for the next two years: interpreting the masses of data that have been collected since July 1 '57, when IGY began.

MINUTEMAN inertial guidance and flight controls get a \$115-million boost. Air Force has awarded the confirming order to North American Aviation's Autonetics division to cover continued development, fabrication and testing of the solid-fuel ICBM's guidance and control gear, including ground support equipment. Award covers the period from mid-1958 to mid-1961. NAA has already tested preprototypes of the systems. Between 25 and 50 percent of the contract amount will probably be subcontracted, according to NAA spokesmen.

unusual capabilities and stability

64 channels in 60"

On these two pages eight fully transistorized Model 860-1500P Preamplifiers appear actual size—each measures approximately 2" x 7" x 14½". In racks of eight, 64 preamplifiers take only 56" of panel space, and a blower unit another 4". Necessary power and chopper excitation is provided by a completely transistorized Model 868-500P Power Supply that mounts at the rear of each 8-preamplifier unit, so that no additional panel space is required.

INPUT CHARACTERISTICS

Input circuit guarded, floating, isolated from output, can be grounded. Input impedance 200,000 ohms min. (Preamplifier also available at extra cost with 4-step attenuator with gains of 10, 20, 50 and 100 and smooth gain control to reach any intermediate setting.)

BANDWIDTH

DC to 70 cps (-3 db).

RISE TIME

25 ms to 99.9% of steady state value.

OUTPUT CHARACTERISTICS

Floating, independent of input, can be grounded.

Capabilities: ± 1 v across 300 ohms, DC to 70 cps
 ± 1.5 v across 300 ohms, DC to 40 cps

Output impedance 100 ohms. Output is across 300 ohm internal load, shunted by internal 4 mfd capacitance. Part or all of this resistance and capacitance can be supplied externally, in any combination to suit your application.

LINEARITY

$\pm 0.1\%$ of full scale output (2 volts)

GAIN

100 (10 mv input for 1 volt output). Preamplifier with gain of 1000 (1 mv input for 1 volt output) also available on special order. Gain stability $\pm 0.1\%$ for min. of 24 hours.

INPHASE REJECTION RATIO

120 db at 60 cps, 160 db at DC, with 5000 ohms unbalance in source.

INPHASE TOLERANCE

250 VDC, 220 VAC

NOISE

2 uv peak-to-peak referred to input (measured over DC to 100 cps). Noise plus ripple for full scale signal not to exceed $\pm 0.1\%$ of signal (measured wide band-ripple is 880 cps).

DRIFT

± 2 uv referred to input, at constant ambient temperature, after 30 minutes' warm-up. Input drift temperature coefficient ± 0.2 uv/°C, max.

OVERLOAD RECOVERY

Preamplifier recovers from fully blocked condition within 20 milliseconds after removal of signal. 10 volts of signal at input will not damage preamplifier.

POWER REQUIREMENTS

Each Preamplifier requires 2.5 watts; Model 868-500P Power Supply handles up to eight Preamplifiers.

New Data Preamplifier model 860

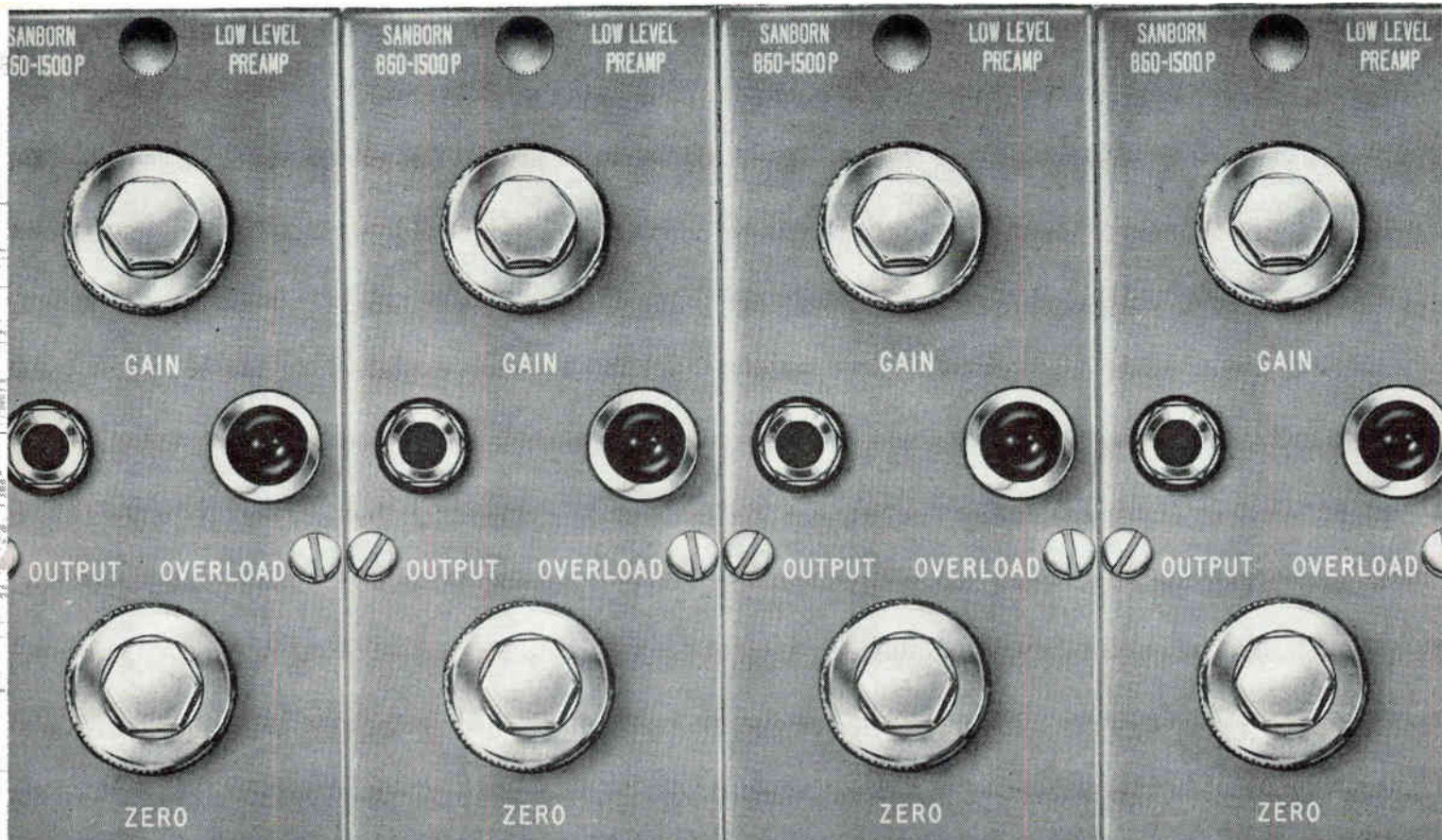

\$462.50
per channel, complete

Each Model 860-1500P Preamplifier costs \$400, each Power Supply for every eight Preamplifiers, \$500. Consider the substantial savings over equipment with comparable specifications — when economy "per channel" is multiplied by the number of channels you're using. (All prices are F. O. B. Waltham, Mass., within continental U. S. A.)

What distinguishes this data preamplifier from others is *not* its specifications *alone*— but the *combination of this performance with high reliability, practical cost and small size.* Together, they make the Sanborn Model 860-1500P the logical choice for data processing systems in which tens or hundreds of channels of information must be handled.

Completely transistorized, the 860-1500P is designed for amplifying low level inputs such as thermocouple, strain gage and resistance bridge outputs. Typical outputs include digital voltmeters, tape recorders, scopes and other readout devices.

Complete engineering data and application assistance is available from Sanborn Company. Contact your nearest Sanborn Industrial Sales-Engineering Representative, or write the main office in Waltham, Mass.



**SANBORN
COMPANY**

INDUSTRIAL DIVISION

175 Wyman St., Waltham 54, Mass.

-1500P



**BARNSTEAD
DEMINERALIZERS**
2500 G. P. H. AND OVER

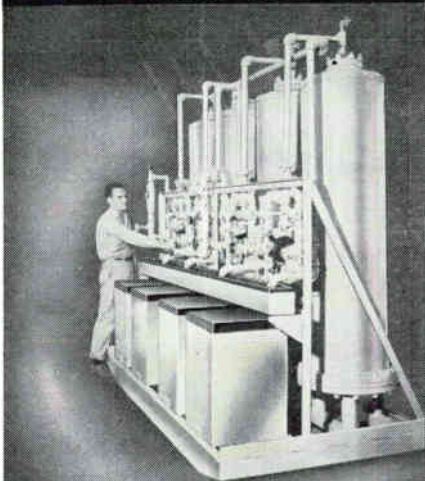

The Barnstead industrial type Four-Bed Demineralizer produces almost three times as much demineralized water as corresponding Two-Bed models with similar flow rate. Shipped completely assembled, ready to connect to raw water supply.

**BARNSTEAD
DEMINERALIZERS**
18,000,000 OHM WATER*

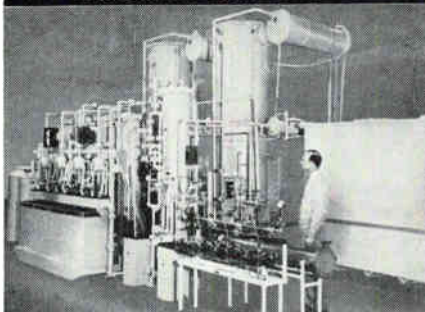

Ionically pure water of 18,000,000* ohms resistance at temperature of 25°C or 26,000,000 ohms resistance at 18°C is produced by the equipment shown above . . . closest thing to HOH absolute—opening up new scientific and industrial frontiers in electronics, nucleonics, chemistry, etc.

**BARNSTEAD
DEMINERALIZERS**
SPECIAL APPLICATION

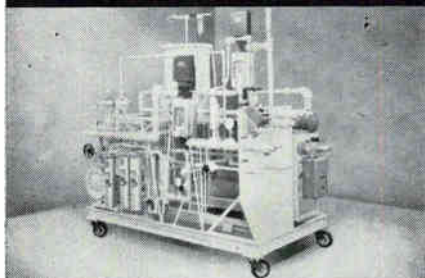

The Cooling Loop (above) maintains ultra pure water at a minimum resistance of 10,000,000 ohms at 25° C. It incorporates a continuous repurification system including oxygen removal, mixed-bed ion exchange, and MF® Sub Micron Filter to remove particles down to 0.45 micron. Write for literature.

Barnstead
STILL AND STERILIZER CO.
84 Lanesville Terrace, Boston 31, Mass.

WASHINGTON OUTLOOK

INCREASING IMPORTANCE of the electronics industry has catapulted it into the political arena. Look for subjects directly pertaining to the industry to pop up in congressional probes with increasing frequency in the future.

The Democrats, starved for election issues in the new year, will be turning with increasing fervor to congressional investigations to provide controversies to harass the Eisenhower administration.

For the electronics industry, the inquiries are likely to have considerable importance reflected in budgets for military and space projects, and in policy for defense in general and defense procurement in particular. The defense and space programs provide the Democrat-controlled congressional probers with the most fertile area to investigate.

Four committees (the Senate and House Armed Services and Space Committees) will be primary investigators. Rep. Overton Brooks (D., La.), chairman of the House Space Committee plans to "probe every facet" of the space program. His objective: To determine whether the U.S. "will take the lead in space exploration or continue to play second fiddle."

The Senate Space Committee, headed by presidential aspirant and Senate Majority Leader Lyndon B. Johnson will likewise conduct a broadgauge inquiry. His special concern: "The drift, delay, and dilution" in the program to develop super rocket boosters such as NASA's Saturn.

Both Committees will be pushing for stronger centralized control over the military and civilian ends of the space program. One scheme under study would involve appointing an executive secretary for the National Space Council with new powers over both Defense Department and NASA projects. The 1958 Space Law provides for such a post but Pres. Eisenhower has never filled it.

- On the military procurement issue, agitation for a greater share of defense business to small firms will increase. A Senate subcommittee headed by Smathers of Florida will play up the question with another investigation.

A broader-ranged inquiry into procurement policy is planned by the Senate and House Armed Services Committees and possibly the Joint Committee on Taxation. This is the study authorized by last year's extension of the renegotiation law; it will delve into buying practices, profit allowances, operation of the renegotiation system and the like.

- On the military budget side, Air Force partisans will seek a show-down on the Pentagon's cutback in manned aircraft programs—B-70, F-108, B-58 and others. The goal: congressional support for reinstatement of funds. The Army will be pushing for congressional backing to start production on Nike Zeus and to boost procurement of a wide range of tactical arms the Pentagon has failed to authorize.
- The Labor Department in the latest edition of its "Occupational Outlook Handbook" reports total employment in the electronics industry at over 450,000 in late 1958—more than double the industry's work force a decade ago. It says 60 percent of industry employment is represented by plant jobs—assembly, machining, and fabricating. About one worker in four in the industry holds an assembly job.

The handbook forecasts "further large increases" in employment in the 1960's. But it cautions that the rise in jobs will "probably not be as great as the expansion in output because technological improvements in production methods are expected to increase output per worker." It implies a leveling-off in jobs for semiskilled workers, predicts a rise for scientists, engineers, technicians and skilled maintenance workers.

SCIENTISTS AND ENGINEERS: There are two sides to the STL coin...

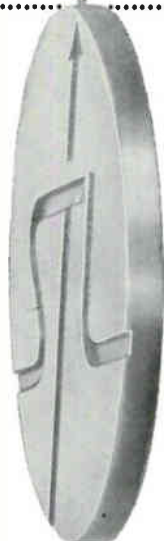

What STL does:

Space Technology Laboratories is making significant contributions in theoretical analysis, research, development and technical management of advanced ballistic missile and space systems. STL conducts advanced space flight experiments under the executive management of the Air Force on behalf of such agencies as ARPA and NASA. In addition STL's leadership in military applications of space technology is illustrated by its successful accomplishments as the contractor responsible for over-all systems engineering and technical direction of the Atlas, Titan, Thor, and Minuteman portions of the Air Force Ballistic Missile Program.



What STL offers:

For scientists and engineers with outstanding capabilities, STL offers unusual growth opportunities in many areas of technical activity, including:

- Electronic and Electromechanical Systems
- Vehicle Engineering and Development
- Propulsion and Guidance Systems
- Computer Technology
- Systems Engineering and Technical Direction
- Telecommunications
- Airborne Systems
- Ground Support Equipment

The Technical Staff of STL is the largest professional group in the nation devoted exclusively to research, development, and systems engineering in the field of ballistic missiles, space projects, and related advanced technology. If you want to apply your skills and talents, in these advanced areas working with leaders in your field, investigate positions at STL now. Please send your resume today to *Mr. Richard A. Holliday*.

*Space Technology Laboratories, Inc., P. O. Box 95004
Los Angeles 45, California*



SPACE TECHNOLOGY LABORATORIES, INC.

CAREERS SAIL SMOOTHLY AT LINK

Far-sighted engineers chart their futures carefully. One who is used to evaluating *all* choices involved in a design problem must be even more discriminating and deliberate in his choice of employment opportunities.

To us here at Link in Binghamton, New York and Palo Alto, California, the conclusion is obvious. Offering projects of keen interest such as Simulation of flight, engines, fuel, fire control, bomb/navigation systems; ASW-AEW; Missile systems and Instrumentation to challenge the mind, and many employment plusses to please the purse, ambitious engineers should look into Link.

Having expanded into these fields from its beginning as pioneers in flight simulation, Link has many positions open to Electronic Engineers with experience in:

- analog computers
- digital computers
- advanced circuit development
- systems analysis
- system design
- instrumentation development

Please send your resume to
Mr. A. S. Darrah

Link Division
General Precision, Inc.
Binghamton, New York

or Mr. C. B. Rutman
Link Division
General Precision, Inc.
P. O. 1318
Palo Alto, California



LINK DIVISION



GENERAL PRECISION INC.

insight at 4 milliseconds

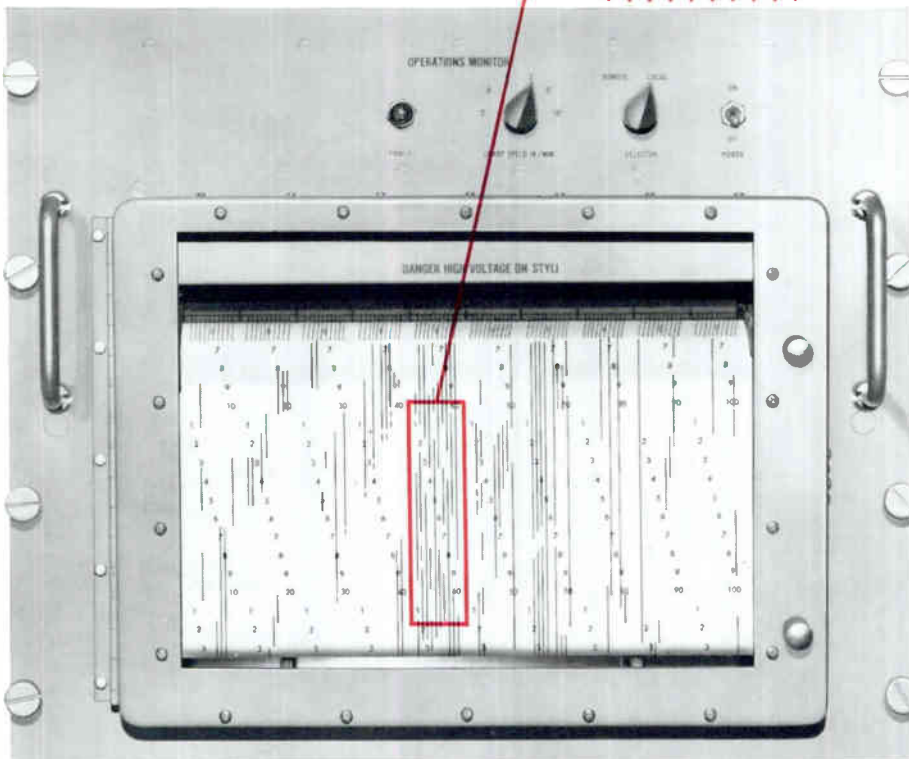
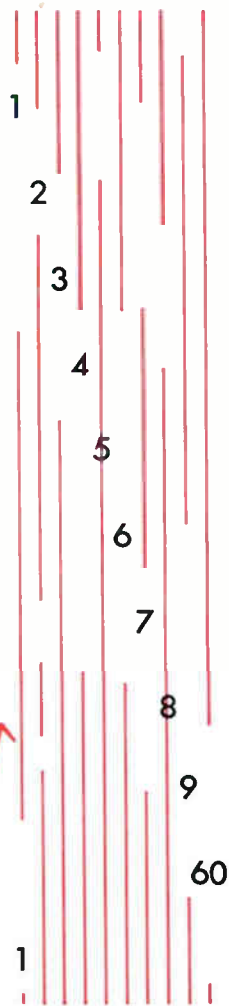

recorded with Brush operations monitors. Multiple high-speed events are reported in writing within 4 milliseconds of occurrence—to establish the basis for split-second, million dollar decisions necessary in today's complex control systems. Up to 120 separate "on-off" event signals are monitored and permanently recorded on a chart only 12" wide. Fixed-stylus electric writing provides sharp, reproducible traces of uniform clarity. Chart speeds from one to 250 mm/sec permit a precise interpretation of all events, with resolution up to 500 signal changes per second. For military or industrial analysis and control, no direct writing recording system can match the capabilities of Brush Operations Monitors. Write today for complete specifications and application data.

brush INSTRUMENTS
DIVISION OF
37TH AND PERKINS **CLEVITE** CORPORATION CLEVELAND 14, OHIO



in direct
writing
systems

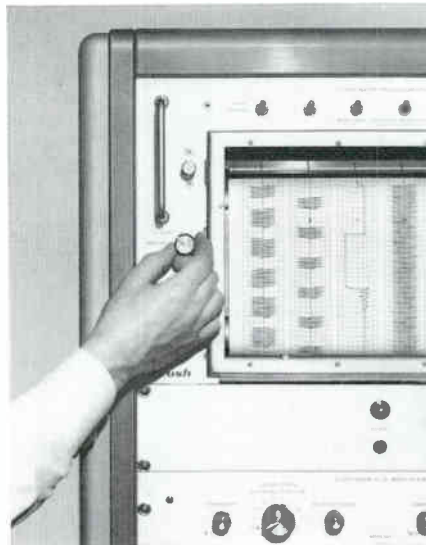

only Brush
eliminates
compromise



Avoid a "second best" choice. Get exactly what you need. Only Brush permits selection of . . . **Writing Method** . . . ink, electric or thermal . . .

Trace Presentation . . . curvilinear or rectilinear . . . **Configuration** . . . vertical or horizontal, rack mounted or portable models. Also . . . chart speeds from 50"/sec to 10"/day . . . functionally designed control panels . . . readily accessible components for fast inspection, simple adjustment . . . complete, easy to understand operating manuals. Get the industry's most advanced design concepts. You never need compromise when you specify Brush. Complete information at your request.

brush INSTRUMENTS
DIVISION OF
37TH AND PERKINS **CLEVITE** CORPORATION CLEVELAND 14, OHIO



Publisher's Price, \$8.00
Club Price, \$6.80

Transistor Circuits and Applications by J. M. Carroll. Detailed information to aid in circuit design.

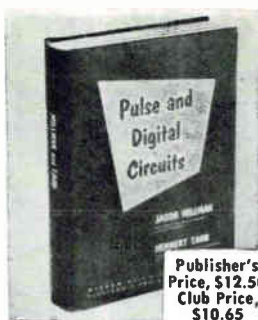

Publisher's Price, \$12.50
Club Price, \$10.65

Pulse and Digital Circuits by J. Millman and H. Taub. Explains circuits for effective system design.



Publisher's Price, \$9.50
Club Price, \$8.10

Sampled-data Control System by J. R. Ragazzini and G. F. Franklin. Covers both analysis and design.



Publisher's Price, \$7.00
Club Price, \$5.95

Operational Mathematics by R. V. Churchill. Theory and applications of Laplace and other transforms.

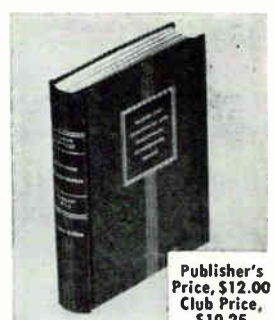

Publisher's Price, \$12.00
Club Price, \$10.25

Electronic Measurements by F. E. Terman and J. M. Pettit. Techniques for use in many electronic fields.



Publisher's Price, \$9.00
Club Price, \$7.65

Modern Physics for the Engineer by L. N. Ridenour. Physical science on which modern engineering is based.

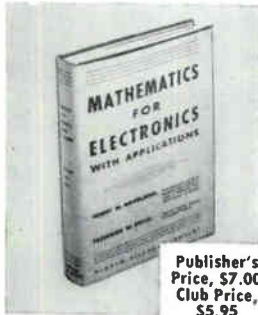

Publisher's Price, \$7.00
Club Price, \$5.95

Mathematics for Electronics with Applications by H. M. Nodelman and P. W. Smith. For solving practical problems.



Publisher's Price, \$7.50
Club Price, \$6.40

Electronic Analog Computers by G. A. and T. M. Korn. How to design and set up problems for computers.



Publisher's Price, \$8.75
Club Price, \$7.45

Handbook of Industrial Electronic Control Circuits by J. Markis and V. Zeluff. Over 300 tested circuits.

To new members of the
**ELECTRONICS AND CONTROL
ENGINEERS' BOOK CLUB**

Special Introductory Offer

ANY ONE FREE

YOURS WITH A CHARTER MEMBERSHIP
AND SENT WITH YOUR FIRST SELECTION

Values from
\$7.00 to \$12.50

Select one AS A GIFT! Choose from *Electronic Measurements*, *Operational Mathematics*, *Pulse and Digital Circuits*, and six other valuable books . . . your introduction to membership in the *Electronics and Control Engineers' Book Club*.

If you're missing out on important technical literature—if today's high cost of reading curbs the growth of your library—here's the solution to your problem. *The Electronics and Control Engineer's Book Club* was organized for you, to provide an economical technical reading program that cannot fail to be of value to you.

All books are chosen by qualified editors and consultants. Their thoroughgoing understanding of the standards and values of the literature in your field guarantees the authoritativeness of the selections.

How the Club operates. Every second month you receive free of charge *The Electronics and Control Engineers' Book Bulletin* (issued six times a year).

This gives complete advance notice of the next main selection, as well as a number of alternate selections. If you want the main selection you do nothing; the book will be mailed to you. If you want an alternate selection . . . or if you want no book at all for that two-month period . . . notify the Club by returning the form and postage-paid envelope enclosed with your *Bulletin*.

We ask you to agree only to the purchase of three books in a year. Certainly out of the large number of books in your field offered in any twelve months there will be at least three you would buy anyway. By joining the Club you save yourself the bother of searching and shopping and save in cost about 15 per cent from publishers' prices.

Send no money now. Just check any two books you want—one FREE and one as your first Club selection—in the coupon below. Take advantage of this offer now, and get two books for less than the regular price of one.

THIS COUPON IS WORTH UP TO \$12.50

The Electronics and Control Engineers' Book Club
330 West 42nd Street, New York 36, N. Y., Dept. L-1-8

Please enroll me as a member of the Electronics and Control Engineers' Book Club. I am to receive my FREE book along with my first selection, both checked at the right. You will bill me for my first selection only at the special club price, plus a few additional cents for postage and handling. (The Club assumes this charge on prepaid orders.) Forthcoming selections will be described to me in advance and I may decline any book. I need take only 3 selections or alternates in 12 months of membership. (This offer good in U. S. only.)

PLEASE PRINT

Name

Address

City Zone..... State.....

Company

NO RISK GUARANTEE: If not completely satisfied, you may return your first shipment within 10 days and your membership will be cancelled.

Check 2 books: We will send the higher priced book as your FREE book:

- Transistor Circuits and Applications, \$6.80
- Pulse and Digital Circuits, \$10.65
- Sampled-data Control Systems, \$8.10
- Operational Mathematics, \$5.95
- Electronic Measurements, \$10.25
- Modern Physics for the Engineer, \$7.65
- Mathematics for Electronics with Applications, \$5.95
- Electronic Analog Computers, \$6.40
- Handbook of Industrial Electronic Control Circuits, \$7.45

L-1-8

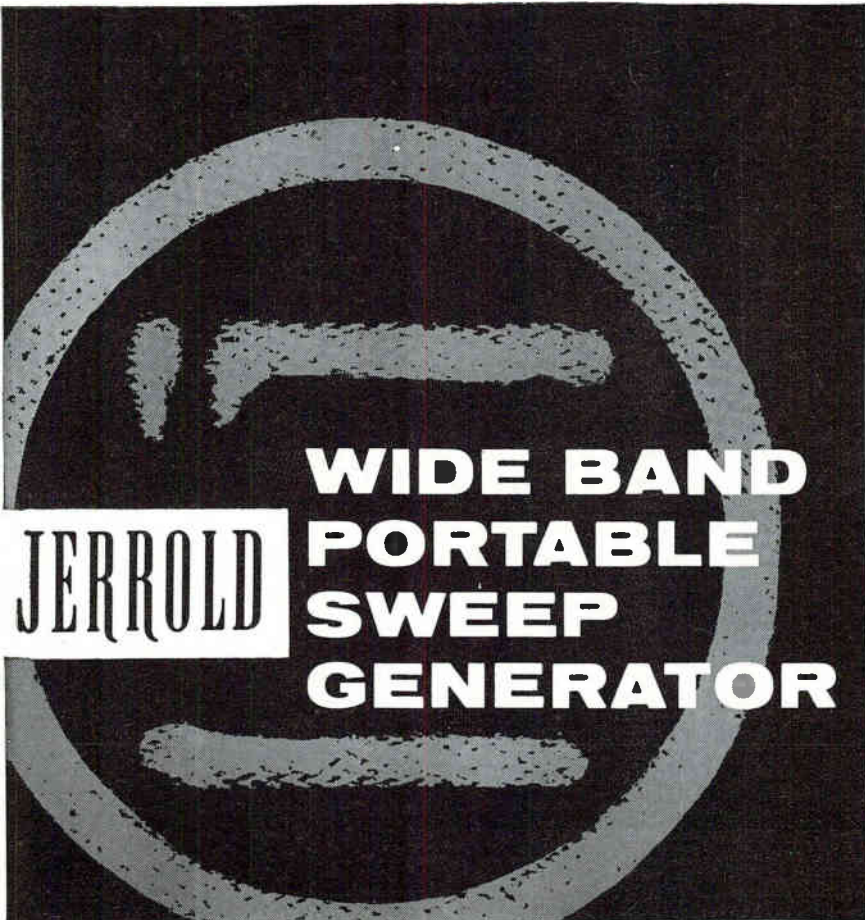

JERROLD **WIDE BAND
PORTABLE
SWEEP
GENERATOR**

**NEVER BEFORE SO
VERSATILE AN INSTRUMENT
AT SO LOW A PRICE!**

\$295⁰⁰

Jerrold's Model 601 and 602 are unexcelled for laboratory and production field use—combining portability and ruggedness with precision performance and versatility usually associated with only the costliest laboratory equipment. NOW ... FULL PRODUCTION ASSURES FAST DELIVERY!

ONE INSTRUMENT COVERS MOST COMMONLY USED I. F. FREQUENCIES

For frequency ranges 12 to 225 mcs ... specify Model 601
For frequency ranges 4 to 112 mcs ... specify Model 602

- All electronic ... saturable reactor sweep circuit
- Fundamental frequency output on all ranges
- Output VSWR less than 1.1
- High output level adjustable by switch attenuators

Write for technical Newsletter #3—circuit and component measurement by bridging loss techniques.



ELECTRONICS CORPORATION, Industrial Products Division
Dept. TED 51 Jerrold Building, Philadelphia 32, Pa.
Jerrold Electronics (Canada) Limited, Toronto
Export Representative: Rocke International, New York 16, N.Y.



**H I G H
OUTPUT!**

601 -1.0 Volt RMS into
50Ω Load
602 -2.5 Volt RMS into
50Ω Load

**W I D E
SWEEP WIDTHS!**

As wide as 5 to 1
As narrow as 1% of C.F.

**F L A T
OUTPUT!**

RF flat within ±0.5 db

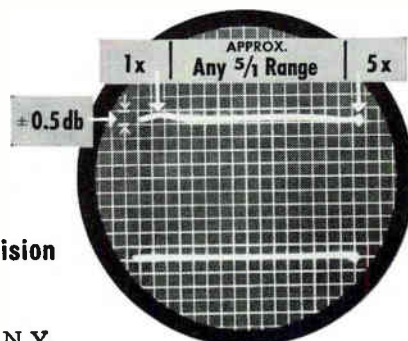

Optimism Keynotes New Year

COLLINS RADIO reports the improved trend in sales and earnings noted in the last half of fiscal 1959 continued in the first quarter of fiscal 1960. The Cedar Rapids company's earnings were \$2,024,317 on consolidated sales of \$42,003,394, unadjusted. This represents earnings of \$1.11 per share on the 1,816,954 shares out.

• **Baird Atomic, Inc.** reports sales increases of more than \$1,300,000 over the previous year, and nearly double the backlog of orders. The sales backlog rose from \$2,400,000 in 1958 to \$4,700,000 in 1959. The combined results of the acquisition of subsidiary companies, increased earnings and new equity raised the Cambridge, Mass., company's net worth from \$3.20 to \$5.44 per share.

• **Laboratory for Electronics**, Boston, shows, in its semiannual report, continued growth in business volume and earnings for the six months ended Oct. 23, 1959. The firm's gross income amounted to \$17,205,000, representing a 132-percent increase over the comparable period of 1958. Net earnings were \$423,000 or 92 cents a share, more than double last year's \$203,000. Backlog is reported at \$27,162,000. This figure represents the present value of letter contracts and will increase by about \$23,000,000 when final contracts are negotiated, according to company officials.

• **Hewlett-Packard Co.** expects to report sales of about \$49 million and earnings of about \$3.6 million, as year-end fiscal accounting takes place. Per-share earnings are anticipated at \$1.11 and will include figures on H-P subsidiaries acquired during the year. The expected figures compare with sales of \$30.3 million and net income of \$2.2 million, or 72 cents a share, in fiscal 1958. Estimated target sales for fiscal 1960: \$60 million.

• **Republic Electronics**, Farm-

ingdale, L. I., reports expectations of \$800,000 in sales in the fiscal year ending April 30, 1960, or about double last year's volume. Receipt of the company's single largest contract—over \$400,000 for an electronic ignition analyzer for Army aircraft—sends the present backlog over \$1 million. Sales goal for next year, according to T. F. LoGuidice, company president, is in excess of \$2 million.

• **Harris - Intertype**, Cleveland, announces completion of the acquisition of **Polytechnic Research & Development Co.** from the Polytechnic Institute of Brooklyn. Purchase was made for 85 percent cash with the remainder in Harris-Intertype stock. The acquisition was made because of H-I's interest in entering the field of microwave test gear in which Polytech specializes.

• **First quarter report from Avien, Inc.**, Woodside, N. Y. shows sales of \$1,269,201, earnings of \$60,225 for period ended Sept. 30, 1959. Same figures for 1958 were slightly higher.

25 MOST ACTIVE STOCKS

WEEK ENDING DECEMBER 24

	SHARES (IN 100's)	HIGH	LOW	CLOSE
El Tronics	1,756	15 $\frac{1}{2}$	13 $\frac{1}{4}$	15 $\frac{1}{2}$
Muntz TV	903	7	5 $\frac{1}{4}$	5 $\frac{3}{4}$
Dynamics Corp Amer	687	12 $\frac{3}{8}$	11 $\frac{1}{2}$	11 $\frac{1}{2}$
Int'l Resistance	630	22 $\frac{1}{2}$	20 $\frac{3}{8}$	20 $\frac{3}{4}$
Avco Corp	626	16	15 $\frac{1}{4}$	16
Gen Electric	607	95 $\frac{7}{8}$	91 $\frac{1}{4}$	95 $\frac{3}{8}$
Raytheon	577	54	50 $\frac{7}{8}$	52 $\frac{3}{4}$
Sperry Rand	573	26 $\frac{1}{2}$	25 $\frac{1}{4}$	25 $\frac{3}{4}$
Ampex	484	123	110 $\frac{5}{8}$	111 $\frac{3}{4}$
Philco Corp	442	33 $\frac{3}{4}$	31 $\frac{1}{2}$	32
Clarostat	425	16 $\frac{3}{4}$	14 $\frac{1}{2}$	15 $\frac{3}{4}$
Reeves Sndcrft	423	12 $\frac{1}{4}$	11 $\frac{1}{8}$	11 $\frac{3}{8}$
Standard Coil	421	18	16 $\frac{3}{8}$	17 $\frac{1}{8}$
Gen Dynamics	405	47	45 $\frac{1}{4}$	46
Spartan Corp	387	8 $\frac{1}{8}$	6 $\frac{3}{8}$	7 $\frac{3}{4}$
Elec & Mus Ind	370	12 $\frac{1}{8}$	11 $\frac{3}{8}$	11 $\frac{3}{8}$
Collins Radio	317	68 $\frac{1}{2}$	63 $\frac{3}{4}$	64 $\frac{1}{8}$
Gen Tel & Elec	280	84 $\frac{1}{2}$	81 $\frac{3}{8}$	82
Litton Ind	272	69	65 $\frac{3}{8}$	67
Beckman Inst	271	69	65 $\frac{1}{2}$	68 $\frac{1}{8}$
Lear Inc	247	207 $\frac{1}{2}$	199 $\frac{3}{8}$	199 $\frac{3}{8}$
Victoreen Inst	236	14 $\frac{3}{8}$	13	13 $\frac{1}{8}$
Univ Control	228	18 $\frac{3}{8}$	17 $\frac{1}{8}$	18
Int'l Tel & Tel	226	397 $\frac{1}{8}$	38 $\frac{1}{8}$	38 $\frac{1}{4}$

The above figures represent sales of electronics stocks on the New York and American Stock Exchanges. Listings are prepared exclusively for ELECTRONICS by Ira Haupt & Co., investment bankers.

NEW
TENTH DEGREE ($\pm 0.1^\circ$)
**PHASE STANDARD
OR SHIFTER**



TYPE 714-A

Secondary

PHASE STANDARD

FEATURES:

- single audio frequency (400 cps standard) to produce known phase angles at output terminals
- use as either a phase shifter or phase standard
- phase angle stability over a variety of operating conditions
- one control—the phase angle selector with choice of 0°, 30°, 60°, 90°, 120°, 150° and 180° or others on special order

... and an extremely useful characteristic for systems application, due to unique design, the 714-A does not require an extremely precise input frequency.

No external calibrating or zeroing controls are required. As one of the output voltages is precisely in phase with the input, it may be used as a phase shifter or phase standard. It may be used to calibrate phase measuring or phase shifting equipment.

SPECIFICATIONS:

- Input Signal: From external source
- Input Frequency: 400 cps. $\pm 5\%$. Other frequencies on special order
- Input Voltage Amplitude: 0 to 10 v. rms.
- Input Impedance: 100K (nominal)
- Phase Angle Accuracy: $\pm 0.1^\circ$
- Output Voltage: 0 to 10 v. rms on each channel (unity gain)
- Output Impedance: Low impedance on each channel (cathode-follower outputs)
- Power Requirement: 105-125 v. rms, 60 cps, 35 W.



Subsidiary of
Technology
Instrument Corp.

Write for full details
ACTON
LABORATORIES INC.
531 Main Street
Acton, Mass.

Magnetic Tape Sales Soar

MAGNETIC TAPE sales in 1960 will increase by 30 to 35 percent over last year, manufacturers report.

They estimate that sales in 1960 will be well over \$40 million, which compares with estimates of the 1959 sales total that vary between \$35 and \$40 million. In 1958 total tape sales were about \$24 million.

Video and precision tape use is increasing rapidly, while use of audio tape is increasing moderately, manufacturers report.

There were 201 video magnetic tape recorders in use at the beginning of 1958 compared with 553 at the end of the year, reports a representative of Ampex Corp., manufacturer of video tape recorders. By end of 1960 Ampex anticipates 850 of the recorders will be in use.

Sales of precision tape used in electronic data processing, telemetering, industrial control, measurement and recording are increasing almost as rapidly as video tape sales, manufacturers claim.

Increasing number of computers manufactured with large tape-storage capacity, growing use of tape-using measuring and recording instruments by military and industry are major factors behind rapidly rising sales of precision tape.

Combined video and precision tape share of total magnetic tape market is probably close to 50 percent today. Year ago, audio tape for radio broadcasting stations and home entertainment had about 60 percent of the tape market.

• Electronics industry will win \$1.6 billion out of \$7.5 billion of Federal Aviation Agency anticipated expenditures through 1970, Electronic Industries Association estimates.

EIA expects annual FAA authorizations to increase from the current level of about \$530 million to \$700 million by 1970. EIA estimates that the electronics share will rise from today's 15 percent to 25 percent by end of a ten-year period.

The Association forecasts that by 1970 annual sales of airborne traffic control equipment for some 110,000 private and executive aircraft will

run about \$30 million.

Electronic equipment now used for air traffic control includes computers, memory drums, digital displays of time and weather information, telephone message recorders and answering devices, high-speed teleprinters, radar indicators, electromechanical calculators and displayboards. In addition, equipment such as long-range and short-range radar, instrument landing systems, radio range stations, radio beacons, location markers and several newly installed electronic computers are taking over some routine arithmetical functions of air traffic controller personnel.

Under its new program of improvement FAA is gradually introducing improved equipment and techniques into the air traffic control system.

Over 550 vhf omnirange stations were placed in operation since the start of the improvement program. By end of 1959 thirteen more VOR's and 62 VORTAC (vor-Tacan) facilities were added and 150 existing VOR's were converted to VORTAC operation.

FAA increased the five long-range radars in operation in 1958 to 40 in 1959. The Agency plans to increase the number of airport surveillance radars from the 47 in use today to 82 by the end of 1961.

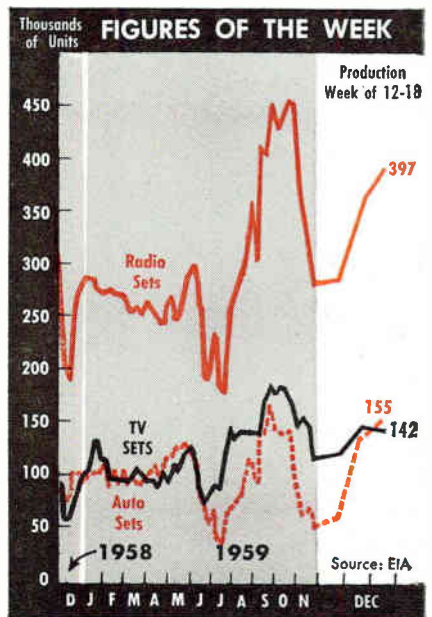

GUARANTEED



CLOSED



OPEN

for
 100,000 CYCLES
 and
 800,000 BREAKS

NEW

miniaturized
solenoid actuated

CAM SWITCH

- ✓ Hermetically sealed
- ✓ Extremely compact, light weight
- ✓ "Reliability engineered" for guaranteed performance
- ✓ Shock & vibration tested in conformance with MIL-E-5272A
- ✓ Operates 24 to 30 volts, DC, at 125°C ambient
- ✓ Rating, 1 amp.
- ✓ Size, 1 3/4" x 1 21/32" x 2 3/4"
- ✓ 7-pole, 18-position shorting with interrupter and homing

Designed to meet standards for guided missile systems, this new Cam Switch is typical of special designs by Tech Labs which can be easily adapted to specific needs. Write for complete data.



TECH
LABORATORIES, INC.®

PALISADES PARK,
NEW JERSEY

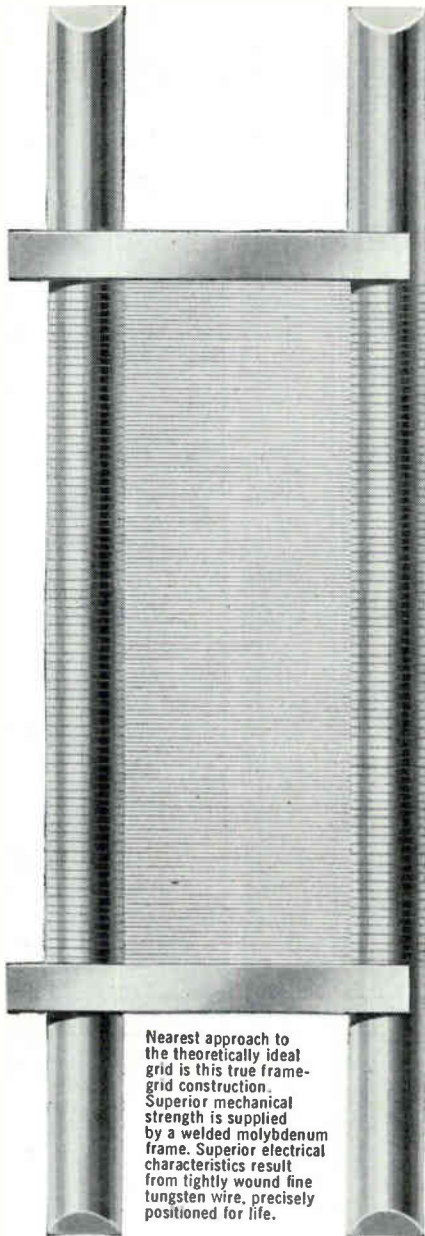

Nearest approach to the theoretically ideal grid is this true frame-grid construction. Superior mechanical strength is supplied by a welded molybdenum frame. Superior electrical characteristics result from tightly wound fine tungsten wire, precisely positioned for life.

ADVANTAGES OF CBS ECC88/6DJ8

- Frame-grid construction
- High transconductance
- High input impedance
- Low noise figure
- Cooler-operating grids
- Trouble-free coiled heater
- Dependable, long life
- Uniform characteristics

CBS ECC88/6DJ8 TYPICAL CHARACTERISTICS

(One Unit)

Heater voltage	6.3 v
Heater current	330 mA
Plate supply voltage	90 v
Grid voltage	-1.3 v
Plate current	15 mA
Transconductance	12,500 μ mhos
Amplification factor	33
Equivalent noise resistance	300 ohms



High-gain Twin Triode



FRAME GRID

ECC88/6DJ8 NOW AVAILABLE

All the advantages of true frame-grid construction are now available from CBS Electronics in the popular ECC88/6DJ8. In new or present equipment, you can benefit from its high level of reliability. In industrial or entertainment applications . . . in instrumentation, industrial controls, nuclear electronics, communications and broadcasting equipment, TV tuners, etc. . . you will find that the CBS ECC88/6DJ8 delivers superior frame-grid performance.

Check the major characteristics . . . constructional features . . . and advantages. Write for complete Technical Bulletin E-369. Order the CBS ECC88/6DJ8 from your local Manufacturers Warehousing Distributor or from any CBS Electronics sales office.



CBS ELECTRONICS, Danvers, Mass.
A Division of Columbia Broadcasting System, Inc.

Sales Offices: Danvers, Mass., 100 Endicott St., Spring 4-2360. Newark, N.J., 32 Green St., Market 3-5832. Melrose Park, Ill., 1990 N. Mannheim Rd., EStebrook 9-2100. Los Angeles, Cal., 2120 So. Garfield Ave., RAymond 3-9081

Missile Interference: Cause and Cure

Constant monitoring of entire radio spectrum is required to keep alien signals from spoiling missile tests

By **G. W. SODERQUIST**, Manager, Special Engineering, RCA Service Co., Patrick AFB, Fla.

ENGINEERS AND TECHNICIANS at the Air Force Missile Test Center at Cape Canaveral, Fla., had been holding a test of the Bull Goose counter-measures missile for four hours and 51 minutes when the word came down to scrub the test. The cause of the delay: interference on one of the telemetry channels to be used in the test.

The source of the interference was never located, and consequently the test had to be put off. This was one of the few cases where spectrum-control facilities at the Cape failed to track down the alien signal. But it and a host of other incidents dramatize the importance of frequency control and analysis to missilemen.

Every missile launched over the AFMTC contains equipment which operates over wide areas of the

radio spectrum. The exact number of channels, and the precise frequencies used, are classified. Furthermore, they vary from test to test. But the office of the Area Frequency Coordinator at Canaveral must control and monitor the frequencies being used whatever they are, and suppress interfering electromagnetic radiation.

Problems

The Bull Goose test that got scrubbed was one of many instances where alien signals either blocked or spoiled a missile test.

A HIRAN transmitter—uhf surveying equipment similar to SHORAN—was using the 230-250 mc band putting out a signal 2.5-mc in bandwidth. It blanketed many of the Cape's telemetry receivers; tests were halted until it was si-

lenced.

An unsuppressed radio in a vehicle operating on the Cape caused one of the AFMTC Mod II radars to lose the missile it was tracking.

A USAF plane using uhf radio caused a tracking telemetry antenna to drop the missile it was tracking and lock onto the aircraft.

A GCA (ground-controlled approach) set at Sanford, Fla., triggered a beacon in a missile. In a couple of freak incidents, a C-band (about 5,000 mc) radar triggered a Jupiter's S-band (about 3,000 mc) beacon; there was no harmonic relationship between the signals. And an X-band (about 10,000 mc) radar triggered a C-band beacon.

Contractor personnel for an air-breathing missile once reported interference; the frequency-control group investigated, found an oscillating power supply in the ground equipment.

No missile has yet been destroyed due to interference, range officials report. But noise in the spectrum has certainly caused trouble, and many of the untraceable "accidents" that have befallen missiles aloft might have resulted from interference.

Frequency Control

Range manager Pan American World Airways subcontracts the planning, engineering and operation of all range instrumentation to

Inside FCA building, masses of monitoring, recording and analyzing gear aid frequency control



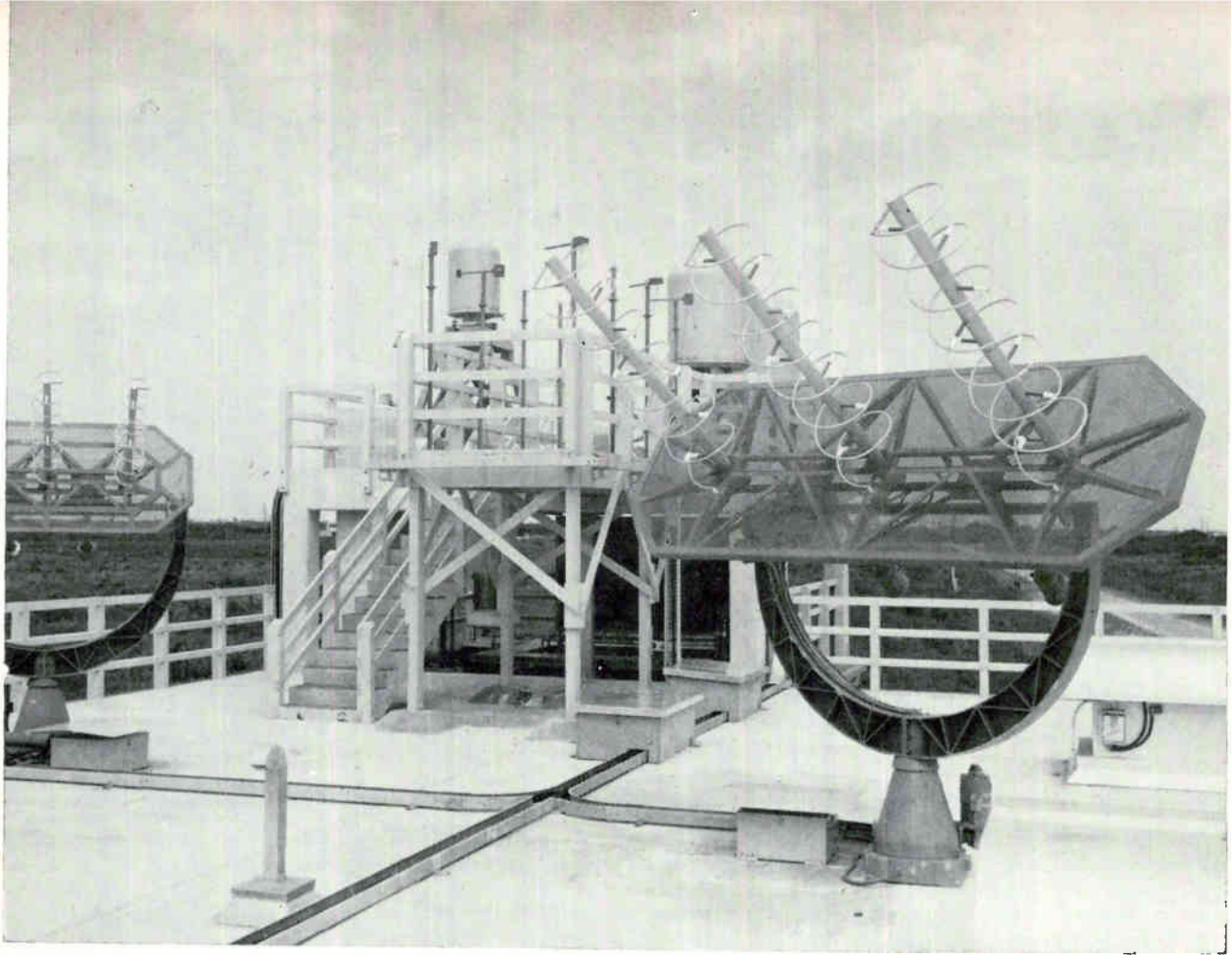

On the roof of FCA building at Canaveral, trihelical antennas get 5-deg fix on interfering signals

RCA Service Co. The subcontractor has set up a frequency control and analysis unit to aid the Area Frequency Coordinator in controlling the airwaves over the 5,000-mile Atlantic Test Range.

Frequencies for use on the range are allocated by the coordinator with the approval of USAF headquarters. RCA makes sure the right equipment is on hand to monitor the frequencies, and range operations schedules the equipment in accordance with the test schedule.

The FCA group operates out of a fully instrumented building in the center of the Cape. Besides the FCA building, there are four vans and six C-131 aircraft outfitted with frequency-monitoring gear.

The vans are located near the test in process, and work in support of the operations in the FCA building. If an interfering signal appears, and the fixed-station gear in the FCA building can't get a good direction fix, range operations scrambles the C-131's.

When airborne, they triangulate on interfering signals in the Florida area until they get an accurate

fix. After the fix, the coordinator takes steps to silence the interference until the scheduled test is completed.

Ultimately, the RCA and Air Force people responsible for instrument procedures hope to be able to shift to noninterfering frequencies instead of imposing restrictions on other users of the airwaves.

Procedures and Equipment

Before and during all missile test flights, the entire radio spectrum from 540 kc to 10,000 mc is constantly monitored. Interference-control equipment—airborne and landbased panoramic receivers and recorders—is adapted from similar reconnaissance and ferreting gear used in the electronic countermeasures field.

The spectrum to be monitored is split into bands, and two antennas, plus sets of preamplifiers, converters and receivers, are used for each band. The 40-to-1,000-mc area, for example, is split into six bands: 40-80, 80-160, 160-320, 320-500, 500-775, and 775-1,000. Eventually spectrum coverage will reach to

12,000 mc and will be accomplished with two basic receivers and two local oscillators.

The six bands in the 40-to-1,000-mc region are displayed on two oscilloscopes, one for the total display and the other with a switching capability for individual display.

The bands are swept automatically at two rates, 60 cps and 1 cps. The fast sweep permits constant surveillance and the slow sweep permits a close look at any interfering signal. On discovery of an alien signal, operators switch to manual and proceed with the analysis of the interference.

All r-f signals radiating on the Cape are analyzed qualitatively. Command signals transmitted to the missiles are constantly monitored and recorded.

Interfering signals are detected within seconds, and frequently can be located in a matter of minutes. Field intensities of any signals can be constantly recorded. Frequency analysis can be performed to accuracies of 0.0001 percent within less than 30 seconds. Direction fixes are generally accurate to 5 deg.

Will tomorrow be a challenge ...or a bore?



If you feel that your present job is not fully tapping your potential, here are 4 new career opportunities for Electronics Engineers that have every bit of the challenge you may be looking for . . .

1 *Site Systems Reliability Engineer:* This position calls for a seasoned engineer capable of integrating and directing on-site reliability assurance activities necessary to secure customer acceptance of the detection system. Unusual combination of technical ability, relations and communications (written and spoken) is

required. Desirable experience includes approximately ten years in design and field installation of transmitters on electronic systems with ability in both electronic and mechanical fields. Ability to motivate technicians for optimum performance is necessary. Salary structure is equal to the challenge.

2 *Radar Equipment Systems Specialist:* This position calls for a creative engineer capable of conceiving and directing the design of long-range radar systems. Desirable experience includes around ten years in

at least one of the following: radar systems design, antenna systems, R.F. components, radar receiver systems or radar data processing systems. Salary structure is equal to the challenge.

3 *Advanced Systems Engineer:* This position calls for a creative engineer capable of defining future defense and space detection problems as well as the ability to conceive and establish the feasibility of optimum systems solutions to these problems—making use of the most advanced techniques and understanding. He must recognize the need for and coordinate the development of new techniques and the exploration of

new phenomena in the area of detection systems. Background desired: Bachelor degree plus a combination of advanced training and several years experience in both the theoretical and practical aspects of detection systems engineering. A desire to work in the conceptual phase of system design with the analytical ability required to evaluate and demonstrate the effectiveness of proposed systems.

4 *Advanced Radar Systems Analysis and Development Engineer:* Engineers are needed who are able to visualize and define future defense and space problems—conceive advanced radar systems to solve them. An advanced degree and/or strong background in system analysis and design is essential. Assignments open

include: analyze and define requirements for advance detection systems and determine broader parameters for such systems, establish their feasibility; analyze long range missile detection systems and specify optimum configuration on the basis of utility, performance, cost and delivery.

228-9

All of these openings are on General Electric missile and satellite detection projects and will be filled with engineers having the capability and desire to make creative contributions.

Write in confidence to T. M. George,
Supervisor—Personnel Administration

Missile Detection Systems Section
HEAVY MILITARY ELECTRONICS DEPARTMENT

GENERAL  ELECTRIC

SYRACUSE, NEW YORK

CIRCLE 27 ON READER SERVICE CARD →

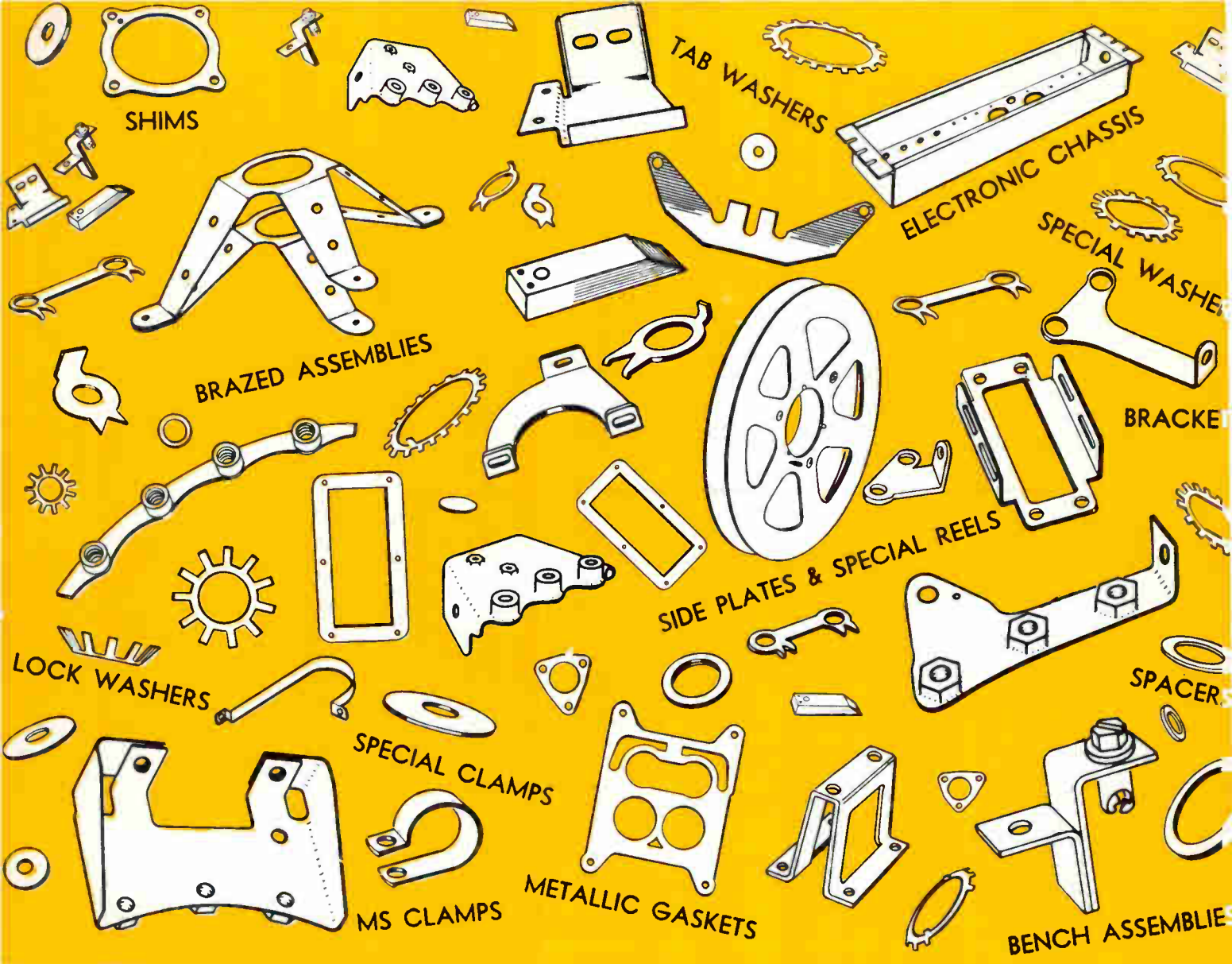

You name it . . . we'll stamp it one or a million @ minimum cost

You'll get better service on Stampings from THE LAMINATED SHIM COMPANY. This is literally true because (a) we've been doing it since 1913, and (b) we've perfected our own special equipment, toolings and techniques—all unknown to

the ordinary stampings shop. Therefore you get exactly what you want, including the degree of precision you need—any contour, often without dies—any size—any quantity—fast, and at a surprisingly low cost—according to our

1

"ONE PLUS" METHOD

Applies when you need just a few pieces for prototypes or experiment. We hold all critical dimensions, yet avoid tooling charges.

2

SHORT RUN METHOD

More than "a few," but less than production quantities. Temporary tooling, simple dies and special presses keep costs down.

3

PRODUCTION RUN METHOD

Applies when quantity, tolerance, size and contour factors justify our standard production tooling and/or nominal die charges.

4

"WATCH DOG" SERVICE

A routine procedure. We re-evaluate repeat orders as to quantity and specs—then use the Method best for you.

Result: lowest possible cost per unit, regardless of quantity. Want more details? And suggestions for ordering Stampings economically? Send for STAMPINGS Folder No. 3—a most helpful reference booklet.



Stampings

DIVISION • THE LAMINATED SHIM COMPANY, INC.

4601 UNION STREET, GLENBROOK, CONNECTICUT

Citizens Radio Crackdown

Indications of tighter control of Class D violators encourage equipment makers seeing 1960 as a springboard to enlarged markets

CRACKDOWN on Class D Citizens Radio may come in 1960 if users don't toe the line, according to Washington spokesmen this week.

Although no provisions are being made at this moment for extra personnel and monitoring equipment, the word is that field offices of the Federal Communications Commission will be watching closely to spot offenders.

A recent sampling of equipment usage among 100 licensees showed 44 were exceeding the distance limitation of 10 miles, 61 were not conducting their communications within the "minimum practicable time." In addition, 57 were off frequency, while over-modulation was found in three cases.

Manufacturers Alert

Producers of Class D equipment are worried about these violation figures. Although manufacturers expect a booming market, they do

not want their equipment to be considered as adult toys.

One manufacturer told ELECTRONICS, his firm is not making any great effort to go after the mass market at this time because of the violation level.

Here are some complaints:

- Licensing—Feeling exists that a Class D license is too easy to get. Frequent contrast is made with the amateur band where a training in the technical and ethical aspects of broadcasting precedes licensing.

- Design—General feeling is that many Class D rigs now in operation are not sufficiently tamperproof. Complainants want to see better frequency control and better safeguards against increasing power

- Education—Many users are allegedly unaware of violations because of a lack of information. Although manufacturers include literature with the equipment, opinion is that public education

should be more intensive

Although no indications exist that there will be much change in present Class D licensing procedures, progress is being made in design and education.

Regarding public education, the main targets will be so-called "hamsters" who confuse their privileges with those of the amateur band. Examples of this are calling "CQ", trying to reach distant stations "just to see if I can do it," general prolonged gossip and experimentation.

Bright Market

Manufacturers are optimistic about the size of the market ahead. There are now about 60,000 licensees in the Class D band. One northeastern company says this is "only a scratch on the surface" of the full potential market.

In actual sales fact today, most Class D gear goes to business organizations with a specific communication need. Construction firms, marine work fleets, surveyors and lumbermen are among important users.

Sales are made chiefly through electronic and electrical distributors who are usually equipped to service the gear.

One notable exception in the cautious attitude toward the wide consumer market is the small-boat and pleasure-craft owner. Retail outlets for pleasure craft often handle the radio equipment.

Do It Yourself

Another pattern emerging is Class D radio selling in kit form. The do-it-yourself trend that has been successful with high fidelity components and other types of consumer electronic equipment is being probed for its value to the Class D radio field. Kits can be purchased for as low as \$34.95.



Pleasure-craft owners as well as a growing number of commercial users are helping to swell the market for Class D radio sales

Looms

Although predictions on the size of the market for kits are being withheld until more evaluation can be made, kit makers are optimistic.

It is likely that next year will see an increase in crystal-controlled gear. Designers, aware of this will have to keep in mind the low-cost level (about \$250) of the Citizens Radio Band's Class D service. Crystal-controlled gear, however, receives type acceptance more readily from FCC than variable frequency units.

Citizens Radio

The Citizens Radio service was established by Federal Communications Commission in Sept. 1958. It is intended for personal or business short-range communications, signaling or control.

The service is open to any U.S. citizen 18 or over, or any company or organization meeting the nationality requirements of the Communications Act of 1934. Citizens Radio service is composed of four classes of operation each having its own frequency and power specifications:

- Class A—Used for voice only in 460.05 to 466.45-mc range. Maximum power input in this class is 60 watts

- Class B—Used for voice and control at 465 mc with a maximum power input limitation of 5 watts

- Class C—Used for control only at specified frequencies in the 26.995 to 27.255-mc range. Maximum power input for the former frequency is 5 watts, for the latter it is 30 watts

- Class D—Used for voice only in channels between 26.965 and 27.225 and 27.255 mc. Maximum power input for all Class D frequencies is 5 watts

Antenna heights for all four classes are kept to a minimum because of the limitation on power output implied in the short-range nature of the Citizens Radio service.

It is the Class D section of the service which has been cited most frequently for violations. This class is intended to be operated with low-cost equipment by a broad segment of the population for business and pleasure. There is a minimum of difficulty in obtaining licenses as no qualifying needs are imposed other than citizenship and age

*When you specify
MASSA you specify
reliability versatility
and...*

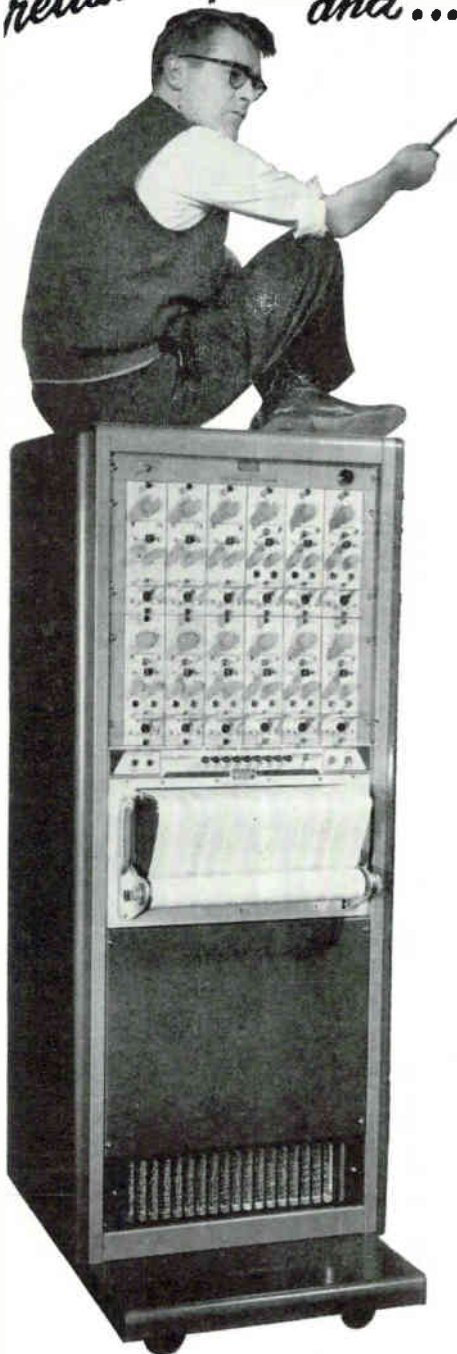

Write for complete information on
High Speed Recording Systems

OTHER MASSA PRODUCTS

TRANSDUCERS
Sonar, Ultrasonic
ACCELEROMETERS
MICROPHONES
HYDROPHONES
AMPLIFIERS

COMPLETE LINE OF MULTI-CHANNEL AND
PORTABLE RECORDING SYSTEMS

12 CHANNEL
DIRECT INK OR ELECTRIC
RECTILINEAR
RECORDING SYSTEM

MORE DATA

PER DOLLAR

This new Recording System, Model BSA-1200, combines all the advantages of rectilinear recording with the economy of ink writing in $\frac{1}{3}$ less space than any comparable system. At an average chart speed of 50 mm/sec., for example, you save \$10,000 every 200 hours in chart costs alone when compared to other rectilinear recording systems. In addition, this system is designed to accept a wide choice of different interchangeable plug-in preamplifiers for each of the 12 recording channels.

ADDITIONAL FEATURES

- High Speed Rectilinear Recording with Ink. Unique pen design provides splatterproof writing to 200 cycles.
- Wide Frequency Range reproduces signals from DC to 200 cps on rectangular coordinate chart paper
- Interchangeable Plug-in Preamplifiers — Low, Medium, High Gain DC, AC, Chopper, Carrier, and Servo
- Automatic one second timer and manual EVENT MARKER
- 18 Speeds — Push-button Controls (Remote control optional)
- Individual Power Supplies and Transistorized Driver Amplifiers for each channel. Prevents cross-talk between channels
- Pen Motor Overload protection
- Interchangeable pens for either Ink or Electric Writing
- Micrometer Pen Motor Adjustments for accurate pen alignment
- Plug-in provisions for remote or centralized control of all functions
- Modular Design throughout for ease of servicing

MASSA

A DIVISION OF

COHU

ELECTRONICS INC

6 FOTTLER ROAD

HINGHAM, MASSACHUSETTS

What did you have in mind, Mr. Engineer?

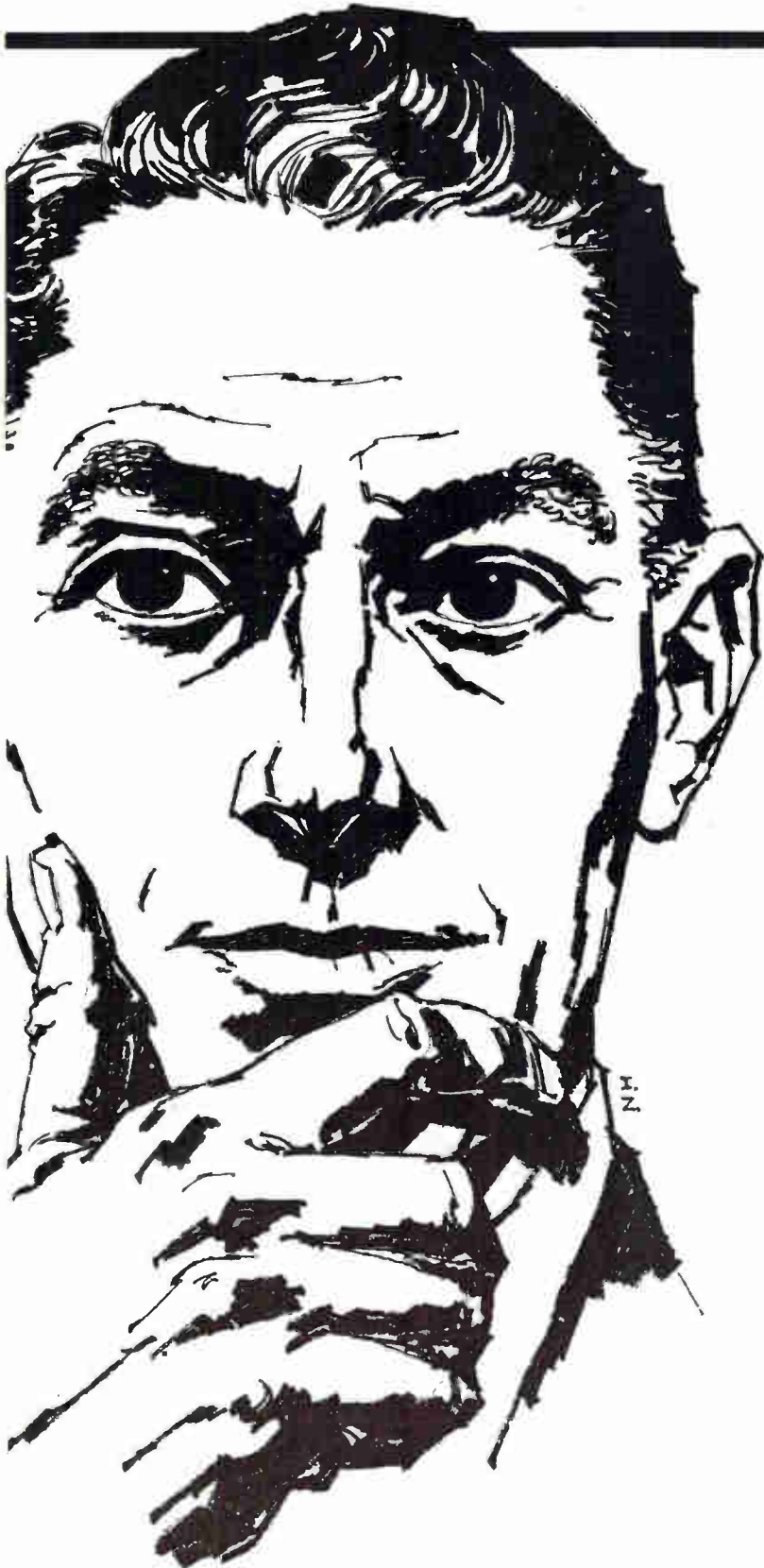

Problems you can really get your teeth into? A job environment where there's *room* to think . . . and *grow*? A secure spot in a fast-growing organization where professional rewards come quickly? Excellent living conditions?

Raytheon Company's Bedford Laboratory offers all these. A key laboratory in the only electronics company with prime contracts for two major missile systems, the Bedford Laboratory is constantly expanding its programs . . . a growth shared by the men who staff it. What's more, it's located in the heart of New England, only minutes from Boston, where relaxed suburban living is only minutes from metropolitan attractions.

In short, Mr. Engineer, you'll *find* what you had in mind . . . at Bedford. Immediate openings for the following men. Can you qualify?

Send your postcard or letter to Mr. Jerry Morris, Professional Employment, Raytheon Company, Missile Systems Division, Bedford, Massachusetts. If you prefer, call (collect) CRestview 4-8884 and ask for Mr. Morris.

Data Handling Engineers with experience in high speed, analog-to-digital conversion techniques, logic design, converter and buffer design. Should have thorough knowledge of tape recorder techniques and digital, servo and digital-computer design.

Circuit Design Engineers with experience in design of high speed switching circuits, pulse techniques, and computer logic. Experience in one of the following areas required: design of navigation, guidance, control circuits, CCM, FM, PCM, PDM, and fusing circuitry.

Packaging Engineers with a knowledge of packaging and production techniques in sheet metal and electronic equipment. Will design electronic portions of guided missiles, radars, computers, test equipment. Thorough knowledge of circuitry required.

Electromechanical Designers will design electromechanical equipment and electronic portions of guided missiles. Will work closely with Design Engineers in developing electronic packaging philosophies. Knowledge of electronics, electronic components, and ability to read schematics required.



**MISSILE
SYSTEMS
DIVISION**

... creates a climate for talent.

Wage Fix Due for Device Makers

Labor Dept. will rule on minimum wages to be paid to workers producing tubes and semiconductors on government contracts

LABOR DEPARTMENT will issue a tentative ruling shortly on minimum wages to be paid production workers in plants making electron tubes and semiconductors on direct government contract.

The spread in wages involved runs from the average \$1.20 hourly rate reported for workers in New England plants making receiving, power transmitting and special-purpose tubes to the \$1.52 national rate the labor unions propose for all types of electron tube and semiconductor plants.

The government ruling will be the first wage determination ever made for the electronics industry under the Walsh-Healey Act. The 1936 law provides for the establishment of a floor on pay rates on government supply contracts of at least \$10,000.

The tentative ruling will be based on a survey of prevailing wages in 157 plants making electron tubes and semiconductors. The survey was made in June 1958 and covered 61,301 workers employed by plants in which electron tubes and semiconductors accounted for at least half of total sales.

Union-Management Dispute

But before the Labor Department sets an official minimum pay rate for the industry, unions and management will be called to a Washington conference—sometime this spring—to air their views on the tentative ruling.

Right now, the tentative ruling is being held up by indecision over two questions:

- Whether the minimum wage should be set on a regional basis, as management wants, or as a national rate. Labor unions espouse the latter approach.

- Whether there should be a uniform rate for all segments of the electron tube and semiconductor industry, as labor prefers, or different rates, as management proposes.

Management wants one rate for



Hand-assembly in power transistor production at GM's Delco Radio division, Kokomo, Ind.

plants making receiving, power transmitting and special purpose tubes, a second one for plants producing solid-state semiconductor materials.

Management also proposes that plants making tv picture tubes, which were covered in the wage survey, be excluded from the Walsh-Healey rate because government purchases are not a significant part of the market.

What the Survey Shows

The government survey showed a median minimum rate of \$1.37 by numbers of plants and \$1.47 by numbers of workers. The Department's tentative ruling will probably be based on an average between numbers of plants and numbers of workers.

The \$1.52 rate proposed by the unions represents a five-cent pay hike over the \$1.47 prevailing minimum wage reported on the basis of numbers of workers 18 months ago.

Regional variations in pay rates showed up as an important factor in the Department's survey. For tubes, a prevailing median rate of \$1.19½ was reported in New Eng-

land; \$1.46 in the Middle Atlantic states; \$1.36½ for the North Central states; and \$1.36 for the rest of the country. These rates represent an average of rates reported by numbers of plants and by numbers of workers.

Also Components and Equipment

Two other Walsh-Healey cases for the electronics industry are also in the mill. One covers functional component parts such as resistors, capacitors, relays and other type of electronic subassemblies and end-items.

The wage survey for the component parts industry is now nearing completion. A labor-management hearing is planned for the spring when results of the survey are known.

The subassembly and end-item determination is still at an early stage. An official wage determination is not likely for at least another two years. A preliminary industry conference was held Dec. 16 to discuss a formal definition of plants to be covered by a survey of prevailing wage rates and the type of questions to be asked.

"That's an extra dividend from our plant's tree farm!"



The same fast-growing forests of hard and soft woods that can supply your Southside Virginia plant for a future unlimited . . . can also supply you with unlimited sport. The same mild climate that cuts your plant building and maintenance costs also gives you a gloriously long season for outdoor living . ■ And it's all within overnight ship-

ping range of New York, Cincinnati, Atlanta and the busy world port of Hampton Roads. For confidential site-finding help in this land of abundant, homegrown manpower, friendly government and pleasant communities, just write, telegraph or telephone VEPCO today.



VIRGINIA ELECTRIC and POWER COMPANY

Clark P. Spellman, Manager—Area Development, Electric Building, Richmond 9, Virginia • Milton 9-1411

SERVING THE TOP-OF-THE-SOUTH WITH 1,990,000 KILOWATTS — DUE TO REACH 2,580,000 KILOWATTS BY 1962



Manson Laboratories, Stamford, Connecticut, designed six GL-7390's into this modulator whose power capability is 78 megawatts peak and 300 kilowatts average.

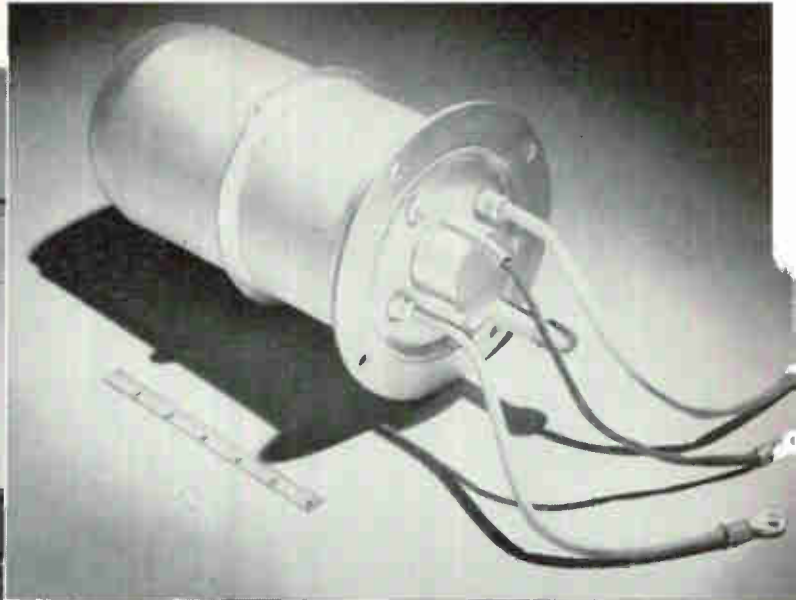

Below are shown the approximate envelope sizes and power outputs of two thyratrons now in use in high-power radar, as compared to the new General Electric tube.

Type 1257

Type 5948

New G-E
Development
(GL-7390)

8 1/2" x 20"

5" x 16"

6" x 11"

Avg. Power 33KW
Peak Power 33MW

Avg. Power 12.5KW
Peak Power 12.5MW

Avg. Power 66KW
Peak Power 33MW

CHARACTERISTICS:

Peak Anode Voltage 33 KV
Average Anode Current 4 amperes
Peak Anode Current 2,000 amperes
Anode Dissipation Factor 30×10^9

Advanced General Electric Hydrogen Thyratron Available **NOW** from Stock!

The new General Electric GL-7390 hydrogen thyratron, which has the highest known power handling capability of any hydrogen thyratron now available, can be shipped immediately from stock. Designed for high-power radar pulse modulators, the GL-7390 features metal-ceramic construction for great mechanical ruggedness, smaller size for important space savings, and ability to switch extremely high average and peak power.

The external anode and grid construction allows direct convection cooling of the anode and grid. Reduced anode and grid temperatures during operation minimize the possibility of arc-back and/or grid emission.

Ceramic-metal construction provides a rugged envelope which enables the GL-7390 to withstand shock and vibration conditions beyond the limits of glass designs. The anode and grid are in the form of solid metal cups solidly brazed to the ceramic body. This is a far stronger design than conventional glass seals and lead supports.

The metal-ceramic construction allows close, accurate, and rigidly fixed spacings of the anode and grid. The result is very reliable high-voltage operation. Application assistance available from your regional General Electric power tube office. *Power Tube Department, General Electric Company, Schenectady 5, New York.*

Progress Is Our Most Important Product

GENERAL  ELECTRIC

9546-8481-23

**TWO OUTSTANDING
HIGH-TEMPERATURE
MAGNET WIRES**



Tetroc

FOR CONTINUOUS OPERATION AT
HOTTEST SPOT TEMPERATURES
UP TO 200°C

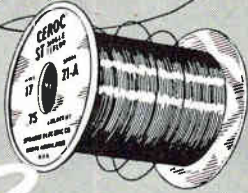

Ceroc

FOR CONTINUOUS OPERATION AT
HOTTEST SPOT TEMPERATURES
UP TO 250°C

For continuous operation at hottest spot temperatures up to 200°C (392°F) and up to 250°C (482°F) for short periods of time—depend upon TETROC—an all Teflon-insulated wire available in both single and heavy coatings.

CEROC is Sprague's recommendation for continuous operation at hottest spot temperatures up to 250°C (482°F) and up to 300°C (572°F) for short periods of time. Ceroc has a flexible ceramic base insulation with either single silicone or single or heavy Teflon overlays. The ceramic base stops "cut-through" sometimes found in windings of all-fluorocarbon wire. Both Tetroc and Ceroc magnet wires provide extremely high space factors.

Write for Engineering Bulletins 405 (Tetroc Wires) and 400A (Ceroc Wires).

SPRAGUE ELECTRIC COMPANY
35 Marshall Street, North Adams, Mass.

SPRAGUE[®]
THE MARK OF RELIABILITY

Computermen Active

American and British companies step up sales, promotional and service activities. All types of computers are in demand



Desk-size computers—like this Burroughs E101—are among units finding a ready market in Europe

COMPUTERMAKERS are showing signs of increased activity in Europe as 1960 begins. Computers of all sizes are being sold and demand on the time of data-processing centers is apparently brisk.

American manufacturers are generally optimistic about opportunities in both the six-nation common market and the seven-nation European Free Trade Area. British manufacturers are making big strides too, with the British government an important sales factor.

Market Contenders

Among recent computer activities in Western Europe were these: Burroughs has staked out a claim in the European medium-computer market with a Burroughs 205 installation for Compta Technic, an independent business-data-processing house in Paris.

The 205, leased from Burroughs for an initial period of two years, will be used for bookkeeping, payroll and business statistics operations for the French firm's clients,

principally banks, insurance companies and chain stores. A second computer is on tap next year for the University of Vienna, which will use the computer for scientific problems and training.

"There is opportunity for considerable expansion, particularly in the business uses of desk-size digital computers," says E. G. Wallace, general sales manager of Burroughs' international division. The company has computer centers in London, Paris, Brussels, Zurich and Frankfurt using its E101 desk-size computers, and has sold others to European concerns.

But Burroughs believes the growing familiarity of European management with the use of electronic computers in various operations and cost controls will boost the market for all types of computers.

Remington Rand, which sold its first Univac solid-state computer to a West German bank in October 1958, now reports that it has 19 of the medium-sized machines operating in Europe.

in Europe

"This great demand for the new solid-state computer will mean increased expansion of our activity abroad," says C. W. Riefel, assistant general manager of Remington Rand's international division. He said the company has received 80 foreign orders for the Univac solid-state computer, mostly from Europe.

Remington Rand operates two computer centers in Zurich, Switzerland, and Frankfurt, West Germany, through subsidiary firms, and expects to open additional centers soon in other major cities.

IBM World Trade Corp. last month opened a computer center in Dusseldorf, its second in West Germany and ninth in Europe. The company recently reported that it had made changes in its European manufacturing operations to adapt them to loosening trade restrictions in Europe and to "develop greater productivity."

Optimistic View

Arthur K. Watson, president of IBM World Trade Corp., declared that "the creation of the European Free Trade Area Association and the Common Market causes our company to take a most optimistic view of the future."

Britain's Ministry of Pensions and National Insurance recently ordered a \$1.5 million E.M.I. Electronics Emidec 2400 computer installation to process pension data for some 25 million people.

Seventeen fast-access one-inch-wide magnetic tape decks will provide the immediate memory, while back-up data storage will comprise five 2,400-ft-long, 4-in. tape storage units. The latter contain names and addresses, amount of each contribution, totals paid to date for each insured person.

Daily four-hour computer run will extract information on persons reaching retirement age that day, with print-out at a rate of 3,000 lines a minute.

British Petroleum Co. has ordered a \$700,000 Ferranti data-processing system based on the Mercury computer for both commercial and scientific use.

New Miniature Tantalum Capacitors for 125 C Operation Without Voltage Derating

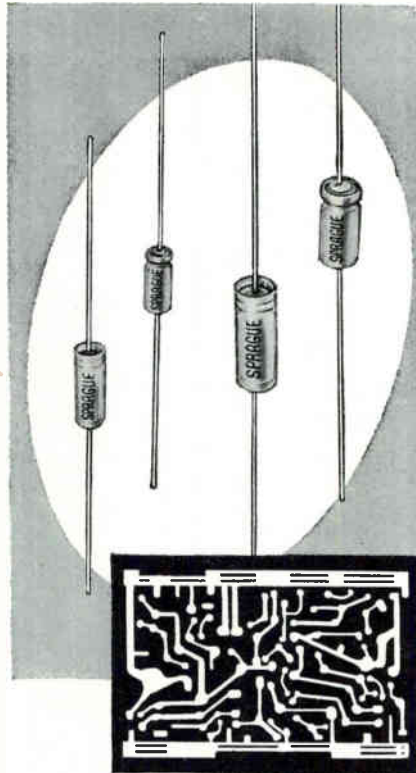

A new series of reliable tantalum capacitors has just been developed by the Sprague Electric Company to meet the vibration and 125 C operation requirements of military and industrial applications.

The remarkable electrical stability of these new Type 130D Wet-Electrolyte Tubular Sintered-Anode Tantalex[®] Capacitors is the result of special aging, the use of inert materials, and a low diffusion seal. Construction is designed to meet 2000-cycle military missile vibration requirements. Shelf life is excellent. Shoulder-less shape simplifies mounting on printed wiring boards.

For complete technical data, write for Bulletin 3701 to Technical Literature Section, Sprague Electric Company, 35 Marshall St., North Adams, Massachusetts.

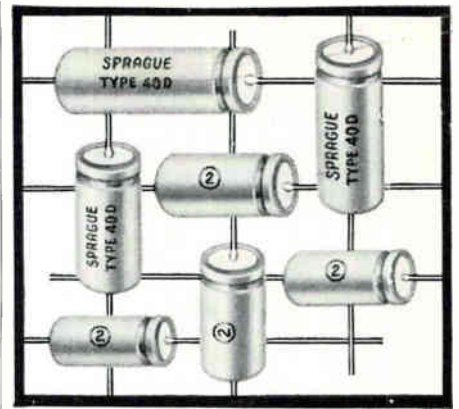

EXTENDED-LIFE TUBULAR DRY ELECTROLYTICS

—the most reliable
miniature tubular
aluminum electrolytics made!

Now...for the first time...an extended-life electrolytic in miniature tubular case styles. Sprague's New Type 40D Tubular Aluminum Electrolytic Capacitors are designed to give more than 10 years of service under normal operating conditions in actual circuit use.

Though similar in many respects to Sprague's famous extended-life telephone and communications electrolytics, these capacitors have broader application because of their low temperature characteristics.

Construction assures freedom from open circuits even after extended periods of operation in the millivolt signal range. Ultra-low leakage currents are the result of special design and processing techniques based on the use of the highest purity anode and cathode foils.

Write for Bulletin 3205 to Technical Literature Section, Sprague Electric Company, 35 Marshall St., North Adams, Mass.



On or off... at a touch

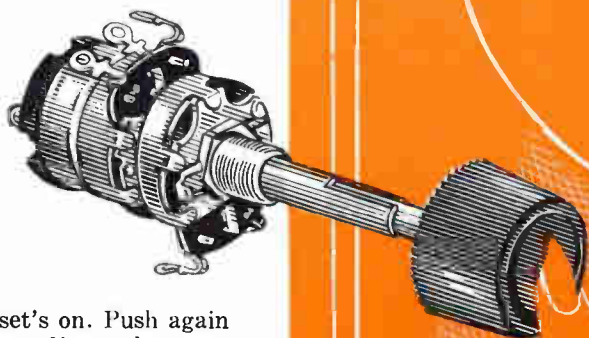

Push a knob . . . the set's on. Push again . . . it's off. No need to readjust volume . . . no undue wear on the control element. It's the new Mallory touch-control switch—a new convenience feature you can put into your TV, radio, stereo and hi-fi designs.

This is the only touch-control switch rated at 5 amps, 125 volts AC, instead of the usual 3 amp rating . . . and at no extra cost . . . ideal for multiple speaker systems.

Mallory supplies this new switch on all variations of controls—dual concentric, tandem dual and single . . . in any combination of single and dual sections. We can furnish the exact style of shafts, bushings and terminals that your designs require.

Mallory ingenuity in engineering controls with various types of hardware, switches and configurations can often save you a big percentage of your control costs. Our engineers will welcome the chance to work with you. Write us today.

Mallory Controls Company
Frankfort, Indiana
a division of

P. R. MALLORY & CO. Inc.
MALLORY

See Mallory Controls Company for



wire-wound
controls

vitreous
resistors

power
rheostats

rotary
switches

plugs
& jacks

New Unit Measures Altitude

Radioisotope density altimeter is designed for missiles and fast new aircraft

NEW RADIOISOTOPE density altimeter for missiles and high-performance aircraft will utilize an improved technique, according to developer Boeing Airplane Co.

The altimeter consists of a probe, a radioactive source, a detector and electronic circuits. The experimental probe is a 30-in. precision-machined aluminum or Lemamine tube with a rounded nose. The radioactive source is a beta-emitting radioisotope with a long half-life such as carbon-14 or promethium-147. This is secured in a rectangular frame mounted in a sampling window in the side of the probe.

The back-scattered particles are detected by a Stilbene-impregnated plastic scintillator mounted within the source frame. The scintillations are sensed by a multiplier phototube, amplified, and counted by a scaler.

Coincidence Circuit

The measured count rate from a four-millicurie source of Pm-147 varies from 161,220 counts per minute at 10,000 ft to 17,000 cpm at 66,000 ft.

Boeing has designed and constructed a coincidence circuit to improve the signal-to-noise ratio by comparing the signals from two multiplier phototubes that are responding to the same source. The possibility of using an ionization chamber to detect back-scatter also is being considered.

Most existing altimeters seek to measure atmospheric pressure. Extensive calibration of the pressure sensors is necessary to compensate for aircraft design and for the design and location of static and dynamic pressure ports. Air must be taken outside of the plane to the sensing device inside. The difficulty in achieving this is magnified with increasing air speed.

Static-port inaccuracies also are common to ionization-chamber instruments such as the Alphanon, which determines a density altitude by ionizing a sample of air inside a

special chamber connected to a static port.

Static-port error can be circumvented if a useful parameter of the air mass can be measured outside the plane. Boeing's altimeter yields a density-measurement error which is directly proportional to the density. While the pressure-altitude error increases with altitude, the density-altitude error decreases up to the point where cosmic and electronic noise becomes significant.

Shift at 25,000 Ft

After a meteorological analysis, Boeing concluded that the advantages of both pressure and density could be utilized by shifting from a pressure to a density system at approximately 25,000 ft. The pressure altimeter is most accurate at altitudes below 15,000 ft, while the density altimeter operates better above 25,000 ft.

Identifies Planes

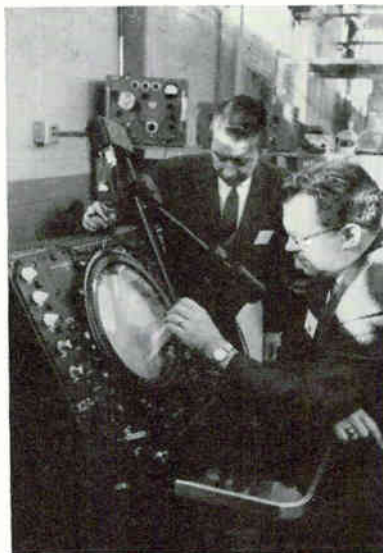

New electronic aircraft identification system is explained to Associate Editor William P. O'Brien (standing), by project engineer J. Farruggio of Radio Receptor Co. Specialized transponders allow planes interrogated by radar to be identified by a code number which appears when scope display "blip" is pinpointed by an optical viewer

D-C POWER

Precisely Regulated for
Missile Testing and
General Use



CHRISTIE SILICON POWER SUPPLIES

available in 30 standardized and militarized models from 30 to 1500 amps... 6 to 135 volts. CHRISTIE'S QUALITY CONTROL is approved by the A.E.C., leading aircraft and missile manufacturers.

Write For Bulletin AC-58-A

**CHRISTIE
ELECTRIC CORP.**

3410 W. 67th Street
Los Angeles 43, Calif.

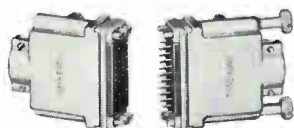

93 SERIES
34, 42 & 50 crimp Poke Home contacts. With housings or as inserts.

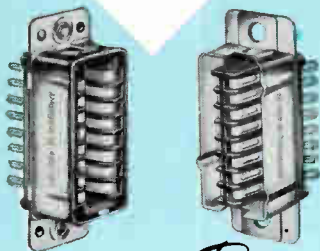

BLUE Ribbon
Remarkable "ribbon" contacts — smooth action, top electrical efficiency.

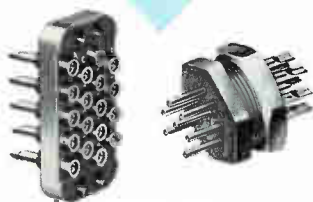

MINIATURES
Hex. and rectangular configurations with 4 to 34 gold-plated contacts.

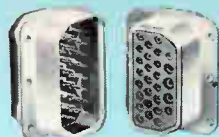

94 SERIES
15 to 63 crimp Poke Home contacts. Coax connectors in 2 inserts.

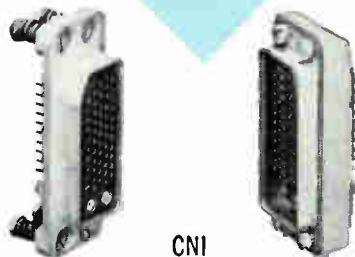

CNI
Environmentally sealed connectors for airborne applications.



Micro RIBBON
Miniaturized "ribbons" with increased reliability up to 50 contacts.



RECTANGULARS
11, 15 & 20 contacts. Available with housings or as separate inserts.

MOST COMPLETE LINE OF RACK & PANEL CONNECTORS — AVAILABLE ONLY FROM AMPHENOL

7 FAMILIES OF ULTRA-RELIABLE RACK & PANEL CONNECTORS



CONNECTOR DIVISION

Amphenol-Borg Electronics Corporation

CHICAGO 50, ILLINOIS

MEETINGS AHEAD

Jan. 11-13: Reliability & Quality Control, National Symposium, ASQC, IRE, EIA, AIEE, Statler Hotel, Washington, D. C.

Jan. 31-Feb. 5: Comparison of Control Computers, Winter General Meeting, AIEE, Statler Hilton Hotel, New York City.

Feb. 1-4: Instrument-Automation Conf. and Exhibit, ISA, Sam Houston Coliseum, Houston, Texas.

Feb. 3-5: Military Electronics, Winter Convention, Biltmore Hotel, Los Angeles.

Feb. 10-12: Solid-State Circuits Conf., AIEE, IRE, Univ. of Penn., Hotel Sheraton, Philadelphia.

Feb. 11-13: Electronic Representatives Assoc., Annual Convention, Drake Hotel, Chicago.

Feb. 20-29: Component Parts and Electronic Tubes, International Exhibition, Porte de Versailles, Place Ballard, Paris.

Mar. 21-24: Institute of Radio Engineers, National Convention, Coliseum & Waldorf-Astoria Hotel, New York City.

Apr. 4-7: Nuclear Congress, EJC, PGNS of IRE, New York Coliseum, New York City.

Apr. 11-13: Protective Relay Engineers, Annual, A&M College of Texas, College Station, Texas.

Apr. 18-19: Automatic Techniques, Annual Conf., ASME, IRE, AIEE, Cleveland-Sheraton Hotel, Cleveland.

Apr. 20-22: Southwestern IRE Conf. & Electronics Show, PGME of IRE, Shamrock Hilton Hotel, Houston, Texas.

May 3-5: Western Joint Computer Conf., Jack Tar Hotel, San Francisco.

Aug. 23-26: Western Electronic Show and Convention, WESCON, Ambassador Hotel & Memorial Sports Arena, Los Angeles.

There's more news in ON the MARKET, PLANTS and PEOPLE and other departments beginning on p 78.

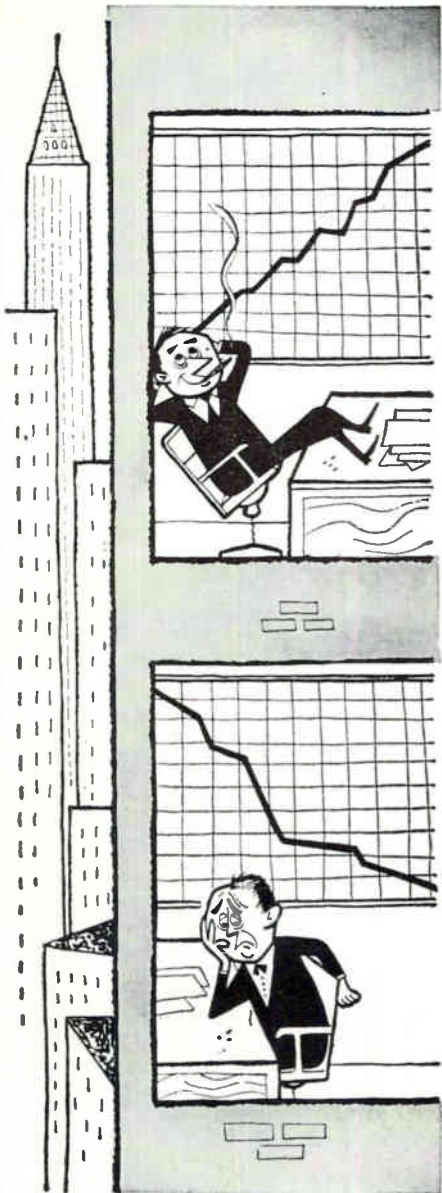

WHO'S MAKING OUT BEST?

A quick, 3-minute Financial Round-up that names electronics companies that have achieved substantial financial gains. Tells where they are and what they make.

Fast visual summary of active stocks each week in the electronics industry. New public issues. Stock price averages.

This highly readable score card helps keep you informed on what counts most on the financial front. This is just one more reason why you should subscribe to *electronics* (or renew your subscription). Fill in box on Reader Service Card. Easy to use. Postage free.

FIND WHAT YOU NEED IN... *electronics*

ELECTRONICS • JANUARY 8, 1960

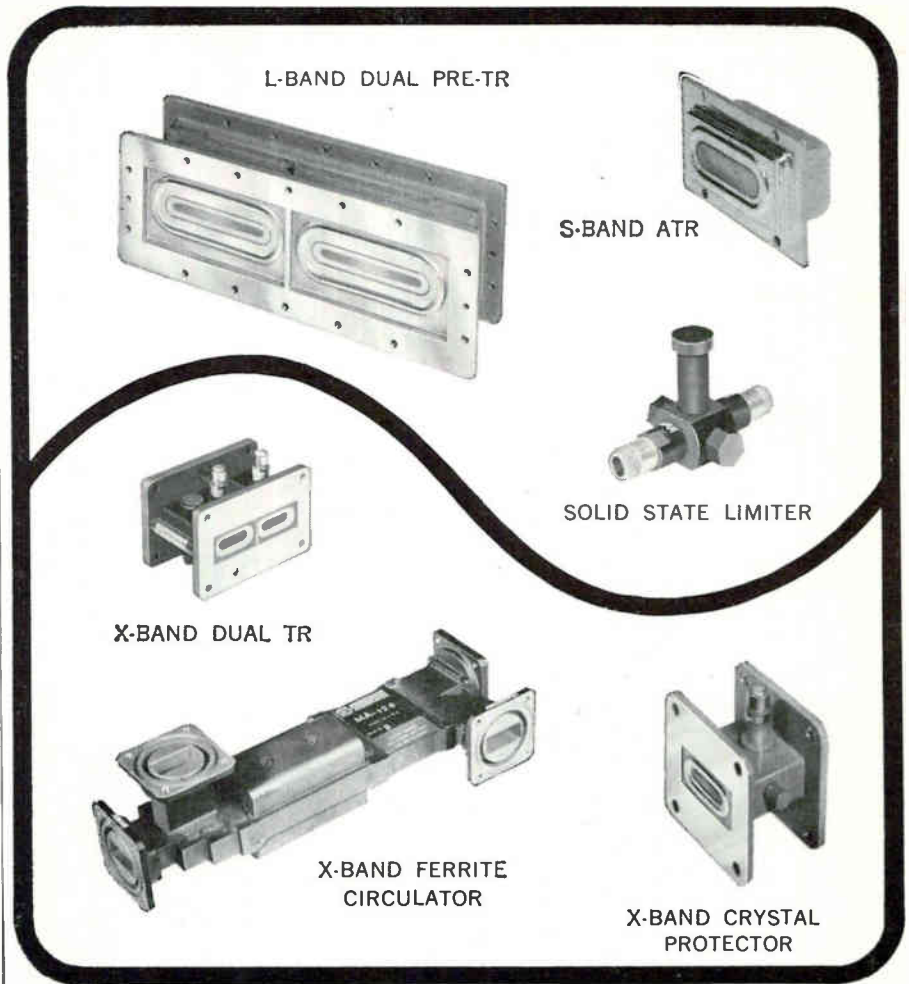

Unique Duplexer Competence

Optimum radar performance depends upon selection of the best possible duplexer consistent with your specific requirements.

This is not easy. There are many possible combinations of duplexer devices, each with its own advantages and limitations. Also, components come in a variety of types and packages, each with different inherent characteristics:

FOR SWITCHING

- PRE-TR
- DUAL PRE-TR
- 4-PORT CIRCULATOR
- BALANCED ATR s
- TEE CIRCULATOR

FOR CRYSTAL PROTECTION

- TR CRYSTAL PROTECTOR
- SEMICONDUCTOR LIMITER

FOR SWITCHING & PROTECTION

- DUAL TR

Microwave Associates can help you select the correct duplexer for your system with no second-guessing. Their long term research and development programs on gas tubes, ferrites, semiconductors, solid-state devices, and duplexer assemblies means excellence in duplexer capabilities. Production facilities are geared to rapidly translate new advances into field availability.

No other manufacturer offers you such comprehensive consultation on duplexer problems without obligation. If you are designing, building, or modifying a system we will be glad to work with you. Write or call:



MICROWAVE ASSOCIATES INC.

Burlington, Mass. • BRowing 2-3000 • TWX. Burlington, Mass. 942

CIRCLE 39 ON READER SERVICE CARD 39

NOW!

an analog output plus control signals from almost any digital input!

**ALL-NEW MOSELEY
MODEL 42
DIGITAL TRANSLATOR**

- 0.1% conversion accuracy
- Permits cartesian plotting of digital data
- Accepts card, perforated tape, magnetic tape, or manual keyboard inputs
- High-speed transistorized control circuits
- Accepts 4 digits and sign per axis; front panel display of matrix contents



Moseley Model 42 Digital Translator allows automatic operation of Autograf or similar X-Y Recorders from digital data supplied by any conventional source. Accuracy of digital-to-analog conversion is 0.1% and the accuracy of Moseley AUTOGRAF recorders, 0.15%, is maintained.

Model 42 is compatible with IBM Summary Punches and Card Readers including Models 514, 519, 523, 524, 526, etc. It may also be driven, without modification to either the Translator or driving equipment, by mechanical punched tape readers such as Friden, Soroban solenoid and Teletype motorized readers.

Model 42 is supplied with a 10-key serial keyboard for manual input. Accessories include magnetic tape adapter, Flexowriter converter, remote decimal contents read-out panel and optical magnetic tape converter. Model 42, including keyboard, \$3,450.00.

Data subject to change without notice. Prices f.o.b. factory.

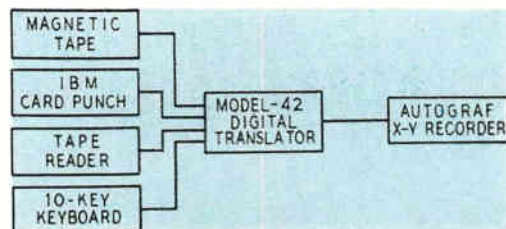

**SEE YOUR MOSELEY REPRESENTATIVE OR
WRITE DIRECT FOR DETAILS**

Pioneer and leader in X-Y and Strip-Chart Recorders



F. L. MOSELEY CO.
Dept. A11, 409 N. Fair Oaks Ave., Pasadena, California
MUrray 1-0208 TWX PASA CAL 7687
Field representatives in all principal areas

6077

Magnetics Model 1092 BQ8. This buffer is capable of having characters available for readout in the same order as they were read in. Readin and readout may take place alternately at a very high rate. When the end of a record is sensed, a stop command is given the tape handler.

As tape characters are placed in the magnetic core storage, a reversible counter adds one count for each character. As characters are removed from the storage, counts are subtracted from the reversible counter, thus keeping an accurate tally of the storage unit contents. When a sufficiently low number of characters remains in the storage unit, and enough capacity remains for another 720-character record, the tape handler is given a start command. In this fashion 120-word records are read consecutively until the end of a complete plot is reached.

Single characters are read from the core storage and placed in a character buffer where a check is made for odd parity and an indication given in case of error. Simultaneously, a cyclic counter adds a count. One counting cycle is completed for each full word read from the core storage. In this way the plotter is able to keep track of the various code locations within a word. Since the beginning of each word contains the operation code and the coordinate line marking codes, the first character is placed in the operation register. The following characters are read into the time register or the data register or both, as determined by the cyclic counter and the operation register.

Time codes are stored in the time register while all associated data values sequentially set the appropriate stylus drivers. All action is then inhibited until the counting of an internal clock shows that the correct time has arrived for the set drivers to write on the moving paper. The comparator determines this time by a direct comparison between time-register and clock-counter counts. Following the write command, the time register and the stylus drivers are reset and the cycle of operation is repeated, starting with the loading of a new time code in the time register.

STYLUS DRIVERS—Each stylus driver consists basically of a flip-flop memory and an amplifier to supply paper marking current. Additionally, the drivers perform several logical functions as shown in Fig. 3.

Each of the 1,024 possible configurations of 10 flip-flops in the data register causes a set command to occur on one of the 1,024 set lines from the decoding matrix. Upon receipt of a set command from the decoding matrix, the proper flip-flop is placed in the ONE condition. Other stylus-driver flip-flops are set successively as required. When the write command is initiated, all previously set flip-flops cause their associated stylus amplifiers to mark the paper. All flip-flops are reset at the conclusion of the write pulse.

Perpendicular coordinate lines are energized by a code in the operation code section of a tape word.

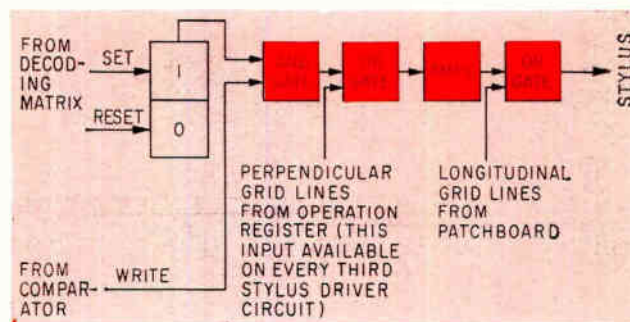

FIG. 3—Typical stylus driver circuit has flip-flop memory and amplifier that generates paper marking current

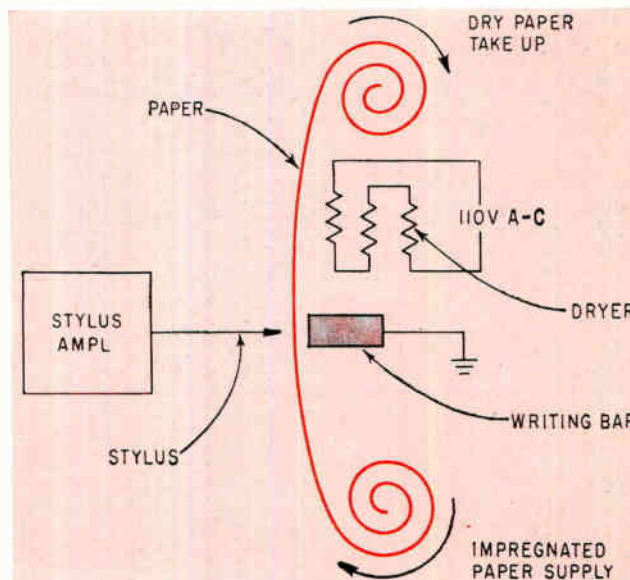

FIG. 4—Electrolytic recording method allows material from writing bar to be electroplated on moving paper

These lines are written independently of data points.

Independent longitudinal coordinate lines are initiated and stopped by the operation code, and their locations are manually chosen by means of a patchboard.

WRITE COMMAND—Marks are ordinarily made on the moving paper at 0.01-inch intervals or increments thereof. At a nominal paper speed of one inch a second, write commands ordinarily occur at a rate of 100 a second. (Paper speed, write command interval and distance between marks are all adjustable variables. The figures given in this article represent the most commonly used mode of operation.) Figure 4 shows the recorder mechanism.

A variable clock generator divides the 100-kc crystal-controlled internal clock down to 100 cps. This frequency is in turn counted by the clock counter, thereby measuring elapsed time in 0.01-second increments. The time register meanwhile has been holding the coded time most recently read in. When an exact comparison is made between the clock counter and time register, a write command is given. Following the write command, a new time code is entered in the time register. If the new code has increased by only one increment, another comparison will be made in 0.01 second.

More Bandwidth for

Head design allows upper limits of instrumentation recorders to be raised. Increased bandwidth requires new circuits

By DAVID R. STEELE, Ampex Corporation, Redwood City, California

MAGNETIC TAPE RECORDERS are usually limited by the frequency response of the record and reproduce heads. When a new head was designed recently—with a response two and a half times greater than previously available—the circuits had also to be redesigned. Existing recording and playback circuits were not suitable because they did not take full advantage of the extended response.

A new instrumentation recorder has been designed using the new heads and new circuits. Design goals of the general-purpose, multi-track recorder were set from the results of a survey of magnetic tape users, including technicians, engineers and company executives. Bandpass of the new recorder is from 250 cps to 250 kc. Even with the increase of the upper limit from 100 kc to 250 kc, signal-to-noise ratio and distortion characteristics are nearly identical to prior systems. Phase response is improved.

System Operation

The new system is composed of the transport, system control bay, two record and reproduce bays, and accessory bays for a seven-track cathode-ray-tube monitor, meter panel and servo tape speed control. The photographs show the modular design and packaging.

Figure 1 is a block layout of the direct record circuit. It is composed of an input emitter follower, head driver, bias amplifier and monitor amplifier. Also included are provisions for the insertion of an a-m carrier as the control track signal for the servo speed control system. The data signal input impedance is 10,000 ohms. A minimum of 180

millivolts will drive the amplifier to the specified record current.

The monitor channel provides 1 volt rms to the meter panel, scope panel, and similar devices that may be required. The monitor signal discloses the amplitude and waveform of the data, and control track when used, that is presented to the record amplifier. Once calibrated, the monitor output corresponds to the effective record current. Thus it is not necessary to place the machine in the record mode to find out what is going on in any particular record channel. The monitor amplifier is so arranged that load switching, or even a short circuit of its output, has no effect on recording. The schematic of the direct record circuit is shown in Fig. 2. It illustrates the resistive network R_1 , R_2 , R_3 and R_4 used to mix the control track signal with the data input and attenuator. Equal control track signal is delivered to both the monitor amplifier and head driver, assuring that the control track signal will appear in perspective in the monitor output.

The head driver portion of the

system consists of Q_1 and the complementary symmetry pair, Q_2 and Q_3 . The constant-current characteristic required by the record head is obtained by using a large amount of negative current feedback. The balanced loop includes R_5 and R_6 . Capacitors C_1 and C_2 provide phase correction and also roll the response down rapidly beyond 300 kc. This feedback establishes a low impedance at the base of Q_1 , making it a summing point for data input and control track input. Additional d-c feedback from the output pair Q_2 and Q_3 is returned to Q_1 emitter by R_7 . The two feedback loops result in an amplifier stable at temperatures in excess of 65 C. Output current of this section can drive the system into saturation while maintaining head current distortion less than 0.4 percent at any frequency.

Equalization

For recorders operating below 100 kc, if the record current is constant with frequency, the amplitude on the tape is assumed constant. There is a high-frequency bias loss, but this is speed/frequency constant. Otherwise, high frequency losses are caused by reproduce-head gap loss, which is also constant with speed/frequency. There are no high frequency losses in the record head of measurable magnitude. In instrumentation recorders, this permits recordings made at any speed to be reproduced at all other speeds, retaining their original amplitude perspective. However, at 250 kc, the accumulated record-head losses, eddy current and leakage, add up to 3 db. These losses must be compensated to retain speed interchangeability. Because the losses

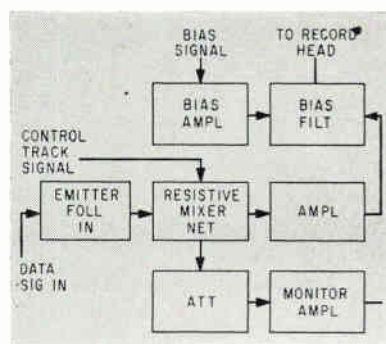

FIG. 1—Direct-record circuit uses separate monitor amplifier

not too critical in relation to input level or waveshape. To obtain the sine wave bias current, the square wave output is filtered by $R_p R_{1m}$, the parallel resonant circuit $L_2 C_1$, and then by the series resonant circuit $L_3 C_2$. The parallel resonant circuit $L_1 C_4$ isolates the head driver from the record bias. After filtering, the total noise and distortion of the bias amplifier is more than 50 db down from the 1.0 mc fundamental at maximum output of 30 milliamperes. Harmonic content is -56 db or less at the specified bias current. This square-wave approach to sine-wave bias may seem unusual, but it is undoubtedly the most practical means of meeting the stringent bias regulation demanded by the extended bandwidth of the recorder.

Direct Reproduce Electronics

The reproduce system performance is dependent not only on the reproduce head, but also on careful use of the signal output. As used in this system, the reproduce head functions as a voltage generator. The predominant factor affecting the signal/noise ratio of the system is, naturally, the output. It is important that the input resonant circuit—formed by head, cable, and preamplifier input capacitance—fall well above the bandpass of the

system. Preamplifiers are mounted on the transport, directly behind the head assembly, minimizing head cable length and associated capacitance. This permits use of a higher inductance head, with correspondingly higher output, than could otherwise be tolerated. The preamplifiers provide a gain of 38 db with fairly low output impedance, and are used with all systems of recording.

The direct reproduce electronics provides three prime functions:

1. Amplification—The preamplifier output from direct tape recording is in the order of 10 to 100 millivolts. From this signal the direct reproduce amplifier will deliver up to 3.0 volts rms into a 600-ohm load.

2. Amplitude Equalization—The amplifier incorporates four independent networks providing proper equalization to produce a flat or linear amplitude characteristic throughout the direct record/reproduce system.

3. Phase Equalization — Frequency selective phase shift is introduced to approximate a linear phase characteristic throughout the direct record/reproduce system. As with amplitude equalization, four separate networks are automatically switched to correspond with tape speed.

The block diagram of the direct

reproduce is shown in Fig. 4. Amplitude equalization is accomplished by the use of a series R-C network, in series with a parallel L-C network, in a shunt feedback loop around the first two stages. Phase equalization is accomplished by an all-pass network immediately following the amplitude equalizer. A three-stage voltage amplifier follows the phase equalizer. Output from this section is fed through the reproduce level control to the output amplifier. The output amplifier is designed to work into a 600-ohm load, although the internal impedance is actually only a fraction of this amount.

Equalizer Switching

Perhaps one of the most interesting and unique features of the four-speed reproduce electronics is the method of switching equalizer networks. The basic principle is illustrated in Fig. 5. Impedance of the amplitude-equalizing networks is represented by Z_A ; Z_B that of the phase-equalizing networks. The system is so arranged that these impedances are much higher than Z_{in} and Z_{out} . Under these conditions, it is seen that any or all of the Z_A - Z_B junctions can be shorted to ground without perceptibly affecting Z_{in} or Z_{out} . As indicated in Fig. 5, the Z_A - Z_B junctions are



Direct-record amplifier rack. Front panel contains attenuator, input and output jacks

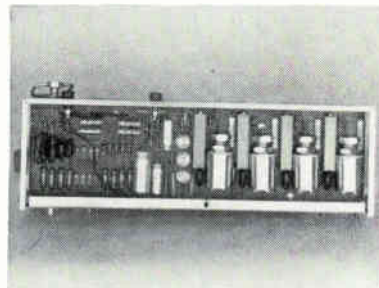

Direct-reproduce amplifier. To the right in the photo are four equalization networks

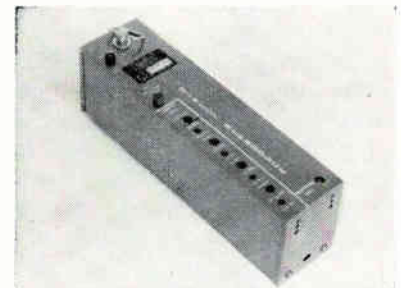

Direct-reproduce amplifier shows compact, modular design of the system. Record amplifier is similar

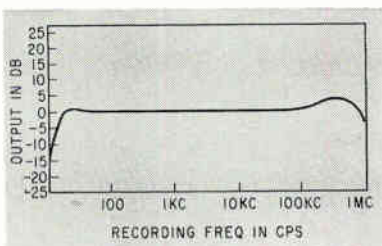

FIG. 3—Frequency response of direct-record amplifier. Overall response of complete system is from 250 cps to 250 kc

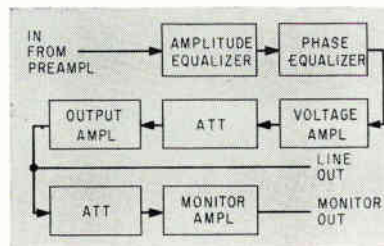

FIG. 4—Direct-reproduce channel gives amplitude and phase equalization, has separate monitor amplifier

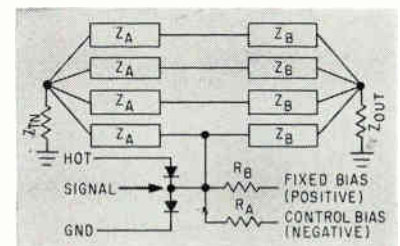

FIG. 5—Switching network for phase equalization. Impedances Z_A and Z_B are much higher than Z_{in} or Z_{out}

Transistor Bias Method

Reverse-biasing technique, which permits transistors to switch voltages higher than their collector-to-emitter rating, can be applied to many switching problems. It is now being used in Trixies, modular units for switching Nixie tube cathodes

By **ARPAD SOMLYODY,**

Circuit Design Analyst, Electronic Tube Div., Burroughs Corp., Plainfield, N. J.

USING TRANSISTORS above their rated collector-to-emitter voltage suggests many possibilities in on-off control circuits. In the application to be described, the technique permits use of lower cost transistors to drive Nixie numerical indicator tubes. The same approach could be used to increase output of more costly transistors having higher voltage ratings.

There are many applications in which medium-voltage, low-speed switching by transistors would be desirable. Examples include flip-flops yielding higher voltage outputs and gating circuits, as well as activation of gas discharge tubes. However, because of cost of transistors with higher collector-to-emitter voltage ratings, other switching methods are often used.

Reverse Biasing

Low-power, audio-type transistors are generally not expensive, but they tend to have low collector-to-emitter voltage ratings. For example, characteristics of the Sylvania 1750 25-volt transistor are listed in Tables I and II. Although maximum collector-to-base rating is 40 volts, it is useable only up to 25 volts in a common-emitter circuit because maximum collector-to-emitter rating is only 25 volts.

More careful analysis reveals that with the base-to-emitter junction reverse biased, collector-to-emitter breakdown voltage increases above the 40-volt collector-to-base rating. Since transistors in switching cir-

cuits are normally operated in either the saturated or off condition, the SYL 1750 can be used in 40-volt switching circuits.

A sample quantity of SYL 1750 transistors were tested with reverse bias applied to the base-to-emitter junction. Collector breakdown potentials were found to fall in the range from 45 to 60 volts with respect to the emitter. An output voltage swing of the same order

can be realized if the base is reverse biased whenever the collector rises to its breakdown potential.

The collector of the SYL 1750 transistor can be operated at these high potentials provided that rated dissipation of the transistor is never exceeded. Dissipation can be limited by two methods: using a suitable constant-current collector supply or providing a sufficiently high load impedance in conjunction with a high-voltage supply. Also, a nonlinear load can be used, as in driving the gas indicator tubes.

Application to Nixie Tubes

The reverse-biasing technique has been successfully used in driving the ten cathodes of the Nixie numerical indicator tube using the basic circuit in Fig. 1. The Nixie

Table I—Absolute Maximum Ratings of SYL 1750 at 25 C

Collector-to-base volts.....	40 v
Collector-to-emitter volts....	25 v
Collector current.....	100 ma
Power dissipation.....	150 mw
Junction temperature.....	85 C

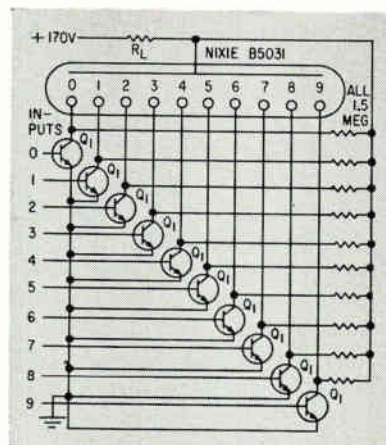

FIG. 1—Transistor bias V_{EB} of -1.5 v (I_D of $-150 \mu a$) enables Sylvania 1750 transistors to switch Nixie tube cathodes. Drive current I_D is $200 \mu a$

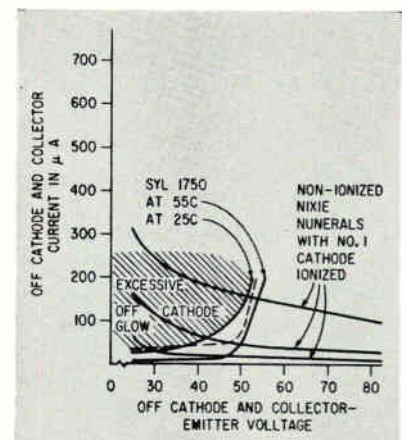
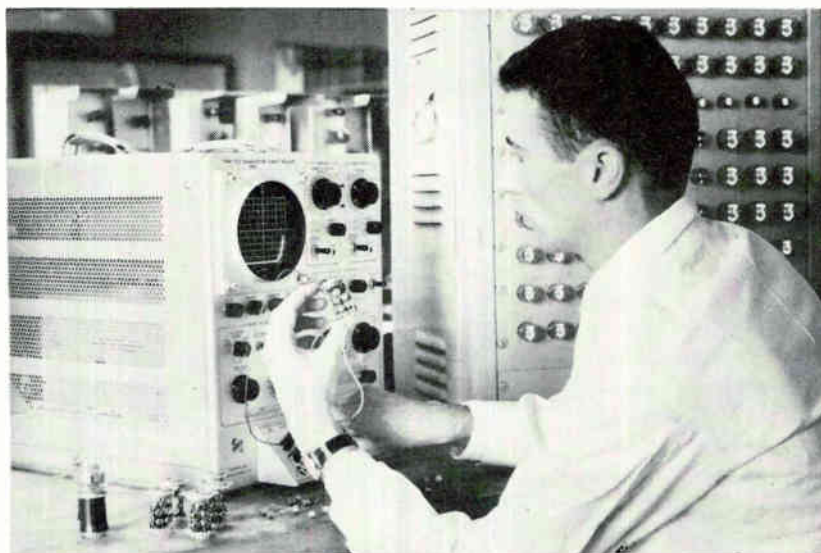

FIG. 2—Plot of volt-ampere characteristics of reverse-biased SYL 1750 transistor and Nixie tube cathodes shows how transistors can be used to switch cathodes

Raises Breakdown Point

Table II—Electrical Characteristics of SYL 1750 at 25 C

Characteristic	Min	Max	Unit
I_{CBO} at $V_{CB}=40$ v, $I_E=0$	—	10	μ a
I_{CER} at $V_{CE}=25$ v, $R_{BE}=10$ K	—	100	μ a
I_{EBO} at $V_{EB}=10$ v, $I_C=0$	—	10	μ a
h_{fe}	15	125	—
h_{ie} at $V_{CE}=6$ v, $I_C=1$ ma, $F=1$ kc	0.8 K	4 K	ohms
fh_{fe} at $V_{CE}=6$ v, $I_C=1$ ma	10	10	kc



THE FRONT COVER. Modular Trixie using ten reverse-biased transistors to switch Nixie tube cathodes is tested by author

tube has ten cathodes in the form of numerals 0 through 9, together with a common anode, all sealed in a neon gas atmosphere. Application of a negative voltage to any one cathode with respect to the anode causes that cathode to glow in the shape of its particular numeral. The potential difference required between anode and selected cathode is ordinarily 150 volts. However, by using the prebiasing technique, input required on the cathode is reduced to between 40 and 60 volts. (Prebiasing consists of holding the nine off cathodes at a potential about 40 to 60 volts above that of the on cathode.)

To adapt this readout device to low-voltage transistor counting and logic circuits, it became necessary to use buffer amplifiers for each of its ten cathodes. Since the cost of one buffer amplifier is multiplied by ten for each decade of readout, the use of high-voltage *npn* switching transistors is impractical for most commercial applications. However, by combining the Nixie tube cathode characteristics with the observed collector characteristics of reverse-biased SYL 1750 transistors a means was found of using these transistors for Nixie tube ac-

tivation without sacrifice of reliability.

Characteristics

Figure 2 indicates a portion of the volt-ampere characteristics of some of the off or non-ionized cathodes of the Nixie tube when the number one cathode is grounded and the anode has about 150 volts applied to it. Operating the off cathodes in the higher current region of their characteristics (shaded part of Fig. 2) should be avoided. As potential on these cathodes is lowered, increasing off numeral glow becomes objectionable, causing difficulty in distinguishing the on numeral.

Figure 2 also shows the collector volt-ampere characteristics of SYL 1750 transistors in the reverse-biased condition at 25 C. When it is superimposed on the Nixie tube curves, the intersection of these curves establishes the average spread of operating points of the Nixie tube when used in this circuit. Transistor dissipation at these intersections does not even approach maximum rating of 150 mw.

As shown in Fig. 2, as temperature is increased, the transistor characteristic curve shifts verti-

cally upward. If the transistor characteristics taken at 55 C are superimposed on the Nixie tube characteristics, some intersections fall inside the region where objectionable background occurs. The increase in I_{CBO} and leakage currents are directly responsible for the rise.

To obviate this condition, a 1.5-megohm resistor can be connected from each collector to the 150-volt point, as shown in Fig. 1. The current through these resistors shifts the transistor curve vertically down, allowing all intersections to lie outside the undesired region.

Trixie Modules

With the addition of the resistors, the reverse-biased circuit becomes applicable to driving Nixie tubes over the temperature range from -30 to 55 C. Such a circuit has been evaluated and is being produced. The units, called Trixies, are modular in design and are available in two forms: One operates standard and superset and the other miniature Nixie tubes.

Success of the reverse-biasing technique here opens the way for further developments in circuit design requiring higher than rated collector-to-emitter voltages.

Microwave Terminations

Characteristics and relative costs of the four major classes of coaxial cable and waveguide terminations are outlined in table and text

By **GLYN BOSTICK**, Chief Engineer, Radar Design Corporation, Syracuse, N. Y.

THE COST of a particular microwave termination depends critically upon its operating requirements. The most important of these are maximum allowable vswr, required power capacity and mechanical ruggedness. Since many microwave systems include several terminations, termination cost can be a significant portion of system cost.

The table gives relative cost and performance for typical coaxial line and rectangular waveguide types in general use.

TYPE I-C—This type is narrow-band because the resistor is shunted by a frequency-sensitive section of short-circuited line. At the design center frequency, where the section length is a quarter wavelength long, the shunt impedance seen at the re-

sistor is theoretically infinite and has no effect on vswr. At lower and higher frequencies, the shunt impedance decreases and causes vswr to depart from unity.

Since the two conductors may be welded together, the assembly is mechanically rugged and little strain is placed on the resistor.

The relative economy of this type termination results from non-critical dimensions and therefore few production rejects. The short-circuited line section is deliberately made too short and is resonated at the design center frequency by tuning a capacitive screw radially into the interspace through the outer tube wall.

TYPE I-W—Except for the form of transmission line, this type is identical with type I-C, above. A flat resistance card is used here and is equivalent to the disk resistor of type I-C.

Materials used are resistive coatings or evaporations on non-conducting bases. Such materials are rated in ohms/square; the resistance between two parallel sides of a perfect square sample.

TYPE II-C—This type is very similar to type I-C, except that the center conductor stops abruptly at the resistor. This abrupt ending creates an equivalent lumped capacitance whose magnitude is directly proportional to the largest line diameter. Therefore, vswr increases roughly proportional to frequency.

Generally, the center conductor is undercut near the resistor to form an inductance notch for tuning out the reactive effect of this capacitance. At an upper frequency limit, dependent on line size, the capacitive reactance becomes small enough to change the equivalent value of resistance from the ideal value of Z_0 and cause mismatch. This constitutes the highest useful frequency.

TYPE II-W—A lossy substance is introduced gradually into the oncoming wave and power intensity is attenuated as the wave travels toward the base of the lossy pyramid. If the pyramid has the proper combination of length and attenuation-per-unit length (decibels/centimeter, for example) only a small percentage of the power traverses the full length of the pyramid and is reflected. The proper amount of attenuation can easily be held over the

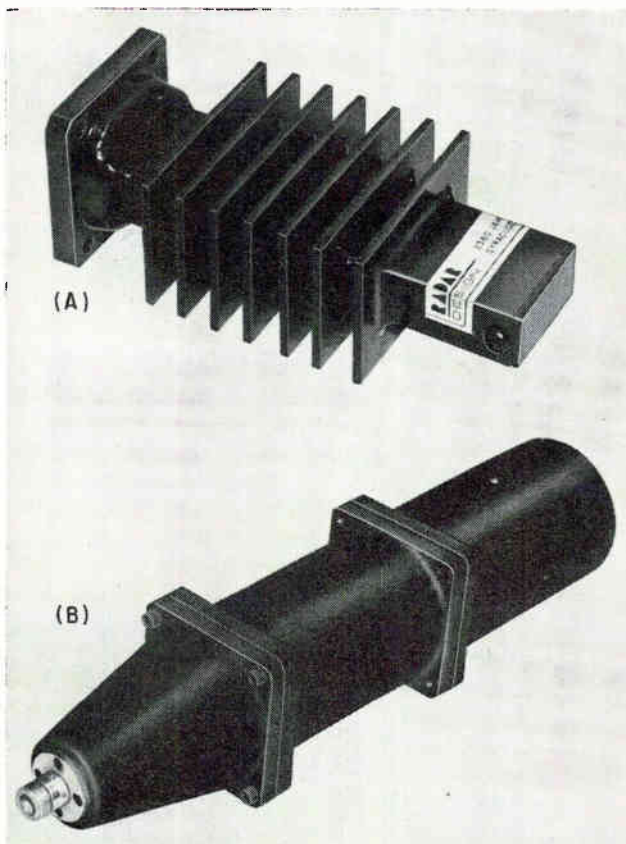

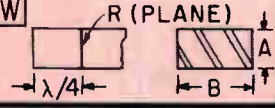



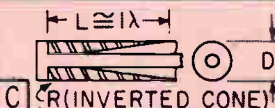
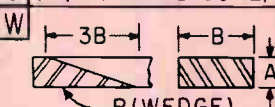

FIG. 1—Type IV-Waveguide termination for 200 watts between 7 and 10 kmc (A) and Type III-Coaxial termination, 100 watts between d-c and 3 kmc (B)

TYPE	APPROX FORM FACTOR (a)	FREQ RANGE FOR VSWR < 1.05	RESISTOR CHARACTERISTICS (b)	APPROX POWER WATTS	RELATIVE COST (c)
I LOW POWER LOW VSWR NARROW BAND	C 	$\pm 3\%$ OF CENTER FREQ	TOTAL RESISTANCE = Z_0 COMMERCIALY AVAILABLE GLASS OR PLASTIC BASE DISCS OR FLAT STOCK OHMS / SQUARE $\cong 200$	APPROX 30"	C W 1
	W 			APPROX 5 x A" x B"	1.5
II LOW POWER LOW VSWR WIDE BAND	C 	DC TO F_λ $\lambda \cong 2D$	TOTAL RESISTANCE = Z_0	APPROX 30"	1.5
	W 	FULL APP- LICABLE WAVEGUIDE BAND	RESIN BASE ATTENUATING PLASTICS	APPROX 2B"	1
III MEDIUM POWER WIDE BAND	C 	DC TO F_λ $\lambda \cong 2D$	TOTAL RESISTANCE = Z_0 COMMERCIAL COATED PYREX OR CERAMIC RODS	APPROX 10D"	2.5
	W 	FULL APP- LICABLE WAVEGUIDE BAND	OHMS / SQUARE $\cong 200$	APPROX 10B" x A"	1.5
IV HIGH POWER WIDE BAND	C 	F_λ TO $F_{\lambda/2}$ $\lambda_2 \cong 2D$	CERAMIC BASE ATTENUAT- ING MATERIALS	APPROX 200D ² (IN.) AND UP	3
	W 	FULL APP- LICABLE WAVEGUIDE BAND		APPROX 600A" x B" AND UP	2.5

a W - WAVEGUIDE: C - COAXIAL

b Z_0 - CHARACTERISTIC IMPEDANCE

c FOR A PARTICULAR COAXIAL LINE OR WAVEGUIDE SIZE

entire waveguide frequency range. Therefore, low vswr is obtained over the entire frequency range.

TYPE III-C—This termination is essentially a uniform resistor (constant ohms/unit length) having the same diameter as the line center conductor. Although the ideal contour for the taper of the outer conductor is a complex curve, a straight line gives satisfactory results for the proportions shown, and is an order of magnitude more economical to fabricate and duplicate in production.

As is generally known, higher-order modes may propagate in the coaxial line when the larger (inside) diameter approaches a half-wavelength. Good vswr above this frequency can not be assured. At all lower frequencies, the termination has a low vswr. The matching action, though somewhat complex has long been known¹.

TYPE III-W—This termination handles more power

than type II-W simply by dividing the power load between several pointed resistor cards. Low vswr over the entire guide range is achieved exactly as for type II-W.

TYPE IV-C and IV-W—Here, material consisting of finely divided iron suspended in a ceramic base is introduced gradually into an oncoming wave so that negligible reflections occur.

Because such materials can withstand high temperatures and are placed in intimate contact with the outer wall for good heat transfer, high power capability results. Low vswr, in the ranges shown in the table, is achieved by the mechanism explained for types III-C and III-W. Types IV merely represent substitution of lossy materials with higher power capabilities.

REFERENCE

(1) C. G. Montgomery, "Techniques of Microwave Measurements", Vol. II, Radiation Laboratory Series, McGraw-Hill Book Co., New York, N. Y., 1948.

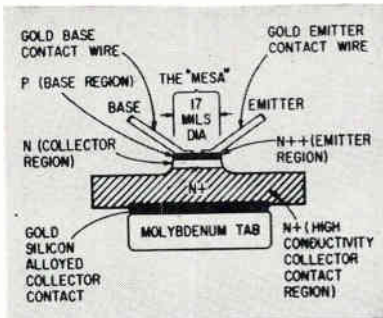

FIG. 1—Cross section of typical vhf silicon transistor

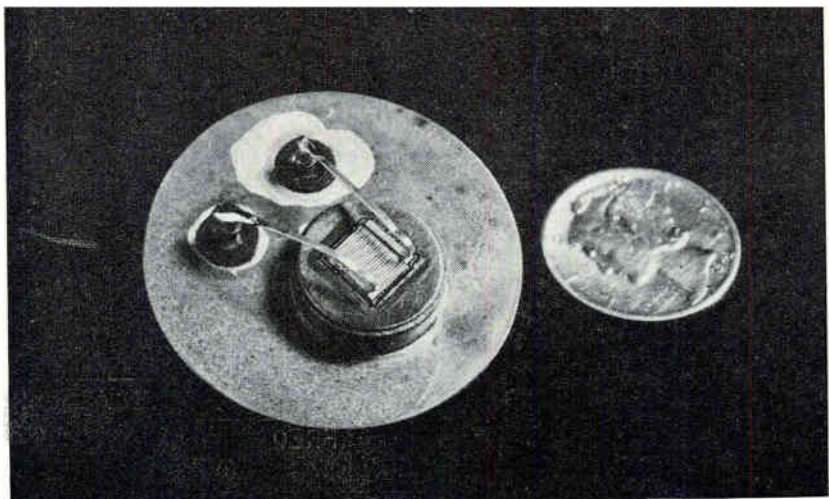

FIG. 2—Comb structure is used in high-power, high-frequency transistor

Designing High-Power Transistor Oscillators

New high-power transistors are usable at over 300 mc. Oscillator design is simplified with step-by-step procedure

By **W. E. ROACH**, Pacific Semiconductors, Inc., Culver City, California

HIGH-FREQUENCY, HIGH-POWER transistors require small structures and the best possible heat dissipation. Small size is necessary to meet the high-frequency requirement. Good heat dissipation is necessary since a large amount of heat is generated in a small volume.

The heat problem is solved by mounting the collector directly on the transistor case, which in turn is usually mounted on a metal plate or fin assembly. Stray capacitance, which must be dealt with in design, is thus introduced from collector to other parts of the circuit. Using the technique described in this article, and new transistors recently developed, oscillators can be built with over 100 watts output at 10 mc. Higher frequency oscillators are possible but at less power; for example, 0.2 watt at 300 mc.

The oscillator design method combines theoretical and experimental procedures to obtain an optimum circuit in minimum time. Amplifier and feedback sections of

the oscillator are designed separately, then combined to produce the final circuit.

New Transistor

The cross section of a typical developmental transistor is shown in Fig. 1. It is a vhf power transistor that can dissipate approximately four watts at the collector with the proper external heat sink.^{1,2}

A high-power transistor, which has a collector dissipation in excess of 100 watts with water cooling, is shown in Fig. 2. A special comb structure is used for the emitter to cut down current crowding which occurs in the emitter at high current levels.³ The comb pattern gives the emitter a large edge-to-area ratio, thus minimizes capacitance for a given current rating. Silicon is used because of its good high temperature characteristics.

The transistors were designed for good performance below 30 volts but they can be operated at higher voltages. The low-voltage capability

means, however, that in many cases d-c power can be taken directly from the primary power source of an aircraft, satellite or motor vehicle. High power output from a single stage permits substantial savings in power and components while the circuit simplification contributes to overall reliability.

Experimental Results

A series of similar oscillators was built for operation from 30 mc to 300 mc. These circuits operate with the collector tied directly to the chassis for maximum heat dis-

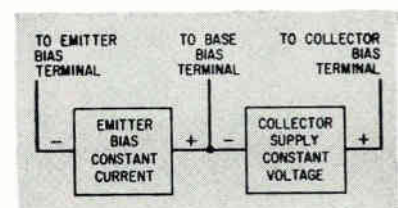

FIG. 3—Two power supplies are used for experimental work. Polarities are for npn transistors

Table I—Performance of Experimental Oscillators

Frequency in mc	V _c in volts	I _c (d-c)	P _{in} , d-c, watts	P _{out} , a-c, watts	Eff. Percent
10	45	4.5 amp	202	110	54
30	67	150 ma	10	5.0	50
70	60	120 ma	7.2	3.1	43
200	50	80 ma	4.0	0.6	15
300	50	80 ma	4.0	0.2	5

Table III—Pi-T Transformation Formulas

$$Z_1 = \frac{Z_A Z_B}{Z_A + Z_B + Z_C} \quad Z_A = \frac{Z_1 Z_2 + Z_2 Z_3 + Z_1 Z_3}{Z_2}$$

$$Z_2 = \frac{Z_B Z_C}{Z_A + Z_B + Z_C} \quad Z_B = \frac{Z_1 Z_2 + Z_2 Z_3 + Z_1 Z_3}{Z_3}$$

$$Z_3 = \frac{Z_A Z_C}{Z_A + Z_B + Z_C} \quad Z_C = \frac{Z_1 Z_2 + Z_2 Z_3 + Z_1 Z_3}{Z_1}$$

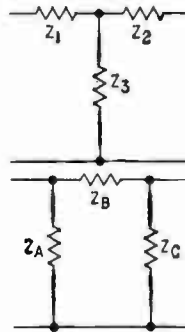

Table II — Pi-Network Design Formulas

The network input impedance is to look like R₁ at the input terminals with R₂ connected to the output terminals. Impedance X₁ may be selected as desired, subject to a sufficient coupling restriction.

$$|X_B| \leq \sqrt{R_1 R_2}$$

$$X_A = \frac{-R_1 X_B}{R_1 \pm \sqrt{R_1 R_2 - X_B^2}}$$

$$X_C = \frac{-R_2 X_B}{R_2 \pm \sqrt{R_1 R_2 - X_B^2}}$$

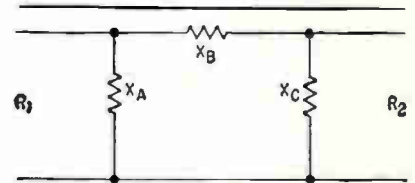

Table IV—Complex Voltage Transfer Function for T and Pi Networks With Resistive Loads

Complex voltage gain, V₂/V₁ = A + jB

$$A + jB = \frac{jX_C R_L}{jX_B jX_C + jR_L (X_C + X_B)} \quad A + jB = \frac{jX_3 R_L}{(jX_1 jX_2 + jX_2 jX_3 + jX_1 jX_3) + jR_L (X_1 + X_3)}$$

Synthesis of network for specified complex voltage gain, A + jB

$$X_A = \frac{R_L B}{(A - 1)(A^2 + B^2)} \quad X_1 = \frac{R_L (A^2 + B^2 - A)}{B (A^2 + B^2)}$$

$$X_B = \frac{-R_L B}{A^2 + B^2} \quad X_2 = \frac{R_L (A - 1)}{B}$$

$$X_C = \frac{R_L B}{A^2 + B^2 - A} \quad X_3 = \frac{R_L}{B}$$

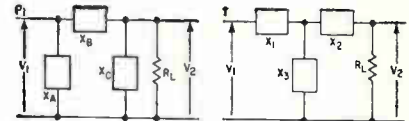

sipation. Table I summarizes the results. Transistors like those shown in Fig. 1 have produced results ranging from 5 watts output at 30 mc to 0.2 watt output at 300 mc. Efficiency decreases with increasing frequency as the efficiency of amplification drops, but appreciable power is obtained at the higher frequencies.

Transistors with the comb structure were tested in a modified circuit. Although tests are not completed, preliminary designs have given a power output of 110 watts at 10 mc, with a collector circuit efficiency of more than 50 percent.

Circuit Considerations

A good high-frequency unit of the type shown in Fig. 1 may typically have an alpha cut-off frequency between 100 and 200 mc. The maximum frequency of oscillation will be several hundred mc, and appreciable output power may be obtained at high frequencies even

though efficiencies will drop as the frequency of operation is raised. In oscillator operation, the requirement for high gain through the transistor is not as important as in amplifier applications, since the oscillator circuit provides its own drive. A power gain greater than one is needed but, in many cases, it is more important to be able to operate the transistor at high d-c input power to get appreciable power output.

In the design of low-level linear amplifiers, small signal theory and a set of parameters such as h parameters permit straightforward design. For high level oscillators, which may operate class B or class C, such procedures are not straightforward. In addition, self-biasing d-c effects may exist in the transistor at high signal levels.

Mode of Operation

The output coupling circuit and load values required for an ampli-

fier or oscillator are a function of the class of operation. In class A, the output impedance of the transistor should be matched. For class C operation, however, the requirements are different.

The load conditions for the circuit may be determined approximately by considering the tank circuit and load resistance only, assuming that the transistor itself is inactive over most of the cycle. Since the energy furnished to the load must come largely from the stored energy in the tank circuit, the amount of energy available in the L-C circuit must be appreciably larger than the amount furnished to the load between pulses of input current to the tank. This is equivalent to saying that the loaded Q of the tank circuit must be of a certain magnitude for sine-wave output. A minimum loaded Q of five is considered satisfactory.

Since the peak voltage swing across the tank should nearly equal

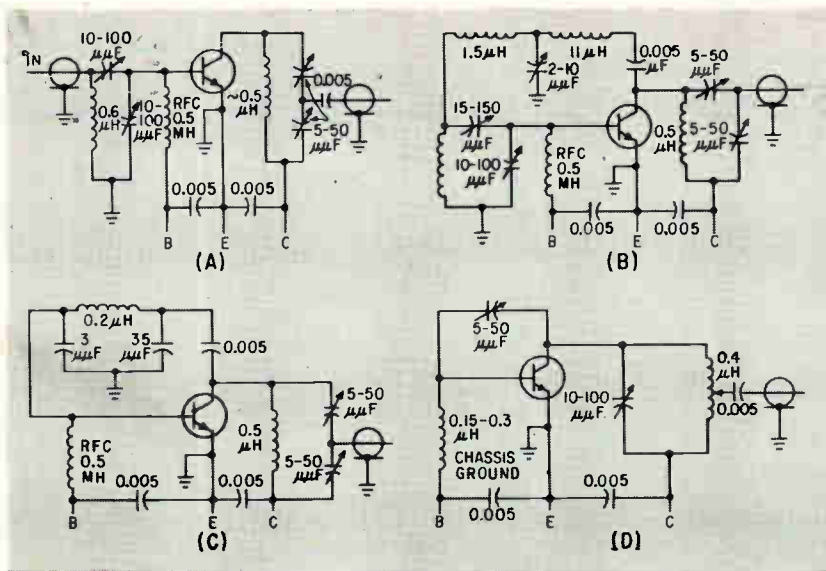

FIG. 4—Steps in oscillator design. First step is to build 70-mc amplifier (A); amplifier is converted to oscillator with separate input, output and feedback networks (B); feedback and input networks are replaced with pi network (C); simplified final circuit with collector connected directly to chassis and output from tapped tank (D)

the collector supply voltage (to provide the high collector efficiency mentioned previously), the load resistance for any given power is found from: peak-to-peak voltage swing across $R_L = 2V_{cc}$, where R_L = load resistance, V_{cc} = d-c collector supply voltage, and V_L = rms voltage swing across R_L ; $V_L = 2V_{cc}/2 \times 1.414 = 0.707 V_{cc}$.

The power delivered to the load is $P_L = V_L^2/R_L = (0.707 V_{cc})^2/R_L = 0.5 V_{cc}^2/R_L$; $R_L = 0.5 V_{cc}^2/P_L$.

For oscillator operation, there is also a starting requirement, which

means that the oscillator must start in a condition approximating class A, though it may then change to a different type of operation. In many cases an internal d-c biasing effect will be observed in the input circuit of the transistor when an a-c signal is applied from a generator or fed back from the output circuit. This effect may shift the operating point.

Network Design

A detailed step-by-step procedure for oscillator design is given in the

design box. In Step 1, networks are designed using standard formulas, shown in Table II, to match the input and output impedances of the transistor to the driving generator and to the load and/or power meter. Since these formulas are shown for resistive input and output, the transistor input and output should be made resistive by adding the necessary reactance in parallel with the input and output terminals. This added reactance may be combined with the matching network. These matching networks should have two or three of the elements variable to permit adjustment.

Two additional considerations may influence the choice of matching network configuration. One is the convenience of d-c bias introduction or isolation. The other is the network response at frequencies other than the operating frequency.

Conversion formulas for T-pi networks are shown in Table III.

The value of R_i used for the output network may be made equal to the resistive output impedance of the network for class A operation, or may be calculated for class C operation by $R_i = 0.5V_{cc}^2/P_{load}$. For class C operation, the loaded Q of the matching circuit must also be considered.

These networks are checked by adding the proper terminating resistance to either the input or out-

Power Oscillator Design Procedure

Basic approach is to design and evaluate each network separately. Analysis or measurements of a complete complex network with several variables is usually difficult—if not impossible—but the problem is considerably simplified by this method.

Step 1—Design input and output matching networks for operation of the devices as an amplifier at the desired frequency

Step 2—Verify amplifier performance at the desired power level

Step 3—Estimate oscillator output by subtracting required drive from amplifier output power

Step 4—Convert the circuit to an oscillator by providing a feedback network

Step 5—Simplify the circuit by consolidating feedback and matching circuits

Design Example

Figure 4 through 4D illustrates the steps and procedures in the design of a 70-mc power oscillator. Typical characteristics of a transistor of the type shown in Fig. 1 are given in Table V.

Step 1—The small-signal common-emitter h -parameters shown in Table V were measured at 70 mc. Exact parameter values have limited meaning, since each impedance will be a function of the terminating impedance at the opposite terminals as well as of bias levels. In addition, at high signal levels the circuit operation is not linear. Nonetheless, such data serves as a useful starting point. Values measured for the unit used are

$$h_{11e} \cong (20 + j2) \text{ ohms} \cong 20 \text{ ohms}$$

$$h_{22e} \cong (5.6 + j4.6) \text{ millimhos}$$

Calculation of the required matching networks (from Table II) resulted in the amplifier configuration shown in Fig. 4A. This circuit was set up and checked for power output as an amplifier with network elements adjusted for optimum performance.

Step 2—The results indicated that the unit could dissipate four watts with external heat sink provisions, and would provide an output as a 70-mc amplifier in excess of 3.2 watts with 7.2 watts d-c input. Input driving power was approximately 0.2 watt; power gain was 12 db.

Failure of oscillation will result in an approximately seven watts being dissipated in the unit, which will probably destroy the transistor unless protection is provided.

put and measuring the impedance at the opposite set of terminals. This procedure may also be used to determine the settings of variable elements in the network.

In Step 4, the feedback network characteristics to convert the amplifier to an oscillator are estimated. The impulses of collector current are to be 180 degrees out of phase with the collector voltage. Thus the feedback network must furnish a phase shift which, with the internal phase shift of the transistor, and that of the input pi network, will accomplish the desired result. The phase shift of the T or pi network is calculated from the formulas in Table IV.

If a specific value for the phase shift of the current gain (h_{21c} or $-\beta$) is not available, -90 degrees may be used, since the angle is near this value for frequencies between about 0.1 α -cutoff frequency to well above α cutoff.

With transistor and input network phase shifts known, the feedback phase shift may be calculated. The voltage gain desired may be approximated using the power levels and impedance levels at the input network and at the collector terminals. The complex voltage feedback is thus specified in polar coordinates; these may be converted to rectangular coordinates and the network calculated from the formu-

Table V—VHF Transistor Characteristics

Parameter	Measurement Conditions	Value
α_o	$I_c = 100$ ma	0.86
β_o	$I_c = 100$ ma, $V_c = 10$ v	6.5
$C_c, \mu\mu\text{f}$	$V_{CB} = 28$ v, reverse	12
V_{bc} , volts	$I_c = 1$ ma	150
V_{sat} (C. E.), volts	current gain = 5, $I_c = 100$ ma	0.45
h_{11c} , ohms	$V_c = 30$ v, $I_c = 30$ ma	$20 - j2$
h_{21c} , mhos	$V_c = 30$ v, $I_c = 30$ ma	$(5.6 + j4.6) \times 10^{-3}$
h_{21c} ($= -\beta$)	$V_c = 30$ v, $I_c = 30$ ma	$0.26 - j1.7$

las in Table IV, using the generator impedance as the value of terminating resistance. The current at the transistor input may be assumed to be in phase with the voltage if the transistor input reactive component has been cancelled.

Step 5, simplification of the circuit, is carried out as shown in the example. In this procedure the internal feedback of the transistor is neglected. Depending on the particular device characteristics, this approximation may require further consideration.

Provision of separate d-c bias power supplies as shown in Fig. 3 has been found to be convenient for initial development and investigation of a-c circuit properties. Single supply biasing may be substituted later if required.

The transistors used were designed and fabricated by the vhf silicon transistor and the power

transistor sections of the research and development department of Pacific Semiconductors. Some of the device development work was done under United States Army Signal Supply Agency Contract No. DA 36-039 SC-74887 and United States Air Force Contract No. AF 33-(600)-35088. The power output measurement of the 10-mc oscillator was performed by the Electronic Components Laboratory, Wright Air Development Center, Dayton, Ohio.

REFERENCES

- (1) J. L. Buie, High Frequency, Silicon, NIPN, Oscillator Transistor, *IRE P.G.E.D. Conference*, Washington D. C., Oct. 1958.
- (2) M. A. Clark, Power Transistors, *Proc IRE*, 46, p 1185, June 1958.
- (3) N. H. Fletcher, Some Aspects of the Design of Power Transistors, *Proc IRE*, 43, p 551, May 1955.
- (4) W. L. Everett and G. E. Anner, *Communication Engineering*, Third Edition, Chap. 11, McGraw-Hill Book Co., Inc., New York, 1956.

Step 3—Minimum power output capability as an oscillator was estimated by subtracting amplifier input from output, giving a result of 3.0 watts.

Step 4—A T-network was chosen for the feedback function.

If the network is connected from the collector to the input network as shown in Fig. 4B, Z_L may be assumed to be equal to the impedance of the generator used for the amplifier tests. The complex value of h_{21c} ($-\beta$), the current gain of the transistor, was measured as $0.26 - j1.7$, as shown in Table V. The phase angle is thus -82 degrees. At the settings used to obtain the power shown in Step 2 above, calculation of the phase shift through the input matching network indicated a value of approximately $+40$ degrees. Assume that the transistor input current and voltages are in phase.

Thus there are -82 and $+40$ degrees of phase shift in the circuit, and a total of 180 is needed around the loop. Therefore an additional phase shift is needed of $180 + 42$, or approximately 220 degrees.

To determine the magnitude of the feedback function, calculate the voltage levels at the input and output of the feedback network, using the power levels and impedance values at these points. This calculation gives three volts rms at the input, 24 volts rms at the collector. The complex voltage gain of

the feedback network is therefor $(3/24) \angle 220 = -0.11 - j0.08$.

Addition of the network resulted in the circuit of Fig. 4B. Output is 3.1 watts at 70 mc.

Step 5—The elements of the feedback and input networks may be consolidated to produce a less flexible but simpler circuit. This is done by reducing feedback and input networks with standard T-pi transformation and consolidation methods.⁴ A more direct method, however, is to calculate a new network having the voltage transfer characteristics of the feedback and input networks combined. In this example, the voltage transfer characteristics for the feedback and input networks are, respectively, 0.55 at an angle of 240 deg, and 0.67 at an angle of 40 deg. Multiplying these together gives 0.37 at 290 deg, or 0.37 at -70 deg; in rectangular coordinates, the value is $0.12 - j0.34$. Substitution of a pi network of this voltage transfer ratio, using a termination value of 20 ohms, yields the circuit in Fig. 4C. Substitution of this circuit, and use of a tapped tank for output power, resulted in the circuit of Fig. 4D, drawn as a grounded collector circuit. This circuit gives performance equal to that of the more complex circuit of Fig. 4B. The transistor was mounted directly on the chassis to provide an adequate heat sink.

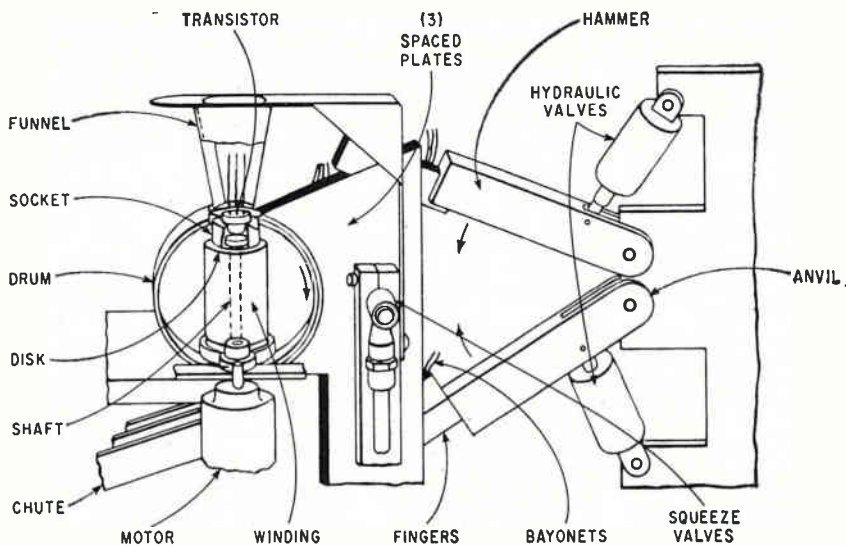
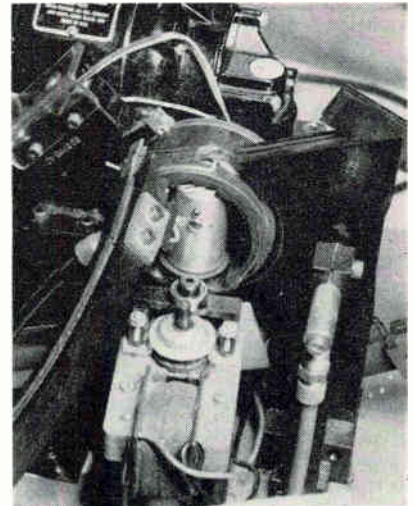

FIG. 1—Rotating drum drops transistor leads between set of plates, where leads are squeezed top, bottom and side by plates and fingers



Drum is in center, feed track at left, plates at right

Squeezer Unkinks Transistor Leads

TRANSISTOR LEADS that are bent or kinked make automatic testing or assembly insertion difficult. The machine illustrated, used by International Business Machines Corp., rapidly straightens the leads by squeezing them between plates and fingers.

Transistors are dumped loose into a vibratory feeder bowl and are oriented with leads up as they pass along the feeder track. They are fed singly into a funnel, so that the cap drops into an insulating socket on the drum (Fig. 1).

The steel disk in the bottom of the socket, and the shaft, are rotated by the motor through a friction drive. The shaft and disk are magnetized by the winding. The magnetized disk causes the transistor base (magnetic material) to rotate in the socket until a lug on the transistor base is seated in a recess.

As soon as the lug is seated, an electrical circuit through the base of the transistor closes. This shuts off the shaft rotating motor and energizes a second motor (not shown in Fig. 1). The second motor turns the drum a quarter-turn to the right, bringing the transistor leads down between the

spaced plates (Fig. 2).

When the drum has completed the quarter-turn, the lower hydraulic valve lifts the anvil and its fingers and bayonets to a horizontal position. Then the squeezer valves



Overall view of machine and accessories

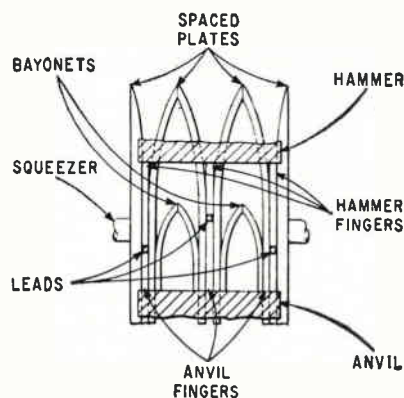

FIG. 2—End view of squeeze position. Plates are shaped to comb leads as they enter

force the plates together. Finally the hammer fingers are driven down between the spaced plates. The combined squeezing actions straighten the leads.

The hammer, anvil and plates return to their original positions. The winding around the shaft is de-energized and the drum is rotated another quarter-turn, allowing the transistor to drop into the discharge chute. The drum continues to turn until it reaches the loading position.

After straightening, the transistors are placed in another vibratory feeder bowl which feeds them to test equipment. Robert D. Essert, of IBM, Poughkeepsie, devised the straightening method.

Ammeter Sorts Out Look-Alike Metals

LOOK-ALIKE METALS can be readily sorted by adapting a milliammeter to detect the polarity of the metals by the thermoelectric effect. The meter is provided with a polarity-indicating dial and 2 leads, one ending in a clamp and the other in a carbon steel file.

After the clamp is attached to the

put and measuring the impedance at the opposite set of terminals. This procedure may also be used to determine the settings of variable elements in the network.

In Step 4, the feedback network characteristics to convert the amplifier to an oscillator are estimated. The impulses of collector current are to be 180 degrees out of phase with the collector voltage. Thus the feedback network must furnish a phase shift which, with the internal phase shift of the transistor, and that of the input pi network, will accomplish the desired result. The phase shift of the T or pi network is calculated from the formulas in Table IV.

If a specific value for the phase shift of the current gain (h_{21c} or $-\beta$) is not available, -90 degrees may be used, since the angle is near this value for frequencies between about 0.1 α -cutoff frequency to well above α cutoff.

With transistor and input network phase shifts known, the feedback phase shift may be calculated. The voltage gain desired may be approximated using the power levels and impedance levels at the input network and at the collector terminals. The complex voltage feedback is thus specified in polar coordinates; these may be converted to rectangular coordinates and the network calculated from the formu-

Table V—VHF Transistor Characteristics

Parameter	Measurement Conditions	Value
α_o	$I_c = 100$ ma	0.86
β_o	$I_c = 100$ ma, $V_c = 10$ v	6.5
$C_c, \mu\text{mf}$	$V_{CB} = 28$ v, reverse	12
V_{bc}, volts	$I_c = 1$ ma	150
$V_{sat} \text{ (C. E.)}, \text{volts}$	current gain = 5, $I_c = 100$ ma	0.45
h_{11c}, ohms	$V_c = 30$ v, $I_c = 30$ ma	$20 - j2$
h_{22c}, mhos	$V_c = 30$ v, $I_c = 30$ ma	$(5.6 + j4.6) \times 10^{-3}$
$h_{21c} (= -\beta)$	$V_c = 30$ v, $I_c = 30$ ma } $f = 70$ mc	$0.26 - j1.7$

las in Table IV, using the generator impedance as the value of terminating resistance. The current at the transistor input may be assumed to be in phase with the voltage if the transistor input reactive component has been cancelled.

Step 5, simplification of the circuit, is carried out as shown in the example. In this procedure the internal feedback of the transistor is neglected. Depending on the particular device characteristics, this approximation may require further consideration.

Provision of separate d-c bias power supplies as shown in Fig. 3 has been found to be convenient for initial development and investigation of a-c circuit properties. Single supply biasing may be substituted later if required.

The transistors used were designed and fabricated by the vhf silicon transistor and the power

transistor sections of the research and development department of Pacific Semiconductors. Some of the device development work was done under United States Army Signal Supply Agency Contract No. DA 36-039 SC-74887 and United States Air Force Contract No. AF 33-(600)-35088. The power output measurement of the 10-mc oscillator was performed by the Electronic Components Laboratory, Wright Air Development Center, Dayton, Ohio.

REFERENCES

- (1) J. L. Buie, High Frequency, Silicon, NPN, Oscillator Transistor, *IRE P.G.E.D. Conference*, Washington D. C., Oct. 1958.
- (2) M. A. Clark, Power Transistors, *Proc IRE*, 46, p 1185, June 1958.
- (3) N. H. Fletcher, Some Aspects of the Design of Power Transistors, *Proc IRE*, 43, p 551, May 1955.
- (4) W. L. Everett and G. E. Anner, *Communication Engineering*, Third Edition, Chap. 11, McGraw-Hill Book Co., Inc., New York, 1956.

Step 3—Minimum power output capability as an oscillator was estimated by subtracting amplifier input from output, giving a result of 3.0 watts.

Step 4—A T-network was chosen for the feedback function.

If the network is connected from the collector to the input network as shown in Fig. 4B, Z_i may be assumed to be equal to the impedance of the generator used for the amplifier tests. The complex value of h_{21c} ($-\beta$), the current gain of the transistor, was measured as $0.26 - j1.7$, as shown in Table V. The phase angle is thus -82 degrees. At the settings used to obtain the power shown in Step 2 above, calculation of the phase shift through the input matching network indicated a value of approximately $+40$ degrees. Assume that the transistor input current and voltages are in phase.

Thus there are -82 and $+40$ degrees of phase shift in the circuit, and a total of 180 is needed around the loop. Therefore an additional phase shift is needed of $180 + 42$, or approximately 220 degrees.

To determine the magnitude of the feedback function, calculate the voltage levels at the input and output of the feedback network, using the power levels and impedance values at these points. This calculation gives three volts rms at the input, 24 volts rms at the collector. The complex voltage gain of

the feedback network is therefor $(3/24) |220 = -0.11 - j0.08$.

Addition of the network resulted in the circuit of Fig. 4B. Output is 3.1 watts at 70 mc.

Step 5—The elements of the feedback and input networks may be consolidated to produce a less flexible but simpler circuit. This is done by reducing feedback and input networks with standard T-pi transformation and consolidation methods.⁴ A more direct method, however, is to calculate a new network having the voltage transfer characteristics of the feedback and input networks combined. In this example, the voltage transfer characteristics for the feedback and input networks are, respectively, 0.55 at an angle of 240 deg, and 0.67 at an angle of 40 deg. Multiplying these together gives 0.37 at 290 deg, or 0.37 at -70 deg; in rectangular coordinates, the value is $0.12 - j0.34$. Substitution of a pi network of this voltage transfer ratio, using a termination value of 20 ohms, yields the circuit in Fig. 4C. Substitution of this circuit, and use of a tapped tank for output power, resulted in the circuit of Fig. 4D, drawn as a grounded collector circuit. This circuit gives performance equal to that of the more complex circuit of Fig. 4B. The transistor was mounted directly on the chassis to provide an adequate heat sink.

Reflex Klystrons as

Using reflex klystrons as microwave-receiver front ends, sensitivity can be improved as much as 42 db, depending on method of cascading

By KORYU ISHII, Department of Electrical Engineering, Marquette University, Milwaukee, Wis.

MOST X-BAND RADAR receivers in use do not have r-f amplifiers. There are newer models with traveling-wave, maser or parametric r-f amplifiers. But these circuits are complex, expensive, weighty and bulky and some are not practicable for mobile radar. A parametric amplifier using a semiconductor diode appears to be a simple stage; yet it requires a tube mount for a pumping oscillator, a power supply, and a waveguide mount for the diode.

To reduce complexity and cost, reflex klystrons have been suggested as 10-kmc receiver r-f amplifiers.^{1,2} A reflex klystron has been installed on a specially designed mount and considerable amplifier gain reported.³

Because of the inherent noise level of reflex klystrons there has been question of their adaptability to X-band r-f amplifiers. Purpose of the research described here was to investigate performance of type 2K25 (723A/B) reflex klystrons in microwave-receiver front ends to improve sensitivity.

Sensitivity Measurements

The block diagram of a test setup for measurement of X-band receiver sensitivity is shown in Fig. 1.

With test gear operational, S_1 , S_2 and S_3 are switched to Position A. Readings of variable attenuator No. 2 and the output indicator are recorded. When control by attenuator No. 2 is increased, output-indicator reading decreases. Attenuation must then be increased until the output indicator indi-

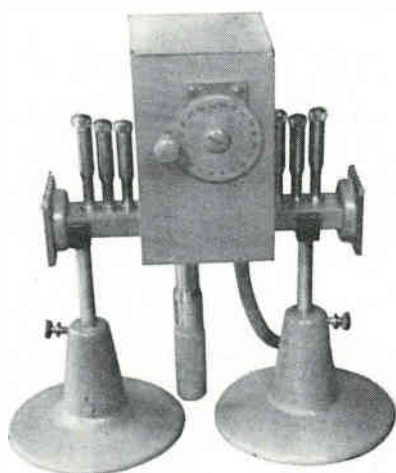

Test amplifier using reflex klystron

cates the noise level only.

Next, S_2 and S_3 are thrown to B position. To obtain the same output-indicator readings as before, attenuator No. 2 must be decreased because the 2K25 r-f amplifier is out of the circuit. Settings of the No. 2 attenuator must be recorded. Finally, S_1 is thrown to the B circuit and the power measured.

From these measurements an input-output level can be calculated; that is, an input-versus output-power curve can be plotted. In this research, sensitivity was defined as the minimum input-signal level which can be detected by the overall receiving system.

An isolator, Fig. 1, was used to prevent local-oscillator disturbance of the 2K25 r-f amplifier. Only the r-f and i-f sections of the APS-3 were used in this experiment. The output indicator was connected to the receiver's video output.

A single 2K25 was installed on a tube mount, as shown in the photograph. Output impedance of the r-f stage was adjusted by six screw tuners and a coaxial shorting plunger located beneath the waveguide. Center conductor of the coaxial shorting plunger was connected to the center conductor of the output coaxial cable of the klystron. The dial shown is for tuning the klystron cavity.

Input r-f is fed into the left-hand opening of the waveguide and amplified by the regenerative action of the klystron. Typical performance of this amplifier was gain of 14 db, bandwidth of 20 mc and a noise figure of 5 db.

The section of the APS-3 receiver used in these tests had a sensitivity of -98 dbm, noise figure of 28 db and a bandwidth of 2 mc. When the single-klystron r-f amplifier was connected ahead of the APS-3 receiver sensitivity was increased to -108 dbm. Sensitivity improvement was 10 db.

It was assumed sensitivity would be further increased if a two-stage amplifier were used. This was not found to be true, however, when two 2K25's were coupled directly. Because of interaction between stages, positive feedback of improper phase and magnitude made the amplifier noisy and consequently the sensitivity improvement was not significant. Sensitivity improvement over the APS-3 receiver was only 4 db. The noise figure of this direct-coupled amplifier was considerably higher, 28 db.

Next, a ferrite isolator, which

Receiver Amplifiers

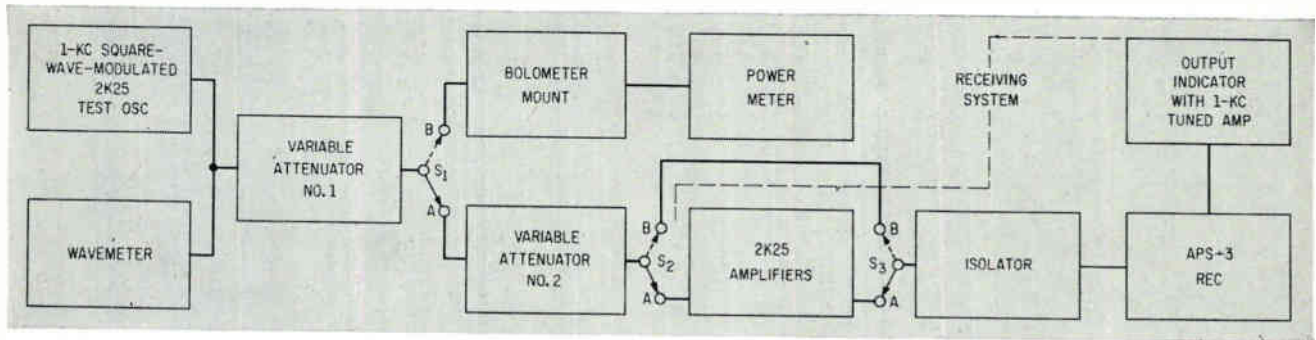

FIG. 1—Block diagram of sensitivity-measuring test setup used in checking performance of reflex klystrons as r-f preamplifiers

had 0.4-db forward attenuation and 30-db backward attenuation, was inserted between the two klystron amplifiers. The noise figure dropped to 26 db and gain was 2 db less than before. Thus, the sensitivity improvement attributable to this isolator-coupled amplifier was 4 db and no different from that of the direct-coupled amplifier.

When a variable phase shifter was used instead of the isolator to couple the klystron amplifiers to obtain proper feedback phase, sensitivity improvement increased to 19 db. This was a considerable improvement over the single-stage amplifier. Use of the phase shifter cut the noise figure to 16 db and gave the amplifier a high gain of 43 db by proper phase adjustment of feedback.

When the isolator and the variable phase shifter were used together to couple the amplifiers, sen-

sitivity was improved further to 22 db over the APS-3. The isolator gave proper isolation (this does not mean ideal isolation in which no feedback is possible) between stages and the phase shifter controlled the feedback for high gain.

As described earlier, use of only one isolator between stages did not show a significant effect on sensitivity. But when two isolators were used in the interstage coupling, sensitivity improvement became 12 db which is considerable in comparison with the single-isolator case.

When two isolators were used together with a variable phase shifter, sensitivity improvement ranged from 26 to 42 db depending on the positions of the isolators inserted in the coupling circuit. The input versus output characteristics of various kinds of two-stage reflex klystron amplifiers are shown in Fig. 2. The relative input-power

levels are expressed in db, taking 0 db, the APS-3 receiver sensitivity, as a reference. As seen in Fig. 2, the amplifiers are linear in the working range.

With the isolators inserted immediately before the second-stage amplifier, sensitivity improvement was 26 db (Curve I). When the isolators were inserted immediately after the first-stage amplifier, which had to amplify the small input signal, the improvement was 28 db (Curve II). Finally, when the isolators were inserted one immediately after the first stage and the other immediately before the second-stage amplifier, the sensitivity was increased to 42 db (Curve III).

The last arrangement eliminated the effect of spurious and residual reflections from the variable phase shifter and isolators to both amplifiers. Thus, adjustments of the amplifier circuit for high sensitivity were made by the stabilizing effect of the isolators. This isolator-phase shifter-isolator coupled amplifier had a gain of 60 db, noise figure of 16 db and bandwidth of 2.4 mc at 9,360 mc.

Thanks are due Professor E. H. Scheibe, University of Wisconsin, and Professor S. Krupnick and L. Heiting, Marquette University.

REFERENCES

- (1) Koryu Ishii, X-band Receiving Amplifier, *ELECTRONICS*, 28, p 202, April 1955.
- (2) Koryu Ishii, Oneway Circuit by the Use of a Hybrid T for the Reflex Klystron Amplifier, *Proc IRE*, 45, p 687, May 1957.
- (3) C. F. Quate, R. Kompfner and D. A. Chisholm, The Reflex Klystron as a Negative Resistance Type Amplifier, *IRE Trans of PGED*, ED-5, No. 3, p 173, July 1958.

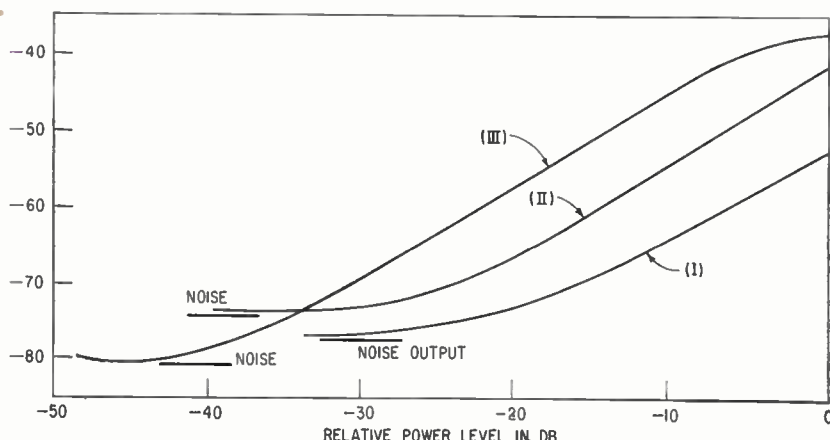

FIG. 2—Sensitivities of cascaded reflex klystron amplifiers. Curve I: phase shifter-isolator-isolator coupling; II: isolator-isolator-phase shifter coupling; III: isolator-phase shifter-isolator coupling

Pulse-Height-to-Digital

Transistorized analog-to-digital converter provides 7-digit binary output for an input of 0 to 2 v at a maximum sampling rate of 13,000 pps

By W. W. GRANNEMANN, C. D. LONGEROT, R. D. JONES, D. ENDSLEY, T. SUMMERS, T. LOMMASSON, A. POPE and D. SMITH,
University of New Mexico Engineering Experiment Station, Albuquerque, New Mexico

PULSE-HEIGHT data reduction can be speeded with pulse-height-to-digital converters. Moreover, tedious arithmetical computation can be avoided by using the converters with a computer. This article describes a transistorized pulse-height-to-digital unit developed for a radar. The counter-type converter provides 7-digit binary output for input signal of 0 to 2 v at maximum sampling rate of 13,000 pps.

Converter Specifications

Function of the converter is to digitize radar return pulses for processing by a datum-reduction system. The unit converts pulsed analog voltage to a full-cycle pulse sequence representing a binary number.

The converter requires two input signals of positive polarity, on separate lines, and produces outputs on two other lines. Input signals are

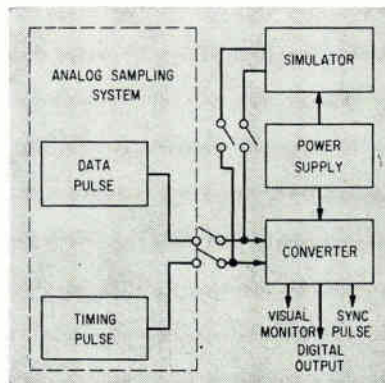

FIG. 1—Block diagram of converter function

Timing pulses have width of one μsec , rise-and-fall time of $0.1 \mu\text{sec}$, amplitude of 15 v. Data pulses have amplitude of 0 to 2 v, width of 0.25 to $5 \mu\text{sec}$, rise-and-fall time of $0.08 \mu\text{sec}$, maximum pps of 13,000. Synchronizing output pulses have width of $1 \mu\text{sec}$, amplitude of 2 v. The first pulse, representing the most significant figure of the binary output, follows the control pulse by $18\text{-}\mu\text{sec}$; appearance of a $4.5\text{-}\mu\text{sec}$ pulse in any other interval depends on amplitude of the data input pulse.

Principles of Operation

Data and timing pulses are received on separate lines, Fig. 1 and 2. Data pulses pass through height-to-width conversion and the new pulses are used to gate clock pulses, proportional to the amplitude of data pulses. After clock pulses are stored by a 7-digit binary counter, the state of the binaries represents the datum-pulse amplitude and the binaries are ready for readout. Timing pulses, leading data pulses by 5 to $10 \mu\text{sec}$, trigger the timing sequence, generating the necessary output pulses at the proper time and delaying readout of the 7-digit binary counter until it has time to count the gated clock pulses.

Operating at 13,000 cps, the converter will complete one cycle in $76.9 \mu\text{sec}$. A full-cycle representation of seven digits at $4.5 \mu\text{sec}/\text{digit}$ accounts for $31.5 \mu\text{sec}$. The data pulse, maximum duration $5 \mu\text{sec}$, follows the timing pulse by maximum of $10 \mu\text{sec}$, accounting for another $15 \mu\text{sec}$. Thirty microsec-

a pulse which initiates a timing sequence in the converter, and an analog-datum pulse following the timing pulse by 5 to $10 \mu\text{sec}$. The converter produces a synchronizing pulse on one output line, a control pulse followed by the binary representation on another line. Output represents amplitude of the input-datum pulse to less than one percent.

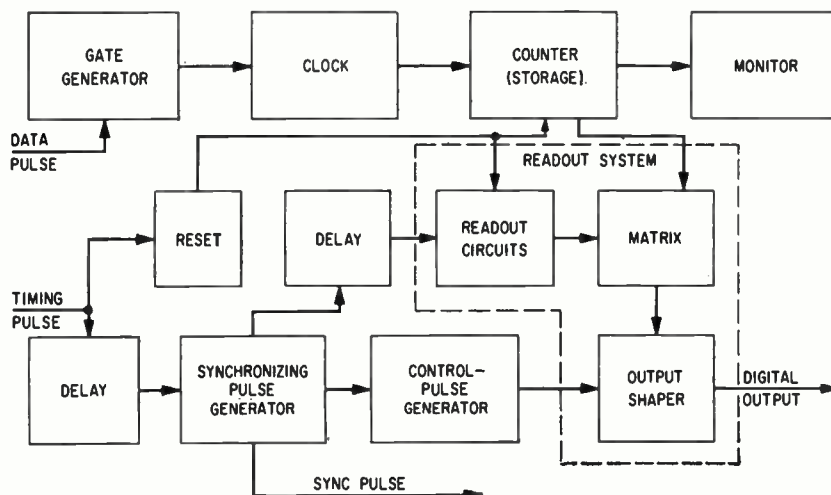

FIG. 2—Block diagram of counter-type converter

Signal Converter

onds is then left for the counting operation.

To achieve one-percent accuracy, requiring a minimum of 100 counts for the maximum input signal, a 7-stage binary counter is required (2^7 or 128). The 30 μsec remaining for counting, when combined with 2^7 , indicates a minimum clock crystal frequency of approximately 4.27 mc; therefore 5.5 mc was selected. This allows rundown of 23.3 μsec for maximum data input signal of 2 v.

Figure 3 shows time relationship between the several converter events. With the 5.5-mc oscillator running continuously, the sequence starts at arrival of the timing pulse that triggers a 21- μsec delay (line 6). This provides part of readout delay until the state of the binaries represents the data signal amplitude. After 21 μsec delay, a 1- μsec pulse generator is triggered—this pulse synchronizes the sweep of a recording scope. The trailing edge of the synchronizing pulse is used to trigger two other stages: the control pulse generator producing a 4.5- μsec pulse for readout reference; and the 18- μsec delay preventing the first binary readout from occurring until 18 μsec after the control or reference pulse. After 18- μsec the trailing edge of the delay pulse triggers a 31.5- μsec gate operating the readout circuits. This gate allows full-cycle representation of the 7-digit counter.

The data pulse follows the timing pulse by 5 to 10 μsec and starts another sequence concurrent with that just described. However, the data pulse is supplied on a separate line and its trailing edge triggers the gate generator which makes the pulse-height-to-pulse-width conversion. Gate width, directly proportional to data pulse amplitude, is applied to the clock circuits to allow clock pulses to pass to the 7-digit binary counter. A maximum of 38.3 μsec is required for the 7-digit counter to collect the information necessary to represent the analog input signal. Readout occurs after 40 μsec has passed.

Conversion of the 0- to 2-volt pulse to a gate is accomplished by a gate generator, Fig. 4. Action of the gate is dependent on a constant-current generator discharging a capacitor. The capacitor is charged through a diode and peaking inductance so that after the pulse has been applied the voltage on the capacitor is of such polarity that the diode is reverse-biased.

Since the capacitor is connected to the collector of the *npn* grounded-base transistor, it starts to discharge after the input pulse has dropped to zero. High impedance in the emitter of the grounded-base 2N332 transistor limits emitter current to a low value, causing the transistor to operate at low collector current. The I_c vs E_c characteristics of this configuration show collector current is constant for wide variation of collector voltage; thus, constant current properties are maintained. The charge on the capacitor is removed at a constant rate; therefore voltage is similarly reduced. With a 7.5- μa constant-current generator rundown is 23.3 μsec for a 2-v input pulse. Temperature control of the critical elements was found essential.

The gate amplifier comprises a differentiator, four amplifiers, and clipping circuits. The gate-generator pulse is differentiated, resulting in a leading-edge spike and gate whose width is proportional to the length of rundown. Following stages clip unwanted spikes and amplify the gate pulse. Output is applied to an oscillator gate, providing control of pulses to be counted.

The oscillator gate, Fig. 5, provides a train of pulses to be read by the 7-digit binary counter. Number of pulses in the train depends on the width of the gate pulse received from the gate amplifier and is proportional to the amplitude of the data input pulse. The oscillator gate is a continuously running crystal-controlled oscillator and gate producing needed pulses at the input to the 7-digit binary counter.

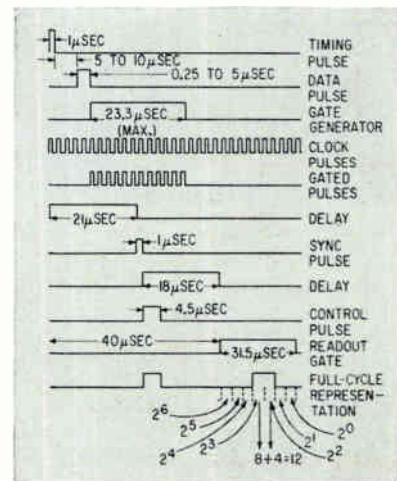

FIG. 3—Timing schedule of converter

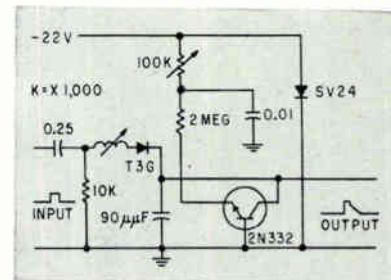

FIG. 4—Schematic diagram of gate generator

Stability is provided by the crystal across the output winding of the three-winding pulse transformer in the free-running blocking oscillator. Gating is accomplished by an emitter-follower and shunt gate. Q_1 , normally conducting, shunts output resistor R_1 except when the transistor is cut off by a positive gate signal at its base.

The 7-digit counter, Fig. 6, stores pulses received from the oscillator-gate, the 128th pulse resetting the counter to zero. The binary counter consists of seven cascaded bistable multivibrators, transformer-triggered. Each pulse to the base of trigger Q_3 provides identical pulses to the bases of binary transistors Q_1 and Q_2 , causing the multivibrator to change state. D_1 is used to reset the binary to its off condition, in which Q_2 is near cut off and Q_1 near saturation. Hence a positive pulse applied at A will reset the binary to its off state if it is not already in that

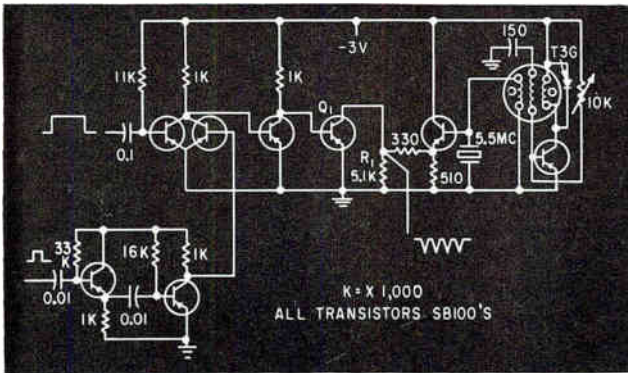

FIG. 5—Continuously running crystal-controlled oscillator gate

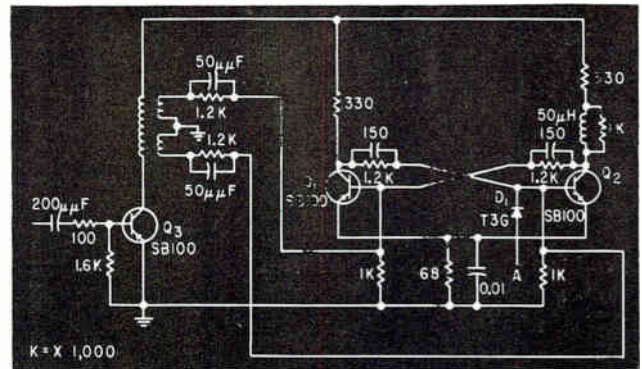

FIG. 6—Single stage of 7-digit binary counter

mode. When the binary is in the off condition there can be no digital output from the binary because of associated matrix circuits, discussed later.

The delay stage, Fig. 7, prevents certain circuits from operating until the proper time and generates and shapes required output pulses. The delay, a monostable multivibrator, is triggered by a positive pulse produced by an input differentiating circuit. Circuits are cascaded, one stage operating from the output of another. The second stage starts its delay coincident with the trailing edge of the first delay output pulse. Output of any stage may also be used to trigger several stages, each of which may be used to actuate an independent event. However, all events will have a common time reference in the trailing edge of the output of the first stage. This delay circuit, with simple modifications, is used for pulses and delays ranging from 0.25 to 32 μ sec and can be used for considerably longer delays.

The readout circuit is composed of an 8-pulse train generator, a 3-digit binary counter, and an AND matrix. Readout is accomplished by

reading the state of each binary in the 7-digit counter.

The 8-pulse train, Fig. 8, consists of the previously described delay circuit triggered by the 18- μ sec delay circuit. The delay generates a 32- μ sec negative gate to pulse a blocking oscillator having a period of 4.5 μ sec. Following the blocking oscillator, the 32- μ sec gate

six transistors in the 3-digit counter appear the output signals, which in conjunction with the states of the binaries of the 7-digit counter operate an AND matrix. This matrix produces pulses, at proper interval, to form a pulse representing amplitude of the data input pulse which has been stored in the 7-digit counter.

The AND matrix is composed of seven AND circuits which read out the states of the binaries in the 7-digit counter. The AND circuits have four inputs, operating on positive signals taken from the six transistors in the 3-digit counter and the seven output transistors in the 7-digit counter. To obtain an output signal of 4.5 μ sec duration, all inputs to a particular AND circuit must be positive and coincide in time for a period of 4.5 μ sec.

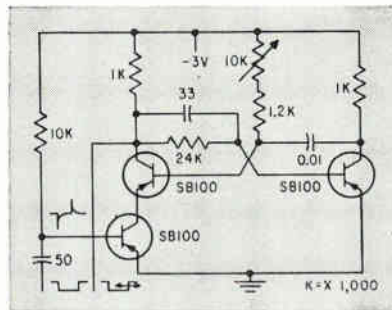

FIG. 7—Schematic diagram of delay stage

produces eight pulses at 4.5- μ sec intervals at the output of the emitter follower.

These pulses put a 3-digit binary counter, consisting of three binary circuits similar to those in the 7-digit counter, through one counting cycle. At the collectors of the

Output Circuits

Output section consists of an OR gate and associated circuits. The OR circuit produces an output for any one or another combination of more than one input. It has eight inputs, seven from the AND matrix and one from a 4.5- μ sec control-pulse generator. The OR gate thus allows the serial output in full-cycle representation.

Output consists of the control pulse followed 18 μ sec later by a train of 4.5- μ sec pulses, 2 v in height. This train represents the analog input signal amplitude.

Another output, a 1- μ sec synchronizing pulse, triggers a display oscilloscope and is provided on a separate line. It precedes the control pulse by 1 μ sec.

The work described in this article was supported by the Naval Research Laboratory.

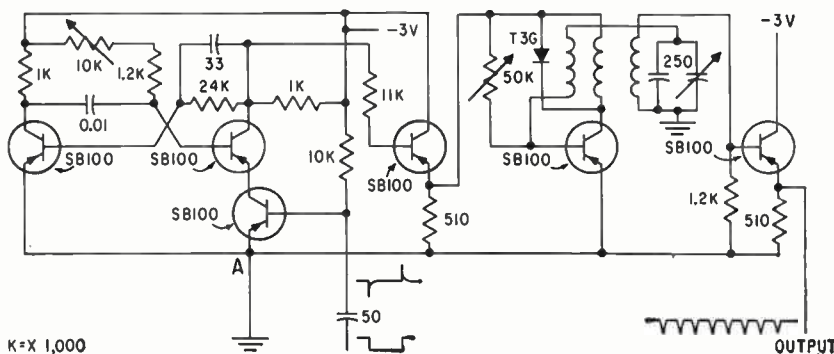
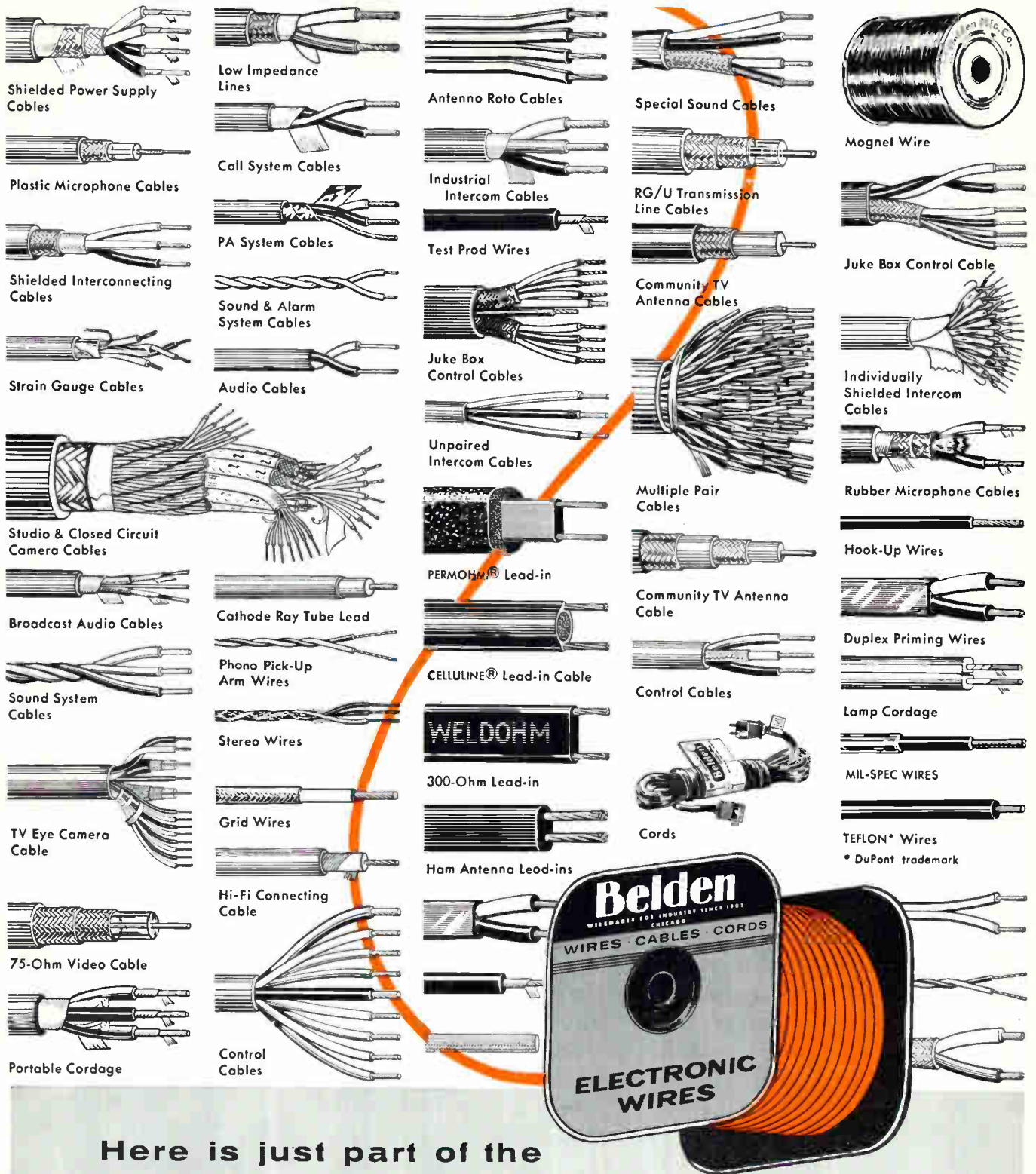

FIG. 8—Eight-pulse train generator



Shielded Power Supply Cables

Plastic Microphone Cables

Shielded Interconnecting Cables

Strain Gauge Cables

Studio & Closed Circuit Camera Cables

Broadcast Audio Cables

Sound System Cables

TV Eye Camera Cable

75-Ohm Video Cable

Portable Cordage

Low Impedance Lines

Call System Cables

PA System Cables

Sound & Alarm System Cables

Audio Cables

Cathode Ray Tube Lead

Phono Pick-Up Arm Wires

Stereo Wires

Grid Wires

Hi-Fi Connecting Cable

Control Cables

Antenna Roto Cables

Industrial Intercom Cables

Test Prod Wires

Juke Box Control Cables

Unpaired Intercom Cables

PERMOHM® Lead-in

CELLULINE® Lead-in Cable

WELDOHM

300-Ohm Lead-in

Ham Antenna Lead-ins

Special Sound Cables

RG/U Transmission Line Cables

Community TV Antenna Cables

Multiple Pair Cables

Community TV Antenna Cable

Control Cables

Cords

Magnet Wire

Juke Box Control Cable

Individually Shielded Intercom Cables

Rubber Microphone Cables

Hook-Up Wires

Duplex Priming Wires

Lamp Cordage

ML-SPEC WIRES

TEFLON® Wires

* DuPont trademark

Here is just part of the
WORLD'S MOST COMPLETE LINE
 of Electronic Wire and Cable!



Available from Stock

One Wire Source for Everything
 Electronic and Electrical

- magnet wire • lead wire • power supply cords • cord sets • portable cordage • electronic wire
- automotive replacement wire and cable • aircraft wire • electrical household replacement cords

8-3-9

Audio Volume Compressor

Transistorized audio compressor has unity gain with expansion of 3 db, compression of 12 db. Gain adjustments are automatic

By E. C. MILLER, Technical Director, Inland Broadcasting Co., Weiser, Idaho

TO MAINTAIN an even recording level during tape-recorded interview sessions, the tape recorder operator may have to make gain adjustments to compensate for variations in speech levels of different speakers and for level changes due to changes in distance between the microphone and the person being interviewed.

At most radio stations, two vol-

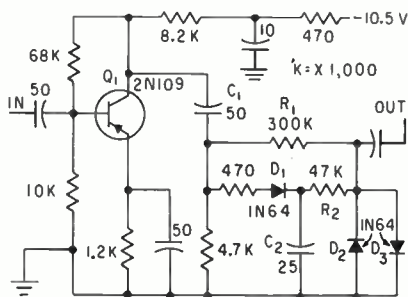

FIG. 1—Audio level compressor is basically a variable L-pad attenuator

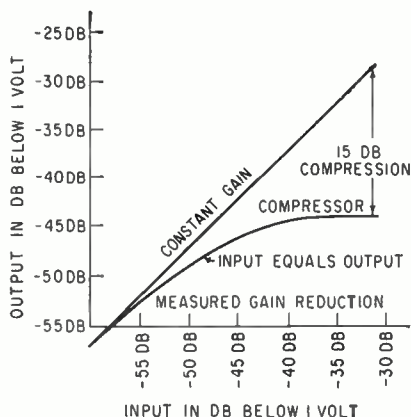

FIG. 2—Approximately 15-db compression is available from the device

ume compressors are used between the studio and transmitter. The first operates as an average program control and the second operates as a peak limiting amplifier to maintain a constant peak percentage of modulation. At some stations, inputs from tape recorders and remote lines have individual automatic gain devices. These are of little help if the signal from the remote line or tape recording is of insufficient level in relation to the line noise.

When interviews are being conducted and recorded by one man, the necessity of making gain adjustments sometimes breaks the reporter's chain of thought during the interview. The transistorized audio compressor is automatic and requires no operating controls. It has the added psychological effect of assuring the reporter of a good recording which allows him to concentrate on the event he is reporting without concern for precise microphone distances or gain control settings.

The audio compressor shown in Fig. 1 is a transistorized unity-gain amplifier having an expansion of 3 db and a compression of 12 db around an average level of approximately 45 db below 1 v at an impedance of 10,000 ohms. The compressor is inserted after the microphone amplifier.

Compressor Operation

The incoming audio signal is amplified by Q_1 , and applied to the diode compressor through C_1 . The diode

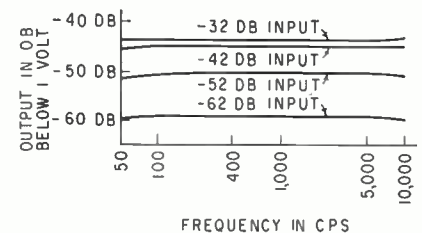

FIG. 3—Frequency response of compressor at various input levels

compressor is essentially an L-pad attenuator with R_1 forming one leg and diode D_1 the other leg.

Diode D_1 rectifies the audio signal and applies the resultant d-c voltage through R_2 to diode D_2 . The impedance of D_2 varies almost logarithmically in inverse proportion to the d-c voltage across it. Diode D_2 protects filter capacitor C_2 from any reverse polarity switching transients that may be applied from the output.

The curves of Fig. 2 show that about 15 db attenuation is available. A portion of this loss is made up in the transistor amplifier thus permitting installation of the unit as a unity-gain amplifier with an expansion of 3 db and compression of 12 db. Total consumption is approximately 0.6 ma.

The frequency response of the compressor for various input levels is shown in Fig. 3.

A tape recorder using this automatic gain compressor has been successfully used to report events from the quiet of an empty hall to the noisy cockpit of a small private plane.

A Gulton "VO" Series
Button Cell Battery
powers this Electro-Larynx
for laryngectomees

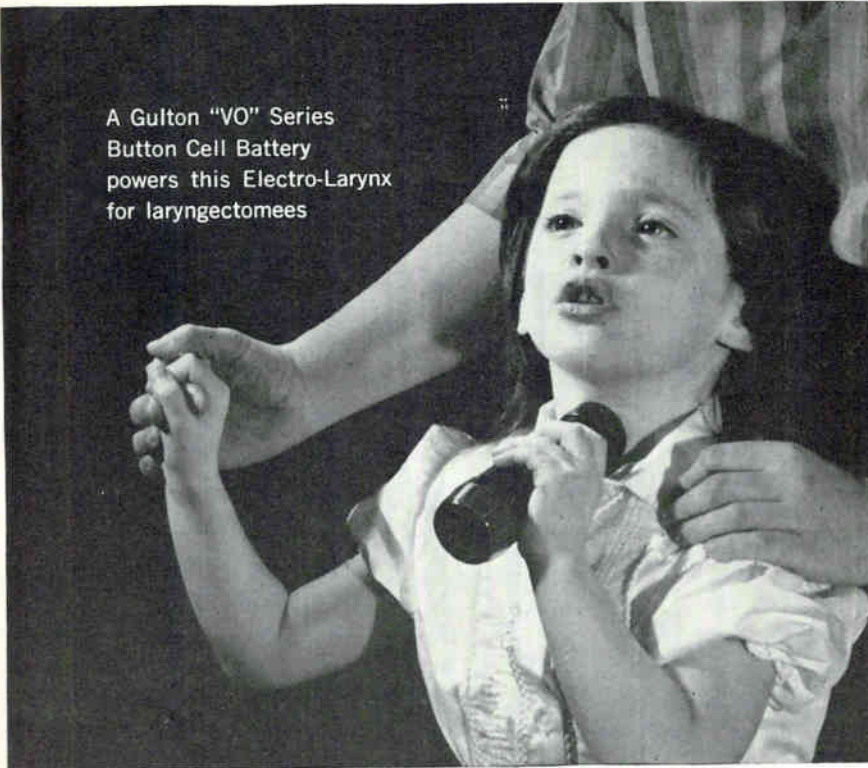

Dependable...long-lived...rechargeable

This child holds a voice in her hand... the Kett Electro-Larynx. A push of a button sets a column of air vibrating in her throat, gives sound to words formed with mute lips.

The Electro-Larynx will prove a boon to thousands of people who cannot speak for one reason or another. To give it a reliable, long lasting, sealed rechargeable source of power, Kett Engineering Corp. chose a Gulton "VO" series sealed nickel cadmium button cell battery.

How Can You Use These Batteries?

Here is a partial list of the many ways imaginative engineers are employing Gulton button cell batteries: transistorized radios, prosthetic devices, missiles, flashlights, photoflash power packs—*wherever small size, large capacity, light weight, long life, no maintenance, complete reliability, and easy recharging are desired.* Like more information? Write us for Bulletin No. VO-110.

		VO-.080	VO-.180	VO-.250	VO-.500
ELECTRICAL SPECS.	Capacity (1 Hour rate):	80 mah	180 mah	250 mah	500 mah
	Charging Current (1c):	2-10 ma	4-18 ma	5-25 ma	10-40 ma
	Charging Time (Constant Current):	150/lc hrs.	270/lc hrs.	375/lc hrs.	750/lc hrs.
	Trickle Charge Rate:	2-5 ma	2-5 ma	2-5 ma	5-10 ma
	Cell Voltage During Charge:	1.4 V	1.4 V	1.4 V	1.4 V
	Maximum Peak Discharge Current:	1.5 A	3 A	5 A	7.5 A
MECHANICAL SPECS.	Diameter:	.900	.975	1.375	1.375
	Thickness:	.200	.270	.1875	.3125
	Weight:	.25 ounce	.35 ounce	.5 ounce	.75 ounce

Available from stock—GLENNITE BATTERY DISTRIBUTORS
92-15 172nd Street, Jamaica, New York



Gulton Industries, Inc.
Alkaline Battery Division, Metuchen, New Jersey,

"VO" SERIES BUTTON CELL BATTERIES

Available Immediately
From These Distributors

ARROW ELECTRONICS
525 Jericho Turnpike
Mineola, L. I., N. Y.
Pioneer 6-8686

D. & H. DISTRIBUTING CO.
2025 Worcester Street
Baltimore, Md.
Saratoga 7-5100

DE MAMBRO RADIO SUPPLY CO.
1095 Commonwealth Avenue
Boston 15, Mass.
Algonquin 4-9000

ELECTRA DISTRIBUTING CO.
1914 West End Avenue
Nashville 4, Tenn.
Alpine 4-8444

ELECTRONIC EQUIPMENT CO.
2701 N.W. 42nd Avenue
Miami 48, Florida
NEwton 5-0421

ELECTRONIC WHOLESALERS, INC.
2345 Sherman Avenue, N.W.
Washington 1, D. C.
HUdson 3-5200

ENGINEERING SUPPLY CO.
1124 East Fourth Street
Tulsa 10, Okla.
DIamond 3-8121

ENGINEERING SUPPLY CO.
6000 Denton Drive
Dallas 35, Texas
FLEetwood 7-6121

ELECTRONIC SUPPLIES
909 Morningside Drive
Melbourne, Florida
PARKway 3-1441

FEDERATED PURCHASER INC.
11275 West Olympic Blvd.
Los Angeles, California
BRadshaw 2-8771

LEW BONN CO.
67 South 12th Street
Minneapolis 3, Minn.
FEderal 9-6351

MILGRAY-NEW YORK
136 Liberty Street
New York 6, N. Y.
REctor 2-4400

NEWARK ELECTRIC CO.
4736 West Century Blvd.
Inglewood, Calif.
ORchard 4-8440

NEWARK ELECTRIC CO.
223 West Madison Street
Chicago 6, Illinois
STate 2-2944

OLIVE ELECTRONIC SUPPLY CO.
6662 Olive Blvd.
University City 5, Missouri
VOLunteer 3-4051

PENINSULA ELECTRONIC SUPPLY
656 South First Street
San Jose, California
CYpress 4-8781

PHILADELPHIA ELECTRONICS INC.
1225 Vine Street
Philadelphia 7, Penn.
LOCust 8-7444

RADIO EQUIP. CORP.
312 Elm Street
Buffalo 3, N. Y.
MADison 9676

SREPCO INC.
314 Leo Street
Dayton 4, Ohio
BALdwin 4-3871



Range Will Aid Antenna Research

CALIBRATION is being completed this month on an unusual model antenna test range. MIT Lincoln Laboratory will put it into operation next year for solving radiation research problems. The facility at Bedford, Mass., two miles from the lab, will permit continuous, all-weather, interference-free testing of antenna radiation patterns.

The Bedford Antenna Test Range will make possible direct recording of patterns for microwave antennas up to 10 ft in diameter and at frequencies from 2 to 16 kmc. Antennas up to 30 ft can be tested at frequencies from 0.3 to 2 kmc. Extension of frequency range to 35 kmc is planned. Using models and scaling techniques, characteristics of large-size antennas can be determined.

Receiving and Transmitting

The receiving building, heart of the five-unit facility, contains four receiving stations. Each is instrumented with antenna positioners, pattern recorders, receivers and control equipment for pattern meas-

urements. At one receiving station, radomes may be mounted around the antenna under test to determine radome performance. The receiving building also contains a laboratory, microwave absorbing cubicle and remote-control equipment.

The short-range transmitting tower houses transmitting antennas, remotely controlled antenna mounts and a low-power signal source continuously tunable by remote control from the receiver building over the range of 0.3 to 2 kmc.

Three transmitting stations and their remotely controlled mounts are in the long-range transmitting building. Each antenna is supplied with r-f energy from a carcinotron oscillator continuously tunable by remote control over a 2-to-1 frequency ratio. The three signal sources cover 2 to 4, 4 to 8 and 8 to 16 kmc.

The short antenna range is 200 by 740 ft; the long, nearly at right angles to the short range, is 200 by 2,000 ft.

Under direction of T. W. Lambe, associate professor of civil engineering at MIT, ground between the receiving house and the two ranges has been resurfaced to be plane within ± 1 in. This requirement, plus freedom from frost heave, necessitated special grading and preparation of topsoil. Both ranges have been planted with grass to limit erosion.

Usually, antenna radiation measurements are taken high in the air to minimize reflections. At the Bedford range, all transmitting, receiving and measuring equipment is placed near ground level, taking advantage of the reflection properties of the ground at low grazing angles. Rather simple calibration procedures compensate interference between direct and reflected rays.

Receiving antennas pick up both direct and reflected rays from highly directional transmitting antennas. Remote-control mechanisms adjust heights and directions of both antennas for maximum receiver response. For this condition, the receiving antenna is illuminated by r-f energy of minimum phase interference. As the receiving antenna is rotated on its mount, patterns are automatically recorded in about 20 seconds.

Other Provisions

The side of the transmitter house facing the receiver building is made of foam plastic, transparent to r-f energy which is directed through the plastic down the range to the receiving antenna. Each receiving antenna is housed in a separate room, with five walls lined with r-f absorbing material. The sixth wall has a metal door that is rolled away for measurements.

Remote controls at the receiver permit adjustments of transmitting frequencies, position and direction of receiving and transmitting antennas, polarization of r-f energy and orientation of radomes. For radar studies, beam shifts as small as 0.01 milliradian can be measured.

Receivers use swept local oscil-

Trainer for DEW Line Operators

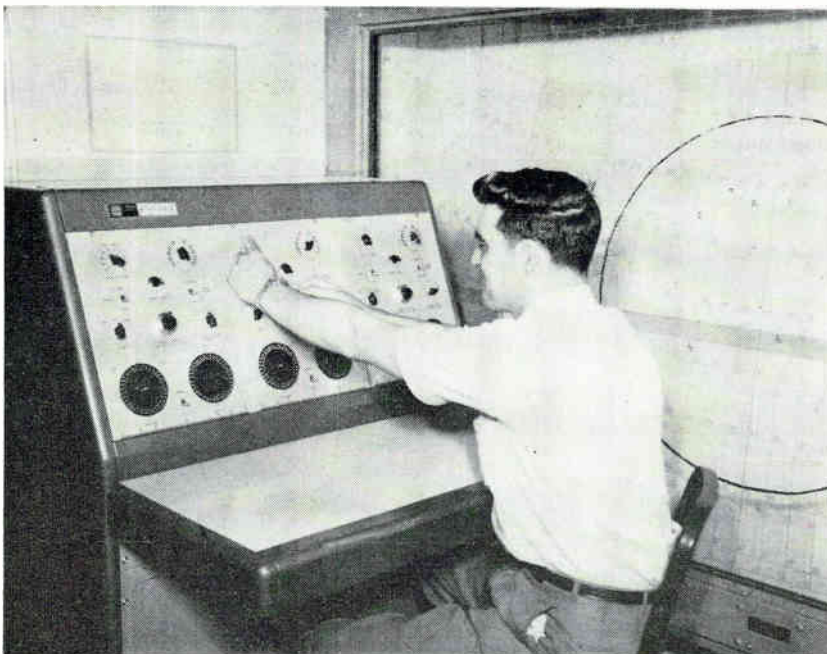

Radar target simulator has been developed by Philco for ITT's Federal Electric. System will be used to train operators of the DEW Line

FIRST
IN
CLASS

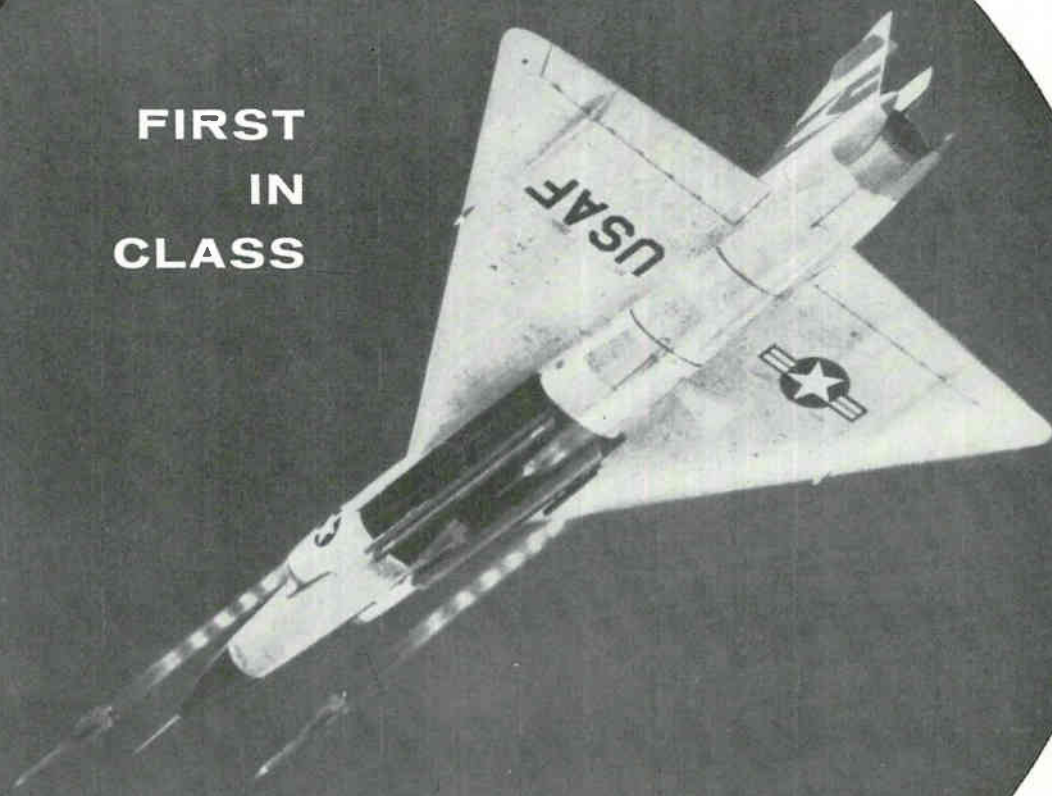

FALCON MISSILE

Playing follow-the-leader at 50 millisecond intervals, three *Super Falcon* missiles rocket ahead of their diamond-shaped supersonic shock waves. Homing in on radar, these deadly air-to-air missiles locate, track, and destroy their prey, with the same killer instinct of the birds they're named after.

Hughes Aircraft, the developer and manufacturer of these missiles and the Armament Control System that triggers them, specified Hitemp magnet and Teflon* wire for their missile, and Teflon wire for its control system.

Hitemp Wires, Inc., the leading specialist in high temperature insulated wires and cables, proudly answers roll call with those developers and manufacturers enlisted in defending our American birthright—*Freedom*.

HITEMP WIRES, INC.

1200 SHAMES DRIVE, WESTBURY, NEW YORK

*Registered trademark for DuPont fluorocarbon resins.



SYNCHROS

MIL-S-20708 | MIL-S-2335



Your complete source for all military type synchros with
"off the shelf" delivery

SIZE 11	CT4c, 26V-CT4c, CX4c, 26V-CX4b, CDX4a, 26V-CDX4b, TR4b, 26V-TR4b, TX4b, 26V-TX4b
SIZE 15	CT4b, CX4b, CDX4b, TR4c, TX4b, TDX4b, CT6b, CX6b, CDX6b, TR6a
SIZE 18	CT4b, CX4b, CDX4b, TR4b, TDX4b, CT6b, CX6b, CDX6b, TX6a, TRX6a
SIZE 23	CT4, CT4a, CT4b, CX4, CX4a, CX4b, CDX4, CDX4a, CDX4b, TR4, TR4a, TR4b, TX4, TX4a, TX4b, TDX4, TDX4a, TDX4b, TDR4, TDR4a, TDR4b, CT6, CT6a, CT6c, CX6, CX6a, CX6c, CDX6, CDX6a, CDX6b, TR6, TR6a, TX6, TX6a, TX6b, TDX6, TDX6a, TDX6b, TDR6, TDR6a, TRX6a
SIZE 31	TR4d, TX4a, TX4d, TDX4b, TDR4b, TR6b, TX6b, TDX6b, TDR6b
SIZE 37	TR4a, TX4b, TDX4a, TDR4a, TR6b, TX6b, TDX6a, TDR6a
TYPE 1	1D, 1F, 1HCT, 1HDG, 1HG
TYPE 3	3D, 3F, 3HCT, 3HDG, 3HG
TYPE 5	5D, 5F, 5HCT, 5HDG, 5HG, 5N
TYPE 6	6HDG, 6HG

WRITE FOR FREE

Rapid Reference Guide to
Military Synchros. →

Write on company letterhead
for Synchro Engineering Catalog.



West Coast Sales and Service Office—117 East Providencia Avenue, Burbank, California
Canadian Sales Office—Aviation Electric Limited, 200 Laurentien Blvd., Montreal, Quebec, Canada
Export Sales and Service—Bendix International, 205 East 42nd St., New York 17, New York

Montrose Division
SOUTH MONTROSE, PA.



lators to compensate shifts in transmitter frequency. Low power of the r-f sources, concentration of energy in a narrow beam aimed horizontally at the receiving station and high-gain receivers reduce interference from and to other services.

Simple Latch Circuit Uses Saturable Reactor

By W. J. REAP Product Development Lab.,
IBM Corp., Endicott, N. Y.

LATCH circuit using saturable reactor offers operating simplicity, high speed and low cost. Although the prototype circuit to be described uses a vacuum tube, a transistor model can switch in less than 0.5 μ sec.

In the circuit in Fig. 1, current is drawn through winding N_1 when V_1 is conducting. This current saturates the transformer core so that practically none of the 350-kc input to winding N_3 is induced across winding N_2 . In this condition, grid-to-cathode voltage is about -9 v, maintaining conduction in the tube.

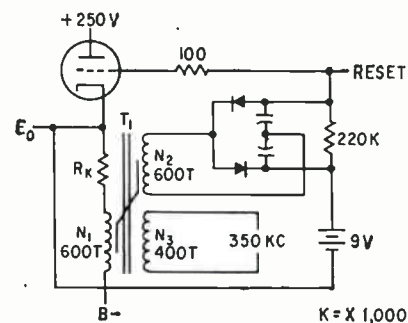

FIG. 1—Current through N_1 when V_1 conducts saturates the core of T_1 .

If a voltage of sufficient magnitude and negative with respect to the cathode is applied to the grid, the tube will be cut off. Current through winding N_1 stops and the core of T_1 is no longer saturated. The alternating current flowing through winding N_3 now induces a voltage across N_2 . This voltage is rectified and filtered and applied between the cathode and grid to keep the tube cut off.

A reset pulse must be applied to the control grid to switch the circuit back to its original condition.

Computer Is Used for Turbidimetric Assays

SUCCESSFUL automatic microbiological testing has been reported at the seventh annual Antibiotics Symposium. The high-speed system uses a computer to calculate laboratory data in six minutes that previously required 30 hours by technicians.

The automatic assay system was developed at the electronic research department of Chas. Pfizer & Co., Inc. Special electronic equipment used in the system was developed by IBM.

System Concept

The system is used in turbidimetric assays—tests to determine potency of antibiotics and other drugs. These tests are based on the fact that bacteria grown in test tube solutions cause cloudiness or turbidity.

Adding an antibiotic to the test tube inhibits bacteria growth, reduces turbidity and causes the solution to appear more transparent. Degree of turbidity is measured by a Bausch & Lomb spectrophotometer, which records amount of light passing through the sample.

Normally large numbers of light readings are recorded by a laboratory technician and are followed by a series of time-consuming slide rule computations. With the new system, all manual operations and calculations are performed swiftly and accurately by electronics.

Without stopping for human analysis, the turbidity readings and other important data are continuously and automatically entered on punched cards. The cards are then processed by a computer.

As well as added efficiency, the system increases confidence in test results. Common errors found in computing sample potencies are said to be eliminated.

A similar electronic system is being developed for plate diffusion assays, another method of gaging strength of antibiotics and other drugs. Electronic equipment is also being installed for collating results of pharmacology, sterility and potency testing. With the introduction of magnetic storage tape, computation time will be reduced to one-sixth that presently required.



... of Standard "Quick Delivery" Magnetic Storage Drums

Bryant's three new series of 5", 7.5" and 10" diameter standard drums offer impressive savings plus prompt delivery. These series, covering the majority of computer requirements, are:

SERIES 5000B 7500B 10000B

TRACKS	BIT CAPACITY	R.P.M.
85 to 280	174,080 to 569,344	3,600 to 24,000
85 to 280	261,220 to 860,160	1,800 to 12,000
85 to 420	348,160 to 1,720,320	1,800 to 6,000

All Bryant standard magnetic drums are made to the same precision standards as are Bryant custom-designed drums. A few of their many features: 1. Drums are precision ground and dynamically balanced. Guaranteed less than .0001" dynamic runout. 2. Powered by exclusive Bryant-designed-and-manufactured integral drive induction motors. 3. Super-precision ball bearings. 4. Exclusive Bryant tapered drum head-setting method, guaranteeing exact head-to-drum spacing. 5. Standard heads providing .200" minimum register arc length. 6. Compatible with MIL-E-4158A and MIL-E-16400-B specifications. Bryant Computer Products Division, P.O. Box 620 Springfield, Vermont, U.S.A.

Write now for complete information

Demand in Europe For Low-Grade Silicon

A SURVEY just completed by Chimel SA, silicon suppliers of Geneva, Switzerland, indicates that demand trend, based on actual interviews with users, is towards lower grade silicon than now used and towards lower-cost, uniform product.

The current Western European consumption, estimated at approximately 2,500 kilograms in 1959, will continue to grow at a high rate for at least five years. Currently, pure silicon is being sold in four purity grades, determined by its resistivity, with the ultimate selling price per kg based on purity: grade I, 3,750 Sw. Fr.; grade II, 2,580 Sw.

Fr.; grade III, 1,520 Sw. Fr.; solar cell grade, 1,000 Sw. Fr. (4.3 Sw. Fr. = \$1.)

The survey discloses that semiconductor device manufacturers are tending to use the lower grades because of the price premium for the higher purities. Intensified development of improved doping procedures and designs utilize the lower grades. The findings indicate that grade 1 or better will be used in comparatively few devices, such as power rectifiers; and the grades close to the present grades II and III will be the dominant market type.

It is significant that only those processes capable of marketing bulk silicon at a price of less than 1,000 Sw. Fr. per kg will survive the competitive shakedown. Five Western European companies have already entered the ring and two others are known to be developing new processes.

A study of the process economics indicates that because of its low raw material and conversion costs, the silicon tetrachloride reduction process may be expected to be the workhorse of the industry in the future, supplying the bulk of the needs of the electronic market.

Floating Mount For Uhf Triode

A TUBE SOCKET for high frequency applications was recently described by inventor A. C. Gregson of Instruments for Industry, Inc., Hicksville, N. Y.

The design was the result of the increased use of high-frequency

tubes, such as the GE GL/6299 uhf triode, in equipment utilizing lumped-constant circuitry. Since no sockets were available for grounded-grid applications of this tube at 1,000 mc or higher, the technique was to solder these triodes directly

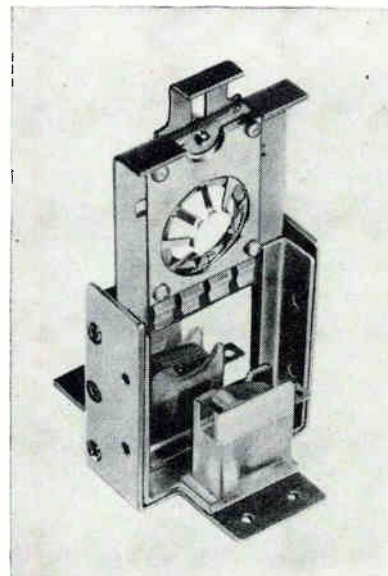

Tube socket developed for 6299 ultra high frequency triode

Silicon Photo Cells as Detectors

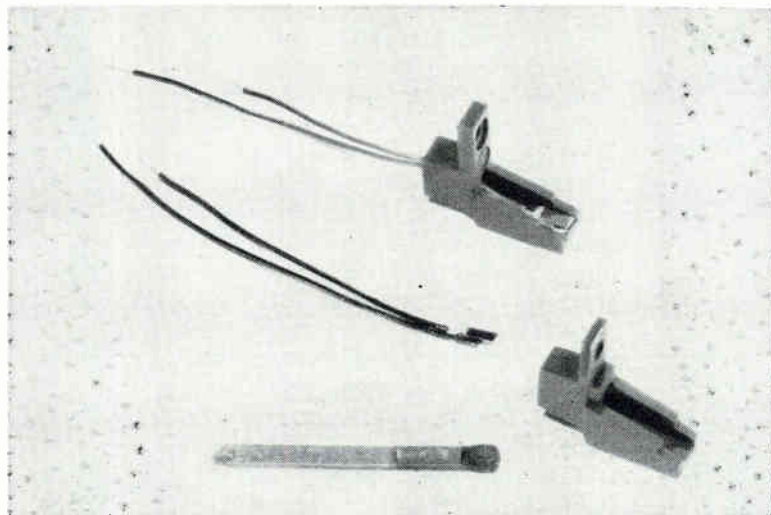

The same types of silicon photo-voltaic cells used in earth satellites are now used as pickup elements for scanning the optical sound track in Eastman Kodak Company's Pageant sound projectors. The cells are purchased from Hoffman Electronics Corp. and mounted in plastic holders at Kodak. The scanning beam does not utilize the entire 0.014 sq. in. of the cell, so extremely fine positioning tolerances are not necessary. At 10,000 footcandles of sunlight, the cells will provide a short circuit current of 2.1 ma and an open circuit voltage of 550 mv. Response time is 20 microseconds or less, depending upon load resistance. Units are shown in actual size

into a circuit to alleviate the problems of poor grounding and high contact inductance, which seriously limited upper operating frequencies. This technique resulted in a shift of circuit values each time a tube was replaced because lead and tube were not consistent.

Grounded Grid

Since the 6299 triode is intended primarily for grounded-grid service, this socket provided a mini-

WESTINGHOUSE SILICON POWER TRANSISTORS

2N1015
2N1016

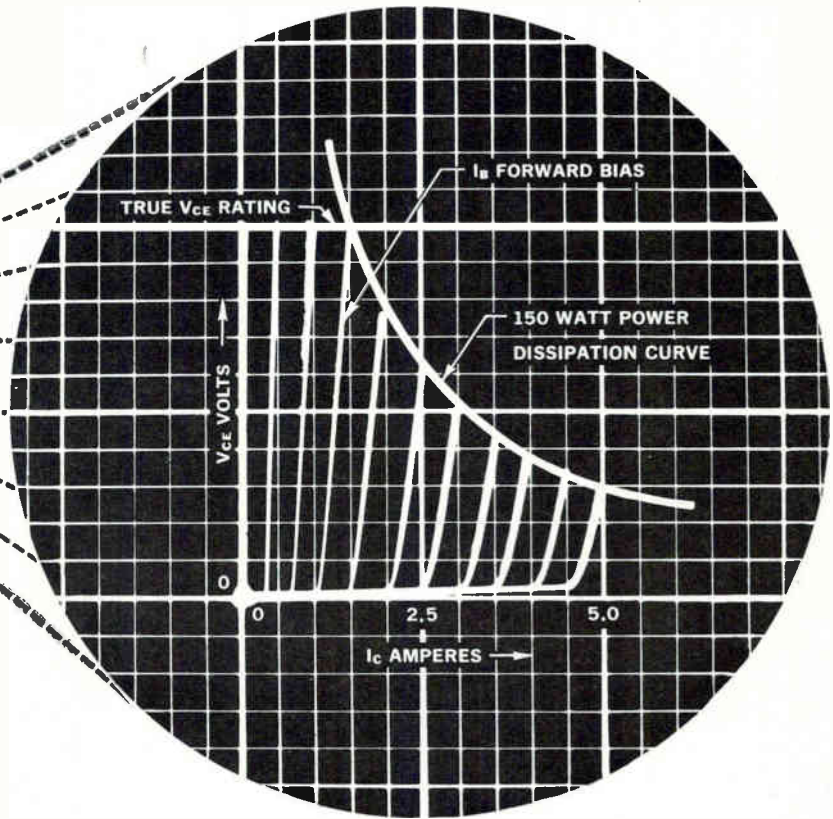

TRUE VOLTAGE RATINGS

Guaranteed by 100% power testing

This Power-voltage Test consists of testing the transistor in common emitter configuration under all bias conditions in the area defined by the *TRUE* voltage rating of the transistor (V_{CE}); the constant power dissipation curve for the transistor (150 watts); and its rated current (2 amps for 2N1015 and 5 amps for 2N1016).

The voltage at which alpha equals one, and other voltage ratings commonly given for transistors such as V_{CES} , V_{CER} , V_{CEX} and V_{CBO} , are *above* the voltage rating given to these transistors.

Each Westinghouse silicon power transistor has been completely tested throughout its rated voltage-power-current region before shipping. Thousands of transistors performing under all types of operating conditions have proved the validity of this method of *TRUE* voltage rating.

TRUE voltage ratings from 30 to 200 volts give you complete freedom in designing your equipment—you can op-

erate Westinghouse silicon power transistors at the manufacturer's ratings without risking transistor failure. This *TRUE* voltage rating of Westinghouse silicon power transistors coupled with their still unequalled low saturation resistance and low thermal drop makes them an ideal first choice for military, industrial and commercial applications.

Type	V_{ce}^*	B (min)	R_s (max)	I_c A (max)	T_j max. operating	Thermal drop to case (max)
2N1015	30	10 @ $I_c=2$ amp	.75 ohms @ $I_c=2$ amp $I_b=300$ ma	7.5	150°C	.7°C/W
2N1015A	60					
2N1015B	100					
2N1015C	150					
2N1015D	200					
2N1016	30	10 @ $I_c=5$ amp	.50 ohms @ $I_c=5$ amp $I_b=750$ ma	7.5	150°C	.7°C/W
2N1016A	60					
2N1016B	100					
2N1016C	150					
2N1016D	200					

**TRUE* voltage rating (The transistors can be operated continuously at the V_{CE} listed for each rating.)

YOU CAN BE SURE...IF IT'S **Westinghouse**

Westinghouse Electric Corporation, Semiconductor Department, Youngwood, Pa.

U T I C A[®]

TOOL

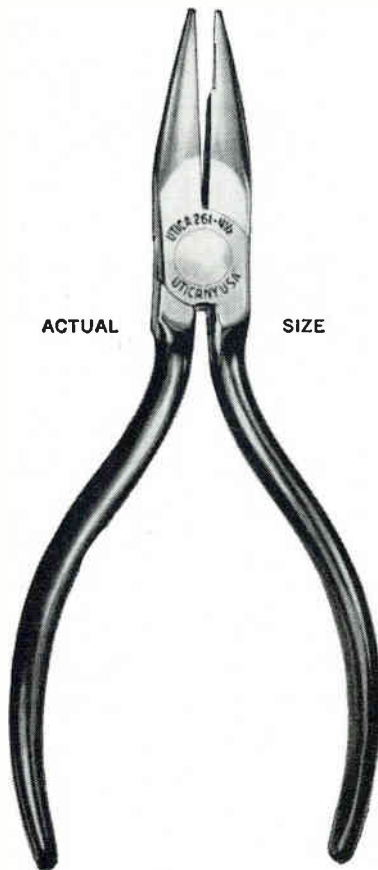

ACTUAL SIZE

Pliers for electronic work are Utica's specialty. With over 1000 different types of pliers in stock, Utica has become the leading supplier to the electronic industry. As plier specialists, Utica can recommend and supply the right tool for the job. To you, the right tool means better, easier work and lower costs. In plant after plant throughout the country, engineers and purchasing men are turning to Utica. Why don't you?

Utica Drop Forge & Tool Division, Kelsey-Hayes Company, Utica 4, N. Y.

tools the experts use!

imum inductance for the grid return path to ground. This socket was used at frequencies up to 1,000 mc and exhibited no resonances. The part of the socket containing the tube slides in and out to permit quick replacement of tubes without disturbing any of the associated circuitry. This is accomplished by the use of spring contact slides on both sides and bottom of this part. When inserted, this piece becomes an electrical ground plane that provides the isolation between input and output. The contacts that are connected directly to the circuit maintain their position in the molded plastic mount. Therefore, removal of the tube cannot cause any shift of circuit elements. For application to uhf with lumped circuit constants this was a major advance.

Multi-Aperture Core Simplifies Winding

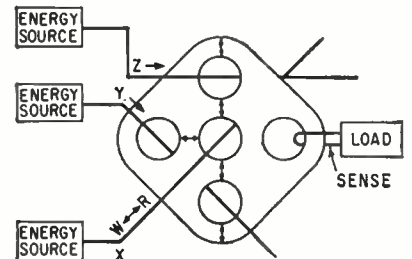

THIS CORE DEVICE, described by F. L. Post of International Business Machines, requires but a single winding through each aperture and may be operated either as a biased flux coincident current device or as an anti-coincident current device.

For anti-coincident current operation, the Y winding is energized at all times when switching of the core is not desired and counteracts either a read or a write current in winding X. With Y de-energized at the time of a write pulse in X, switching of the core may be inhibited by a current in the Z winding. The sense winding detects switching of the core.

For coincident current operation, a bias winding threads two apertures while the X and Y windings thread one aperture each. Coincident currents in X and Y overcome the bias and switch the core. A

fifth aperture is threaded by a sense winding. A sixth aperture may be provided for an inhibit winding.

Gallium Phosphide Withstands 1,500 F

THE ARMY SIGNAL Corps has built a gallium phosphide diode which withstands temperatures seven times higher than silicon and germanium. Switching devices with the material have also been designed.

The material may also be used in building solar-cell power plants for space stations, according to Brigadier General J. C. Monahan, Chief of the U.S. Army Signal Corps Research and Development Division. "As a rugged core of tiny electrical devices, it may be used in making electronic parts for mis-



Heart of this new diode is a tiny crystal of gallium phosphide. The heat resistant ability of this component may help it to become the forerunner of a new family of parts that operate in intense heat

iles, satellites and space probes of the future."

Resembling yellow ground glass, the material was home grown at Fort Monmouth, New Jersey. The material is still under study to pinpoint its unique properties before release to Army Signal Corps equipment development engineers.

TIE TIMING SIGNALS

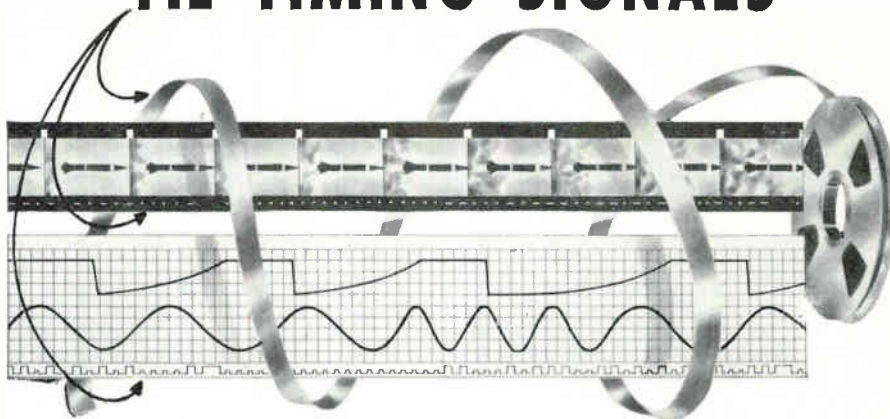

to different recording media with

HERMES TIMING EQUIPMENT



Model 270
DIGITAL
TIMING GENERATOR



Model 220
RETARDED
BIT RATE UNIT

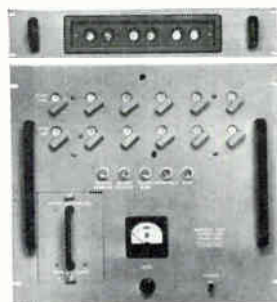

Model 202
MAGNETIC
TAPE SEARCH UNIT

Hermes Timing Equipment is specifically designed to correlate precise timing signals with data on different recording media such as recording cameras, plotting boards, strip charts and high or low speed oscillographs. This timing equipment consists of a Digital Timing Generator and Retarded Bit Rate Unit which operate during periods of data acquisition and a Magnetic Tape Search Unit which operates during periods of data reduction.

Digital Timing Generator, Model 270, is an all solid-state instrument which generates binary coded decimal signals as recorded on magnetic tape providing a precise digital index in terms of elapsed time. The Generator also visually displays the exact time in hours, minutes, and seconds as illuminated digits. An Airborne Digital Timing Generator, Model 206A, which meets all the essential requirements of MIL-E 5400 is also available.

Retarded Bit Rate Unit, Model 220, operates in conjunction with Timing Generators, Models 270 or 206A, to provide a pulse-height, pulse-width signal, for recording time on equipments other than magnetic tape recorders.

Magnetic Tape Search Unit, Model 202, is used to control a magnetic tape transport during periods of data reduction for automatically searching the tape on the basis of time indices previously recorded by any one of the two Timing Generators. The Retarded Bit Rate Unit, Model 220, can also be used with Model 202 for reproducing time on oscillographs as previously recorded on the tape.

Auxiliary equipment including a Run Code Selector, Model 225, for inserting data run code numbers and a Tape Input Programmer, Model 230, for automatically programming tape search are also available.

Write for Technical Bulletins
on Hermes Timing Equipment.

The new name for HYCON EASTERN, INC. is



Hermes Electronics Co.

75 CAMBRIDGE PARKWAY • DEPT A • CAMBRIDGE 42, MASSACHUSETTS

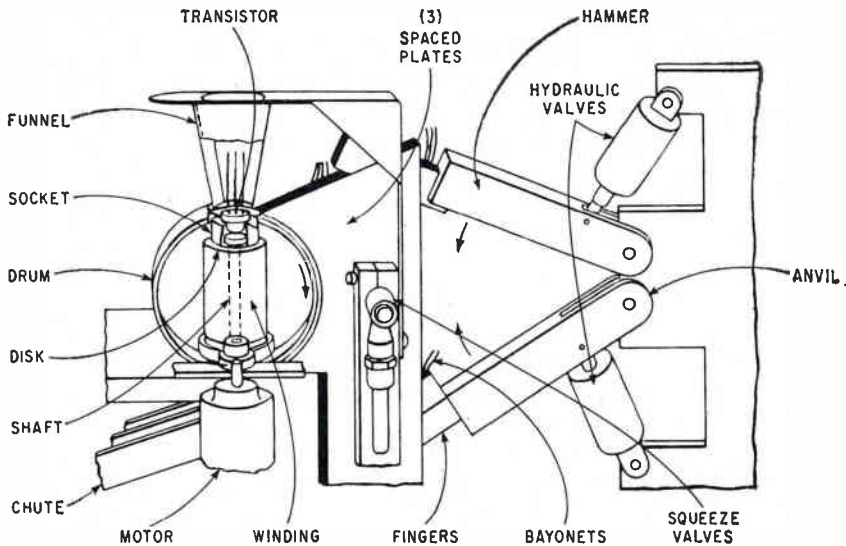
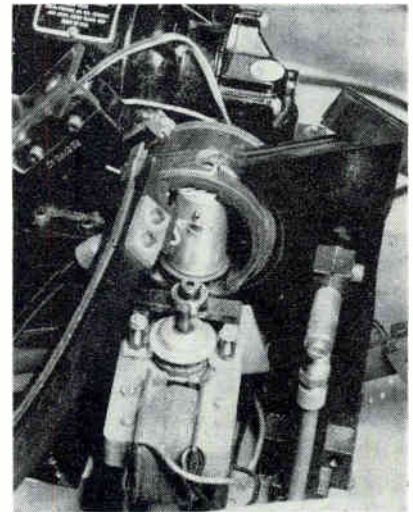

FIG. 1—Rotating drum drops transistor leads between set of plates, where leads are squeezed top, bottom and side by plates and fingers



Drum is in center, feed track at left, plates at right

Squeezer Unkinks Transistor Leads

TRANSISTOR LEADS that are bent or kinked make automatic testing or assembly insertion difficult. The machine illustrated, used by International Business Machines Corp., rapidly straightens the leads by squeezing them between plates and fingers.

Transistors are dumped loose into a vibratory feeder bowl and are oriented with leads up as they pass along the feeder track. They are fed singly into a funnel, so that the cap drops into an insulating socket on the drum (Fig. 1).

The steel disk in the bottom of the socket, and the shaft, are rotated by the motor through a friction drive. The shaft and disk are magnetized by the winding. The magnetized disk causes the transistor base (magnetic material) to rotate in the socket until a lug on the transistor base is seated in a recess.

As soon as the lug is seated, an electrical circuit through the base of the transistor closes. This shuts off the shaft rotating motor and energizes a second motor (not shown in Fig. 1). The second motor turns the drum a quarter-turn to the right, bringing the transistor leads down between the

spaced plates (Fig. 2).

When the drum has completed the quarter-turn, the lower hydraulic valve lifts the anvil and its fingers and bayonets to a horizontal position. Then the squeezer valves

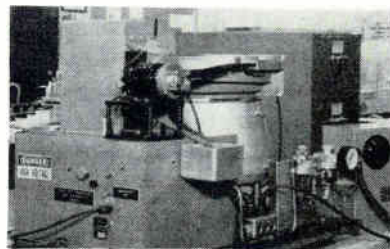

Overall view of machine and accessories

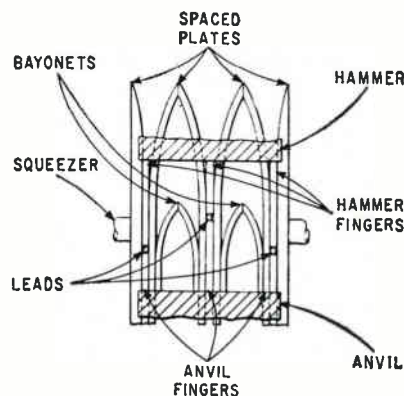

FIG. 2—End view of squeeze position. Plates are shaped to comb leads as they enter

force the plates together. Finally the hammer fingers are driven down between the spaced plates. The combined squeezing actions straighten the leads.

The hammer, anvil and plates return to their original positions. The winding around the shaft is de-energized and the drum is rotated another quarter-turn, allowing the transistor to drop into the discharge chute. The drum continues to turn until it reaches the loading position.

After straightening, the transistors are placed in another vibratory feeder bowl which feeds them to test equipment. Robert D. Essert, of IBM, Poughkeepsie, devised the straightening method.

Ammeter Sorts Out Look-Alike Metals

LOOK-ALIKE METALS can be readily sorted by adapting a milliammeter to detect the polarity of the metals by the thermoelectric effect. The meter is provided with a polarity-indicating dial and 2 leads, one ending in a clamp and the other in a carbon steel file.

After the clamp is attached to the



More performance per pound *This is the actual size of the Bendix-Pacific Subcarrier Oscillator. In addition to a sub-sub-miniature package, the Model TOE-300 Oscillator combines high density, extreme accuracy and extended reliability. Wire, write or call for complete specifications.*

Bendix - Pacific, Division of Bendix Aviation Corporation, North Hollywood, California

When you've got big plans for the future — you have good reasons for reading your businesspaper mightly carefully. This is where a man who means business gets facts, news, ideas . . . information he needs to do business. Issue after issue you find meaty stuff to keep your job and your business growing — in both the advertising and editorial pages of . . . your businesspaper.



PHOTO ON LOCATION BY EHRENBERG

Where there's business action, there's a businesspaper . . . where there's electronics business, there's

electronics

A McGraw-Hill Publication • 330 W. 42nd Street • New York 36, N. Y.



One of a series of advertisements prepared by the ASSOCIATED BUSINESS PUBLICATIONS

metal whose identity is in doubt, the file is briskly rubbed against the metal. The friction causes a localized hot spot which produces a measurable current (about 5 to 10

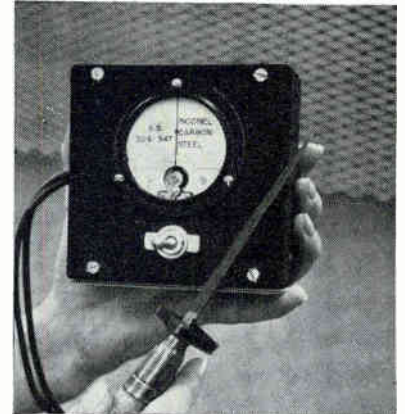

Milliammeter dial is labelled to differentiate between metals according to their polarity



Device being used to check stock identification

milliamperes for Inconel or stainless steel).

Thermocouple lead hookups can also be checked by using the meter as a polarity indicator. If polarity is not indicated, the circuit is incomplete. A small magnet placed in the handle of the file provides a quick identification of carbon steel.

The device was developed by George Martin, of Knolls Atomic Power Laboratory, operated for the AEC by General Electric Co., Schenectady, N. Y. It is used there to differentiate between Inconel and stainless steel, Zircaloy-2 and zirconium, and Zircaloy-2 and hafnium. The polarities of these pairs of nonmagnetic metals differ with respect to carbon steel. The meter avoids mistakes in returning unused pieces of metal to stock.

electronics READER SERVICE

Use these handy prepaid
READER SERVICE POST CARDS
for more detailed information on:
PRODUCTS ADVERTISED
NEW PRODUCTS "On the Market"
LITERATURE of the WEEK

Circle the number on the READER SERVICE post card at the right that corresponds to the number at the bottom of Advertisement, New Product item, or the Literature of the Week selection in which you are interested.

Please print clearly. All written information must be legible in order to be efficiently processed.

ALL FOREIGN INQUIRIES that cannot reach electronics before the expiration dates noted on the Reader Service Post card, must be mailed directly to the manufacturer.

TO SUBSCRIBE TO OR TO RENEW electronics — Fill in the "For Subscriptions" area on the card if you desire to subscribe to or renew your present subscription to electronics. Send no money. electronics will bill you at the address indicated on the Reader Service post card.

*MULTI-PRODUCT ADVERTISEMENTS —

For information on specific items in multi-product advertisements note area marked by asterisk (*) on post card. Print circle number of advertisement and name of product(s) in which you are interested.

JAN. 8 • 60
Card Expires
MAR. 8 • 60
For Foreign Mailings
FEB. 27 • 60

Name _____ Title _____
Company _____
Address _____

JAN. 8 • 60
Card Expires
MAR. 8 • 60
For Foreign Mailings
FEB. 27 • 60

Name _____ Title _____
Company _____
Address _____

INSIDE FRONT COVER		INSIDE BACK COVER	
1	21 41 61 81 101 121 141 161 181 201 221 241 261 281 301 321 341 361 381	1	21 41 61 81 101 121 141 161 181 201 221 241 261 281 301 321 341 361 381
2	22 42 62 82 102 122 142 162 182 202 222 242 262 282 302 322 342 362 382	2	22 42 62 82 102 122 142 162 182 202 222 242 262 282 302 322 342 362 382
3	23 43 63 83 103 123 143 163 183 203 223 243 263 283 303 323 343 363 383	3	23 43 63 83 103 123 143 163 183 203 223 243 263 283 303 323 343 363 383
4	24 44 64 84 104 124 144 164 184 204 224 244 264 284 304 324 344 364 384	4	24 44 64 84 104 124 144 164 184 204 224 244 264 284 304 324 344 364 384
5	25 45 65 85 105 125 145 165 185 205 225 245 265 285 305 325 345 365 385	5	25 45 65 85 105 125 145 165 185 205 225 245 265 285 305 325 345 365 385
6	26 46 66 86 106 126 146 166 186 206 226 246 266 286 306 326 346 366 386	6	26 46 66 86 106 126 146 166 186 206 226 246 266 286 306 326 346 366 386
7	27 47 67 87 107 127 147 167 187 207 227 247 267 287 307 327 347 367 387	7	27 47 67 87 107 127 147 167 187 207 227 247 267 287 307 327 347 367 387
8	28 48 68 88 108 128 148 168 188 208 228 248 268 288 308 328 348 368 388	8	28 48 68 88 108 128 148 168 188 208 228 248 268 288 308 328 348 368 388
9	29 49 69 89 109 129 149 169 189 209 229 249 269 289 309 329 349 369 389	9	29 49 69 89 109 129 149 169 189 209 229 249 269 289 309 329 349 369 389
10	30 50 70 90 110 130 150 170 190 210 230 250 270 290 310 330 350 370 390	10	30 50 70 90 110 130 150 170 190 210 230 250 270 290 310 330 350 370 390
11	31 51 71 91 111 131 151 171 191 211 231 251 271 291 311 331 351 371 391	11	31 51 71 91 111 131 151 171 191 211 231 251 271 291 311 331 351 371 391
12	32 52 72 92 112 132 152 172 192 212 232 252 272 292 312 332 352 372 392	12	32 52 72 92 112 132 152 172 192 212 232 252 272 292 312 332 352 372 392
13	33 53 73 93 113 133 153 173 193 213 233 253 273 293 313 333 353 373 393	13	33 53 73 93 113 133 153 173 193 213 233 253 273 293 313 333 353 373 393
14	34 54 74 94 114 134 154 174 194 214 234 254 274 294 314 334 354 374 394	14	34 54 74 94 114 134 154 174 194 214 234 254 274 294 314 334 354 374 394
15	35 55 75 95 115 135 155 175 195 215 235 255 275 295 315 335 355 375 395	15	35 55 75 95 115 135 155 175 195 215 235 255 275 295 315 335 355 375 395
16	36 56 76 96 116 136 156 176 196 216 236 256 276 296 316 336 356 376 396	16	36 56 76 96 116 136 156 176 196 216 236 256 276 296 316 336 356 376 396
17	37 57 77 97 117 137 157 177 197 217 237 257 277 297 317 337 357 377 397	17	37 57 77 97 117 137 157 177 197 217 237 257 277 297 317 337 357 377 397
18	38 58 78 98 118 138 158 178 198 218 238 258 278 298 318 338 358 378 398	18	38 58 78 98 118 138 158 178 198 218 238 258 278 298 318 338 358 378 398
19	39 59 79 99 119 139 159 179 199 219 239 259 279 299 319 339 359 379 399	19	39 59 79 99 119 139 159 179 199 219 239 259 279 299 319 339 359 379 399
20	40 60 80 100 120 140 160 180 200 220 240 260 280 300 320 340 360 380 400	20	40 60 80 100 120 140 160 180 200 220 240 260 280 300 320 340 360 380 400

*Circle No.	Product	Circle No.	Product	*Searchlight Section
460	463 466 469 472 475 478	460	463 466 469 472 475 478	
461	464 467 470 473 476 479	461	464 467 470 473 476 479	
462	465 468 471 474 477	462	465 468 471 474 477	

FIRST CLASS
PERMIT NO. 64
(SEC. 34.9 P.L.&R.)
NEW YORK, N. Y.

BUSINESS REPLY MAIL

NO POSTAGE STAMP NECESSARY IF MAILED IN THE UNITED STATES

6¢ Postage Will Be Paid By
electronics
Reader Service Dept.
330 West 42nd Street
New York 36, N. Y.

FIRST CLASS
PERMIT NO. 64
(SEC. 34.9 P.L.&R.)
NEW YORK, N. Y.

BUSINESS REPLY MAIL

NO POSTAGE STAMP NECESSARY IF MAILED IN THE UNITED STATES

6¢ Postage Will Be Paid By
electronics
Reader Service Dept.
330 West 42nd Street
New York 36, N. Y.

THE ELECTRONICS MAN... A SPECIAL BREED

In most industries the management man went to business school and doesn't concern himself with design problems.

In most industries the design engineer doesn't concern himself with management problems.

The electronics man is different. He is many things. He is in Research-Design-Production-Management. His interests are in any or all of the four areas.

No matter where you find the electronics man his engineering background enables him to influence the purchase of electronic components and equipment. Your advertising must reach him if you are to sell electronic goods.

This is the strength of electronics, the one magazine published weekly and edited to reach this engineering oriented electronics man, wherever he is.

THE ELECTRONICS MAN
"BUYS" WHAT HE READS IN...

electronics

and in the
electronics BUYERS' GUIDE

A MCGRAW-HILL PUBLICATION
330 West 42nd St., N.Y. 36, N.Y.

Portable Welding Gun Carries Own Filler

PORTABLE WELDING handgun, capable of welding aluminum and other metals in light gauges, is announced by Westinghouse Electric Corp., Pittsburgh, Pa. The gun has a consumable electrode and inert gas shielding.

The gun weighs 4 pounds with 1 pound of filler wire. Controls weigh 20 pounds. An air-cooled wire feed drive motor and wire supply reel are integral with the gun. One gun model feeds filler wire 1/50 to 3/64-inch diameter at speeds of 350 to 750 inches per minute. Another feeds 3/64 to 1/4 inch wire at 120 to 350 ipm. Field tests indicate that average travel speed for horizontal fillets is 22 ipm with 1/4-inch wire.



Gun is used on radar system cabinets



Filler wire is on spool, feed motor is in handle

The guns have been used by Westinghouse's electronics division in Baltimore to seam weld the large aluminum panels of aluminum consoles and cabinets for military radar systems. Low heat input resulted in absence of heat distortion, or corrective fixturing for large panels, the firm reports.

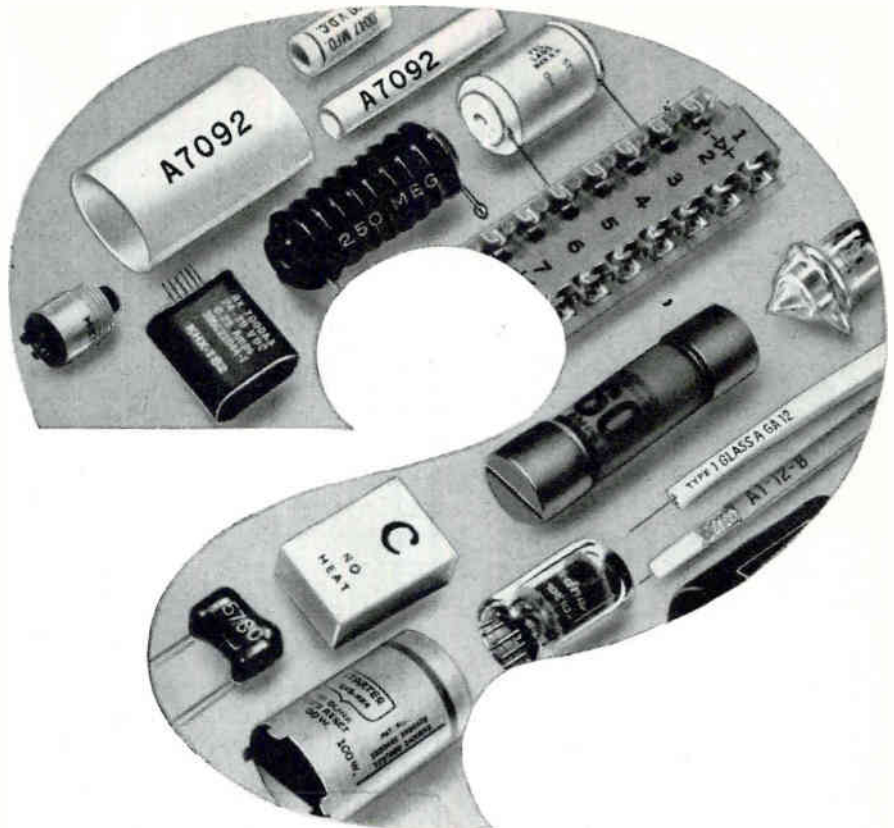

practical answers to your marking problems



This 12-page booklet explains how the electrical or electronic product *you* make can be marked — at production speeds — with clear imprints that hold. Are you looking for a way to mark odd shapes — a *practical* short-run marking method — an ink that will hold on an unusual surface, or withstand temperature, handling, moisture or other conditions? This catalog describes machines, printing elements and inks that will meet *your* requirements in the marking of products ranging from subminiature components to panels and chassis. There are special sections with practical answers to color banding, Underwriters' Laboratories manifest label legend marking, tape and label printing, wire and tube marking, efficient "in-line" marking. For your copy of the Markem Electrical Catalog, write Markem Machine Co., Electrical Division, Keene 5, New Hampshire.

MARKEM

EVERYTHING INDUSTRY NEEDS . . . FOR PROFITABLE MARKING . . . SINCE 1911

On The Market



Heat Sinks for transistors

RELCO PRODUCTS, Box 8327, University Park Station, Denver 10, Colo. Almost all power transistors can be accommodated by these all aluminum heat radiators. They feature integral extended surfaces for

compactness and efficiency. Thermal resistances are from 0.5 to 0.7 deg C/w with 10 cfm air. A protective black anodized finish gives optimum heat radiation. The modular units can be used with the company's series of manifolds to simplify cooling system design.

CIRCLE 301 ON READER SERVICE CARD

Trimming Pot highly stable

HELIPOT DIVISION OF BECKMAN INSTRUMENTS, INC., 2500 Fullerton Road, Fullerton, Calif., announces the series 50 Helitrim trimming pot. Ceramic/metal construction—a conductive resistance element



fused to a steatite frame—makes it possible to use this small pot in an

ambient temperature range of -55 C to $+200$ C. It is virtually insensitive to vibration and can ride out 100 g shock. Standard resistance range is 100 to 20,000 ohms, with essentially infinite resolution except for 2 ohm maximum end resistance at either end.

CIRCLE 302 ON READER SERVICE CARD

L-V Power Supply high-current

POWER SOURCES, INC., Burlington, Mass. Type PS4022 l-v, high-current, transistor regulated power supply is designed for ultrastable output under varying line, load and temperature conditions. It operates on an input of 105-125 v, 57-63 or 380-420 cycle a-c to produce 4.5 to

9.0 v d-c output with load currents from 0-10 amperes. The heavy-duty unit provides total regulations of better than ± 0.1 percent change in set output voltage for any combination of input voltage or load current conditions. Total ripple and noise is less than 2.0 mv rms. Temperature stabilization insures minimum drift in the output for operating temperatures from -20 to $+65$ C.

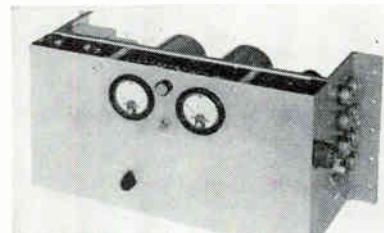

Output impedance is less than 0.02 ohm from d-c to 1,000 cycles.

CIRCLE 303 ON READER SERVICE CARD



Tube Sockets easy mating type

ELCO CORP., M St. below Erie Ave., Philadelphia 24, Pa. The E-Z mate sockets are available in 7 and 9 pin miniature models with shield base, saddle for top mounting, and snap-on base. They are interchangeable with corresponding military type

sockets per specification MIL-S-12883A. A positioning key at the top of the socket causes the tube to slide until it reaches the correct position for insertion. In this way, tubes may be easily inserted in blind and inaccessible locations without fear of damage to tube pins.

CIRCLE 304 ON READER SERVICE CARD

Pulse Delay modular unit

NAVIGATION COMPUTER CORP., 1621 Snyder Ave., Philadelphia 45, Pa. Model 304 pulse delay module contains five independent, all semiconductor, delay circuits. Each section

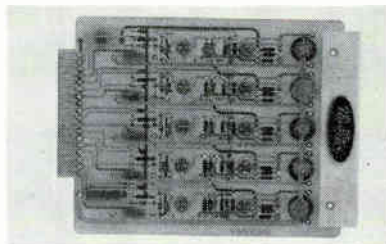

provides a delayed pulse output and a square wave output for the delay duration. Unit is a 5 in. by 6 in. glass-epoxy p-c card, $\frac{1}{8}$ in. thick, and is for use with an 18 pin p-c receptacle. Delay range of each delay section is adjustable from 3 to 30 μ sec. The delayed

Designed for



Application

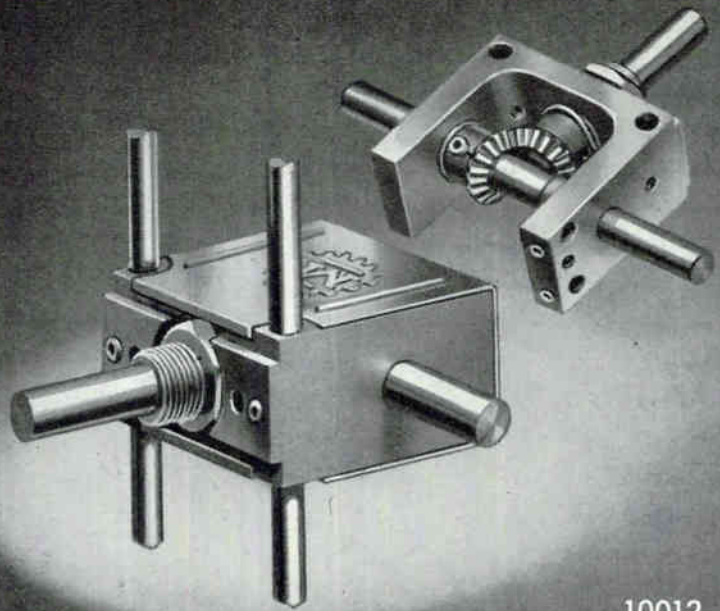

10012

RIGHT ANGLE DRIVES

Extremely compact, with provisions for many methods of mounting. Ideal for operating potentiometers, switches, etc., that must be located, for short leads, in remote parts of chassis. No. 10012 for $\frac{1}{4}$ inch shafts. No. A012 Miniature for $\frac{1}{8}$ inch shafts.

JAMES MILLEN MFG. CO., INC.

**MALDEN
MASSACHUSETTS**

CIRCLE 200 ON READER SERVICE CARD

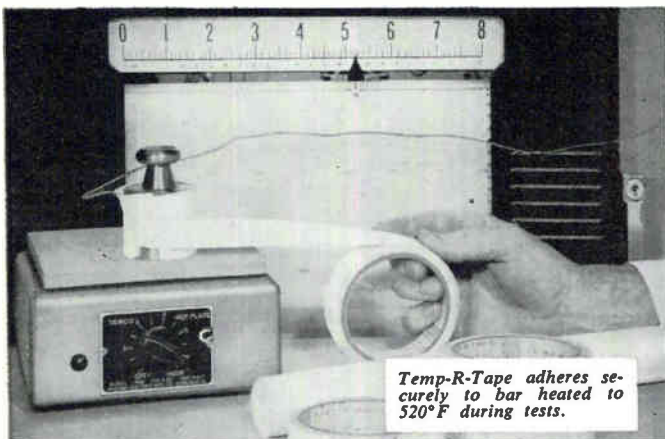

Temp-R-Tape adheres securely to bar heated to 520°F during tests.

CHR PRESSURE-SENSITIVE TEFLON® TAPES

- -100°F to 500°F applications
- Class H and Class C insulation
- Non-stick and low friction facing
- Chemical resistant facing
- Easy to apply

Temp-R-Tape is available from stock in rolls and sheets. All four types — Temp-R-Tape T; TH; C and TGV — combine some form of Teflon backing with silicone polymer adhesive to provide easy-to-apply pressure-sensitive and thermal curing pressure-sensitive tapes for electrical and mechanical applications. Designed for extreme temperatures, Temp-R-Tapes possess high dielectric strength, low power factor, high elongation, negligible moisture absorption, are non-corrosive and non-contaminating.

FREE SAMPLES and folder — write, phone or use inquiry service.

CHR

CONNECTICUT HARD RUBBER

*duPont TM

Main Office: New Haven 9, Connecticut

CIRCLE 201 ON READER SERVICE CARD

ELECTRONICS • JANUARY 8, 1960



Model M-2

VERSATILE MULTI-RANGE METER TESTER

... POWER SUPPLY ... LIMIT BRIDGE

Precise, self-contained unit for laboratory and production use. For DC instrument calibration from 25 μ a full scale to 10 ma full scale, and 0-100 VDC; sensitivity and resistance measurement; DC current-voltage source; limit or bridge measurements from 0-5000 ohms. Regulated power supply. Stepless vacuum tube voltage control. Accuracy exceeds $\frac{1}{4}$ % (current), $\frac{1}{2}$ ohm or $\frac{1}{2}$ % (resistance). For 115V, 60 cycle AC. Complete — needs no accessories. Bulletin on request. Marion Instrument Division, Minneapolis-Honeywell Regulator Co., Manchester, N. H., U.S.A. In Canada, Honeywell Controls Limited, Toronto 17, Ontario.

Copyright © 1959, Marion

Honeywell

75th YEAR
PIONEERING THE FUTURE



First in Control
SINCE 1880

CIRCLE 79 ON READER SERVICE CARD

79

pulse output is a negative differentiated pulse, - 3 v unloaded, 1 ma loading capability. The square-wave output for the delay duration is - 12 v switching to - 0.2 v. Rise and fall times of 0.3 μ sec remain constant for full range of pulse width adjustment.

CIRCLE 305 ON READER SERVICE CARD

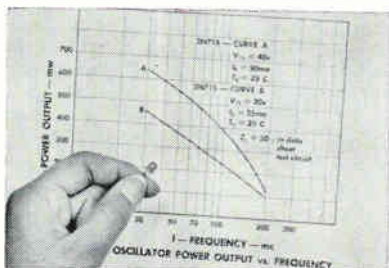

Silicon Transistors mesa type

TEXAS INSTRUMENTS INC., P. O. Box 312, Dallas, Texas. The 2N715 and 2N716 silicon mesa transistors are capable of a guaranteed minimum power output of 500 mw at 70 mc. They will deliver approximately 50 mw at 200 mc. Both are

packaged in the subminiature JEDEC-outline TO-18 case. They have a guaranteed beta spread of 10 to 50 and a collector reverse voltage of 50 and 70 v (for the 2N715 and 2N716 respectively). Collector reverse current at 25 C is 1 μ a maximum and 100 μ a maximum at 150 C. Temperature limits are at -65 C and 175 C.

CIRCLE 306 ON READER SERVICE CARD



Circuit Breakers electromagnetic

AIRPAX ELECTRONICS INC., Cambridge, Md. For positive protection of current sensitive components common to transistor circuitry, series 500-I circuit breakers provide

tripping action within 25 millisecc on overloads of 150 percent of rated current. The miniature, hermetically sealed units are available with current ratings from 50 ma to 10 amperes. Designed for use at d-c (50 v maximum) and a-c (120 v rms maximum, 60 or 400 cps), they can be supplied in ganged assemblies to save space and to automatically trip two or three circuits when an overload occurs in any one breaker.

CIRCLE 307 ON READER SERVICE CARD

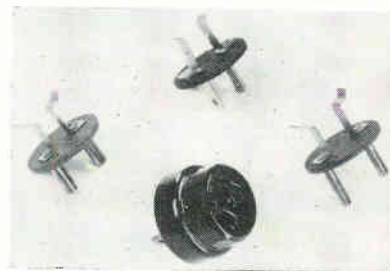

Wiring Devices plastic molded

SUPEREX ELECTRONICS CORP., 4 Radford Place, Yonkers, N. Y., has

Is your pot in armor, too?

Choose from SPECTROL's complete new line of METAL Multi-Turn Precision Potentiometers

At first you may wonder what in blazes our friend in armor, Sir Spectrol, is doing in a serious magazine like this. Well, it's just a bit of trickery on our part to call your attention to Spectrol's 8 new metal multi-turn pots. *The first complete line anywhere.* Also, to remind you Spectrol makes many other pots, special and standard. There will be more trickery with Sir Spectrol in future issues, but you can easily see through it and there will be plenty of accompanying facts, figures, photos and specs.

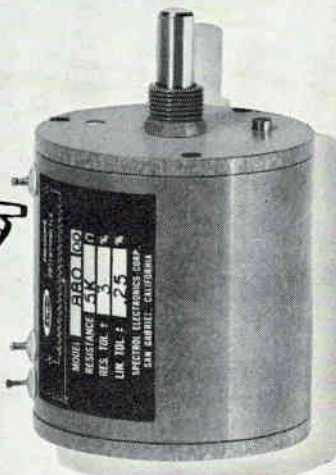

available a new line of universal wiring devices. Molded with U.L. approved thermosetting plastic, the units can be supplied without tool costs and in various combinations for series or parallel use. All units feature heavy duty brass blades and phosphor bronze spring contacts.

CIRCLE 308 ON READER SERVICE CARD

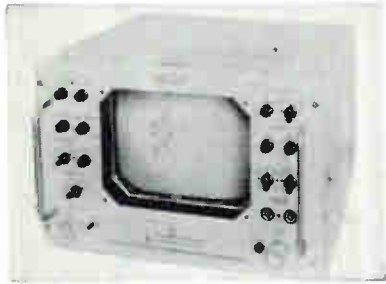

Test Instrument
0.5 to 400 mc

ROHDE & SCHWARZ, 111 Lexington Ave., Passaic, N. J. Type SWOB Polyskop, a test instrument for 2- and 4-terminal network measurements, features 2-channel frequency-response display, 0.5 to 400

mc frequency range, and sweep width of ± 0.2 to ± 50 mc. It displays frequency response of voltages which, depending upon the check point on the circuit being tested, is a direct measure of attenuation, gain, linearity, matching, etc. Instantaneous indication makes it highly suitable for alignment work and for determination of the optimum proportions of circuit elements. Range of attenuation measurement is 45 db.

CIRCLE 309 ON READER SERVICE CARD



Static Inverter
for airborne uses

VARO MFG. CO., INC., 2201 Walnut St., Garland, Texas, has produced a 500 va static inverter. Operating

from 28 v d-c power, model 4312 produces both single and three phase power. The single phase output voltage is regulated to ± 5 percent for input and load changes. A phase adapter converts a portion of the single phase output to three phase power for operation of gyros. Frequency regulation of ± 0.1 percent and 5 percent maximum harmonic content are also featured. Unit is sealed to provide high altitude capabilities. Total weight is 15 lb in a space 5 by 8 by 10.5 in.

CIRCLE 310 ON READER SERVICE CARD

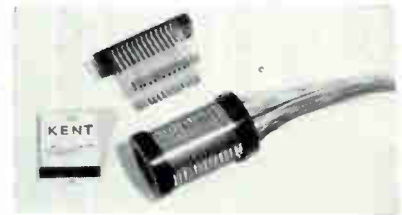

Slip Ring Assemblies
for rotary antennas

ROTARY DEVICES CORP., 30 Jay St., Englewood, N. J., has developed a line of standard slip ring and brush

The Metal Pots

Spectrol offers four 3-turn and four 10-turn models. All feature anodized aluminum cases with 3/16-inch thick walls. These 8 precision wire-wound pots absorb no moisture—dissipate heat fast and stay dimensionally stable. They operate from -55°C to $+125^{\circ}\text{C}$ and withstand relative humidity of 95%.

You can choose diameters of 7/8, 1, 1-5/16 and 1-13/16 inches in both 3 and 10-turn models. Resistance ranges to 1,000,000 ohms with standard linearity tolerances of $\pm 0.25\%$ (0.020% on special order). Like Sir Spectrol, the new multi-turns will take a respectable jolt. They function to 20g vibration from 55 to 2,000 cps and withstand 30g shocks.

Please write for literature, or consult the yellow pages of your phone book for your Spectrol engineering sales representative.

SPECIFICATIONS

MODEL	540	530	580	560	780	790	880	840
No. of coil turns	10	3	10	3	10	3	10	3
Diameter (inches max.)	7/8	7/8	1	1	1 1/8	1 1/8	1 1/8	1 1/8
Standard resistance range in ohms ($\pm 3\%$)	25-125K	10-36K	25-150K	10-40K	30-300K	10-90K	50-400K	20-120K
Special resistance to	250K	75K	250K	75K	750K	240K	1 meg	330K

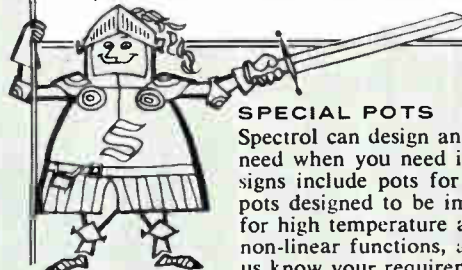

SPECIAL POTS

Spectrol can design and deliver the pot you need when you need it. Recent custom designs include pots for airborne computers, pots designed to be immersed in fuel, pots for high temperature application, pots with non-linear functions, and many others. Let us know your requirements.

STANDARD POTS

Popular single and multi-turn models and turns counting multi-dials are stocked in 30 electronics supply houses in the U. S. and Canada. Ten resistance ranges from 100 ohms to 200 k ohms with standard linearity tolerances of $\pm 0.3\%$ are available.

SPECTROL

ELECTRONICS CORPORATION

1704 SOUTH DEL MAR AVENUE • SAN GABRIEL, CALIFORNIA

17

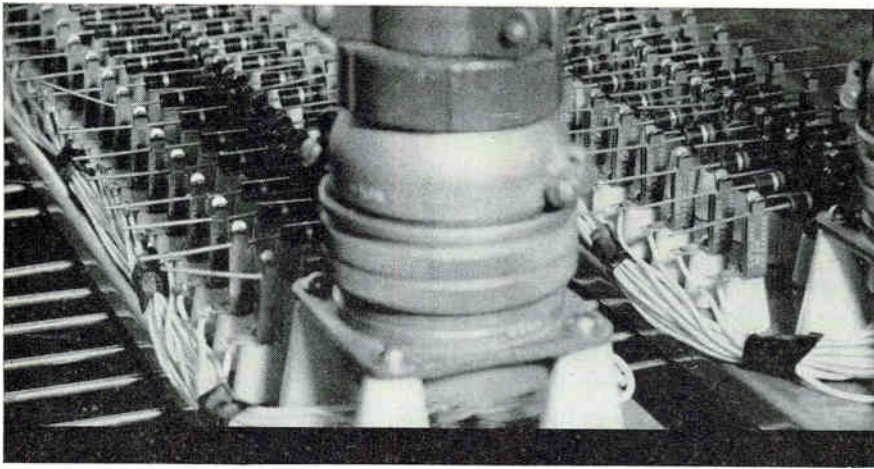

Reliability Testing **AUTOMATED FOR YOU** at United States Testing Company

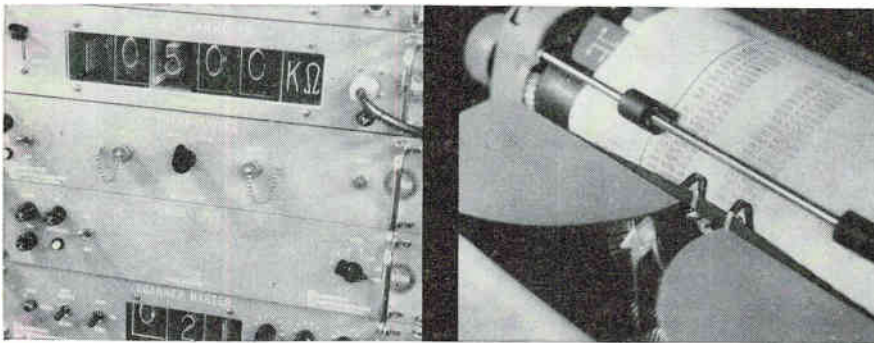

You can profit from the cost-saving, time-saving digital read-out system which automates Quality Assurance programs done by United States Testing Company. Now, under all environmental conditions, readings can be machine-recorded, error-free, every 3 seconds with accuracies of 0.1%. Reliability of resistors, capacitors, semi-conductors, transformers and other components...also systems...can be predicted quickly and economically...failures analyzed. Tests meet military, government and commercial specifications.

Complete environmental laboratory includes facilities for simulating high and low temperatures, humidity, altitude, immersion, salt spray, sand and dust, rain, fungus, vibration, shock and acceleration.

Save investment in laboratory equipment...free needed operating funds. Use United States Testing Company's extensive facilities. Detailed confidential reports at completion of project. Write for quotation. No obligation.

Complete facilities in the fields of chemistry, metals chemistry; metallurgy; physical testing of materials; engineering analysis of mechanical, electro-mechanical, and electronic devices; site inspection; package testing; psychometrics and certification services for product quality control.

United States Testing Company, Inc.

1415 Park Avenue, Hoboken, N. J.



FREE!
Send for facilities bulletin
5801.

**Branch
Laboratories**

BOSTON • BROWNSVILLE • DALLAS
DENVER • LOS ANGELES • MEMPHIS
NEW YORK • PHILADELPHIA
PROVIDENCE • TULSA

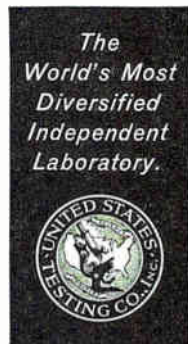

assemblies suitable for use in rotary antenna arrays. Because of modular construction, from standard parts, the units can be furnished with from 3 to 40 circuits to fit shafts ranging from $\frac{1}{4}$ in. to 1 in. in diameter. Features include noble metal rings, fungicidally impregnated high temperature dielectric, Teflon insulated leads, beryllium copper brush leaves, silver graphite brushes and stainless steel bores. Lapped brush faces and ring surfaces eliminate brush bounce and jitter and thus insure long life and very low noise.

CIRCLE 311 ON READER SERVICE CARD



Variable Inductor miniature size

ESSEX ELECTRONICS, Div. of Nytronics, Inc., 550 Springfield Ave., Berkeley Heights, N. J., announces a line of miniature variable inductors with inductance ranges of 0.10 to 4,700 μ h. Measuring 0.400 in. o-d and $\frac{1}{2}$ in. in height, they are encapsulated in epoxy resin for protection against climatic and mechanical conditions and meet MIL-C-15305A, Grade 1 and Class B. Units have stable inductance at extreme temperature variations and also high reliability along with the light weight and miniature size factors.

CIRCLE 312 ON READER SERVICE CARD

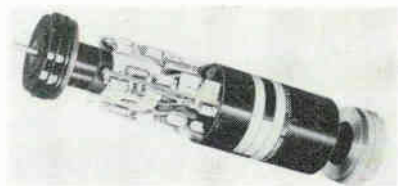

Amplifier/Resolver three in. long

AMERICAN ELECTRONICS, INC., 9503 W. Jefferson Blvd., Culver City, Calif. The Amplisolver consists of

a size 8 winding compensated resolver and a dual channel amplifier within a size 15 frame. Weighing only 8 oz, it offers unity transformation ratio with zero phase shift over a temperature range from -55 C to +125 C. It features an input impedance of 1 megohm minimum with a low output impedance of 270 + j 400 ohms. Cable connections have been eliminated by direct drive from resolver to amplifier. Its versatile design permits adapting Amplisolver to computing chain functions.

CIRCLE 313 ON READER SERVICE CARD

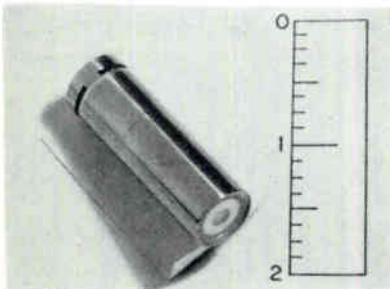

Infrared Detector for airborne uses

RAYTHEON Co., Waltham 54, Mass. The QK748 is a very sensitive P type gold doped germanium infrared detector of all metal construction with hermetically sealed windows. Due to its extremely small physical size and rugged metal envelope, it is ideally suited to airborne applications. Detector area is 3.5 by 3.5 mm; impedance range, 50,000 ohms to 1 megohms; acceptance angle, approximately 100 deg; time constant, less than 1 μ sec.

CIRCLE 314 ON READER SERVICE CARD

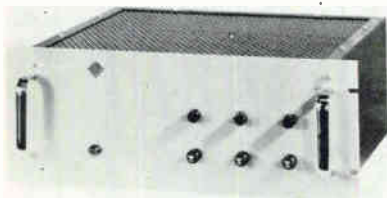

Power Supply transistorized

MID-EASTERN ELECTRONICS, INC., 32 Commerce St., Springfield, N. J. Model 155 provides regulated outputs in three ranges: 15 v d-c at 300 ma, 8 v d-c at 700 ma, and 30 v d-c

ELECTROMECHANICAL SWITCHES FOR TELEMETERING SYSTEMS!

Specifications, performances, applications for typical electro-mechanical commutators for long-range sampling, programming. Quick comparisons let you know what's going on . . . see

October 2nd, 1959 issue (did you miss it?). Another reason to subscribe to electronics (or renew your subscription). Fill in Reader Service Card box. Easy to use. Postage free.

FIND WHAT YOU NEED IN...

electronics

FOR MORE DEPENDABLE CONTACT . . .

HERMAN H. SMITH, INC. BANANA PLUGS

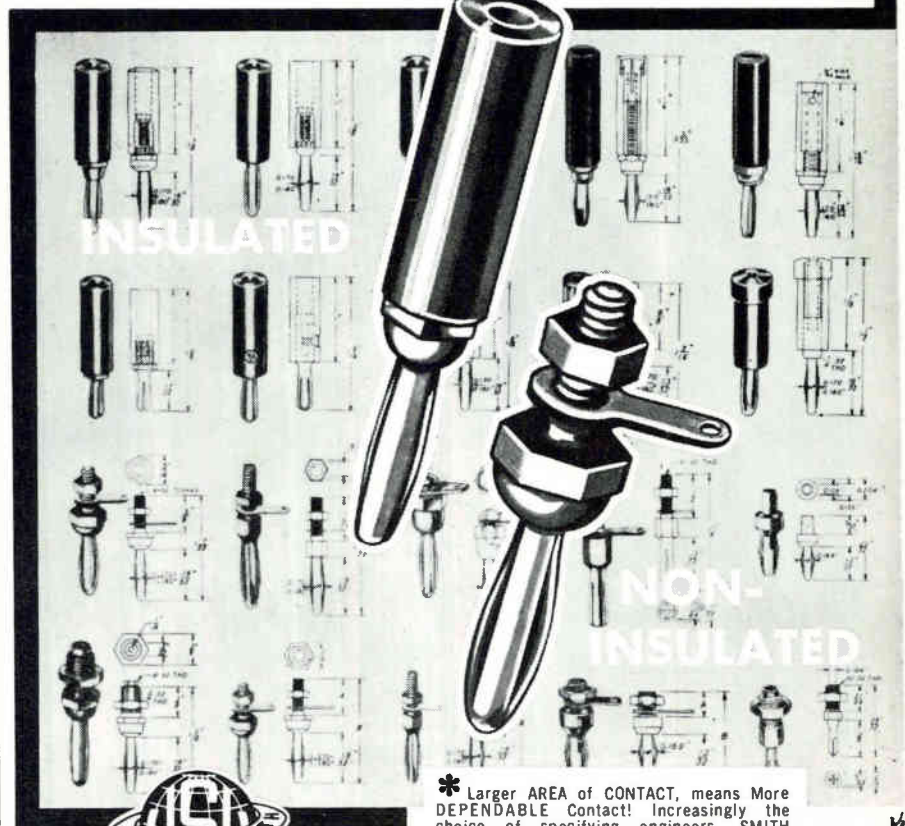

* Larger AREA of CONTACT, means More DEPENDABLE Contact! Increasingly the choice of specifying engineers, SMITH Banana Plugs feature specially designed curved spring for:

1. Lower Circuit Density at contact point.
2. Lower Contact Resistance.
3. Minimizes heating at contact point.
4. Handles higher currents.

Available in a wide variety of colors. SMITH Electronic Components are stocked by Distributors from coast to coast. Inquiries are invited for production runs, and special requirements.

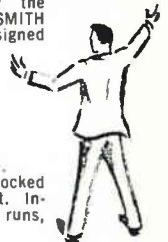

HERMAN H. SMITH, INC.

2326 NOSTRAND AVENUE
BROOKLYN 10, N. Y.
Telephone: CLOverdale 3-7900

MANUFACTURERS of

PLUGS • JACKS • LUGS • TEST LEADS
BINDING POSTS • ALLIGATOR CLIPS
SHAFT ACCESSORIES • TERMINAL STRIPS

FREE CATALOG

You'll find the entire line of SMITH Plugs, Jacks, Connectors and other Electronic Components fully listed in our latest Catalog #59 — the Industry's "BUYING GUIDE" for small components. Send today for your free copy.

to HERMAN H. SMITH INC. P.O. BOX 36,
2326 Nostrand Ave., B'klyn 10, N. Y.

Send Free Catalog Have representative call

NAME.....

ADDRESS.....

CITY..... ZONE..... STATE.....

Raytheon relies on

COUCH RELAYS*

for
the

Sparrow III



* CVE type

SERVICE: U. S. NAVY
STATUS: Operational
TYPE: Air to Air
POWERPLANT: Solid Propellant
SPEED: Supersonic
LENGTH: 12 feet
WEIGHT: 350 lbs.
GUIDANCE: Radar homing

Developed by the Raytheon Company, the U.S. Navy's Sparrow III is notable for a new radar guidance system which insures effective attacks on evasive targets. For this highly advanced missile, Raytheon chose Couch Relays. Other leading missile builders also rely on Couch Relays . . . and for the same reason. Couch has coupled stringent quality control techniques with simple, rugged design to assure performance of proven reliability under severest environmental extremes. In the broad Couch line, there's a dependable relay ready to work for you. Write today for complete specifications.

Write for our new catalog on the full Couch line of rugged rotary relays.



ORDNANCE INC.

A subsidiary of S. H. Couch, Inc.

3 Arlington Street

North Quincy, Mass.

at 1.5 amperes, all regulated within 0.1 percent. Outputs are floating, either negative or positive side may be grounded, and voltages may be adjusted over approximately 10 percent of the range. Ripple is 0.01 percent; recovery 50 μ sec maximum; and overshoot is less than 1.0 percent of the voltage setting. Input power is 105-125 v 400 cps. Price is \$995.

CIRCLE 315 ON READER SERVICE CARD

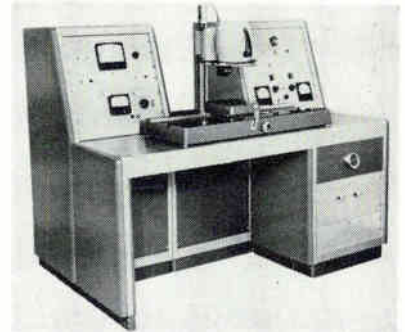

Desk-Type Console tests detectors

INFRARED STANDARDS LABORATORY, 10555 Magnolia Ave., Riverdale, Calif. The 301 infrared detector test console is designed for use with photoconductors, photovoltaic detectors, bolometers and thermocouples. It will test detectors in production quantities and has a test rate as high as 500 to 1,000 detectors per day measuring signal, noise, and resistance for a specific operating condition. Unit may also be adapted to modified testing programs.

CIRCLE 316 ON READER SERVICE CARD



Tape Recorder subminiature

PRECISION INSTRUMENT Co., 1011 Commercial St., San Carlos, Calif. A two-channel tape recorder measures 5 in. by 4 in. by 2 in. complete, including all electronics. Total

weight is 2 lb. All applicable portions of MIL-E-4158A for ground applications are met by the recorder, but it can also be furnished for special flight and other uses. Power requirements are 2½ w (d-c source). It will operate at any tape speed up to 48 ips, bidirectional, with end-of-tape sensing. Frequency response is up to 160 kc, ± 3 db at 48 ips. Recorder nominally employs 4-in. coaxially stacked reels which hold 900 ft of ½-mil tensilized Mylar tape, ¼ in. wide.

CIRCLE 317 ON READER SERVICE CARD



C-C Tv Camera ruggedly built

DAGE TELEVISION DIVISION, Thompson Ramo Wooldridge Inc., Michigan City, Ind. Rugged construction and optimum picture quality are combined in the model 70-A c-c tv camera. Designed for heavy-duty industrial use as well as general closed-circuit applications, the camera features a transistorized video amplifier which eliminates microphonics and provides 600-line resolution. Completely self-contained, it requires only 45 w of 115 v 60 cycle power to be placed in operation. It is 7½ in. high, 5½ in. wide and 11½ in. long. Price is under \$1,400.

CIRCLE 318 ON READER SERVICE CARD

Slip Clutch adjustable

NORTHERN UNION, INC., 1020 Holly Ave., Arcadia, Calif. An adjustable slip clutch is available for use in precision gear trains, computers, servo mechanisms, breadboard setups, recorders and other devices requiring precision overload protection. Qualifications are: adjustable, wide torque range 0 to 100 in. oz; repeatable breakaway torque; no backlash, chatter, or galling; corrosion resistant materials; small size and light weight; concentricity to 0.0003 in.

CIRCLE 319 ON READER SERVICE CARD

AIRPAX

Transistor Choppers

Airpax produces an extensive line of transistor choppers. They are characterized by the same compliance to rigid standards that has made Airpax the unquestioned leader in the electro-mechanical chopper field.

Low null outputs, phase angles of approximately zero degrees, and symmetrical dwell times of nearly 180°, are characteristics of all Airpax transistor choppers. Drive power requirement is low and may be either sine or square wave.

Listed below are representative types.



TYPE	Characteristic	Frequency Range	Temperature Range
6010	Sub-miniature	DC to 100 KC	- 40 to + 70° C
*6025	High voltage	50 CPS to 5 KC	0 to + 55° C
*6045	High temperature	50 CPS to 5 KC	- 55 to + 125° C

**Self contained drive transformer*

Bulletin C-61 available on request.



CAMBRIDGE DIVISION, CAMBRIDGE, MARYLAND

CM47

DIRECT USE—without auxiliary amplification

DIRECT WRITING—without servos or linkage drives



You get them both with the new **ESTERLINE-ANGUS RECORDING D.C. MICROAMMETER**

Here's the recording instrument of a thousand-and-one uses in every field of research and production.

Ranges: 0 to 50 microamperes with approximately 200 ohms input resistance. Also 0-10/50/200 millivolts D.C.

Power Supply: 120 volts, 60 cycles.

Response: 1 second, independent of external circuit resistance.

It's ruggedly built for continuously reliable results in rough use. It's quickly and easily set up. Send for Catalog Section No. 41.

The Esterline-Angus Company

No. 1 in fine Graphic Instruments for more than 50 years.

DEPT. E, P. O. BOX 596, INDIANAPOLIS 6, INDIANA
CIRCLE 202 ON READER SERVICE CARD

NEW BOOKS

Feedback Control Systems, Analysis, Synthesis, and Design

By J. C. GILLE, M. J. PELEGRIN and P. DECAULNE.

McGraw-Hill Book Co., Inc., New York, 1959, 793 p, \$16.50.

THIS book is a comprehensive exposition of most of the major problems and theories that are of interest to control systems engineers. Moreover, the development of the material is graduated in difficulty. Thus, the early parts of the book are suitable for use as an undergraduate textbook in feedback control systems whereas the later parts will find their greatest use as a reference book for the practicing engineer.

This division in purpose is supported by the arrangement of the material. The fundamental theory of linear and nonlinear servomechanisms is first considered. Thereafter, a discussion of components for servosystems and examples of practical designs are given. In addition, the appendix includes a five-language glossary of most of the automatic-control terminology. This will be of special use to the student or engineer who wishes to pursue the foreign literature on control systems. In fact, some subjects are presented in this book that have not previously been published in the English language.

This is an excellent and comprehensive presentation of the entire field of control systems engineering. It should be successful both as a textbook and as a reference book.

ARMEN H. ZEMANIAN, *College of Engineering, New York University, N. Y.*

Introduction to Monopulse

By D. R. RHODES.

McGraw-Hill Book Co., Inc., New York, 1959, 119 p, \$6.00.

THIS monograph on monopulse radar systems is the first general treatment of the topic available in comprehensive form.

The author develops in vigorous mathematical fashion a unified the-

WHEN

NULLS - PHASE - VOLTS - COUNT . . .

specify **NORTH ATLANTIC'S PHASE ANGLE VOLTMETER**—
"A standard of industry"

FEATURES

- Direct reading 0-360°, no ambiguity, 1mv to 300v full scale.
- VTVM operation to 50kc.
- 10 microvolt null sensitivity.
- 10 meg input impedance.
- Available in any frequency.
- Unaffected by harmonics with optional filters.
- Low noise.
- Signal and/or Reference Isolation.

PLUG-IN ACCESSORIES

- Reference Isolation Module
- Bridging Transformer Module
- Summing Module

READS DIRECTLY VOLTAGE QUADRATURE IN-PHASE DEGREES

NORTH ATLANTIC industries, inc.
603 main street, westbury, n. y. EDgewood 4-1122

ory of monopulse consisting of the following three postulates: (1) monopulse angle information appears in the form of a ratio; (2) sensing ratio for a positive angle of arrival is the inverse of the ratio for an equal negative angle; (3) the angle output function is an odd real function of the angle of arrival. By application of this definition it is possible to analytically describe the operation of a monopulse system by a sequence of mapping transformations of a complex variable from one complex plane to another.

Also developed is a special theory associated with specific cases which is used to describe systems that may be evolved and indicating some of the pitfalls to be avoided. Systems involving dual-plane sensing are discussed in general terms using four beams and monopulse antenna principles. The final chapter is devoted to a discussion of the characteristics of the most unique monopulse system which the author categorizes as a Class 1 or sum-and-difference system.

This book is well written and should provide anyone interested in radar principles with stimulating reading. The author is to be congratulated for the clear, concise, yet comprehensive way in which the material was covered.

JOHN KINN, JR., *IBM, New York, N. Y.*

Paris Symposium on Radio Astronomy

By R. N. BRACEWELL.

Stanford University Press, California, 1959, 612 p., \$15.00.

ABOUT the first week of August, 1958, over 160 astronomers, physicists, and electronic engineers from 17 countries attended a symposium on radioastronomy held in Paris. The thick report (over 600 pages) of this meeting was held under the auspices of the International Astronomical Union (IAU) and the International Scientific Radio Union (URSI). The participants, and the editor, R. N. Bracewell, deserve a rousing cheer for the speed with which this volume has appeared; anything less than eighteen months in preparation for a work of this

If you are looking for an industrial location . . .

HERE'S HOW GPU *Site-Service* CAN HELP YOU!



Six years ago GPU *Site-Service* was set up to help growth-minded businessmen.

Although offered by an electric utility, its assistance far exceeds electric utility matters. It is a complete area development service.

At GPU headquarters and in the electric service companies, *Site-Service* offers you the assistance of plant location specialists. These specialists are ready to provide detailed information about an industrial area second to none. They will furnish economic data for individual communities and areas. They can answer your questions about labor, taxes, transportation, water, raw materials and services. Free of charge, they offer *first-hand* facts and figures that could cost you unnumbered man-hours to obtain.

What's more, *Site-Service* understands your problems. Its headquarters and area representatives know the special needs of industries of all types, large and small. They have on hand the specifications of existing buildings and available sites of all sizes. From among these can be selected those most suitable for your requirements. You are thus able to make the soundest possible final decision.

Contacting *Site-Service* is the first step towards locating for profitable growth within overnight shipping of 55 million consumers. Why not do it today? Your inquiry will receive prompt, *confidential* attention.

**GPU *Site-Service* — the one central source of information
for nearly half of Pennsylvania and New Jersey**

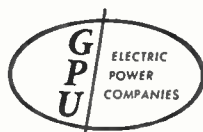

Metropolitan Edison Co.
Pennsylvania Electric Co.
New Jersey Power & Light Co.
Jersey Central Power & Light Co.



GENERAL PUBLIC UTILITIES CORPORATION

Att: Wm. J. Jamieson, Area Development Director, Dept. E-1
67 Broad St., New York 4, N. Y. Whitehall 3-5600

THE OFFNER ALL TRANSISTOR DYNOGRAPH

TYPE
R

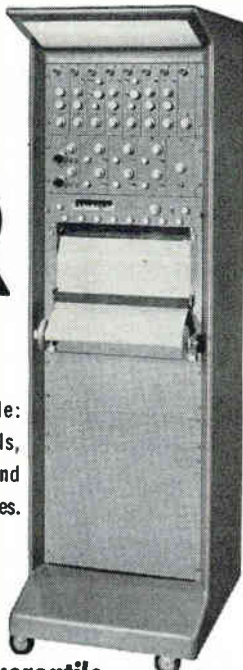

Models available:
1 to 19 channels,
console, rack, and
portable assemblies.

*the most versatile . . .
most sensitive direct-writing
recorder available*

Whatever your application for direct-writing oscillograph recording . . . investigate the ability of the Offner Type R Dynograph to do the job *better* and more *simply*. Its features of superiority are *unmatched!*

- ✓ High Sensitivity: 1 microvolt d-c per mm
- ✓ High Frequency Response: 0-150 cps — ± 10%
- ✓ Large Linear Deflection: over 6 cm — ½% linearity
- ✓ Wide Ambient Range: —20° C to + 50° C
- ✓ Versatile: d-c, a-c, carrier, all with one set of amplifiers
- ✓ Convenient: Plug-in input couplers for all bridge balancing
- ✓ Stable: Drift—1 microvolt per hour at maximum sensitivity
- ✓ Recording Media readily interchangeable: Heat, Electric, Ink; Rectilinear, Curvilinear
- ✓ Compact: Eight channels in only 35" of rack space.

Write for full specs and complete details

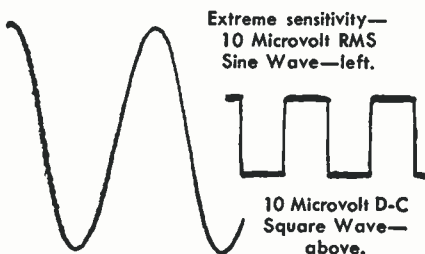

**OFFNER
ELECTRONICS**

River Road, Schiller Park, Ill.
(Suburb of Chicago)

type is considered better than par, but this report made it in less than a year.

The emphasis on research results makes this report especially valuable to astronomers and physicists who are interested in the design and operation of the universe. Those who are more concerned with the design and operation of equipment will have to wait for another symposium. Also excluded were discussions of meteors and scintillations.

These lectures, taken together, are an excellent review of progress to date in radioastronomy. A quick review of the information developed through the presentation and discussion of papers is afforded by the concluding lectures.

Aside from the papers themselves, a most valuable contribution of this volume is the abundant use of literature citation. The six-page index is arranged to include author identification of references, so that the index itself may afford a key to a large part of the current literature of radioastronomy.

This report belongs on the desk of every one interested in radioastronomy, either as an astronomer or an engineer. This book is particularly useful to those engineers and physicists working to conquer space, since it encompasses in one place virtually all that must be considered in terms of radio-frequency environment and possible noise background to be encountered by their radio equipment outside of our atmosphere.

K. L. FRANKLIN, *Associate Astronomer, Hayden Planetarium—American Museum of Natural History, N. Y.*

THUMBNAIL REVIEWS

Transistors in Radio, Television, and Electronics. By M. S. Kiver, McGraw-Hill Book Co., Inc., New York, N. Y., 1959, 424 p, \$7.95. Though primarily conceived as a guide for radio, television and electronics technicians in the practical aspects of transistor circuits, this book also contains design information of interest to electronics engineers.

Electron Physics and Technology. By J. Thomson and E. B. Callick, The Macmillan Co., New York, 1959, 527 p, \$10.00. This book is designed to give the student of physics and

SEE IT!



SHOOT IT!



SHOW IT!

...in only

2 MINUTES

**on Polaroid® Land
Projection Film**

Just a few minutes from the time you record oscilloscope traces with this new Beattie Oscillotron and Polaroid® Land Film Type 46, you can project a transparency. Also produces 60 sec. paper prints with the new, very fast Polaroid® 3000 Speed Film. Records up to 10 traces on a single frame and offers these many other advantages:

- Direct binocular view of CRT while recording.
- Non-reversed image.
- Camera swings back for easy access to lens and shutter, or lifts off completely. Can be rotated.
- Electric shutter-actuator available.
- Attaches easily to bezel of 5" CRT. Adaptable to other sizes. No special tools.

"Polaroid" ® by Polaroid Corp.

Write today for full details



1000 N. Olive St., Anaheim, California
Branch: 437 Fifth Ave., New York, N.Y.

CIRCLE 20 ON READER SERVICE CARD
JANUARY 8, 1960 • ELECTRONICS

electrical engineering a grounding in the basic principles of electron physics. Microwave and other special purpose tubes are described in detail. Unique section is included on emitters, phosphors, and materials and processes for tube construction, vacuum technology and semiconductors.

Model Radio-Control. By E. L. Saford, Jr., Gernsback Library, Inc., New York, N. Y., 1959, 192 p, \$2.65. General elements of control systems are discussed along with circuit and construction details of coders, decoders, receivers, transmitters and associated equipment.

Proceedings of the Third Conference on Carbon. Edited by M. Mrozowski et al, Pergamon Press, Ltd., New York, 1959, 718 p, \$20. Consisting of some 80 papers presented at a 1957 international conference, this book is primarily of interest to physicists and chemists interested in carbon analysis, application and production. Extensive data on magnetic, semiconducting and other electrical properties of various carbon forms, compounds and single crystals are presented along with analytical techniques.

The Language and Symbolology of Digital Computer Systems. RCA Service Co., Government Service Dept., Camden 8, N. J., \$2.00. This publication presents symbols and word definitions preferred by the Air Force's Cambridge Research Center; symbols in common use by various manufacturers are cross-referenced to the preferred symbols. Sections are also included on basic characteristics of digital computers and Boolean algebra.

Basic Electronics. By Bernard Grob, McGraw-Hill Book Co., Inc., New York, 1959, 524 p, \$9.25. Textbook introducing electronic fundamentals, simple circuit construction and troubleshooting, instruments and components. Math is limited to algebra, trigonometry and exponents which are explained in an appendix. Work is based on a course for technicians at RCA Institutes.

Guide to Mobile Radio. By Leo G. Sands, Gernsback Library Book No. 77, 160 p, paper cover \$2.85. Covers general types of systems, including paging, dispatching, industrial, railroad and citizens' band radio. Other topics include mobile and base station operation, types of receivers and transmitters, power supplies, antenna systems, remote control, portable equipment, maintenance and licensing. Helpful to radio technicians, mobile equipment sales engineers, and purchasers and operators of mobile equipment.

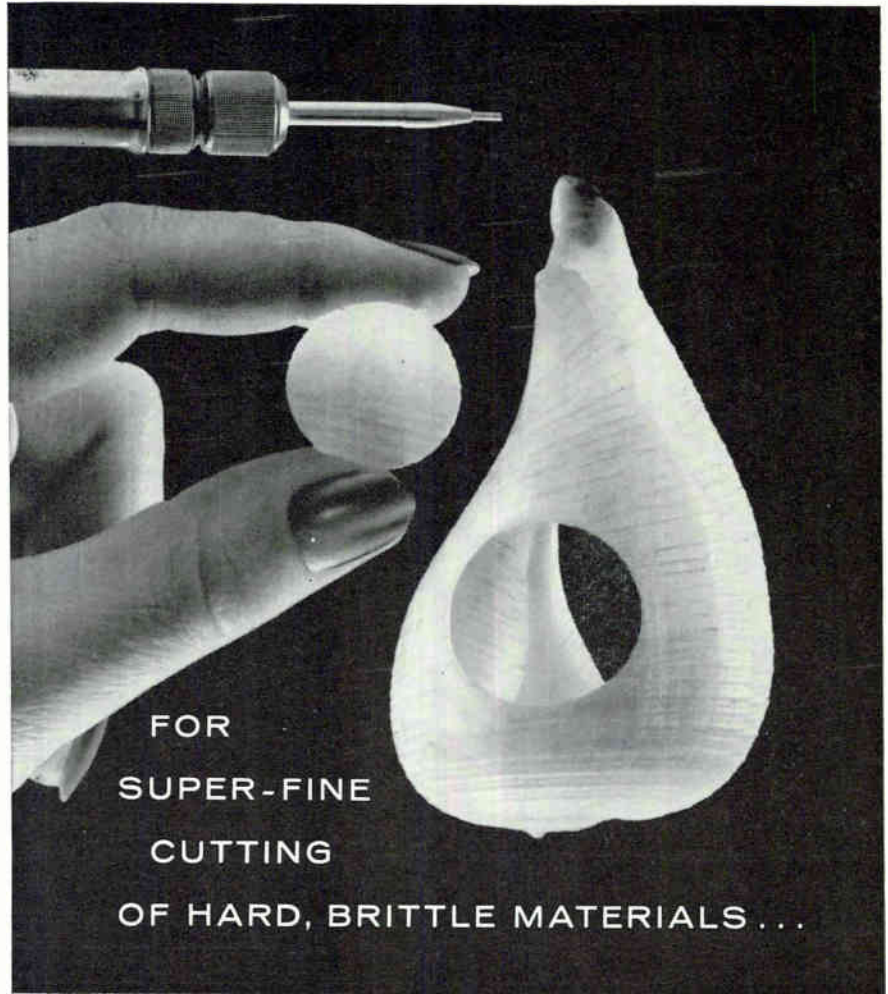

FOR
SUPER-FINE
CUTTING
OF HARD, BRITTLE MATERIALS . . .

THE *S.S. White* Industrial Airbrasive® Unit

We cut a section from this fragile sea shell just to show that *in a matter of seconds* almost any hard, brittle material can be cut or abraded with the S.S. White Industrial Airbrasive Unit.

Cool, shockless, super-precise, the unit uses a controlled stream of fine abrasive, gas-propelled through a small nozzle. It is so flexible in operation that the same simple tool can frost a large area or can make a cut as fine as .008" . . . on a production basis!

Almost every day new uses are being discovered for the Airbrasive Unit, in the lab or on the production line . . . shaping . . . deburring . . . wire-stripping . . . drilling . . . engraving . . . frosting . . . materials testing . . . cleaning off surface coatings.

All types of hard brittle materials . . . glass, germanium and other fragile crystals, ceramics, minerals, oxides, metal, certain plastics.

Send us your most difficult samples and we will test them for you.

1089



SEND FOR
BULLETIN 5705A
...complete information



New dual Model D!

S.S. White®

S.S. WHITE INDUSTRIAL DIVISION • Dept. EU • 10 East 40th Street, New York 16, N. Y.

Exclusive representatives for Arizona and California • WEIGHTMAN AND ASSOCIATES, Burbank, Calif.

what's in a name?

Your name **MR. JOHN H. RICHARDS** gives you identity. A tool



has a "name" A part has a "name"



A switch has a "name" Everything



in your plant has a name, from **R. WHALEN** who

works for you to the **ELEVATOR** Engrave all

these "names" permanently

with unskilled labor by

Engravo
graph

Send for booklet ZT-3

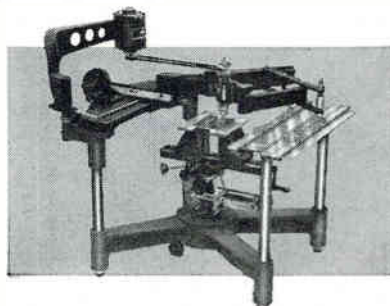

new hermes ENGRAVING MACHINE CORP. 154 WEST 14TH STREET
NEW YORK 11, N. Y.

CIRCLE 204 ON READER SERVICE CARD

AUGAT'S REVOLUTIONARY ELASTACLAMP*

The answer to more effective cooling of subminiature tubes!

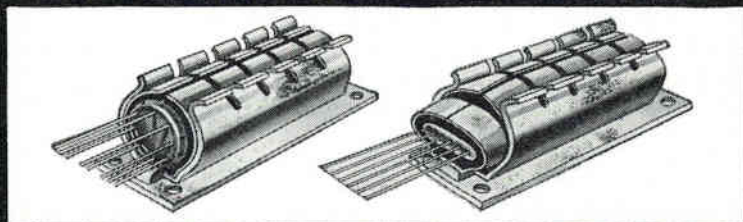

Heat-dissipating subminiature tube shield with elastic thermal conductor



Enlarged section of Elastaclamp's inner cartridge.

Resilient elastomer will completely conform to pronounced irregularities of glass surface thus reducing dangerous hot spots.

Tubes protected from severe shock and vibration by rubber-like elastomer which cushions glass.

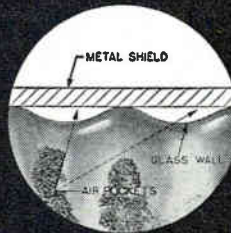

Enlarged section conventional heat-dissipating tube shield.

For additional information write for bulletin No. 559.

AUGAT BROS., INC.

*Trademark

31 Perry Avenue • Attleboro, Mass.

Literature of

COMPONENTS BULLETIN. National Radio Co., Inc., Melrose, Mass., has available bulletin 59-6 covering dials, drives and mechanisms.

CIRCLE 375 ON READER SERVICE CARD

PROCESS DATA HANDLING SYSTEM. Kybernetes Division of Hagan Chemicals & Controls, Inc., Pittsburgh 30, Pa. A complete description of the Kybernetes series 2000 data system is provided in a 12-page brochure.

CIRCLE 376 ON READER SERVICE CARD

POTENTIOMETER PRESSURE PICKUP. Consolidated Electrodynamics Corp., 360 Sierra Madre Villa, Pasadena, Calif. The 4-380A potentiometer pressure pickup for missile use is described in bulletin 1604.

CIRCLE 377 ON READER SERVICE CARD

LINEAR DIFFERENTIAL TRANSFORMERS. MinAtron Corp., 14 Cliveden St., Belle Mead, N. J. An 8-page bulletin is available of condensed semitechnical notes on basic design of control systems using linear differential transformers as a-c transducers with a-c or d-c outputs.

CIRCLE 378 ON READER SERVICE CARD

SMALL INDUCTORS. Arnold Magnetics Corp., 4613 W. Jefferson Blvd., Los Angeles 16, Calif. Two-sided catalog sheet describes a line of small, lightweight toroidal inductors which have exceptionally high Q values.

CIRCLE 379 ON READER SERVICE CARD

SELF-BALANCING POTS. Daystrom Pacific, 9320 Lincoln Blvd., Los Angeles 45, Calif. A 4-page, 2-color brochure describes the applications, operation and specifications of a line of self-balancing potentiometer models that can be used in flight test instrumentation as pyrometers or millivoltmeters.

CIRCLE 380 ON READER SERVICE CARD

POWER INVERTER. Southwestern Industrial Electronics Co., 10201 Westheimer, Houston 19, Texas. Model TPI-3 transistorized power inverter, for power inversion in any airborne environment, is described and illustrated in a

the Week

bulletin which outlines its specifications, features, and includes a simplified circuit diagram.

CIRCLE 381 ON READER SERVICE CARD

CUSTOM MOLDED CONNECTORS. Dychro Corp., 12 Centre Ave., Newton 58, Mass., has available literature on cable assemblies custom molded to standard commercial or military connectors.

CIRCLE 382 ON READER SERVICE CARD

FACILITIES BROCHURE. Horkey-Moore Associates, 24660 Crenshaw Blvd., Torrance, Calif. A 2-color, 6-page service file describes the engineering, research and development, production and testing facilities offered by the company.

CIRCLE 383 ON READER SERVICE CARD

D-C POWER SUPPLIES. General Electric Co., Schenectady 5, N. Y. Bulletin GEA-6926, four pages, gives detailed information on a complete line of d-c power supplies for all h-v electronic applications.

CIRCLE 384 ON READER SERVICE CARD

ZENER VOLTAGE TESTER. Electronic Research Associates, Inc., 67 Factory Place, Cedar Grove, N. J. Two-color catalog sheet No. 115 describes Zener voltage tester, model DT100.

CIRCLE 385 ON READER SERVICE CARD

POWER TRANSISTORS. Silicon Transistor Corp., Carle Place, N. Y., has available an engineering bulletin on two types of *npn* high power silicon transistors featuring extreme low saturation resistance.

CIRCLE 386 ON READER SERVICE CARD

CONNECTORS. Harco Laboratories, New Haven, Conn., has published a catalog sheet containing technical details on a line of high temperature connectors.

CIRCLE 387 ON READER SERVICE CARD

DATA LOGGING. Datex Corp., 1307 S. Myrtle Ave., Monrovia, Calif. Bulletin No. 200 describes the Datex-Monroe Data/Log digital printing and calculating machines.

CIRCLE 388 ON READER SERVICE CARD

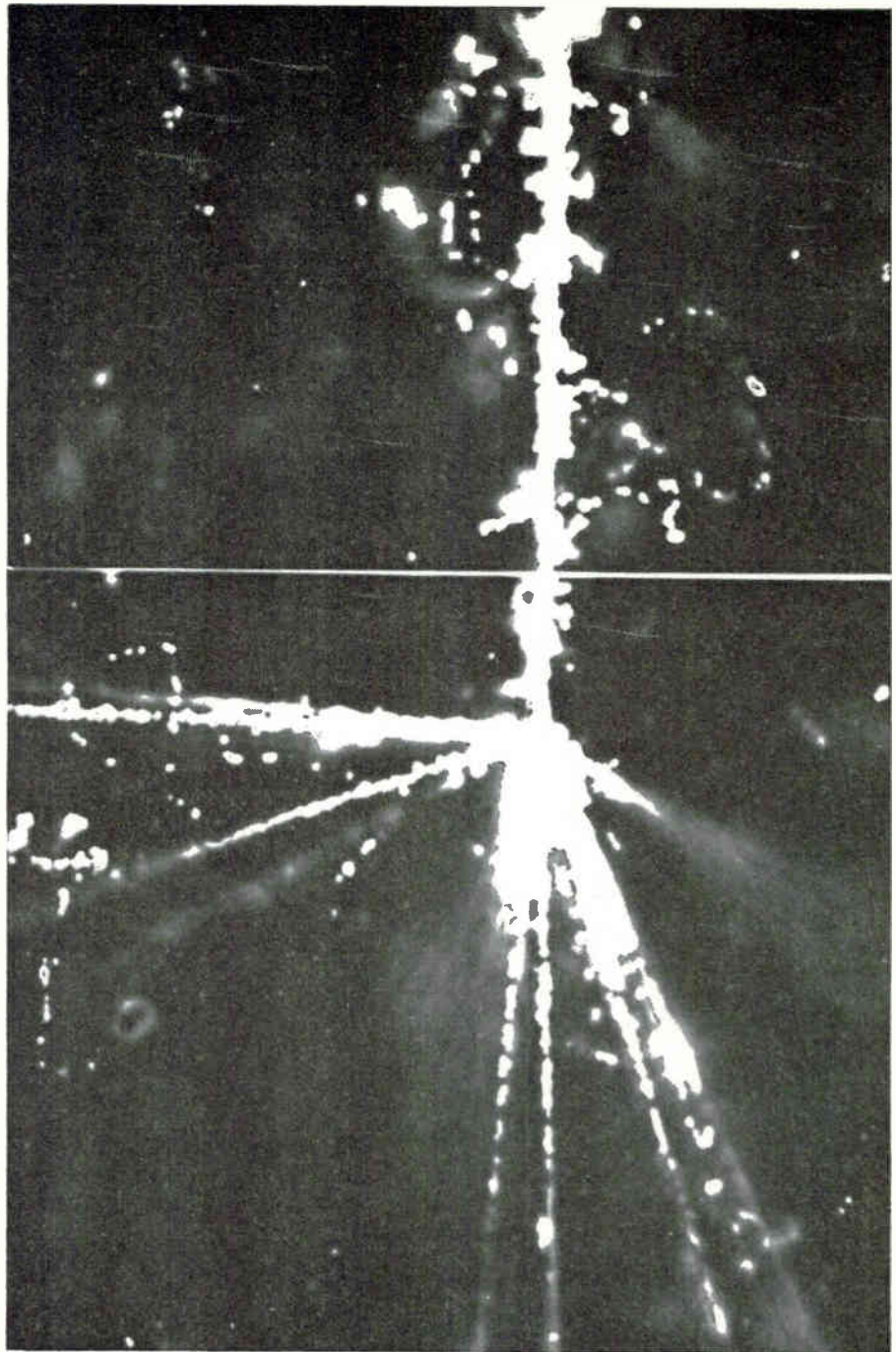

BASIC RESEARCH AT LOS ALAMOS INCLUDES NUCLEAR PLATE STUDIES OF HIGH ALTITUDE RADIATION PHENOMENA.

FOR EMPLOYMENT
INFORMATION WRITE:
PERSONNEL DIRECTOR,
DEPARTMENT 60-3

los alamos
scientific laboratory
OF THE UNIVERSITY OF CALIFORNIA
LOS ALAMOS, NEW MEXICO



Consultants in 3rd Expansion

MARC SHIOWITZ AND ASSOCIATES, INC., consultants in the design and use of electronic data processing equipment, recently moved into a new 12,000 sq ft building in Hawthorne, Calif.

This move marks the second expansion for MS&A in a year, and the third since the firm was established two and a half years ago.

MS&A contracts involve engineering on navigation computers for aircraft and missiles of the future as well as design and programming of computers for commercial air traffic control, and business data processing. The company's clients include major southern California firms, such as Hoffman Electronics, Librascope, Litton Industries, Northrop, Space Technology Laboratories, and Thompson Ramo Wooldridge.

The new facilities house MS&A's administrative offices, its staff of programmers for business data processing, and its group of computer engineering experts. Since some of the company's work requires the development of new electronic components and advanced computer circuits, the new facility also contains an electronics laboratory for this type of research and development.

Offer Awards for Gravity Essays

IN 1960, for the eleventh year, the trustees of the Gravity Research Foundation, New Boston, N. H., are offering five awards (ranging from \$100 to \$1,000) for short essays for the purpose of stimulating thought and encouraging work on harnessing gravity.

These awards will be made on June 1, 1960 for the best 1,500 word essays on the possibilities of discovering:—(a) some partial insulator, reflector or absorber of gravity, or (b) some alloy, or other substance, the atoms of which can be agitated or rearranged by gravity to throw off heat, or (c) some other reasonable method of harnessing, controlling, or neutralizing gravity.

Essays must be received at the Foundation office before April 15, 1960.



Magasiny Joins Schaevitz

APPOINTMENT of Irving P. Magasiny as director of engineering at

Schaevitz Engineering, Pennsauken, N. J., is announced. He joins the electronics specialty firm after more than 11 years of management, research and development engineering experience with the Philco Corp., and Tele-Dynamics, Inc., both of Philadelphia, Pa., where he directed systems, circuit design and special projects staffs.

Plan Conference On Solid-State

THE 1960-International Solid-State Circuits Conference will be held February 10, 11 and 12 at Irvine Auditorium and University Museum, University of Pennsylvania, and the Sheraton Hotel, Philadelphia, Pa. Sponsors are: IRE Professional Group on Circuit Theory, AIEE Committee on Electronics, IRE Philadelphia Section, AIEE Philadelphia Section, and the University of Pennsylvania.

Conference will feature eight sessions at the University devoted to broad advances in the field of solid-state device applications and circuits. Forty-three papers covering new magnetic and semiconductor devices and circuits for digital storage and logic will be offered. Also presented will be a number of survey reports on tunnel diodes, thin magnetic films and microwave properties of semiconductors.

Twelve informal sessions, conducted by leaders in the solid-state field, will be held on the evenings of Feb. 10 and 11 in the Sheraton Hotel. They will provide registrants an opportunity to discuss tunnel diodes and their applications, storage techniques, reliability, noise theory, logic circuits, microelectronics, parametric applications and energy conversion.

Tucor Acquires Wiltec

TUCOR, INC., has acquired Wiltec Electronics, Inc., of South Norwalk, Conn., manufacturer of various types of special-purpose gaseous and vacuum miniature and sub-miniature thyratrons, indicating devices, trigger and timer tubes,



EARTHBOUND AND BEYOND

CANNON RF COAXIAL PLUGS MEET ANY CHALLENGE...ANYWHERE

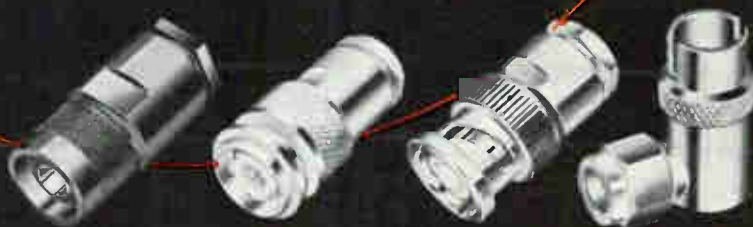

CANNON

PLUGS

Cannon's complete line of RF coaxial plugs meet the exacting demands of today's technology with room to spare! Wherever coaxial cable is used; land, sea, air, or outer space, Cannon's RF plugs—standard, miniature, and light-weight aluminum—provide the exact type and size for any application . . . whether industrial or military • Aircraft • Missiles • Ground Support Equipment • Ships • Submarines • Write for literature to:

CANNON ELECTRIC CO., 3208 Humboldt Street, Los Angeles 31, California • Please refer to Department **120**.

Largest Facility in the World for Plug Research—Development—Manufacture

When you've got big plans for the future—you have good reasons for reading your businesspaper mighty carefully. This is where a man who means business gets facts, news, ideas . . . information he needs to do business. Issue after issue you find meaty stuff to keep your job and your business growing—in both the advertising and editorial pages of your businesspaper.



PHOTO ON LOCATION BY EHRENBURG

Where there's
business action,
there's a
businesspaper

. . . where there's electronics
business, there's

electronics

A McGraw-Hill Publication
330 W. 42nd Street, New York 36, N.Y.



One of a series of advertisements prepared by the ASSOCIATED BUSINESS PUBLICATIONS

and regulator and rectifier tubes.

The staff and physical equipment of the Wiltec plant is being moved to Tucor's 12,000 sq ft facility in South Norwalk. President John Erstad of Wiltec will head the new line of Tucor-Wiltec tubes, and Bruce Kunkel, Wiltec's vice president becomes production head for this line.



Elect Bellows Director

ELBERT G. BELLOWS, vice president of the Contracts Division, has been elected a director of The W. L. Maxson Corp., New York, N. Y.

He joined Maxson in 1953 as assistant vice president and assistant secretary. Later, in 1955, he was assigned to the Contracts Division. In 1957 he was elected a vice president of the corporation and placed in charge of the Contracts Division.

The W. L. Maxson Corp. is engaged in research, design, development and production of a diverse group of military and industrial products ranging from subminiature switches to highly complex missile guidance systems.

Convair Sets Up New Department

CONVAIR (San Diego) Division of General Dynamics Corp. has set up its own electronics department.

B. F. Coggan, division manager, said it will be known as Convair-San Diego Electronics and will be



ROUND



SQUARE



KEY



"D"

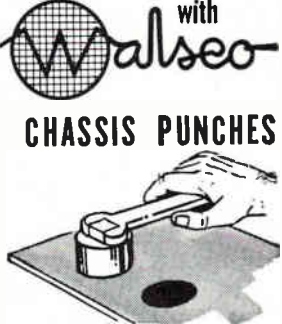

with
Walsco
CHASSIS PUNCHES



(*L.T. is Walsco's exclusive "Low-Torque" design)

Make any size hole you want for sockets, plugs, meters, others . . . do it faster with less effort with famous Walsco L.T.* Chassis Punches. Easy to use . . . last a lifetime. Send postcard for free literature.

WALSCO ELECTRONICS MFG. CO.

Division of Textron Inc.

Western Plant: Los Angeles 18, California
Main Plant: ROCKFORD, ILLINOIS, U.S.A.

CIRCLE 207 ON READER SERVICE CARD

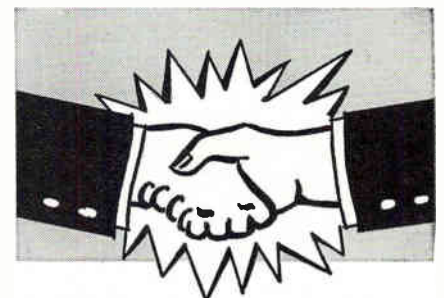

**35 YEARS of PROVEN
DEPENDABILITY**



**ELECTROLYTIC
AND
PAPER TUBULAR
CONDENSERS**

COSMIC CONDENSER CO.

853 WHITTIER STREET, BRONX, N. Y.
LUdlow 9-3360

CIRCLE 208 ON READER SERVICE CARD
JANUARY 8, 1960 • ELECTRONICS

headed by R. E. Homer, former assistant chief engineer for electronics.

He said the expansion will facilitate increased electronics developments such as recent airborne and ground-based radar, special ground test equipment, data handling instrumentation and other products.

At its Plant 1 in San Diego, Convair-San Diego now has 730 employees in electronics working in 300,000 sq ft of manufacturing, engineering, research and office space.

News of Reps

Acton Laboratories, Inc., a subsidiary of Technology Instrument Corp. of Acton, Mass., producer of electronic laboratory test instruments, has appointed the following companies to extend its nationwide sales and service:

Landers, Zachary & Peterson Co., Denver, Colo., for Colorado, Utah, and Wyoming; Premco of Arizona, Scottsdale, Ariz., for Arizona, New Mexico, and El Paso County, Texas.

McDowell-Redlingshafer Sales Co., with operating offices in Kansas City, Mo., and in St. Louis, Mo., has been appointed representative for Sola Electric Co., Chicago, Ill. Firm will handle Sola's complete line of constant voltage transformers and regulated d-c power supplies in Missouri, Kansas, Iowa, Nebraska, and in Quincy, Ill.

Three new reps were recently appointed by the Electronics Division of The Gabriel Co., Needham Heights, Mass.

Harry W. Persson Associates of Oxford, Mass., will handle sales in all six New England states; Griffiss Air Force Base, New Jersey; Pennsylvania, and New York City.

E. C. Raymond and Associates of Madeira Beach, Fla., will represent the company in Florida, Georgia, Alabama, and North and South Carolina.

R. P. Kennedy Co. of Rochester, N. Y., will cover upper New York State.

**TEMPERATURE
CONTROL
FOR
COMPONENTS**



**BLILEY
TYPE
BCO-10**

For temperature stabilization of diodes, the new Bliley BCO-10 oven will hold $\pm 1^\circ\text{C}$ with ambient temperature variation from -10°C to $+50^\circ\text{C}$. Stability is better than $\pm 4^\circ\text{C}$ from -55°C to $+70^\circ\text{C}$.

Compact unit has multiple contacts (20 terminals) for mounting up to 10 diodes. Dimensions, less brackets, are $1\frac{15}{32}'' \times 1\frac{1}{4}'' \times 1\frac{29}{32}''$. Design features an hermetically sealed snap-action thermostat and non inductive heater winding to minimize noise and interference in low level circuitry.

Standard models are available for operation at 50°C or 75°C with 12.6 volt, 26.5 volt or 115 volt heaters as required.

Request Bulletin 517 for Complete Information.



BLILEY ELECTRIC COMPANY
UNION STATION BUILDING • ERIE, PENNSYLVANIA

CIRCLE 210 ON READER SERVICE CARD

Only EDI brings you 3 Megacycle Range Induction Heaters...

New EDI Induction Heaters provide an extremely versatile tool for all manufacturing operations requiring controlled area heating. Modern 3 megacycle units supply instantaneous pin-point heat with no contamination and no preheating, permitting a safer, more accurate and reliable method of sealing semiconductors, diodes and transistors, as well as soldering, brazing and heat treating. All EDI Induction Heaters are designed for use on regular factory voltages and completely automatic units can be built to satisfy individual requirements.



Silver Soldering



Production Brazing



Automatic Production Unit

Write
for
detailed
literature.



SHERMAN INDUSTRIAL ELECTRONICS
Division of H F Induction and Dielectric Heaters
ELECTRONICS DEVELOPMENT, INC./STATE COLLEGE, PENNSYLVANIA

"SPOOLY"
SAYS...



Super-Temp FOR A COMPLETE LINE OF **COAXIAL CABLES**

Any high temperature coaxial cable . . . military or commercial . . . Teflon* or polyethylene. You design it, or we'll help you! Either way, you get it faster from Super-Temp.

ALSO: Miniature Cables, Jumbo Cables, Tapes
Magnet Wire, Airframe Wire, Hook-up Wire
Teflon or Silicone Rubber Insulations

*DUPONT'S TFE RESIN

Save Time WITH Super-Temp

American Super-Temperature Wires, Inc.

8 West Canal Street, Winooski, Vermont • UNiversity 2-9636

General Sales Office: 195 Nassau St., Princeton, N. J. • WAlnut 4-4450

A Subsidiary of Haveg Industries, Inc., Wilmington, Del.

Free! Send for 1960
Catalog. 88 pages of
valuable data.



CIRCLE 217 ON READER SERVICE CARD

COMMENT

Undersea Monitor

Leigh Sanders' letter (Comment, p 114, Dec. 11 '59) bears frightening thoughts, possibly true.

However, one question seems to be in order. How do we "know they (the Russians) monitor the cable that connects Jupiter, Fla., to Puerto Rico"?

WILLIAM R. MURPHY
NORRISTOWN, PA.

How reader Sanders knows we cannot say. We printed his comment because, among other reasons, we believe it to be true. Our opinion is based on a reasonable appraisal of certain fragmentary bits of information supplied to us by people in and out of government, both intentionally and accidentally. It is a single-conductor cable, the one in question, and so rather easy to monitor without alerting the users.

R-f and Microorganisms

Your article "Germ-Gas Detectors Needed," (p 34, Dec. 4 '59) was most interesting. There were several remarks which particularly caught my attention.

The first: ". . . but h-f energy in the 1-to-20-meter band stimulates growth of many microorganisms. The reaction is apparently not a function of heat, but seems to be due to electrical fields acting on the microorganism."

The second: "Researchers have proved that ultrasonic energy also affects reproductive rates of microorganisms. This effect too seems to be frequency specific."

Though I follow the literature on the biological effects of microwaves and ultrasound, I have not seen definitive articles which substantiate these remarks. . . .

WALTER E. TOLLES
AIRBORNE INSTRUMENTS
LABORATORY
HUNTINGTON, N. Y.

In the Dec. 4 '59 issue of ELECTRONICS, in the article "New Bio-Effects of R-F Energy" (p 38), it is stated that investigations at the University of California at Berkeley have established that



FOREMOST
in
**MARINE
LORAN**

EDO CORPORATION
College Point, L.I., N.Y.
Since 1925



WHO DROPPED THE BINOCULARS? THE BINOCULARS?

With everybody watching each other along the DEW line and the Iron Curtain these days, electronics has replaced binoculars.

What's happening in the giant markets for missile controls, radar and communications equipment?

electronics tells how things are going, keeps you informed of developments as they occur. This is a good time to subscribe or renew your subscription. Just fill in box on Reader Service Card. Easy to use. Postage free.

FIND WHAT YOU NEED IN... **electronics**

**EXECUTIVES...
"site-see"
INDUSTRIAL COLORADO**

**...right
at
your
desk!**



- Discover how your company can profit positively in Colorado.
- Learn why Colorado has become "the State that more than meets your site requirements."
- Examine the documented facts on Colorado's great wealth of Manpower, Materials, Markets.
- See why Pleasant Living, a product of Colorado's magic climate, is such a valuable bonus to industry.

This revised-to-the-minute 9-booklet portfolio, "Industrial Colorado," presents an informative, concise analysis of the opportunities awaiting new and expanding industry in Colorado.

WRITE FOR YOUR COPY TODAY!

COLORADO

DEPARTMENT OF DEVELOPMENT
63 STATE CAPITOL BLDG., DENVER 2, COLO.
Your inquiry will be held in strictest confidence.

CIRCLE 212 ON READER SERVICE CARD

STEPPING SWITCHES
SIGMA KURMAN
HERMETICALLY SEALED
KURMAN
WARD LEONARD
WARD LEONARD
STRUTHERS M. AUTOMATIC
DUNN ELECTRIC
ROTARY LEACH
RACHET CLARE
ALLIED EVENS
LEDEX NOLD
CLARE ANCE
LEACH ALLIED
MINIA CRAFT
SIGMA LEDEX
NORTH KEYING
ELECTRIC PHILLIPS
DORMEYER CONTROLS
TELEPHONE AMPERITE
TYPE
KURMAN PRODUCTION WESTERN
STEVENS QUANTITIES ELECTRIC
ARNOLD MOST MAKES CUTLER
IN STOCK HAMMER
CONTACT GENERAL
MERCURY Send for Latest Catalog E ELECTRIC
SOLENOIDS GUARDIAN
ADVANCE CONTACTORS
ALLEN BRADLEY PRICE ELECTRIC
POTTER SQUARE D WESTON
BRUMFIELD MINIATURE AIRCRAFT

**LARGEST
STOCK OF
RELAYS
IN THE
WORLD**

Universal RELAY CORP.
42 WHITE ST., NEW YORK 13, N. Y. • WALKER 5-9642

CIRCLE 213 ON READER SERVICE CARD
ELECTRONICS • JANUARY 8, 1960

growth of microorganisms is stimulated by r-f.

I am quite interested in securing more detailed information on this work . . .

D. R. BIANCO

JOHNS HOPKINS UNIVERSITY
SILVER SPRING, MD.

Our sources were several. Most of the information concerning the effects of radio-frequency energy on the growth and reproductive rates of microorganisms, although available to us in verbal form earlier, was substantiated by a series of reports made at the 12th Annual Conference on Electrical Techniques in Medicine and Biology, held in Philadelphia last November. Several research groups independently demonstrated the influence of alternating electrical fields on bacteria, amoebae and other protozoa. Effects of ultrasound have been mentioned to various members of this magazine's staff by highly-respected researchers working in this area of the technology, but the data have not been published elsewhere. This work, like the work in r-f effects, is related to activities of the Chemical Corps, and is consequently under a reasonably strict classification. When nondefense-oriented researchers have a go at it, we will probably be able to report some definitive results.

The Materials Report

Your special report on materials ("Materials for Environmental Extremes," p 81, Dec. 4 '59) is quite a work. I found a lot of it fairly familiar stuff, and quite a bit of it new—about par for a report that wraps up a whole cross-section of the technology. The graphical presentations were especially valuable, but I suppose the most important thing about the report was that it brought so much related data together in one place.

One thing amused me, though. On p 82 there is a subsection headed "Civilian Electronics." I suppose such a classification is inevitable, with so much military work going on—but I still think it's funny.

H. N. STOVER

CHICAGO

**MINIATURE AND
SUB-MINIATURE
CAPACITORS**

iei

**TANTALUM
CAPACITORS**

iei

**ALUMINUM
CAPACITORS**

iei



iei, originator of miniature aluminum foil electrolytic capacitors, now offers a full range of miniature and sub-miniature types and sizes:

- Polar and non-polar
- Plain foil and etched foil tantalums
- Multi-section aluminum types
- Reliable over a wide temperature range

Tantalum capacitors are made in accordance with Military Specs. High capacities, low DC leakage ideal for transistorized circuits. Write for bulletins 81558 and 41858.

International Electronic Industries, Inc.
Box 9036-B, Nashville, Tennessee.

iei

AN **SPS** COMPANY

where reliability replaces probability

CIRCLE 97 ON READER SERVICE CARD 97

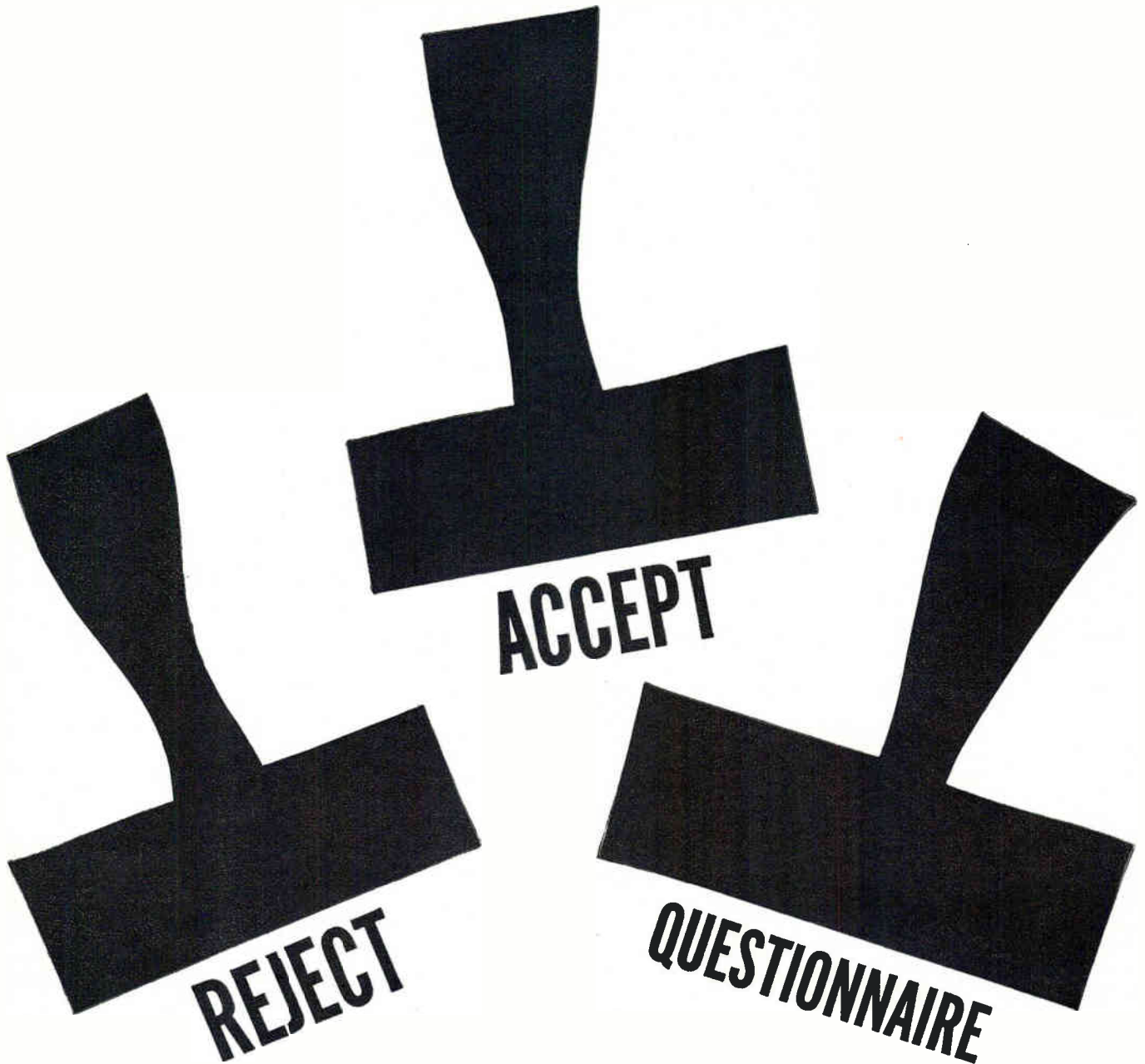

THREE TOOLS FOR QUALITY CIRCULATION

Members of a select group, the readers of **electronics**

As fast as subscription orders are received they are examined individually—by Hugh J. Quinn, Circulation Manager, who stamps each card:

ACCEPTED — to indicate a subscriber is actually engaged in research-design/production/management as a maker or user of electronics equipment.

QUESTIONNAIRE — to delay acceptance until information concerning the subscriber—his function, his company, his title are definitely known.

REJECTED — whenever the order indicates that the in-

dividual is NOT within the editorial field of the publication.

electronics is a member of a select group too—The Audit Bureau of Circulation publications—comprised of those magazines and newspapers whose publishers believe that a reader's interest in a publication is best demonstrated when he pays to receive it—those publishers willing to submit to exhaustive periodic audits in order to prove that their circulation is among those individuals they are pledged to serve, and among screened *selected* individuals ONLY.

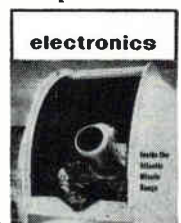

The Electronics Man "buys" what he reads in...

 ATMcGRAW-HILL PUBLICATION / 330 WEST 42nd STREET, NEW YORK 36, N. Y.

General Electric's Missile & Space Vehicle Dept. Building New \$14,000,000 Space Research Center

17 miles from Philadelphia, Near Valley Forge Park

Back in 1956 this General Electric organization outgrew its quarters in Schenectady, N. Y. and moved to Philadelphia. Since then its research and development staff has increased 5-fold. A new move is fast becoming imperative and will be met by the \$14,000,000 Space Research Center now under construction on a 132 acres site near Valley Forge Park. This construction will feature unique facilities, to be utilized in a long-term program, to expand the activities in the realm of space research and the development of space vehicles and systems—areas in which MSVD has already contributed so many notable advances:

- the FIRST re-entry at ICBM range with both heatsink and ablation methods
- the FIRST recovery of payload from space
- the FIRST movies of earth from space
- the FIRST flight demonstration of effective space vehicle stabilization control and navigation (control systems of interplanetary capacity)
- the FIRST measurements in space of earth's magnetic field and infrared radiation
- the FIRST meteorological information from space
- the FIRST organic plastic ablation material for nose cone re-entry protection capable of withstanding temperatures from 5,000 to 13,000°F

Currently a broad diversity of programs are under way at MSVD, offering assignments of exceptional interest to engineers and scientists qualified to work with a research-oriented organization. Your inquiries are invited regarding the following areas: SYSTEMS ENGINEERING • AERODYNAMICS • THERMODYNAMICS • GUIDANCE & CONTROL • INSTRUMENTATION & COMMUNICATION • PLASMA PHYSICS • GAS DYNAMICS • AEROMEDICAL DESIGN ENGINEERING • ANTENNA & MICROWAVE DESIGN • SPACE MECHANICS • STRUCTURAL DESIGN • ENERGY CONVERSION • HUMAN FACTORS • ADVANCED POWER SYSTEMS • RELIABILITY ENGINEERING • PRODUCIBILITY ENGINEERING • ARMING AND FUZING SYSTEMS • APPLIED MATHEMATICS & COMPUTER PROGRAMMING

Write in confidence to: Mr. Thomas H. Sebring, Div. 69WA
Missile & Space Vehicle Department

GENERAL  ELECTRIC

3198 Chestnut St., Philadelphia 4, Pa.

**DIVERSITY OF
ADVANCED PROGRAMS
NOW UNDER WAY
AT MSVD INCLUDE:**

- Follow-on contracts for 2nd generation nose cones
- NERV (Nuclear Emulsion Recovery Vehicles) for NASA to study the lower Van Allen radiation belts at altitudes from 200 to 1800 miles
- STEER—a communications satellite to provide global military radio communications.
- Study programs in the area of accessory space power for a variety of missions, including chemical, nuclear and solar energy sources, electrolytic fuel cells and thermoelectric and thermionic converters
- Studies for three of the nation's space agencies to develop more accurate "space maps" than have hitherto existed to guide rockets and manned flights to the moon and planets

A well qualified scientist or engineer is likely to find advanced work going on at MSVD on almost any field of space research of special interest to him.

A campus-like setting is planned for the new Space Research Center which General Electric's Missile and Space Vehicle Department is building close to historic Valley Forge Park. Situated at the junction of the Schuylkill Expressway and Pennsylvania Turnpike, the Center will be easily reached by engineers and scientists living in the Philadelphia area and in southern New Jersey.

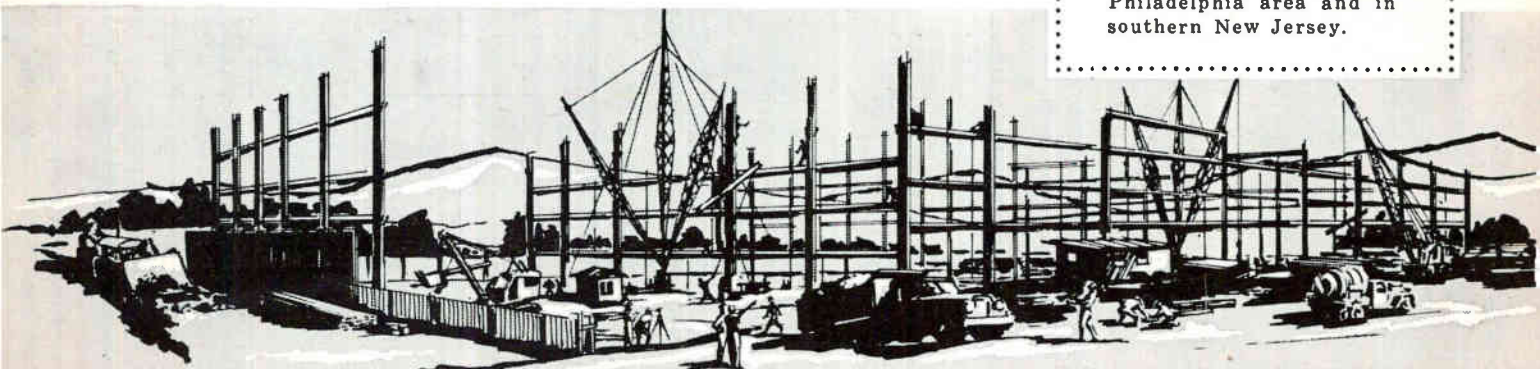



STIMULATING!

Motorola engineers are the most stimulated and enthusiastic individuals you'll find anywhere. And, for sound reasons.

First, the work. Electronics—challenging fields that plead for vision, creativeness and imagination.

Secondly, the company, An "engineers' company"—developed by technical minds dedicated to engineering excellence. A rewarding company—quick to recognize and advance skill. A secure, diversified company—not wholly dependent on one single market.

Thirdly, the place, Chicago—exciting and quiet. Cosmopolitan and suburban. Mid-America's nucleus of culture, education and entertainment—where everyone can find the perfect environment.

- Radar transmitters and receivers
- Radar circuit design
- Electronic countermeasure systems
- Military communications equipment design
- Pulse circuit design
- IF strip design
- Device using klystron, traveling wave tube and backward wave oscillator
- Display and storage devices
- 2-WAY RADIO COMMUNICATIONS
- VHF & UHF receiver
- Transmitter design and development
- Power supply
- Systems engineering
- Antenna design
- Selective signaling
- Transistor applications
- Crystal engineering
- Sales engineering
- Design of VHF & UHF FM communications in portable or subminiature development
- Microwave field engineers
- Transistor switching circuit design
- Logic circuit design
- T.V. circuit design engineering
- Home radio design
- New product design
- Auto radio design
- Mechanical engineering
- Semi-conductor device development
- Semi-conductor application work

Also splendid opportunities in
Phoenix Ariz., and Riverside, Calif.



MOTOROLA Inc.

Mr. L. B. Wrenn, Engineering Personnel Mgr., Dept. D
4501 Augusta Blvd., Chicago 51, Illinois

Without obligation, send copy of
"Selecting an Engineering Career with a Future"

NAME _____

ADDRESS _____

CITY _____ ZONE _____ STATE _____



DEVELOPMENT ENGINEERS

career opportunities

For 75 years, Honeywell has been "first in controls"—in the home, in industry, in business, and now climbing into space. Within this diversified area, choice and lasting careers currently exist for the following engineers:

INFRA-RED. Graduate engineer with 3 to 5 years' experience in the field of electronics. One to 2 years' experience in infra-red systems, design and applied research. Knowledge of optic system application desirable.

RF-VHF. Graduate engineer with 3 to 5 years' RF development experience. Design experience in radio frequency circuits in VHF range and up. Radar type pulse circuits and antenna design experience desirable.

If you are a qualified engineer interested in one of these openings, send information on your background and accomplishments to F. W. Miller, Dept. 250, Honeywell, 2753 Fourth Avenue South, Minneapolis.

To explore professional opportunities in other Honeywell operations coast to coast, send your application in confidence to H. D. Eckstrom, Honeywell, Minneapolis 8, Minn.

Honeywell

First in Controls

ELECTRONIC COMPONENT PRODUCT ENGINEER

For supervision of electronic component product engineering section and liaison between sales and manufacturing. Applicant must be capable of preparing product process instructions for manufacturing.

REQUIREMENTS

Electrical Engineer at Bachelor of Science level, with at least 4 years experience in design and production of precision components including carbon film and metal film resistors, capacitors, relays and switches. A first-hand knowledge of commercial and military specifications and familiarity with current instrumentation design is a prerequisite. A working knowledge of the micro-miniature module concept is desirable but not essential.

Salary: \$9,000 per annum, plus bonus

Age: 25 to 40

Must locate in Independence, Kansas

AIRMAIL COMPLETE RESUME TO:

W. E. HERCHER, *Associated Personnel*
118 South Main Street, Wichita 2, Kansas
(NO FEE FOR PLACEMENT)

ENGINEER INSTRUCTORS

Electronics Firm in the computer field requires men with an E.E. degree or equivalent experience to teach theory and maintenance of new data processing equipment to engineers and technicians of the company and its clients. Salary to \$10,000. Fee paid. Please send resume to:

LEWIS-PLACEMENTS
4 Gordon St., Waltham, Mass.

not just another pebble . . .

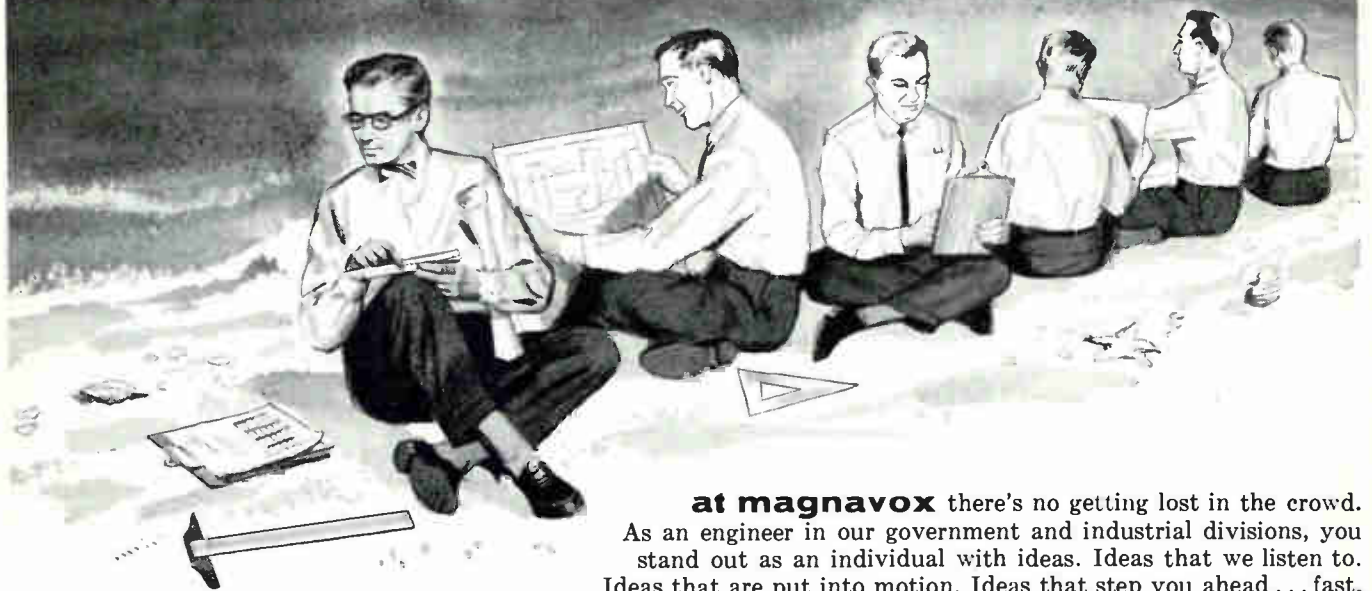

at magnavox there's no getting lost in the crowd. As an engineer in our government and industrial divisions, you stand out as an individual with ideas. Ideas that we listen to. Ideas that are put into motion. Ideas that step you ahead . . . fast. But while we gladly admit to NOT being a giant, neither do we take a back seat to anyone in the kind of creative climate we offer engineers. We are, in fact, currently engaged in a vast number of highly specialized areas of electronic activity and our customers rank among the principal names in business and government both here and abroad.

At present, we need engineers to carry on expanding programs in communications, airborne radar, missiles, anti-submarine warfare systems and data processing equipment. The projects we have on tap are broad and challenging. The men we offer as your associates are high caliber creative scientists like yourself. And the technical facilities we provide are the finest, most complete anywhere.



FORT WAYNE, INDIANA



URBANA, ILLINOIS



LOS ANGELES, CALIFORNIA

If you're a man who likes to accept challenge—and wants to be recognized for it—we'd be glad to hear from you. Phone Dick Eary (collect, of course) at Eastbrook 9721 in Fort Wayne or write him today for complete information.

Magnavox



COMMUNICATIONS



RADAR



DATA HANDLING



ASW



MISSILES

THE MAGNAVOX CO. • DEPT. 212 • Government and Industrial Division • FORT WAYNE, IND.

Electronic Engineers / Physicists

Senior level positions
available with the
Scientific Research Staff
and the
Applied Research and
Development Division of
REPUBLIC AVIATION

The Scientific Research Staff

Here, theoretical and experimental studies are performed in the various disciplines of the physical sciences. Research scientists and engineers with masters' or doctors' degrees are invited to participate in current programs or to initiate new studies. Our interests include research in such areas as electromagnetic radiation, information theory, data transmission, quantum mechanical electronic devices, solid state physics, and infrared which will lead to a product technology applicable to space exploration and weapons utilization components and systems.

Applied Research & Development Division

Here, conceptual thinking is translated into practical methods which will eventually result in prototypes of advanced ballistic missile systems, strategic orbital systems, space vehicle programming and tracking systems, and lunar observatory reconnaissance stations.

Openings at all levels (including top level supervisory) in nearly every area of Electronics related to Advanced Flight & Weapons Technology:

- | | |
|---|---|
| Navigation & Guidance Systems | Countermeasures |
| Radar Systems | Digital Computer Development |
| Information Theory | Telemetry-SSB Technique |
| Radio Astronomy | Radome & Antenna Design |
| Solid State & Thermionic Devices | Microwave Circuitry & Components |
| Radiation & Propagation | Receiver & Transmitter Design |
| (RF, IR, UV) | Miniaturization-Transistorization |

Address your resume in confidence to:

Mr. George R. Hickman

Engineering Employment Manager, Dept. 11A-2



REPUBLIC AVIATION

Farmingdale, Long Island, New York

*"Put Yourself in the
Other Fellow's Place"*

TO EMPLOYERS
TO EMPLOYEES

Letters written offering Employment or applying for same are written with the hope of satisfying a current need. An answer, regardless of whether it is favorable or not, is usually expected.

MR. EMPLOYER, won't you remove the mystery about the status of an employee's application by acknowledging all applicants and not just the promising candidates.

MR. EMPLOYEE you, too, can help by acknowledging applications and job offers. This would encourage more companies to answer position wanted ads in this section.

We make this suggestion in a spirit of helpful cooperation between employers and employees.

This section will be the more useful to all as a result of this consideration.

Classified Advertising Division

**McGRAW-HILL
PUBLISHING CO., INC.**

330 West 42nd St.

New York 36, N. Y.

ENGINEERS RESEARCH OPPORTUNITIES

Aeronutronic, a new division of Ford Motor Company, has immediate need for computer engineers to staff its new \$22 million Research Center in Newport Beach, Southern California. Here, you have all the advantages of a stimulating environment, working with advanced equipment, located where you can enjoy California living at its finest.

Look into these ground floor opportunities in research and development work that is challenging and exceptionally rewarding to qualified men.

POSITIONS NOW OPEN:

**Systems Engineer
Magnetic Memory
Engineers**
**Communications
Engineers**
**Digital Computer
Programmers**
**Transistorized
Circuit Engineers**
**Logical Designers
Circuit Engineers**
Mechanical Engineers
Optical Engineers

Qualified applicants are invited to send resumes or inquiries to Mr. R. E. Durant, Aeronutronic, Box NK-486, Newport Beach, California.

Computer Operation

AERONUTRONIC

a Division of

FORD MOTOR COMPANY

Newport Beach
Santa Ana • Maywood, California

SYSTEMS ENGINEERING

and

SYSTEMS MANAGEMENT

The strategic battlefield and support requirements of the modern ARMY for mobility, communications, and dispersion require the broadest and most sophisticated engineering solutions. The General Electric Company, through its **SPECIAL PROGRAMS SECTION**, is now staffing to meet this critical need.

Within SPS, a technical team has been created to focus all of General Electric's varied technical capabilities on the solution of the Army's requirements. Its small numbers afford maximum freedom and informality and permit an unequalled flexibility in responding to the Army's needs with advanced systems concepts and systems management approaches.

In staffing our technical positions we have chosen men of the highest ability and achievement; men who have broad experience in various facets of their technical fields. Each of them sees his discipline as an elemental part of the whole system and conversely, recognizes that the most sophisticated system is but an integration of complex technologies. Many hold advanced degrees (although this is not a prerequisite). Most are thoroughly familiar with the new Army's requirements (again, not essential). All thrive on the challenge of building a vital new group and the unlimited opportunities which it presents.

A limited number of these opportunities still exist — all at the senior level. Included are positions in **MISSILE ENGINEERING, WEAPONS SYSTEMS ENGINEERING, COMMUNICATIONS, MICROWAVE & RADAR, NAVIGATION & GUIDANCE, PASSIVE DETECTION, DATA LINKS, NUCLEAR WEAPONS EFFECTS, AEROBALLISTICS, and SYSTEMS ANALYSIS.**

Confidential interviews will be arranged very shortly for qualified candidates with our Manager of Engineering or our Manager of Electronics Engineering. Interested individuals should direct their response to:

Dr. W. Raithe, Manager—Engineering
Special Programs Section, Dept. 315
GENERAL ELECTRIC COMPANY
21 S. 12th Street • Philadelphia 7, Pa.

*The Special Programs Section moves in February 1960 to a completely new facility on the Main Line—Philadelphia's finest and one of the country's most attractive suburban locations.

SPECIAL PROGRAMS SECTION | **GENERAL ELECTRIC**

DEFENSE SYSTEMS DEPARTMENT

A Department of the Defense Electronics Division

New Multi-Million Dollar Engineering Research and Manufacturing Facility

for **NORDEN**

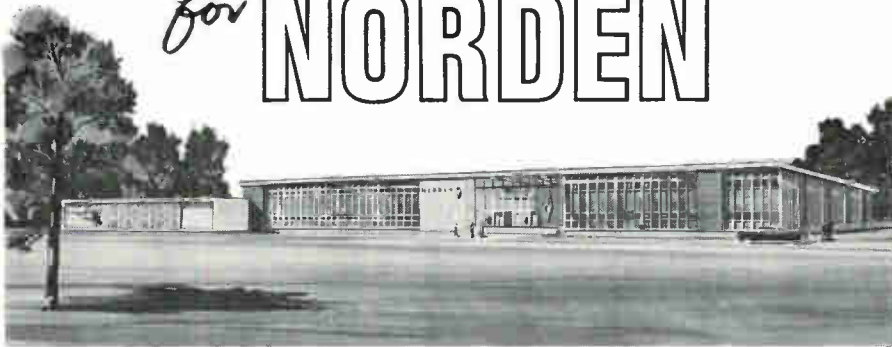

Now Under Construction in NORWALK, CONNECTICUT

Next fall the Norden Division of United Aircraft Corporation will consolidate in its new 350,000 sq. ft. Norwalk home the operations it is now carrying on in plants and laboratories in White Plains, New York and Stamford and Milford, Connecticut. The Ketay Department, however, a prominent leader in the field of rotating components, will continue operations at its modern facilities in Commack, Long Island.

An Unmatched Combination of Professional and Living Advantages

The ultra-modern new building on a spacious 80-acre site will contain the most up-to-date laboratory equipment. Norden's expanding programs offer a wide choice of assignments in advanced electronics areas. Typical projects include: AN/ASB-7 BOMB-NAV SYSTEM • 3-DIMENSIONAL TERRAIN PRESENTATION FOR LOW-FLYING AIRCRAFT • METEOROLOGICAL RADAR • AUTOMATIC TRACKING TV THEODOLITES • INERTIAL NAVIGATION SYSTEMS • SPACE INSTRUMENTATION SYSTEMS.

On the personal side are such advantages as living in picturesque New England, where both traditional and modern homes are available, though only 41 miles from New York City. And Norwalk may be said to have "more than its share" of cultural activities, boasting the largest community art center in the East and its own symphony orchestra. Outdoor recreation also abounds, with golf courses, beaches on Long Island Sound and excellent boat basins.

Openings now at all levels in two locations— White Plains, New York and Stamford, Connecticut

Fire Control Systems
Radar Systems
Communications Equipment
Infrared Equipment
Data Processing Equipment
Television Systems

Inertial Guidance Systems
Navigational Systems
& Components
Microwave Equipment
Aircraft Instrumentation
Anti-Submarine Warfare

Send resume to:
Technical Employment Manager



NORDEN LABORATORIES

NORDEN DIVISION OF UNITED AIRCRAFT CORPORATION
121 Westmoreland Avenue—White Plains, New York

ELECTRONIC PRODUCTION ENGINEERS

Experienced in production
trouble-shooting and de-
sign of test equipment.
Emphasis in audio field

BELL & HOWELL
7100 McCormick
Chicago 45



**MANUFACTURERS'
REPRESENTATIVES**
IN THE ELECTRONIC INDUSTRY

SAMUEL K. MACDONALD, INC.
manufacturers representatives over 25 years
1531 SPRUCE STREET, PHILA. 2, PA.
Territory: Pennsylvania • New Jersey
Delaware • Maryland
Virginia • West Virginia
District of Columbia
Other Offices:
Pittsburgh
Baltimore
Washington, D.C.

PROFESSIONAL SERVICES

**ERCO RADIO
LABORATORIES, INC.**
Radio Communications Equipment
Engineering - Design - Development - Production
Our 30th Year in Air to Ground
Communication and Radio Beacons
Garden City • Long Island • New York

TELECHROME MFG. CORP.
Electronic Design Specialists
COLOR TELEVISION EQUIPMENT
Flying Spot Scanners, Color Synthesizers, Keyers,
Monitors, Oscilloscopes and Related Apparatus
Telemetering for Guided Missiles.
J. R. Popkin-Chirman, Pres. & Dir. of Eng.
28 Ranick Dr. Amityville, L. I., N. Y.

Consult
these SPECIALISTS

Let them save your time by bringing their
broad experience in their specialty to
bear on your problems.

RADIO RESEARCH INSTRUMENT CO.

550 FIFTH AVE. NEW YORK JUDSON 6-4691

1 MEGAWATT PULSER

MIT Radiation Lab Model 9 pulser. Desc. in "Rad. Lab. Series" Vol. 5, pps. 152-160. Supplies 1 megawatt output using 6'21 tubes. Complete modulator 115v 60 cycle unit enclosed in single cabinet. Also 22000v power supply for magnetron in second cabinet. As new condition. In stock for immediate delivery.

AN/APS-10 3 CM. X BAND RADAR

Complete RF head including transmitter, receiver, modulator. Uses 2442 magnetron. Fully described in MIT Rad. Lab. Series Vol. 1, pps. 616-625 and Vol. 11, pps. 171-185. \$375.00. Complete X band radar system also avail. Incl. 360-deg. antenna, PPI, syn. pwr supply. Similar to \$17,000 weather radar now in use by airlines. \$750 complete.

10 CM. WEATHER RADAR SYSTEM

US Navy Raytheon 275 KW peak output S band. Rotating yoke Plan position Indicator. Magnetron supplied for any S band frequency specified. Incl. Weather Band, 4, 20 and 80 mile range, 360 degree azimuth scan. Sensitive rot using 2K28/707B and 1N21B. Supplied brand new complete with instruction books and installation drawings. Can be supplied to operate from 32VDC or 115 volts. Price \$850. Ideal for weather work. Has picked up clouds at 50 miles. Weight 488 lbs.

ANTENNA PEDESTAL SCR 584—MP 61B

Full azimuth and elevation sweeps, 360 degrees in azimuth, 210 degrees in elevation. Accurate to 1 mil. over system. Complete for full tracking. Complete description in McGraw Hill Radiation Laboratory Series, Volume 1, page 284 and page 209, and Volume 26, page 233.

AUTOMATIC TRACKING RADAR

SCR 584 is in like new condition, ready to go, and in stock for immediately delivery. Ideal for research and development, airway control, GCA, missile tracking, balloon tracking, weather forecasting, anti-aircraft defense, tactical air support. Write us. Fully Desc. MIT Rad. Lab. Series, Vol. 1, pps. 207-210, 238, 284-286.

CIRCLE 460 ON READER SERVICE CARD

The Battery That's Used in Guided Missiles Now Released as Government Surplus For Photography, Aircraft, Models, Searchlights, Radios, etc. \$1.95 ea. Postpaid



Sintered-plate Nickel-Cadmium alkaline storage batteries designed for "NIKE" missile and now surplus due to design change. A lifetime battery with no known limit of service (over 5000 recharges on test without loss of capacity). Other features: Virtually indestructible, compact & lightweight, withstands heavy shock and vibration. Flat voltage curve during discharge retaining charge year or more, high discharge rate up to 50 amps. for this cell, no corrosive fumes to harm clothing or equipment, spill-proof construction, discharge in any position. Infinite storage without deterioration, operates in temperatures -60° F to +200° F. Each cell is approx. 6 ampere hour capacity.

Nominal voltage per cell is 1.2 volts. (A 6 V. battery requires 5 cells.) Cell size 6" H. x 2" W. x 1/2" T. Wt. 6 oz. ea. Uses Potassium-Hydroxide (30%) electrolyte. Negligible loss during lifetime service. Add only distilled water once a year.

Used Test Cells..... \$1.95 ea. Postpaid
Brand New Cells..... 2.95 ea. "
24 V Battery (20 cells) in metal case—used \$40.00 new \$60.00

Plastic battery cases may have slight cracks-repaired easily or add 25¢ to price to insure uncracked case. All cells guaranteed. No money refunded (less postage).

ESSE RADIO CO., Dept N2, 42 W. South St., Indianapolis 25, Ind.

CIRCLE 461 ON READER SERVICE CARD

CAPACITORS

OIL—Fm 50 V. to 100 KV
MICA—All Types
GLASSEAL—Complete Selection

CAPACITOR SPECIAL
1mf—7.5 KV @ \$7.95

ALSO

"J" & "JJ" type potentiometers @ \$.75
POWER RESISTORS & RHEOSTATS
QUOTATIONS RENDERED

MONMOUTH RADIO LABS
BOX 159 — OAKHURST, N. J.
CAPITOL 2-0121 ART HANKINS, Owner

CIRCLE 462 ON READER SERVICE CARD

ELECTRONICS • JANUARY 8, 1960

SEARCHLIGHT SECTION

(Classified Advertising)

BUSINESS OPPORTUNITIES

EQUIPMENT - USED or RESALE

DISPLAYED

RATES

UNDISPLAYED

The advertising is \$24.75 per inch for all advertising other than on a contract basis. AN ADVERTISING INCH is measured 7/8" vert. on a column, 3 cols.—30 inches—to a page. EQUIPMENT WANTED or FOR SALE ADVERTISEMENTS acceptable only in Displayed Style.

\$2.40 a line, minimum 3 lines. To figure advance payment count 5 average words as a line. BOX NUMBERS count as one line additional. DISCOUNT of 10% if full payment is made in advance for four consecutive insertions.

Send NEW ADVERTISEMENTS or Inquiries to Classified Adv. Div. of Electronics, P. O. Box 12, N. Y. 36, N. Y.

The publisher cannot accept advertising in the Searchlight Section, which lists the names of the manufacturers of resistors, capacitors, rheostats, and potentiometers or other names designed to describe such products.

SPECIAL PURPOSE TUBES

OA2..... .70	5RP1A..... 10.00	348A..... 2.75	1603..... 3.75	5915..... .75
OA3..... .85	5RP11A..... 10.00	349A..... 2.50	1614..... 2.25	5930/2A3W... 3.75
OB2..... .50	5SP1..... 25.00	350A..... 3.50	1619..... .15	5922/6L6WGA 2.50
OB3..... .80	5SP7..... 25.00	350B..... 3.50	1620..... 3.35	5933/807W... 1.00
OC3..... .35	5Y3WGT..... 1.15	352A..... 6.50	1624..... 1.00	5948/175A... 75.00
OD3..... .30	6AC7W..... .50	354A..... 10.00	1846..... 60.00	5956..... 12.50
1AD4..... 1.50	6AG7Y..... .90	355A..... 6.50	2050..... 1.10	5963..... .75
1B24..... 3.75	6AN5..... 2.00	F-375A..... 6.00	5528..... 2.00	5964..... .90
1B35A..... 4.75	6AR6..... 1.00	393A..... 4.00	5545..... 15.00	5965..... 1.00
1B63A..... 10.00	6AS6..... .85	394A..... 2.50	5550..... 30.00	5967..... 7.50
CIK/B..... 12.50	6AS7G..... 2.50	396A/2C51... 2.00	5636..... 1.50	5969..... 7.50
1P21..... 30.00	6C4W..... 2.50	398A/5603... 4.50	5639..... 2.50	5975..... 2.00
1P25..... 7.50	6C21..... 10.00	401A/5590... 2.00	5642..... 1.25	5977/6K4A... 1.50
1P28..... 13.50	6CJ..... 9.00	403A/6AK5... 1.00	5643..... 2.50	5981/5650... 20.00
2AP1A..... 2.50	6J4..... 1.00	403B/5591... 2.50	5644..... 2.50	5987..... 6.50
2BP1..... 4.50	6J6W..... .60	404A/5847... 10.00	5646..... 2.00	5992..... 3.00
2C36..... 25.00	6L6WGA..... 2.50	408A/6028... 2.50	5647..... 2.00	5993..... 4.00
2C39A..... 7.50	6L6WGB..... 2.00	409A/6A56... 2.00	5651..... .75	6004..... .60
2C39B..... 16.50	6S17WGT... 1.25	416A..... 50.00	5654/6AK5W... 1.25	6005/6AQ5W... 1.35
2C40..... 7.50	6S17WGT... 1.25	417A/5842... 10.00	5656..... 4.00	6021..... 2.00
2C43..... 7.50	6SN7WGT... .75	418A..... 15.00	5670..... 1.25	6032..... 10.00
2C50..... 4.25	6V6GT..... .60	420A/5755... 7.50	5672..... 1.25	6037/QK-243 20.00
2C51..... 2.00	6X4W..... .75	421A/5998... 6.00	5675..... 7.50	6045..... 1.35
2C52..... 1.75	6X5WGT... 1.35	422A..... 8.50	5676..... .65	6062..... 1.35
2D21..... .50	7MP7..... 17.50	429A..... 8.50	5678..... 1.10	6072..... 2.25
2D21W..... .85	12DP7..... 7.50	GL-434A..... 5.00	5684/C3J/A... 10.00	6073..... .85
2E22..... 3.00	FG-17..... 3.85	450TH..... 35.00	5686..... 2.00	6080..... 3.25
2E24..... 2.25	HK-24..... 1.25	450TL..... 45.00	5687..... 1.50	6080WA..... 4.50
2E26..... 3.35	26Z5W..... 1.50	575A..... 15.00	5691..... 5.25	6087/5Y3WGT 3.00
2J51..... 75.00	35T..... 4.75	578..... 5.00	5692..... 4.25	6097..... 1.25
2K25..... 8.00	35TG..... 1.75	631-P1..... 4.00	5693..... 3.75	6098/6AR6WA 4.00
2K26..... 30.00	FG-57..... 5.00	673..... 15.00	5703..... 1.00	6099..... .80
2K29..... 25.00	FG-67..... 5.00	676..... 27.50	5704..... 1.00	6100/6C4WA... 1.35
2K30..... 50.00	BL-75..... 5.00	677..... 27.50	5718..... 1.00	6101/6J6WA... 1.15
2K33A..... 150.00	FG-95..... 13.00	715C..... 7.50	5719..... 1.00	6106..... 1.00
2K34..... 85.00	100TH..... 9.00	719A..... 6.50	5721..... 125.00	6111..... 2.75
2K35..... 150.00	FG-105... 25.00	721B..... 4.00	5725/6A56W... 1.25	6112..... 2.75
2K41..... 50.00	FG-172... 17.50	723A/B..... 3.00	5726/6AL5W... .85	6115/QK-351 45.00
2K42..... 125.00	HF-200... 15.00	725A..... 3.50	5727/2D21W... 1.25	6130/3C45... 5.00
2K44..... 100.00	212E..... 25.00	726B..... 3.50	5740/FP-54... 50.00	6134/6AC7WA 3.25
2K45..... 30.00	212D..... 1.50	726C..... 7.00	5744..... .75	6135..... 1.50
2K47..... 85.00	244A..... 5.00	750TL..... 50.00	5749/6BA6W... .75	6136/6AU6WA... 1.50
2K50..... 50.00	245A..... 3.50	803..... 1.50	5750/6B66W... 1.50	6137/65K7WA... 1.50
2X2A..... .85	249B..... 5.00	804..... 15.00	5751/12AX7W 1.75	6146..... 3.90
3AP1..... 1.00	249C..... 5.00	805..... 3.00	5763..... 1.35	6151..... 3.50
3B24W..... 3.00	250R..... 7.50	807..... 1.20	5777..... 150.00	6152..... 4.50
3B25..... 3.50	252A..... 6.00	807W..... .85	5783..... 2.25	6177..... 50.00
3B28..... 3.75	254A..... 2.00	809..... 3.75	5784..... 3.00	6186/6AG5WA 2.00
3C22..... 35.00	257A..... 3.50	810..... 12.50	5787..... 3.00	6189/12AU7WA 2.00
3C23..... 5.75	259A..... 2.75	811..... 3.50	5794..... 3.75	6197..... 1.75
3C24..... 2.00	262B..... 3.00	813..... 9.50	5800..... 4.00	6199..... 30.00
3C45..... 4.00	264C..... 3.50	814..... 1.00	5801..... 3.00	6201/12AT7WA 2.25
3D22..... 12.50	267B..... 5.00	815..... 1.50	5803..... 2.00	6202/6X4WA... 1.75
3E29..... 5.00	271A..... 10.00	816..... 1.75	5814A..... 1.50	6211..... .65
3J21..... 25.00	272A..... 3.00	827..... 8.50	5824..... 1.85	6236..... 150.00
3J31..... 35.00	274A..... 3.50	829B..... 7.50	5828..... 3.00	6247..... 6.00
3K21..... 125.00	275A..... 4.00	832..... 3.00	5829..... .60	6263..... 12.50
3K22..... 125.00	283A..... 3.00	832A..... 6.50	5839WA..... 1.20	6264..... 10.00
3K27..... 150.00	287A..... 2.00	833A..... 40.00	5837..... 67.50	6265..... 2.50
3K30..... 75.00	QK-288... 150.00	836..... 1.25	5839..... 3.00	6282/BL-11... 65.00
3KP1..... 10.00	293A..... 4.50	837..... 1.00	5840..... 2.00	6336..... 10.00
4-125A..... 25.00	HF-300... 25.00	845..... 7.50	5841..... 2.25	6350..... 1.35
4-400A..... 40.00	300B..... 6.50	866A..... 1.75	5844..... .75	6352..... 6.00
4B31..... 17.50	304TH..... 25.00	866 JR..... 1.50	5851..... 3.25	6386..... 5.00
4C35..... 17.50	304TL..... 35.00	872A..... 1.75	5852..... 2.85	6390..... 125.00
4E27..... 9.50	310A..... 4.75	884..... 1.00	5854..... .85	6438..... 4.75
4J52..... 25.00	311A..... 3.00	885..... .85	5876..... 6.00	6463..... 1.25
4X150A..... 12.50	313C..... 1.50	889RA..... 75.00	5879..... 1.00	6482..... 9.50
4X250B..... 32.50	323A..... 6.50	913..... 7.50	5881/6L6WGB 2.00	6517..... 200.00
5BP1A..... 9.75	328A..... 3.00	918..... .75	5886..... 3.85	6626/OA2WA 2.50
5C22..... 15.00	329A..... 5.00	927..... .85	5894..... 17.50	6627/OB2WA... 2.50
5CP1A..... 9.75	336A..... 3.00	931A..... 3.50	5896..... 1.85	6754..... 15.00
5LP1..... 6.75	337A..... 2.50	959..... .65	5899A..... 2.75	6897..... 16.50
5R4GY..... 1.00	339A..... 5.00	1000T..... 100.00	5902..... 2.50	8013A..... 3.00
5R4WGY... 2.00	347A..... 2.50	1500T..... 120.00	5903..... 6.00	8020..... 1.25

ALL TUBES ARE NEW, INDIVIDUALLY CARTONED, FULLY GUARANTEED

western engineers

ELK GROVE, CALIFORNIA

SUPPLIERS OF TUBES SINCE 1932

Orders for less than \$10 cannot be processed

Prices are FOB shipping point

CIRCLE 463 ON READER SERVICE CARD

RELIABLE TUBES

0A2WA..... 1.75	2K39..... 125.00	6AJ5..... 2.50	SRX92..... 250.00	BL800..... 135.00	5783WA..... 5.00	6247..... 4.25
0A5..... 5.00	2K41..... 90.00	6AN5..... 2.25	VA201..... 150.00	BL803..... 135.00	5787WA..... 5.00	6247WA..... 8.50
0B2WA..... 1.75	2K42..... 100.00	6AN5WA..... 6.00	VT227A..... 6.00	832A..... 5.00	5817..... 100.00	6316..... 110.00
CIK/B..... 6.00	2K43..... 100.00	6BL6..... 40.00	QK259..... 70.00	K1303..... 5.00	5836..... 65.00	6326..... 250.00
1B38..... 15.00	2K44..... 100.00	6BM6..... 55.00	QK288..... 250.00	K1309..... 500.00	5837..... 65.00	6339..... 22.00
1B44..... 12.00	2K45..... 35.00	6BM6A..... 70.00	QK289..... 225.00	1698..... 850.00	5841..... 3.00	6344..... 800.00
1B45..... 20.00	2K48..... 52.50	6D21..... 200.00	QK290..... 225.00	5527..... 75.00	5876..... 8.00	6356..... 20.00
1B56..... 20.00	2K50..... 110.00	6L6GAY..... 1.50	QK291..... 225.00	5556..... 12.00	5886..... 3.75	6378..... 22.50
1B59..... 12.50	3B22..... 5.00	7C23..... 100.00	K302..... 90.00	5593..... 175.00	5893..... 12.50	6390..... 145.00
1Q22..... 25.00	3C22..... 25.00	8DS15..... 6.00	QK381..... 110.00	5607..... 1000.00	5932..... 4.00	6414..... 5.00
1Q23..... 30.00	3C45..... 6.50	X-13..... 125.00	QK386..... 100.00	5646..... 2.75	5939A..... 30.00	6551..... 550.00
1Q26A..... 85.00	3E29..... 7.50	SMX32..... 2100.00	QK404..... 70.00	5654..... 1.50	5981/5650..... 75.00	6573..... 425.00
2A1A..... 5.50	3KP1..... 10.00	SAL39..... 2000.00	416B..... 40.00	5675..... 6.00	6021..... 3.00	6587..... 20.00
2AC15..... 3.00	4B31..... 25.00	V51XR..... 75.00	QK436A..... 110.00	5697..... 3.50	6043..... 55.00	6695..... 600.00
2BP1..... 5.00	4C35..... 12.50	FP54..... 125.00	XU523F..... 295.00	5702WA..... 3.50	6111A..... 4.00	6754..... 20.00
2B23..... 28.00	4D32..... 25.00	SRU55A..... 200.00	KU618..... 10.00	5703WA..... 3.50	6115..... 69.50	6832..... 15.00
2J51..... 75.00	4J63..... 200.00	V58..... 395.00	KU628..... 20.00	5704..... 2.00	6116..... 115.00	6835/QK464..... 600.00
2K22..... 20.00	4X150A..... 15.00	SAS60B..... 1100.00	WL672..... 22.50	5721..... 130.00	6152..... 5.50	6845..... 165.00
2K25..... 15.00	5C22..... 16.75	V63..... 675.00	721B..... 6.00	5727..... 1.25	6229..... 300.00	6888..... 4.00
2K28..... 35.00	5J26..... 260.00	V82..... 4500.00	726A..... 15.00	5777..... 165.00	6230..... 400.00	6896..... 900.00
2K33A..... 175.00	C6J..... 12.00	VA87C..... 7500.00	726B..... 15.00	5778..... 165.00	6236..... 145.00	6940..... 110.00

ALL mdse. guaranteed. 24-hour telephones take your orders any time for prompt servicing. Material subject to prior sale.

PAGE ELECTRONICS

136 Liberty Street

CORtlandt 7-4245

New York 6, N. Y.

CIRCLE 464 ON READER SERVICE CARD

FOR SALE... available in QUANTITIES

KLYSTRONS		PARTIAL LISTING			
2K25..... 9.50	2K48..... 45.00	QK288..... 250.00	726C..... 17.50	QK291..... 350.00	5650..... 50.00
2K26..... 29.50	2K50..... 130.00	707A..... 2.50	6115..... 75.00	707B..... 3.50	6116..... 100.00
2K28..... 27.50	2K54..... 9.50	723A..... 5.95	6210..... 125.00	723A/B..... 7.50	6236..... 175.00
2K29..... 29.50	2K56..... 50.00	726A..... 4.50	6390..... 175.00	726B..... 12.50	D178161..... 50.00
2K33A..... 120.00	3K21..... 150.00				
2K41..... 75.00	3K30..... 150.00				
2K44..... 135.00	QK185..... 35.00				



MAGNETRONS Practically all types of Magnetrons

- from 2J21 thru 2J63
- from 3J21 thru 3J31
- from 4J21 thru 4J78
- from 5J26 thru 5J32
- also QK types

All at exceptionally low prices. Every Magnetron tested before shipment on special high power pulsed in our laboratory. Save thousands of dollars. Inquire.

Thousands of other tubes—Magnetrons, Power Tubes, Infra-Red, UHF, Semi-conductors, Microwave Test Equipment. We buy and sell surplus inventories.

New York's
Radio Tube
and Test
Equipment
Headquarters



LIBERTY ELECTRONICS, INC.

Our New Address and Phone Number . . . Please Change Your Records

582 Broadway, New York, N. Y. WA 5-6000

If you do not see the type you want, please inquire.

CIRCLE 465 ON READER SERVICE CARD

IF YOU PURCHASE TUBES OR COMPONENTS . . . YOU MUST HAVE A COPY OF THE NEW 1960 *"GREENSHEET"

* A complete catalog of specialized industrial electronic tubes and components . . . featuring BARRY ELECTRONICS savings to industry. Write today . . . to Dept. 18E . . . for your copy.

We carry the largest, diversified stock of unused tubes . . . in the country!

Authorized Factory Distributors For:

- WESTINGHOUSE • CBS • NATIONAL ELECTRONICS • EIMAC and SONOTONE •
- TUBES and SEMI-CONDUCTORS—

(We . . . are a Member of NEDA)

— HIGH QUALITY AT SENSIBLE PRICES —

WALKER 5-7000
TWX: NY1-3731

BARRY ELECTRONICS

CORPORATION

512 BROADWAY, NEW YORK 12, N. Y.

CIRCLE 466 ON READER SERVICE CARD

WANTED ALLEN-BRADLEY RESISTORS & POTENTIOMETERS LEGRI S COMPANY

391 Riverdale Ave. Yonkers 5, N. Y.

CIRCLE 467 ON READER SERVICE CARD

For Additional Information About Classified Advertising

Contact the McGraw-Hill Office Nearest You.

ATLANTA, 3 1301 Rhodes-Haverty Bldg. M. MILLER	Jackson 3-6951
BOSTON, 16 350 Park Square M. J. HOSMER	H Hubbard 2-7160
CHICAGO, 11 520 No. Michigan Ave. W. HIGGINS—E. S. MOORE	MOhawk 4-5800
CLEVELAND, 13 1161 Illuminating Bldg. W. B. SULLIVAN—T. H. HUNTER	Superior 1-7000
DALLAS, 2 1712 Commerce St., Vaughn Bldg. Riverside GORDON JONES—F. E. HOLLAND	7-5117
DETROIT, 26 856 Penobscot Bldg. J. R. PIERCE	W Woodward 2-1793
LOS ANGELES, 17 1125 W. 6th St. C. YOCOM	H Huntley 2-5450
NEW YORK, 36 500 Fifth Ave. H. T. BUCHANAN—R. P. LAWLESS T. W. BENDER	OXford 5-5959
PHILADELPHIA, 3 Six Penn Center Plaza H. W. BOZARTH	LOcust 8-4330
ST. LOUIS, 8 3615 Olive St. JEfferson 5-4867	
SAN FRANCISCO, 4 68 Post St. S. HUBBARD	DOuglas 2-4600

SEARCHLIGHT Equipment Locating Service

NO COST OR OBLIGATION

This service is aimed at helping you, the reader of "SEARCHLIGHT", to locate Surplus new and used electronic equipment and components *not currently advertised*. (This service is for USER-BUYERS only).

How to use: Check the dealer ads to see if what you want is not currently advertised. If not, send us the specifications of the equipment wanted on the coupon below, or on your own company letterhead to:

Searchlight Equipment Locating Service
c/o ELECTRONICS

P. O. Box 12, N. Y. 36, N. Y.

Your requirements will be brought promptly to the attention of the equipment dealers advertising in this section. You will receive replies directly from them.

Searchlight Equipment Locating Service
c/o ELECTRONICS

P. O. Box 12, N. Y. 36, N. Y.

Please help us locate the following equipment components.

NAME

TITLE

COMPANY

STREET

CITY 1/8/60

Announcing the

BE6

BAND ELIMINATION FILTER

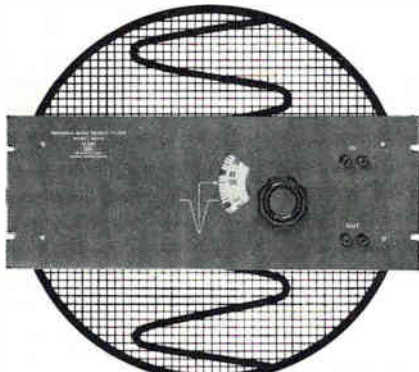

BE6 - \$385.00
Rack Mount Model Illus.

A New Allison Filter With Single Knob Control

The Allison Model BE6 Band Elimination Filter is a passive network filter with a direct reading dial, continuously tunable over full audio frequency range from 20 cps to 20,000 cps. It will transmit all frequencies from DC to more than 100 kcps, except for the reject band to which the filter is tuned.

SPECIFICATIONS

- More than 40 db attenuation at one frequency.
- Passive network—no power supply.
- No vacuum tubes.
- Impedance (in and out), 600 ohms.
- Reject band less than 1 octave wide.
- Loss in pass bands, 1/2 db.
- Single dial control.
- Direct reading frequency dial.
- Maximum input for minimum distortion, 5 V.
- Size of portable units, excluding knobs and handle, 17" long, 5 3/4" deep, 8" high.
- Rack models are mounted on 7" rack panel.

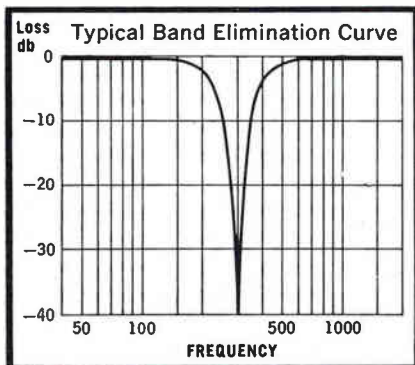

Write today for complete literature and prices

**Allison
Laboratories, Inc.**

11301-C OCEAN AVENUE
LE HABRA, CALIFORNIA

Virginia Electric & Power Co. 32

- Walsco Electronics Mfg. Co. 94
- Westinghouse Electric Corp. 69
- White Co., S. S. 89
- Worklon, Inc. 107

PROFESSIONAL SERVICES 104

CLASSIFIED ADVERTISING
F. J. Eberle, Business Mgr.

EMPLOYMENT OPPORTUNITIES 99-104

EQUIPMENT
(Used or Surplus New)
For Sale 105, 106

WANTED
Equipment 106

ADVERTISERS INDEX

- Aeronutronic, Division of Ford Motor Co. 103
- Associated Personnel 100
- Barry Electronics Corp. 106
- Bell & Howell Co. 104
- Esse Radio Co. 105
- General Electric Co. 99-103
- Honeywell 100
- Legri S Co. 106
- Lewis Placements 100
- Liberty Electronics Inc. 106
- Magnavox Co. 101
- Monmouth Radio Laboratories. 105
- Motorola Inc. 100
- Norden Laboratories, Norden Div.,
United Aircraft Corp. 104
- Page Electronics 106
- Radio Research Instrument Co. 105
- Republic Aviation 102
- Western Engineers 105

• See advertisement in the June, 1959 Mid-Month ELECTRONICS BUYERS' GUIDE for complete line of products or services.

This Index and our Reader Service Numbers are published as a service. Every precaution is taken to make them accurate, but ELECTRONICS assumes no responsibilities for errors or omissions.

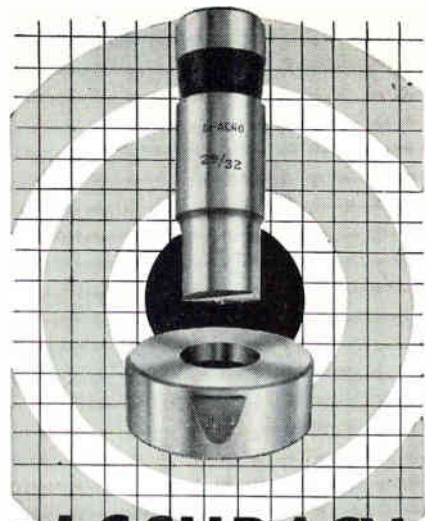

ACCURACY ASSURED

WITH DI-ACRO PRECISION PUNCHES AND DIES

Immediate Delivery from factory stock

Accurate hole location is easily achieved with Di-Acro Precision Punch and Die sets because the centering point on the punch is ground concentric to the cutting edges, there is no "slop" even when several holes are punched in a blank. Hole sizes are accurate due both to the high degree of concentricity of the punch and die set and the choice of clearance which allows you to obtain clean, burr free holes no matter what material thickness is to be perforated. All Di-Acro punches and dies are precision made of high quality tool steel.

Over 500 standard sizes of Di-Acro Precision Punches and Dies in 12 standard styles are stocked. Punch Adapters and Die Holders are available to fit all styles of punch presses.

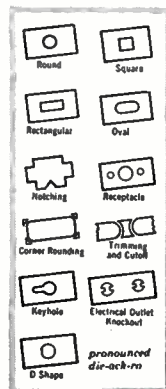

Consult the Yellow Pages of your phonebook under Machinery—Machine Tools for the name of your Di-Acro distributor or write us for catalog and price list.



**O'NEIL-IRWIN
MFG. CO.**

321 Eighth Avenue
Lake City, Minnesota

CIRCLE 214 ON READER SERVICE CARD
JANUARY 8, 1960 • ELECTRONICS

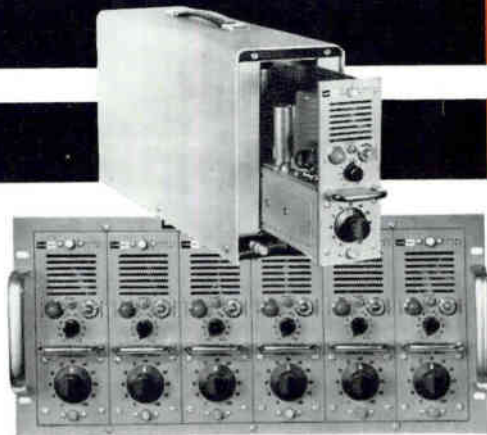

111BF DC amplifiers in Model 195
single-amplifier cabinet and
Model 190 six-amplifier 19" rack module.

KIN TEL 111BF DC wideband amplifiers allow extremely accurate measurement of dynamic physical phenomena such as strain, temperature, vibration, pressure, flow, torque, and displacement. They greatly simplify the design of data measurement systems, offering more bandwidth and accuracy, reduced maintenance, and none of the capacitive balance problems inherent in AC carrier equipment. KIN TEL's proved chopper amplifier circuitry with multiple feedback loops assures operational stability and uniform frequency response regardless of load or gain changes. The capability of providing full bandwidth and full output into large capacitive loads, at high gain settings, places virtually no restrictions on the type of output device that can be driven and allows the use of longer output cable runs.

The 111BFO, an operational version of the 111BF, has an open-loop position instead of a zero-gain position. In this position the user may employ external networks to provide up to 100% resistive or capacitive feedback around the amplifier, allowing its use as an integrator, active filter, or to generate complex linear transfer functions.

Many thousands of KIN TEL DC amplifiers, with millions of cumulative hours of operation, are in day-to-day use. Virtually all major missile programs—including ICBM—employ KIN TEL DC amplifiers in ground support instrumentation.

HERE'S WHY THE KIN TEL 111BF DC AMPLIFIER IS THE BASIC COMPONENT FOR ACCURATE, DRIFT-FREE AMPLIFICATION OF MICROVOLT-LEVEL SIGNALS:

- Less than $2\mu\text{v}$ drift for 100's of hours
- DC – 40kc bandwidth
- 0.1% gain stability
- $\pm 45\text{v}$, $\pm 40\text{ma}$ output
- $100\text{k}\Omega$ input, $< 1\Omega$ output impedance
- 20 to 2000 gain
- Full output into $1\mu\text{f}$ loads
- Integral power supply

Prices:

111BF DC Amplifier	\$625
111BFO DC Amplifier	\$635
195 Single-amplifier Cabinet	\$125
190 Six-amplifier 19" Rack Module.	\$295

Immediate delivery from stock on reasonable quantities.

(Note: Amplifiers must be operated
in 190 Module or 195 Cabinet.)

*KIN TEL manufactures electronic instruments
for measurement and control, and closed circuit TV.
Representatives in all major cities.
Write for detailed literature or demonstration.*

5725 Kearny Villa Road, San Diego 11, California. Phone : BRowning 7-6700



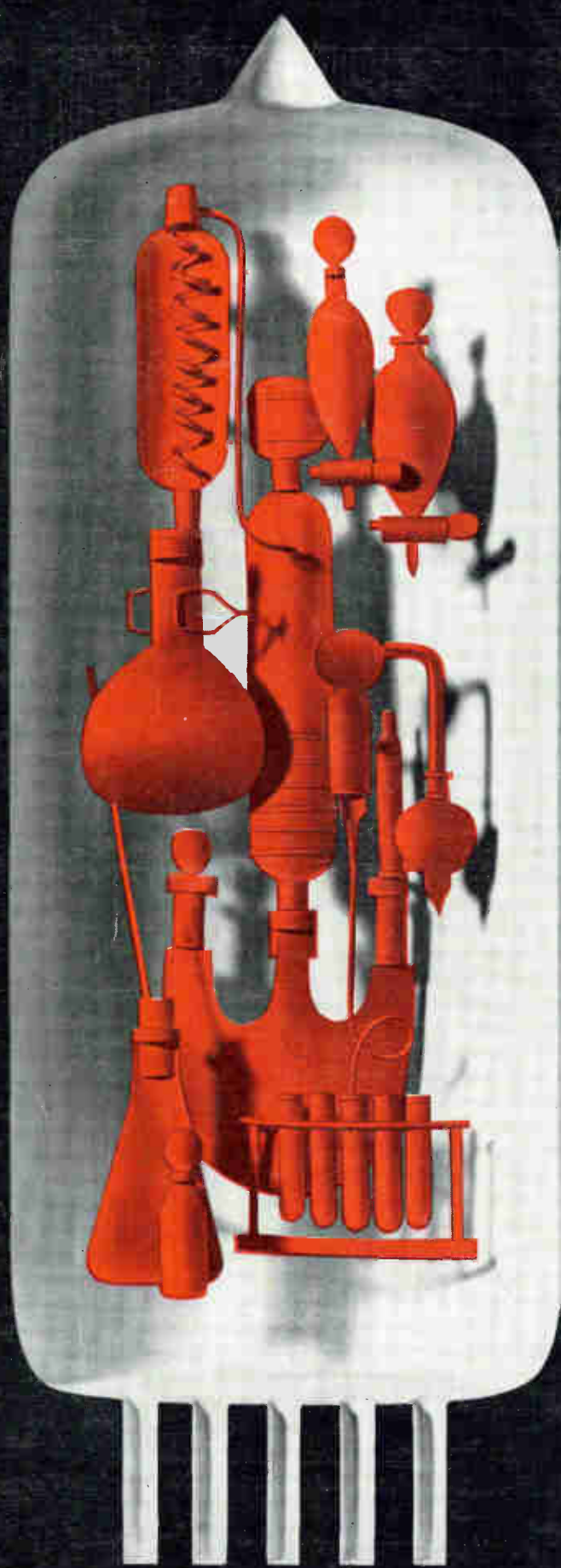

RCA

ELECTRON TUBE...

A CHEMICAL SYSTEM!

In electron tube manufacture, precise control of the chemistry of the tube's heart—the cathode—can greatly increase the life of the tube and enhance its performance.

This fundamental consideration has led RCA tube research scientists to develop a unique process for cathode-base material manufacture—and ultimately, to produce **the remarkable N-132 cathode-base material.**

N-132 is a "true balance" of essential chemical elements—nickel, carbon, magnesium, manganese and silicon. High-vacuum melting of the purest metal eliminates oxidation and reduces to lowest levels contaminants such as copper and sulphur. Precise control of process timing—to the second—yields exceptional uniformity from one melt to another, making it possible to hold cathode characteristics within strict limits. In addition, the process eliminates the use of solid deoxidizing agents usually employed in producing air-melted nickel. This feature eliminates unwanted residues and enhances purity of the alloy.

RCA tubes utilizing N-132 cathode material can add a greater element of reliability to your circuits. Get the complete story from your RCA Field Office.



RADIO CORPORATION OF AMERICA
ELECTRON TUBE DIVISION **HARRISON, N. J.**

EAST: 744 Broad Street, Newark 2, New Jersey,
HUmaldt 5-3900

MIDWEST: Suite 1154, Merchandise Mart Plaza,
Chicago 54, Ill., WHitehall 4-2900

WEST: 6355 East Washington Boulevard, Los
Angeles 22, Calif., RAYmond 3-8361