

October 14, 1960

# electronics

*Engineer precools apparatus with liquid nitrogen during study  
of superconducting circuits and devices for computers. See p 84*  
*Highway communications system uses inductive pickup. See p 81*

A McGraw-Hill Publication 75 Cents

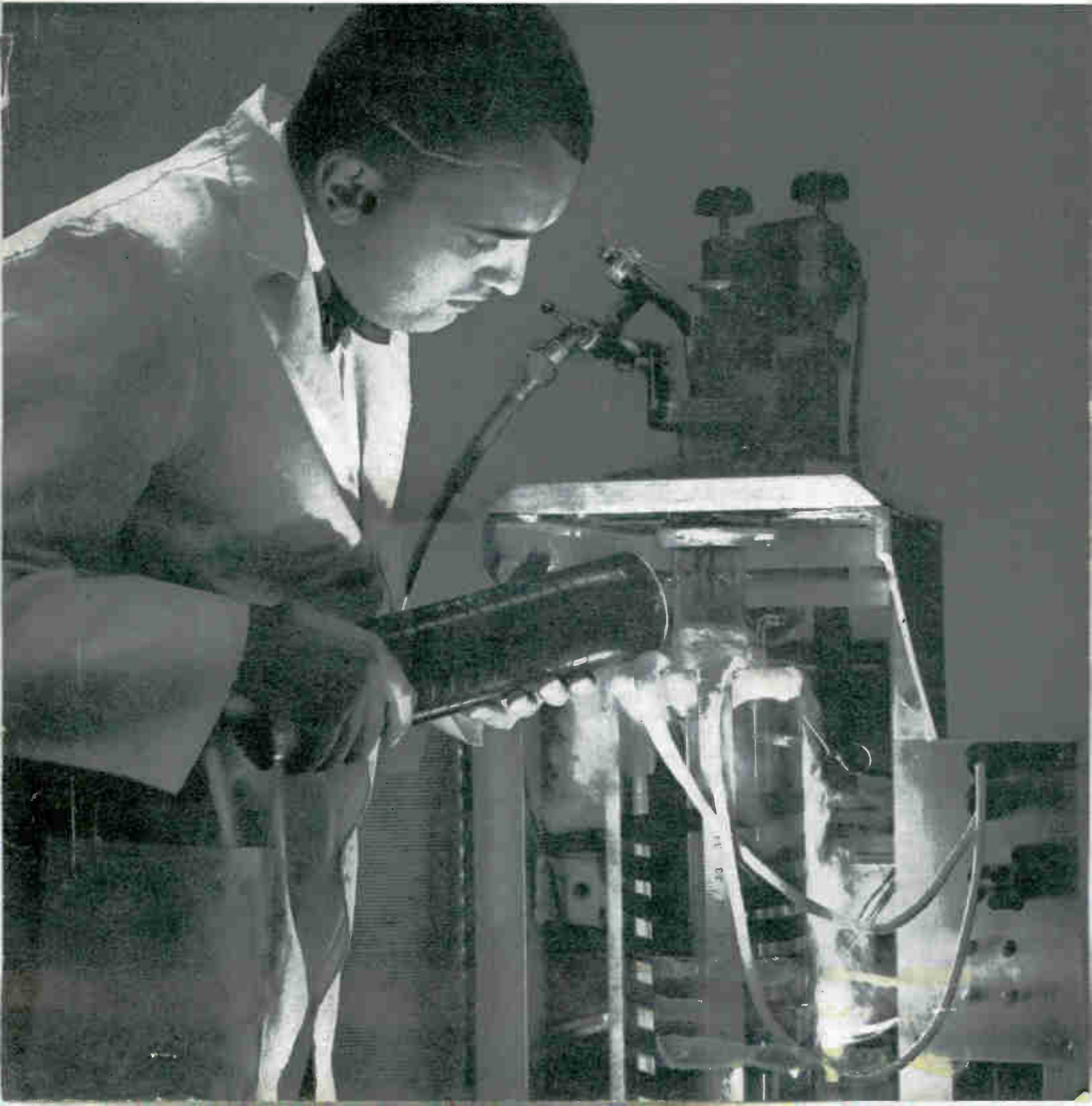

# Measure dc currents 0.3 ma to 1 ampere

*with*

No Breaking of Leads  
No DC Connection  
No Circuit Loading

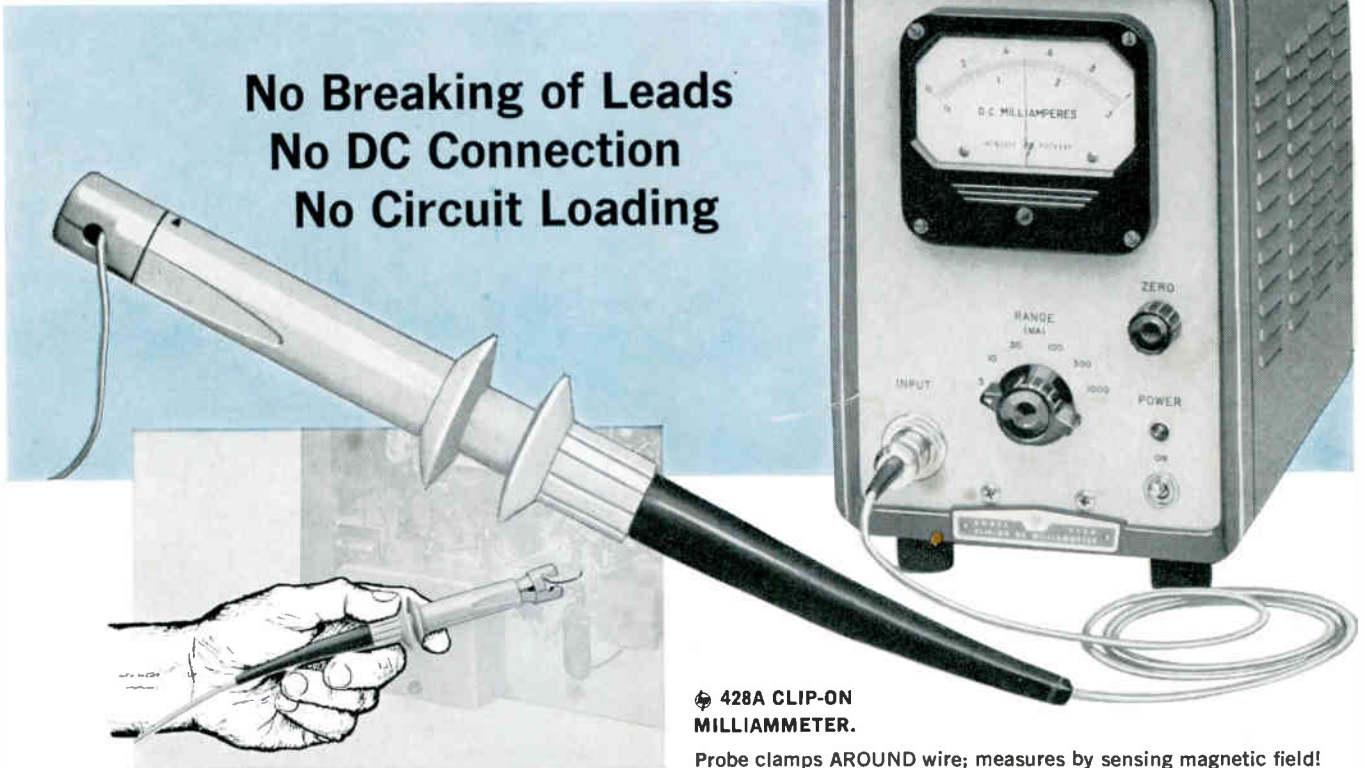

428A CLIP-ON  
MILLIAMMETER.

Probe clamps AROUND wire; measures by sensing magnetic field!

Think of the measuring convenience, time saved and accuracy gained when you don't have to break into a circuit, solder on a connection, or worry about probe loading.

With the 428A Milliammeter and its new probe, you literally "clamp around" and read! You get maximum accuracy because there is no effective circuit loading from the 428A's dc probe. The instrument easily measures dc currents in the presence of ac. And insulation is more than adequate to insure safe measurements at all normal voltage levels.

For extremely low current level measurement, sensitivity can be increased by looping the conductor through the "jaws" of the 428A probe two or more times.

Brief specifications are given here; for complete details and demonstration *on your bench*, call your representative or write direct.

## Specifications

**Current Range:** Less than 0.3 ma to 1 amp, 6 ranges. Full scale readings from 3 ma to 1 amp: 3 ma, 10 ma, 30 ma, 100 ma, 300 ma, 1 amp.

**Accuracy:**  $\pm 3\% \pm 0.1$  ma.

**Probe Inductance:** Less than 0.5  $\mu$ h maximum.

**Probe Induced Voltage:** Less than 15 mv peak.

**Effects of ac in circuit:** Ac with peak value less than full scale affects accuracy less than 2% at frequencies different from the carrier (40 KC) and its harmonics.

**Power:** 115/230 v  $\pm 10\%$ , 50-60 cps, 70 watts.

**Size:** Cabinet mount, 7½" wide, 11½" high, 14¼" deep. Weight 19 pounds. Rack mount, 19" wide, 7" high, 12½" deep. Weight 24 pounds.

**Probe Tip Size:** Approximately 5/8" x 7/16". Wire aperture diameter 3/16".

**Price:** (Cabinet) \$475.00; (Rack) \$480.00.

Data subject to change without notice.

Prices f.o.b. factory.

## HEWLETT-PACKARD COMPANY

1005A PAGE MILL ROAD • PALO ALTO, CALIFORNIA, U.S.A.  
HEWLETT-PACKARD S.A., RUE VIEUX BILLARD NO. 1,  
GENEVA, SWITZERLAND

CABLE "HEWPAKSA" • TEL. NO. (022) 26. 43. 36

CABLE "HEWPACK" • DAVENPORT 6-7000

Field representatives in all principal areas

Test the new  405A DC Digital Voltmeter

# electronics

A McGraw-Hill Publication 75 Cents



W. W. MacDONALD, Editor

J. M. CARROLL, Managing Editor  
 SENIOR ASSOCIATE EDITORS: Samuel Weber, Roland J. Charest. ASSOCIATE EDITORS: Frank Leary, Michael F. Tomaino, Sylvester P. Carter, William P. O'Brien, John F. Mason, William E. Bushor, Thomas Emma, Sy Vogel, Leslie Solomon, M. M. Perugini, George J. Flynn. ASSISTANT EDITORS: Michael F. Wolff, Nilo Lindgren, Stanley Froud, Stephen B. Gray. REGIONAL EDITORS: Harold C. Hood (Pacific Coast, Los Angeles), Thomas Maguire (New England, Boston). MARKET RESEARCH EDITOR: Edward DeJongh. BUYERS' GUIDE EDITOR: George Sideris. ART DIRECTOR: Harry Phillips; Howard R. Berry. PRODUCTION EDITOR: John C. Wright, Jr. EDITORIAL ASSISTANTS: Gloria J. Filippone, Arlene Rudd, Bernice Duffy, Patricia Martine, Lorraine Rossi, Virginia T. Bastian, Ruth Ayres.

JAMES GIRDWOOD, Publisher

## BUSINESS

Bearingless Gyroscope Makes Debut at NEC. Report from Chicago	38
Air Agency Displays Electronics Progress. Investigating infrared	40
NEREM Lists Over 300 Papers. New England set for meeting	43
Air Force Plans Materials Study. New radiation laboratory	44
Reps Join in Traveling Show. Marketing technique catches on	46
New Contracts Push Missiles, Space. R&D subcontractors needed	49
Hi-Fi Ions Impress Chicago Crowds. Cavity replaces diaphragm	53
Crosstalk	4
Comment	6
Electronics Newsletter	11
Electronics Abroad	13
Washington Outlook	14
Financial Roundup	20
25 Most Active Stocks	20
Marketing	24
Current Figures	25
Meetings Ahead	54

## ENGINEERING

Liquid nitrogen is used to precool low-temperature apparatus used with superconducting computer elements. See p 84	COVER
Communication System for Highway Traffic Control. Contact with auto radios by vlf induction. By E. A. Hanysz, J. E. Stevens and A. Meduvsky	81
Superconducting Devices and Circuits. Use of thin film cryotrons described. By D. R. Young	84
Determining Closure Time In Missile Control Valves. Solenoid current shaped to trigger timing circuit. By R. L. Kissner	88
Digital Instrumentation of Antenna Measurements. Decreases antenna-field measuring time. By E. K. Damon	90
Designing Back-Biased Diode Pulse Gates. Design factors for a-c and d-c gates. By I. F. Barditch	94
How to Design Broadband Microwave Cavities. Design equations for two types of rhumbatrons. By A. Kiriloff	96
Low-Cost Transistor Overload Safety Circuit. Can use rejected diodes and transistors. By K. Redmond	102

## DEPARTMENTS

Research and Development. Program-Controlled Tractors	104
Components and Materials. Switch Works Like Combination Lock	108
Production Techniques. Built-in Coil Magnetizes Large Speakers	112
New On the Market	116
Literature of the Week	168
People and Plants	170
Index to Advertisers	180

## X-BAND ISOLATORS FOR BROADBAND APPLICATIONS



### HIGH-POWER X-BAND ISOLATOR IXH7 AVAILABLE FROM STOCK

PRICE: \$175.00

#### TYPICAL SPECIFICATIONS X-BAND ISOLATOR MODEL IXH7

Frequency range (mc) .....	8,200-12,400
<b>Isolation</b>	
Minimum .....	23 db
Maximum .....	30 db
<b>Insertion loss</b>	
Minimum .....	0.5 db
Maximum .....	0.8 db
<b>Power</b>	
Peak .....	25 kw
Average .....	150 watts
<b>VSWR</b>	
Minimum .....	1.04
Maximum .....	1.17
Weight (max.) .....	2.5 lbs.
Max. dimension .....	3.75 in.
Flanges .....	UG 39/U
Waveguide .....	RG 52/U

### COMPACT, HIGH-POWER ISOLATOR PROVIDES 20 DB OF ISOLATION OVER ENTIRE BAND FROM 8,200 TO 12,400 MC

The operating characteristics of the Model IXH7 isolator are maintained at peak power levels up to 25 kw over a 4.2 kmc bandwidth. Isolation is 20 db, minimum and insertion loss is 0.8 db, maximum.

High-power broadband capabilities coupled with unusually compact design make this isolator ideally suited for microwave test equipment applications and microwave system needs to appreciably reduce load mismatch.

To learn more about this significant development or other important Raytheon advances in microwave ferrite devices, please write, stating your particular area of interest, to the address below.



THE MOST MODERN FACILITY devoted exclusively to microwave ferrite device and materials development, testing and production.

**RAYTHEON COMPANY**  
SPECIAL MICROWAVE DEVICE OPERATIONS  
WALTHAM INDUSTRIAL PARK  
WALTHAM 54, MASSACHUSETTS

*In Canada, contact Raytheon Canada, Ltd.  
P. O. Box 152, Waterloo, Ontario*



EXCELLENCE IN ELECTRONICS



Here's why:

**Reduce parts inventory.** By using identical parts throughout the series (where feasible), and by designing the tools with built-in interchangeability features, Cleco has made it possible for you to *simplify and reduce parts inventory.*

**Cost less to operate.** No. 10 Series motors are more powerful, yet actually require less air per h.p. output. Well-balanced, and easy-to-handle, these tools are constructed of heavy duty material (high quality Ni, Cr, Mo alloy steel pinion and planet gears, for example) that can really take the demolishing punishment of high production operations. Friction-free clutch permits longer, *much longer* periods of maintenance-free operation.

**Speed production, while improving quality con-**

**trol.** No. 10 Series Drills and Screwdriver—Nut-Runners have design features that reduce time lost and rejects. *No. 10 Drills:* are equipped with 3-idler planetary gear trains for all gear reductions; have a low noise level; and develop  $\frac{1}{3}$  h.p. Drill speeds range from 500 to 20,000 r.p.m. *No. 10 Screwdriver*—Nut-Runners are available in speeds from 500 to 5,000 r.p.m. Equipped with a no-drift locking device, No. 10 Screwdrivers have unequalled torque holding ability. They cannot over-torque, strip threads, crack plastic, or damage screw heads.

You will not believe that these tools could possibly have so many positive advantages until you see them for yourself, so contact your local Cleco® representative for a no-obligation demonstration. For specifications and literature, write:



A DIVISION OF REED ROLLER BIT COMPANY  
P. O. BOX 2119 • HOUSTON 1, TEXAS, U.S.A.

IN CANADA: Cleco Pneumatic Tool Company of Canada, Ltd., 927 Millwood Road, Leaside (Toronto), Ontario

# CROSSTALK

## electronics

Oct. 14, 1960 Volume 33 Number 42

Published weekly, with Electronics Buyers' Guide and Reference annually, by McGraw-Hill Publishing Company, Inc. Founder: James H. McGraw (1860-1948).

Title registered U.S. Patent Office; Copyrighted 1960, McGraw-Hill Publishing Company, Inc. All rights reserved, including the right to reproduce the contents of this publication, in whole or in part.

Executive, editorial, circulation and advertising offices McGraw-Hill Building, 330 West 42nd Street, New York 36, N. Y. Telephone Longacre 4-3000. Teletype TWX N.Y. 1-1636. Cable McGrawhill, N.Y. Printed in Albany, N. Y.; second class postage paid.

Subscription price U.S. and possessions \$6 per year; single copies 75¢, Buyers' Guide \$3. Other countries, and longer periods, on request. Subscriptions solicited only from those actively engaged in the field of the publication and in a manner served by its contents; position and company should be indicated.

Subscribers: Please address all correspondence, change of address notices, subscription orders or complaints to Fulfillment Manager, Electronics, at above address. Change of address notices should provide old as well as new address, including postal zone number if any. If possible, attach address label from recent issue. Allow one month for change to become effective.

Postmaster: Please send Form 3579.

FEDERAL AVIATION AGENCY is proposing a new administrative regulation that would govern the maximum height of all structures "affecting the safety of aircraft in flight." The new set of rules, lumped together as Part 626 of the *Regulations of the Administrator*, defines what are and are not hazards to air navigation (item: any structure 500 ft high; any structure 170 ft high within 5 miles of a visual-flight-rule flyway). It also sets up notification procedures and the quasi-legal forms for hearings and appeals.

To work around the needs of broadcasters, FAA proposes to set up a number of antenna farm areas. Locations, sizes and permissible antenna heights of the farms are not spelled out in the draft regulations, so we can't say whether they'll be adequate or not. We assume from the wording that permissible antenna heights inside the farms will be higher than outside. The adequacy of these antenna farms is vital. Outside the farms, any tall structures will apparently be severely restricted, especially near flyways—and flyways are being established over more and more of the U. S. every year. So the farms must be big enough, and the top limits within them high enough, to allow for the growing needs of the electronics industry.

FAA will hear comments on the proposed new rule (Airspace Docket 60-WA-159) until Oct. 31. The agency wants comments submitted in triplicate to the Docket Section, FAA, Room B-316, 1711 New York Ave. N. W., Washington. If you have any stake in the free use of the air just above the ground, better stick your oar in soon.



HIGHWAY COMMUNICATION. Portable highway communication system shown in the accompanying photograph could be carried by police officers, set up within a few minutes and used to broadcast messages to motorists, such as warning of road blockage because of accident or storm.

System consists of an induction radio link operating in the vlf band and is currently undergoing evaluation. For an explanation of how it functions, turn to the article (p 81) by E. A. Hanyasz, J. E. Stevens and A. Meduvsky of General Motors Research Laboratories.

## Coming In Our October 21 Issue

MINIATURIZED AUTOPILOT. Missile space and weight problems can be alleviated by miniaturizing the autopilot system used to maintain the missile flight path. In our next issue, J. H. Porter of RCA's West Coast Missile and Surface Radar division describes an autopilot system whose micromodular construction permits mounting in the airframe bulkhead. A mockup of the autopilot without gyros occupies 0.035 cu ft and weighs slightly over 3 lb.

# Surest Way To Count Anything

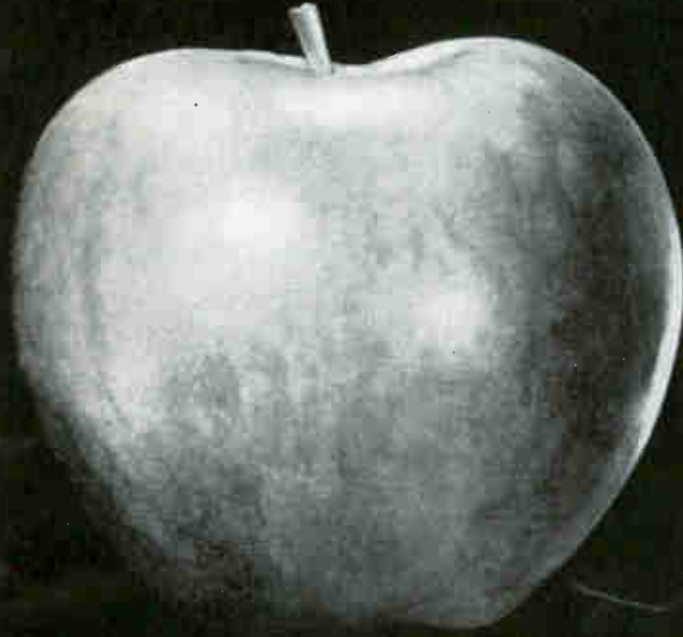

## From Apples To Oranges



Raytheon's versatile decade counter tubes provide long reliable service in equipment and systems designed for counting, sampling, or coding anything from apples to oranges.

The Raytheon CK6909, CK6910, CK-6802, and CK6476 are cold cathode bi-directional ring stepping types providing visual neon glow and electrical readout. They feature negligible power dissipation, short resolution time, no moving parts, extremely long life, and the use of simple, low cost circuitry.

Complete Raytheon engineering facilities are available to aid you in the application of these tubes to any operation you may be planning—timing, frequency dividing, matrixing, telemetering, controlling, counting, sampling, or coding. For additional information and technical data on these or any of Raytheon's expanding line of industrial and military gas-filled tubes, please write to: Raytheon Industrial Components Division, 55 Chapel St., Newton 58, Massachusetts.

*For Small Order or Prototype Requirements See your Local Franchised Raytheon Distributor*

### CHARACTERISTICS AND TYPICAL OPERATION

TYPES	CK6909 CK6910*	CK6476* CK6802
DC Supply	450 volts	425 volts
Anode Resistor	0.27 meg ohms	0.82 meg ohms
Nominal Tube Drop	235 volts	195 volts
Cathode Resistor	24 K ohms	100 K ohms
Output (Across Cathode Resistor)	15 volts	30 volts
Speed	to 100 kc	to 4 kc

\*All ten cathodes brought out independently for electrical readout.

RAYTHEON COMPANY

INDUSTRIAL COMPONENTS DIVISION



# IN LESS THAN 4 SECONDS

FROM THIS

TO THIS

OR THIS

WITH THE REVOLUTIONARY  
PRODUCTION AID TOOL!

## "PIG-TAILOR"®



Foot operated  
No accessories  
3 minute set up

**\$125.00**

## 'PIG-TAILORING'

a revolutionary new mechanical process for higher production at lower costs. Fastest PREPARATION and ASSEMBLY of Resistors, Capacitors, Diodes and all other axial lead components for TERMINAL BOARDS, PRINTED CIRCUITS and MINIATURIZED ASSEMBLIES.

**PIG-TAILORING eliminates:** • Diagonal cutters • Long nose pliers • Operator judgment • 90% operator training time • Broken components • Broken leads • Short circuits from clippings • 65% chassis handling • Excessive lead tautness • Haphazard assembly methods.

**PIG-TAILORING provides:** • Uniform component position • Uniform marking exposure • Miniaturization spacing control • "S" leads for terminals • "U" leads for printed circuits • Individual cut and bend lengths • Better time/rate analysis • Closer cost control • Invaluable labor saving • Immediate cost recovery.

**Pays for itself in 2 weeks**

## "SPIN-PIN"®

Close-up views of "SPIN-PIN" illustrate fast assembly of tinned-lead wire to terminal.

- No Training
- No Pliers
- No Clippings
- Uniform Crimps
- 22 Sizes

**PAYS FOR ITSELF  
THE FIRST DAY!**

**\$500**  
EACH

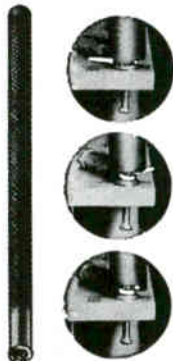

Write for illustrated book to Dept. E-11



**BRUNO-NEW YORK INDUSTRIES CORP.**  
DESIGNERS & MANUFACTURERS OF ELECTRONIC EQUIPMENT  
460 WEST 34th STREET • NEW YORK 1, N. Y.

## COMMENT

### Shifty Constellations

There are published rumors ("Successful Moon Bounce . . ." p 31, Aug. 19) that the Bell System seriously proposes some 50 Echo-like satellites circling the earth.

I hear Echo I is getting wrinkles—and a good thing, too. Can you imagine 50 satellites, about 25 above the horizon, all with the brilliance of a first-magnitude star?

Get out of my sky!

H. A. COOK

AIRPAX ELECTRONICS  
FT. LAUDERDALE, FLA.

About fifty would be necessary for reasonably efficient worldwide communications. Probably no more than ten or fifteen would ever be visible at a time. Anyway, think of the poetic fancies which such a system would make possible: instead of the unchanging stars and the fickle moon or the restless sea, we could now have a whole new poetic vocabulary based on the shifting constellations.

### Pattern Recognition

Many attempts to make pattern-recognizing devices have indeed been made, as indicated by Leon D. Harmon in his article ("Line-Drawing Pattern Recognizer," p 39, Sept. 2).

The scanning pattern which would appear to be ideal for gestalt recognition is the logarithmic spiral, or circle with an exponentially expanding radius. As I pointed out in an article entitled "Scanning and Form" (*Astounding Science Fiction*, 1954), this pattern gives a linear (rather than two-dimensional) output which is practically independent of orientation and size, recognizing any form that is centered and in the field. If a tv camera is used for scanning, this pattern (the logarithmic spiral) is no more difficult to generate than any other.

While the pattern suggested by Harmon is responsive to differences in size, the ideal gestalt system would be oblivious to size variations. The functions of size detec-

tion and centering can be conveniently handled by independent circuits.

As a nonspecialist reader, I find this kind of article very interesting and like to find them in ELECTRONICS.

RICHARD C. PINKERTON  
BATON ROUGE, LA.

### Radio Beacons

(Ref. "Radio Beacon Helps Locate Aircraft Crashes," by D. M. Makow, p 54, Jan. 22) . . .

For a matter of months I have been communicating with a Mr. Maurice Clemson of Westchester, Penna., who has developed an impact switch that can be used with a crash-locator beacon. I have arranged appointments for him with Federal Aviation Agency officials in Washington, and am assisting him in the collection of available documentation on the subject of crash-locator beacons. He evidenced a great interest in the above-referenced article after discussions with FAA officials who recommended that he should obtain a copy . . .

ALLEN BARNABEI  
NATIONAL BUREAU OF STANDARDS  
WASHINGTON, D. C.

Reader Barnabei asked us to send him a copy of the January 22 issue for nonreader Clemson, which we were of course delighted to do. Always glad to help an inventor.

### Klystron

One of our engineers pointed out some errors found in the Newsletter for July 29 on p 11 ("Japanese Push Over-Horizon Systems"—the item discussed the development by Nippon Electric of a high-power klystron, among other things).

Price should read \$17,000, not \$170,000; the type should be LD-427, not LD-247; efficiency is 33 percent, not 38 percent, and the gain is 35 db instead of 85 db . . .

YASMASA TOGO  
NIPPON ELECTRIC COMPANY  
KAWASAKI CITY, JAPAN



# NEW Electronic Chemicals Brochure for manufacturers of



semi-conductors  
electronic tubes  
thermistors  
ferrites

## J. T. BAKER ELECTRONIC CHEMICALS

Acetic Acid, Glacial	Cobalt Carbonate	Nickelous Nitrate
Acetone	Cobalt Oxide	Nickelous Sulfate
Aluminum Nitrate	Cobalt Nitrate	Nitric Acid
Aluminum Sulfate	Ether, Anhydrous	Petroleum Ether
Ammonium Carbonate	Hydrochloric Acid	Potassium Dichromate
Ammonium Chloride	Hydrofluoric Acid	Potassium Hydroxide
Ammonium Hydroxide	Hydrogen Peroxide,	iso-Propyl Alcohol
Ammonium Phosphate	30% and 3% Solution	Radio Mixture No. 3
Antimony Trioxide	Lithium Carbonate	Silicic Acid
Barium Acetate	Lithium Chloride	Sodium Carbonate
Barium Carbonate	Lithium Nitrate	Sodium Chloride
Barium Fluoride	Lithium Sulfate	Sodium Hydroxide
Barium Nitrate	Magnesium Carbonate	Sodium Phosphate Dibasic
Benzene	Magnesium Chloride	Strontium Carbonate
Boric Acid	Magnesium Oxide	Strontium Nitrate
Cadmium Chloride	Manganese Dioxide	Sulfuric Acid
Cadmium Nitrate	Manganese Nitrate	Toluene
Cadmium Sulfate	Manganese Sesquioxide	Trichloroethylene
Calcium Carbonate	Manganous Carbonate	Triple Carbonate
Calcium Chloride	Methanol	Xylene
Calcium Fluoride	Nickel Carbonate	Zinc Chloride
Calcium Nitrate	Nickel Oxide, Black	Zinc Nitrate
Calcium Phosphate	Nickel Oxide, Green	Zinc Oxide
Carbon Tetrachloride	Nickelous Chloride	

This new brochure . . . just off the press . . . tells you how Baker Electronic Chemicals can help you achieve operating economies.

The Electronic Chemicals listed on the left bring you these benefits:

1. Highest purity defined to meet your critical electronic manufacturing needs.
2. Purity is proved — the 'Baker Analyzed' Reagent label shows the actual lot analysis.
3. Prices are economical for electronic processing use.
4. Deliveries are fast in each marketing area.

Write for your copy of "Electronic Chemicals of Defined Purity." Address J. T. Baker Chemical Co., Phillipsburg, New Jersey, Department E.

**ELECTRONIC CHEMICALS**  
OF  
**DEFINED PURITY**  
*'Baker Analyzed' Regents*



**J. T. Baker Chemical Co.**  
Phillipsburg, New Jersey

# ***No, it's not a transistor...***



***... it's the new Spectrol ultraminiature trimmer ... the smallest trimming potentiometer on the market! Measuring 1/3" in diameter, weighing only 1 gram, and designed specifically for transistor circuits, the Spectrol Model 80 is a remarkable breakthrough in component technology.***

***Design engineers can now shrink printed circuit packages in all three dimensions. The single turn adjustment is from the top, rather than the side. It is ideal for printed circuit applications. Sealed construction allows complete package encapsulation.***

THE MODEL 80 is approximately one-quarter the size of ordinary trimmers, yet it offers greater resolution and resettability because the resistance element is nearly twice as long. These trimmers meet all applicable military and commercial specifications including the most severe humidity cycling and immersion tests.

**AND TWO NEW MINIATURE POTENTIOMETERS, TOO!**

Sturdy construction provides reliable operation at a modest price. Only one-half inch in diameter, the new bantam weight Models 140 and 150 rotary potentiometers are well suited to trimming, control and servo applications where space and environmental conditions are critical. Standard linearity is  $\pm 1.0\%$  with  $\pm 0.5\%$  available on special order. Servo mount ball bearing type units have standard linearity of  $\pm 0.5\%$ . Slotted shafts are standard on all models.



**SPECIFICATIONS**

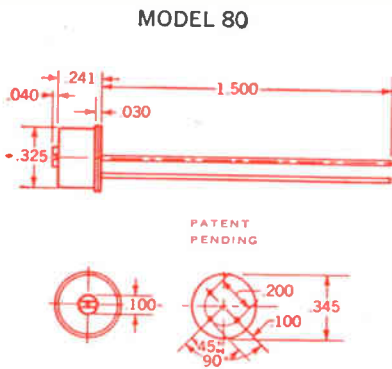

DIAMETER: 0.345"  
 STANDARD RESISTANCES (ohms): 50, 100, 200, 500, 1K, 2K, 5K, 10K  
 RESISTANCE TOLERANCE:  $\pm 5\%$   
 NO. TURNS: ONE  
 POWER RATING: 1 watt at 70°C  
 LINEARITY:  $\pm 1.0\%$   
 NOISE: 100 $\Omega$ ENR per NAS-710  
 SHOCK: 50 G  
 VIBRATION: 30 G to 2,000 CPS  
 HUMIDITY: MIL-E-5272C, Proced. I (10 days, cycling) and MIL-STD-202A, Method 104, Condition A (immersion in hot water)  
 SALT SPRAY: MIL-STD-202A, Method 101A, Condition A (96 hours)  
 LOAD LIFE: 1000 hours  
 WEIGHT: 1 Gram  
 PRICE (1-9 units): \$6.00 each

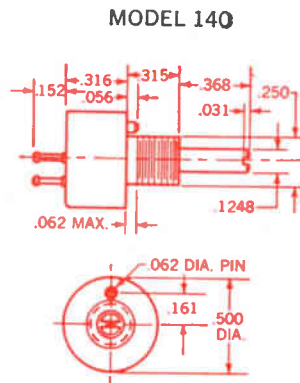

DIAMETER: 0.500"  
 STANDARD RESISTANCES (ohms): 50, 100, 200, 500, 1K, 2K, 5K, 10K  
 RESISTANCE TOLERANCE:  $\pm 5\%$   
 NO. TURNS: ONE  
 POWER RATING: 2 watts at 70°C  
 LINEARITY:  $\pm 1.0\%$  standard,  $\pm 0.5\%$  special ( $\pm 0.5\%$  standard on servo mount)  
 NOISE: 100 $\Omega$ ENR per NAS-710  
 SHOCK: 50 G  
 VIBRATION: 30 G to 2,000 CPS  
 HUMIDITY: MIL-E-5272C, Proced. I (10 days, cycling)  
 SALT SPRAY: MIL-STD-202A, Method 101A, Condition A (96 hours)  
 LOAD LIFE: 1000 hours  
 WEIGHT: 0.1 oz.  
 PRICE (1-9 units): \$10.00 each

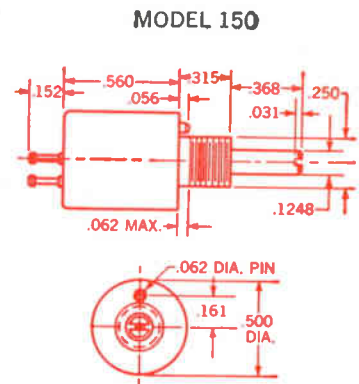

DIAMETER: 0.500"  
 STANDARD RESISTANCES (ohms): 20K, 50K, 70K (50 ohms to 20K also available)  
 RESISTANCE TOLERANCE:  $\pm 5\%$   
 NO. TURNS: ONE  
 POWER RATING: 2 watts at 70°C  
 LINEARITY:  $\pm 1.0\%$  standard,  $\pm 0.5\%$  special ( $\pm 0.5\%$  standard on servo mount)  
 NOISE: 100 $\Omega$ ENR per NAS-710  
 SHOCK: 50 G  
 VIBRATION: 30 G to 2,000 CPS  
 HUMIDITY: MIL-E-5272C, Proced. I (10 days, cycling)  
 SALT SPRAY: MIL-STD-202A, Method 101A, Condition A (96 hours)  
 LOAD LIFE: 1000 hours  
 WEIGHT: 0.15 oz.  
 PRICE (1-9 units): \$12.00 each

The Spectrol name, your assurance of quality. New Spectrol trimmers and miniature potentiometers are produced to the same exacting standards of quality and reliability engineered into the entire Spectrol potentiometer line...the largest selection in the industry.

Available now for immediate delivery. Standard models of Spectrol trimmers and miniature potentiometers, as well as other standard precision potentiometers, are available from your nearby Spectrol distributor. For complete technical information, contact your Spectrol engineering representative or write directly to the factory. Please address Dept. 42.



26

**ELECTRONICS CORPORATION**

1704 South Del Mar Avenue • San Gabriel, California  
 Phone: ATLantic 7-9761

Manufacturers of precision and miniature wirewound potentiometers, trimmers, solid state power supplies, servo mechanisms and other precision electronic components.



Model 187B-SL

# COMPLETE LINE



Model 187B-S

# OF VERSATILE, EFFICIENT



Model 187B-C

# WAVEGUIDE WATER LOADS



Model 187B-XB

# for SL, S, C, XB and X Frequency Bands

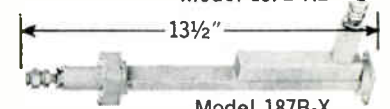

Model 187B-X

- Five models covering five bands
- Three models useful in pressurized systems
- VSWR less than 1.10
- Can handle 2-20 kw average power
- Low rf radiation
- Calibration heaters in all models

These Sierra high-power waveguide terminations are extremely useful as dummy loads in calorimetric power-measuring systems. They feature rugged construction, with rigid plastic water tube mounted in waveguide section, diagonally oriented for impedance matching. Chokes and shielding minimize rf leakage, and a heater element built into each model permits rapid, accurate calibration of a calorimetric power-measurement system against a low-frequency standard.

## CHECK ALL THESE SPECIFIED ADVANTAGES!

Model Number:	187B-SL	187B-S	187B-C	187B-XB	187B-X
Frequency Range:	1.7 to 2.6 kmc	2.6 to 4.0 kmc	5.8 to 8.2 kmc	7.0 to 10.0 kmc	8.2 to 12.4 kmc
VSWR:	< 1.10 to 2.4 kmc < 1.15 to 2.6 kmc	less than 1.10	less than 1.10	less than 1.10	less than 1.10
Power Average: (Unpressurized)	20 kw	10 kw	5 kw	3 kw	2 kw
Peak Power:	2 megawatts	1 megawatt	500 kw	250 kw	150 kw
Max. Air Pressure:	*	*	45 psig	45 psig	45 psig
Waveguide:	RG-105/U	RG-75/U	RG-50/U	RG-51/U	RG-52/U
Connector:	UG-437A/U	UG-584/U	UG-344/U	UG-51/U	UG-39/U
Recommended Water Flow:	2 gpm for 10 kw	2 gpm for 10 kw	1 gpm for 5 kw	0.6 gpm for 3 kw	0.4 gpm for 2 kw
Pressure Drop at Rated Flow:	10 psi	10 psi	10 psi	10 psi	10 psi
Max. Water Pressure:	80 psig	80 psig	80 psig	80 psig	80 psig
Water Temperature:	0 to 70° C	0 to 70° C	0 to 70° C	0 to 70° C	0 to 70° C
Water Capacity:	18.5 cu. in.	3.5 cu. in.	0.85 cu. in.	0.42 cu. in.	0.20 cu. in.
Water Renewal at Rated Flow:	Once per 2.5 sec.	2 times per sec.	4.3 times per sec.	5.3 times per sec.	7.4 times per sec.
Heater Resistance:	4.5 ohms	9 ohms	14 ohms	20 ohms	20 ohms
Heater Rating:	10 kw at 2 gpm	5 kw at 1 gpm	3 kw at 1 gpm	1 kw at 0.6 gpm	1 kw at 0.4 gpm
Length:	50 in.	32 in.	20 in.	17.25 in.	13.5 in.
Price:	\$600.00	\$500.00	\$425.00	\$400.00	\$375.00

\*Not pressurized

Data and prices subject to change without notice. Prices f.o.b. factory

For complete details, see your Sierra Representative or write direct.



**NEW!** Sierra also offers its Model 186 Series Coaxial Water Loads, covering dc to 4 kmc.

## SIERRA ELECTRONIC CORPORATION

A Division of Philco Corporation

6807A BOHANNON DRIVE • Davenport 6-2060 • MENLO PARK, CALIFORNIA, U.S.A.

Sales representatives in all principal areas

Canada: Atlas Instrument Corporation, Ltd., Montreal, Ottawa, Toronto, Vancouver  
Export: Frazar & Hansen, Ltd., San Francisco, Los Angeles

6807

# ELECTRONICS NEWSLETTER

## MIT Programs Computer To Understand English

ARTIFICIAL INTELLIGENCE group at MIT's Lincoln Laboratory is coding up a computer program which the group's programmers hope will answer questions put to it in "raw" English.

The program, being developed by B. F. Green Jr. and Oliver Selfridge, combines techniques used in some automatic-code programs with tricks learned from the language-translation projects. It will use sophisticated storage and retrieval techniques, will have to perform a syntactic analysis of a string of words to find the verbs, nouns and other important parts.

Some compilers and other automatic codes already in existence can recognize a limited vocabulary of a few score or a few hundred words in specified contexts. The MIT program aims at greater flexibility, will require the IMB7090 for which it is being written to remember the meanings of a large basic vocabulary and also to handle the standard syntactic forms of ordinary English.

## Courier, Scout Score On Space Anniversary

SECOND and last try at orbiting a Courier, and the "economy" space probe Scout, both went successfully into space on the third anniversary of Sputnik last week.

Army's Courier IB (see ELECTRONICS, p 44, July 15; p 38, July 22; and p 26, Sept. 2) carried aloft 300 lb of communications equipment to receive, record and rebroadcast messages. It operates normally as a delayed repeater, can be used as a simultaneous repeater if both ground stations can see it. On a single 5-min pass, it can receive or transmit 372,000 words.

The 61-in. satellite was aimed at a 700-mile circular orbit, hit an ellipse 745 miles at apogee, 500 miles at perigee. It carries five magnetic-tape recorders; a vhf transmitter and receiver, each with a standby; two microwave transmitters and two microwave receivers, with a standby for each; storage batteries and decoder equip-

ment. It is covered with 19,152 solar cells which charge the storage batteries.

ITT, AP and UPI will experiment with teletypewriter transmissions; Army will also use Courier for communications.

NASA's Scout, called the economy probe for its inexpensive Minneapolis-Honeywell guidance system, carried 192 lb of instruments designed principally to study the performance of the vehicle, also carried a hitchhiker in the second trial package of USAF's nuclear-emission detection experiment. The experiment is testing the feasibility of spotting radiation emitted by sneak nuclear explosions from high above the atmosphere.

## Japan Moves to Cut Television-set Surplus

JAPAN'S Ministry of International Trade & Industry decided last week to appropriate additional funds to help the Overseas Communications Cooperation Association build 10-Kw tv broadcasting stations on Ceylon and Taiwan. MITI appropriated \$140,000; OCCA member firms will contribute another \$140,000. Tokyo observers figure this is an obvious attempt to help get rid of the monthly tv production of some 300,000 sets which is threatening to flood the domestic Japanese market.

MITI action came faster than usual in an attempt to make an end run around RCA, now reportedly offering easy terms to the Chinese Nationalist government to set up a tv broadcasting company on Taiwan. Outside of Japan and possibly mainland China, only Thailand and the Philippines now operate tv stations in the Orient.

MITI also suspended the transistor-radio export privileges of 1,240 trading firms last week subject to further notice. The firms had no record of exports prior to the quota reshuffle last July, had received temporary approval to export "not more than 400 monthly" for all of them. MITI was sure the overall quota was being exceeded, stopped them all. Between January and June, Japan exported 1,840,179

transistor radios with more than three transistors; the value of these exports peaked over \$25 million. In July, 274,599 sets worth \$3.4 million were exported to the U.S.

In the U.S. last week, Nippon Electric introduced a small channel-filter with a high figure of merit. The 3 $\frac{3}{4}$ -cu-in. filter uses Neferrite, a proprietary NEC ferrite material, is designed for multichannel translation from voice band to subgroups in carrier operations.

## Communications Agency To Open Next Spring

DEFENSE COMMUNICATIONS AGENCY will have its first control center in action by the deadline date of Mar. 7, 1961, DCA chief Rear Admiral William D. Irvin says. Speaking last week at a luncheon meeting of the Washington chapter of the Armed Forces Communications & Electronics Association, Irvin said that Philco has been given a contract to set up an interim control center by that time, added that the 1962 budget will provide for four regional control centers and five secondary regional control centers.

The Admiral said that first priority, after the interim center is operating, will be a national center located on a hard site with adequate strategic communication facilities and survival resources. The agency will not be ready to begin procurement or contracting for two or three years.

## Measures R-F Interference At High Altitudes

PROTOTYPE INSTRUMENT to measure r-f interference at satellite altitudes is being developed by Armour Research Foundation for the Air Force. The instrument will ultimately be used to gather information of use in the design of aerospace communications systems.

Armour researchers indicate that the complete instrument—minus power pack—will occupy about 2 cu ft, weigh less than 100 lb. The package would be lofted in a satellite, measure the electromagnetic environment over "selected ranges of the frequency spectrum," store information in digital form on tape, play it back to an earth station on command.

# World's Most Compact, Lightweight 8½" x 11" XY-T\* RECORDER:

## \$1,375

\*Built-in Time Base

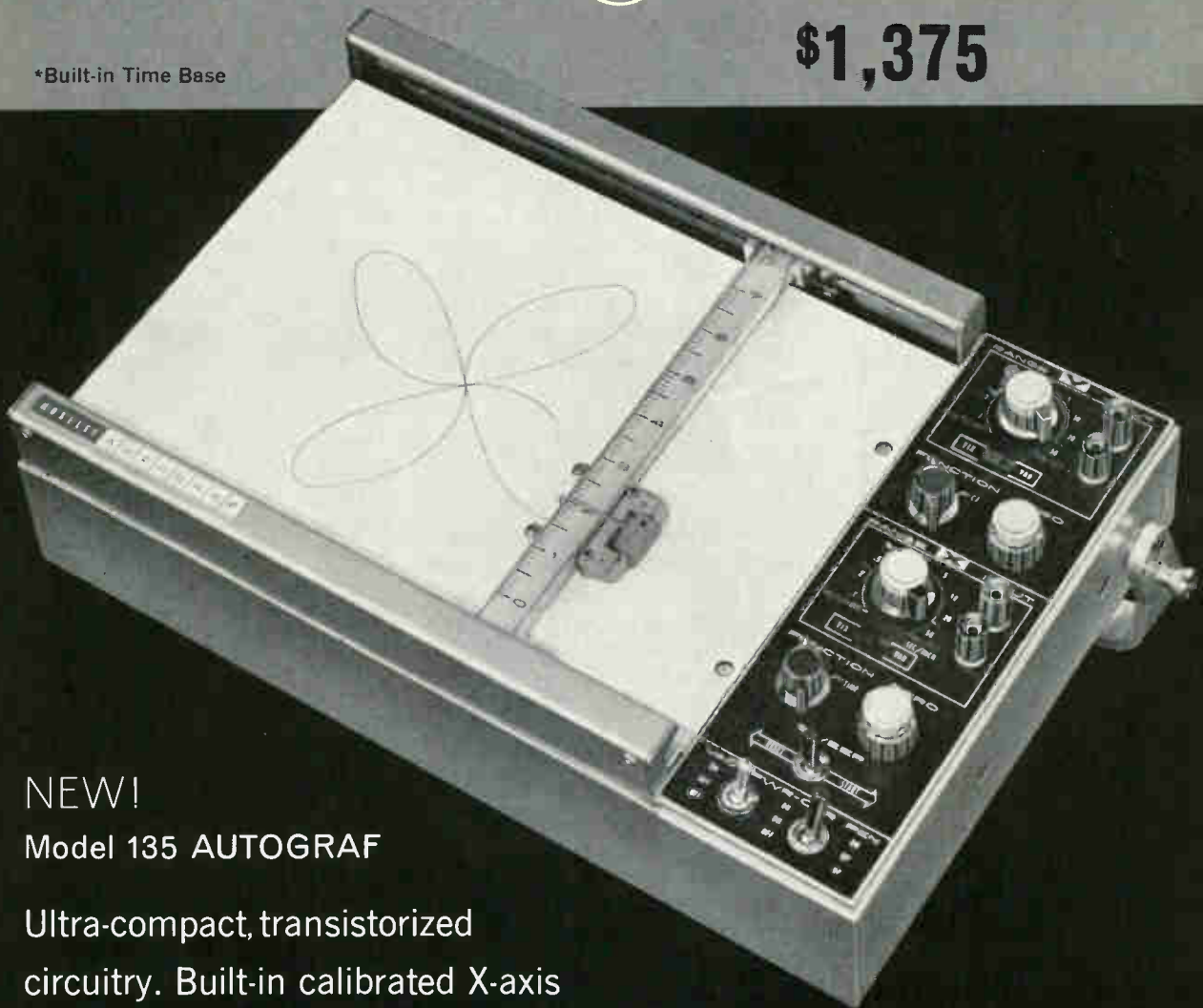

NEW!

Model 135 AUTOGRAF

Ultra-compact, transistorized circuitry. Built-in calibrated X-axis time sweeps, 16 calibrated ranges (each axis) plus stepless range control. Portable, rack or table mount, 10½" x 16⅛" x 4½", weighs only 20 lbs.! Includes all popular AUTOGRAF features for maximum usefulness, versatility.

*Data and price subject to change without notice*

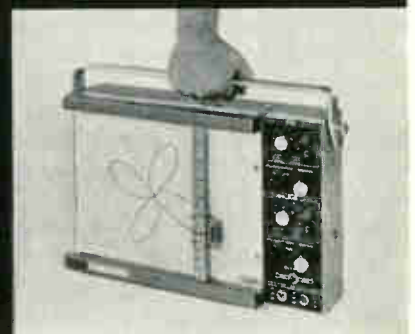

**AUTOGRAF** recorders

**F. L. MOSELEY CO.**

Dept. A10, 409 N. Fair Oaks Avenue, Pasadena, California  
Murray 1-0208 TWX PASA CAL 7687  
Field representatives in all principal areas

6845

# ELECTRONICS ABROAD

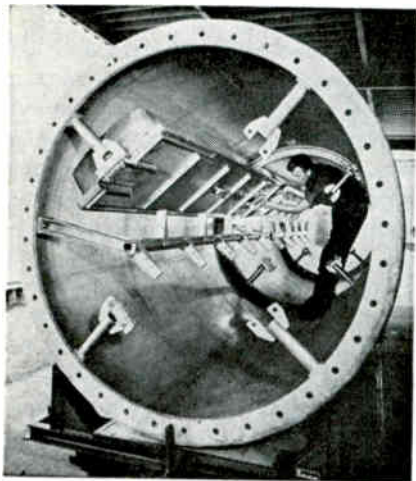

## German Antennas Ready For Italian Television Net

ZURICH—Special antennas designed by Siemens & Halske AG, Munich, are being readied here for use by Italy's second television system. The new design relies on a self-supporting glass fiber cylinder specially weatherproofed. Depending on required antenna gain, up to eight such units (see photo) are joined together. The antennas will be used with antennas for Italy's Band IV transmitters being readied in major Italian cities.

## Microwave Beacons To Guide Blind Landings

LONDON—New microwave beacon guidance system under development by Elliott Brothers, Ltd., will see its first experimental use before the end of this year. Tests will be held at the Blind Landing Experimental Unit at Bedford with two mobile units positioned on either side of the runway. The new beacons provide azimuth direction on final approach to incoming aircraft. Operating in the Q band, specially designed antennas give overlapping patterns of field intensity, the port and starboard patterns being modulated with one-thousand and two-thousand cycle frequencies. An airborne receiver provides a visual indication of azimuth position relative to the runway.

Antenna beam accuracy of the overlapping patterns has been achieved from over 40 computer design runs performing Fourier integrations to achieve the optimum antenna slot pattern. The 3-db response points of the antenna pattern occur at points 10 ft off the runway centerline.

## Five Japanese Networks Start Tv Colorcasts

TOKYO—Five radio-tv systems here have inaugurated color television broadcasting within the past three weeks. Three of the five stations are in Tokyo: Nippon Hoso Kyokai (Japan Broadcasting Corp.) the government station, Nippon Television Network and Radio Tokyo. The other two, Osaka Yomiuri, an NTV subsidiary, and Ashai Tv, are in Osaka.

The Ministry of Post and Communications, after approval by its advisory agency, the Radio Wave Control Council, authorized the color operations. NTV has been broadcasting color tv programs daily for two or three hours in the last two years. NHK and Radio Tokyo have been airing 30-minute color programs daily for the same period. All these have, up to now, been trial broadcasts.

With the formal opening of these color stations, expectations are that monthly production of color tv receivers, now about 800, will rise to 2,000 when production of tubes catches up.

Toshiba has just completed a \$300,000 color tv receiver plant, the nation's first, in Kawasaki, near Tokyo. Plans are to step up plant output to 500 sets by the end of the year, and make more than 1,000 sets next year.

## Rhodesian Company Plans Shannon Airport Factory

SHANNON—The Rhodesian firm, Chassey Brother (PVT), Ltd., of Balawayo, Rhodesia, announces plans to set up a factory in Shan-

non Airport's industrial section. The African company, producing radios under the trademark Supersonic, has formed an Irish company, Supersonic (Ireland) Ltd., to make portable radios and phonographs at Shannon.

Company officials say that in cooperation with the Irish Industrial Development Authority and the Shannon Free Airport Development Company, they have leased two standard factory bays of 16,500 sq ft each and will start operations in January.

In the first year, 120 people will be employed. By 1962, it's expected the number will be 200.

## German Exhibits Stress Automatic Control

HANOVER—Last month's biennial machine tool show staged by the German Association of Machine Tool Manufacturers emphasized the increased role of control equipment in tool manufacturing. Plug-board programming appeared to be a popular method for positioning control, but there were strong indications that the possibilities of numerical control are being carefully studied for adaptation to European requirements.

Reportedly, none of the eight manufacturers exhibiting tape control gear made an impressive showing. This leads observers to believe the Germans are anxious to keep their use of numerical control equipment quiet until they know which way the machine tool users will jump. Expectations are that if the Germans do begin using more numerical control, they will turn to British-type five-channel tape in preference to the eight-channel system used in the U. S.

An advanced example of numerical control shown at Hanover was a German contour miller (Droop & Rein) fitted with a tape control system by Britain's EMI Electronics. This unit senses programming or tape irregularities in advance and cuts in safety devices before the machine makes a faulty cut.

# PUREST DISTILLED WATER AUTOMATICALLY

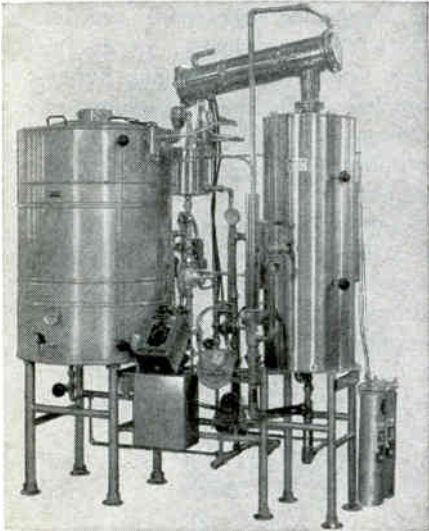

## FROM THE BARNSTEAD STILL YOU NEVER NEED CLEAN

Barnstead Steam Heated Stills with Feedback Purifier produce distilled water of from 800,000 to 2,000,000 ohms electrical resistance with total solids from 0.1 to 0.5 parts per million. Maintenance and upkeep completely eliminated.

### FULL AUTOMATIC CONTROLS

Provide full automatic operation with continuous supply of freshly distilled water... no attention needed... Still is self-starting, self-flushing and self-stopping.

### ULTRA VIOLET TANK WITH VENTGARD

Storage tank equipped with Ventgard which prevents airborne contamination from entering tank as water is drawn off. Ultra Violet light not only keeps bacteria from forming but also kills any bacteria present.

### PUOMATIC CONTROLLER

Samples distilled water being produced and diverts to waste water of substandard purity and continues to do so until condition has been rectified.

### TIN LINED PIPING

Complete line of Tin Lined Piping, Fittings and Valves for distilled water distribution systems, maintaining purity to point of use.

### NEW CATALOGS

Write for Catalog "G" describing Barnstead's complete line of Water Stills, and Catalog #160 on Barnstead Demineralizers.

## **Barnstead**<sup>®</sup> STILL AND STERILIZER CO.

84 Lanesville Terrace, Boston 31, Mass.

BOSTON Jamaica 2-8490 CHICAGO Rogers Park 1-6173 LOS ANGELES RYan 1-6663	NEW YORK Kingsbridge 8-1557 PHILADELPHIA BRoadway 9-3146 SAN FRANCISCO TEmplebar 2-5391	CLEVELAND Academy 6-6622 WASHINGTON, D.C. District 7-1142 DETROIT ENterprise 7422
--	---	---

# WASHINGTON OUTLOOK

ELECTRONIC INDUSTRIES ASSOCIATION is petitioning the Labor Department to reconsider the tentative decision setting nationwide minimum-pay rates for electron-tube and semiconductor workers under the Walsh-Healey Act. But don't expect any change in the ruling.

*EIA wants the department to abandon its one national rate and set instead four separate regional minima. Department's policy is that a national scale is set whenever there is broad competition for government contracts from all sections of the country. Regional rates are set only when competition is restricted to specific areas. In the past seven years, for instance, only one of the score or more major Walsh-Healey cases has been settled on a regional basis, and that involved the bituminous coal industry.*

"There is no indication that bids for government electron-tube and semiconductor orders are restricted by region because of cost differentials," a high-level Labor Department official told **ELECTRONICS** last week.

The department's tentative decision was made in August, sets a \$1.42 minimum for electron-tube producers and a \$1.35 minimum for semiconductor manufacturers. Tv picture tubes are not covered; only contractors who sell to the government are affected.

*EIA's brief opposing the decision says New England producers would "suffer a particularly heavy blow" if the tentative determination is made official. It cites "higher transportation and utility costs and taxes," says the proposed rates are 18 to 20 cents above prevailing N. E. scales.*

The association's brief also challenged the basis for the scales as established in the tentative ruling. It argues that the rates are "unduly inflated" because the basis is "lowest worker earnings rather than lowest established hiring rates."

NATIONAL AERONAUTICS & SPACE ADMINISTRATION may authorize development of an active communications satellite. A decision on the matter is expected within the next few weeks. Right now, NASA is experimenting only with passive satellites in its Echo series; Army is running the nation's active satellite program, which involves Courier and Advent.

Some NASA officials are privately plugging to get an active communications satellite program of their own underway. They argue that military requirements are making active satellites far more complex than needed for a commercial satellite communications system.

ELECTRONICS INDUSTRY'S growth in the metropolitan Washington area is pointed up in a U.S. Employment Service forecast that demand for electrical and electronics engineers will increase approximately 13 percent by 1962. The forecast is based on a personal survey made in December 1957.

Latest figures show 2,966 electrical and electronics engineers employed by private industry in the capital district, with 1,943 more working for the federal government. Outlook for 1962 is for 4,070 to be employed in industry and 2,137 in government jobs. About 75 percent of the projected increase reflects growth needs as against replacement requirements.

POST OFFICE'S facsimile mail-transmission program, "Speed Mail," will start a 30-day operational test on Monday. The system links Washington, D. C., Chicago, and Battle Creek, Mich.; it has been under engineering test since Oct. 3 when AT&T lines were cut in.

Speed Mail retains the traditional sanctity of private mail. Letters can be either handwritten or typed on forms similar to wartime V-mail. They are opened, transmitted, printed and resealed by machine. Scanning and printing equipment was developed by Stromberg-Carlson and Haloid. ITT's Intelix is prime contractor on the project.

Meanwhile, the Postmaster General announced that the automatic address reader which was developed by Farrington Manufacturing for sorting mail is undergoing modification to allow it to read both envelopes addressed entirely in capital letters and also postal zone numbers. The device previously analyzed the topography of an address typed in caps and lower case, skipped over the zone.



## The national security need for Space Technology Leadership

Space is a medium in which many military missions can be most effectively performed • The U. S. arsenal of ballistic missiles—in being and forthcoming — the Air Force Thor, Atlas, Titan, and Minuteman, the Navy Polaris, and the Army Jupiter, are all designed to deter the outbreak of a nuclear World War III or to retaliate overwhelmingly if it should occur • If our ballistic missiles are to realize their greatest potential in carrying out their dual task, they must be supported by a number of companion space systems for such missions as early warning, reconnaissance, communications, navigation, weather forecasting. Space Technology Laboratories is proud of its contributions to the national space effort as a principal contractor in carrying out major programs for the Air Force Ballistic Missile Division, National Aeronautics and Space Administration, and Advanced Research Projects Agency • The increasing scope of STL's activity is opening up exceptional opportunities for the exceptional scientist and engineer, who will find creativity given encouragement and recognition in an organization synonymous with Space Technology Leadership. Resumes and inquiries will receive meticulous attention.

**SPACE TECHNOLOGY LABORATORIES, INC.** P. O. BOX 95004, LOS ANGELES 45, CALIFORNIA

Los Angeles • Santa Maria • Edwards Rocket Base • Cheyenne



Cape Canaveral • Manchester, England • Singapore • Hawaii

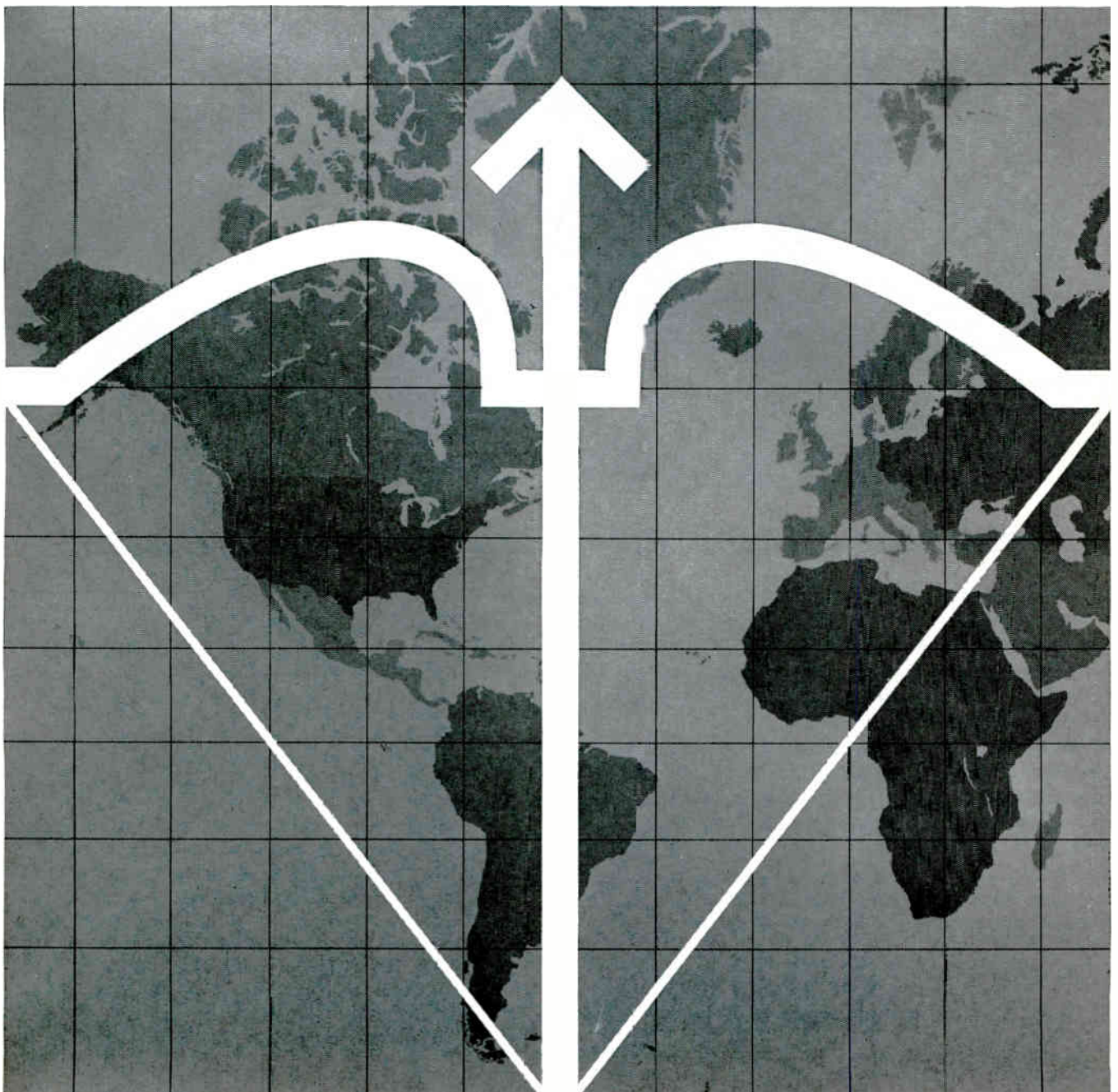



Give your  
"spec" cables  
the protection  
they deserve...

**Resinite** EP-145\*  
jacketing

## *Light, strong, tough, exceptionally abrasion-resistant*

To protect your cables from the rough treatment and extreme climatic conditions encountered in missile, aircraft, and ground control applications, we suggest Resinite EP-145 vinyl jacketing. **TOUGHER**—EP-145 has greater tear strength and abrasion resistance . . . exceeds all important specs of MIL-R-6855 (for synthetic rubber) and MIL-I-3930.

**LONGER LIFE**—EP-145 does not deteriorate when exposed to gasoline or oil. There's no cracking, no ozone embrittlement.

**PERMANENT FUNGUS AND FLAME RESISTANCE**—EP-145 will not rot. And it has outstanding self-extinguishing characteristics.

Your Resinite Distributor has complete information on EP-145 and other Resinite materials (including Resinite vinyl tape filler). For samples and performance data, write:

RESINITE DEPARTMENT

THE **BORDEN**  
**CHEMICAL**  
COMPANY



© BORDEN CO.

1 Clark St., North Andover, Mass., • P.O. Box 430, Compton, Calif.

### **RESINITE EP-145**

- Abrasion resistance is 11 to 31 times better than neoprene at varying test cycles.
- Lighter, stronger, easier to handle. Allows thinner walls, less material.
- Resists exposure to gasoline and oil. No deterioration. Exposure increases tensile strength.
- Superior cold bend and impact properties (lower than -100°F).
- Smooth, glossy surface does not rub off or smudge.
- Fungus resistant. Flameproof.
- Color: Black. Other sizes and colors on special order.
- Readily applied by standard methods.

*Resinite®—specialists in vinyl sleeving and tubing for the aircraft, electronics, electrical and pharmaceutical fields.*

*\*Available as a resin. Ask for Borden 5410.*

# ELECTRON TUBE NEWS

...from **SYLVANIA**



## **NOW!** Sylvania adds the advantages of **“BONDED SHIELD”** to industrial-military **CATHODE RAY TUBES**

- reduces reflecting surfaces 50%
- improves image visibility
- protects against breakage
- provides wide-angle viewing
- simplifies mounting and styling

Sylvania pioneered the quantity production techniques of laminating “Bonded Shield”—a scratch-resistant, annealed-glass safety cap—to the face of television picture tubes. Drawing upon this vast experience, Sylvania now makes available “Bonded Shield” industrial-military cathode ray tubes—screen sizes from 3” to 27”—on flat and spherical, rectangular and circular faces.

Sylvania “Bonded Shield” one-piece design cuts the number of reflecting surfaces by 50%—reduces specular images, increases apparent light transmission and contrast to provide improved image readability. “Bonded Shield” increases strength of tube face. Reduces the danger of implosion. It eliminates the need for conventional safety glass. Brings image display “out-front” for wide-angle viewing and simplifies cleaning of the tube face (especially important in environmentalized “sealed” equipment). “Bonded Shield” makes practicable reductions in equipment weight and over-all length.

“Bonded Shield” can serve as a usable writing surface. Further, it is possible to permanently etch the bonded safety cap with a calibrated reference scale, thereby reducing view-errors caused by parallax. You can find out more about these and other “Bonded Shield” advantages from your Sylvania Sales Engineer.

## NEW "BONDED SHIELD" C.R.T.'s

Sylvania-19ARP4, monitor tube for commercial and industrial TV. 19" tube with 114° deflection, it features an over-all length of only 12" including "Bonded Shield" safety cap; neck length is 5 1/8". 19ARP4 is available with specially treated cap that can diffuse reflections as much as 70%.

"Bonded Shield" Type	Equivalent Standard Type	"Bonded Shield" Type	Equivalent Standard Type
ST-2843	16WP4B	ST-3081	12KP4A
SC-3074	5UP1	ST-3082	5FP4
SC-3076	SC-3074*	ST-3083	10FP4A
ST-3077	5QP4	ST-3084	17BP4A
ST-3078	7SP4	ST-3085	24YP4A
ST-3079	7TP4	ST-3086	17HP4B
ST-3080	10SP4		

\*Denotes IRE scale printed on face

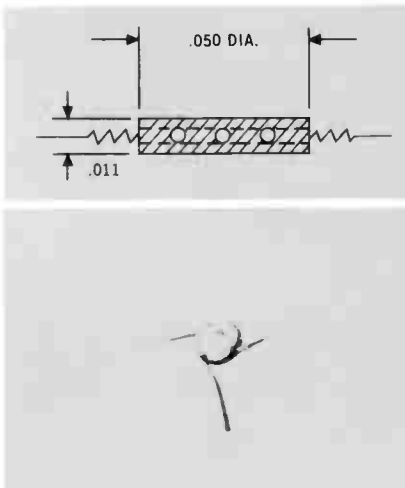

Illustration (top) shows compact dimensions of new low power heater-cathode assembly (below).

## NEW! Sylvania C.R.T.'s feature LOW-POWER HEATER—1.5V @ 140mA— open new design areas for battery-powered, portable 'scopes

Continuing Sylvania research into modern materials and techniques has led to a remarkable low-power heater-cathode assembly. It requires only 1.5V @ 140mA—less than 6% of the power normally needed—offering lower tube operating temperatures and low drain from battery or flyback heater supplies.

Advanced powder metallurgy processes

make possible a flat, pancake-like heater-cathode assembly, only .050" in diameter and .011" thick. Extremely low mass minimizes possibility of damage from vibration and shock.

Sylvania continues expansion of its line of C.R.T.'s utilizing this important heater-cathode development. Current examples include SC-3016 and -3BMP1.

KEY CHARACTERISTICS	3BMP1	SC3016
Heater Ratings	1.5V/140mA	1.5V/140mA
Anode No. 3 Voltage	6600*	— Vdc
Anode No. 2 Voltage	2200*	2750* Vdc
Anode No. 2 Input	6.0*	— Watts
Anode No. 1 Voltage	1500*	1100* Vdc
Face Dimension	3	1 1/8 Inches
Over-all Length	10	6 Inches

\*Absolute Maximum Ratings



SYLVANIA SC-3016—featuring high deflection sensitivity, compact length of only 6", flat circular 1 1/8" face, electrostatic focus and deflection. Available with several different screen phosphors.



SYLVANIA-3BMP1—a 3"-diameter tube with flat, clear faceplate. It offers electrostatic focus and deflection, features post-deflection acceleration. Available with a wide choice of screen phosphors.

## SYLVANIA-7AUP7 FOR MARINE RADAR

7" diameter face—short over-all length for compact designs—7/8" diameter neck for reduced deflection power requirements—features aluminized screen for image brilliance—electrostatic focus, magnetic deflection—utilizes 9-pin miniature basing arrangement.



Virtually all popular C.R.T.'s can be supplied with "Bonded Shield" and/or low power heater-cathode assembly. For further information, contact the Sylvania Field Office nearest you. Or, write Electronic Tubes Division, Sylvania Electric Products Inc., Dept. J., 1100 Main Street, Buffalo, N. Y.

# SYLVANIA

Subsidiary of **GENERAL TELEPHONE & ELECTRONICS** 

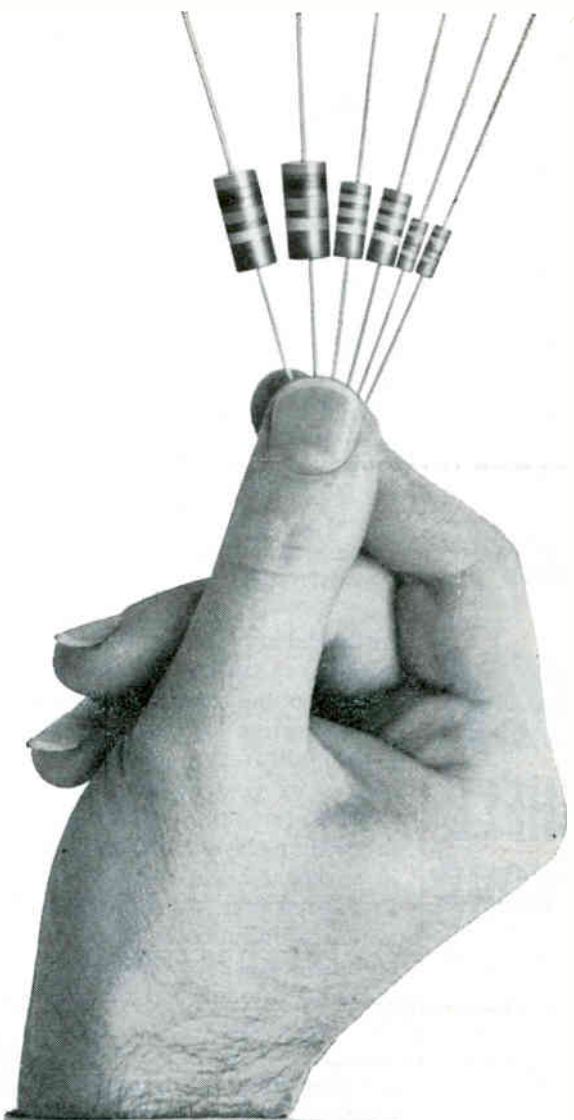

*for the service  
you need...  
for the sizes you want...*

# SPEER RESISTORS

You're sure to find the sizes and types you want in Speer's complete line of 1/2-, 1- and 2-watt fixed composition resistors, which meet or exceed the requirements of specifications MIL R11 and RS 172. The fast, efficient service for which Speer has gained a wide reputation can also help you eliminate costly production delays. So next time, specify Speer! Speer now offers these new sizes:

Speer Type	MIL Style	Rating in watts	Body		Wire Size	Lead
			Nominal Diameter	Nominal Length		Nominal Length
SR 1/2	RC 20	1/2	.138	.390	A.W.G. # 20	1 1/2
SR 1	RC 32	1	.225	.562	# 18	1 1/2
SR 2	RC 42	2	.312	.688	# 17	1 1/2

*Other Electronics Divisions of Speer Carbon Company  
Jeffers Electronics, Du Bois, Pa.  
Onondaga Electronics, Syracuse, N. Y.*



**Speer Resistor Division**  
Speer Carbon Company, Bradford, Pennsylvania

ALL UNITS ACTUAL SIZE

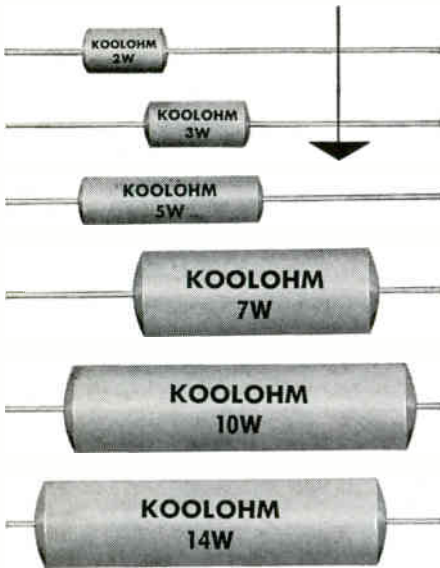

# KOOLOHM<sup>®</sup>

## INSULATED SHELL POWER RESISTORS

Sprague's Koolohm Resistors are designed to meet military and industrial requirements for insulated power wirewound resistors that will perform dependably.

New axial-lead Koolohm construction features include welded leads and winding terminations. Exclusive Ceron<sup>®</sup> ceramic-insulated resistance wire, wound on special ceramic core makes possible multilayer non-inductive windings and extra-high-resistance-value conventional windings. Dense, non-porous ceramic outer shells provide both humidity and mechanical protection for resistance elements. All resistors are aged-on-load to stabilize resistance value.

The advanced construction of these improved Koolohm Resistors allows them to operate at "hottest spot" temperatures up to 350°C. You can depend upon them to carry maximum rated load for any given physical size.

Send for Engineering Bulletin 7300A for complete technical data.

**SPRAGUE ELECTRIC COMPANY**  
35 Marshall Street, North Adams, Mass.



## FINANCIAL ROUNDUP

### Raytheon Acquires West Coast Firm

RAYTHEON CO., Waltham, Mass., announces acquisition of the assets of Panel Wires, Inc., San Francisco, a supplier of computer and data-processing accessories and other precision electromechanical components. Certain portions of the California company's line will continue to be marketed under the PWI label. The company will be operated as part of Raytheon's Commercial Apparatus and Systems division.

Anton-Imco reports shareholders decision to transfer the company's assets to the Lionel Corporation. Under terms of the agreement, Lionel will issue one and one-third shares of its common stock for each outstanding share of A-I, other than the 40,000 shares which it purchased prior to the date of the agreement, July 5, 1960. The action will increase Lionel's outstanding stock by 278,455 shares, common. Lionel will also assume A-I's liabilities.

C-E-I-R, Inc., Arlington, Va., independent computer and data processing operator, announces a merger with Engleman & Co., Washington, D.C., specialists in electronics research. The merger is C-E-I-R's second in four months. A merger with General Analysis Corp., Los Angeles, was made in July. The newly-merged company will provide the Arlington firm with electronic communication specialists needed for a planned nationwide network of research centers. Engleman sales in the fiscal year ended last January were \$273,853, with profits after taxes of \$17,173.

Aircraft Armaments, Inc., Cockeysville, Md., reports conclusion of an agreement to acquire a Philadelphia firm, B&F Instruments. The transaction provides for an exchange of stock, with B&F to be operated as a subsidiary.

Giannini Scientific Corp., New York City and Santa Ana, Calif.,

announces its third acquisition this year. The latest is Micro-Balancing Inc., Garden City Park, L. I., N. Y. The Long Island firm manufactures a line of dynamic balancing machines and photocell control devices. Giannini has four other subsidiaries: Flight Research Inc., Richmond, Va.; Plasmadyne Corp., Santa Ana, Calif.; Plasmakote Corp., Culver City, Calif. and Wiley Electronics Co., Phoenix, Ariz.

Waltham Precision Instrument Co., Waltham, Mass., reports acquisition of Boesch Manufacturing, Danbury, Conn. The purchase agreement, originally initiated last April, will add more than \$1,250,000 to Waltham's annual sales, according to L. R. Ripley, president of the Massachusetts firm. Boesch manufacture a patented line of toroidal coil winding machines, accessories and control instruments. The acquisition is Waltham's second this year. In February, the company acquired Electro-Mec Laboratory, Long Island City, N. Y. Waltham Pre-

### 25 MOST ACTIVE STOCKS

	WEEK ENDING SEPTEMBER 30, 1960			
	SHARES (IN 100'S)	HIGH	LOW	CLOSE
Gen Tel & Elec	2,293	27¾	26	27½
Ampex	2,261	25½	22½	24¼
RCA	1,340	54¼	51½	54
Gen Electric	1,168	75¼	70¼	73¾
Avco	1,146	14¾	13¾	14¾
Gen Dynamics	1,141	38½	34¾	38½
Sperry Rand	877	20¼	19½	20½
Standard Kollsman	811	20¾	18¾	20½
Litton Ind	795	74¼	68½	77½
Int'l Tel & Tel	752	37¾	36	37½
Collins Radio	747	51	45¾	51
Raytheon	718	37¾	31¾	37¼
Westinghouse	709	49¾	46¾	49¾
Gen Inst	680	36¾	31¾	36¾
Univ Controls	648	16¾	15½	16¾
Varian Assoc	520	48¾	41½	48¾
Texas Inst	503	184¾	171¼	184½
Zenith	498	115½	110¼	115
Beckman Inst	475	90¾	83¾	90¾
Elec & Mus Ind	474	6¾	6½	6¾
Telectro	448	17½	15¾	15¾
Philco Corp	439	21¾	19¾	21¾
Loral	413	79¾	70¾	79½
Reeves Sndcrft	395	4¼	6½	7¼
Transitron	327	39¼	35½	38¾

The above figures represent sales of electronics stocks on the New York and American Stock Exchanges. Listings are prepared exclusively for ELECTRONICS by Ira Haupt & Co., investment bankers.

cision was once the Waltham Watch Co.

**American Research and Development Corp.**, Santa Monica, Calif., and **Radar Relay, Inc.**, in the same city, announce that American Research has made an investment of \$175,000 in Radar Relay to finance additional growth. The Santa Monica company designs and manufactures electronic display components for airborne systems, missile ground support gear and automation equipment. American Research and Development is a closed-end investment company with a participating interest in 34 companies engaged principally in technical developments.

**Techno Fund, Inc.**, Columbus, O., small business investment company, reports that it has committed to invest \$500,000 in convertible debentures of **Shepherd Industries, Inc.**, Nutley, N. J. The investment is Techno's first since its public subscription on August 18. At that time, more than \$5 million in stock was sold to enable expansion of financing aid to small business. Shepherd Industries manufactures digital and analog magnetic tape recorders, magnetic memory drums, magnetic heads and other equipment. The New Jersey firm reports backlog equivalent to three months' orders and expects sales of more than \$1 million this fiscal year.

**Transistor Electronics Corp.**, Minneapolis, reports first-quarter sales of \$138,840 for the period ending July 31, 1960. This figure is up 206 percent over the similar period of 1959 when sales were \$67,213, according to D. V. Hamilton, president. Current order backlog for TEC's miniature transistorized inductors and switches is \$170,000.

**Energy Fund Inc.**, New York City, reports a climb in net assets as of Sept. 30 this year to \$12,225,885, as compared with \$7,462,770 in the same date last year. In 1958, the figure was \$4,927,588. Net assets per share for the three periods are: \$19.65, \$18.51 and \$15.76, respectively. Figures do not include these capital gains paid: 1959—\$1.03; 1960—\$0.88.



IN  
PERFORMANCE  
AND  
DESIGN

ULTRA PRECISION  
**SNAP  
ACTION  
CRYSTAL  
OVEN . . .**

The unique multiple cavity design makes possible a maximum temperature cycling of  $\pm .05^{\circ}\text{C}$  from minus  $55^{\circ}\text{C}$  to within  $15^{\circ}\text{C}$  of operating temperature.

Slope of control temperature is less than  $.003^{\circ}\text{C}$  per degree centigrade change in ambient temperature.

The inner cavity can be utilized to house packaged circuitry requiring precise temperature control.



DESIGNED and  
PRODUCED  
by

**ovenaire**

I N C O R P O R A T E D

● P.O. BOX 845 · CHARLOTTESVILLE, VA.

AVAILABLE IN CANADA THROUGH OUR AFFILIATE: GROVEN LTD., WHITBY, ONT.

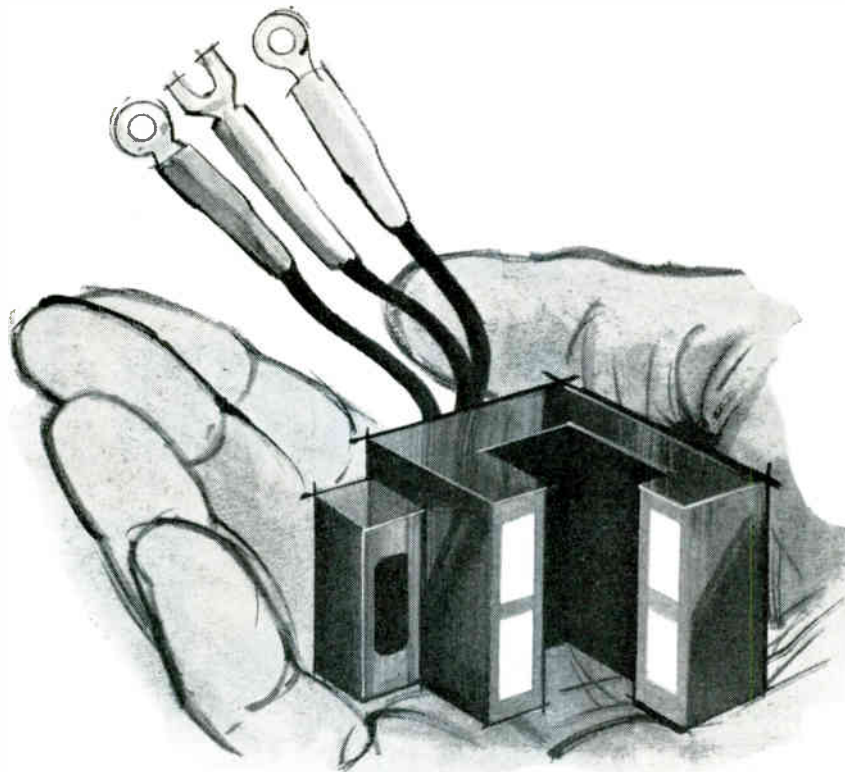

## How your epoxy resin potting systems can beat the heat... even above 500° F.

Turn an appraising eye on the chart below, and you will see why it is now possible to get good electrical properties in your epoxy potting compounds even at temperatures of 500° F. and higher.

These data were obtained in tests of epoxy systems which had been cured with Du Pont's pyromellitic dianhydride (PMDA).

Note the unusual stability of electrical properties at elevated temperatures. Equally outstanding thermal resistance is a bonus characteristic of PMDA cured systems.

PMDA is now available in commercial quantities, to

help you add these exceptional electrical and thermal characteristics to *your* epoxy resin potting, encapsulating, and laminating systems.

**There's more.** PMDA provides several advantages in addition to outstanding electrical and thermal properties.

If you wish, you can get long pot life—up to 2 days at room temperature or 6 hours at 165° F. On the other hand, if you want a quick cure—say, 15 minutes at 355° F.—you can get it by simply changing the formulation and at no sacrifice in electricals.

Why not take advantage now of such outstanding performance and use PMDA to achieve improvements in your product. PMDA is now available in quantity from Du Pont's new commercial-size plant. Recent price reduction to \$1 per pound\* also makes this a practical means of improving your epoxy resin systems.

For more details or for samples of PMDA, write to Du Pont, Explosives Department, 6539-K Nemours Building, Wilmington 98, Delaware.

*\*Price quoted is f.o.b. Gibbstown, New Jersey for material in standard containers and is subject to change without notice.*

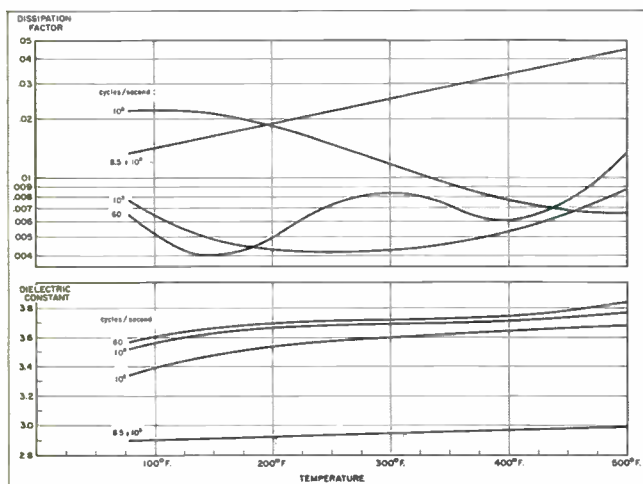

**DU PONT** PMDA  
REG. U.S. PAT. OFF.  
**(PYROMELLITIC DIANHYDRIDE)**

**BETTER THINGS FOR BETTER LIVING  
 ... THROUGH CHEMISTRY**



# NEW SUBCARRIER OSCILLATOR

For FM Telemetry

# DORSETT O-20

- Stable Data  
From  $-55^{\circ}\text{C}$  to  $+125^{\circ}\text{C}$
- For Aerospace and  
Industrial Applications
- All IRIG Channels



Typical packaging of Model O-20 VCO and of other Dorsett "20" series components soon to be announced.

## SPECIFICATIONS

**Input:** 0 to 5 volts, or  $\pm 2.5$  volts.

**Output:** 0 to 4 volts RMS (adjustable).

**Power Requirements:** Less than 70 milliwatts ( $+20$  volts and  $-20$  volts). Specify model PS-20 power supply for 28 volt systems.

**Impedance:** Output, 10 K. Input, 1 megohm.

**Linearity:** Less than .5% deviation from best straight line.

**Harmonic Distortion:** Less than 1%.

**Stability:** Temperature, 2% fbw change in center frequency or band width for any  $50^{\circ}\text{C}$  change between  $-55^{\circ}\text{C}$  and  $+125^{\circ}\text{C}$ .

No more than  $\pm 1\%$  fbw shift in center frequency or deviation sensitivity under 50 G linear acceleration; 20 G vibration, 55-2000 cps; or following a 100 G, 11 millisecond shock.

**Size:** 2.25" x 1.875" x .875".

**Weight:** Less than 4 ounces.

**Holddown:** Special captive screws.

**Controls:** Output. Centering. Deviation Sensitivity.

# DORSETT ELECTRONICS

LABORATORIES, INC.



119 WEST BOYD STREET • NORMAN, OKLAHOMA • JE 4-3750

*The Allison 201  
Continuously  
Variable Filter*



**HERE'S A NEW  
PASSIVE NETWORK  
FILTER IN THE  
SUB-AUDIO RANGE**

The new Allison 201 Filter goes into the sub-audio range, yet retains the desirable characteristics of Allison Filters in the audio range. The low noise, low distortion and excellent transient handling capabilities of the 201 make it excellent for heart studies, geophysical work, low frequency vibrations, servo-systems and similar sub-audio frequency spectrum studies.

**ALLISON 201 SPECIFICATIONS**

- Impedance—600 ohms
- Passive network
- 30 db per octave attenuation rate
- Independent high cutoff and low cutoff sections
- Low insertion loss
- Smooth pass band
- Negligible ringing
- Frequency coverage — 1 to 256 cps
- Shipping weight: 35 lbs.
- Price: \$695.00 FOB Factory



Write for new catalog of Allison Analyzing Instruments

*Proved  
dependable in  
years of service*



**Allison  
Laboratories, Inc.**  
11301 OCEAN AVENUE  
LA HABRA, CALIFORNIA

**MARKETING**

# Continued Growth Seen For Electronics Industry

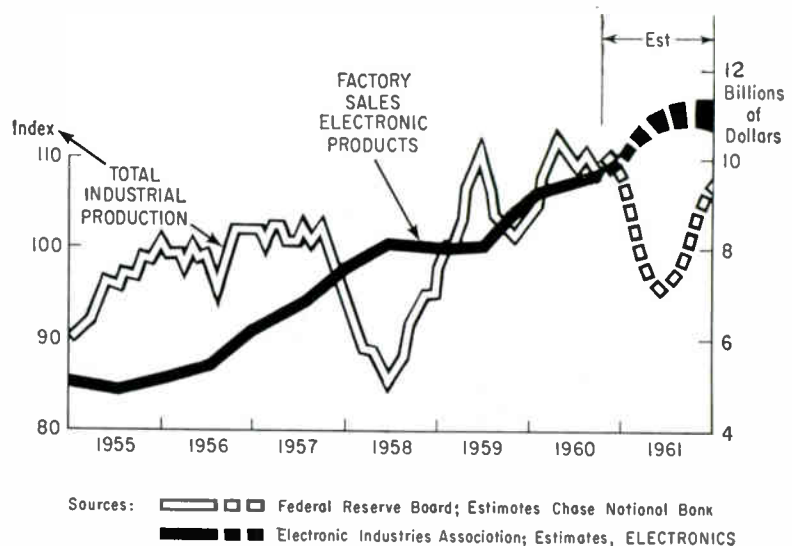

ELECTRONIC INDUSTRY sales growth will continue through 1961 despite expectations by at least one economist that U. S. business may run into a slight downturn in the first quarter of 1961.

This prediction was made recently by V. Stevens Hastings, Chase National Bank business economist, before an electronics oriented American Marketing Association chapter — Northern New Jersey.

Contrasting picture of the expected behavior of our industry and general industry in the period ahead is shown in the chart with total industrial production projected to decline 10 to 15 percent in 1961 and factory sales of electronics to climb to \$10 billion this year and \$11 billion in 1961.

Main reason total electronics sales will rise is because military expenditures will increase during 1961 and the electronics percentage of total military expenditures will also increase, Hastings said.

However, a projected decline in consumer durable expenditures may affect sales of some entertainment products. Current estimates for 1960 retail television set sales have

been reduced half a million units from 6.5 million sets estimated at beginning of year. By June 1961, an upturn in general business is expected.

Information on share of the market held by individual manufacturers is of interest to market investigators. Here is a bit on the computer market released recently by RCA's president, Frank Burns.

He indicated RCA's electronic data processing division sales in 1959 amounted to about \$67 million and are running at rate of \$133 million for this year. RCA's record compares with total computer industry sales of \$350 million in 1959 and \$400 million to \$450 million in 1960.

Burns also said that industry edp volume would amount to about \$1.1 billion for 1965 and \$2.3 billion in 1970. Above estimate includes entire edp systems with both analog and digital computers and auxiliary equipment with rental values translated at sales value (fifty times monthly rate); and military computers for both tactical and non-tactical use. Sales value represents computers delivered, not on order.

Sales of airborne electronic equipment for light planes will reach at least \$85 million in 1965, an increase of 57 percent over this year's anticipated sales of \$54 million, an industry market investigation shows. Equipment for helicopters is not included.

There are 72,000 planes in the general aviation category in the U. S. today, according to V. F. Acri, marketing manager of Sperry-Rand, and by 1975 the number is expected to increase to approximately 105,000.

A University of Illinois survey on the selection, training and compensation of electronics reps was used in a recent Chicago workshop of the Electronic Representatives Association. The survey was organized by the University's Bureau of Business Management.

**MARKETING APPOINTMENTS.** Edward J. Verity appointed manager of the marketing research department of Garlock Inc., producer of seals, packings and related products. . . . Tenso Electronics, Inc., has named Arnold R. Baker to the new post of marketing director. Tenco makes precision electronic, magnetic and digital components, plus a line of production test equipment. . . . Epsco, Inc., announces the appointment of Stanley A. Radler as director of marketing services.

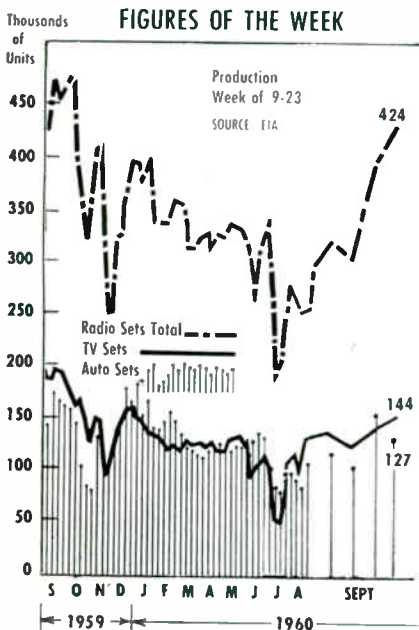

October 14, 1960

# NEW PRECISION TAPES SOLVE ELECTRICAL INDUSTRY PROBLEMS

## Solve insulating, bonding problems with SCHJELBOND THERMOPLASTIC TAPES

Schjebond tapes combine an extremely strong bond with high dielectric strength. Manufactured to close dimensional tolerances, and with high electrical purity, they meet the most exacting standards.

**SCHJELBOND 100**—.0025" thick Polyester dry strip adhesive without backing.

**SCHJELBOND 300**—"Mylar"\* backing, adhesive coated on one side.

**SCHJELBOND 400**—"Mylar" backing, adhesive coated on both sides.

(Schjebond 300 and 400 available with precise adhesive thicknesses from .0002-in. to .003-in., on .005-in. to .010-in. "Mylar".)

**DIELECTRIC STRENGTH**—"Mylar" rated at 4000 volts/mil.

**BONDS**—"Mylar", iron, steel, copper, glass, aluminum, wood, paper, cotton, silk, linen, nylon, wood fabrics, phenolics and ferrites.

**SPECIAL LAMINATIONS**, "Mylar" to "Mylar," are available.

**SCHJELBOND ADHESIVE** is also available with "Teslar" and other backing materials on special order.

\*Du Pont trademark for its polyester film

## "GIVE US A CHALLENGE..."

...and we will give you what you want. We at G. T. Schjeldahl Co. thrive on challenges. Our people specialize in making products to solve our customers' problems.

Our company is organized so we can move quickly to solve your problems. We have made many special laminations using Schjebond for manufacturers of electric and electronic equipment. Our tape is suitable for many insulating jobs—from coil windings to flat cable.

If you have a problem in bonding, with a need for high dielectric strength, or if you need a special lamination, let us help. We can set up a complete production process for you. Send this coupon for further information."



*Gilmore F. Schjeldahl*



Please send me further detailed information about SCHJELBOND and special laminating.

Name \_\_\_\_\_ Title \_\_\_\_\_  
 Firm Name \_\_\_\_\_  
 Address \_\_\_\_\_  
 Town \_\_\_\_\_ State \_\_\_\_\_



**G.T. Schjeldahl Co.**

NORTHFIELD, MINNESOTA

Putting Tomorrow's Materials to Work Today

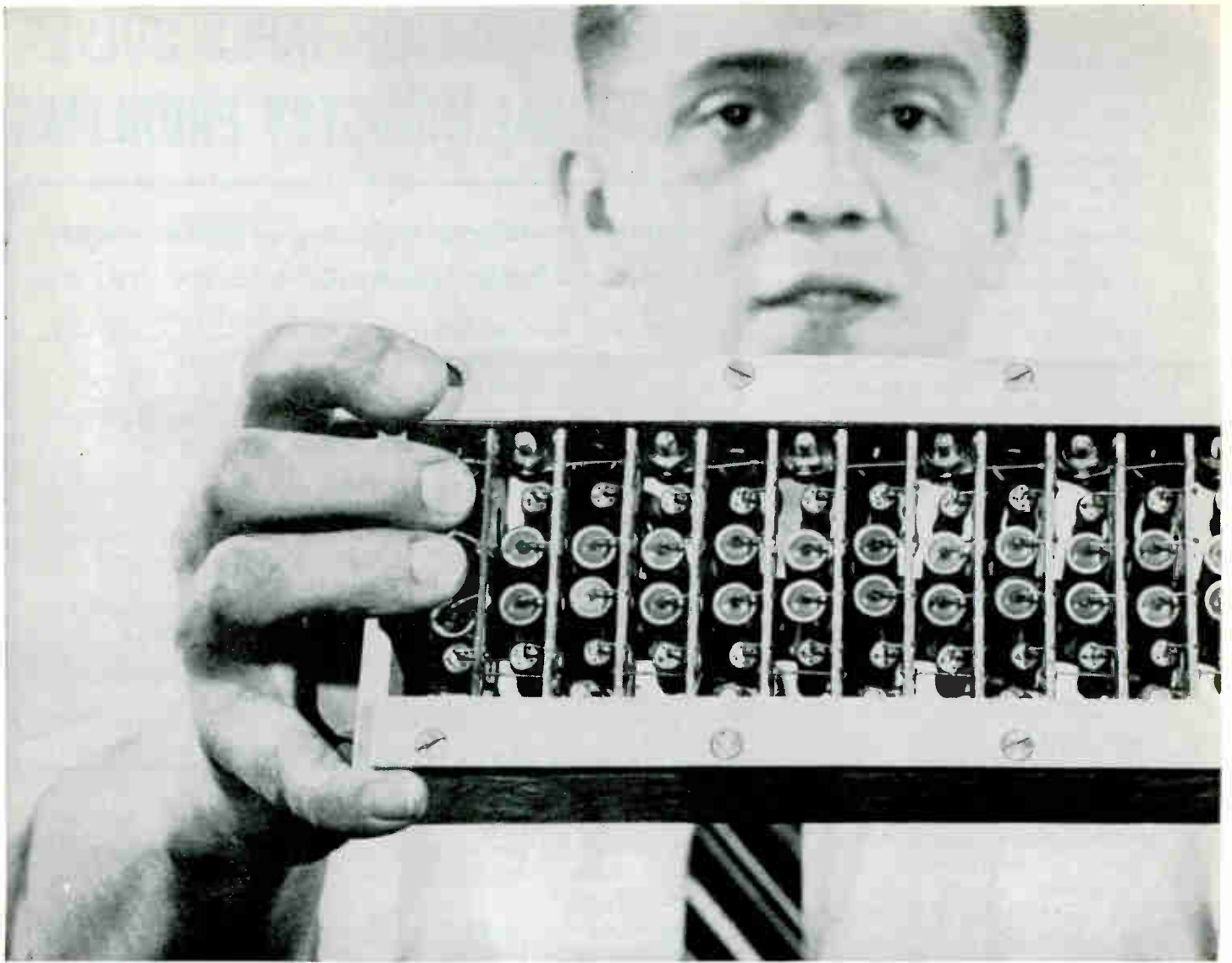

# **10,000,000 FAILURE-FREE STACK-HOURS!**

**RELIABILITY PROVEN BY 14,000 KW IN FIELD APPLICATIONS**

## **WESTINGHOUSE SILICON HIGH- VOLTAGE RECTIFIER STACKS**

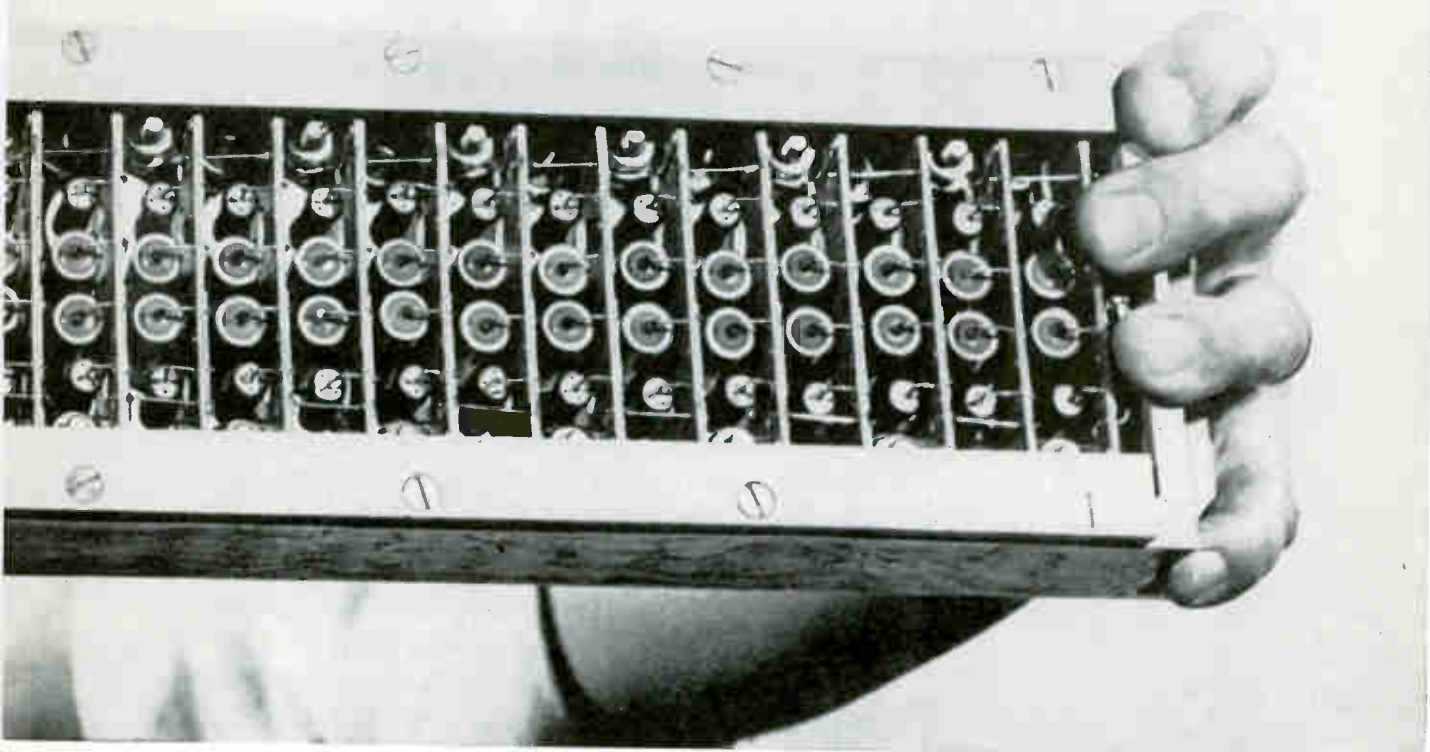

Westinghouse silicon rectifier stacks offer the most reliable source of high-voltage rectified power available today. In precipitator applications alone, more than ten million stack-hours have been achieved without a single stack failure. Exclusive Westinghouse design features guarantee uniform division of reverse voltage, provide optimum transient, steady state, and overload characteristics. Stacks assembled in compact, unitized packages take less space, require minimum maintenance, operate in ambient temperatures as high as 110°C. Stacks are available in current ratings from 1.2 Amps to 18 Amps, and in PRV ratings from 9.6 KV to 35 KV. For extremely high voltage requirements, stacks may be connected in series (up to three stacks without additional capacitance compensation).

For full information, or engineering assistance in your installation, contact your local Westinghouse representative, or write: Westinghouse Electric Corp., Semiconductor Department, Youngwood, Pennsylvania.

You can be sure...if it's **Westinghouse**



#### MIL TYPE COMPONENTS

Unique Westinghouse modular inserts feature MIL Type shunting resistors, capacitors, and mounting boards. All components are 100% tested before and after assembly.

#### APPLICATIONS

- Electrostatic precipitators
- Radio broadcasting transmitters
- Radar transmitters
- Ultrasonic transducers
- Radar pulse forming networks



**A STATEMENT  
OF POLICY  
FROM  
A NEW  
MANUFACTURER  
OF ETCHED WIRING**



Chemprint Corporation recently began manufacturing etched wiring and precision-plated circuit boards. We, the management, wish to state at the outset our policies, plans, and capabilities.

Our plant, at 4000 Campbell Avenue, Menlo Park, California, is one of the largest (23,000 square feet) and most modern in the West. All operations in the production of precision plated circuit boards for military and industrial use will be performed in this plant. We offer complete engineering design services, rigid quality control, and complete environmental test facilities.

You can depend on Chemprint quality and service. Management and technical personnel will include specialists in the fields of chemistry, process engineering, production, and quality control. The facility's full operating complement will number 120 persons.

It will be a continuing policy of the Corporation to stay abreast of the "state of the art" in the printed circuit field, as well as peripheral areas. We feel this can be accomplished by working closely with major industrial and military users across the nation. We are particularly pleased to be located in one of the fastest-growing electronics areas in the country, door to door with some of the outstanding firms in the industry.

We expect Chemprint Corporation to be always progressive, a leader in its field. But at the same time we insist on following the old-fashioned principle that people make a company what it is.

We feel we have the people.

*We will be glad to supply further information  
about Chemprint upon request.*

**CHEMPRINT CORPORATION**



**4000 CAMPBELL AVENUE • MENLO PARK, CALIFORNIA • OAvenport 3-1841**

*Probing new dimensions in Electronics  
through Stackpole Research . . .*



## A MAJOR NEW FERRITE

### FOR TELE-COMMUNICATIONS

Permeability: 1800

Temperature Constant:  $1.8 \times 10^{-6}$  per °C (—20° to 120° C)

Avg. Temperature Coefficient (un-gapped cores):  
0.29% per °C (—20° to 85° C)

$\mu_0$  (merit factor): Greater than 200,000 at 100 kc

. . . these in brief are the salient electrical characteristics of Stackpole *Ceramag 501*—a remarkable new low-loss ferrite grade for the 10 kc to 250 kc range. Already revolutionizing the design of carrier-current communications filters, the material shows considerable promise for electronic switching circuits and others as well.

Cup cores of *Ceramag 501* no larger than a quarter enable the design of filters with such narrow pass bands that message-handling capacities of communications systems can be increased from 2 to over 90 messages per channel. The extraordinary high gain of filters using *Ceramag 501* combine with other inherent advantages—smaller size, no aging or life problems—for a significant contribution to system reliability.

But equally significant is the extremely close tolerances to which these cores are made. To achieve the exact air gap required, *Ceramag 501* cups are supplied in matched pairs. Special Stackpole-designed mounting hardware and tuning slugs can also be supplied to assure easy assembly and maximum electrical performance with your own coil designs.

Almost four years in development, *Ceramag 501* represents another basic contribution based on magnetic ceramic research and engineering by the oldest commercial ferrite producer in the United States.

Complete details on *Ceramag 501* and the remarkable research facilities that made it possible are available upon request to the *Electronic Components Division*, Stackpole Carbon Company, St. Marys, Pa.



# STACKPOLE

*Ceramag*

## FERRITE CORES

CERAMAG® FERRITE CORES • VARIABLE COMPOSITION RESISTORS • SLIDE & SNAP SWITCHES • CERAMAGNET® CERAMIC MAGNETS • FIXED COMPOSITION CAPACITORS  
BRUSHES FOR ALL ROTATING ELECTRICAL EQUIPMENT • ELECTRICAL CONTACTS  
GRAPHITE BEARINGS, SEAL RINGS ANODES • HUNDREDS OF RELATED CARBON & GRAPHITE PRODUCTS.



NOW...call your

**CLARE**

DISTRIBUTOR...



**1** Puget Electro Products  
5028 First Avenue  
Seattle 1, Washington

**2** Bell Electronic Corporation  
306 E. Alondra  
Gardena, California

**2** Bell Electronic Corporation  
1070 O'Brien Drive  
Menlo Park, California

**3** Radio Specialties Co., Inc.  
6323 Acoma Road, S. E.  
Albuquerque, New Mexico

**4** Engineering Supply Company  
6000 Denton Drive  
Dallas 35, Texas

**5** Harrison Equipment Co., Inc.  
1422 San Jacinto St.  
Houston 1, Texas

**6** Busacker Electronic Equipment  
Co., Inc.  
1216 West Clay St., Houston 19, Texas

**7** Relay Sales  
P. O. Box 186  
West Chicago, Illinois

**8** SrepcO, Inc.  
314 Leo Street, Dayton 4, Ohio

**9** Pioneer Electronic Supply  
Company  
2115 Prospect Avenue, Cleveland 15, Ohio

**10** Relay Supply, Inc.  
1492 Highland Avenue  
Needham 92, Massachusetts

**11** Avnet Electronics Corporation  
70 State Street  
Westbury, L. I., New York

**12** Electronic Supply  
1301 Hibiscus Boulevard  
P. O. Drawer 1655, Melbourne, Florida



**CIRCLE 30 ON READER SERVICE CARD**





Type F relay—small, sealed, postage-stamp sized relay with unusual flexibility for long-life operation.

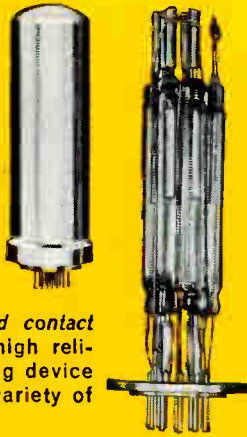

CLAREED sealed contact reed relay—A high reliability switching device available in a variety of packages.

# for immediate delivery at factory prices

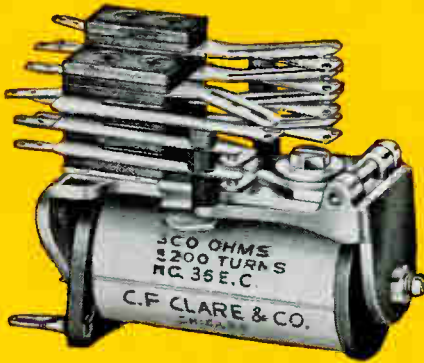

Type J relay—a compact telephone-type relay of unequalled long life and superior performance.

Mercury-wetted contact relay capable of billions of extremely fast operations with no maintenance.

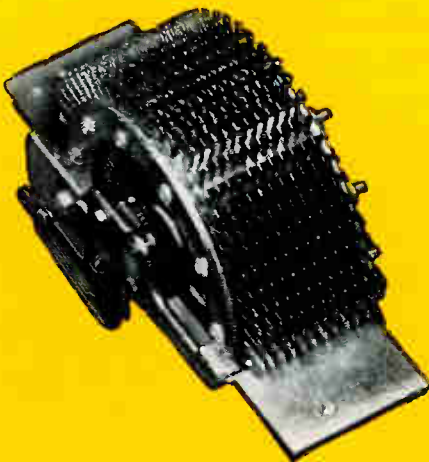

Stepping switches—a full line with capacities from 10 to 52 points and capable of millions of steps without readjustment.

Here's what this new CLARE service means to you:

**Top quality**—the same fine design and long life you get in CLARE custom-built relays and switches

**Fast service**—overnight delivery on many items

**Easy purchasing**—because you can order CLARE devices along with other components

**Able engineering assistance**—available through CLARE field engineers, working in close cooperation with CLARE distributors.

When *standard* CLARE relays or switches meet your needs, distributor service saves you time, costs no more. When your special needs require custom design and production, CLARE *custom-built* devices give you exactly what you require.

C. P. Clare & Co., 3101 Pratt Blvd., Chicago 45, Illinois. In Canada: C. P. Clare Canada Ltd., P.O. Box 134, Downsview, Ontario. Cable Address: CLARELAY

# CLARE

Relays and  
Related Control Components

CIRCLE 31 ON READER SERVICE CARD

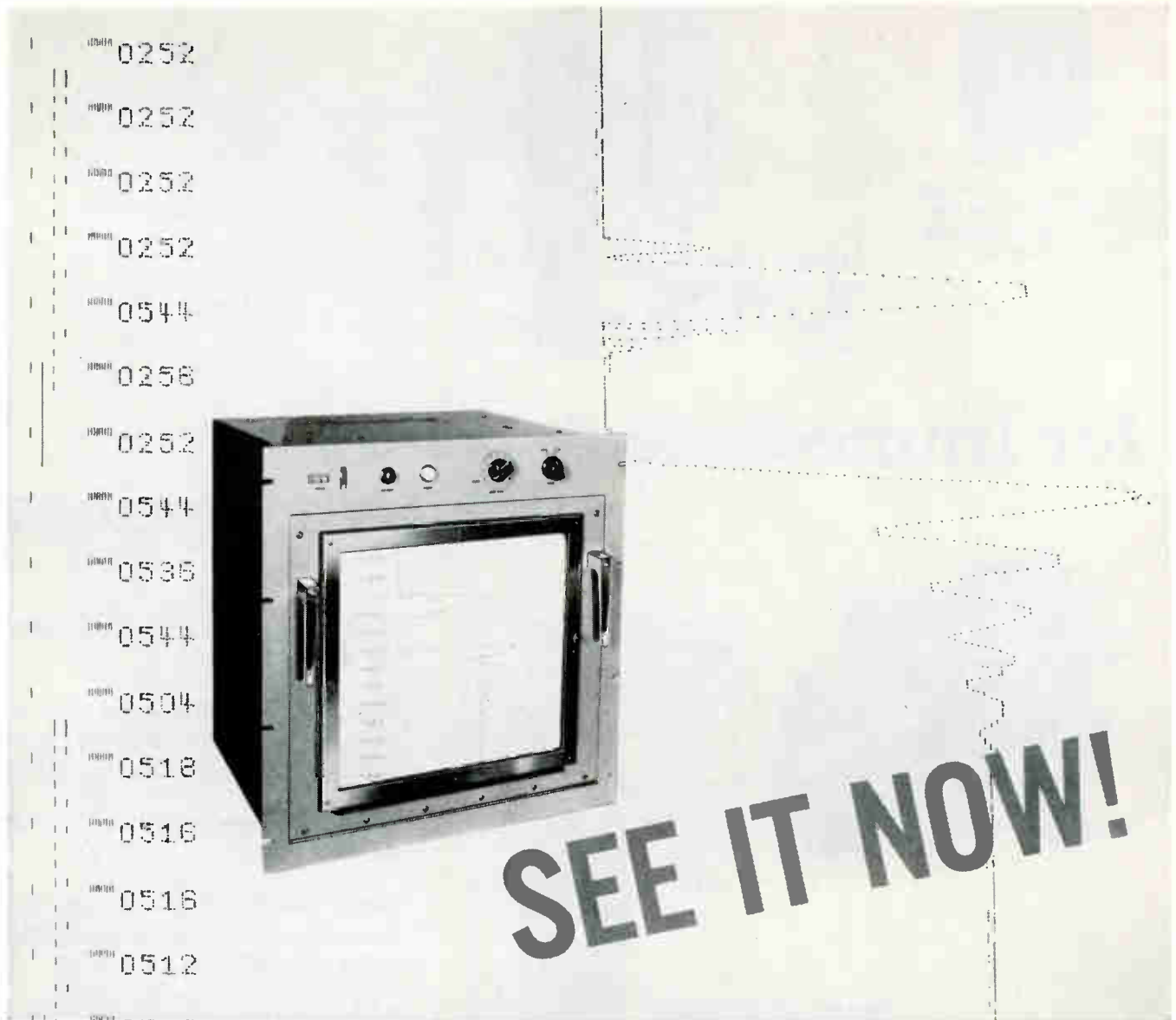

## **RADICORDER provides instant visual readout of data**

Radiation's RADICORDER—and only the RADICORDER—lets you view digital data in alpha-numeric printed form *as the data are generated*.

The RADICORDER employs fixed styli to record up to 646 specific levels on electrosensitive paper. On-off operations, discrete-level analog plotting, alpha-numeric printing, and direct printout in any digital-code format may be performed individually or simultaneously by the unit.

The RADICORDER can be integrated easily into any high-speed data processing or analysis system requiring real-time data presentation. As an editing building block, its Quick-Look feature permits direct analysis of raw data, thus reduces computer workloads.

Features and typical capabilities of the RADICORDER are more fully described in Bulletin A-100. Write for it. Radiation Incorporated, Dept. EL-10, Melbourne, Fla.

### **THE ELECTRONICS FIELD ALSO RELIES ON RADIATION FOR...**

**RADIPLEX** — 50-channel low-level multiplexer with broad data processing applications. Features rugged solid-state circuitry, almost unlimited programming flexibility, unique modular construction for compactness and exceptional ease of operation and maintenance.

**TELEMETRY TRANSMITTER** — Model 3115 is a ruggedized 215-260 MC unit with extremely linear FM output under the most severe environmental conditions. With its record of outstanding performance in many missile programs, Model 3115 is specified by leading missile manufacturers.

**TDMS** — Telegraph Distortion Monitoring System pinpoints type and source of trouble on teleprinter, data processing and similar communications links without interrupting traffic. Ultra-compact TDMS can replace most test equipment now required for teleprinter maintenance and monitoring.



**RADIATION**  
INCORPORATED

# LOG FOR LESS

... \$575 to \$1100 less with the new NLS 484 digital voltmeter



Here is the only 4-digit voltmeter to provide printer connection and automatic print control for only \$2150 . . . the only digital voltmeter at this price to provide heavy duty *plug-in stepping switches*, snap-out readout, and simple single-package design. With plug-in NLS accessories it forms a host of automatic data logging systems. Performance? The 484 retains the basic design and quality construction of the NLS 481, the world's most popular 4-digit voltmeter. Contact NLS for complete information on the 484 if you require  $\pm 0.01\%$  accuracy and printout at low cost.

*BRIEF SPECIFICATIONS: Accuracy  $\pm 0.01\%$  of full scale on each range . . . ranges:  $\pm 9.999/99.99/999.9$  volts DC,  $\pm 99.99/999.9$  millivolts DC using NLS 140 Preamplifier,  $9.999/99.99/999.9$  volts AC using NLS 125B AC/DC Converter . . . input impedance: 10 megohms at balance, 1000 megohms on lowest range by modification . . . automatic range and polarity selection . . . balancing time: 1 sec., average . . . internal standard cell for verification of calibration . . . simple conversion to ratio meter.*



Originator of the Digital Voltmeter

**non-linear systems, inc.** DEL MAR (SAN DIEGO), CALIFORNIA

# Nickelonic News



DEVELOPMENTS IN NICKEL AND NICKEL ALLOYS AND THEIR APPLICATIONS

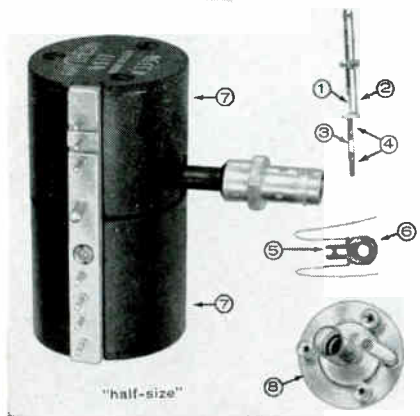

## Designers insure magnetron reliability with 4 nickel alloys

WALTHAM, MASS: Recently announced by Raytheon Company, the #6177 Magnetron is compactly designed for height finding, other airborne radar uses. Size is small, weight only 1 lb, range is 4261-4300 megacycles at 1 watt.

To insure the magnetron's operating reliability, Raytheon designers use 4 nickel alloys in 13 critical parts. (8 parts are numbered in above photo.) Designers report why:

Electronic Grade "A" Nickel offers outstanding purity in ribbon (1).

Inco "220" Nickel assures proper outgassing in washer ring (2), tube (3), tube shield (4).

Another nickel-chromium alloy retains non-magnetic characteristics in reed (5), and reed coil support (6).

Alnico (nickel-iron alloy) magnets provide stability (7); cupro-nickel pole support provides strength, non-magnetic characteristics (8).

**Pertinent Literature:** Send for 51-B; "Nickel Alloys for Electronic Uses" (see box, below) and T-15; "Engineering Properties of Nickel."

Circle 563 on Reader-Service Card

Newly Revised Booklet—"Nickel Alloys for Electronic Uses"—gives you facts on 17 freely available nickel alloys useful in the electronics industry... facts on typical applications, physical and chemical properties, available mill forms. Ask us for your copy.

## Metal that acts like air wraps half-mile vacuum

UPTON, N. Y. In the huge new 25-Bev Synchrotron at Brookhaven National Laboratory, Inconel "X" age-hardenable nickel-chromium alloy—"a metal that acts like air"—is used to contain a 1/2-mile-long proton beam vacuum cavity.

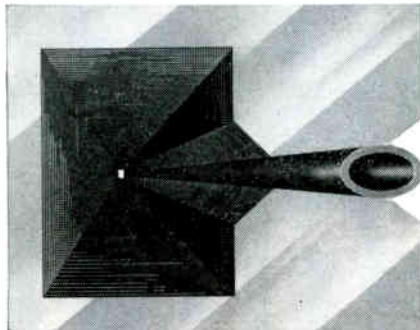

Tube of low-magnetic Inconel "X" alloy carries Synchrotron's 25-Bev proton beam between magnet jaws. Tube's assembled, in sections, into a circle 1/2 mile around.



Inspecting one of Synchrotron's 240 magnets. This one weighs about 17 tons. Inconel "X" tube fits into narrowest gap between jaws.

Principal reason for the selection of Inconel "X" alloy, reports Brookhaven, was its high electrical resistivity. This resistivity, about 740 ohms per circular mil-foot, results in the avoidance of high eddy currents. In addition, the low magnetic permeability of Inconel "X" alloy, approximately the same as air, has virtually no effect on the strong magnetic field passing through the tube walls to guide the proton beam.

### Inconel "X" also benefits vacuum cavity tube in other ways

Its high structural strength permits thin-wall construction—tensile strength after heat treatment, above 130,000 psi. Other physical properties important to this application—the alloy's low vapor pressure, good degassing, freedom from porosity.

Inconel "X" alloy provides good fabricability, too—tube is formed in sections from 0.078-inch sheet, welded and flanged.

**Pertinent Literature:** Send for 51-B; "Nickel Alloys for Electronic Uses."

Circle 564 on Reader-Service Card

## Monel speeds sound brazing of resistor caps

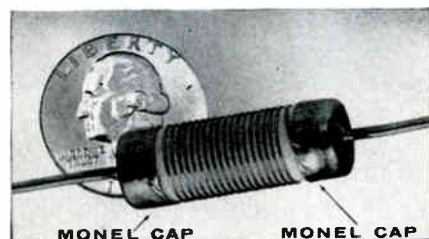

Close-up of Monel caps soundly brazed to wire winding and leads of semi-finished resistor. Made by Sage Electronics Corporation, 302 N. Goodman St., Rochester 7, N. Y.

ROCHESTER, N. Y.: Monel<sup>®</sup> nickel-copper alloy now makes possible, fast, sure brazing of connections in resistors designed for severe service by Sage Electronics Corporation (see photo, left).

In the caps, Monel alloy also gives excellent resistance to corrosion in murderous environments...and provides essential strength for anchoring leads.

### Monel boosts durability in other electronic components, too

In one magnetron, for example, Monel alloy provides an output flange and mounting plate with the toughness and strength needed for 6000-hr life. In fastenings, Monel alloy stands up against both corrosion and hard knocks. In backing for contact points, Monel alloy contributes important strength and brazing properties.

**Pertinent Literature:** Send for 51-B; "Nickel Alloys for Electronic Uses" and T-5—"Engineering Properties of Monel and 'R' Monel."

<sup>®</sup>Inco trademark

Circle 565 on Reader-Service Card



# ALLOY PRODUCTS

**THE CREATIVE CAPACITY OF MAN IS EQUAL TO THE CHALLENGE OF SPACE.** This is the supreme equation of our time. Scientists and engineers at Martin-Denver are among those who have made significant contributions toward proving it. You may be aware of their advances in the physical and bio-sciences, in space vehicles and systems. If you would like to join them, write: N. M. Pagan, Director of Technical and Scientific Staffing, Martin-Denver, P.O. Box 179A1, Denver, Colorado.

---

**MARTIN**  
DENVER DIVISION

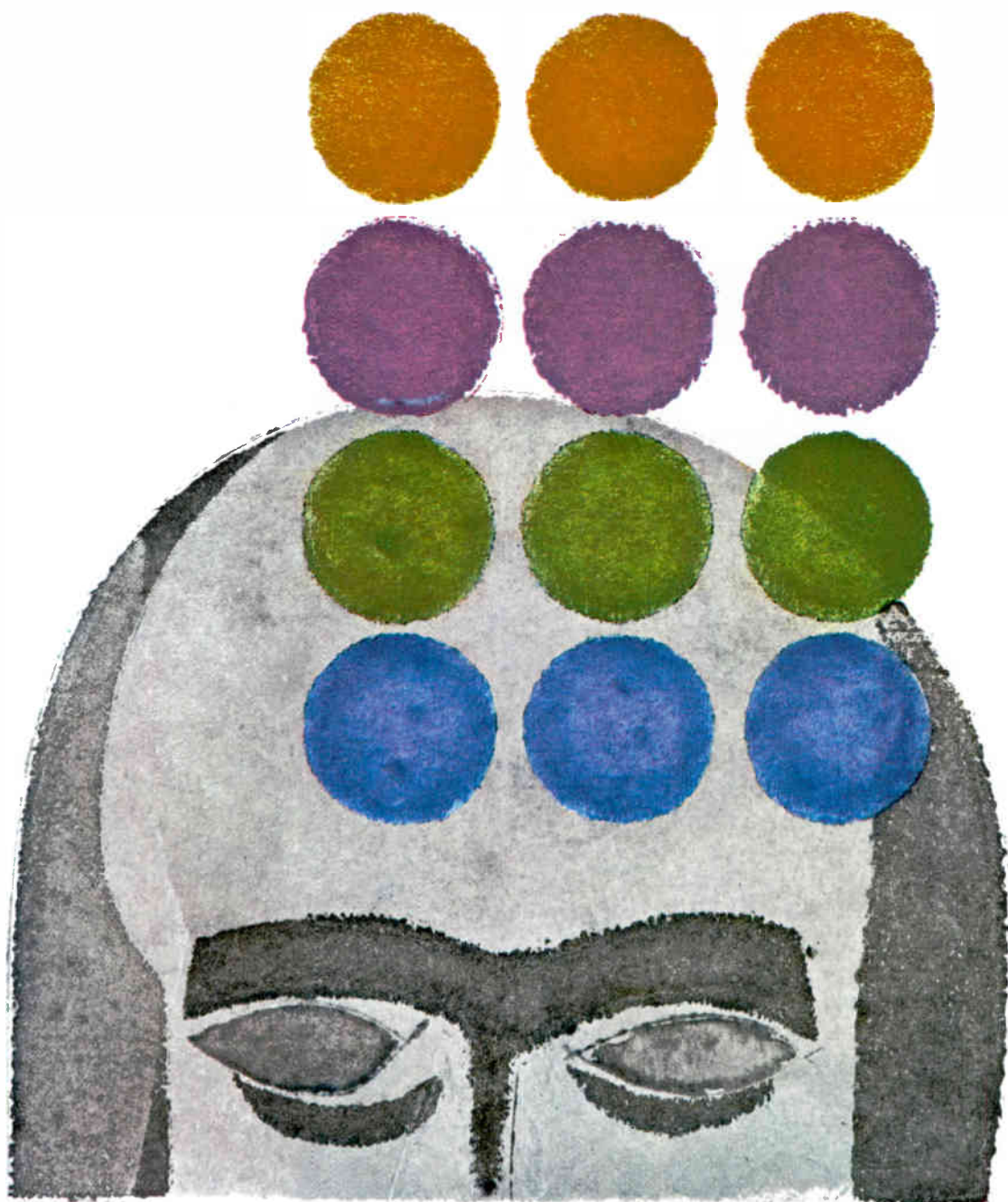

DESIGN: ALDCROFT



**The Man who** runs the Mincom plant has just told us we can't use advertising's favorite cliché—the competitive comparative. You know: “richer, fuller, milder, more popular” and like that. Richer than *what*, he says. Okay. No use crying over spilt milk, just makes it salty for the cat.

This heartless ukase does cramp our style today, though, because we want to give you the story of Extended Frequency Response at Lower Tape Speeds, or, why You Too should own the one-rack-wonderful Mincom Model CM-100 Instrumentation Recorder Reproducer.

We were going to say that the CM-100 gives you twice the performance (which it does) and then the Man said twice *what* performance and that was that.

### You Be The Judge

Anybody who knows the difference between passband and bandwidth ought to realize this: When you have a system like the Mincom CM-100 that records and/or reproduces 1 mc at 120 ips for 12 minutes, it's giving you twice *something*. Even if it's only twice 500 kc at 120 ips for 12 minutes. But if you want to play *that* way, the irrepressible CM-100 gives you 24 minutes with 500 kc at 60 ips, and that's the way it goes for all of its six fashionable speeds. Here's a handy, businesslike (and dull) tabulation that tells the story:

Frequency	Speed	Recording Time
62.5 kc	7½ ips	3 hours and 12 minutes
100 kc	12 ips	Two fun-filled hours
125 kc	15 ips	96 minutes (1.60 hrs.)
250 kc	30 ips	48 minutes (lunch)
500 kc	60 ips	24 minutes (call your wife)
1 mc	120 ips	12 minutes (coffee break)

Greater bandwidths at slower speeds equal longer recording time. Q.E.D.

### All This And The DC Top Plate, Too

The Model CM-100 is graced in its upper story by the Mincom DC Top Plate. (So is our C-100, but that's for another day.) Both functionally and artistically, this top plate, the darling of the instrumentation business, is the living end. We made the glass in the dust door a lot bigger recently, just so you could see the trouble that isn't there any more. Only 12 moving parts and four easy adjustments, and the whole DC assembly is so cross-referenced, phase-referenced and interlocked that you have lots more control in the lab than you ever will at home with your loving family.

The ancient and honorable chore of belt-changing is passé. Now, with the DC top plate, you simply figure out what speed you want, take dead aim and push the button.

Instantly you get your choice of the six favorite speeds listed in the table in column at left.

Dynamic braking, performed swimmingly by smooth little DC torque fields, makes life sweeter by far than it was when those troublesome and extinct mechanical brakes were in vogue. Three similar shunt-type motors do the job on takeup, capstan and rewind. This means that if you have six motors and two CM-100's you are (all else being equal) in business.

### The Commercial

With the higher bandwidths at lower speeds, plus the DC top plate, you ought to be pretty interested in the Mincom Model CM-100 by now. We have a Most Informative Brochure with dandy four-color pictures all through it. Why don't you send for it today? (Please.)



...WHERE RESEARCH IS THE KEY TO TOMORROW

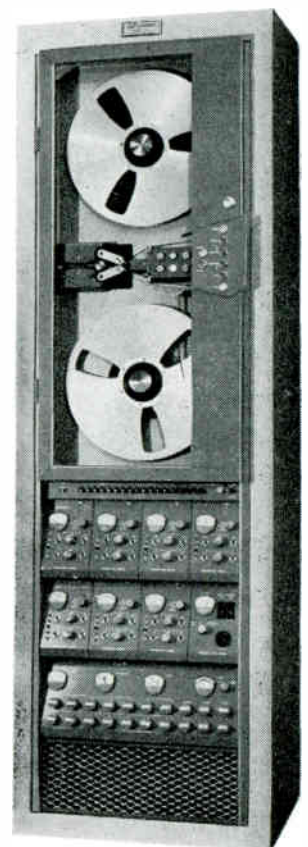

**MINCOM** DIVISION **MINNESOTA MINING AND MANUFACTURING COMPANY**  
2049 SOUTH BARRINGTON AVENUE, LOS ANGELES 25, CALIFORNIA • 425 13TH STREET N.W., WASHINGTON 4, D. C.

New application for  
microwave links with NEC's transistorized

13 kmc transmitter-receiver

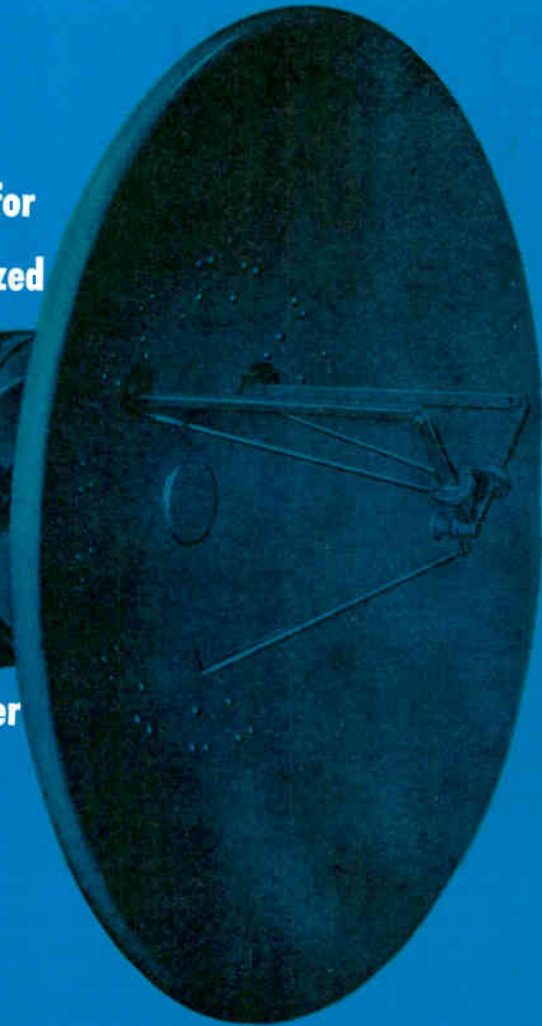
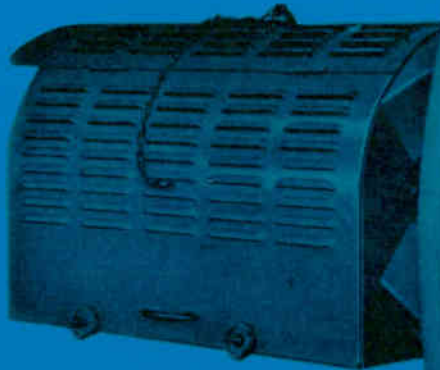

4-foot antenna and attached housing for 13 kmc transmitter-receiver.



Terminal bay contains channel equipment and power supply panel.

This equipment is designed as a short-haul multi-channel telephone, remote control, and telemetering link for use especially at locations with difficult access. Circuits are fully transistorized except for a single klystron. Power consumption is 30 W.

Though not designed as portable equipment, it is so compact and light-weight that it is adaptable for use in emergency and disaster communications. It also makes a low-cost temporary communications link such as required at a construction site.

**Summary of features:** • Operates at 13 kmc, where the spectrum is relatively uncrowded and antenna gain is high. • Single reflex klystron (VA92C equivalent) is used for both transmitter and receiver local oscillator. • Polemounted transmitter-receiver with power output of 100 mw. • Operates from commercial power line or 24 dc volts. • Provides 4 am or 12 ssb telephone channels. Carrier equipment available to provide up to 60 ssb telephone channels.



*Nippon Electric Co., Ltd.*

Tokyo, Japan

Communications Systems / Electronics

# Bearingless Gyroscope Makes Debut

*This week's National Electronics Conference also hears*

*about continuously tunable parametric amplifier and technique  
for coupling subsurface communication systems*

CHICAGO—VISITORS to this week's National Electronics Conference here had an opportunity to hear 119 speakers discussing 25 different subjects ranging from combinational logic to engineering management.

A look at the papers indicates engineers are becoming more embroiled in theoretical concepts, with all attendant mathematical complexities. Most papers were directed at people deeply immersed in a field—few papers treated broad subjects of general interest.

A bearingless, magnetohydrodynamic gyroscope capable of sensing Coriolis forces about two axes simultaneously was described by R. V. Monpole. Developed by Speidel Corp. on a proposal of P. F. Maeder of Brown U., the device has given test results indicating its practicability.

The gyro, shown in the figure, consists of a cylinder concentrically mounted inside a sleeve with the space between them (annulus) filled with mercury. Both cylinder and sleeve are made of high permeability magnetic material. The ends of the annulus are closed with copper rings which conduct current passing through the mercury.

Ports in the copper rings provide means for measuring pressures the mercury exhibits at points displaced 90 degrees around the spin axis. Longitudinal slots (not shown) containing copper wires wound like stator windings of a three-phase

induction motor are spaced around the cylinder's outer circumference.

Three-phase currents in the stator windings cause a rotating magnetic field to be directed radially across the annulus. Interaction between the eddy currents induced in the mercury by the field and the field itself causes the mercury to be driven around the closed annular path.

When the gyro is rotated about any axis other than the spin axis, a Coriolis force acts on the spinning fluid, creating a pressure gradient along the spin axis. Magnitude and direction of the pressure differential developed from one end of the fluid annulus to the other are a function of magnitude and direction of the input angular velocity.

Conversion of the pressure signal to an electrical output signal can be done by using mercury cutoff switches or differential transformers. In the former, the tip of a metallic contact placed in mercury is either covered or uncovered by an insulating diaphragm actuated by the differential pressure, thereby opening or closing an electrical circuit. In the latter, the differential pressure acting on a diaphragm or piston causes linear motion of a magnetic core within standard differential transformer windings.

With input power of less than 10 watts, output obtained was 1/10 of an mm of H<sub>r</sub> pressure/deg/sec of input rotation. Greater sensitivities can be obtained using higher

input power in a larger device when space and weight are not limiting factors.

M. C. Gittinger of GE reported encouraging experimental results with a negative resistance parametric amplifier capable of continuous tuning over 350-1,200-Mc.

Intended for use in satellite and space probe tracking operations, the frequency range includes transmitting frequencies of most space probes launched to date.

The amplifier uses a waveguide H-plane cross for the pump and idler circuits and a fixed pump frequency of 10 Gc as shown in the figure. This design is mechanically simple, lends itself ideally to electrical requirements and permits up to six filter and cavity tuning elements to be closely coupled to the diode giving an unusual large tuning range.

Net gain of 30 db was obtained in an experimental model over the operating frequency range. Test results show that successful continuous reception of signals is possible, providing care is taken with power supply, voltage stability and temperature control.

Techniques for coupling electromagnetic energy from the radiator or transmitter antenna to a highly conducting medium, such as earth, were described by R. N. Ghose of Space Electronics Corp. He said the difficulty is maintaining an appreciable current in a horizontal or a vertical linear antenna immersed



# at NEC

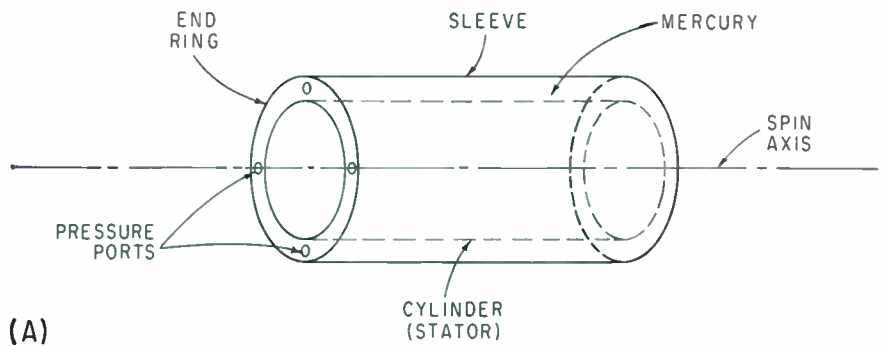

(A)

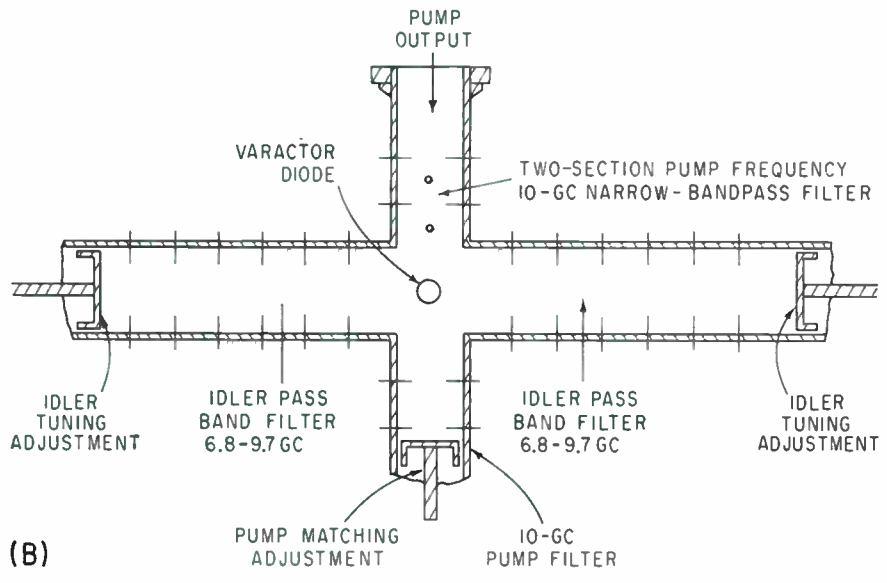

(B)

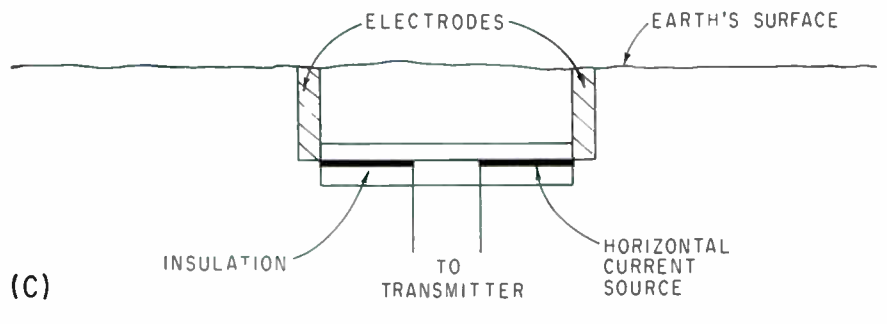

(C)

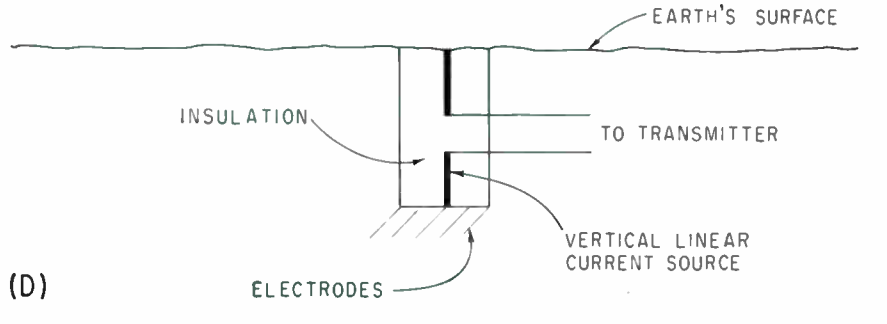

(D)

in the conducting medium.

Since earth's conductivity is usually very high, the skin depth for the earth is very low for frequencies of interest in subsurface communication. Consequently, it is exceedingly difficult to maintain a current in an appreciable length of underground transmitting antenna.

Effective energy coupling can be obtained by placing the current source in an air-filled cavity where earth constitutes the cavity walls. Radiators are linear current sources oriented parallel or perpendicular to the earth's surface as shown in the figure. Electrodes are necessary for impedance matching, particularly when electrical length of the radiator is small in comparison with the half-wavelength.

The problem of optimizing the radiating antenna is solved in four distinct steps. First, the field from a horizontal, linear current source having an arbitrary current distribution is determined. Second, current distribution along a typical subsurface antenna is found. Third, the electromagnetic field at the receiver is evaluated from various arbitrary antenna parameters, such as length and insulation thickness of the radiating wire. Fourth, the receiver field is maximized by adjusting the antenna parameters.

Theoretical expressions for finding antenna characteristics and radiation patterns have been derived and results have been verified experimentally.

*Symbolic diagram (A) shows MHD gyro. Cylinder and windings are potted in epoxy resin. Construction of waveguide cross assembly for continuously tunable parametric amplifier is shown in (B). Horizontal and vertical underground radiating antennas for subsurface communication are arranged as indicated in (C) and (D), respectively*

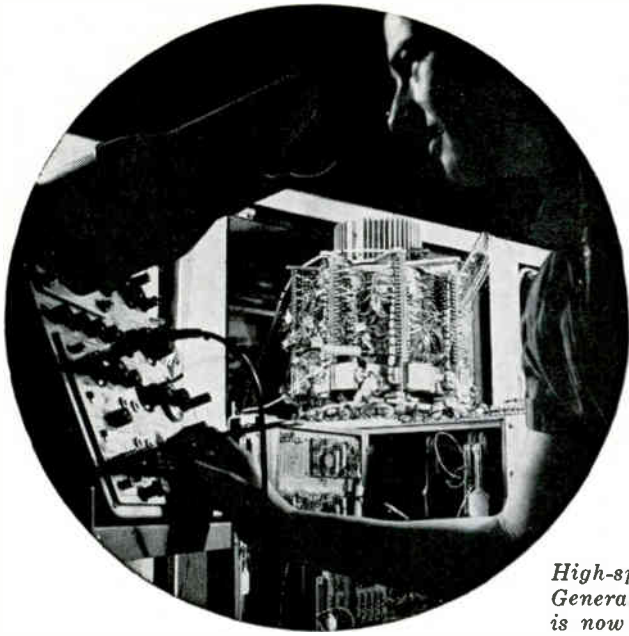

## Air Agency Displays Electronics Progress

*Weather facilities, collision warning  
and avoidance and height-finding  
radars are key jobs.  
Infrared is being investigated*

*High-speed buffer memory drum of  
General Precision's air-traffic computer  
is now undergoing test at NAFEC*

BIG FLY-IN held recently by Federal Aviation Agency's Bureau of Research & Development showed aviation and industry observers many of the new devices under development and evaluation. The fly-in (plus associated clambake) was held at National Aviation Facilities Experimental Center near Atlantic City, N. J.

NAFEC's exhibition of programs and projects at the fly-in was the second of what FAA expects to be an annual series. The air agency uses the occasion to inform general aviation about its overall program and progress.

The show was in many respects as diverting as the boardwalk attractions found during the summer 11 miles away in Atlantic City. New runway lights, light-modulated proximity-warning indicators and brilliant high-visibility paints provided the necessary flash and color. And the electronics projects (see "What Our Air-Traffic-Control Dollars Buy," *ELECTRONICS*, p 28, Sept. 2) provided the main attractions.

Immediate NAFEC projects involve improved airborne equipment for general-aviation craft, better weather information for pilots, and more efficient use of existing airport facilities. For the future, weather facilities, collision warning and avoidance and height-finding radars are key jobs. Infrared techniques are presently being in-

vestigated for collision-warning potentialities.

Further off, FAA plans to work on better recognition and guidance of aircraft in airport traffic patterns, ground-speed indicators, a standardized instrument panel for general-aviation planes, and the problem of turbulence in and around air terminals not caused by aircraft.

FAA has completed a study of the shortcomings in existing weather observation and reporting, will shortly report its findings. Another study is looking at the value of putting the pilot and the weather forecaster in direct conversation,

The agency says it is close to development of an airborne distance-measuring equipment instrument, and two companies are working on the development of a general-aviation transponder for use with groundbased radar in air-traffic control. Another project aims at a minimum airborne navigation system, which also could be used by the general-aviation pilot.

So far in 1960, NAFEC has reported more than three dozen finished projects to FAA headquarters. Electronics projects completed are minor by comparison with the ones still in the house. They include installation of a Mark D Decca navigator in a C-131 for continuing evaluation of this controversial system; evaluation of Bulova's altimeter; an experimental

video teaching system; evaluation of doppler Vor (vhf omnirange) sideband transmitters; development of cockpit voice-recording equipment.

The center has also simulated traffic patterns at a total of 10 metropolitan airports, from Los Angeles to Atlantic City. It has evaluated voice-intelligibility equipment and modified the standard Alford loop antenna to work with doppler Vor.

Safety in the air is the theme of all its projects from the evaluation of the Convair 440 fire-extinguishing system to the development and installation of aircraft arresting gear.

One key program may result in development of multiple air routes "from anywhere to anywhere" using only existing airway ground aids. Experiments involve pictorial displays and small pilot-carried computer devices.

ACF Electronics and ITT Laboratories have developed prototype pictorial displays about 8 in. square and 3 in. thick that the pilot can hold in his lap. These displays are connected to the airborne receivers which are tuned to the range stations that mark the airways. A symbol on the display marks the position of the craft, moves across a chart as the plane progresses. FAA estimates that production models should cost about \$1,000.

ACF Industries is also building

a prototype of a pictorial computer for larger craft (including commercial carriers). This computer would be connected to both the radio ranges and the automatic pilot, is meant to fly the plane accurately on any route designated between any two points using the ground stations as guides.

Prominent on the NAFEC grounds is the new air-height surveillance radar antenna, raised late last month. The antenna was made by W. L. Maxson, weighs 100 tons, stands 168 ft high. It is a triangular prism standing on its cross-section; each of three sections covers 120 deg in azimuth, consists of 10 miles of drilled aluminum wave-guide making up 1,056 antenna elements.

Another experiment new this month is use of ocean-based Vortac (Vor with Tacan-compatible distance-measuring equipment). The U.S. Coast Guard cutter *Andros-coggin* has been outfitted with Vortac, is sailing in and around Chesapeake Bay this month to check out the feasibility of providing navigational guidance on air routes over water expanses with this standard navigational aid.

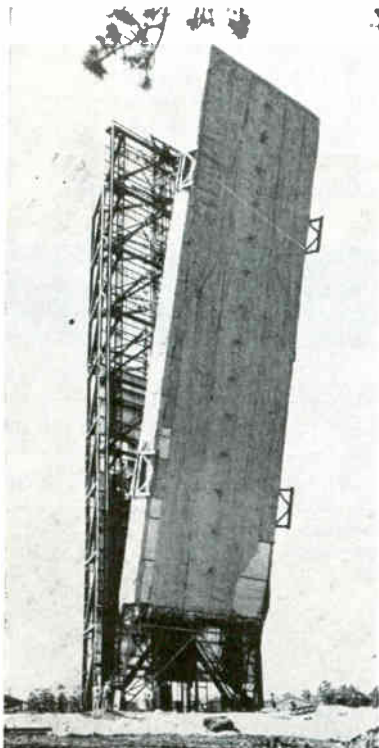

Antenna tower 168 ft high went up at NAFEC last month for FAA's air-height surveillance radar

October 14, 1960

## For 400 CPS Cooling Applications



# AXIMAX-3

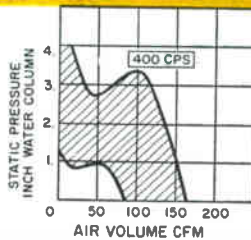

For airborne and missile cooling applications, the AXIMAX-3 when turning at 20,000 rpm will deliver 165 cfm at free delivery. This performance is possible although the fan is only 2.8" in diameter, 2.3" in length and weighs a mere 14 ounces.

Variation in driving motors include constant speed and Altivar designs. The latter automatically vary their speeds inversely with density and thereby approach constant cooling with a minimum of power drain and noise.

Mounting is simplified by the provision of "servo" clamping rims at either end of the barrel. Airflow can be reversed by turning the fan end-for-end. Electrical connection is made to a compact terminal block. Power requirement is 400 cps, 1 or 3 phase.

Write today for complete technical details to . . .



## ROTRON mfg. co., inc.

WOODSTOCK, NEW YORK

In Canada: The Hoover Co., Ltd., Hamilton, Ont.

CIRCLE 41 ON READER SERVICE CARD

41

# NEW CR\* POWER SUPPLY



**NJE Offers Greatest Power Per Panel Inch!**

0-36 V	0-6 A	3 1/2" High
0-36 V	0-20 A	7" High
0-18 V	0-30 A	7" High

- \*Controlled Rectifiers
- Low Cost
- Remote Sensing
- Remote Programming

- \*Fully Transistorized
- Series Operation
- Parallel Operation
- Constant Current #

- Convection Cooled, No Blowers

Output		Model No.	Input Power		Max. Ripple mv	Static Regulation		Dimensions H x W x D	Approx. Weight Pounds	Price
Volts	Amps		Volts	Freq.††		Load†	Line†			
0-36	0-6	CR-36-6	105-125	55-65	3 P-P	±0.005% or ±0.5 mv	±0.02% or ±0.5 mv	3 1/2 x 19 x 16 5/8	45	\$595
0-36	0-20	CR-36-20	105-125	55-65	3 P-P	±0.01 % or ± 1 mv	±0.02% or ± 1 mv	7 x 19 x 16 5/8	70	845
0-18	0-30	CR-18-30	105-125	55-65	3 P-P	±0.01 % or ± 1 mv	±0.02% or ± 1 mv	7 x 19 x 16 5/8	70	845

†Whichever is greater  
††Available for 400 cycle operation

\*Preload of 1 ampere required for operation of 0-6 VDC  
\*\*Preload of 1.5 ampere required for operation of 0-3 VDC  
#Contact factory or local representative



WRITE TODAY FOR COMPLETE TECHNICAL DATA

# NJE

## CORPORATION

20 Boright Avenue · Kenilworth, New Jersey  
BR. 2-6000 · TWX Cranford, NJ 51 · FAX-FFP

# NEREM Schedules Over 300 Papers

BOSTON—Northeast Electronics Research and Engineering Meeting (NEREM), third largest industry show and technical meeting, will be held here Nov. 15-17.

Nearly 400 exhibits will be housed at the Commonwealth Armory, and 40 technical sessions will be split between the armory and the Sheraton-Plaza Hotel.

Held in conjunction with the meeting will be the 4th annual National Conference of the IRE Professional Group on Production Techniques. Two of the NEREM sessions have been arranged by the PGPT.

In addition, the Bureau of Naval Weapons will sponsor two classified sessions on anti-submarine warfare, reportedly the first time the Navy has linked such a gathering to the national meetings of a professional society.

More than 13,000 attended NEREM last year, and this record is expected to be broken next month.

For the first time, a digest of the more than 300 papers will be available at the opening of the conference.

IRE Sections sponsoring NEREM have this year concentrated on a national, and even international flavor in the technical sessions. Among papers from overseas will be a British presentation on automatic testing of transistors.

Among features of the technical program will be a session on oceanographic instrumentation, a workshop on engineering writing and speech, and an evening discussion of "New Frontiers in Space Electronics."

Keynote address of the conference will be delivered by Jerome B. Wiesner, director of the MIT Research Laboratory of Electronics.

## Nuclear Explosion Simulator Designed

DESIGN STUDIES have been completed for a linear accelerator that may be carried aloft in a missile and used to simulate certain aspects of high altitude nuclear detonation, reports Samuel Horowitz, Propagation Sciences Laboratory, Electronics Research Directorate of the Air Force Research Division.

The airborne linear accelerator will weigh about 200 lb and has an energy range of 100 Kev to 2 Mev. At these energy levels the accelerated electrons will simulate the beta radiation of nuclear explosions.

The accelerator's light weight is made possible by the fact that no heavy vacuum gear will be associated with the equipment, since it will operate only at the outer fringes of the atmosphere, above 62 miles, where a high vacuum exists.

Of special interest will be tests to determine electron depletion processes in the D layer. The design study was carried out by Aeronutronics Systems, Inc.

## University Sets Up Metrology Institute

FORMATION of an Institute of Measurement Science is announced by George Washington University's school of engineering. The metrology institute will be set up on the school's Washington campus, will operate with the support of the National Bureau of Standards.

GWU engineering dean Martin Mason points out that the U. S. seriously lags the USSR in the field of metrology (item: the Soviets claim to be able to measure temperatures accurately to 6,000 C; NBS can calibrate only to 4,200 C). NBS spokesmen stress the urgency of the situation, point out that electronics and space industries, more than any other field of technology, need accurate measurement standards.

The Martin Co., Baltimore, provided the original funds to set up the institute.

## Hospital Communications Use Uhf Paging System

INTEGRATED HOSPITAL COMMUNICATIONS system was announced last week by Dahlberg subsidiary of Motorola. The system includes a transistorized nurse-call system, along with a uhf paging unit to permit calls within a 15-mile radius of the hospital.

A pillow speaker puts the nurse into two-way communications with each patient; the patient's speaker ties into a 19-inch tv, a-m and f-m radio, and the hospital's internal radio-tv net.

The nurse-call system projects the patient's room number, bed number and the critical priority of the patient to a central control station. Dahlberg says that one nurse could monitor up to 396 patients.

The uhf paging unit will be used to locate doctors when they are out of the hospital as well as when they are on duty. The company estimates that the system can handle up to seven thousand patients.

## Courier Satellite Nerve Center

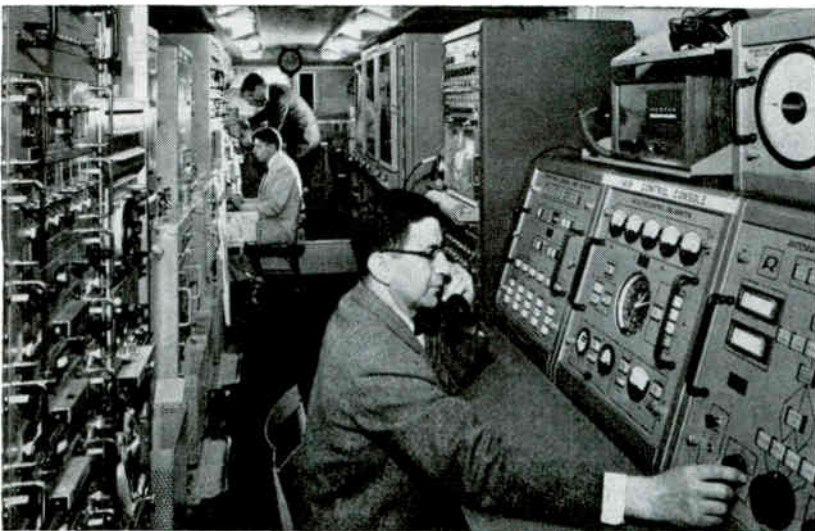

Working in control van, ITT engineers direct ground communication system for Courier satellite. Console monitors and controls entire ground complex and electronic functions of satellite

# Air Force Plans Materials Study

*New radiation lab will check performance under conditions of radiation, extreme temperatures, vibration and acceleration*



*Van de Graaff generator (vacuum tank removed) installed at new radiation physics lab*



*Output equipment, on floor below generator. Targets bombarded are placed in front of horizontal tube at left*

BOSTON—"YOU CAN'T STUDY radiation effects on electronic materials by just sticking them in a reactor to see what happens," an Air Force scientist told *ELECTRONICS* last week. "Today you have to consider an environment combining radiation, extremely high or low temperatures, vibration and acceleration."

And early next year the Air Force will have just the place to carry on advanced work in materials. It's the new radiation physics laboratory at Cambridge Research Laboratories in Bedford.

The lab will use a 3-Mev Van de Graaff generator, a 1.5-Mev Dynamitron type of electron accelerator and a 10,000-currie cobalt-60 source. Of course there will be equipment for analyzing materials before and after radiation. Bernard Manning of AFCRL's electronic materials sciences lab will direct the program.

Air Force researchers say that it is of little use to know how a transistor acts in a nuclear reactor at room temperature when you really want to find out what material to use in developing a device to rectify 1 amp alternating current in a  $10^{17}$  nvt (integrated neutron flux) at liquid hydrogen temperatures and also at 1,000 C.

Gaps in our knowledge of how materials behave show up in trying to design electronic equipment compatible with a nuclear-powered liquid-hydrogen-fueled ramjet. Data collected on components and equipment at 30 to 100 C will have to be set aside and the work repeated at liquid-hydrogen temperatures.

At this low temperature, atomic displacements caused by radiation are largely frozen in and the effects of radiation are, therefore, enhanced over effects produced at room temperature where considerable annealing can take place. Will glass envelopes of tubes crack, will plastic insulators crack, will some metals and alloys become superconductors? Will ferromagnetic mate-

rials be as resistant to radiation?

The AF program is concerned basically with learning in detail how presently used materials and devices react to radiation, to determine the physical, chemical and electrical alterations induced in solid-state materials. The approach envisions irradiation with known monochromatic particles (very fine, clean sources) and gamma rays at known intensities, leading to the development of prediction theories. A quantitative analysis is sought, where efforts to date have been largely qualitative.

At present, the researchers say, it is impossible to declare that the effect of a 1 Mev electron is  $\frac{1}{3}$  that of a 25 Mev electron, or that the effects of a 1-Mev proton is or is not similar to a 0.01-Mev neutron in producing atomic displacements.

The radiation physics lab program will embrace more than study of radiation effects. It will include testing before and after radiation, preparation of pure chemicals and perfect physical specimens, special device fabrication, physical testing and data analysis.

Also needed is determination of the effects of temperature on annealing rates. Lack of knowledge in these areas is almost complete, AF scientists say. Scientists do know details of the annealing curves as indicated by resistance changes and/or recombination velocity changes for germanium, silicon and copper.

But the minimal energy incident radiation damage thresholds should be known, not only for these elements but for the many elemental and compound semiconductors so vital to miniature electronics.

Also needed but not available are information on: shifts or creation of energy levels; alteration of surface conductive properties with interaction with environments; decay time of active electronic states; transient effects caused by short bursts of radiation on conductivity and lifetime; more details on radiation effects at low temperatures.



Engineered for  
**OUTSTANDING**  
**LONG-LIFE**  
**CHARACTERISTICS**

**AEROTAN**®

## **SOLID TANTALUM CAPACITORS**

Whenever your spec calls for miniature size, light weight and long-life performance over a wide range of severe environmental conditions there can only be one answer...Aerovox AEROTAN Solid Tantalum capacitors.

Aerovox offers you a complete line of solid electrolyte units manufactured in the industry's newest and most advanced production facility. These subminiature units are housed in hermetically sealed metal cases and feature a semiconductor electrolyte to assure a completely dry assembly with absolute freedom from corrosion or leakage.

You'll find Aerotan capacitors most applicable in DC blocking, AC coupling and bypass and filtering applications as well as in integration, storage phasing and timing applications. Manufactured in un-insulated case styles (ST12) and insulated cases (ST13) they are designed for continuous operation over the temperature range of  $-80^{\circ}\text{C}$  to  $+125^{\circ}\text{C}$  in voltage ratings of 6, 10, 15, 20, and 35 VDCW for  $85^{\circ}\text{C}$  operation; in 4, 7, 10, 13, and 23 VDCW for  $125^{\circ}\text{C}$  operation.

Get all the facts on these superior solid tantalum capacitors by writing to...

**AEROVOX CORPORATION**

NEW BEDFORD, MASSACHUSETTS



## SQUARE-LOOP TAPE CORES TO MEET YOUR TOUGHEST SPECIFICATIONS

Speed your specs to Dynacor when you want square-loop tape cores *to exact requirements—fast!* Here you'll find a dependable combination of personnel, experience and facilities—the know-how to deliver parameters to your very tightest tolerance requirements for switching time, flux, and noise.

Dynacor Square-Loop Tape Cores are manufactured with the high permeability alloys—Grain-Oriented 50-50 Nickel Iron, 4-79 Molybdenum Permalloy, and Grain-Oriented 3% Silicon Iron . . . with fully guaranteed uniformity . . . under rigid standards of control and inspection.

Look to Dynacor for reliable production and swift delivery of your tape core requirements. For your convenience a full line of standard units are stocked for immediate off-the-shelf delivery—Send for bulletins DN 2000, DN 2001, DN 2002.



# DYNACOR

**DYNACOR, INC.**  
A SUBSIDIARY OF SPRAGUE ELECTRIC CO.

1006 Westmore Ave.  
Rockville, Maryland



*Officers of Electronic Engineering Representatives' traveling road show: Roland Reisley (Burlingame Associates) vice president; Ivan Robinson (I. E. Robinson Co.); Bob Asen (RMC Associates) president; Walt Knoop (Gawler-Knoop Co.) treasurer; and Curt Engel (G. Curtis Engel and Associates) secretary*

## Reps Join in Traveling Show

OPENING next week in Watchung, N. J., will be the sixth annual instrument road show of a group of four manufacturers' representatives known as Electronics Engineering Representatives. It represents a marketing technique that is catching on throughout the country.

Two years ago in Texas, a group of representatives began a similar series of local shows. A group of noncompetitive instrument manufacturers has also organized a traveling show. Several manufacturers' representative groups are known to be considering traveling shows.

The traveling show is a compromise between the regional trade show that necessarily takes the engineer away from the plant and the sales van operation in which a manufacturer or representative drives his single line right up to the plant. The traveling show provides a chance to compare competitive product lines as can be done at a regional trade show.

The group consists of Burlingame Associates, G. Curtis Engel & Associates, Inc., the Gawler-Knoop Company, and RMC Associates, all of whom cover the New York and Philadelphia metropolitan areas—with the exception of RMC Associ-

ates, who is replaced in the Philadelphia area by the I. E. Robinson Company.

When the group organized their traveling show they set up the following specifications: the show should be small enough to be seen comprehensively in a reasonable amount of time; it must be unhurried, uncrowded and uncluttered; it should encompass a broad spectrum of engineering products, including a number of competitive types of each basic instrument; and instruments should be dynamically demonstrated—not just on display but working. The show is small because of the limited number of participants, and attendance is held to reasonable numbers because it is presented locally in several different places within the four representatives' territory so that it comes within comfortable reach of all the engineers in the area. It is kept uncluttered by limiting the displays to electronic test equipment. Self-imposed rules limit the kind and quantity of purely promotional display. The exhibit is leisurely and informal, yet intimate and detailed. The hours are noon to 10:00 p.m. Light refreshments are served. Over half a million dollars worth of



equipment, produced by nearly sixty different manufacturers, will be displayed. Fifty field representatives and twenty-five factory engineers will be on hand for booth service. Indeed, there are at times more show representatives than visitors on the floor.

The range of equipment exhibited is broad. The four organizations represent manufacturers with 400 different products, including many parallel and competitive instruments of the same type. The visitor interested in direct-writing oscillographs may examine those offered by four leading manufacturers, each of which retains one or another of the member representatives in the area.

The group's first exhibit was presented in 1955, in a series of one-day showings in Philadelphia, White Plains, New York, Garden City, L. I., and Cedar Grove, N. J. In 1958 Summit, N. J., was added to the itinerary. This year the show will visit Watchung, N. J., instead of Summit and present 11 day-long showings in five localities.

Organizing the exhibits is a joint responsibility. Each day's session is supervised by a floor manager who is drawn from each of the member organizations in turn. Positions of members' booths are interchanged in each locality.

### Network to Install News Alert System

NETWORK ALERT is being provided to all affiliates of Columbia Broadcasting System. The alert will be used to signal affiliates when important news breaks.

Coded signals for six levels of emergency are sent out from net control in New York. (The sixth level, CBS spokesmen say, would be used only if "all hell breaks loose.") Signals are sent over the broadcast carrier on a subcarrier, are not audible to the audience. At the affiliate station, the signal triggers off a set of alarms.

Whether on net or local programming—or even if it's off the air—the station can switch over and pick up the news break. On request, the network will also put remote units in station executives' homes so that they can receive the alert.

## Solid-Electrolyte Tantalex® Capacitors

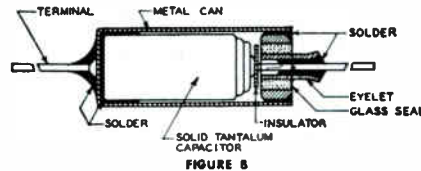
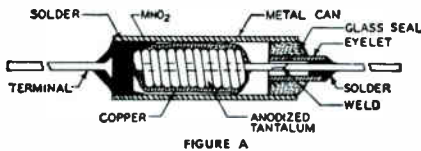

The ultimate in reliability, achieved through constant research, is evident in Sprague Type 150D Solid-Electrolyte Tantalex Capacitors. True miniaturization and excellent stability of electrical characteristics make them ideal for transistor circuits in military and industrial applications.

Figure A shows a typical construction used for low capacitance values. The anode is a coil of smooth-surfaced tantalum wire which has been anodized to obtain the dielectric surface film. This type of anode is used only for fractional capacitance values.

Figure B shows a typical porous anode, hermetically-sealed capacitor. The anode is of the sintered tantalum pellet-type which exhibits a large gain in surface area per unit volume. Thus, the resulting capacitor has a large capacitance-to-volume ratio. It cannot leak or corrode even if the hermetic seal of the outer-metal case be broken or destroyed.

These capacitors may be used wherever stable capacitance and low dissipation factors are dictated over a wide temperature range. The capacitance varies by only a few per cent from room temperature down to -80°C or up to +85°C and the dissipation factor is nearly constant. These capacitors can be used at 125°C with proper voltage derating.

Write for Engineering Bulletin 3520C to Technical Literature Section, Sprague Electric Co., 35 Marshall St., North Adams, Mass.

CIRCLE 226 ON READER SERVICE CARD

## New Molded Dual-Dielectric Capacitors Defy Heat and Humidity

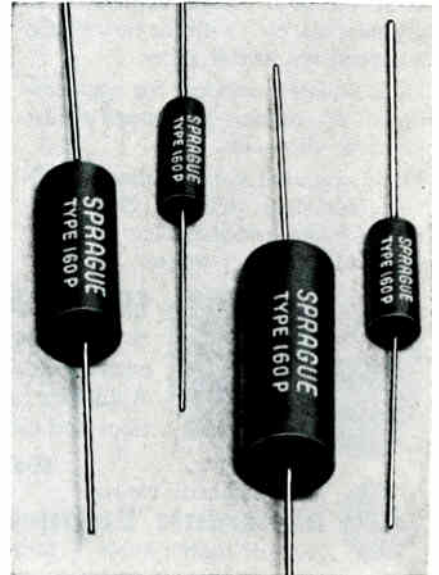

A new line of molded tubular capacitors for entertainment and commercial electronics that can survive the high temperature and humidity of tropical and sub-tropical climates has just been announced by the Sprague Electric Company. Called DIFILM® Black Beauty® Capacitors, these high performance components have a new dual paper-film dielectric and solid impregnant combination which gives both the proven long life of paper capacitors and the effective moisture protection of plastic film capacitors. Units are small in size and low in cost.

These DIFILM Capacitors offer the circuit designer many important characteristics: very high insulation resistance, low power factor, moderate capacitance change with temperature, excellent retrace under temperature cycling, and superior long-term capacitance stability. Maximum operating temperature is 105 C without voltage derating.

For complete specifications on DIFILM Black Beauty Capacitors, write for Bulletin 2025 to Technical Literature Section, Sprague Electric Co., 35 Marshall Street, North Adams, Massachusetts.

CIRCLE 47 ON READER SERVICE CARD 47

# LET'S PLUG

## FOR BETTER TESTING WITH EECo'S TEST SOCKETS

Now all header-terminal components automatically become plug-in devices for test and evaluation, when you test solder-terminal relays, transformers, crystal cans, etc., with the new EECo universal test socket series.

Dual, isolated contacts for each terminal on header eliminates solder joints or clip leads.

Many standard configurations available, immediate delivery. New techniques make special sockets available at standard socket prices.

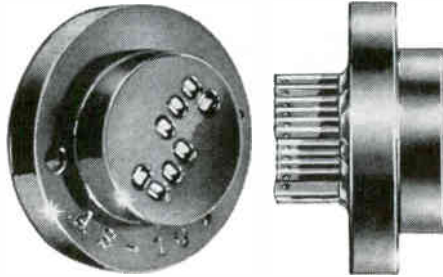

AS-Series Test Sockets



**EECo RT-905 RELAY TESTER** for faster, more accurate testing. Measures voltage and current simultaneously, both pull-in and drop-out time, contact bounce. Automatic relay driving circuitry. Oscilloscope connections and circuitry.

SEND FOR DATA SHEETS AS-101 AND RT-905.



Anaheim Electronics Division

**Electronic Engineering Company of California**

1601 East Chestnut Avenue • Santa Ana, Calif. • Kimberly 7-5501 • TWX: S Ana 5263

EE O-13

CIRCLE 48 ON READER SERVICE CARD



Get the technical facts in **electronics**, the magazine that features the latest engineering developments and technically interprets markets, business statistics, trends. Special issues on Electronic Markets and other reports you'll want to file and keep. Mail the reader service card (postpaid) and start your own subscription to **electronics**, the magazine that helps you to know and therefore to grow! Rates: three years for \$12, one year for \$6; Canadian, one year for \$10; foreign, one year for \$20. Annual **electronics** BUYERS' GUIDE (single issue price \$3) included with every subscription.

subscribe today to **electronics**

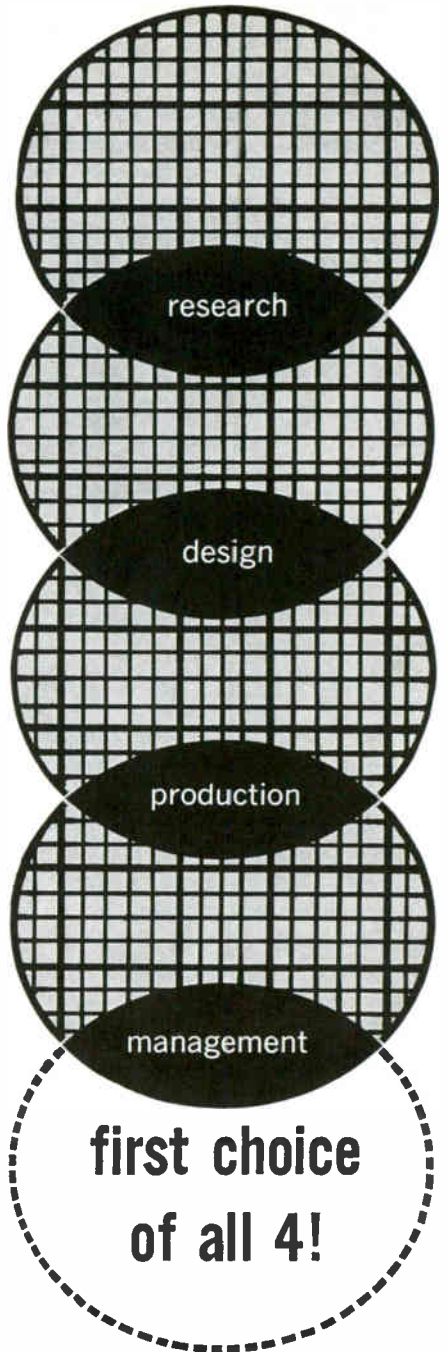

**Because** it is so simple and easy to use. Did you know there are 162 manufacturers of "CAPACITORS-FIXED" keyed to 27 different types starting on page P33 of the BUYERS' GUIDE . . . all listed in the one heading? Only the BUYERS' GUIDE has been edited for the research men, design men, production men and management men who use it. Can't be matched for completeness and accuracy. It's the *basic buying book* of every segment of the industry!

gives more to all 4!

**electronics**  
**BUYERS' GUIDE**  
and REFERENCE ISSUE

## New Contracts Push Missiles, Space

MINUTEMAN and Titan ICBMs and space projects continue to receive large chunks of defense money as the political quadrennium closes and the cold war shows no substantial abating.

Sylvania has received a \$7.5-million contract for development and engineering of command communications for the radio launch system of USAF's Minuteman. The subsystem will carry the launch commands to the silo-stored missiles, will also be time-shared to provide antijam tactical communications among launch-control facilities. Prime contractor Boeing, whose aerospace division awarded the contract, is reported to be considering a system using buried antennas to transmit messages to the solid-fueled ICBM through the earth by way of telluric currents.

Bell Labs and Martin Denver have added a refinement to the Titan guidance system which gives roll control to the ground station. The Titan, as it rises, rolls into position so that when it tips over it'll go in the right direction. Until now, roll control has been preset into a programmer in the missile's first stage; ground control was not exercised until second stage. Slight errors have sometimes required massive correction at second-stage ignition time. Now the ground-based Athena computer sends roll instructions to the first stage, providing a simpler and easier control method.

The refinement was recently proved out in tests conducted at Cape Canaveral.

Navy's Eagle air-to-air missile project is moving apace. Sanders Associates has received \$1.1 million more from Bendix to put the seeker device into preproduction. Bendix is prime for the missile and its fire-control system. Eagle will have both anti-aircraft and counter-missile applications.

In the space field, Advanced Research Projects Agency has bowed out of both Courier and Advent communications satellite projects. Army Signal Corps takes over; the shift is responsive to Pentagon decision to assign management responsibility of active communications satellites to the Army.

GE's missile and space vehicle department has disclosed first details of Advent's power system. According to GE engineers, electrical power for the vehicle will be drawn from the sun, converted by silicon voltaic cells. The tens of thousands of cells will be distributed over one side of each of two paddles; the paddles will be free to rotate in order to keep facing the sun. Energy will be stored in nickel-cadmium batteries for trips into the earth's shadow; maximum dark period for the 22,300-mile-high orbit will be 75 minutes.

Boeing is looking for subcontractors to share in R&D work on USAF's Dynasoar manned space glider project. Glider nose cap, accessory power unit, reaction control system for stabilizing and orienting the glider in space, pilot compartment pressure and temperature controls and secondary attitude reference are among major subcontracts still to be discussed.

Aerojet-General has received a contract for program management of all phases of the Ablestar upper-stage vehicle, including control, analysis, design, fabrication, check-out, ground- and flight-testing. Aerojet has teamed with Space Electronics, newly acquired subsidiary of Pacific Automation Products, for the electronic work.

### Electronic Ferris Wheel



*Movements of missile component test boom generate striking nighttime pattern at Ford's Aeronutronic division research center*

"SO LITTLE  
YET SO **BIG**"

(TRITE BUT TRUE)



miniature instrumentation designed for space vehicle and airborne applications is little in size but big, really big in performance. Reliability is inherent in the design and rugged construction.



**Miniature  
Wide-Band  
Amplifier  
MODEL 8-12**

**FEATURES:**

- Gain Stability to 90° C.
- Compact — 1-3/8" x 2-5/8" x 1-3/16"
- Excellent Linearity — Low Distortion
- Ultra Stable
- Wide Band
- Continuously Adjustable Gain
- Lightweight



**Miniature Solid-State  
Regulated DC-DC  
Converter  
MODEL  
4-28**



**FEATURES:**

- Compact — 3" x 3" x 1" — 9 cu. in.
- Regulation — Better than .08%
- Extremely Rugged
- Output Voltage Adjustable by Customer
- Lightweight — 9 oz.
- Completely Encapsulated — Hermetically Sealed



**ROTOFLEX<sup>®</sup>  
COMMUTATOR  
MODEL 6-15**

**FEATURES:**

- Low Noise — No Sliding Contacts
- Variable Sweep Rate
- Small, Rugged, Compact — 2-13/16" x 3-1/4" x 1"
- External Shaft for Synchronization (Drive or Driven) with other Precision Instrumentation
- Continuous Current Rating 50 ma
- Open Circuit Resistance — Greater than 5 x 10<sup>9</sup> Ohms

All are environmentally tested to surpass MIL-E-5272C for Vibration, Shock and Acceleration.

These are typical of modular type, off-the-shelf catalog items in the line of space instrumentation.



For details write,  
wire or call

**ACTON LABORATORIES, INC.**

subsidiary of

**TECHNOLOGY INSTRUMENT CORP.**

517 Main Street, Acton, Massachusetts  
West Coast Office

8530 Wilshire Blvd., Beverly Hills, California

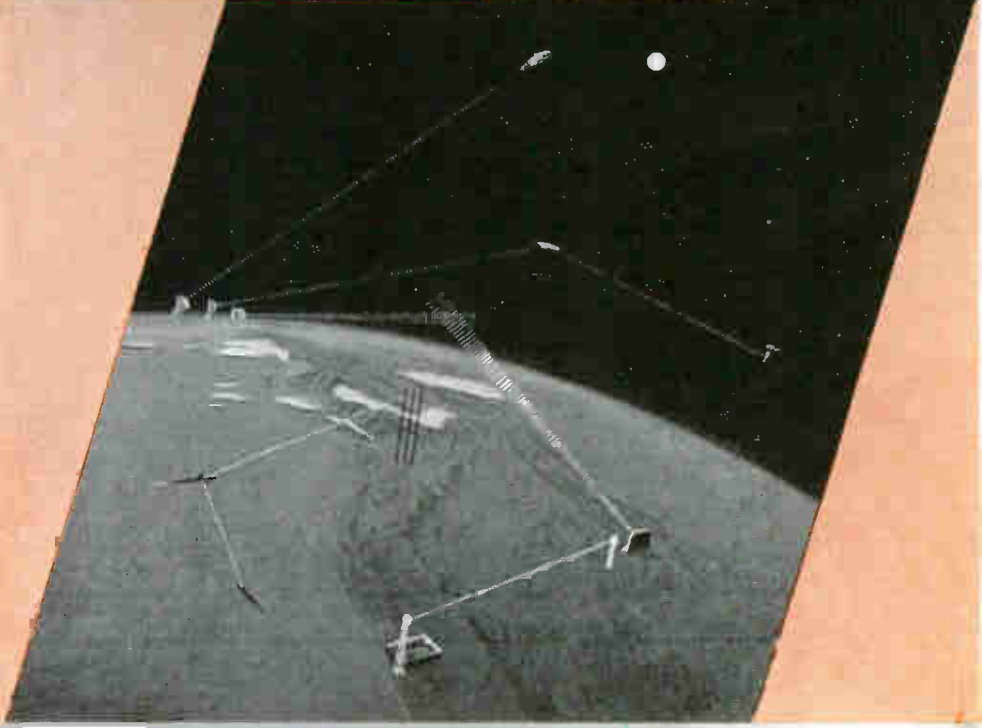
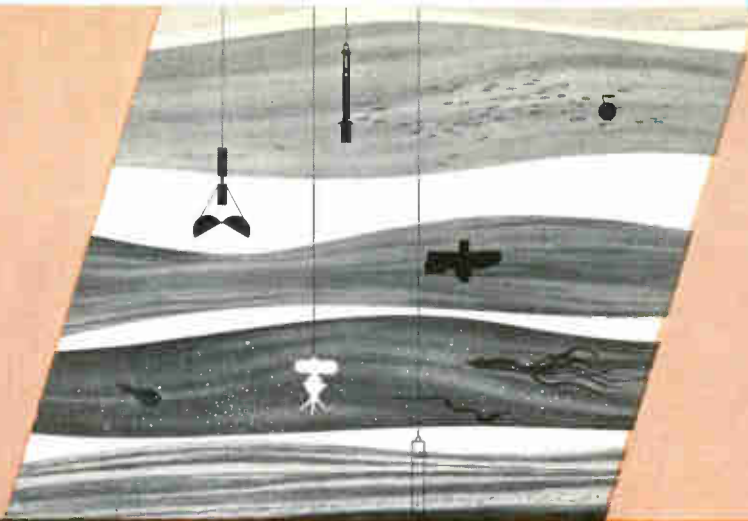

## RESEARCH AND DEVELOPMENT AT LOCKHEED

*...is setting the pace in space for years ahead*

Lockheed Missiles and Space Division's progress transcends even that of an era marked by phenomenal scientific growth. To an important degree, the Division's research and development activities are considered to be the basis of its success.

As systems manager for the Navy POLARIS Missile and the Air Force AGENA Satellite in the DISCOVERER, MIDAS and SAMOS programs, the Division is engaged in extensive research in many diverse engineering and scientific fields. Some highlights of current research and development activities include: Operations research and preliminary design; nuclear and space physics; physical electronics; chemistry; materials; mathematics; engineering mechanics; electronic communications and instrumentation; and computer research and development.

Research is a concept which holds many different meanings to those concerned with science and technology. At Lockheed, a distinction is made between the *nature* of the work and its *objectives*. Consequently, such terms as basic research, applied research, systems or operations analysis, engineering and development are used. A given individual might find that his personal inclination often leads him quite naturally from one type of research to another. Recognition of this desire is reflected in the scope of work conducted in the Research Branch at Lockheed Missiles and Space Division. Principal research activities are: Pure and applied research; advanced design; engineering analysis; electronic prototype development; and machine computation.

Organization is determined by the *technical field* rather than by the *type of research*. For example, a structural dynamicist, as a member of the Structures Department, may, on one occasion, work on future space vehicle configurations, at another time be associated with current projects such as the POLARIS or Satellite programs, or he may be engaged in basic research at the research laboratory. In each case, the individual has the opportunity to maintain as much or as little contact as he wishes with others in his field of interest.

Important staff positions at Lockheed's Research and Development Branch in Palo Alto are available. Those scientists and engineers with experience related to the above areas are invited to write to: Research and Development Staff, Dept. I-17, 962 West El Camino Real, Sunnyvale, California. U.S. citizenship or existing Department of Defense industrial security clearance is required.

**Lockheed** / **MISSILES AND SPACE DIVISION**

SUNNYVALE, PALO ALTO, VAN NUYS, SANTA CRUZ, SANTA MARIA, CALIFORNIA  
CAPE CANAVERAL, FLORIDA • HAWAII

# this standing wave amplifier defies comparison

## FEATURES:

- A new low in noise levels — down to  $0.007 \mu\text{v}$  providing  $0.02 \mu\text{v}$  full scale sensitivity at minimum bandwidth.
- 5 db steps
- Attenuation range of 85 db
- FOUR regular VSWR scales plus one expanded
- All meter scales automatically normalized when switching ranges
- Large  $5\frac{3}{4}$ " meter with 1% linearity
- Continuous gain control over 15 db range
- Continuously variable bandwidth control
- Front panel meter monitors bolometer bias current

## SPECIFICATIONS:

**Frequency:** 1,000 cps; adjustable over a 2% range.

**Sensitivity:**  $0.02 \mu\text{v}$  at minimum (4 cps) bandwidth.  $0.1 \mu\text{v}$  at maximum (40 cps) bandwidth.

**Noise Level:** 5db below full scale ( $0.007 \mu\text{v}$  at minimum bandwidth).

**Amplifier Q:** 250 at 4 cps; 25 at 40 cps.

**Bandwidth:** Continuously variable from 4 to 40 cps.

**Calibration:** Square Law. Meter reads SWR, db.

**Range:** 85 db. Input attenuator provides 70 db in 5 db steps. Gain control provides 15 db adjustable. Accuracy  $\pm 0.1$  db per 10 db. Maximum cumulative error of  $\pm 0.2$  db at 40 cps bandwidth.

**Scale Selector:** Expanded, Regular, and Bolometer Current. Meter scale always normalized when switching from scale to scale or from expanded to regular.

**Meter Scales:** SWR: 1-4; SWR: 1.8-6; SWR: 3.2-10; SWR: 6-15; Expanded SWR: 1-1.3; db: 0-10; Expanded db: 0-2.3.

**Input Selector:** 220,000 ohms; Crystal; Bolometer. Bias provided for high 8.4 ma bolometer or 4.3 ma low current bolometer. Bias adjustable  $\pm 15\%$ . A bolometer protective circuit permits any switching operation or cable connect-disconnect without damage to bolometer.

**Output:** Jack for 1500 ohm recorder, 1 ma full scale deflection.

**Input Connector:** BNC Jack.

**Power:** 115/230 v  $\pm 10\%$ , 50-60 cps, 40 watts.

**Dimensions:** Cabinet:  $7\frac{3}{4}$ " wide,  $10\frac{1}{2}$ " high, 11" deep.

**Weight:** 14 lbs. net.



The new portable PRD 277-B Standing Wave Amplifier is designed to meet the present and future needs of microwave test laboratories. Due to its extremely low inherent noise,  $0.007 \mu\text{v}$ , weak signals which once were undetectable by conventional instruments can now be measured. Attenuation in 5 db steps combined with 4 VSWR scales and a large meter permit VSWR measurements to be made with maximum resolution and accuracy.

To find out more about the new PRD 277-B Standing Wave Amplifier, contact your local PRD representative or phone, write, or wire:



**PRD ELECTRONICS INC.**  
A Subsidiary of Harris-Intertype Corporation

Formerly Polytechnic Research & Development Co., Inc.  
Factory and General Office: 202 Tillary Street, Brooklyn 1, New York, ULster 2-6800  
Western Sales Office: 1608 Centinele Ave., Inglewood, Calif. ORegon 8-6922



Speaker unit houses Ionovac, mid-range speakers and woofer. System includes (inset) power supply, modulator mounted at rear of acoustic horn

## Hi-Fi Ions Impress Chicago Crowds

*Diaphragm-less tweeter, reverberation circuits are among technical features of annual hi-fi show*

CHICAGO—An intermittently glowing ionized cavity replaced a conventional speaker diaphragm in one exhibit of Chicago's ninth annual high fidelity home entertainment show at the Palmer House here. The recent show featured displays by 90 manufacturers, drew 20,000 visitors.

Ionovac, displayed by DuKane, of St. Charles, Ill., focuses high-frequency oscillations into a small open-ended cavity at the final stage of an audio circuit to ionize molecules within the aperture.

Signals from final amplifier stages modulate the ionized particles, shaping the audio waves fed into a narrow horn, which delivers them to the room as sound waves.

Elimination of speaker diaphragm frees Ionovac from transient distortion, according to the company, resulting in more faithful reproduction of high-frequency nuances in vocal and instrumental performances in the range of 3,500 to 20,000 cycles.

Acquiring the North American manufacturing license from its inventor, Sigfried Klien, physicist

who conducted many ionic cloud sound reproduction experiments, the St. Charles company reports it has been perfecting Ionovac over the past three and a half years and is now working on industrial and medical applications for the future.

Reverberation applications included Motorola's stereo units that feature three separate amplifier channels and a centertapped field coil for the input transducer of the reverb circuit.

Zenith and Magnavox reverb units were on display.

Overall, displays ranged from stereo headsets through book publishers and f-m stations to a movie distributor and a teen-age hi-fi club.

Promotional effort for this year's show was keyed to the home market, with component exhibitors offering matched units and cabinets to help "Decorate Your Home With Music."

Heavy referral business was reported following the three-day show. Six multiple-room display units have been engaged in advance for the 1961 show, which is scheduled for late September in the Palmer House.

**SPACE AGE RESEARCHERS:**

**if you use  
electronic  
flash tubes**

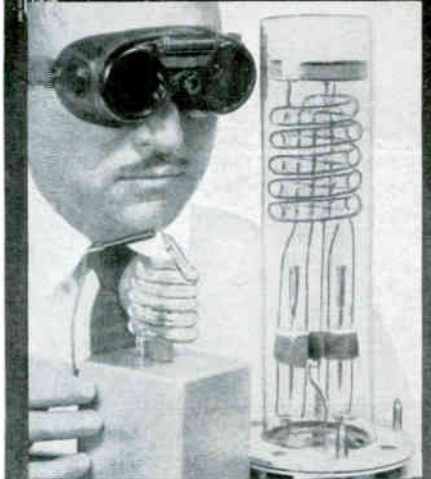

**ascor® has**

*available in stock now*

**the equipment to  
power the tubes**

*for these applications:*

- Missile tracking
- Long range visual aircraft perception
- Extreme temperature research
- Airport runway lighting
- High intensity beacons
- Black light and infra-red
- Laser (light amplification research)
- Plasma propulsion
- Photography • Stroboscopy

Join the impressive list of space age researchers who rely on Ascor for energy discharge equipment. Whether you require very low power or the maximum 40,000 watt-sec., Ascor has the immediate answer, **in stock!** This, to you, is an important time and money saving factor as it eliminates the need for costly designing and construction by your own staff. And even if custom equipment is required, here too, our use of standard components keeps costs down. Unrivalled quality is assured by Ascor's specialization, experience and leadership in the field of electronic flash for 15 years.

Our staff of skilled engineers look forward to helping you solve tomorrow's research problems . . . today! Write for additional information.

**American Speedlight Corporation**  
63-03 Metropolitan Ave., Middle Village 79, N.Y.

New from

**CFI**  
CORPORATION  
ceramics for industry

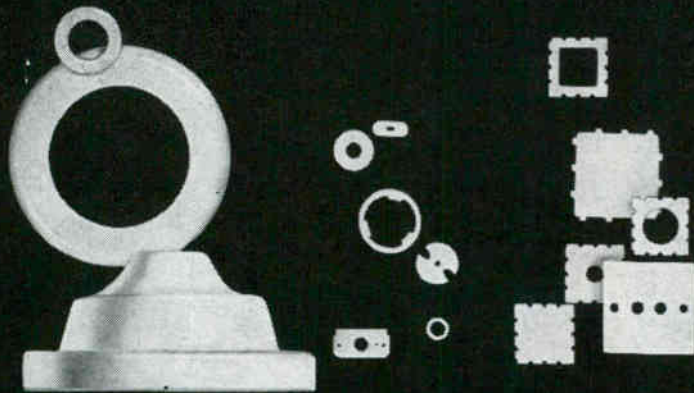

Ceramics shown are actual size

## Precision Technical Ceramics and Composites

CFI Corporation provides integrated skills and facilities specifically adapted to the design, prototype development and production of high-temperature ceramics, components, ceramic-metal vacuum composites, glass-metal seals and specialized body compositions.

Typical ceramic products include modular forms, spacer and abrasion-resistant elements, metallized parts, multi-terminal composites, compact high-temperature power lead through elements and envelope assemblies.

Body compositions comprise high Alumina, Steatite, Forsterite, and customized materials, such as Series 1000 LOSSY ceramic for microwave attenuation.

For complete details on CFI custom-designed ceramics and ceramic-metal composites to fit your specifications, call CFI today. We're ready to work with you right now!

**CFI**

An Integrated Ceramics Service

CFI Corporation  
Department E, Cottage Place  
Mineola, New York—Pioneer 6-0571

Gentlemen: Please send me, without obligation, the following literature on CFI ceramics:

- "Custom Ceramic Parts for Industry" Brochure  
 Microwave Ceramics Spec Sheet  
 Have technical representative contact me.

Name \_\_\_\_\_

Title \_\_\_\_\_

Company \_\_\_\_\_

City \_\_\_\_\_ Zone \_\_\_\_\_ State \_\_\_\_\_

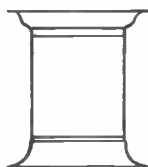

Send for free  
CFI ceramics data

## MEETINGS AHEAD

Oct. 14-15: Quality Control Conf., ASQC, Broadview Hotel, Wichita, Kan.

Oct. 16-22: High Speed Photography, Soc. of Motion Picture and Tv Engineers, Sheraton Park Hotel, Washington, D. C.

Oct. 17-19: Adaptive Control Systems Symposium, IRE, Garden City Hotel, Garden City, N. Y.

Oct. 18-20: Battery Symposium, Ministry of Aviation, S.R.D.E., The Pavilion, Bournemouth, England.

Oct. 19-26: International Congress & Exhibition for Instrumentation & Automation, INTERKAMA, Dusseldorf, Germany.

Oct. 24-26: Aero & Nav. Elec. Conf., PGANE of IRE, Lord Baltimore Hotel, Baltimore, Md.

Oct. 26-27: Computer Applications Symposium, Armour Research Foundation & Illinois Inst. of Tech., Morrison Hotel, Chicago.

Oct. 26-28: Non-Linear Magnetics and Magnetic Amplifiers, AIEE, PGIE of IRE, Bellevue-Stratford Hotel, Philadelphia.

Oct. 27-28: Magnetodynamics, Engineering Applications, Engineering Institutes, Univ. of Wisconsin, Madison, Wis.

Oct. 27-28: Electron Devices Meeting, PGED of IRE, Shoreham Hotel, Washington, D. C.

Oct. 31-Nov. 2: Radio Fall Meeting, IRE, EIA, Syracuse Hotel, Syracuse, N. Y.

Oct. 31-Nov. 4: Seventh Institute on Elec. in Management; American Univ., Washington, D. C.

Oct. 31-Nov. 2: Electronic Techniques in Medicine & Biology, PGME of IRE, AIEE, ISA, Sheraton Park Hotel, Washington, D. C.

Nov. 4: Automatic Data Processing Systems, Institute of Electronics in Management, American Univ., Washington, D. C.



ANOTHER QUALITY PRODUCT FROM **EFCON**

# POLYSTYRENE

**Excellent Retrace Performance Under Adverse Conditions - Time, Temperature, Environment**

EFCON'S line of polystyrene dielectric capacitors provide greater dependability for precision circuit integration required in missiles, computers, industrial controls, etc. Reliability and Precision is ensured through carefully controlled processes in EFCON'S "clean room", where exacting conditions for humidity, temperature and airborne contaminants are maintained. Capacity remains through thermal cycling over the range of  $-65^{\circ}\text{C}$  to  $+85^{\circ}\text{C}$ , without derating. Voltage ratings available -100, 200, 400, 600 volts and higher.



*Write today*

**FOR TECHNICAL BULLETINS ON**

- Miniature Polystyrene, types PH, RH and PC
- Miniature Mylar
- High Temperature Teflon
- Solid Tantalum

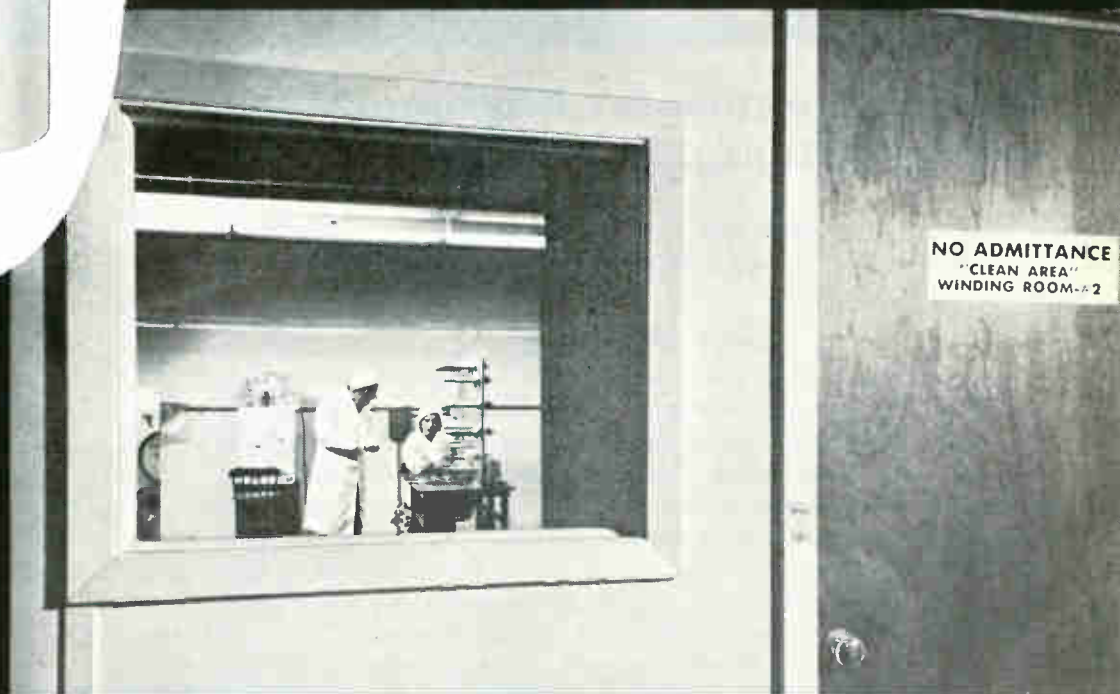

**EFCON** INCORPORATED

Patterson Place • Roosevelt Field • Garden City • L. I., New York

# When Going Is Rough

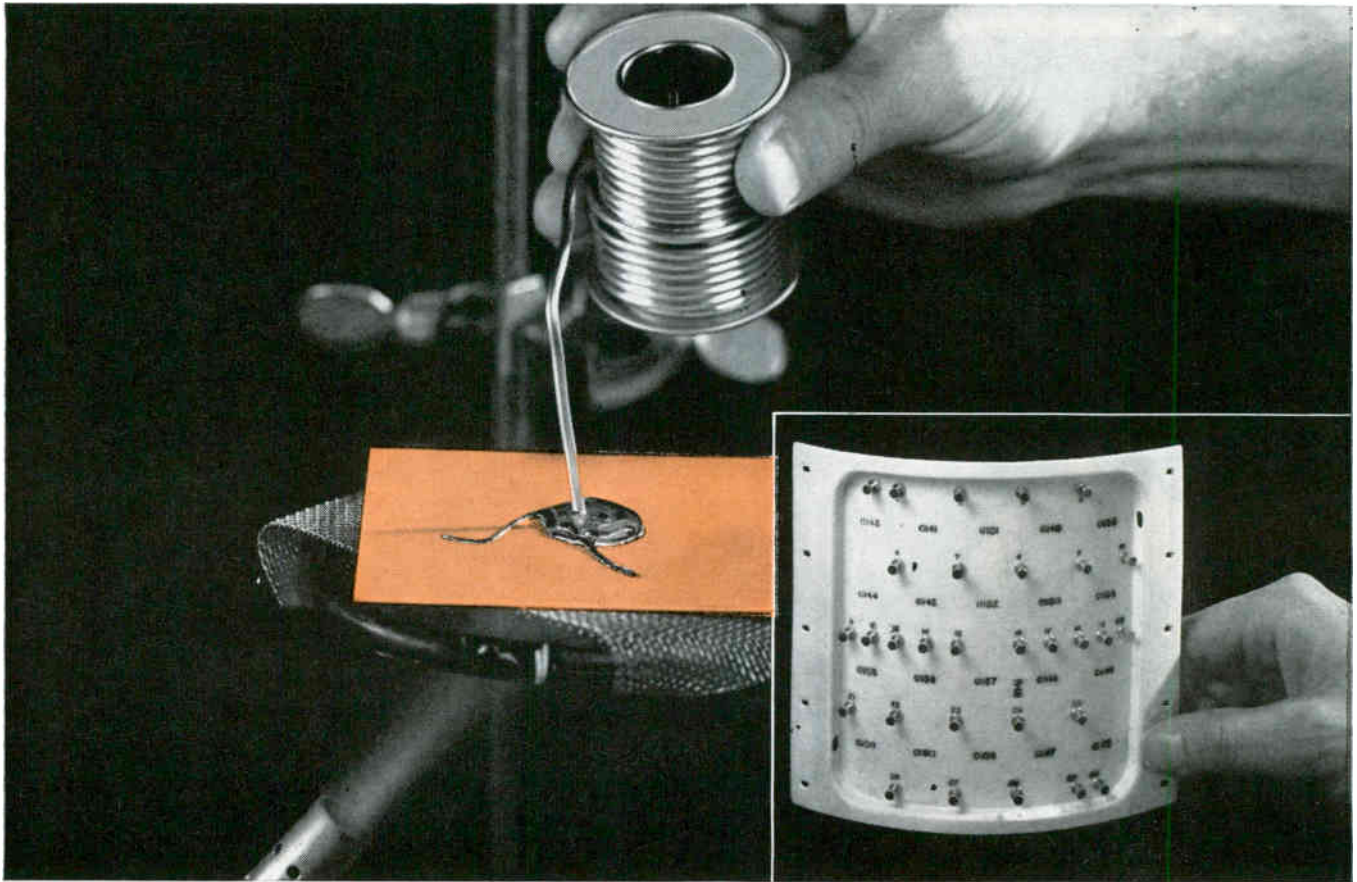

## For Environmental Engineering... Select Silicone-Glass Laminates

LOX cold . . . high Mach heat . . . corona . . . ozone . . . launching and sonic shock — more and more environmental challenges are being met by Dow Corning Silicones.

Take glass laminates bonded with Dow Corning silicone resins, as examples. Silicone glass laminates have good mechanical strength, low loss factor, low moisture absorption, excellent resistance to arcing, corona, corrosive atmospheres, fungus and contaminants. What's even more important, they retain these properties despite elevated temperatures, storage, environmental aging, rapidly changing ambients, vibration and shock. Heat resistance of silicone-glass laminates is exceptional . . . up to 250 C continuous for years . . . much higher for short time periods. Lastly, silicone-glass laminates, even in thin sections, have fine machinability and resist creep under pressure of terminal fasteners.

Lear, Inc., Grand Rapids, Michigan mounts the mica capacitors of their Model 2013J Stable Platform on this formed silicone-glass laminate terminal board. Lear engineers chose glass laminates after an intermediate material had been tried. Tolerance requirements, plus assembler variations, dictated a material that could be formed . . . would withstand soldering temperatures . . . would hold its form despite environmental extremes. Environmental conditions are: -40 to 160 F; shocks of 30 G's for about 11 milliseconds each; complex wave vibration for 20 minutes in each plane as follows — 30-100 cps: 0.46 g<sup>2</sup>/cps and 100-2000 cps: 0.015 g<sup>2</sup>/cps.

Silicone-glass laminates made with Dow Corning resins are available from leading laminators. Write for a list.

For 12-page manual  
"Silicones for the Electronic Engineer"  
Write Dept. 3510



**Dow Corning**

CIRCLE 289 ON READER SERVICE CARD

# ...Specify Silicones

## Flexible from -100 to 300 F

Silastic®, the Dow Corning silicone rubber, is specified by Airtron, a division of Litton Industries, for the jacket of their silver-plated brass, and all-aluminum flexible waveguide designed to resist operating temperatures from -100 to 300 F. With its Silastic jacket, Airtron's Flexaguide is particularly suited for applications in the missile field where environmental operating conditions are severe. In addition, the jacket supports the waveguide during flexure, insures airtightness for pressurized applications. Silastic resists a long list of environments including: cold, heat, ozone, oxygen, voltage stress, thermal cycling, corona, corrosive atmospheres, and weathering.

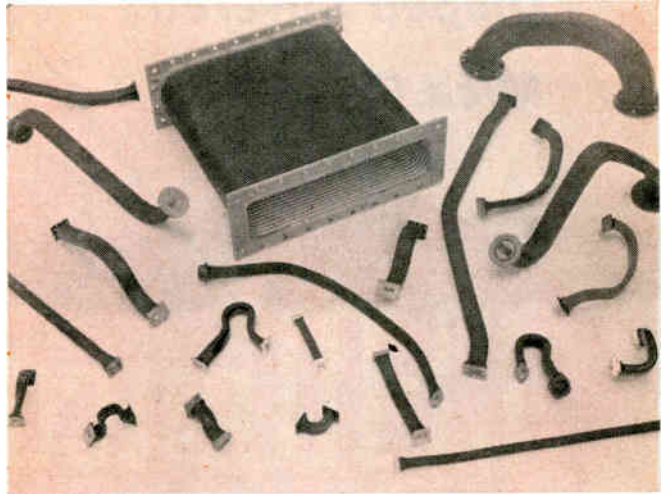

CIRCLE 290 ON READER SERVICE CARD

## Rigid, Void-Free Protection

This induction heating coil is used to keep metal molten. Metal splatter caused frequent insulation and coil failure until the decision was made to encapsulate the unit in Dow Corning solventless silicone resin. The resin — with zirconium orthosilicate filler — forms a tough, rigid armor that withstands temperatures as high as 300 C indefinitely . . . much higher for short time periods. With no solvents to evaporate, the resin cures without voids. Note the excellent fill between plates of an encapsulated test capacitor.

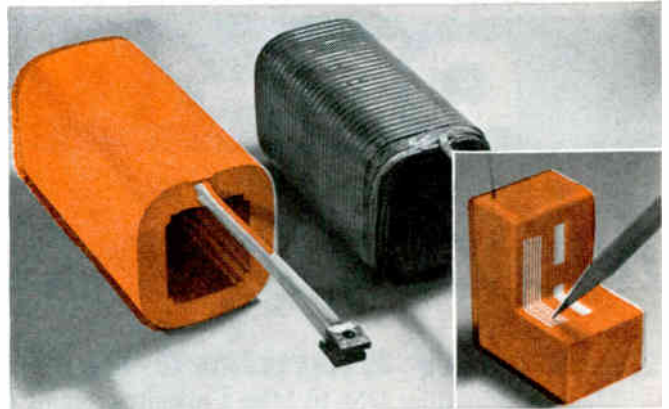

CIRCLE 291 ON READER SERVICE CARD

## For Rapid Heat Dissipation

Dow Corning silicone fluids are used as dielectric coolants for rapid heat dissipation because of their thermal stability and relatively flat viscosity-temperature curves. They can be pumped at high speeds without breakdown due to shear; maintain consistency from -65 to 250 C; and they will not oxidize or act as corrosives to metals even at high temperature. For these reasons and because of low vapor pressure, Sierra Electronics, Menlo Park, California specifies Dow Corning 200 Fluid as the heat transfer medium in their 100 and 500 watt, 60 ohm coaxial RF loads.

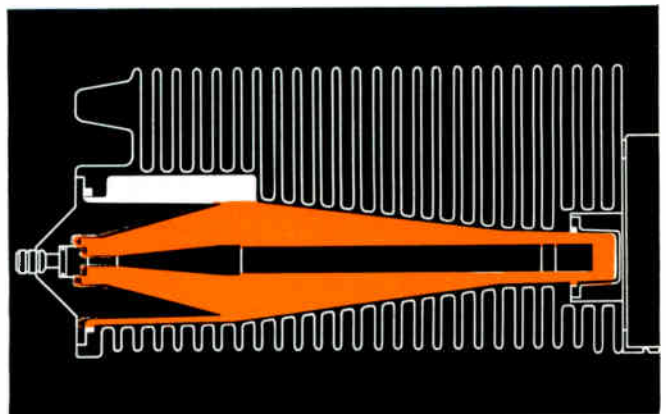

CIRCLE 292 ON READER SERVICE CARD

**CORPORATION** MIDLAND, MICHIGAN

branches: ATLANTA BOSTON CHICAGO CLEVELAND DALLAS LOS ANGELES NEW YORK WASHINGTON, D.C.

# Another *New* Achievement from **El-Menco**

**A New Smaller Size**

**Dipped Silvered**

**Mica Capacitor**

**El-Menco's**  
**SUB-MINIATURE**

**DM-10**



Approx.  $\frac{5}{16}$ " long ...

$\frac{1}{4}$ " wide ...

$\frac{1}{8}$ " thick!

Smaller than a  
1-carat diamond!

## Mica Capacitor...

### Sets New Standard in Miniature Reliability!

■ This sub-miniature DM-10 Mica Capacitor retains the same superior electrical characteristics of silvered mica capacitors as found in much larger sizes. It assures a high order of performance in extreme miniaturization applications — missiles, printed circuits and all compact electronic equipment. Parallel leads provide greater versatility. Tough phenolic casings protect against physical damage and penetration of moisture.

#### Capacity and Voltage Ranges

Working Voltage	Capacity Range
100 WVDC	1 MMF thru 360 MMF
300 WVDC	1 MMF thru 300 MMF
500 WVDC	1 MMF thru 250 MMF

**Operating Temperature:** up to 150° C.

**Characteristics:** C, D, E and F, depending on capacitance value

**Leads:** #26 AWG (.0159") Copperweld wire

EL-MENCO'S DM-10 MEETS ALL THE ELECTRICAL REQUIREMENTS OF MILITARY SPEC. #MIL-C-5B AND EIA SPECIFICATION RS-153

Other sizes also ideal for miniaturization applications —

**DM-15** ... up to 820 mmf at 300 VDCW, up to 400 mmf at 500 VDCW.

**DM-19** ... up to 5400 mmf at 300 VDCW, up to 4000 mmf at 500 VDCW.

WRITE FOR SAMPLES OF EL-MENCO DM-10 CAPACITORS and brochures describing El-Menco's complete line of capacitors.

EL-MENCO'S SUB-MIDGET DM-10 ... THE NEW SMALLER MINIATURE MICA CAPACITOR

**El-Menco**  
Capacitors

### THE ELECTRO MOTIVE MFG. CO., INC.

Manufacturers of El-Menco Capacitors  
WILLIMANTIC CONNECTICUT

- molded mica • dipped mica • mica trimmer • dipped paper
- tubular paper • ceramic • silvered mica films • ceramic discs

Arco Electronics, Inc., 64 White St., New York 13, N. Y.  
Exclusive Supplier To Jobbers and Distributors in the U.S. and Canada



## We Can Make Precision Ceramic-to-Metal Assemblies for Your Stock or Special Requirements

On your right is a specialized ceramic-to-metal assembly that we make in small quantity. This vacuum tight assembly includes several thicknesses of metal, two sizes of ceramic envelopes, brazed together with close dimensional tolerances.

On your left are some of our stock terminal insulators. They are made in large runs for economical, off-the-shelf delivery. We also have customers who require large runs of ceramic-to-metal assemblies to meet their own production demands.

Coors furnishes either metalized ceramic parts ready for brazing by the customer, or complete ceramic-to-metal assemblies in sizes up to 10" OD by 12" length. High temperature subsequent brazes can be made up to 1500° F. Braze bond strengths are from 9,000 to 12,000 PSI. Coors offers a variety of alumina or beryllia ceramic materials for use in your metalized assemblies.

If you need ceramic-to-metal assemblies, in quantity or prototype, get in touch with us here in

Golden, contact the Coors regional sales manager nearest you, or write for new bulletin.

### REGIONAL SALES MANAGERS

*West Coast*.....William S. Smith, Jr.  
EM 6-8129 - Redwood City, Calif.  
*Midwest*.....John E. Marozeck  
FR 2-7100 - Chicago, Ill.  
*Central*.....Donald Dobbins  
GL 4-9638 - Canton, Ohio  
*East Coast*.....John J. McManus  
MA 7-3996 - Manhasset, N. Y.  
*New England*.....Warren G. McDonald  
FR 4-0663 - Schenectady, N. Y.  
*Southwest*.....Kenneth R. Lundy  
DA 7-5716 - Dallas, Texas  
*Southwest*.....William H. Ramsey  
UN 4-6369 - Houston, Texas

# Coors

# Alumina Ceramics

COORS PORCELAIN COMPANY • 600 NINTH STREET, GOLDEN, COLORADO



GM 6025

# Electronic

## **Internal calibration**

It should be noted that *all* Philips electronic voltmeters contain calibration standards which enable the user easily and rapidly to check, and, if necessary, to re-calibrate his voltmeter at any time without the use of additional instruments.

**PHILIPS** *electronic measuring*

*Sold and serviced by Philips Organizations all over the world*

Further information will gladly be supplied by:

**N.V. Philips' Gloeilampenfabrieken, EMA-Department, Eindhoven, the Netherlands**

*For Canada: Philips Electronics Ind. Ltd., Leaside, Toronto 17, Ont.*

## VHF Voltmeter, type GM 6025

frequency range up to 800 Mc/s  
sensitivity 10mV f.s.d.

### Frequency range

0.1 Mc/s - 800 Mc/s flat from 1 Mc/s - 300 Mc/s  
- 1dB at 0.1 Mc/s (see graph below)  
+ 1dB at 800 Mc/s

### Measuring range

10 mV (f.s.d.) - 10 V divided into 7 ranges in a 1-3-10 sequence.

### Accuracy

The overall accuracy is better than 5% with respect to full scale.

### Input impedance

Input capacitance:  $1\mu\text{F}$   
Input resistance at:  
1 Mc/s 65 k $\Omega$   
100 Mc/s 50 k $\Omega$   
200 Mc/s 35 k $\Omega$

### Linear scale

Thanks to voltage-dependent feed-back the scale is linear. It is calibrated directly in the r.m.s. value of the VHF voltage and has an effective length of 5".

### Calibration voltages

The frontpanel contains a calibration socket which for any setting of the range selector provides the appropriate calibration voltage for that range.

### Replacement of the probe crystal

The probe crystal can be easily replaced and the instrument rapidly re-calibrated by the user.

### Coaxial T-connector

For measurements on 50 $\Omega$ -coaxial lines the T-connector, type GM 6050T can be ordered separately.



GM 6012

2 c/s - 1 Mc/s, 1 mV (f.s.d.) - 300 V

GM 6014

1 kc/s - 30 Mc/s, 1 mV (f.s.d.) - 30 V



# millivoltmeters

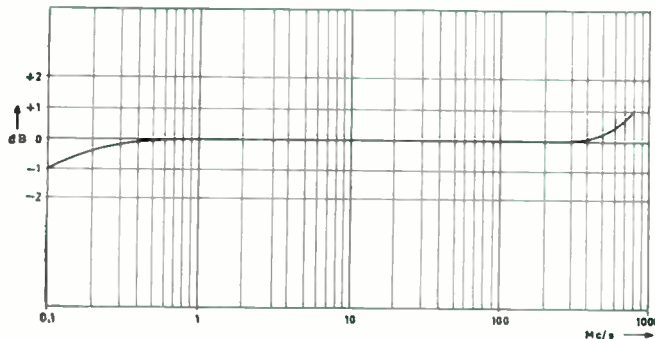

Response curve with T-connector, type GM 6050T

GM 6020 D.C. 100  $\mu\text{V}$  (f.s.d.) - 1000 V



*instruments:* quality **tools** for industry and research



**In science ...**

This "diary" of an airframe in wind-tunnel flight is an instantly-readable record taken on a Model 906A Visicorder by ARO, Inc., at the USAF Arnold Engineering Development Center, Tullahoma, Tennessee, the ARDC wind tunnel facility. This record measures damping-in-pitch derivatives for a clipped-delta-wing-body configuration over a Mach number range of 2.0 to 5.0 so that these measurements could be compared with Mach number trend predicted by theory. The values discovered through this experiment showed discrepancies from theoretical values because the theory pertained to simpler bodies than that used in the tests. The new set of Visicorder data will result in more accurate predictions for future design.

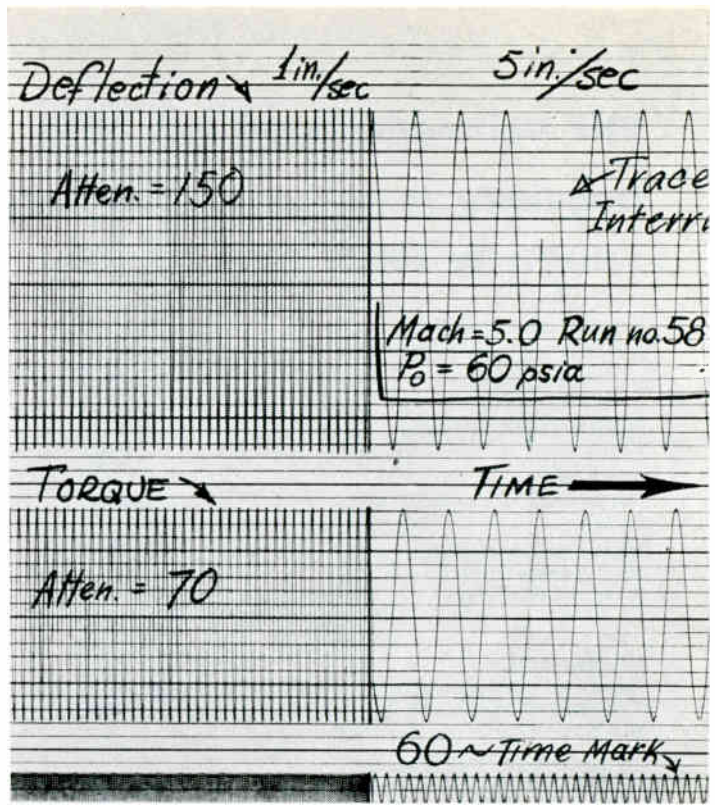

**these are records of leadership**

**In industry ...**

This "cardiogram" of a diesel engine was taken on a Model 906 Visicorder by research engineers at the Worthington Corporation. It is a directly-recorded chart of pressure variations in the exhaust manifold, cylinder, and intake manifold of a Worthington Tripower diesel operating at 450 RPM and developing 265 HP per cylinder. These pressure-variation studies enable Worthington engineers to determine optimum valve timing and engine configuration, and led to changes in the Tripower engine for best performance. In these and in hundreds of other scientific and industrial applications, Visicorders are bringing about new advances in product design, computing, control, rocketry, nucleonics, and production.

For information on how to apply the unlimited usefulness of the Visicorder to your specific problems, phone your nearest Honeywell Industrial Sales Office.

The Honeywell Visicorder provides instantly-readable, high-sensitivity data at frequencies from DC to 5000 CPS. There are models with 8, 14, 24, or 36-channel capacities.

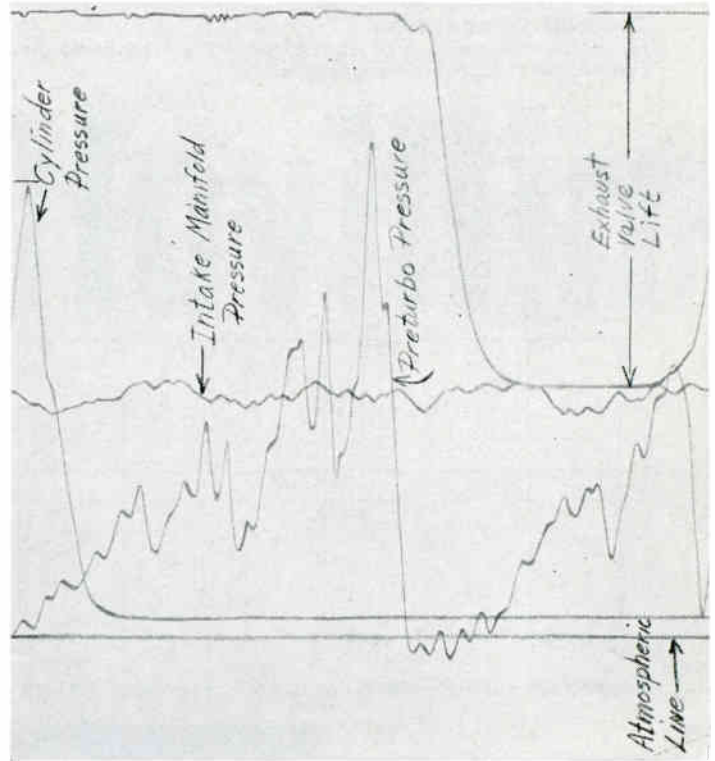
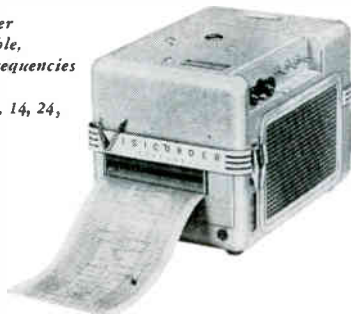

Visicorder records 2/3 actual size.

**Honeywell**



Industrial Products Group

Reference Data: Write for specifications on Visicorders 906B, 1108 and 1012.

Minneapolis-Honeywell Regulator Co., Industrial Products Group, Heiland Division, 5200 E. Evans Ave., Denver 22, Colorado



# OHMITE RESISTORS



**THE EXACT RESISTOR YOU NEED—WHEN YOU NEED IT—FOR EVERY INDUSTRIAL AND MILITARY REQUIREMENT**

Fixed . . . adjustable . . . tapped . . . noninductive . . . precision metal film and encapsulated wire-wound . . . thin type . . . high-current—practically any resistor you need, you can find in the Ohmite line.

**W**ORLD'S LARGEST STOCK FOR IMMEDIATE DELIVERY—Chances are Ohmite's huge stock of several million resistors in more than 2000 sizes and types contains a unit that fits your requirements. Many types are also available through Electronic Parts Distributors located across the Nation.

**Y**OUR CUSTOMERS KNOW THE VALUE OF OHMITE QUALITY—When a purchaser sees Ohmite resistors in a piece of equipment, he knows that equipment is designed and built for dependability.

**O**HMITE ENGINEERING ASSISTANCE ASSURES THE RIGHT UNIT—Selecting the right resistor for the job is sometimes a tough problem. Why not call on Ohmite application engineers to help out. Take advantage of their specialized skills and background.

*Write on Company Letterhead for Catalog and Engineering Manual 58*

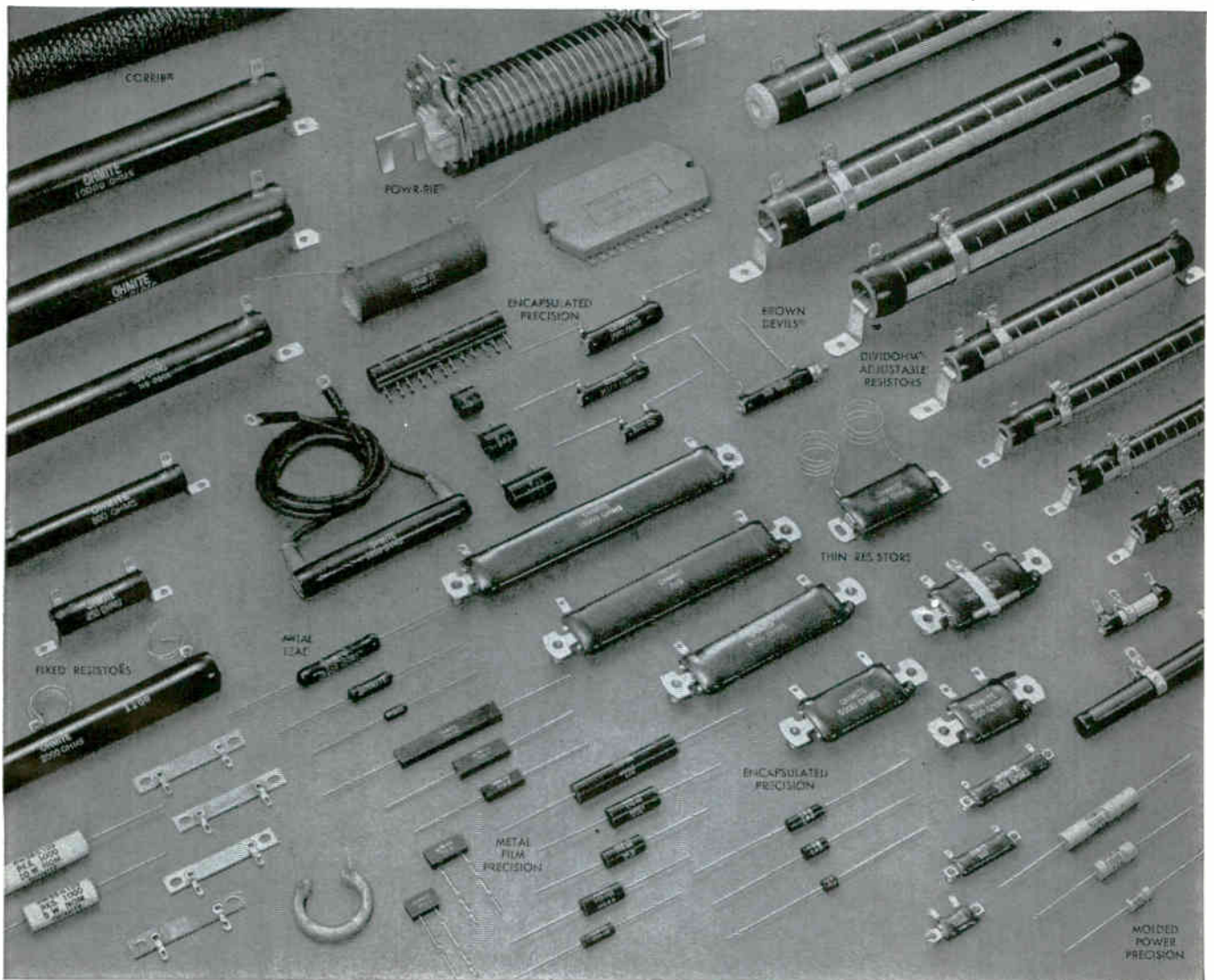

# OHMITE

**OHMITE MANUFACTURING COMPANY**  
3610 Howard Street, Skokie, Illinois

## Quality Components

**RHEOSTATS • RESISTORS • TAP SWITCHES**  
**RELAYS • R.F. CHOKES • TANTALUM CAPACITORS**  
**VARIABLE TRANSFORMERS • GERMANIUM DIODES**

# new product designs get extra



● **FOR LONG LIFE**—The "Angler" Fathometer is a portable, transistorized depth finder made by Raytheon Company for

fishing and boating enthusiasts. It aids in navigation and finding fishing holes by means of ultrasonic sound beams, pow-

ered by Mallory mercury batteries. Their longer life eliminates inconvenience of frequent battery changes.

# sales appeal from

## MALLORY MERCURY BATTERIES

Look to the amazing capabilities of Mallory mercury batteries for extra performance values, new sales appeal in your battery-powered electronic equipment . . . both in new designs and in product improvements. Pioneered and perfected by Mallory, mercury batteries give you features far superior to other commercial dry cells.

**SMALLER SIZE**—Mallory mercury batteries have a high energy-to-volume ratio, are miniaturized without performance loss.

**HIGH STABILITY**—Output remains so constant that they can be used as reference voltage standards. Constant voltage discharge is ideal for transistor circuitry.

**EXTRA DEPENDABILITY**—Mallory mercury batteries give at least four times longer service life than conventional types. Tests prove they can be stored as long as six years without appreciable loss of capacity. They operate over wide temperature ranges.

**EXTRA CONVENIENCE**—Longer life reduces frequency of battery changes.

The examples shown here are but a few of the many new electronic products now utilizing the outstanding characteristics of Mallory mercury batteries. Our application engineers will welcome the chance to discuss how *you can apply these extra values to your products*. We have a wide line of standard single and multiple voltage cells available . . . and we can develop customized power packs to your specifications. Write today for a consultation, and for our latest mercury battery engineering data.

MALLORY BATTERY COMPANY  
North Tarrytown, N. Y.

a division of

P. R. MALLORY & CO. Inc.  
**MALLORY**

In Canada, Mallory Battery Company of Canada Limited, Toronto 4, Ontario  
In Europe: Mallory Batteries Ltd., Dagenham, England

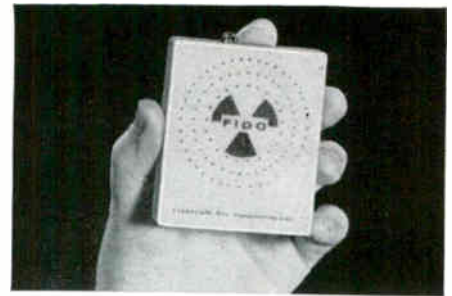

### IDEAL FOR TRANSISTOR CIRCUITS

A pocket-size radiation detection alarm for personal and area protection, FIDO® produces a warning sound clearly heard many feet away. Controls for Radiation, Inc. chose Mallory mercury batteries as the power pack because they ideally fit transistor circuit requirements for compactness and steady voltage output.

© Trademark—Fallout Intensity Detection Oscillator.



### SMALL SIZE, STEADY VOLTAGE

This noise survey meter is used for measuring noise hazard in industrial hygiene studies, for noise reduction surveys and for architectural acoustic measurements. This small portable instrument is powered by a single Mallory mercury battery, chosen for its small size, steady voltage and long life.



### FOR ACCURATE OUTPUT

This new small boat tachometer designed by McCulloch Corporation's Marine Products Division depends on Mallory mercury batteries as a voltage reference source. Open circuit output stays constant within 1% over periods up to 36 months.



### NEW LOW-TEMPERATURE CELL

The RM-1450R mercury cell, using ribbon wound anode, gives considerably higher capacity at low temperatures. Ideal for emergency beacons, marker lights, rescue transceivers, it produces over 10 times as much output as earlier mercury cells at 32°F, and gives useful output even at -20°F. Capacity of packs is up to 45 watt-hours per pound. Write for new folder.

In FLAT, FLEXIBLE CABLE

if it's news, expect it first from IRC

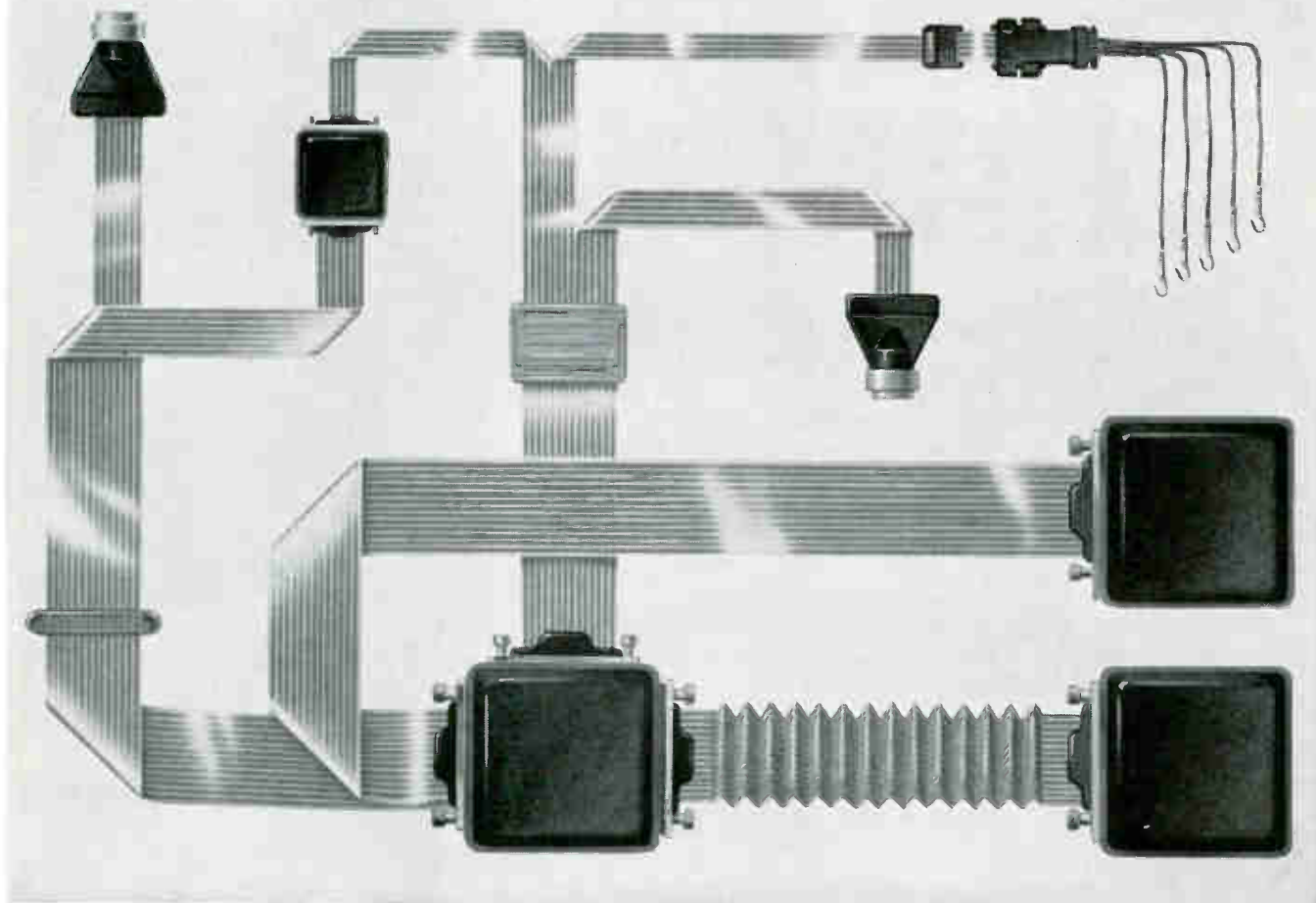

## Polystrip® . . . the dynamic approach to reliable miniature and high density wiring packages

IRC Polystrip is a thin, multiple conductor, flexible cable. It consists of a number of parallel, flat copper wires sandwiched between plastic layers. This cable occupies little volume, and is flexible enough to fit into irregular spaces. All conductors are pre-positioned in the same plane permitting simultaneous stripping, terminating or dip soldering to printed wiring boards or connectors.

This new concept of wiring offers many advantages to an electronic circuit engineer:

- Space Savings—7:1 ratio over conventional cable
- Weight Reduction—up to 10:1 depending on insulation and design
- High Strength—inherent in the unitized web construction
- Flexibility—no failure after over a million cycles without tension
- Cost Savings—achieved in installation costs
- Current Carrying Advantages—increases up to 2:1 for given temperature rise
- Chemical and Moisture Resistance—good to excellent
- Reliability—assured by pre-formed cables and sealed insulation

IRC Polystrip is now available in five standard types—from Polyester to Teflon insulations, operational in temperatures up to 200°C, and resistant to most environmental conditions. Additional types possible depending on your application.

For further information on Polystrip, write for Bulletin S-9, International Resistance Co., 401 N. Broad St., Philadelphia 8, Pa.

Teflon is a Reg. T.M.-E.I. du Pont de Nemours & Co.



*Leading supplier to manufacturers of electronic equipment*

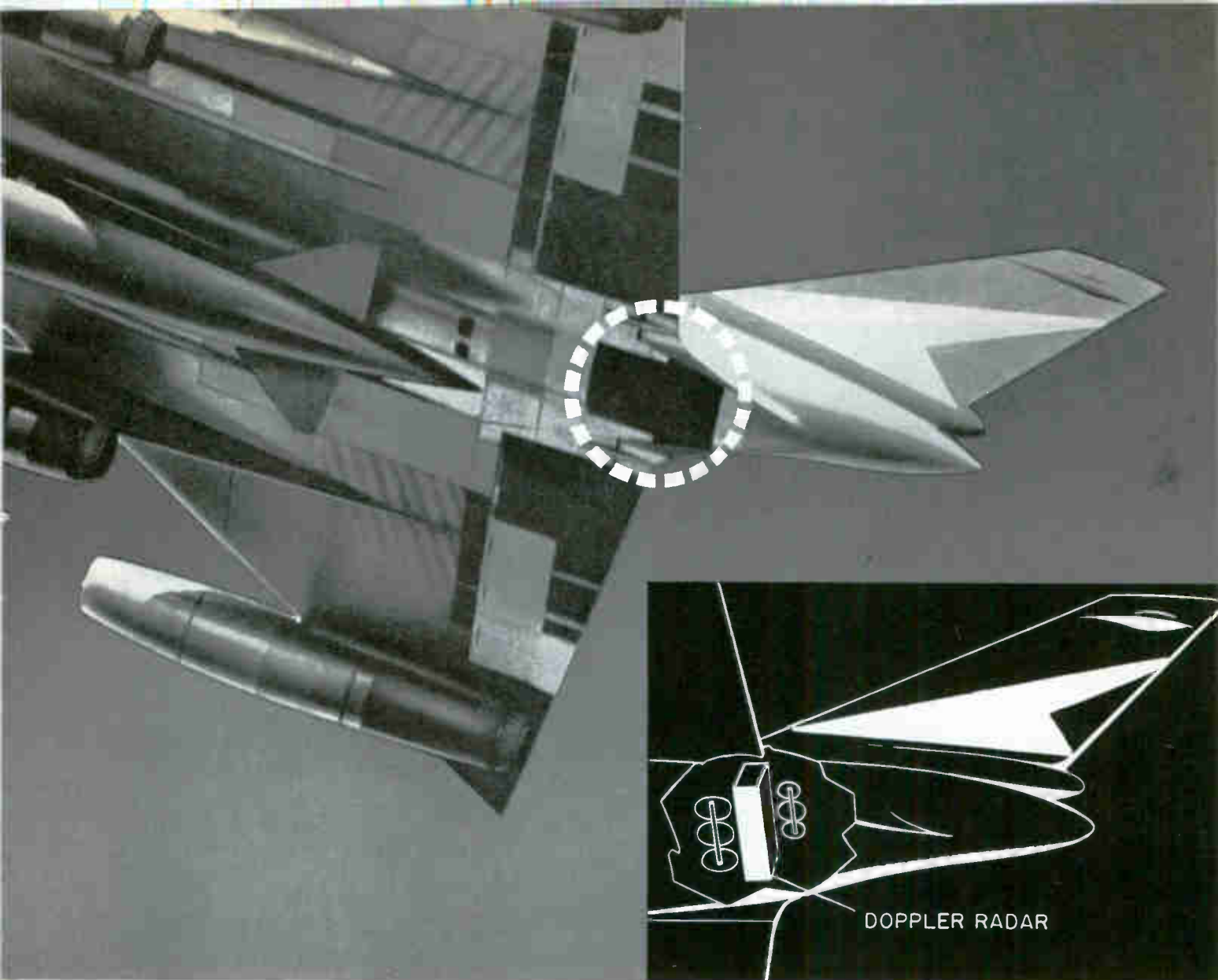

## Put a Doppler here? Raytheon did!

Located in the tail section of the Convair B-58 Hustler, Raytheon's Doppler radar is subject to all the following: transonic and supersonic shock waves, intense tail-pipe and skin friction heat, turbulence from the pod, extreme vibration and acoustic noise levels, and very high altitudes.

Despite this environment, Raytheon's Doppler radar meets SAC's stringent accuracy requirements. It is boresighted on the ground, eliminating in-flight calibration, and is a prime sensor to Sperry Gyroscope Company's Bomb-Navigation System.

This Doppler is designated AN/APN-113. It was designed, developed and produced by Raytheon to operate reliably under the severest environmental

conditions encountered by any aircraft today. It is a dramatic demonstration of Raytheon's capability to overcome environmental barriers.

*For New Airborne Operations Brochure Write:*

DIRECTOR OF MARKETING,  
Equipment Division,  
Department K-2, Raytheon Company,  
West Newton, Massachusetts



*EXCELLENCE IN ELECTRONICS*

## SOLVING MATERIAL DESIGN PROBLEMS HEAT RESISTANCE

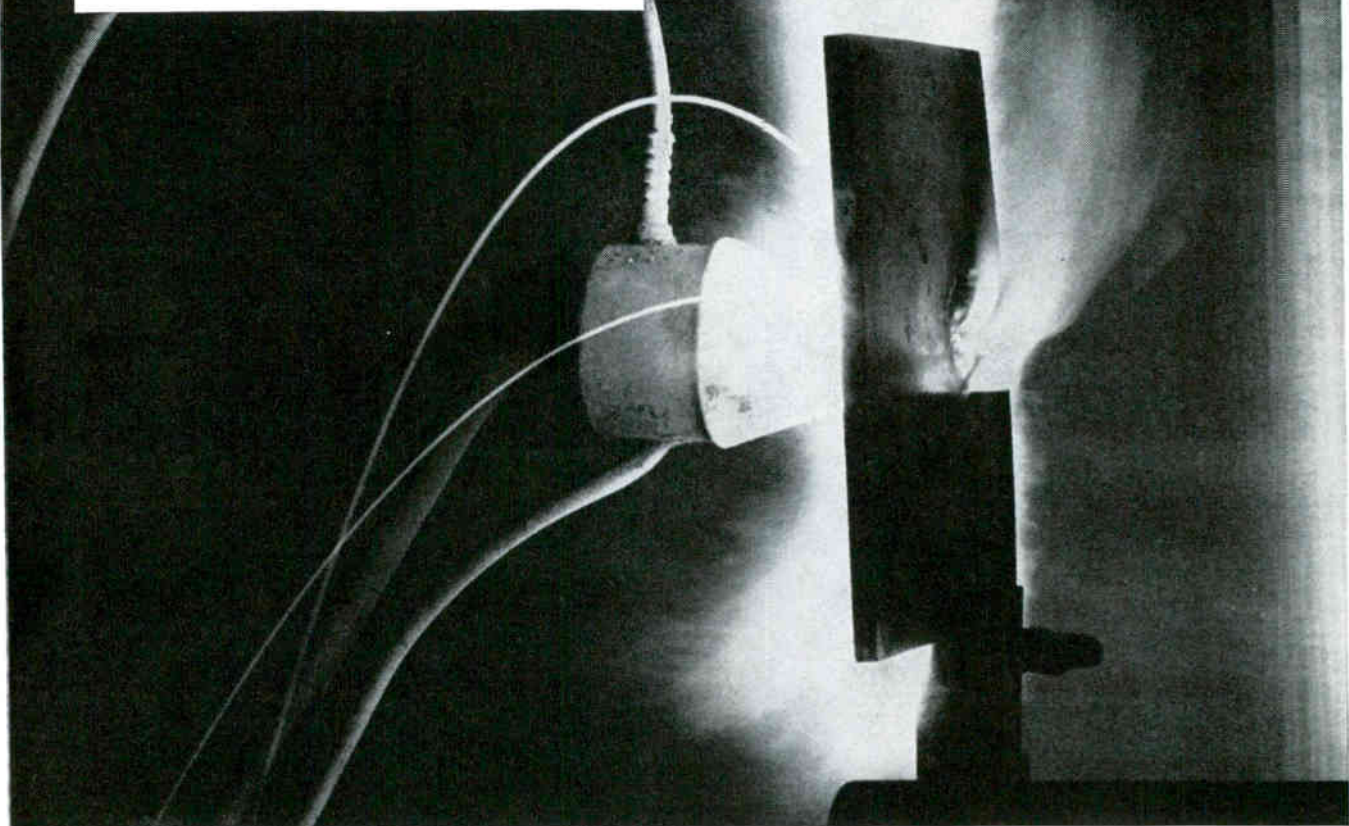

A 5000° flame takes ten minutes to penetrate a one-quarter inch piece of CDF's new Dilecto RD-105 laminate. The same thickness of cold-rolled steel is pierced in less than forty seconds.

Molded from graphite fabric impregnated with a heat (ablation)-resistant phenolic resin, new CDF grades RD-105 and RD-115 are being evaluated in solid propellant rocket motors.

Dilecto laminates are only one family of products from industry's largest selection of non-metallic

structural materials and electrical insulations. Vulcanized fibre, silicone rubber and mica, and thermosetting moldings are also supplied by CDF.

CDF can provide both quality and true economy in selecting plastic materials best suited to your needs. Refer to SWEETS PD file or write to us for General Folder 60.



## CONTINENTAL-DIAMOND FIBRE

® A SUBSIDIARY OF THE *Bush* COMPANY • NEWARK 16, DEL.  
In Canada, 46 Hollinger Road, Toronto 16, Ont.

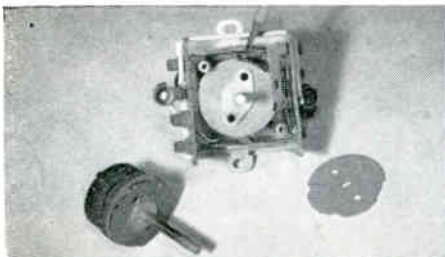

Moisture-resistant and low cost Dilecto cams for automatic washer and dryer controls.

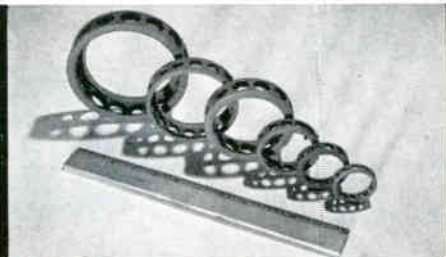

Dimensionally stable, light weight, oil-resistant Dilecto ball bearing retainer rings.

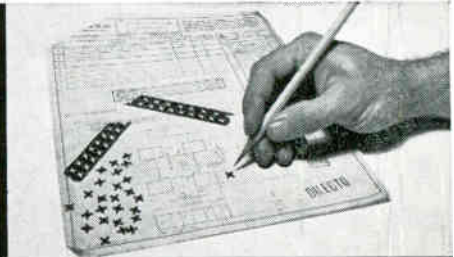

Easily fabricated paper-base, punching grade Dilecto precision switch insulators.

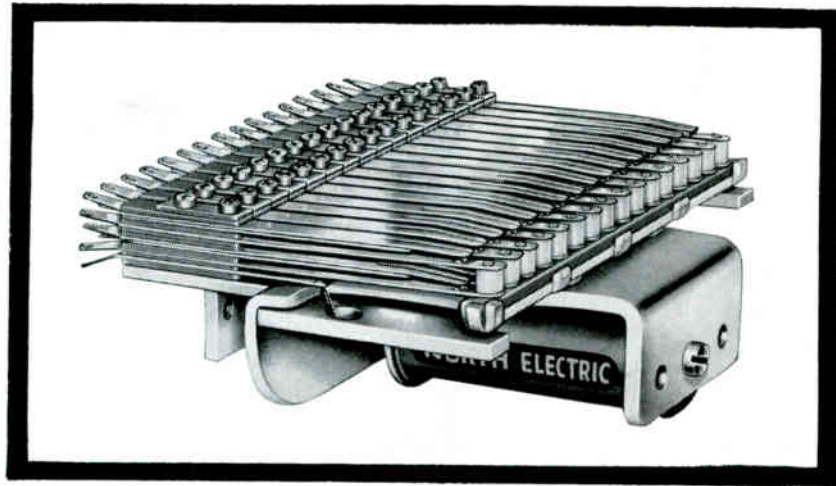

# FOR MULTIPLE CIRCUIT SWITCHING

## NORTH 700 SERIES "GANG" RELAYS

Where reliability is a must—North 700 Series "gang" relays combine fast action multiple circuit switching capabilities with the proven dependability of a telephone type open relay for use in computers, sorting and punching machines and similar applications. North 700 Series relays provide up to 16 pile-ups and are available to 32 form A or to 16 form B or form C contact arrangements.

These relays are also available with double coils for heavy spring loads or extra fast action. Double coil relays are identified as 7200 series and can be supplied with 50 form A or 32 form B or form C contact arrangements.

For applications where the small number of relays in a switching system make a common DC power supply uneconomical, the North 7300 Series is available with AC rectifiers.

North "gang" relays can be supplied with Double Gold Alloy or Solid Silver contacts, with solder type or AMP #78 type contact terminals, and with 12, 24, 48, 75 and 110 volt coils (110 V.A.C. for 7300 Series). Operating speeds range from 30 MS to 70 MS at approximately 2.2 watts. Faster speeds can be obtained with increased power.

For detailed specifications on North "Gang" 700, 7200 and 7300 Series relays, write ...

*ELECTRONETICS DIVISION*

**NORTH ELECTRIC COMPANY**

6410 SOUTH MARKET ST., GALION, OHIO



*Designed for*

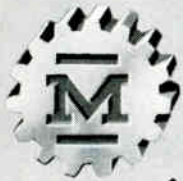

*Application*

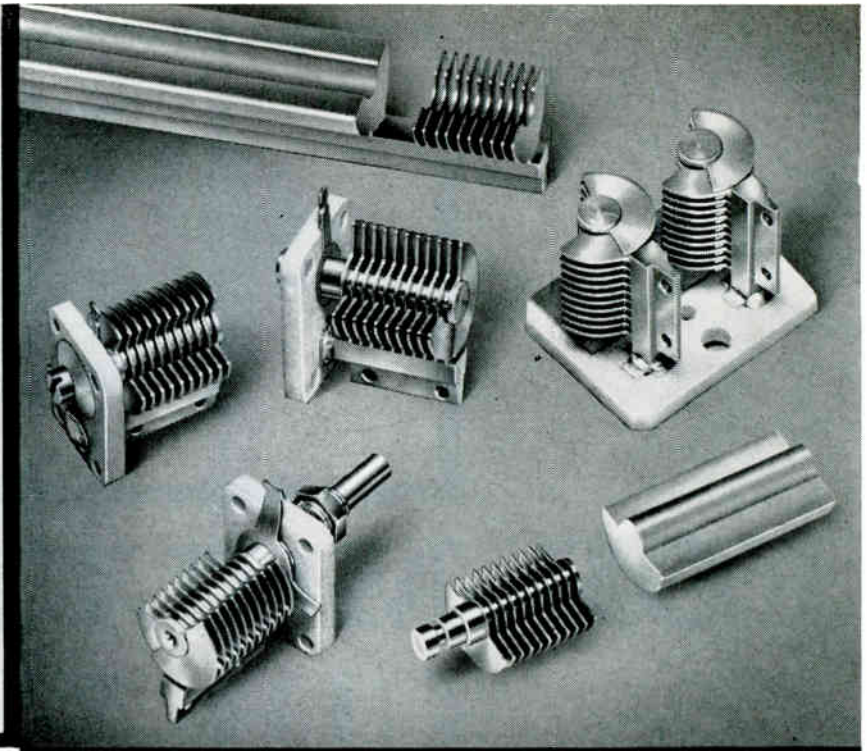

**NO. 25000 SERIES HIGH Q MINIATURE  
VARIABLE AIR CAPACITORS**

High Q at high frequencies. Rotors and Stators precision machined from extruded solid brass. Terminal integral part of Stator block. Shaft an integral part of Rotor. Screw-driver slot adjustment or  $\frac{1}{8}$ " extended shaft for knob. Only 6 parts to a complete Capacitor. Stock sizes 15, 25 & 35 mmfd. single or dual units.

**JAMES MILLEN MFG. CO., INC.**

**MALDEN  
MASSACHUSETTS**

CIRCLE 200 ON READER SERVICE CARD

*work in Southern California on the*

**EAGLE**



## ADVANCED OPPORTUNITIES FOR SENIOR ENGINEERS

Bendix-Pacific Division, North Hollywood, California, as a member of the Bendix Corporation "EAGLE" Development Team, is a major contributor to the Navy's newest air-to-air Missile "EAGLE." This weapon system is a second generation air-to-air Fleet Defense System and offers challenging design opportunities to the creative engineer.

**ADVANCED POSITIONS ARE OPEN TO MEN WITH BACHELOR, MASTER AND DOCTOR DEGREES IN ELECTRICAL AND MECHANICAL ENGINEERING WITH EXPERIENCE IN ELECTRONIC CIRCUIT DESIGN AND MECHANICAL PACKAGING. OTHER HIGH-LEVEL ELECTRONIC ENGINEERING POSITIONS AVAILABLE**

*Please send resume to*

**W. C. WALKER,**

ENGINEERING EMPLOYMENT MANAGER

**Bendix-Pacific Division**

11602 SHERMAN WAY  
NORTH HOLLYWOOD, CALIFORNIA



CIRCLE 377 ON READER SERVICE CARD

electronics



satisfies more  
application requirements...  
faster, easier, at low cost

# Panoramic **Subsonic** Spectrum Analyzer

MODEL

## LF-2a

### 0.5 cps. to 2500 cps.

#### EXCLUSIVE FEATURES:

- Adjustable scan widths—2 cps to 500 cps
- 10 second "quick look" on external scope
- Exceptional adjustable resolution (selectivity): 0.1 cps to 20 cps
- Low cost ● Easy to use

Unusually flexible and versatile, the economical Model LF-2a automatically separates and measures the frequency and amplitude of discrete or random signals between 0.5 and 2500 cps . . . and displays these data on either an integral chart recorder or external scope.

More application requirements are satisfied by providing analyses of spectrum segments—as narrow as 2 cps, as wide as 500 cps—plotted over the full width of the calibrated 12" x 4½" chart record. A calibrated tuning control enables rapid selection of the center frequency of the spectrum portion of interest. Frequency selectivity—or resolution—is independently adjustable from 0.1 cps to 20 cps for more accurate detection and measurement of either closely spaced discrete signals or noise.

Scan intervals range from just 10 sec. for "quick look" location and evaluation of signals on an external scope, to 16 hours for thorough statistical analysis.

Among the LF-2a's many proven uses are: ● Vibration and Acoustic Analysis ● Random Waveform Studies ● Power Spectral Density Analysis ● Medical Investigations ● Servo Analysis ● General Low Frequency Waveform Studies

With optional auxiliary equipment, the LF-2a is used for Power Spectral Density Analysis and Frequency Response Curve Tracing. Adding the Panoramic LP-1a Sonic Analyzer extends the analysis range to 22.5 Kc.



530 South Fulton Avenue, Mount Vernon, N. Y.  
Phone: OWens 9-4600 — TWX: MT-V-NY-5229  
Cables: Panoramic, Mount Vernon, N.Y. State



#### SUMMARY OF SPECIFICATIONS:

Frequency range: 0.5 cps to 2500 cps in two operating modes:

X1.0—Linear segments 500, 100 or 20 cps wide, centerable between 0 and 2250 cps

X0.1—Linear segments 50, 10 or 2 cps wide, centerable between 0 and 225 cps

Sensitivity: 10 mv to 100v for full scale deflection

Amplitude scales: Linear and 2 decade log

Chart size: 12" length, usable width 4½"

Resolution: 0.1 cps to 20 cps in 11 steps

Sweep Rate: One scan in 10 seconds, and 1, 2, 4, 8 or 16 minutes; also may be scanned in 1, 2, 4, 8, or 16 hours (optional)

Stability: better than 0.05 cps/hr. in X0.1 mode—0.5 cps/hr. in X1.0 mode

Input Impedance: 5 megohms

Frequency Markers: Self contained

Optional: LF-2aM, with automatic frequency advance after each scan interval provides unattended analysis from 0.5-2000 cps.

Write, wire or phone today for complete Model LF-2a specifications, applications and prices. Send for Panoramic's NEW CATALOG DIGEST.

See PANORAMIC's complete range of versatile instruments . . . in dynamic action . . . at—EIME—1 pm to 9 pm: Meadowbrook, Cedar Grove, N. J.—Oct. 17; Cherry Hill Inn, Phila.—Moorestown, N. J.—Oct. 19-20—NEREM—Booth 132.

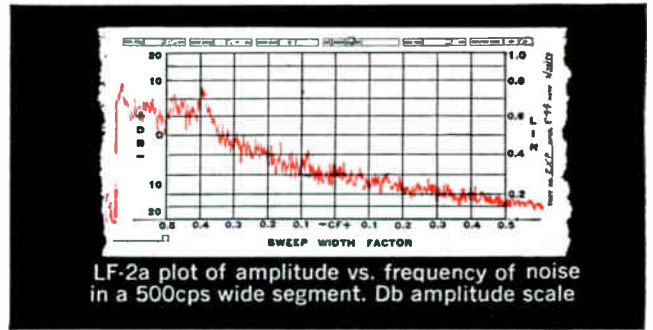

# JONES & LAMSON OPTICAL COMPARATORS

the man who needs  
a new machine tool is  
already paying for it

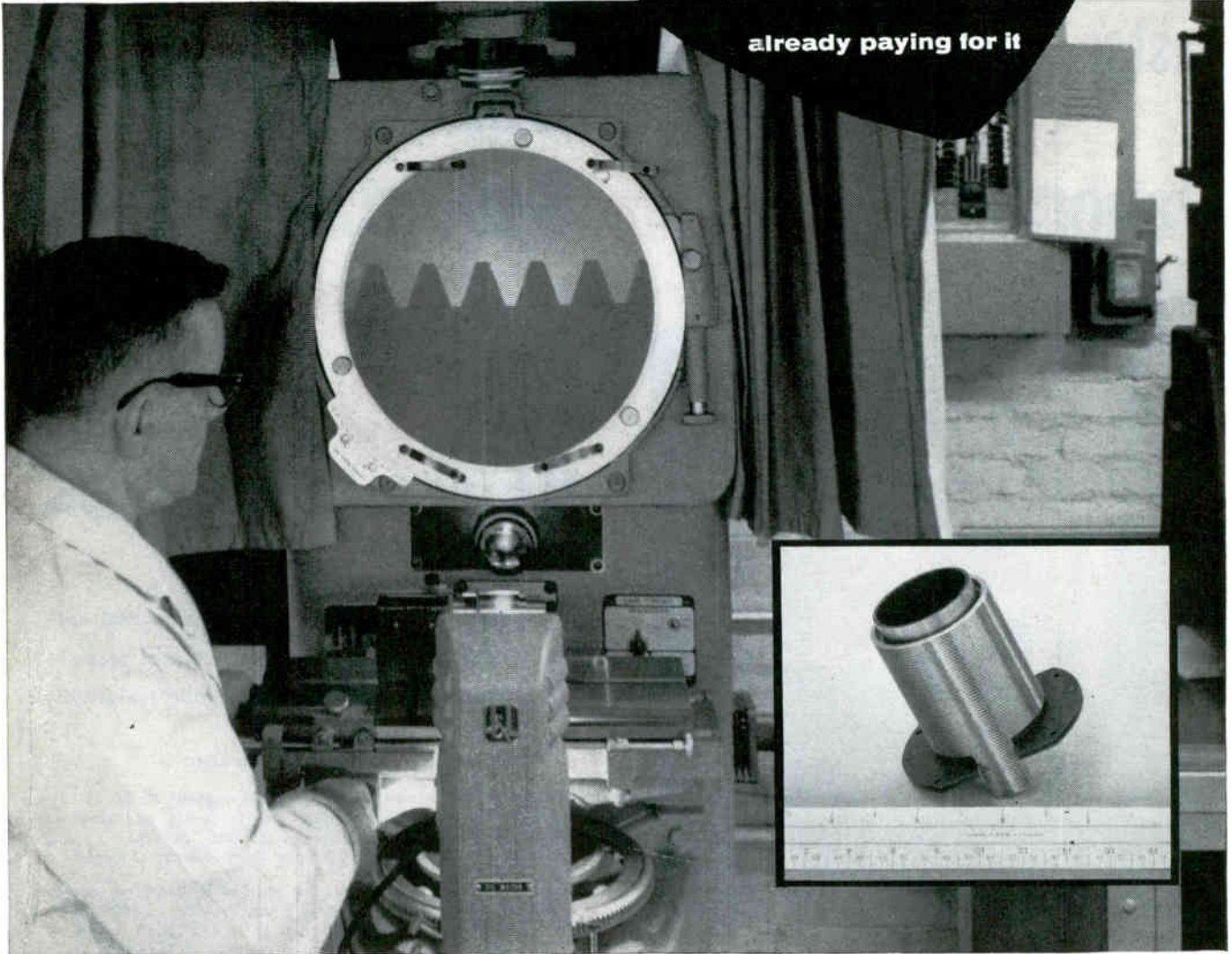

Unretouched photo (above) shows this cylindrical rack being inspected at 62.25X. Photo, courtesy of Baird-Atomic Inc., Cambridge, Mass.

## 4000% Increase in Inspection Efficiency through use of a J & L Optical Comparator

Baird-Atomic, Inc., Cambridge, Mass., manufacturer of scientific and research instruments needed a rapid and precise method for the quality control measurement and inspection of various components. After experimentation with various types of inspection equipment, a J & L FC-14 Optical Comparator was given a trial. It met all requirements perfectly.

The inspection of a cylindrical rack, heart of the Baird-Atomic Periscopic Sextant, used in advanced aircraft, gives an illustration of the J & L Comparator's efficiency.

The rigid quality control tolerances for this part include: tooth-to-tooth tolerance, .0002"; tooth-to-tooth error, .0003"; com-

posite error, .0003"; pitch dia. within .0005"; concentricity within .0005" TIR.

Adequate inspection and measurement by conventional methods proved laborious and time-consuming: inspection rate was little better than one rack per day. Now, using a J & L FC-14 Optical Comparator, average inspection rate is 42 per day, an increase of approximately 4000%!

Investigate the possibilities of J & L Comparators in *your* production set-up. Available in 12 different models, both floor and table types.

Write today for Comparator Catalog 5700. Jones & Lamson Machine Company, 539 Clinton Street, Springfield, Vermont.

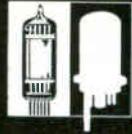

*Bendix Craftsmanship at work for you*

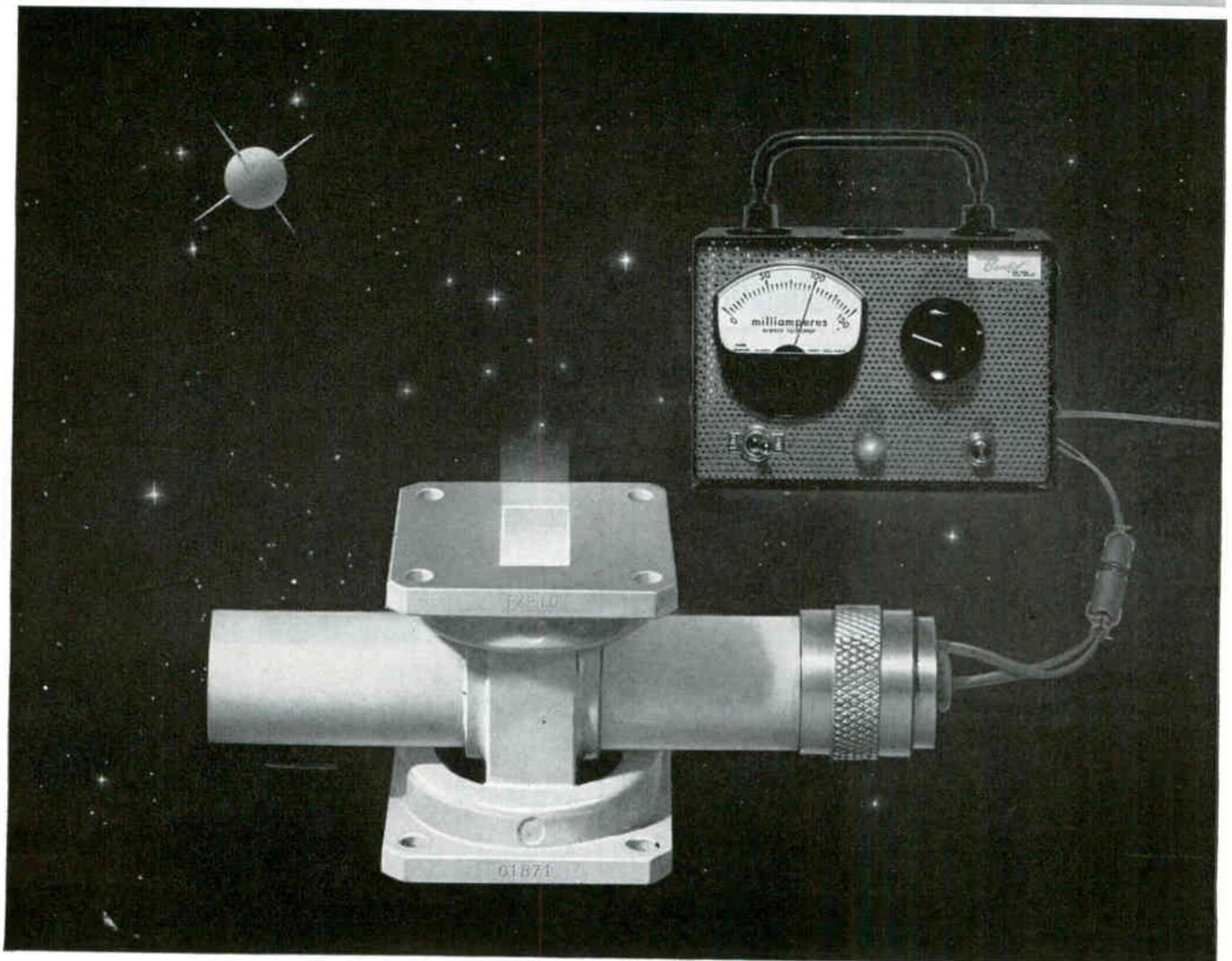

Shown in the background above is the Bendix TA-3 Power Supply

**NEW BENDIX® 6-OUNCE NOISE GENERATOR** meets need for fast, accurate noise measurement in miniaturized package. It has special value on noise monitoring applications—such as microwave and radar receivers—where size, weight, and power drain rank equally important with band width. This Bendix model TN-1 is only 2.00" x 4.25" over-all, weighs a mere six ounces, features low power drain, and is ruggedly built for long, trouble-free service. Designed for transmission-type use over frequency range of 8500 to 9600 mc. For further information, write . . .

ELECTRON TUBE PRODUCTS

**Red Bank Division**

EATONTOWN, NEW JERSEY



Precision  
**FREQUENCY  
 STANDARDS  
 AND  
 FORK OSCILLATOR  
 UNITS**

OUR NEW HOME, DOUBLING OUR FORMER CAPACITY

Watch Master  
 ELECTRONICS

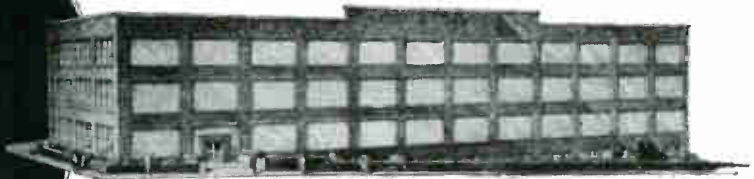

Our instruments, 40 to 30,000 cycles, are used extensively by industry and on government projects where enduring accuracy and maximum durability are required. Your inquiries on related products are invited.

**PRECISION FORK OSCILLATOR UNITS**

TYPE 2003



*Size 1½" dia. x 4½" H. Wght. 8 oz.*  
 Frequencies: 200 to 4000 cycles  
 Accuracies:—  
 Type 2003 ( $\pm .02\%$  at  $-65^{\circ}$  to  $85^{\circ}\text{C}$ )  
 Type R2003 ( $\pm .002\%$  at  $15^{\circ}$  to  $35^{\circ}\text{C}$ )  
 Type W2003 ( $\pm .005\%$  at  $-65^{\circ}$  to  $85^{\circ}\text{C}$ )  
 Double triode and 5 pigtail parts required.  
 Input, Tube heater voltage and B voltage  
 Output, approx. 5V into 200,000 ohms

TYPE 2007-6



**TRANSISTORIZED, Silicon Type**  
*Size 1½" dia. x 3½" H. Wght. 7 ozs.*  
 Frequencies: 360 to 1000 cycles  
 Accuracies:  
 2007-6 ( $\pm .02\%$  at  $-50^{\circ}$  to  $+85^{\circ}\text{C}$ )  
 R2007-6 ( $\pm .002\%$  at  $+15^{\circ}$  to  $+35^{\circ}\text{C}$ )  
 W2007-6 ( $\pm .005\%$  at  $-65^{\circ}$  to  $+85^{\circ}\text{C}$ )  
 Input: 10 to 30 Volts, D. C., at 6 ma.  
 Output: Multitap, 75 to 100,000 ohms

TYPE 2001-2



*Size 3¾" x 4½" x 6" H., Wght. 26 oz.*  
 Frequencies: 200 to 3000 cycles  
 Accuracy:  $\pm .001\%$  at  $20^{\circ}$  to  $30^{\circ}\text{C}$   
 Output: 5V. at 250,000 ohms  
 Input: Heater voltage, 6.3-12-28  
 B voltage, 100 to 300 V., at 5 to 10 ma.

ACCESSORY UNITS FOR 2001-2



- L—For low frequencies multi-vibrator type, 40-200 cy.
- D—For low frequencies counter type, 40-200 cy.
- H—For high freqs, up to 30 KC.
- M—Power Amplifier, 2W output.
- P—Power supply.

**PRECISION FREQUENCY STANDARDS**

TYPE 2005A

*Size 8" x 8" x 7¼" High  
 Weight, 14 lbs.*

Frequencies:  
 50 to 400 cycles (Specify)  
 Accuracy:  
 $\pm .001\%$  from  $20^{\circ}$  to  $30^{\circ}\text{C}$   
 Output, 10 Watts at 115V  
 Input, 115V. (50 to 400 cy.)



TYPE 2121A

*Size  
 8¾" x 19" panel  
 Weight, 25 lbs.*

Output: 115V  
 60 cycles, 10 Watt  
 Accuracy:  
 $\pm .001\%$   $20^{\circ}$  to  $30^{\circ}\text{C}$   
 Input,  
 115V (50 to 400 cy.)



TYPE 2111C

*Size, with cover  
 10" x 17" x 9" H.  
 Panel model  
 10" x 19" x 8¾" H.  
 Weight, 25 lbs.*

Frequencies: 50 to 1000 cy.  
 Accuracy:  
 $\pm .002\%$  at  $15^{\circ}$  to  $35^{\circ}\text{C}$   
 Output: 115V, 75W.  
 Input: 115V, 50 to 75 cy.



WHEN REQUESTING INFORMATION, PLEASE SPECIFY TYPE NUMBER

ATP  
**American Time Products  
 Inc.**  
 61-20 Woodside Avenue  
 Woodside 77, N. Y.

# NOT FOR SALE....

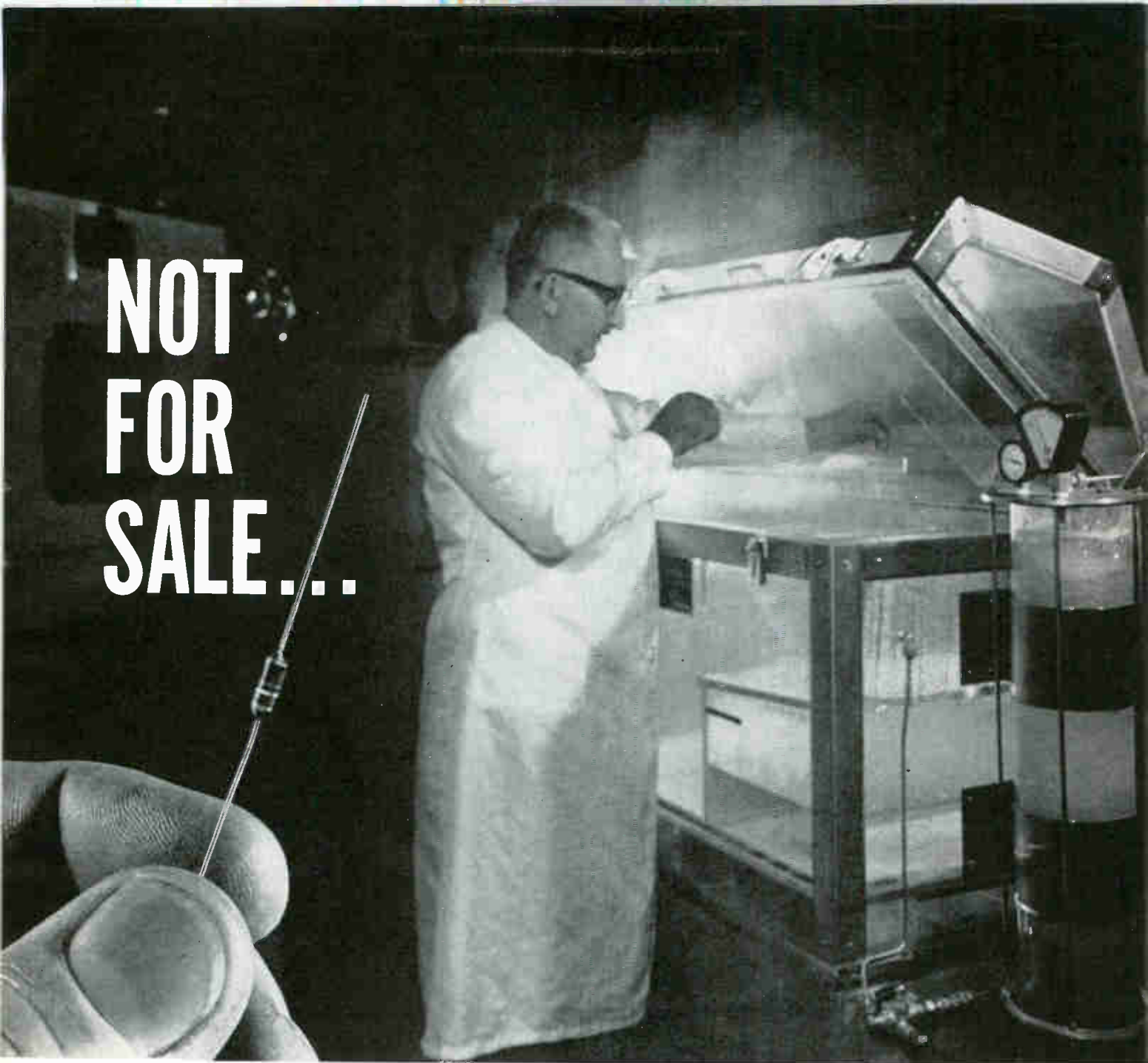

**UNTIL** all Saratoga Semiconductors have qualified under a battery of gruelling, fully controlled tests totalling thousands of hours.

The rigid 20% salt atmosphere test (pictured above) verifies resistance to salt corrosion, permanence of markings and strength of the hermetic seal.

Altitude, humidity, temperature, impact shock, vibration and 20,000 "G" radial acceleration tests are among those that must be passed.

These tests are reasons why the Saratoga can be called the "Thoroughbred of Semiconductors."

Send for our new catalogue SS-2001 outlining details, specifications, and applications of Saratoga silicon zener regulators\* and silicon power rectifiers.\*

**SARATOGA SEMICONDUCTOR DIVISION, Saratoga Springs, N.Y.**

**ESPEY MFG. & ELECTRONICS CORP.**

\* Meet all requirements of MIL S-19500B

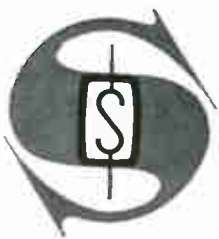



## THERMOSETTING RESINS

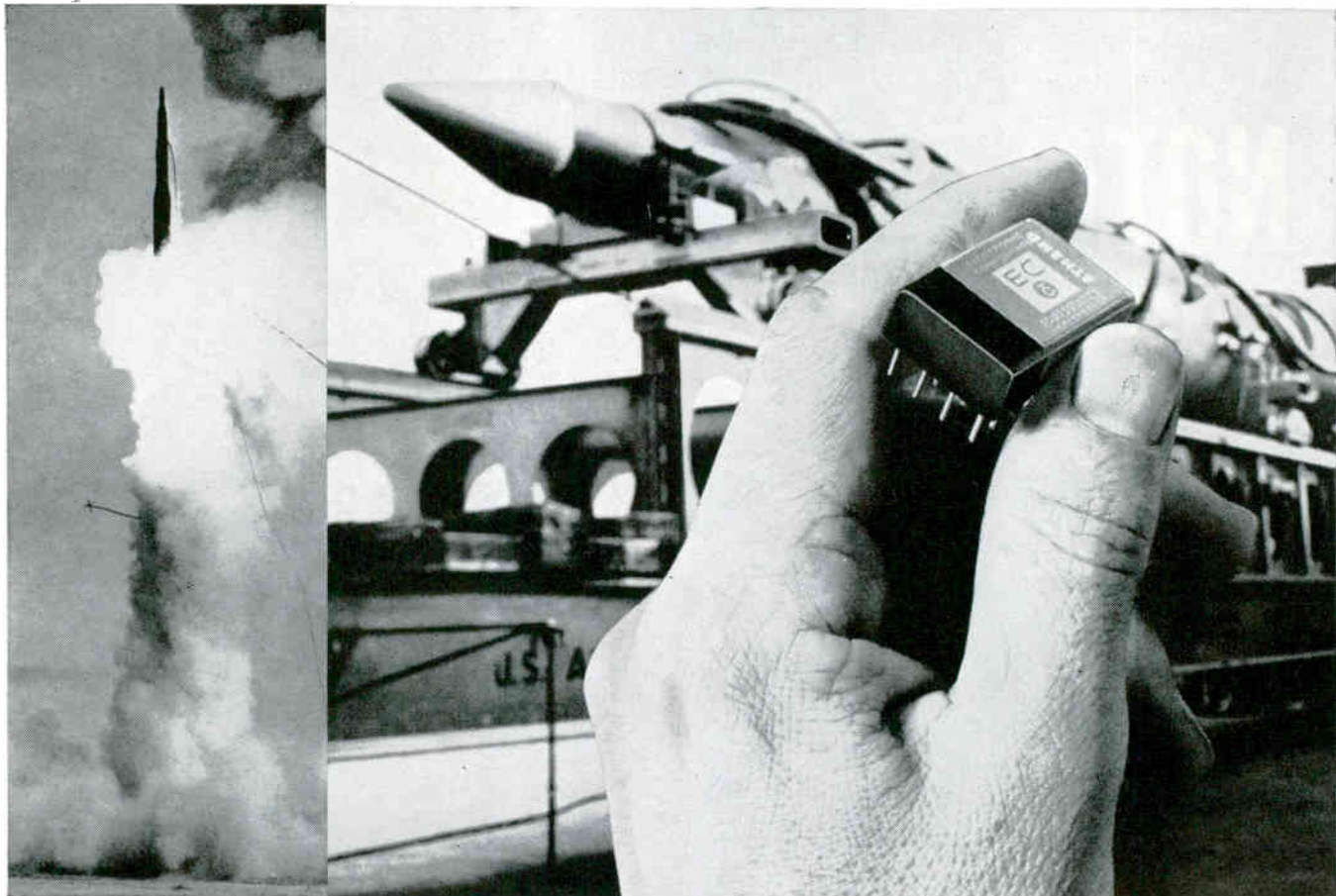

"For insulating relays in the guidance system of the Minuteman . . .

### WE RELY ON DOW EPOXY NOVOLAC FOR POTTINGS!"

"Our micro-miniature relays are an important part of the ground checkout system for the Air Force's Minuteman intercontinental ballistic missile," states H. E. Wardein, Customer Relations Manager of the Electronics Components Division of Telecomputing Corporation. "So to be sure of the mechanical stability and insulation resistance of the terminal connector potting, we ran a series of heat and chemical endurance tests. The results convinced us that Dow Epoxy Novolac (D.E.N. 438) was by far the best potting compound for this highly critical application!" Telecomputing supplies the relays to the Autonetics division of North American Aviation, Inc., associate prime contractor for the Minuteman's guidance and flight control systems.

The tests used by Telecomputing Corporation to determine the effects of a prolonged, intense heat on relay terminal pottings took place in a 180°C. oven. After five hours, a terminal potted with an ordinary epoxy resin compound cracked. But after 100 hours, the terminal potted with Dow Epoxy Novolac was unharmed!

A chemical resistance test compared the ability of potting compounds to withstand the action of high-powered degreasing solvents. An ordinary epoxy resin was completely dissolved after only 48 hours in the stripper. But the Dow Epoxy Novolac showed no significant change, even after two weeks immersed in the same stripper!

These results prove once again that if you're potting, molding, encapsulating, or laminating in an application where performance is critical, use Dow Epoxy Novolac (D.E.N. 438) for that extra meas-

ure of physical and chemical stability. For full information, call your nearest Dow sales office, or write to THE DOW CHEMICAL COMPANY, Midland, Michigan, Plastics Merchandising Department 1969JG10-14.



In heat resistance tests, ordinary epoxy resin (left) cracked. Dow Epoxy Novolac (right) was unharmed!

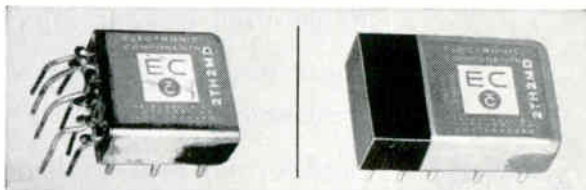

Soaked in a solvent stripper, epoxy resin (left) dissolved. Dow Epoxy Novolac (right) showed no change!

**THE DOW CHEMICAL COMPANY • MIDLAND, MICHIGAN**



Model PS4232M  
115-325 volts DC out  
at 1.5 amp maximum

# 30 DAY DELIVERY

on all  
models



Model PS4315M 0-36 volts DC out at 15 amp maximum

## NEW TRANSISTOR - REGULATED

- *Five-Year Warranty*
- *Transient-Free Output*
- *Exclusive Regulator Circuit*

Two new lines of power supplies — one high and one low voltage line — are available now from POWER SOURCES, INC. Both lines feature the exclusive POWER SOURCES regulator circuit that provides full protection for the transistors *without* DC fuses. Both lines are warranted for *five full years*. Warranty includes all semi-conductor components. Cooling systems of advanced design insure long life and trouble-free operation.

For prices and complete specifications on POWER SOURCES high and low voltage solid state power supplies, write, wire or phone today.

## POWER SUPPLIES

### High Voltage Supply Specifications

	PS4222	PS4230	PS4232
DC Output Range	35-215 volts 0-1.5 amps	90-300 volts 0-1.5 amps	115-325 volts 0-1.5 amps
AC Input	105-125 volts, 50-60 cps*, all models		
Regulation (line)	Better than 0.1% or 0.2 volts over entire input range (whichever is greater)		
Regulation (load)	Better than 0.1% or 0.2 volts for no-load to full load (whichever is greater)		
Transient Response	Output remains within regulation limits for step-function change of $\pm 10$ volts in 105-125 volt input range  Output remains within regulation limits for changes from no-load to full-load or full-load to no-load		

### Low Voltage Supply Specifications

	PS4305	PS4315	PS4330
DC Output Range	0-36 volts 0-5 amps	0-36 volts 0-15 amps	0-36 volts 0-30 amps
AC Input	105-125 volts, 50-60 cps*, all models		
Regulation (line)	Better than 0.025% or 3 mv over input range (whichever is greater)		
Regulation (load)	Better than 0.05% or 5 mv, no-load to full-load variation (whichever is greater)		
Transient Response	Output remains within regulation limits for line voltage steps of $\pm 10$ volts within input range  Output recovers in 100 usec for no-load to full-load or full-load to 50% load step changes.		

\*400 cps available on order

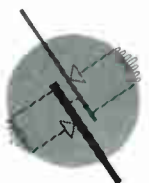

Specify POWER SOURCES BY

**POWER SOURCES, INC.** Burlington, Massachusetts

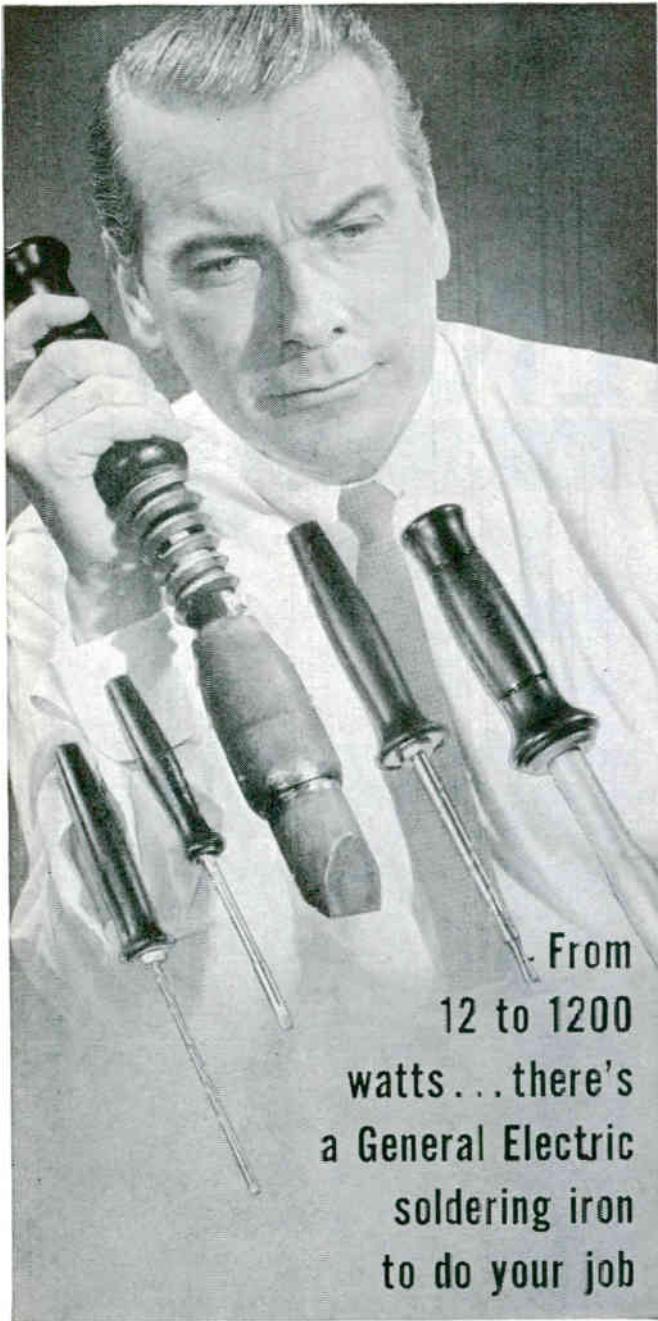

From  
12 to 1200  
watts... there's  
a General Electric  
soldering iron  
to do your job

**... AND GENERAL ELECTRIC WILL HELP YOU  
CHOOSE THE EXACT IRON YOU NEED**

Whatever your soldering requirements may be—from complex miniature electronic sub-assemblies to heavy-duty industrial uses—one of the high-speed soldering irons in General Electric's complete line will do the job. The G-E irons shown above include (left to right):  
**MINIATURE** for production-line soldering of sub-miniature assemblies.

**MIDGET** for pinpoint soldering of hard-to-reach joints.  
**EXTRA HEAVY-DUTY** for industrial high-wattage soldering.  
**LIGHTWEIGHT** for soldering of most electronic components.  
**INDUSTRIAL** for general industrial soft-solder applications.

For expert assistance in choosing the exact iron you need, contact your General Electric distributor or local G-E Apparatus Sales Office; or write Section 758-03, General Electric Co., Schenectady 5, N. Y.

*Progress Is Our Most Important Product*

**GENERAL  ELECTRIC**



I have a feeling in the pit of my photocell that you are open to this page. Why not have a look at these data while you are here.

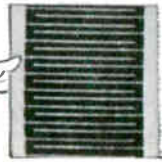

**CdS-  
Photoconductive  
CELLS**

Capable of dissipating especially high power up to one watt.

- RUGGED
- ECONOMICAL

Various standard types with different electrical and physical characteristics available to meet your specifications.

WRITE:

**NATIONAL SEMICONDUCTORS LTD.**

230 AUTHIER ST. Montreal 9, P. Q.  
Phone: RI: 4-2946

CIRCLE 201 ON READER SERVICE CARD

- Operate in any position
- Hermetically sealed against moisture and explosions
- Not affected by high or low temperature, nor pressures
- Small, compact, rugged

**DRS-5**  
Silver plated in 20 lb. hydrogen pressure  
Rated: 50V amp up to 250 volts



**HAMLIN**  
*magnetic reed  
switches*

- High sensitivity
- Rapid cycling, up to 400 cycles
- Long, dependable life

for relays, timers, limit switches, commutators, flow meters, etc.

Send for bulletin

**DRG-1**  
Gold plated in inert atmosphere.  
Rated: 15V amp up to 250 volts

**HAMLIN INC**

Dept. EL • Lake and Grove Streets • Lake Mills, Wisconsin  
CIRCLE 202 ON READER SERVICE CARD



# 67

... good reasons why  
you can standardize with

**\* WIDE RANGE MODELS**

D-C OUTPUT		MODEL NUMBER	DIMENSIONS IN INCHES		
VOLTS	AMPS		H	W	D
0-7	0-30	*TO7-30	15 <sup>3</sup> / <sub>4</sub>	19	16
0-7	0-15	*TO7-15	8 <sup>3</sup> / <sub>4</sub>	19	15
0-7	0-10	*TO7-10	7	19	15
0-7	0-5	*TO7-5	5 <sup>1</sup> / <sub>4</sub>	19	15
0-7	0-3	*TO7-3	3 <sup>1</sup> / <sub>2</sub>	19	12 <sup>1</sup> / <sub>2</sub>
0-14	0-20	*TO14-20	15 <sup>3</sup> / <sub>4</sub>	19	16
0-14	0-10	*TO14-10	8 <sup>3</sup> / <sub>4</sub>	19	15
0-14	0-7.5	*TO14-7.5	7	19	15
0-14	0-5	*TO14-5	5 <sup>1</sup> / <sub>4</sub>	19	15
0-14	0-3	*TO14-3	3 <sup>1</sup> / <sub>2</sub>	19	12 <sup>1</sup> / <sub>2</sub>
0-32	0-30	TO32-30	15 <sup>3</sup> / <sub>4</sub>	19	16
0-32	0-15	TO32-15	8 <sup>3</sup> / <sub>4</sub>	19	15
0-32	0-10	TO32-10	7	19	15
0-32	0-5	TO32-5	5 <sup>1</sup> / <sub>4</sub>	19	15
0-32	0-3	TO32-3	3 <sup>1</sup> / <sub>2</sub>	19	12 <sup>1</sup> / <sub>2</sub>
0-36	0-30	TO36-30	15 <sup>3</sup> / <sub>4</sub>	19	16
0-36	0-15	TO36-15	8 <sup>3</sup> / <sub>4</sub>	19	15
0-36	0-10	TO36-10	7	19	15
0-36	0-5	TO36-5	5 <sup>1</sup> / <sub>4</sub>	19	15
0-36	0-3	TO36-3	3 <sup>1</sup> / <sub>2</sub>	19	12 <sup>1</sup> / <sub>2</sub>
0-60	0-15	TO60-15	15 <sup>3</sup> / <sub>4</sub>	19	15
0-60	0-7.5	TO60-7.5	8 <sup>3</sup> / <sub>4</sub>	19	15
0-60	0-5	TO60-5	7	19	15
0-60	0-2.5	TO60-2.5	5 <sup>1</sup> / <sub>4</sub>	19	15
0-60	0-1.5	TO60-1.5	3 <sup>1</sup> / <sub>2</sub>	19	12 <sup>1</sup> / <sub>2</sub>

\* MODELS MARKED WITH AN ASTERISK ARE PROGRAMMABLE.

**† NARROW RANGE MODELS**

5-7.5	0-30	T6-30	15 <sup>3</sup> / <sub>4</sub>	19	16
5-7.5	0-15	T6-15	8 <sup>3</sup> / <sub>4</sub>	19	15
5-7.5	0-10	T6-10	7	19	15
5-7.5	0-5	T6-5	5 <sup>1</sup> / <sub>4</sub>	19	15
5-7.5	0-3	T6-3	3 <sup>1</sup> / <sub>2</sub>	19	12 <sup>1</sup> / <sub>2</sub>
7-11	0-15	T9-15	8 <sup>3</sup> / <sub>4</sub>	19	15
7-11	0-10	T9-10	7	19	15
7-11	0-5	T9-5	5 <sup>1</sup> / <sub>4</sub>	19	15
11-14	0-30	T12-30	15 <sup>3</sup> / <sub>4</sub>	19	16
11-14	0-15	T12-15	8 <sup>3</sup> / <sub>4</sub>	19	15
11-14	0-10	T12-10	7	19	15
11-14	0-5	T12-5	5 <sup>1</sup> / <sub>4</sub>	19	15
11-14	0-3	T12-3	3 <sup>1</sup> / <sub>2</sub>	19	12 <sup>1</sup> / <sub>2</sub>
14-17	0-15	T16-15	8 <sup>3</sup> / <sub>4</sub>	19	15
14-17	0-10	T16-10	7	19	15
14-17	0-5	T16-5	5 <sup>1</sup> / <sub>4</sub>	19	15
17-20	0-15	T19-15	8 <sup>3</sup> / <sub>4</sub>	19	15
17-20	0-10	T19-10	7	19	15
17-20	0-5	T19-5	5 <sup>1</sup> / <sub>4</sub>	19	15
20-23	0-15	T22-15	8 <sup>3</sup> / <sub>4</sub>	19	15
20-23	0-10	T22-10	7	19	15
20-23	0-5	T22-5	5 <sup>1</sup> / <sub>4</sub>	19	15
22.5-27	0-30	T25-30	15 <sup>3</sup> / <sub>4</sub>	19	16
22.5-27	0-12	T25-12	8 <sup>3</sup> / <sub>4</sub>	19	15
22.5-27	0-10	T25-10	7	19	15
22.5-27	0-5	T25-5	5 <sup>1</sup> / <sub>4</sub>	19	15
22.5-27	0-3	T25-3	3 <sup>1</sup> / <sub>2</sub>	19	12 <sup>1</sup> / <sub>2</sub>
25-31	0-30	T28-30	15 <sup>3</sup> / <sub>4</sub>	19	16
25-31	0-12	T28-12	8 <sup>3</sup> / <sub>4</sub>	19	15
25-31	0-10	T28-10	7	19	15
25-31	0-4.5	T28-4.5	5 <sup>1</sup> / <sub>4</sub>	19	15
25-31	0-3	T28-3	3 <sup>1</sup> / <sub>2</sub>	19	12 <sup>1</sup> / <sub>2</sub>
31-33.5	0-30	T32-30	15 <sup>3</sup> / <sub>4</sub>	19	16
31-33.5	0-12	T32-12	8 <sup>3</sup> / <sub>4</sub>	19	15
31-33.5	0-10	T32-10	7	19	15
31-33.5	0-5	T32-5	5 <sup>1</sup> / <sub>4</sub>	19	15
31-33.5	0-3	T32-3	3 <sup>1</sup> / <sub>2</sub>	19	12 <sup>1</sup> / <sub>2</sub>
33.5-36	0-30	T35-30	15 <sup>3</sup> / <sub>4</sub>	19	16
33.5-36	0-12	T35-12	8 <sup>3</sup> / <sub>4</sub>	19	15
33.5-36	0-10	T35-10	7	19	15
33.5-36	0-5	T35-5	5 <sup>1</sup> / <sub>4</sub>	19	15
33.5-36	0-3	T35-3	3 <sup>1</sup> / <sub>2</sub>	19	12 <sup>1</sup> / <sub>2</sub>

† ALL NARROW RANGE MODELS ARE PROGRAMMABLE.



MODEL TO36-5M

# REGATRAN<sup>®</sup>

## SEMICONDUCTOR

# POWER SUPPLIES

### SPECIFICATIONS

\*REGULATION: 0.03% or 0.01 V from no load to full load and 105 to 125 V line. (0.1% or 0.01 V for 3-amp models.)

RIPPLE: Less than 1 millivolt rms.

INPUT: 105 V to 125 V, 50 to 60 cps.

CIRCUIT PROTECTION: Four-year field-tested electronic and electrical circuit protection.

MOUNTING: Rack and table.

\*0.01% or 0.003 V regulation available on special order.

REQUEST BULLETIN 721A.



® Reg. U.S. Pat. Off. Patents Issued and Pending.

# COLLINS SINGLE SIDEBAND SYSTEMS provide global air-ground communications with structures by Dresser-Ideco

The latest HF high-gain directional antennas now make it possible for an Air Force pilot to maintain contact with his home base from anywhere in the world. For this purpose, 11 major antennas and structures of the Wullenweber and Billboard types have been fabricated by Dresser-Ideco for the Collins Radio Company, which designed the antennas, and Collins' Systems Management subsidiary, Alpha Corporation, which performed the installation.

Installed near principal Air Force Bases, these antennas are links in AF longhaul air-ground communications. And in commercial aviation, now served by relatively short-range radio, the faster and farther flights of the new jets may soon require a civilian version of these electrically steerable antennas to maintain world-wide contact with headquarters ground bases.

Spanning a 3.5 mc to 30 mc frequency range, the towers and antenna elements involved ultra-critical tolerances on dimensions, alignment and positioning. In fabricating the many precisely located weldments for bolted assembly, special welding techniques were employed to prevent warpage and distortion. Dresser-Ideco also attached all the insulators and conducted load tests on the steel pipe radiator elements.

Although, in this instance, antennas and structures were built to the customer's detailed specifications, Dresser-Ideco also offers fully staffed and widely experienced services for structural research and for development of structural prototypes; for assembly and testing; and for the large-scale manufacture and erection of antenna towers and the structural components of large antennas.

Preliminary evaluation and cost estimates on your tower and antenna structural requirements are available without obligation. Write or call Dresser-Ideco Company, A Division of Dresser Industries, Inc., 875 Michigan Avenue, Columbus 15, Ohio. Phone: AXminister 9-2123

## DRESSER-IDECO COMPANY



*Collins-Wullenweber antenna of the electrically steerable type used by the Air Force for global single sideband air-ground communications.*

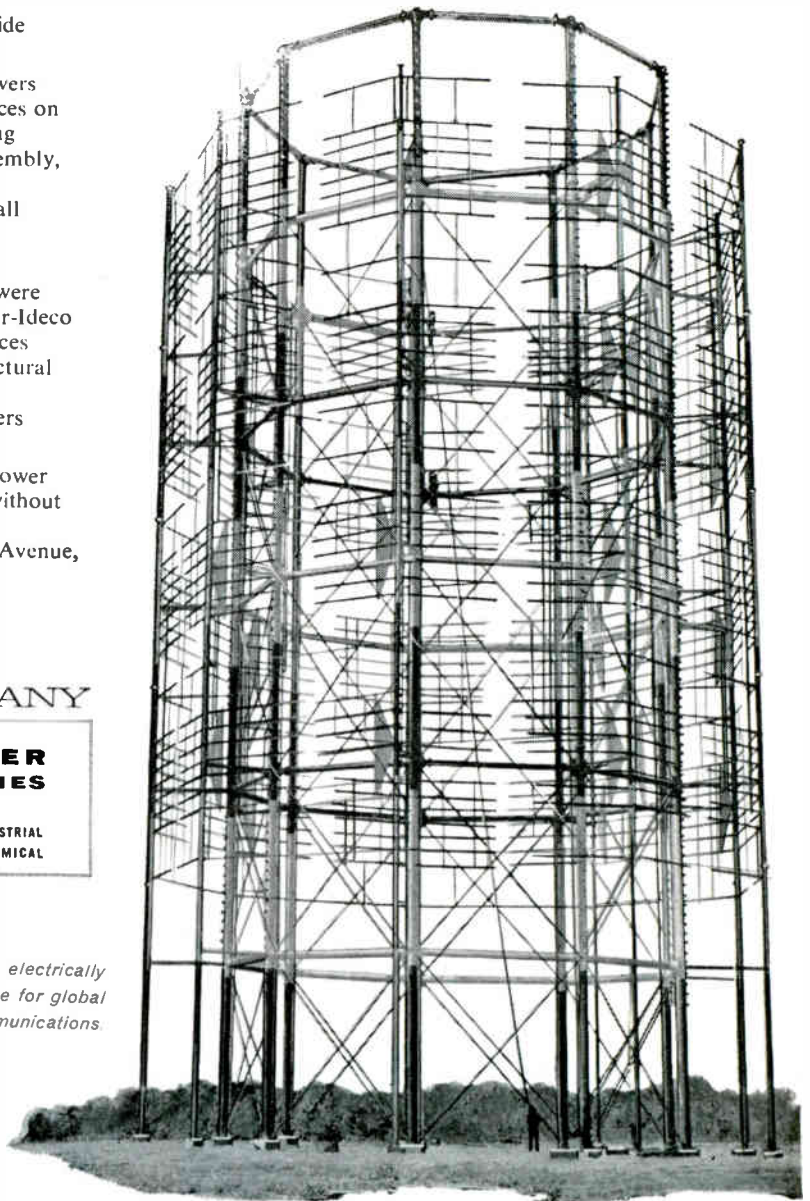

*Induction radio link using vlf transmitter and car radio relays messages from roadside to driver. Repeater for transmitting continuous, fixed messages uses playback which exerts no frictional force on tape*

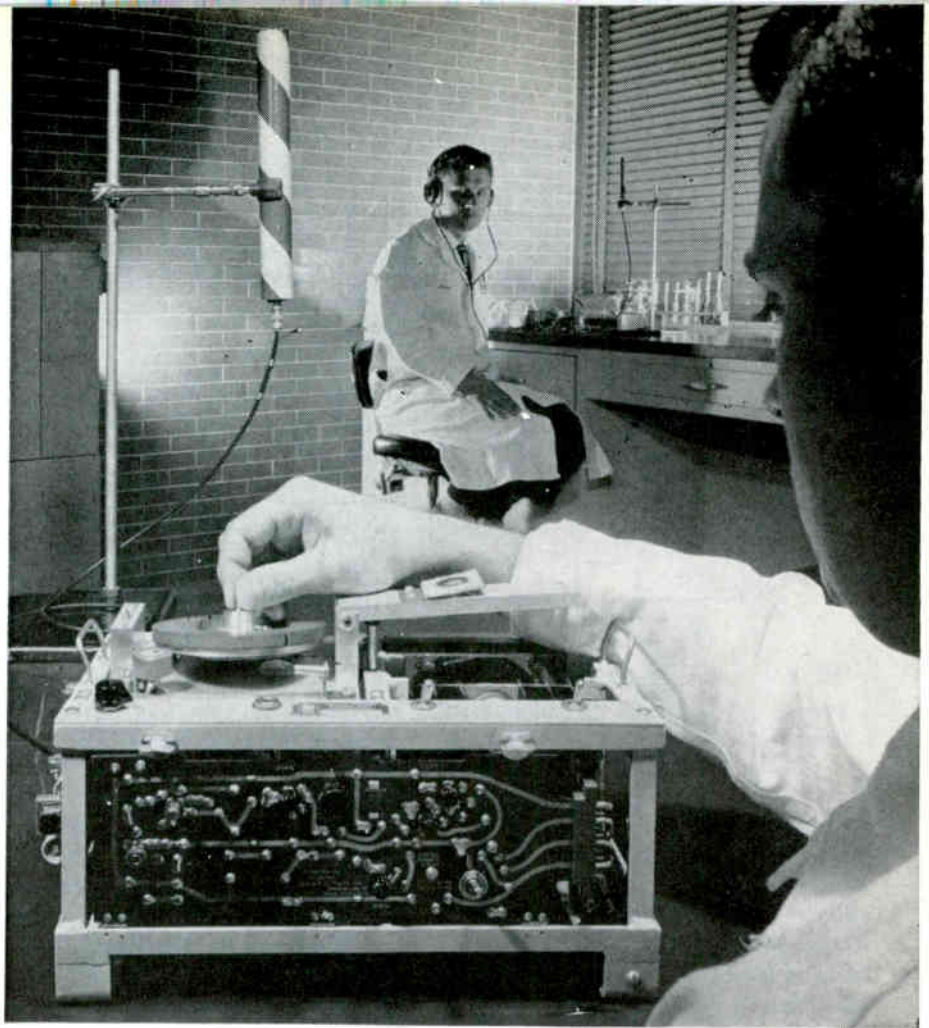

*Engineer places tape-wrapped drum containing special instructions to drivers in repeater portion of highway communication system*

## Communication System For Highway Traffic Control

By E. A. HANYSZ, J. E. STEVENS and A. MEDUVSKY  
General Motors Research Laboratories, Warren, Mich.

COMMUNICATION of voice messages to motorists passing roadside stations has long been considered as an aid to safer highway travel.

Electromagnetic radiation would be convenient for such a link. However, the inability to confine radiation to the exclusive use of a select group of vehicles defeats its practicality. Microwaves are more directional, but not simple.

A communication system consisting of an induction radio link operating in the vlf band may be the answer to the driver aid problem.

Termed Hy-Com, the system was conceived by the General Motors Research Laboratories and uses a loop transmitting antenna alongside the road to set up an amplitude-modulated magnetic induction field over the highway adjacent to the loop. Vehicles with receivers pick up the message as they pass through the field.

Through use of telephone lines, messages such as *accident ahead—detour to Main Avenue* can be transmitted moments after accident happens. Modulation can also

be obtained from tape repeaters and on-the-spot microphone announcements by law enforcement agencies. A rectangular loop with 5-ft. spacing between lines and stretching as far along the highway as necessary makes up the antenna. Both antenna and transmitter can be buried for permanent installations. Emergency antennas composed of a multiplicity of ferrite core solenoids can be substituted.

The Hy-Com transmitter shown in Fig. 1A is a slight departure from conventional transmitters. Modulation is accomplished at the lowest carrier power level with the oscillator delivering only 8.4  $\mu$ w of 9-Kc power to the modulator. As



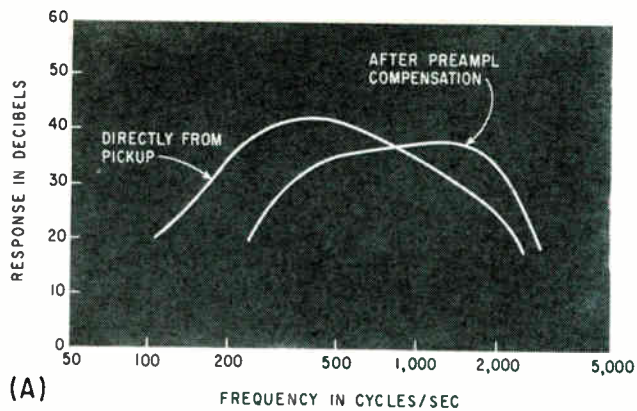

(A)

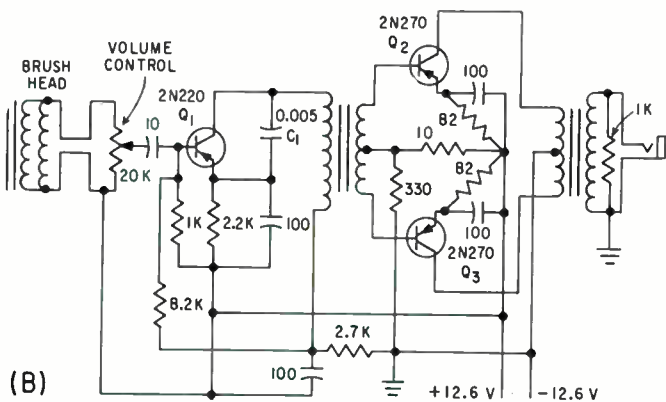

(B)

FIG. 3—Frequency response of modulating signal before and after compensation (A). Maximum gain provided by the message repeater preamplifier (B) is 58 db

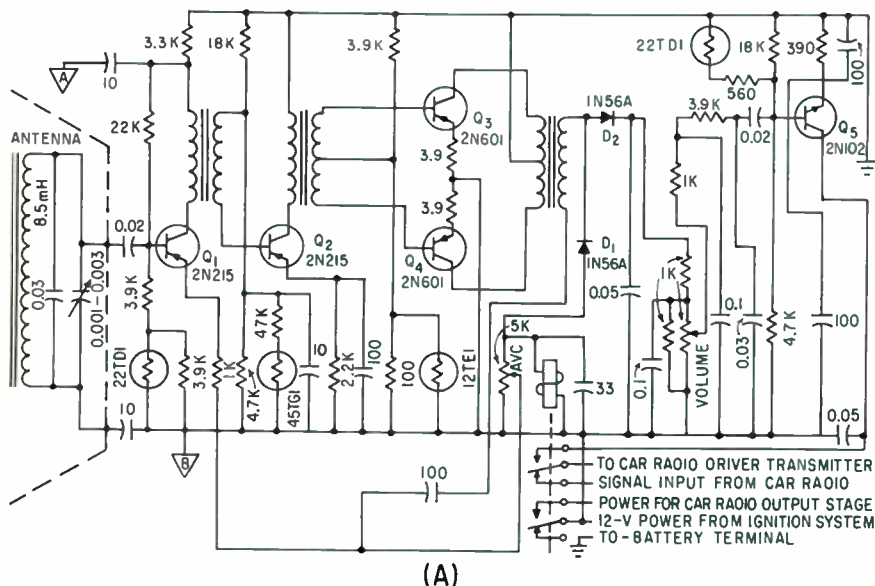

(A)

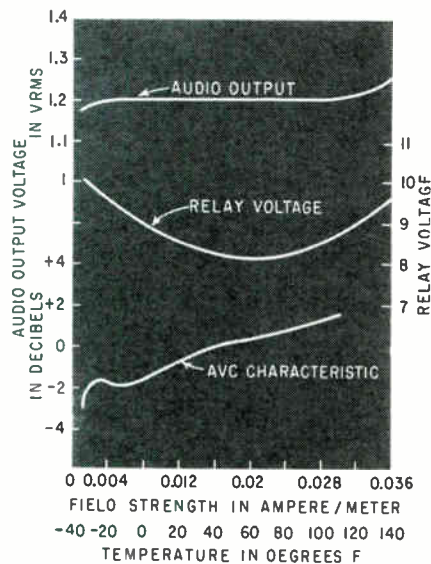

(B)

FIG. 4—A thermistor network in base of each transistor of the receiver provides thermal compensation. Temperature and avc characteristics of receiver are shown in (B); audio output and relay voltage curves are plotted as function of temperature; avc curve is a function of field strength

common output stage and loudspeaker. Figure 1B shows the receiver is a low-pass amplifier; the little selectivity required is obtained by tuning the ferrite-rod antenna. The message control section keeps the audio muted until a minimum field strength is intercepted ( $10^{-3}$  amp per meter) to prevent automobile ignition noises ( $10^{-1}$  amp per meter) from being heard. The message control section also controls the B+ power to the audio output stage when the standard broadcast radio is off and selects either the message or standard broadcast audio depending upon the presence or absence of a message field.

The receiver schematic is shown in Fig. 4A. Stabilizing networks provide invariant reception over the temperature range of  $-30$  to

$+140$  F. The antenna is wound on a  $\frac{1}{2}$ -inch diameter ferrite core 8 inches in length. When tuned to the operating frequency and loaded with the input impedance of the first stage, the 8.5 mH inductance of this antenna provides 3,000-cps bandwidth.

To obtain a low standby current drain from the battery, it was necessary to use a class-B push-pull stage,  $Q_3$  and  $Q_4$ , to achieve the 80 mw required to actuate the message control relay and to provide avc and audio signal voltage.

The output of the push-pull stage is fed into two parallel diode detector circuits,  $D_1$  and  $D_2$ . One provides power for avc and actuates the message control relay. The avc voltage is adjusted to cause the relay to pull in at  $10^{-3}$  am per meter; the avc characteristic in db output

vs field strength is shown in Fig. 4B. Audio signals from the other detector are fed to the volume control.

The carrier, being a-f, requires filtering to prevent it from appearing in the output. This filtering is provided by a two-section, low-pass R-C network. The message signal is fed to the base of audio amplifier  $Q_5$ , and then coupled to the driver transformer in the car radio through the contacts of the message control relay. If the car does not have a radio, a power amplifier with self-contained loud speaker could be used simplifying the function of the message control relay.

#### REFERENCES

- (1) E. A. Hanyasz, Highway Alert Radio, 1960 *IRE Nat. Conv. Rec.*
- (2) C. E. Quinn, New Voice System Alerts Drivers, *Traffic Eng.*, July, 1959.

# Superconducting Devices and Circuits

*High-speed switching and storage capability are obtained in superconducting computer circuits with thin film cryotrons. In this article, principles of cryotron operation are explained and some sample circuits are described*

By DONALD R. YOUNG,

Research Laboratory,  
International Business Machines Corp.,  
Poughkeepsie, N. Y.

THE UNUSUAL PROPERTIES of superconductors are so well adapted to the needs of modern computers for switching and memory devices, it now appears that the advantages to be gained well outweigh the difficulties associated with the low-temperature operation.

Resistance of metals generally decreases as the temperature decreases; however, in a superconductor the resistance abruptly falls to zero at a well-defined critical temperature,  $T_c$ , as shown in Fig. 1A. If a magnetic field is applied, the transition to zero resistance occurs at a lower temperature. The relationship between the critical field and the temperature is approximately parabolic. (See Fig. 1B.)

At a temperature such as  $T/T_c = 0.9$ , a relatively small magnetic field can force the superconductor into the normal (resistive) state. This yields the control possibility needed for the use of superconductors in practical devices.

Devices using these principles were built by D. A. Buck at MIT and called cryotrons. His cryotron consisted of a superconducting tantalum wire surrounded by a superconducting niobium coil. Current in the coil generates the magnetic field for control, as shown in Fig. 2A.

Resistance of the gate,  $R_g$ , as a function of control current,  $I_c$ , is shown in Fig. 2A and is seen to have the properties needed for a switching device. The limitation in the magnitude of current that can be switched arises from the fact that current applied to the gate also generates a magnetic field that can by itself force the gate into the normal state if it is large enough.

The wire-wound cryotron can control a larger current than that required to do the controlling because a given current in the solenoid generates a larger magnetic field than the same current applied to a straight wire. The field generated by the solenoid is axial, whereas the field generated by current applied to the wire is cylindrical. Consequently these fields must be added in quadrature with the resultant characteristic shown by the ellipse of Fig. 2B.

Current gain is defined as the ratio of gate current at 0 deg K to control current at 0 deg K; it must be greater than unity to make it possible for one cryotron to drive another.

The control winding is made of niobium, which has a much larger critical field than the tantalum gate, therefore it remains in the superconducting state for the usual range of applied currents. As a result the energy dissipated in the control winding is zero.

When these cryotrons are used to build useful circuits, the speed of operation is determined by the L/R time constant, where L is the inductance of the solenoid and R is the resistance in the normal state. This time constant for the Buck cryotron was  $10^{-3}$  to  $10^{-4}$  second. Since this is not competitive with modern techniques, recent work has been directed towards the development of thin film devices to yield a much higher speed.

The thin film cryotron is shown schematically in Fig. 3A. The device and associated circuit are mounted on top of a superconducting shield plane (ground plane) but separated from it with a thin insulating layer of thickness 5,000 to 10,000 angstroms. This shield plane reduces the inductance by a factor of about 1,000 from that of wire-

wound devices, since the region of intense magnetic field is confined to the small volume between the conducting film and the ground plane. (See Fig. 3B).

This reduction in inductance is largely responsible for decreasing the L/R time constant from  $2 \times 10^{-4}$  second to  $2 \times 10^{-7}$  second.

The smaller cross sectional area of the film yields a larger resistance per unit length than for wire; however, this is partially offset by the fact that the length of the gate going normal is much smaller for the thin film devices since the field is only applied to that region under the relatively narrow control film.

Current gain is obtained by using a gate film that is wider than the control film. The average magnetic field under a film carrying current is inversely proportional to the width, therefore a given current applied to the narrow control film will generate a much larger magnetic field than the same current applied to the gate. As a result the critical field will be reached for a much smaller current in the control than for the gate. This indicates that the current gain should equal the width ratio. In practice it is found to be less than this because the magnetic field penetrates the superconducting gate film.

Under the best conditions a gain of 3 for a width ratio of 5 has been observed. The tin used has a critical temperature of 3.72 K whereas lead has a critical temperature of 7 K. Since the devices are operated about 3.5 K the critical field of the tin is much less than for the lead. As a result the lead always remains superconducting for the currents used.

According to the Meissner effect, the magnetic field is zero inside a superconductor. However, the field actually penetrates a distance of

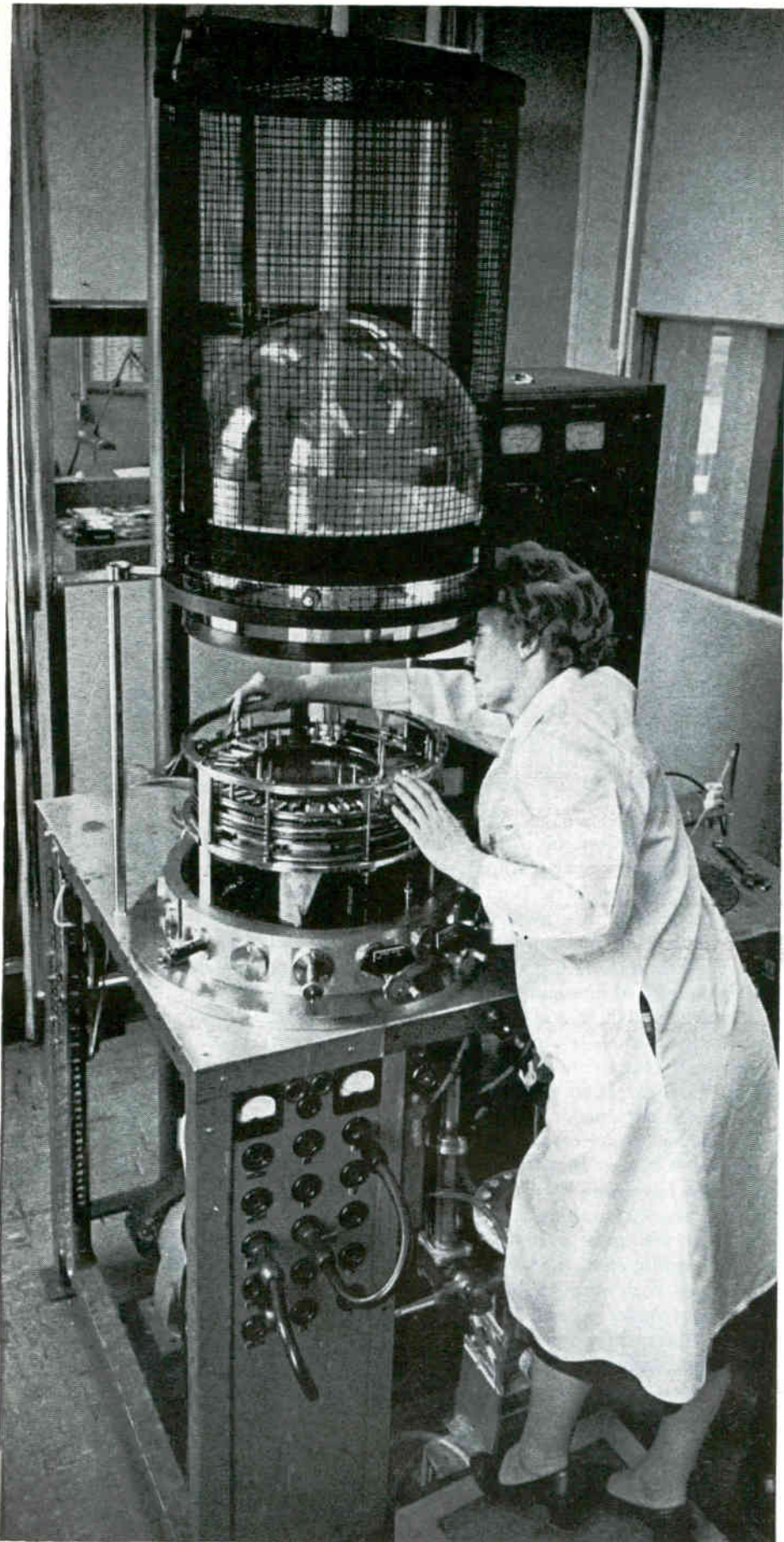

Vacuum equipment for evaporating cryogenic thin film circuits on glass substrate can make up to 30 circuits at one time. To date, equipment has deposited up to 24 layers a circuit

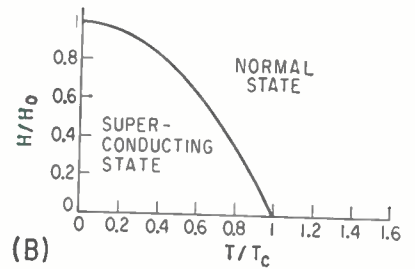
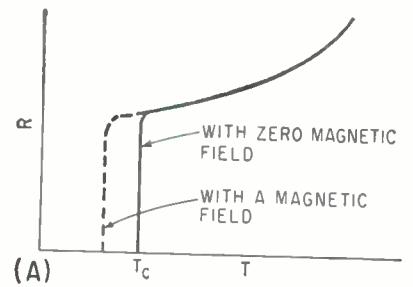

FIG. 1—Resistance of superconductor as a function of temperature is affected by application of magnetic field (A); critical magnetic field for transition from superconducting to normal state as a function of temperature is shown in (B)

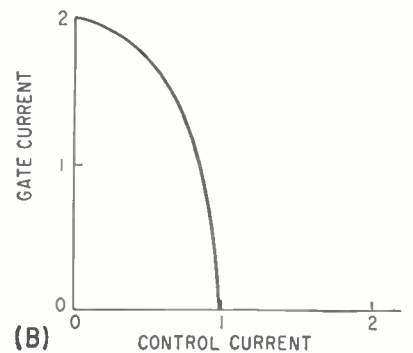
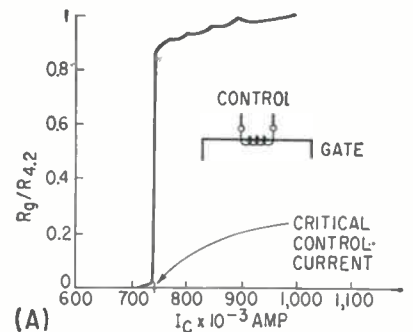

FIG. 2—Gate resistance of wire-wound cryotron as a function of control current is shown in (A); control characteristic of wire-wound cryotron with gain of 2 is shown in (B)

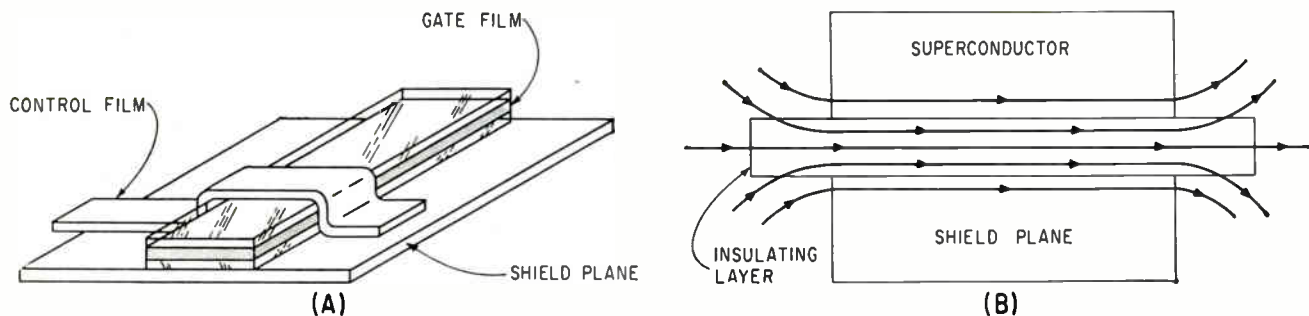

FIG. 3—Thin film planar cryotron (A) has magnetic field configuration illustrated in (B)

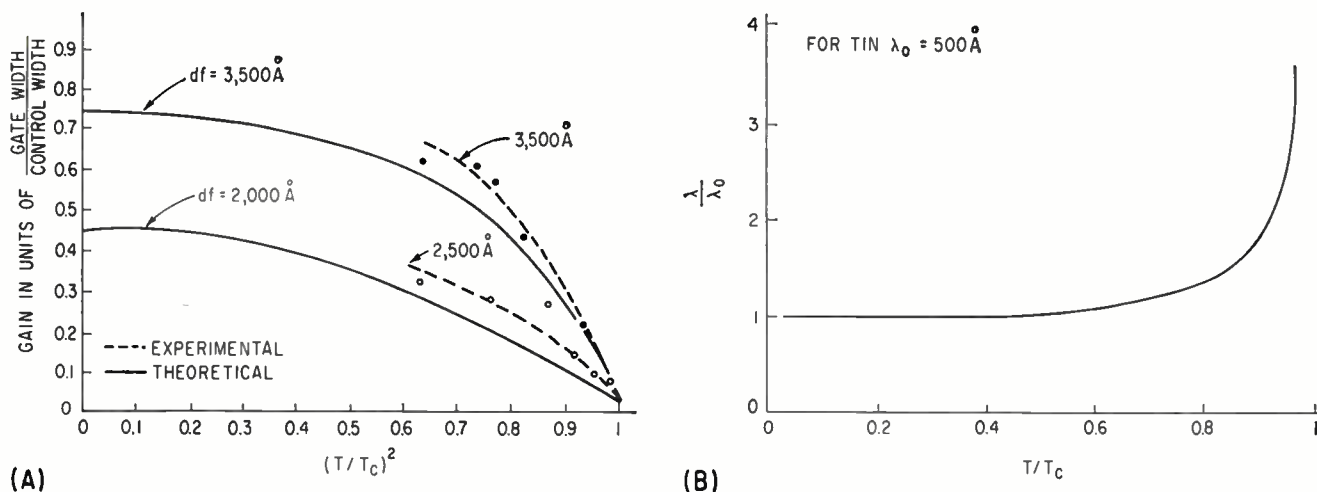

FIG. 4—Cryotron gain varies with reduced temperature (A); penetration depth varies with temperature (B)

500 to 1,000 angstroms which is negligible for bulk superconductors but profoundly affects the operation of devices made of thin films whose thickness is comparable to the penetration depth. The gain of cryotrons has been observed to vary with temperature as shown in Fig. 4A. This has been interpreted as arising from the variation of the penetration depth,  $\lambda$ , with temperature as shown in Fig. 4B. Results obtained to date indicate that the film thickness,  $df$ , must be at least comparable to the penetration depth to provide current gain. Therefore, as the film thickness is decreased to increase  $R$  and thus the circuit speed, the devices must be operated at a lower temperature. This increases the critical field and consequently increases the applied current that must be used. The energy dissipated per transfer is equal to  $\frac{1}{2}LI^2$  and therefore more energy is dissipated. In a practical device a compromise must be reached between speed and energy dissipation.

One of the major problems of work on thin film devices arises from the difficulty of making these films in a reproducible manner. The

films are deposited in a high-vacuum system by evaporation techniques. For a material such as tin the evaporation rate must be such that the rate of metal atoms striking the substrate is large compared with the rate of ambient gas atoms.

To accomplish this either a high evaporation rate is needed or an ultrahigh vacuum must be used. Tin films with excellent characteristics have been obtained by both methods. In the former case evaporation rates of 1,000 to 10,000 angstroms a second have been obtained with a vacuum of  $10^{-6}$  millimeter of mercury.<sup>2</sup> In the latter case, a vacuum of  $10^{-9}$  millimeter of mercury<sup>3</sup> has been used with evaporation rates of 100 angstroms a second. The nature of the edges of the films also affects the superconducting characteristics in a major way.<sup>2</sup>

Construction of practical circuits requires the evaporation of many layers of complex patterns of tin, lead and the silicon monoxide insulation material. These patterns are controlled by masks. It is essential that the entire operation be done while maintaining a high degree of vacuum, otherwise it is difficult to

make superconducting contacts between the metallic layers. These masks must be changed and positioned accurately within the vacuum by external controls. Equipment to accomplish this has been developed for  $\frac{1}{2}$ -inch substrates. Each substrate will hold about 32 cryotrons.

Consider the superconducting loop circuit shown in Fig. 5A. The applied current,  $I$ , will divide between the branches as follows. For zero resistance in the loop,  $L_1 (dI_1/dt) = L_2 (dI_2/dt)$  or, upon integration,  $L_1 I_1 = L_2 I_2$ , for zero initial current. Since  $(I_1 + I_2) = I$ ,  $I_1 = [L_2/(L_1 + L_2)] I$  and  $I_2 = [L_1/(L_1 + L_2)] I$ . The current division is determined by the inductance of the branches.

If cryotrons are placed in each branch, as shown in Fig. 5B, then the division of current can be controlled. If inputs 1 and 2 are zero then a current  $I$  applied to the loop will divide equally for the symmetrical case of  $L_1 = L_2$ . If we apply current to input 1 a resistance will be introduced into branch 1 which will force the applied current to flow entirely in branch 2 since this



branch has zero resistance. This situation can be seen to be equal to the linear addition of the applied current dividing equally in both branches and a circulating current equal to  $I/2$  as shown in Fig. 5C.

If input 1 is subsequently removed, then the current division will be unchanged. As the applied current is changed, the circulating current component will remain constant if the loop is entirely superconducting and the resultant branch currents will equal the sum of the applied current divided equally between branches and the constant circulating current. The net current in branch 1 returns to zero when the applied current is returned to the value it had when input 1 was applied. These constant circulating currents can be used to store information.

The state of the circuit can be observed without interfering with its operation by adding two more cryotrons as in Fig. 5D. Current flowing in branch 2, for example, will render output cryotron 2 resistive; a current flowing in branch 1 will make output cryotron 1 resistive. These output cryotrons can be used to control other loop circuits to permit the construction of ring circuits and shifting register circuits.

As an example of a computer circuit, Fig. 6 shows one stage of a full binary adder using 14 cryotrons. The dashed lines show the path followed by the current for carry in = 1,  $A = 0$ ,  $B = 0$ . In this case,  $A = 1$  means that a current is applied to that input line. The circuits are arranged so that a current is always applied to the 1 or the 0 lines.

The author is indebted to W. B. Ittner and A. E. Brennemann for the results on the temperature dependence of the gain of cryotrons. The circuit diagram for the full binary adder was supplied by J. L. Sanborn.

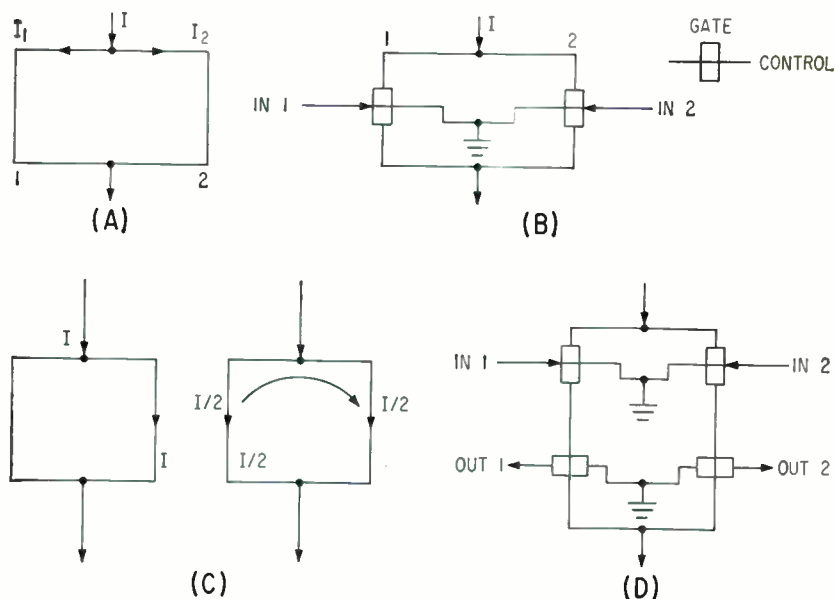

FIG. 5—Division of current in superconducting loop circuit (A) can be controlled by placing cryotrons in each branch (B); constant circulating currents (C) can be used to store data and control output cryotrons (D)

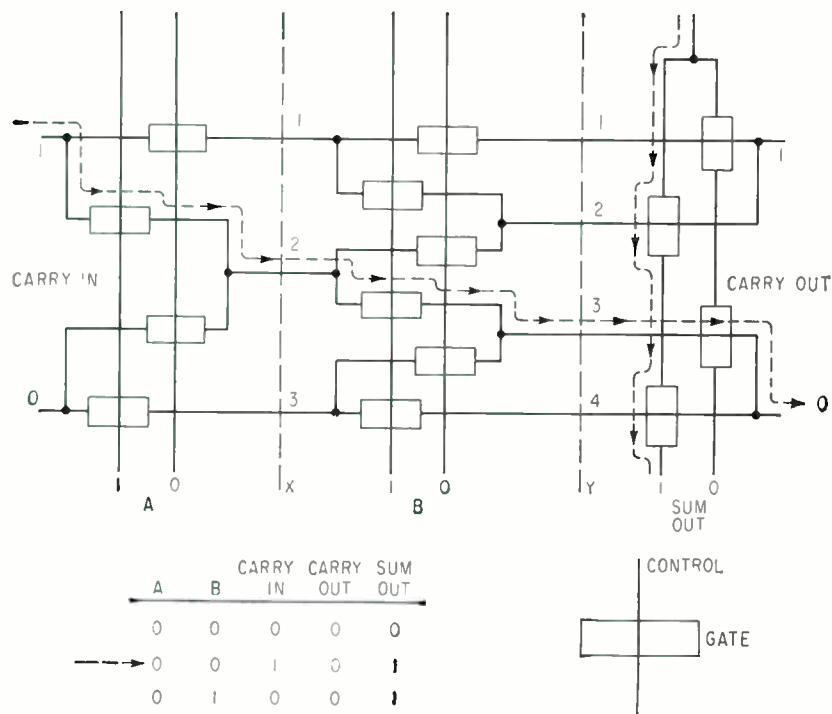

FIG. 6—Thin film cryotrons are used in one stage of full binary adder

## OTHER DEVICES

The crossed film cryotron discussed in this article depends for its operation on the fact that a sufficiently strong magnetic field will restore resistance to a superconductor. Other superconducting devices that have been proposed such as the Crowe Cell

and the Persistron<sup>5</sup> depend on the fact that the superconducting state can also be destroyed if a large enough current is applied. Because the cryotron has current and power gain, one cryotron can be used to drive another. This is not the case for the Persistron and the Crowe cell

## REFERENCES

- (1) D. A. Buck, *Proc IRE*, 44, p 482, 1956.
- (2) R. B. DeLano, A. E. Brennemann and G. J. Kahan, *IBM Jour.* 3, p 173, 1960.
- (3) H. L. Caswell, to be published.
- (4) J. W. Crowe, *IBM Jour Res Dev*, 1, p 294, 1957.
- (5) E. C. Crittenden, Jr., *Proc of the Fifth International Conf on Low Temp Phys and Chem*, Univ of Wisconsin, Madison, 1957.

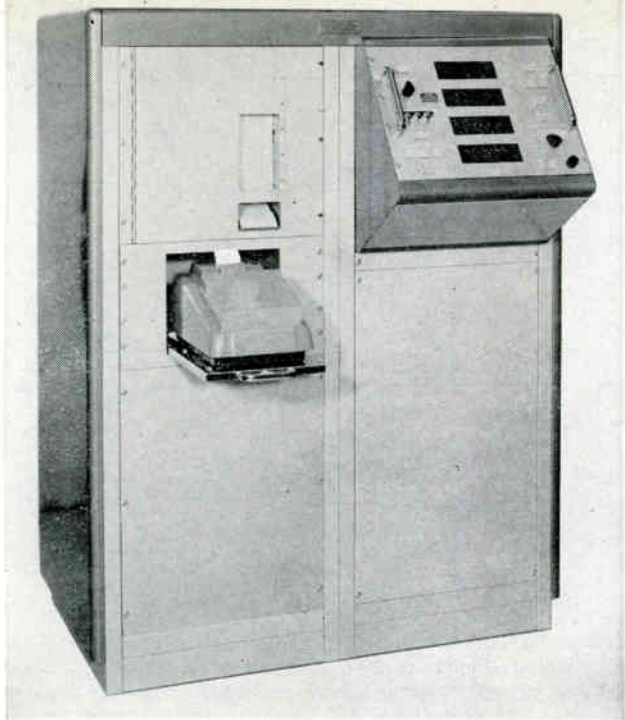

*Analyzer has digital displays for sequence timing printer for permanent record, pen recorder for solenoid positions*

A MAJOR PROBLEM in testing missile valve operation is the accurate determination of the various time intervals in a sequence. For example, the master control valve of many missiles is a solenoid-actuated pilot valve. Operating characteristics of this solenoid pilot valve are therefore a critical factor in the operating sequence of missile valves.

Because electrical contacts are not available at the solenoid pilot valve, it was not previously possible to measure accurately the actual time of valve operation with respect to the time that energy is applied to the solenoid coil. The method described here shows how to ascertain the exact time of valve closure by monitoring the waveshape of the current into the solenoid coil.

A complex set of non-linear differential equations is required to describe even the simplest solenoid valve. These equations are in the following form:

$$E = IR + K \frac{\partial I/x}{\partial t}$$

$$F(x, t) = K \frac{\partial I^2/2x}{\partial x}$$

where  $E$  = voltage applied to solenoid coil,  $I$  = current through coil,  $R$  = resistance of coil,  $K$  = constant depending on the physical configuration,  $x$  = valve displacement,  $t$  = time, and  $F$  = mechan-

ical force exerted on the valve's moving member.

The solution to this set of equations, representing variation of actual valve current with respect to time, is illustrated in Fig. 1A. Analysis of this waveform, in conjunction with the above equations, reveals that the valve is in its closed position at the time the slope of current ceases to be negative.

This fact facilitates the design of a circuit for indicating the exact time of valve closure. The circuit of Fig. 2A is such a design. For the purpose of analysis and description, the circuit is divided into two sections, stage 1 and stage 2. Equivalent circuits for stage 1 are shown in Fig. 2B and 2C. The simplified version (Fig. 2C) is sufficient for the following analysis. By setting up loop equations, a transfer function (Eq. 1) is obtained that relates the solenoid current to the collector current of  $Q_1$ . The transfer function is a constant multiplied by the Laplace  $s$ ; that is, it is the result of a simple first-order differentiation.

*FIG. 1—Waveforms show solenoid current (A), first differentiation of solenoid current (B), second differentiation of solenoid current (C) transfer characteristic of wave shaper (D), and output wave shape (E)*

# Determining

By ROBERT L. KISSNER,\*

Project Engineer,  
Consolidated Avionics, Westbury, N. Y.

The result of this operation on the input wave form is shown in Fig. 1B.

The collector current of  $Q_1$  is fed to the base of  $Q_2$ , as shown in the equivalent circuit of Fig. 2D. The transfer function (Eq. 2) that relates the  $Q_2$  base current and  $Q_1$  collector current is again a first-order differentiation. The result of this operation is shown in Fig. 1C.

Because transistor  $Q_2$  is in a state of saturation, it has the non-linear transfer characteristic shown in Fig. 1D. The result of this wave-shaping circuit is the final pulse output of Fig. 1E. The trailing

\* Now with International Electric Corp., Paramus, N. J.

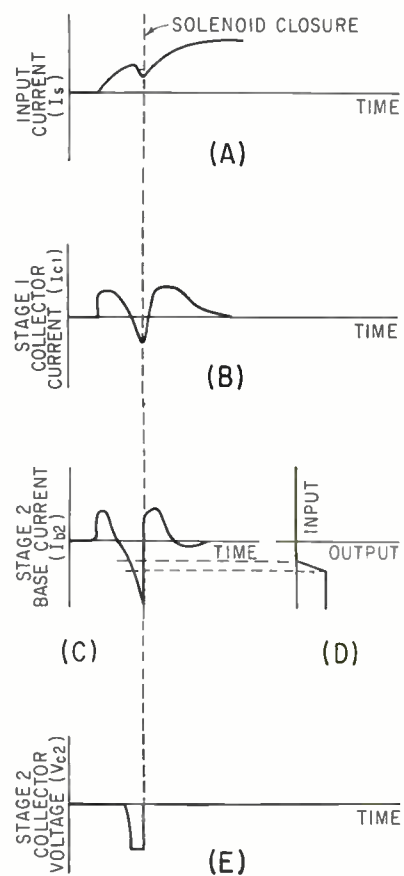



# Digital Instrumentation of Antenna Measurements

*This test system slashes the time required to process the data obtained from highly precise antenna-field measurements*

By E. K. DAMON, Antenna Laboratory, Dept. of E. E., The Ohio State University, Columbus, O.

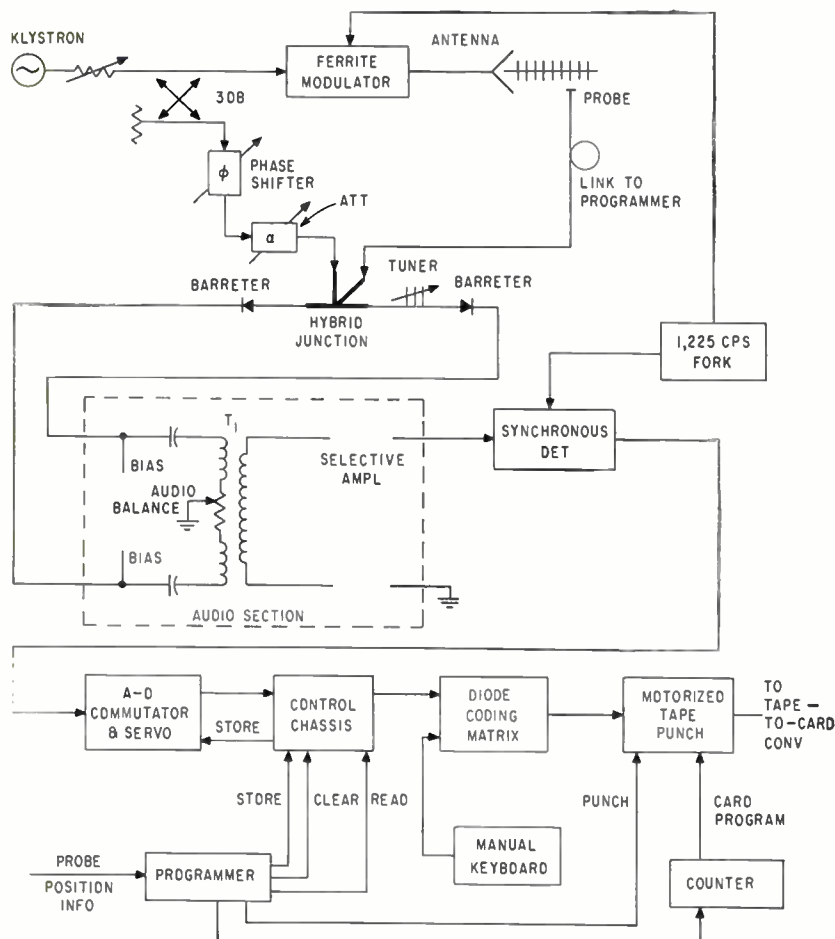
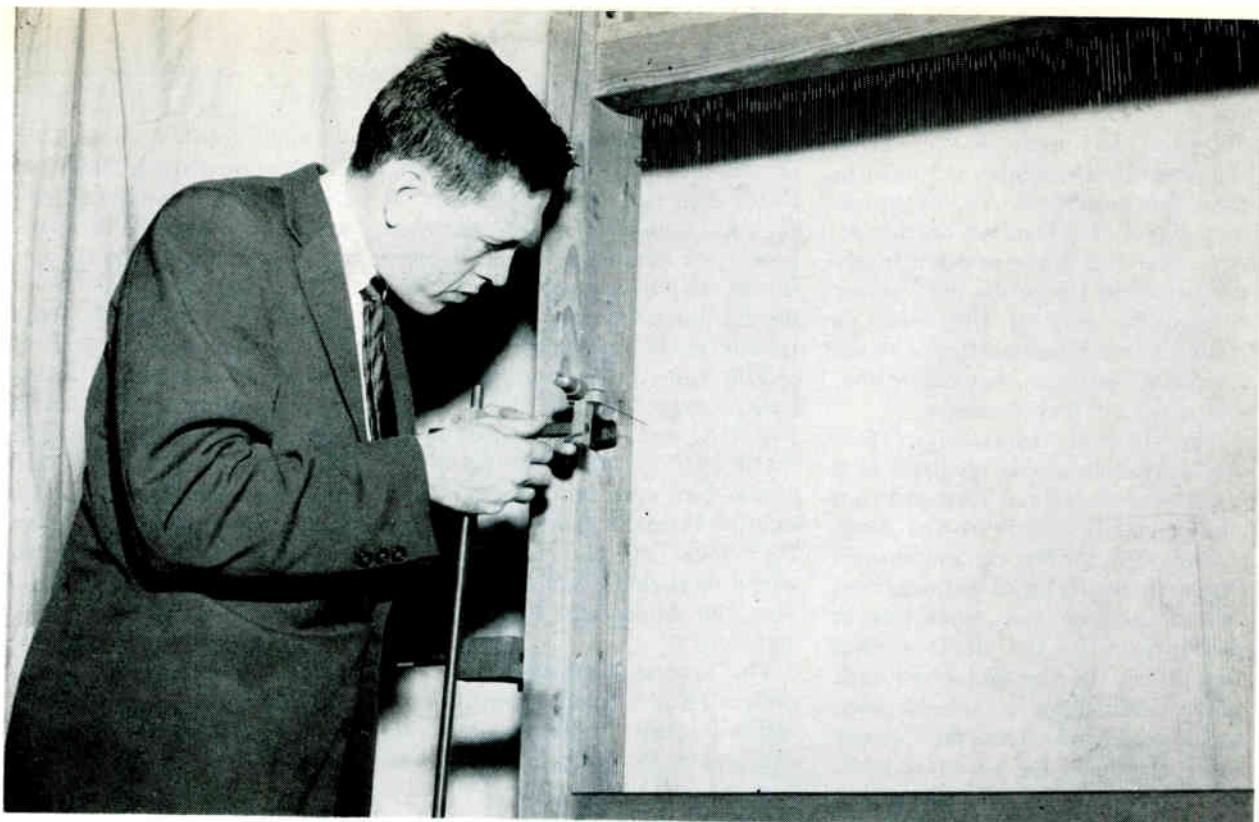

FIG. 1—Microwave and digital sections of test system. After data is converted to punched cards, a digital computer (not shown) completes data processing

WHILE INVESTIGATING the near fields of long end-fire antenna arrays, the need for improved instrumentation became apparent. These arrays are of the order of 35 wavelengths long, and support a propagating mode with a phase velocity that is within a few percent of the free-space phase velocity. The problem therefore was to measure and record in a convenient form a total phase change of some 12,000 degrees to an accuracy of 20 degrees. If the array is operating under the Hansen-Woodyard condition, the change from free-space phase velocity yields a differential phase shift of 180 degrees over the length of the array. The instrumentation described here measures the amplitude and differential phase shift of the signal at a large number of points along the array.

The microwave portion of the instrumentation system (Fig. 1) measures in-phase and quadrature components of the microwave signal.<sup>1</sup> This portion of the system produces a d-c signal that is a function of the amplitude and phase of the microwave signal on the array.

The signal source is an unmodulated X-band klystron operating in an oil bath for temperature stabilization. A portion of the unmodu-



Author adjusts dipole pickup probe (less feed cable) near array elements. Array is excited by circular aperture (center). Elements are positioned on support strings to form array of desired element length and overall length

lated signal is extracted with a directional coupler as the reference signal  $A$ , while the remaining signal is modulated by a ferrite modulator and is fed to the array under test. The probe then measures the signal  $E$  at a point near the array.

Signal  $A$  and signal  $E$  are connected to the two orthogonal arms of a balanced hybrid junction. Consequently, signals  $(A + E)$  and  $(A - E)$  appear at the barreters on the two collinear arms. If reference signal  $A$  is arbitrarily assigned a phase angle of zero, and the modulation waveform is  $m(t)$ , then the microwave voltages at the barreters are

$$\begin{aligned} E_1 &= A \cos \omega t + Em(t) \cos (\omega t - \phi) \\ E_2 &= A \cos \omega t - Em(t) \cos (\omega t - \phi) \end{aligned}$$

After passing through the square-law barreters and filtering of the r-f terms, the audio voltage obtained from barreter No. 1 is

$$V_1 = \frac{1}{2} [(A + Em(t) \cos \phi)^2 + (Em(t) \sin \phi)^2]$$

The expression for  $V_2$ , the audio voltage obtained from barreter 2, is

$$V_2 = \frac{1}{2} [(A - Em(t) \cos \phi)^2 + (Em(t) \sin \phi)^2]$$

Audio transformer  $T_1$  is so connected that the output it delivers to the selective amplifier is the difference between  $V_1$  and  $V_2$ , or

$$V_0 = 2 A Em(t) \cos \phi$$

Since  $A$  is a constant reference signal, the output voltage is proportional to  $E \cos \phi$ , or the in-phase component of the probed signal. If now  $A$  is shifted in phase by 90 degrees, it is readily seen that the output voltage becomes  $V_0 = 2AE \sin \phi$ , which is proportional to  $E \sin \phi$ , the quadrature component.

The modulation method used offers two advantages. The first is obtained by operating the klystron unmodulated, thus reducing the frequency modulation of the signal and consequently allowing a more precise balance of the hybrid tee. The second advantage is that a less critical audio null is required with an unmodulated reference signal. If the strong reference signal were modulated, a slight unbalance would produce a residual audio output rather than the d-c component ( $A$ ) which is produced by the unmodulated reference.

Signal  $V_0$  is amplified by a narrow-band selective amplifier, converted to d-c by a synchronous detector; it then goes to the digital portion of the system for recording.

The amplitude and phase of field  $E$  is determined by taking two measurements of  $V_0$ , the second with the phase of  $A$  shifted 90 deg,

calculating the near field from

$$\begin{aligned} E^2 &= (E \cos \phi)^2 + (E \sin \phi)^2 \\ \phi &= \tan^{-1} (E \sin \phi / E \cos \phi) \end{aligned}$$

The system is adaptable to dipole or waveguide probes, or the signal  $E$  may be from a scatterer if another hybrid tee is used.

Note that the method does not require any servos in the microwave section. Maximum information rate is determined solely by the system passband and the recording method. This advantage is partially offset by the need of taking two measurements at each point and the need for subsequent calculation.

The output of the microwave system is not direct reading in amplitude or phase. These quantities must be calculated from the data, and this is done most conveniently if the data are recorded digitally. The first step is the digitizing of the analog d-c output of the synchronous detector; this is done by a null-balancing servo and a mechanical commutator. To eliminate ambiguities in the commutator, a modified binary system is used, and this output is recorded in the control chassis to a decimal form. The control chassis also performs the reading, storing and clearing. Since these operations must be performed at specified positions on the array,

all operation commands come from the programmer, which is linked to the probe movement. The programmer starts at a location on the array, receiving probe position information from the probe link. After a complete scan of the array is made at one phase-shifter setting, the phase shifter is changed 90 deg, and a second scan is made.

The decimal information from the control chassis is recorded to a binary-coded decimal form with an odd-bit parity check by the diode coding matrix. The control chassis stores three digits of information, and the programmer reads this in serial form to the diode coding matrix and to the motorized tape punch, delivering a simultaneous punch command. This tape punch has 8 channels. Each 3-digit number is separated on the tape with a space code.

To facilitate the transfer of data from perforated tape to punched cards without error, the counter changes every 16th space code to a card-release code. Since 16 three-digit numbers are stored on each card, this produces a check to assure that the tape and card are in step, or that no digits have been omitted or double-punched. The odd-bit parity check prevents data conversion if the diode coding matrix is not functioning properly. Either type of error automatically stops the tape-to-card conversion.

The punched cards are suitable for digital computer calculations. The 16 columns of card space not used by data are prepunched with identification of run number, card number, commutator center-scale reading and in-phase or quadrature component identification.

The programmer must furnish properly spaced impulses to initiate all operations, and it must also reproduce these impulses at the same probe position for both the in-phase and quadrature field components. This is done by a series of cam-driven microswitches that program the operations. The programmer's camshaft is linked to the probe by a magnetic clutch. When the probe carriage reaches a specified point, it trips a limit switch that engages the magnetic clutch, thus connecting the camshaft to the probe's electrical drive. A similar limit

microswitch disengages the clutch at the end of the probing path. Successive runs may be compared for total number of points recorded as a check against possible slippage in the clutch or probe drive. The programmer records 15 points per inch of probe travel.

The time programming of the programmer impulses is shown in Fig. 2A, and its equivalent schematic in Fig. 2B. Mechanically, a single cam operates the four READ microswitches, another operates the four PUNCH microswitches wired in parallel, and a third operates the STORE and CLEAR microswitches.

The analog-to-digital conversion system (Fig. 1) uses a conventional self-balancing potentiometer arrangement to obtain a shaft rotation proportional to the d-c input. Since the input voltage may be of either polarity, a biasing supply is used to convert it to a center-scale-zero device. The angular shaft position is measured by a Giannini Datex encoder, which defines each discrete shaft position by a unique combination of contact closures. To eliminate ambiguities, the encoder uses a binary-coded cyclic decimal code, such that any two adjacent numbers differ by only one contact closure. A shaft position corre-

sponding to the number 599, for example, may read as 598 or 600, but the ambiguous results of 500 or 699, which are possible in the Arabic decimal form, do not exist.

The control chassis has several functions. The first is the reading of the encoder's contact closures with a 25- $\mu$ sec pulse. A thyatron corresponding to each contact closure is thereby triggered and the information stored. A matrix formed by relays in the plate circuits of these thyratrons then forms the necessary contact closures to translate the binary-coded decimal code to the Arabic decimal code.

The angular position of the self-balancing potentiometer is thus digitized into 1,000 discrete steps, represented by the numbers 000 to 999, and stored in the control chassis until the thyratrons are extinguished.

The programmer's STORE command operates a relay in the control chassis which reads and stores the digitized shaft position. After the information has been punched, and before the command to punch the space, a CLEAR command from the programmer extinguishes the thyratrons of the control chassis and releases its control relay in readiness for the next STORE command.

The recording medium used is a Commercial Controls Model 2 motorized tape punch, which uses 8-channel perforated tape. The tape code used is the standard binary code with an odd-bit parity check. A simple diode coding matrix is sufficient to recode the arabic decimal information to the tape code, and since the information is entered on the tape in serial form, only one matrix is required for the three decades of information.

The programmer activates the hundreds, tens, and units decade of the control chassis relays in sequence (Fig. 2A), activating the proper code solenoids of the tape punch and simultaneously initiating the punch cycle for each decade. The control chassis is now cleared, ready for the next store command, while the programmer initiates the space code punching cycle, thus completing the four-digit information word at each point.

The punched-card format adopted

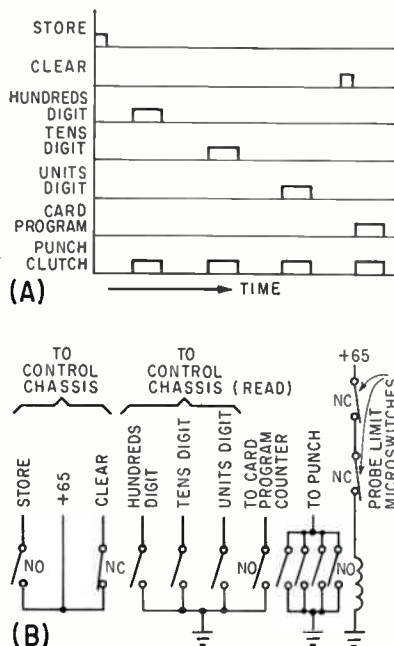

FIG. 2—One cycle of programmer's commands (A). Simplified circuit equivalent of programmer (B)

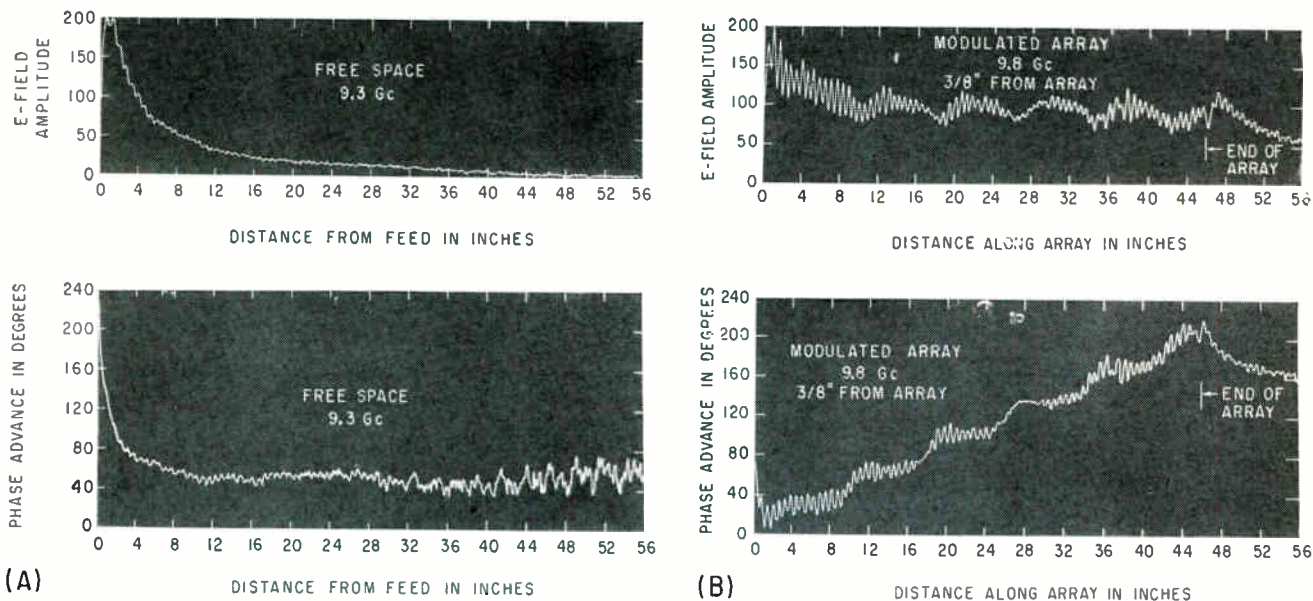

FIG. 3—Free-space field measurements in front of open-ended waveguide (A). Field measurements of antenna array (B)

for the computer program uses 10 8-digit words, two for identification and eight for data. Each 8-digit data word contains two four-digit data words, or 16 data words per card. The data words on the tape are therefore separated into blocks of 16 as a check against missing or extra digits during the tape-to-card conversion. Each STORE command actuates a four-stage binary counter and at the completion of 16 counts a diode logic circuit operates a relay to change the space code to an end-of-line code. If this code is not present at the proper time during the tape-to-card conversion the operation stops, and the source of error may then be investigated visually. If the code is present at the proper time, operation continues automatically.

A detailed computer program is available.<sup>2</sup> After the computer unpacks the data, the computer's program is essentially a conversion of complex numbers in rectangular form to polar form. The modulus of the resulting number is the desired amplitude of the microwave field at that point. The phase at the same point of a wave traveling with free-space phase velocity is computed and subtracted from the argument of the complex number. Since the argument is multivalued, the difference is adjusted in steps of 360 deg until it differs from the phase of the previous point by less than 180 deg, so that a continuous

curve may be drawn through the points.

The resulting angle, the phase advance, is the difference between the phase of the traveling wave on the array and that of a corresponding free-space wave. This phase advance will be less than 200 deg for most end-fire arrays, being more convenient than the total phase, which may be of the order of 10,000 deg for a high-gain array.

The computer output yields the in-phase and quadrature components, the amplitude, and the phase advance of the microwave field.

A very convenient check of instrumentation accuracy may be made by measuring the amplitude and phase advance of a free-space wave launched by a small horn. The phase advance of the free-space must be zero by definition. A non-zero result implies incorrect calibration or measurement of frequency. Errors in the microwave or zero balance of the system, as well as positional errors for the read command or short-term frequency drift, will result in periodic variations about the mean phase advance. Random errors affect the calculated phase advance, particularly at low signal levels. A typical free-space measurement is shown in Fig. 3A; this indicates that the 20-deg accuracy has been maintained.

Figure 3B shows a typical phase advance and amplitude plot of the

field along a space-modulated array, that is, one having elements of constant length but periodic variations in spacing. The periodic variations in the rate of phase advance, which is simply related to the phase velocity, is evident. Similar information on other arrays has been published.<sup>3</sup>

The digitizing system described may be easily adapted to other recording tasks. The recording of antenna radiation patterns in digital form for calculations of directivity or gain is one such application. Echo-area measurement, propagation studies, and control systems behavior can also frequently benefit from the availability of digital data.

The research reported here was sponsored by The U. S. Army Signal Research and Development Laboratory, Ft. Monmouth, N. J.

The assistance of E. D. Boyer in the construction of the near-field instrumentation and in the array measurements is gratefully acknowledged.

## REFERENCES

- (1) J. H. Richmond, Measurement of Time-Quadrature Components of Microwave Signals, *IRE Trans of PGMT & T*, MTT-3, p 13, April 1955.
- (2) E. K. Damon, Digital Instrumentation for Antenna Near-Field Measurements, Report 662-22, Antenna Laboratory, The Ohio State U. Research Foundation, prepared under Contract DA 36-939-sc 70174 with U. S. Army Eng. Lab., Ft. Monmouth, N. J., p 17, Feb. 1, 1959.
- (3) Annual Engineering Report, Antenna Phenomena Research, Report 662-19, Antenna Lab, The Ohio State U. Research Foundation, prepared under Contract DA 36-039 sc 70174, Nov. 1, 1958.

# DESIGNING BACK-BIASED

*High-speed pulse gates have many applications in electronic circuits and can be designed for pulse widths of a fraction of a microsecond. Gates for both a-c and d-c signals are discussed*

By I. F. BARDITCH, Air Arm division, Westinghouse Electric Corp., Baltimore, Maryland

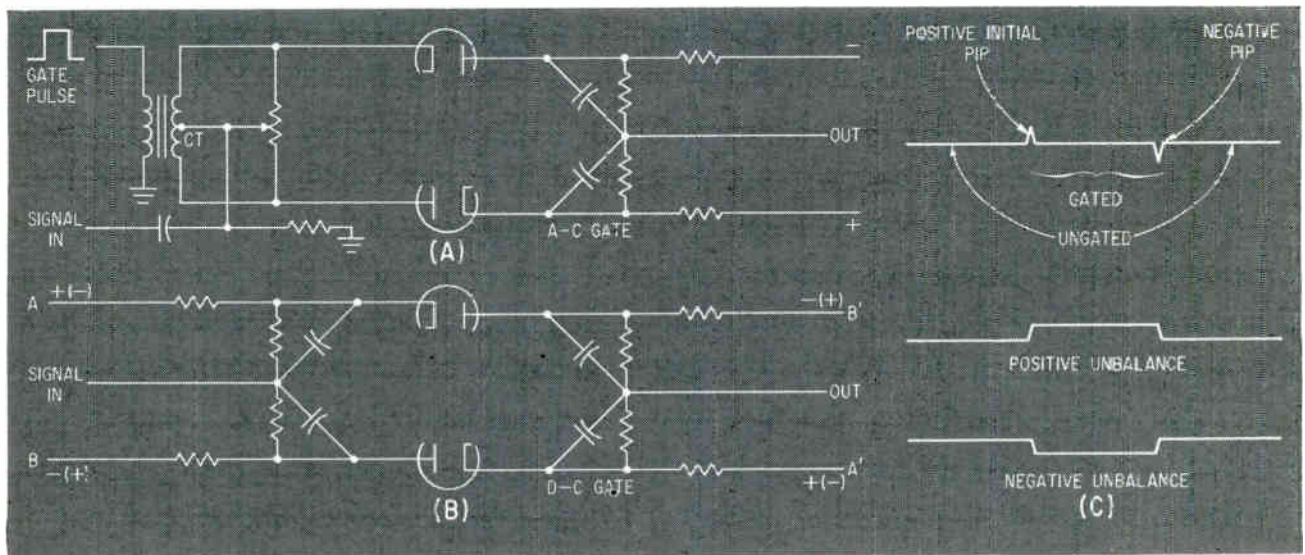

FIG. 1—Pulse gate for a-c signal (A) is driven into conduction by gating pulse. Gate for d-c signal (B) has relatively high insertion loss. Waveforms (C) show opening and closing transients and unbalanced conditions

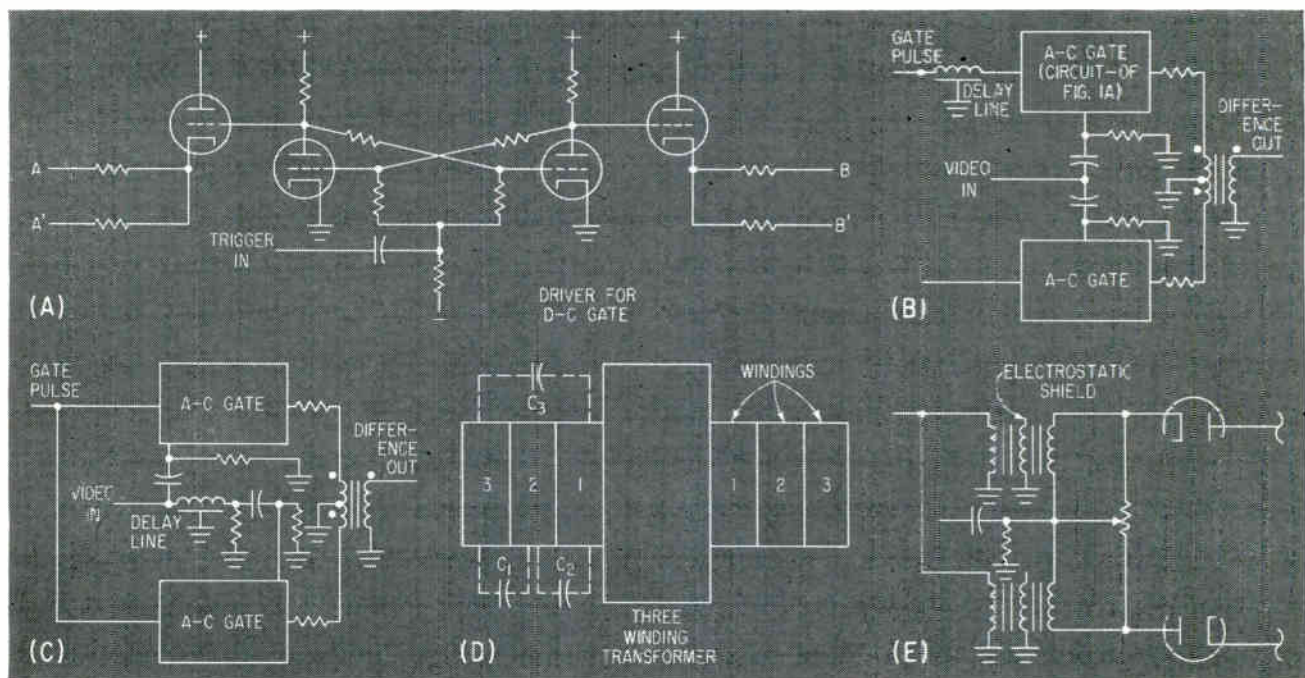

FIG. 2—Typical driver for d-c pulse gate shown in (A); early-gate, late-gate difference circuit (B) for automatic range tracker; variation of range tracker circuit (C); transformer interwinding capacitance (D) can be reduced to negligible value by using third winding as shield (E)



# DIODE PULSE GATES

THE A-C, BACK-BIASED diode gate is a pair of diodes that have been biased into nonconduction and are pulsed into conduction. The input signal to be gated or passed through is present at all times. Because the diodes conduct only when driven by a gating pulse, circuit action is the same as a relay; the input signal is fed to the output only when the gate pulse is present.

In the schematic of an a-c gate, shown in Fig. 1A, the input transformer centertap is returned to ground through high resistance, with the input signal capacitively coupled into this junction; the potentiometer has a low resistance. The diodes and resistor-capacitor output network are fed from a grounded centertapped voltage source. Since the plate of the upper diode is held negative and the cathode of the lower diode is held positive, signal conduction to the output terminal cannot take place except through the small diode capacitances. When the gating voltage is applied to the primary of the transformer, the upper cathode is driven negative and the lower plate is driven positive so that the blocking level set by the resistive divider is overcome. This results in a condition where both upper and lower diodes are fully conducting. The input signal, depending on its polarity, passes to the output terminal by either the upper or lower diode. This circuit can be used for pulse widths down to a fraction of a microsecond. The performance is tied closely to transformer and diode characteristics and the impedances of the divider networks. There is only minor insertion loss in this gating system.

In operation, the output waveform is accompanied by a small positive pip at gate opening and a small negative pip at gate closing. In most applications, the subsequent circuits introduce enough stray capacitance and inductance filtering so that the switching transient has no effect. The base line of the scope sweep when the gate is open will be exactly in line with the nongated sweeps if the

gate is balanced. If the gate is not balanced, the base line with the gate open will be displaced relative to the gate-closed position. To balance, the voltage across the output resistance divider is adjusted until the output is zero with respect to ground; the potentiometer across the input transformer secondary is adjusted to balance out any dissymmetry in the output waveform caused by unequal impedances in the positive and negative signal paths. The circuit can be adjusted to give a fast switching gate with negligible transients. The input transformer should have a low interwinding coupling capacitance, or gate pulse feedthrough will be a problem. The bias source should be centertapped and balanced with respect to ground. Signals extending into the high megacycle regions can then be satisfactorily gated.

Figure 1B is a d-c version of the same type of circuit; because resistive coupling is required throughout, there is an insertion loss of appreciable magnitude. The upper diode in Fig. 1B has its cathode returned to a positive voltage and its plate returned to a negative voltage; the lower diode is in similarly biased. If the potentials applied to the ends of the dividers feeding the respective plates and cathodes are reversed, the diodes are driven into full conduction. The input and output signals behave as in the a-c gate. Adjustments must be made for d-c level and symmetry of the input signal and if the diode characteristics are not matched, it may be necessary to alter the biasing potential or select the diodes. One circuit suitable for driving the d-c pulse gate is shown in Fig. 2A.

The driver is a toggled bistable multivibrator that can be triggered from one stable state to another and feeds two cathode followers that provide the isolation and current to drive the d-c pulse gate.

Fig. 2B shows an early-gate, late-gate differencing unit that is useful in pulse radar automatic range tracking systems. The advantage of the circuit is that it does not require expensive or delicate multigrid

vacuum tubes, but instead uses only diodes and transformers. Gating signals enter the terminal at left and divide at this point, passing through a line with a delay about half the width of the pulse being tracked. This is conventional early-pulse, late-pulse system. Upon passing through the delay line, a delayed gate pulse enters the primary of a pulse transformer (circuit of Fig. 1A). The video signal to be gated enters the centertap of the transformer. The early video branches downward and is gated by the undelayed gate signal. The early-gate channel and late-gate channel are identical. The gated signal output of each channel is then passed through an isolation resistor and into a transformer that is connected to take the difference between its inputs. The signal is then treated in the same manner as in a conventional early-gate, late-gate automatic tracker.

The delay line could be inserted in the video channel, as in Fig. 2C, instead of in the gate pulse channel and a single simultaneous pulse then applied to the gate circuits. Performance would be the same if a suitable delay line were used. For best results, a special transformer with low capacitance coupling design may be desirable but it is possible to use conventional three-winding transformers. Generally, a three-winding pulse transformer appears as if each winding were layered on top of the preceding one, as indicated in Fig. 2D. As a result, the winding in the center has a capacitance to each of the other two windings; these two capacitances,  $C_1$  and  $C_2$  in Fig. 2D, are approximately equal while  $C_3$  is small. Therefore, if the winding that lies between the other two has one end grounded (Fig. 2E), it will act as a shield, preventing the interwinding capacitive feedthrough of the gate pulse, which can void the performance of the circuit.

The circuit provides a satisfactory substitute for a special transformer. The primary windings in general require damping resistors to control ringing and transients.

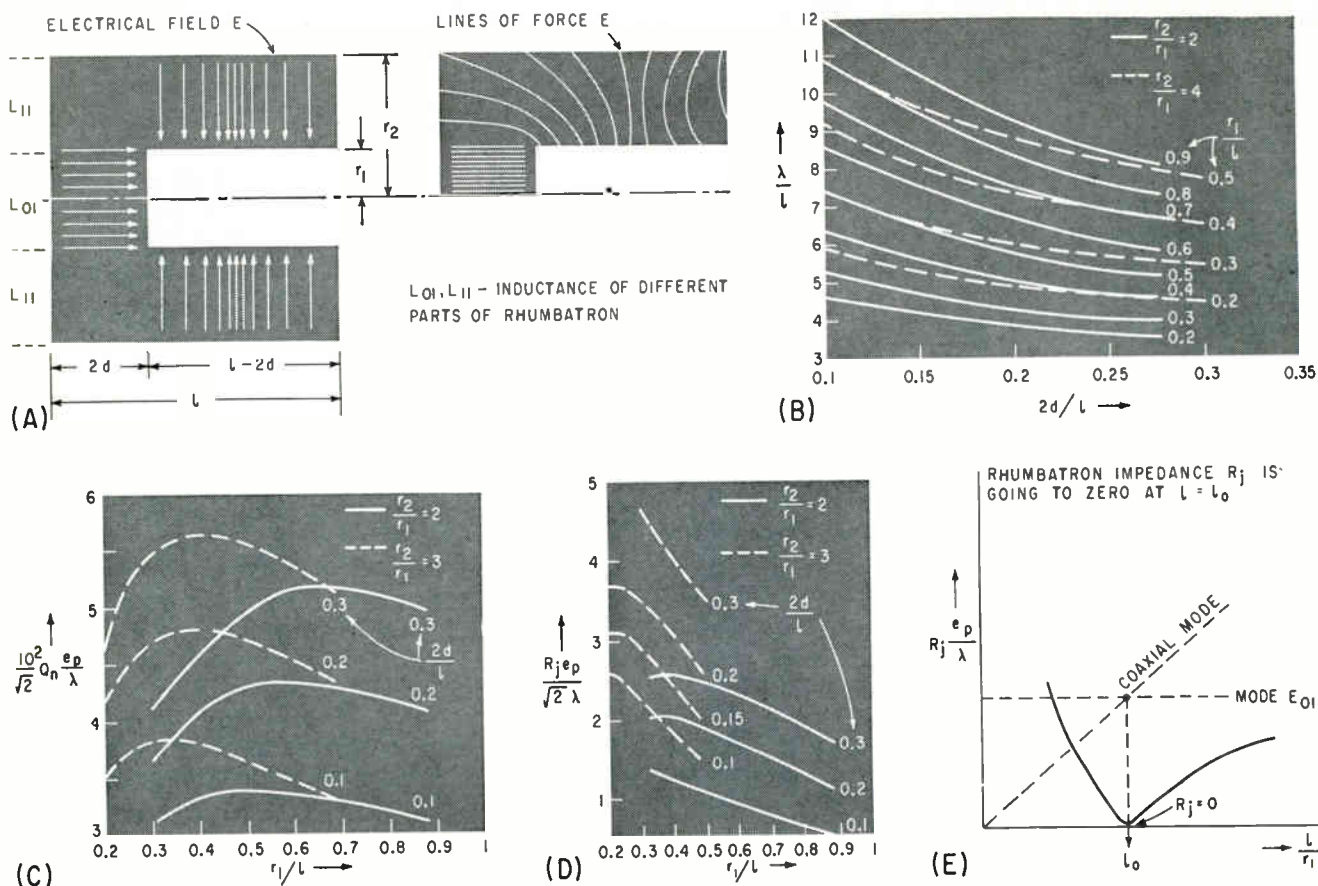

FIG. 1—Rhumbatron cavity of revolution form (A), the fundamental frequency of resonance (B), determination of unloaded  $Q$  (C), graphical determination of shunt resistance (D) and superposition of modes in the rhumbatron for  $l = l_0$  (E)

# HOW TO DESIGN BROADBAND

*Calculations show how to design revolution and prismatic types of microwave cavities*

By A. KIRILOFF,  
 Research Engineer,  
 Electronic Research Laboratories,  
 Columbia University, New York

THE RHUMBATRON is a microwave cavity used in constructing klystrons and other devices. The revolution and prismatic forms of the rhumbatron are easy to construct and convenient to use in coaxial- and waveguide-type devices with the advantage of being able to regulate the rhumbatron impedance by selecting parameters and modes.

The rhumbatrons of revolution or prismatic form have the same properties. The prismatic rhumbatron

has a broader bandwidth. In choosing between coaxial-cylindrical lines and rectangular waveguides connected with rhumbatrons, the properties to be considered are; size, power-handling ability, attenuation, bandwidth, ease of fabrication and reliability.

At S-band (approximately 10 cm), the largest permissible coaxial-cylindrical line is about 1½ in. diameter. This upper limit prevents the generation of higher-order modes.

At X-band (approximately 3 cm), the largest permissible coaxial-cylindrical line is about ½-in. diameter. Practically, the largest per-

missible coaxial-cylindrical line is about half the size of the smallest permissible rectangular waveguide for the same conditions. Attenuation of coaxial-cylindrical guides is about twice that of rectangular waveguides. The bandwidth of coaxial line is greater by a factor of 1.7 or more than the corresponding rectangular waveguide. The bandwidth of a rectangular waveguide can be improved by a ridged rectangular waveguide. Rectangular waveguides are used at the higher microwave frequencies.

An important advantage of the broad bandwidth rhumbatron is its use in f-m microwave radars where

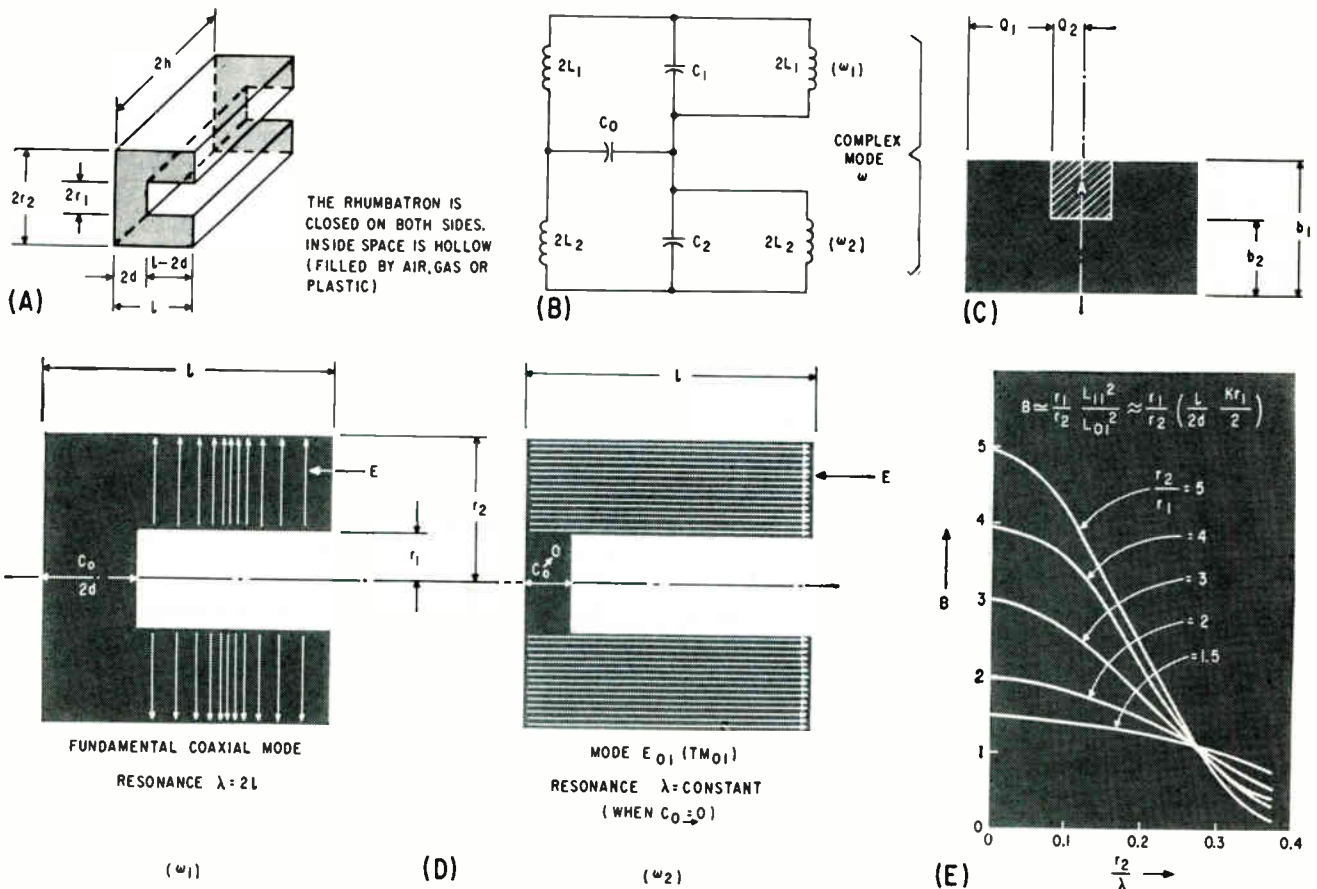

FIG. 2—Rhumbatron of prismatic form (A), representation by a lumped network (B), variation of  $\lambda_r$  in the function of ridge A (C), superior mode of rhumbatron (D) and (E) shows the graph used with Table I to determine factor B

# MICROWAVE CAVITIES

with broad bandwidths, high outputs and good impedance matching qualities

the f-m swing may be so large that the usual narrow-band rhumbatron cannot respond to the broadband deviations.

The general mathematical analysis of the rhumbatron as a method of determination of similarity, symmetry, electromagnetic field and energy distribution, modes and other properties will not be considered in this article.

The analysis given is based on King<sup>1</sup>, Hansen<sup>2</sup>, Hahn<sup>3</sup> and particularly Bernier<sup>4</sup> when the volume of the rhumbatron can be divided in the simple volumes and then coupled together.

For certain forms of rhumba-

trons, the method has been simplified and leads to analytic expressions for parameter and design data. An attempt has been made to describe the design parameters when a shunt impedance of a rhumbatron is zero or near zero with decreasing Q and increasing bandwidth. This is possible for certain parameter conditions as a superposition of two modes—fundamental coaxial mode and mode  $E_{01}$ .

This technique is applicable to broad-band rhumbatrons of the reentrant type, the regulation of impedance, output power, matching and losses.

The general form of the broad-

band rhumbatron is shown in Fig. 1A. This form can be either revolution or prismatic.

The revolution rhumbatron may be represented in two types—the long type when  $l \geq r_2 - r_1$ ; and the short type when  $l < r_2 - r_1$ .

Formulas and parameters used in basic rhumbatron design of revolution form are given in Table I.

Fundamental characteristics of the rhumbatrons ( $Q_n$ ,  $R_j$ ,  $L\omega$ ,  $Z_n$ ,  $C_n$ ,  $\lambda$  or  $f$ ) have been determined by the relationship between geometrical parameters of the cavity such as  $r_1$ ,  $r_2$ ,  $2d$ ,  $l$  and  $h$ .

Using Table I and the curves of Fig. 1B, C and D, the following

design procedure may be applied.

Choose  $\lambda$  or  $f$  of the rhumbatron. Choose characteristic impedance  $Z_o$  in the function of  $r_2$  and  $r_1$ :  $Z_o = (1/2\pi) (\sqrt{\mu_o/\epsilon_o}) \log r_2/r_1$ . Keep  $r_2/r_1 = 2, 3$  or  $4$  to use the curves of Fig. 1B, C and D.

Calculate  $C_o$  from the resonance equation  $Z_o C_o \tan Kl = 1$ . By using the curves of Fig. 1B, determine  $l, 2d, K$  and  $\tan Kl$  (see example).

Determine unloaded  $Q_n$  by using curves of Fig. 1C. Here the expression  $(100/\sqrt{2}) Q_n (e_p/\lambda)$  is given as a function of  $r_1/l$  for different  $2d/l$  and  $r_2/r_1 = 2$  or  $3$ .

For copper:  $(\mu_o/\mu) (\lambda/e_p) = 2.6 \times 10^4 \sqrt{\lambda_{cm}}$ ;  $\mu_o/\mu = 1$  (for air) where  $\mu_o$  is in absolute vacuum and  $\mu$  is given material.

Here,  $(100\sqrt{2}) Q_n (e_p/\lambda) = 100/\sqrt{2} \times [1/(2.6 \times 10^4 \sqrt{\lambda_{cm}})] Q_n$ .

Graphical determination of shunt resistance  $R_j$  is given by the curves of Fig. 1D<sup>5,6,7</sup>. Complex expression  $R_j e_p/\sqrt{2\lambda}$  is given in the function  $r_1/l$  for different  $2d/l$  and  $r_2/r_1 = 2$  or  $3$ .

To illustrate this procedure, it is convenient to represent the design by numerical examples.

As a numerical example of a revolution rhumbatron of the long type where  $l > r_2 - r_1$ , assume that fundamental  $\lambda = 30$  cm ( $f = 1,000$  Mc) and  $l = \lambda/8 = 3.75$  cm.

Arbitrarily from the curves of Fig. 1B for  $l = \lambda/8$ :  $2d/l = 0.2$ , (where  $2d = 0.75$  cm),  $r_2/r_1 = 2$  (where  $r_2 = 2.8 \times 2 = 5.6$  cm),  $r_1/l = 0.75$  (where  $r_1 = 0.75 \times 3.75 = 2.8$  cm). Determine  $2d/l$  or  $2d$  (on abscissa) from the given  $\lambda/l, r_1/l$  and  $r_2/r_1$  as the point of intersection  $\lambda/l, r_1/l$  and  $r_2/r_1$ .

The gap capacitance from Table I is  $C_o = \epsilon_o (\pi r_1^2/2d) = 32.8$  pf, where  $\epsilon_o = 1$  (air),  $r_1 = 2.8$  cm and  $2d = 0.75$  cm.

At resonance (from Table I),  $Z_o C_o \omega \tan Kl = 1$  where  $K = 1, l = \lambda/8$  (45 degrees) and  $\tan 45$  degrees = 1:  $Z_o = 1/(32.8 \times 2\pi \times 10^9) = 1/(33 \times 10^{-12} \times 2\pi \times 10^9) = 5$  ohms, where  $\omega = 2\pi f = 2\pi \times 10^9$  cps,  $Z_o$  is ohms and  $C_o$  is farads.

Nonloaded  $Q_n$  is determined from Fig. 1C ordinate for  $r_1/l = 0.75, 2d/l = 0.2$  and  $r_2/r_1 = 2$ . From the complex expression  $(10^2/\sqrt{2}) Q_n (e_p/\lambda) \cong 4.2$ , with  $\lambda/e_p = 2.6 \times 10^4 \sqrt{\lambda_{cm}} = 14.3 \times 10^4$  ( $\lambda = 30$  cm) for copper,  $Q_n = (2.2\sqrt{2}/10^2) (\lambda/e_p) = 8,000$ .

The shunt resistance  $R_j$  is determined from Fig. 1D where  $r_1/l = 0.75, 2d/l = 0.2$  and  $r_2/r_1 = 2$ .

Table I—Formulas and Parameters used in Basic Rhumbatron Design of Revolution Form

	Characteristic Impedance ( $Z_o$ )	Resonance Condition	Reactance ( $L\omega$ )	Unloaded ( $Q_n$ )	Shunt Resistance ( $R_j$ )	Capacitance ( $C$ )
Long Revolution Rhumbatron ( $l \geq r_2 - r_1$ )	$Z_o = \frac{1}{2\pi} \sqrt{\frac{\mu_o}{\epsilon_o}} \log \frac{r_2}{r_1}$	$Z_o C_o \tan Kl = 1$	$L\omega = \frac{1}{C\omega}$ $= Z_o 2Kl \frac{(\sin Kl)^2}{1 + \frac{\sin 2Kl}{2Kl}}$	$Q_n = \frac{\mu}{\mu_o} \frac{e_p}{2} \left( \frac{2}{l} \times \frac{1 + \cos^2 Kl}{1 + \frac{\sin^2 Kl}{2Kl}} + \frac{1}{\log \frac{r_2}{r_1}} + \frac{1}{\log \frac{r_2}{r_1}} \right)$	$R_j e_p \mu = 2\pi^2 \times \frac{1 + \frac{\sin 2Kl}{2Kl}}{\sin^2 Kl} \times \frac{1}{\log \frac{r_2}{r_1}} \left( 1 + \frac{l}{2r_2} \frac{1 + \frac{r_2}{r_1}}{\log \frac{r_2}{r_1}} \right)$ $R_j$ (at resonance) = $Q_n \times L\omega$	$C = C_o \left( 1 + \frac{2}{\sin 2Kl} \right)$
Short Revolution Rhumbatron ( $l < r_2 - r_1$ )	Same as above	Same as above	$L\omega = \frac{1}{C\omega} = \frac{\lambda d}{\pi^2 r_1^2}$ $\times \frac{R_o}{1 - l + \frac{2d}{\lambda^2} \frac{l}{2dB}}$	Same as above	Same as above	$C = C_o \left( 1 - \frac{2d}{l} \frac{\pi^2 r_1 r_2}{\lambda^2} \frac{l}{2d} \frac{1}{B} \right)$

#### DEFINITIONS

$Z_o$  = characteristic impedance, in ohms  
 $l$  = length of rhumbatron in cm or inches  
 $r_2$  and  $r_1$  = outer and inner radius of rhumbatron in cm or inches  
 $2d$  = distance of a gap in cm or inches  
 $\mu_o = 1.256 \times 10^{-6}$ , magnetic permeability, absolute vacuum, in henry/meter  
 $\epsilon_o = 8.854 \times 10^{-12}$ , dielectric constant, absolute vacuum, in farad/meter

$R_o = \sqrt{\frac{\mu_o}{\epsilon_o}} = 120\pi \times 377$  ohms — intrinsic impedance

$C_o = \epsilon_o \frac{\pi r_1^2}{2d}$  in pF (capacitance at gap)

$K$  = numerical factor (even or odd) may be determined from  $\cos Kl$  or  $\sin Kl$ ;  $\cos^2 Kl = 1$ , when  $Kl = 0$  or  $Kl = \pi/2$

$e_p$  = skin depth =  $\sqrt{\frac{2}{\omega \mu \sigma}}$  in cm or inches

$\sigma$  = conductivity =  $5.8 \times 10^9$  in mho/m (for Cu)

$\frac{\mu_o}{\mu} \frac{\lambda}{e_p} = 2.6 \times 10^4 \sqrt{\lambda_{cm}}$

Factor  $B$  has a complex form:  $\frac{r_1}{r_2} \frac{L_{11}^2}{L_{01}^2}$

$\frac{L_{11}}{L_{01}} = \frac{l}{2d} \frac{J_{11}}{J_{01}} \cong \frac{l}{2d} \frac{Kr_1}{2}$ , where:  $J_{11}$  and  $J_{01}$  are Bessel functions and  $L_{11}$  and  $L_{01}$  are inductances of different parts of rhumbatron (see Fig. 1).

$B$  may also be found from curves of Fig. 2E.

For these values, the complex expressions of ordinate  $(R_s/\sqrt{2}) (e_p/\lambda) \cong 1.6$  with  $\mu = 1$ . From this expression,  $R_s = 1.6 \sqrt{2} (\lambda/e_p) = 310,000$  ohms. For copper,  $\lambda/e_p = 14.3 \times 10'$  where  $\lambda = 30$  cm.

Note that bandwidth  $Q_n$  is broader when the expression  $(10^2/\sqrt{2}) Q_n (e_p/\lambda)$  of Fig. 1C is lower and when  $R_s$  is lower (superposition of two modes as shown in Fig. 1E).

A rhumbatron of prismatic form is shown in Fig. 2A'. Resonance is determined by  $(1/\lambda^2) = (1/\lambda_c^2) + (p/4h)^2$  where  $\lambda$  is known in cm or inches,  $\lambda_c$  is cutoff  $\lambda$  in the same units as  $\lambda$  shown in Table II,  $p + 1$  is the number of plans where the electric field is zero (plans of extremities are also included, a plan being a part of the cavity where electrical field  $E$  is zero) and the numerical factor is usually equal to 2 and  $2h$  is the length of the rhumbatron in the same units as  $\lambda$ .

Reactance is given as  $L\omega = 120 (\lambda/h) (F/A)$  in henries where  $F$  and  $A$  are dimensionless factors from Table II and  $\lambda$  and  $h$  are in the same units (cm or inches).

Determine  $Q_n$  from  $(\mu_o \lambda)/(\mu Q_n e_p) = [(\sqrt{2} \lambda^3)/\lambda_c^2 Ad] [(p \lambda_c)^2/(4h)] [2c + 4(d/l) E + 2A(d/h) + 2B + 4D(d/l)]$ . Factors  $A, B, C, D, \lambda_c, d, l, h$  and  $e_p$  can be found in Table II;  $\lambda$  is given.

To design a prismatic rhumbatron, choose  $\lambda$  or  $f$  in the function of  $l$  (for example:  $l = \lambda/4$ ).

Determine  $\lambda_c$  from Table II as ratio  $\lambda_c/l$  for a given  $2d/l$ . Determine  $r_1/l$  for a given  $2d/l$  from Table II;  $2h$  and  $2r_1$  are chosen arbitrarily at the request of bandwidth and  $Z_n$ . For  $Z_n$  of a short revolution type, the same formula as for a long revolution rhumbatron may be used (Table I) with some approximation.

Determine the reactance  $L\omega$  from the equation for  $L\omega$  (previously given) using factors  $F$  and  $A$  from Table II. These factors depend on  $r_1/l$  or  $2d/l$ . For a given  $R_s$  and  $F/A$ , the broader bandwidth rhumbatron requires a greater  $L\omega$  and  $\lambda/h$  (see formula  $R_s = Q_n L\omega$  of Table I).

Determine  $Q_n$  (unloaded  $Q$ ) from  $(\mu_o \lambda)/(\mu Q_n e_p) = [(\sqrt{2} \lambda^3)/\lambda_c^2 Ad] [(p \lambda_c)^2/(4h)] [2c + 4(d/l) E + 2A(d/h) + 2B + 4D(d/l)]$  using Table II, where factors  $A, B, D, E$

(and others) have been determined.

As a numerical example of prismatic rhumbatron design, assume  $\lambda = 30$  cm. Arbitrarily from Table II for:  $l = \lambda/4 = 7.5$  cm,  $2h = l = 7.5$  cm,  $2d/l = 0.1$ ,  $2d = 0.75$  cm,  $r_1/l = 0.5$ ,  $F = 1.1$ ,  $A = 27.24$ ,  $B = 0.65$ ,  $C = 10.61$ ,  $D = 35.18$ ,  $E = 10.29$ ,  $\lambda_c/l = 5.12$  and  $\lambda_c = 38.4$  cm.

By using the complex equation above, and Table II,  $(\mu_o/\mu) (1/Q_n)$

$(\lambda/e_p) \cong 2.130$  where  $\mu_o/\mu = 1$  and  $Q_n = (\lambda/e_p) (1/2,130) = 70.0$ . For copper,  $\lambda/e_p = 14.3 (10')$  where  $\lambda = 30$  cm.

From Table I, shunt resistance  $R_s = Q_n (L\omega)$ . The reactance is equal to  $L\omega = 120 (\lambda/h) (F/A) \cong 36$  henries and  $R_s \cong 70.0 (36) = 2,500$  ohms.

A rhumbatron of revolution or prismatic form can be represented by a lumped network as shown in



Example of typical rhumbatron of revolution form

Table II—Factors  $A, B, C, D, E, F, \lambda_r, d, r,$  and  $l$  of Prismatic Rhumbatron

$2d/l$	$l - r_1/l$	$r_1/l$	$F$	$A$	$B$	$C$	$D$	$E$	$\lambda_r/l$
0.1	0.4	0.4	1.07	22.52	0.46	8.41	30.2	10.27	4.7
		0.5	1.1	27.24	0.65	10.61	35.18	10.29	5.12
		0.6	1.13	31.8	0.86	12.98	39.9	10.22	5.50
0.3	0.8	0.4	1.1	8.95	0.157	2.83	7.62	3.4	4.21
		0.5	1.13	10.5	0.203	3.61	7.97	3.4	4.50
		0.6	1.17	12.15	0.260	4.42	8.64	3.4	4.82

Fig. 2B. This illustration shows rhumbatron operation in the complex wave  $\omega$ .

The resulting and complex wave  $\omega$  of rhumbatron operation is given by two modes  $\omega_1$  and  $\omega_2$ . Other possible superior modes in the rhumbatron are not considered in this article. Wave  $\omega_1^2 = 1/L_1 C_1$  and wave  $\omega_2^2 = 1/L_2 C_2$  coupled by capacitance  $C_0$  of the gap.

Therefore,  $2L_1 C_0 \omega^2 = [(1 - 2\omega^2/\omega_1^2)/2 (1 - \omega^2/\omega_1^2)] + [(L_1/L_2) (1 - 2\omega^2/\omega_2^2)/2 (1 - \omega^2/\omega_2^2)]$ .

As shown in Fig. 2D, if the upper part of the rhumbatron with the appropriated parameters  $L_1, C_1$  is resonated on the fundamental coaxial mode of  $\omega_1$  ( $\lambda = 2l$ ) and the bottom part with the parameters  $L_2, C_2$  is resonated on the mode  $E_{01}$  of  $\omega_2$  (resonance  $\lambda$  is constant), superposition of these modes is possible for certain conditions of parameters derived from the above equation. From this equation,  $C_0$  depends on  $r_1, r_2$  and  $\lambda$ . The calculation is accurate when  $C_0$  is considered as a large capacitance and true for the condition  $r_1/\lambda \leq 0.38$  (or  $\lambda \geq 2.5 r_1$ ),  $r_2/\lambda = 0.88$  (or  $\lambda = 1.13 r_2$ ) and  $r_2/r_1 = 2.3$ .

When  $r_1/\lambda > 0.38$ , capacitance  $C_0$  acts as an inductance and the point of intersection of coaxial and  $E_{01}$  modes disappears. Figure 1E shows the superposition of these modes. Rhumbatron impedance  $R_j$  is going to zero at  $l = l_0$ .

For  $l > l_0$  or  $l < l_0$ ,  $\omega$  becomes  $\omega_1$  or  $\omega_2$ . The possibility to reduce or to change a rhumbatron impedance  $R_j$  up to zero as an interaction of capacitance  $C_0$  between two modes of rhumbatron  $\omega_1$  and  $\omega_2$  is important. In this way, the output power reflection and matching conditions can be improved with a broader bandwidth than in an ordinary rhumbatron because  $R_j = Q_n (L\omega)$  ohms and the bandwidth is

increasing when  $R_j$  is decreasing. However, the experimental realization of this condition and selection of two modes (coaxial  $l = \lambda/2$  and  $E_{01}$  with  $\lambda$  constant) requires the proper choice of dimensions  $C_0$  or other combinations of dimensional parameters.

As a numerical example of a rhumbatron of revolution form when shunt resistance  $R_j$  is going to zero, assume  $\lambda = 30$  cm ( $f = 1,000$  Mc),  $r_1/\lambda \leq 0.38$ ,  $r_1 = 0.38 \lambda = 11.4$  cm (superior limit),  $r_2/\lambda = 0.88$ ,  $r_2 = 0.88 \lambda = 26.4$  cm and  $r_2/r_1 \approx 2.3$ .

As is shown in Fig. 1A, rhumbatrons of revolution or prismatic forms have been formed by an electrical short circuit on one end and by a connection with the gap at the other end. The gap is narrow and presents a high lumped capacitance  $C_0$ . The gap is formed by a ridge of length  $|l - 2d|$  and diameter  $2r_1$  at distance  $2d$  as in a ridged waveguide.

The resonance frequency of a rhumbatron is given by  $K (r_2^2/4d) \tan K |l - 2d| \times \ln (r_2/r_1) = 1$  where  $K = 2\pi/\lambda$ ,  $r_2$  and  $r_1$  are the outer and inner radius of the rhumbatron in cm or inches,  $2d$  is the distance or interval of a gap in cm or inches and  $|l - 2d|$  is the length of a ridge in cm or inches.

The resonance frequency  $f_0$  (or  $\omega_0$ ) depends on  $r_1$  of the gap (or of a ridge in a ridged waveguide) for  $K, d, r_2$  and  $|l - 2d|$  constant. It is clear from the equation for bandwidth ( $BW = \omega_0/Q$ ) that the quality factor  $Q$  is decreasing and the bandwidth is increasing with the angular variation of frequency  $\omega_0$  in the function of diameter  $2r_1$  and the length  $|l - 2d|$  of a ridge. Therefore, the gap of a rhumbatron of  $2d$  acts as a ridged waveguide.

Here is an example: a regular waveguide at the frequency band

2.6 to 3.95 Gc has a ratio of high  $f$  to low  $f$  of 1.5, between 3.95 and 5.85 the ratio is approximately 1.5 and between 7.05 and 10 Gc the ratio is approximately 1.4. Compare this to a commercial ridged waveguide over the frequency band of 4.75 to 11 Gc with a ratio of 2.3. By proper choice of dimensions, it is possible to obtain 4:1 ratios between cutoff frequencies for the  $TE_{10}$  mode in the waveguide. As shown in Fig. 2C,  $\lambda_r$  is displaced\* as  $\lambda_r = [90 \text{ degrees}/(Q_1 + Q_2)] \lambda_{r0}$  where  $\lambda_{r0}$  is cutoff  $\lambda$  without post A. Both  $\theta_1$  and  $\theta_2$  satisfy the approximate equation— $\cot \theta_1 + (b_1/b_2) \cot \theta_2 = 0$  when  $\theta_1$  and  $b_1/b_2$  are small. A prismatic type rhumbatron is more convenient to use in rectangular waveguide type devices.

The name rhumbatron is derived from the Greek word meaning rhythmic oscillation.

The writer thanks John Bose of Columbia University for permission to publish this article.

## REFERENCES

- (1) L. V. King, On the Electrical and Acoustic Conductivities of Cylindrical Tubes Bounded by Flange, Phil. Mag., Jan. 1936.
- (2) W. W. Hansen, On the Resonant Frequencies of Closed Concentric Lines, J. Appl. Phys., Jan. 1939.
- (3) W. C. Hahn, New Method of the Calculation of Cavity Resonator, J. Appl. Phys., Jan. 1941.
- (4) J. Bernier, Une Methode de Recordement Pour le Calcul des Cavities Electromagnetique, C. R. Acad. Science, 31, Jan. 1944 (in French).
- (5) R. Warnecke, Tubes A Modulation de Vitesse, Edition Gauthier Villards, Paris (in French).
- (6) Bernier, Abaques, Pour le calcul des Constantes de Rhumbatron, Rapport C.S.F. W1909, Jan. 1943 (in French).
- (7) Bernichon, Determination de Reseau de Courbes, Rapport C.S.F. W3351 et W3363, Aout, 1946 (in French).
- (8) R. G. E. Hutter, "Beam and Wave Electronics in Microwave Tubes," Van Nostrand Company, p. 69, 1959.
- (9) Reference Data for Radio Engineers, III.

## BIBLIOGRAPHY

- C. Vincent, Calcul des Cavities Cylindriques pour Tubes A Large Bands Passante, Rapport, C.S.F. 2581, Dec. 1944 (in French).
- C. Fauve, Calcul d'un Rhumbatron Double Sans Grille, Rapport C.S.F. W2736, Mars, 1945 (in French).
- Bernier, Quelques Principes Aidant du Calcul de Cavities Electromagnetique, C. R. Acad. Sc., t 217, Nov. 29, 1943 (in French).
- K. Spangenberg, G. Walters and F. Schott, Electrical Network Analyzers for the Solution of Electromagnetic Field Problems, Proc. IRE, July 1949.
- T. Moreno, "Microwave Transmission Design Data", McGraw-Hill Book Company, New York, 1948.
- A. Kirilloff, Cavities in the Range of 500 Mc and its Application, Report N-13/151, Electronics Research Laboratory, Columbia University, April 14, 1959.

\*Note Report N-26/151, Electronics Research Laboratories, School of Engineering, Columbia University, New York 27, New York, October 1959.



*Instructor G. E. Olsen explains servo mechanism control principles to student L. P. Hilton in laboratory of nationally-known Electronics Institute, Detroit.*

## **SOUTHEASTERN MICHIGAN'S SCIENTIFIC CLIMATE —**

**a stimulating environment for electronics firms.** The fast-moving electronics industry relies on skilled technicians to assist in the development and production of electronic materials and systems, well schooled technical graduates like those accredited by the Electronics Institute, Detroit. And the Institute is but one sample of the technical schools in this area.

They all are important contributors to the scientific climate of Southeastern Michigan — an invaluable, local resource that should interest electronics firms. It's a resource which encompasses a complete range of educational facilities, from trade schools to pioneering research opportunities at world-famous universities.

Southeastern Michigan possesses other resources. In the area are many progressive communities which have well-founded plans for industrial growth. All the basic elements now considered necessary for the mutual growth and prosperity of a community, and the industry it contains, have been provided.

If you are looking for a site which offers the right environment and growth conditions, write for information to Detroit Edison, Plant Location Service, Area Development Division, Detroit 26, Michigan.



# **DETROIT EDISON**

# Low-Cost Transistor Overload Safety Circuit

*Transistor across the supply line is cut off by static potential of a diode until an overload occurs. When the transistor conducts, the fuse is opened by current that would ordinarily destroy the transistors*

By K. REDMOND,  
Amperex Electronic Co., Hicksville, N. Y.

SEALED TRANSISTOR UNITS require protective circuits to prevent total destruction of the units when excessively high supply voltages are applied. Unless small, fragile and expensive fuses are used, it is possible to burn out the transistors in sealed units before the fuse opens. The destruction may result from either voltage breakdown or high current. A circuit is required that will cause the fuse to open before the transistors are destroyed.

A possible solution is a Zener diode that will break down when excessive voltages are applied, and thus open the fuse; however, the cost of such a device for a protective circuit may be prohibitive.

The requirements of an alternate solution are: relatively low cost, low current drain at the proper supply potentials and relatively high current drain at excessive supply voltages. The circuit for a low-cost alternate solution is shown at the top. The protective circuit uses one resistor, one diode and one transistor. The transistor unit to be protected is represented by the 1,000-ohm load.

The voltage drop across the series resistor is in such a direction as to turn the transistor on; however, the static potential across the diode is in such a direction as to keep the transistor off. If the series resistor is adjusted to hold the transistor just at cutoff when the

proper line voltage is supplied, a voltage higher than the proper line voltage will cause the voltage across the series resistor to become greater than the voltage across the diode, and cause the protective transistor to conduct. The current through the transistor will aid in opening the fuse faster than if the current to open the fuse were drawn solely from the load. In addition, if a resistor is placed in series with the line, the current drawn through the transistor will aid in dropping the voltage across the load, and prevent damage to the load from voltage breakdown.

The top drawing shows the circuit constructed to test this theory. The components and values are by no means optimum—low-priced or rejected diodes and transistors would work well in this application.

It was desired to operate the load at 18 v and have the fuse open when a voltage about or in excess of 24 v was supplied. The current drawn at 18 v was 18 ma, accounting for the 1,000 ohms specified as the load. With the components shown, at 18 v the current was 18 ma and at 24 v the current was 48 ma. If the load were purely resistive, at 24 v, 24 ma would have been drawn; however, the transistor conducted sufficiently to draw an additional 24 ma. Transistors increase in resistance as the supply voltage is increased, especially if

they have a substantial emitter resistor, and therefore an even greater percentage of the total current would flow through the protective transistor. Even though the current through the protective transistor is in excess of its nominal current, this current is a transient and its purpose is to open a fuse. Rejected power transistors may be used for this application, in which case their current and dissipation ratings will not be exceeded.

With slight modification, the circuit can serve as a voltage reference or regulator by placing a large resistor in series with the supply line. Any increase in voltage above a preset level will cause current to flow through the transistor. The current flowing through the transistor will tend to drop the voltage across it, and thereby establish a voltage-stabilizing action.

Another modification that can be made, which will lower the dissipation of the protective transistor and have only a slight effect on performance, is to add a resistor in series with the collector of the transistor. The series collector resistor also has the advantage of lowering the voltage across the protective transistor when excessive line voltages are applied. A circuit embodying these modifications and connected with a series resistor to serve as a voltage regulator is shown at the bottom.

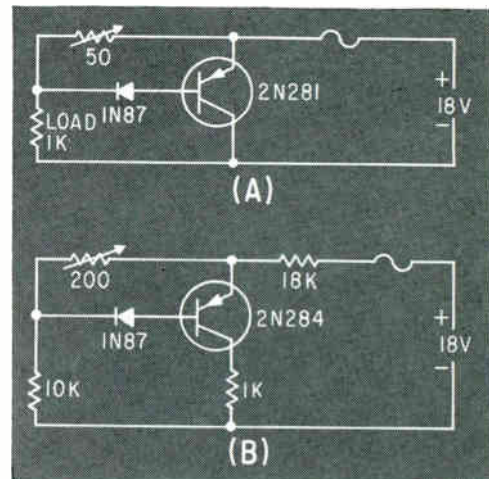

Overload safety circuit (A) has variable breakdown voltage. Modification (B) to lower the dissipation has a transistor current characteristic similar to that of a Zener diode



# Which cable has the **Beldfoil\***?

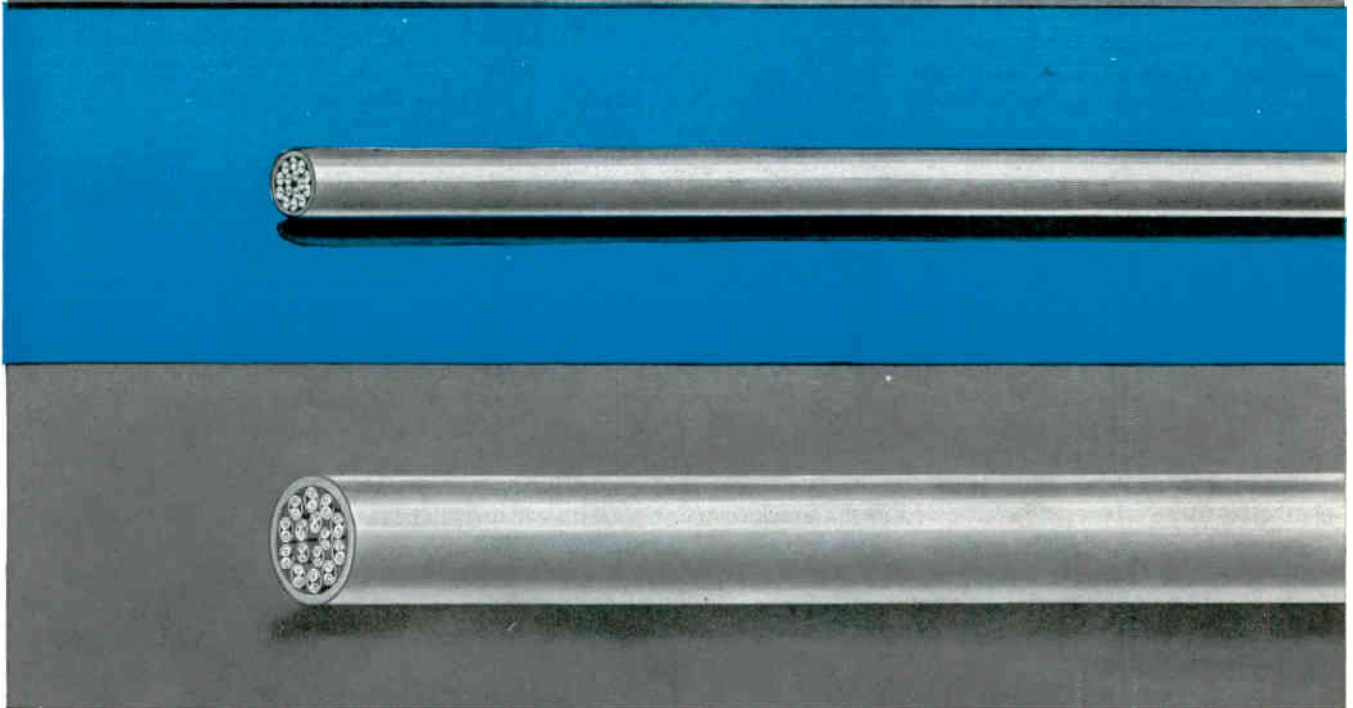

Both shielded cables have the same number of twisted pairs with identical AWG. But . . . the cable with exclusive Belden BELDFOIL is smaller in diameter.

**What does this mean to you?** It means that when you specify BELDFOIL, you are really buying extra space—extra conduit space, extra raceway space, extra console and rack space.

A new development by Belden—BELDFOIL shielding is 100% effective. It is a major development in quiet cables. BELDFOIL eliminates crosstalk and is superior for stationary or limited flexing at both audio and radio frequencies.

BELDFOIL shielding is a lamination of aluminum foil with Mylar which provides a high dielectric strength insulation that is lighter in weight, requires less space, and is usually lower in cost. For multiple-paired cables, with each pair separately shielded, the Mylar is applied *outside* with an *inward* folded edge.\*\* This gives 100% isolation between shields and adjacent pairs.

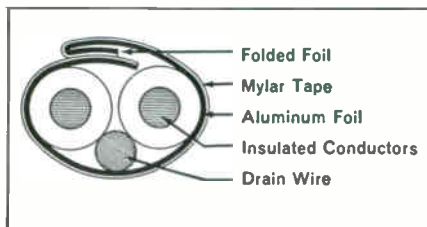

**For complete specifications, ask your Belden electronics jobber.**

\*Belden Trademark  
Reg. U. S. Pat. Off.  
\*\*Patent applied for



power supply cords • cord sets and portable cordage • electrical household cords • magnet wire • lead wire • automotive wire and cable • aircraft wires • welding cable

# Program-Controlled Tractors Haul Freight

TRAILERS loaded with cargo from railroad freight cars are being towed by electronically controlled tractors. Five of the battery-powered vehicles are operating over pre-programmed routes at the Wolverhampton freight terminal in England. Courses and stopping points are selected or changed by pushbutton switches.

The installation is part of a British Railways modernization program. The tractors, called Robotugs, were developed by E. M. I. Electronics, Ltd. The operation is the result of a two-year experiment with two of the tractors at Newton Abbot Goods Shed by British Railways and E. M. I. Purpose of the project was to combine the best features of other mechanized freight-handling methods.

The five tractors at Wolverhampton are moving cargo to reloading areas for highway distribution to surrounding districts. Efficiency of the installation is such that savings in labor costs are expected to offset cost of the vehicles in a few months. The highly flexible system is also said to be adaptable to fluctuations in traffic and destination.

The electronic system, in addition to starting, steering and stopping the tractors, is equipped with a complex of safety interlocks. The vehicles only travel at 2 mph, which is felt to be adequate. However, the interlocks prevent collisions between vehicles and stop a tractor if it encounters an obstacle. Protection is also provided against vehicle breakdown or faulty control equipment.

Guidance of the tractors is accomplished with the buried-wire technique. Alternating current through the single conductor, buried one-half inch below the surface, is one-sixth amp. The field around the wire induces voltage in two sensing coils mounted on the under-part of the tractors. Output from each coil is fed to a two-stage transistor amplifier. A motor powered by the amplifiers steers the vehicle through reduction gearing

connected to the steering mechanism.

When the tractor is on the correct course, the low voltages induced in the sensing coils are insufficient to operate the steering motor. However, if the tractor veers from its programmed course, the higher voltage induced in the coil nearer to the wire results in corrective rotation of the steering motor.

The interlock arrangement protects the system if an open circuit develops in the guide wire. The starting relay for the electrically powered tractor is de-energized and the brakes are applied.

The bumper on the front of the vehicle is mounted on four springs. If the vehicle encounters an obstruction, movement of the bumper opens a microswitch. Again an interlock relay is de-energized and the tractor is stopped.

Vehicle courses are divided into blocks similar to those used on railroads. These sections permit simultaneous control of several vehicles on a variety of routes. Power is normally not applied to the entire guide-wire system but only to that section over which a tractor is passing or is about to pass. There is always a de-energized block between each tractor and all other tractors.

The program unit incorporated in each vehicle selects routes in accordance with a predetermined sequence of stopping points. Selection of stopping points is based on sorting arrangements for different types of freight, ultimate destination and similar needs. The control system is programmed by numbered pushbutton switches. The tractor is stopped at these points by count coils buried in the floor. The count coils, energized by current from the guide wire, indicate the position of the tractor in the circuit to the program unit.

Faults in a tractor or a portion of the control system result in stopping the vehicle or removing power from the faulty section until the trouble has been corrected. If the

complete system should become inoperative because of the absence of current or other reasons, a driver can operate the vehicle with power supplied by its independent battery. The tractor can also be operated from beside it using a stick tiller control, which can be quickly fitted to the steering pillar.

## Firms Join to Develop Practical Fuel Cells

PRACTICAL fuel cells that would use an inexpensive fuel would have many advantages over gasoline engines. They could be more efficient and they could provide power in applications in which gasoline engines would not be practicable. For these and other reasons, two companies with experience relevant to fuel-cell development have joined forces in a research and development program.

An initial two-year agreement to combine experience in their respective fields was made by Thomas A. Edison Research Laboratory division of McGraw-Edison and the research and development department of Standard Oil Company (Indiana). The contract is subject to renewal after the first two years.

Standard Oil researchers will contribute their knowledge of cat-

## Built-In Tv Zoom Lens Has Short Focal Range



*Minimum focal range of two to four inches can be changed continuously through magnification stages in new tv camera jointly developed by BBC and Rank Precision Industries in England*



# THESE 50-Volt CAPACITORS



## SOLVE SPACE PROBLEMS

### TRANSISTOR COMPANIONS

Ideal transistor "companions" where hermetic sealing is required. Both types are smaller than comparable MIL-C-25A designs yet exceed all requirements of this specification. Their extremely miniature size saves space and weight with no sacrifice in reliability.

#### CAPACITY TOLERANCES TO $\pm 1\%$

Inherent stability of these designs leads to widespread use in tolerances of  $\pm 5\%$ ,  $\pm 2\%$  and  $\pm 1\%$ .

#### SUPERIOR STABILITY WITH LIFE

Exhibit excellent retrace following temperature cycling or accelerated life testing:

#### HIGH RELIABILITY CAPABILITY

These designs are capable of being produced to high reliability specifications comparable to MIL-C-14157 and MIL-C-26244 (USAF). Such customer applications are handled on a "project" basis, and the amount of premium cost varies depending on the level of performance required and on the lot acceptance testing specified.

#### 50-VOLT DIMENSIONS

Capacitance in Mfd.	626G*		627G		628G*		629G		616G†		617G†	
	D	L	D	L	D	L	D	L	D	L	D	L
.001	.173 x $\frac{3}{32}$	.173 x $1\frac{1}{32}$	.173 x $\frac{3}{32}$	.173 x $1\frac{1}{32}$	.173 x $\frac{3}{32}$	.173 x $\frac{3}{32}$	.173 x $\frac{3}{32}$	.173 x $\frac{3}{32}$	.173 x $\frac{3}{32}$	.173 x $\frac{3}{32}$	.173 x $\frac{3}{32}$	.173 x $\frac{3}{32}$
.0022	.173 x $\frac{3}{32}$	.173 x $1\frac{1}{32}$	.173 x $\frac{3}{32}$	.173 x $1\frac{1}{32}$	.173 x $\frac{3}{32}$	.173 x $\frac{3}{32}$	.173 x $\frac{3}{32}$	.173 x $\frac{3}{32}$	.193 x $\frac{1}{16}$	.193 x $\frac{1}{16}$	.193 x $\frac{1}{16}$	.193 x $\frac{1}{16}$
.0047	.173 x $\frac{3}{32}$	.173 x $1\frac{1}{32}$	.173 x $\frac{3}{32}$	.173 x $1\frac{1}{32}$	.173 x $\frac{3}{32}$	.173 x $\frac{3}{32}$	.173 x $\frac{3}{32}$	.173 x $\frac{3}{32}$	.193 x $\frac{1}{16}$	.193 x $\frac{1}{16}$	.193 x $\frac{1}{16}$	.193 x $\frac{1}{16}$
.01	.173 x $\frac{3}{32}$	.173 x $1\frac{1}{32}$	.173 x $\frac{3}{32}$	.173 x $1\frac{1}{32}$	.173 x $\frac{3}{32}$	.173 x $\frac{3}{32}$	.173 x $\frac{3}{32}$	.173 x $\frac{3}{32}$	.193 x $\frac{1}{16}$	.193 x $\frac{1}{16}$	.193 x $\frac{1}{16}$	.193 x $\frac{1}{16}$
.022	.233 x $\frac{3}{32}$	.233 x $\frac{7}{32}$	.233 x $\frac{3}{32}$	.233 x $\frac{7}{32}$	.193 x $\frac{1}{16}$	.193 x $\frac{1}{16}$	.193 x $\frac{1}{16}$	.193 x $\frac{1}{16}$	.233 x $\frac{7}{32}$	.233 x $\frac{7}{32}$	.233 x $\frac{7}{32}$	.233 x $\frac{7}{32}$
.047	.312 x $\frac{3}{32}$	.312 x $\frac{7}{32}$	.312 x $\frac{3}{32}$	.312 x $\frac{7}{32}$	.233 x $\frac{7}{32}$	.233 x $\frac{7}{32}$	.233 x $\frac{7}{32}$	.233 x $\frac{7}{32}$	.312 x $\frac{7}{32}$	.312 x $\frac{7}{32}$	.312 x $\frac{7}{32}$	.312 x $\frac{7}{32}$
.1	.312 x $\frac{3}{32}$	.312 x $\frac{7}{32}$	.312 x $\frac{3}{32}$	.312 x $\frac{7}{32}$	.312 x $\frac{7}{32}$	.312 x $\frac{7}{32}$	.312 x $\frac{7}{32}$	.312 x $\frac{7}{32}$	.400 x $\frac{1}{4}$	.400 x $\frac{1}{4}$	.400 x $\frac{1}{4}$	.400 x $\frac{1}{4}$
.22	.400 x $\frac{1}{4}$	.400 x $\frac{1}{4}$	.400 x $\frac{1}{4}$	.400 x $\frac{1}{4}$	.400 x $\frac{1}{4}$	.400 x $\frac{1}{4}$	.400 x $\frac{1}{4}$	.400 x $\frac{1}{4}$	.500 x $\frac{1}{4}$	.500 x $\frac{1}{4}$	.500 x $\frac{1}{4}$	.500 x $\frac{1}{4}$
.47	.500 x $\frac{1}{4}$	.500 x $\frac{1}{4}$	.500 x $\frac{1}{4}$	.500 x $\frac{1}{4}$	.500 x $\frac{1}{4}$	.500 x $\frac{1}{4}$	.500 x $\frac{1}{4}$	.500 x $\frac{1}{4}$	.562 x $\frac{1}{4}$	.562 x $\frac{1}{4}$	.562 x $\frac{1}{4}$	.562 x $\frac{1}{4}$
1.0	.560 x $1\frac{1}{32}$	.560 x $1\frac{1}{32}$	.560 x $1\frac{1}{32}$	.560 x $1\frac{1}{32}$	.560 x $1\frac{1}{32}$	.560 x $1\frac{1}{32}$	.560 x $1\frac{1}{32}$	.560 x $1\frac{1}{32}$				

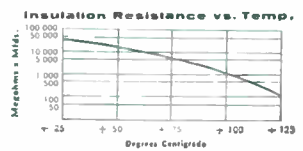
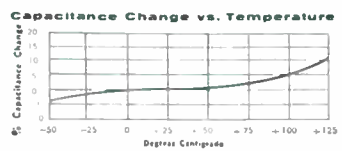

#### Full Rated to 85°C

Types **626G - 627G** (Extended foil)

Types **628G - 629G** (Inserted tab)

Temperature Range—Full rating at 85° C — to 125° C with 50% derating.

Life Test—500 hours at 85° C and 125% of rated voltage.

Capacity Tolerance—All tolerances to  $\pm 1\%$ .

Insulation Resistance—40,000 meg. x mfd. at 25° C but need not exceed 70,000 megohms.

Case Styles—Available in all case style variations in MIL-C-25A.

#### Full rated to 125°C

Type **616G** (Extended foil)

Type **617G** (Extended foil)

Temperature Range—Full rating to 125° C — to 150° C with 50% derating.

Life Test—500 hours at 125° C and 125% of rated voltage.

Capacity Tolerance—All tolerances to  $\pm 1\%$ .

Insulation Resistance—50,000 meg. x mfd. at 25° C but need not exceed 100,000 megohms.

Case Styles—Available in all case style variations in MIL-C-25A.

\*These types have one lead grounded to the case. Others have both leads insulated. †Also available in 150V, 400V, & 600V ranges.

AVAILABLE AT AUTHORIZED INDUSTRIAL DISTRIBUTORS

Write for detailed literature



**GOOD-ALL ELECTRIC MFG. CO. • OGALLALA, NEBRASKA**  
A SUBSIDIARY OF THOMPSON RAMO WOOLDRIDGE INC.



power alone  
is not enough...

it's the ultra low distortion — .005%  
in this audio amplifier  
that makes the big difference!

Here's a fifty-watt power amplifier with harmonic and intermodulation distortion of less than .005%. Distortion so low — you'd need special equipment to measure it!

That's why the UF-101A is a natural as a reference source, with a suitable oscillator, for low distortion measurement of power components, as well as a highly linear amplifier within the audio band.

The other characteristics of the UF-101A are equally outstanding. Phase distortion is negligible —  $\pm 2^\circ$  maximum deviation from linear phase shift. Total hum and noise level less than 10 microvolts input equivalent. Frequency range is from 20 cps to 20 kc. For convenience, the UF-101A has taps for matched load impedances from 1 to 225 ohms.

Some of the applications of this ultra-low distortion amplifier are: checking the residual distortion of distortion-measuring equipment, reproducing non-sinusoidal wave forms faithfully, and as an ultra-low distortion, high power source to supply test benches. Write for full information on the UF-101A.

Other Krohn-Hite amplifiers include the direct-coupled, wide band DCA-10 (10 watts), and DCA-50 (50 watts). Also, *Krohn-Hite Oscillators, Filters and Power Supplies.*



## KROHN-HITE CORPORATION

580 Massachusetts Avenue • Cambridge 39, Mass.

Pioneering in Quality Electronic Instruments

alysis, combustion oxidation and petroleum fuel characteristics. The Edison Laboratory specializes in electrochemistry, electrochemical cell construction, electrolytes, cell reactions and electrode construction and activation.

The fuel cell by electrochemically oxidizing a fuel produces electricity directly. The joint project is directed at finding a practical and economical method for oxidizing hydrocarbon, alcohol or hydrogen as fuel for the cell.

Some experimental cells have already been developed. However, a practical cell that converts an inexpensive fuel into electrical energy is being sought. It must provide sufficient power for practical commercial application.

The Primary Battery division of McGraw-Edison has been producing a semi-fuel cell for more than ten years. It produces electricity using zinc and air as fuels.

## Termination Simplifies Microwave Measurements

STABILITY, durability and ease of adjustment are characteristics of a new instrument that facilitates many microwave measurements. It is an adjustable sliding waveguide termination developed by the National Bureau of Standards that greatly reduces reflections.

The termination, which is simpler in construction than devices previously used, can be scaled to different waveguide sizes. It provides a wide range of reflection coefficients and minimum vswr is less than 1.0002 (return loss more than 80 db). Adjustment is simplified by independent variation and locking of three separate mechanical settings.

One application of the adjustable sliding waveguide termination is measuring directivity of directional couplers. The Bureau, which is presently using the device for this type measurement finds it accurate and convenient.

A signal component coupled out of the sidearm of the coupler exists because of finite directivity. Reflection from the adjustable sliding termination is varied in magnitude and phase until this signal com-

ponent is cancelled.

The termination is then adjusted for maximum coupler output, under which condition the signals add. With the termination replaced by a short circuit, coupler output is compared with sidearm output. The ratio of the two outputs is half coupler directivity if the system was first tuned so that reflection coefficient looking into the coupler output waveguide was zero. If reflection coefficient was not zero, reflection interactions decrease measurement accuracy.

The new termination can also be used to measure reflections from waveguide discontinuities, flanges, obstacles and steps in height of rectangular waveguide. No ambiguity needs to be resolved and the simple nulling adjustments are very sensitive. The procedure is similar to that for the directivity measurement. However, a directional coupler-tuner combination, previously adjusted for infinite directivity, is now used to indicate total reflection. The sum of fixed reflection from the discontinuity and the phasable reflection from the adjustable sliding termination comprise total reflection.

The auxiliary tuners of a single directional coupler reflectometer can conveniently be adjusted for infinite directivity and match back with the sliding termination. This technique usually shortens adjustment procedure and is used in the NBS Electronic Calibration Center to calibrate microwave reflection standards.

Other applications of the adjustable sliding termination have been suggested. For example, an adjustable vswr standard can be constructed using this principle. It can be calibrated using comparison techniques. Comparison technique errors are limited if the two loads being compared have essentially the same impedance.

#### REFERENCES

(1) U. S. Patent No. 2,922,963, January 26, 1960.

(2) G. E. Schafer and R. W. Beatty, A Method of Measuring the Directivity of Directional Couplers, *IRE Trans on Microwave Theory and Tech.*, October 1958.

(3) G. F. Engen and R. W. Beatty, Microwave Reflectometer Techniques, *IRE Trans on Microwave Theory and Tech.*, July 1959.

(4) R. W. Beatty and D. M. Kerns, Recently Developed Microwave Impedance Standards and Methods of Measurement, *IRE Trans on Inst.*, December 1958.

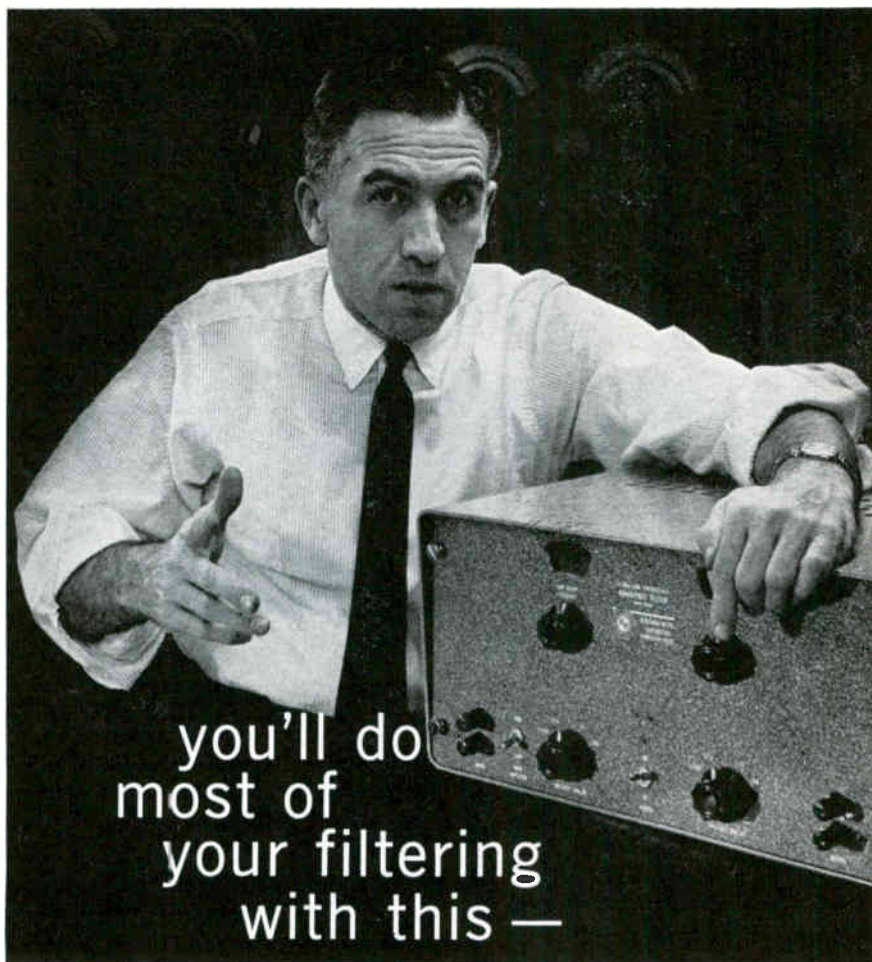

because only the 330-M is continuously variable from 0.2 cps to 20 kc!

Now you can cover the complete frequency range from sub-audio through audio with one convenient variable electronic filter! Its bandwidth covers the most widely used frequencies in circuitry design, testing, measurement and research. The 330-M can replace — in a 17" x 8" x 12" size — banks of fixed filters, and massive inductors and capacitors.

More than this most frequently used bandwidth, the 330-M band-pass filter offers rapid attenuation beyond the cut-offs. Unwanted signals are attenuated up to 80 db, and maximum attenuation is *maintained* at all frequencies beyond cut-off. Low cut-off, high cut-off and center frequency are all continuously variable. Cut-off frequency dials are single log-scale, direct reading. Band switches give frequency ranges in five decades. Attenuation is 24 db per octave outside the pass-band, reaching 70 db in less than three octaves. Signal-to-noise ratio is greater than 80 db.

Write for full information on this wide-band, light-weight band-pass filter. Its convenient coverage of low frequencies through audio, and direct reading, continuously variable cut-offs give you real workload flexibility. Other Krohn-Hite band-pass filters include Models 330-A (0.02 to 2,000 cps), 310-AB (20 to 200,000 cps); and rejection filters as well. Also, *Krohn-Hite Oscillators, Amplifiers and Power Supplies.*



**KROHN-HITE CORPORATION**

580 Massachusetts Avenue • Cambridge 39, Mass.

Pioneering in Quality Electronic Instruments

# Switch Works Like Combination Lock

## SIMPLIFIES AUTOMATIC CONTROL OF CURRENTS

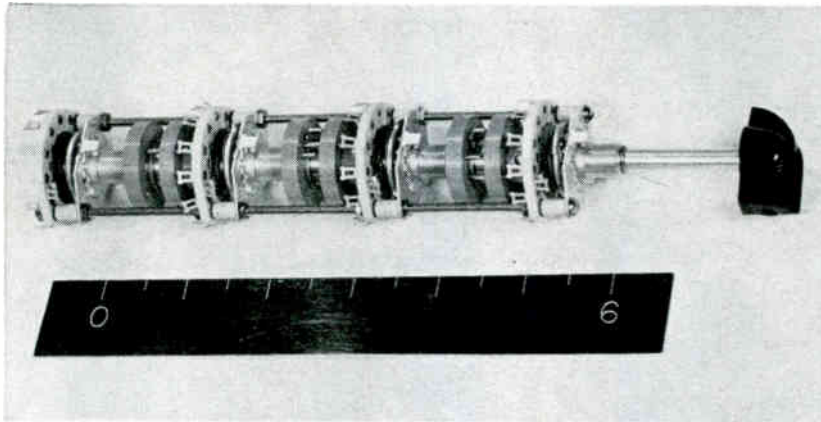

*The new n-digit decade switch, developed at MIT Instrumentation Laboratory, stores multiple-digit numbers by using principles of the ordinary combination lock. Photograph of the four-digit prototype shows control knob at left. Note three sets of drive tumblers and fly tumblers which control inner switch indexes and wafers*

CAMBRIDGE, MASS.—AN ELECTRICAL memory switch, capable of storing multiple-digit numbers by using principles of the ordinary combination lock, has been developed by P. D. Shannon of the Massachusetts Institute of Technology Instrumentation Laboratory.

So close does the switch follow combination lock principles that Shannon obtained parts for his first prototype by stripping discarded Laboratory locks. In operation the switch is first "cleared" and then digits are set into it by turning the shaft alternately right and left and one less revolution each time, after the fashion of a combination lock.

Most memory switches store only one digit. Thus, multiple switches, each with its own dial, are needed to store numbers containing several digits.

The new device, called the n-digit decade switch, was planned as a possible method of simplifying automatic control of electrical currents used in testing gyroscopes employed in inertial guidance systems for missiles and space vehicles.

But because of its flexibility, the device could be used to simplify a variety of automatic control systems by reducing the number of switches and dials needed.

The n-digit switch consists of sets of switch indexes and wafers coaxially arranged with tumbler-type couplings between them. The number of indexes depends on the number of digits to be stored. The prototype stores four-digit numbers and, therefore, uses four switch indexes and wafers.

The number of positions on each index wafer depends on the function for which the switch is designed. Twelve-position indexes were used in the prototype so that each digit could be 0 to 9 or plus or minus.

The device uses sets of drive and fly tumblers like those found in standard combination locks. Each index, except for the outermost one, is associated in operation with a drive tumbler-fly tumbler set.

In the operation of the prototype four-digit switch, as the shaft turns continuously in one direction, the first drive tumbler rotates until its drive pin engages the first fly. The fly rotates, at the most, about 60 degrees, then engages the fly pin portion of the fly tumbler. The first fly tumbler rotates the shaft, turning the second drive tumbler until its drive pin engages the second fly, fly pin and fly tumbler. In this manner, after three revolutions at the

most, rotary motion is transmitted to the fourth index and it can be set in the desired position. The other three indexes are set—as in the combination lock—by turning the input shaft alternately one way and then the other and one less revolution each time. The outermost index is set lastly—and directly—by final rotation of the shaft.

After the n-digit switch has been assembled, it must be adjusted for the proper sequence of operation. First, the positions of the shaft must be given values—0 to 9 or plus or minus in the case of the 12-position index. Next, drive tumbler set screws are loosened and all drive pins aligned in approximately a straight line with each wafer set in the same position.

The set screws are tightened and the fly tumblers rotated until each fly is snug between a drive pin and a fly pin in such a way that all four shafts can be rotated in one direction with each index progressing properly through its detents. When all detents are working properly, the set screws are tightened. All six tumblers—in the case of the four-digit prototype—are then drilled, reamed and pinned to their respective shafts with taper pins.

### New Low-Noise Tubes For Tv Front End

TWO TUBE TYPES, the 6BL8 and the 6FY5, which together compose a tv front end of exceptionally low noise, high gain and reliability, have been announced by Amperex Electronic Corporation.

The 6BL8 is a miniature triode-pentode with separate cathodes, especially designed for use as an oscillator—mixer in tv receivers.

Incorporated into the 6BL8 are construction features which minimize leakage and hum: an undercut anode, whereby the anode is joined to the mica mount at only two

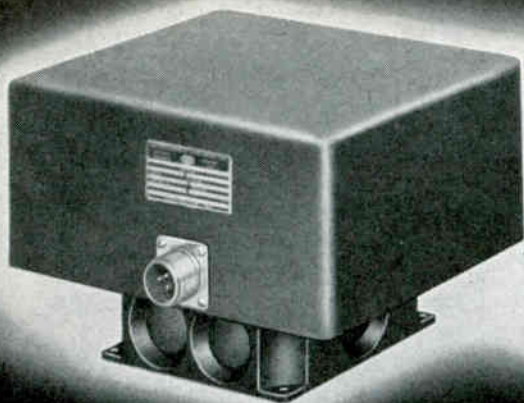

# Where can you use solid-state inverters with performance like this?

- **Wide operating temperature ranges**—Models now available and in development, designed for ambients ranging from a low of  $-55^{\circ}\text{C}$  to  $+125^{\circ}\text{C}$ .
- **Closer frequency regulation**—As close as  $\pm 0.02$  cps under full load at ambients from  $+60^{\circ}\text{F}$  to  $175^{\circ}\text{F}$  in some models.
- **Voltage regulation to  $\pm 0.87\%$**  under full load at ambients ranging from  $-20^{\circ}\text{F}$  to  $+175^{\circ}\text{F}$ .

Features like these, in addition to small size and high power output-to-weight ratios, make Hamilton Standard static inverters ideal for such military and commercial applications as:

- aircraft emergency power supplies
- missiles, satellites
- gyro and instrument power supplies
- stand-by power for remote stations
- mobile equipment power supplies
- industrial computer power supplies

Hamilton Standard static inverters have already been chosen by the three principal military services. A variety of 100 and 500 va models, single- and three- phase, are now under development for WADC, Army Signal Corps, NARDC.

- **High-power-conversion efficiencies** under full load 28v dc input.
- **Protection against output overloads**—100 va models will withstand 100 va overloading, for 10 minute periods once an hour.
- **Transient voltage suppression**—Transient suppressor removes or attenuates voltage spikes—safeguards semi-conductor elements.

## CHARACTERISTICS OF 100-VA STATIC INVERTERS

CATALOG NO.	ECB-1.1-AA	ECB-1.1.7-AA	ECB-1.1.13-AA
Output Voltage	115v $\pm 1v$	115v $\pm 5\%$	115v $\pm 5v$
Frequency	400 $\pm \frac{1}{4}$ cps	400 cps $\pm 1\%$	400 $\pm 1\%$
Phases	Three	Three	Single
Transient protection	Yes	Yes	Yes
Efficiency (Minimum)	80%	75%	75%
Input Voltage			
Nominal	28v dc	28v dc	28v dc
Range	18-29v dc	20-29v dc	18-29v dc
Dimensions	5"x6"x8 $\frac{3}{4}$ "	5"x6"x7 $\frac{1}{2}$ "	5 $\frac{1}{2}$ "x5 $\frac{1}{8}$ "x8 $\frac{3}{8}$ "

Complete specifications and data are available on these and other Hamilton Standard static inverters from 100 to 500 va, single and polyphase.

**STATIC INVERTER GUIDE**—New Engineering data booklet available for the asking. Just clip coupon and mail today to:

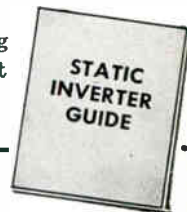

# HAMILTON STANDARD

**DIVISION OF  
UNITED AIRCRAFT CORPORATION  
ELECTRONICS DEPARTMENT  
BROAD BROOK, CONNECTICUT**

ENVIRONMENTAL CONDITIONING SYSTEMS • ENGINE & FLIGHT CONTROLS  
ELECTRONICS • GROUND SUPPORT EQUIPMENT  
HYDRAULICS • STARTERS • PROPELLERS

**HAMILTON STANDARD • Electronics Department  
90 Main Street, Broad Brook, Conn.**

Name \_\_\_\_\_  
Position \_\_\_\_\_  
Company \_\_\_\_\_  
Address \_\_\_\_\_

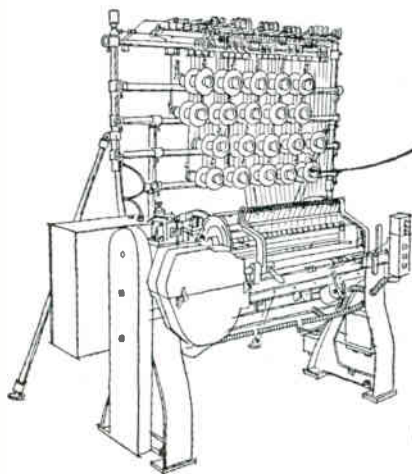

Investigate the super-precise fully automatic Leeson No. 107 Coil Winder for Paper Insulated Coils · Speeds up to 2500 rpm · Short Paper ( $1\frac{3}{8}$ " insert) Attachment · Paper Miss Detector · Space Wind Attachment for High Voltage Coils · One operator for two or more machines! Leeson Corporation, P.O. Box 1605, Providence 1, Rhode Island. (formerly Universal Winding Company)



238.0.1

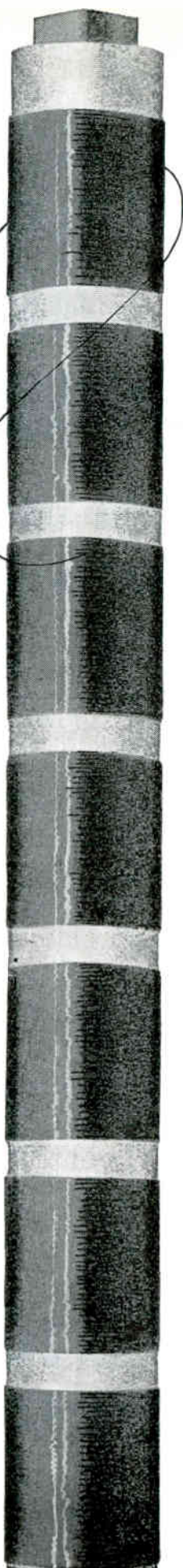

points for minimum number of leakage paths—slotted micas, incorporating specially placed slots to lengthen and, therefore, attenuate any possible leakage path—a folded helical heater for maximum hum cancellation.

Special techniques in design and manufacture insure cathode stability, despite area to area variation in line voltage.

The type 6BL8 is priced significantly below conventional, equivalent tubes. It is also available in controlled warmup versions.

The 6BL8 can also be used as a horizontal oscillator, a video and sound i-f Amplifier, and in sync circuits.

The 6FY5 is an Ampliframe triode with remote cutoff characteristics. It is an improved version of the type 6ER5, having 1 db less noise and 2 db higher gain. The 6FY5 is especially designed for service in vhf tuners for tv receivers. It is controlled for low noise figure at 220 Mc and is operational at lower supply voltage for greater design flexibility.

Incorporated into the tube is the Ampliframe frame grid which makes it possible to maintain close grid-to-cathode spacing for high transconductance and input impedance. These give the 6FY5 a very high gain-bandwidth factor; the remote cutoff characteristics insure low intermodulation distortion. The two cathode pins make possible a low lead inductance, and the internal screening shields reduce direct grid-to-plate capacitance. The 6FY5 incorporates a tongue mica clamp for reduced microphonics. The tube is also available in controlled warmup versions.

### Tube Sees Fire Up to a Mile Away

AN ULTRAVIOLET sensing device that may be the key to more reliable fire detection systems has been developed by Thomas A. Edison Research Laboratory. The device, a gas discharge tube with two symmetrical electrodes, is one-and-one-eighth inches in diameter and one-and-one-quarter inches long. It detects flames up to a distance of one mile and is insensitive to direct sunlight,



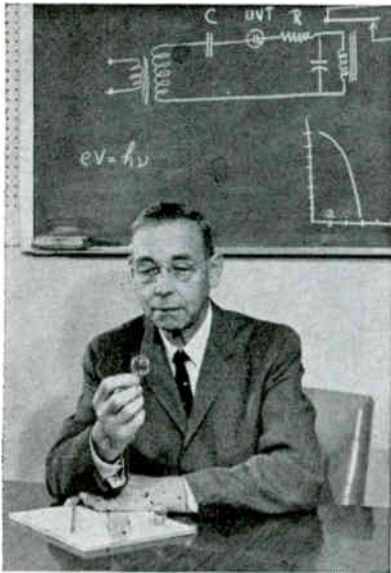

*U-V Detector tube, developed to detect fires and provide a nearly instantaneous alarm, is shown being held by J. B. Johnson of Thomas A. Edison Industries' Instrument Division*

to normal sources of illumination enclosed in glass and to cosmic and nuclear radiation. Spectral response peaks at 2200A.

When used in flame-out applications the tube, manufactured by the Instrument Division of McGraw-Edison Company, detects the absence of flames in boiler fire boxes, furnaces and other combustion chambers. Other applications foreseen include use as a communications device in ship-to-ship or man to man signaling; as a solar blind remote control; as a smoke detection in storage vault and ventilation ducts; and as an arc detector in motors switchgear and welding control.

## Magnet Wire Takes 1,000 F

ZURICH—A FLEXIBLE ceramic insulated wire, used for winding magnet coil, is claimed to be suitable for continuous operation at 1,000 F, and takes 1,700 F for short periods.

The wire, named Ceramicite, was introduced by Wandleside Cable Works, Garratt Lane, London, and has a space factor comparable with enamel wire. The wire has good electrical properties, an insulation strength of nearly 600 v/mil at room temperature, and insulation resistance at 1,000 F of 2 megohms/100 ft for a wall thickness of 0.35 mils.

# Bryant Memory Drums For Every Storage Application

Whatever your immediate or long-range computer requirements, Bryant is equipped to provide "right now" response to your needs for prompt delivery of custom-designed memory drums, standard storage units, read/record heads, and other precision memory system components.

**Remember—Bryant Magnetic Memory Drums offer these special features:**

- Time-proven reliability
- Super-precise ball bearing suspension
- Dynamic runout less than .0001"
- Dynamically balanced at operating speed
- Precision integral-drive induction motors
- Exclusive tapered drum design



### GENERAL MEMORY

**Capacity**—20,000 to 2,500,000 bits @ 130 bits per inch . . . **Tracks**—40 to 420 . . . **Speed**—600 to 24,000 rpm . . . **Size**—5" dia. x 2" long to 10" dia. x 19" long . . . **Access time**—As low as 2.5 ms (one head per track).

### MASS MEMORY

**Capacity**—Up to 6,210,500 bits on a single drum . . . **Tracks**—Up to 825 . . . **Speed**—900, 1800 or 3600 rpm . . . **Size**—18.5" dia. x up to 34" long . . . **Access time**—As low as 16.6 ms (one head per track).



### BUFFER APPLICATIONS

**Capacity**—Up to 225,000 bits . . . **Tracks**—Up to 150 . . . **Speed**—Up to 60,000 rpm . . . **Size**—3" to 5" dia. x 1" to 8" long . . . **Access time**—As low as 0.25 ms (4 heads per track @ 60,000 rpm).

### AIRBORNE SYSTEMS

**Capacity**—60,000 to 180,000 bits . . . **Tracks**—50 to 150 . . . **Speed**—Up to 18,000 rpm . . . **Size**—As small as 6" dia. x 6" long . . . **Weight**—As light as 7 lbs. . . . **Access time**—As low as 3.3 ms (one head per track).



### SPECIAL PURPOSE MEMORIES

**Analog recording** . . . **Multispeed operation** . . . **Speed**—As low as 2.5 rpm . . . **Aerodynamic heads** for high density, high frequency recording . . . **Flux-sensitive heads** for low-speed playback . . . **Air bearing drums** . . . **Magnetic Disc Files** for mass storage up to 150,000,000 bits.

For more detailed information, or if you'd like to discuss your particular storage drum application problems, contact your Bryant Representative, or write direct.

60-C-1

## BRYANT

## COMPUTER PRODUCTS

860 LADD ROAD • WALLED LAKE, MICHIGAN  
MARket 4-4571

A DIVISION OF EX-CELL-O CORPORATION

EX-CELL-O FOR PRECISION

XLO



Magnetizing coils are placed around large magnets before magnet assembly is put together

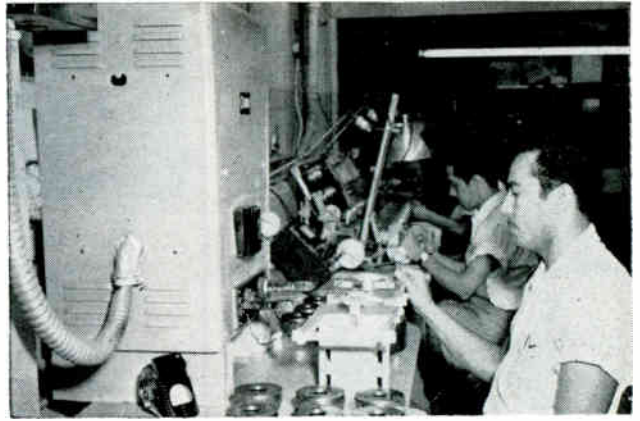

Smaller speaker magnet assemblies are magnetized after assembly by external coil in fixture

## Built-in Coil Magnetizes Large Speakers

PERMANENT MAGNETS in speaker assemblies are generally magnetized after full assembly of the speaker. Magnetization after assembly avoids handling problems and prevents attraction of iron particles and entrance of airborne dust into the magnetic gap.

Magnets of small assemblies are commonly magnetized by placing the full pot assembly in a heavy coil which is part of a permanent fixture. As assembly mass or magnetic structure increases in size, the method becomes less efficient.

To magnetize large Alnico V speaker magnets weighing as much as five pounds, in heavy cast iron keepers or housings, Audax Division of Rek-O-Kut Company, Inc., Corona, N. Y., builds a magnetizing coil into each assembly.

The coil is placed directly around the magnet. In this position, the charging coil ensures saturation of the magnet without excessive diversion of charging flux into surrounding iron. Leads of the coil pass through the housing and are clipped off after magnetization. The coil remains dormant in the assembly.

The 220-volt a-c line supplies power for the magnetizer used by the firm. The coil gets about 80,000 ampere-turns in 1/120 second as the magnetizer clips a peak of the 60-cycle power. A synchronous welding time control fires an ignitron which passes the heavy peak

current. The timer is set to clip any desired number of cycle peaks of the same polarity.

Among other techniques used by Audax is the winding of voice coils on resin-impregnated glass fiber bobbins. The winding bobbin and diaphragm are assembled with thermosetting cement. To preserve their shape, these parts remain on the winding mandrel during oven curing.

While the speaker is being assembled, the voice coil's roundness

and alignment to the air gap is assured by a fixture placed over the cone frame or basket. The fixture holds the voice coil assembly in a protective ring until the magnet and cone assemblies are joined.

Cones are suspended from the frame by a foam rubber ring cemented to the frame and outer cone edge. Foam plastic struts are cemented to the outside of the cone to strengthen it and make it rigid. According to Audax, these methods produce large freedom of excu-

## Sandwich Forms Radar Reflector

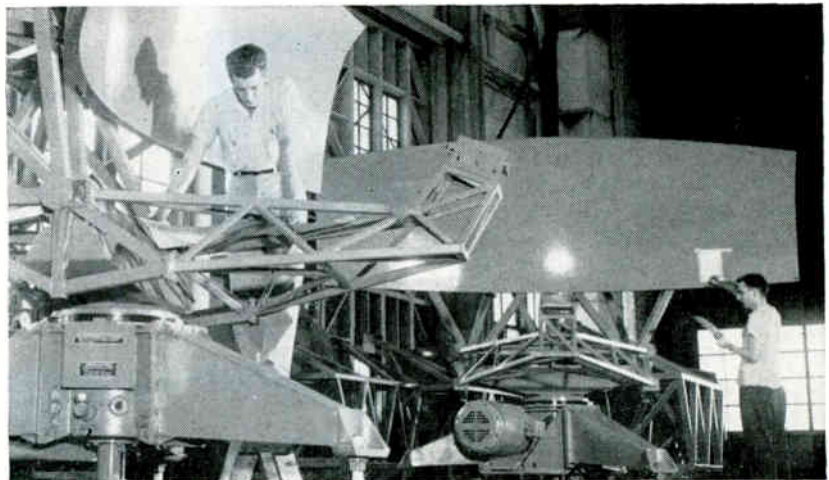

Production models of a new radar reflector are made of sandwich material consisting of stretched aluminum faces with an aluminum honeycomb core. Reflectors are part of rotating antenna system made by Goodyear Aircraft Corp., Akron, Ohio, for airport taxi radar developed by Airborne Instruments Laboratory

# Allen-Bradley Type AH Precision Resistors

**GUARANTEE  
INCREDIBLE  
STABILITY  
FOR YEARS**

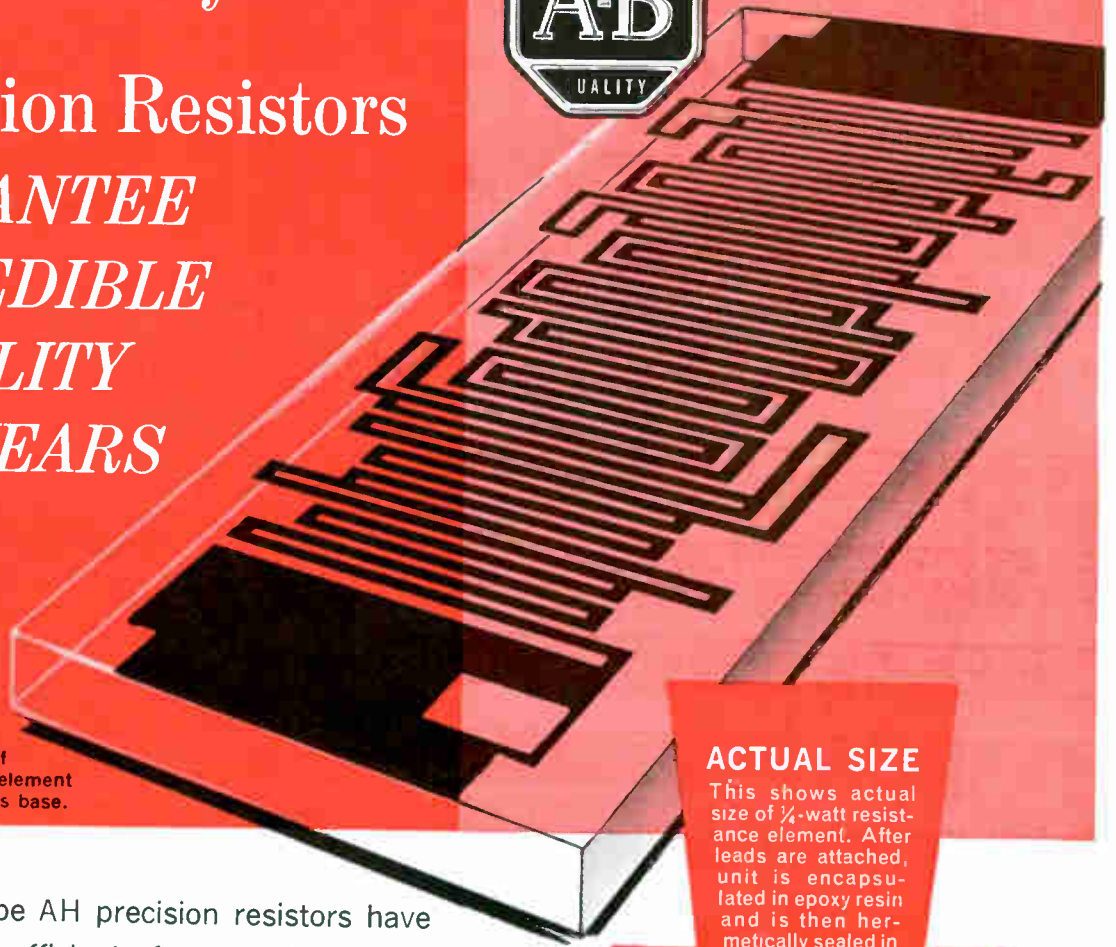

Enlarged illustration of metal grid resistance element mounted on clear glass base.

### ACTUAL SIZE

This shows actual size of 1/4-watt resistance element. After leads are attached, unit is encapsulated in epoxy resin and is then hermetically sealed in a ceramic tube.



Allen-Bradley Type AH precision resistors have a temperature coefficient of  $\pm 25$  PPM or less

Allen-Bradley hermetically sealed precision resistors have an assured long-term resistance stability that is unsurpassed. In addition, *all* characteristics exceed MIL Specs for film and wire-wound precision resistors. The unique design of the metal grid is noninductive, providing excellent high frequency performance. The noise level is of the same low order of magnitude as wire-wound resistance units. With the metal grid deposited on a clear glass substrate, the resistance element is given a visual inspection under extreme magnification, to make certain that it is completely free of possible defects. Unlike conventional metal film resistors, these units are calibrated *without* disturbing the actual current path in the grid.

Allen-Bradley Type AH precision metal grid resistors are available in 1%, 0.5%, 0.25%, and 0.1% tolerances, and with temperature coefficients of  $\pm 25$  PPM or less. Considering the meticulous care with which they are produced, the Type AH resistor could not be cheap. However, where accuracy and reliability are essential—there isn't a resistor on the market which is equal to the Allen-Bradley Type AH precision resistor. Please write for more detailed information.

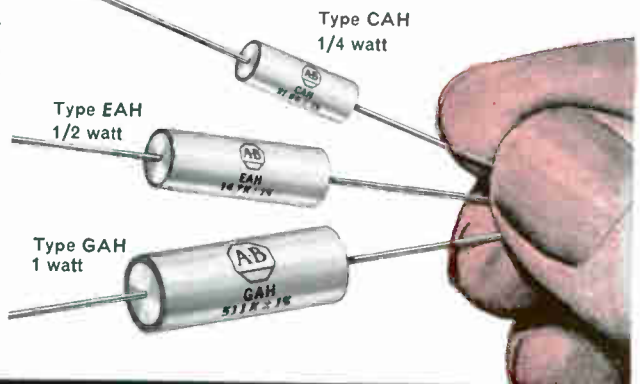

# ALLEN - BRADLEY

Allen-Bradley Co., 1315 S. First St., Milwaukee 4, Wis.  
In Canada: Allen-Bradley Canada Ltd., Galt, Ont.

**QUALITY  
ELECTRONIC  
COMPONENTS**

*product of the pioneer*

# WE'RE "PLUGGIN" THE MOST VERSATILE OSCILLOSCOPE IN THE WORLD



*A few of the many plug-ins available are shown above*

The first oscilloscope with digital *and* printed ReadOut, now provides—through an ever increasing selection of functional plug-ins—the greatest versatility available in any commercial high-frequency oscilloscope. It defies obsolescence. Two plug-ins used simultaneously—unique with the 425—provide the most complete, technically-sound combinations of circuit functions obtainable for universal testing.

- DC to 35 mc—useful to 60 mc
- Accurately repeatable measurements—even by untrained personnel
- Direct-reading digital ReadOut of measurements
- Two plug-ins used simultaneously
- Analog to digital converter—external recorders of all types
- Electronic switches on X, Y and Z axis

PLUG-INS PRESENTLY AVAILABLE	
Type	Description
4201 Y-Preamplifier:	dc-35 mc, sensitivity 50 mv/cm to 20 v/cm
4202 Dual Trace:	dc-33 mc on both traces; 11 nsec rise time
4203 Delaying Sweep:	25 nsec to 10 sec delay, continuously variable
4204 X Input:	deflection factor 2–10 v/cm; dc to 4 mc
4205 Y-Preamplifier:	dc-21 mc; sensitivity 5 mv/cm to 2 v/cm
4207 Y-Test:	provides signals for adjusting 425/425-R
4208 Power Access:	Supplies multiple potentials for breadboarding or testing
4209 Micro Delay:	0–100 nsec delay; resolution better than 0.1 nsec
4211 Sweep Expander & X-Preamplifier:	permits time shared X vs Y and Y vs Sweep displays; dc to 1.5 mc
4213 Raster Display:	Provides a crystal controlled raster for precision time measurement



**PRICE \$2750.00**  
(without plug-in)

*precision electronics is our business*

Send inquiries to:  
INSTRUMENT  
SALES DEPT.

**ALLEN B. DU MONT LABORATORIES, CLIFTON, N. J.,**  
DIVISIONS OF FAIRCHILD CAMERA AND INSTRUMENT CORPORATION  
Du Mont International Division, 515 Madison Avenue, New York 22, New York

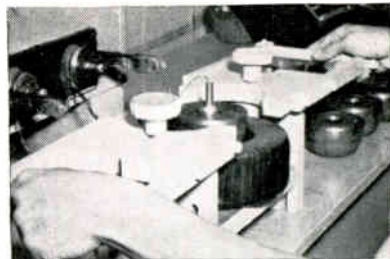

*Magnetizing fixture opens for insertion of assembly*

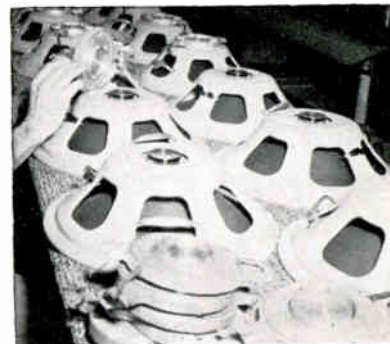

*Metal fixture protects voice coil*

sion, low fundamental resonance and reduced cone breakup at high operating levels

## Optical Projectors Guide P-C Drillers

METAL TEMPLATES used for printed circuit board drilling can be made from dimensionless drawings by a vertical miller equipped with an optical projector.

The template preparation method is used by Electralab Printed Electronics Corp., Needham Heights, Mass., when dimensions are not given on printed circuit board drawings. A negative, prepared from the drawing, serves as an actual size layout for drilling.

The negative is placed on the milling machine table under an optical

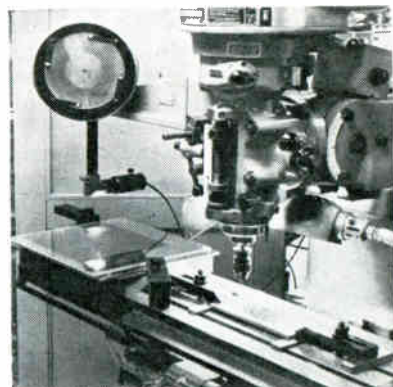

*Templates are prepared on miller*

projector secured to the milling head by a support arm. Reference points on the negative and the template are aligned. The operator then centers each hole position of the negative on the projector's screens and drills the template.

The optical projector is a machine tool model made by Stocker & Yale, Inc., Marblehead, Mass. This firm also recommends the setup sketched for accurate drilling of printed circuit boards. It can be used for component insertion hole drilling in prototype boards or for registration hole drilling in production boards.

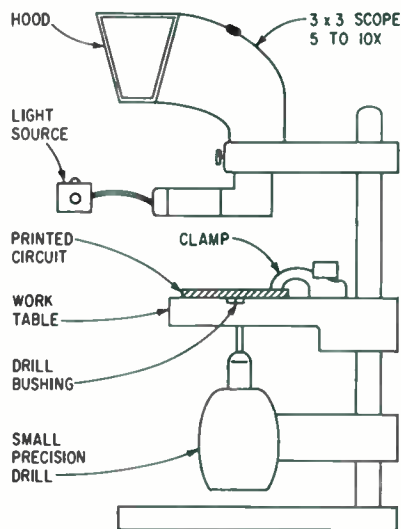

Circuit board drilling setup



Hole positions are centered in screen crosshairs

The projector is mounted on an arm which can be traversed on a vertical column for focusing. Crosshairs of the viewing screen are lined up with the drill point. Each hole position on the board is then located under the projector and drilled. The boards can be held by hand and the drill operated manually. For semi-automatic operation, a foot control can be used to lower a rocker clamp and raise the drill.

# AIRPAX



## SERIES 500 MINIATURE MAGNETIC CIRCUIT BREAKERS

- RATINGS FROM 50 MA TO 10 AMPS
- DC, 60 CPS and 400 CPS TYPES
- MINIATURE CASE; SIZE ONLY 1 3/4" x 1 1/2" x 5/8"
- TRIP LEVEL INDEPENDENT OF TEMPERATURE

- INSTANTANEOUS OR DELAY TYPES
- HERMETICALLY SEALED
- SERIES - SHUNT - RELAY TYPES
- TWO AND THREE GANG ASSEMBLIES AVAILABLE

### Positive Protection

Slightly larger than a conventional panel switch, the breaker serves as switch, fuse and relay.

*Bulletin B-97 on request*



CB23

CAMBRIDGE DIVISION • CAMBRIDGE, MD.

# New On The Market



## Electrostatic Printers

20,000 CHARACTERS PER SECOND

FOUR NEW electrostatic printer tubes that can translate electronic signals into printed words and pictures have been introduced by Raytheon Company's Industrial Components Div., 55 Chapel St., Newton, Mass. The tubes can print 20,000 characters per second or more than 10,000 lines of computer output information a minute.

The tubes resemble flattened crt's with wire matrices across their faces. Tiny wires, 0.001 inch thick and spaced 250 to the inch, extend brush-like through the tube faces. The varying cathode ray beam current inside the tube passes through the wire brush, or matrix, depositing electrostatic charges on paper as it passes the front face of the tube. Pictures printed in this manner have high resolution.

Applications for the tubes include printing photographs transmitted over telephone and telegraph lines and radio channels at the rate of

three 8½ by 11 inch sheets per second. The QV130 and QV131 tubes have 3 inch matrices and were designed especially for label and short copy printing. Tubes of this type are planned for installation in addressing machines that will be used to print subscriber address labels from information stored on tapes. The electrostatic printer tubes will make possible the printing of two million different labels in an eight-hour day.

Two of the tubes, the QV132 and the QV133, are 10 inch printer tubes and print on full-page sheets.

All four of the tubes have medium persistence green fluorescence and magnetic deflection and focusing. Deflection angle is 40 degrees. The tubes, which are made with either one or 40 rows of wire elements, are available to customers' specifications within 60 days.

CIRCLE 301 ON READER SERVICE CARD

cept phone plugs used on transistorized radios and other miniaturized applications.

The Micro-Jack is a 2-conductor single closed circuit design, also usable as a 2-conductor open circuit type. Features include internally keyed nylon insulation, mechanically interlocked springs and solder lugs to eliminate shorts, positive tip spring grip with springs of nickel silver alloy for minimum contact resistance. Mounting bushing is



## Miniaturized Jack

2-CONDUCTOR CIRCUIT

MINIATURIZED JACK, one-tenth the size of a standard jack, has been introduced by Switchcraft, Inc., 5555 N. Elston Ave., Chicago, Ill. Called the TR-2A, the jack will ac-

brass, sleeve terminal is silver plated; opening for plug is 0.101 inch; mounts in panels of maximum thickness of ⅜ inch.

CIRCLE 302 ON READER SERVICE CARD

## Semiconductor Tester

THERMAL RESISTANCE

PRECISE MEASUREMENT of the thermal resistance of semiconductor power diodes and transistors is possible with a new instrument announced by Wallson Associates, Inc., 912 Westfield Ave., Elizabeth, N. J. The model 149 thermal resistance tester uses forward voltage drop at a constant low-level metering current to measure junction temperature.

In operation, the heating current



is interrupted for 800 microseconds at a 10 cps rate while a metering current pulse is injected for 100 microseconds. Junction temperature is sampled quickly after termination of the heating current, before the junction can cool. A behind-the-panel adjustment permits control of the delay between heating and measuring according to the type of semiconductor under test. Forward voltage drop of the measuring pulse at ambient and operating conditions may be viewed directly on the instrument's oscilloscope. The differential between the initial forward voltage drop (which is nulled out) and the forward voltage drop with heating is displayed. In this mode a differential amplifier gain is calibrated, resulting in a display of 1 mv per degree C directly on the oscilloscope.

When accuracy is critical, the differential circuit can null the forward drop with the diode at equilibrium in an oven or high temperature oil bath. Then, with the diode removed to a heat sink, heating



**DU MONT** offers the most complete—yet individually specialized—family of cathode-ray tubes available for work in the high to ultrahigh (*kilomegacycle*) frequency range. Du Mont has contributed special developments on electrode adjustments, plate mounts, timing marker plates, integral mu-metal shields, r-f coaxial connectors, and many other designs specifically oriented to the high-frequency field. Only Du Mont can provide such completeness in selection and design.

\*Of acute mental vision or discernment. keen.

### SPECIALTY FEATURES

- 5BHP**—High sensitivity, astigmatism and pattern adjustment electrodes for distortionless displays
- 5XP**—High vertical sensitivity, low capacitance
- K1409**—Type C r-f coaxial connectors and special deflection plate mounting for UHF applications. Integral mu-metal shield
- K1524**—50 ohm distributed deflection system using Type C r-f coaxial connectors. Integral mu-metal shield
- K1546**—High voltage, high writing speed
- K2082**—Traveling wave vertical deflection plates, high sensitivity
- K1570**—50 ohm distributed vertical deflection; Type C r-f coaxial connectors. Extra horiz. and vert. deflection plates for introduction of timing marks. Interplate shield reduces crosstalk between adjacent deflection plates. Integral mu-metal shield.

Shaded areas indicate traveling wave types

TYPE	A <sub>1</sub> (KV.)	A <sub>2</sub> (KV.)	SENSIBILITY (V/TRACE WIDTH)		USEFUL SCAN (IN.)		USEFUL SCAN (TRACE WIDTHS)		FREQ. 3 db DOWN (Mc.) (VERT.)	WRITING SPEED† (TW/US.)						
			HOR	VERT	HOR	VERT	HOR	VERT								
5BHP	10	1.65	1.54	0.33	3.9	1.6	195	80	220	9000						
5XP	12	2	2.90	0.94	4.25	1.6	220	80	460	9000						
K1409	30	7.5	2.5	1.75	4.2	2.8	420	280	1650	120,000						
K1524	35	10	2.2	0.65	3.5	0.75	435	90	2800	205,000						
K1546	24	4	4.2	1.0	4.0	1.6	160	105	325	33,600						
K2082	12	1.4	1.65	0.43	3.94	1.97	120	60	4100	9000						
			D <sub>1</sub> D <sub>2</sub> D <sub>3</sub> D <sub>4</sub> D <sub>5</sub> D <sub>6</sub> D <sub>7</sub>		D <sub>1</sub> D <sub>2</sub> D <sub>3</sub> D <sub>4</sub> D <sub>5</sub> D <sub>6</sub> D <sub>7</sub>		D <sub>1</sub> D <sub>2</sub> D <sub>3</sub> D <sub>4</sub> D <sub>5</sub> D <sub>6</sub> D <sub>7</sub>									
K1570	35	10	1.4	1.6	1.0	0.55	4.5	3.5	1.25	1.75	650	575	200	280	1400	205,000

† Writing speed determined at 25 ua beam current. Tests made on 35 mm Tri-X film, 4.7 to 1 reduction ratio, f/1.5 lens.



*precision electronics is our business*

Write for complete details  
ELECTRONIC TUBE DIVISION

*Allen B. Du Mont*

ALLEN B. DU MONT LABORATORIES, CLIFTON, N. J.,  
DIVISIONS OF FAIRCHILD CAMERA AND INSTRUMENT CORPORATION  
Du Mont International Division, 515 Madison Avenue, New York 22, New York

current can be increased until the null is again attained. Absolute measurements can be made within 5 percent under standard conditions.

Heating current is 1 to 5, or 1 to

50 amp; measuring current is 1 to 100 ma; measuring pulse width is 100 microseconds; cooling time is 650 microseconds max.; sampling rate is 10 per second.

**CIRCLE 303 ON READER SERVICE CARD**

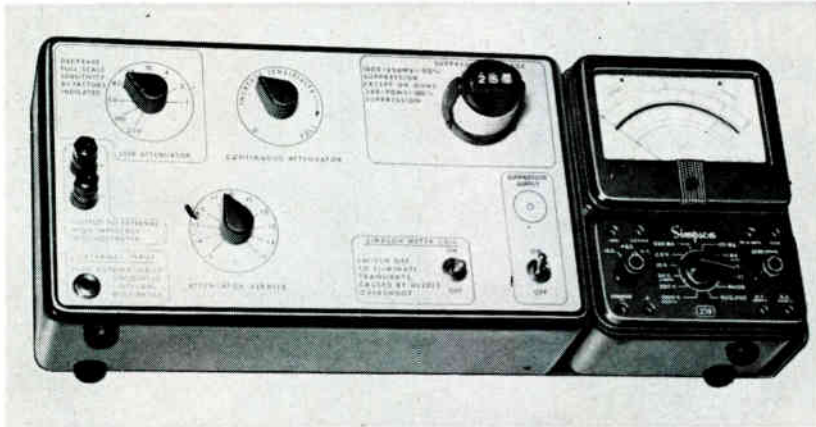

## Incremental Multimeter

### EXPANDS RANGE OF MEASUREMENT

AN INCREMENT multimeter that enables increments of any range of the unit to be expanded about any point in the range and displayed on an external servo recorder, has been developed by Tensor Electric Development Company, Inc., 1873 Eastern Parkway, Brooklyn, N. Y.

Called the #5880 incremental multimeter, the entire package consists of a Simpson #270 multimeter to which are attached a suppressor power supply and an attenuator. Range and accuracy of the unit are identical to the basic meter and its attachments. No additional error of any significance is introduced by the external circuitry. Typical accuracies are 1.5 percent on d-c and

2 percent on a-c.

A 5-mv sensitivity external servo recorder will permit expansions to + or - 1 percent of the full scale value of the range. The attenuator enables the expansion to be adjusted to any value from 1 to 100 percent. Input may be used single ended or differential, provided the external millivoltmeter is capable of differential operation.

Applications include studies of line voltage variations and power supply regulation. Increments as small as 0.01 percent can be measured and recorded. The unit sells for about \$250.

**CIRCLE 304 ON READER SERVICE CARD**

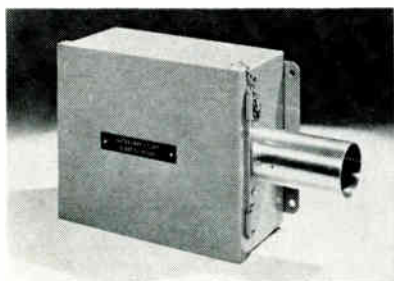

## Infrared Relay

### ADJUSTABLE DEVICE

ULTRA-SENSITIVE, directional infrared ray operated relay for detecting temperature changes has been announced by Daystrom Inc., Weston Instruments Div., 614 Frelinghuy-

sen Ave., Newark, N. J. Designated model 5121 Infra-Ray Relay, the adjustable heat-sensing device can be employed at distance from hot forming processes to actuate water sprays, take-up reels, pouring devices, furnace doors, conveyors, shears, counters and other equipment.

The optical system and detector element provide a discriminate field of vision approximately 12 inches square at a distance of 20 feet from the relay, 6 inches square at 10 feet, etc. When set for maximum sensitivity, the relay is energized by an object 10 feet distant as small as 1 inch square, at a temperature

of 1,100 F and moving at a speed of up to 6 inches per second. As long as the hot object remains in the optical field of vision, the relay will remain energized. Water cooling is not required.

The spdt contacts are rated 1 ampere, 115 volts a-c. Power requirements are 115 volts  $\pm 10$  percent, 60 cps, 1 ampere.

**CIRCLE 305 ON READER SERVICE CARD**

## X-Band Delay Line

### SMALLER SIZE

TO MEET the demand for compact and lightweight test equipment packaging, Turbo Machine Co., Lansdale, Pa., has reduced the size of conventional X-band delay lines. The new technique provides the same delay in a package whose physical size is reduced as much as 50 percent over conventional X-band delay lines. The size reduction has been accomplished while main-

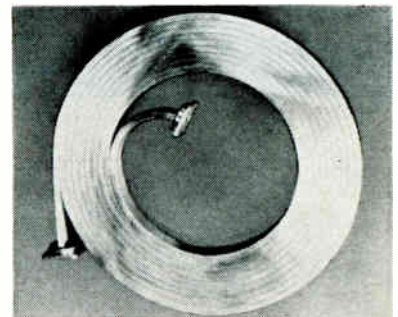

taining the same low loss and low reflection properties of standard delay lines.

The delay lines can be furnished either as individual units or as packaged assemblies in fixed or variable lengths. Bends, interconnections and adapters are available as separate items.

**CIRCLE 306 ON READER SERVICE CARD**

## Reflecting Electric Eye

### SOLID-STATE PHOTOCELL

A REFLECTING electric eye relay with a common housing for light source and photocell has been announced by Photomation Inc., 96 S. Washington Ave., Bergenfield, N. J. The unit is small enough to mount in hitherto inaccessible places in process and automation operations. The model RFU-7 is designed to provide a compact self-contained



# 4-STAGE PROTECTION

GUARANTEES EXCEPTIONAL CAPACITOR PERFORMANCE  
IN EXTREME ENVIRONMENTS

U.S. ARMY PHOTO



Micro-miniature

**CERAMIC  
CAPACITORS**

Meets MIL-C-11015/18 and 19 (USAF)



UNCASED



CASED

- 47–10,000 mmf
- –55°C to 150°C
- 200 vdc rating
- Small case size:  
 .2 x .2 x .1 through 1000 mmf  
 .3 x .3 x .1 through 10,000 mmf
- Also available uncased  
 for complete assembly  
 encapsulation.



.... Rugged pre-molded flame-resistant outer case assures standard wall thickness, guaranteeing environmental immunity and absolute product uniformity. Square modular shape affords highest capacity per usable volume.

..... Epoxy potting solidly anchors, hermetically seals capacitor within case; increases mechanical strength and eliminates humidity leaks around leads.

..... Resilient, moisture-proof plastic sheathing protects unit during assembly and absorbs thermal shock at extremes of temperature cycling.

..... Uniformly exact dielectric margins around electrodes eliminate short circuiting and breakdown across edges under surge voltages through 400% of rating. Single standard 0.2" lead dimension for all values simplifies circuit design.

**Vitramon<sup>®</sup>**

INCORPORATED

Box 544, Bridgeport 1, Conn.

# NEW!

## Most Versatile Rectifiers Known!

# Sarkes Tarzian Modular Silicon Rectifiers

**100 to 600 PIV**      **500 to 1000 MA**

*Compact...Rugged...Low Cost...Easy to Assemble*

Modular Silicon Rectifiers can be used individually—as open bridges—or in a variety of circuit combinations, and are designed for printed circuits on terminal strips. Units are enclosed in epoxy-filled phenolic housing and their .032" diameter copper wire leads are silver-plated.

### S-5536 thru S-5541

Primarily for use as voltage doubler or center tap.

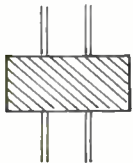

S. T. CODE NUMBER	UNITS USED	INDIVIDUAL DIODE CURRENT RATING	PIV
S-5536	F1	500 MA.	100
S-5537	F2	500 MA.	200
S-5538	F3	500 MA.	300
S-5539	F4	500 MA.	400
S-5540	F5	500 MA.	500
S-5541	F6	500 MA.	600

### S-5544 thru S-5549

For connection into 3 phase half wave, or 2 modules into 3 or 6 phase connection.

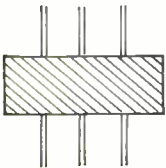

S. T. CODE NUMBER	UNITS USED	INDIVIDUAL DIODE CURRENT RATING	PIV
S-5544	F1	500 MA.	100
S-5545	F2	500 MA.	200
S-5546	F3	500 MA.	300
S-5547	F4	500 MA.	400
S-5548	F5	500 MA.	500
S-5549	F6	500 MA.	600

### S-5462 thru S-5468

For use as open bridge for magnetic amplifiers or connected into bridge. Also as half wave sections—individual, series, or parallel.

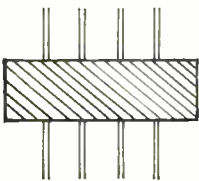

S. T. CODE NUMBER	UNITS USED	INDIVIDUAL DIODE CURRENT RATING	BRIDGE CIRCUIT CURRENT RATING	PIV
S-5462	F1	500 MA.	1000 MA.	100
S-5463	F2	500 MA.	1000 MA.	200
S-5464	F3	500 MA.	1000 MA.	300
S-5465	F4	500 MA.	1000 MA.	400
S-5466	F5	500 MA.	1000 MA.	500
S-5467	F6	500 MA.	1000 MA.	600

For additional information on these three basic styles of modular silicon rectifiers, write Section 5555A. Sarkes Tarzian is a leading producer of semiconductor devices in production quantities, including silicon power rectifiers, silicon tube replacement rectifiers, and selenium rectifiers.



## SARKES TARZIAN, INC.

World's Leading Manufacturers of TV and FM Tuners • Closed Circuit TV Systems • Broadcast Equipment • Air Trimmers • FM Radios • Magnetic Recording Tape • Semiconductor Devices

**SEMICONDUCTOR DIVISION • BLOOMINGTON, INDIANA**  
In Canada: 700 Weston Rd., Toronto 9 • Export: Ad Auriema, Inc., New York

adjustable pick-up for use with various controls such as timers, pulse stretching circuits, counters, etc.

The position of the light source

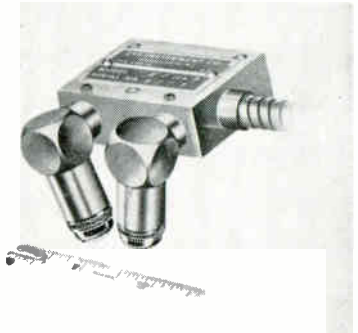

and the photo unit is adjustable as to the angle and reflection of spot distance. The relay amplifier is supplied with two controls, one for adjusting light intensity and the other for photo sensitivity. The amplifier relay in conjunction with the reflector-type pickups may be used for close registration applications.

**CIRCLE 307 ON READER SERVICE CARD**



## Miniature Relay

FOR PRINTED CIRCUITS

MINIATURE spdt relays are 1/2 inch on a side, can be packed 8 per cubic inch—13,824 per cubic foot. Comparable in size with other printed circuit components, the relays can be furnished with long or short leads for printed circuits, or hook terminals for standard wiring. Terminals are arranged in multi-

# ANY SWITCHING COMBINATION FROM SPST to TPDT

## with Centralab Switch Type Variable Resistors

CENTRALAB engineering took the conventional Model 2 composition variable resistor and developed these ingenious switching arrangements not available previously, with ratings up to 6 amps, 125 VAC. For use as single, dual concentric, or twin units, they are especially suitable for high fidelity and stereo, radio, television and phonograph applications. The use of these push-pull, push-push, and slide-switch units reduces the number of front panel controls, simplifies operation, and reduces component handling.

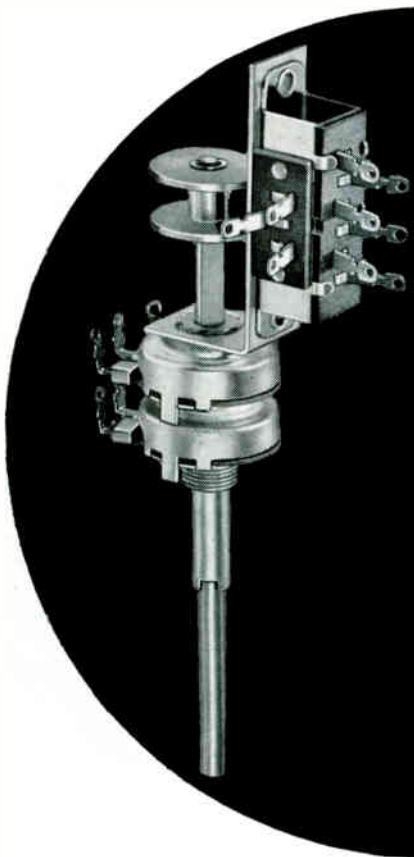

### MODEL 2 VARIABLE RESISTOR SPECIFICATIONS

Rating 1/2 watt; Size 15/16" diam.  
Resistances: 200 ohms to 10 megohms,  
any taper



### SLIDE SWITCH SPECIFICATIONS

Mounting Depth: 2 1/2" from control surface, in any desired radial position for easy assembly of leads

Switch: Positive or spring return styles, 1/2, 1, 3 or 6 amp, SPST to TPDT, 125 VAC

### PUSH-PULL, PUSH-PUSH SPECIFICATIONS

Mounting Depth: push-push; 2 3/2" from control surface  
push-pull; 1 3/16" from control surface

Switch: SPST, 3 amp, 125 VAC

Industrial quantities of push-pull and push-push types available for immediate delivery at factory prices from your near-by CENTRALAB industrial distributor.

# Centralab

B-6040 

The Electronics Division of Globe-Union Inc.  
914K East Keefe Avenue • Milwaukee 1, Wisconsin  
Centralab Canada Limited • Ajax, Ontario

ELECTRONIC SWITCHES • VARIABLE RESISTORS • CERAMIC CAPACITORS • PACKAGED ELECTRONIC CIRCUITS • ENGINEERED CERAMICS

Two tin cans, a lengthy piece of taut string and two kids...many wondrous "bits" of information have been communicated by this process. As a matter of fact, the signals were oftentimes so conditioned that no adult decommutator existed that could decode them. Through experience such as this (plus quite a bit of an exorbitantly more technical nature), Canoga has developed a number of telemetry components...from the ground up (or vice versa, as the case may be). From transmitter, amplifier and airborne antenna to ground telemetry, tracking antenna and receiver...all at 2200 mc... Canoga ties both ends together.

# TELEMETRY/1923

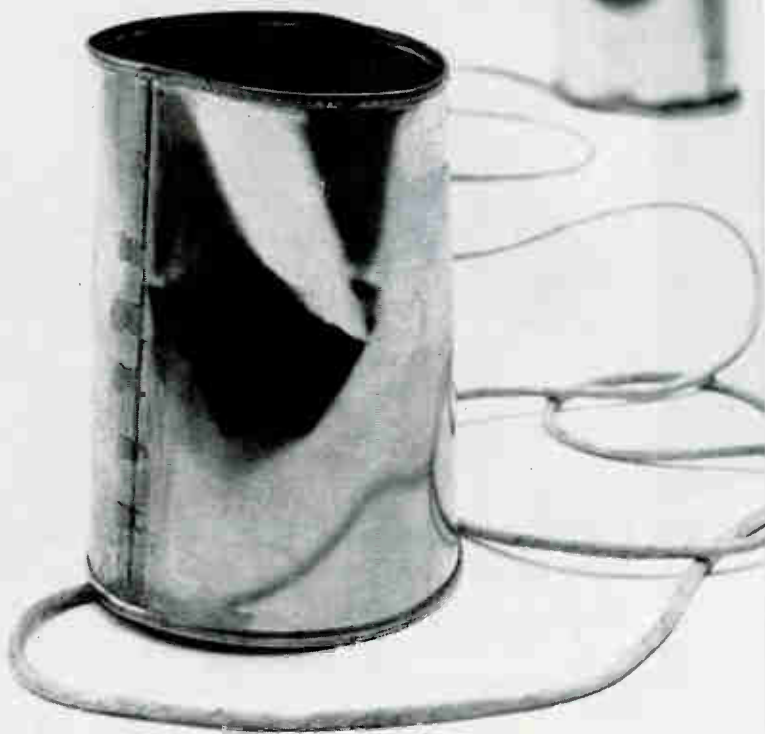

**C A N O G A**

CANOGA/A SUBSIDIARY OF THE UNDERWOOD CORPORATION VAN NUYS, CALIFORNIA FORT WALTON BEACH, FLORIDA

ples of standard 0.1 inch grid board spacing, with one pin off-set for keying purposes. Contacts are rated from dry circuit conditions to 1 amp resistive; temperature range is from -65 C to 125 C; insulation resistance is 1,000 v rms. All military relay specifications are met for components of this size. The units are manufactured by Hi-G. Inc., Bradley Field, Windsor Locks, Conn.

**CIRCLE 308 ON READER SERVICE CARD**

## Pressure Transducer MICROMINIATURE

STATHAM INSTRUMENTS, INC., 12401 W. Olympic Blvd., Los Angeles 64, Calif., announces a new microminiature, flush diaphragm absolute pressure transducer that is drastically reduced in size and weight. Unit is smaller than a dime and was designed for airborne, missile and wind tunnel applications where small size and light weight are critical. The transducer features a flush diaphragm with high frequency response; ranges are 0-10 psia to 0-100 psia; and size is 0.590 in. diameter by 0.050 in. thick.

**CIRCLE 309 ON READER SERVICE CARD**

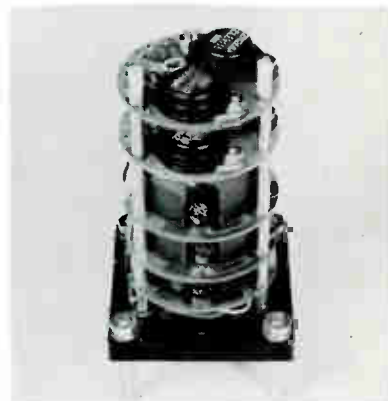

## Semiconductor Relay HIGH SPEED

RIXON ELECTRONICS, INC., 2414 Reddie Drive, Silver Spring, Md. Model SCR-60 high speed semiconductor relay operates at up to 2,500 bits/sec. It is packaged as a direct replacement for the WE-255A. The same basic design also lends itself to repackaging for other high speed nonmechanical switching applications. The relay operates as a spst unit with input coil and output circuit isolation. Output transistors are operated in series or parallel to

# CBS **MADT**\* HIGH-SPEED SWITCHING TRANSISTORS OFFER YOU... MORE

**SPEED**  
**EFFICIENCY**  
**ECONOMY**  
**UNIFORMITY**  
**RELIABILITY**

FROM THESE COMBINED ADVANTAGES... CHECK THEM



### Diffused Base

Low base resistance and collector capacitance minimize delay, rise and fall times. Storage time is radically reduced by built-in field.



### Electrochemical Etching

Storage time is shortened and circuit simplified by optimized collector positioning. Low collector saturation voltage reduces power supply costs, increases efficiency.



### Microalloy Cadmium Junctions

High-injection emitter achieves greater efficiency; more accurate device geometry provides greater uniformity.

### Automated Mass Production

Exceptional reliability is assured by uniform, in-line mass production permitting 100% quality control of each transistor and resulting in minimized costs.



\*Micro Alloy Diffused-base Transistor, trade-mark Philco Corp.

**YOUR LOGICAL CHOICE** ... for high-speed switching is CBS MADT\* transistors. You get more speed, more efficiency, more economy, more uniformity, and more reliability. Order the CBS 2N501 and 2N501A ... ask for engineering data ... today from your local sales office or Manufacturers' Warehousing Distributor.



**semiconductors**

**CBS ELECTRONICS**, Semiconductor Operations, Lowell, Mass. • A Division of Columbia Broadcasting System, Inc.

Sales Offices: Lowell, Mass., 900 Chelmsford St., GLEnview 2-8961 • Newark, N. J., 231 Johnson Ave., TALbot 4-2450 • Melrose Park, Ill., 1990 N. Mannheim Rd., ESTebrook 9-2100 • Los Angeles, Calif., 2120 S. Garfield Ave., RAYmond 3-9081 • Atlanta, Ga., Cary Chapman & Co., 600 Trusco Way, S. W., PLaza 8-4506 • Minneapolis, Minn., The Heimann Co., 1711 Hawthorne Ave., FEderal 2-5457 • Toronto, Ont., Canadian General Electric Co., Ltd., LEnnox 4-6311

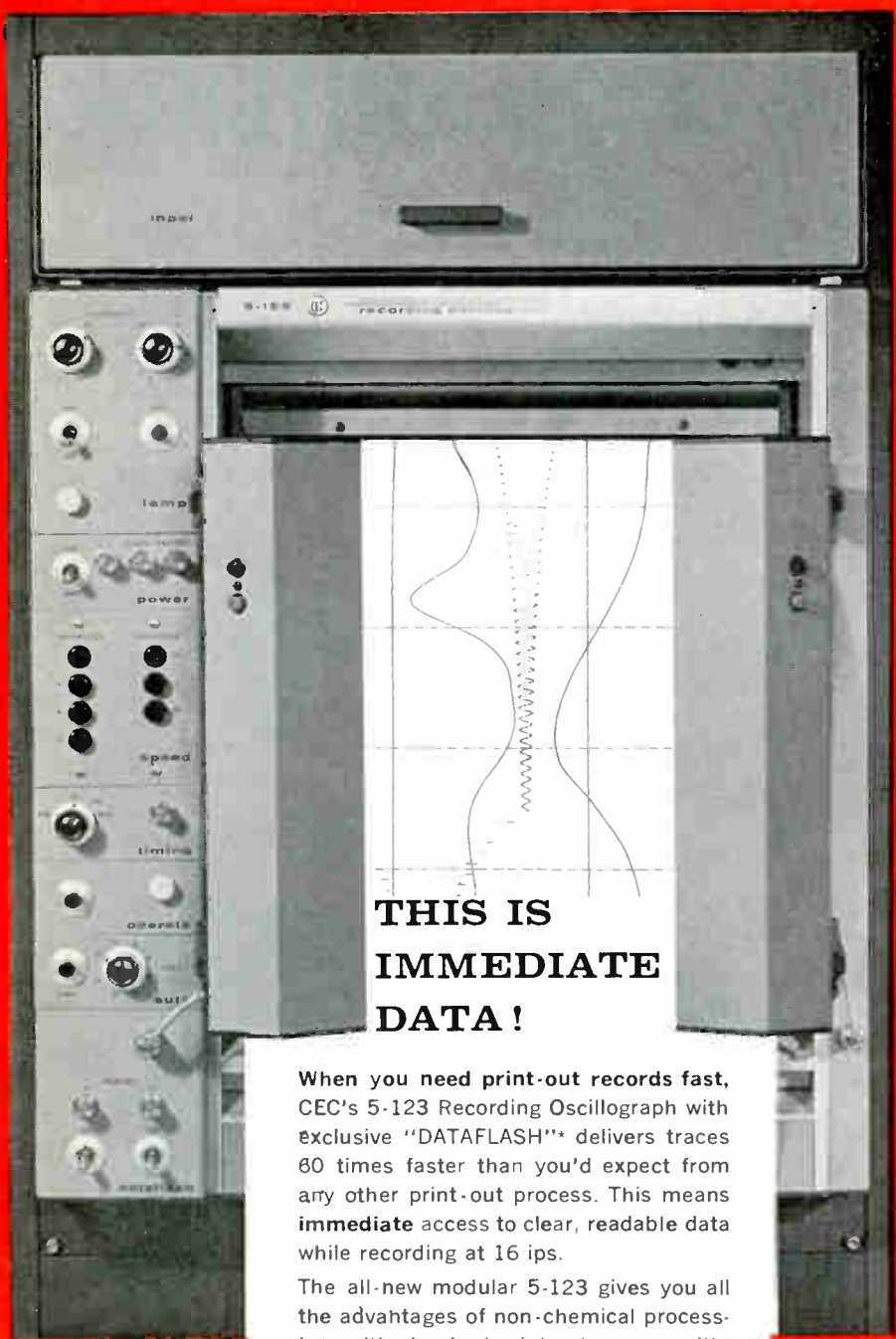

**THIS IS  
IMMEDIATE  
DATA!**

When you need print-out records fast, CEC's 5-123 Recording Oscillograph with exclusive "DATAFLASH"\* delivers traces 80 times faster than you'd expect from any other print-out process. This means **immediate** access to clear, readable data while recording at 16 ips.

The all-new modular 5-123 gives you all the advantages of non-chemical processing—with standard print-out papers—without latensification delay.

**The last word in mounting versatility...** Rack it vertically, lay it horizontally for table-top use, or stand it on a bench. The 5-123 is unmatched for versatility. You'll also like its full front accessibility and pushbutton controls that change speeds instantly from 0.1 to 160 ips while recording 36 to 50 channels of data.

**For complete information, contact your nearest CEC sales and service office, or write for Bulletin CEC 1623-X8.**

\*Patent Pending.

key circuit loads of up to 300 v d-c. Independent isolation of transistor inputs provides a variety of series or parallel connections.

**CIRCLE 310 ON READER SERVICE CARD**

**Close Tolerance Tubing  
VARIED SIZES, COLORS**

CABLE DESIGNS INC., 66 Rushmore St., Westbury, L. I., N. Y., has developed a technique for manufacturing Teflon tubing to close tolerance for high reliability. This new product is 100 percent electrically tested for pin holes and other imperfections. The tubing is available in various sizes and colors. For extra color coding it is also available in spiral stripes. It can be provided in several wall thicknesses and when bonding is required, the tubing can be Tef-O-Bonded.

Also developed by the company are a shielded and Teflon jacketed tubing; a flexible Teflon-glass fiber laminated tubing; and a metal jacketed Teflon tubing.

**CIRCLE 311 ON READER SERVICE CARD**



**Resistance Cards  
FOR MICROWAVE USE**

FILMOHM CORP., 48 W. 25th St., New York 10, N. Y. The Filmcard kit includes 11 metal film resistance cards, 2½ in. by 6 in., and one metalized mica resistance card, 2 in. by 2½ in., plus fabrication instructions and technical notes. Price is \$40. Recommended for microwave applications requiring accurate reproducible dissipation at low r-f power, these cards may be punched, drilled, machined or sanded to suit one's own needs. Meeting MIL-P-18177 specifications, Filmcards are available in a resistance range of from 25 to 750 ohms/square and in standard values of from 50 to 500 ohms. They are guaranteed electrically, uniform and dimensionally stable, and have a standard resistance tolerance of ± 10 percent per

← **CIRCLE 124 ON READER SERVICE CARD**

*Electro Mechanical Instrument Division* **CEC**

**CONSOLIDATED ELECTRODYNAMICS / pasadena, cali-ornia**

A SUBSIDIARY OF **Bell & Howell** • FINER PRODUCTS THROUGH IMAGINATION

## Important facts to know about Laminated Plastics

# LAMINATED PLASTICS *What they are, where they can be used*

Taylor laminated plastics, also known as reinforced plastics, are thermosetting-type materials formed by impregnating paper, cotton cloth, asbestos, glass cloth, nylon or other base materials with synthetic resins and fusing them into sheets, rods, tubes and special shapes under heat and pressure. These materials exhibit a valuable combination of characteristics, including high electrical insulation resistance, structural strength, strength-to-weight ratio, and resistance to chemical reaction; also adaptability to fabricating operations.

### **Types of laminated plastics made by Taylor**

There are four basic types of Taylor laminated plastics commonly specified and used throughout industry today. They are as follows:



**Phenolic Laminates.** Paper, cotton fabric or mat, asbestos, glass cloth or nylon bases impregnated with phenol formaldehyde resins. These provide strength and rigidity, dimensional stability, resistance to heat, chemical resistance, and good dielectric characteristics. Some Taylor grades are excellent basic materials for gears, cams, pinions, bearings and other mechanical applications. Others are widely used in terminal boards, switchgear, circuit breakers, switches, electrical appliances and motors. Also in radios, television equipment and other electronic devices; and in missiles as nose cones, exhaust nozzles, and combustion chamber liners.

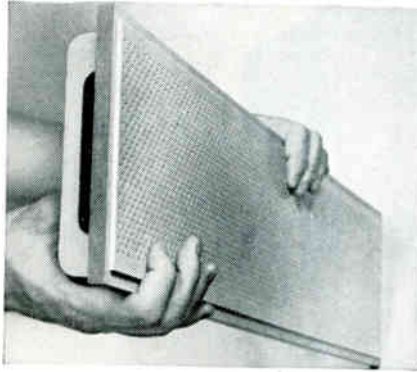

**Melamine Laminates.** Glass cloth or cotton fabric impregnated with melamine formaldehyde resin. Taylor melamine laminates have superior mechanical strength and are especially desirable for their arc-resistant qualities. Good flame and heat resistance, good resistance to the corrosive effects of alkalis and most other common solvents, besides other favorable characteristics. Typical applications include arc barriers, switchboard panels, and circuit-breaker parts in electrical installations.

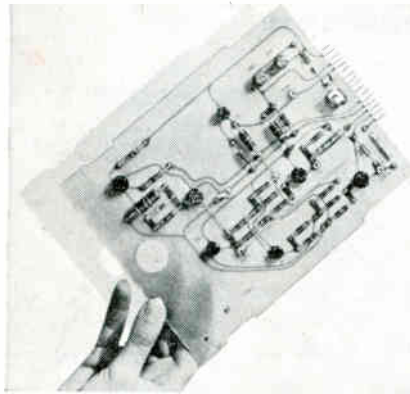

**Silicone Laminates.** Continuous-filament woven glass fabric impregnated with a silicone resin. These laminates combine high heat resistance (up to 500°F. continuous) with excellent electrical and mechanical properties. They are primarily used in high-temperature electrical applications and high-frequency radio equipment.

**Epoxy Laminates.** Continuous-filament woven glass fabric or paper impregnated with epoxy resin. Glass-fabric grades are designed for use in applications requiring high humidity-resistance, good chemical resistance,

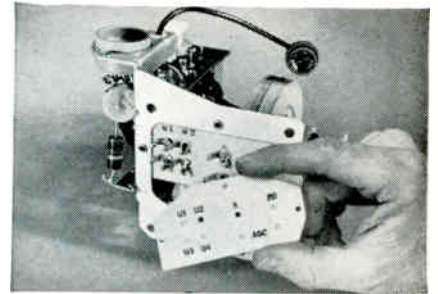

and strength retention at elevated temperatures. Paper grades are used under high-humidity conditions where resistance to acids and alkalis is required. Both grades are characterized by good dielectric strength, low dielectric losses, and high insulation resistance even following severe humidity conditions.

Recent technical advances in the bonding of various metallic and nonmetallic materials to laminated plastics have opened up new design opportunities. It is now possible to bond virtually any compatible material with a laminated plastic to form a composite which combines the advantages of both. One of the first composite materials was a copper-clad laminate used for printed circuits. More recent composite laminates, usually manufactured to customer specification, include the following: Taylorite® vulcanized fibre-clad, rubber-clad, asbestos-clad, aluminum-clad, beryllium-copper-clad, stainless-steel-clad, magnesium-clad, and silver-and gold-clad. Any one of these materials can be sandwiched between sheets of laminates, too, and can be molded to fit specific requirements.

Send for complete information about any or all of these Taylor laminates. And remember Taylor's new selection guide will simplify your problems in choosing the right laminate for your specific application. Taylor Fibre Co., Norristown 40, Pa.

# Taylor

LAMINATED PLASTICS VULCANIZED FIBRE



## Power Transistor Test System

# FLEXIBLE, ACCURATE COMPLETE LAB SYSTEM



MODEL PTT-1

**APPLICATIONS ENGINEERING  
QUALITY CONTROL  
RECEIVING INSPECTION**

For the first time, a complete power transistor test system is available in one "package." It provides complete DC characterization of transistors with output ranges up to 20 amperes and input current ranges from 10 micro-amperes to 2 amperes. The patch panel arrangement is such that any meter or power supply can be connected to the test transistor. Readout of breakdown voltage, emitter floating potential, saturation voltage, leakage current, input voltage and current plus output voltage and current are possible with this system. Individually designed systems for special requirements are also available.



**SOLID STATE RELAYS**—for microsecond switching application extremely resistant to high shock and vibration environments.

**WRITE FOR  
INFORMATION  
ON COMPLETE  
SOLID STATE  
RELAY LINE**

INTER MOUNTAIN INSTRUMENTS BRANCH • ELECTRONICS DIVISION

**CURTISS  WRIGHT**

CORPORATION • P. O. BOX 8324, ALBUQUERQUE, N. M.

**SOLID STATE RELAYS • TRANSISTOR TEST INSTRUMENTS AND  
SYSTEMS • DIGITAL DATA ACQUISITION AND PROCESSING SYSTEMS**

126 CIRCLE 126 ON READER SERVICE CARD

square. While attenuation values up to 70 db are obtainable, the vswr can be held to less than 1.10 over broad bands.

**CIRCLE 316 ON READER SERVICE CARD**

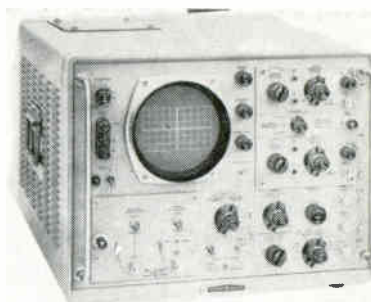

## Oscilloscope HIGHLY VERSATILE

HEWLETT-PACKARD CO., 1501 Page Mill Road, Palo Alto, Calif., Model 160B, a 15 Mc oscilloscope, meets MIL-E-16400B for shock, vibration, humidity and temperature. Its versatility is enhanced by a series of newly-designed time axis plug-in units. These include the model 166C display scanner, model 166D sweep delay generator, and model 162A dual trace amplifier. Model 160B scope provides 24 calibrated sweep times, 0.1  $\mu$ sec/cm to 5 sec/cm, with  $\pm 3$  percent accuracy. A sweep magnifier increases the fastest sweep to 0.02  $\mu$ sec/cm. Horizontal amplifier sensitivity is 0.1 v/cm to 10 v/cm. Bandwidth d-c to 1 Mc.

**CIRCLE 317 ON READER SERVICE CARD**

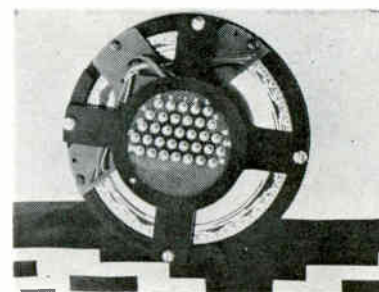

## Encoder MINIMUM SIZE

NORDEN DIVISION, United Aircraft Corp., Wiley St., Milford, Conn., is producing a shaft position encoder which provides 1,024 counts per shaft rotation. With an output in Gray Code and packaged in a standard BuOrd Size 33 synchro mount, the device supplements the manufacturer's existing line of Gray Code encoders which includes a Size



**Metrisite...** is the only device available today that provides a near-perfect combination of

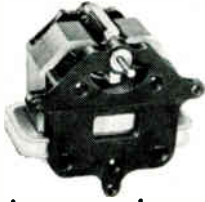

**ideal** transducer characteristics. The unusual properties of this remarkable new motion-sensing development are:

**extreme resolution...**

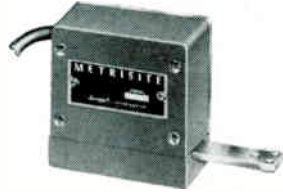

easily measures one

ten-millionth of an inch; **minute operating force...** absolute minimum bearing friction; **negligible reactive force...** a frac-

tion of a milligram; **true linearity...** a proven accuracy of 1/10%;

**high electrical output...** up to 100 volts without amplifica-

tion; **wide range of shapes and sizes...** from sub-miniature

on up; **exceptional ruggedness...** can meet military shock

and vibration tests. Now, many of the obstacles that have plagued control technology can be eliminated. Write for **Metrisite** details.

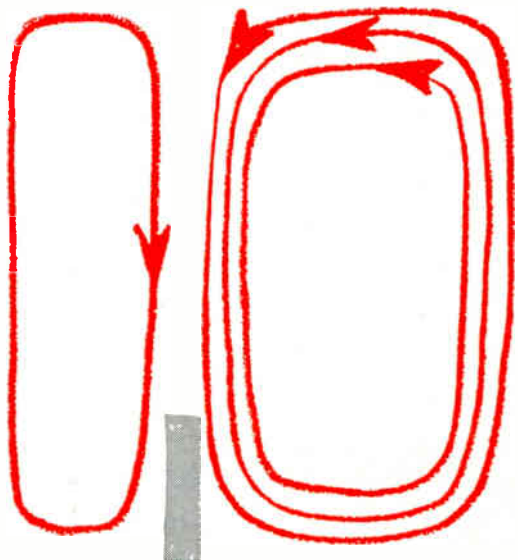

**brush** INSTRUMENTS  
DIVISION OF  
37TH AND PERKINS **CLEVITE** CORPORATION CLEVELAND 14, OHIO

CIRCLE 127 ON READER SERVICE CARD

**SOMETHING REALLY NEW IN PANEL METERS!**



## THIS SLIM-LINE, TRIM-LINE STYLIST

Have a look at the most distinctively different meter design in years. Start with styling (as your customers do): note the thoroughbred leanness, the crisply drawn detail, the overall look of precision. Consider function: see how the picture-window dial is recessed and angled back for easier reading. Ponder practicality: observe that the self-trimming case is installed with just a single panel cutout. Sample the specifications: choose from two sizes—Model 561, 5" x 2 $\frac{7}{8}$ ", and Model 361, 3 $\frac{1}{2}$ " x 2"; both in satin-finish Bakelite; both available in standard microampere, ampere, millivolt and volt ranges, AC or DC. Prices and other data? Ask for Bulletin 107.



**ASSEMBLY PRODUCTS, INC.**

**Chesterland 4, Ohio**

128 CIRCLE 128 ON READER SERVICE CARD

18 providing 256 counts and a Size 23 providing 512 counts per turn. All are one-half the diameter of encoders supplying an equivalent count in binary code. The Gray Code configuration guarantees a nonambiguous output signal without the need for V-Scan or other complicated circuitry at a consequent saving in size and cost. Applications include those where minimum size encoders are of extreme importance and where computer circuitry for code translation is available.

**CIRCLE 318 ON READER SERVICE CARD**

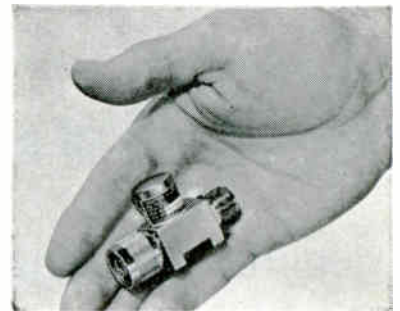

## Coaxial Attenuator

**REMOTE CONTROLLED**

DON-LAN ELECTRONICS INC., 1131 Olympic Blvd., Santa Monica, Calif., has developed a miniature coaxial remote controlled attenuator which operates at a speed of 0.005 sec. The high speed unit produces a "straight-through" coaxial connection (type "N") when voltage is applied. Upon removal of operating voltage, the unit becomes a 20 db bidirectional attenuator, usable from 50 Mc to 3,500 Mc. with excellent r-f characteristics. The unit, weighing only 2.85 oz, is available for 28 v d-c or 115 v a-c 400 cycle a-c operation, and meets MIL-E-5272C environmental requirements.

**CIRCLE 319 ON READER SERVICE CARD**



## Time Code Generator

**SOLID STATE CIRCUITRY**

ELECTRONIC ENGINEERING CO. OF CALIFORNIA, 1601 E. Chestnut Ave., Santa Ana, Calif. The ZA-803 time

electronics

# At Last— High Reliability in Carbon - Film Potentiometers!

Bourns Trimpot® carbon-film potentiometers now offer you twice the stability of any carbon unit heretofore available... at temperatures as high as 150°C. Now, for the first time, you can incorporate high-resistance, infinite-resolution potentiometers in your circuit without sacrificing reliability. The reason: Resiston®, a remarkable new carbon element that virtually eliminates the problems normally caused by extremes of temperature and humidity.

Thanks to this exclusive Bourns development, Trimpot carbon units can operate at temperatures

up to 150°C—with resistance shift only half that of ordinary carbon elements. In addition, they far exceed the requirements of Mil-Specs for humidity and MIL-R-94B.

Trimpot Resiston units are available from factory and distributor stocks with three terminal types... three mounting styles... and standard resistances ranging from 20K to 1 Meg. Resiston elements are available in most Bourns configurations. Write for the new Trimpot summary brochure and list of stocking distributors and representatives.

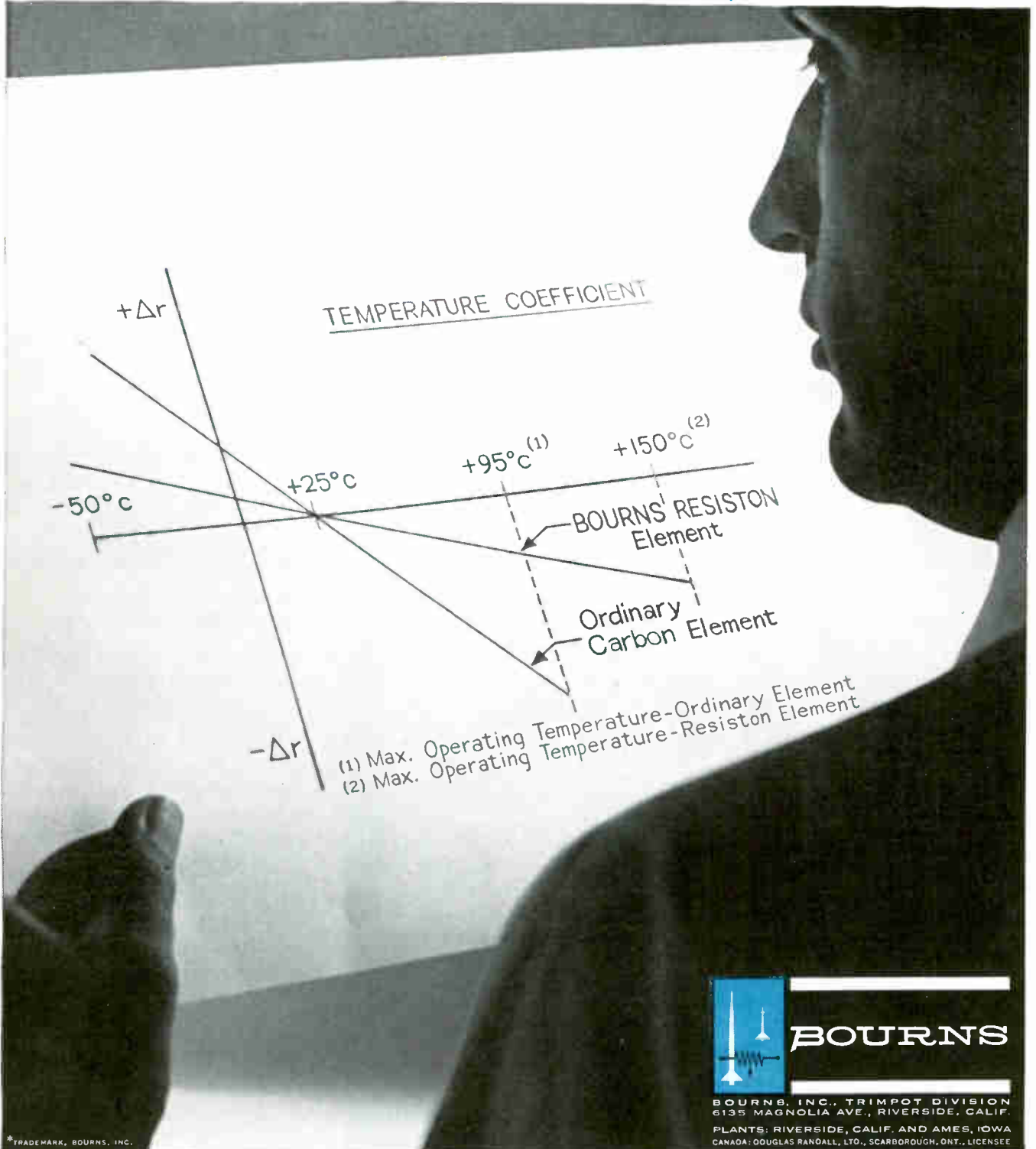

\*TRADEMARK, BOURNS, INC.

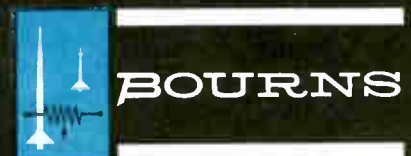

BOURNS, INC., TRIMPOT DIVISION  
6135 MAGNOLIA AVE., RIVERSIDE, CALIF.  
PLANTS: RIVERSIDE, CALIF. AND AMES, IOWA  
CANADA: DOUGLAS RANDALL, LTD., SCARBOROUGH, ONT., LICENSEE

Exclusive manufacturers of Trimpot®, Trimit® and E-Z-Trim®. Pioneers in transducers for position, pressure and acceleration.

# LINDE High-Purity RARE GASES & High-Accuracy MIXTURES

*keep pace with the expanding  
needs of electronic progress*

LINDE special mixtures of monatomic and diatomic gases—with purity as high as 99.9975 per cent—serve as fills in many electronic devices. These include thyratrons, Geiger-Muller, and high-voltage regulator tubes; x-ray fluorescence analyzers, high-voltage insulation, incandescent and special-type lamps and many other uses.

Optimum *purity* is the keystone of all LINDE produced gases—optimum *accuracy* the keystone of LINDE gas mixtures.

Whatever your rare gas mixture requirements, LINDE's huge productive capacity can supply them—and LINDE's widespread distribution system is ready to make fast delivery throughout the country.

For complete data on rare gases or combinations, write for a copy of F-1002C, "Linde High Purity Gases." Address Dept. E102, Linde Company, Division of Union Carbide Corporation, 270 Park Avenue, New York 17, N. Y. *In Canada:* Linde Company, Division of Union Carbide Canada Limited, Toronto 7.

**LINDE  
COMPANY** **UNION  
CARBIDE**

LINDE and UNION CARBIDE are  
registered trade-marks.

code generator supplies a 24-hr, 20-bit time-of-day code. It supplies a BCD time code which is read out once per second at a rate of 25 pps. Frequency stability is 3 parts in  $10^9$  which is equivalent to 1 second per month. Provision is made for the use of an external 1 Mc or 100 Kc frequency standard when greater accuracies are required. The serial BCD code is supplied as both d-c level shift and a modulated 250 cycle carrier. Parallel BCD code is supplied as d-c level shift. A 1 pps positive pulse synchronizing signal is available on the unit for comparison with WWV time signals. Unit is 7 in. high, 19 in. wide, 17 in. deep, and weighs 30 lb. Power requirements are 100 to 130 v a-c, 50 to 400 cps, 65 w. Price is \$7,925.

**CIRCLE 320 ON READER SERVICE CARD**

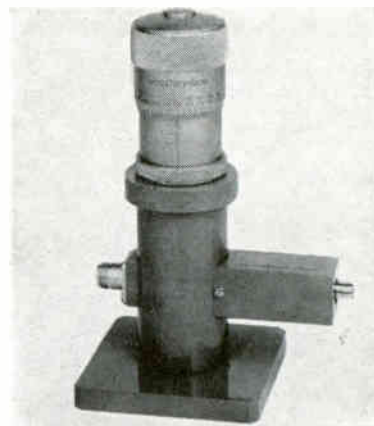

## Coaxial Wavemeters TRANSMISSION TYPE

WAVELINE INC., Caldwell, N. J., has a new line of transmission type coaxial wavemeters covering the frequency range from 2,300 Mc to 8,200 Mc. Units are equipped with oversized 2-in. micrometers directly readable to 0.0001 in. The meters are calibrated every 50 Mc. Standard models are available with female type N input and output connectors or with a direct d-c output through a female type BNC connector. The latter crystal output model numbers are suffixed with CR: these meters are adjusted to give a minimum of  $20 \mu\text{a}$  d-c output with 1 mw input power. Model 950 crystal current indicator is an accessory for use with all wavemeter models. A  $50 \mu\text{a}$  3 in. square meter adds to the ease and precision with which the resonant frequency can be adjusted. Instrument is equipped with a fe-

# Measure transistor characteristics —

Alpha ( $h_{fb}$ )  
Beta ( $h_{fe}$ )  
Input Resistance ( $h_{ib}$ )

— with the new BRC Type 275-A Transistor Test Set



Price: \$935.00 F.O.B. Boonton, N. J.

## Exclusive BRC features —

- Unique null-type measuring circuit completely unaffected by signal level fluctuations
- Reads Alpha to three significant figures
- Accurately measures at extremely low emitter currents

## — plus

- Permanent Calibration
- Direct Readout of Alpha, Beta, and Input Resistance on large easy-to-read dial
- Built-in adjustable, metered collector and emitter power supplies
- Handles up to 5 amperes emitter current
- Measures both NPN and PNP transistors
- Special test circuit guards against transistor burnout

Precision Electronic Instruments since 1934



**BOONTON RADIO CORPORATION**

BOONTON • NEW JERSEY • U.S.A.

The BRC Type 275-A is an exceedingly flexible and efficient instrument for the precise measurement of basic transistor parameters over an extended range of operating conditions. It can also be used to measure the characteristics of diodes and other semi-conductor devices. Direct readout of the following parameters —

- Alpha ( $h_{fb}$ ) • Beta ( $h_{fe}$ )
- Input Resistance ( $h_{ib}$ )

is presented on a large, easy-to-read dial without correction or interpolation. Two built-in, fully regulated, low ripple power supplies furnish completely variable emitter current and collector voltage.

## SPECIFICATIONS

### Alpha Measurement ( $h_{fb}$ ):

RANGE: (a) 0.100 to 0.999 (b) 0.9001 to 0.9999

ACCURACY: (a)  $\pm (0.1 + \frac{0.09}{h_{fb}}) \%$  \* (b)  $\pm 0.2 \%$  \*

\* when  $f_{\alpha} \geq 500$  Kc.

### Beta Measurement ( $h_{fe}$ ):

RANGE: 7 to 200

ACCURACY:  $\pm (0.6 + \frac{30}{h_{fe}}) \%$  \*

\* when  $f_{\alpha} \geq 500$  Kc.

### Input Resistance Measurement ( $h_{ib}$ ):

RANGE: (a) 0.30 to 30 ohms (b) 3.0 to 300 ohms  
(c) 30.0 to 3000 ohms

ACCURACY: (a)  $\pm 3 \%$  \* (b)  $\pm 3 \%$  \* above 30 ohms  
(c)  $\pm 3 \%$  \*

\* for linear impedances

### Collector Voltage Supply:

RANGES: Internal: 0 to 100 V.D.C.

External: 0 to 100 V.D.C.

METERING: Range: 0 to 2, 5, 10, 20, 50, 100 volts

Accuracy:  $\pm 1.5 \%$  full scale

### Emitter Current Supply:

RANGE: Internal: 0 to 100 ma D.C.

External: 0 to 5 amp. D.C. \*

\*  $h_{fb}$  only;  $I_B \geq 100$  ma D.C.

$I_E$  and  $I_C$  metered externally

METERING: Ranges: 0 to 0.1, 0.2, 0.5, 1, 2, 5,  
10, 20, 50, 100 ma.

Accuracy:  $\pm 1.5 \%$  full scale

Where do you go for fast  
electronic parts delivery?

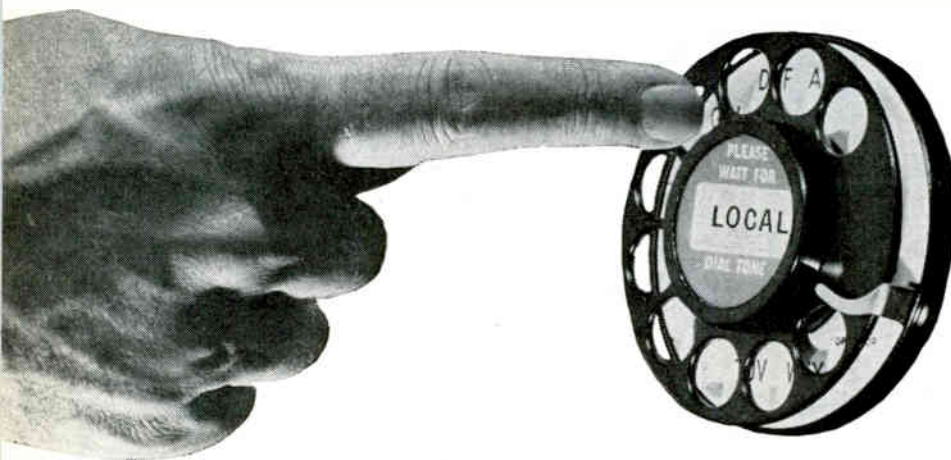

To the telephone! And call your  
local RAYTHEON distributor.



Quality Products at Factory Prices  
Plus Complete Technical Data  
Available from the Raytheon Distributor  
Nearest You . . .



**RAYTHEON COMPANY**

DISTRIBUTOR PRODUCTS DIVISION • WESTWOOD, MASS.

RECEIVING AND INDUSTRIAL TUBES • SEMICONDUCTOR PRODUCTS  
MECHANICAL COMPONENTS • RAYTHEON/MACHLETT POWER TUBES  
VOLTAGE REGULATORS • MICROWAVE TUBES • CAPTIVE HARDWARE

CIRCLE 132 ON READER SERVICE CARD

**Raytheon Distributors**  
**Serving Key Markets Include:**

**Alabama**  
Birmingham  
Forbes Distributing Company  
AL 1-4104  
MG Electrical Equipment Company  
FAirfax 2-0449  
**Mobile**  
Forbes Electronic Distributors, Inc.  
HE 2-7661  
**Arizona**  
Phoenix  
Radio Specialties & Appl. Corp.  
AL 8-6121  
Tucson  
Standard Radio Parts, Inc.  
MA 3-4326  
**California**  
Burbank  
Valley Electronic Supply Co.  
VICTORIA 9-3944  
Glendale  
R. V. Weatherford Co.  
VICTORIA 9-2471  
Hollywood  
Hollywood Radio Supply, Inc.  
HO 4-8321  
Inglewood  
Newark Electronics Company  
ORchard 7-1127  
Los Angeles  
Graybar Electric Company  
ANGelus 3-7282  
Kierulff Electronics, Inc.  
RICHMOND 8-2444  
**Oakland**  
Brill Electronics  
TE 2-6100  
Elmar Electronics  
TEmpair 4-3311  
**Palo Alto**  
Zack Electronics  
DA 6-5432  
**San Diego**  
Radio Parts Company  
BE 9-9361  
**San Francisco**  
Fortune Electronics  
UN 1-2434  
**Santa Monica**  
Santa Monica Radio Parts Corp.  
EXbrook 3-8231  
**Colorado**  
Denver  
Ward Terry Company  
AMherst 6-3181  
**Connecticut**  
East Haven  
J. V. Electronics  
HOBart 9-1310  
**District of Columbia**  
Electronic Industrial Sales, Inc.  
HUDson 3-5200  
Kenyon Electronic Supply Company  
DEcatur 2-5800  
**Florida**  
Miami  
East Coast Radio & Television Co.  
FRanklin 1-4636  
Electronic Equipment Co., Inc.  
NEWton 5-0421  
West Palm Beach  
Goddard Distributors, Inc.  
TEmple 3-5701  
**Illinois**  
Chicago  
Allied Radio Corporation  
HAYmarket 1-6800  
Newark Electronics Corp.  
STATE 2-2944  
**Indiana**  
Indianapolis  
Graham Electronics Supply Inc.  
MElrose 4-8486  
**Maryland**  
Baltimore  
Wholesale Radio Parts Co., Inc.  
MUIberry 5-2134  
**Massachusetts**  
Boston  
Cramer Electronics, Inc.  
COpley 7-4700  
DeMambro Radio Supply Co., Inc.  
AL 4-9000  
Graybar Electric Co.  
HUBbard 2-9320  
Lafayette Radio Corp. of Mass.  
HUBbard 2-7850  
Cambridge  
Electrical Supply Corporation  
UNiversity 4-6300  
**Michigan**  
Ann Arbor  
Wedemeyer Electronic Supply Co.  
NORmandy 2-4457  
**Detroit**  
Ferguson Electronics, Inc.  
UN 1-6700  
**Minnesota**  
Minneapolis  
Electronic Expeditors, Inc.  
FEderal 8-7597

Mississippi—Jackson  
 Ellington Radio, Inc.  
 FL 3-2769

Missouri  
 Kansas City  
 Burstein-Applebee Company  
 Baltimore 1-1155

St. Louis  
 Graybar Electric Company  
 Jefferson 1-4700

New Hampshire—Concord  
 Evans Radio  
 Capital 5-3358

New Jersey  
 Camden  
 General Radio Supply Co.  
 WO 4-8560 (in Phila.: WA 2-7037)

New Mexico  
 Alamogordo  
 Radio Specialties Company, Inc.  
 HEmlock 7-0307

Albuquerque  
 Radio Specialties Company, Inc.  
 AM 8-3901

New York  
 Binghamton  
 Stack Industrial Electronics, Inc.  
 RA 3-6326

Buffalo  
 Genesee Radio & Parts Co., Inc.  
 DElaware 9661

Whele Electronics Inc.  
 TL 4-3270

Elmira  
 Stack Industrial Electronics, Inc.  
 RE 3-6513

Ithaca  
 Stack Industrial Electronics, Inc.  
 IThaca 2-3221

Mineola, Long Island  
 Arrow Electronics, Inc.  
 Pioneer 6-8686

New York City  
 H. L. Dalis, Inc.  
 EMpire 1-1100

Milo Electronics Corporation  
 BEekman 3-2980

Sun Radio & Electronics Co., Inc.  
 ORegon 5-8600

Terminal Electronics, Inc.  
 CHelsea 3-5200

Ohio  
 Cincinnati  
 United Radio Inc.  
 CHerry 1-6530

Cleveland  
 Main Line Cleveland, Inc.  
 EXpress 1-4944

Pioneer Electronic Supply Co.  
 SUperior 1-9411

Columbus  
 Buckeye Electronic Distributors, Inc.  
 CA 8-3265

Dayton  
 Srepco, Inc.  
 BAldwin 4-3871

Oklahoma—Tulsa  
 S & S Radio Supply  
 LU 2-7173

Oregon—Portland  
 Lou Johnson Company, Inc.  
 CApital 2-9551

Pennsylvania  
 Philadelphia  
 Almo Radio Company  
 WAInut 2-5918

Radio Electric Service Co.  
 WAInut 5-5840

Pittsburgh  
 Marks Parts Company  
 FAirfax 1-3700

Reading  
 The George D. Barbey Co., Inc.  
 FR 6-7451

Tennessee  
 Knoxville  
 Bondurant Brothers Company  
 3-9144

Texas  
 Dallas  
 Graybar Electric Company  
 RIVERSIDE 2-6451

Houston  
 Busacker Electronic Equipment Co.  
 JACKSON 6-4661

Harrison Equipment Company  
 CApitol 4-9131

Utah—Salt Lake City  
 Standard Supply Company  
 EL 5-2971

Virginia—Norfolk  
 Priest Electronics  
 MA 7-4534

Washington—Seattle  
 Western Electronic Company  
 AT 4-0200

West Virginia—Bluefield  
 Meyers Electronics, Inc.  
 DAvenport 5-9151

Wisconsin—Milwaukee  
 Electronic Expeditors, Inc.  
 WOODRUFF 4-8820

CIRCLE 203 ON READER SERVICE CARD

male type BNC input connector and a variable sensitivity adjustment.

CIRCLE 321 ON READER SERVICE CARD



### Vswr Monitor MISSILE-BORNE

SIGMA ELECTRONICS RESEARCH CORP., 15735 Ambaum Blvd., Seattle 6, Wash., has introduced a new vswr monitor qualified for missile flight. Model SMT-2 utilizes two calibrated crystals to generate d-c signals proportional to the incident and reflected r-f power. It has 120 w c-w power capacity. Output is 50 mv d-c with 50 w r-f in. Vswr is less than 1:05 to 1:0 and insertion loss is less than 0.2 db. Accuracy is  $\pm 5$  percent, it weighs less than 9 oz and has directivity greater than 25 db. The SMT-2 can be built to operate at any narrow band between 100 and 5,000 Mc up to 1,000 w.

CIRCLE 322 ON READER SERVICE CARD



### D-C Power Supply TRANSISTORIZED

KEPCO INC., 131-38 Sanford Ave.,  
 Flushing 55, N. Y. Model SM-75-8



## LOOKING FOR THE IDEAL TERMINAL SETTER?

STOP. You've found it. A Black & Webster Electropunch or full automatic Electroset can solve your terminal setting problems **\$135<sup>00</sup>** — for as little as



**SHORT RUNS: Electropunch** — sets hand fed terminals twice as fast as conventional methods. All electric. Foot switch operated.

**LONG RUNS: Electroset** — automatically feeds and sets terminals up to 3600 per hour. All electric. Customized to your needs.



**WHAT'S YOUR PROBLEM?**  
 Black & Webster can help.  
 Send sample terminal and requirements.

Write today for free 12-page catalog describing our complete line of production tools.

**BLACK & WEBSTER, INC.**  
 Dept. E, 570 Pleasant St.  
 Watertown, Mass.

CIRCLE 133 ON READER SERVICE CARD 133

# Another "impossible" job done by the Airbrasive®...



...cutting semiconductors

abrading • cutting • deburring • stripping • drilling • cleaning • scribing

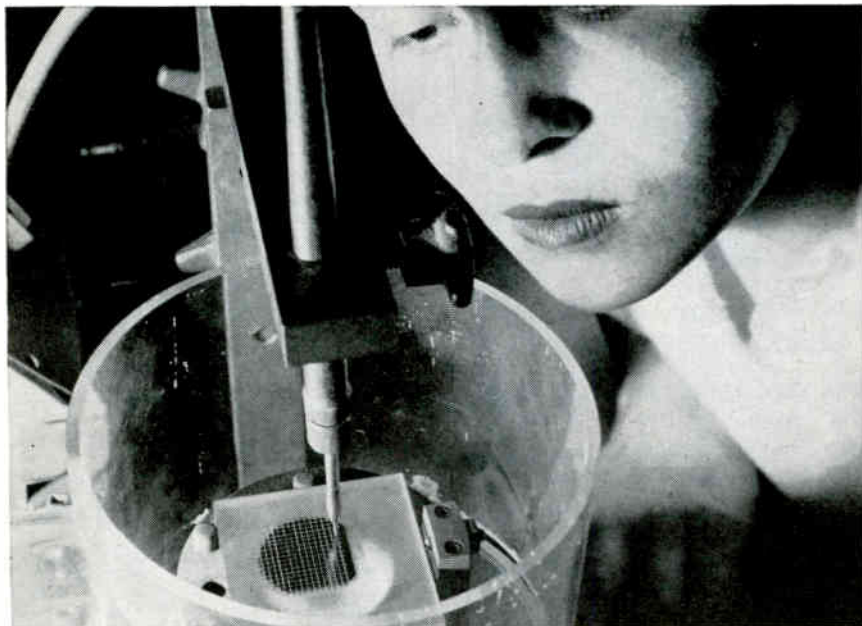

Hughes cuts fancy figures in silicon. Reports "Airbrasive is the only tool capable of handling the process!"

Hughes Aircraft uses the Industrial Airbrasive linked to a pantograph to cut intricate patterns and shapes in semiconductor wafers. And what's more they are doing it accurately and with *complete safety to the fragile part*.

The secret of this unique tool is a superfine jet of abrasive particles and dry gas, directed through a carbide nozzle. The resulting cutting action in hard brittle materials is cool, rapid, precise, and completely shockless.

The Airbrasive is being used to solve hundreds of seemingly impossible jobs... precision deburring... to remove surface deposits... form and adjust microminiaturized circuits... cut glass, germanium, tungsten, ferrites, and others.

Low in cost too. For under \$1,000.00 you can set up your own Airbrasive cutting unit!

Send us samples of your "impossible" jobs and we will test them for you at no cost.



SEND FOR BULLETIN 6006... complete information.

**S. S. White**

S. S. White Industrial Division  
Dept. EU, 10 East 40th Street, New York 16, N. Y.

New dual  
Model D1



1135

voltage regulated power supply delivers 0-75 v d-c, 0-8 amperes. Regulation for line or load is 0.1 percent or 3 mv, whichever is greater; stability—0.1 percent or 6 mv, whichever is greater, for 8 hr; ripple—less than 1 mv rms; temperature coefficient—output voltage variation less than 0.50 percent per deg C; recovery time—50  $\mu$ sec; output impedance—0.01 ohm from d-c to 1 Kc, 0.1 ohm from 1 Kc to 100 Kc; power requirements—105-125 v a-c, 60 cps.

CIRCLE 323 ON READER SERVICE CARD



## UHR Bridge HIGH ACCURACY

MID-EASTERN ELECTRONICS, INC., 32 Commerce St., Springfield, N. J. Selection of computer-grade one-megohm resistors to a tolerance of 0.05 percent is a push-button operation with this UHR (Ultra High Resistance) bridge. Set up as a deviation bridge, the instrument makes it possible for unskilled personnel to sort resistors within blocks of 0.025 percent in a matter of seconds. Such accuracies are required by computer manufacturers for divider networks. The UHR bridge is capable of measurements from 1,000 ohms to 110 million megohms. Inherent accuracy is 0.08 percent at  $10^6$  ohms and 0.2 percent at  $10^{13}$  ohms.

CIRCLE 324 ON READER SERVICE CARD

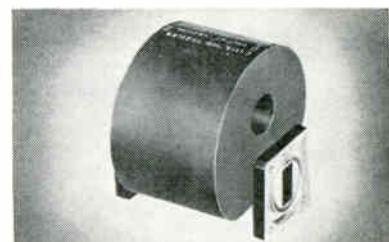

## Ku-Band Isolator VSWR IS 1.06 MAXIMUM

RAYTHEON CO., 130 Second Ave., Waltham 54, Mass., has introduced



# space age research

ATOMIC PARTICLES WITH A LIFE SPAN OF ONE  
TEN-THOUSANDTH OF A MILLIONTH OF A SECOND!

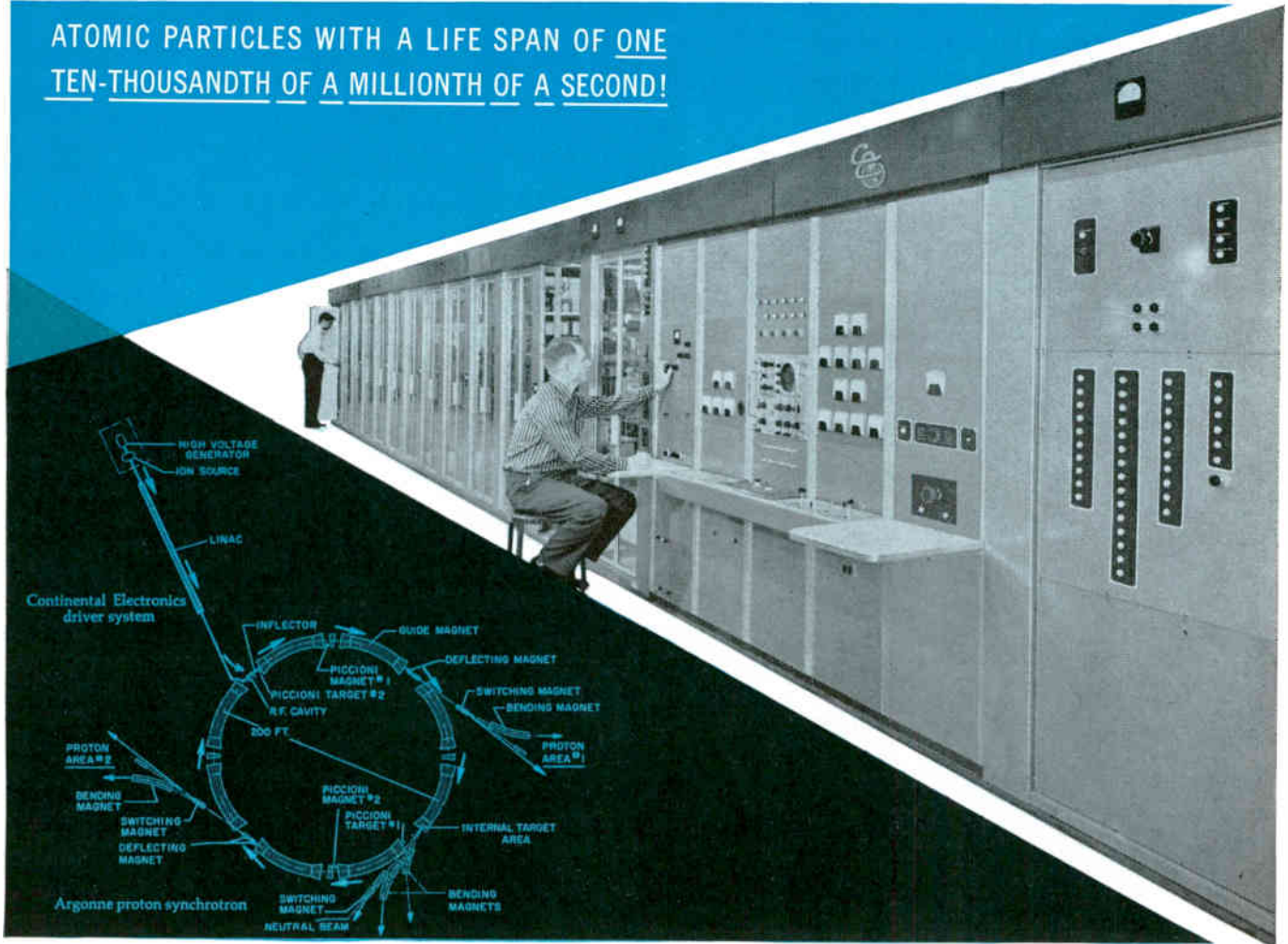

Continental Electronics, specialist in super power electronics equipment, is building the radio frequency driver system for the linear accelerator injector for the proton synchrotron now under construction for the Argonne National Laboratory. This driver system will have a peak power of 5 megawatts, with an average power of 25 kilowatts, operating at a frequency of 200 megacycles with a 500 micro-second pulse.

When completed, the Argonne proton synchrotron will accelerate protons to an energy of 12.5 billion electron volts, enabling scientists conducting atomic research to experiment with known phenomena and discover new phenomena that occur when protons of high energy collide with other protons at rest. This collision

usually results in the production of rare, short-lived particles; some with a life span of one ten-thousandth of a millionth of a second!

To achieve the high energy required to produce these rare atomic phenomena, protons from a conventional ion source are first accelerated to 750,000 electron volts with a conventional high voltage supply. They are then increased to 50 million electron volts by passing through the linear accelerator, reaching final energy of 12.5 billion electron volts in the synchrotron.

Continental Electronics is proud to be a contributor to the Argonne National Laboratory's atomic research program which is dedicated to increasing scientific understanding of atomic energy.

## Continental Electronics

MANUFACTURING COMPANY

4212 SOUTH BUCKNER BLVD. • DALLAS 27, TEXAS • EVERgreen 1-1135

SUBSIDIARY OF LING-TEMCO ELECTRONICS, INC.



DESIGNERS AND BUILDERS OF THE WORLD'S MOST POWERFUL RADIO TRANSMITTERS

October 14, 1960

CIRCLE 135 ON READER SERVICE CARD 135

*when every bit counts...*

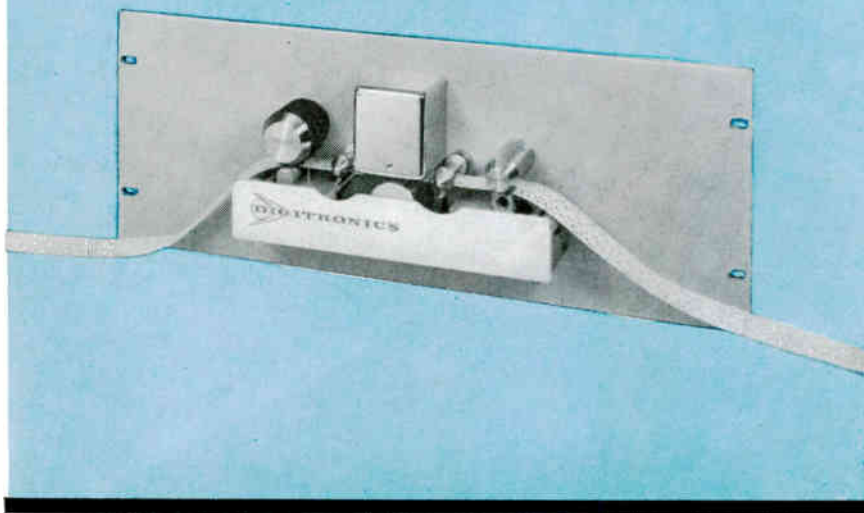

## DYKOR® HIGH SPEED PERFORATED TAPE READER

*This completely transistorized photo-electric unit is the utmost in reading reliability. At 1000 characters per second it stops before the next character...reads any standard tape including 40% transmissive paper, and handles 5 to 8-level tapes interchangeably. Outputs are compatible with either PNP or NPN transistor circuits. The user may select single or dual speeds, 10½" reel models or 8" spooler accessories.*

  
**DIGITRONICS**  
ALBERTSON, NEW YORK • PIONEER 7-5090

INQUIRIES FOR DIGITAL SYSTEMS ARE INVITED

a new Ku-band isolator fully tested for high power handling capabilities of 135 Kw peak and 100 w average. Model 1KuH8, only 2.44 in. long, covers frequencies in the Ku-band region from 16,000 to 17,000 Mc. Insertion loss is 0.3 db maximum with isolation of 13 db minimum and 20 db maximum. Vswr is 1.06 maximum. The new isolator, weighing only 1.4 lb, is equipped with choke type UG-541/U flanges and RG-91/U waveguide. Delivery is 6 to 8 weeks from date of order.

**CIRCLE 325 ON READER SERVICE CARD**

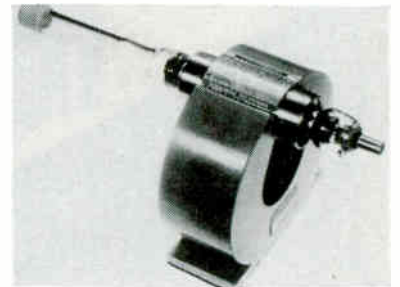

## Ionization Pump ULTRA-HIGH VACUUM

HUGHES AIRCRAFT CO., 2020 Short St., Oceanside, Calif. New line of ion pumps, manufactured in several sizes, contain no moving parts, refrigerants, traps, oils, nor heating elements, and therefore can provide cleaner, drier and more trouble-free vacuum pumping for up to 50,000 hr. One model in the line is a compact, lightweight six-liter pump that is only one-fourth the size of conventional units with the same capacity. It pumps at the rate of six liters a second, can achieve pressures of less than  $10^{-9}$  mm Hg in either metal or glass vacuum systems, and can be used concurrently as a vacuum gage.

**CIRCLE 326 ON READER SERVICE CARD**



## H-V Power Supply HIGH RELIABILITY

JOHN FLUKE MFG. CO., INC., P. O. Box 7161, Seattle 33, Wash. Model

# METALS and ALLOYS

for use in conjunction with  
Semi-Conductor  
Products



## Gold Wire for Mesa Bonding

Gold Wire, 99.99% pure, is available in any size down to .0005". Supplied in various tempers as required . . . Recent developments indicate that an alloy of 2% Platinum—98% Gold may be successfully used for this application. It is somewhat stronger than pure gold.

Since 1901



Write for this New ►  
Brochure; no obligation

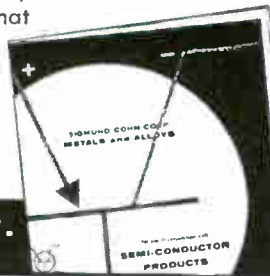

**SIGMUND COHN CORP.**

121 So. Columbus Ave. • Mt. Vernon, N. Y.

CIRCLE 204 ON READER SERVICE CARD

# ZIP

and  
it's  
covered!

## Zippertubing®

Instant Covering for All  
Applications!

Zippertubing, an economical on-the-job method of jacketing, is a flat tape, available in a wide range of materials, that has a patented extruded plastic track electronically welded to both edges. The tape or jacket is wrapped around the object to be covered so that the tracks engage, then "zip" shut. If permanent closure is required, a special sealant is provided that fuses the tracks together.



### GENERAL PURPOSE

Standard without overlap. Generally conforms to MIL-I-631C.



### MILITARY TYPE

with overlap Type 74 meets requirements of MIL-I-7444B. Type 63 meets MIL-I-631-C. QPL certificates of conformance or test reports furnished on request.



### SHIELDED ZIPPERTUBING®

NEW! These conductive metals are laminated to vinyl-impregnated Nylon or glass cloth. When zipped around wires, it provides immediate 100% coverage for grounding RF and UHF interference.

### THERMAZIP

Protects cables or pipes from high temperature exposures. Type ALAS utilizes aluminized asbestos cloth. Type ALSR utilizes silicon rubber-impregnated glass cloth.



### ZT PROTECTORS®

NEW! Protective plastic covers with plastic zipper closure for splices and break-outs. Installation time is measured in minutes — not hours! Full range of sizes and colors.



**SPECIAL CONSULTATION**  
At your request, our Field Engineer will call or you can mail your design concept to us for evaluation and quotation. All requests confidential.

Pat. or Pat. App. For

**THE Zippertubing® CO.**

752 S. SAN PEDRO STREET  
LOS ANGELES 14, CALIFORNIA  
PHONE MA 4-6664

CIRCLE 205 ON READER SERVICE CARD

CIRCLE 137 ON READER SERVICE CARD

137

Reliable products depend on reliable parts

The worldwide success of Japan's transistor radios is a tribute to their highly efficient yet minute components, of which the ultra-small Mitsumi FT Poly-vari-con is typical. With other superb Mitsumi parts, it is being extensively used by leading radio manufacturers.

For Transistor Radio Parts



IFT

Intermediate  
Frequency  
Transformer



POLY-VARI-CON

Variable  
Capacitor



# Mitsumi Parts

**MITSUMI ELECTRIC CO., LTD.**

1056-1, Koadachi, Komae-cho, Kitatama-gun, Tokyo, Japan  
TEL: (416) 2619 2692 2219

October 14, 1960

## PRODUCT APPLICATION

HANSEN  
**SYNCHRON**  
TIMING MOTORS

Hansen  
**SYNCHRON**  
motors,  
the "heart"  
controlling  
the split-second  
timing of  
Schulmerich  
Carillonic  
Bells

Schulmerich  
electro-mechanical  
**CARILLONIC BELL**  
systems . . .

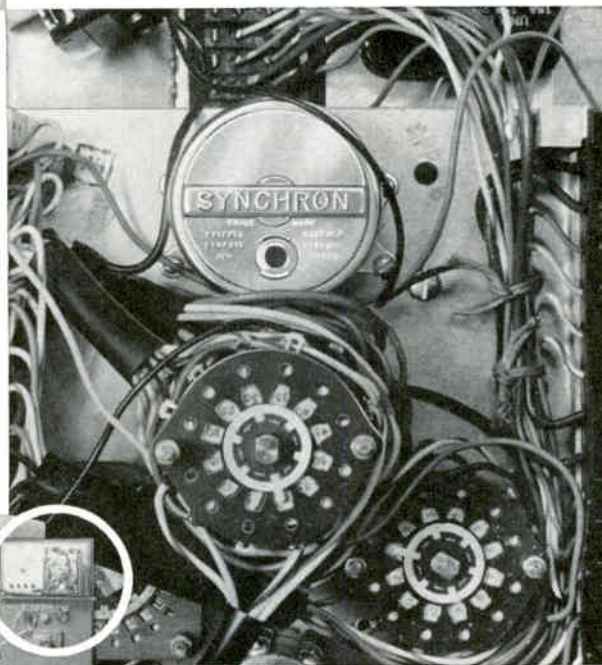

SCHULMERICH CARILLONS, INC., world's largest manufacturer of electro-mechanical carillons, uses Hansen SYNCHRON Timing Motors to drive the program clock governing the all-automatic operation of these precision, perfect-tone instruments. Clock programming is offered at 15-minute intervals, 24 hours a day, 7 days a week. Scheduled to play at specified times, exactly to the minute — there is no allowance for plus or minus variation.

HANSEN SYNCHRON TIMING MOTORS were selected as an integral part of Schulmerich Carillonic Bells because they outperformed all other motors tested. Carefully controlled testing was based on four specifications: (1) instantaneous starting, (2) no time loss or gain, (3) absence of malfunction, and, (4) reliable, continuous operation for periods of a year or more. Depending on installation, motors operate at either 110 or 220 volts — 50 or 60 cycles.

SEND TODAY for informative folder containing specifications and technical data on all Hansen SYNCHRON motors and clock movements.



HANSEN REPRESENTATIVES:  
THE FROMM COMPANY  
5150 W. Madison, Chicago, Illinois  
H. C. JOHNSON AGENCIES, INC.  
Rochester, N. Y. — Buffalo, N. Y. — Syracuse, N. Y.  
Binghamton, N. Y. — Schenectady, N. Y.  
ELECTRIC MOTOR ENGINEERING, INC.  
Los Angeles, Calif. — (WEbster 3-7591)  
Oakland, California  
WINSLOW ELECTRIC CO.  
New York, N.Y. — Essex, Conn. (SOuth 7-8229)  
Philadelphia, Penn. — Cleveland, Ohio

Sweet's Product  
Design File



408A h-v power supply provides direct read-out of output voltage to an accuracy of better than 0.25 percent. Capable of providing 500-6,010 v, it offers 10 mv resolution over the entire output range plus a 0-20 ma current rating. Line or load is better than 0.01 percent and output ripple is less than 5 mv rms. Stability is 0.005 percent per hr or 0.03 percent per day. Designed with many safety features and voltage interlocks, the unit provides either positive or negative output plus a 1.02 v sample for potentiometric monitoring. Generous derating of all components, use of printed circuits, epoxy encapsulated transformer, and silicon rectifiers all contribute to the exceptional reliability of this unit.

CIRCLE 327 ON READER SERVICE CARD



### Isolated Power Supplies MEDIUM VOLTAGE

ELCOR, INC., Falls Church, Va., has available three new low-capacitance isolated power supplies (Isoplys) with output ratings of 300 v at 20 ma, 255 v at 25 ma, and 215 v at 25 ma respectively. Featuring shunt-to-ground distributed capacitance of only 25  $\mu\text{f}$ , these supplies may be inserted anywhere in a circuit in a manner similar to a battery, without requiring the grounding or by-passing to ground of one side of the output circuit. Hum and noise in ungrounded applications is less than 4  $\mu\text{v}$  rms per kilohm impedance to ground. In addition to low capacitance, these power supplies also feature leakage

CIRCLE 139 ON READER SERVICE CARD →



**Come to the  
1960  
Insulation Conference  
on New Methods,  
Materials for  
Equipment Design**

Once a year the National Conference on the Application of Electrical Insulation tells you, and shows you, what is going on in the whole field of electrical insulation. It brings you up to the minute on current and advanced phases of the art . . . spreads out for you a dynamic display not only of products but of techniques, technology and trends which it would be difficult to get in any other way—even if you had the time.

This is what the annual Insulation Conference was organized to do. Many tell us that their attendance and participation in past conferences have led them to decisions that are bringing them more sales, bigger profits, today!

So set down the date and the place. Then mail the coupon below for complete information on the conference schedule, registration, fees, and the technical sessions and displays—also, how to plan for an exhibit if your company is interested.

**third annual  
NATIONAL  
CONFERENCE ON  
THE APPLICATION  
OF ELECTRICAL  
INSULATION**



National Conference on the Application of Electrical Insulation, 155 East 44th Street, New York 17, N. Y.

Please send all information about the 3rd annual National Conference on the Application of Electrical Insulation.

NAME \_\_\_\_\_ TITLE \_\_\_\_\_

COMPANY \_\_\_\_\_

STREET \_\_\_\_\_

CITY \_\_\_\_\_ ZONE \_\_\_\_\_ STATE \_\_\_\_\_

Please include details on becoming an exhibitor.

An invitation to

## DEVICE DEVELOPMENT ENGINEERS

TEXAS INSTRUMENTS  
S-C DIVISION  
offers you

1. A key position with the leader in the field.
2. Real opportunity for personal, professional advancement.
3. Relaxed living in modern Dallas, Texas.

At Texas Instruments, solid state device development engineers will find the opportunity to pioneer in the application of unique phenomena in semiconductor materials to create specialized components. Studies involve high-speed, high-frequency germanium mesa transistors; tunnel diodes; computer devices; silicon transistors.

*Requirements:* degree in Electrical Engineering, Physical Chemistry of Physics and experience in semiconductor or related development areas.

TEXAS INSTRUMENTS INCORPORATED  
Semiconductor-Components Division  
Box 312, Dept. 142, Dallas, Texas



For more information on opportunities for Device Development Engineers with TI in Texas, please return coupon together with brief statement of your qualifications.

NAME \_\_\_\_\_  
ADDRESS \_\_\_\_\_  
CITY \_\_\_\_\_  
STATE \_\_\_\_\_

resistance in excess of 100 kilomegohms and breakdown voltage in excess of 3,000 v.

CIRCLE 328 ON READER SERVICE CARD

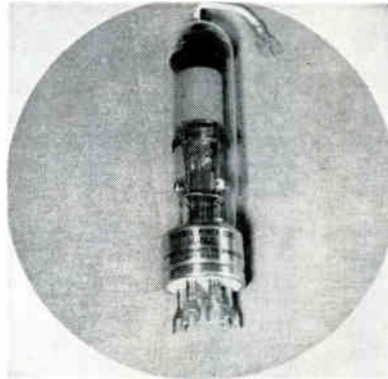

Half-Wave Rectifier  
HIGH CURRENT

NATIONAL ELECTRONICS, INC., Geneva, Ill. The NL-664L, a 10 ampere, 1,000 peak inverse voltage rectifier, was especially designed for those control applications requiring a high current half-wave rectifier. It incorporates the company designed lug base as a standard feature. It is also available with the bracket base and flying leads for panel mounting under the type designation NL-664P. Other ratings are: filament volts, 2.5; filament current, 25 amperes; peak anode current, 120 amperes and condensed mercury temperature limits of -40 to +100 C.

CIRCLE 329 ON READER SERVICE CARD

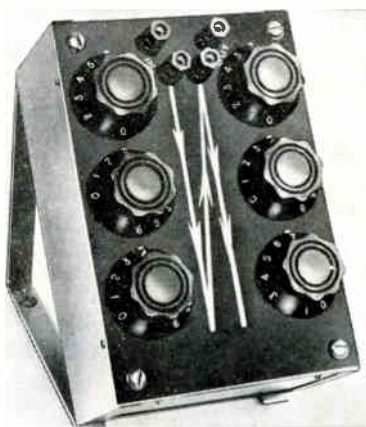

Voltage Dividers  
SMALL SIZE UNITS

CONSOLIDATED RESISTANCE CO. OF AMERICA, INC., 44 Prospect St., Yonkers, N. Y. The VDR series Kelvin Varley dividers are available in three grades of accuracy featur-

## TIME-SAVING GUIDE FOR... SPECIFYING DEFLECTION YOKES



Helps speed your project. Eliminates confusion in choosing the right yoke.

Engineers have saved countless hours, many dollars and numerous headaches by using this simple Guide Sheet For Specifying Deflection Yokes.

Offered as a public service to engineers by SYNTRONIC INSTRUMENTS, INC., YOKE SPECIALISTS, the only firm devoted primarily to deflection yoke manufacture; therefore preeminently qualified to help you specify the correct yoke for your application. Complete line for every military and special purpose—in production quantities or custom designed to your specific requirement.

Phone our nearest rep. today for your Time-Saving Guide Sheet.

New York Area: Jules J. Bressler Co.  
Phone: N.Y. Oxford 5-0255;  
N.J. UNION 4-9577

Philadelphia Area: Massey Associates  
Phone: MOhawk 4-4200

Washington-Baltimore Area:  
Massey Associates  
Phone: GRANite 4-2071

Indianapolis: Joe Murphy  
Phone: VICTor 6-0359

Los Angeles: Ash M. Wood Co.  
Phone: CUmberland 3-1201

No obligation. We are glad to help you.

*syntronic*  
INSTRUMENTS, INC.  
100 Industrial Road, Addison, Illinois  
Phone: KLingswood 3-6444

CIRCLE 206 ON READER SERVICE CARD  
electronics

# An Invitation to Come Alive

Not to suggest that you're dead if you aren't on the TI team!



## TI PEOPLE-- they pioneer, invent, succeed

"It's a fact that an individual's opportunities at TI S-C are limited only by his own ability. That — and the highly interesting work and good people — makes this company unique in my opinion." — Harry Goff (BS/EE, Texas '51), Manager of Silicon Power Transistor Department (upper right).

"I've enjoyed my 10 years with TI because of the constant challenge, growth opportunities, association with creative people who don't depend on handbooks for answers." — Art Evans (BS/EE, SMU '49) Section Head, Semiconductor Networks Department, holder of patent for Temperature Control System for S/C Crystal Puller (upper left).

"The most appealing thing about working at TI S-C is the freedom I have on technical programs. To an engineer this is all-important." — Elmer Wolff (BS/EE, SMU '52) Project Manager, Silicon Design Engineering, participant in development of the first silicon mesa transistor (lower photo).

➔ We are suggesting, though, that you consider some of the factors that make Semiconductor-Components division of TI an unusually lively atmosphere for achieving a keen sense of personal, professional accomplishment. Consider, for example . . .

## TI PRODUCTS

*... they pace the industry*

TI manufactured the first commercially-available silicon transistors . . . developed the first semiconductor network . . . originated high voltage silicon rectifiers . . . produced the first VHF transistors . . . made the first high-gain low-cost radio frequency transistor (making possible the first "pocket" radio) . . . developed the first 400 milliampere 200-600 volt diffused silicon glass diodes.

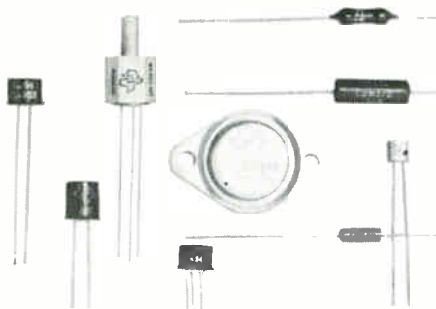

## TI LOCATION-IT ENCOURAGES RELAXED LIVING

Dallas provides many advantages for wholesome family living. It's an outdoor, informal way of life . . . combined with the convenience and stimulation of one of America's most modern cities.



## TI MANAGEMENT -- It Stresses Research, Creates Markets

"Texas Instruments leads the industry in sales, and in technology it's considered second only to Bell. In 1959, it scored net sales of \$193-million, about half attributable to its broad line of semiconductors which includes silicon and germanium transistors of all types, silicon diodes and rectifiers, and silicon controlled rectifiers . . . Most of this growing has been

done on self-generated capital, thanks to the Semiconductor-Components division, undoubtedly TI's most profitable operation. The company has won its eminence by astute assessment of new products and canny timing. Its broad technological skills have made it first with many semiconductor devices." — *Business Week*, March 26, 1960.



Scientists and engineers in semiconductor and related fields are invited to investigate TI's opportunities for professional advancement and personal accomplishment. The coupon below will bring you our booklet detailing the TI and Dallas stories.

TEXAS INSTRUMENTS INCORPORATED  
Semiconductor-Components Division  
Box 312, Dept. 141, Dallas, Texas

NAME \_\_\_\_\_  
ADDRESS \_\_\_\_\_  
CITY \_\_\_\_\_ STATE \_\_\_\_\_

My professional field is \_\_\_\_\_  
My specialty is \_\_\_\_\_



*magnetic  
controls  
company*

*has made*

**6147  
GYRO  
TEMPERATURE  
CONTROLS**

*for these  
missiles*

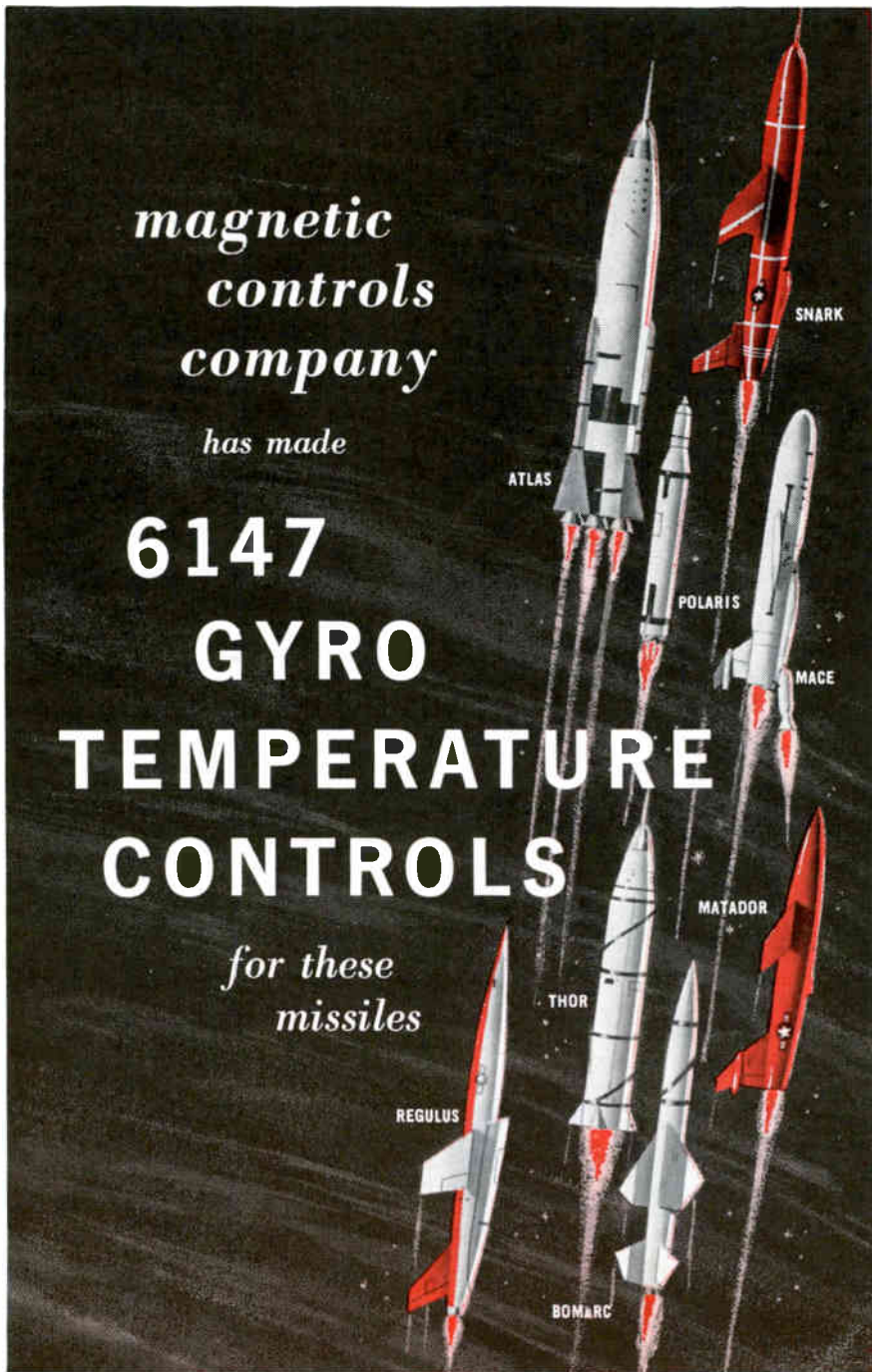

Missile manufacturers demand light, accurate, reliable gyro temperature controls—delivered on time. Magnetic Controls Company pioneered this field in 1952. Since then we have reduced the weight and size of these controls by 90% while *increasing* accuracy and reliability. This is why so many missile makers rely on Magnetic Controls Company. For experienced advice and detailed facts on specific applications, phone or write:

**MAGNETIC CONTROLS COMPANY**

6411 CAMBRIDGE STREET • MINNEAPOLIS 26, MINN. • WE. 9-4691

Heat Control Systems • Static Inverters • Voltage Monitoring Systems

142 CIRCLE 142 ON READER SERVICE CARD

ing from 5 to 7 switch controlled decades of  $\pm 2$  ppm maximum absolute linearity and 0.1 ppm maximum resolution in resistance values from 100 ohms to 10 megohms. The divider weighs approximately 5 lb, measures 9 in. long by 6 in. wide by 4 in. high, and is suitable for table, panel or rack mounting. Design modifications to customer's specifications are possible. Price is \$200 through \$700 each, depending on accuracy, resistance and quantity.

CIRCLE 330 ON READER SERVICE CARD

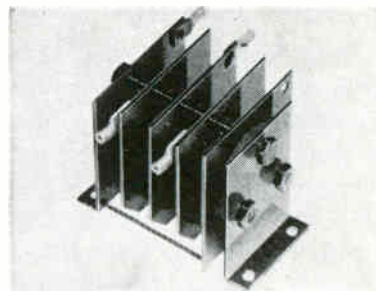

**Silicon Rectifiers  
DOUBLE DIFFUSED**

TRANS-SIL CORP., 55 Honeck St., Englewood, N. J., announces a series of double diffused silicon power rectifiers that will deliver up to 6 amperes in half wave and 30 amperes in full wave circuits. These amplifiers are suitable for magnetic amplifier and power supply applications and can be used at ambient temperatures to 250 C with no detectable change in characteristics due to aging. They are available in bridge and center tap assemblies and are completely assembled for wiring directly into the circuit. Delivery time is 10 days or less.

CIRCLE 331 ON READER SERVICE CARD



**Nanovoltmeter  
HIGHLY SENSITIVE**

KEITHLEY INSTRUMENTS, 12415 Euclid Ave., Cleveland 6, Ohio, has announced the model 149 nanovoltmeter. Ranges cover from 0.1  $\mu$ V

CIRCLE 143 ON READER SERVICE CARD →



YOU CAN SPECIFY savings in weight, improvements in performance, increases in reliability for your electronic systems from this box. This is Sperry's Speci-File—a complete electronic and physical biography of the traveling wave and klystron tubes offered by Sperry Gainesville. To speed your specifying, to make it more accurate and to secure the benefits of outstanding microwave tube performance for your systems, order your free Sperry Speci-File today. Just fill in and mail the attached coupon.



Gainesville, Florida A Division of Sperry Rand Corporation

Section C-101  
Sperry Electronic Tube Division  
Gainesville, Florida

**Please send me a FREE Sperry  
Speci-File:**

NAME \_\_\_\_\_

TITLE \_\_\_\_\_

COMPANY \_\_\_\_\_

ADDRESS \_\_\_\_\_

CITY \_\_\_\_\_

STATE \_\_\_\_\_

**SPERRY SPECI-FILE**

**EXPERIMENTAL**

**10 WATTS NOM**

**C BAND**

**STC 236 TRAVELING WAVE TUBE**

A versatile parametric resonant circuit construction...  
...with a variable attenuator for impedance match...  
...and for higher...

**PERFORMANCE DATA**

Frequency range: 10.0 to 10.5 GHz

Power output: 10 W (nominal)

Gain: 10 dB

Efficiency: 10%

Bandwidth: 100 MHz

Operating temperature: -55 to +125°C

Physical dimensions: 1.5" x 1.5" x 1.5"

Weight: 10 grams

Lead time: 4 weeks

Availability: Limited

Ordering information: STC 236

Part number: STC 236

Manufacturer's part number: STC 236

Sperry part number: STC 236

Sperry part number: STC 236

Sperry part number: STC 236

Sperry part number: STC 236

Sperry part number: STC 236

Sperry part number: STC 236

Sperry part number: STC 236

Sperry part number: STC 236

Sperry part number: STC 236

Sperry part number: STC 236

Sperry part number: STC 236

Sperry part number: STC 236

Sperry part number: STC 236

Sperry part number: STC 236

Sperry part number: STC 236

Sperry part number: STC 236

Sperry part number: STC 236

Sperry part number: STC 236

Sperry part number: STC 236

Sperry part number: STC 236

Sperry part number: STC 236

Sperry part number: STC 236

Sperry part number: STC 236

Sperry part number: STC 236

Sperry part number: STC 236

Sperry part number: STC 236

Sperry part number: STC 236

Sperry part number: STC 236



**X BAND**

8.2 to 12.4 GHz

**J BAND**

10.4 to 18 GHz

**P BAND**

18.8 to 26.5 GHz

**ELECTRONIC  
TUBE  
DIVISION**

**SPERRY**

**80 WATT PEAK**

**Ku BAND**

**STC 231 OSCILLATOR KLYSTRON**

A versatile parametric resonant circuit construction...  
...with a variable attenuator for impedance match...  
...and for higher...

**PERFORMANCE DATA**

Frequency range: 10.0 to 10.5 GHz

Power output: 10 W (nominal)

Gain: 10 dB

Efficiency: 10%

Bandwidth: 100 MHz

Operating temperature: -55 to +125°C



**SPERRY**

**ELECTRONIC  
TUBE  
DIVISION**

*Sperry Quality  
Performance*



## Heart of the Control System

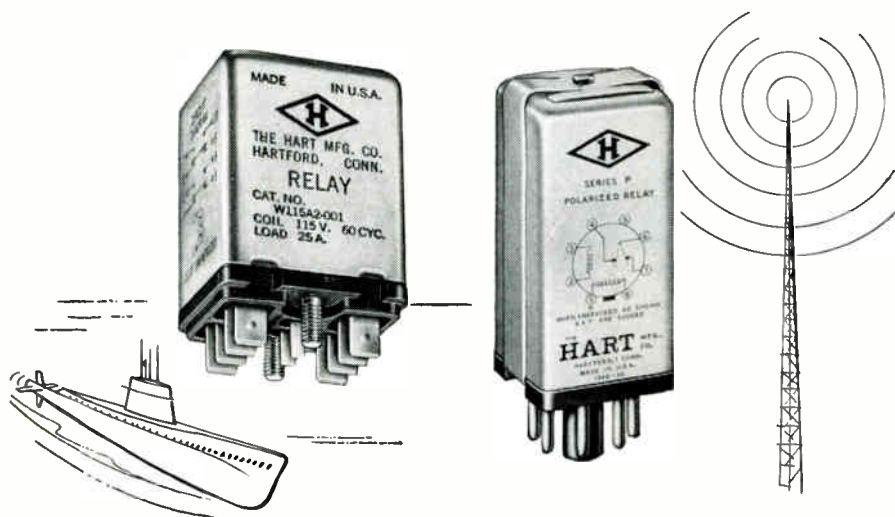

## "DIAMOND H" Relays

Look into the heart of the control system for a missile, a computer, a nuclear submarine, or a great many other critical applications. You might be surprised how often you'll find "Diamond H" relays.

Unless, of course, you're one of the increasing number of engineers who've already selected "Diamond H" relays for a spot where they just have to work despite all sorts of adverse conditions.

Hart makes relays of three basic types: miniature, hermetically sealed, aircraft-missile relays (Series R/S); high speed, sensitive, polarized relays (Series P), and general purpose AC, DC relays (Series W).

Technical literature outlining the wide range of characteristics available with each type relay is yours for the asking. You'll find "Diamond H" engineers uncommonly adept at working out a variation of the basic designs to meet your set of specific requirements.

Tell us your needs . . . by phone, wire or letter.

**THE HART MANUFACTURING COMPANY**

202 Bartholomew Ave., Hartford 1, Conn.

to 100  $\mu\text{v}$  full scale in 1X and 3X steps. Amplifier gain, correspondingly, varies from 10<sup>7</sup> on most sensitive range to 100 on least sensitive range. Stability, at relatively constant ambient temperatures and after a one-hour warm-up, is within 0.01  $\mu\text{v}$  per hr, 0.03  $\mu\text{v}$  per 8 hr, and within 1  $\mu\text{v}$  over the life of the instrument. Speed of response to 90 percent of full scale is less than 0.5 sec on most ranges. Other features include zero suppression up to 100 times full scale with a maximum of 10 mv; floating or grounded operation; a 10 v, 5 ma output for a full scale deflection on any range.

CIRCLE 332 ON READER SERVICE CARD

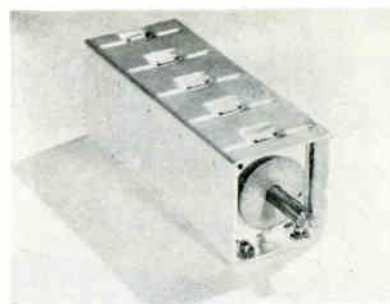

## Inductance Tuners COMPACT DEVICES

P. R. MALLORY & CO. INC., Indianapolis 6, Ind. The series 300 Inductuners are available in one to seven ganged sections approximately 1.5 in. square and 1 in. in length per section. They are intended for vhf applications covering a range of 20 to 300 Mc, for use in military and commercial communication systems. They offer up to 4-1 frequency-vs-rotation ratios, high gain and high Q. Low rotational torque is achieved with either ball bearings or porous brass bearings, to make them adaptable for servo tuning use. Linearity of  $\pm 150$  Kc is available in specific applications.

CIRCLE 333 ON READER SERVICE CARD



## Header and Base HERMETIC SEAL

WALLACE E. CONNOLLY & CO., P. O. Box 295, Menlo Park, Calif. The

# CHRISTIE

Specialists in Power Supplies for 30 Years

# D-C POWER



WITH ENGINEERED AND CONTROLLED

## RELIABILITY

- Static-Tubeless
- All Silicon
- Built to MIL-E-4970
- Overload and Short Circuit Protection
- 500% Overload Capability

Write for new D-C Power Supply Bulletin AC-60

**CHRISTIE ELECTRIC CORP.**

3400 W. 67th Street, Los Angeles 43, California

### 300 AMP. POWER SUPPLY

Model MH32-300KP4

#### Electrical Specifications:

NOMINAL D-C OUTPUT:

28 v. @ 300 amp. (continuous)

VOLTAGE ADJUSTMENT RANGE:

22 to 32 v. d-c

VOLTAGE REGULATION:

±0.5% — combination of rated load and a-c input variations (Sensing: local or remote)

VOLTAGE RIPPLE:

1% rms. (-20°C to +55°C)

VOLTAGE RECOVERY (63%):

0.1 sec. — full load application or removal

D-C CURRENT OVERLOAD

CAPACITY:

125% for 5 min. every 20 min.

250% for 5 sec. every 20 sec.

350% for 1 sec., 500% peak

A-C INPUT:

400-490 v., 3-ph., 57-63 cps.

(other voltages available)

A-C CURRENT AT 440 V.:

25 amp.

AMBIENT TEMPERATURE RANGE:

Operating: -55°C to +55°C

Storage: -62°C to +70°C

ENVIRONMENT, SHOCK,

VIBRATION:

Built to MIL-E-4970

RADIO INTERFERENCE:

Built to MIL-I-26600

#### Mechanical Specifications:

CABINET STYLE: STATIONARY

Also other styles below

SIZE & WEIGHT:

19" W x 19" D x 31" H. — 355 lbs.

#### Standard Features:

VOLTMETER & AMMETER:

3½" ruggedized (MIL-M-10304)

Recessed behind removable panel

OVERLOAD PROTECTION:

Magnetic & thermal

PARALLEL OPERATION:

Includes load sharing provision

OTHER FEATURES:

Input Contactor, Pilot Light, Fan,

Fan Failure Protection.

Over 200 Models in  
6 Cabinet Styles



Stationary



19" Rack



2-Wheel



Caster



Lab Cabinet



3-Wheel

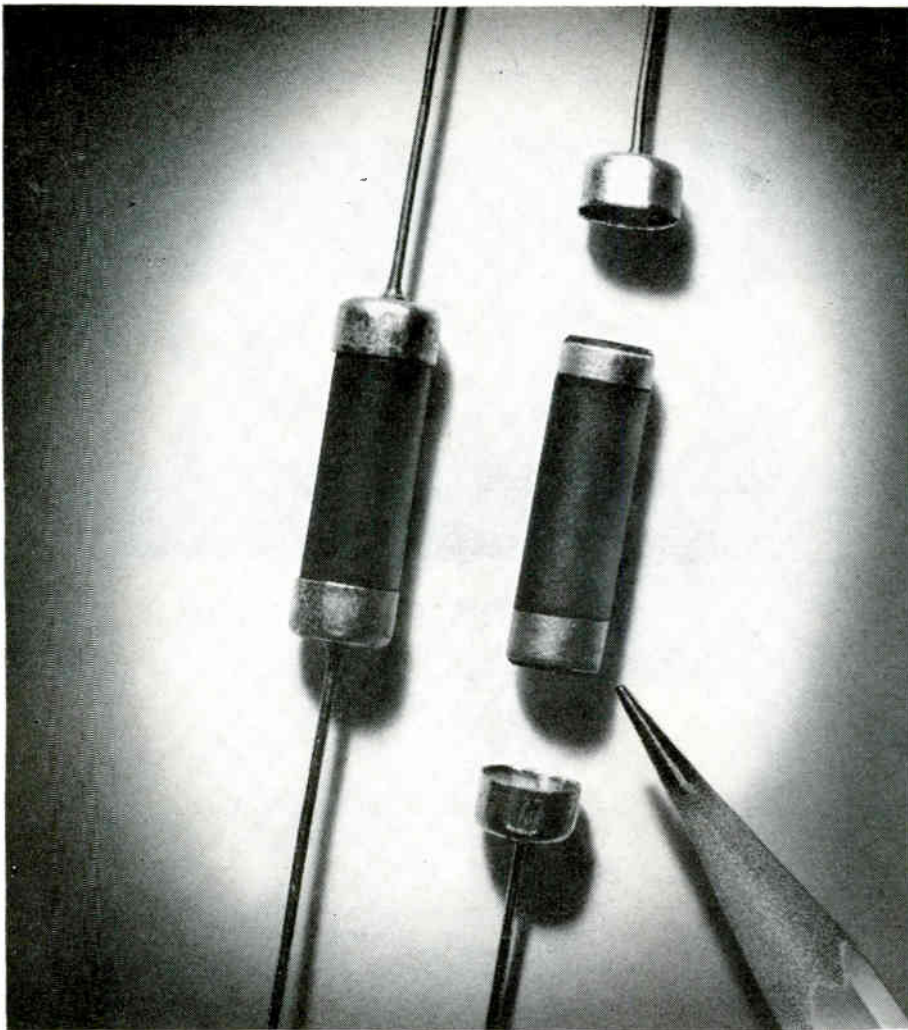

Wire leads are cemented to resistor by Du Pont thermosetting silver composition.

## Du Pont CONDUCTIVE CEMENTS are easy to apply... eliminate soldering

Du Pont offers high-quality thermo-setting gold and silver cements, especially formulated for application on silicon, germanium, carbon and other bases. These Du Pont conductive cements are easily applied by dip, brush or squeegee . . . eliminate soldering:

- Thermosetting gold compositions #5780 and #7728 are suitable for dip, brush or squeegee application.
- Thermosetting silver composition #5504A is suitable for application by squeegee—composition #5815 for application by dip or brush.

After proper curing and drying, these compositions exhibit good adherence, electrical conductivity and abrasion resistance.

Du Pont conductive cements find wide application for lead attachments in diodes, transistors, resistors and similar components. Gold cements are particularly suitable for applications where

resistance to strong etching acids is required.

**Silver Preparations:** Du Pont also offers a full line of silver preparations—conductive coatings used in the electronic industry. Du Pont silver preparations are solderable . . . easy to handle . . . have excellent electrical properties.

For more detailed information, write for bulletins on high-quality Du Pont Conductive Cements or silver preparations. Mention the application you have in mind so that appropriate literature can be supplied. Du Pont, Electrochemicals Department, Ceramic Products Division, Wilmington 98, Del.



REG. U.S. PAT. OFF.

Better Things for Better Living . . . through Chemistry

Sentriseal hermetic seal metal to glass header and base cover are now available in type HC-6/U crystal holder to MIL-C-3098. Designed to overcome the common problems of undetected cracked seals they are constructed with a small disk of Kovar type metal attached to the pins at the outer surface of the glass. The glass bead is sealed to both disk and pin. Pins can be broken and bent without failure of seal. Seal strength will exceed the 25 lb push-pull test required in specification. It is impossible to damage the seal by bending the pin. Headers and bases are available in production quantities. Samples for evaluation will be forwarded at no charge.

**CIRCLE 334 ON READER SERVICE CARD**



### P-C Toroids MOLDED TYPE

TOROTEL, INC., 5512 E. 110th St., Kansas City 37, Mo., has available for immediate delivery molded printed circuit toroids. Inductance values range to 4 Hy, with Q values to 220, depending on frequency. Cores 45, 50 and 51 as shown in the standard catalog are available in this package. Size is  $\frac{3}{8}$  by  $\frac{3}{8}$  by  $\frac{3}{8}$  high plus 0.025 boss. Prices available on request.

**CIRCLE 335 ON READER SERVICE CARD**

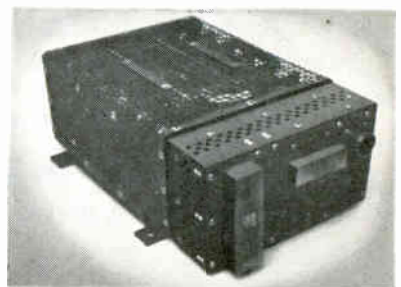

### Power Supply COMPLETELY STATIC

INTERNATIONAL TELEPHONE AND TELEGRAPH CORP., Industrial Products Division, San Fernando, Calif., has developed a 28 v d-c, 100 ampere

**CIRCLE 147 ON READER SERVICE CARD** →

# Specialists in precision displays

# Celco YOKES

## Celco YOKES FOR CHARACTER DISPLAYS & HIGH RESOLUTION APPLICATIONS

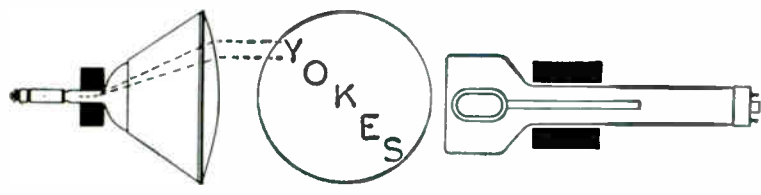

Deflection yokes for difficult character displays and high resolution problems are another achievement in advanced design and engineering at Celco.

Celco Deflection Yokes permit rapid presentation of random character and alpha numeric displays. Low hysteresis, high accuracy and fast Recovery time with emphasis on spot approach to absolute zero, assures highest performance of magnetic deflection character displays.

Celco High Sensitivity Yokes minimize the deflecting currents required from the deflection drivers, resulting in high efficiency for your system.

For best utilization of the New High Resolution CRT's CELCO YOKES assure minimum defocusing at large deflections.

The construction of our yokes makes it possible to achieve sensitivities, linearities, responses and distortion-free deflecting fields not possible with the usual types of yoke.

## Celco FOR STANDARD, COMMERCIAL & MILITARY APPLICATIONS

Single units or production quantities immediately available in wide range of inductance - resistance - Recovery time - pin cushion corrected or optimum focus as required. Also available 2-1/8" and 2-1/2" neck CRT yokes.



**TYPE BY**  
Transistorized encapsulated yokes for 70° 7/8" neck CRT and 1" neck image storage tubes.



**TYPE AY**  
Push-pull or single ended yokes for 52°, 70° and 90° deflections for 1-7/16" neck CRT.



**TYPE RY**  
Rotating deflection yokes for PPI displays. Gears, bearings, slip rings and contact assembly included.



**TYPE CF**  
Electromagnetic focusing coil for 7/8", 1" and 1-7/16" neck CRT.

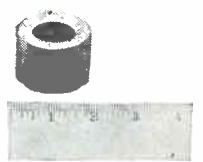

**TYPE MY**  
Miniature light weight deflection yoke coils or assemblies for incorporation into customer housings.

## Celco ENGINEERED YOKES FOR PRECISION DISPLAYS



**TYPE DP**  
Dual purpose yoke custom designed. Deflection system plus axial off-centering coils.



**TYPE HS**  
Special high sensitivity deflection yoke with critical damping provisions.



**TYPE PI**  
Plug in type encapsulated deflection yoke for rapid insertion.



**TYPE ER**  
Encapsulated rotating, 4 axis slip ring precision deflection yoke.



**TYPE MS**  
Miniature deflection yoke for rotating or fixed coil radar system.

Write for **CELCO DEFLECTION YOKE Catalogue & Design Sheets** or for assistance Call your nearest **CELCO Plant** listed below.



*Constantine Engineering Laboratories Company*

Main Plant: MAHWAH, N. J. DAVIS 7-1123

• Pacific Division - Cucamonga, Calif. - YUKON 2-2688

How United States  
Testing Company helps

# SELECT THE BEST COMPONENT FOR YOUR PRODUCT

Trouble-free performance of a missile control demanded a power unit that would take severe environments and a heavy duty cycle. The control manufacturer's tight schedule and overloaded testing laboratory led him to call in United States Testing Company.

Our engineers set up an evaluation program to "lock in" with his tight schedule... tested each competing power unit in environments of heat, cold, vibration, and acceleration ...and submitted a "performance profile" for the best one... ahead of schedule...and within his budget.

Our complete evaluation facilities ...and engineers who knew where a product would "give" first... spelled quick testing service...high reliability...and low cost. Why not write or phone us about your evaluation problem.

power supply that uses a trimmer transformer to give a current balance of almost 100 percent from no load to full load conditions. The 21 lb supply uses Delta-Max-core interphase transformers with no air gap to reduce the low load transition current requirement to a minimum value. The P529A is of the unregulated transformer-rectifier type and is completely static. Although designed to specific military requirements, it can also be used for other airborne a-c to d-c power requirements in environments of high ambient temperature and altitudes over 60,000 ft. An output of 26 to 31 v d-c with a ripple voltage of one volt peak can be obtained from an input of 196 to 210 v. 300 to 420 cps. Unit measures 10.5 by 5.5 by 15 in. and is rated at 88 percent efficiency.

**CIRCLE 336 ON READER SERVICE CARD**

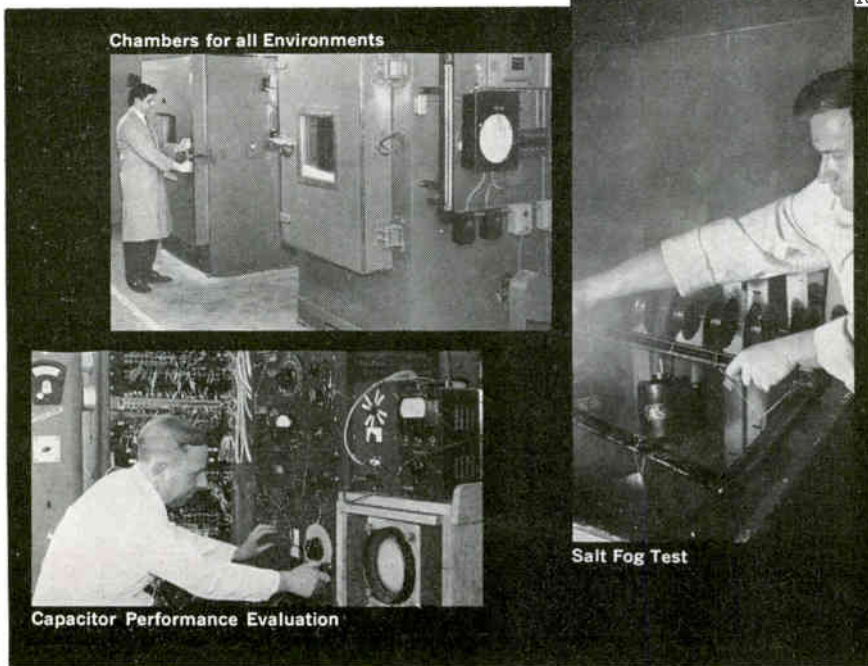

## Constant Power Tubes TWO NEW TYPES

AMPEREX ELECTRONIC CORP., 230 Duffy Ave., Hicksville, L. I., N. Y., announces the types 7804 (illustrated) and 7805 constant power tubes. The 7804, with a plate dissipation rating of 15,000 w, is a forced air cooled, high vacuum power triode of the external plate type. The radiator is an integral part of the tube. Tube is designed primarily for use as an oscillator at frequencies up to 30 Mc in industrial, dielectric and induction heating applications. The 7805 is the water cooled version of the 7804. It has a separate waterjacket which



Send for free bulletin  
describing our evaluation  
and R/D services

**United States Testing Co., Inc.**  
1415 Park Avenue, Hoboken, N. J.

Branch Laboratories

BOSTON • BROWNSVILLE • DALLAS • DENVER • LOS ANGELES  
MEMPHIS • NEW YORK • PHILADELPHIA • TULSA

The  
World's Most  
Diversified  
Independent  
Laboratory.





**HUNDREDS  
OF DIES,  
READY AT AN  
INSTANT'S  
NOTICE FOR...**

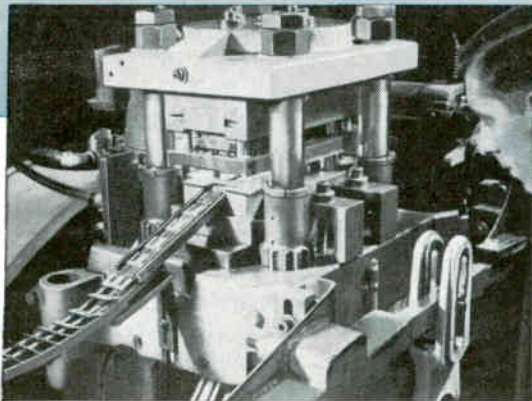

**the magnetic core  
laminations you need,  
when you need them**

Dies for the laminations you need in a hurry are held ready in this bomb-proof, fire-proof vault. No delays or extra costs of tooling up, on most orders. These are the finest high-precision dies, built and maintained by our own skilled craftsmen, available in a wide range of sizes and shapes . . . and one of the reasons for the consistently high level of Magnetic Metals quality.

Another reason is our stock of magnetic alloys—the largest stock in the world, making available to you the widest choice of electrical characteristics. Moreover, special, highly flexible annealing techniques

provide final assurance of the exact performance you require in magnetic core laminations.

Most of the nation's best-known transformer manufacturers gain the extra advantages of Magnetic Metals laminations. You should, too. Tell us about your application, and we'll go to work on it right away.

**MAGNETIC**  
 **METALS**

transformer laminations • motor laminations • tape-wound cores  
 powdered molybdenum permalloy cores • electromagnetic shields

MAGNETIC METALS COMPANY • Hayes Avenue at 21st Street, Camden 1, N.J.

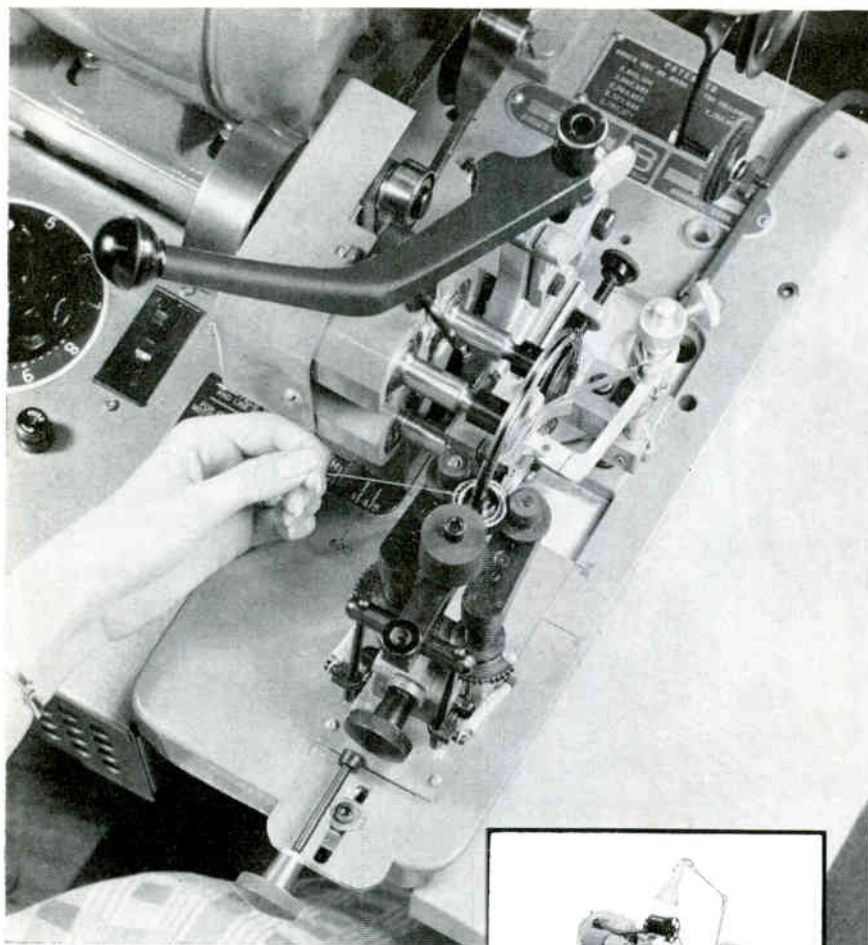

# BOESCH

*semi-automatic  
toroidal winders*

- Wind #20 to #42 AWG wire with constant uniformity at speeds up to 1200 RPM.
- Finished coils from 7/32" ID through 5" OD.

Low cost, high production winders. Core oscillated manually, clamped manually. Both machines wind standard size cores without additional attachments—use interchangeable shuttle heads. Capabilities identical except that TW-251 has built-in turns counter and variable speed motor.

Accessory, electronic, predetermined turns counters available for both machines . . . automatically stop winding at a preset number of turns—results in faster winding because operator does not have to watch counter. Both the TW251 and TW201 are bench-type machines with the following standard equipment: motor, core holder, shuttle opening lever, wire tension device, predetermined mechanical linear counter, reversing switch, 3" shuttle head, choice of 3" standard or 3S shuttle with slider.

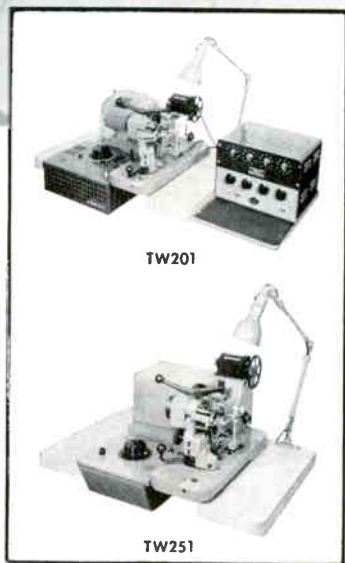

Write for complete data.



**BOESCH MANUFACTURING  
COMPANY, INCORPORATED  
DANBURY, CONNECTICUT**

makes possible quick and safe tube replacement. Both feature a specially designed cathode having high peak emission, which permits intermittent overloads without damage to the cathode. Both incorporate the "K" grid which permits very high grid dissipation ratings due to the high melting point of the grid material.

**CIRCLE 337 ON READER SERVICE CARD**



## Dummy Load

FOR L-BAND RADAR

AIRTRON-PACIFIC, 5873 Rodeo Rd., Los Angeles 16, Calif. Model 890374 dummy load for L-band radar dissipates 8 Kw of average power and 2,200 Kw of peak power without liquid cooling. It can be used in a frequency range of 1,120 to 1,700 Mc. Size is 32 1/2 in. long, 8 1/2 in. wide and 11 1/2 in. high. Weight is approximately 80 lb. It is compatible with the RG-103/U waveguide, and is designed for rugged environmental conditions. A liquid-cooled version also is available for use with significantly higher powers. Use of inert, high-temperature silicon carbide as the absorptive element minimizes water absorption, increases stability, and prolongs trouble-free life.

**CIRCLE 338 ON READER SERVICE CARD**



## Coaxial Isolators

"L" AND "S" BAND

RAYTHEON CO., 130 Second Ave., Waltham 54, Mass., announces two



Reliable stability for  
regulated power supplies

# TUNG-SOL VOLTAGE REFERENCE TUBES

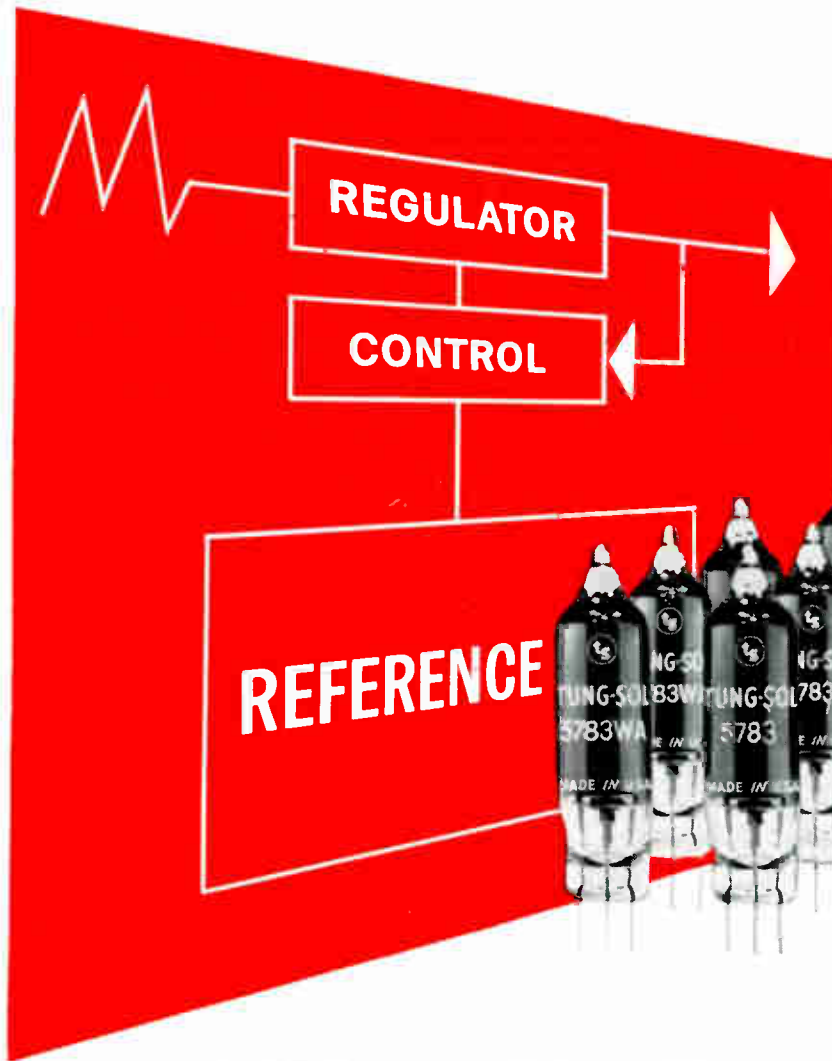

## Newest Member of Tung-Sol Reference Tube Family



# OG3

"Made In USA"  
Replaces European  
type 85A2

Nominal Operating Volt-  
age—85 volts.

Minimum Operating Cur-  
rent—1 mA<sub>dc</sub>.

Maximum Operating Cur-  
rent—10 mA<sub>dc</sub>.

A regulated power supply is only as stable as its reference element.

By using rugged, reliable Tung-Sol miniature and sub-miniature reference tubes in regulated power supply designs, you're guaranteed long-life stability in spite of temperature changes, repetitive on-off cycles and current shifts. Long-term drift and noise are minimized by superior tube design, extensive factory stabilizing schedules and severe test criteria. These inert-gas-filled, cold cathode glow discharge diodes feature high shock and vibration ratings. They are particularly suited for applications where size and weight must be held to a minimum. Write for complete technical details. Tung-Sol Electric Inc., Newark 4, N. J. TWX: NK193.

 **TUNG-SOL**

Technical Assistance is available from the following sales offices: Atlanta, Ga.; Columbus, Ohio; Culver City, Calif.; Dallas, Texas; Denver Colo.; Detroit, Mich.; Irvington, N. J.; Melrose Park, Ill.; Newark, N. J.; Philadelphia, Pa.; Seattle, Wash. Canada: Toronto, Ont.

# DURANT

Your answer  
to an infinite number of  
variable demands for  
**PRECISION  
CONTROLS**



Model "D" SERIES  
Wheel diameter: 1"  
Figures: 1/4" high

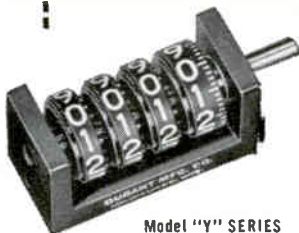

Model "Y" SERIES  
Wheel diameter: 3/4"  
Figures: 3/16" high

## DIGITAL READ-OUT COUNTERS

Many stock variations, easily adapted for **MISSILE TRACKING, RADAR CONTROLS, COMPUTERS, NAVIGATION INSTRUMENTS, GAUGING INSTRUMENTS, and ANY other indicator applications.**

- Standardized in two basic families to cut costs, save time, and simplify installation.
- Meet rigid military specifications.
- Component parts may be purchased separately to meet design requirements.
- High speeds, lower torque, and lower moment of inertia for long operating life.
- Non-corrosive, one piece precision molded pinions and wheels, large legible figures.
- One piece aluminum die cast frame.
- Single, 1 1/2 or double width wheels; right or left hand drive; clockwise or anti-clockwise rotation.
- Base mounting. Threaded mounting holes may be in frame top or ends.
- "Y" Series, single or double bank types.
- In addition, Durant can develop designs for any special counter requirements.

Send for Catalog Number 400

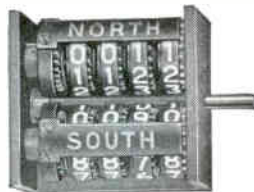

MODEL "Y" 9425  
DUAL BANK SERIES



MODEL "Y" 8831  
DUAL BANK SERIES

### DURANT MANUFACTURING CO.

dependable since 1879

1912 North Buffum St.  
Milwaukee 1, Wisconsin  
12 Thurbers Ave.  
Providence 5, R. I.

# DURANT

## COUNTING INSTRUMENTS

Accurately Count Everything . . . EVERYWHERE



MODEL "YE"  
ELECTRIC  
HIGH SPEED  
QUICK RESET



COUNTER  
FOR TRUE  
AIRSPEED  
INDICATOR



INSTRUMENT  
COUNTER WITH  
LUMINESCENT  
FIGURES



HIGH SPEED  
COUNTER FOR  
NAVIGATING  
INSTRUMENT



DEGREES AND  
MINUTES  
INSTRUMENT  
COUNTER

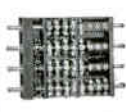

INSTRUMENT  
COUNTER FOR  
INCREMENTAL  
OSCILLATOR

REPRESENTATIVES IN ALL PRINCIPAL CITIES

new broadband coaxial isolators. Model IcLM3 (illustrated) operates in the "L" band region from 1,250 to 1,600 Mc. Designed to handle peak power of 5 Kw and average of 25 w, it has minimum isolation of 20 db, a vswr of 1.25, and insertion loss of 1.0 db maximum. Overall length of the 3.8 lb unit is 12 in. Model IcSM2 covers 2,000 to 4,000 Mc in "S" band and handles peak power of 5 Kw with an average power capability of 5 w. Maximum isolation is 30 db with a minimum of 20 db. Maximum vswr is 1.25. Maximum insertion loss is 2.0 db with 1.0 db possible over a narrow band. Overall length of the new isolator is 9.8 in. Weight is 2.3 lb. Both units have type N female connectors.

CIRCLE 339 ON READER SERVICE CARD

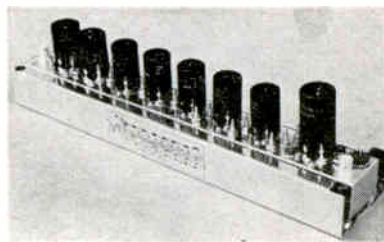

### I-F Amplifier GENERAL PURPOSE

TRIDEA ELECTRONICS, 1020 Mission St., So. Pasadena, Calif. Model 10A low-cost, general purpose i-f amplifier for radar receiver or instrumentation incorporates only MIL approved components and is fully compliant with FAAR-777. New design incorporates a low-noise cascade input circuit utilizing the 417A triode, double-tuned interstage coupling for maximum gain-bandwidth, excellent skirt selectivity, and a low-impedance cathode-follower output. Typical characteristics are: noise figure 1.75 db, 60 Mc center frequency, 10 Mc-3 db bandwidth, 20 Mc-40db bandwidth, 70 db gain control range. Special designs can be engineered by the company's engineering staff to meet desired performance specifications.

CIRCLE 340 ON READER SERVICE CARD

### PNP Transistors MEET MIL-S-19500B

SYLVANIA ELECTRIC PRODUCTS INC., Woburn, Mass. Types 2N650, 2N651 and 2N652 general purpose

Experience—the added alloy in **A-L Electrical Steels**

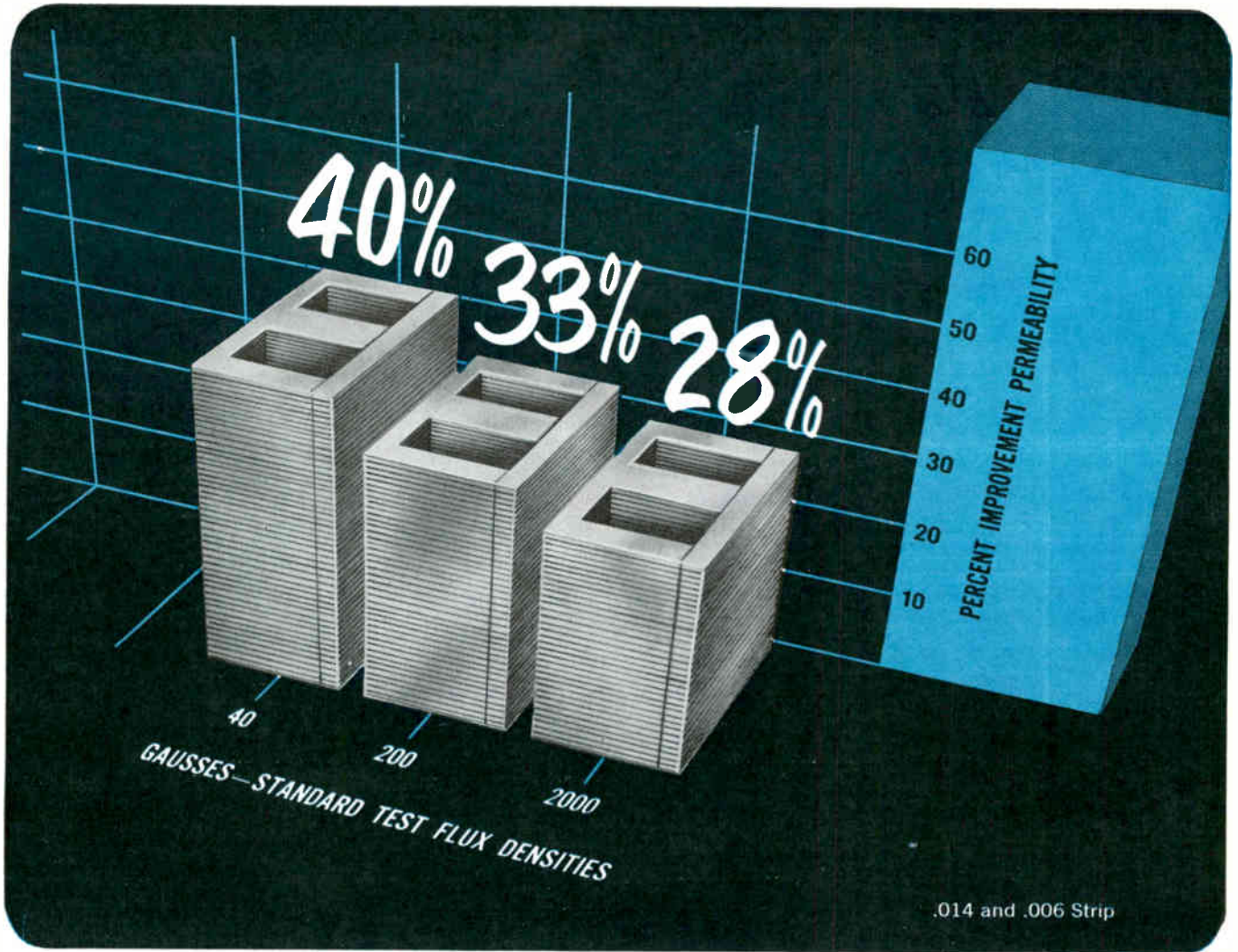

## Higher permeability values now guaranteed for Allegheny Ludlum's Moly Permalloy

### Means new, consistent and predictable magnetic core performance

Molybdenum Permalloy nickel-iron strip is now available from Allegheny Ludlum, with higher guaranteed permeability values than former typical values. For the buyer, this new high quality means greater uniformity . . . more consistent and predictable magnetic core performance.

This higher permeability is the result of Allegheny Ludlum's intensive research on nickel-bearing electrical alloys. A similar improvement has been made in AL-4750 strip steel. A-L continues its research on silicon steels,

including Silectron, well-known grain-oriented silicon steel, and other magnetic alloys.

Complete facilities for the fabrication and heat treatment of laminations are available from Allegheny Ludlum. In addition, you can be assured of close gage tolerance, uniformity of gage throughout the coil, and minimum spread of gage across the coil-width.

If you have a problem relating to electrical steels, laminations or magnetic materials, call A-L. Prompt technical assistance will be yours. And write for more information on Moly Permalloy. *Allegheny Ludlum Steel Corporation, Oliver Building, Pittsburgh 22, Pa.*

*Address Dept. E-10.*

WSW 7490

**ALLEGHENY LUDLUM**  
STEELMAKERS TO THE ELECTRICAL INDUSTRY

Export distribution, Electrical Materials: AIRCO INTERNATIONAL INC., NYC 17  
Export distribution, Laminations: AD. AURIEMA, NYC 4



# DIRECTIONAL COUPLERS • RF LOAD RESISTORS COAXIAL TUNERS • RF WATTMETERS • VSWR METERS



RF Power and VSWR measuring instruments are rugged and accurate in both field and laboratory use. The patented circuit produces an output essentially independent of frequency. Over 3800 models of coupler units available. MICRO-MATCH instruments meet highest government and commercial standards, combine highest quality with low cost.



RF POWER and VSWR Instruments			
Model No.	Frequency Range (mcs.)	Power Range Incident & Reflected (watts)	RF Connectors and Impedance
263	0.5 - 225	0 - 10; 100; 1000	Type N* 52 ohms
706N	28 - 2000	0 - 400	Type N* 52 ohms
711N	25 - 1000	0 - 30; 75; 300	N plus 83-1R Adapters
712N	25 - 1000	0 - 2.5; 5; 10	N plus 83-1R Adapters
722N	1000 - 3000	0 - 4	Type N 52 ohms
723N	1000 - 3000	0 - 12	Type N 52 ohms
40588	28 - 2000	0 - 4000	1 1/2" Flange 51.5 ohms
445A10	20 - 2000	0 - 40,000	3 1/8" Flange 50.0 ohms

## DC OUTPUT DIRECTIONAL COUPLERS

Model No.	Frequency Range (mcs.)	Power Range Incident & Reflected (watts)	RF Connectors and Impedance
576N1	42 - 2000	1.2	Type N* 52 ohms
576N6	28 - 2000	0 - 400	Type N* 52 ohms
596N2	1000 - 3000	0 - 4	Type N 52 ohms
596N3	1000 - 3000	0 - 12	Type N 52 ohms
40288	28 - 2000	0 - 4000	1 1/2" Flange 51.5 ohms
442A9	28 - 2000	0 - 12,000	3 1/8" Flange 50.0 ohms

## RF OUTPUT DIRECTIONAL COUPLERS

Model No.	Frequency Range (mcs.)	Coupling Attenuation	RF Connectors and Impedance
313N3	300 - 2000	30 db	Type N* 52 ohms
313N5	60 - 2000	50 db	Type N* 52 ohms
442A40	200 - 1000	40 db	3 1/8" Flange 50.0 ohms

## ABSORPTION TYPE RF WATTMETERS

Model No.	Frequency Range (mcs.)	Power Range (watts)	RF Connectors and Impedance
621N	1 to over 1000	0 - 120 milliwatts	Type N* 52 ohms
625C5	50 - 1000	0 - 120	Type C 50 ohms
651N	25 - 1000	0 - 25; 100; 500	Type N 52 ohms
611A7	50 - 1000	0 - 1200	3 1/8" Flange 50 ohms
612A	44 - 1000	0 - 6000	3 1/8" Flange 50 ohms

## RF LOAD RESISTORS

Model No.	Frequency Range (mcs.)	RF Power Dissipation (watts)	RF Connectors and Impedance
603N	3000	20 (air cooled)	Type N 52 ohms
633N	3000	50 (air cooled)	Type N* 52 ohms
636N	3000	600 (air cooled)	Type N* 52 ohms
638A	2000	6000 (water cooled)	3 1/8" Flange 50.0 ohms

## CALORIMETRIC TYPE Primary Standard of RF Power

Model No.	Frequency Range (mcs.)	Power Range	RF Connectors and Impedance
641N	0 - 3000	0 - 3; 10; 30; 100; 300	Type N 52 ohms

## COAXIAL LINE TUNERS

Model No.	Frequency Range (mcs.)	Range of Correction	RF Connectors and Impedance
151N	200 - 1000	Tunes a load with a VSWR of 2.00 max. down to a VSWR of 1.00	Type N 50 ohms
152N	500 - 4000	Tunes a load with a VSWR of 2.00 max. down to a VSWR of 1.00	Type N 50 ohms

\*Also available with UHF, C, and HN Connectors.

For more information, write:

**M. C. JONES ELECTRONICS CO., INC.**

185 N. MAIN STREET, BRISTOL, CONN.

SUBSIDIARY OF



hermetically sealed *pnp* germanium alloy transistors are designed for both amplifier and switching applications in the audio frequency range. They have a maximum collector to base voltage of 45 v, maximum collector to emitter voltage of 25 v, maximum collector current of 250 ma, and a maximum junction temperature of 100 C. All three types use a TO-5 JEDEC package and have a maximum free air power dissipation of 200 mw.

CIRCLE 341 ON READER SERVICE CARD



## Servo Amplifier PUSH-PULL TYPE

LUMEN, INC., Moen Ave., Joliet, Ill. Model 1057 push-pull servo magnetic amplifier is extremely sensitive. It has a signal input level of  $\pm 100 \mu\text{a}$  at an input impedance of 500 ohms. Nevertheless, the unit has an output of 26 v with a power rating of 3.1 w. It is designed to meet a wide range of environmental conditions and is extraordinarily stable. Null voltage remains below 0.5 v for any 10 percent change in voltage and frequency throughout the operating range specified. Delivery is 5 to 6 weeks. Sample units are priced at \$275 each and there is a considerable price reduction for larger quantities.

CIRCLE 342 ON READER SERVICE CARD



## D-C Power Supplies REGULATED UNITS

HARRISON LABORATORIES, INC., 45 Industrial Road, Berkeley Heights,





TOROIDAL TRANSFORMERS

## FOR ADVANCED TECHNIQUES IN:

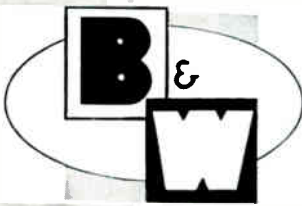

### Test Equipment

- Audio Oscillators
- Distortion Meters
- Audio Frequency Meters
- R-F Signal Generators
- Grid Dip Meters

### Components

- Filters—Low & High Frequency
- Low Pass
- High Pass
- Band Pass
- Band Rejection
- Toroidal Coils
- I-F and R-F Transformer Assemblies
- T-R Switches
- R-F Filament Chokes
- Audio Phase Shift Networks
- Band Switching Pi-Networks
- Cyclometer-type Counters
- Oscillator Coils
- R-F and Audio Filters
- R-F Chokes
- Air Wound Inductors
- Transmitting Condensers (Variable Air)
- Frequency Multipliers
- Band Switching Turrets
- Rotary Coils
- Antenna Tuning Networks
- Baluns

### Special Equipment

- Mobile Radio Teletype Equipment
- AM-SSB Transmitters and Receivers



PI-NETWORKS



PHASE SPLIT NETWORKS



FILTERS



BALUNS

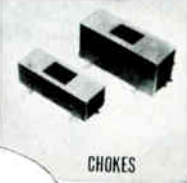

CHOKES

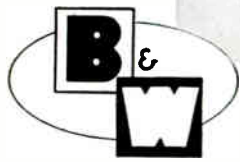

*Barker & Williamson, Inc.*

Canal Street & Beaver Dam Road • Bristol, Penna.

CIRCLE 207 ON READER SERVICE CARD

- Filters
- Toroidal Transformers
- Phase Split Networks
- Coils
- Baluns

... B&W's specialized facilities and experience in design, engineering and production are ready to solve your unique problems in these fields. You are assured immediate action and short delivery on special components, assemblies and equipment. We invite you to ask for bulletins or better yet, drop us specs covering your specific requirements.

APPROVED INTERNATIONALLY



## SUPERIOR ELECTRON GUN MOUNTS

Superior Electronics Corporation, oldest and largest exclusive manufacturer of Electron Gun Mounts, manufactures a complete line of standard Electron Gun Mounts for television, commercial and industrial application as well as prototypes and special purpose guns for the military and for research and development.

Superior Electronics has a full complement of engineers whose professional skills are at your service. Samples, catalogs and prices are available on request.

**SUPERIOR ELECTRONICS CORP.**  
 Dept. EL-60 • 208 Piaget Ave.  
 Clifton, N. J. • GRegory 2-2500

# NEW IDEAS FOR SALE!

Words and pictures tell you about the top new product ideas each week in "On the Market". Who makes 'em and what they'll do for you. Easy way to keep in touch with the latest and best.

Another reason why it will pay you to subscribe to *electronics* (or renew your subscription) right now. Fill in the box on Reader Service Card. Easy to use. Postage free.

FIND WHAT YOU NEED IN...

# electronics

**NEW**

# DC driven CHOPPERS



## What... No AC?

In transistorized d-c amplifiers, the use of a d-c driven Chopper instead of the usual a-c drive, removes an additional source of stray a-c signals from the critical chassis wiring. The 94 cycle chopping rate also eliminates the null off-sets resulting from the use of a 60 cycle chopping rate.

In portable d-c amplifiers, the advantages of low level operation plus a 94 cycle chopping rate are now available, using a 12, or 24 volt battery as the chopper drive source.

Write for  
Catalog 554.



# STEVENS INCORPORATED ARNOLD

QUALITY SINCE 1943

7 ELKINS ST., SOUTH BOSTON 27, MASS.

S/A-20-7/2

N. J. Model 865 transistor power supply is continuously variable from 0 to 40 v at any current from 0 to 500 ma. Unit can be connected in series or parallel for higher voltage or current requirements. Maximum output current is continuously adjustable by means of a front panel knob over an appropriate range of 25 to 550 ma. Line or load regulation is less than 5 mv, and ripple is below 500  $\mu$ v. The units are fully protected for all overload conditions including direct short across output terminals; there is no voltage overshoot on either turn-on or turn-off. Low internal impedance over a wide frequency band and fast transient response are other features of the model 865 along with remote programming (100 ohms per v). Line input is 105-125 v a-c, 50-440 cps. Price is \$185 with case.

**CIRCLE 343 ON READER SERVICE CARD**

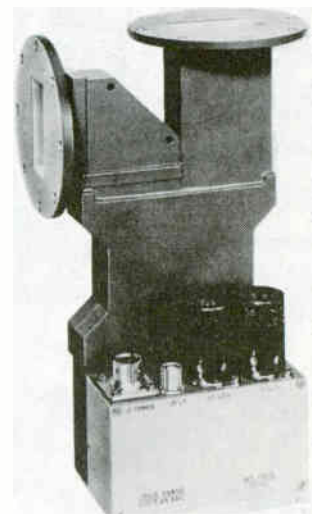

Mixer-Preamplifier  
SPACE SAVING

MICROWAVE DEVELOPMENT LABORATORIES, INC., Wellesley, Mass. A 5,150 to 5,850 Mc combination mixer-preamplifier for microwave and guidance systems has been developed. It eliminates the problem of variable parameters resulting when separate mixers and preamplifiers are combined. Overall mounting space is the same as that previously required for the mixer unit alone. Model 187MB-360F1 integrated mixer-preamplifier serves as a low-noise, wide-band downconverter for maser and parametric r-f amplifiers. Noise figure is less than 7 db, with minimum gain of 25 db. The pre-

# new career opportunities with

## SENIOR RADAR DESIGN & DEVELOPMENT ENGINEERS

BS or MS degree and radar experience in one of the following specialized areas:

- ... experience in design of blanking circuits, deflection circuits, and video signal amplifiers, plus background in the field of processing of radar information to include smoothing and filtering of radar data as part of human factors engineering.
- ... experience in video and high-frequency computing circuits. For example, phase deflector multiplier circuits, IF amplifier circuits, summing video circuits, magnetron circuits, AFC circuits, and gated video circuits. Capable of design analysis of circuits and correction of design deficiencies. Experience should include packaging, grounding, and shielding of video and RF circuits.
- ... experience in systems engineering on airborne radar equipment.

## COMMERCIAL COMMUNICATIONS ENGINEERS

BS or MS in Electronics/Electrical Engineering to perform advanced development, product design, and production engineering of commercial products. Background preferred in VHF and UHF communications, airborne and ground equipment—FM, AM, single sideband, selective signaling encoders and decoders, transistorization of RF, Audio and pulse circuitry.

## ENVIRONMENTAL TEST ENGINEERS

Experienced electronic engineers to develop test methods and procedures for complex electronic components and systems.

**Inquire about other opportunities in Milwaukee.**

For additional information write the Director of  
Scientific and Professional Employment:

MR. ROBERT ALLEN

Oak Creek Plant, 7929 S. Howell Ave., Milwaukee 1, Wisconsin.



**AC Spark Plug • The Electronics Division of General Motors**  
Milwaukee, Wisconsin • Los Angeles, California • Boston, Massachusetts

**Hermetic Seal**  
transformer co.



**NOW . . . REGULATE 1KV WITH THIS HERMETIC SEAL  
Miniaturized AC REGULATOR**

NOW . . . nearly a kilowatt of AC power can be regulated by this special Hermetic Seal Unit weighing less than 10 pounds. Built to Mil-E-5400 and Mil-E-5272 specifications, it is primarily magnetic assuring high reliability for critical aircraft and missile power regulation requirements. For regulating three-phase power, a package of three units performs efficiently. Write for literature describing electrical and mechanical characteristics of this entire family of AC Regulators.

**SPECIFICATIONS: MODEL NO. VRAC-104**

**ELECTRICAL CHARACTERISTICS: ENVIRONMENT CONDITIONS:**

INPUT: 108 to 122 volts  
 FREQUENCY: 380 to 420 cycles  
 OUTPUT: 115V ± 1V from 2 to 8 amperes  
 RESPONSE: <100 ms / 9V<sub>1N</sub> increments  
 DISTORTION: 5% max over input voltage and frequency range (exclusive of source)  
 OPERATING TEMPERATURE RANGE:  
 —55°C to +71°C  
 DUTY CYCLE: Continuous

Altitude: to 50,000 ft.  
 Humidity: 95% 50°C 360 hours  
 Shock: 15 g's  
 Vibration: 10 g's 5 to 500 cycles

**MECHANICAL CHARACTERISTICS:**

Size: 5" x 5" x 12"  
 Weight: Less than 10 lbs.

**WRITE FOR BULLETIN NPB-106**

HST Special Products Division designs and produces customized regulators, power supplies, servo amplifiers, and other special packaged electronic components for industrial and military uses. Write us your requirements; we will gladly submit recommendations and quotations without obligation.

<p><b>Hermetic Seal</b> transformer co.</p> <p>MAGNETIC IRON-CORE COMPONENTS                  ENVIRONMENTAL TESTING                  POWER SUPPLIES—SERVO AMPLIFIERS</p>	<p><b>DRESSER INDUSTRIES INC.</b></p> <p>ELECTRONIC OIL • GAS CHEMICAL INDUSTRIAL</p>

**You Get Things Done With Boardmaster Visual Control**

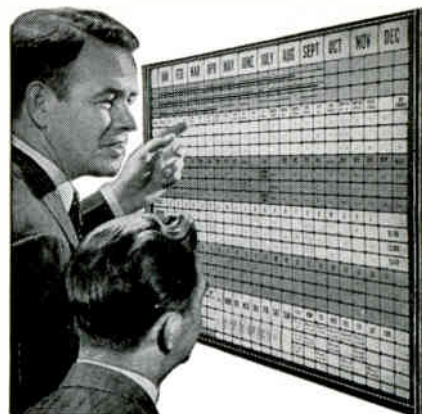

- ☆ Gives Graphic Picture of Your Operations—Spotlighted by Color
- ☆ Facts at a glance — Saves Time, Saves Money, Prevents Errors
- ☆ Simple to operate — Type or Write on Cards, Snap in Grooves
- ☆ Ideal for Production, Traffic, Inventory, Scheduling, Sales, Etc.
- ☆ Made of Metal. Compact and Attractive. Over 500,000 in Use

Complete price **\$4950** including cards

**FREE** 24-PAGE BOOKLET NO. C-20 Without Obligation

Write for Your Copy Today

**GRAPHIC SYSTEMS**

Yanceyville, North Carolina  
**CIRCLE 222 ON READER SERVICE CARD**

*Colorado*  
**...CENSUS-PROVEN OUTSTANDING NEW INDUSTRIAL MARKET**

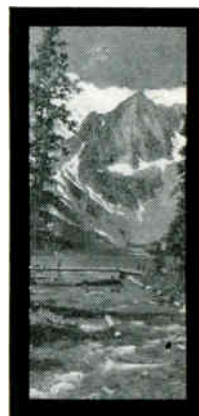

Census-proven one of the fastest growing states in the nation ...survey-proven one of the outstanding new industrial markets, Colorado offers new industry Profits with Pleasant Living.



Discover the new markets and opportunities awaiting your company in Colorado. "Site-See" Industrial Colorado now...right at your desk.

**Send for Free Executive Portfolio "INDUSTRIAL COLORADO"**

Newly revised 9-booklet portfolio with up-to-the-minute data on Colorado's industrial sites, assets, opportunities and weekend vacation wonderlands. All inquiries held confidential.

**COLORADO DEPT. OF DEVELOPMENT**  
 20 STATE CAPITOL • DENVER 2, COLO  
**CIRCLE 223 ON READER SERVICE CARD**

electronics



amplifier is fix-tuned, with a highly-effective stabilizing circuit that eliminates need for realignment after replacement of tubes or crystal. Preamplifier output is precisely matched to 50 ohms, allowing the main amplifier to be remotely located.

**CIRCLE 344 ON READER SERVICE CARD**



### Current Source PRECISION UNIT

ELCOR, INC., Falls Church, Va. Model CS-309A precision current source provides 12 currents of either positive or negative polarity over the range from 1 ma to 3 nanoamperes with an accuracy of 1 percent. The unit is specifically designed for use in calibrating current measuring instruments having relatively low input impedance, but may be used in other applications. Source of the current is 1.34-v mercury cell in combination with precision resistors.

**CIRCLE 345 ON READER SERVICE CARD**



### Capacitor Blocks MULTISECTION

FILM CAPACITORS, INC., 3400 Park Ave., New York 56, N. Y., announces a new line of precision multisection capacitor blocks for use in frequency determining and

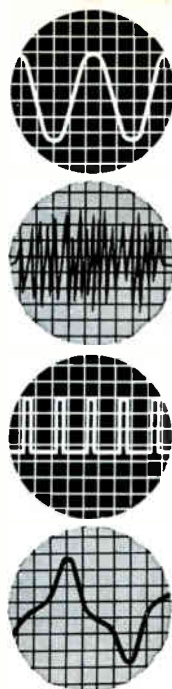

measures  
from

# 100 MICROVOLTS to 320 VOLTS

regardless  
of  
waveform

Price:  
\$445.

# TRUE RMS

frequency range 5 to 500,000 cps

### FEATURES

Built-in calibrator . . . easy-to-read 5 inch log meter . . . immunity to severe overload . . . useful auxiliary functions

### SPECIFICATIONS

**VOLTAGE RANGE:** 100 microvolts to 320 volts

**DECIBEL RANGE:** -80 dbv to +50 dbv

**FREQUENCY RANGE:** 5 to 500,000 cycles per second

**ACCURACY:** 3% from 15 cps to 150KC; 5% elsewhere. Figures apply to all meter readings

**MAXIMUM CREST FACTORS:** 5 at full scale; 15 at bottom scale

**CALIBRATOR STABILITY:** 0.5% for line variation 105-125 volts

**INPUT IMPEDANCE:** 10 MΩ and 25 μf, below 10 millivolts; 10 MΩ and 8 μf above 10 millivolts

**POWER SUPPLY:** 105-125 volts; 50-420 cps, 75 watt. Provision for 210-250 volt operation

**DIMENSIONS:** (Portable Model) 14 3/8" wide, 10 1/8" high, 12 3/8" deep—Relay Rack Model is available

**WEIGHT:** 21 lbs., approximately

Write for catalog for complete information

## BALLANTINE VOLTMETER Model 320



— Since 1932 —

## BALLANTINE LABORATORIES INC. Boonton, New Jersey

CHECK WITH BALLANTINE FIRST FOR LABORATORY AC VACUUM TUBE VOLTMETERS, REGARDLESS OF YOUR REQUIREMENTS FOR AMPLITUDE, FREQUENCY, OR WAVEFORM. WE HAVE A LARGE LINE, WITH ADDITIONS EACH YEAR. ALSO AC/DC AND DC/AC INVERTERS, CALIBRATORS, CALIBRATED WIDE BAND AF AMPLIFIER, DIRECT-READING CAPACITANCE METER, OTHER ACCESSORIES.

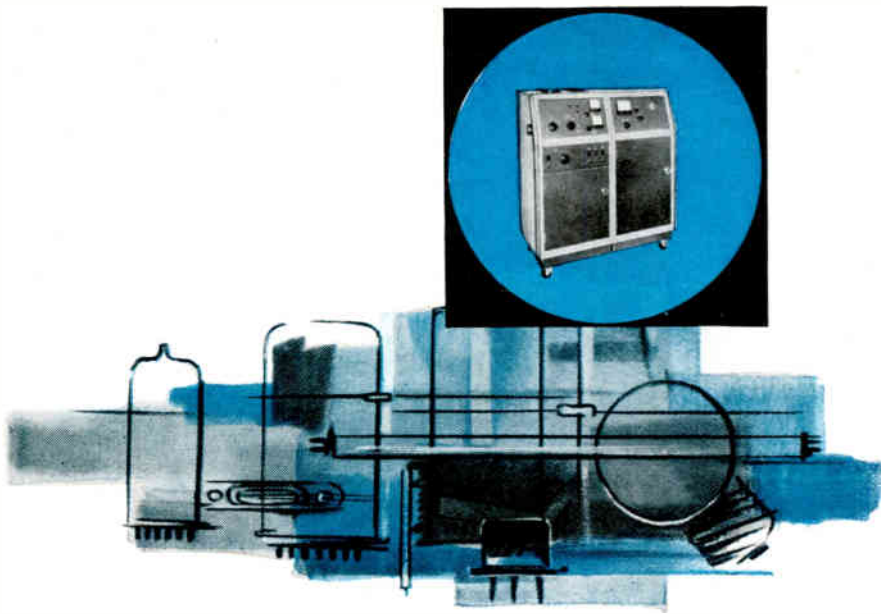

**ULTRA SENSITIVE MASS  
SPECTROMETER LEAK  
DETECTOR\*... 1000 TIMES MORE  
SENSITIVE THAN ANY OTHER  
HELIUM ACTUATED UNIT.**

Sensitivity of  $10^{-13}$  cc/sec. (S.T.P.) permits critical testing beyond go/no-go providing an important increase in the operating reliability and shelf life of all hermetically sealed and pressurized devices. The new Crosby-Teletronics Model 700 is an outgrowth of the mass spectrometer leak detection technique originally developed in conjunction with Manhattan Project. Perfected and refined through utilization of two magnetic analyzers in series, this unit takes its place with other advance-design hardware developed by Crosby-Teletronics, a leader in test equipment, long range communications and

# vacuum research



Crosby-Teletronics Corporation • 54 Kinkel Street • Westbury, Long Island, New York

\*pat. pend.

160 CIRCLE 160 ON READER SERVICE CARD

timing circuits, such as L-C and R-C oscillators, scope sweep circuits, integrators, etc.; as circuit elements in capacitance, comparison, impedance and incremental bridges; and as standards of capacitance. Capacitance per section ranges from  $0.001 \mu\text{f}$  to  $10 \mu\text{f}$ , with voltage ratings from 100 v d-c upwards. Capacitors can be matched to each other as closely as 1 percent absolute. These capacitor blocks are available in polystyrene, Teflon and Mylar dielectrics. The capacitor blocks are furnished in hermetically sealed metal cases with solder-seal terminals. Each capacitor element is clearly identified.

**CIRCLE 346 ON READER SERVICE CARD**

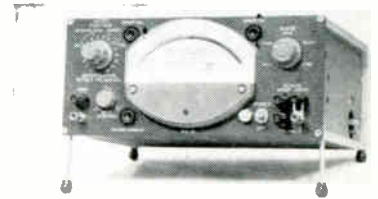

**Frequency Meter  
WIDE-RANGE**

GENERAL RADIO CO., West Concord, Mass. Type 1142-A electronic frequency meter, a wide-range instrument (3 cps to 1.65 Mc), is also a linear low-noise discriminator. Logarithmic meter indication with 1 percent accuracy is provided; any 10 percent segment of the scale can be expanded to cover the entire scale. Output current (d-c) is available up to 5 ma  $\pm 0.2$  percent; sensitivity is 10 to 20 mv.

**CIRCLE 347 ON READER SERVICE CARD**

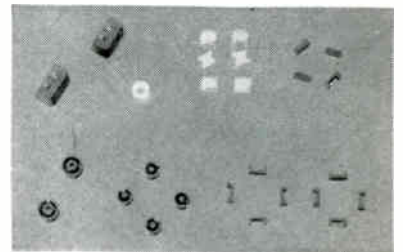

**Core Kit  
FOR R&D WORK**

FERROXCUBE CORP. OF AMERICA, Saugerties, N. Y., announces a new engineering kit for R&D work, designated the UEP-1 Ferroxit, containing tiny ferrite E and U cores, bars and pot cores for pulse trans-

electronics

## Read INSULATION RESISTANCE

### to FIVE MILLION MEGOHMS

VIBROTEST® Megohmmeters provide direct reading resistance measurements to five million megohms of electronic circuits, cable assemblies, transmission lines, motors, generators, servos, components and insulating materials. Push-button operation makes possible high speed production testing. Self-contained high voltage supply eliminates cranking and leveling. Write for complete manual.



Model 250 VIBROTEST Megohmmeter with ranges to 50,000 megohms. Complete \$279.50.

### HIGH VOLTAGE BREAKDOWN Insulation Leakage Current

HYPOT Test Sets provide direct reading of insulation leakage current in accord with military and commercial test specifications. Models are available to supply a-c and d-c test potentials to 150 kv and higher. Optional features include automatic rate of voltage rise control, automatic test cycling and others to meet every test application.



Model 424 HYPOT provides 0-5000 v d-c for testing cables, condensers, coils, transformers and assemblies. Measures leakage 0.1 to 100 microamperes over four scale ranges. Rapid charging of capacitors with 5 ma. output. Self-contained power supply. Complete \$497.00.

Write for Manual H-66



**ASSOCIATED RESEARCH, Incorporated**  
"Electrical Testing Instruments Since 1928"

3781 W. Belmont Avenue • Chicago 18, Illinois

10-35-20

CIRCLE 208 ON READER SERVICE CARD

### TELEMETRY PREAMPLIFIER

for Reliable

## LOW NOISE RECEPTION



The LEL TP-5 Telemetry Preamplifier is designed to be installed at a telemetry receiving antenna. The unit is weatherproofed for outdoor use. Ceramic tubes are used to provide a low noise figure and stable performance without forced air cooling.

#### Specifications:

Gain ..... 23db  
Bandpass ..... 215-260mc  
Noise Figure ..... 3.5db Typical  
Weight ..... .6 lbs.  
Size ..... 7-7/8" x 8" x 4-3/4"

**LEL INC.**

Send for comprehensive Microwave, IF, RF Amplifier Catalog.  
75 AKRON ST., COPIAGUE, N. Y.

CIRCLE 209 ON READER SERVICE CARD

October 14, 1960

## OTHER FUSE POSTS MAY LOOK LIKE THESE... BUT ONLY LITTELFUSE HAS PIDQ\*

A Fuse Post to meet every application—every requirement.

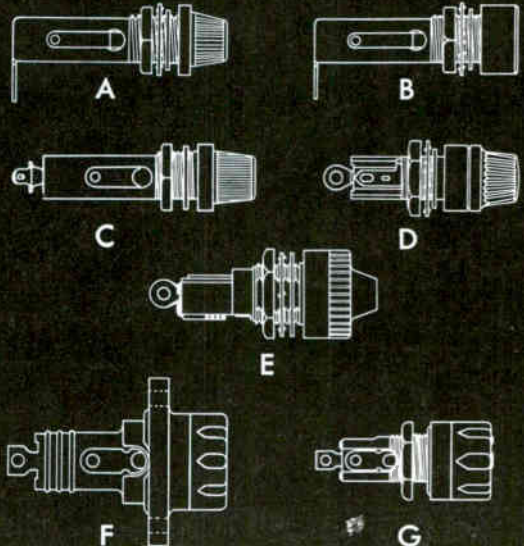

EXTRACTING FUSE POST! Fuse is held in end of removable knob for quick, safe and easy replacement of blown fuse. Safe "dead front" fuse mountings assured. U/L Approved.

A—3AG Fuse Post (finger operated knob)—No. 342001

A—8AG Fuse Post (finger operated knob)—No. 372001

B—3AG Fuse Post (Screwdriver Slot)—No. 341001

B—8AG Fuse Post (Screwdriver Slot)—No. 371001

C—4AG Fuse Post (Finger Operated Knob)—No. 442001

D—3AG Miniature Fuse Post (Finger Operated)—No. 342012

E—NEW INDICATING 3AG FUSE POSTS! (344,000 series) It Glows When The Fuse Blows. Long life incandescent bulb for low voltage ranges—2½-7V; 7-16V; 16-32V. New high degree vacuum neon lamp for high voltage ranges for greater brilliance and visibility—90-125V; 200-250V.

WATERTIGHT FUSE POSTS Specially designed for use where excessive moisture is a problem.

F—5AG Watertight Fuse Post. Has flange mounting.—No. 571004.

G—3AG Watertight Fuse Post—No. 342006

G—4AG Watertight Fuse Post—No. 442006

For complete details on these items and quotations on special application requirements, write to:

\*Precision Engineering  
Design Know-how  
Quality Craftsmanship

**LITTELFUSE**  
DES PLAINES, ILLINOIS

CIRCLE 161 ON READER SERVICE CARD

161

# THE A. W. HAYDON COMPANY

MIRROR IMAGE ON BOTH COASTS  
**EAST** ELECTRICAL TIMING DEVICES  
 WATERBURY, CONNECTICUT

ELECTRONIC TIMING DEVICES  
 CULVER CITY, CALIFORNIA **WEST**

Have it your way: electronic or electro-mechanical timing devices and test equipment. ■ The A. W. Haydon Company will design and manufacture either type...or both...to your rigid specifications. And with the same precision, compactness and high reliability as always. ■ For electro-mechanical devices call on our timing specialists at Waterbury, Conn. If your requirements are electronic, our Culver City, Calif. plant can meet your needs. ■ On either coast...on both coasts...there's only one A. W. Haydon.

# THE A. W. HAYDON COMPANY

former and kindred applications. The kit, priced at \$10, contains 1 set of 0.570 in. E cores in 3C material; 6 sets of 0.295 in. U cores and bars in 3C, 3C3 and 3E materials with 6 nylon bobbins; 2 sets of 0.272 in. diameter pot cores in 3C material without nylon bobbins and 1 set of 0.368 in. diameter pot cores in 3C material with 1 nylon bobbin. Complete technical data are provided with each kit. Orders will be filled the day they are received.

**CIRCLE 348 ON READER SERVICE CARD**

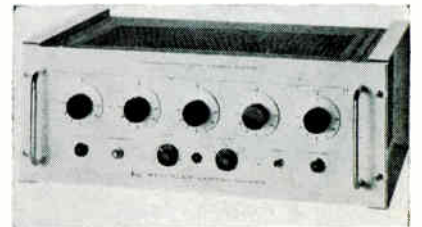

**High Voltage Supply  
 REGULATED UNIT**

KEITHLEY INSTRUMENTS, INC., 12415 Euclid Ave., Cleveland 6, Ohio. Model 241 regulated high voltage supply is the successor to d-c secondary standards that employ mechanical choppers and standard cells. It offers freedom from adjustment and calibration, long term stability to voltage or temperature variations, and immunity to shock and vibration. High output accuracy, within 0.05 percent, is assured through the use of encapsulated wirewound resistors with 0.02 percent divider accuracy. Extreme stability of 0.005 percent per hr is assured by a highly stable, shockproof Zener diode, wirewound standards in critical positions, and a highly stable, long life photo modulator which is immune to shock and vibration. Other features include a position which removes voltage from the output, making possible connections while the instrument is operating; bench or rack operation.

**CIRCLE 349 ON READER SERVICE CARD**

## T-W Tubes FOR TEST EQUIPMENT

SYLVANIA ELECTRONIC TUBES, Mountain View, Calif., announces two new low-cost twt's for use in electronic test equipment and other commercial applications. The new

# 140 KMC

**ULTRAMICROWAVE\***  
**EQUIPMENT**  
 BY 

E=mc<sup>2</sup>  

— it works

— it's accurate

— it's available

Complete data on request



**DE MORNAY—BONARDI**

780 SOUTH ARROYO PARKWAY • PASADENA, CALIF.

\*TRADE MARK De Mornay-Bonardi  
for its millimeter wave equipment

**CIRCLE 210 ON READER SERVICE CARD**

for 34 years



SYMBOL  
of  
**EXCELLENCE**

**EDO CORPORATION**  
College Point, L.I., N.Y.  
Since 1925

**CIRCLE 211 ON READER SERVICE CARD**

October 14, 1960



INDUSTRIAL PLANTS like Sylvania Electric must maintain rigid quality standards in their precision work. Lint problems have been minimized with uniforms of "Dacron".

## LINT-FREE UNIFORMS

start with DACRON® polyester fiber

Lint, often found to be a cause of problems in quality control, is absent with uniforms of "Dacron"® polyester fiber. The smooth surface of "Dacron" just can not generate lint. But that isn't all—uniforms of "Dacron" provide built-in economy and lasting good looks as well.

Plant personnel get a vacation from upkeep problems, too—uniforms of "Dacron" resist wrinkling, endure machine washing and drip drying, need only touch-up ironing.

**FOR SPECIAL ADVICE ON UNIFORMS** write: Uniform Counseling Service, E. I. du Pont de Nemours & Co. (Inc.), Textile Fibers Dept., Centre Road Building, Wilmington 98, Delaware.



BETTER THINGS FOR BETTER LIVING... THROUGH CHEMISTRY

REG. U.S. PAT. OFF.  
© "DACRON" IS DU PONT'S REGISTERED TRADEMARK FOR ITS POLYESTER FIBER. DU PONT MAKES THE FIBERS, NOT THE FABRIC OR UNIFORMS SHOWN.

**CIRCLE 163 ON READER SERVICE CARD**

163

# New Gertsch Freq Meter

MEASURES AND GENERATES: 20 mc to 1000 mc

ACCURACY: 0.0001%, exceeding FCC requirements 5 times

MODULATION: AM, 30% at 1000 cps; FM, 1 kc at 30 mc  
5 kc at 150 mc, or 15 kc at 450 mc max.

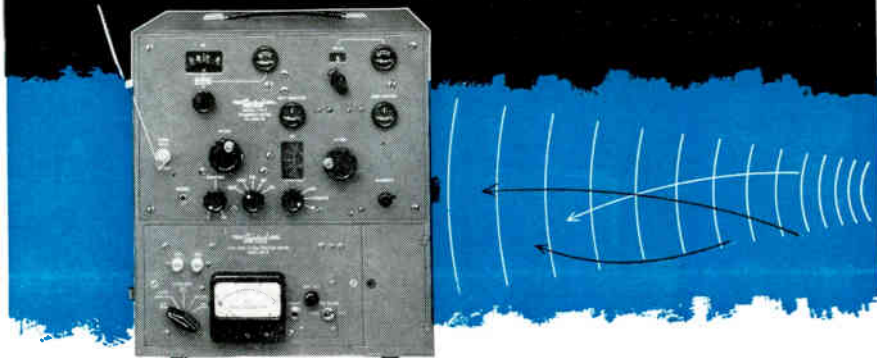

This portable instrument in one complete package enables you to measure both frequency and frequency deviations in the maintenance of mobile communications systems.

As optional equipment the FM-7 Frequency Meter can be combined with the new DM-3 Deviation Meter as illustrated. The DM-3 is a dual-range deviation meter with 15 kc and 7.5 kc full scales.

By combining the FM-7 and the DM-3 you get a single instrument capable of measuring and generating carrier frequencies plus reading peak modulation deviation.

Write for complete literature.

**Gertsch**

**GERTSCH PRODUCTS, Inc.**

3211 South La Cienega Boulevard, Los Angeles 16, California • UPTON 0-2761 - VERMONT 9-2201

**CIRCLE 212 ON READER SERVICE CARD**

$$\Delta E_o = \frac{\partial E_o}{E_o} = \left[ \frac{-1}{1 + R_1 \frac{E_2}{E_1}} \right] \Delta R_1 + \left[ \frac{-1}{1 + R_2 \frac{E_1}{E_2}} \right] \Delta R_2$$

... This equation relates operational amplifier accuracy to the error contribution in each of 2 coefficient resistors. It occurs on page 5 of our technical manual "Networks for Computers".

We manufacture resistors and networks that maintain total  $\Delta E_o$  accuracy of  $\pm 0.005\%$  when required. This performance includes the effects of:

- Initial Tolerance
- Long-term Aging
- Wide Temperature Changes
- Self-heating
- Temperature Retrace Offset
- Voltage Retrace Offset
- Humidity Retrace Offset
- Mechanical Stresses

Ordinary "precision" resistors cannot even approach such performance ... frequently are rated in terms of initial accuracy only. That is why the largest computer manufacturers purchase all critical resistors and networks from us. Prices are surprisingly moderate.

Free to computer design engineers

**JULIE RESEARCH LABORATORIES, INC.**

603 W. 130th St., New York 27, N. Y.  
Telephone AUdubon 6-9200

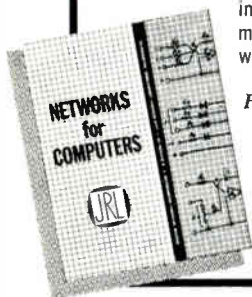

S-band units employ permanent magnet focusing, thus greatly decreasing size and weight at no sacrifice in electrical characteristics. Type TW-4260 has a minimum output power of 1 w over the full 2,000-4,000 Mc octave. Type TW-4261 delivers 10 mw minimum power and 37 db minimum gain over the same range. The tubes weigh 3 lb and have a maximum diameter of 2 1/2 in. The small quantity price for both types is \$925. Tubes for engineering evaluation are available for immediate delivery. Small quantities are available about 60 days after receipt of order.

**CIRCLE 350 ON READER SERVICE CARD**



## Attenuator

REMOTELY CONTROLLED

STRAZA ELECTRONICS, 790 Greenfield Drive, El Cajon, Calif., has developed a miniature remotely-controlled attenuator to provide attenuation of any signal from d-c to relatively high frequencies. Model A-601 is a compact passive device which will replace expensive follow-up servos, variable mu vacuum tube circuits and other complex circuitry generally required for remote control purposes. Only 3/4 in. in diameter by 1 1/2 in. long, the unit is encapsulated as a plug-in module with a 7-pin base. It can be used as an attenuator, automatic gain control, phase shifter and so on. Only two unshielded control wires of unlimited length are required. Control voltage may be d-c, a-c or any waveform of relatively stable rms magnitude. Attenuation may be smoothly varied by simply changing the control voltage with a remote potentiometer. The control circuit is electrically isolated from the signal circuit. Cost per unit is \$22.50.

**CIRCLE 351 ON READER SERVICE CARD**

# SPERRY Tunnel Diodes

for engineering test  
or application

Any quantities available  
for immediate delivery  
from any Avnet office.

Call your  
Avnet  
Applications  
Engineer

For dependable service



and immediate delivery\*  
**AVNET**

\* AVNET-70 State St., Westbury, N.Y. - ED 3-5800  
AVNET-45 Winn St., Burlington, Mass. - BR 2-3060  
AVNET-4180 Kettering Blvd., Dayton 39, Ohio - AX 8-1458  
AVNET-2728 N. Mannheim Rd., Melrose Park, Ill. - GL 5-8160

CIRCLE 213 ON READER SERVICE CARD

October 14, 1960

## HIGHLY RELIABLE

### SHAFT POSITION-TO-DIGITAL CONVERTERS



Kearfott's rugged shaft position-to-digital converters are resistant to high shock and vibration and high and low temperature environments. Ideally suited for missile applications, these converters are available for many uses, including latitude, longitude, azimuth or conventional angular shaft displacement conversion and decimal count conversion. Exclusive drum design provides large conversion capacity (typical unit 2<sup>15</sup>) in smallest available size. Combination counter-converter assemblies for both visual and electrical readout also available.

KEARFOTT DIVISION  
Little Falls, New Jersey



GENERAL PRECISION, INC.  
Other Divisions GPL Librascope Link

CIRCLE 214 ON READER SERVICE CARD

*Ideal for*  
ANTENNA CONNECTIONS  
PHOTO-CELL WORK  
MICROPHONE CONNECTIONS

## JONES SHIELDED TYPE PLUGS & SOCKETS



P-101-1/4

S-101

LOW LOSS PLUGS AND  
SOCKETS FOR HIGH  
FREQUENCY  
CONNECTIONS.  
SUPPLIED IN 1 AND 2  
CONTACT TYPES:

101 Series can be furnished with 1/4", .290", 5/16", 3/8" or 1/2" ferrule or cable entrance. Knurled nut securely fastens unit together. Plugs have ceramic insulation and sockets have bakelite. Quality construction. Fine finish. Assembly meets Navy specifications. For full details and engineering data ask for Jones Catalog No. CS-22

**JONES MEANS  
Proven Quality**



HOWARD B. JONES DIVISION  
CINCINNATI MANUFACTURING COMPANY  
CHICAGO 24, ILLINOIS  
DIVISION OF UNITED-CARE FASTENER CORP.

CIRCLE 215 ON READER SERVICE CARD

Transistorized DC Power

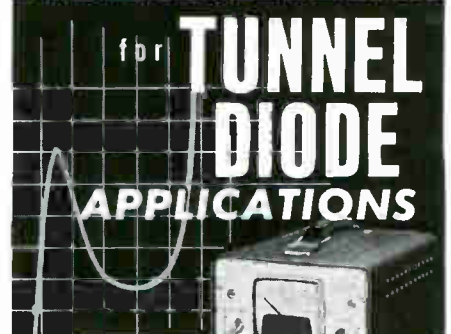

**\$199.50**

Supplies regulated voltage output down to the millivolt region for tunnel diode biasing applications. Switchable to a constant current supply. Settable short circuit protection also makes it an ideal unit for general laboratory use.

T50-600	0-50VDC @ 0-600 ma 0.05% Regulation, 0.5 mv Ripple
T20-1	0-20VDC @ 0-1 amp. 0.05% Regulation, 0.5 mv Ripple

SEND FOR COMPLETE CATALOG

**TRYGON ELECTRONICS INC.**  
111 Pleasant Ave.,  
Roosevelt, N. Y.

CIRCLE 167 ON READER SERVICE CARD 167

# MASSA RECORDERS

**MORE DATA**

**PER DOLLAR**

ONLY SOURCE FOR

# HIGH SPEED RECTILINEAR INK WRITING

NOW IN 4 CHANNEL — 40 MM

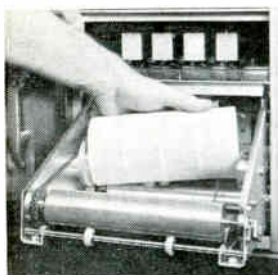
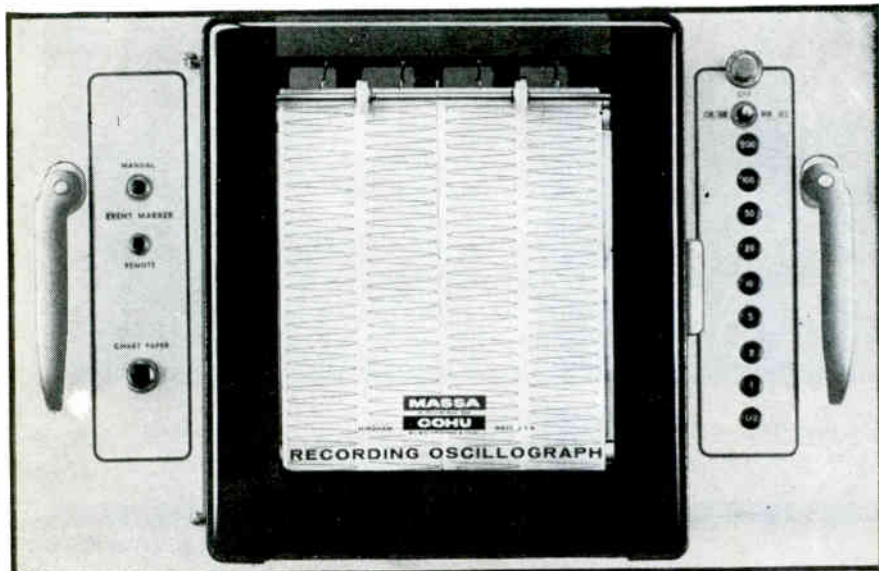

Convenient, instant chart paper reloading from front of recorder.

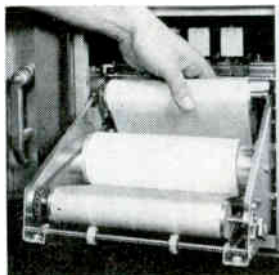

Easy threading of chart paper to internal take-up roll for data storage.

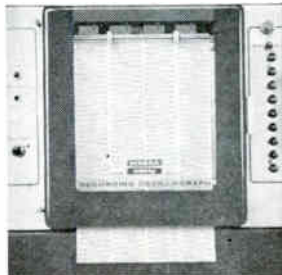

Alternately, chart paper may feed out from front as shown.

All of the exclusive features incorporated in previous Massa Recorders, including the *New Controlled Linearity Oscillographs*, are incorporated in the NEW 4 CHANNEL RECORDING SYSTEM. The all new front design greatly simplifies chart paper loading and permits full instant view of pen action and recorded signals on 7 x 10" writing table. Improved tracking, instant loading, accurate performance, are some of the novel features included in the new design.

Other features: 40 mm (full scale) Oscillographs, DC to 120 cps • Ink or electric rectilinear writing • 18 chart speeds, from 0.5 cm/hr to 20 mm/sec • Event Marker • Automatic warning light for low chart indicator.

The new 4 channel recorder is now available in complete recording systems including individual transistorized driver amplifiers and power supplies for each channel, and a choice of interchangeable plug-in preamplifiers including DC, AC, Carrier and Chopper.

**MASSA**

A DIVISION OF

**COHU**

ELECTRONICS, INC.

6 FOTTLER RD.

HINGHAM, MASSACHUSETTS

## OTHER MASSA PRODUCTS

COMPLETE LINE OF  
MULTICHANNEL AND PORTABLE RECORDING SYSTEMS

ACCELEROMETERS  
HYDROPHONES

MICROPHONES  
AMPLIFIERS

SONAR TRANSDUCERS

## Literature of

**MICROWAVE CATALOG** Orion Electronic Corp., 108 Columbus Ave., Tuckahoe, N. Y. A new catalog describes the company's line of modular i-f amplifiers, automatic frequency controls for klystrons, microwave i-f converters and high temperature transistorized power supplies.

CIRCLE 352 ON READER SERVICE CARD

**FILTERS AND HIGH Q COILS** United Transformer Corp., 150 Varick St., New York 13, N. Y. The new 1960-1961 16-page supplement catalog offers complete information on electric wave filters and high Q coils. It is especially prepared for separate filing.

CIRCLE 353 ON READER SERVICE CARD

**TRANSISTOR TESTERS** The Hickok Electrical Instrument Co., 10527 Dupont Ave., Cleveland 8, Ohio. Model 870 dynamic beta transistor tester and model 850P portable transistor analyzer are described in a new 4-page brochure.

CIRCLE 354 ON READER SERVICE CARD

**ISOLATORS** Barry Controls Inc., 700 Pleasant St., Watertown 72, Mass. Bulletin 60-07 describes series L21 and L22 miniature "LO" isolators which provide a high degree of shock and vibration protection for aircraft electronic equipment.

CIRCLE 355 ON READER SERVICE CARD

**SAFETY ENCLOSURE CATALOG** Kewaunee Scientific Equipment, 4015 Logan St., Adrian, Mich. A 32-page catalog illustrates and describes a line of glove, vacuum and dry boxes; and controlled atmosphere systems for research and production purposes.

CIRCLE 356 ON READER SERVICE CARD

**MICROWAVE PRESSURE WINDOWS** Microwave Associates, Inc., Burlington, Mass., has available a new 12-page brochure describing waveguide pressure windows, their applications, and installation suggestions.

CIRCLE 357 ON READER SERVICE CARD

**TELEPHONE TYPE RELAYS** Potter & Brumfield, Princeton, Ind. A four-page full color folder shows a complete line of telephone type



# the Week

relays. Included is a chart showing all of the electrical and mechanical characteristics of the seven basic types of relays as well as coil data and available enclosures.

CIRCLE 358 ON READER SERVICE CARD

**POWER OSCILLATOR** Industrial Test Equipment Co., 55 E. 11th St., New York 3, N. Y. A recent bulletin illustrates and describes the model 1040, a compact precision oscillator providing 3 watts output.

CIRCLE 359 ON READER SERVICE CARD

**SELENIUM RECTIFIERS** Sarkes Tarzian, Inc., 415 College St., Bloomington, Ind. Selenium rectifier catalog No. 4002 carries cell ratings and detailed specifications and dimensions with maximum and minimum voltage and current ranges of high voltage stacks, power stacks, and a-c and d-c surge suppressors.

CIRCLE 360 ON READER SERVICE CARD

**PULSE GENERATOR** Valor Instruments, Inc., 13214 Crenshaw, Gardena, Calif. A 12-page booklet describes the uses and applications of pulse generators with particular emphasis on high-speed transistorized circuits.

CIRCLE 361 ON READER SERVICE CARD

**MEMORY CORE HANDLER** Rese Engineering, Inc., 731 Arch St., Philadelphia 6, Pa. Technical bulletin 60-A describes model CH-58 automatic memory core handler for testing miniature ferrite cores.

CIRCLE 362 ON READER SERVICE CARD

**SUBCARRIER OSCILLATOR** Dorsett Electronics Laboratories, Inc., 119 West Boyd, Norman, Okla. Detailed specifications on the new model 0-20 voltage controlled subcarrier oscillator for telemetering are presented in a two-color, four-page folder.

CIRCLE 363 ON READER SERVICE CARD

**READ-OUT INDICATOR LIGHTS** Dialight Corp., 60 Stewart Ave., Brooklyn 37, N. Y. A 4-page colorful brochure surveys the subject of read-out indicator lights—that is, Dialco assemblies which illuminate digits, letters, symbols, or words.

CIRCLE 364 ON READER SERVICE CARD



**NO SPRINGS  
IN KEARFOTT'S  
RELIABLE  
SERVO VALVE**

Kearfott's unique approach to electrohydraulic feedback amplification design has resulted in a high-performance miniature servo valve with just two moving parts. Ideally suited to missile, aircraft and industrial applications, these anti-clogging, 2-stage, 4-way selector valves provide high frequency response and proved reliability even with highly contaminated fluids and under conditions of extreme temperature. Titanium construction provides high strength-to-weight ratio.

KEARFOTT DIVISION  
Little Falls, New Jersey



GENERAL PRECISION, INC.  
Other Divisions GPL Librascope Link

CIRCLE 216 ON READER SERVICE CARD

the New and Complete series of

## COSMICAR LENSES FOR 16mm - ITV

12.5mm f/1.4	50mm f/1.9
12.5mm f/1.9	75mm f/1.4
15.8mm f/1.4	75mm f/1.9
25mm f/1.4	75mm f/2.5
25mm f/1.9	150mm f/4.5
50mm f/1.4	

All available in C-mounts

Write for further details, prices, and your project requirements to



## ICHIZUKA OPTICAL IND. CO., LTD.

designers · manufacturers · exporters

588, 2-CHOME, SHIMOOCHIAI, SHINJUKU-KU, TOKYO, JAPAN  
CABLE ADDRESS: "MOVIEKINO" TOKYO

... one of Japan's foremost optical companies ... the only firm presenting wide range of quality lenses for 16mm - ITV in Japan

CIRCLE 217 ON READER SERVICE CARD

send for this

# FREE

**EICO Electronics Catalog**



you save 50% on Top-Quality Test Instruments  
**HI-FI • Ham Gear**  
**KITS AND WIRED**  
for professional and home use

<b>TEST INSTRUMENTS</b> battery eliminators battery testers bridges decade boxes electronic switch flyback tester oscilloscopes probes signal and sweep generators tube testers transistor tester vacuum tube voltmeters volt-ohm-milliammeters	<b>HI-FI stereo and monaural</b> tuners preamplifiers power amplifiers integrated amplifiers speaker systems
	<b>HAM GEAR</b> cw transmitter modulator-driver grid dip meter

**OVER 2 MILLION** EICO instruments in use throughout the world.

LIFETIME service and calibration guarantee. IN STOCK at your neighborhood EICO dealer. Send now for FREE catalog E10A



33-00 N. Blvd., L. I. C. I, N. Y.  
... praised by the experts as BEST BUYS IN ELECTRONICS

© 1960 ELECTRONIC INSTR. CO., INC.

CIRCLE 169 ON READER SERVICE CARD 169

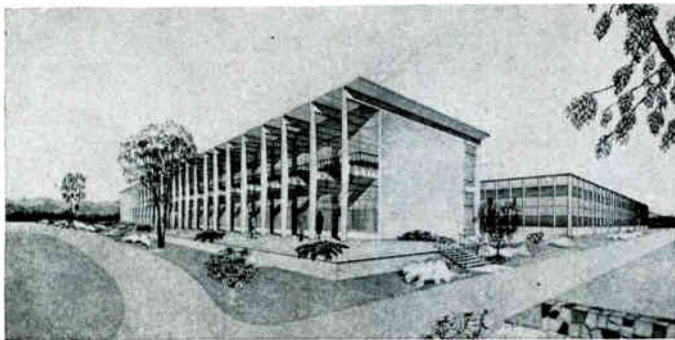

## Perkin-Elmer Still Expanding

CONSTRUCTION of a new plant, which will increase its present facilities by 40 percent, has been announced by the Perkin-Elmer Corp., Norwalk, Conn. The plant represents the third major building expansion by the company in the past four years.

The structure will be a modern, air-conditioned two-story building of 100,000 sq ft. It will be situated on a 16-acre plot in Wilton, Conn., a short distance from Perkin-Elmer's main Norwalk plant, and is scheduled to be ready for occupancy by the late spring of 1961.

The Wilton plant will be occupied by the engineering and advanced research and development groups of the company's Electro-Optical division. The division develops and makes electronic-optical systems for a variety of space and defense programs.

The new building will consist of three interconnecting wings. Administrative staff functions will be housed in a "T" office building at the front, and the engineering and advanced research and development departments in a two-story building to the rear. The link between the administrative and engineering buildings contains training rooms and a cafeteria.

### Pettegrew Heads EIA'S Walsh-Healey Committee

MARION E. PETTEGREW, senior vice president of the Sylvania Home Electronics Division, has been appointed chairman of the Electronic

P-E's Electro-Optical division is currently producing viewing periscopes for the Project Mercury manned space capsule, a series of missile alignment theodolites for most of the major missile programs, and the 36-in. aperture balloon-borne telescope for high altitude astronomy under Project Stratoscope. The division developed and built the long range ROTI missile tracking systems in use on the Atlantic Missile Range, and the "weather eye" scanners carried aboard the Vanguard II weather satellite to survey the earth's cloud layer. The division is also engaged in the development of reconnaissance systems and military infrared systems.

Perkin-Elmer also is a producer of chemical analytical instruments for research, product quality control and process stream control, and produces a line of electronic components.

Since 1951, the company's plant operating space has increased by 520 percent. In addition to its main plant, P-E maintains three branch plants in the Norwalk area, and an advanced research and development facility in Los Angeles to serve space and defense industries in the West.

Industries Association's Walsh-Healey Policy Committee.

The committee is responsible for coordinating EIA representations to the Labor Department in proceedings under the Walsh-Healey Minimum Wage Act and for imple-

menting association efforts for repeal or modification of the act.

Electronic Industries Association is actively resisting efforts by the Labor Department to establish a nationwide minimum wage for assembly workers in electron tube and transistor fabricating plants. The association says minimum-wage determinations, if made, should be on a regional basis. In a recent brief filed with Labor Secretary James Mitchell, EIA says "The tentative minimum wage determination would adversely affect the growth of small businesses which comprise the larger part of the electronics industry and would substantially increase national defense costs since a great amount of military procurement is for electronic equipment."



### Hull Takes Over Newly Created Post

GENERAL INSTRUMENT CORP. has named Robert W. Hull as vice president in charge of reliability of its recently expanded semiconductor division, a newly created post. He will head up a special reliability department to analyze and evaluate process techniques, materials, test and rating procedures at the division's three major plants in Newark, N. J., Jamaica, N. Y., and Woonsocket, R. I. When in full operation, the new department will use data processing computers to "digest" and analyze a huge volume of test data automatically recorded on punch cards.

Hull, one of the scientists who founded the division five-and-a-half years ago, was formerly the division's director of research. Before joining General Instrument, he was

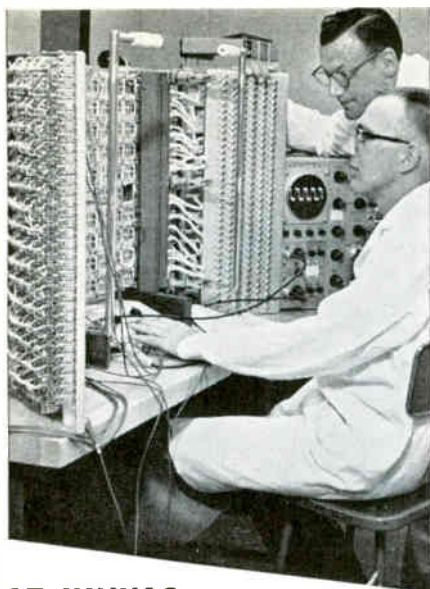

## AT UNIVAC... OPPORTUNITIES FOR Transistor Circuit Designers

Immediate openings are now available at Remington Rand Univac for Transistor Circuit Designers, as well as other professional personnel who are seeking a career opportunity.

Investigate these opportunities and make your step toward enjoying the many benefits of a position in Univac's atmosphere of achievement.

### ■ TRANSISTOR CIRCUIT DESIGNERS

Applicants should have an electrical engineering degree with a minimum of 3 years actual hardware experience in the development of data processing utilizing solid state devices.

Other openings include:

- COMMUNICATIONS ENGINEERS
- SERVO-ENGINEERS
- SYSTEMS ENGINEERS
- MECHANICAL ENGINEERS
- ENGINEER WRITERS
- MILITARY PUBLICATIONS EDITORS
- RELIABILITY ENGINEERS
- QUALITY CONTROL ENGINEERS
- PRODUCTION ENGINEERS
- STANDARDS & SPECIFICATIONS ENGINEERS

Send resume of education and experience to:  
R. K. PATTERSON, DEPT. T-10

**Remington Rand**  
**Univac**

DIVISION OF SPERRY RAND CORPORATION  
2750 West Seventh St., St. Paul 16, Minn.

There are also immediate openings in all areas of digital computer development at our other laboratories. Inquiries should be addressed to:

**F. E. NAGLE**, Dept. T-10  
REMINGTON RAND UNIVAC  
1900 West Allegheny  
Philadelphia 29, Pa.

**D. CLAVELOUX**, Dept. T-10  
REMINGTON RAND UNIVAC  
Wilson Avenue  
South Norwalk, Conn.

CIRCLE 380 ON READER SERVICE CARD

October 14, 1960



## MINIATURE, HIGH PERFORMANCE MAGNETIC BRAKE CLUTCHES

Typical applications involving these Size 11 magnetic clutches, brake clutches, and brakes include service as output controls in mechanical differential computers, as motor brakes, and as speed changers and uncouplers. Kearfott can also provide magnetic clutches, brake clutches and brakes in various other sizes to suit desired applications. Unit illustrated features clutch torque of 4 in. oz. and brake torque of 6 in. oz.



KEARFOTT DIVISION  
Little Falls, New Jersey



GENERAL PRECISION, INC.  
Other Divisions: GPL, Librascope, Link

CIRCLE 218 ON READER SERVICE CARD

## NOW... MULTIPLE INDICATORS in a compact "package" -

### Ready to Install

in a minimum of space!



The DIALCO **DATA MATRIX**<sup>®</sup>  
Manufacturing Service aids you 3 ways:

(1) Supplies ultra-miniature Lamp Holders with read-out Lamp Cartridges... (2) Fabricates panels to order... (3) Assembles Lamp Holders on panels. For computers, data processing equipment, etc.

Lamp Holders accommodate DIALCO's own Lamp Cartridges. Shown 1/2 size: DATA MATRIX No. DM-7538-40 with 40 Lamp Holders and Cartridges... Shown actual size: Incandescent Cartridge No. 39-6-1471 with short cylindrical lens; Neon Cartridge No. 38-1531 with long cylindrical lens. Many other features.

Complete details in Brochure L-160B.

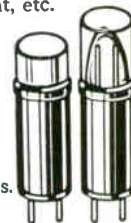

**DIALCO**<sup>®</sup>

PILOT LIGHTS  
"The Eyes of  
Your Equipment"



Foremost Manufacturer of Pilot Lights

**DIALIGHT**  
CORPORATION

58 Stewart Avenue, Brooklyn 37, N. Y. • HYacinth 7-7600

CIRCLE 171 ON READER SERVICE CARD

171

As tall as a  
7-story  
building...  
but it uses  
tiny BRISTOL  
CHOPPER

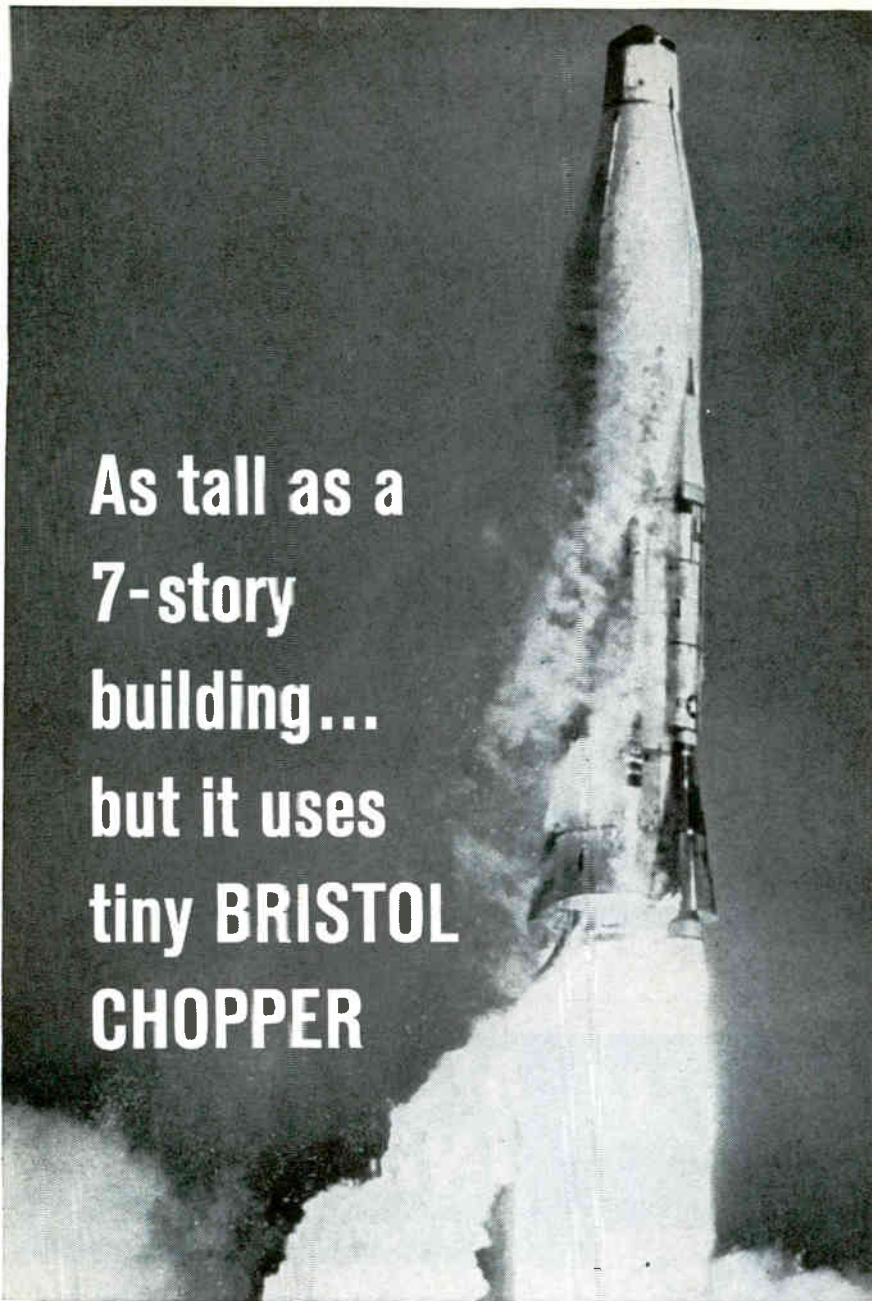

More than 40,000 parts, each of which must meet the most stringent reliability standards, make up the U. S. *Atlas* intercontinental ballistic missile, built by prime contractor Convair (Aeronautics) Division, General Dynamics Corporation.

Among these parts is the Bristol Syncroverter\* chopper . . . adding to its record of service in U. S. guided missile systems of almost every type since their very beginnings.

**Billions of operations.** To insure the reliability so necessary in aircraft and missile operations, Bristol Syncroverter choppers are constantly under test at Bristol, with and without contact load. One example: We've had five 400-cycle choppers operating with 12v, 1ma. resistive contact load, for more than 26,000 hours (2.96 years) *continuously* without failure—over 37-billion operations!

Many variations of Bristol Syncroverter choppers and high-speed relays are available—including external-coil, low-noise choppers. Write for full data. The Bristol Company, Aircraft Equipment Division, 152 Bristol Road, Waterbury 20, Conn.

\*T.M. Reg. U. S. Pat. Off.



actual size

**BRISTOL** FINE PRECISION INSTRUMENTS FOR OVER SEVENTY YEARS

See us in Booth 508 at the National Electronics Conference

on the scientific staff of Bell Telephone Laboratories and Germanium Products Corp.



### Servomechanisms Hires Chief Engineer

THOMAS H. MANSFIELD has been appointed chief engineer at Servomechanisms, Inc., El Segundo, Calif.

Former manager of the guidance and controls department at Hughes Aircraft Co., he was in supervisory or staff positions within the Hughes organization for the past six years.

Mansfield comes to SM/I with extensive experience in electronic research and the development of airborne systems, such as the MG-10 and MA-1 fire control systems and instrumentation, and in the administration of scientific programs. Before joining Hughes, he was associated with Tracerlab, Inc., directing the development of nuclear instrumentation.



### Electronic Associates Advances Adamson

ARTHUR L. ADAMSON was recently elected chairman of the board and chief financial officer of Electronic Associates, Inc., Long Branch, N. J. Formerly executive vice president and treasurer, he will devote a major portion of his time to plans for

MODEL P-25

MODEL EW-16

MODEL FL-202

MODEL VO-38

MODEL TR-A

MODEL VR-2P

MODEL TR-B

MODEL TR-C

MODEL TK-20A

MODEL TK-70B

MODEL VTVM-500

**KYORITSU ELECTRICAL INST. WORKS, LTD.**  
 No. 120, Nakone-cho, Meguro-ku, Tokyo, Japan  
 Cable Address: "KYORITSUKEIKI TOKYO"  
 Tel: (717) 0131-5

CIRCLE 219 ON READER SERVICE CARD

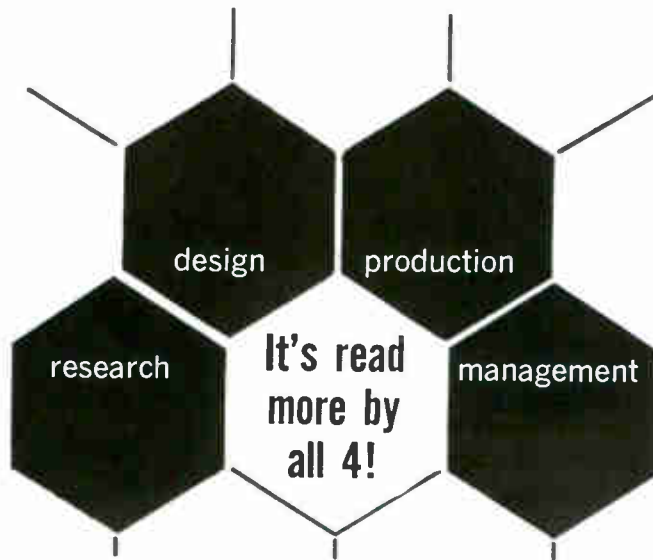

There's more data in **electronics**, the magazine that gives you the latest technical and engineering information every week *plus* business and government trends. Subscribe now. Mail the reader service card (postpaid) to **electronics**, the magazine that helps you to know and to grow! Rates: three years for \$12, one year \$6, Canadian, one year for \$10; foreign, one year for \$20. Annual **electronics BUYERS' GUIDE** (single issue price \$3.00) included with every subscription.

subscribe today to **electronics!**

October 14, 1960

# Applied Research inc.

## BANDPASS FILTERS

### 100 kcs to 4000 mcs

High selectivity

**LOW** insertion loss  
 peak/valley ratio  
 VSWR



ARI bandpass filters are rugged and compact, and in their remarkable performance meet the most advanced design requirements.

Model HFF filters operate in the frequency range of 100 kcs to 1000 mcs, and offer bandwidths of 5% to 25% of center frequency.

Model HFF-T filters operate in the frequency range of 200 to 4000 mcs. Bandwidths of 1% to 15% of center frequency are available.

#### SPECIFICATIONS

	Model HFF	Model HFF-T
Center frequency	100 kcs—1000 mcs, preset	200-4000 mcs, preset
Bandwidth	5%-25% of $f_0$ , preset	1%-15% of $f_0$ , preset
Impedance	50 ohms	50 ohms
V.S.W.R.	$\leq 1.2$ in pass band, consistent with peak to valley ratio	
Insertion loss	$\leq 1$ db	$\leq 1$ db
Peak to valley ratio	$\leq 5$ db	$\leq 5$ db
Selectivity	Defined by number of resonant elements. Doublets to sextuplets or greater are available	
Power rating	25 watts	100 watts
Connectors	BNC or Type N	BNC or Type N

Bandpass filters with other bandwidths, power ratings, etc., are available on special order. Also available — a wide variety of tunable filters.

For additional information request brochure or circle appropriate number on reply card, or send letter with technical requirements.

# Applied Research inc.

76 South Bayles Avenue—Port Washington, N.Y.

CIRCLE 173 ON READER SERVICE CARD

173

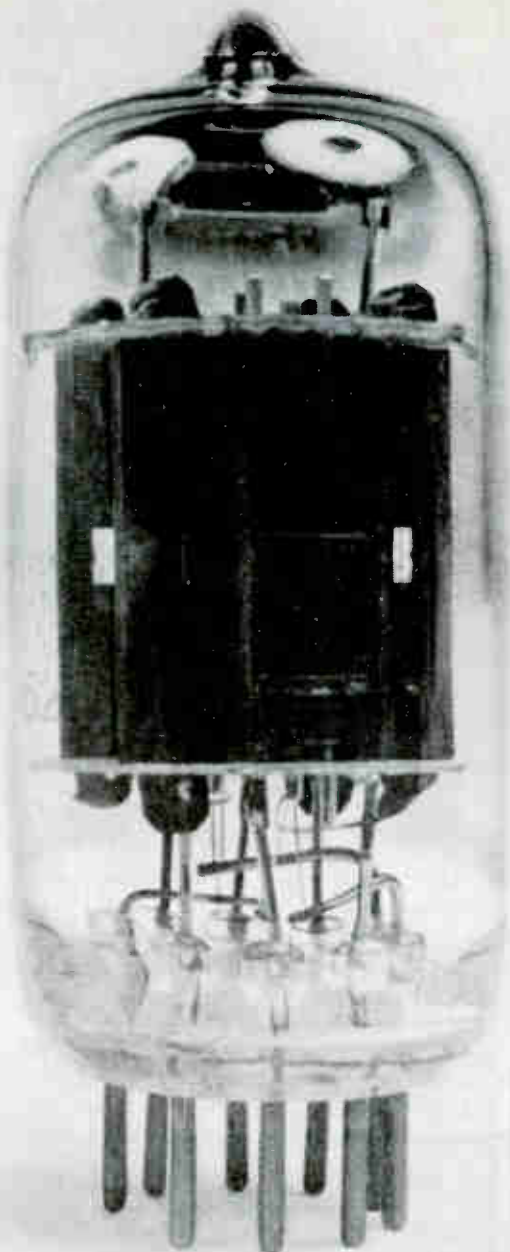

## SHIP IT FAST! SHIP IT SAFE! SHIP IT AIR FRANCE JET!

Tubes...condensers...diodes...rectifiers. The fast safe way to ship all electronic parts overseas is Air France Jet. Speed fragile items non-stop to Paris, gateway to all Europe, on 10-mile-a-minute Boeing 707 Jets. Cargo compartments are pressurized...temperature-controlled...perfect for even the most sensitive parts. Total of over 21 jet flights a week—from New York, Chicago, Los Angeles. Fast jet connections throughout Europe, Africa and the Middle East. You save money on crating, shipping weights. Lower insurance costs, too. And no one offers lower jet cargo rates than Air France. Air France speeds cargo to more cities in more countries than any other airline.

EAI's future growth, as well as having responsibility for special assignments in the financial area.

Electronic Associates, Inc., which has plants here and in England, develops and manufactures general purpose analog computing, data processing and process control equipment.



### Douglas Research Elects Saltzman

THE DOUGLAS MICROWAVE CO., INC., of Mount Vernon, N. Y., has announced the formation of a new division, Douglas Research Corp., to engage in research and development activities in the electronic fields of microwave subsystems, antennas and major equipments.

Henry Saltzman—formerly head of antenna and microwave development at the GPL division of General Precision, Inc., Pleasantville, N. Y.—has been elected president of Douglas Research.



### Audio Devices Adds To Management Staff

ORLANDO O. SCHAUS has joined Audio Devices, Inc. of New York, manufacturer of magnetic tapes, as manager of research and engineering.

Schaus has been technical director of Cyanamid of Canada for the last six years. He is a director of the Chemical Institute of Canada.

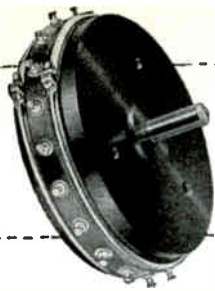

## 360° of versatility

Gamewell SG-270 Precision Rotary Switch.

A precious metal ring is the heart of a Gamewell Style SG-270 Precision Rotary Switch.

This perfect circle of metal may be cut into as many angular segments or positions as desired . . . providing the precise basis for a highly versatile switching component . . . can be assembled with potentiometer sections if desired.

Custom designed, the SG-270 switch is ideal for circuit sampling, sequencing, programming, digital generators, etc. Connections to the segments are made through terminals adjacent to the segments on the periphery of the housing. Precious metal rings and brushes provide smooth, trouble-free action with either Make Before Break (MBB) or Break Before Make (BBM) contacts. Multiple gangs can be assembled to provide multi-pole switches. Cased in special plastic, the SG-270 switch is inherently fungus resistant . . . stable at high temperatures . . . sizes  $\frac{5}{8}$ " —  $1\frac{1}{4}$ " —  $1\frac{5}{8}$ " — 2" — 3" — 5" diameter in various mounting styles. It can be used with confidence over a wide range of environmental requirements. Write, stating requirements, to THE GAMEWELL COMPANY, 1381 Chestnut Street, Newton Upper Falls 64, Massachusetts



**Precision Potentiometers**  
"Integrals of High Performance"

CIRCLE 227 ON READER SERVICE CARD

FOR MAXIMUM RELIABILITY

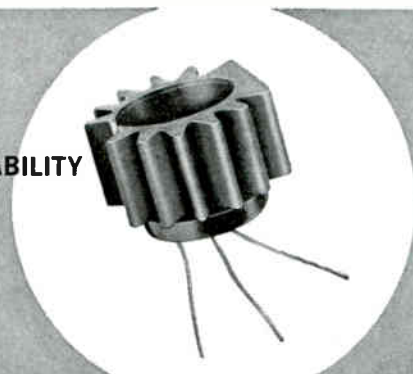

**INCREASE TRANSISTOR EFFICIENCY**  
25% - 27% and prevent thermal runaway

### THERE'S A BIRTCHEK RADIATOR FOR MOST TRANSISTORS!

Birtcher transistor radiators for most sizes of transistors permit you to get up to 25% to 27% better output efficiency. You can now either increase your input wattage up to 27%, or eliminate up to 27% of the heat with Birtcher radiators.

*and thermal runaway is prevented!*

To assure circuitry reliability . . . specify Birtcher radiators. Birtcher qualification tests conducted under MIL standards prove these performance results.

FOR CATALOG and TEST REPORTS write: THE BIRTCHEK



Sales engineering  
representatives in  
principal cities.

**CORPORATION** industrial division

745 S. Monterey Pass Rd.  
Monterey Park, Calif.  
ANgelus 8-8584

CIRCLE 221 ON READER SERVICE CARD

# Lepel

HIGH FREQUENCY  
INDUCTION  
HEATING  
UNITS



Lepel induction heating equipment represents the most advanced thought in the field of electronics . . . the most practical and efficient source of heat developed for numerous industrial applications. You are invited to send samples of work with specifications. Our engineers will process and return the completed job with full data and recommendations without cost or obligations.

### FLOATING ZONE UNIT FOR METAL REFINING AND CRYSTAL GROWING

A new floating zone fixture for the production of ultra-high purity metals and semi-conductor materials. Purification or crystal growing is achieved by traversing a narrow molten zone along the length of the process bar while it is being supported vertically in vacuum or inert gas. Designed primarily for production purposes, Model HCP also provides great flexibility for laboratory studies.

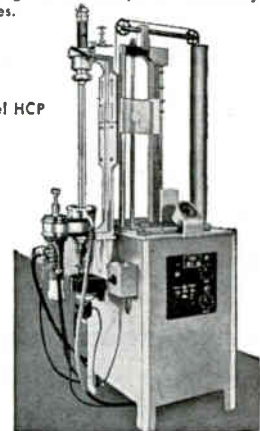

Model HCP

### Features

- A smooth, positive mechanical drive system with continuously variable up, down and rotational speeds, all independently controlled.
- An arrangement to rapidly center the process bar within a straight walled quartz tube supported between gas-tight, water-cooled end plates. Placement of the quartz tube is rather simple and adapters can be used to accommodate larger diameter tubes for larger process bars.
- Continuous water cooling for the outside of the quartz tube during operation.
- Assembly and dis-assembly of this system including removal of the completed process bar is simple and rapid.

WRITE FOR NEW LEPEL CATALOG  
Electronic Tube Generators from 1 Kw to 100 Kw.  
Spark Gap Converters from 2 Kw to 30 Kw.

**Lepel** HIGH FREQUENCY  
LABORATORIES, INC.

55th ST. & 37th AVE., WOODSIDE 77, N. Y.

(CHICAGO OFFICE: 6246 W. North Ave.)

CIRCLE 175 ON READER SERVICE CARD 175

# EMPLOYMENT OPPORTUNITIES



The advertisements in this section include all employment opportunities—executive, management, technical, selling, office, skilled, manual, etc.

## — RATES —

**DISPLAYED:** The advertising rate is \$34.33 per inch for all advertising appearing on other than a contract basis. Contract rates quoted on request.

An advertising inch is measured 7/8" vertically on a column—3 columns—30 inches to a page.

Subject to Agency Commission.

**UNDISPLAYED:** \$2.40 per line, minimum 3 lines. To figure advance payment count 5 average words as a line.

Box numbers—count as 1 line.

Discount of 10% if full payment is made in advance for 4 consecutive insertions.

Not subject to Agency Commission.

Send New Ads on **ELECTRONICS**

Class. Adv., P. O. Box 12, N. Y. 36, N. Y.

## NSL FIELD ENGINEERS

For assignment in the United States and overseas. Must be experienced in one or more of following systems:

**MICROWAVE COMMUNICATIONS  
RADAR**

Airborne or Ground

**RADIO**

Airborne or Ground

**SONAR**

**COMMUNICATIONS CENTERS**

For information phone, wire or write

**R. G. WHITMORE  
NATIONAL SCIENTIFIC LABORATORIES, INC.  
2010 Massachusetts Ave., N. W.  
Washington 6, D. C.  
HUdson 3-4030**

**CIRCLE 383 ON READER SERVICE CARD**

ADDRESS BOX NO. REPLIES TO: Box No.  
Classified Adv. Div. of this publication.  
Send to office nearest you.  
NEW YORK 36: P. O. Box 12  
CHICAGO 11: 520 N. Michigan Ave.  
SAN FRANCISCO 4: 68 Post St.

### SELLING OPPORTUNITY AVAILABLE

**Relays-Switches. Midwest mfr., well-established,** requires representation to OEM. and industry for our new division of relays and switches. Must have following. RW-5387. Electronics.

### Your Inquiries to Advertisers Will Have Special Value . . .

—for you—the advertiser—and the publisher, if you mention this publication. Advertisers value highly this evidence of the publication you read. Satisfied advertisers enable the publishers to secure more advertisers and—more advertisers mean more information on more products or better service—more value—to YOU.

## PROFESSIONAL SERVICES

### ERCO RADIO LABORATORIES, INC.

*Radio Communications Equipment*  
Engineering - Design - Development - Production  
Our 30th Year in Air to Ground  
Communication and Radio Beacon  
Garden City • Long Island • New York

### EUGENE MITTELMANN, E.E., Ph.D.

Consulting Engineer, Physicist  
**ELECTRONICS FOR INDUSTRY**  
Analysis, Research and Development  
549 West Washington Boulevard  
Chicago 6, Illinois  
Central 6-2983

### TELECHROME MFG. CORP.

*Electronic Design Specialists*  
**COLOR TELEVISION EQUIPMENT**  
Flying Spot Scanners, Color Synthesizers, Keyers,  
Monitors, Oscilloscopes and Related Apparatus  
Telemetering for Guided Missiles.  
J. R. Popkin-Curman, Pres. & Dir. of Eng.  
28 Ranick Dr. Amityville, L. I., N. Y.

### LEGAL NOTICE

STATEMENT REQUIRED BY THE ACT OF AUGUST 24, 1912, AS AMENDED BY THE ACTS OF MARCH 3, 1933, AND JULY 2, 1946 (Title 39, United States Code, Section 233) SHOWING THE OWNERSHIP, MANAGEMENT, AND CIRCULATION

Of Electronics, published weekly at Albany, New York for October 1, 1960.

1. The names and addresses of the publisher, editor, managing editor, and business manager are: Published by McGraw-Hill Publishing Company, Inc., 330 West 42nd St., New York 36, N. Y.; Editor, W. W. MacDonald, 330 West 42nd St., New York 36, N. Y.; Managing editor, J. M. Carroll, 330 West 42nd St., New York 36, N. Y.; Business manager, R. S. Quint, 330 West 42nd St., New York 36, N. Y.

2. The owner is McGraw-Hill Publishing Company, Inc., 330 West 42nd St., New York 36, N. Y. Stockholders holding 1% or more of stock are: Donald C. McGraw & Willard T. Chevalier, Trustees under Indenture of Trust m/b James H. McGraw, dated 1/14/21 as modified; Donald C. McGraw & Harold W. McGraw, Trustees under an Indenture of Trust m/b James H. McGraw, dated 7/1/37 as amended; Donald C. McGraw, individually; Estate of Mildred W. McGraw, Donald C. McGraw and Catharine McGraw Rock, Executors; (all of 330 West 42nd Street, New York 36, N. Y.); Grace W. Mehren, 536 Arenas St., LaJolla, Calif; Affiliated Fund, Inc., 63 Wall St., New York, N. Y.; Genoy & Co., P. O. Box 491, Church St. Station, New York, N. Y.; Touchstone & Co., c/o Wellington Fund, Inc., Claymont, Delaware.

3. The known bondholders, mortgagees, and other security holders owning or holding 1 percent or more of total amount of bonds, mortgages, or other securities are: None.

4. Paragraphs 2 and 3 include, in cases where the stockholder or security holder appears upon the books of the company as trustee or in any other fiduciary relation, the name of the person or corporation for whom such trustee is acting; also the statements in the two paragraphs show the affiant's full knowledge and belief as to the circumstances and conditions under which stockholders and security holders who do not appear upon the books of the company as trustees, hold stock and securities in a capacity other than that of a bona fide owner.

5. The average number of copies of each issue of this publication sold or distributed, through the mails or otherwise, to paid subscribers during the 12 months preceding the date shown above was: 52,325.

McGraw-HILL PUBLISHING COMPANY, INC.  
By JOHN J. COOKE, Secretary.  
Sworn to and subscribed before me this 15th day of September, 1960.

[SEAL] JANET A. HARTWICK.  
(My commission expires March 30, 1961)

# SEARCHLIGHT Equipment Locating Service

## NO COST OR OBLIGATION

This service is aimed at helping you, the reader of "SEARCHLIGHT", to locate Surplus new and used electronic equipment and components *not currently advertised*. (This service is for USER-BUYERS only).

How to use: Check the dealer ads on pages 127, 128 & 129 to see if what you want is not currently advertised. If not, send us the specifications of the equipment wanted on the coupon below, or on your own company letterhead to:

### Searchlight Equipment Locating Service

c/o **ELECTRONICS**

P. O. Box 12, N. Y. 36, N. Y.

Your requirements will be brought promptly to the attention of the equipment dealers advertising in this section. You will receive replies directly from them.

### Searchlight Equipment Locating Service c/o **ELECTRONICS**

P. O. Box 12, N. Y. 36, N. Y.

Please help us locate the following equipment components.

.....  
.....  
.....  
.....  
NAME .....

TITLE .....

COMPANY .....

STREET .....

CITY ..... 10-14-60



**DISPLAYED RATE**

The advertising rate is \$24.75 per inch for advertising appearing on other than a contract basis. Contract rates quoted on request. AN ADVERTISING INCH is measured 7/8 inch vertically on one column, 3 columns—30 inches—to a page. EQUIPMENT WANTED or FOR SALE ADVERTISEMENTS acceptable only in Displayed Style.

**UNDISPLAYED RATE**

\$2.40 a line, minimum 3 lines. To figure advance payment count 5 average words as a line. BOX NUMBERS count as one line additional in undisplayed ads. DISCOUNT of 10% if full payment is made in advance for four consecutive insertions of undisplayed ads (not including proposals.)

The publisher cannot accept advertising in the Searchlight Section, which lists the names of the manufacturers of resistors, capacitors, rheostats, and potentiometers, or other names designed to describe such products.

Send NEW ADS or inquiries to Classified Adv Div. of Electronics P. O. Box 12, N. Y. 36, N. Y.

**UHF, TV & AUDIO TEST EQUIPMENT**

Standard Laboratory Receiver APR-4 w/4 Tuning Units. Freq. 38-2200MC. \$239.50	Measurements Corp. 79-B Pulse Generator. Checked Out. 39.50
Gen. Elec. Computer Tester. 29.95	RCA UHF Sweep-Marker Generator Model WR 40A. 249.50
RCA UHF Sweep-Marker Generator Model WR 40A, rack mount. 89.50	RCA UHF Sweep Generator Model WR 41A. 99.50
RCA Video Sweep Generator Model WA 21A, rack mount. 49.95	RCA TV Sweep Generator Model WR 55B. 79.95
RCA TV RF Sweep Generator Model WR 94A. 39.50	RCA Distortion & Noise Meter, rack mount. 44.95
TIC Tel-Instrument Co., Wobobulator Type 1501, rack mount. 99.50	Invar Instrument Co., TV UHF Sweep Generator, Type 5GB. 69.95
Kay Marka-Sweep TV Sweep-Marker Generator Model RF-P. 104.50	Kay Mega-Plx. 59.50
Kay Mega-Marker SR. 24.95	Kay Spartan Radio TV Switched IF Oscillator. 29.95
General Radio VTM Type 726-A. 24.95	New London Instrument Co., Noise Source Model 175A. 39.95
D&R Flutter Meter Model FL-3B. 49.95	Measurements FM Signal Generator Model 78FM. 29.95
Ferris Microvoter Model 24A. 34.95	Dumont 5" Oscilloscope Model 208B. 34.95
Sylvania Polymer Type 134Z. 24.95	Industrial Instruments Model LB-1 Limit Bridge with Type DK-2AA 3 capacitor decades. 79.50
Bendix Lab TV Transmitter Channel 5, rack mount. 49.95	Hazeltine Picture Modulated Generator, rack mount. 39.50
Hazeltine Power Supply, Picture Modulated Gen., rack mount. 10.00	Hazeltine Alignment Generator, Channels 1-6, rack mount. 22.50
Hazeltine Power Supply, Alignment Gen. Chan. 1-6, rack mount. 10.00	Hazeltine Alignment Generator, Channels 7-13, rack mount. 22.50
Hazeltine Power Unit, Allgn. Gen. Chan. 7-13, rack mount. 10.00	Hazeltine Impulse Signal Generator, rack mount. 25.00
Magnavox Video Distribution Amplifier, rack mount. 35.00	Magnavox Marker Pip Generator, switchable 12 channels. 12.95
Magnavox UHF Sweep-Crystal Marker Generator, switched middle Freq. 471.5, 671.5, 869.5 mc & Auto., rack mount. 29.95	Magnavox Test Pattern Generator, rack mount. 39.50
Magnavox Signal Generator-Tuner IF Sweep. 14.50	Magnavox Crystal IF Oscillator 455kc. 9.95
Magnavox HI-Pass Filter, Electronic, Model 100, rack mount. 10.00	Magnavox Signal Generator 455kc Crystal, rack mount. 14.95
Lecher wire, 300-1500 mc., with indicator loop, bulb & slider. Silver plated brass rods. 3.95	Hi-Fi Headsets w/regular voice coil, 600 ohm freq. range 40-14,000. 8.95
We also have in stock APS 19&20 Receiver-Transmitter equip.	

WRITE FOR BARGAIN FLYER

**RW ELECTRONICS**

2430 S. Michigan Ave., Chicago 16, Ill. CALumer 5-1281

CIRCLE 460 ON READER SERVICE CARD

lab grade TEST EQUIPMENT for sale standard brands—military surplus (new or professionally reconditioned) experienced problem solvers and budget-cutters

ENGINEERING ASSOCIATES

434 Patterson Road Dayton 19, Ohio

CIRCLE 461 ON READER SERVICE CARD

## SPECIAL PURPOSE TUBES

OA2. .70	4X150A. 12.50	348A. 2.50	5528/C6L. 1.50	5896. 1.50
OA3. .85	4X250B. 30.00	349A. 2.50	5545. 12.50	5899A. 2.50
OB2. .70	58P1A. 12.50	350A. 3.50	5552/FG-235. 45.00	5902. 2.35
OB3. .50	5C22. 16.00	350B. 3.50	5557/FG-17. 4.25	5903. 4.00
OC3. .50	5CP1A. 10.50	352A. 6.50	5558/FG-32. 7.50	5932/6L6WGA. 5.00
OD3. .30	5LP1A. 20.00	354A. 10.00	5559/FG-57. 10.00	5948/1754. 150.00
IAD4. 1.25	5R4GY. .90	355A. 10.00	5560/FG-95. 15.00	5956/E36A. 10.00
1B24A. 10.00	5R4WGB. 5.00	393A. 3.50	5586. 100.00	5963. .85
1B35A. 3.00	5R4WGY. 2.50	394A. 2.50	5632/C3J. 8.50	5964. .85
1B59/R1130B. 9.00	5RP1A. 10.00	396A/2C51. 2.50	5637. 1.00	5965. 1.00
1B63A. 12.50	5Y3WGT. 1.15	398A/5603. 4.00	5639. 2.00	5975. 2.00
CIK. 6.00	6AC7W. .35	401A/5590. 1.50	5642. 1.25	5977/6K4A. 1.50
1P21. 25.00	6AG7Y. .75	403A/6AK5. 1.00	5643. 4.50	5981/5650. 25.00
1P25. 10.00	6AK5W. 1.00	403B/5591. 3.00	5644. 2.50	5992. 2.00
1P28. 20.00	6AN5WA. 3.00	404A/5847. 10.00	5646. 2.00	5993. 4.00
2-OIC. 12.50	6A57G. 2.35	407A. 3.50	5647. 2.25	6005/6AQ5W. 1.25
2AP1A. 2.50	6B4G. 2.50	408A/6028. 2.00	5651. .70	6012. 5.00
2BP1. 6.00	6BL6. 30.00	409A/6A56. 2.00	5654/6AK5W. 1.00	6021. 2.00
2C39. 2.50	6BM6. 30.00	412A. 4.00	5656. 3.50	6032. 25.00
2C39A. 7.50	6BM6A. 30.00	415A. 3.00	5665/CT6J. 28.50	6036/QK-243. 25.00
2C40. 7.00	6C21. 10.00	416B/6280. 30.00	5670WA. 1.35	6045. 1.25
2C43. 7.50	6CJ. 12.50	417A/5842. 10.00	5675. 7.00	6072. 1.75
2C50. 4.00	6J4WA. 1.50	418A. 15.00	5676. 1.25	6073. .80
2C51. 1.50	6J6W. .60	420A/5755. 5.00	5678. 1.25	6080. 2.85
2C52. 1.50	6L6GAY. .90	421A/5998. 7.50	5684/C3J/A. 11.80	6080WA. 4.85
2D21. .50	6L6WGB. 1.75	422A. 10.00	5685/C6J/A. 15.00	6080WB. 10.00
2D21W. 1.00	6Q5G. 2.50	423A/6140. 5.00	5686. 1.85	6082. 3.00
2E24. 2.50	6S7WGT. 1.00	429A. 9.00	5687WA. 2.00	6087/5Y3WGTB. 3.00
2E26. 2.50	6S7WGT. .85	450TH. 30.00	5691. 5.00	6099. .75
2J42. 35.00	6SN7WGT. .65	450TL. 30.00	5692. 2.00	6100/6C4WA. 1.25
2J51. 50.00	6V6GY. 7.5	575A. 12.50	5693. 3.50	6101/6J6WA. 1.00
2K25. 8.50	6X4W. .75	631-PI. 4.25	5702WA. 2.75	6111A. 2.00
2K26. 25.00	6X5WGT. 1.00	673. 12.50	5703WA. 3.00	6112. 2.50
2K29. 25.00	7MP7. 17.50	676. 27.50	5704. 1.00	6115/QK-351. 50.00
2K30. 75.00	10KP7. 20.00	677. 27.50	5718. 1.00	6130/3C45. 8.50
2K34. 100.00	12AT7WA. 1.40	714AY. 10.00	5719A. 1.50	6136/6AU6WA. 1.25
2K35. 250.00	HK-24. 1.00	715C. 10.00	5720/FG-33. 17.00	6137/6SK7WA. 1.50
2K41. 25.00	2K41. 7.50	719A. 7.50	5721. 125.00	6146. 3.75
2K42. 125.00	26Z5W. 1.25	721B. 3.00	5725/6A56W. 1.00	6252. 4.50
2K43. 125.00	35T. 7.50	723A/B. 2.50	5726/6AL5W. .60	6186/6AG5WA. 1.50
2K44. 125.00	35TG. 2.50	725A. 5.00	5727/2D21W. 1.00	6189/12AU7WA. 1.50
2K47. 125.00	FG-105. 33.35	726B. 3.25	5728/FG-67. 7.50	6197. 1.75
2K50. 65.00	FG-172. 17.50	750TL. 87.50	5740/FP-54. 50.00	6199. 35.00
2X2A. 1.00	212E. 25.00	BL-800A. 50.00	5744WA. 2.75	6201/12AT7WA. 1.75
2X1000A. 95.00	244A. 2.50	802. 4.50	5749/6BA6W. .75	6202/6X4WA. 1.50
3AP1A. 10.00	245A. 3.50	804. 15.00	5750/6BE6W. 1.35	6211. .65
3B24W. 3.50	249B. 10.00	805. 3.00	5751/12AX7W. 1.35	6216. 2.50
3B25. 3.00	249C. 5.00	807. 1.25	5763. 1.50	6236. 170.00
3B28. 4.00	250R. 7.50	809. 3.75	5777. 100.00	6263. 9.00
3BP1A. 7.50	252A. 6.00	810. 12.50	5778. 150.00	6264. 9.00
3C22. 30.00	254A. 2.00	811A. 4.75	5783. 2.00	6265. 2.25
3C23. 4.50	257A. 3.50	813. 8.50	5784WA. 3.50	6299. 37.50
3C24/24G. 2.50	259A. 3.50	814. 1.50	5787. 2.50	6336. 8.00
3C45. 3.00	262B. 3.50	815. 1.50	5799/VX-21. 3.00	6352. 8.50
3D22. 9.50	267B. 7.50	816. 1.75	5800/VX-41. 3.50	6364. 150.00
3E29. 3.50	271A. 10.00	828. 7.00	5801/VX-33A. 3.00	6390. 170.00
3J21. 35.00	272A. 4.00	829B. 7.25	5802/VX-32B. 3.50	6438. 4.00
3J31. 50.00	274A. 2.50	832. 2.00	5803/VX-55. 1.50	6463. 1.25
3K21. 150.00	275A. 4.00	833A. 33.00	5814A. 1.25	6517/QK358. 500.00
3K22. 150.00	283A. 3.50	836. 1.00	5819. 45.00	6533. 6.50
3K23. 250.00	287A. 2.50	837. .90	5824. 2.50	6544. 250.00
3K27. 185.00	293A. 4.50	845. 7.50	5828. 3.00	6550. 4.25
3K30. 75.00	300B. 5.00	866A. 1.85	5829WA. 1.50	6626/OA2WA. 2.00
3K31. 10.00	304TH. 30.00	872A. 1.65	5836. 60.00	6627/OB2WA. 2.00
3X2500A3. 148.00	304TL. 30.00	884. 1.00	5837. 60.00	6655. 40.00
4-65A. 9.50	310A. 3.50	913. 7.50	5839. 2.50	6754. 10.00
4-125A. 20.00	311A. 2.50	927. 1.25	5840. 2.00	6784. 250.00
4-250A. 30.00	313C. 1.00	931A. 3.00	5845. 4.85	6897. 18.75
4-400A. 32.50	323A. 6.50	959. .50	5852. 2.50	6901. 10.00
4-1000A. 90.00	328A. 2.50	1000T. 97.50	5854. 1.50	8005. 5.00
4AP10. 10.00	329A. 3.50	1500T. 150.00	5876. 7.50	8013A. 3.00
4B31. 15.00	336A. 2.50	1614. 2.50	5879. 1.00	8020. 1.50
4C35. 15.00	337A. 3.50	1620. 3.50	5881/6L6WGB. 1.75	8025. 3.00
4E27. 7.50	339A. 4.00	1624. .75	5886. 3.00	9002. .35
4J52. 25.00	347A. 1.50	2050. 1.00	5894. 15.00	9005. 3.00

ALL TUBES ARE NEW, INDIVIDUALLY CARTONED, FULLY GUARANTEED

## western engineers

ELK GROVE, CALIFORNIA

SUPPLIERS OF ELECTRON TUBES SINCE 1932

Orders for less than \$10 cannot be processed

Prices are FOB shipping point

CIRCLE 462 ON READER SERVICE CARD

# "TAB"

**NEW \*SILICON 750 MA RECTIFIERS WORKING VOLTS RMS-ACV INPUT!**

Order 10 or More 750Ma Deduct 10%

rms/piv 35/50 19¢	rms/piv 70/100 29¢	rms/piv 140/200 34¢	rms/piv 210/300 43¢
rms/piv 280/400 50¢	rms/piv 350/500 62¢	rms/piv 420/600 80¢	rms/piv 490/700 95¢
rms/piv 560/800 \$1.05	rms/piv 630/900 \$1.25	rms/piv 700/1000 \$1.70	rms/piv 770/1100 \$2.00

Use in Bridge or C.T. up to 1 amp DC  
 "TAB" Special General Purpose Silicons  
 400 PIV @ 300Ma 39¢ @ .25 for \$8.00  
 \*Deduct 20% for Capacitive Input  
 Write for Data & Qty Prices

New Low Prices

## "SOLA"

**CONSTANT VOLTAGE DC POWER SUPPLIES LINE & LOAD REGULATED**



Chassis Type, 1% regulation & up to 10% line regulation on output. Ripple 1% or Less. DC Output 47V at 4.5 AMP & AC/FIL 6.3V at 3 AMP. Input Line 92 to 125-184 to 250VAC/60Cps/1ϕ  
 SOLA #28119 Cost \$325—SPECIAL \$79.

SOLA #28140 Output 120VDC at 1Amp Regulation 1% Ripple 1%. Inpt 95 to 125VAC/60Cps/1ϕ. Cost \$285.—SPECIAL \$88.

SOLA #28172 Output 100 VDC at 7 Amps. Input 200 to 260VAC/60Cps/1ϕ. Cost \$383.—SPECIAL \$120.

### TRANSISTORS & ACCESSORIES

2N411 \$3. 2N442 \$4.50. 2N277 \$4. 2N278 \$5. 2N155 \$1.39. 2N176 \$1.80. 2N177 \$1. 2N178 \$1.75. 2N247 \$1.50. 2N255 \$1.20. 2N270 \$9.95. 2N274 \$1.25. 2N408 \$8.80. 2N444 \$1.20. 2N578 \$1.80. 2N579 \$2.20. 2N581 \$1.25. 2N582 \$2.10. 2N174 \$8.50. 2N443 \$6.50.

DIAMOND BASE MICA MOUNTING KIT.....\$30  
 DELCO ROUND BASE MICA MOUNTING KIT. 30  
 DELCO POWER HEAT SINK WITH FINS.....\$1.00

"CHRONISTOR"® BERGEN LABS  
 ELECTRO-CHEMICAL ELPSER TIME INDICATOR. 1000 HOUR \$1.50 @ .5 for \$5

**WESTERN ELECTRIC TD-2 MICROWAVE SYSTEM GENERATOR UWV GEN**



#J683330G/SD59409  
 Write for Complete Specs  
 P/O the TD-2 Microwave Relay Crystal OSC. @ 17.5-19Mc Multiplying to 3780-4100Mc Xtal Oven, 3 Tuneable Cavities 630-683. 1890-2050. 3780-4100. Uses 416B's. 2-C43. Relay Rack 10 1/2". Requires DC 12V/6A. 130V/.052Ma. 250V/80Ma (XTAL NOT INCLUDED) W. E. Cost \$2361. Special L/N \$99.

**"BRIICH" SIX CHANNEL OSCILLOGRAPH**  
 Late Model RD2661-00 six channel direct writing instantaneous recording. Eight speed transmission 1, 2, 5, 10, 25, 50, 125 & 250mm per sec chart paper. Contains six channels. Chart regulation better than 3/4%. Power input 105-125V at 60 cys. 185 Watts. 19" Rack MTG. 12 1/2" h. In like new condition cost \$2525 Special \$1000.

Write for complete specs  
 RA2961-80 chart paper 850 ft lgh (CP \$15) per roll.

### "TAB" SPECIAL TEST EQUIPMENT!

LAMBDA 35 spec, 100 to 200VDC @ 300Ma.....\$110  
 TS497B/URR Sig Gen 200-400Mc's Late Model. 0.1 to 100,000Mc Cost \$1900 Special \$295  
 Measurements #78E1RF aligner.....\$50  
 GR 107M variable inductor 0 to 30 MH.....\$39  
 GR 726A AC VTVM 0-1.5, 5, 15, 50.....\$49  
 RCA lab-teawagon scope-flat to 11Mc's.....\$135  
 GR 508A fixed freq audio OSC 200-4KC.....\$25  
 Snerly #188 wattmeter .007 to 5MW.....\$37  
 Snerly #193A wattmeter .002 to 10MW.....\$48  
 Doolittle FD9A freq deviation monitor.....\$99  
 Doolittle FD8E freq deviation monitor.....\$99  
 Snerly microline #436A/5-5.2K MC T.S.....\$350  
 Sylvania #5E Synchroscope.....\$109  
 1-177 Hickok type mu-cond tube chkr.....\$35  
 BC221 freq meter .01%/125 to 20Mc's newly recond by Sig Corps Labs.....\$100

WE BUY SELL & TRADE!!!!

### SELENIUM PHOTOCELL—"SUNTAB"®

5AP Round 1 3/4" Dia. 250µa.....\$1.00  
 10AP Round 1 3/4" Dia. 360µa.....\$1.75  
 15AP Round 2" Dia. 750µa.....\$3.00  
 2BP Rect 3/4 x 7/16-75µa......70  
 5BP Rect 200µa.....\$1.35  
 10 BP Rect 1-11/16 x 7/8-360µa.....\$1.80  
 KIT ALL SIX ONE EACH.....\$7.00  
 Order qty's ten or more deduct 20%

WANTED TEST EQUIPMENT

SEND 25¢ FOR NEW INDUSTRIAL CATALOG  
 WANTED 304TL TUBES & KLYSTRONS 726C

**"TAB"** TERMS: Money Back Guaranteed  
 Our 15th year. \$2 min. order  
 F.O.B. N.Y.C. Add ship. charges  
 or for C.O.D. 25% Dep. Prices  
 shown subject to change.  
 111 EX LIBERTY ST., N. Y. G. N. Y.

Send 25¢ for Catalog

PHONE: RECTOR 2-6245  
**CIRCLE 463 ON READER SERVICE CARD**

### MIT MODEL 9 PULSER 1 MEGAWATT-HARD TUBE

Output pulse power 25KV at 40 amp. Max duty ratio: .002. Uses 6C21 pulse tube. Pulse duration .25 to 2 microsec. Input 115 volts 60 cycle AC. Includes power supply in separate cabinet and driver. Fully guaranteed as new condition. Full Desc. MIT. Rad. Lab. series "Pulse Generators." Vol. 5 pp. 152.

### MIT MODEL 3 PULSER

Output: 144kw (12kv at 12 amp). Duty ratio: .001 max. Pulse duration: .5. 1 and 2 micro sec. Input: 115v 400 to 2000 cps and 24vdc. \$325 ea. Full desc. Vol. 5 MIT Rad. Lab. series pp. 140.

### AN/TPS-1D RADAR

500 KW. 1220-1350 MCS. 160 nautical mile search range P.P.I. and A Scopes. MTI. Thyatron Mod. 5126 Magnetron. Like new. Complete system incl. Spare parts and gas generator field supply.

## RADIO RESEARCH INSTRUMENT CO.

550 FIFTH AVE.  
 NEW YORK  
 JUDSON  
 6-4691

### ANTENNA PEDESTAL SCR 584—MP 61B

Full azimuth and elevation sweeps. 360 degrees in azimuth. 210 degrees in elevation. Accurate to 1 mil. or better over system. Complete for full tracking response. Angle acceleration rate: AZ. 9 degrees per second squared EL. 4Z degrees per second squared. Angle slewing rate: AZ 20 degrees per sec. EL. 10 degrees per sec. Angle tracking rate: 10 degrees per sec. Includes pedestal drives, selsyns, potentiometers, drive motors, control amplifiers. Excellent condition. Quantity in stock for immediate shipment. Ideal for missile & satellite tracking, antenna pattern ranges, radar systems, radio astronomy, any project requiring accurate response in elevation and azimuth. Complete description in McGraw-Hill Radiation Laboratory Series, Volume 1, page 284 and page 209, and Volume 26, page 233.

### AUTOMATIC TRACKING RADAR

SCR 584 is in like new condition, ready to go, and in stock for immediate delivery. Ideal for research and development, airway control, CCA, missile tracking, balloon tracking, weather forecasting, anti-aircraft defense, tactical air support. Write us Fully Desc. MIT Rad. Lab. Series, Vol. 1, pp. 207-210, 238, 284-286.

### CIRCLE 478 ON READER SERVICE CARD

### 0.1% SORESEN Line Voltage Regulator

±50005. Brand new at low surplus price! Input 95-130 V, 1 ϕ., with taps for 50 or 60 cy. Use for any power up to 5000 watts. Output adjustable 110-120 V and holds to ±0.1% at line frequency, or to ±0.25% if line frequency drifts 5%. Regulates against line changes of 95-130 V and against load changes from 0 to 5 KVA. Maximum harmonics less than 3%! Recovery time 0.15 seconds. Input to the control section can be moved to the point where you wish use the power, thus compensating for line drop. In rack cabinet 28" h, 22" wd, 15" dp. Net wt 190 lbs. Ship wt 285 lbs FOB Utica, N. Y. In original factory pack suitable for export, including SPARE PARTS group. Sorensen catalog net price is \$695.00 \$349.50 less spares. Our price, WITH SPARES.....



It is smart planning to buy this 5 KVA capability even if your present need is for lower power, because: 1. It works just as well at lower power. 2. Price is as low as a 1 KVA unit! (Sorensen's prices, LESS SPARES, are \$320.00 for 1 KVA, \$460.00 for 2 KVA, \$520.00 for 3 KVA, and \$695.00 for 5 KVA.)

### MEASUREMENTS CORP. Pulse Generator

MEAS. CORP. MOD. 79-B PULSE GENERATOR, 60-100,000 cps pulses 1/2-40 usecs wd, and 4 sync pulses delayed 1/2 period. Can pulse modulate an external RF source and can be synched by an external sine source. This is the model preceding the current catalog model which sells for \$495.00. Brand new in original packing, with instruction book, 40 lbs fob Harrisburg, Pa. .... \$97.50

Circle Readers Service Card for our new listing of budget stretchers selected for you from surplus.

### R. E. GOODHEART CO.

P. O. Box 1220-E Beverly Hills, Calif.

**CIRCLE 465 ON READER SERVICE CARD**

### BERGER & CO.

816 Connecticut Avenue  
 Washington 6, D. C.  
 STerling 3-1184

### INVESTMENTS

Specialized Negotiators for the Purchase, Sale or Merger of Electronic and Research and Development Companies.

**CIRCLE 466 ON READER SERVICE CARD**

the Country's largest and most dependable supplier of

## CONNECTORS FITTINGS & CLAMPS

We stock more than 5,000,000 MS/AN CONNECTORS . . . 50,000 variations!

These include . . .

- "MS" (AN) • 89
- "MS"-E • DPD
- "W" • 164
- K • 126
- MRE
- TBF
- K-RK
- GS

"MS" (AN) CONNECTORS, CLAMPS and FITTINGS are available at "O.E.M." PRICE . . . and LOWER . . . in PRODUCTION QUANTITIES.

AMPHENOL — BENDIX — CANNON — WINCHESTER — CONTINENTAL — DEJUR AMSCO — H. H. BUGGIE — IPC KINGS — CINCH — JONES — DAGE — DIAMOND

Send for FREE . . . latest brochure and list price chart

### Wilgreen Industries, Inc.

100 Warren Street, New York 7, N. Y.  
 WOrth 4-2490-1-2 Wire: FFK

**CIRCLE 467 ON READER SERVICE CARD**

### 400 CYCLE GASOLINE DRIVEN GENERATOR

Delivers 1400 watts 120V AC 400 cycle and 28.5V DC @ 14.3 Amp. Mfg. Homelite, Signal Corps PUB/TPS-1. Used—good condition. Wt. 200 lbs. FOB N.Y.C. \$250.00.

DERF RADIO CO.  
 17 Hudson St. NYC 13 WALKER 5-2366

**CIRCLE 468 ON READER SERVICE CARD**

### MINIATURE CONNECTORS

- \* WINCHESTER
- \* CONTINENTAL
- \* U. S. COMPONENTS

Tremendous Inventory . . . At Below Factory Prices

A. MOGULL CO.  
 17 Warren St. N.Y.C. 7 WO 4-0865

**CIRCLE 469 ON READER SERVICE CARD**

### SPECIAL SERVICE

Want development—Manufacture—Service—Installation—Sales of Electrical, Electronic Products. 30 yrs engineering experience. Tel—Tech 1110 N.E. 4 Ave. Ft. Lauderdale Fla.

**BARRY**

**ELECTRONICS . . . where you BUY WITH CONFIDENCE**

• SPECIAL OFFERINGS •

Auto-Transformer. Input: 230 Volts @ 60 CPS. Output: 80 to 125 Volts by means of 9 taps 5 Volts apart. 2.25 KVA. 1600 Volt insulation. 9" H x 7 1/2" W x 6 1/2" D. Brand new in original boxes . . . \$15.00

Kenyon Modulation Transformer. 2500 Watts max. audio. Pri. impedance: 12 K Ohms. Sec. imp: 7500/5000 Ohms. (150 to 3500 CPS ± 3 db). New in orig. wooden box. . . \$75.00

VHF Transmitter (excellent for Telemetry work). Perfect for 2 meter and/or 1 1/4 meter conversion. Uses two 6210's into single Amperex 6360 twin Tetrode. Complete with A & B Battery Pack, connection cable, schematic and conversion info. . . \$15.00

H.P. Model 300A Harmonic Wave Analyzer \$495.00

Dumont Model 303/303A 5" Lab 'Scope...\$349.00

Dumont Model 224-A 3" Lab 'Scope...\$125.00

M. C. Jones Model 632. 600 Watt Dummy Load Resistor (RF Coax type). 51 Ohms. 0 to 3000 Mcs. . . \$75.00

PRD Type 852 Spectrum Analyzer. R.F. units with PRD type 854 Universal type Spectrum Analyzer. Both for . . . \$1500.00

G.E. Type YTW-3 Industrial Tube Analyzer. \$350.00

Power Supply. Input: 115/1/60. Output: 115/1/60 @ 500 MA and 630 VDC @ 230 Ma. Uses Pair of 866A rectifiers. . . \$39.00

Regulated Power Supply. PP-777/BPS-4. Input: 115/1/60. Output: 425 Volt approx. 1 Amp. Uses 3B28's plus 6 regulator tubes. Unused, orig. boxed . . . \$175.00

Regulated Power Supply. PP-778/BPS-4. Input: 115/1/60. Output: 375 Volts approx. @ 210 Ma. Uses three 5RWG's and four 0D3W's. Unused, orig. boxed . . . \$125.00

General Comm. Co. Model CBX. "X" Band Test Set—8430 to 9660 MCS (similar to TS-147B). Input: 115/1/50. 1600 CPS. . . \$495.00

Barkeley DPDT Knife-Switch (Manually operated). Type H. 200 Amp. 500 VAC. 250 VDC. Brand new . . . \$35.00

Berkeley Selective Amplifier Model 5585..\$195.00

Berkeley Reference Generator Model 5580 with 5 reference heads included. Complete. . . \$350.00

Browning Model OL-23 Synchroscope. . . \$350.00

H.P. Model 430-A Milli-Watt Power Meter \$125.00

N.I.E. Model L-700 Regulated Power Supply. Variable. 0-300 Volts DC @ 0-600 Ma. \$275.00

Lavoie Model LA-239C Lab 'Scope. . . \$595.00

G.R. Model 700-A Wide Range B.F.O. . . \$375.00

G.R. Model 761-A Vibration Meter with 761-P1 replacement pick-up . . . \$390.00

TS148-UP Spectrum Analyzer. Freq. range: 8470 to 9630 Mc. . . \$595.00

H.P. Model 405AR Automatic D.C. Digital Voltmeter. Range: .001 to 999 VDC. Accuracy: within plus or minus 0.2% of reading. . . \$750.00

H.P. Model 623B Freq. and Power Meter 5B25 to 7725 Mcs. . . \$1100.00

Mobile Transmitter. Uses 5618 crystal oscillator into CBS 5516 amplifier. Modern design. Includes built-in 6V vibrator power supply. Completely enclosed in aluminum cabinet. Can be modified for citizen's band. With tubes. . . \$13.95

BC-640-B VHF Transmitters. (100 to 156 MCS). Used by airlines all over the world. Also ideal for 2 meter Ham operation. Completely enclosed in deluxe relay rack. Operates from 115 or 230 VAC at 60 CPS. Final consists of pair of 3C24's (24G's) putting out over 50 watts R.F. output. These units are in original packing. . . \$395.00

Gammascint Scintillation Counter Model CAE-1002. Self-contained portable Scintillation type Gamma-Ray Detector, designed for prospecting, radiation monitoring, etc. Complete with tubes, headphone, leather strap, batteries, ready to operate. Regularly sold for \$245.00. Brand new in

original Mfr's cartons. . . \$49.95 each  
Altec-Lansing Output Transformer. Hermetically sealed. Pri: 3300 Ohms center-tapped. Sec: 500 Ohms (tapped down at 250 Ohms). A \$20.00 value for only . . . \$2.50

Heavy-Duty Swinging Choke. 1/2 Hy-at 3 Amps to 4 Hy's at 500 Ma. 10,000 V. Insulated. . . \$17.50

Westinghouse H.V. Power Supply. Input: 115 VAC 60 Cy. Single phase. Output: 80,000 V.D.C. at 4 Ma. (Also 25,000 V.D.C.) . . . \$500.00 less tubes

Acme 50 KW Plate Transformer. Model TPO-401-7,000 Volts. Puts out 7,000 Volts D.C. at 9.3 Amps, or 6000 Volts D.C. at 10.82 Amps. Primary: 440/460/480 V. 50-60 Cps, 3 phase delta connected. Brand new in crates. FOB N.J. \$650.00

RCA Hi-Frequency Type 63B3 Power Triode Water or Forced-Air Cooled. Full input up to 2,000 Mc. Fil-6.3 VAC at 3.4 Amps. Plate Voltage 1500 Max. at 400 Ma. 600 Watts input per tube. Brand new in original RCA-JAN cartons. . . \$30.00

Westinghouse Model CL-2 Caesium Tubes. Transmit on a light beam. Many lab and experimental uses. Tubes are unused and in original Westinghouse cartons. All data is enclosed. Original cost \$155.00 each. A real special. . . \$7.50

All equipment and components are subject to prior sale.

Send for your copy of the Mid-Summer/Fall edition of BARRY'S "GREENSHEET".

A complete catalog of specialized industrial electronic tubes and components.

When ordering from this advertisement, please send your inquiry to: Dept. E-10.

Walker 5-7000  
TWX: NY1-3731

**BARRY ELECTRONICS**

CORPORATION

512 BROADWAY NEW YORK 12, N. Y.

CIRCLE 470 READER SERVICE CARD

SAVE TIME & EXPENSE  
ON PURCHASING

**RELAYS**

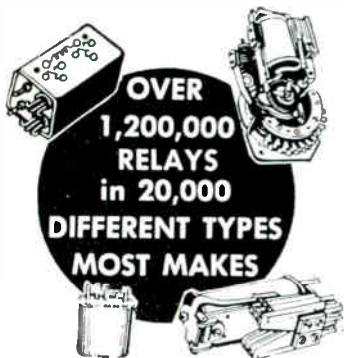

OVER  
1,200,000  
RELAYS  
in 20,000

DIFFERENT TYPES  
MOST MAKES

- PRODUCTION QUANTITIES IN STOCK
- DELIVERY ON OFF-THE-SHELF ITEMS WITHIN 48 HOURS. DELIVERY WITHIN ONE WEEK ON RELAYS REQUIRING ASSEMBLY AND/OR ADJUSTMENT.

**WE DELIVER RELAYS  
NOT PROMISES**

SEND FOR CATALOG E

**Universal RELAY CORP.**

42A White St., New York 13, N. Y. • WALKER 5-9257

CIRCLE 471 READER SERVICE CARD

October 14, 1960

Send for the most widely used ROTARY EQUIP. and ELECTRONIC COMPONENTS GUIDE

**ELECTRO SALES**

COMPLETE 176 PAGE 1961 CATALOG . . . FREE!

Send for it! Your buying guide to the world's largest stocks of Rotary Equipment and Electronic Components for industry.

- |            |            |           |
|------------|------------|-----------|
| BLOWERS    | GENERATORS | RELAYS    |
| CABLE      | INSULATORS | RESISTORS |
| CAPACITORS | METERS     | SOCKETS   |
| CONTROLS   | MOTORS     | XFORMERS  |
| CONVERTERS | RECTIFIERS | TUBES     |
| DYNAMOTORS | REDUCERS   |           |

Please reply on company letterhead and indicate company position

CHECK THESE VALUES

AMERTRAN TRANSTATS  
Max. KVA Output. . . 11.5 Single Phase. . . 5/60 cps  
Fixed Winding . . . 115 V Commutator Range. 0-130V  
Max Amperage . . . 100

Can be used by reconnection on 220V—max. 50A. Diagram available. WHILE THEY LAST . . . \$150.00

400 CPS INDUCTION MOTOR GENERATOR  
Louis Allis Type POGH—204. Input: 440V.3 ph  
60 cps 3450 rpm. Output: 115V.1 ph 400 cps.  
8.7A 90% P.F. 1.0KVA 4 bearing cont.  
duty separately excited.

SPECIAL . . . \$125.00  
Reconnected for 220/3/60. Input: \$150.00

Send for  
FREE  
Catalog

Electro Sales Co., Inc. • 50-58 Eastern Ave. • Boston 9, Mass.

Large stock of 400 cycle generators and control panels—Large stock of 60 cycle power plants, single and three phase, gasoline driven.

Write for catalogs.

Reliable Electric Motor Repair Co., Inc.  
19-21 California Ave. Paterson, N. J.

CIRCLE 473 READER SERVICE CARD

WESTON METER SPECIAL  
Model 622 AC-DC Thermo Voltmeter. Volt Ranges 3, 30, 150, 300. Complete with correction charts. SALE PRICE . . . \$225.00  
Model 639 (Type II) INDUSTRIAL ANALYZER. For use on 3 Phase, 3 Wire circuits. Original cost \$819.50. OUR PRICE. . . \$350.00  
Low Resistance Model 622 DC Microammeter. Ranges from 0-200 U.A. 7.83 ohms. SALE PRICE. \$150.00  
A. COTTONE & CO., INC.

340 Canal St. New York 13, N. Y.  
Digby 9-2188

CIRCLE 474 READER SERVICE CARD

CIRCLE 472 READER SERVICE CARD

Phone:

Walker 5-6000

SPECIALS IN  
• KLYSTRONS •

- |                 |         |
|-----------------|---------|
| 2K25 . . . . .  | \$13.50 |
| 2K26 . . . . .  | 33.50   |
| 2K28 . . . . .  | 27.00   |
| 2K29 . . . . .  | 27.50   |
| 2K33A . . . . . | 200.00  |
| 2K42 . . . . .  | 170.00  |
| 2K43 . . . . .  | 144.00  |
| 2K44 . . . . .  | 126.00  |
| 2K45 . . . . .  | 35.00   |
| 2K50 . . . . .  | 72.00   |
| 2K56 . . . . .  | 50.00   |
| X12 . . . . .   | 475.00  |
| 5721 . . . . .  | 125.00  |

Many other types

See pages 594, 595 of 1960 Electronics Buyers' Guide for a more complete listing

Cables:  
TELSERSUP

LIBERTY  
ELECTRONICS  
INC.

582 BROADWAY  
New York 12, N. Y.

CIRCLE 475 READER SERVICE CARD

179

# You can look at Philbrick's USA-3 Amplifier at least 3 ways

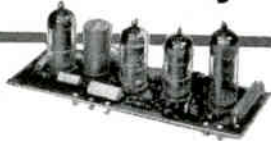

**1. Undressed** — Here's the basic unit itself — more performance per dollar than any other operational amplifier. Highly reliable — no electrolytic capacitors or glow tubes. Designed to prevent self-destruction, even when output is grounded. Drift, noise, offset under 100 microvolts. Output,  $\pm 115$  vdc. Wide frequency range — dc to 100 kc (attenuation less than 3 db) when connected as gain-of-ten amplifier. Printed circuit board, 7" x 2½". Price, 1 to 9 units: **\$95**



**2. Dressed** — In a neat 3" x 7½" ventilated aluminum package, it becomes the USA-3-M3. It has sufficient room for the user to implement its operational destiny by installing additional circuit components. For example, you make it into a complete diode function generator, or integrator, or whatever you wish. The important feature of plug-in interchangeability is enhanced by the 4 to 7 spare terminals on the Blue Ribbon Connector. Price, 1 to 9 units: **\$125**



**3. Dressed-up** — Now it's a full fledged utility packaged amplifier, known as the UPA-2. Combining a new level of convenience and flexibility, it is immediately operational when plugged into any Philbrick power supply. It can be made to drive a 12,000 ohm load to 100 volts in either direction. Designed for bench top use, it comes installed in a 3½" rack adapter, from which it is easily removed. The UPA-2 is ideal for analog computing, measurement and control, continuous data reduction, and many other feed-back operations. Price, 1 to 9 units: **\$149**

- OEM's: write, wire, or phone for quantity prices
- Military equivalents available
- 8 page technical manual available on request



**GEORGE A. PHILBRICK RESEARCHES, INC.**

285 Columbus Avenue, Boston 16, Mass.  
Commonwealth 6-5375, TWX: BS1032, FAX: BSN  
Representatives in principal cities

Export Office: 135 Liberty Street, New York 6, N. Y.  
Tel. Worth 4-3311, CABLE: TERMRADIO

# INDEX TO ADVERTISERS



Audited Paid Circulation

*AC Electronics .....	157	Textile Fibre .....	163
*Acton Laboratories, Inc.....	49	Explosives Dept. ....	22
Aerovox Corp. ....	45	Durant Manufacturing Co.....	152
Air France .....	174		
*Airpax Electronics, Inc.....	115	Edo Corporation .....	163
Allegheny Ludlum Steel Corp.....	153	*Efcon Inc. ....	55
Allen-Bradley Co. ....	113	*Electo Motive Mfg. Co., Inc.....	58
Allison Laboratories, Inc.....	24	Electronic Engineering Company...	48
American Speedlite Corporation ...	53	*Electronic Instrument Co., Inc.	
*American Time Products, Inc.....	74	(EICO) .....	169
Angelica Uniforms .....	182	Electronic Measurements Co., Inc..	79
*Applied Research, Inc. ....	173	Espey Mfg. & Electronics Corp.....	75
Assembly Products, Inc. ....	128		
*Associated Research, Inc. ....	161		
Avnet Electronics .....	167		
		*Gamewell Co. ....	175
*Baker Chemical Co., J. T. ....	7	*General Electric Co.	
*Ballantine Laboratories, Inc.....	159	Apparatus .....	78
Barker & Williamson, Inc. ....	155	Gertsch Products, Inc.....	164
*Barnstead Still & Sterilizer Co.....	14	Good-All Electric Mfg. Co.....	105
*Belden Mfg. Co.....	103	Graphic Systems .....	158
*Bendix Aviation Corp.			
Bendix-Pacific Division .....	70	Hamilton Standard, A Division of	
Red Bank Division.....	73	United Aircraft Corp.....	109
*Bircher Corporation .....	175	Hamlin, Inc. ....	78
Black & Webster, Inc. ....	133	Hansen Mfg. Co., Inc.....	138
Boeing Airplane Co.....	182	*Hart Manufacturing Co.....	144
Boesch Mfg. Co., Inc. ....	150	*Haydon Co., Inc., A. W.....	162
*Boonton Radio Corp. ....	131	*Heiland, Division of Minneapolis-	
Borden Chemical Company, Resinite		Honeywell .....	62
Dept. ....	16	*Hermetic Seal Transformer Co.....	158
Bourns Laboratories, Inc.....	129	*Hewlett-Packard Company....	2nd Cover
Bristol Company, The .....	172		
Bruno-New York Industries, Corpora-		Ichizuka Optical Co., Ltd.....	169
tion .....	6	International Nickel Company, Inc..	34
*Brush Instruments, Division of		International Resistance Co.....	66
Clevite Corporation .....	127		
*Bryant Computer Products, Division		Jones, Howard B., Division of Cinch	
of Ex-Cello Corporation.....	111	Mfg. Co. ....	167
		*Jones Electronics Co., Inc., M. C....	154
CBS Electronics .....	123	*Jones & Lamson Machine Co.....	72
Canoga Corp. ....	122	*Julie Research Laboratories, Inc....	164
*Celco-Constantine Engineering			
Laboratories .....	147	*Kearfoot Division, General Precision,	
*Centralab, A Division of Globe-		Inc. ....	167, 169, 171
Union, Inc. ....	121	*Kintel, Division of Cohu Electronics	
Ceramics for Industry Corporation..	54	Inc. ....	3rd Cover
Chemprint Corp. ....	28	*Krohn-Hite Corp. ....	106, 107
Christie Electric Corp.....	145	Kyoritsu Electrical Instruments....	173
Clare & Co., C. P. ....	30, 31		
*Cohn Corp., Sigmund.....	137	Leesona Corp. ....	110
Colorado Dept. of Development....	158	LEL, Inc. ....	161
Consolidated Electrodynamics Corp.	124	Linde Company .....	130
*Constantine Engineering Laboratories	147	Littelfuse .....	161
Continental Electronics Company...	135	Lockheed Electronics & Avionics.50,	51
*Continental-Diamond Fibre Subsidiary			
of The Budd Company.....	68	Magnetic Metals .....	149
*Control Electronics Co., Inc.....	181	*Magnetic Controls Company.....	142
Coors Porcelain Co. ....	59	Mallory & Co., Inc., P. R.....	64, 65
*Crosby-Teletronics Corporation ...	160	Martin Co. ....	35
*Curtiss-Wright Corp. ....	126	*Massa, A Division of Cohu Elec-	
		tronics, Inc. ....	168
		Millen Mfg. Co., Inc., James.....	70
*DeMornay-Bonardi .....	163	Minnesota Mining & Mfg.—Min-	
Detroit Edison Co.....	101	Com Division .....	36
*Dialight Corporation .....	171	Mitsumi Electric Co., Ltd.....	137
Digitronics Corp. ....	136	*Moseley Co., F. L.....	12
Dorsett Electronics .....	23		
Dow Chemical Co. ....	76		
*Dow Corning Corp.....	56, 57		
*Dresser-Ideco Co., A Division of			
Dresser Industries, Inc.....	80		
DuMont Laboratories Inc.,			
Allen B. ....	114, 117		
Du Pont De Nemours & Co.			
Electrochemicals Dept.—Ceramic			
Products Division .....	146		

\* See Advertisement in the July 20, 1960 issue of Electronics Buyers' Guide for complete line of products or services.

NJE Corp. ....	42
National Conference—Application of Electrical Insulation .....	139
National Semiconductors, Ltd. ....	78
Nippon Electric Co., Ltd. ....	37
*Non-Linear Systems, Inc. ....	33
North Electric Co. ....	69
Ohmite Mfg. Co. ....	63
Ovenaire Incorporated .....	21
*Panoramic Radio Products, Inc. ....	71
*Philbrick Researches, Inc., George A. ....	180
Philips Gloeilampfabrieken, N. V., .....	60, 61
Power Sources, Inc. ....	77
PRD Electronics, Inc. ....	52
Radiation, Inc. ....	32
*Radio Corporation of America. 4th Cover	
*Raytheon Company .. 2, 5, 67, 132, 133	
Reed Roller Bit, Cleco Div. ....	3
Remington Rand Univac, Division of Sperry Rand Corporation. ....	171
Rotron Manufacturing Co., Inc. ....	41
Sarkes Tarzian, Inc. ....	120
Schjeldahl Co., G. T. ....	25
*Sierra Electronic Corporation. ....	10
Space Technology Laboratories. ....	15
Spectrol Electronics Corp. ....	8
Speer Carbon Co. ....	19
*Sperry Electronic Tube Division, of Sperry Rand Corp. ....	143
Sprague Electric Co. ....	20, 46, 47
Stackpole Carbon Co. ....	29
*Stevens-Arnold, Inc. ....	156
Superior Electronics Corp. ....	155
*Sylvania Electric Products, Inc. Electron Tube Division .....	17, 18
*Syntronic Instruments, Inc. ....	140
Taylor Fibre Co. ....	125
*Texas Instruments, Incorporated Semiconductor-Components Division .....	140, 141
Trygon Electronics .....	167
*Tung-Sol Electric, Inc. ....	151
United States Testing Co. ....	148
*Vitramon, Inc. ....	119
*Westinghouse Electric Corp. ....	26, 27
White, S. S. ....	131
*Zippertubing Co., The. ....	137

Professional Services ..... 176

**CLASSIFIED ADVERTISING**  
F. J. Eberle, Business Mgr.

**EMPLOYMENT OPPORTUNITIES**... 176

**SPECIAL SERVICES**..... 178

**NOTICES**

Legal ..... 176

**EQUIPMENT**

(Used or Surplus New)  
For Sale .....177-179

\* See Advertisement in the July 20, 1960 issue of Electronics Buyers' Guide for complete line of products or services.

# FUNDAMENTALLY SPEAKING;

**SUBJECT:**  
**Use of Variable MAGLINES\* as  
RADAR RANGE SIMULATORS**

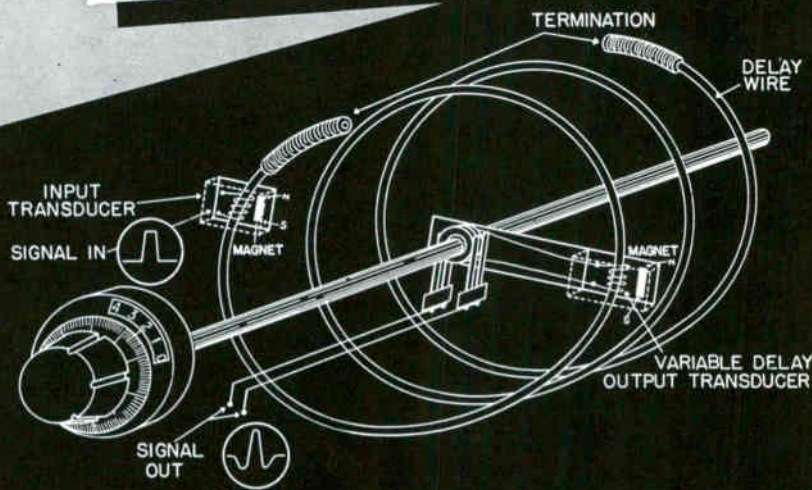

**VARIABLE MAGLINE SCHEMATIC DIAGRAM**

Radar Range is readily simulated or calibrated with these new Variable MAGLINES (Variable magnetostrictive delay lines). Any pulse time delay up to 10 milliseconds can be set or varied with infinite resolution with these compact, rugged and highly accurate devices.

### How It Works:

An understanding of the principles of operation of "Maglines" will make clear the versatility and simplicity of adaptation of these devices as delay triggers in radars, radar range simulators and calibrators. The basis of operation of the Magline depends upon these principles:

- (1) The magnetostrictive effect or Joule effect;
- (2) The propagation of sonic energy in an elastic medium;
- (3) The inverse magnetostrictive effect or Villari effect.

The magnetostrictive effect refers to the fact that if a magnetic field is applied to a sample of magnetostrictive material, such as nickel, parallel to its length, it will undergo a change in length. The inverse magnetostrictive effect refers to the fact that if the sample is subjected to a mechanical strain while biased in a magnetic field there will be a change of flux in the sample.

The magnetostrictive effect is used at the input in the following way. When the current is turned on it passes through the transmitting transducer coil, generating a magnetic field parallel to the length of the line. This causes the material underneath the coil to contract, thus launching a rarefaction. This rarefaction is propagated down the delay line, and when it arrives at the receiver coil an emf is generated in the output transducer coil through inverse magnetostriction.

A variable Magline, as illustrated, consists of a length of magnetostrictive wire, wound in a helix to conserve space. The delay wire is threaded through two solenoidal transducers which are so mounted that their spacing can be varied. In order to prevent the pulses from being reflected from the ends, special terminating dampers are used. The output pulse from Magline is considerably attenuated and distorted, and must be amplified and restored. Variable Magline are made to provide delays up to 10,000 microseconds, simulating radar ranges up to 820 nautical miles. They can be calibrated to provide extreme accuracy. Rugged construction allows for hand or motor drive application.

### Variable Maglines By CEC

Delay Range	MODEL VM 1030 3 to 500 $\mu$ sec.	MODEL VM 1090 3 to 4000 $\mu$ sec.
Impedance Range	50 ohms to 4K ohms	50 ohms to 4K ohms
Min. Pulse Spacing	3 $\mu$ sec.	3 $\mu$ sec.
Output when driven with 15 V.Pk.—1 $\mu$ sec. pulse	12 mv.	6 mv.
Turns for full delay	10	28
Size	4" OD. x 4.5" L.	9" OD. x 3 3/8" L.
Weight	2 lb.	5 lb.

Also available: A complete line of Fixed and Variable Maglines and associated drivers and shapers.

\*MAGLINE—Trade name used to designate CEC's magnetostrictive delay lines

*CEC for years has been a leading supplier of Delay Lines of all types to industry and the military. Its engineering staff is geared to pulse techniques and pulse-time problems. They will be happy to meet with you on any Delay problem.*



**CONTROL Electronics CO., INC.**  
Ten Stepar Place, Huntington Station, N.Y.

# LINT-FREE

# FREE

ACID RESISTANT • STATIC FREE



specify

## ANGELICA UNIFORMS

Wherever utmost cleanliness is a must, Angelica is the scientific choice! Engineered "down to the last thread" for full protection of delicate assemblies. Smooth monofilament fabrics create no lint—Angelica's superb tailoring allows none to gather. Acid-resistant and static free fabrics in styles for every job—comfortable, easy to launder, long wearing.

Whether you rent or buy, your Angelica representative will help you, as he has others—to choose the right garments for your needs.



1427 OLIVE ST., ST. LOUIS 3, MO.  
107 W. 48th ST., NEW YORK 36, N. Y.  
177 N. MICHIGAN AVE., CHICAGO 1, ILL.  
1900 W. PICO BLVD., LOS ANGELES 6, CALIF.  
317 HAYDEN ST. N.W. ATLANTA 13, GA.

### ADVERTISERS INDEX

Barry Electronics Corp.....	179
Berger & Co.....	178
Cottone & Co., Inc., A.....	179
Derf Radio Co.....	178
Electro Sales Co., Inc.....	179
Engineering Associates.....	177
Goodheart Co., R. E.....	178
Liberty Electronics Inc.....	179
Mogull Co., Alexander.....	178
National Scientific Laboratories Inc.....	176
R W Electronics.....	177
Radio Research Instrument Co.....	178
Reliable Electric Motor Repair Co.....	179
TAB.....	178
Universal Relay Corp.....	179
Western Engineers.....	177
Wilgreen Industries Inc.....	178

This index and our Reader Service Numbers are published as a service. Every precaution is taken to make them accurate, but ELECTRONICS assumes no responsibilities for errors or omissions.

### electronics



Audited Paid Circulation

BRUCE A. WINNER,  
Advertising Sales Manager

R. S. QUINT, Assistant Advertising Sales Manager and Buyers' Guide Manager; FRED STEWART, Promotion Manager; RICHARD J. TOMLINSON, Production Manager; GEORGE E. POMEROY, Classified Manager; HUGH J. QUINN, Circulation Manager.

ADVERTISING REPRESENTATIVES: NEW YORK Donald H. Miller, Henry M. Shaw, George F. Werner; BOSTON William S. Hadgkinson, Donald R. Furth; PITTSBURGH David M. Watson; PHILADELPHIA Warren H. Gardner, William J. Boyle; CHICAGO Harvey W. Wernecke, Martin J. Gallay; CLEVELAND P. T. Fegley; SAN FRANCISCO T. H. Carmady, R. C. Alcorn; LOS ANGELES Carl W. Dysinger, D. A. McMillan, Marshall Freeman; DENVER J. Patten; ATLANTA M. Miller; DALLAS Robert T. Woad; LONDON Edward E. Schirmer; FRANKFURT Stanley R. Kimes; GENEVA Michael R. Zeynel.

BRANCH OFFICES: National Press Bldg., Washington 4, D.C.; McGraw-Hill Bldg., Capley Square, Baston 16; Fair Gateway Center, Pittsburgh 22; Six Penn Center Plaza, Philadelphia 3; 520 North Michigan Avenue, Chicago 11; 55 Public Square, Cleveland 13; 68 Past Street, San Francisco 4; 1125 West Sixth St., Los Angeles 17; 1740 Broadway, Denver 2; 1301 Rhades-Haverty Bldg., Atlanta 3; 901 Vaughn Bldg., Dallas 1; McGraw-Hill House, London E.C.4; 85 Westendstrasse, Frankfurt/Main; 2 Place de Part, Geneva.

OFFICERS OF THE PUBLICATIONS DIVISION: Nelson L. Band, President; Shelton Fisher, Wallace F. Traendly, Senior Vice Presidents; John R. Callahan, Vice President and Editorial Director; Joseph H. Allen, Vice President and Director of Advertising Sales; A. R. Venezian, Vice President and Circulation Coordinator.

OFFICERS OF THE CORPORATION: Donald C. McGraw, President; Joseph A. Gerardi, Hugh J. Kelly, Harry L. Waddell, Executive Vice Presidents; L. Keith Gadrach, Vice President and Treasurer; John J. Cooke, Secretary.

## Primary Standards Measurement Engineers

Boeing, major contractor on such advanced programs as the Dyna Soar boost-glide vehicle and the Minuteman ICBM, has a number of openings in the field of Primary Standards Design Analysis. Requirements are an advanced degree in ME, EE or Physics; or a BS degree plus experience in fields related to research and applied metrology.

Assignments are available in Research Design Analysis of Precision Measurement Instrumentation in:

ELECTRICAL		
Voltage	Phase	Magnetics
Current	Frequency	VSWR
Resistance	Q	Attenuation
Power	Impedance	Field Strength
PHYSICAL		
Acceleration	Flow	Mass
Velocity	Temperature	Dimensional
Acoustics	Infrared	Pressure
Vacuum	Optics	

Send your resume, today, to: Mr. W. B. Evans, Boeing Airplane Company, P. O. Box 3707 - ECC, Seattle 24, Washington.



CIRCLE 381 ON READER SERVICE CARD



### WHO DROPPED THE BINOCULARS?

With everybody watching each other along the DEW line and the Iron Curtain these days, electronics has replaced binoculars.

What's happening in the giant markets for missile controls, radar and communications equipment?

electronics tells how things are going, keeps you informed of developments as they occur. This is a good time to subscribe or renew your subscription. Just fill in box on Reader Service Card. Easy to use. Postage free.

## FIND WHAT YOU NEED IN... electronics

**For high-accuracy  
data logging...to checkout  
missiles or meters, to test transducers  
or transistors...checkout a  
KinTel digital  
system**

*-like this...*



This system, one example of KIN TEL'S digital system experience, takes eight measurements at each of 7200 different data points. Outputs include visual readout, digital printer, X-Y recorder, and tape punch. Tape is perforated for direct entry into a digital computer. To provide 0.01% accuracy for low-level inputs, alternate channels scan calibration signals. These, with the unknown input signal, are fed to the computer and correction is made for any inaccuracy in the system itself. Cost: about \$20,000.

*...or like this*



This data system consists of a KIN TEL 453M scanner and 501 DC digital voltmeter, plus a parallel entry printer. Briefly, the system will accept 400 one-wire, 200 two-wire, or 100 four-wire inputs, and will provide both visual and printed indication of the channel being scanned and DC input signals from  $\pm 100$  microvolts to  $\pm 1000$  volts. Accuracy is 0.01%  $\pm 1$  digit, and ranging and polarity indication are automatic. The complete system costs approximately \$6850. At the present time, delivery is off the shelf.

**KIN TEL  
DIGITAL SYSTEM  
CAPABILITIES**

**You can have any number of channels:** A single 453M scanner (\$2500) accepts 400 one-wire, 200 two-wire, or 100 four-wire inputs. Additional scanners can be added if more inputs are required.

**You can measure DC from  $\pm 1 \mu\text{v}$  to  $\pm 1000$  volts:** The KIN TEL 501 DC digital voltmeter (\$2995) measures from  $\pm 100 \mu\text{v}$  to  $\pm 1000$  volts. Addition of a KIN TEL digital preamplifier increases sensitivity to  $1 \mu\text{v}$  DC.

**You can measure AC from  $10 \mu\text{v}$  to 1000 volts:** Addition of a 452 AC converter (\$850) to the 501 DC digital voltmeter permits measurement of RMS AC voltages from 1 mv to 1000 volts in the frequency range of 30 cps to 10 kc. A KIN TEL preamplifier can be added to increase AC measurement sensitivity to  $10 \mu\text{v}$  from 30 cps to 2 kc.

**You can measure DC/DC and AC/DC voltage ratios:** The 507B digital voltmeter/ratiometer (\$3835) measures DC voltages from  $\pm 100 \mu\text{v}$  to  $\pm 1000$  volts and DC/DC ratios from .0001:1 to 999.9:1. Accuracy is 0.01%  $\pm 1$  digit. Addition of an AC converter permits AC/DC ratio measurements.

**You can get 0.01% DC and 0.2% AC accuracy:** The KIN TEL 502 AC/DC digital voltmeter (\$3845) measures DC from  $\pm 100 \mu\text{v}$  to  $\pm 1000$  volts with 0.01%  $\pm 1$  digit of reading accuracy; and AC from 1 mv to 1000 volts, 30 cps to 10 kc, with 0.2% of full scale accuracy.

**You can have 10,000 megohm input impedance:** The KIN TEL 458A digital voltmeter preamplifier (\$1225) has gain positions of 100 (for DC and 30 cps to 2 kc AC measurement) and +1 HI Z (for DC only). On the +1 gain position input impedance is  $> 10,000$  megohms and gain accuracy is 0.001%. Input range for +1 operation is 0 to 40 volts.

**You can have visual, printed, or any other form of output:** KIN TEL digital voltmeters provide visual indication of the measured quantity on a single-plane in-line readout. They are capable of directly driving commercially available 10-line parallel input digital printers. Converters are available for driving other types of printers, paper tape punches, typewriters, and IBM card punches.

To find out how a KIN TEL digital system can solve your particular data acquisition problem, send us an outline of your requirements, or contact your nearest KIN TEL engineering representative.

5725 Kearny Villa Road, San Diego 12, California



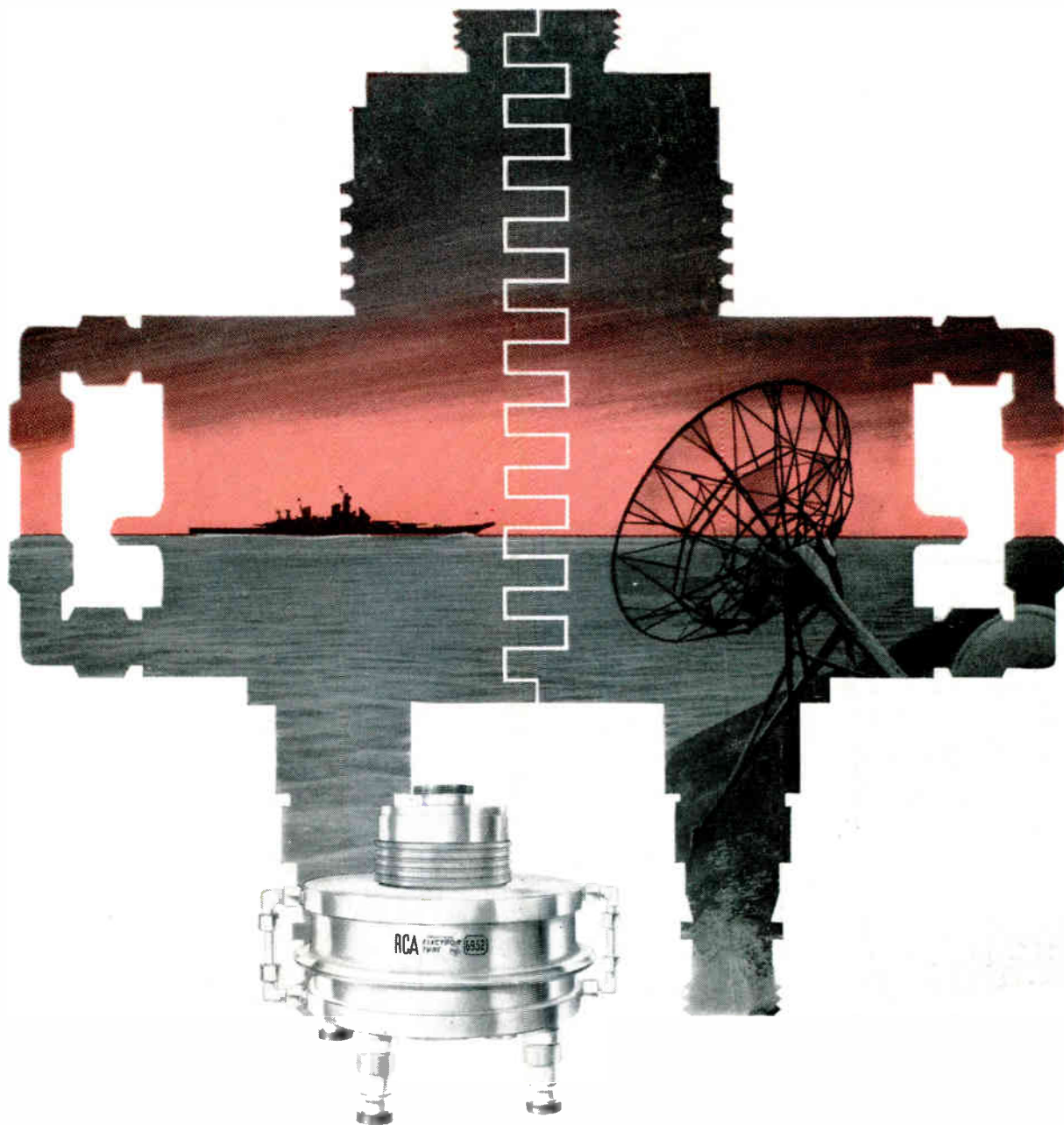

## NOW RCA-6952 PACKS TWICE THE PUNCH

RCA announces higher ratings for RCA-6952 Super-Power Tube to permit 2 megawatts useful peak power output. Already proved in sea duty for more than 5000 hours at the lower ratings, these new, higher ratings are based on extensive tests performed under the auspices of the Bureau of Ships, U.S. Navy. Proven life capability at the new ratings is 1000 hours minimum.

Variants of the RCA-6952 can be supplied for applications requiring longer pulse lengths to 2000 microseconds...higher average power to 20 kilowatts...higher-frequency operation to 1000 Mc.

For information on the availability of this remarkable Super-Power Tube—and variants tailored for your radar applications—contact your nearest RCA Field Office, or write Marketing Manager, Industrial Tube Products, RCA Electron Tube Division, Lancaster, Pennsylvania.

Typical Operation—RCA-6952

Useful Peak Power Output (megawatts)	Freq. (Mc)	Pulse Length $\mu$ sec.	Duty Factor	Power Gain
2	425	13	0.004	100

ATTENTION, DESIGNERS: For a complete technical bulletin on RCA-6952, write RCA, Commercial Engineering, Section J-19-Q2, Harrison, N. J.

RCA ELECTRON TUBE DIVISION FIELD OFFICES... Industrial Products Sales: Detroit 2, Michigan, 714 New Center Building, TRinity 5-5600 • NEWARK 2, N. J., 744 Broad St., HUmboldt 5-3900 • Chicago 54, Illinois, Suite 1154, Merchandise Mart Plaza, Whitehall 4-2900 • Los Angeles 22, Calif. 6355 E. Washington Blvd., RAYmond 3-8361 • Burlingame, Calif., 1838 El Camino Real, OXford 7-1620 • Government Sales: Harrison, N. J., 415 S. 5th Street, HUmboldt 5-3900 • Dayton 2, Ohio, 224 N. Wilkinson St., BALdwin 6-2366 • Washington 7, D. C., 1725 "K" St., N.W., FEderal 7-8500.



The Most Trusted Name in Electronics  
RADIO CORPORATION OF AMERICA