

MAY 29, 1959

# electronics

A MCGRAW-HILL PUBLICATION

VOL. 32, No. 22

PRICE SEVENTY-FIVE CENTS



*Special*

**Designing for Reliability**

MORNINGSIDGE COLLEGE  
LIBRARY  
SIOUX CITY IOWA



*This new precision DC VTVM is also  
a wide range, precision ohmmeter and ammeter!*



# 1% accuracy 100 $\mu$ v to 1,000 volts!

Also 2% accuracy, 1  $\mu$ a to  
1 amp full scale.

Measures 0.02 ohms to  
5,000 megohms.

No zero adjustment. 1 minute  
warm-up.

Floating chassis. \$1,000 worth  
of convenience for \$350!

Haven't you wished for one compact, simple instrument that would make *precision* dc voltage, dc current and resistance measurements over a wide range?

The new  $\text{hp}$  412A is it! In its VTVM circuit, the 412A uses an exclusive  $\text{hp}$  photo-chopper instead of old-style mechanical vibrators—no drift, no 60 cps pickup. Input is floating, with resistance increasing from 10 megohms on the 1 mv range to 200 megohms on ranges above 100 mv. Current and voltage ranges have a 10 db sequence for

maximum readability and overlap. The ohmmeter is a modified Kelvin bridge eliminating lead resistance error; you measure resistance accurately on hook-up wire sections as short as 6".

Model 412A also includes a 1 v or 1 ma recorder output, and 3 separate probes. Call your  $\text{hp}$  rep today for a demonstration on your bench. Price, \$350.

#### HEWLETT-PACKARD COMPANY

1001H PAGE MILL ROAD • PALO ALTO, CALIFORNIA, U.S.A.  
CABLE "HEWPACK" • DAVENPORT 5-4451  
FIELD REPRESENTATIVES IN ALL PRINCIPAL AREAS



#### $\text{hp}$ 400L LOGARITHMIC VOLTMETER—\$325

New  $\text{hp}$  voltmeter covers 10 cps to 4 MC; accuracy high as  $\pm 2\%$  of reading or 1% of full scale. Voltage range 0.3 mv to 300 v, 12 ranges, 1-3-10 sequence. Max. full scale sensitivity 1 mv. Large 5" true log voltage scale, linear 12 db scale, generous overlap. High stability, high input impedance. Also useful as amplifier for small signals, or to monitor waveforms.



#### $\text{hp}$ 400H PRECISION VOLTMETER—\$325

Extreme accuracy as high as  $\pm 1\%$  to 500 KC,  $\pm 2\%$  to 1 MC,  $\pm 5\%$  full range. Frequency coverage 10 cps to 4 MC. Large 5" meter with precision mirror scale. Voltage range 0.1 mv to 300 v; max. full scale sensitivity 1 mv. High 10 megohm input impedance minimizes circuit disturbances. Amplifier with 56 db feedback insures lasting stability. Reads direct in db or volts.



#### $\text{hp}$ 400D WIDE RANGE VOLTMETER—\$225

Highest quality, extremely versatile. Covers 10 cps to 4 MC. Highly sensitive, accurate to within  $\pm 2\%$  to 1 MC. Measures 0.1 mv to 300 v; max. full scale sensitivity 1 mv. Reads direct in dbm. High 10 megohm input impedance virtually eliminates circuit loading. 56 db amplifier feedback insures high stability and freedom from change due to external conditions.

*Data subject to change without notice. Prices f.o.b. factory*

5028



**complete precision voltage measuring equipment**

## Issue at a Glance

A MCGRAW-HILL PUBLICATION  
Vol. 32 No. 22

JAMES GIRDWOOD, *Publisher*

W. W. MacDONALD, *Editor*

JOHN M. CARROLL, *Managing Editor*

*Associate Editors:* Frank Leary, Michael F. Tomaino, Howard K. Janis, Sylvester P. Carter, Haig A. Manoogian, Roland J. Charest, William P. O'Brien, George Sideris, John F. Mason, William E. Bushor, Ronald K. Jurgen, Thomas Emma, Samuel Weber, Sy Vogel, Leslie Solomon, M. M. Perugini.

*Pacific Coast Editor* (Los Angeles) Harold C. Hood; *Midwestern Editor* (Chicago) Harold Harris; *New England Editor* (Boston) Thomas Maguire.

*Art Director*, Harry Phillips, Roy Thompsen.

*Production Editor*, John C. Wright, Jr., Bernice Duffy, Jean L. Matin.

*Market Research*, Edward DeJongh, Marilyn Koren.

*Editorial Assistants*, Gloria J. Filippone, Arlene Schilp, Patricia Landers, Catherine McDermott, Eleanor Schaefer, Carol Weaver.

**BRUCE A. WINNER**, *Advertising Sales Manager*. R. S. Quint, *Assistant Advertising Sales Manager and Buyers' Guide Manager*. Fred Stewart, *Promotion Manager*. Frank H. Ward, *Business Manager*. George E. Pomeroy, *Classified Manager*. Hugh J. Quinn, *Circulation Manager*.

*New York:* Donald H. Miller, Henry M. Shaw, William J. Boyle. *Boston:* Wm. S. Hodgkinson. *Philadelphia:* Warren H. Gardner. *Chicago:* Harvey W. Wernecke, Martin J. Gallay. *Cleveland:* P. T. Fegley. *San Francisco:* T. H. Carmody, R. C. Alcorn. *Los Angeles:* Carl W. Dysinger, D. A. McMillan. *Denver:* J. Patten. *Atlanta:* M. Miller. *Dallas:* Gordon L. Jones, Robert T. Wood. *London:* E. E. Schirmer. *Frankfurt:* Michael R. Zeynel.

### Business

Big Bid for Bank Market. Magnetic-ink systems write new chapter . . .	40
Fair Exchange of Electronics? Comparing U.S.-Russian expositions . . .	47
Selective Calling Grows. And as it does, so do equipment sales . . . . .	52
West Germany Plans to Buy. Talk with Defense Minister Strauss . . . . .	59
Shoptalk . . . . .	4
Electronics Newsletter . . . . .	11
Washington Outlook . . . . .	14
Financial Roundup . . . . .	23
Over The Counter . . . . .	23
Market Research . . . . .	30
Current Figures . . . . .	30
Meetings Ahead . . . . .	60

### Engineering

Reliability. Automatic test of transistors keeps production standards high. See p 65. . . . . **COVER**

**Designing for Reliability.** How to select components and put them together into reliable circuits and systems. . . . . By F. Leary 65

High-Speed Readout for Data Processing. Teletypewriter prints faster than 3,000 words/minute . . . . .	By R. E. West 83
Single-Ended Amplifiers for Class B Operation. Circuits are used in high-fidelity amplifier . . . . .	By H. C. Lin and B. H. White 86
Intelligibility Evaluation of Voice Communications. System measures understandability of speech . . . . .	By H. Schwarzlander 88
Synthesizing Timbre for Electronic Musical Tones. How portable transistorized device works . . . . .	By W. S. Pike and C. N. Hoyler 92
Heat Expansion of Materials. Handy guide for selection of over 100 electronic materials . . . . .	95
Holding Video Level While Switching Studios. Automatic video processor has constant output . . . . .	By J. O. Schroeder 96
Radar Tracking Losses. Charts find blind speeds for any passing track offset . . . . .	By B. M. Compton and F. DuCharm 100

### Departments

Research and Development. Electrostatic Unit Prints Photos Dry . . .	102
Components and Materials. V-Loop Antennas for Beacon-Telemetry . . .	106
Production Techniques. Instrument Finds Mica Waviness . . . . .	110
On the Market . . . . .	114
Literature of the Week . . . . .	148
Plants and People . . . . .	150
News of Reps . . . . .	152
Comment . . . . .	154
Index to Advertisers . . . . .	160

Electronics progress through chemistry and metallurgy

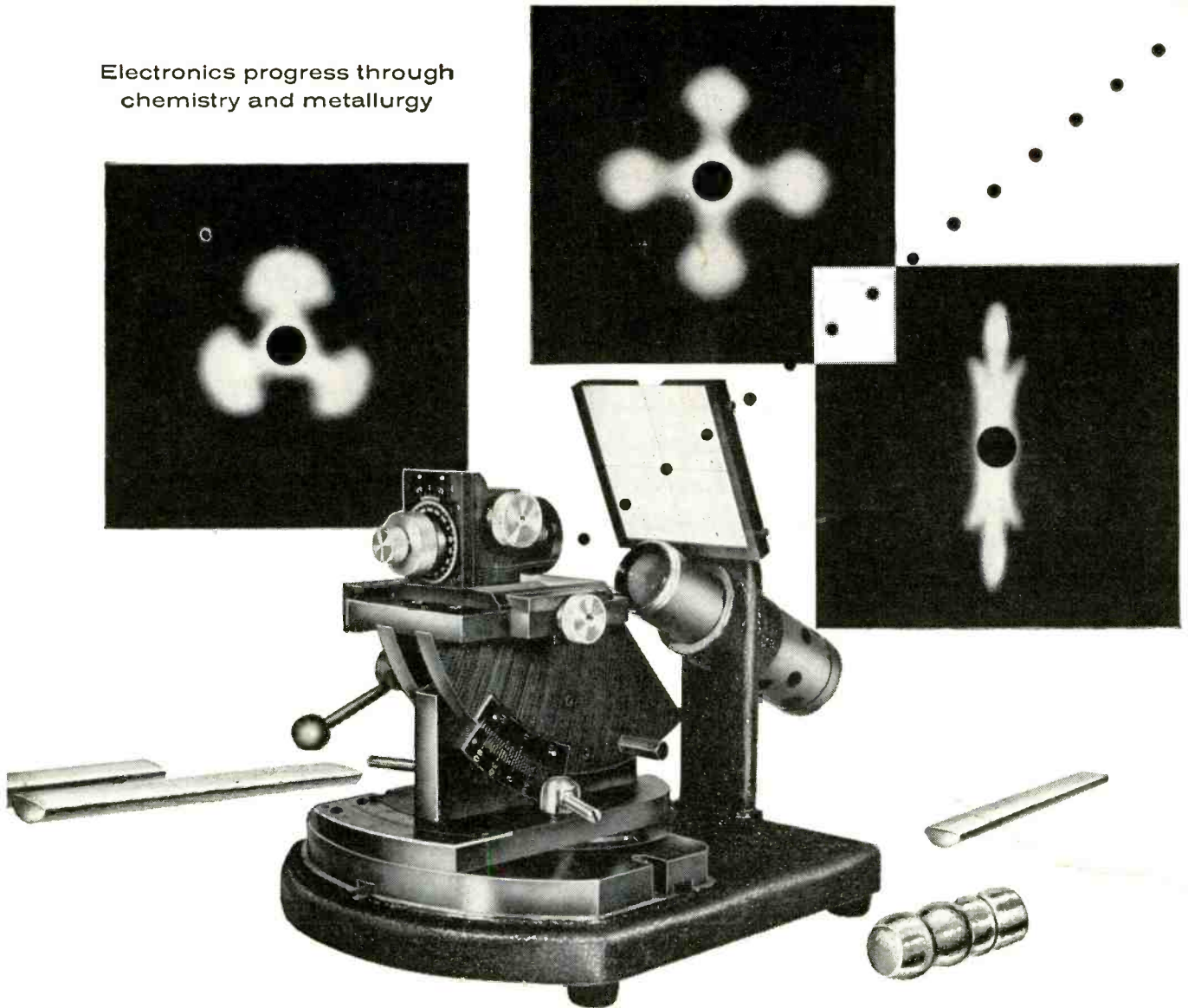

## New look in Crystals...

**Sylvania develops a new optical instrument for easy, accurate alignment of single-crystal germanium and silicon**

Semiconductor manufacturers and research laboratories can now orient monocrystalline germanium and silicon quickly and easily without the use of X ray, microscope or other methods requiring skilled operators or extensive processing.

Sylvania has developed a versatile new Crystal Orientation Instrument that is especially adaptable to the preparation of germanium and silicon single-crystal slabs for dicing, to seed crystal preparation, and many other uses. The device reveals the symmetry and orientation of a crystal

through the light pattern it reflects from the facets in the etched surface of the crystal.

Here are some of the advantages of the Sylvania Crystal Orientation Instrument:

**SPEED**—Cutting, preparation, etching and evaluation of a crystal in as little as 15 minutes.

**SIMPLICITY**—Clean design allows easy operation by unskilled personnel.

**ACCURACY**—to  $\pm 12$  minutes of arc.

**ECONOMY**—Lower initial and operational costs than X ray and other techniques.

**SAFETY**—Non-hazardous operation—no radiation risk.

**VERSATILITY**—Can be used on any monocrystalline material in which etch pits can be produced.

**FLEXIBILITY**—Top mount can be rotated or removed. It can be set up on duplicate base units in other locations.

The Sylvania Crystal Orientation Instrument is available as a complete assembly or in individual parts. For complete particulars on this newest aid to the semiconductor industry from the Chemical & Metallurgical Division, contact your Sylvania representative or write the division directly in Towanda, Pa.

**SYLVANIA**

Subsidiary of  
GENERAL TELEPHONE & ELECTRONICS



Sylvania Electric Products Inc.  
Chemical & Metallurgical Div.  
Towanda, Penna.





## "OVER-THE-HUMP" SCATTER ANTENNA BY KENNEDY

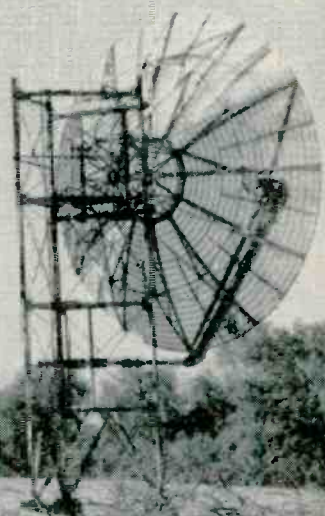
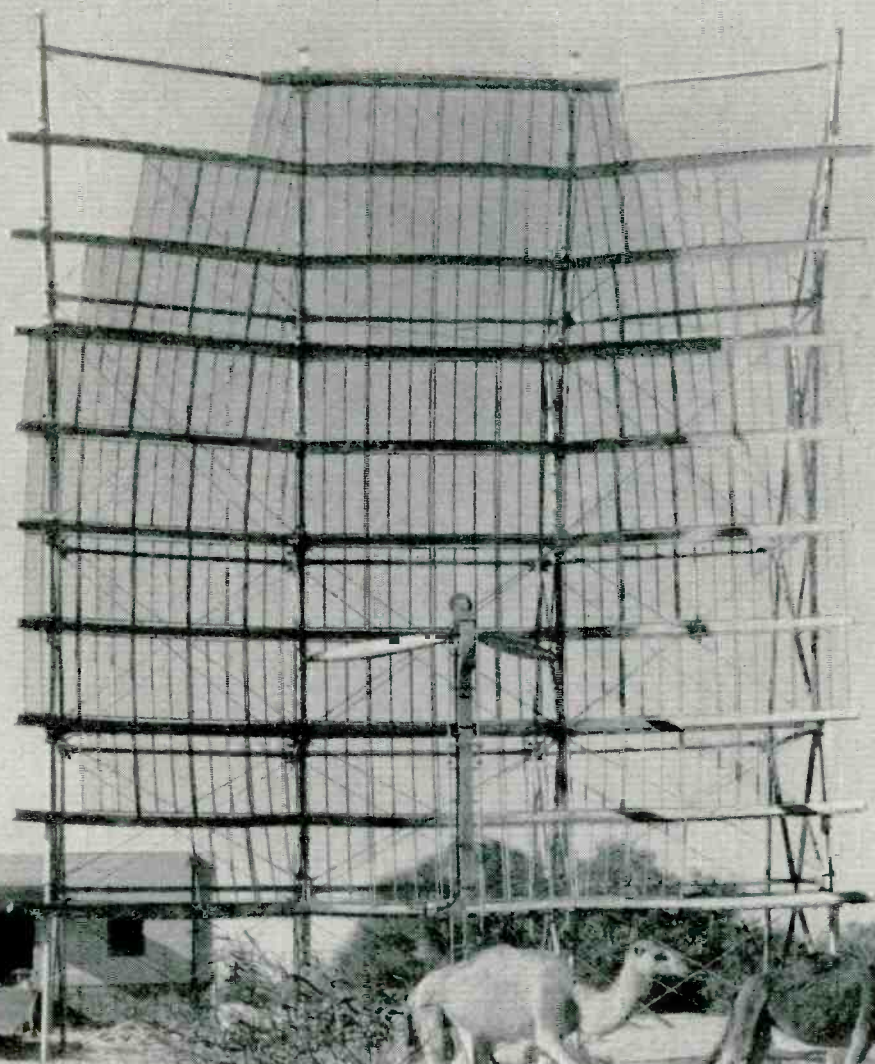

THESE CAMELS HAVE JUST WALKED A MILE to view the latest 60-foot steel and 28-foot aluminum antenna systems at a relay station in one of our overseas tropo scatter communications networks.



ANTENNA EQUIPMENT

**D. S. KENNEDY & CO.**

COHASSET, MASS. EVERGREEN 3-1200

*Down-To-Earth SOLUTIONS to  
Out-Of-This-World PROBLEMS*

Tracking Antennas  
Radio Telescopes  
Radar Antennas  
"Trans-Horizon" Antennas  
Tropospheric Scatter  
Ionospheric Scatter

## electronics

May 29, 1959 Vol. 32, No. 22

Published weekly, with an additional annual BUYERS' GUIDE and REFERENCE Issue in mid-June, by McGraw-Hill Publishing Company, Inc., James H. McGraw (1860-1948) Founder.

Executive, Editorial, Circulation and Advertising Offices: McGraw-Hill Building, 330 W. 42 St., New York 36, N. Y. Longacre 4-3000. Publication Office: 99-129 North Broadway, Albany 1, N. Y.

See panel below for directions regarding subscriptions or change of address. Donald C. McGraw, President; Joseph A. Gerardi, Executive Vice President; L. Keith Goodrich, Vice President and Treasurer; John J. Cooke, Secretary; Nelson L. Bond, President, Publications Division; Shelton Fisher, Senior Vice President; Ralph B. Smith, Vice President and Editorial Director; Joseph H. Allen, Vice President and Director of Advertising Sales; A. R. Venezian, Vice President and Circulation Coordinator.

Single copies in the United States, U. S. possessions & Canada 75¢; \$1.50 for all other foreign countries. Buyers' Guide in the United States, U. S. possessions & Canada \$3.00; all other foreign \$10.00. Subscription rates—United States and possessions, \$6.00 a year; \$9.00 for two years; \$12.00 for three years. Canada, \$10.00 a year; \$16.00 for two years; \$20.00 for three years. All other countries, \$20.00 a year; \$30.00 for two years; \$40.00 for three years. Second class postage paid at Albany, N. Y. Printed in U.S.A. Copyright 1959 by McGraw-Hill Publishing Co., Inc.—All Rights Reserved. Title registered in U. S. Patent Office. BRANCH OFFICES: 520 North Michigan Avenue, Chicago 11; 68 Post Street, San Francisco 4; McGraw-Hill House, London E. C. 4; 85, Westendstrasse, Frankfurt/Main; National Press Bldg., Washington 4, D. C.; Six Penn Center Plaza, Philadelphia 3; 1111 Henry W. Oliver Bldg., Pittsburgh 22; 55 Public Square, Cleveland 13; 856 Penobscot Bldg., Detroit 26; 3615 Olive St., St. Louis 8; 350 Park Square Bldg., Boston 16; 1301 Rhodes-Haverty Bldg., Atlanta 3; 1125 West Sixth St., Los Angeles 17; 1740 Broadway, Denver 2; 901 Vaughn Bldg., Dallas 1. ELECTRONICS is indexed regularly in The Engineering Index.

Subscription: Address correspondence to: Fulfillment Manager, Electronics, 330 W. 42nd St., New York 36, N. Y. Allow one month for change of address, stating old as well as new address, including postal zone if any. Subscriptions are solicited only from persons engaged in theory, research, design, production, management, maintenance and use of electronics and industrial control components, parts and products. POSITION and COMPANY CONNECTION must be indicated on subscription orders.

Postmaster: please send form 3579 to Electronics, 330 W. 42nd St., New York 36, N. Y.



Member ABP and ABC

**WHICH FOOT FORWARD?** Sometimes a "fair" exchange can be robbery. On p 47 Associate Editors Manoogian and Janis tell in detail about the U.S. electronic equipment to be shown this summer at our fair in Moscow's Sokolniki Park and about the Soviet equipment to be shown concurrently at their fair in New York's Coliseum.

The Russians are showing scientific instruments, industrial control devices and space-age electronic equipment. The U.S. is devoting its exhibit largely to tv sets, radios and hi-fi.

Perhaps our exhibit is calculated to impress the Russian man-in-the-street with U.S. affluence and show up the quantity and quality of consumer goods in the USSR. It may do that—if the man-on-the-street sees it. However, with a controlled press, long work week and a problem of mass transportation it is doubtful that very many ordinary Russian citizens outside of Moscow will hear about the U.S. show—far less see it.

On the matter of attendance, though, one thing seems sure. Soviet engineers, scientists and managers *will* see the U.S. exhibition. For this reason, it seems unfortunate that the American electronics industry is not better represented in the form of an exhibition of the latest and best precision equipment for science and industry.

**RELIABILITY.** We recall a recent television murder mystery in which the victim was crushed under a pile of newspapers, magazines and other documents. Such a possibility gives the management of this magazine pause indeed when we consider the amount of information one of our editors gathers each time we do a special report.

Frank Leary, while putting the final touches on his special report, *Designing for Reliability*, worked with a stack of documents and interview notes more than two feet high. However, as evidence that Leary was not "done in", you can read the essence of all these facts beginning on p 65.

**SHARE THE SURVEY.** That's what Hoffman Electronics Labs did with its recent study of silicon transistor growth potentials. Company execs decided to let *ELECTRONICS* in on the nonconfidential portion of the survey, which is reported under Market Research this week.

Next time you make a survey why not let us report some of your findings to others in the industry? In addition to helping the industry you may help yourself. Publication could mean reactions, suggestions and all sorts of supplementary information from other knowledgeable people.

**Coming In Our June 5 Issue . . .**

**THIN FILM MEMORIES.** As demands increase for greater speed in today's digital computers, research is being conducted to find ways of producing new and economical elements with rapid access time and simple read-write circuits. Thin ferromagnetic films offer many advantages in the fabrication of memory planes.

According to the Burroughs Corporation's E. E. Bittmann, thin film depositions on hot-glass substrates show preferred directions of magnetization. This property makes it possible to use these depositions as binary elements in a memory system.

**TUBE-TRANSISTOR HYBRIDS.** There has been a good deal of lively discussion recently about the relative merits of tubes and transistors and how best to employ their intrinsic advantages in circuit design.

One unconventional approach to this problem is to combine the best features of tubes and transistors into a single circuit design. N. C. Hekimian and G. A. Dunn of the Department of Defense have achieved notable success with hybrid design of regenerative circuits.



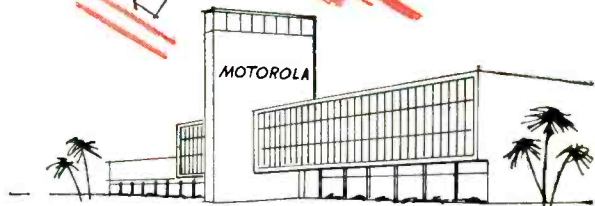

# RELIABLE SUBMINIATURE TUBES

averaged one-third the rejection rate of all other tubes used in a Missile Guidance System at **MOTOROLA INC.**

WESTERN MILITARY ELECTRONICS CENTER  
Phoenix, Arizona

Raytheon Flat Press Reliable Subminiature Tubes averaged 0.9% removals in critical Terrier missile system tests compared to 2.8% for all other types. Raytheon Flat Press construction provides superior mechanical features including:

- longer and stronger glass-to-lead wire seal
- no burned leads
- complete lead tinning
- optimum lead arrangement for wiring, socketing or dip soldering
- maximum seal reliability for operation and shelf storage

Raytheon Reliable Subminiature Tubes possess the electrical ratings and specifications that assure top performance as well as reliability. They have always been designed and constructed to assure reduced vibration output after shock, tighter limits for important characteristics and greater resistance to shock, fatigue and other environmental factors. The latest refinements are embodied in a new family of Reliability Plus Subminiature Tubes for which types and typical characteristics are listed below.

RAYTHEON RELIABLE SUBMINIATURE TUBES For Guided Missile, Military and All Other Critical Applications												
TYPICAL CHARACTERISTICS												
TYPE	DESCRIPTION	Vibration Output* (maximum) mVac	Vibration Output** peak to peak mv	Heater Volts mA		Plate Volts mA		Cathode Bias Resistor ohms	Screen Volts mA		Amplification Factor	Mutual Conductance μmhos
CK5702WB	Video Amplifier, Pentode	50	240	6.3	200	120	7.5	200	120	2.6	—	5000
CK5703WB	High Frequency Triode	10	50	6.3	200	120	9.4	220	—	—	25.5	5000
CK5704WA	High Frequency Diode	—	25	6.3	150	Max. inverse peak = 460 volts; max. I <sub>0</sub> = 10 mA						
CK5744WB	High Mu Triode	15	75	6.3	200	250	4.2	500	—	—	70	4000
CK5783WA	Voltage Reference	20	—	—	—	Operating voltage approximately 85 volts between 1.5 and 3.5 mA						
CK5784WB	RF Mixer Pentode	75	300	6.3	200	120	5.5	230	120	4.1	—	3200
CK5787WA	Voltage Regulator	20	—	—	—	Operating voltage approximately 98 volts between 5 and 25 mA						
CK6247WA	Low Microphonic	2.5	25	6.3	200	250	4.2	500	—	—	60	2650
CK6533WA	Low Microphonic Triode	1.0	15	6.3	200	120	0.9	1500	—	—	54	1750

Each type is electrically and mechanically interchangeable with earlier versions of the same basic type. Developed under Navy sponsorship.

Bulb temperature ratings to 220°C

\*15g, 40 cps, fixed frequency  
\*\*15g, 30 to 1000 cps sweep



## INDUSTRIAL TUBE DIVISION

55 CHAPEL STREET, NEWTON 58, MASSACHUSETTS

RELIABLE MINIATURE & SUBMINIATURE TUBES • GAS & VAPOR TUBES • CATHODE RAY TUBES • HARD-GLASS POWER TUBES

BOSTON: Bigelow 4-7500 • NEW YORK: PLaza 9-3900 • CHICAGO: NAtional 5-4000 • LOS ANGELES: NOrmandy 5-4221

BALTIMORE: SOutfield 1-1237 • CLEVELAND: WInton 1-7716 • KANSAS CITY: PLaza 3-5330

GOVERNMENT SALES . . . BOSTON: Bigelow 4-7500 . . . WASHINGTON, D.C.: MEtropolitan 8-5205 . . . DAYTON: BAldwin 3-8128

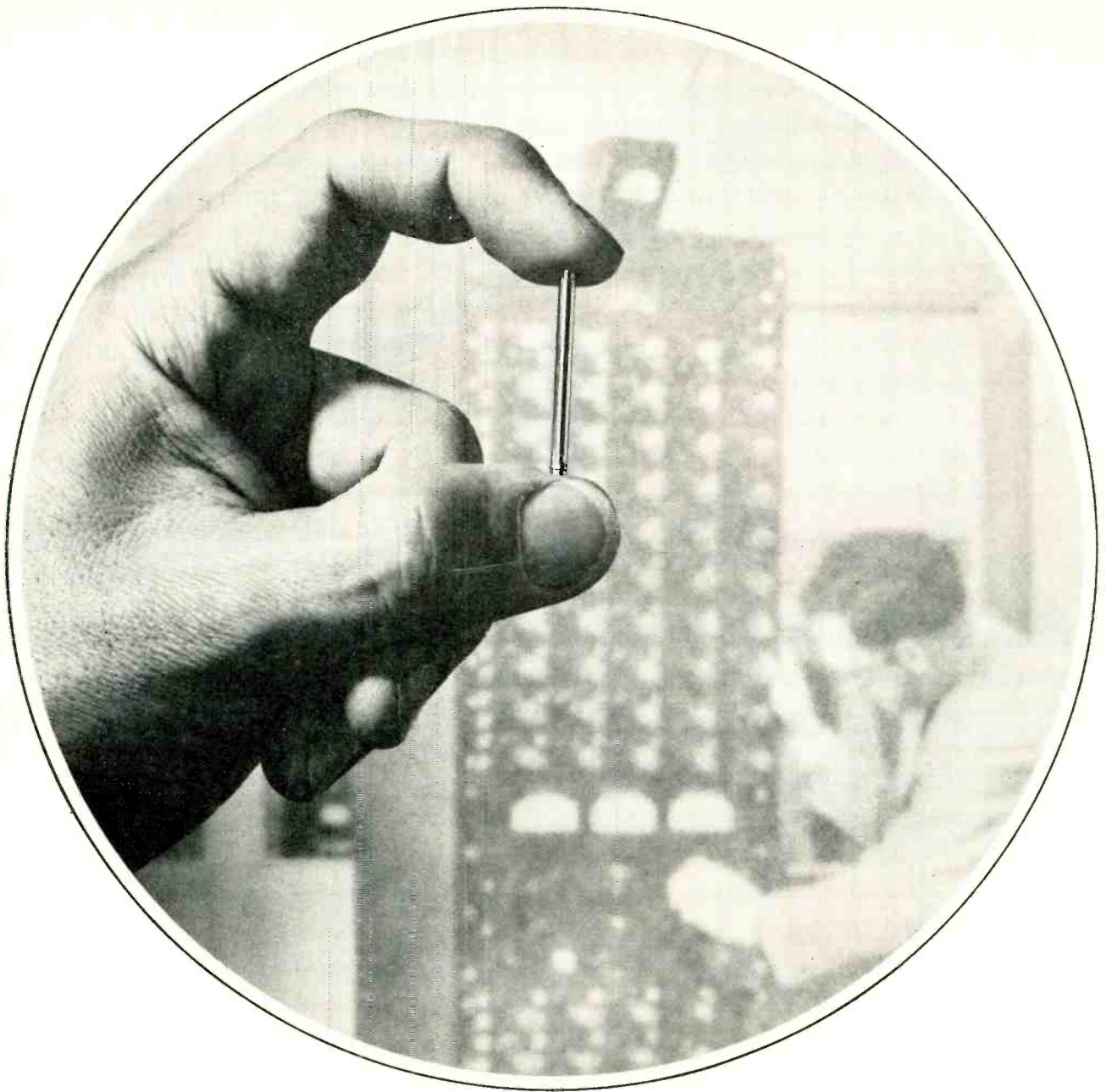

## Superior Probes Deeper into Cathode Metallurgy

### **VACUUM MELTED CATHODE MATERIALS AND VACUUM ANNEALED CATHODES**

There has been considerable interest lately in vacuum melted and vacuum annealed cathodes. On the part of Superior Tube, too—its engineers have been probing the subject for almost 10 years.

Today Superior offers vacuum annealed cathodes in more than a dozen cathode alloys in Seamless/Weldrawn® form. In addition, vacuum melted heats of Superior's Cathaloy® materials are available in all cathode forms . . . Seamless/

Weldrawn, Lockseam,\* and Lapseam. The full benefits to users of electron tubes await further exploration and testing.

Why not investigate these alloys in your own laboratory. Cathodes can be supplied in any desired size for pilot testing or in quantity lots. Superior engineers will be glad to work with you in comparing laboratory findings and in providing analysis information. Superior Tube Company, 2500 Germantown Ave., Norristown, Pa. \*Manufactured under U.S. patents

# *Superior Tube*

The big name in small tubing

**NORRISTOWN, PA.**

Johnson & Hoffman Mfg. Corp., Mineola, N.Y.—an affiliated company making precision metal stampings and deep-drawn parts



Quality Features of

# OHMITE®

# VITREOUS ENAMELED RESISTORS

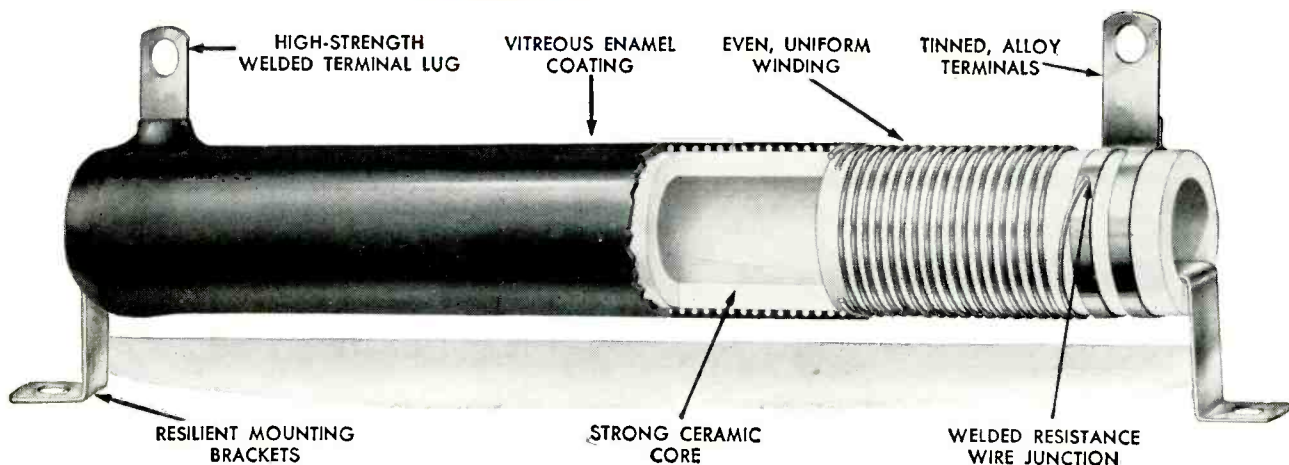

**Balanced Thermal Expansion**  
prevents crazing  
and moisture entrance

In Ohmite resistors, spot welding replaces soldering, brazing, and mechanical fastening. Spot welding produces strong connections that are not affected by vibration or high temperatures. Ohmite welded construction also produces an almost flush connection between the resistance wire and terminal. This prevents thin spots or bulges in the vitreous enamel coating which might cause future trouble and failure. Many different types of terminals are available besides the lug illustrated.

## Ohmite can supply all of your resistor needs

### some of the many types available

- |   |  |
|---|--|
| Axial Lead  | Live Bracket Mounting Resistors  |
| Brown Devil® Wire Lead                                    | Edison Screw Base Mounting Resistors   |
| Fixed, Lug Type   | Riteohm® Wire-Wound Precision Resistors, Encapsulated; Vitreous Enameled; Molded Jacket; Hermetically Glass Sealed |
| Dividohm® Adjustable                                      | Riteohm® Metal Film Resistors  |
| Thin Type   | Resistors to meet MIL Specifications   |
| Noninductive  | High-Shock Resistors   |
| Powr-Rib®, High Current, Round or Ribbon Wire, Open Wound |  |
| Corrib®, High Current, Corrugated, Edgewound Ribbon       |  |
| Resistors with Heat Conducting Studs                      |  |
| Ferrule Mounting Resistors                                |  |

The almost endless variety of Ohmite resistors in many sizes and types—in a wide range of wattages and resistances—makes it possible to meet each individual need. Many of these can be supplied from the world's largest factory stock. Whatever your resistor requirements may be, chances are you will find exactly the type you need in industry's most complete line of high-quality resistors.

Be Right with



**Ohmite Manufacturing Company**  
3610 Howard Street  
Skokie, Illinois

- |                       |              |             |
|-----------------------|--------------|-------------|
| RHEOSTATS             | RESISTORS    | RELAYS      |
| TANTALUM CAPACITORS   | TAP SWITCHES |             |
| VARIABLE TRANSFORMERS | DIODES       | R.F. CHOKES |

Write on company letterhead for Catalog 58

Design better products with

# DOW CORNING SILICONE COMPOUNDS

improve transistor performance

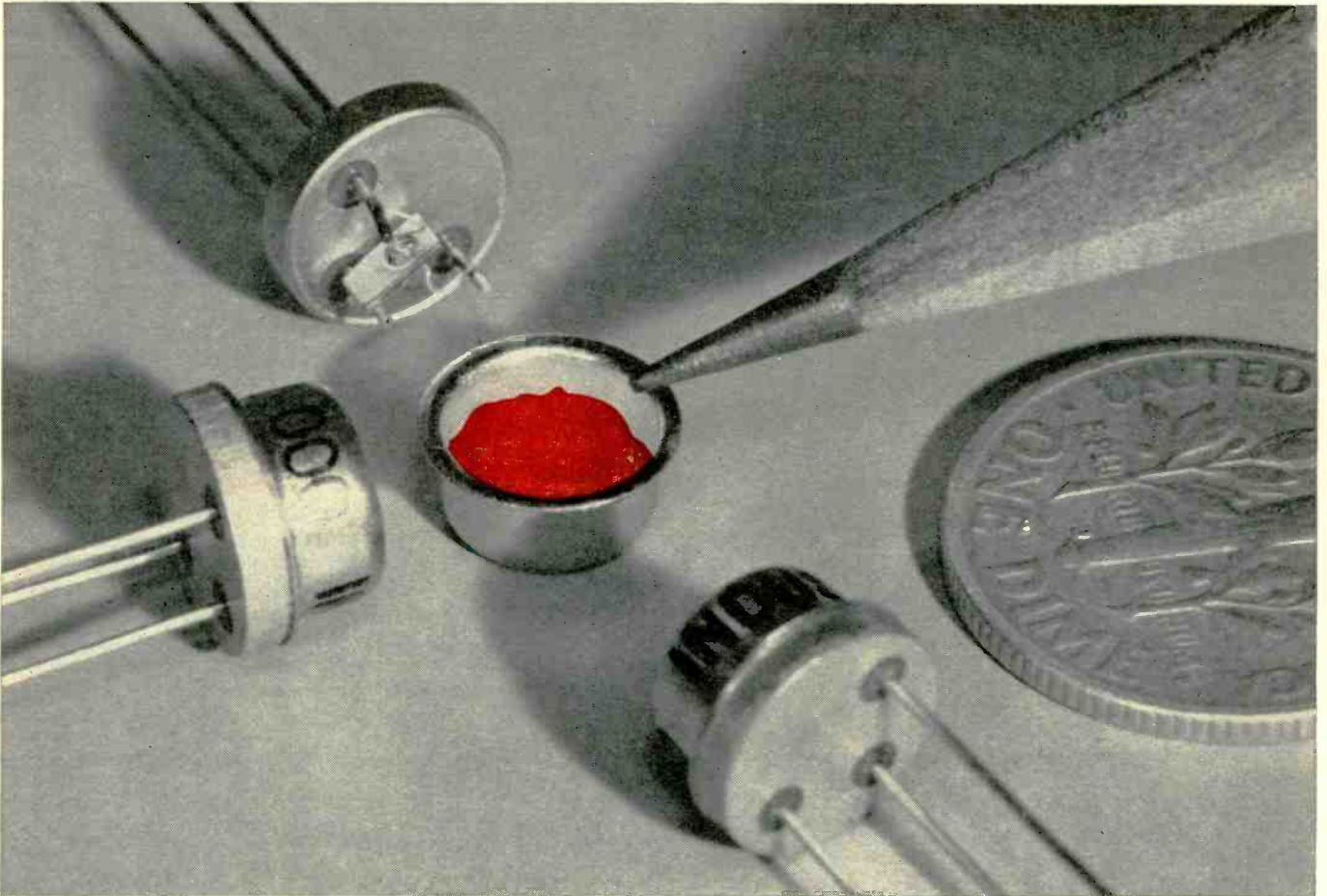

Made by Industro Transistor Corp., these miniature transistors are potted with a Dow Corning silicone compound to cushion vibration, improve heat dissipation, prevent contamination of the junction.

#### TYPICAL PROPERTIES OF DOW CORNING COMPOUNDS

Color	colorless, translucent
Penetration (ASTM D216-52T)	
unworked	200 to 240
worked, maximum	300
Electric Strength, volts per mil, at 10 mils	500
Dielectric Constant at 23 C (ASTM D150-54T)	
at 100 kc	2.85
Condition C-96/23/96†, at 100 kc	3.00
Dissipation Factor at 23 C (ASTM D150-54T)	
at 100 kc	0.0009
Condition C-96/23/96†, at 100 kc	0.003
Arc Resistance, seconds (ASTM D495-56T)	80

† Condition C, tested after 96 hours at 96 percent relative humidity and 25 C.

Used for potting transistor junctions, Dow Corning silicone compounds improve heat dissipation, serve as damping agents to cushion vibration, prevent metallic contamination when covers are welded in place. Silicone compounds are inert, nonmelting, nongumming . . . maintain their grease-like consistency over a temperature span from as low as -75 C to 200 C and higher. In addition to transistor potting, Dow Corning silicone compounds are used in a wide variety of electronic components and devices to protect against arcs, grounds, shorts; impart a high order of surface resistivity. Silicone compounds apply easily, need no cure. Free sample available.

CIRCLE 103 READER'S SERVICE CARD

first in  
silicones

**Dow Corning CORPORATION**  
MIDLAND, MICHIGAN



# Dow Corning Silicone Dielectrics



AiResearch miniature motor combines Sylkyd wire and silicone varnish.

## REDUCE SIZE, WEIGHT WITH SILICONE INSULATING MATERIALS

Specify Sylkyd® enameled magnet wire to help reduce the size and weight of transformers, servo motors, and other devices by as much as 50%. Equal in diameter to Class A magnet wires, it serves at 180 C . . . withstands the higher temperatures of miniaturization. Impregnated with Dow Corning 997 Varnish, Sylkyd enameled magnet wire and other silicone insulating components are bonded into moisture resistant insulation systems having high dielectric strength, maximum reliability over a wide range of temperatures and environmental conditions. Write for new, illustrated brochure.

CIRCLE 104 READER'S SERVICE CARD

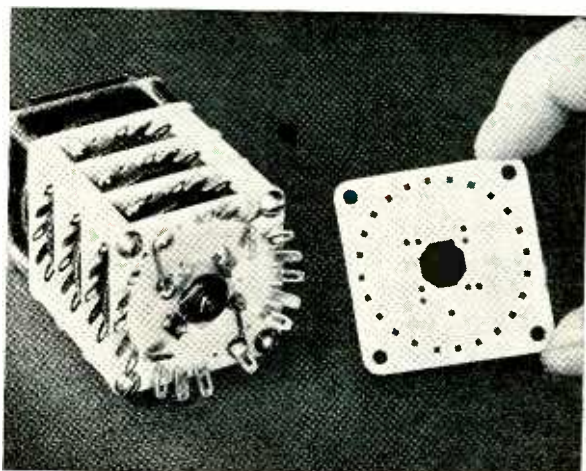

Shallcross Manufacturing rotary switch decks.

## SILICONE-GLASS LAMINATES RESIST CONTINUOUS 250 C HEAT

Laminates made of glass cloth bonded with Dow Corning silicone resins provide heat-stable structural and insulating materials . . . withstand soldering heat during assembly of electronic equipment . . . resist continuous exposure to temperatures up to 250 C. Silicone-glass laminates resist moisture, arcing, corona. They are lightweight, strong, rigid . . . supplied in many shapes and forms by leading laminators.

CIRCLE 105 READER'S SERVICE CARD

## SILASTIC ENCAPSULATION ABSORBS VIBRATION, SHOCK

Sensitive electronic parts withstand vibration and shock longer when encapsulated with Silastic®, the Dow Corning silicone rubber. That's because Silastic retains all its superior properties on aging. Silastic has low moisture absorption, stays resilient over a wide temperature range . . . is easy to apply. Available in many forms, including molded parts, extrusions, tapes, sheets and pastes.

CIRCLE 106 READER'S SERVICE CARD



Electronic tube encapsulated with Silastic.





## Low transistors are tested in Texas . . . 1900 per hour!

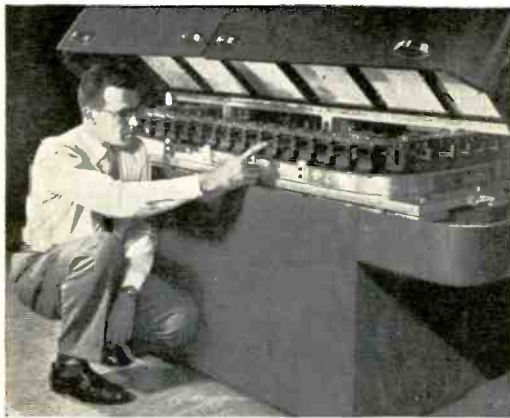

TI—designed, completely automatic transistor evaluator, FAST, tests up to 12 parameters, classifies as many as 5 transistor types within each of 3 families, and is capable of punching test results onto 8-hole paper tape . . . at rates up to 1900 per hour.

Increased reliability, greater uniformity and lower unit costs accrue to users of TI transistors through entirely automatic testing by FAST, the most sophisticated semiconductor test apparatus in industry usage today. Built at TI, this **F**acility for **A**utomatic **S**orting and **T**esting tests and classifies production transistors at rates up to 1900 per hour . . . completely eliminating human error.

Only advanced facilities can produce advanced components.

FAST automatically tests for parameters and classifications of each transistor, encodes results on a mechanical binary memory built into the corresponding test block, and checks the calibration of all test circuits after every test. Upon completion of tests, the machine sorts transistors into appropriate bins. By means of the block memory, FAST is also capable of punching results onto 8-hole paper tape for in-process control.

Continuous improvements in production technology at TI provide engineers the world over with precise reliable devices of practical economy, and make possible new areas of semiconductor application.

Write Dept. 1095 on your company letterhead for comprehensive summary of all TI semiconductor products



THE WORLD'S LARGEST SEMICONDUCTOR PLANT

TEXAS



INSTRUMENTS

INCORPORATED  
SEMICONDUCTOR-COMPONENTS DIVISION  
DALLAS, TEXAS



## **ELECTRONICS NEWSLETTER**

**STRATOSPHERE PLATFORMS** that would derive propulsion power from microwave energy transmitted from the ground in narrow beams are under study by the Air Force. Raytheon has proposed development of the sky stations, which would convert microwave energy to heat for further conversion into mechanical power to drive helicopter-type rotary wings. Antenna size would determine platform altitude. Firm says a number of high-frequency, high-power Amplatron tubes could produce enough power for antenna-focusing on the platform to keep it hovering in a fixed position for long periods. Lightweight chemical power plant would lift the platform initially, later lower it to earth.

*Performed semiconductor crystal for device fabrication is called for by The National Inventors Council, U. S. Department of Commerce, Washington 25, D. C. NIC lists 28 new problems and five revised ones in "Supplement to Technical Problems Affecting National Defense."*

**HYPERSOUND WIND TUNNEL** for testing missiles and space vehicles at 10 to 27 times the speed of sound will use more than 2,000 capacitors in its giant energy storage bank. GE is completing the unit this summer for Boeing. Capacitor bank will store 7 million joules of energy and discharge it in an arc of 5 million amperes in a compressed air chamber. Arc will raise compressed air temperature to 18,000 F, pressure to 30,000 psi to create a high-energy shock wave of ionized atoms. Special rectifier equipment will charge the capacitor bank with d-c in about 30 seconds. Gear includes voltage control, monitoring and protective devices.

**BASIC RESEARCH SPENDING** in the U.S. amounts to some \$670 million annually, with 48 percent being spent by the government, 33 percent by industry and 19 percent by universities and other nonprofit institutions. The total includes expensive research tools such as particle accelerators, research rockets and radiotelescopes. Figures were reported by Alan T. Waterman, director of the National Science Foundation, at a Symposium on Basic Research at the Rockefeller Institute in New York. President Eisenhower told symposium delegates the government was planning a two-mile linear accelerator at Stanford University to cost \$100 million over six years. New national facility would be about 50 times the length of a linear accelerator now used at Stanford and would be powered by similar klystron amplifiers. New machine would have 10 to 15 bev power compared to 700 mev from existing unit.

**VHF OMNIRANGE EQUIPMENT** in the form of 140 "package" VOR systems has been purchased by the Federal Aviation Agency from Topp Industries of Los Angeles. Topp says \$2.75 million worth of gear is now being installed with an antenna system whose azimuth signal under test conditions is accurate to one-half degree. One degree equals 1.75 mi at a distance of 100 mi, reports the firm. Topp claims a 100-percent improvement over earlier equipment.

**ELECTRONIC LARYNX** which uses a tiny transducer held against the throat is under development at Bell Telephone Laboratories for persons who have lost their voices through surgical removal of vocal chords. Cylinder shaped unit is 1 $\frac{1}{4}$  in. in diameter, 3 $\frac{1}{4}$  in. long, and contains a modified telephone receiver, a transistorized pulse generator with pitch control and a battery. User presses vibrator against his throat and switches on the pulse generator. This transforms the vibrations transmitted by the usable mechanisms in his vocal tract into speech.

**SYNCHOREADER**, a Japanese recording and playback machine that operates on a film of material on the back of a paper sheet, is now being produced by the Canon Camera Co. Firm says it expects to make 2,000 units a month by the fall in response to large orders from Japanese firms, adds that it has no export plans at present. Inventor Yasushi Hoshino says several U.S. firms are discussing the possibility of manufacturing rights. Present model will sell for about \$380, but Hoshino believes a smaller version could be produced for about \$100.

*Behind the transistorization of Sage (ELECTRONICS, p 11, May 15) is believed to be this reason: Vast rooftop air-conditioning facilities are now needed to counteract the heat generated by thousands of tubes. It's feared that an attack would knock out air-conditioning, rendering equipment inside bomb-proof structures useless.*

**SOVIET AEROFLOT** line plans to try out the British Decca short-range air navigation system for six months in Moscow, British sources report. They say both the U.S. vhf omnirange system (VOR) and Decca were studied before the Russians decided to try the British system. An Aeroflot official reportedly said that Decca would be extended throughout Russia after the trial "if it is as good as we think it is." Some British sources think the Soviets may seek a licensing agreement to make the gear. The official added that the Soviets are also considering use of the Decca long-range nav-aid. Final details of the trial were slated to be set at the end of this month.



Al Mitchell takes the

stand for

**electronics**

I. Allen Mitchell is President and a founder of United Transformer Corporation, a company which placed its first advertisement in electronics more than 25 years ago.

United Transformer manufactures 700 stock items for virtually every application in the electronics field. Mr. Mitchell is a graduate engineer who entered college at the age of 14. At 16 he was the chief engineer of a transformer company and at 18 the director of engineering.

Do you, Mr. Mitchell, directly or indirectly influence the purchase of electronic equipment for your organization?

*Naturally, I do.*

Do you use the electronics BUYERS' GUIDE as your source book for electronic purchases?

*Yes. I keep it available in my office at all times.*

How long have you been a subscriber to electronics?

*Since the day of its inception.*

Why have you continued to pay for electronics when you can receive ten other electronic publications free?

*To me electronics has a peculiarity. It has excellent technical coverage. It has the most pages of advertising, and naturally I want to keep abreast of the industry in terms of the products shown in the ads. For a number of years your company has reserved the inside front cover of electronics for its sales messages. What is behind this decision?*

*Basically, we are a key manufacturer in our field for engineering products. As such we prefer to maintain a prestige position in the prestige magazine of our industry.*

If it's about electronics, read it in electronics

# electronics

Published WEEKLY plus the mid-year electronics BUYERS' GUIDE  
A McGraw-Hill Publication • 330 West 42nd Street, New York 36, N. Y.





**NEW!** Electro Instruments totally-transistorized, modular

# XY recorders!



## NEW ENGINEERING IMPROVEMENTS THROUGHOUT!

- Faster slewing speeds—  
Pen: 30"/sec.;  
Carriage: 30"/sec.
- Greater accuracies—  
Static: 0.1%;  
Dynamic: 0.2%.
- 0.05% internal  
calibration.
- High precision internal  
Zener diode reference.
- New improved vacuum  
hold-down system.
- Vernier control between  
ranges.
- Input function modules  
in rack mountable case  
can be removed from  
plotter for remote  
operation.
- Calibrated scales on  
both axes.
- Front panel gain control.
- Vacuum release on  
front panel.
- Visible ink supply.

One basic plotter with input modules available for  
general purpose, computer, low level differential, time base,  
curve following and other specialized functions.

	Model 410 Computer Module	Model 420 General Purpose Module	Model 430 Low Level Differential Module	Model 450 Curve Follower Module	Model 460 Time Base Module
<b>Input Ranges</b>	Single Ended 0.1, 1.0, 10v/in, calibrated vernier	Single-Ended 16 steps, 1m v/in to 100 v/in, plus vernier	Differential 16 steps, 1m v/in to 100 v/in, plus vernier	Single-Ended	Single-Ended 0.1, 0.2, 0.3, 0.6, 1.0, 2.0 in/sec
<b>Accuracy: Static</b>	±0.1% F/s	±0.1% F/s	±0.15% F/s	±0.25% F/s	(time) ±1.0% F/s
<b>Accuracy: Dynamic</b>	±0.2% F/s	±0.2% F/s	±0.2% F/s	±0.1% F/s	(sweep) ±0.5% F/s
<b>Linearity</b>					
<b>Input Resistance</b>	2 megs, all ranges	1 meg to 3 megs Depending on range	1 meg to 3 megs Depending on range		
<b>Zero Adjust</b>	Full scale X and Y plus 9" offset	Full scale X and Y plus 9" offset	Full scale X and Y plus 9" offset		
<b>Reference</b>	Internal Zener diode and external ±100v computer	Internal Zener diode	Internal Zener diode		Internal Zener diode
<b>Calibration</b>	Internal 0.1, 1.0, 10v Accurate to ±0.05%				
<b>Common Mode Rejection</b>			DC, 120 db AC, 100 db at 60 cps 50 v dc or peak ac		
<b>Max. Common Mode Voltage</b>					
<b>Principle of Operation</b>				60 cps magnetic induction	Electronic integration
<b>Zero drift</b>				None	

Dimensions All Modules: 8½" W x 3½" H x 7¾" D

### Model 400 Plotter



3540 Aero Court  
San Diego 11, California

- Recording Size: 10" x 15"
- Slewing Speed: X, 40"/sec; Y, 30"/sec
- Inputs: X and Y inputs, and computer reference
- Power: 115 ±10 v, 60 cps
- Dimensions: 19" W x 19½" H x 11¾" D
- Ambient Temperature Range: 0-55°C
- Controls: Power off, standby, operate, pen; vacuum release; curve follower, amplifier; local, remote.

# Electro Instruments, Inc.

# NEW

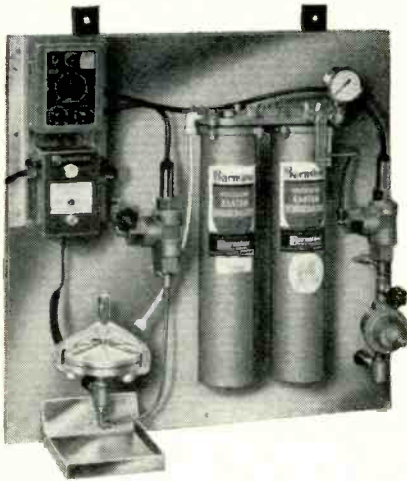

## ADD THOUSANDS OF HOURS TO UHF TRANSMITTING TUBE LIFE

with BARNSTEAD cooling water repurifying system

**PAYS FOR ITSELF OVER AND OVER IN REPLACEMENT TUBE SAVINGS . . . REQUIRED BY SOME MAKERS BEFORE THEY GUARANTEE TRANSMITTING TUBES.**

Research by a leading transmitting tube manufacturer shows that the life of UHF transmitting tubes is drastically shortened by impurities in cooling water. Dissolved impurities and suspended particles in the cooling water deposit on the tube anode forming an insulation. This causes overheating, and shortened tube life results. The most damaging of these impurities is copper oxide which is formed when carbon dioxide dissolves copper particles in the cooling water. The Barnstead Cooling Water Repurifying System substantially reduces and sometimes completely eliminates the copper oxide deposits by removing the dissolved copper, carbon dioxide and oxygen. Other dissolved scale-forming impurities are removed at the same time including submicroscopic particles. For the answer to your Pure Water Problems why not write to Barnstead today!

**Barnstead**  
STILL AND STERILIZER CO.

84 LANESVILLE TERRACE, BOSTON 31, MASS.

NEW YORK  
Kingsbridge  
8-1557

CLEVELAND  
Academy  
6-6622

CHICAGO  
Mulberry  
5-8180

BOSTON  
Jamaica  
4-3100

PHILADELPHIA  
Locust  
8-1796

LOS ANGELES  
Ryan  
1-6663

SAN FRANCISCO  
Templebar  
2-5391

CIRCLE 14 READERS SERVICE CARD

# WASHINGTON OUTLOOK

THE LONG-SIMMERING DEBATE over the electronics-dominated air defense program is building to a climax. Items:

1. Defense Secy. McElroy told the Senate Defense Appropriations Subcommittee the Pentagon is "taking another hard look at air defense missile programs with a view to eliminating any duplications which may still exist."

New procurement orders for the Nike-Hercules, Hawk and Bomarc surface-to-air missiles will drop some \$390 million next year to about \$710 million. But new orders for the Navy's Talos, Terrier and Tartar ship-to-air missiles will increase.

2. Word leaked out that the Air Force recently cancelled the hush-hush "Project Dams", a multimillion dollar program for development of an aircraft-borne antimissile system. Contractors were Stavid Engineering, Bausch & Lomb, Olin Mathieson and United Shoe Machinery.

3. The Senate Armed Services Committee ordered a freeze on construction of new Nike-Hercules missile bases, tied up \$50 million appropriated last year (but still not contracted out) for construction of 25 sites in the continental U.S. and facilities for eight missile batteries in Hawaii.

4. The policy debate was aired at the Aviation Writers Association's convention here. Douglas Aircraft's chief missile engineer made a plea for a Nike-Zeus speedup, argued that production of the system should be started. Sylvania vice president H. L. Richardson said future missile defense systems will be based on infrared and optical detection techniques.

The Air Force's new Assistant Secretary for R&D, J. V. Charyk, called missile defense today's "key military technical challenge", but voiced what is now Washington's official line—that the development status of Zeus still does not justify authorization of production.

● The Senate Committee's action on Nike-Hercules reflects widespread Congressional dissatisfaction with Pentagon air defense policy. The freeze order was linked to the Committee's action on a military construction authorization bill for next year. It did not directly affect the military procurement budget. But it's now likely the Army will hold back production orders—except for replacement parts and such—unless the construction freeze is lifted.

Congress has long pushed the Pentagon to decide on one of the two competing anti-aircraft missiles—the Army's Nike-Hercules or the Air Force's longer range Bomarc. The Pentagon, however, has continued plans for both—the Hercules for close-in or "point" defense of cities, the Bomarc for "area" or far-out defense.

The committee called the Hercules system "virtually obsolete", and implied the rival Bomarc should now be pushed faster. It asked McElroy to come up with a "master plan" on anti-aircraft missiles before Congress adjourns this year.

The current Bomarc program covers construction of 19 bases. Four are now under construction, building contracts on 10 more will be placed within three months, five others are planned.

Next year's budget includes funds for construction of five more Bomarc sites—for a total of 24 installations.

● A House investigation of the radio spectrum problem will kick off a week from Monday, June 8-9, with a high-level "panel discussion" on ways to use the spectrum space more efficiently. The Commerce Subcommittee headed by Rep. Oren Harris (D., Ark.) has sent out invitations to a dozen top representatives in government, industry and universities.



Space Technology Laboratories is responsible for the over-all systems engineering, technical direction and related research for the Air Force Intercontinental and Intermediate Range Ballistic Missile Programs and for the highly successful Thor-Able series of ICBM range re-entry launches. ■ In addition, STL carries out special experimental projects for such agencies as the National Aeronautics and Space Administration and the Advanced Research Projects Agency. On behalf of these agencies and in conjunction with the Air Force Ballistic Missile Division, STL designed and produced the Pioneer I payload, one of the most sophisticated fact-finding devices ever launched into space. In addition, STL provided systems engineering and technical direction for the Air Force satellite, the Atlas SCORE. ■ In support of these and future requirements, STL's activities provide a medium through which scientists and engineers are able to direct their interests and abilities towards the solution of complex space age problems. STL invites inquiries regarding staff openings in any of the five major areas of the company's activities.

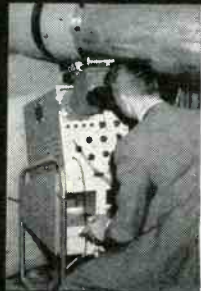

**Physical Research Laboratory**

... conducts basic research including analytical and experimental investigations in magnetohydrodynamics, thermonuclear power, plasma physics, and low temperature solid state physics.

**Electronics Laboratory**

... provides technical direction for, and conducts studies leading to, design and specifications of advanced guidance, control, and communication systems; also packaging, environmental testing and over-all checkout.



**Astrovehicles Laboratory**

... conceives, evaluates, designs, develops, and tests space vehicle systems; provides technical direction of propulsion, nose cone, and airframe subsystems; explores new propulsion, airframe, re-entry, and ground handling techniques.



**Computation & Data Reduction Center**

... provides a centralized mathematical and computing facility and engages in advanced research in data systems, information theory, computation systems and automatic programming, systems and hardware simulation, and applied mathematics.



**Systems Engineering Division**

... has the over-all responsibility for the system integration of the Atlas, Titan, Thor, and Minuteman weapons systems, in addition to responsibility for technical direction of the airframe, sub-system, assembly and test, and ground support activities; evaluates proposed future weapons and space systems.





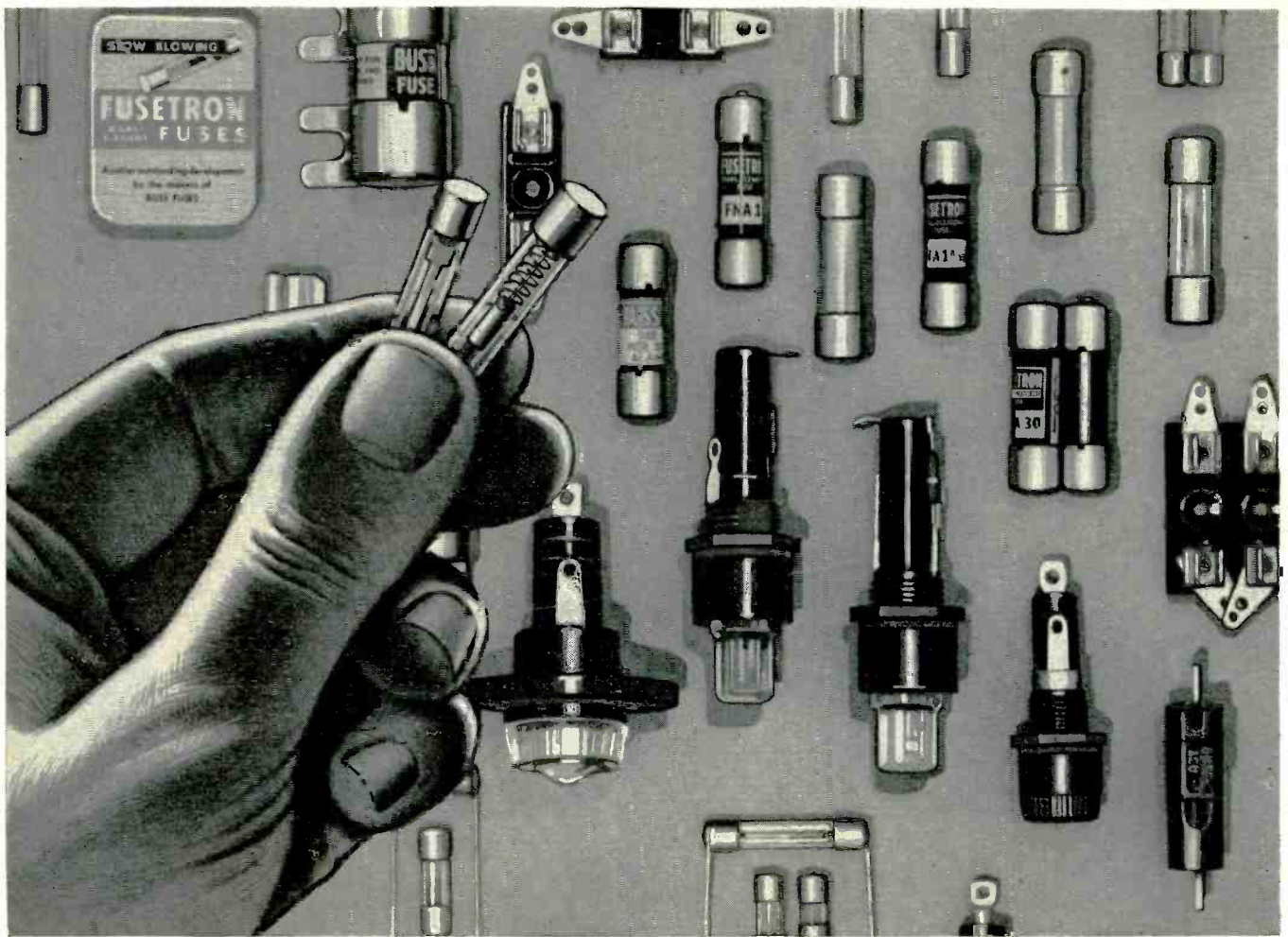

## For Every Electrical Protection Requirement . . . *there's a safe and dependable BUSS or FUSETRON Fuse!*

BUSS fuse engineers have consistently pioneered the development of new fuses to keep pace with the demands of the Electronic Industry. Today, the complete line includes:

Single-element fuses for circuits where quick-blowing is needed;—or single-element fuses for normal circuit protection;—or dual-element, slow-blowing fuses for circuits where harmless current surges occur;—or indicating fuses for circuits where signals must be

given when fuses open. Fuses range in sizes from 1/500 amperes up—and there's a companion line of fuse clips, blocks and holders.

**Dependable protection under  
 all service conditions.**

Every BUSS or FUSETRON fuse is tested in a sensitive electronic device that automatically rejects any fuse not correctly calibrated, properly constructed and right in all physical dimensions.

**If you have a special  
 protection problem.**

The world's largest fuse research laboratory, plus the experience gained by solving all types of electrical protection problems is on call to you at all times. Our engineers, work with yours and can most probably save you time and trouble.

*For more information, write for  
 BUSS bulletin SFB.*

**BUSSMANN MFG. DIVISION,  
 McGraw-Edison Co.  
 University at Jefferson, St. Louis 7, Mo.**

*BUSS fuses are made to protect - not to blow, needlessly.*

*BUSS makes a complete line of fuses for home, farm, commercial,  
 electronic, electrical, automotive and industrial use.*







## IN THE WORLD OF SPACE A BRILLIANT NEW CONSTELLATION

OF THE FIRST MAGNITUDE is Radiation's proven problem-solving ability in the varied fields of SPACE ELECTRONICS.

This ability is founded on Radiation's stellar achievements and diversified experience in the design, development and production of Electronic Systems and Sub-Systems for the Government, the Military, and Private Industry.

Radiation's physical facilities for Research and Development, Production, and Test-Evaluation combine to set the pace for state-of-the-art advancements in electronic techniques.

ALSO OF THE FIRST MAGNITUDE are the many men of renowned stature in specialized areas of Science and Engineering, Technics and Administration who are contributing to Radiation's meteoric growth.

For further information about the field that most interests you, write to Radiation, Inc., Melbourne, Florida.



**RADIATION, INC.**

MELBOURNE AND ORLANDO, FLORIDA  
ASTRONICS • AVIONICS • INSTRUMENTATION

IMPORTANT CAREER OPPORTUNITIES NOW AVAILABLE



RESEARCH

DATA SYSTEMS

TELEMETRY

RADAR AND REFLECTIVITY

ANTENNA DEVELOPMENT

RF SYSTEMS

MISSILE CHECKOUT

COMMUNICATIONS

COUNTERMEASURES

Visit our booths  
at the IRE NTC,  
Denver, Colorado  
and AFCEA,  
Washington, D.C.

\*Norman Allen is account supervisor, Mohr & Eicoff, Inc., advertising agency for Burnell & Co., Inc.



## Norman Allen\* takes the stand for **electronics**

One day last week in a discussion of engineering techniques with Norman Burnell, President of Burnell & Co., pioneer manufacturer of toroids, filters and related networks, I commented that the chain of production was no stronger than its weakest link. Mr. Burnell thought a moment and gave this highly meaningful reply. "I believe," he said, "you mean the chain of production is no stronger than its weakest *think*."

There's a lot of significance to that sentence when it comes to publications as well as people. It's one of the reasons why **electronics** has been on Burnell's advertising schedule since the company's inception—a schedule which today includes seventeen full pages.

I regard **electronics** as an indispensable medium of advertising—because it represents one of the strong 'thinks' in Burnell's production plans. Advertising in **electronics** informs industry of Burnell's product development, new designs, new circuit components, new production methods and advances in miniaturization. Moreover, **electronics'** advertising, news and feature columns have been an endless source of ideas and information. They help the Burnell engineering staff keep abreast of developments and anticipate the electronics industry's needs. In summing up, I'd say advertising in **electronics** has been of considerable help in establishing Burnell & Co. as a leader in the field of toroids, filters and related networks.

If it's about electronics, it's advertised and read in **electronics**.

# electronics

Published WEEKLY plus the mid-year electronics BUYERS' GUIDE  
A McGraw-Hill Publication • 330 West 42nd Street, New York 36, N. Y.





another **MOTOROLA** first . . .



# 25amp power transistors

## FOR HIGH CURRENT SWITCHING and AUDIO APPLICATIONS

- 25 amps D.C. collector current
- Collector to base voltage; up to 80 volts
- High current gain: 25 at 25 amps (typical)
- Exceptionally rugged dynamic breakdown characteristic
- Low saturation resistance: 0.012 ohms (typical)
- Standard TO-3 package with oversized pins . . . available with or without low impedance solder terminals
- Excellent Beta linearity
- Meets or exceeds mechanical and environmental requirements of MIL-T-19500A
- Conservative maximum ratings and special testing methods assure long life . . . extreme reliability
- Immediately available "off the shelf" from your Motorola distributor

MAXIMUM RATINGS			
JEDEC NUMBER	COLLECTOR TO BASE VOLTAGE volts	COLLECTOR TO EMITTER VOLTAGE volts	COLLECTOR D. C. CURRENT amps
2N1162	50	35	25
2N1164	80	60	25
Maximum Junction Temperature — continuous			90°C
Maximum Junction Temperature — intermittent			100°C
Collector Dissipation for Mounting Base Temperature of 30°C: 50 watts			
Operating Temperature Range: -65° to 90°C			

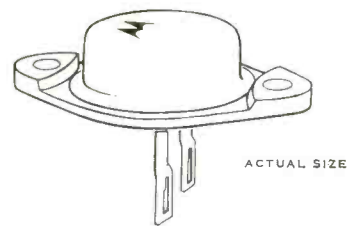

**Other Motorola Quality Products Include:**

- Switching Transistors
- Mesa Transistors
- Zener Diodes
- Silicon Rectifiers
- Audio Transistors

**REGIONAL OFFICES:**

- RIDGEFIELD, NEW JERSEY  
540 Bergen Boulevard  
Whitney 5-7500
- CHICAGO 44, ILLINOIS  
4900 West Flournoy Street  
Estebrook 9-5200
- HOLLYWOOD 28, CALIFORNIA  
1741 Ivar Avenue  
Hollywood 2-0821



"DEPENDABLE QUALITY - IN QUANTITY"

**MOTOROLA SEMICONDUCTORS**

MOTOROLA INC., 5005 E. McDOWELL, PHOENIX, ARIZONA

# Oster<sup>®</sup> to the Outside



## MISSILE QUALITY SERVOS

For trouble-free systems, missile designers specify Oster reliability. Choose from the Complete Line for Missile, Aircraft & Ground Support Applications.

- Sizes 8, 10, 11, 15, 18, 23, 29 in 400 cycle. Sizes 15, 18, 23 in 60 cycle.
- -55° to +125°C temperature range. Higher temperature servos available for special applications.
- Meet MIL-E-5272A & MIL-E-5400.
- Available with leads & terminals to your requirement.
- Immediate delivery from stock of many types in sample quantities.



BURTON BROWNE ADVERTISING



### NEW 24-page SERVO MOTORS CATALOG No. 5000

Lists 40 basic servo types for military, scientific and industrial applications. Write for your free copy on company letterhead today.

#### OTHER PRODUCTS INCLUDE:

Synchros	Computers
Resolvers	Indicators
Motor Tachs	Servo Mechanisms
DC Motors	Servo Torque Units

*John Oster*

#### MANUFACTURING CO.

Your Rotating Equipment Specialist  
Avionic Division  
Racine, Wisconsin

#### NEW YORK OFFICE

237 North Main Street  
Hempstead, L.I., New York  
Phone: 1Vanhoe 3-4653  
TWX Hempstead N. Y. 705

#### NEW JERSEY OFFICE

517 Lyons Avenue  
Irvington, New Jersey  
Phone: ESsex 3-2361

#### WESTERN OFFICE

5333 So. Sepulveda Blvd.  
Culver City, California  
Phone: EXmont 1-5742  
TEXas 0-1194  
TWX S. Mon 7671

Engineers For Advanced Projects:

Interesting, varied work on designing transistor circuits and servo mechanisms.  
Contact Mr. Robert Burns, Personnel Manager, in confidence.



# CONTINENTAL'S BURN-IN PROCESS

## 200 HOURS AT

## 200° CENTIGRADE

### FOR SILICON DIODES

All Continental general purpose diodes are "burned-in" for 200 hours at 200°C—before being tested for specification parameters.

This burning-in process is a high temperature aging which accelerates chemical reactions of any contaminants within the diode envelope. Under normal operation, these reactions might extend well into the service life of the diode, resulting in gradual performance degradation or even complete failure. An extremely high percentage of silicon diodes that survive burn-in remain stable over an indefinite life.

Burn-in, together with the **CFT**\* of junction formation, are but two of the important elements which

*\*Controlled Fusion Technique*

comprise Continental's Reliability Assurance Program. This program represents a significant forward step by assuring built-in reliability during manufacture and providing the necessary checks to allow the diodes to be used with confidence of trouble-free operation. To insure the reliability of your important equipment, it will pay you to investigate the full Reliability Assurance Program pioneered by Continental. A description of this program is available upon request.



**CONTINENTAL DEVICE CORPORATION**

12911 CERISE AVE., HAWTHORNE, LOS ANGELES CO., CALIF.

# NOW... FROM NORTH ELECTRIC 4 & 6 POLE RELAYS FOR MILITARY AND INDUSTRIAL APPLICATIONS



## North Electric Relay Designs, Buys RCA Equipment

Announcement was made today that North Electric Company has purchased from the Radio Corporation of America all designs, manufacturing equipment, machinery and tooling used in the manufacture of their line of relays.

Included in the purchase were machinery, tooling and design for 2, 4, and 6 pole hermetically sealed sub-miniature relays and design data for micro-miniature types not heretofore produced by RCA or North Electric. The purchase price was not disclosed.

Commenting on the acquisition, William Tucker, president of North, indicated that this is an important step in a program intended to place North in a stronger position in the relay field. Concurrently, new type relays which have been developed in the North laboratories are being released for manufacture. These, together with the RCA relays, should add several million dollars in sales in 1959.

The program includes plans for expanding the North Research and Development facilities for the development of additional types that will give North a pre-eminent position in the relay market.

Machinery and equipment is now being removed from RCA's plants in Camden, N. J., and is expected to be set up and operating in the Galion plant within 60 days.

Reprinted from  
the Galion Inquirer,  
Feb. 19, 1959

Subminiaturized, ruggedized, hermetically sealed relays—designed for superior performance and maximum reliability in missile and airborne applications, these relays meet and exceed the stringent specifications of MIL-R-5757A, B, C and MIL-R-25018 (USAF).

4 and 6 PDT relays available for AC, DC and Dry Circuit use.

For full spec data and complete listing of types available, write—

INDUSTRIAL DIVISION

**NORTH ELECTRIC COMPANY**

496 SOUTH MARKET STREET, GALION, OHIO





# New Issues Ready for Market

NEW SECURITIES ISSUES by electronics companies are in the forefront for the third time since the beginning of this year. The income will reduce bank loans, finance expansion or aid in growth.

• **Nuclear Electronics Corp.**, Philadelphia, has filed with SEC seeking registration of 200,000 shares of common stock. It will be offered at \$3.75 a share. Of net proceeds of the stock sale, \$150,000 will be used to liquidate an indebtedness to another company; \$120,000 will be used to pay a bank loan; \$250,000 will go for research, development, production and marketing. The balance will be used to promote sales and for general working capital.

• **Telecomputing Corp.**, Los Angeles, has filed a registration statement for 500,000 shares of common stock. Of this, 250,000 shares will be publicly offered. Proceeds of the sale will be applied against the company's short-term bank loans incurred to finance performance of contracts. Telecomputing is engaged in design and manufacture of aircraft and missile control devices, data analysis equipment, nuclear weapon test equipment.

• **Narda Ultrasonics Corp.**, Westbury, N. Y., plans to register 20,000 shares of common stock. Net proceeds will be used to retire a \$100,000 outstanding bank loan and for general corporate purposes. The firm now has 774,500 common shares outstanding, of which 40 percent are owned by Narda Microwave Corp. The company makes ultrasonic cleaners and plans to introduce additional ultrasonic equipment, including a line of domestic and institutional dishwashers.

• **Raytheon Manufacturing Co.**, Waltham, Mass., seeks to register 350,602 shares of its \$5 par common stock and 100,000 shares of \$50 par 5½ percent series (cumulative), serial preferred stock. The 5½ percent series will be conver-

tible until February 1, 1969 into Raytheon common at an initial conversion price of \$62.86. The number of such common shares reserved for conversion is 79,542.

• **Polarad Electronics**, Long Island City, N. Y., plans to register 100,000 shares of common stock to be offered by an underwriting group headed by Kidder, Peabody & Co. The registration statement also covers an additional 80,000 shares under restricted stock option plans.

## OVER THE COUNTER

1958 LOW	BIDS HIGH	COMMON STOCKS	WEEK ENDING	
			May 8 BID	May 15 BID ASKED
3¾	20½	Acoustica Assocs	34½	34½ 38½
1¾	3	Advance Industries	27½	23¼ 33½
3½	6½	Aerovox	11½	10½ 13¼
5½	15	Appl'd Sci Princet	11	9½ 12½
1½	87½	Avien, A	10½	10 11¼
6¾	24	Baird-Atomic	34	32 38¼
9¾	13½	Burdny	15¾	17¼ 19½
6¾	9	Cohu Electronics	7½	7½ 8¼
11	22½	Collins Radio	37	36 397½
32½	49	Cook Electric	46½	46½ 507½
4	7	Craig Systems	10¼	10½ 12
17½	25¾	Eastern Industries	18½	18½ 20¾
1¾	8¾	Elco Corp	9	8 97½
10½	21	Electro Instr	26	28½ 32¼
34	49	Electronic Assocs	45	45 49¼
5	11	Electronic Res'rch	18	18 19½
8½	12¾	Electronic Spec Co	15¾	16 187½
15¼	49½	Epsco, Inc	37	38 47¼
5½	9¾	Erie Resistor	9¾	10½ 14¼
10	17½	Fischer & Porter	12¼	13½ 17¼
5½	10½	G-L Electronics	12¼	12¼ 14½
12	27	Giannini	33½	33 36¾
...	...	Haydu Elec Prod	5¼	5¼ 6½
30	39½	Hewlett-Packard	47½	48 52½
23¼	48	High Voltage Eng	63	62 70
1¾	3	Hycon Mfg	3½	3¾ 4¾
1½	5½	Industro Trans'or	6	57½ 7
...	...	Internat'l Rec'fr	27	26 295½
...	...	Interstate Engin'g	21	24½ 27½
1½	4¾	Jerrold	6½	6¼ 67½
21	30	D. S. Kennedy	27¼	27 33
3¼	29	Lab For El'tronics	35½	36¼ 415½
19¼	28	Leeds & Northrup	31	31¼ 347½
2	3¼	Leetronics	3½	3½ 4½
5	18¾	Ling Electronics	26½	255½ 28¼
3¼	8¼	Magnetic Amplifiers	9½	9½ 105½
27½	4½	Magnetics, Inc	6½	6¼ 67½
4½	12	W. L. Maxson	14½	145½ 16½
10½	29	Microwave Assocs	26	24¼ 28
5¼	11¾	Midwestern Instr	12	11¼ 13¼
1½	7	Monogram Preci'n	12¼	12 13¾
3½	7¼	Narda Microwave	11½	11 12¾
...	...	Narda Ultrasonics	11	11½ 12¾
9¼	16	National Company	23½	25 297½
14¼	56	Nuclear Chicago	38	38½ 42¾
4½	7¾	Pacific Mercury, A	12¼	12¼ 13¾
10½	27½	Packard-Bell	42	46½ 52½
4¼	9¾	Panellit, Inc	7½	7½ 8½
21	53¾	Perkin-Elmer	48	54 59
11¾	19½	Radiation, A	22¾	23¼ 25¾
2½	7¾	Reeves Soundcraft	6¾	7½ 8
13	32½	Sanders Associates	34	37½ 41¾
...	...	Silicon Transistor	10¾	9¾ 11¾
7	12	SoundScriber	17¼	17¼ 21¾
22¾	40	Sprague Electric	48½	50½ 55
26	35	Taylor Instruments	32¾	33 38¼
5½	15	Technical Operat'ns	20	24 28¼
5½	15¾	Telechrome Mfg	19	20½ 26¾
3¼	7¾	Telecomputing	12¼	127½ 14½
1½	2¾	Tel-Instrument	2¼	2¼ 3¾
8¾	16¼	Topp Industries	15½	15 17¼
3¾	10¾	Tracerlab	9¾	10¾ 12¾
1½	3¾	Universal Trans'or	1¼	1¾ 1¾
14¼	40	Varian Associates	36¼	37½ 407½

The above "bid" and "asked" prices prepared by the NATIONAL ASSOCIATION OF SECURITIES DEALERS, INC., do not represent actual transactions. They are a guide to the range within which these securities could have been sold (the "BID" price) or bought (the "ASKED" price) during preceding week.

# MINIATURE PRECIOUS METAL CONTACTS

For MAXIMUM PERFORMANCE

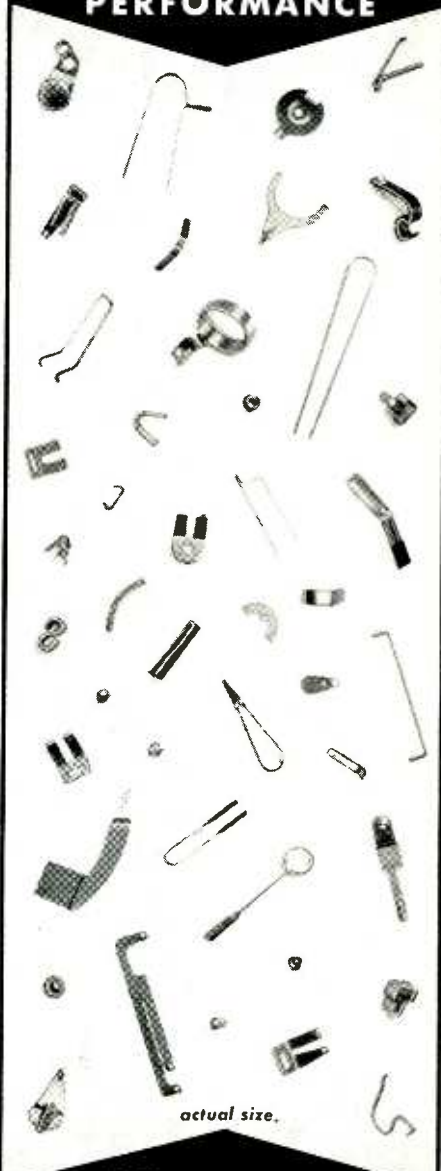

actual size.

- Slip Rings
- Micro Brushes
- Springs
- Rivets
- Potentiometers
- Synchros
- Relays
- Switches

INDUSTRIAL DIVISION

## GENERAL FINDINGS AND SUPPLY COMPANY

Sales Offices: New York  
Chicago • Los Angeles • Attleboro  
Precision custom fabrications of all precious metal contact alloys. Miniature contacts using wire as fine as .005", sheet as thin as .00075", and tubing as small as .030" diameter. Precision base metal fabrications also available.

For prompt quotations to your print and specifications, write

52 Pearl Street, Attleboro, Massachusetts

CIRCLE 23 READERS SERVICE CARD

# Automation cut its teeth on the

*...how ITT's early work in telephony advanced*

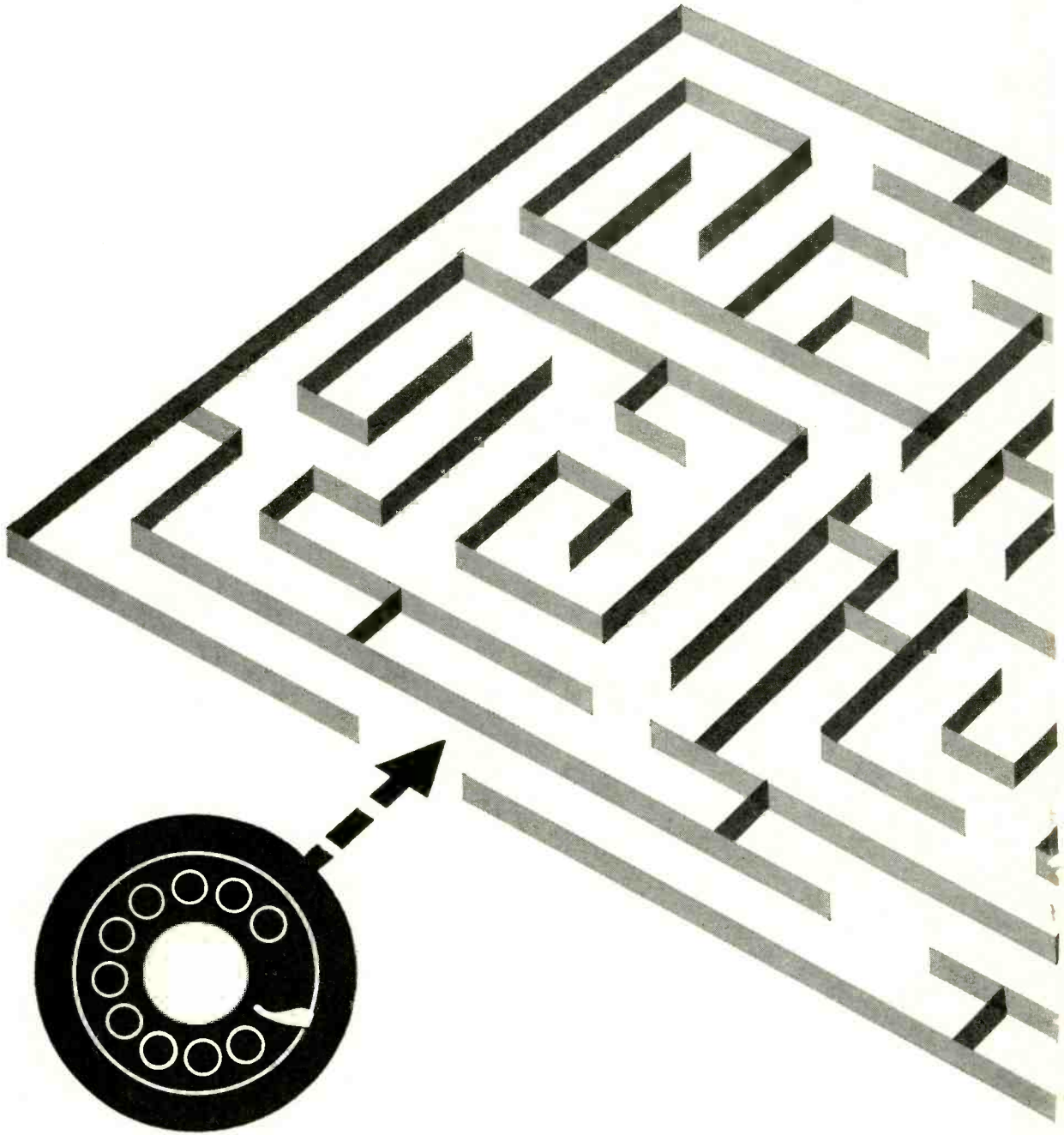



# telephone

*the art of automation*

The dial telephone exchange was one of the first examples! Today, automatic switching and new electronic techniques for automation are altering the operations of virtually every business and industry.

It was natural that ITT System companies, pioneers in the first, should be leaders in the second.

Customers have ranged from mail-order houses, railroads, libraries and oil companies to the air forces of several NATO governments.

There have been dramatic results.

One example is the automatic check-processing system developed by ITT System companies for one of the nation's largest banks. It codes, sorts and verifies checks. It performs all normal bookkeeping and accounting operations for demand deposits.

Another is the automation system for a large steel mill which records the program of requirements for every job, then feeds back information to production control centers as each phase is completed.

Still another: the first automatic U. S. post office, now under construction in Providence, Rhode Island.

Hundreds of others could be cited. Each required a complete understanding of automation from the design of a simple switch to the functioning of a fully-integrated electronic complex.

The ITT System has many specialists in this field. Among them: Intelx Systems Incorporated in retained-document automation; Kellogg Switchboard and Supply Company in automatic switching; Airmatic Systems Corporation in automatic-switch pneumatic tube and document-conveyor systems; ITT Federal Division in automatic test equipment, both military and industrial. ITT's European subsidiaries add to this experience.

To learn more about ITT's abilities in the area of automation, write for further information.

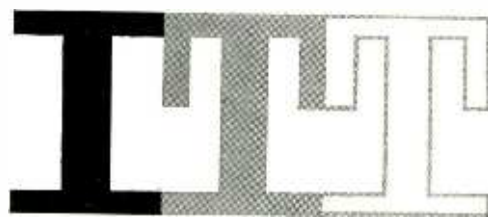

*... the largest American-owned world-wide electronic and telecommunication enterprise, with 101 research and manufacturing units, 14 operating companies and 130,000 employees.*

**INTERNATIONAL TELEPHONE AND TELEGRAPH CORPORATION** 67 Broad Street, New York 4, N. Y.

ITT COMPONENTS DIVISION • ITT FEDERAL DIVISION • ITT INDUSTRIAL PRODUCTS DIVISION • ITT LABORATORIES • INTELEX SYSTEMS INCORPORATED  
AIRMATIC SYSTEMS CORPORATION • KELLOGG SWITCHBOARD AND SUPPLY COMPANY • ROYAL ELECTRIC CORPORATION • AMERICAN CABLE & RADIO  
CORPORATION • FEDERAL ELECTRIC CORPORATION • ITT COMMUNICATION SYSTEMS, INC. • INTERNATIONAL ELECTRIC CORPORATION • INTERNATIONAL  
STANDARD ELECTRIC CORPORATION • LABORATORIES AND MANUFACTURING PLANTS IN 20 FREE-WORLD COUNTRIES

# Now...

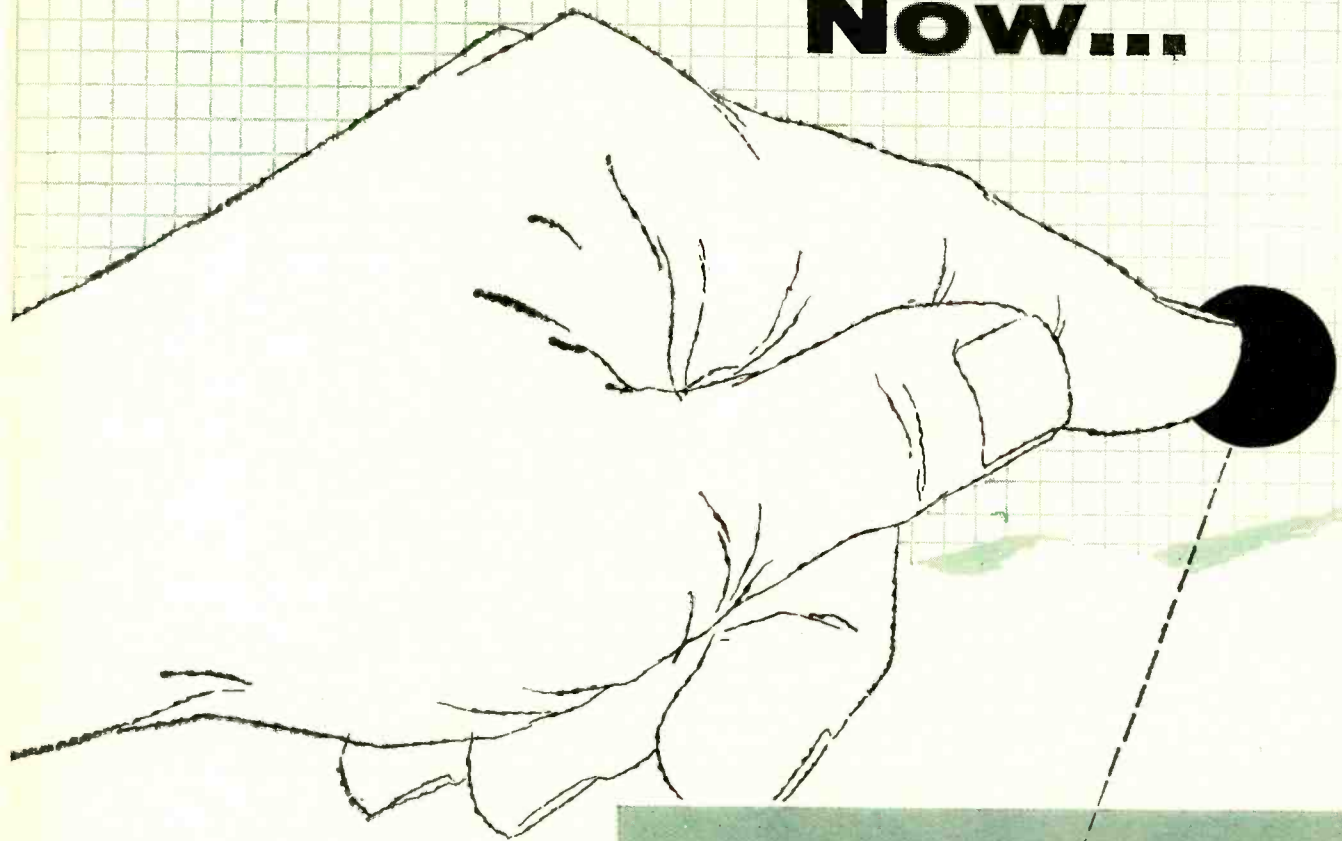

## Packaged Systems in ratings from 25 to 1500 pounds force

Now Ling presents the Sine-O-Matic series —completely packaged sine wave vibration testing systems for automatic programming and push-button operation over an extended frequency range! Designed, built and priced to provide an efficient system for conducting all tests called for under MIL-E-5272. Ideal for production line as well as prototype design testing...once system is programmed, it can be operated with ease by regular production personnel. Ling Sine-O-Matic makes it practical and profitable for even the small equipment or components manufacturer to set up a reliability testing program!

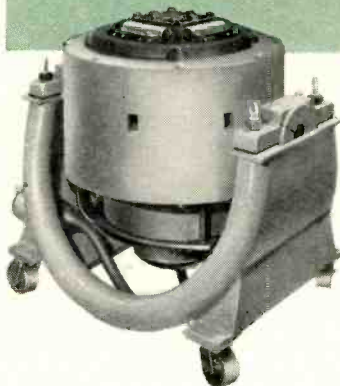
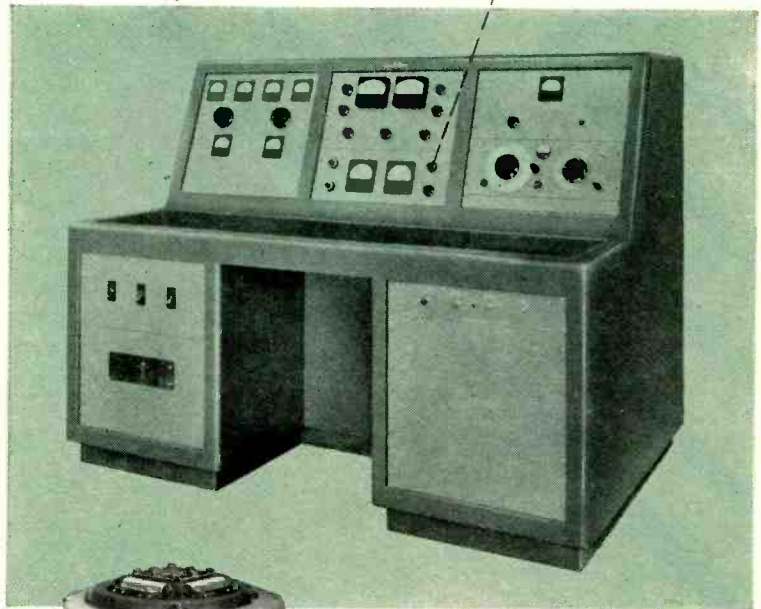

**Sine-O-Matic Model CP-5/6  
—Model A-174 Shaker**  
Ling Model CP-5/6 Sine-O-Matic with Model A-174 Shaker. Provides shaker force output of 1500 pounds. Systems in 500 and 1200 pound ratings available in similar packaging.



## Fully Automatic Vibration Systems for Production Line Testing!

# LING

## SINE-O-MATIC SERIES

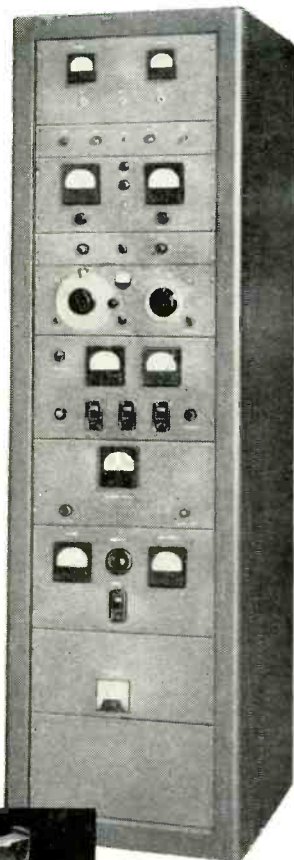

**Sine-O-Matic  
Model RP-1/2  
(Vertical Case)  
—Model 6-C Shaker**  
Ling Model RA-250  
Sine-O-Matic, with  
Model 6-C Shaker,  
provides output of 25  
pounds force.  
Systems in 100 and  
150 pound ratings  
available in  
similar packaging.



- ◊ Extended frequency range—from 5 up to 10,000 cps.
- ◊ No impedance changing or manual power factor correction required over entire frequency range.
- ◊ All components except shaker are housed in single, compact control console, either desk type or vertical.
- ◊ Consoles equipped with swivel casters for mobility—can be easily moved, as required.
- ◊ Sine-O-Matic systems meet all specifications called for under MIL-E-5272... can be profitably used by *all* equipment or components manufacturers!
- ◊ Fully automatic programming and push-button operation—ideal for production line testing!

### SINE-O-MATIC SHAKER FORCE OUTPUTS

Sine-O-Matic Model	Shaker	Rated Continuous Output in Watts	Amplifier Plate Dissipation in Watts	Sine Wave Pounds-Force Vector
RA-250	6-C	250	200	25
RA-500	A-88	500	600	100
RP-1/2	227	1,000	2,000	150
CP-3/4	219	3,000	4,000	500
CP-3/4	A-174	3,000	4,000	1,200
CP-5/6	A-174	5,000	6,000	1,500

# LING

ELECTRONICS, INC.

Factory Sales  
Offices:

9937 West Jefferson Blvd., Culver City, California  
TEXAS 0-7711

120 Cross St., Winchester, Mass. • WINCHESTER 6-3810

*“... an investment  
that makes  
all other  
investments  
worthwhile”*

JOHN COLLYER  
Chairman of the Board  
The B. F. Goodrich Company



“For much of our nation’s progress, technologically, economically and socially, we must look to the excellence of our institutions of learning, whose students of today will be the scientists, the managers, the statesmen and the cultural and religious leaders of tomorrow.

“It is the responsibility of the American people and American industry to provide the financial aid so urgently needed now by our colleges and universities.

“Join this important crusade. Contribute today to the university or college of your choice. You will be making *an investment that makes all other investments worthwhile.*”

If you want more information on the problems faced by higher education, write to:  
Council for Financial Aid to Education, Inc., 6 E. 45th Street, New York 17, N. Y.

*Sponsored as a public service, in cooperation with the  
Council for Financial Aid to Education*

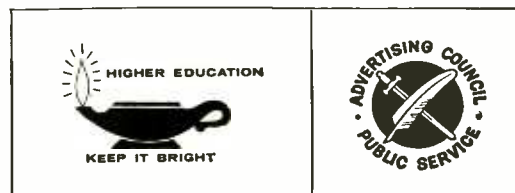



# NEW!

## DIGITAL DELAY GENERATOR

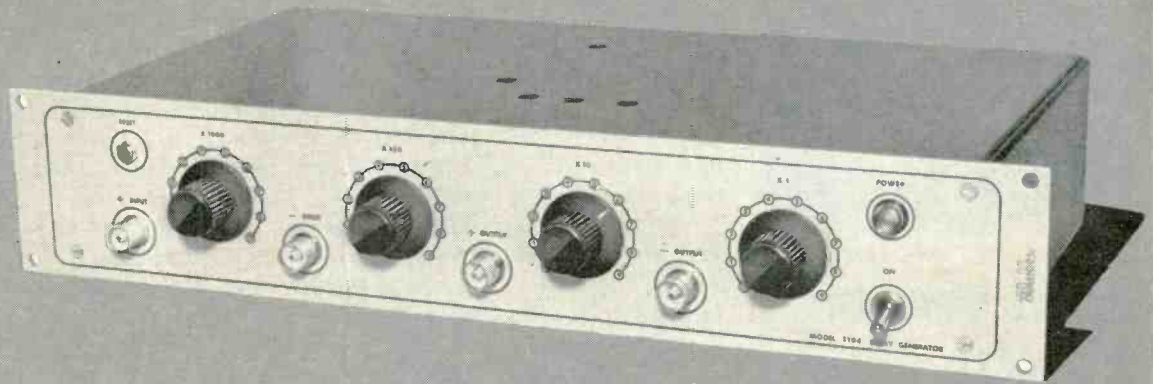

*Used to delay a pulse at a precise time interval following a trigger signal... or as a jitterless pulse generator.*

The NAVCOR Model 1104 is a completely semiconductor delay generator engineered to fill the need for a precision digital instrument that combines the simplicity of dial setting with the reliability and low power requirements of transistorized circuitry. Any delay increment may be set in between the range of 10 to 10,000 microseconds, to a resolution of one microsecond. This unit may also be connected as an accurate jitterless digital generator in the 100 cps to 50KC frequency range. Introduction of the Model 1104 extends the NAVCOR concept of completely transistorized system blocks to the precision digital test equipment field.



**NAVIGATION COMPUTER CORP.**  
1621 SNYDER AVE. • PHILADELPHIA 45, PA.  
HOward 5-7700

### SPECIFICATIONS

- RANGE: 10 to 10,000 microseconds
- ACCURACY: Plus or minus .01% at full scale
- DIGITAL RESOLUTION: 10 to 10,000 microseconds in 1 microsecond steps
- INPUT: 0 cps to 50KC, 7 to 40 volts, either polarity
- TEMPERATURE: 60°F to 135°F, ambient
- JITTER: Less than plus or minus 0.5 microseconds
- SYNC OUTPUT: 1 MC sine wave, 10 volts, 2000 ohms
- OUTPUT: 10 volts, both polarities, 0.25 microsecond rise time, 1.5 to 5.0 microseconds adjustable width
- SQUARE WAVE OUTPUT: 10 microseconds to 10,000 microseconds in steps of 10. Rise time 0.3 usec. Fall time 0.75 usec. Amplitude 12V, positive or negative going, 1K Source
- OUTPUT IMPEDANCE: 40 ohms — Minimum load resistor in Output = 100 ohms
- INPUT IMPEDANCE: 5000 ohms
- POWER: 115V, 50 to 60 cps — 7 watts
- WEIGHT: 8 lbs. Net
- DIMENSIONS: 3½" x 19½" wide x 9" deep
- PRICE: \$790.00

We got our start  
in Santa Clara  
County,\*  
California



**HEWLETT-PACKARD  
COMPANY**

...and we're  
glad to  
be here!\*

Mr. David Packard, President of Hewlett-Packard, points out these specific reasons for their location:

"A good location is directly related to the growth of a new firm. For this reason, we feel that Santa Clara County has made a major contribution to our development. The all-year mild climate and higher educational institutions serve as magnets for the kind of scientific manpower we need."

As a world leader in the manufacture of electronic test equipment, Hewlett-Packard is a firm whose unqualified endorsement of this community should be very significant.

Give your firm an opportunity for maximum growth by choosing this livable community at the southern tip of San Francisco Bay.

**WRITE FOR FREE REFERENCE DATA**

Take a minute now to send for the informative booklet, "What Does Santa Clara County, California offer the ELECTRONICS INDUSTRY?"



**Greater San Jose  
Chamber of Commerce**  
Dept. 19, San Jose, California

**Santa Clara County  
CALIFORNIA**

CIRCLE 30 READERS SERVICE CARD

**MARKET RESEARCH**

**Silicon Transistors Surveyed**

RECENT STUDY by Hoffman Electronics Corp. throws new light on dynamic sales of silicon transistors.

Purpose was to determine the general growth pattern and types expected to be in heavy demand. The study included an informal market investigation and a mail survey of engineer requirements among 2,500 IRE members. Ten percent replied. Eight percent were design users or planned to be.

Silicon transistor sales are entering their greatest growth period, report concludes. But the growth rate for total transistor sales is expected to slacken after 1960.

**What's Expected**

Sales of silicon types will increase to 96.6 million units in 1962, 24 percent of sales anticipated for all transistors, predicts the firm's market research manager, James T. Parry.

Responding engineers indicated they will more than treble their 1957 usage this year. But no forecasts of dollar sales were made because of changing marketing and price conditions.

In 1957 some 1,436,900 silicon transistors were sold, five percent of the 28,738,000 transistors sold that year. Using an average unit price of \$15, silicon dollar sales for 1957 were calculated at \$21.5 million, about 30 percent of the all-transistor dollar total, \$69.7 million.

Since 1957, number of silicon transistor manufacturers has increased from six to eleven, report states. The report lists the following: Texas Instruments, General Electric, Philco, Raytheon, Transatron, Bogue Electric, Hughes Aircraft, Fairchild Camera, Westinghouse and RCA.

It also lists six others with silicon transistor development programs: CBS Electronics, Minneapolis-Honeywell, Motorola, Pacific Semiconductors, Sprague Electric and Sylvania.

Computers and missiles are the two most important applications for silicon transistors. Some 34.7 percent of replying engineers said computers were their greatest application. Missiles were in second

place with 28.3 percent. Percent of mentions for other applications: communications and microwave, 10.7; industrial controls, 7.0; radar and sonar, 5.4; test equipment, 5.3; aircraft, 4.3; radio and tv, 4.3.

Switching performance was given as the most desired feature for both computer and missile applications. Low reverse current was particularly important for computer applications.

For future applications, engineers most desired silicon transistors with medium and low rating specifications.

The engineers showed little preference between npn and pnp types. But they want manufacturers to produce both types with matched characteristics.

Engineers said they want to redesign circuitry to substitute a broad range of germanium transistors with silicon transistors of like characteristics, when they become available.

**Engineers' Problems**

The two greatest problems encountered by engineers in the use of silicon transistors were high saturation resistance and wide variations of parameters for units of the same kind. Price was considered the major deterrent to large scale purchases.

Engineers reported they desire manufacturers to provide more complete specification data and applications notes, and to inform them of new silicon transistors as introduced. Engineers also want better delivery and industry standardization in presentation of silicon transistor specifications.

**FIGURES OF THE WEEK**

**LATEST WEEKLY PRODUCTION FIGURES**

(Source: EIA)	May 8, 1959	Apr. 10, 1959	Change From One Year Ago
Television sets	106,359	106,691	+56.1%
Radio sets (ex. auto)	244,083	254,390	+52.6%
Auto sets	111,747	99,188	+141.8%

**STOCK PRICE AVERAGES**

(Standard & Poor's)	May 13, 1959	Apr. 15, 1959	Change From One Year Ago
Electronics mfrs.	98.65	86.91	+92.5%
Radio & tv mfrs.	111.68	99.36	+144.4%
Broadcasters	105.00	99.11	+74.7%

CIRCLE 31 READERS SERVICE CARD →





NOW  
AVAILABLE IN  
TRANSITRON'S  
NEW  
PACKAGE

# SILICON CONTROLLED RECTIFIER

handling  
10KW power

Transitron's Silicon Controlled Rectifier is a PNP high power bistable controlled switching device. It is analogous to a thyatron or ignitron, with far smaller triggering requirements and microsecond switching. The low forward voltage drop permits high current ratings and provides high efficiency with low cooling requirements. The PNP design permits higher voltage ratings and lower saturation resistance than power transistors. This permits the smallest packaging for high power control yet made possible.

Ratings currently available extend to 10 amperes at 100°C case temperature and up to 400 volts forward and inverse ratings. *Operation at 125°C is now permissible with derating.* Full ratings are possible at 35°C ambient with a 5" square heat sink. The peak control power is typically 1/200,000 of the output power!

Transitron's Silicon Controlled Rectifier has been designed into a new package for more rugged, convenient, and practical application. The 11/16" hex base and the general outline coincide with EIA standards for the 20-ampere rectifier.

TYPE	MINIMUM PEAK REVERSE VOLTAGE (Volts)	MINIMUM FORWARD BREAKDOWN VOLTAGE (Volts)	MAXIMUM AVERAGE FORWARD CURRENT (amps)	
			at T case = 100°C	at T case = 25°C
TCR 102	100	100	10	20
TCR 202	200	200	10	20
TCR 302	300	300	10	20
TCR 402	400	400	10	20

Maximum Storage Temperature Range — 65°C to +150°C  
Maximum Operating Temperature Range — 65°C to +125°C  
Send for Bulletin TE 1356

OTHER  
TRANSITRON  
SILICON  
PRODUCTS  
FOR  
HIGH POWER  
USE

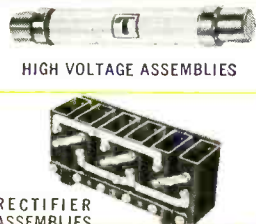

**Transitron**  
electronic corporation  
wakefield, massachusetts

**NEW**

**RI**

**KEMETAL**

# *tip* CAPACITORS

LESS THAN .100 DIAMETER

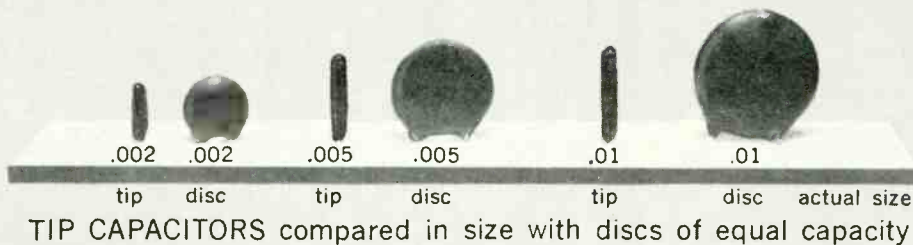

# SPACE SAVERS

Made in 1/4", 3/8", 1/2", 5/8" and 3/4" lengths. Maximum diameter .100. Available in Stable, By Pass and Temperature Compensating types.

Can be mounted vertically or (when specified) horizontally. Leads can be furnished straight, short or crimped.

PHONE OR WRITE THE RI REPRESENTATIVE NEAREST YOU FOR COMPLETE DESCRIPTIVE FOLDER.

**R. B. Barnhill and Associates**  
MARYLAND, WASHINGTON, D.C.,  
DELAWARE, VA., N. C., FLORIDA

19 W. Pennsylvania Ave.  
Towson, Baltimore 4, Md.  
Phone: VALley 5-3431

**Reed-Tollefson Corp.**  
UPPER NEW YORK STATE

2815 Monroe Avenue  
Rochester 10, New York  
Phone: Hillside 5-0450

**Mr. Elmer Jordan**  
MICHIGAN, INDIANA, OHIO

2024 Glen Drive  
Jackson, Michigan  
Phone: STate 2-0694

**Packard Associates**  
TEXAS, OKLAHOMA, ARKANSAS,  
NEW MEXICO

404 Love Field  
Air Terminal Bldg.  
Dallas 35, Texas  
Phone: Fleetwood 7-5713

**Mr. Thomas F. Muckenfuss**  
**Mr. E. J. Edmunds**  
CAMDEN, N. J., PHILADELPHIA AREA

10 Tanner St.  
Haddonfield, New Jersey  
Phone: HAZel 8-4400

IN CANADA: **Automatic Coil Manufacturing Co. Ltd.**  
50 Wingold Ave., Toronto 19, Ontario  
Phone: RUssell 1-6174

**H. G. Richter Co.**  
ALL NEW ENGLAND, METROPOLITAN  
NEW YORK, NEW JERSEY

467 Hillside Avenue  
Westfield, New Jersey  
Phone: ADams 3-4615

EXPORT REPRESENTATIVES: **Dage Corporation**  
219 East 44th St., New York 17, N. Y.  
Phone: MURrayhill 2-6755

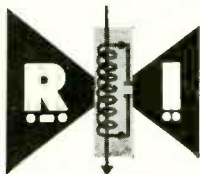

**RADIO INDUSTRIES, INC.**

666 Garland Place  
Des Plaines, Illinois



# Precision Is The Standard At Coors

## Micro-Module Wafers

The hottest news in extreme miniaturization of electronic equipment is the micro-module—an amazingly small combination of sub-miniature electronic circuit components. The fundamental unit of a micro-module is the high alumina ceramic base plate—a tiny ceramic wafer, approximately 0.300" square x 0.010" thick. Upon this is deposited or metalized a component of a circuit—a resistor, capacitor, transistor, diode, etc. The micro-module is a combination of several of these elements in a small space to serve a specific circuit function—amplifier, oscillator, etc.

Coors is manufacturing these precision wafers in large quantity production runs for several manufacturers working on the same project. Coors holds all dimensions of the tiny ceramic wafer to extremely close tolerances so that the micro-elements produced from them are entirely interchangeable from manufacturer to manufacturer.

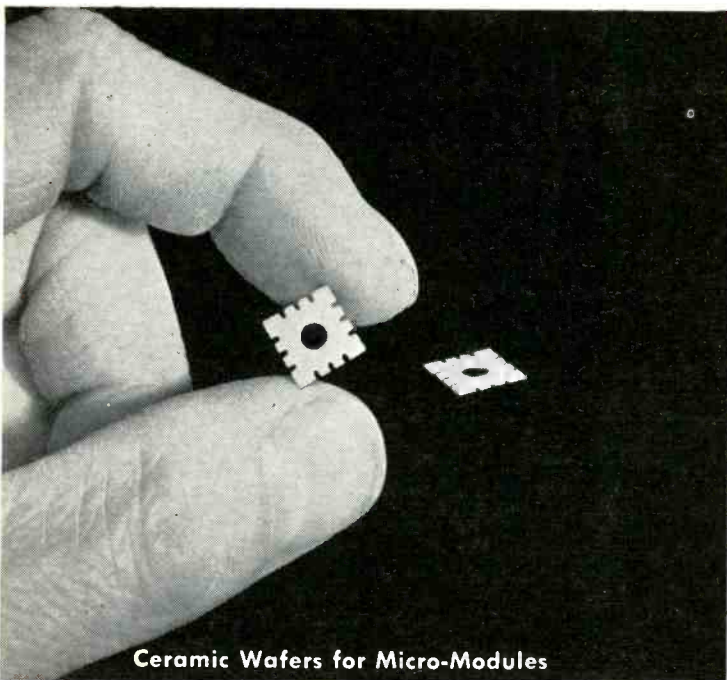

Ceramic Wafers for Micro-Modules

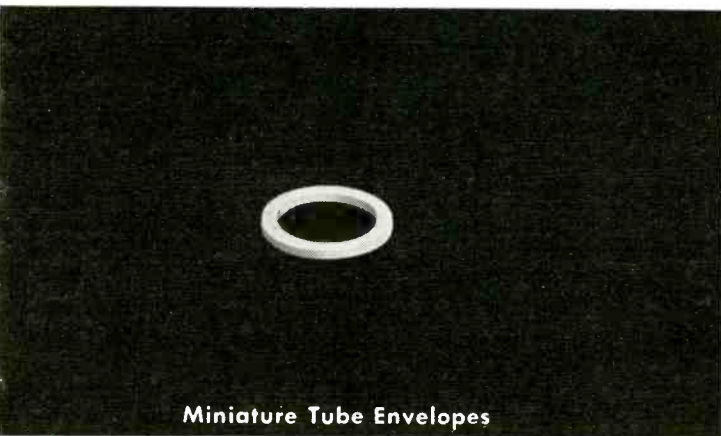

Miniature Tube Envelopes

## Tube Envelopes

Coors makes high strength ceramic envelopes to extremely close dimensional tolerances and in a wide range of sizes for use in modern electron tubes. Certain of the Coors ceramic compositions were developed specifically to meet the rigorous operating conditions and reliability requirements to which high power, high frequency tubes are subjected.

Illustrated here is one of the miniature ceramic envelopes in regular production. Coors regularly produces many other sizes up to 10" O.D. Larger sizes can be manufactured.

Coors ceramics have outstanding electrical and physical characteristics. These properties are not affected by high outgassing or high operating temperatures.

**LOWER COSTS for Precision Ceramic Parts Through Quantity Production**—Coors has been able to make substantial reductions in manufacturing costs by stepping up production of high precision parts through automation.

All this adds up to these advantages for you: 1. Faster delivery on large quantity orders. 2. Precision parts—uniform and interchangeable, permitting you to use them on a production basis. 3. Prices that are correspondingly low.

For further information about Coors Space Age Ceramics and for a complete description of physical properties, write for Bulletin 858.

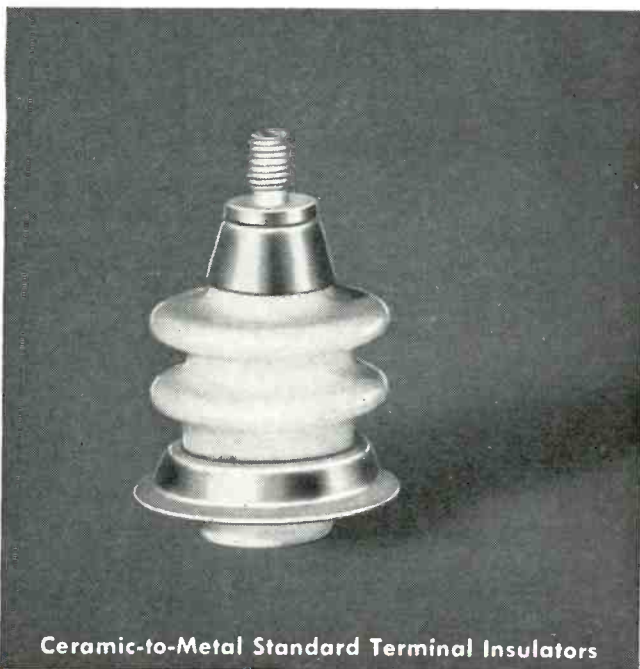

Ceramic-to-Metal Standard Terminal Insulators

## Standard Terminal Insulators

Coors furnishes *standard* terminal insulators—available from stock—in various ratings and, also, can manufacture custom made insulators to meet your specific requirements. In the range of standard sizes, metal parts are bonded to the ceramic by Coors High Temperature Metalizing Techniques, thus producing strong hermetic ceramic-to-metal seals. The result is standard terminal insulators available for a wide range of requirements—insulators that have superior electrical and mechanical characteristics. Production is on a large quantity basis—you do not pay a premium for high quality, precision terminals.

*Coors*

**COORS PORCELAIN  
COMPANY**

600 Ninth Street, Golden, Colorado

Engineers/Designers! Ask for this G-C

# MICROWAVE FERRITE APPLICATION CHART

MICROWAVE FERRITE APPLICATION CHART				
MATERIAL	BAND	LOWEST OPERATING FREQUENCY**	TYPICAL APPLICATION	TYPICAL POWER LEVEL
R-1	X	8,500 megacycles	Phase Shifter	Low Power
R-4	X	7,000 megacycles	Phase Shifter	Can be used above resonance at peak power > 1 Megawatt (2)
R-4	S	2,500 megacycles	Resonance Isolator (1)	Low Power
R-5*	C	5,000 megacycles	Phase Shifter	Can be used above or below resonance at peak power > 1 Megawatt (2)
R-5*	S	2,500 megacycles	Phase Shifter	Can be used above resonance at peak power > 1 Megawatt (2)
R-5*	L	1,000 megacycles	Resonance Isolator	Low Power
R-6*	S	2,500 megacycles	Phase Shifter	Similar to R-5
R-6*	L	1,000 megacycles	Resonance Isolator	Low Power

\*NEW PRODUCT

REMARKS:

- (1) R-4 saturates more rapidly than R-1 resulting in faster reduction at low field losses. See hysteresis loop data.
  - (2) Operating power levels reported by customers. It has also been reported that R-5 and R-6 can be used as low as 500 Mc/s in certain phase shifter applications.
- R-1 and R-4 are Mg-Mn ferrites. R-5 and R-6 are Mg-Mn-Al ferrites.
- \*\*Lowest Recommended Frequency—can be used at frequencies above published value.

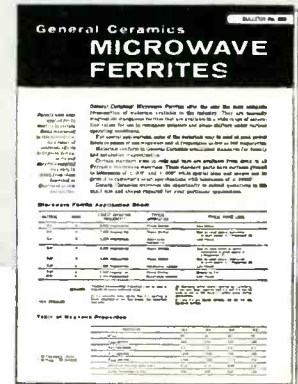

**— it's included in the new General Ceramics Data Bulletin on Microwave Ferrites**

This new comprehensive bulletin contains technical data on the most complete cross-section of materials in the industry, including two grades introduced for the first time. Included are hysteresis loops, magnetic and dielectric properties vs. frequency, and magnetic induction vs. temperature curves on ferrite materials R1, R4

and newly-developed R5 and R6. Application data, magnetic properties tables, and drawings and dimensions of available stock parts are also contained in new Bulletin 259. Request your copy of this informative literature, today; please address inquiries to General Ceramics Corporation, Keasbey, New Jersey—Dept. E.

## GENERAL CERAMICS

The World's Largest Producer of Microwave Ferrites

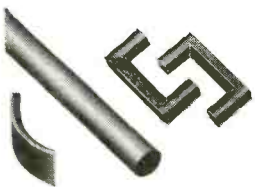

TV and Radio Cores

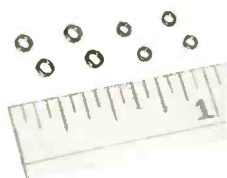

Magnetic Memory Cores

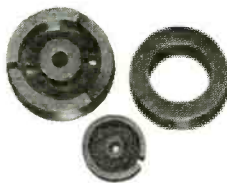

General Purpose Cores



Recording Head Cores

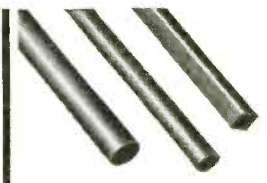

Microwave Ferrites



# Electron Tube News

## —from SYLVANIA

### SYLVANIA CREATES A

# New Profile of Dependability

### IN GOLD BRAND TUBES

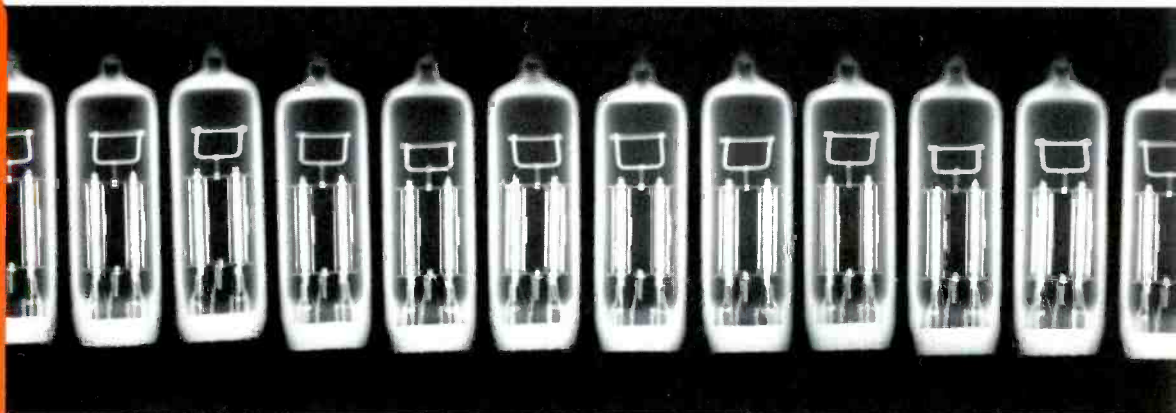

RADIOGRAPH PROFILE shows the superior uniformity of Gold Brand Tubes

**Exclusive design, production and identification techniques add extra reliability and efficiency to Gold Brand Tube performance**

The perfect uniformity of its physical profile is symbolic of the new level of reliability in Sylvania Gold Brand Tubes. It represents the results of exclusive design and production techniques developed and refined at one of the world's most advanced tube facilities, The Sylvania Gold Brand Plant in Burlington, Iowa.

The unmatched reliability of the Gold Brand "New Concept Bulb" is evident in latest test data. Hourly thermal shock tests (100°C to 0°C) indicate less than 2/10% tip failure during the past two years. This record is due to Sylvania-developed automation equipment, such as the "New Concept" tubulated bulb machines, and to tight quality controls maintained throughout the entire Gold Brand manufacturing process.

The Production Lot Letters etched on its envelope are another indication of the extra dependability of Sylvania Gold Brand Tubes. They are the key to a profile of lot production and test data that offers the user more precise application information and provides for better quality control.



**THE EXCLUSIVE LOT LETTERS** on each Sylvania Gold Brand Tube identify a complete file of production and test characteristics for individual tube lots

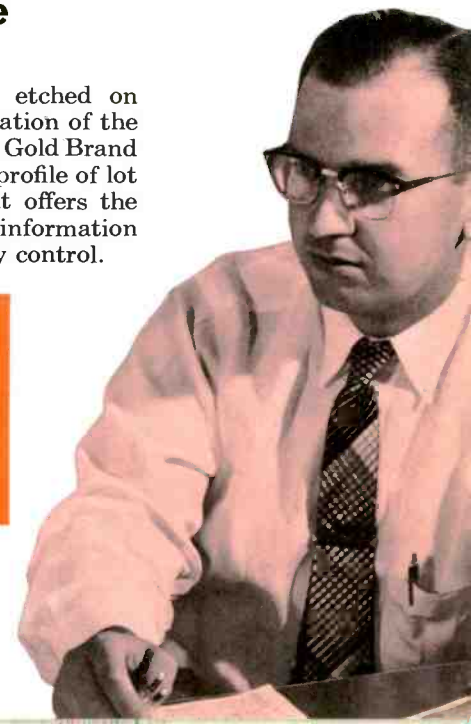

## SYLVANIA CREATES A NEW PROFILE OF

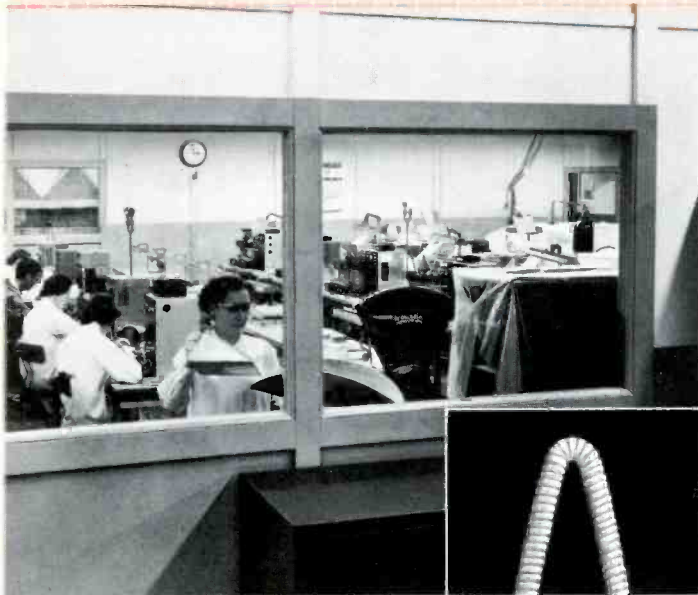

SYLVANIA'S ORIGINAL folded coil heater design is processed in this ultra-clean room to prevent contamination

### New heater design increases tube efficiency

Sylvania has increased the efficiency profile of Gold Brand Tubes by an exclusive heater design, automatic cathode tabbing and by extra control over the environment in which cathode and heater operations are performed.

The Sylvania-pioneered folded coil heater used in Gold Brand Tubes permits use of heavier wire for extra ruggedness, permits use of heavier insulation, and allows the cathode to run at higher temperatures for added

efficiency at lower heater voltages. The U shaped coil used in double section tubes requires but two welds instead of four, giving extra reliability.

All coating and tabbing operations for heaters and cathodes are performed in a specially air conditioned and filtered room within Sylvania's Gold Brand air-conditioned plant in Burlington, Iowa. Greater cleanliness is achieved to eliminate possible impurity contamination.

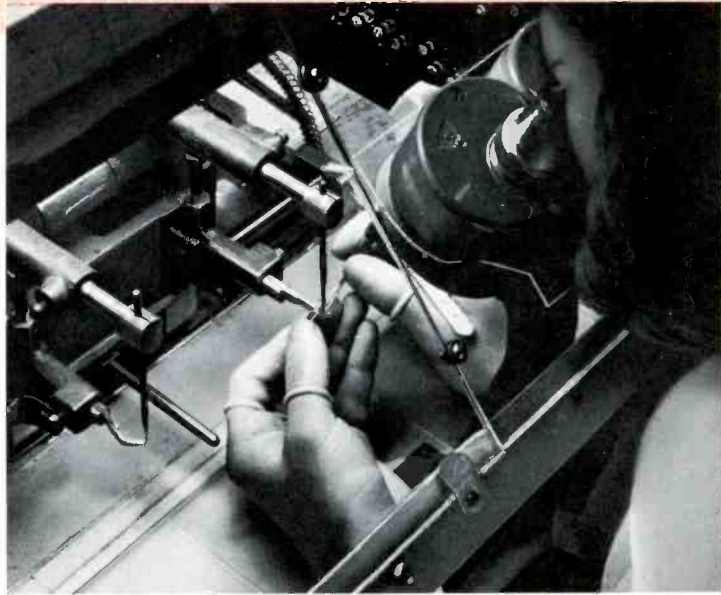

ALL TUBE MOUNTS are precision-welded under stereo microscope

### Microscopic welding adds ruggedness

All fine welding operations such as heater welds for Gold Brand Tubes are made under stereoscopic microscope to assure weld perfection.

Specially developed weld energy sources such as phase control, slope control and stored energy units are utilized. Weld pressure and current are constantly controlled through Sylvania-patented measuring devices to obtain the strongest and most reliable welds.

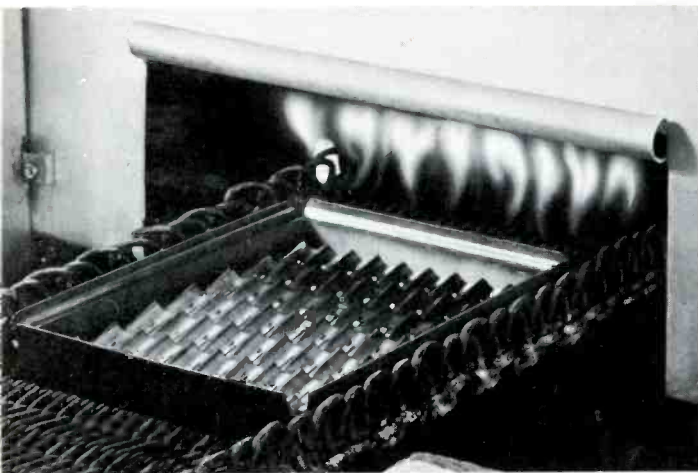

EXCLUSIVE FLAME SHIELD firing of grids and parts removes microscopic lint particles

### Exclusive flame shield process improves tube performance

All Gold Brand grids and parts undergo Sylvania's exclusive flame shield firing just prior to processing in a high-temperature reducing atmosphere. Contaminations such as lints, oxides and gases are eliminated. The flame shield removes microscopic lint particles.

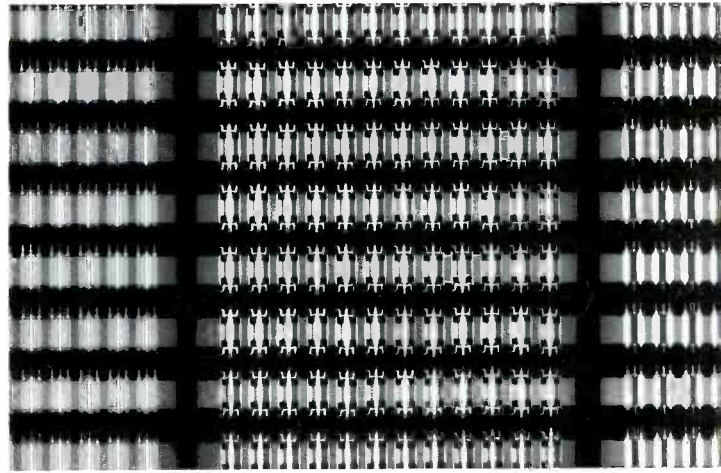

RADIOGRAPH PROFILES of Gold Brand mounts insure against hidden defects

### X-ray reveals mount reliability

Even though every mount for Gold Brand Tubes undergoes 100% microscopic inspection, Sylvania carries quality control a step further by using X-ray as a process control on all Gold Brand mounts. X-ray is also used as a 100% inspection tool where appropriate throughout the entire manufacturing process.



## DEPENDABILITY IN GOLD BRAND TUBES



**OVER 1.5 MILLION TUBES** a month receive burn-in stabilization on specially designed stabilization equipment

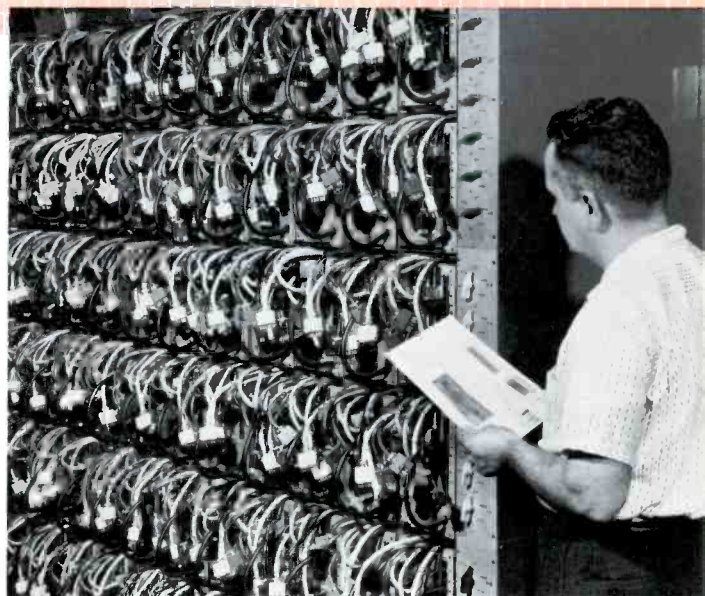

**ALL SYLVANIA GOLD BRAND TUBES** receive thermal and electrochemical aging on Sylvania designed equipment

### Advanced testing techniques insure top Gold Brand performance

Through continual improvement of its processing and testing methods, Sylvania Gold Brand Tubes are setting new performance records.

All Gold Brand Tubes receive thorough burn-in to insure optimum stability of electrical characteristics both initially and throughout life. Sylvania burn-in facilities are among the industry's largest. Up to 2 million tubes are stabilized each month!

Every Gold Brand Tube also receives highly refined thermal and electrochem-

ical aging on Sylvania designed automatic equipment. Specialized Cyclic processing is used for optimum pulse emission levels and reduced hum levels.

In addition to heater cycle life tests, environmental tests and thermal shock tests, every Gold Brand Tube goes through a final electrical test for pulse emission, AF noise, mutual conductance at rated and reduced EF, static characteristics, shorts, and continuity. Gold Brand Tubes are also subjected to 100% microscopic inspection.

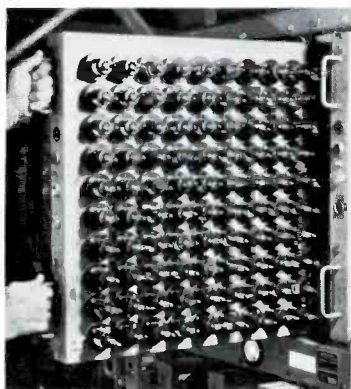

### Better vacuums achieved for Gold Brand Tubes

More efficient vacuums have been achieved for Gold Brand Tubes through the use of improved exhausting and gettering techniques. Evacuation is performed on auto-

matic equipment with tubes individually evacuated on oil diffusion pumps.

Control charts are maintained over all phases of sealex operation including vacuum measurements on individual heads to improve vacuums. An emission activation control chart

is also maintained to reflect control of emission related items.

After sealing, pure barium getters are post flashed to insure maximum gas elimination. Specially designed RF induction heating installations are used so that other tube elements are not affected.

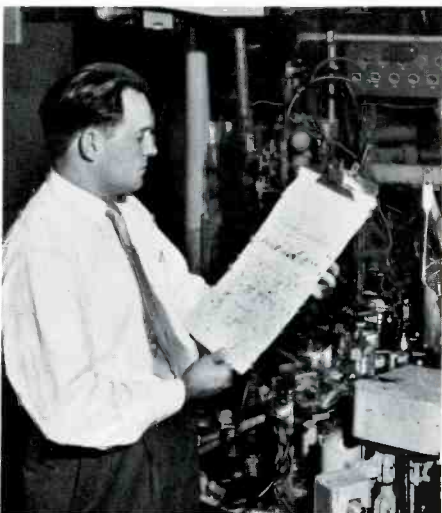

**EVACUATION AND SEALING** are rigidly controlled automatically

Postage  
Will be Paid  
by  
Addressee

No  
Postage Stamp  
Necessary  
If Mailed in the  
United States

### BUSINESS REPLY CARD

First Class Permit No. 2833 Sec. 34.9 P.L.&R., Buffalo 9, N.Y.

**SYLVANIA ELECTRIC PRODUCTS INC.**

1100 Main St.  
Buffalo 9, N.Y.

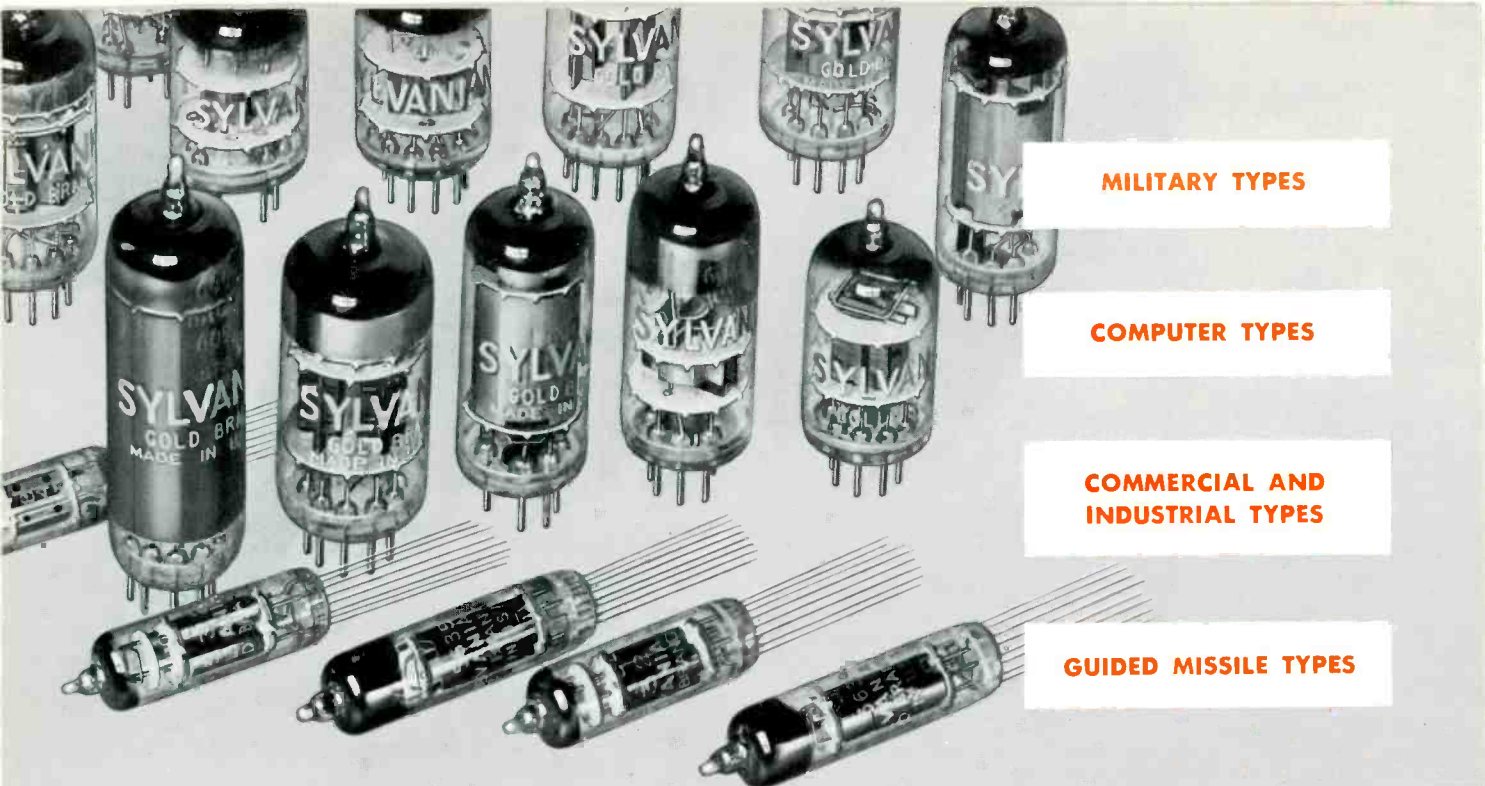

**MILITARY TYPES**

**COMPUTER TYPES**

**COMMERCIAL AND INDUSTRIAL TYPES**

**GUIDED MISSILE TYPES**

**SYLVANIA GOLD BRAND LINE** is comprised of Military Types, Guided Missile Types, Commercial and Industrial Types and Computer Types

**The Sylvania Gold Brand Line—premium tubes designed for specific applications**

There are over 100 types of Sylvania Gold Brand Reliable Tubes ranging in size from subminiature to miniature and larger. They include types specifically designed to cover electronic circuits in four main application areas: Military Applications, Guided Missile Applications, Commercial and Industrial Applications and Computer Applications.

Sylvania Gold Brand Military Types, originally used in proximity

fuzes, are now designed for application in a wide range of ground, sea and air equipment. Nearly 20 of the types are currently used in the control system of the F-106 fighter.

Sylvania Gold Brand Guided Missile Types are specifically designed to meet the tough requirements of military missiles and rockets. Today some 14 Sylvania Gold Brand originals are used in the Falcon missile alone.

Sylvania Gold Brand Commercial and Industrial Types are used in commercial airline equipment, mobile communications equipment and in industrial control equipment.

Gold Brand Reliable Computer Types, designed to meet the special requirements of data processing equipment, are used in many of the major computers on the market today. When dependability counts, specify Sylvania Gold Brand Tubes.



# SYLVANIA

SYLVANIA ELECTRIC PRODUCTS INC.  
1740 Broadway, New York 19, N. Y.  
In Canada: Sylvania Electric (Canada) Ltd.  
P. O. Box 1190, Station "O," Montreal 9.

LIGHTING • TELEVISION • RADIO • ELECTRONICS • PHOTOGRAPHY • ATOMIC ENERGY • CHEMISTRY-METALLURGY

Please send additional information on the items checked below:

- |  |   |
|--|---|
| <input type="checkbox"/> Gold Brand Military Types       | <input type="checkbox"/> Gold Brand Commercial & Industrial Types |
| <input type="checkbox"/> Gold Brand Guided Missile Types | <input type="checkbox"/> Gold Brand Computer Types                |

Name \_\_\_\_\_

Address \_\_\_\_\_

Company \_\_\_\_\_

**Use this handy business reply card to request additional information on these important new Sylvania developments**



# SUPRAMICA<sup>®</sup> 555 ceramoplastic

the world's most nearly perfect  
precision-moldable electronic insulation

50 CHANNELS per mc

39 mc

40 mc

41 mc

42 mc

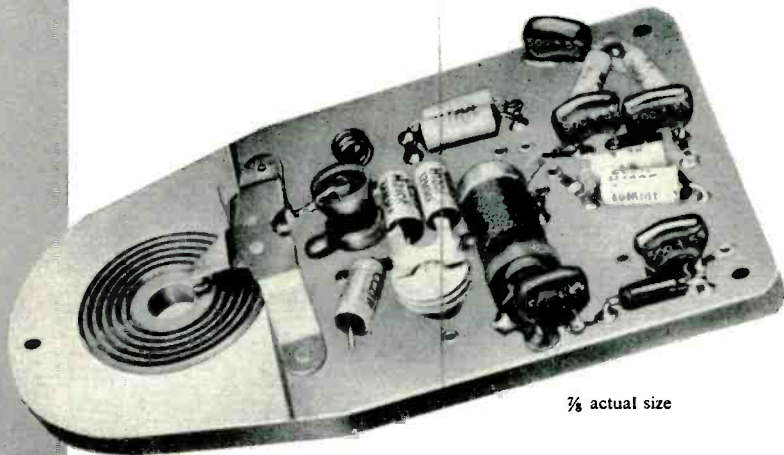

$\frac{1}{4}$  actual size

gives AVCO twice the channel capacity  
... in far less space!

This amazingly compact AVCO oscillator circuit, built for a Signal Corps radio receiver . . . 32.5-57.5 mc . . . was made possible by the insulating qualities of its SUPRAMICA ceramoplastic base.

Over a temperature range, in this application, from  $-67^{\circ}\text{F}$  to  $+167^{\circ}\text{F}$  and, in other uses, at operating temperatures as high as  $700^{\circ}\text{F}$ , SUPRAMICA 555 shows no change, no warpage. It has *complete dimensional stability*. The fragile silver ribbon circuit is molded precisely and permanently in place. Numerous tuning crystals—and their problems—are eliminated. Frequency drift is reduced to an absolute minimum. Channel capacity is doubled.

Other advantages of SUPRAMICA 555: the base can be reproduced *exactly*; electrical loss is negligible; moisture absorption is nil; dielectric strength is high.

Mycalex Corporation of America makes a complete line of precision-moldable and machinable glass-bonded mica and ceramoplastic insulation materials to solve electronic design problems at operating temperatures up to  $1550^{\circ}\text{F}$ . To learn how we can serve you, write *today*.

General Offices and Plant: 120-C Clifton Blvd., Clifton, N. J.  
Executive Offices: 30 Rockefeller Plaza, New York 20, N. Y.

WORLD'S LARGEST MANUFACTURER OF GLASS-BONDED MICA AND CERAMOPLASTIC PRODUCTS

THE FIRST SYNTHAMICA SYNTHETIC MICA  
SINCE 1919 MYCALEX THE INSULATOR  
THE FIRST SUPRAMICA CERAMOPLASTIC

**MYCALEX**  
CORPORATION OF AMERICA

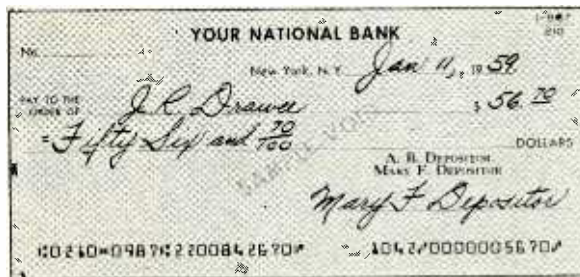
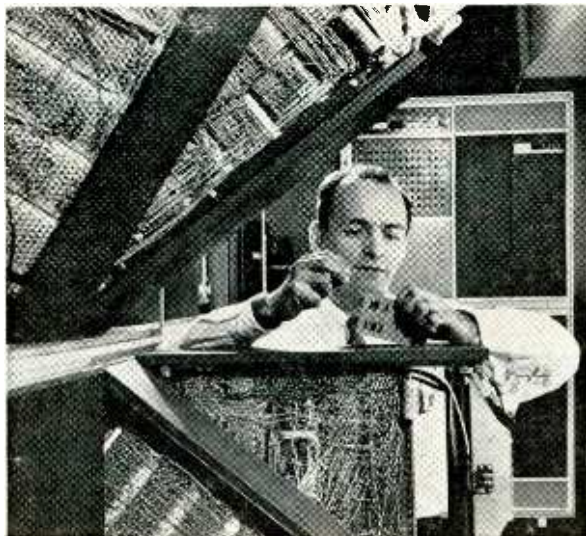

ABA standard numerals along bottom of check are necessary to automatic bank-bookkeeping systems

Solid-state circuitry is used throughout IBM's new 1200-series bank system

# Big Bid for Bank Market

Magnetic-ink character recognition systems signal major advance in automatic electronic bookkeeping for banks

COMPUTERMAKERS are taking a giant step toward solving the bank-bookkeeping problem.

Burroughs and IBM are both readying production plans for automatic equipment operating on principles of magnetic-ink character recognition (first reported in *ELECTRONICS*, p 26, Dec. 10, '57). Burroughs announced its MICR gear in March, and IBM followed suit early this month.

General Electric's computer division is working on still a third system for Bank of America. National Cash Register, Addressograph, Standard Register and other office equipment producers are also known to be active in the field, but have not yet released equipment details.

Key machines in the systems are inscribing machines to print data in magnetically susceptible ink on checks, and high-speed electronic sorters to read the magnetic signals and order the checks in account-number sequence. Both IBM and Burroughs have developed novel reader-decoder circuitry to handle the magnetic characters and solid-

state equipment to perform the high-speed sorting operation.

Technical details of the new gear are being held under fairly tight wraps, but *ELECTRONICS* learned that IBM's reader station uses a multiple-track head which samples the printed numerals at several points from top to bottom, and at several time intervals. One report indicates that the reader has fifteen tracks, which are sampled 10 times per digit field. A decoding matrix identifies the printed digit by the presence or absence of signal on the several tracks at each sampling time.

The Burroughs reader, on the other hand, uses a single wide head which produces a complex stepped pulseform, unique for each of the 10 digits and five code symbols.

## Massive Problem

Big problem in this era of consumer banking is demand-deposit accounting—keeping books on customer checking accounts, which are subject to withdrawal on demand. About 90 percent of all debts in this country are paid by checks

drawn on such accounts; in 1958, some 10 billion checks cleared through the nation's banks. The number of checks cashed has been doubling every five years or so, and the Federal Reserve System figures that by 1963 it will double again.

As with most accounting, an automatic system to do demand-deposit accounting needs a big memory to store account details and a rapid means of posting credits and debits to individual accounts. Electronic systems are now made in all shapes and sizes to handle these jobs. The unique problem of bank bookkeeping lies in the source of data—individual checks, which are not easily "machinable."

American Banking Association, which has been wrestling with this problem since 1953, insisted that punched cards and other "machine" document forms were out: they place too many restrictions on the bank customer. Then, within the last couple of years, ABA settled on magnetic characters, printed on the check, which can be read by both men and machines. Development of bookkeeping systems followed di-



rectly on ABA's standardization of numeral size and format.

### Bank Systems

Both Burroughs and IBM already have a big stake in the bank market: many banks use IBM proof machines in their transit departments and Burroughs bookkeeping machines in their bookkeeping departments.

New equipment is built to ABA standards. It can handle intermixed random-sized paper or card checks ranging in width from 2 $\frac{3}{8}$  in. to 3 $\frac{3}{8}$  in., in length from 6 in. to 8 $\frac{3}{8}$  in., and in thickness from 0.0035 in. to 0.0067 in.

When the system is in full operation, all checks will be inscribed before they are issued with check-routing and ABA transit numbers (the numbers now printed on most checks as a fraction in the upper right corner or near the bank name), and with the customer's account number. When the check is presented for payment, or when it is finally returned to the bank on which it is drawn, it will be post-inscribed with the amount and with process-control or operating codes.

All this information will be printed in 8-to-the-inch numerals of a form and shape standardized by ABA (picture). Characters are printed in magnetically susceptible ink, in a line  $\frac{3}{16}$  in. from the bottom of the check, starting  $\frac{3}{8}$  in. from the left corner. The minimum 6-in. check leaves room for 42 usable printing spaces, including a two-space blank between preinscribed and postinscribed data.

Prequalifying data go on at the time the checkbook is issued or printed. Postqualifying data go on as part of the teller's settling and proving operation. From that time on, the checks can be handled by machine.

Equipment will be able to handle most smeared or mutilated checks. The equipment flashes the inked track with a strong uniform magnetic field just before it goes to the reading station, can read through a layer or two of Scotch tape where this is used to mend tears. Thoroughly mutilated checks go through the system in special carrier envelopes which are inscribed with the qualifying data.

# FAIRCHILD POTS ARE TORTURE TESTED

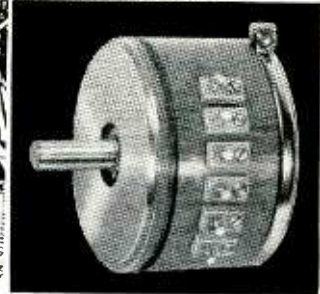
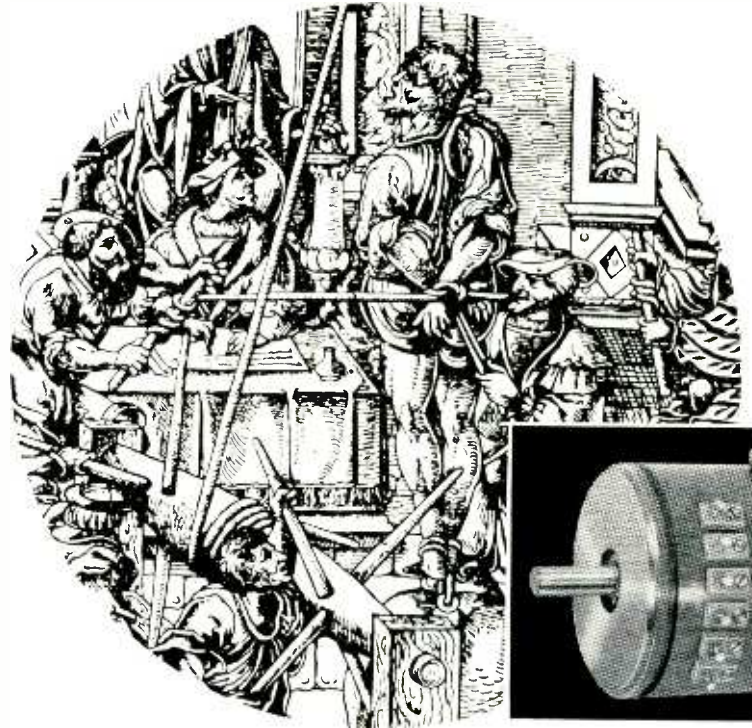

## ONLY FAIRCHILD TORTURE-TESTS 1 OUT OF EVERY 100 PRODUCTION UNITS

### Check these additional Fairchild Reliability Features:

- ✓ **FAIRCHILD** Quality Control also continuously samples production for compliance with engineering specified standards for materials and processes in accordance with MIL Q 5923C and MIL STD 105A.
- ✓ **FAIRCHILD** has complete test equipment on the line and each assembler checks his own work — in addition there is an independent 100% sub-assembly and final inspection.
- ✓ **FAIRCHILD** has complete environmental facilities in duplicate for engineering prototype as well as production testing.
- ✓ **FAIRCHILD** development units are tested to complete environmental exposure before they are released to production.
- ✓ **FAIRCHILD** uses pilot production to insure performance before full production begins.
- ✓ **FAIRCHILD** pots are type tested to insure performance beyond applicable military and customer specifications.

Only Fairchild Linear and Non-Linear Pots incorporate all of the above Reliability features. These High Reliability units can be had in  $\frac{3}{8}$ " to 5" diameters, single and multi-turn, in standard and high temp versions and with accuracies as high as .009%.

For more information write Dept. 28-E



**FAIRCHILD**  
CONTROLS CORPORATION

### COMPONENTS DIVISION

225 Park Avenue      6111 E Washington Blvd.  
Hicksville, L. I., N. Y.      Los Angeles, Cal

A Subsidiary of Fairchild Camera and Instrument Corporation  
Potentiometers • Gyros • Pressure Transducers • Accelerometers

# tells the whole story...with impact!

## miniature tape recorder

ACTUAL SIZE

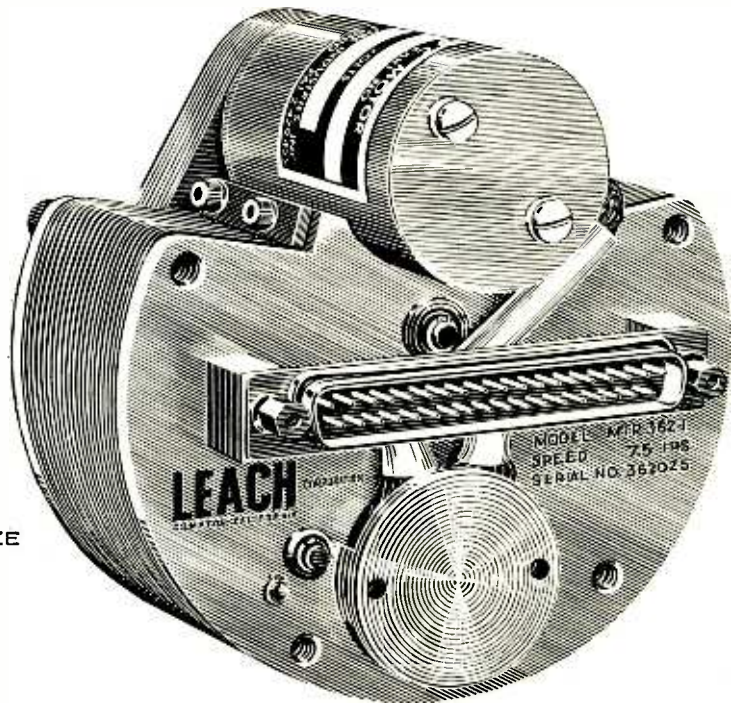

## newest new product from Inet!

Testing under severe environments... in extremely limited space? Inet's rugged new Miniature Tape Recorder simultaneously records data on 1 to 14 in-line channels, never loses a record because it's built to survive high impacts.

Here are the features to look for: precision in-line recording head; adjustable motor speed and tape tension; molded rubber pressure roller and driver wheels; and precision ball bearings at both ends to support all revolving parts.

Weighs just 24 ounces and operates at tape speeds of from  $\frac{1}{4}$  to 15 inches per second in a temperature range of  $-50^{\circ}\text{F.}$  to  $+200^{\circ}\text{F.}$  Among its applications: in-flight and static tests; atmospheric, blast, explosion, and wind tunnel studies; and acceleration and actuation tests. *Write today for complete specifications.*

**AVAILABLE** → **LOOK TO LEACH**  
INET DIVISION... LEACH CORPORATION  
18435 SUSANA ROAD, COMPTON, CALIFORNIA

DISTRICT OFFICES AND FIELD REPRESENTATIVES IN PRINCIPAL CITIES OF U.S. AND CANADA • EXPORT: LEACH CORP., INTERNATIONAL DIVISION



A COMPLETELY NEW *Concept* IN

# BOBBINLESS RESISTORS \*

New Subminiature Precision Wirewound Bobbinless Resistors feature exceptional stability, reliability and performance

General Transistor has developed a new concept for precision bobbinless resistors incorporating these exclusive features . . . the bobbinless construction eliminates wire stress and strain . . . a special viscous medium is used providing extreme shock and vibration resistance . . . welded case for positive hermetic sealing . . . the temperature coefficient of resistance of the finished resistor is the same as the wire and is not affected by the container. This insures repeatability and minimum hysteresis of resistance characteristics with temperature cycling.

These positive hermetically sealed units are designed for printed circuit boards and subminiature assemblies for airborne and missile applications.

The quality of materials and production superiority of these resistors is the same that has made General Transistor the Fastest Growing Name in Transistors.

Write today for complete technical information.

## SPECIFICATIONS

	Style R-2	Style R-5
Resistance Range	0.1Ω to 750KΩ	0.1Ω to 750KΩ
Resistance Tolerance	±0.05% min. at 25°C	±0.05% min. at 25°C
Power Rating	1/4 watt continuous in free air (increased dissipation possible with heat sink)	1/3 watt continuous in free air (increased dissipation possible with heat sink)
Temperature Range	-65°C to +125°C	-65°C to +125°C
Maximum Operating Voltage	250V, DC	500V, DC
Temperature Coefficient of Resistance	±20 parts per million/°C	±20 parts per million/°C
Dielectric Strength	500V rms, winding to case	1000V rms, winding to case

Construction - Terminations: - Welded

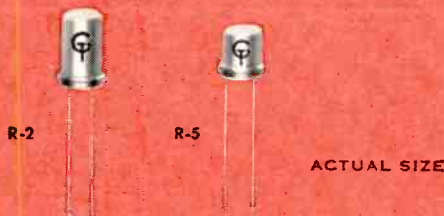

another QUALITY PRODUCT FROM GENERAL TRANSISTOR

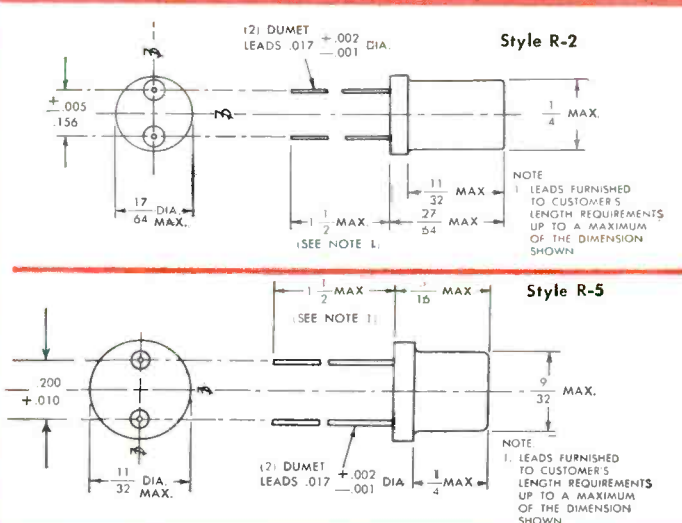
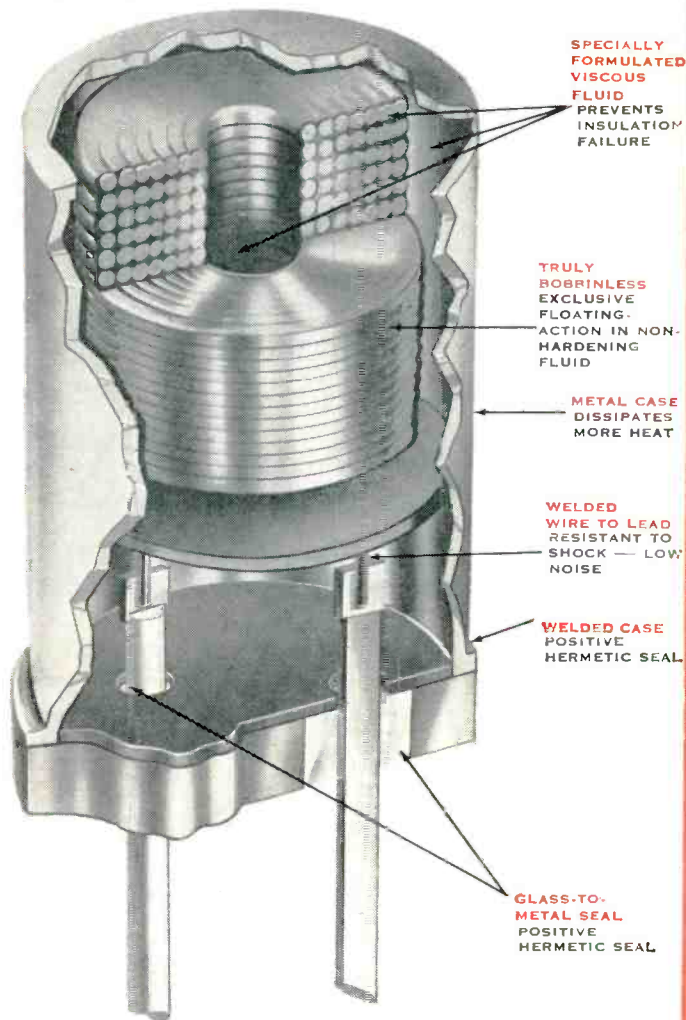

# GENERAL TRANSISTOR

C O R P O R A T I O N  
91-27 138TH PLACE JAMAICA 35, NEW YORK

IN CANADA: DESSER E-E LTD., 441 ST. FRANCIS XAVIER, MONTREAL 1, QUEBEC  
FOR IMMEDIATE DELIVERY FROM STOCK CONTACT YOUR NEAREST AUTHORIZED GENERAL TRANSISTOR DISTRIBUTOR  
OR GENERAL TRANSISTOR DISTRIBUTING CORP., 91-27 138TH, PLACE, JAMAICA 35, NEW YORK  
FOR EXPORT: GENERAL TRANSISTOR INTERNATIONAL CORP., 91-27 138TH PLACE, JAMAICA 35, NEW YORK

\*Pat. Pending



## *It takes Tough Testing to build Timing Performance*

When you buy a Haydon Timing Motor or Timing Device, you buy high quality and superior performance, because every production model and every new design has *proved* itself by passing the toughest, most exhaustive series of tests that our engineers can devise.

Quality control at Haydon starts with a careful inspection of all in-coming materials. It continues throughout production — with all parts and assemblies gaged, inspected or physically tested after every operation that can affect the performance of the finished motor or device. Final step is an inspection of completed motors and timing devices. All units are performance tested for many hours under varying conditions and are checked for quiet operation. Percentage samples of each lot are checked for torque rating, timing accuracy, and accuracy and alignment of gears and shafts. In addition, all new designs and periodic samplings from production are subjected to special "life endurance" tests in which hundreds of units are run continuously under various load conditions. In some instances, units have now been running ceaselessly for more than 10 years . . . proving their ability to perform *millions of cycles without failure!*

When you submit your timing problems to Haydon, you can be certain that our teams of engineers and other Timing Specialists have the experience, knowledge and facilities to supply devices designed, produced and tested to meet your needs exactly and perform according to your specifications.

*For further information, write now, outlining your timing requirements.*

# Haydon

AT TORRINGTON

DIVISION OF  
GENERAL TIME CORPORATION

**2429 EAST ELM STREET  
TORRINGTON, CONNECTICUT**

*Headquarters for Timing*



### **TIME DELAY TIMER**

*Provides time delay in ranges up to 9.5 minutes. Ideal for such applications as the protection of power tubes and/or operating preset operating cycles. Available in 120 or 240 volt, 50 or 60 cycle current.*

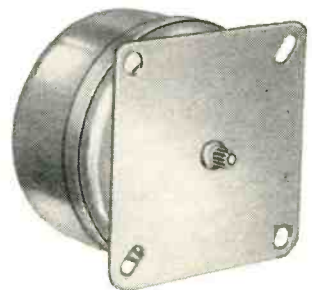

### **400 CYCLE MOTOR**

*These split phase motors provide the military an accurate approach to timing control for military applications. Rotor speed is 3,000 RPM at 400 cycles, 115 volt normal. Two models are available — Heavy Duty with 18 gram millimeters torque at the rotor, and the Miniature with 5 gram millimeters at the rotor. These motors may be applied to Haydon gear trains if desired.*

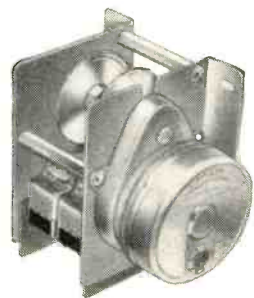

### **CYCLE TIMER**

*These units repeat a set cycle or sequence of operations as long as the motor is energized. Available in a wide choice of speeds, a broad range of timing intervals, and with a wide range of enclosed single pole, double throw switches for 120 and 240 volt operation, for 50 and 60 cycles.*



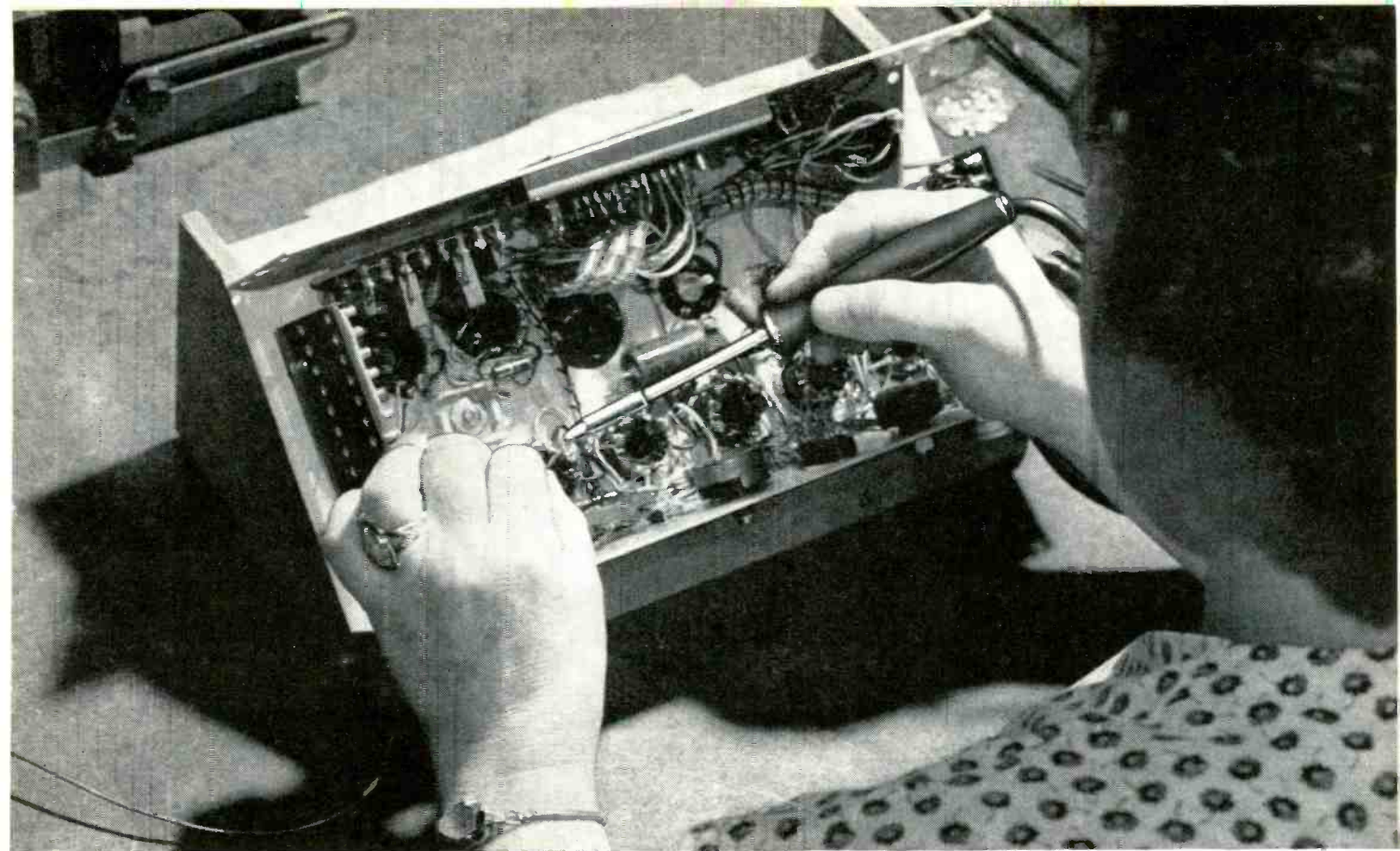

**HARD-TO-REACH JOINTS** in Sanborn Co.'s electro-cardiographs are soldered quickly with the fine-point G-E Midget iron—with no damage to adjacent parts. Weight of iron—less

than 3 ounces—helped increase output by reducing operator fatigue. The Midget's ironclad-copper tip saves Sanborn ½ hour cleaning and tinning time daily, per operator station.

## Sanborn speeds assembly 13% with G-E Midget iron, a small soldering iron with big-iron efficiency

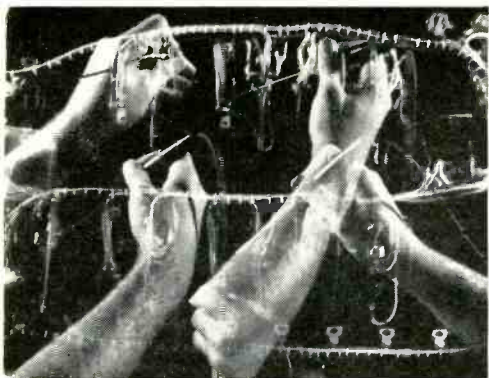

**FASTER HEAT RECOVERY** and lower maintenance of G-E soldering irons have been proved by many manufacturers under their own production conditions—along with competitive soldering irons. If you would like to compare General Electric irons with the irons you are now using, call your G-E distributor.



**DELIVERY TODAY** is now possible on popular soldering irons and other General Electric heaters and devices from a local distributor near your plant. Your replacement inventory may be reduced. For the name of your nearest stocking distributor for G-E heaters and devices, call your General Electric Apparatus Sales Office.



**SAVINGS ACHIEVED** by several users and information about the construction features of General Electric soldering irons are included in a new bulletin, "Save While You Solder," GED-3553. For a copy, call your G-E distributor or write Section 724-9, General Electric Company, Schenectady 5, New York.

**GENERAL**  **ELECTRIC**

CIRCLE 45 READERS SERVICE CARD

# NEW! BAUSCH & LOMB STEREOMICROSCOPES

FEATURING

STEREO

ZOOM

CONTINUOUSLY  
VARIABLE POWER



Here's a completely new optical concept to speed and simplify work requiring 3D views. Just turn the magnification knob and watch the crisp stereo image zoom to the *exact* size you need. Not just a few fixed powers, but *any* power within the wide stereo range. The newest step forward to faster, easier 3D work . . . exclusive with Bausch & Lomb.

**Featuring Exclusive POWER POD Design Concept**

- Sealed to prevent dust and foreign matter from entering optical system!
- No nosepiece!
- No individual objectives . . . no objectives to change!
- No image jump!
- No image blackout!

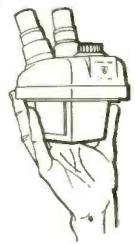

**Featuring NEW LOW PRICE**

. . . about one-third lower than previous line!

BAUSCH & LOMB OPTICAL CO.  
70941 St. Paul Street, Rochester 2, N. Y.

- Send me new B&L Stereomicroscope Catalog D-15.
- Schedule a demonstration at my convenience.
- I'd like to borrow a B&L Stereomicroscope for 15-day trial without cost or obligation.

Name, Title .....

Company .....

Address .....

City ..... Zone ..... State .....

**BAUSCH & LOMB**



America's only complete optical source  
. . . from glass to finished product

**MAIL COUPON NOW!**



# Fair Exchange of Electronics?

Soviet Union exposition—which opens next month in New York City—will cover a broader range of electronics than U.S. one in Moscow

SOVIET UNION EXPOSITION, which starts June 30 in New York's Coliseum, promises to offer a far broader exhibition of electronics than the American exposition, which opens July 25 in Moscow's Sokolniki Park, unless last-minute changes are made.

Each signatory to the "science, technology and culture" agreement, which set up the exchange of expositions, retained the right to choose its own exhibits under those broad categories.

Selection of the exhibits for the American exposition has been in the hands of an architectural and industrial design firm, the George Nelson Co. of New York.

In line with showing "the American way of life"—how we function as a society, what American family groups do during a five-day work week and on weekends, and the infinite variety of consumer products available to all—the U.S. exhibits representing electronics consist almost entirely of television, radio and hi-fi sets.

One electronic computer will be shown, an IBM RAMAC, set up to respond to questions from Soviet visitors about America. Answers will be displayed by a CBS tv system consisting of four pickups and four monitors. RCA plans eight hours of color programming a day over a closed-circuit tv system.

Vladimir Alkhimov, commercial counselor to the Soviet embassy, told *ELECTRONICS* that seven different electronic computers "from simple to complicated" would be shown at the USSR exposition. Some, he said, are used in the control of manufacturing processes. Both semiconductor and tube types will be shown.

He said a variety of industrial and space electronic exhibits will be shown in addition to Soviet radios, tv receivers, home tape recorders, transducers and hi-fi sets.

Alkhimov informed *ELECTRONICS* that the Soviet exposition would

contain a "Radio-Electronics Section." This, he said, would include communications equipment, semiconductor and electron tube instrumentation, infrared techniques, electron microscopes, and air and marine navigation gear, in addition to consumer products.

Full-sized models of the three Soviet sputniks with their electronic instrumentation will be shown, he said.

Alkhimov reports that an "Automation Section" in the Soviet exposition will display electronic control applications in oil fields and fully automatic machine tools.

## Emphasize Electronics

Remotely controlled manipulators and other devices operated on bio-currents will also be featured, he said. Alkhimov did not elaborate on these, but presumably they operate by means of translation of human muscle movements into remote manipulation of equipment.

The Soviet spokesman said electronics would be covered in a section on "Atoms for Peace."

The Soviets will display "data on

the growth of scientific personnel in the USSR, the network of research institutions and the activities of the Academy of Sciences and its institutes."

Use of isotopes in Soviet technology, medicine, biology and agriculture will be shown in the exhibit of peaceful applications of the atom.

The Nelson firm said that it knew of no industrial electronic equipment being shown, although there was no intention to either include or exclude such gear. It said "time, budget and logistics played decisive roles."

A spokesman for the U.S. Information Agency said revisions were still being made in exhibition plans, particularly with regard to science, and that NASA and AEC were participating.

He said models of U.S. satellites and instrumentation would probably be shown, as well as models of high-altitude research aircraft such as the X-15; a color film on space research; and a display of radioisotopes used in industry. Technical experts will be available to answer questions, he said.

## Tv System Watches Radioactive Fuel



Closed-circuit tv camera attached to loading face shield (left) of sodium nuclear power reactor allows safe viewing of radioactive fuel elements (right) as they are transferred to the system's core. Tv equipment was designed by Atomics International, a division of North American Aviation

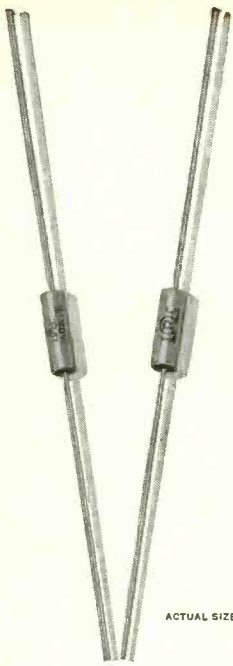

# Small-World Resistors with out-of-this-world Reliability

Miniaturization is a severe test of performance, for reliability tends to shrink faster than size. Here, where critical equipment had to be made smaller, yet more reliable, Bendix-Pacific pinned performance to the reliability of IRC precision film resistors.

IRC Molded Metal Film Resistors combine excellent stability on load with a low, controlled temperature coefficient that is far superior to other precision film resistors. They exceed requirements for extremely close design tolerances and have excellent high frequency characteristics. Where these superior characteristics are not required, IRC Molded Deposited Carbon Resistors offer excellent all-around performance and economy. Both types available in  $\frac{1}{8}$ ,  $\frac{1}{4}$ ,  $\frac{1}{2}$ , 1 and 2 watt sizes . . . and exceed MIL-R-10509B specifications. For design data, write for Bulletins B-3 and B-9.

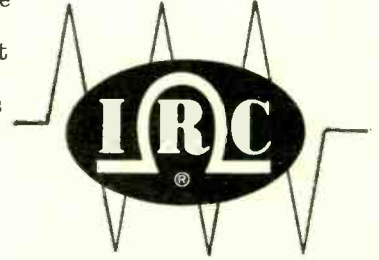

INTERNATIONAL RESISTANCE CO. • Dept. 377, 401 N. Broad St., Phila. 8, Pa. In Canada: International Resistance Co., Ltd., Toronto, Licensee

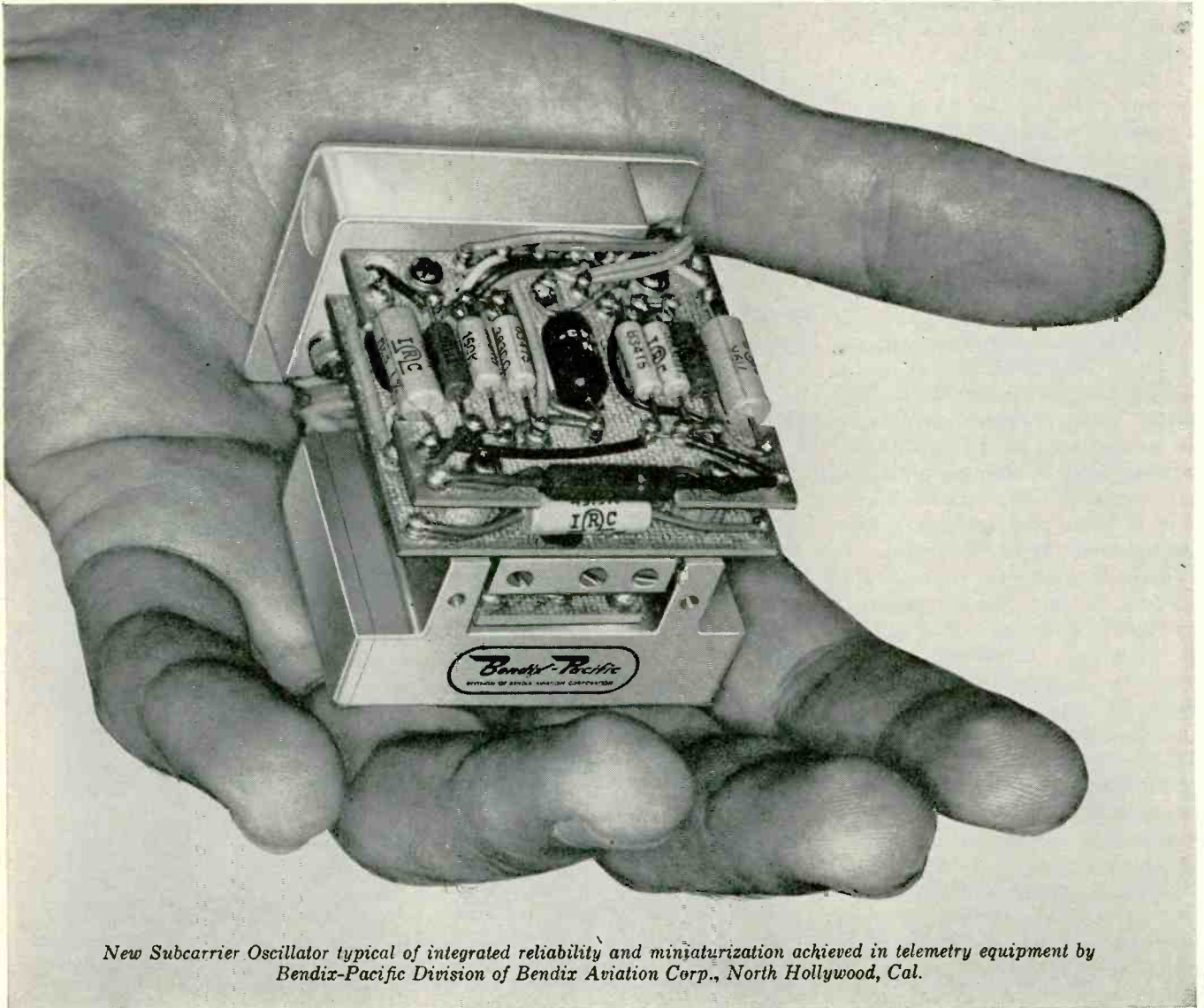

*New Subcarrier Oscillator typical of integrated reliability and miniaturization achieved in telemetry equipment by Bendix-Pacific Division of Bendix Aviation Corp., North Hollywood, Cal.*



*the first real "BREAK" for airborne harnesses*

THE ALL NEW **AMP**

# HELICON

## CONNECTOR



### FEATURES

- helical construction imparts a connection so firm that a special A-MP tool is required to connect and disconnect.
- "o" ring and metal wire-insulation ring make moisture-tight seal
- wiping action cleans pin and socket for assured maximum conductivity
- positive wire-stops prevent over-insertion of stripped conductor

### FEATURES

- serrations inside barrel assure maximum crimp-contact between barrel and conductor
- inspection ports permit examination of conductors in barrel
- environmental proofing: moisture resistant, corrosion resistant, vibration and shock resistant

Never before has such a unit been available—a reliable, pre-insulated "manufacturing break" for aircraft and missile harnesses. Designed as a quick connect/disconnect for all high-reliability circuits, the all new A-MP HELICON Connector is completely environmental-proofed and fully pre-insulated. Equally important, it requires a special A-MP tool to connect and disconnect, thereby preventing tampering and unintentional breaks in circuits.

The HELICON Connector can be attached to airborne circuit wires with remarkable speed and ease . . . permits multiple connect/disconnects without harm to unit . . . offers the highest reliability.



*This is the product that the Avionics Industry has needed for years.  
There is nothing else on the market like it. Write for more information.*

# AMP INCORPORATED

**GENERAL OFFICES: HARRISBURG, PENNSYLVANIA**

A-MP products and engineering assistance are available through subsidiary companies in: Canada • England • France • Holland • Japan

*These Sylvania NPN  
Switching Transistors can be*

# on your breadboard today



**YOU** CAN take immediate advantage of the outstanding performance of Sylvania's most popular NPN switching transistors. They are now available, through local authorized Sylvania distributors, in a new Switching Transistor Sampler pack. It contains 3 each of the six most popular NPN types in Sylvania's extensive switching transistor line. It also contains an 8-page booklet giving complete specifications and data on each type.

Included in the pack are types 2N356, 2N357, 2N358 with 100 mw dissipation and types 2N377, 2N385 and 2N388 with 150 mw dissipation (base internally connected to case for added dissipation). Each type features the Sylvania welded her-

metic seal for full protection against humidity and other environmental conditions. Each meets JEDEC TO-5 or TO-9 dimensions.

The complete 18-transistor sampler is available while this offer lasts at a suggested industrial user cost of \$72.95 . . . that's \$28.63 LESS than

the regular small-quantity price . . . from your authorized Sylvania Distributor. He has the new package in stock now. So call, write or drop by the Sylvania Distributor near you. He'll be glad to give you full particulars on these high-stability Sylvania NPN Switching Transistors.

Type	CHARACTERISTICS				
	Max. Dissipation at 25° Ambient	Max. Junction Temp (°C)	Max. $I_c$ (ma)	Current Gain $h_{FE}$	Max. Rise Time, $t_r$ (Microseconds)
2N356	100 mw	85	500	30	2.0
2N357	100 mw	85	500	30	1.2
2N358	100 mw	85	500	30	0.8
2N377*	150 mw	100	200	40	2.5
2N385*	150 mw	85	200	70	—
2N388*	150 mw	100	200	110	1.0

\*Base internally connected to the case



SYLVANIA ELECTRIC PRODUCTS INC.  
Semiconductor Division  
100 Sylvan Rd., Woburn, Mass.





These authorized Sylvania Semiconductor Distributors can provide off-the-shelf delivery of this NPN Switching Transistor Sampler

#### EAST COAST

##### BALTIMORE

Radio Electric Service  
5 N. Howard Street  
LExington 9-3835

##### BOSTON

DeMambro Radio Supply  
Company  
1095 Commonwealth Avenue  
ALgonquin 4-9000

A. W. Mayer Company  
859 Boylston Street  
COpley 7-5330

##### NEW YORK

Buffalo  
Genesee Radio Inc.  
2550 Delaware Avenue  
DElaware 9661

Metropolitan Area:  
Arrow Electronics Inc.  
525 Jericho Turnpike  
Mineola, L. I., N. Y.  
JAmaica 6-0300  
Pioneer 6-8686

Federated Purchaser  
1021 U. S. Rte. 22  
Mountainside, N. J.  
ADams 2-8200

Lafayette Radio Corp.  
100 Sixth Avenue  
WORTH 6-5300

Terminal Radio Corp.  
85 Cortlandt St.  
WORTH 4-3311

#### PENNSYLVANIA

Philadelphia  
Al Steinberg & Company  
2520 No. Broad Street  
BALdwin 3-9400

Pittsburgh  
South Hill Electronics  
1420 W. Liberty Street  
FieLdbrook 1-6200

State College  
Alvo Electronic Distributors  
103 South Pugh Street  
ADams 8-6277

#### SOUTH CAROLINA

Greenville  
Carolina Radio Supply Company  
221 West Washington Street  
CEdar 2-6740

WASHINGTON, D. C.  
Electronic Wholesalers  
2345 Sherman Avenue, N.W.  
DUpont 7-6500

#### CENTRAL

ILLINOIS  
Chicago  
Allied Radio  
100 N. Western Avenue  
MAymarket 1-6800

Newark Electric  
223 W. Madison  
STate 2-2944

Benton  
Lampley Radio  
452 E. Church Street  
GENERAL 5-8194

#### INDIANA

Indianapolis  
Radio Distributing Company  
1013 N. Capitol Avenue  
MElrose 5-8311

#### MICHIGAN

Ann Arbor  
Wedemeyer Electronic Supply  
215 N. Fourth Avenue  
NOrmandy 2-4457

Detroit  
Glendale Electronic Supply  
12866 Woodward  
TUlsa 3-1500

#### MINNESOTA

Minneapolis  
Northwest Electronic Supply  
52 So. 12th Street  
FEderal 9-6346

#### MISSOURI

St. Louis  
Ebinger Electronics  
8126 Gravois Avenue  
MOhawk 4-7700

#### OHIO

Cincinnati  
United Radio  
1314 Vine Street  
CHerry 1-6530

Cleveland  
Pioneer Electronic Supply  
2115 Prospect Avenue  
SUperior 1-9410

#### Dayton

Srepco  
314 Leo Street  
BALdwin 4-3871

Toledo  
Warren Radio Company  
Box 1004  
1002 Adams Street  
CHerry 8-3364

#### WISCONSIN

Madison  
Satterfield Electronics  
1900 So. Park Street  
ALpine 7-4801

Milwaukee  
Radio Parts Company  
940 No. 27th Street  
WEst 3-5131

#### SOUTHERN

TEXAS  
El Paso  
Midland Specialty Company  
599 W. Paisana Drive  
KEystone 3-9555

#### WESTERN

COLORADO  
Denver  
L. B. Walker Company  
620 Broadway  
ALpine 5-3695

#### PACIFIC

CALIFORNIA  
Glendale  
R. V. Weatherford  
6921 San Fernando Blvd.  
THornwall 5-3551

Long Beach  
Dean's Electronics  
2310 American Avenue  
GARfield 7-0955  
NEvada 6-1783

Los Angeles  
Federated Purchaser  
11275 Olympic Blvd.  
BRadshaw 2-0831

Radio Products Sales  
1501 So. Hill St.  
RiChmond 9-7471

Universal Radio Supply  
1727 So. Los Angeles St.  
RiChmond 9-5421

Oakland  
Brill Electronics  
610 East 10th Street  
TE 2-6100

Elmar Electronics Inc.  
140 11th Street  
HIgate 4-7011

Pasadena  
Electronic Supply Corp.  
2085 E. Foothill Blvd.  
RYan 1-5291

San Jose  
Peninsula TV & Radio  
656 South 1st Street  
CYpress 4-8781

San Francisco  
Zack Electronics  
1426 Market Street  
MARket 1-1422

WASHINGTON  
Tacoma  
C & G Radio Supply Co.  
2502 Jefferson Avenue  
BRoadway 2-3181

# Selective Calling

Increased need to decrease communication traffic and pinpoint mobile units is giving rise to a growing market for selective calling gear

## 2 OUTSTANDING HIGH-TEMPERATURE MAGNET WIRES

*Tetroc*<sup>®</sup>

FOR CONTINUOUS OPERATION AT  
HOTTEST SPOT TEMPERATURES  
UP TO 200°C

*Ceroc*<sup>®</sup>

FOR CONTINUOUS OPERATION AT  
HOTTEST SPOT TEMPERATURES  
UP TO 250°C

For continuous operation at hottest spot temperatures up to 200°C (392°F) and up to 250°C (482°F) for short periods of time—depend upon TETROC—an all Teflon-insulated wire available in both single and heavy coatings.

CEROC is Sprague's recommendation for continuous operation at hottest spot temperatures up to 250°C (482°F) and up to 300°C (572°F) for short periods of time. Ceroc has a flexible ceramic base insulation with either single silicone or single or heavy Teflon overlays. The ceramic base stops "cut-through" sometimes found in windings of all-fluorocarbon wire. Both Tetroc and Ceroc magnet wires provide extremely high space factors.

Write for Engineering Bulletins 405 (Tetroc Wires) and 400A (Ceroc Wires).



SPRAGUE  
ELECTRIC  
COMPANY

35 Marshall Street,  
North Adams, Mass.

**SPRAGUE**<sup>®</sup>

THE MARK OF RELIABILITY

CIRCLE 52 READERS SERVICE CARD

A GROWING NUMBER of microwave and mobile radio users are learning that selective calling systems can add a number of valuable features to their operations.

In general, selective calling systems in use today are operated by telephone-type dials or by pushbutton panels. The user is able to contact single vehicles, individual planes or particular stations along a pipeline.

Other uses are: monitoring flood control stations along the banks of a river, gathering data from rainfall indicators in a watershed system, and snow depth indicators in winter danger areas.

### Use Tones, Pulses

Most existing selective calling systems rely on tone combinations or pulse code transmissions to select the particular receiver desired. One manufacturer presently using the tone system for contacting aircraft is Motorola. The system, labeled Selcal, allows control tower operators to trigger a transponder in any aircraft over the airport. The transponder in turn automatically sends back data pinpointing

the plane's location, giving amount of fuel remaining, and other related information.

If voice communication is necessary, the tower crew can select the aircraft and speak to the pilot. The advantage is that the pilots do not have to listen to all communications to sift out messages. United and American Airlines' new jets are equipped with Selcal.

Similar equipment is finding increased applications in motor vehicle fleets. Electrical Communications of San Francisco reports users ranging from newspaper delivery vehicles to produce trucks in the California farm regions.

One installation in Sarasota, Fla., in addition to allowing selected vehicles to be dialed directly, is also equipped to allow vehicles in the field to dial other vehicles.

The system, called Secode, allows mobile units to contact other vehicles by asking a base station for a "line" and then dialing the code number for the desired vehicle. In addition to the 60-vehicle network in Sarasota, additional facilities linking 100 units are being installed for a Tampa installation.



Mobile communications systems like this one by Lenkurt allow callers in vehicles to hold private conversations at will



# Grows

A pushbutton system designed by RCA is available for vehicles equipped with a two-way radio. The equipment allows individual vehicles to be contacted, and also allows conference calls to be set up.

In commenting on the increased market for selective systems, manufacturers say this is due to the increased demand for spectrum space. In many municipalities, official service groups, such as police and fire departments, must share space with other users.

In practice, this means that a radio patrol car team must listen to all communications during a tour of duty. One official estimates that less than 30 percent of the total traffic is of interest to the patrol car.

"Selective calling," one user says, "can make mobile radio a first-rate communications tool instead of the great loud party line it is now."

## Notifies User

In reducing the amount of communication traffic to an individual receiver, selective systems save drivers the trouble of having their sets tuned to maximum volume if they leave the vehicle.

Most available systems can be made to sound the horn or blink the headlights when a call comes in. Provision can also be made to leave an indicator light on if a call is not answered.

To counter the fatigue-inducing condition of having a receiver operating at audible volume, a system devised by DuMont mutes the receiver when a call is terminated and turns it back up to audible level when the next call comes in. In operation, the base station also derives benefit from this because the transmitter remains muted until one of the field units calls in.

Personal paging devices are among the most recent to utilize selective calling systems. In municipal use, belt radios are carried by policemen who can be signaled individually by a tone. The system does not include facilities for conversation, but notifies the wearer to go to the nearest call-box and phone in.

## Miniature Pulse Transformers

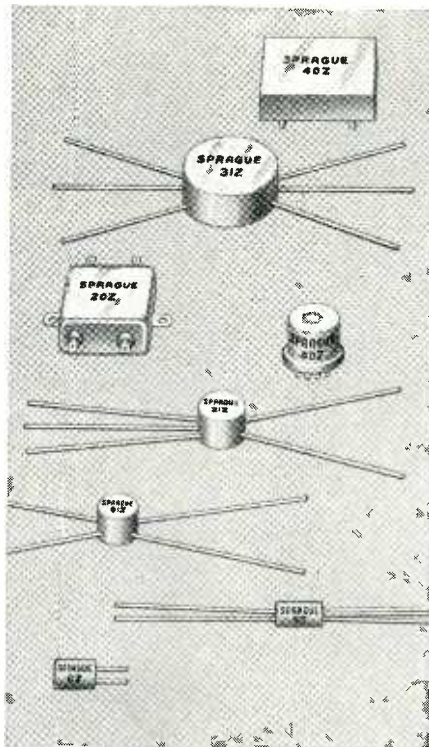

Sprague miniature pulse transformers are ideally suited for application in low-power, high-speed computer circuitry where pulse signals may range up from 20 millimicroseconds and wider in duration, at repetition rates as high as 10 megacycles, with pulse levels ranging from fractions of a volt to several hundred volts.

Typical circuits utilizing Sprague Pulse Transformers include *pulse amplifiers* (for current or voltage step-up, impedance matching, decoupling, pulse inversion and push-pull operation); *pulse shaping and differentiating*; *blocking oscillators* (in regenerative circuits of the triggered and self-triggered type); *general transistor circuits*.

Choose from Sprague's wide variety of mounting styles, shapes and encasements... for conventional or printed wiring board assembly.

Write for the complete series of engineering bulletins to Technical Literature Section, Sprague Electric Company, 35 Marshall Street, North Adams, Massachusetts.

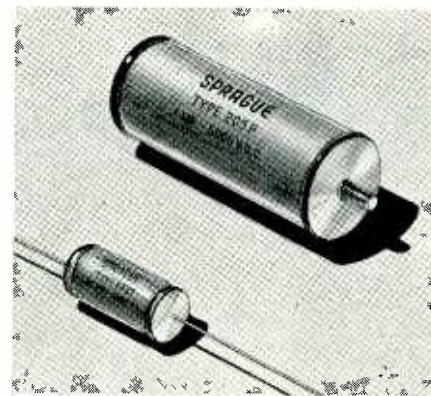

## HIGH-VOLTAGE GLASS-ENCASED DIFILM® VITAMIN Q® CAPACITORS

solve corona problems at high altitudes

Sprague Type 205P DIFILM Vitamin Q Capacitors are ideal for use in high-voltage airborne electronic equipment.

Type 205P capacitors also find application in high-voltage ground equipment... in coupling and bypass applications in industrial electronic control devices. They are designed to meet military performance requirements, and are available as standard in ratings up to 10,000 volts for both 85°C and 125°C ambient temperatures.

These capacitors are made with a new dual dielectric which combines the proven long life of paper capacitors with the best properties of polyester film units. In addition, a new end-seal design eliminates impregnant leak problems.

For complete technical data, write for Engineering Bulletin No. 2312 to Technical Literature Section, Sprague Electric Company, 35 Marshall Street, North Adams, Massachusetts.

**SPRAGUE**  
THE MARK OF RELIABILITY

# ELECTRONICS

**made it possible!**

## THE WORLD'S FASTEST JETLINER



# ***TWA BOEING 707***

Our congratulations to you—the scientific planners, engineers and technicians of the great United States electronics industry! Thanks to your skill, air travelers today are enjoying the miracle of pure-jet flight. So fast they fly half a mile every three seconds. So quiet, smooth and vibration-free, they relax completely. Thanks to your inventive genius, they are enjoying the magnificent **TWA BOEING 707**—fastest Jet airliner in the world!

**TWA**  
**TRANS WORLD AIRLINES**



# HEAT PROBLEMS?

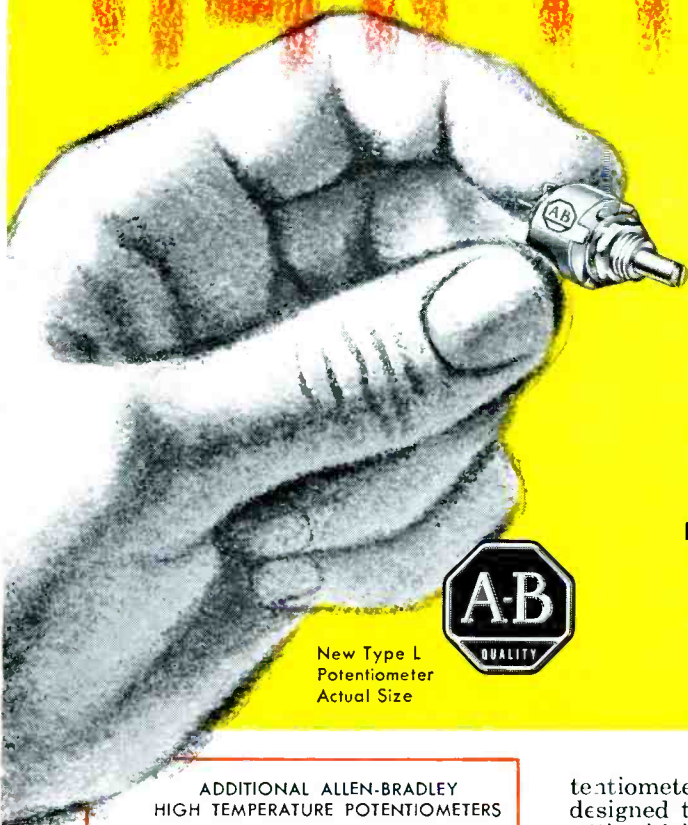

## NEW Allen-Bradley POTENTIOMETERS for use in TEMPERATURES UP TO 150°C!



New Type L Potentiometer Actual Size

### ADDITIONAL ALLEN-BRADLEY HIGH TEMPERATURE POTENTIOMETERS

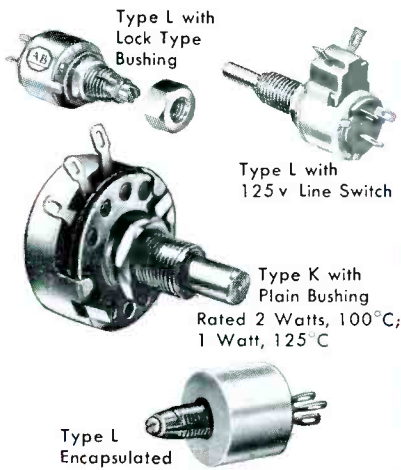

This new Allen-Bradley potentiometer—the Type L—is especially designed to solve problems associated with high ambient temperatures—and space conservation. Although extremely compact—0.5 inch in diameter—the Type L control has a conservative rating of 0.5 watt when operating in an ambient temperature of 100°C. And, it provides reliable performance when operated at a temperature of 150°C—under “no load” conditions. (See graph at right.)

The new Type L control features the same solid, hot molded resistance element that has proved unequalled for long life, smooth operation, and low “noise” characteristic in Allen-Bradley’s popular Type J, Type K, and Type G potentiometers. When temperature and space problems in your designs plague you, this new A-B “high temperature” potentiometer is a reliable answer. Please send for complete information, today.

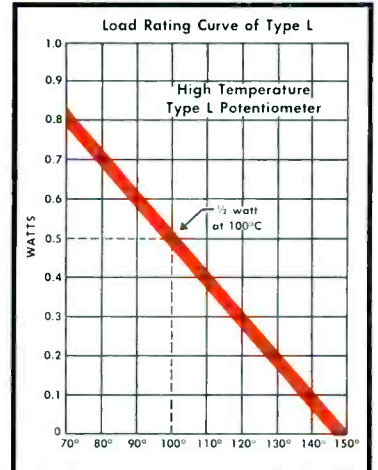

AMBIENT TEMPERATURE °C. Load Capabilities of Type L below the Critical Resistance Value. Type L Far Exceeds the Requirements of MIL-R-94B.

# ALLEN - BRADLEY

## Quality Electronic Components

Allen-Bradley Co., 222 W. Greenfield Ave., Milwaukee 4, Wis. • In Canada: Allen-Bradley Canada Ltd., Galt, Ont.

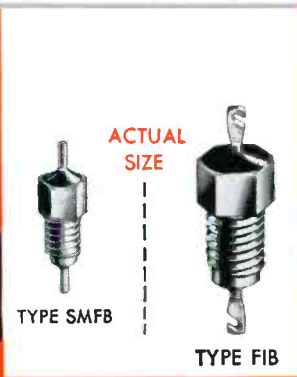

# Broad Band High Frequency Filters

Allen-Bradley cascaded ceramic feed-thru filters provide effective filtering up to and beyond 5,000 MCS

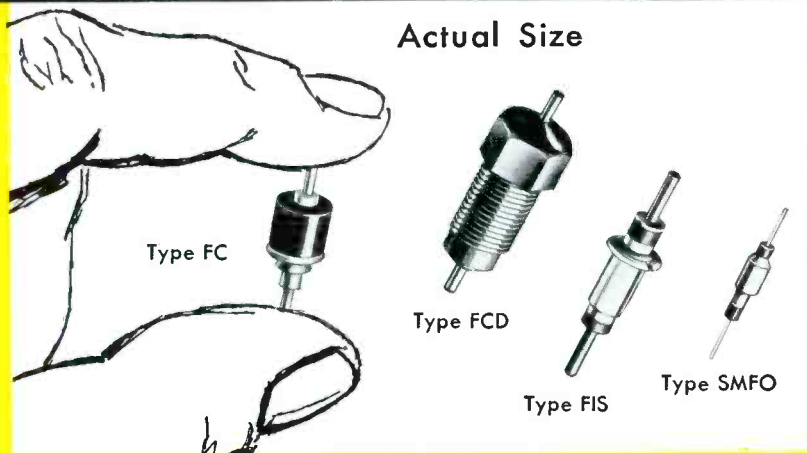

Here's an entirely new concept in ultra-high frequency filtering—Allen-Bradley's new ceramic feed-thru filters. Their high insertion loss—up to 60 db—effectively prevents feedback and radiation from low power circuits operating in the frequency range from 50 mcs to 5000 mcs.

Astounding in performance, these new A-B filters are actually superior to the theoretical *ideal* capacitor over a wide frequency range. Note, in the graph at right, their effective filtering increases with frequency—and they have none of the undesirable resonance characteristics of standard tubular capacitors. In addition, A-B filter elements provide far greater effective capacitance values than practical with conventional capacitor designs. Filters are available in voltage ratings up to 500 v DC at 125°C. Send for Technical Bulletin 5410.

Allen-Bradley Co., 222 W. Greenfield Ave., Milwaukee 4, Wis.  
In Canada: Allen-Bradley Canada Ltd., Galt, Ont.

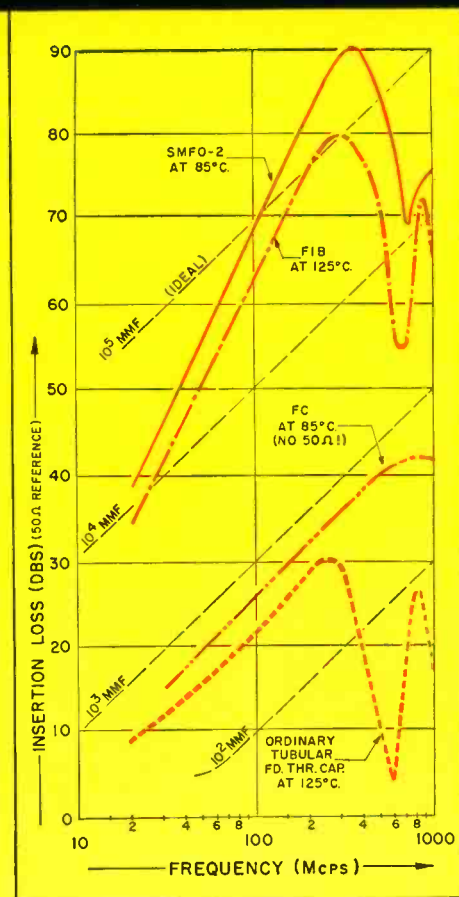

3-59-E

# ALLEN-BRADLEY

Quality  
ELECTRONIC  
COMPONENTS



# Magnavox

a leading company



in a wonderful city

**Champaign-Urbana,  
Illinois**



offers unlimited opportunity for  
**Design Engineers**

**Yes, Magnavox is a leading company . . .** not only in television and high fidelity but in the Government and Industrial Division too. Our new modern facilities in Champaign-Urbana, Illinois, represent a young but extremely productive organization. Within 3 months we are expanding over 100%. We can offer digital, communications and packaging design engineers unlimited opportunities with permanent positions on our growing staff.

*"Champaign-Urbana A Fine Place To Live and Work" say Magnavox Engineers . . .*

**Here's why . . .**

Excellent Public School System for Children and Teenagers • Home of the University of Illinois with its Highly Rated Electronics Engineering School, Big Ten Sporting Events, and fine Campus • Minimum Commuting Time from Home to the Office, Low Cost of Living • Magnavox Assistance Toward Advanced Education.

*If you are a Design Engineer in the Digital, Communications or Packaging Fields, please write Mr. D. M. Ormiston today. You'll be glad you did.*

**THE MAGNAVOX COMPANY • URBANA, ILLINOIS**

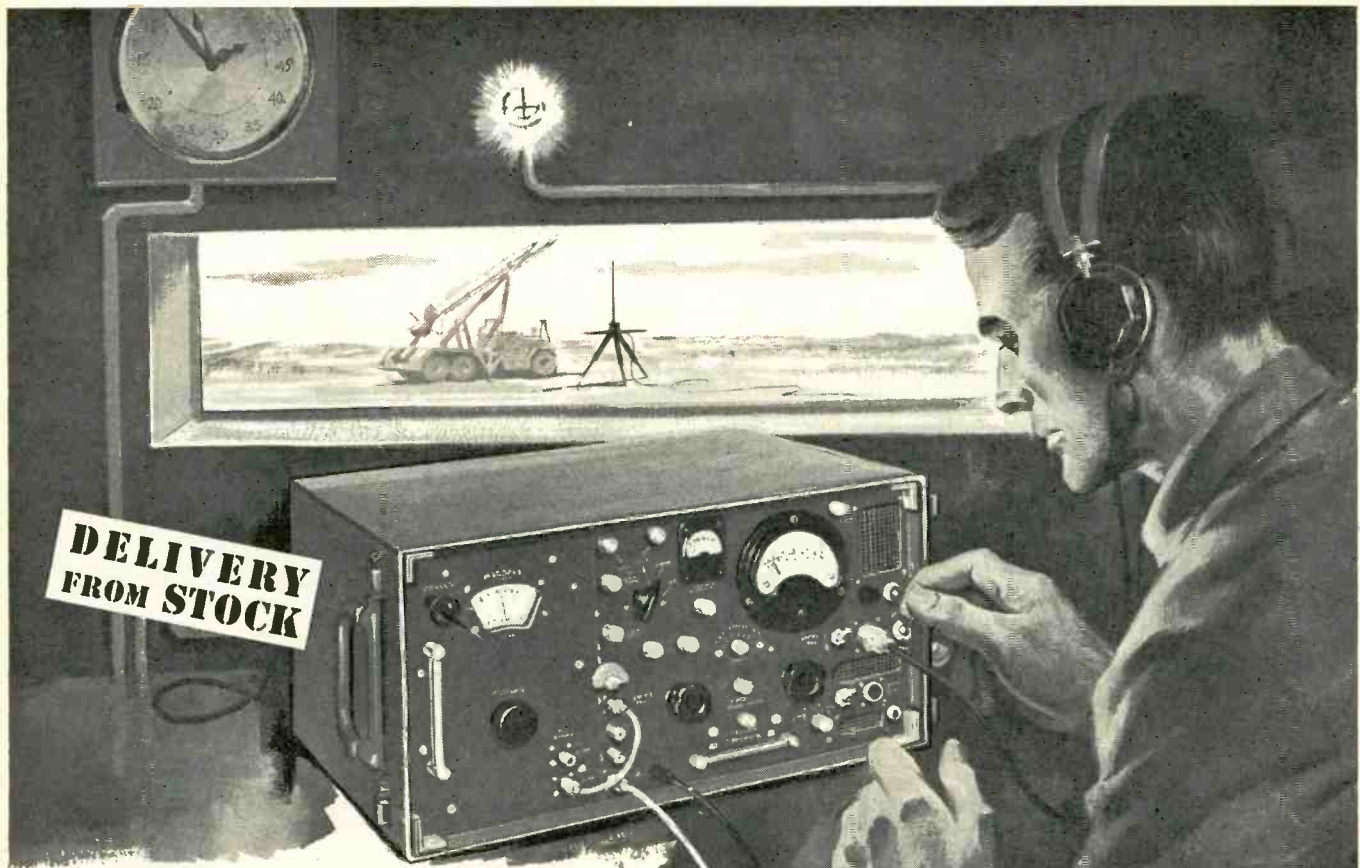

**DELIVERY  
FROM STOCK**

**FLEXIBILITY IN THE FIELD...**

just one of the many useful features of

**EMPIRE'S  
NOISE & FIELD INTENSITY METER  
MODEL NF-105**

Model NF-105 remotely located from its antenna, for personnel safety.

- Measures 150 kilocycles to 1000 megacycles accurately and quickly with only one meter.
- Approval status: MIL-I-6181B, Class 1, MIL-I-6181C, Category A; MIL-I-26600 (USAF).
- Direct substitution measurements by means of broad-band impulse calibrator, without charts, assure repeatability.
- Self-calibrating, for reliability and speed of operation.
- True peak indication by direct meter reading or aural slideback.
- Four interchangeable plug-in tuning units for extreme flexibility.
- Economical . . . avoids duplication.
- Safeguards personnel . . . ALL antennas can be remotely located from the instrument without affecting performance.
- Compact, built-in regulated A and B power supply, for stability.
- Minimum of maintenance required, proven by years of field experience.



Only the Model NF-105 is so simple to operate that one technician can take readings over the entire frequency range in less time than required by three engineers manning any other three separate instruments.

Send for our Catalog No. N-358



**EMPIRE DEVICES PRODUCTS CORP.**  
AMSTERDAM, NEW YORK VICTOR 2-8400

MANUFACTURERS OF:  
FIELD INTENSITY METERS • DISTORTION ANALYZERS • IMPULSE GENERATORS • COAXIAL ATTENUATORS • CRYSTAL MIXERS



# West Germany Plans to Buy

Defense Minister Strauss tells Electronics his nation is depending on U.S. companies

WEST GERMANY'S military buildup will depend on U. S. electronics and missile manufacturers during the next few years, Defense Minister Franz-Joseph Strauss told ELECTRONICS during a recent United States visit.

"Most of our missiles will be U. S. missiles, or else they will be designed in the U. S. and produced in Europe under agreement between our governments and industry in America," he said.

"We do not intend to start German design of German armed forces missiles with its problems of logistics. Spare parts are so expensive it would be entirely unwise if we would go our own way in the manufacture of missiles."

## Gives Goals

Goal in buildup of the German Armed Forces (Bundeswehr) is 12 Army divisions, 26 air squadrons and 22 naval squadrons.

An aid to Strauss reported that each Army division will get one

Honest John rocket unit, with three Nike battalions and one Matador unit for all the forces. Hawk missiles are also being purchased, but no figures are available on their number or the expenditure for them.

## Orders This Year

Strauss indicates that military orders during the present fiscal year are expected to total about \$500 million. The Defense Ministry has already ordered about \$2.3 billion worth of heavy equipment and materiel, divided about equally between foreign and domestic firms. West Germany's Navy buildup alone is said to amount to \$720 million.

"We don't want to build up a self-supporting German armament industry," Strauss said. "We are for standardized equipment for NATO forces. We're not building up armament capacities when other NATO countries, especially the U. S., have such capacities."

## Monitoring Northern Skies

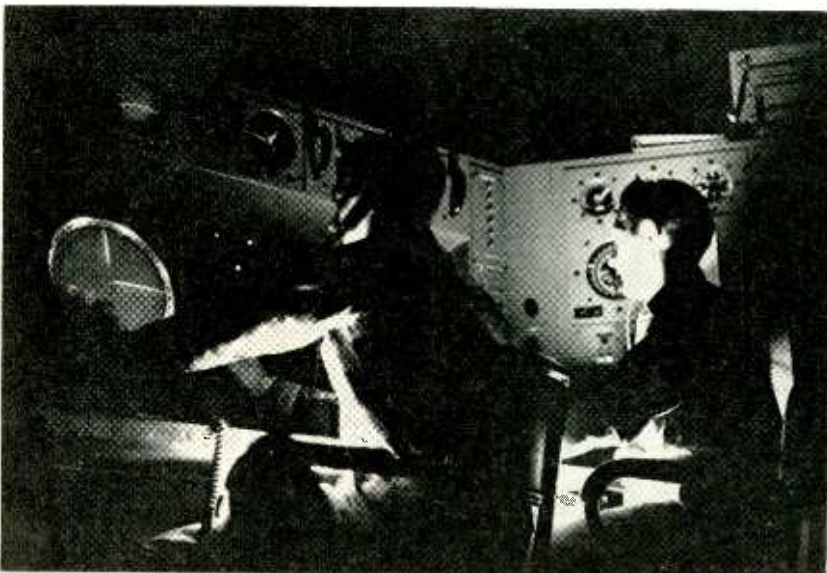

USAF radar technicians watch scopes at one of six new DEW Line stations installed in the Aleutian chain to prevent sneak attacks from Siberia

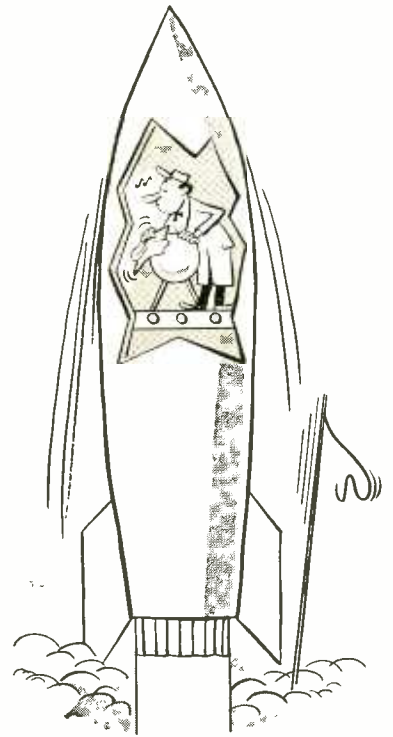

## Clean precision parts more safely

New Freon\* solvents by Du Pont minimize cleaning hazards

- **Low toxicity**—"Freon" solvents are odorless and much less toxic than ordinary solvents—vapors won't cause nausea or headaches.
- **Won't burn or explode**—Underwriters' Laboratories report "Freon" solvents non-explosive, non-combustible and non-flammable.
- **Non-corrosive**—"Freon" solvents remain neutral through repeated degreasing use without the need of inhibitors.
- **Negligible effects on plastics, elastomers, insulation and color codes**—"Freon" solvents remove oil and grease with minimum swelling of plastics or rubber and without crazing or softening paint, wire coatings or insulation.
- **Leaves no residue**—"Freon" solvents evaporate completely, leave no deposit.

New "Freon" solvents by Du Pont degrease sensitive mechanical and electronic assemblies without damage to delicate parts. Since no inhibitors are needed, no residue is left on the parts, and "Freon" solvents can be recovered and reused without re-inhibiting. Write for free "Freon" solvents booklet. E. I. du Pont de Nemours & Co. (Inc.), "Freon" Products Division 525, Wilmington 98, Delaware.

\*Freon is Du Pont's registered trademark for its fluorinated hydrocarbon solvents.

**FREE BOOKLET!**  
No obligation—write for booklet which tells how new "Freon" solvents by Du Pont minimize cleaning hazards.



Better Things for Better Living  
...through Chemistry

CIRCLE 59 READERS SERVICE CARD



you  
can  
customize  
any  
trio labs  
build-in  
instrument  
as was  
done  
for...



... in the General Electric Line Maintenance Tester for the Flight Control System installed in the Republic F-105 Thunderchief Fighter-Bomber.

Here the trio labs "standard" Model D multi-range AC VTVM was custom-modified to special ranges plus external input jacks and modified mounting.

Trio Labs offers you the industry's pioneer and complete line of miniaturized panel-mounting electronic *build-in* instruments . . . AC and DC VTVMs, null and phase meters, etc. They permit you to . . . customize test systems . . . save space . . . save time and money . . . make monitoring foolproof . . . improve system reliability . . . increase overall design freedom.

Write for free "how to" Engineering Guide to Dept. E-5B



TAC's  
supersonic  
fighter-  
bomber  
— Republic's  
Thunderchief

Trio Laboratories, Inc., Plainview, Long Island, New York

© 1959, TRIO LABORATORIES, INC.



## MEETINGS AHEAD

June 1-3: Microwave Theory and Techniques, National Symposium, PGMTT of IRE, Paine Hall, Harvard Univ., Cambridge, Mass.

June 4-5: Production Techniques, National Conference, PGPT of IRE, Villa Hotel, San Mateo, Calif.

June 7-11: Microwave Tubes, International Congress, Verband Deutscher Elektrotechniker, VDE, Brienner Strasse, Munich, Germany.

June 15-20: Information Processing, International Conf., UNESCO, PGEC of IRE, AIEE, ACM, UNESCO House & Palais de Exhibition, Paris, France.

June 15-20: Electromagnetic Theory Symposium, USSI, PGAP and PGMTT of IRE, Univ. of Toronto, Ontario, Canada.

June 16-18: Circuit & Information Theory, International Symposium, PGCT & PGIT of IRE, Univ. of Calif., Los Angeles.

June 24-26: Nuclear Instrumentation Symposium, ISA, Idaho Falls, Ida.

June 24-27: Medical Electronics, International Conf., UNESCO, CIOMS, PGME of IRE, Rockefeller Inst., UNESCO House, Paris.

June 29-July 1: Military Electronics, National Convention, PGMIL of IRE, Sheraton-Park Hotel, Wash., D. C.

July 1-5: Television Convention, International, British Institution of Radio Engineers, Univ. of Cambridge, England.

Aug. 17: Ultrasonics, National Symposium, PGUE of IRE, Stanford Univ., Stanford, Calif.

Aug. 18-21: Western Electronics Show and Convention, WESCON, Cow Palace, San Francisco.

Aug. 23-Sept. 5: British National Radio & Tv Exhibition, British Radio Industry Council, Earls Court, London.

Sept. 14-16: Quantum Electronics, Resonance Phenomenon, Office of Naval Research, Shawanga Lodge, Bloomingburg, N. Y.

Sept. 15-17: Electronic Exposition, Twin Cities Electronic Wholesalers Assoc., Municipal Auditorium, Minneapolis.

There's more news in ON the MARKET, PLANTS and PEOPLE and other departments beginning on p 114.



Meet Mr. Mu, the man from  
Magnetic metals



*Need tape-wound cores . . . fast?  
We make 'em to order  
and deliver in one week, by George!*

Just send us your specs. Within a week, you'll have matched Centricores measuring up to your toughest physical and electrical demands. If you like, we'll send along complete test data, too.

Centricores are made from thin gauge materials with such singular names as Squaremu "79", Microsil and "49" alloys.\* There's a fine variety of standard sizes, in either metallic or phenolic cases, available for fast delivery.

Our large inventory of cores and raw materials permits us to adapt our shipments readily to *your* precise specifications. Selection and classification of the finest raw materials available . . . high precision winding machines . . . special annealing processes . . . all these factors contribute to the high degree of uniformity of our cores. Tell us what you need.

*\*Other materials include Molybdenum Permalloy, Supermalloy, Orthonic, Sillectron, Deltamax, Hipernik and Hymu.*

**MAGNETIC**  
 **METALS**

transformer laminations • motor laminations • tape-wound cores  
powdered molybdenum permalloy cores • electromagnetic shields

MAGNETIC METALS COMPANY • Hayes Avenue at 21st Street, Camden 1, N. J.



## what's behind the clouds?

BEHIND THE CLOUDS hides a cunning enemy with ever-improving weapons to threaten our security. To deter these airborne aggressors is the job of the all-weather interceptor, our first line of defense.

Partaking in a giant chess game, a Hughes Airborne Systems Engineer is constantly fed intelligence information regarding the most recent enemy advances. He asks the question, "How effective are present interceptors against the new enemy capabilities, and how can we counter this challenge?"

The Hughes Airborne Systems Engineer

is concerned with the design of hardware, but he does not design hardware. He is more interested in the broader systems aspects. Taking an analytical approach, he must solve the interacting problems of performance, reliability, maintainability, and operability.

If this type of systems engineering interests you, investigate the assignments now open in:

SYSTEMS ANALYSIS • SYSTEMS EVALUATION  
SYSTEMS DESIGN • SYSTEMS FLIGHT TEST  
SYSTEMS DESIGN CO-ORDINATION

The salary structure for these positions reflects the advanced nature of the assignments. Please inquire by writing directly to Dr. Allen Puckett, Director, Hughes Systems Development Laboratories.

HUGHES AIRCRAFT COMPANY  
CULVER CITY 23, CALIF.

**HUGHES**

© 1958, HUGHES AIRCRAFT COMPANY

May 29, 1959 — ELECTRONICS



The many advance design features of the Trimpot have proved themselves repeatedly in major aircraft/missile systems and in commercial electronic equipment where reliability, accuracy plus miniature size are of prime importance. Pinpoint settings made on the Trimpot remain stable under the most severe environmental conditions. And—these units save important space—typical size is 1 1/4" x 5/16" x 3/16". Bourns offers the world's largest selection of leadscrew actuated potentiometers...over 500,000 units in distributors' warehouses across the nation to fill your orders. Before specifying, investigate Bourns Trimpot, the original leadscrew actuated potentiometer. Write for our new Model Summary Brochure #4 and list of stocking distributors.

## ONLY BOURNS TRIMPOT® GIVES YOU ALL THESE OUTSTANDING FEATURES

**SPRING** — Carriage spring provides positive no-slip performance during rotation plus a reliable idling feature at mechanical limits of travel.

**LEAD SCREW** — Stainless steel lead screw for low noise, high performance during rotation.

**O-RING** — Silicon rubber O-Ring seals potentiometer against humidity. Prevents flash-over to shaft head for high voltage operation.

**SHAFT HEAD** — Stainless steel with machined slot for screw-driver adjustment. Meets military salt spray requirements.

**WIPER CARRIAGE** — Gold-plated carriage is welded to precious metal wiper for low noise.

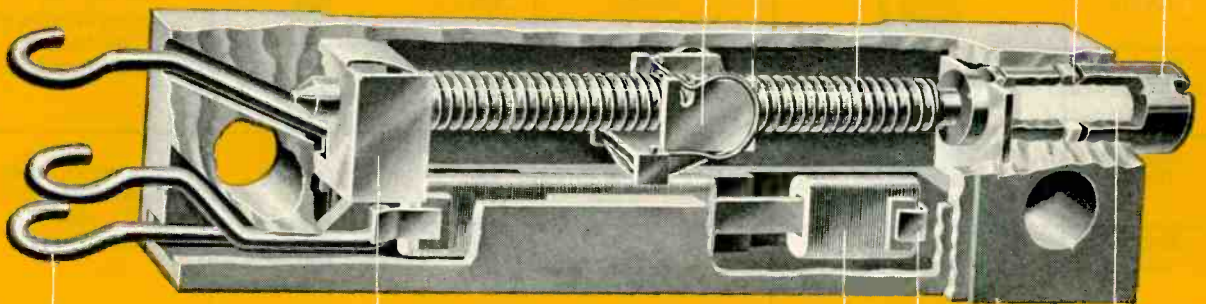

**SOLDER TERMINALS** — Tinned terminals are compact, yet large enough for easy soldering. Teflon-insulated leads and printed circuit pins are also available.

**SILVERWELD\* TERMINATION** — Exclusive with Bourns potentiometers. Unequaled in ruggedness. A metal-to-metal bond from the terminal to the resistance wire.

**PICK-OFF** — Gold-plated beryllium copper pick-off maintains constant pressure on lead screw.

**ELEMENT** — Special ceramic element card for maximum reliability is precision wound with low-temperature-coefficient resistance wire.

**SHAFT RETAINER** — Shaft is locked in place for top performance under extreme shock, vibration and acceleration.

**SHAFT INSULATOR** — High-dielectric-strength, ceramic insulator isolates shaft head from internal circuits.

*This cutaway of Model 224 is typical of the design of all Bourns potentiometers though some features vary from model to model.*



ACTUAL SIZE

Most models available with insulated stranded leads, solder lugs or printed circuit pins in resistances from 10Ω to 1 Meg.

**BOURNS**  
Laboratories, Inc.

P.O. Box 2112A, Riverside, California  
Plants: Riverside, Calif and Ames, Iowa

\* TRADEMARK

Exclusive manufacturers of TRIMPOT®, TRIMIT®. Pioneers in potentiometer transducers for position, pressure and acceleration

the right capacitor for the application...

your job... and **Centralab's**







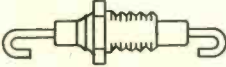
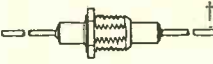

choose from

**TEN TYPES  
of Centralab  
FEED-THRU  
CAPACITORS**

in a wide range of values, voltage ratings,  
tolerances and physical sizes

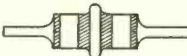
Wherever you need a feed-thru capacitor, you can be sure that CENTRALAB can meet your needs. The table below shows the many varieties that make up the most complete line in the industry—and you get the added benefit of CENTRALAB'S unequalled experience in the design and manufacture of ceramic capacitors. Whether it's for high frequency, filtering, bypass, or coupling, you'll find the unit you need in this group.

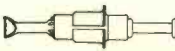
CENTRALAB Engineering Bulletins (FT Group) give you all the details. Write for your copies today.

TYPE	ACTUAL SIZE ILLUSTRATION †	CAP. RANGE mmf	RATING		APPLICATIONS
			VDCW	VDCT	
Bushing type DA-717		10-4000	500	1000	High frequency filtering, bypass, etc. ± 5% tolerance in lower values
Bushing type DA-720		10-5000	500-1500	1000-3000	
Step type DA-728		10-1500	500	1000	Med. freq. use, bypass, TV tuners, etc. ± 10% tolerance below 200 mmf.
Step type DA-729		10-1500	500	1000	
Ring type DA-740*		10-1000	500	900-1300	Symmetrical design. Inserts from either end... ideal for automatic insertion
Ring type DA-741*		10-1000	500	900-1300	
Eyelet type DA-784		25-1000	500	1000	For high frequency filtering and bypass, where size is important
Eyelet type DA-785		25-1000	500	1000	
Eyelet type DA-787		25-1000	500	1000	
Resistor-Capacitor type 732		470 gm. v. .3 to 1.0 meg. only	1000	**	Resistor-Capacitor in parallel. ** 1500 VAC test when immersed in Silicone oil cooled with dry ice.

\*patents pending

†Units marked † are 1/2 actual size

**Centralab**  
D-5913 

A Division of Globe-Union Inc.

914B E. KEEFE AVE. • MILWAUKEE 1, WIS.

In Canada: 669 Bayview Avenue, Toronto 17, Ontario

VARIABLE RESISTORS • ELECTRONIC SWITCHES • PACKAGED ELECTRONIC CIRCUITS • CERAMIC CAPACITORS • ENGINEERED CERAMICS



# DESIGNING FOR RELIABILITY

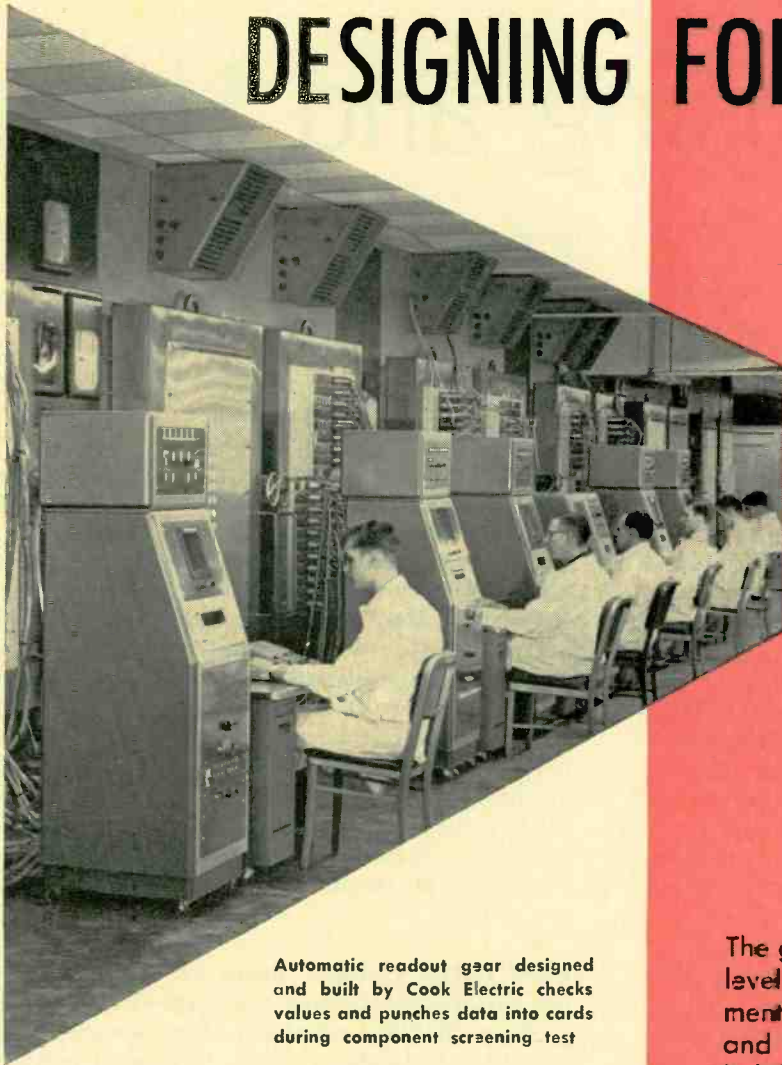

Automatic readout gear designed and built by Cook Electric checks values and punches data into cards during component screening test

RELIABILITY is a measure of the probability that a device will perform its objective adequately for the period of time intended under the operating conditions encountered.

Nothing man-made can be perfectly reliable. Even accepting the limitations of a specific environment and a specified time period, the highly subjective nature of adequacy complicates the meaning of reliability.

When the electronics industry was really the radio industry, reliability was frequently among the last of design considerations. It was subject to tradeoff for increased performance on the one hand or economy in production on the other. Growth in industrial and military electronics has forced a change. It has become painfully apparent that the cut-and-try methods of twenty years ago are no longer appropriate.

Reliability can be achieved only if it is set as a goal at the beginning of the design procedure. Whether the engineer works jointly with a reliability organization which coordinates design efforts at staff level, or is solely responsible for his design, reliability must enter his consideration at the outset.

Its achievement depends on three interlocked factors. First is the choice of components, with an eye to their stability and reproducibility. Second is the application of the component within the circuit. Third is the design of specific circuits and systems.

## Choosing and Using Components

## Tests, Tools and Measures

## Designing Reliable Circuits

## Reliable Systems

By **FRANK LEARY**, Associate Editor

The greatest cause of the present unacceptable level of reliability in military electronic equipment is the lack of maturity of product design, and the failure to evaluate the inherent unreliability of design through realistic engineering tests . . .

Sound engineering during development is the foundation of electronic equipment reliability. If an equipment does not have this foundation it is almost certain to have poor reliability in service, regardless of the quality of electron tubes used or the excellence of the production process . . .

J. M. BRIDGES, Director of Electronics  
Office of Assistant Defense Secretary

### THE COVER

The cover illustration of this issue of *Electronics* shows an automatic test set designed by Raytheon engineers to test semiconductor products at the firm's Needham Heights, Mass., division. Equipment segregates transistors according to various combinations of test parameters, including emitter and collector current cutoff, frequency cutoff, a-c beta, d-c beta, breakdown voltages, input voltage, collector capacitance, extrinsic base resistance, gain.

Operator puts the transistor in a socket and pushes a button; test set makes a series of go-no-go tests and lights a classifying light.

# Choosing and Using

DURING RECENT YEARS there has been a marked tendency toward increased complexity of design. This comes as a natural result of striving for high performance under forced draft; time does not always allow for finding the elegant or simple solution to a problem.

Complexity means more parts. The probability that a device will function adequately falls off more and more sharply as the number of parts increases, as Fig. 1 illustrates.

Catastrophic failures render a component suddenly and unpredictably useless, as when a tube loses vacuum or develops an open heater, or a resistor burns out, or a connection breaks. These can be due to a basic fault in the component, or to misapplication.

Deterioration or degradation of component performance is an immutable fact of design life. Cathodes gradually lose their strength or develop interfaces, connectors fatigue, resistors drift. Environmental effects can increase or decrease the rate at which the usefulness of the component decays.

Intermittent operation is usually due to some mechanical fault either in the part itself or in its connection into the circuit.

**FAILURE PATTERNS**—For simple parts with homogeneous deterioration characteristics—like resistors and capacitors—the failure rate is an increasing function of age and the frequency of failure assumes a normal or Gaussian distribution.

More complex parts and systems possess several

deterioration mechanisms operating at different rates. In this case a constant failure rate is not unusual, and an exponential decrease in failure frequency results.

**INITIAL VALUES**—The initial tolerances in quality of a purchased component are usually specified by the manufacturer. Most components which are mass-produced under reasonably strict controls have a normal or Gaussian distribution of qualities, approximately symmetrical about the mean value of the controlled quality and asymptotic at the base.

Figure 2 shows distribution curves for two lots of resistors. Both are skewed versions of the idealized Gaussian bell-curve. The stated tolerance of most parts is roughly equivalent to the spread of the curve almost to its two tails.

Besides the initial variations in quality characteristics, many components exhibit a random short-term fluctuation in key values. This random fluctuation in characteristics is usually a smaller percentage than the manufactured tolerance, and is largely caused by environmental factors such as temperature, humidity and altitude.

**ELECTRON TUBES**—There are several different life patterns for electron tubes, shown in Fig. 3.

High-reliability tubes are often assembled in air-conditioned, lint-free rooms; carbonized particles of foreign matter have proved to be the cause of many intermittent failures in tubes. High-performance

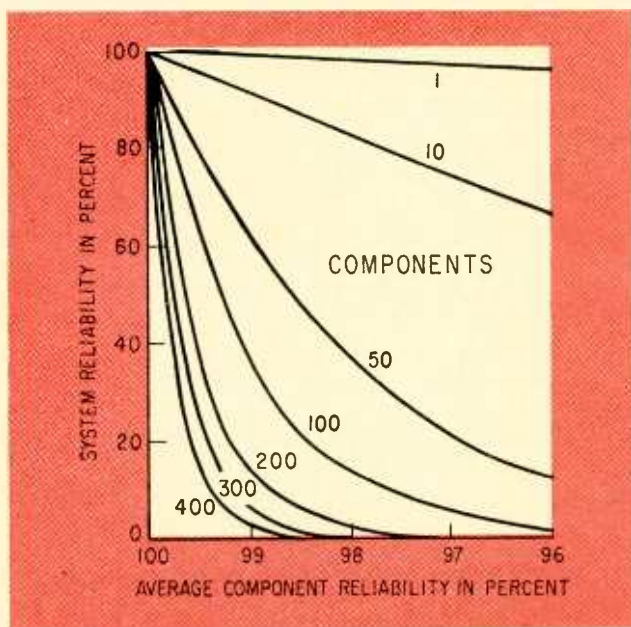

FIG. 1—Increasing the number of components in a system causes reliability to drop sharply

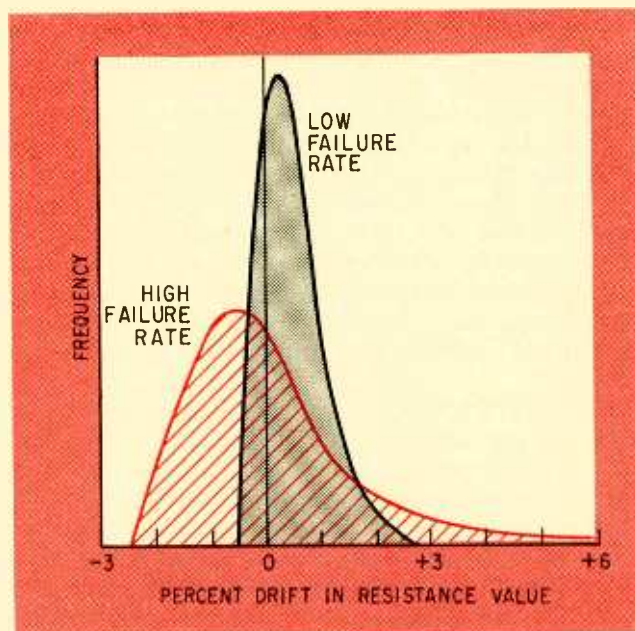

FIG. 2—Resistors with high failure rate demonstrate wider drift in resistance value than those with lower failure rate



# Components

tubes may not be as reliable as less sophisticated types. It has been said that requirements for high transconductance and high reliability are frequently mutually exclusive.

Rugged grid structures with interelectrode spacing of upwards of 0.005 in. can minimize shorts and permit rougher treatment.

Heater voltages should be regulated within 2 percent or less, since tube life varies inversely as the seventh power of heater voltage.

Bulb temperatures in excess of 100 C can cause electrolysis of glass between base pins and the release of gas from the envelope material.

For best tube life, the ratings given by the manufacturer for plate current and plate dissipation should be decreased.

**TRANSISTORS**—Transistors sometimes exhibit a high infant mortality. This is due generally to contamination in manufacture and after fabrication. After its final etch, the device must be handled under clean conditions and in a well-controlled humidity. A hermetic seal is desirable for long life.

Power dissipation in transistors depends on good thermal design. Temperature at the collector junction of a germanium transistor cannot ordinarily exceed about 85 C, and provision for conducting heat away to an external heat sink is a must. Abnormally high temperatures cause transistors to deteriorate rapidly. Silicon transistors are often used in designs where high temperatures are unavoidable.

Aging in transistors can bring about increase in collector leakage current, decrease in current gain, and a drop in breakdown voltage.

Accelerated life tests of transistors at increased temperatures are of doubtful value in predicting actual life data, since the higher temperatures may cause additional failure mechanisms to be brought into play.

**DIODES**—Semiconductor diodes are used by the millions in today's electronic equipment. Extreme care in selecting units to fulfill requirements of circuit and environment is required.

High reverse voltages cause the back resistance to drop off and the diode may cease to rectify. Reverse breakdown voltage must be well above the highest back voltage applied in the circuit. A factor of 2 is not too generous for safety.

Forward and reverse recovery characteristics are of special importance in pulse circuits. Recovery time is frequently a substantial fraction of a microsecond, and in some junction diodes recovery of back resistance may take hundreds of microseconds.

Moisture and other contaminants can change the back resistance of a diode during life. A sealed hous-

Table 1—Marginal Tests Useful in Design

Component	Marginal Test	What it Does
Tubes	Vary supply voltage	Simulates age
	Drop heater voltage	Simulates partially depleted cathode
Pentodes	Reduce screen potential	Simulates drop in emission; equivalent to reducing available zero-bias plate current
	Increase screen potential	Raises required cutoff voltage; checks adequacy of design bias
Triodes	Reduce plate supply	Simulates aging
Diodes	Shunt resistor	Simulates low back resistance
	Series resistor	Simulates high forward resistance
Resistors	Vary voltage	Simulates change in resistance
Resistors, Capacitors and Inductors	Replace with parts of different value	Simulates variations in value

ing provides excellent protection from ambient humidity. Derating of back resistance specifications by a factor of 5 provides a reasonable assurance of reliable operation to end of life.

Use of diodes in series to increase rated back voltage or in parallel to increase current-handling ability is not always wise. The diode with the highest back resistance in a series connection will develop the largest fraction of the voltage, and its longevity may be reduced. The diode with the lowest forward resistance in the parallel connection will similarly carry the greatest part of the current.

**CONNECTORS**—Connectors are one source of intermittent circuit faults. Inadequate contact pressure permits accumulation of oxides or other insulating films on the contact surface. Spring contacts formed from flat metal stampings may tend to resume the flat shape after a number of flexings; the contact opens, reducing contact pressure.

Spring contacts should be relatively long to avoid concentrating stress, and should be made of a stress-resistant metal. Brass is adequate for most purposes. Beryllium copper is indicated if the contact is to be more frequently stressed than usual.

Long contact surfaces permit the mating members to wipe each other clean as the contact is made, breaking down insulating films.

Plating should be nontarnishing. Silver is excellent wherever its tendency to migrate in humid ambients does not interfere with circuit operation. Gold is a perfect plating material, but its cost is frequently prohibitive. Rhodium is likewise quite costly, and the techniques of rhodium plating are not as highly developed as those for the noble metals. Cadmium is satisfactory for many purposes.

Insertion forces should be kept low to minimize

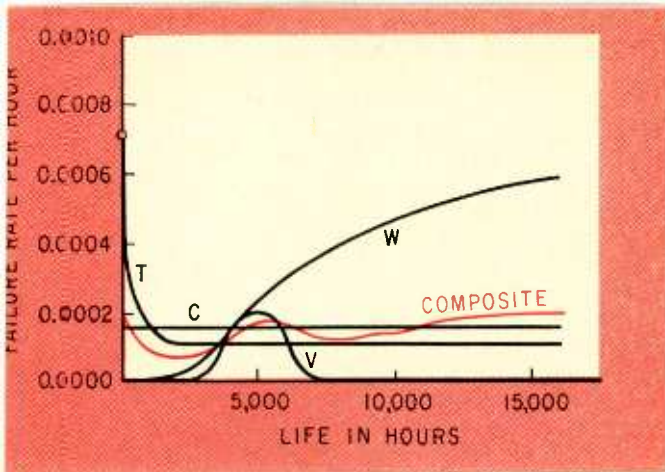

FIG. 3—Failure patterns in tubes: curve C is constant wearout rate; curve T shows infant mortality; curve W shows single late-developing wearout mechanism; curve V is adolescent mortality caused by latent defect. Actual cases usually correspond to composite curve

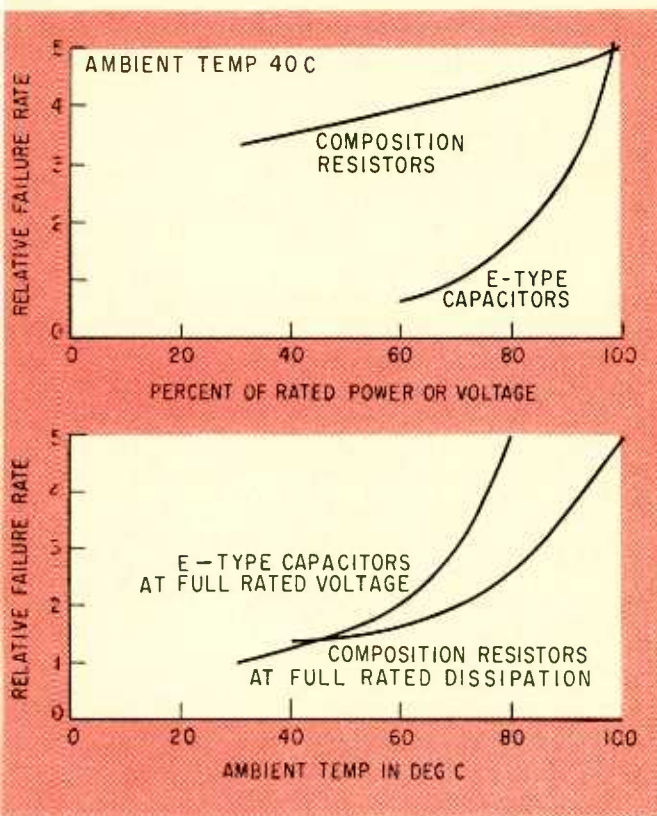

FIG. 4—Failure rates of composition resistors and E-type capacitors. Working too close to specified ratings drives up the rate of failure (top); so does increasing temperature

the possibility of damaging parts of connectors.

**RELAYS**—Relay operation can cause transients in the power supply if large currents are applied or interrupted by the relay. If operation at minimum current is not possible, decoupling networks and filters may be necessary.

Natural organic insulators—paper, cotton and so forth—can contribute to corrosion of windings in the presence of both moisture and large d-c potentials. Many synthetic materials are relatively free from this effect.

Hermetic seals are valuable for applications in high altitudes, or moist or salty environments, or where tampering may occur.

The time delay between application of coil current and the closing of contacts will increase with the life of the relay as spring members fatigue. If close timing is important, such things as external circuits, copper slugs in the relay core, and air dashpots can be used to control the delay.

**RESISTORS**—Resistors will enjoy much longer life if they are derated from manufacturer's power and voltage specifications.

A 5-percent composition carbon resistor may drift within 20-percent tolerance during the first years of its life. It is wise to derate power figures by 50 percent and guard carefully against overheating, as Fig. 4 illustrates.

A film resistor of 1-percent initial tolerance will, over a long useful life, exhibit an excursion close to  $\pm 5$  percent. Deposited carbon film types should be used at 50 percent of rated power dissipation, and it is desirable that they be hermetically sealed. Metal and glass film types need not be derated as much as 50 percent.

A precision wire-wound 1-percent resistor will stay within  $\pm 5$  percent for a long useful life if derated by 50 percent of manufacturer's specification and not subjected to extremes of temperature. Such resistors are highly reactive, however, and of limited use in high-speed or pulse circuits.

Wire-wound power bleeders should not be used at more than 50 percent of rating. Mounting brackets should conduct heat to chassis or panel for dissipation.

**CAPACITORS**—Capacitors, like resistors, are dependable if carefully specified and conservatively used. Figure 4 illustrates the sharp rise in failures caused either by working too close to ratings or operating in high temperatures.

Value of paper capacitors frequently varies as much as 12 percent during life. Applied voltage should not exceed 50 percent of the manufacturer's rating; if operating temperatures above 50 C are to be experienced, a further derating is necessary.

Design tolerance for nonsilvered mica capacitors can be taken as  $\pm 10$  percent beyond the manufacturer's tolerance; for silvered electrodes, only 5-percent added tolerance is sufficient. Silvered electrodes are subject to migration of the silver across insulating boundaries under the influence of moisture and d-c potentials.

Design tolerance for small value ceramic capacitors should be considered as  $\pm 10$  percent of the manufacturer's rating. Units with greater than 0.001 micromicrofarads capacitance are generally made with a ceramic of high dielectric constant which is less stable.

So-called telephone-quality electrolytic capacitors are intended to give up to 10 years of useful life. Voltage ratings should usually be reduced by at least 10 percent. Surge voltages expected should never exceed the manufacturer's rating for working voltage. Electrolytics must be reformed after any prolonged period of disuse; the unit should be connected for an hour in series with a 1,000-ohm resistor to a source capable of developing the rated voltage across the capacitor.



# Tests, Tools and Measures

**PREDICTION** of reliability by calculations from the reliability indexes of components is a necessary part of the design process. But reliability must ultimately be measured.

**EARLY TESTS**—During the design phase, tests for performance and life of components are undertaken.

Where two or more experimental units or configurations are available, the use of Latin squares (see Fig. 5) to interchange components between the two assemblies isolates those components or characteristics which exert the greatest influence on predictability of performance.

Marginal tests in the breadboard stage are also useful in locating trouble spots and pinpointing where more engineering effort is needed. Some fruitful tests of this type are given in Table I on p 67.

**ENVIRONMENTAL TESTS**—Environmental tests early in the game are useful in supporting the first predictions of reliability, and allow the engineer to analyze variations between prediction and performance.

Nondestructive tests in adverse conditions of heat, humidity, vibration and shock show up instabilities and weak links in design which might lead to catastrophic or degradation failure in field use. Destructive tests demonstrate the existence or adequacy of safety margins.

Heat is perhaps the most serious environmental problem for electronic gear. Active and passive parts alike exhibit rapid deterioration in the presence of abnormal heat levels. A 30 C drop in internal temperatures in one system, for example, reduced tube failures 3 to 1, and increased the mean time between

failures by 53 percent. A blower unit added in another case almost doubled the mean time between failures, from over 700 to over 1,400 hours.

Heat-dissipating tube shields can extend tube life from 4 to 20 times. The requirements for heat transfer—firm-fitting wrappers or shields, or subminiature tubes sunk into metal blocks which act as heat sinks—are fortunately coincident with requirements for isolation from shock and vibration.

Vibration is an important enemy of reliable operation. In tests on subsystems in a tactical air-to-air missile, 96 percent of vibration failures were caused by tubes and broken wires.

Also at early stages in design, a fruitful test procedure is the introduction of nondestructive malfunctions. This establishes the adequacy of safety margins, shows whether the circuit can accommodate shifts in operating or signal levels or circuit parameters.

**PRODUCTION STAGE**—As a unit moves from development into production, testing continues. Early production units should be culled out and the components interchanged by Latin squares. Units close to each other on the line and others distant from each other should be compared.

Random-balance polyvariable analysis is a powerful tool if 20 or more units are available for test.

Any unit returned from field use with a history of intermittent operation should be completely checked. All available records of the unit's operation, and the corresponding operating history of units near it in production, should be checked.

**SCREENING**—Screening tests are used whenever 100-percent inspection is required to establish a high order of reliability. Screening tests identify and segregate parts that exhibit marginal or abnormal performance under field service conditions. Tests may be electrical, mechanical or environmental, must be nondestructive, must neither degrade performance of acceptable parts nor affect life expectancy, nor physically alter the part.

Humidity, temperature and power-cycling tests are common. Other screening tests check exact values of key parameters.

This type of test can be quite costly, and many firms use outside testing laboratories to perform them. One major testing lab concludes, after screening a quarter of a million parts, that from 0.1 to 10 percent of any lot will be rejected for anomalous behavior.

ENVIRONMENT	GROUP			
	A	B	C	D
TEMPERATURE	1	2	3	4
HUMIDITY	2	3	4	1
VIBRATION	3	4	1	2
SHOCK	4	1	2	3

FIG. 5—Latin square used for setting up experiment to determine the effects of various environmental parameters

# Designing Reliable

**PRINCIPAL CHALLENGE** for the circuit designer is to make reliable and stable circuits with components that are subject to deterioration, catastrophic failure, intermittent faults and occasional maladjustments.

He must allow for realistic variations in component values, especially where mass production is the end in view. He should be especially cautious not to trim too closely to specifications: as Fig. 6 demonstrates, a small mistake on the slope of a bell curve can have a marked effect on failure rate.

Safety margins are an increasingly more evident concern to the engineer. Designers of mechanical systems on which lives depend habitually allow safety factors of 4 or more. In some cases, they allow a factor of ignorance—where the exact nature of the stress is unknown—of 2 or so, sometimes even of 10. Today one finds the electronics engineer borrowing this same habit.

By selecting components with long life spans the circuit designer can make his equipment operate in the early tail of the bell-shaped parts-failure distributions. His equipment will then obey the pattern shown in Fig. 7, with a long level stretch of relatively low failure.

Maintenance must be relied on to prevent the exponential curve from assuming a skewed Gaussian shape when the majority of the parts approach wear-out.

**EXAMPLE OF A RELIABLE SYSTEM**—A computer designed for reliability uses 10,000 transistors, 30,000 semiconductor diodes and 35,000 resistors.

Circuit parameters were figured out by another computer. A close working relationship was set up between design, manufacturing, reliability and quality-control groups. Reliability was the first consideration of all.

The mean time between failures established itself within the first months of operation at about 200 hours, a five-to-tenfold improvement over earlier systems of equivalent complexity.

Components were chosen for maximum stability. Performance of individual parts was traded off for reliability, and total number of parts was increased to arrive at performance requirements. Some 75 percent of the circuitry was made up of one standard circuit, of which over 3,000 were used, some as amplifiers and inverters, some interconnected to form trigger pairs.

The circuit as designed could endure substantial

Derating of manufacturer's specifications should be a matter of course. Derating usually brings a substantial improvement in circuit reliability.

To predict the failure rate for a circuit, multiply the statistically derived failure rate for each component by the population of that component in the circuit; then multiply these totals to derive the grand total failure rate. The reciprocal of this figure is the mean time between failures.

**DESIGN CRITERIA**—One of the first circuit design criteria is that a circuit should meet its performance specifications with all components at their worst initial tolerances, and with any component at its worst end-of-life tolerance.

End-of-life tolerances are always wider than initial or installed tolerances. The specified tolerance of a resistor may be  $\pm 5$  percent; its installed tolerance may drift a percentage point or two above this, but its end-of-life tolerance is likely to be near  $\pm 15$  percent.

When a circuit configuration performs properly with its component values drifted as described, the designer can add other forms of assurance. One key criterion of safe and reliable design is that loss of voltage in the circuit or in any circuit connected to it should not cause component damage. Where possible, it should also not run free. This is a special

excursions of component value without malfunction. After beta gain on both the two transistors in the basic circuit drops to  $\frac{2}{3}$  of the specified value and diode reverse currents increase from 50 to 400 microamperes, and all the resistors drift 10 percent in the worst direction, the circuit can endure a 10-percent variation in supply voltage without failure.

Assembly is a clean-room operation. Circuits are mounted two in a can, sealed and pressurized. Completed units are given temperature shock and tested. Final bakeout under high vacuum eliminates moisture inside the package. Contacts are gold-plated. Poor solder seals are caught with a helium-leak detector.

Humidity sensing elements are mounted inside the circuit can. A panel connector permits a check of humidity.

One of the engineers on the project summed up in one word the reason for the success of the venture: "Attitude."



# Circuits

problem in regenerative circuits. The equipment should be made to fail safe.

Circuit designs should include some means for detecting changes in parameters during use, similar to the marginal techniques mentioned earlier, as an aid to preventive maintenance. Proper selection of marginal situations permits the circuit to give advance warning of a threatening malfunction, so that replacement or repair can be undertaken during preventive maintenance periods or at other normal inoperative times.

**KEY CIRCUITS**—like a missile command-destroy system, or a computer's control circuits—should have a test or check provision to give the operator confidence in its correct operation.

Interactions between components are sometimes beneficial; the wise designer will exploit them. A resistor in the emitter circuit of a transistor can improve its stability; a resistor shunted across a series of diodes can even out the differences between the diodes. In both cases, not only are life and stability improved, but also interchangeability is made more feasible.

**TRADEOFFS**—Economic considerations enter into the design process at this and later stages of design, as illustrated in Fig. 8. Quantitative specification of reliability early in the design stage permits intelligent tradeoffs between performance, reliability and cost.

The cost of unreliability and risk of failure is traded off against design and development expense, and against the cost of manufacture where more reliable design will bring steeper manufacturing costs. The cost of field maintenance, and consideration of who is to perform the maintenance—how highly trained, and by whom?—are traded off against development and manufacturing costs.

**OTHER CONCEPTS**—One other concept is that of operational effectiveness, the product of performance and reliability, in those cases where a natural superiority in performance can make up for residual unreliability. This is particularly useful in the design of weapons systems.

Another is system availability:

$$A = m / (m + d)$$

where  $m$  is the mean time between failures and  $d$  is equal to down time. This concept is useful in cases where a circuit or system can lose part but not all of its capability, as when one of several independent channels in a communications system goes out, or when a computer loses the use of one or more of perhaps a dozen tape units.

In some such circumstances, failure frequency is less meaningful than failure duration or failure severity.

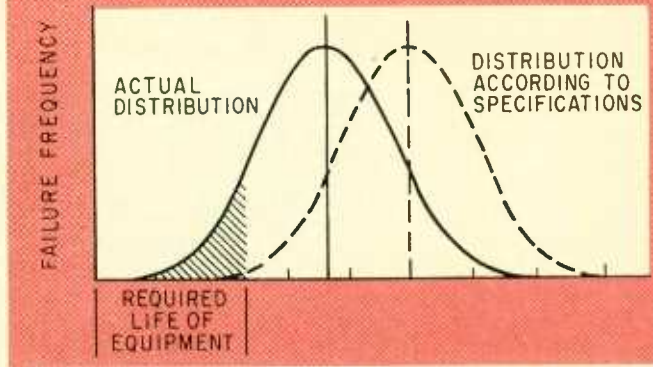

FIG. 6—Small disagreement between specified life characteristics of components, and actual characteristics, can make a big difference in failure rate (shaded area)

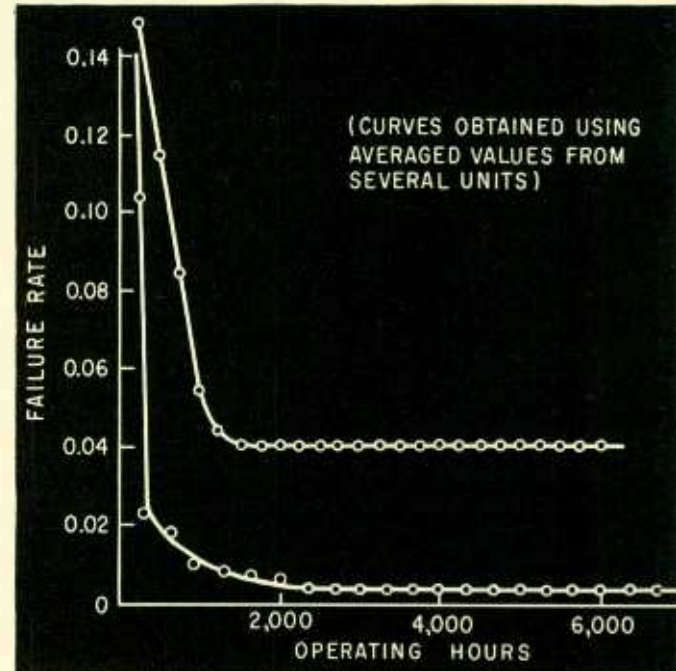

FIG. 7—Actual failure-rate curves for two complex electronic subsystems illustrate exponential behavior. Steep initial slope is usual during debugging period. Well designed gear has long flat section

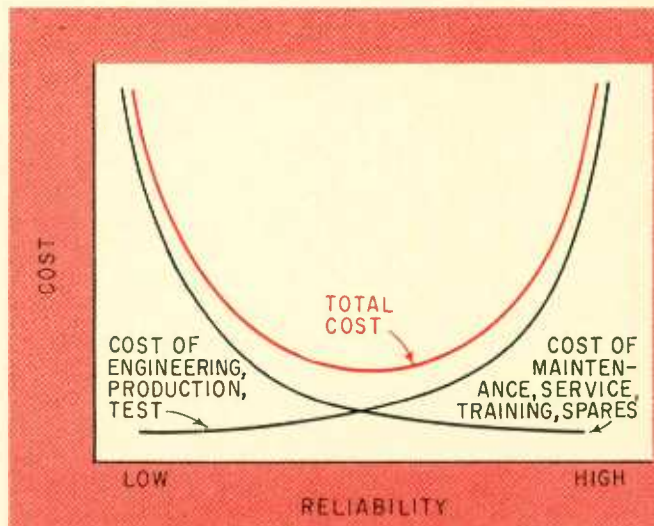
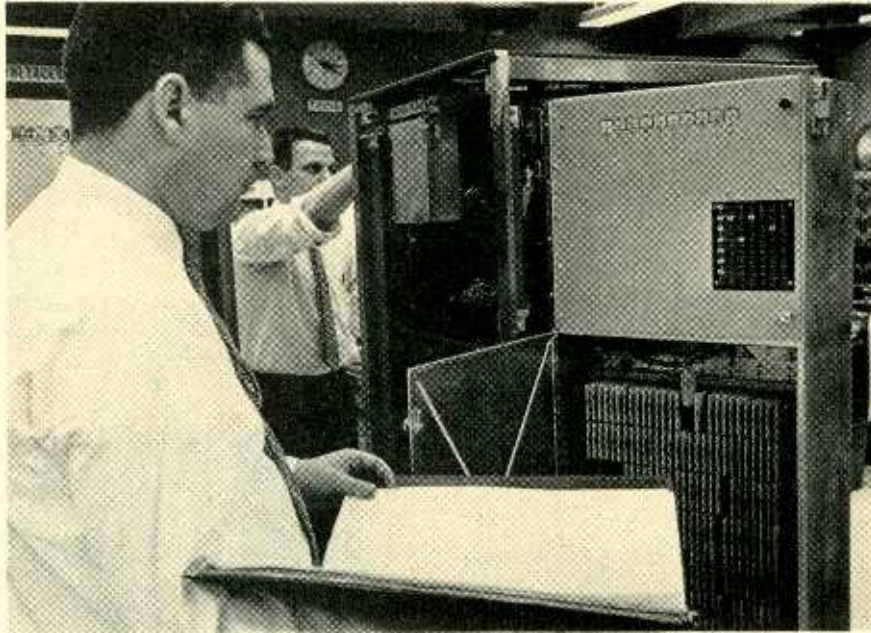

FIG. 8—Effect of reliability on cost. Minimum dip on the cost curve is frequently associated with a reliability index near 0.95



Trouble panel on face of IBM's 729 tape unit shows maintenance man sources of trouble, helps him diagnose faults

# Reliable Systems

RELIABILITY of an electronic system is affected by the way it is operated, the ease with which it can be maintained and serviced.

System design frequently makes up for shortcomings that can not be designed out of a circuit. Environmental sensing elements inside a chassis, for example, can bring to the operator's panel warning of dangerous conditions inside. Checking circuits in information-handling systems inspect the parity or consistency of the code not only to catch errors, but also, with proper code, to correct them.

Operator's adjustments and controls should be human-engineered to simplify operation and minimize maladjustments. Ideally, no adjustment performed by an operator should be capable of causing catastrophic malfunction in the equipment.

Modular design and construction, with replaceable subassemblies, have an advantage in speeding maintenance and service. Coupled with automatic fault-detection and locating circuits, they can reduce down time to a negligible fraction of equipment life.

Microcircuitry, molecular electronics, solid circuits formed *en bloc* by deposition of active material layers, all hold promise of great inherent reliability.

**REDUNDANCY**—Redundancy in design is one way of making the system compensate for circuit shortcomings. Many computer and control systems make wide use of redundancy; so does nature.

Redundant design necessarily uses more parts, and these may increase unreliability if not carefully chosen. All too frequently the recognition of failure

in a circuit and the calling in of its duplicate call for high-performance controls which may be more prone to failure than that which they control.

Nature's design of living organisms is the method employed in the completely duplicated FSQ-7 computer for the Sage system. Several subsystems share the work, or perform it jointly and redundantly. When one subsystem fails, it can retire temporarily from operation while the others, working harder for the time, carry on with the load. When the ailing subsystem is repaired, it goes back to work and the load is redistributed.

If a certain value of resistance is critical in a circuit, it can be attained with four resistors in series-parallel, each the same value as the required resistance. If one opens, the whole resistance will double; if one shorts, the whole resistance will be approximately halved. A circuit designed to operate at partial effectiveness with halved or doubled resistance would continue to work with the one part catastrophically failed.

Reliability in a duplicate system improves logarithmically: twice as much hardware means a tenfold improvement in reliability. However, where a system handles information in coded form, attention to the design of the code and its logic can open the way to equivalent improvements in reliability without the cost of duplication.

Engineering estimates indicate that a ten-fold increase in reliability can be achieved by logical checks with only a third to half the increase in circuitry, perhaps with as little as a quarter.



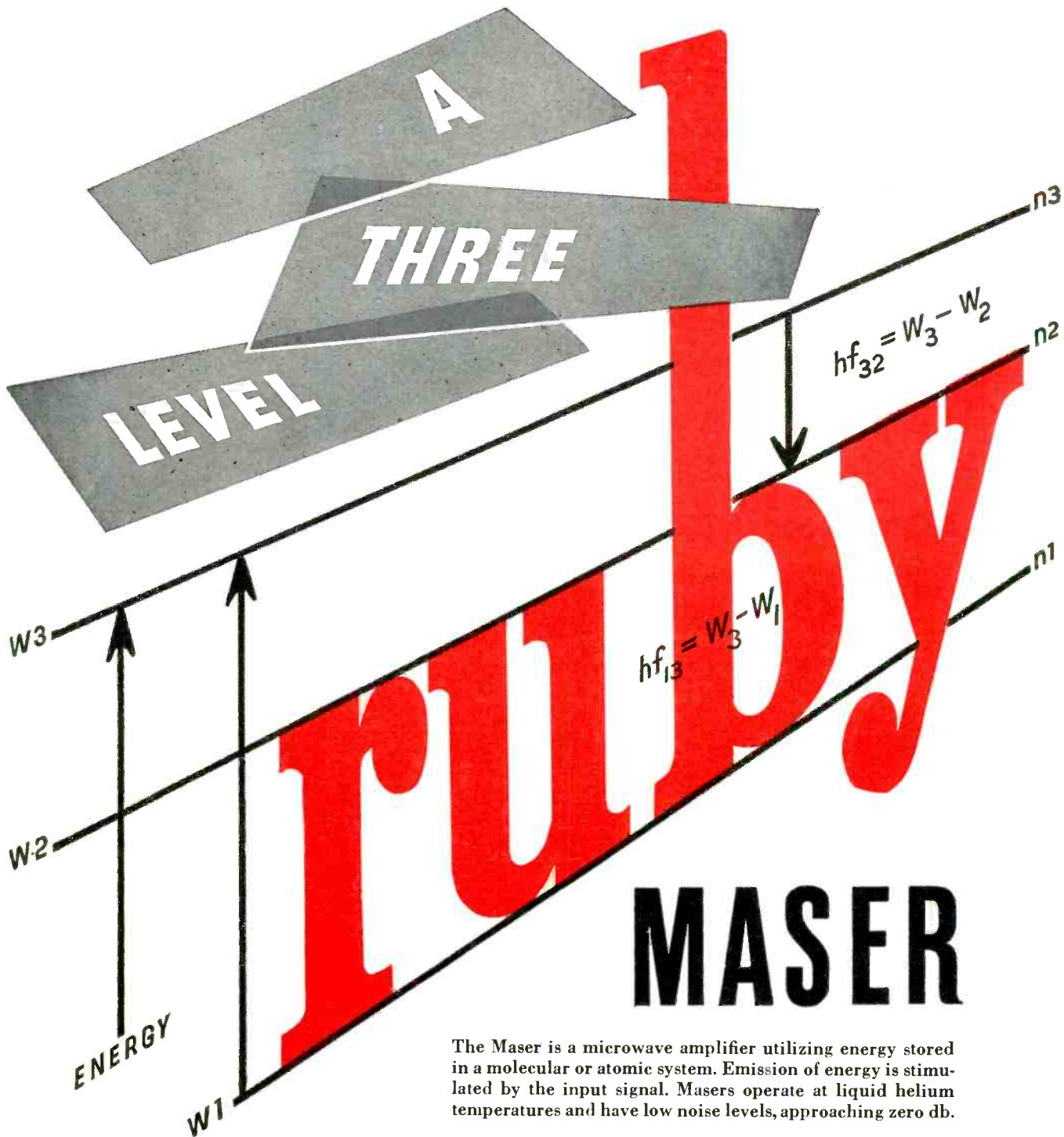

The Maser is a microwave amplifier utilizing energy stored in a molecular or atomic system. Emission of energy is stimulated by the input signal. Masers operate at liquid helium temperatures and have low noise levels, approaching zero db.

Recently, a university research laboratory† used LINDE single crystal synthetic ruby ( $Al_2O_3$  with  $Cr_2O_3$  additive) in a three-level solid state Maser. The ruby crystal was placed in the Maser's tuned cavity and a magnetic field of 4200 gauss was applied. To bring electrons from a ground state into a permissible higher energy level, a pumping frequency of 24 kMc was used and the Maser amplified signals at 9.3 kMc.

LINDE supplies other crystals, including rutile, spinel, and sapphire. ( $Al_2O_3$ ). Sapphire is used in infrared optical sys-

tems, windows for higher power microwave tubes, spacers and supports in vacuum tubes, radiation pipes. It has strength at elevated temperatures, melts at  $2040^\circ C.$ , is hard, inert, non-porous, and can be sealed to metals and glasses. Sapphire is available in the shape of domes, windows to  $4\frac{1}{2}$  inches in diameter, rods and special configurations.

For more information, write Crystal Products Department, LINDE COMPANY, Division of Union Carbide Corporation, 30 East 42nd Street, New York 17, N. Y.

†Maser Action in Ruby, by G. Makhov, C. Kikuchi, J. Lambe, and R. W. Terhune. "Physical Review," Vol. 109, No. 4, p. 1399, Feb. 15, 1958.

"Linde" and "Union Carbide" are registered trade-marks of Union Carbide Corporation.

*Linde*  
TRADE-MARK



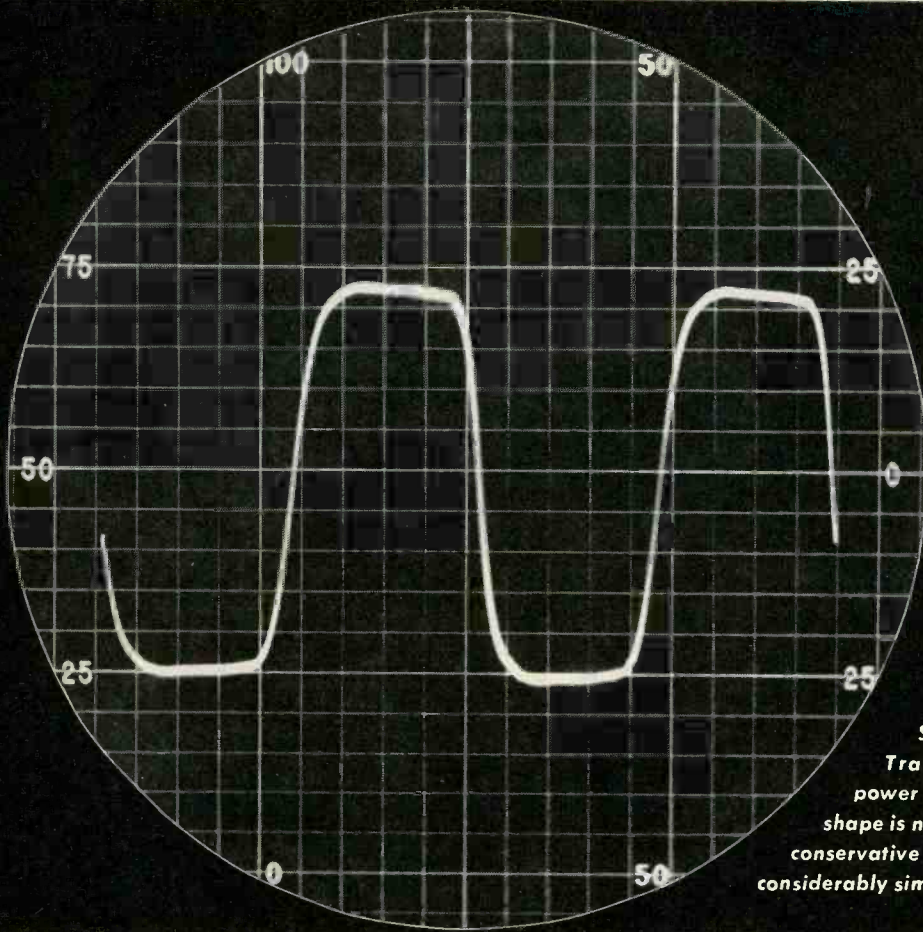

Oscillogram shows ac output of special Sola Constant Voltage Transformer which feeds power supply's rectifier. Wave shape is nearly square, permitting conservative loading of rectifier — considerably simplifying ripple filtering.

## Square-wave output of special transformer gives high efficiency in Sola's regulated dc power supply

Sola engineers (men with a keen eye for a trim wave shape) designed a special constant voltage transformer having nearly a square-wave output. Then they linked the transformer with two other components to produce a regulated dc power supply which has notable efficiency.

They fed the regulated output of this transformer into a semiconductor rectifier . . . the low-peak characteristic of the square wave results in a conservative loading on the economical rectifier assembly. It can deliver considerable amounts of current as long as you don't over-voltage it—and over-volting just doesn't happen when the input to the rectifier is Sola-regulated to within  $\pm 1\%$ .

The rectified voltage feeds into the third component in this happy combination—the high-capacitance filter. The capacitor's filtering job is made easier because the rectified square wave contains a comparatively small

amount of ripple. Final dc output from the filter has less than 1% rms ripple . . . for many applications there is no need for a voltage-dropping, efficiency-cutting choke coil.

The Sola Constant Voltage DC Power Supply has output in the ampere range, regulates within  $\pm 1\%$  even under  $\pm 10\%$  line voltage variations, and is suitable for intermittent, variable, and pulse loads. It has low output impedance, is very compact, and provides about all you could ask for in maintenance-free dependability.

Hundreds of ratings of these dc power supplies have been designed and produced to meet widely varying electrical and mechanical requirements of equipment manufacturers. In addition, there are six stock variable-output models and six stock fixed-output models with ratings from 24 volts at six amps to 250 volts at one amp.

For complete data write for Bulletin 7E-DC

Sola Electric Co., 4633 W. 16th St., Chicago 50, Ill., Blshop 2-1414 • Offices in principal cities • In Canada, Sola Electric (Canada) Ltd., 24 Canmotor Ave., Toronto 18, Ont.

# SOLA

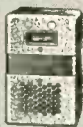

CONSTANT VOLTAGE TRANSFORMERS



REGULATED DC POWER SUPPLIES



MERCURY LAMP TRANSFORMERS



FLUORESCENT LAMP BALLASTS

A DIVISION OF BASIC PRODUCTS CORPORATION



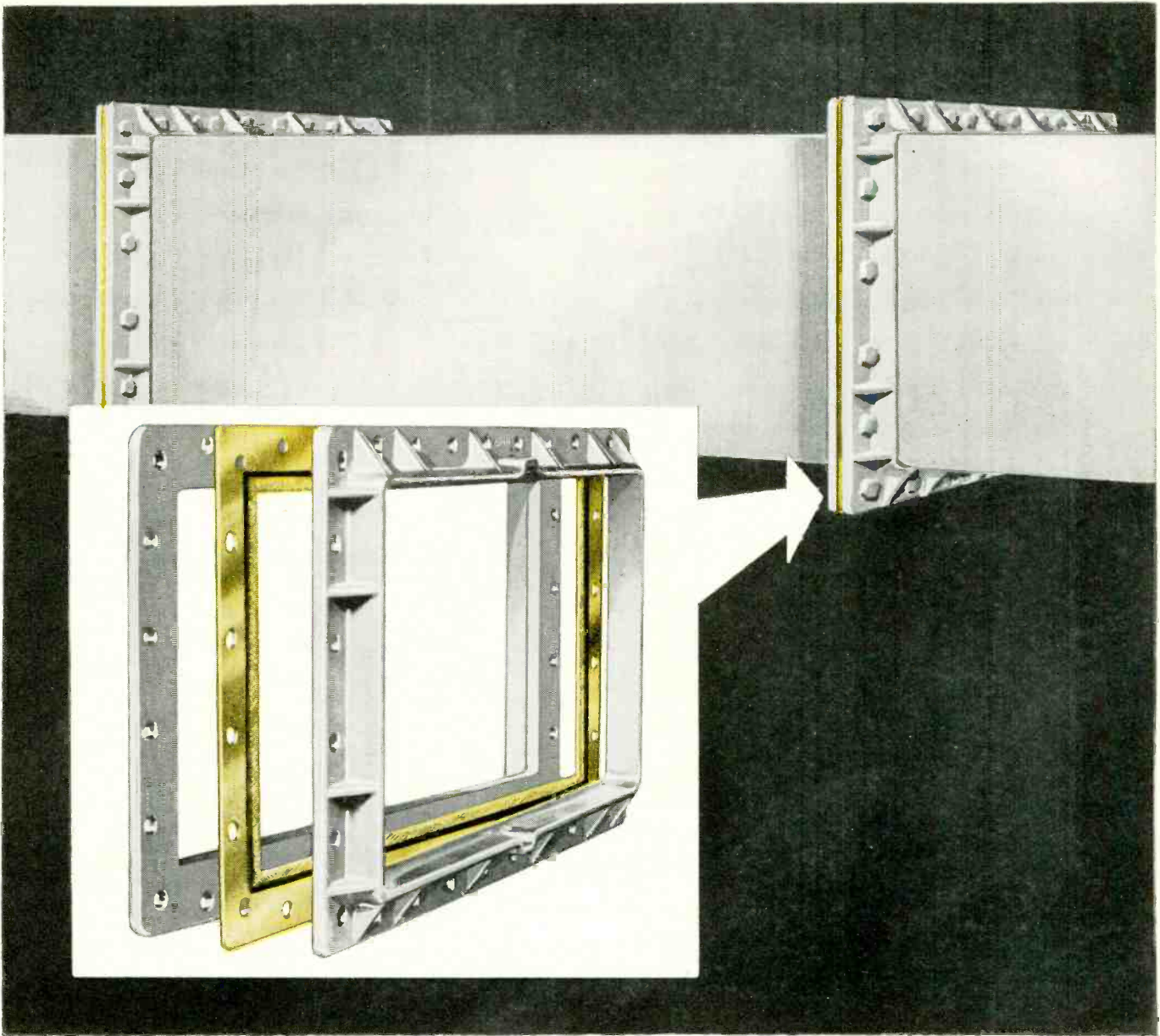

## THESE WR WAVE GUIDE SEALS PROVIDE POSITIVE SEALING; PREVENT R/F LEAKAGE, ARCING & BURNING

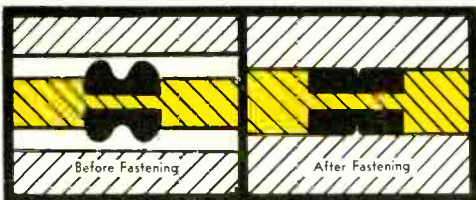

Electr-O-Seals are now available to fit all EIA (RETMA) standard WR series wave guide flanges, WR90 thru WR2300 as well as specials.

These seals not only provide near perfect sealing and complete electrical continuity, but offer many economical advantages — made by the makers of Parker O-rings, Stat-O-Seal®, and Gask-O-Seal®.

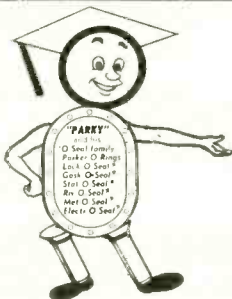

# Parker SEAL COMPANY

CULVER CITY, CALIFORNIA and CLEVELAND, OHIO

A DIVISION OF PARKER-HANNIFIN CORPORATION

# Simpson's New VOM

featuring . . .

1½% Accuracy

Excellent Repeatability

Predictable Accuracy  
over wide temperature range

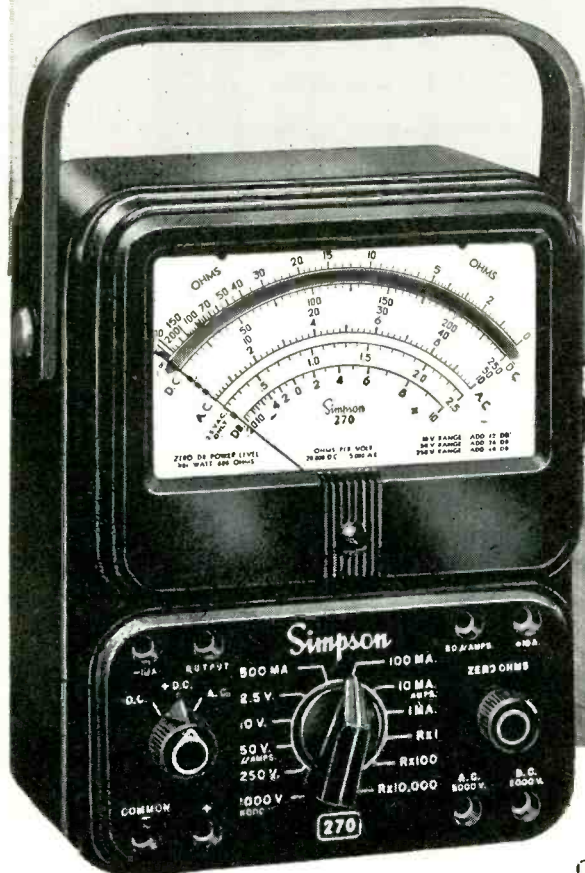

Photo courtesy of Admiral Corp. Engineer shown is using the Model 270 in evaluating operating characteristics of developmental type deflection tube.

## Model 270

AC-DC VOLT-OHM-MILLIAMMETER

- MIRROR SCALE
- ½% RESISTORS
- GOLD BONDED DIODES
- FAMOUS "STAY ACCURATE" MOVEMENT
- POLARITY SWITCH

# Simpson

## ELECTRIC COMPANY

5203 W. Kinzie St., Chicago 44, Illinois

Phone: EStebrook 9-1121

In Canada: Bach-Simpson Ltd.

London, Ontario

Do you need to check day-to-day variations in circuit operation? Or know what accuracy you're getting at different temperatures? If so, you especially will appreciate the capabilities of this new volt-ohm-milliammeter. For example, any particular voltage value will give identical readings today, next week, next month at an accuracy you can pinpoint from 67° to 87° F. The 270 is an engineer's VOM. Its base accuracy of 1½% DC (77°F, at full scale) covers a wide range of critical checks. It is portable, self-powered, built to have the rugged dependability typical of all Simpson VOMs. Accessories include carrying case and a variety of probes. Look it over at your Electronic Parts Distributor soon.

**DC Voltage** (20,000 ohms-per-volt):  
0-250 mv; 0-2.5 v; 0-10 v; 0-50 v;  
0-250 v; 0-1000 v; 0-5000 v. (Accu-  
racy, 1½%)

**AC Voltage** (5000 ohms-per-volt):  
0-2.5 v; 0-10 v; 0-50 v; 0-250 v;  
0-1000 v; 0-5000 v. (Accuracy, 2%)

**AF Output Voltage** (With .1 micro-  
farad internal series capacitor):  
0-2.5 v; 0-10 v; 0-50 v; 0-250 v.

**Volume Level in Decibels** (Zero DB  
equal to 1 milliwatt across a 600-ohm

line): -20 to +10 DB; -8 to +22 DB;  
+6 to +36 DB; +20 to +50 DB.

**DC Resistance:** 0-2000 ohms (12 ohms  
center); 0-200,000 ohms (1200 ohms  
center); 0-20 megohms (120,000  
ohms center).

**Direct Current:** 0-50 mu a; 0-1 ma;  
0-10 ma; 0-100 ma; 0-500 ma; 0-10  
amp.

**Model 270**, complete with test leads  
and Operator's Manual . . . . . **\$59.95**

WORLD'S LARGEST MANUFACTURER OF ELECTRONIC TEST EQUIPMENT



# MERCK HAS ALL FOUR FORMS OF Silicon IN PRODUCTION QUANTITIES

**MERCK DOPED SINGLE CRYSTAL SILICON**—offers doped float zone single crystals of high quality at low costs. Yields of usable material are reported to be especially high when device diffusion technics are used with these crystals. Float zone single crystals doped either "p" or "n" type with resistivities from 3 to 300 ohm cm. any range plus or minus 25% and a minimum lifetime of 100 microseconds are available in diameters of 18 to 20 mm., and random lengths of 2 to 10 inches.

*NOTE: Doped single crystals in other diameters, resistivities, or lifetimes not listed above can be furnished as specials.*

**MERCK HIGH RESISTIVITY "P" TYPE SINGLE CRYSTAL SILICON**—offers float zone single crystals of a quality unobtainable by other methods. Available with minimum resistivity of 1000 ohm cm. "p" type and a minimum lifetime of 200 microseconds, diameter 18 to 20 mm., random lengths 2 to 10 inches.

**MERCK POLYCRYSTALLINE BILLETS**—have not previously been melted in quartz, so that no contamination from this source is possible. Merck guarantees that single crystals drawn from these billets will yield resistivities over 50 ohm cm. for "n" type material and over 100 ohm cm. for "p" type material. Merck silicon billets give clean melts with no dross or oxides.

**MERCK POLYCRYSTALLINE RODS**—are ready for zone melting as received . . . are ideal for users with float zone melting equipment. Merck polycrystalline rods are available in lengths of 8½ to 10½ inches and in diameters of 18 to 20 mm. Smaller diameters can be furnished on special order. In float zone refining one can obtain from this material single crystals with a minimum resistivity of 1000 ohm cm. "p" type with minimum lifetime of 200 microseconds or the material can be doped by user to his specifications.



For additional information on specific applications and processes, write Merck & Co., Inc., Electronic Chemicals Division, Department E-4, Rahway, New Jersey.

© Merck & Co., Inc.

ULTRA-PURE **Silicon** —a product of **MERCK**

**BASE BORON CONTENT BELOW ONE ATOM OF BORON PER SIX BILLION SILICON ATOMS**

# Nickelonic News

DEVELOPMENTS IN NICKEL AND NICKEL ALLOYS AND THEIR APPLICATIONS



## Underseas two years: Atlantic phone cable amplifier tubes retain full emission, promise 20 years continuous service

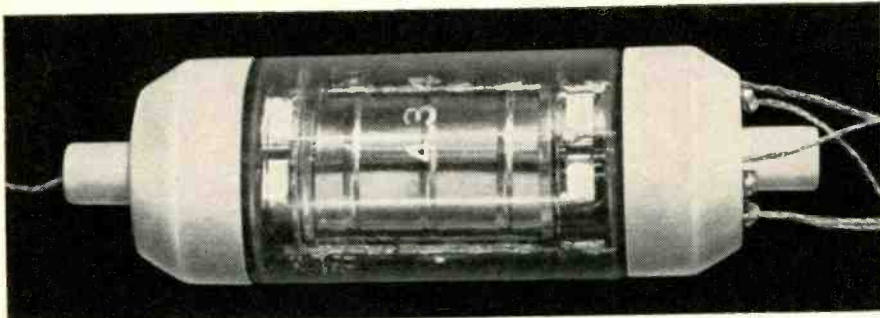

175HQ amplifier tube used in underseas phone cable repeaters. There are 306 tubes in the Atlantic cable. All rely on parts made of Nickel.

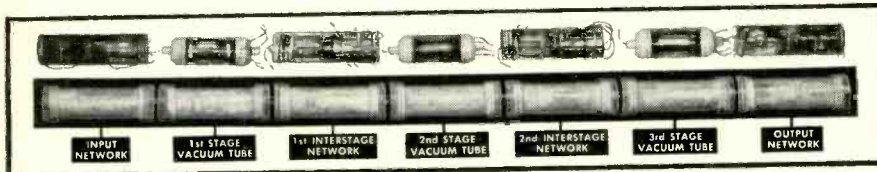

Nickel parts are essential in the 175HQ tubes, shown in this portion of phone cable repeater unit. Tubes designed and built at Bell Telephone Laboratories, Inc.

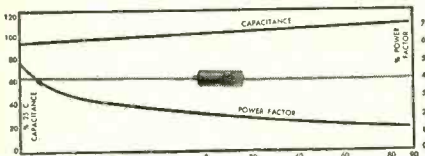

New G-E Solid Tantalum Capacitors. Electronic grade "A" Nickel lead wires help make it rugged.

### Small, rugged electrolytic capacitor... Nickel leads boost its strength

HUDSON FALLS, N. Y.: The new Solid Tantalum® capacitor is designed for low voltage circuits — its capacitance changes not more than 20% from +85°C down to -80°C. General Electric designers gave it unusual resistance to mechanical shock with Electronic grade "A" Nickel lead wires. They chose Nickel for three good reasons: (1) welds easily — high thermal coefficient of electrical resistivity aids

\*Trademark. The International Nickel Co. Inc.

quick, strong spot welding. (2) solders easily — speeds hermetic sealing, and assembly into circuits. (3) meets stringent mechanical specifications — leads (0.0201" diameter) withstand 30 second pull test of 3 pounds, four 90° alternate bends.

**Pertinent literature:** Inco Technical Bulletin T-15. (Circle R. S. # 107).

© General Electric Co.

### Non-magnetic Monel "403" alloy aids precise tuning by klystron bellows

SAN BRUNO, CAL.: The low permeability of Monel "403" non-magnetic nickel-copper alloy (1.1 max. at 27°F) in the tuning bellows of this new Eimac X-639 Klystron permits precise frequency adjustment without disturbing the tube's magnetic circuit. And... the good forming and brazing characteristics of Monel "403" alloy make for easy bellows manufacture.

Inco Nickel for the cathode assures stable emission characteristics. Electronic grade "A" Nickel for the focus electrode is readily formed, does not contaminate vacuum. Monel nickel-copper alloy for the neck provides strength at elevated temperatures... withstands oxidation and corrosion.

**Pertinent literature:** Inco Technical Bulletin T-5. (Circle R. S. # 109).

Nickel and Monel alloys aid manufacture, operation of this Eimac X-639 Klystron by Eitel-McCullough, Inc. Delivers 50 watts in 7100-8500 mc range.

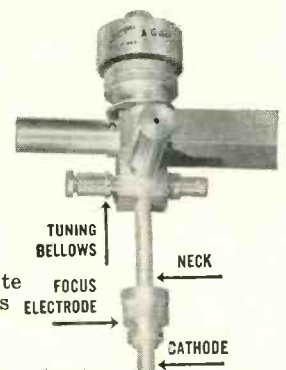

THE INTERNATIONAL NICKEL COMPANY, INC. • 67 Wall Street • New York 5, N. Y.







## recti/riter® systems offer you the widest recording ranges available

Versatile "recti/riter" recorders, both Single and Dual channel, have established new standards for *reading ease, full-scale accuracy, and up-front operator conveniences*. Now, the applicability of the "recti/riter," or other graphic recorders of one-milliampere sensitivity, is extended to the widest practical limits by the use of Series 300 accessories, which presently include models:

301 DC AMPLIFIER	353 LINE VOLTAGE MONITOR
350 MULTI-VOLTAGE MONITOR	354 LINE CURRENT MONITOR
351 AC MULTI-CURRENT MONITOR	333 LINE SERVICE MONITOR
352 LINE FREQUENCY MONITOR	(a single-package combination of 352, 353, and 354)

Only the "recti/riter" systems, recorders and matching accessories, offer these wide ranges for recording electrical parameters:

10 millivolts to 1000 volts . . .  
500 microamperes to 1000 amperes . . .  
Monitor standard frequencies—40, 60, 400 cps.

**FULL SCALE RANGES**—Accessory scales give quantities per division equal to decimal multiples or sub-multiples of 1, 2, and 5 in keeping with standard 50-division chart of recorders.

**ACCURACY**—Combined recorder-accessory response departs from true value at any point not more than 2 per cent of the full scale value.

**POWER REQUIREMENTS**—No auxiliary power required for transducer accessories . . . a 45-volt battery or optional AC supply is used with the DC Amplifier.

**SIZE**—Aluminum cases 2½" H., 7½" W., 10" D. (Monitors may be mounted inside as integral part of recorders.) Mountings are available for relay racks, flush mounting, portable, or desk use.

To select the "recti/riter" recorder-accessory system that meets your exact measurement requirements, let TI give you complete technical assistance . . . write or call today!



**TEXAS INSTRUMENTS**  
INCORPORATED

INDUSTRIAL INSTRUMENTATION DIVISION

3609 BUFFALO SPEEDWAY • HOUSTON, TEXAS • CABLE: TEXINS

#### OTHER TI/IID PRODUCTS

- Complete Geophysical Instrumentation
- DATA-MAC Measurement and Control Systems
- Automatic Test Equipment

# JOURNAL OF APPLIED CONTROL DEVICES THAT NEVER WEAR OUT

For Control Engineers Who Are Wearing Out Before Their Time

TYPICAL SIGNAL FROM ONE OR ALL OF THESE

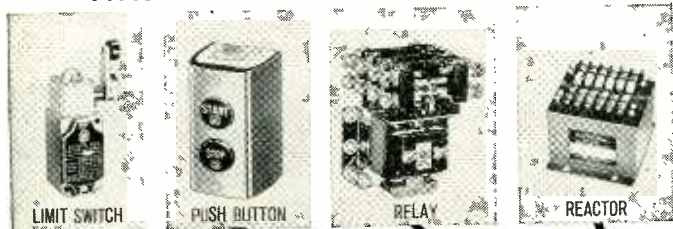

**STATIC CONTROL  
COMPLICATED?**

**DON'T YOU BELIEVE IT!**

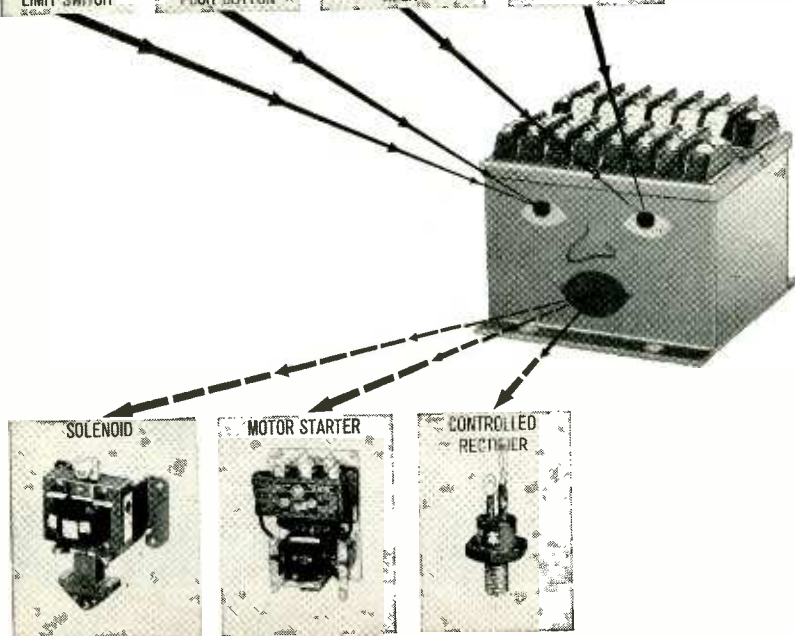

CONTROLS ANY ONE OF THESE

An engineering friend of ours working on blast furnace controls uses a CONTROL switching reactor to take signals from a series of limit switches, temperature controllers, and relays to operate the solenoid which triggers the air blast motor. Dollars ahead he was when he saw this *selective* device would take signals from many sources, compile them, remember them, and when told to act (by the same standard input signals), leap into action. "So simple," he said—"nothing but the standard inputs we always use, switching reactor and outputs. If that's static control, I'm the new president of the C.S.R\* Booster Club." *You, too, can beat the drum. Write for our catalog about Simple Static Control.*

\*CONTROL Switching Reactor

## **PUSH, PULL, CLICK, CLICK** (or how to feed a switching reactor)

Persons who hear push-pull-click-click sounds in industrial plants are not to be suspected of an affinity for the razor business. They are listening to the music of push buttons, limit switches and relays, all feeding signals into CONTROL'S switching reactors (which are engaged in static control). Our reactor is *selective*. As you dictate, it responds to control voltages which add,

which oppose, or which work in combination, regardless of source. What's more, our reactor can be fed by a transducer whose output is electrical—even if it doesn't say "push, pull" or "click, click."

*If you have an affinity for money-making musical sounds, perhaps you'd like to know more about these CONTROL switching reactors. Write us.*

## **CLICK, CLICK, PULL, PUSH** (or how a switching reactor feeds you)

Here is the click-click-pull-push (output) side of the CONTROL switching reactor. Not only is it *selective* as to source and combinations of inputs, but it is a real bear for working such loads as solenoids, motor contactors and magnetic clutches. It shines, too, as a practical way of operating the new solid state thyatron from a variety of input sources. A reactor can control a single load up to 300-VA to a fare-thee-well. Loads are statically

switched with nary a moving part. What's more, there is no auxiliary hardware (transformers, relays or single purpose logic units) to clutter the minds and hearts of your control engineers and purchasing agents.

*Sizes? A complete range, including 15, 75, 150, and 300 VA. There's also one especially for the solid state thyatron. Why not write for more details about our CONTROL switching reactors.*

Reliability begins with

# CONTROL

A DIVISION OF MAGNETICS, INC.

DEPT. E-62, BUTLER, PENNSYLVANIA



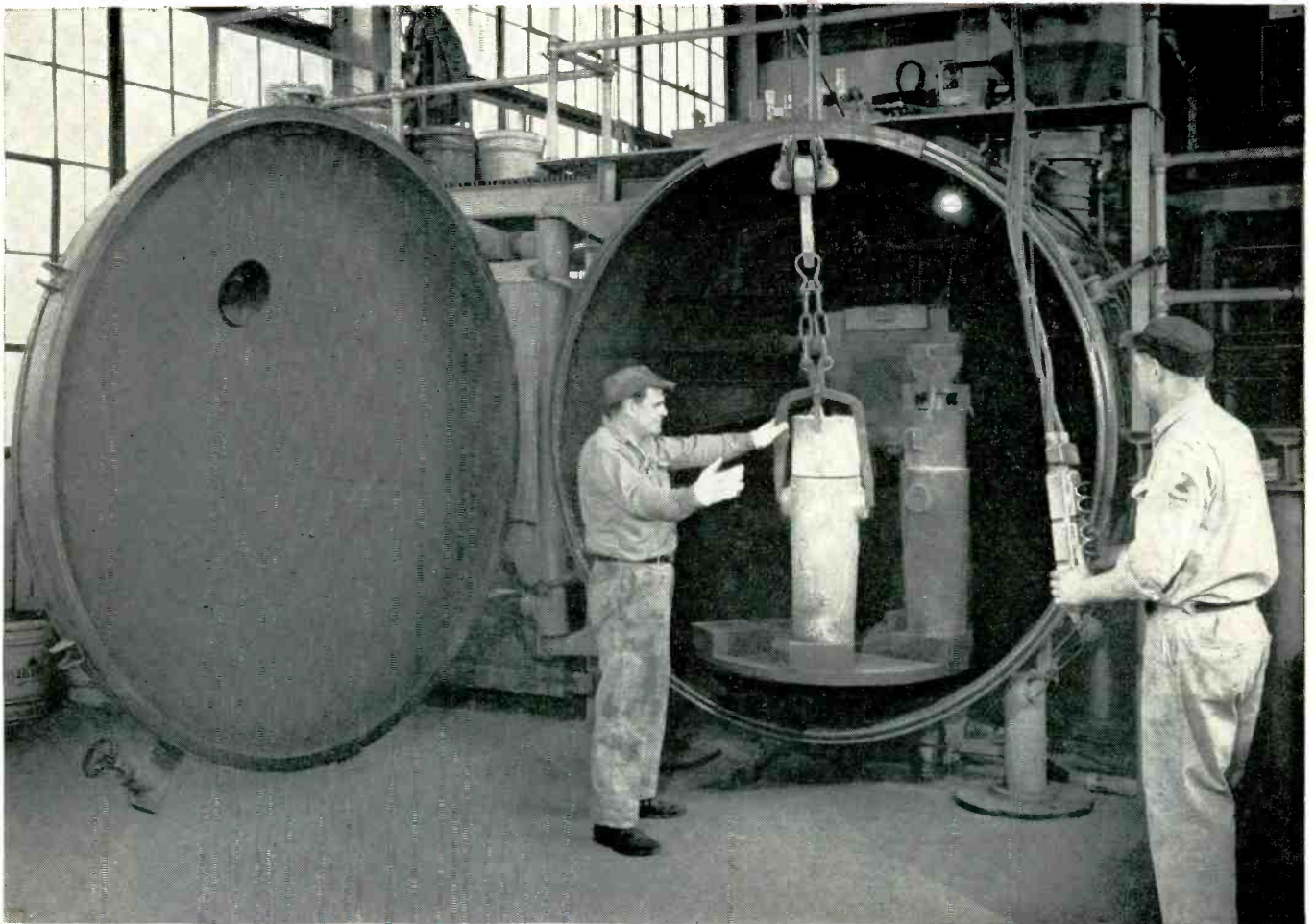

# NOW EXCLUSIVELY VACUUM MELTED KARMA High Resistance Alloy THERLO Glass Sealing Alloy

This dramatic "first" in the manufacture of nickel alloys by Driver-Harris has been achieved by expanded vacuum melting capacity. It is still another example of our continued leadership in producing electrical and electronic nickel alloys of the highest purity.

D-H vacuum melting produces alloys of higher ductility and tensile properties. These are achieved by greatly reducing inclusions, especially oxides and nitrides. Other direct bene-

fits are elimination of gas, not only from the surface but from the entire mass, and general improvement in the electrical, electronic and mechanical properties to meet critical specifications.

For additional information about Karma, Therlo and the other 130 high-nickel alloys manufactured by Driver-Harris, write for a copy of the D-H Alloy Manual.

\*T.M. Reg. U.S. Pat. Off.



### VACUUM MELTED KARMA\* High Resistance Wire

The temperature coefficient of superior KARMA resistance wire has been improved to less than  $\pm 10$  parts per million from  $-60^{\circ}\text{C.}$  to  $+125^{\circ}\text{C.}$  Higher stability and linearity are added to these important properties.

- Low thermal EMF against copper (equaled only by Manganin)
- Improved ductility
- High resistance to oxidation
- Wire sizes down to .0005"
- 800 ohms per circular mil foot



### VACUUM MELTED THERLO\* Glass Sealing Alloy

Improved workability is the major result of vacuum melting THERLO... the long established cobalt, nickel, iron alloy for sealing to hard or thermal shock resistant glass.

THERLO also:

- Produces a permanent vacuum-tight seal with simple oxidation procedure
- Resists mercury
- Is readily machined and formed—deep drawn or spun
- Can be welded, soldered, brazed
- Is available as rod, wire, strip, sheet foil—and in special shapes

## DRIVER-HARRIS\* COMPANY

HARRISON, NEW JERSEY • BRANCHES: Chicago, Detroit, Cleveland, Louisville

Distributor: ANGUS-CAMPBELL, INC., Los Angeles, San Francisco • In Canada: The B. GREENING WIRE COMPANY, Ltd., Hamilton, Ontario

MAKERS OF THE MOST COMPLETE LINE OF ALLCYS FOR THE ELECTRICAL, ELECTRONIC, AND HEAT-TREATING INDUSTRIES



These features of  
**new Brush**  
**ultralinear**  
**recording**  
**systems...**



**... give you more application versatility!**

Simplified Chart Re-loading.

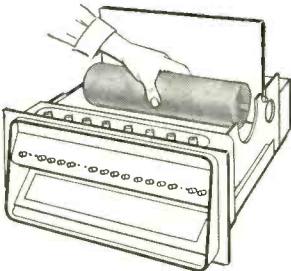

Interchangeable, plug-in signal conditioners.

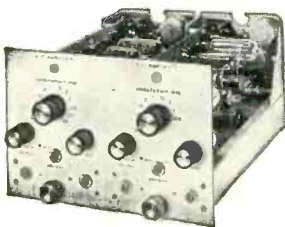

Positive Chart Take-up Drive.

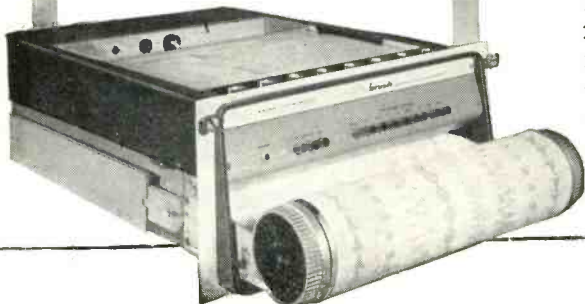

In the fields of telemetry, ground support systems, analog computing and laboratory testing, Brush recording systems have incorporated features which have consistently kept ahead of engineering requirements. Here are a few that show why—

**INTERCHANGEABLE PLUG-IN SIGNAL CONDITIONERS.** You get your choice of sensitivities—you get high input impedance—zero suppression.

**SIMPLIFIED FAST CHART RE-LOADING.** Loaded from the top—features automatic alignment and tracking.

**ACCURATE, EASILY REPRODUCIBLE RECORDINGS.** Your choice of rectilinear or curvilinear charts—rugged “throw-proof” pens.

Illustrated above is a Brush RD-1684 rectilinear, 8 channel recording system. Sensitivity of 10 millivolts per chart line—input impedance, 10 megs balanced or 5 megs grounded. Complete system includes mobile cabinet, oscillograph and 8 signal conditioners. No additional preamplifiers required. Available from stock.

**brush INSTRUMENTS**

DIVISION OF

37th & PERKINS



CLEVELAND 14, OHIO



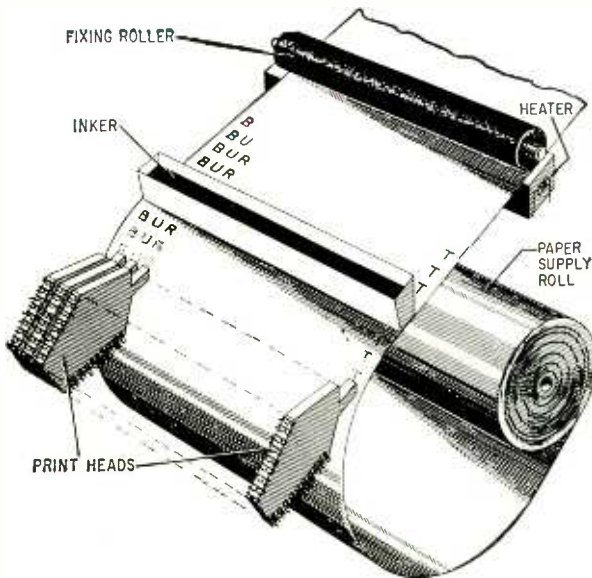

FIG. 1—Each of 72 print heads carries matrix of 35 pins. Energized pins form charge pattern of character on paper

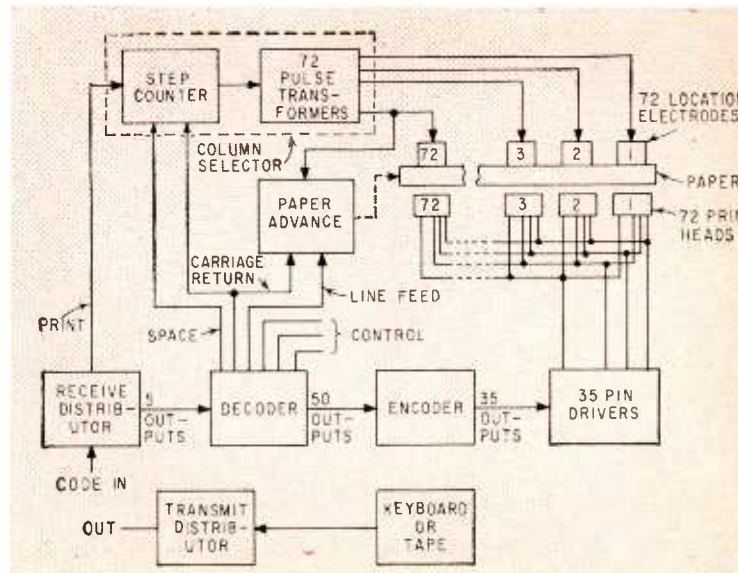

FIG. 2—Column selector sequentially pulses location electrodes to print characters one at a time

# High-Speed Readout for Data Processing

Input tape pulses teletypewriter print heads which charge surface of paper. Powdered ink adheres to paper, forming 3,000 words/min

By **RALPH E. WEST**, Research Center, Burroughs Corp., Paoli, Pennsylvania

EXISTING COMMUNICATIONS SYSTEMS have not been able to use the full capabilities of normal telephone circuits because of the inherent speed limitations of mechanical printers. The high-speed electrostatic teletypewriter to be described can print more than 3,000 words/minute when driven by a parallel input or 750 words/minute when receiving a Baudot teletype code.

**ELECTROSTATIC RECORDING**—In the first recording step, an electrical charge pattern of the desired character configuration is formed by pulsing appropriate print pins that are within the print heads illustrated in Fig. 1. The negative voltage applied to

a pin causes a spot of excess charge to be deposited on the surface of the paper without physically touching the paper. This charge disposition is made in less than a  $\mu$ sec.

The charged patterns are then made visible by bringing the paper in contact with a dry inking powder which clings to the charged areas by electrostatic attraction.

A heater permanently fixes the ink by softening a thermoplastic coating on the paper while a roller presses the powder into the coating.

**OVERALL OPERATION** — The teletypewriter, shown in block form in Fig. 2, can be used to trans-

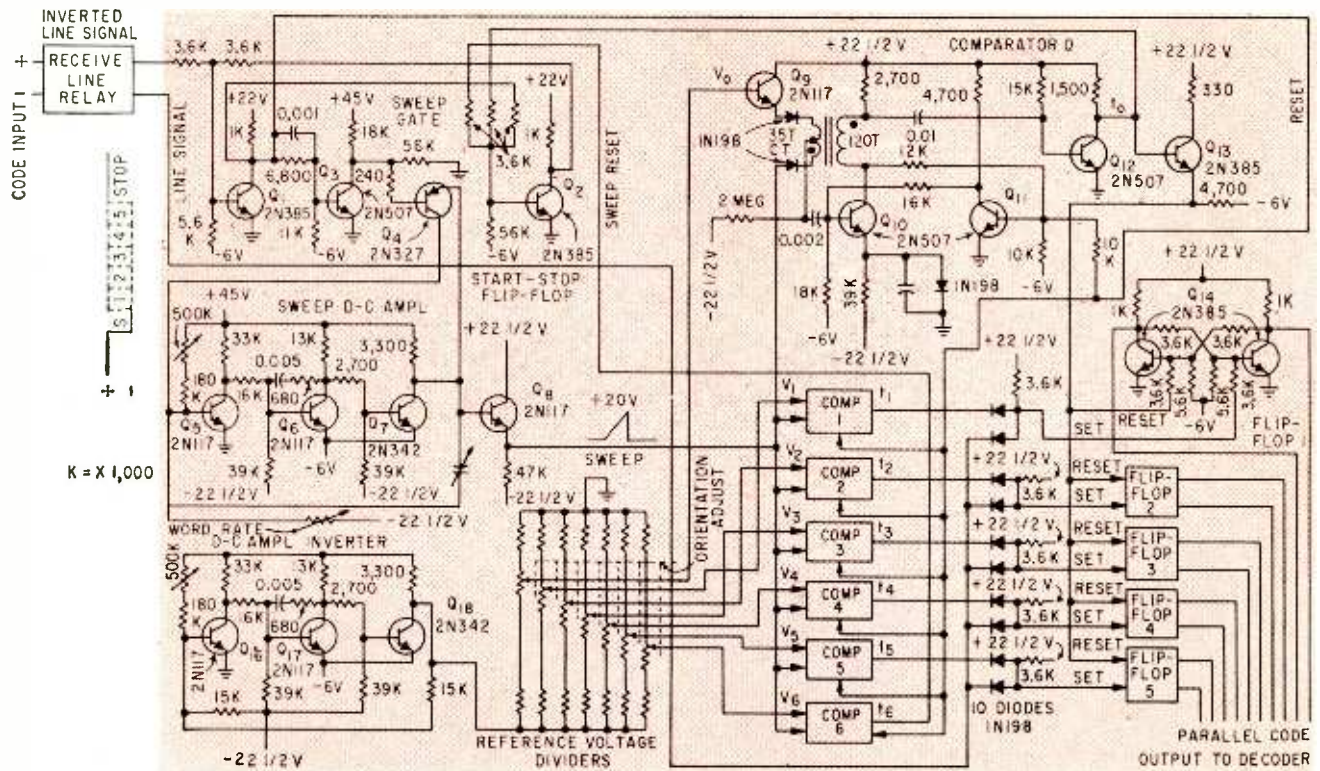

FIG. 3—Receive distributor converts tape-code input to five-bit parallel code at flip-flops. Rising sweep voltage successively triggers the comparators. If line signal is positive at triggering time, flip-flop corresponding to triggered comparator is set to its one state

mit as well as to receive messages. In the receiving operation, five information bits contained in the serial teletype code are converted to a five-bit parallel code by the receive distributor. These five bits plus a sixth figures-letters bit are decoded into one of 50 voltages that represent characters (letters, numerals, punctuation) or to one of six voltages that represent control functions.

A decoded-character voltage drives the encoder, which selects the print-pin drivers. These drivers pulse their print pins, which form the character configuration. There are 35 print pins in each of the 72 print heads that compose a line of type. By pulsing one of the 72 location electrodes beneath the paper, the charge pattern formed by the selected print pins appears only at the space below one print head. Location pulses come from the column selector which delivers them in sequence. With each print pulse from the receive distributor the column selector pulses successive locations, advancing the print along the page line.

The transmitter portion of the teletypewriter can be set up to receive information from either a keyboard or a tape reader. The tape reader is normally used as it is much faster.

Conventionally, the transmitter operates in conjunction with the receive distributor so that the receiver monitors outgoing messages. The transmitter can also operate in one message loop at the same time that the receiver prints information from another source.

**RECEIVE DISTRIBUTOR**—The receive distributor is an analog of a mechanical distributor. Shown in Fig. 3, it contains a linear sweep that is triggered

by the code-input signal. Sweep is applied to voltage comparators 0 to 6. Each comparator compares the voltage level of the sweep to a reference voltage. When the sweep rises to a certain level, a comparator produces an output pulse,  $t$ . Comparator 0 produces pulse  $t_0$ , which resets flip-flops 1 to 5. The other comparators pulse diode AND gates. If the incoming signal is positive at the times the comparators pulse their AND gates, the flip-flops corresponding to the opened AND gates go to the ONE state.

In this manner each of the five incoming information pulses is read one after the other into the flip-flops. Word rate is changed merely by changing the slope of the linear sweep. To compensate for dis-

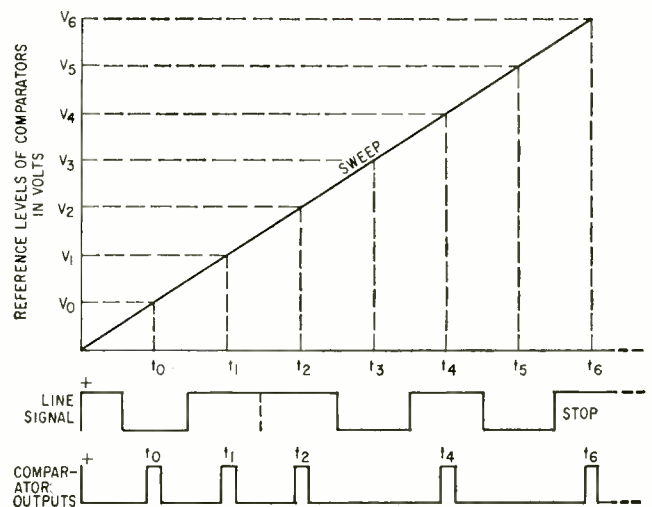

FIG. 4—Time relationships of sweep, reference-level, line-signal and comparator-output voltages



torted incoming signals, the reference voltages may be adjusted by an orientation control which shifts the sampling time to an optimum position along the sweep.

Referring to Fig. 4, the mark-to-space transition on the incoming signal line starts the sweep. If this is only a narrow noise pulse the sweep will be reset. The first comparator pulse clears the storage flip-flops and the next five comparator pulses sample the information pulses as they appear consecutively on the incoming signal line. If the information pulse in question is in the marking condition, a pulse is generated at the output of the associated AND gate. The pulse sends a storage flip-flop into the ONE state. If the first information pulse is in the spacing condition the flip-flop remains in the ZERO state. The last comparator pulse,  $t_n$ , resets the sweep circuit. The distributor is then ready to accept the next character to appear on the incoming signal line.

A common power supply and amplifier arrangement is used by the sweep generator and the reference-voltage dividers. Consequently, a change in power-supply voltage changes the slope of the linear sweep and the reference voltages proportionally, with no net timing error.

**DECODER**—The five flip-flop outputs go to the decoder, which contains a diode matrix.<sup>1</sup> A sixth input to the decoder comes from a figures-letters flip-flop. This flip-flop is set in the appropriate state by an incoming letters shift or figures shift from the signal line.

A letters shift decodes all subsequent incoming code groups to letters until a figures shift is received. Each of 50 available decoder outputs represents a letter, number or punctuation mark. To prevent spurious decoder outputs while the storage flip-flops accumulate information, the decoder is switched on only when the teletypewriter is ready to print.

**ENCODERS AND DRIVERS**—The decoder output that represents the character to be printed signals the diode-matrix encoder. This matrix selects the character-forming print pins by applying inputs to the switch tubes in Fig. 5 that drive these print pins.

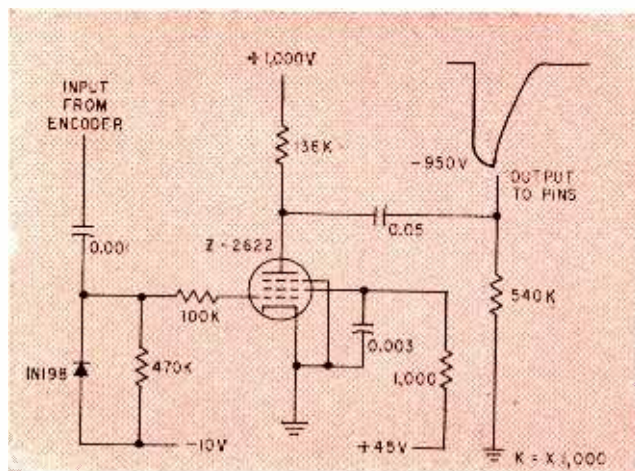

FIG. 5—Although each of 35 identical pin-drivers pulses 72 pins, only the pin above the selected location electrode charges the paper

**PRINT-HEAD SELECTOR**—Pulsing one of the location electrodes in Fig. 2 produces a charge on the paper at that electrode. One of the 72 pulse transformers in Fig. 6 energizes a location electrode each time the receive distributor delivers a print signal to the pulse shaper and pulse generator.

Two ring counters composed of flip-flops select the transformers in sequence. Both counters start from count No. 1. The ring-of-eight counter then progresses through counts 1 to 8 and the first eight characters are printed. After the eighth count, the ring-of-nine counter is advanced to position two where it remains for the printing of characters 9 to 16. This process continues until the counters are either reset by a carriage return signal or reach a full count. When the counters return to count one, a line-feed signal goes to the paper advance (Fig. 2) to avoid overprinting the previous line.

**CODE TRANSMISSION**—When the operator depresses a keyboard key (Fig. 2), a system of mechanical bars operates five switches that generate the code group for the key. The keyboard is interlocked with the transmit distributor so another key cannot be depressed until the previous code group is transmitted.

This distributor, which is similar to the one used in the receiving section, sequentially samples five flip-flops that contain the code for the character. Sampling causes the line relay, a transistor switch, to generate a Baudot start-stop code.

A start pulse sets the line relay flip-flop to zero, which is the spacing state. Following the start pulse, the first sampling pulse places a mark or space in the line-relay flip-flop, depending on whether the first bar-operated switch is open or closed. In sequence, switches two to five are similarly read. Following the fifth information pulse, a stop pulse sets the line relay flip-flop to the one, or mark, state where it remains until the next character begins.

The author acknowledges the mechanical design by R. Jones and the assistance of V. Z. Smith in circuit design.

#### REFERENCE

- (1) Brown and Rochester, *Proc IRE*, 37, 2, Feb. 1949.

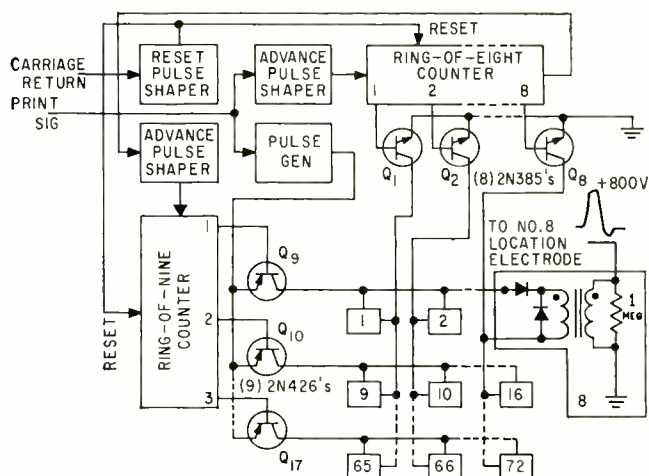

FIG. 6—Each of column selector's 72 pulse-transformer circuits is the same as the eighth, which is shown in the L-shaped box

# Single-Ended Amplifiers

Single-ended transistor amplifier uses capacitors and diodes to couple class A driver to class B output stage. Output circuit is discussed in detail and a practical high-fidelity amplifier circuit is shown. Here's design data, too

By H. C. LIN and B. H. WHITE,

Semiconductor Applications Laboratory, CBS-Hytron, Danvers, Mass.

**S**INGLE-ENDED OUTPUT circuits, using transistors operated class B, have advantages over the conventional push-pull output. One advantage is the elimination of the output transformer. The required load impedance of the single-ended output circuit is much lower than that of a push-pull output and can be directly coupled to commercial loudspeakers.

In the single-ended output the transistors are connected in series with the power supply, while in the push-pull circuit the transistors are connected in parallel with the power supply. Thus the maximum voltage and therefore the breakdown voltage requirements of the transistors are less in the single-ended circuit.

Table I—Amplifier Design Data

	Push-Pull	Single-Ended
Load Impedance	$\frac{2V^2}{P}$	$\frac{V^2}{8P}$
Peak $V_{ce}$	$2V$	$V$
Power Gain (Class B)	$\frac{h_{FE}^2 V^2}{2P r_{bb'}}$	$\frac{h_{FE}^2 V^2}{8P r_{bb'}}$
Peak $I_c$	$\frac{2P}{V}$	$\frac{4P}{V}$

$V$  = supply voltage  
 $P$  = max sine wave power output  
 $r_{bb'}$  = extrinsic base resistance  
 $h_{FE}$  = collector to base current gain

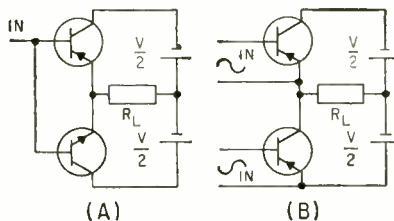

FIG. 1—Complementary (A) and push-pull (B) single-ended output circuits

Most of the known single-ended output circuits have some disadvantages. Use of the complementary circuit<sup>1</sup> (Fig. 1A) is limited due to the lack of commercially available *npn* power transistors.

In the single-ended output circuit using the same types of transistors (Fig. 1B), the inputs are of opposite or split phase. If the phase splitting is accomplished by an input transformer,<sup>2</sup> all the disadvantages of a transformer are present. Instead of a single driver, the quasicomplementary single-ended output circuit<sup>3</sup> requires two complementary transistors as a phase splitter.

Since the input circuit of the output stage is a series return path for the driver, the single-ended push-pull amplifier<sup>4</sup> shown in Fig. 2A can operate satisfactorily only in class A. How single-ended push-pull circuits can be adapted for class B operation to achieve high efficiency and high fidelity will be discussed.

In Fig. 2A, if the driver is to be

operated class A and the output pair in class B, a return path for the driver other than the input of the nonconducting transistor must be furnished. If resistors  $R_1$  and  $R_2$  are used as a return path they will also shunt useful signal from the input and output stages. If capacitors  $C_1$  and  $C_2$  are used, they will be charged to a potential equal to the peak of the signal, reverse-biasing the transistors. The transistors will then be in class C operation, resulting in crossover distortion.

To couple a class A driver to a class B output stage the circuit shown in Fig. 2B is used. The driver and output stage are separated by blocking capacitors and diodes are connected between the base and emitter of the output transistors. The diodes are connected in a reverse direction to the base-emitter of the transistors.

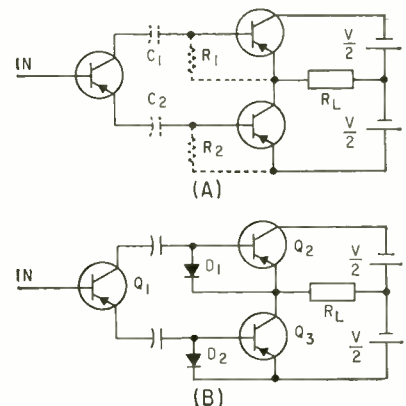

FIG. 2—Basic single-ended push-pull amplifiers for class A (A) and class B (B)



# for Class B Operation

Each diode provides a low impedance return path for the output current of the driver when its associated transistor is not conducting, but does not shunt the signal when its associated transistor is conducting. When the diodes are connected as shown in Fig. 2B no reverse bias is created at the base of the transistors to cause crossover distortion. Crossover distortion is completely eliminated by applying a small forward bias to the diodes and transistors.

## Practical Circuit

A practical modification of Fig. 2B, using a single supply voltage, is shown in Fig. 3. The collector of the driver transistor is coupled to the base of  $Q_2$  through  $R_5$ .

If  $C_1$  were not used, the input impedance of the grounded collector of

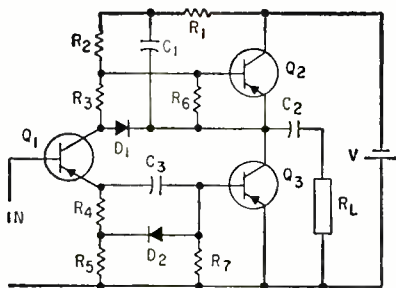

FIG. 3—Practical class B single-ended push-pull amplifier with single driver

$Q_1$  would be so high that a large amount of useful signal would be shunted by  $R_1$  and  $R_2$ , and  $Q_2$  would never saturate. When  $C_1$  is used,  $Q_2$  can be considered as in a common emitter configuration with  $R_1$  connected in parallel with  $R_L$  in the collector circuit. The signal current flowing into the base of  $Q_2$  returns through the parallel combination of  $R_1$  and  $R_L$ . When  $R_1 \gg R_L$  and  $R_2 \gg r_{bb2}$  (where  $r_{bb2}$  is the extrinsic base resistance of  $Q_2$ ), there is little signal degeneration.

The forward biases for  $Q_2$  and  $Q_3$  are supplied from the voltage drops across  $R_6$  and  $R_7$ . The forward bias for  $D_2$  is derived from a portion of

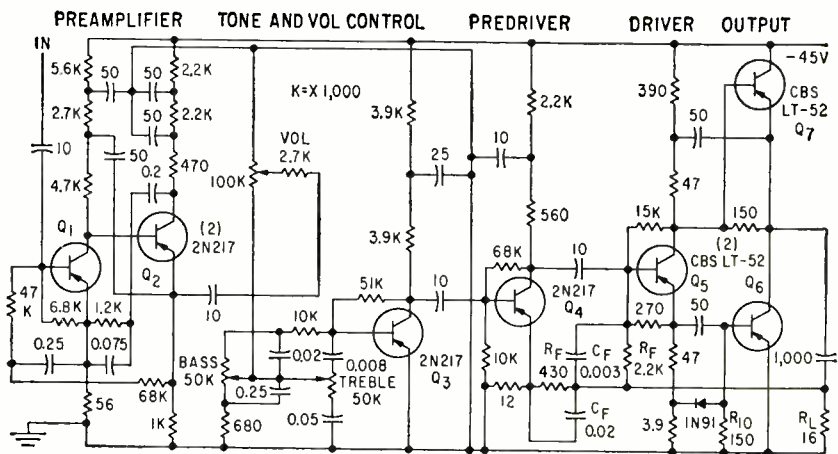

FIG. 4—Ten-watt high-fidelity amplifier employs class B single-ended push-pull output. Input stages are equalized for RIAA curve

the d-c voltage drop in  $R_1$ - $R_5$  in series with the emitter. The forward bias for  $D_1$  is similarly derived from the d-c voltage drop in the collector's series resistance.

Actually,  $D_1$  and  $R_5$  can be eliminated without effecting performance appreciably. During the conduction of  $Q_2$ , since  $R_1 \gg R_L$ , negligible signal current flows through  $C_1$  to reverse bias  $Q_2$  and crossover distortion is negligible. During the cutoff period of  $Q_2$ , the signal current which would flow from  $D_1$  to  $C_2$  and  $R_L$  can detour, in the absence of  $D_1$  and  $R_5$ , from  $R_2$  to  $C_1$  to  $C_2$  to  $R_L$ . The bias on  $Q_2$  due to this current through  $C_1$  is in the forward direction and does not cause objectionable distortion. To compensate for the voltage drop due to the detoured signal current flowing through  $R_2$  and to avoid collector saturation the supply voltage is increased by an amount equal to the peak driver current times  $R_2$ .

## Complete Amplifier

Figure 4 is a schematic of a 10-watt high-fidelity amplifier employing the single-ended push-pull class B output circuit. The amplifier is designed to work between a variable reluctance pickup and a 16-ohm voice coil.

The only difference between the circuit shown in Fig. 3 and the last

two stages of Fig. 4 is that negative feedback has been added to the complete amplifier to reduce distortion and to lower the output impedance for loudspeaker damping. Negative feedback is provided by  $R_f$  and  $C_f$ .

If the amplifier is to be operated over a wide temperature range, temperature compensation can be obtained by using a thermistor in place of  $R_{10}$ .

The total harmonic distortion is less than 1 percent at 10-watt output. Frequency response is flat within 1.5 db from 30 to 15,000 cps. Noise is more than 65 db below the maximum signal output.

Table I is used to design single-ended amplifiers with other output or load requirements than the amplifier just described. Information on the conventional push-pull amplifier is included for comparison.

Transistors used in the single-ended output circuit should have reasonably high gain at peak current to keep distortion low.

## REFERENCES

- (1) G. C. Szeklai, Symmetrical Properties of Transistors and Their Application, *Proc IRE*, June 1953.
- (2) H. C. Lin, A 20-Watt Transistor Amplifier, "Transistors I," RCA Laboratories, 1956.
- (3) H. C. Lin, Quasi-Complementary Transistor Amplifier, *ELECTRONICS*, Sept. 1956.
- (4) A. Peterson and D. B. Sinclair, A Single-Ended Push-Pull Audio Amplifier, *Proc IRE*, Jan. 1952.

# Intelligibility Evaluation of

Electronic instrumentation system measures understandability of speech transmitted over communication systems. Advantages over listener tests include objective and repeatable results with savings of man-hours of testing. Index of intelligibility obtained agrees closely with scores of human listeners

By HARRY SCHWARZLANDER, General Electronic Laboratories, Inc., Cambridge, Mass.

WHEN DESIGNING communications systems for human voice transmission, one of the most important considerations is how well the message can be understood at the system outputs. To determine the understandability of a speech sample after it has been modified by distortion or by noise and other interference, human listeners have up to now been employed in listener tests. In such tests, the percent articulation or intelligibility of the speech after passing through a communication system is determined.

The word articulation is used when the contextual relations among the units of speech material play an unimportant role in the listener's perception; the word intelligibility is then applied where context significantly affects the understandability. The articulation score, sometimes also called word score, for a communication channel operating under specified conditions, is obtained from a listener test if a list of single-syllable words is read into the system and the listeners are scored in terms of percentage of words understood correctly.

Listener tests require an elaborate test setup to assure controlled conditions and the results are still affected by human factors such as learning and fatigue. A computational method developed some time

ago for determining speech articulation at the output of a channel is limited in applicability to channels that disturb the speech signal by the addition of random noise or by reduction of the signal bandwidth.<sup>1</sup>

To enable simple and reliable articulation testing of many types of voice communication systems under a wide variety of interference conditions and distortions, the speech intelligibility measuring system to be described was developed.

## System Theory

The power spectrum of speech can be plotted as a function of time, with time the abscissa, frequency the ordinate and amplitude plotted as elevation in a three-dimensional plot or as relative darkness in a two-dimensional representation. Such a time-varying or running power spectrum of voice signals can be obtained with a sound spectrograph.

The measuring system operates on the principle that intelligibility is a unique monotonic function of the degree to which the pattern of the running power spectrum of the original speech signal is preserved.

That the information of a speech message is contained in the running power spectrum is illustrated by the fact that visible speech, as obtained from a sound spectrograph can be read by a trained per-

son, and that speech passing through a speech-encoding device that preserves mainly the running power spectrum of the speech is intelligible.

The system was therefore designed to determine an index of correlation between the patterns of the running power spectra of the original speech signal and the speech signal at the output of the communication system being tested. However, there are some properties of the spectral pattern which are of no importance to the intelligibility of the message.

Intelligibility of speech is inde-

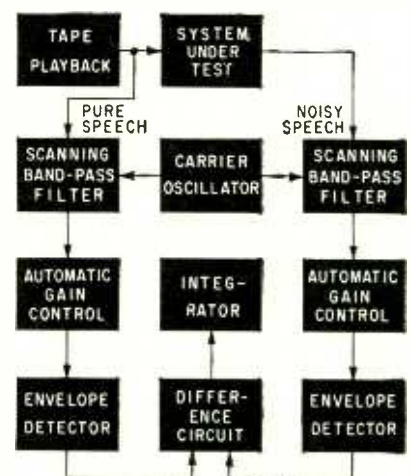

FIG. 1—Simplified representation of speech intelligibility measuring system



# Voice Communications



Operator performs test on speech intelligibility measuring system. Test run takes approximately 15 minutes to perform

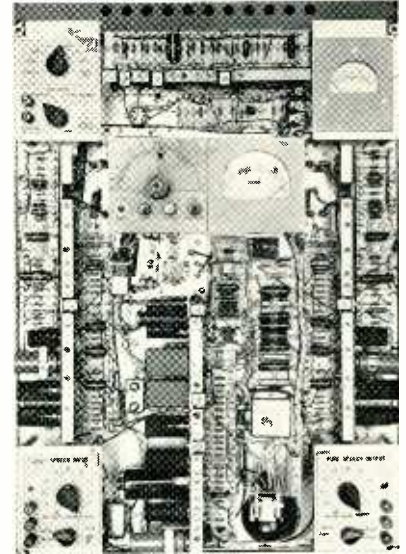

Closeup of measuring system chassis shows timer dial and index meter

pendent of absolute sound-pressure level unless the signal is weak (near absolute threshold) or strong (above threshold of discomfort). The intensive variable that governs intelligibility is the speech-to-noise ratio. The measuring system therefore includes avg circuits to make the compared signals independent of their input levels unless they are extreme.

Intelligibility is not greatly affected by slow fluctuations in speech level as a function of time or as a

function of frequency, provided these fluctuations are not too marked. This characteristic is taken care of in the system by the use of avg time constants.

## Phase Distortion

Moderate amounts of phase distortion have essentially no effect upon intelligibility, even though they alter the speech waveform as seen on an oscilloscope. The system is designed to be blind to relative phase shifts unless they correspond

to significant time delays.

The various parts of the audio-frequency scale are not equally important for speech intelligibility. The relevant transformation of the frequency scale is defined by the importance function, which gives more weight to the lower frequency components of speech. This transformation is incorporated into the measuring system.

What measure of correspondence between the original and received speech patterns is most appropriate is mainly empirical. On the basis of experimental tests a measure closely related to cross correlation was adopted; this numerical result has been named pattern correspondence index and is approximately equal to  $(1 - k) \int_0^t \int_0^t D df dt$ , where the integrals are taken over the duration  $t$  of a speech sample and the speech-frequency band  $f$  in the range important to speech intelligibility (200 to 6,100 cps).

If  $D$ , the discrepancy between the two signals in a narrow frequency band at a given time, were the square of the difference between the two voltage signals, the above expression would be the product-moment correlation between the two patterns. However, assuming

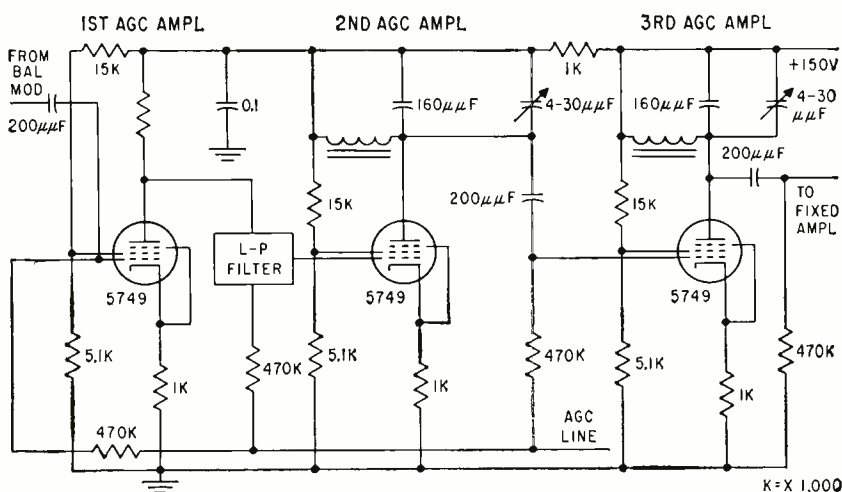

FIG. 2—Logarithmic gain change as a function of bias voltage is provided by three-stage agc amplifier

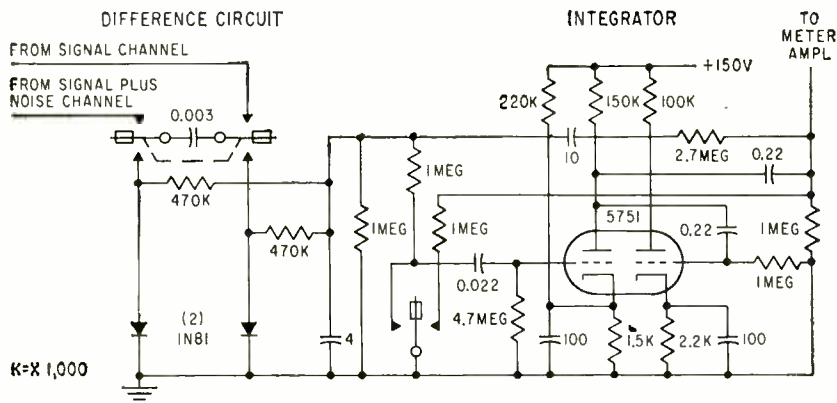

FIG. 3—Absolute-difference and integrator circuits incorporate mechanical choppers

discrepancy  $D$  to be the absolute value of the voltage differences reduces the weight given to extreme amplitude values.

The index may still be considered as a measure of correlation. Coefficient  $k$  in the expression is merely a normalizing coefficient, which makes the index zero when there is no relation at all between the two signals compared.

A phonetically balanced group of sentences is used as a standard speech sample in all measurements.

### Instrumentation of Theory

In reducing the above considerations to a workable electronic system, it was decided not to perform the comparison between the two running power spectra of interest over all frequency spectrum components simultaneously, but rather to look at only a narrow frequency band at a time. The patterns of the running power spectra at the input and output of the communication channel under test are thus compared on a small region basis by scanning each, in frequency and in time, with identical apertures.

The aperture sizes in the frequency direction are fixed by band-pass filters and in the time direction by low-pass time constants. The heights of the small regions falling within the apertures at any instant in terms of voltage are compared; their absolute difference is obtained after the necessary normalization.

Scanning in the frequency direction is accomplished by slowly moving the two patterns past a pair of narrow-band filters, using a heterodyne filtering arrangement. Scanning in the time direction is ob-

tained by allowing the standard speech sample to go through one cycle, while a given frequency is within the filter pass-band. The time required to scan the whole time-frequency pattern of the test signal in this manner is approximately 15 min, although the duration of the standard speech sample is only about 15 sec.

Bandwidth of the scanning filters, which determines the aperture size in the frequency direction, is 200 cps. This bandwidth was chosen because fine frequency detail falling within this range does not affect intelligibility.

### System Description

Figure 1 is a simplified block diagram of the measuring system.

A standard speech sample is obtained from a continuous loop tape playback contained in the system. This signal is fed through the communication channel under test and is also applied to the pure-speech channel at the left, which is one of the two identical signal-processing or normalizing channels in the system. The output of the channel being tested is then applied to the noisy speech channel on the right.

Circuits in the signal-processing channels perform the required operations on the signal before comparison. As the filter center frequency is 25 kc, the voice spectrum is shifted to this frequency in a balanced modulator. By using a carrier frequency that gradually sweeps through the range from 25.2 to 31.1 kc, one of the sidebands produced in the balanced modulator is gradually moved past the filter, over a range corresponding to audio

frequencies from 200 to 6,100 cps.

The common carrier oscillator capacitors are cam driven, to make the sweep rate nonuniform in accordance with the importance function; for the lower frequencies, which are of greater importance to intelligibility, the sweep is slower and proportionately more time is spent in the comparison of those portions of the two spectra.

The agc amplifier makes the output of the processing channels fairly independent of input level and compensates for gradual level changes as functions of time; this means changes in level as functions of frequency are also compensated for, since the frequency scale is translated into a time scale by the swept heterodyne filter.

The narrow spectrum component passing through the agc amplifier is amplitude detected in a full-wave rectifier envelope detector.

Only the amplitude fluctuations in the approximate range from 0.2 to 12 cps appear to contribute significantly to intelligibility. Filtering eliminates fluctuations outside this range from the outputs of the two signal processing channels; slow amplitude fluctuations are previously cancelled through agc action.

The output from each of the two signal-processing channels is a voltage which fluctuates about zero, corresponding to the normalized envelope fluctuations of a narrow portion of the input spectrum to the channel. Outputs are identical if the same speech signal is present at the input to each channel. After obtaining the absolute value of the

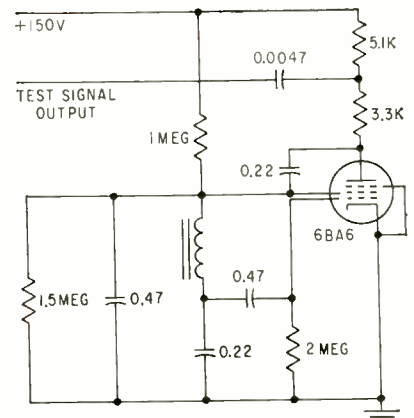

FIG. 4—One-kilocycle test signal source



instantaneous voltage difference between the two outputs, the difference voltage is integrated over the whole 15-min test run and therefore over the whole input spectrum.

The result of a measurement with the speech intelligibility measuring system is a meter reading which indicates integrated voltage. The meter can be calibrated to read full-scale, corresponding to a pattern correspondence index of zero, when there is no correlation at all between the signals entering the pure-speech and noisy-speech channels.

### Circuit Details

Some of the electronic circuits employed are of sufficient interest to warrant more detailed description.

Following the signal path through one of the signal-processing channels, the balanced modulator is a simple two-transistor switch. Switching voltage is obtained from the sweep oscillator, where a conventional Wien-bridge circuit is used with transformer output to provide the low-impedance switching signals for the two balanced modulators.

The agc amplifier, which also contains the 25-kc filter, is shown in Fig. 2. The stages have been designed to produce a logarithmic gain change as function of bias voltage over a wide operating range, to make the agc response independent of input level. Rather than using an additional fixed-gain driver tube for the band-pass filter, the filter was incorporated after the first agc stage. Though this arrangement has the shortcoming that the first agc stage must handle a fairly large signal, the circuit operates satisfactorily. A chopper-stabilized d-c amplifier at the detector output supplies the agc control voltage.

Figure 3 shows the absolute difference circuit and integrator. The difference circuit contains a two-pole chopper with a capacitor connected across the two reeds. During half a chopper cycle, this capacitor is charged to the voltage difference between the outputs from the two signal processing channels. During the other half-cycle, this charge is transferred to the integrator input, while the positive side

of the capacitor gets clamped to ground by one of the two diodes.

The integrator is an active circuit because a long time constant is required. It consists of a chopper-stabilized d-c amplifier with capacitive feedback. Amplifier gain is 200, and the integration time constant is 1½ hr.

A source of fluctuating-amplitude audio tone is included in the measuring system to simulate speech in a narrow spectrum region. Out-

When the pointer is reset to the initial position, the integrator capacitor is discharged in about 20 sec by a time-delay relay, making the system ready for the next test run. At the end of the run, the operator records the index reading from the meter and, with a calibration curve, the value of word articulation score or sentence intelligibility for the particular measurement being obtained.

### Test Results

Index readings obtained when the input to the speech-plus-noise channel consists of the sum of the pure speech signal and random noise of uniform spectrum through the audio range are plotted as functions of signal-to-noise in Fig. 5. Also shown on the same graph is a composite curve of word score as a function of signal-to-noise ratio compiled from several published listener test results for speech mixed with white noise. The two curves have been combined in the calibration curve of Fig. 6 to relate pattern correspondence index to word score.

Tests have been conducted with the speech intelligibility measuring system on speech when subjected to various types of audio interference for which published listener test data was available. Machine test results showed good agreement with published data, after conversion from pattern correspondence index to word score, for clipped speech, interrupted speech, interfering single and multiple tones, and low and high-pass filtering.

The speech intelligibility measuring system was originally developed by J. C. R. Licklider, who also formulated the theoretical basis for the device. Considerable development work on the device was done by W. M. Grim, Jr. and Edward Maddox. Mechanical design was conceived by Peter Lindenmuth. The device described was developed under contract from the Signal Corps.

### REFERENCE

- (1) L. L. Beranek, The Design of Speech Communication Systems, *Proc IRE*, p 880, 1947.

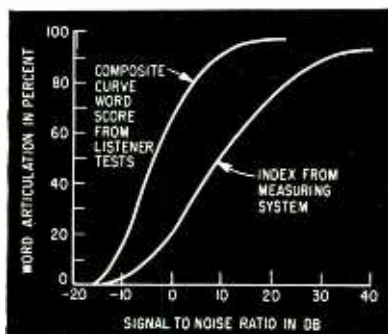

FIG. 5—Test results for speech signal mixed with white noise

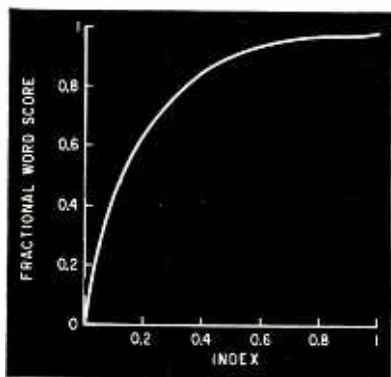

FIG. 6—Relation of pattern correspondence index to word score

put of this test signal generator can be switched into the pure speech and noisy channels. The circuit, shown in Fig. 4, is an electron-coupled 1-kc Colpitts oscillator modified to hunt at approximately 10 cps.

### System Use

A semiautomatic operating sequence control circuit facilitates measurements. A large timer dial, which rotates through 90 deg during the 15-min test run, indicates elapsed time and also the frequency being scanned at any given time.

ELECTRONICS—May 29, 1959

which base resistor  $R_1$  is returned. This voltage is controlled by the resistors in series with the playing keys. The emitter of  $Q_1$  is returned to a low negative voltage determined by  $R_6$  and  $R_7$ . Unless a playing key is depressed  $Q_1$  is biased off and will not oscillate as its base will be returned to ground through set-octave control  $R_7$ .

As chords cannot be played on

divider  $Q_2$ ,  $Q_3$ . As the operating stability margin of the ternary divider is less than that of the binary, bias adjustment  $R_8$  is provided.

The outputs of the two dividers of chain A are filtered by R-C filters to remove all but the fundamental frequencies of the dividers, which correspond to the fundamental and second harmonic of the output signal. The filters are a compromise

ters controlling the fundamental and second harmonic. By connecting this potentiometer from the collector of  $Q_2$  to the collector of  $Q_3$ , phase reversal of the third harmonic may be achieved. In this case the filter is placed after the potentiometer.

This method of phase switching avoids the generation of switching transients that might cause spuri-

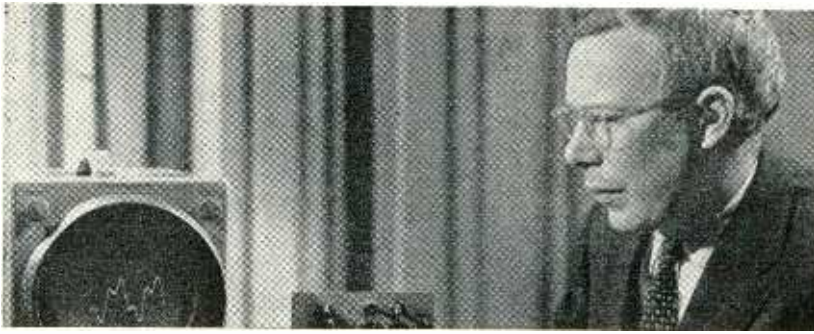

ous triggering of the divider.

A disadvantage of this method is that due to the dissimilarity between the rise time and the fall time of the divider transistors, with  $R_3$  set at midposition, the output is not zero but consists of a small pulse signal at the master oscillator frequency. When third harmonic in the output signal is not desired, shorting switch  $S_1$  may be closed to eliminate this spurious signal.

Amplifier  $Q_{10}$  raises the output level of the instrument to compensate for the attenuation of the filters and mixing network; emitter follower  $Q_{11}$  drives a long cable to an external amplifier or drives the envelope control amplifier to be described.

#### Initial Adjustments

To set up the device,  $R_7$  is adjusted to the middle of its range and, with a playing key held down, the outputs from the fundamental, second harmonic and third harmonic circuits are checked. The second harmonic should be an octave above the fundamental and the third harmonic should be an octave and a fifth above the fundamental.

The bias control on the ternary divider may require adjustment. Too little bias may result in continuous oscillation or triggered oscillation at  $6f$  instead of  $2f$ . Too much bias will suppress all output from this stage and also remove the input signal from the following divider, resulting in zero output from the fundamental circuit as well.

If output is not obtained from any divider, the master oscillator is suspect and a different setting of  $R_7$  should be tried.

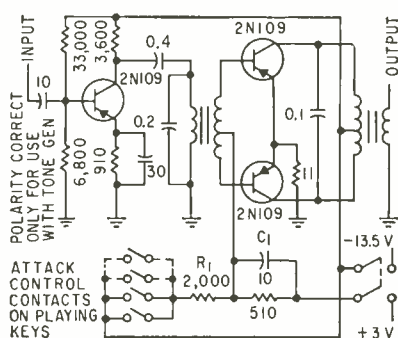
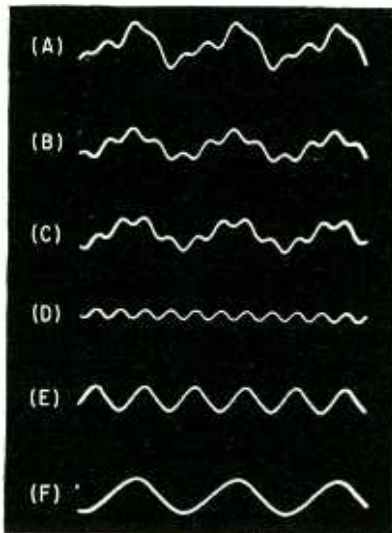

FIG. 3—Attack control amplifier enables tone generator to be also used as musical instrument



Typical output waveforms include fundamental, second and third harmonics (A), fundamental with third harmonic normal (B) and reversed (C), third harmonic (D), second harmonic (E) and fundamental (F)

Having obtained operation, the instrument must be tuned up. The adjustable resistor in series with the bottom note of the keyboard is set at its midpoint. This note and the note one octave higher are then alternately played while  $R_7$  is adjusted to produce an octave relationship between these two notes. If the desired octave relationship cannot be achieved, the bottom note resistor is readjusted. The remaining notes of the scale may then be tuned in any convenient manner by adjusting their associated resistors.

Control  $R_7$  may need occasional adjusting to compensate for battery aging.

#### Applications

The timbre demonstrator has been used by one of the authors in lectures and demonstrations to many groups of people. Usually an oscilloscope and a loudspeaker system are used simultaneously.

A note is held down on the keyboard and the various components of the output signal observed singly and in combination. Notes near the upper end of the keyboard are usually selected as better sinusoidal waveforms because of the filter characteristics.

The change of waveform due to change of phase of the third har-

monic is best demonstrated by adjusting the fundamental control to about midposition and the second harmonic to zero. If the third-harmonic control is then rotated rapidly from one extreme to the other there will be a pronounced change in the appearance of the resulting waveform, but little or no change in the audible sound.

#### Musical Use

This device could be used for purely musical purposes if desired. For such use, its most serious limitations are its restricted range, marginal tuning stability, lack of control of the attack and decay of the tones produced. At the cost of slightly increased complexity this may be partially remedied by the attack control amplifier shown in Fig. 3, which requires an extra contact be added on each playing key.

The attack control amplifier has a push-pull output that is normally biased off. Depressing any playing key causes this bias to be removed at a rate determined by  $R_1$  and  $C_1$ , thus producing a gradual attack. Each key contact for this amplifier should be adjusted to close slightly after the frequency control contact of the corresponding key.

The attack control amplifier will deliver about 250 mw to its load. In this form, the device could be used as a monophonic adjunct to another instrument such as a piano or, with readjustment of the filter and master oscillator frequencies, as an inexpensive pedal division of an electronic organ.

If more than one octave is to be covered, readjustment of the blocking oscillator frequency controlling circuit will be necessary. In addition, the filters should be simplified by removing at least one section from each to minimize the drop in output which occurs in the upper register of the instrument.

Other harmonics may be added by employing more dividers. An additional binary divider in each chain, for example, would permit the inclusion of the fourth and sixth harmonics. Alternatively, the sixth harmonic alone could be added by utilizing the direct output of the master oscillator.





Automatic video-processing amplifier instantaneously compensates for wide variations in color or monochrome input signal levels to maintain output signal components at correct levels. Amplifier can feed video tape recorder to obtain maximum signal-to-noise capabilities of recorder

By **JOHN O. SCHROEDER**, Project Engineer, The Daven Company, Livingston, N. J.

# Holding Video Level

**T**ELEVISION PLANTS comprising many studios present considerable problems to video transmission engineers. Many programs integrate material from all of these sources simultaneously, as in the case of split-screen or insertion-type special effects. Broadcasting of NTSC color signals compounds the existing problems as, in addition to the sync and luminance portions of the composite video signal, the engineer is required to maintain the amplitude of the subcarrier burst signal at its prescribed level within narrow limits.

Maintenance of video levels, in spite of rapid switching between widely separated studios and the use of the various electronic special effects devices, makes the use of an automatic-control device desirable.

The automatic video-processing

amplifier to be described accepts an incoming composite black-and-white or color television signal and automatically reprocesses it so that its various components are restored to their correct amplitudes, regardless of whether the input signal components are above or below normal. The unit also provides a 4-v source of stable sync, which is derived from the input signal for use in genlock applications.

Automatically switching between color and black-and-white operation, the amplifier enables the transmission engineer to adjust the level of each of the signal components, after processing, to its prescribed level either locally or remotely; this level is automatically maintained by the amplifier. When automatic operation is not desired the complete system can be locally or remotely switched to manual, in which case

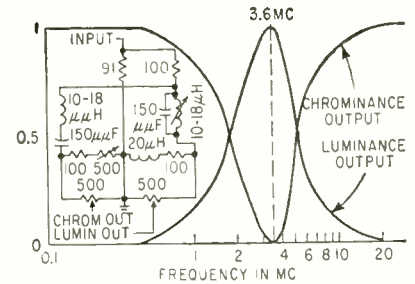

FIG. 2—Crossover filter and characteristics

the device becomes a regular stabilizing amplifier; the operator then has complete control of the sync, luminance and burst output levels.

Output video is free from any hum, tilt or low-frequency disturbance which may be present at the input. The sync portion of the output signal is always tilt-free and clean regardless of the condition of the input sync waveform, since only

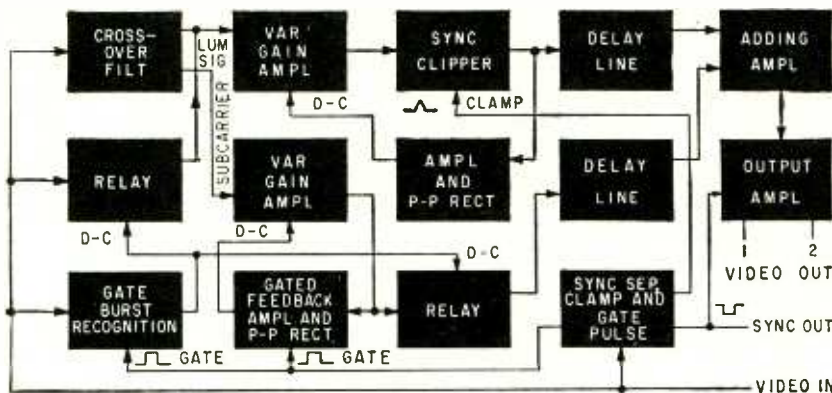

FIG. 1—Block representation of automatic video processing amplifier

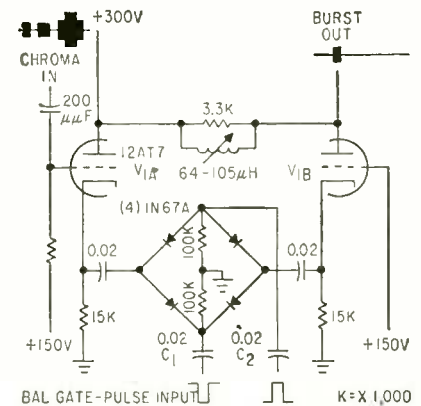

FIG. 3—Diode gating circuit



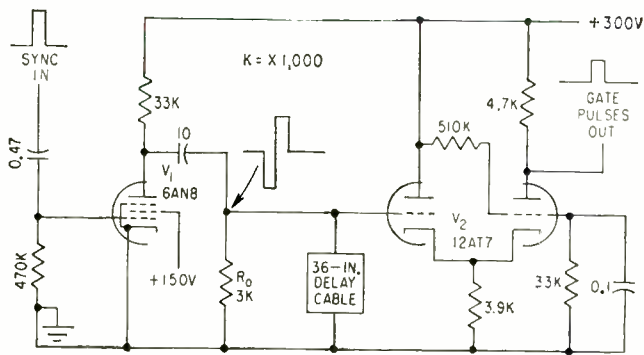

FIG. 4—Color-burst gating-signal generator

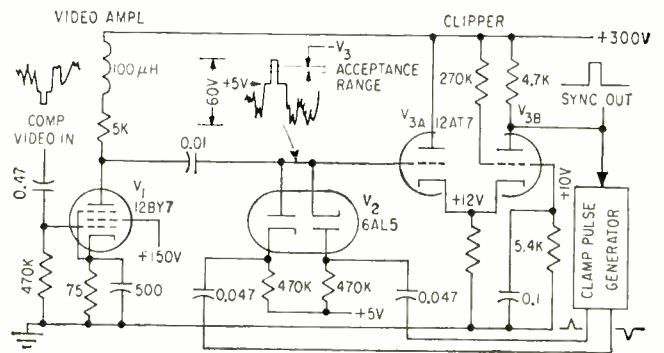

FIG. 5—Clamped sync separator circuit

# While Switching Studios

a small slice of the input sync is utilized to form the processed output sync signal.

The amplifier can be used to provide a video-only output signal from a composite input signal by simply turning the sync amplitude control fully off. In the automatic condition, the amplitudes of the luminance and burst components of the output signal will be maintained at their proper levels; in the manual condition the operator has complete control over these levels.

## Theory of Operation

Referring to Fig. 1, the composite video signal passes through a crossover filter that separates the 3.58-mc color subcarrier and its sidebands from the luminance and sync portion of the signal.

The luminance signal is fed through a balanced variable-gain amplifier and then through a clamped sync clipper that accurately clips the sync at black level and also clamps out hum, tilt and any low-frequency disturbances. Amplified output of the sync clipper is applied to the peak-to-peak rectifier, whose d-c output controls the gain of the variable gain stage to complete the agc feedback loop. The action of this entire luminance control section produces a video-only signal at its output whose black to peak-white level is maintained constant despite changes in overall input, sync or picture level.

The resultant processed lumi-

nance signal is fed through an adding amplifier and finally to a negative-feedback type line amplifier<sup>1</sup>, which is suitable for feeding several 75-ohm coaxial lines and also serves as a sync adding amplifier. Total path delay of the luminance chan-

side bands, which constitute the chrominance signal, are separated from the composite color signal by the crossover filter and applied to a variable-gain amplifier. The amplifier output feeds a gated feedback amplifier and peak-to-peak rectifier, which in turn feeds d-c to the variable-gain stage to control its gain and complete the feedback control loop.

The feedback amplifier which feeds signal to the error detector is gated on only during the time interval occupied by the burst portion of the chrominance signal. In this manner only the burst signal controls the gain of the chrominance channel and therefore is maintained constant by the agc loop. The regulated chrominance signal is fed to the adding amplifier to form the NTSC composite color output through a short length of delay cable for time-delay matching purposes.

To derive stable clamping, gating and sync pulses from the incoming composite signal, a special clamped type of sync separator forms the basis for the generation of all other pulses required. Processed sync from this section is added back onto the sync-free video signal produced by the adding amplifier to form the final complete composite output signal.

The gated burst recognition circuit causes the two relays to drop out whenever the burst component of the input signal drops below a

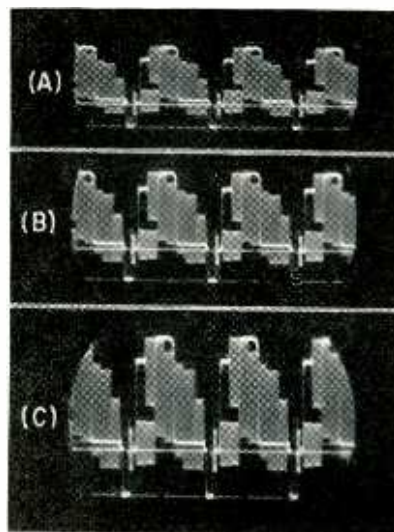

FIG. 6—Variable input signal levels (A, B) are kept at constant output level (C)

nel is matched to the delay of the sync channel, which has the longest delay, by a short length of RG-65/U delay cable at the input to the adding amplifier.

## Subcarrier Control

The subcarrier control section of the unit operates similarly, with one important exception.

The 3.58-mc subcarrier and its

predetermined level, indicating the presence of a black-and-white signal. Under this condition, one of the relays removes the crossover filter from the circuit to make the luminance channel wide band. The chrominance channel is disabled and prevented from adding any noise to the output signal by the other relay which grounds the input of the adding amplifier.

### Circuitry

The general circuitry of the luminance portion of the amplifier has been described in the literature.<sup>2</sup>

The crossover filter which separates the chrominance information from the luminance signal is shown in Fig. 2 along with its response characteristics. The Q adjust control permits the operating Q values of the series and parallel resonant branches to be made equal; this assures that the two outputs will fit back together again and provide a flat frequency response when they are combined in the adder stage. Designed to operate from a 75-ohm source impedance, the filter provides a relatively constant 75-ohm input impedance for proper termination of transmission lines.

Diode gating circuitry for the burst-sampling portions of the amplifier is shown in Fig. 3. The balanced diode switch is normally in a nonconducting state due to the reverse bias voltage stored across  $C_1$  and  $C_2$ . Balanced gate pulses cause the switch to be turned on during the gate interval.

By using the diode switch as a coupling element between the cathodes of the triode sections of  $V_{1A}$ , the input and output impedances are kept low and loss of gain incurred in  $V_{1A}$  and the switch is compensated for in cathode-driven grounded-grid amplifier  $V_{1B}$ . This gating action causes only clean amplified burst to be present at the output of  $V_{1B}$  when a chrominance signal is applied to the input of  $V_{1A}$ .

### Diode-Switch Gating

Burst gating pulses for operation of the diode switch are obtained with the circuit shown in Fig. 4.

Sync pulses separated from the composite input signal are applied to the grid of  $V_1$ , which is biased so that plate current flows only

during the sync pulse interval. The plate load impedance of  $V_1$  consists of the resistor  $R_o$  and a length of delay cable whose receiving end has been short-circuited; therefore, the plate current produces a large amplitude negative voltage pulse that travels down the delay cable and is reflected back to the sending end. There it appears as a delayed positive pulse that is completely absorbed by the  $R_o$ , which is equal to the characteristic impedance of the cable.

The positive-going pulse, which has a width about equal to the horizontal sync pulse and is delayed by twice the delay cable time delay, is processed into a clean gate pulse with steep sides and flat top by cathode-coupled clipper  $V_2$ , which is biased to take a narrow slice out



FIG. 7—Input (top) and output (bottom) levels of burst portion of color signal

of the positive-going pulse at its input grid.

Pulses so generated extend from the trailing edge of sync to almost the leading edge of blanking and possess the time relationship required for proper gating of the sub-carrier burst signal.

A cathode-coupled phase splitter follows  $V_2$  to provide the push-pull balanced gating pulses required by the diode switch.

### Sync Separation

The method of separating sync from the composite input signal is somewhat unusual.

Referring to Fig. 5,  $V_1$  amplifies the 1-v composite video signal at its grid to about 60 v peak-to-peak. Dual-diode  $V_2$ , which is supplied with high-level keying pulses timed to occur during the horizontal back-porch interval, clamps the video signal presented to the grid of clipper  $V_3$  at +5 v.

Due to the +10-v bias applied to the grid of  $V_{3B}$ , plate current flow

through the cathode resistor maintains the cathodes of  $V_3$  at approximately +12 v. As the signal applied to  $V_{3A}$  goes positive, conduction of plate current is transferred to  $V_{3A}$  and the cathodes of both sections are driven positive by cathode-follower action;  $V_{3B}$  becomes cut off since its grid is biased at +10 v and it cannot follow the cathode positively.

These operating conditions cause a relatively small slice to be taken out of the center region of the sync pulse presented to the clipper stage. As a result, positive sync pulses at the plate of  $V_{3B}$  are exceptionally clean and stable. This sync separator has performed consistently with signals that have caused conventional types to fail completely.

Because the signal is first clamped and then sliced without any r-c time constants or grid current flow, separation is immune to hum, low-frequency tilt and severe sync modulation. Recovery is instantaneous when the composite video input level is abruptly increased or decreased.

### Performance

Figure 6A illustrates an input signal reduced 3 db below normal and Fig. 6B shows the signal at 3 db above normal. In both cases the output signal, Fig. 6C, is maintained at its correct level. If the input signal had been high in chroma, low in luminance or high in sync simultaneously, the output would still be normal because each of these signal components is regulated separately. When the entire input signal was dropped to -12 db below normal, the sync component of the output signal remained normal in level while the luminance and chrominance components were approximately -6 db below normal as the maximum gain increase of the agc system is purposely limited to 6 db.

Figure 7 shows the peak-to-peak input and output levels of the burst portion of a color signal recorded during a color program. Random changes in burst level are caused by switching and lap-dissolves between cameras and studios.

### REFERENCES

- (1) J. O. Schroeder, Studio Amplifier Design for Color Television, *ELECTRONICS*, Mar. 1955.
- (2) J. O. Schroeder, A Video Automatic Gain Control Amplifier, *RCA Rev. Dec.* 1956.



# COMMAND DESTRICT

The flight testing of second generation missiles—more versatile and powerful than their predecessors—requires a device for sure termination of any missile flight that might endanger the test range or surrounding area.

Ramo-Wooldridge engineers, under a United States Army Signal Corps contract, have successfully developed and delivered the first sub-miniature, completely transistorized radio "command destruct" receivers.

Specifically designed for missile flight safety operations, the receiver (AN/DRW-11) can actuate safety mechanisms or destruct devices. It has three command channels, each of which actuates a control relay.

The "command destruct" receiver accepts frequency modulated signals in the UHF radio command control band. It is designed to operate with closer radio frequency and command frequency channel spacing than has been used to date, thus making possible more efficient use of the available radio spectrum.

Compact and rugged, the radio receiver's modular construction permits rapid and complete accessibility to all components. One module houses the basic receiver. The second module contains the three command channels and relays. This integrated package occupies 115 cubic inches, and weighs 4 pounds. The receiver requires no pressurization and operates reliably under the adverse environmental conditions encountered in missile flight testing.

Engineers and scientists interested in being associated with some of the nation's most advanced research and development programs are invited to acquaint themselves with current opportunities at Ramo-Wooldridge. The areas of activity listed below are those in which R-W is now engaged and in which openings exist.

- Missile electronics systems
- Advanced radio and wireline communications
- Information processing systems
- Electronic language translation
- Anti-submarine warfare
- Air navigation and traffic control
- Analog and digital computers
- Infrared systems
- Electronic reconnaissance and countermeasures
- Basic and applied physical research

For a copy of our brochure, *An Introduction to Ramo-Wooldridge*, or other additional information write to Mr. Donald L. Pyke.

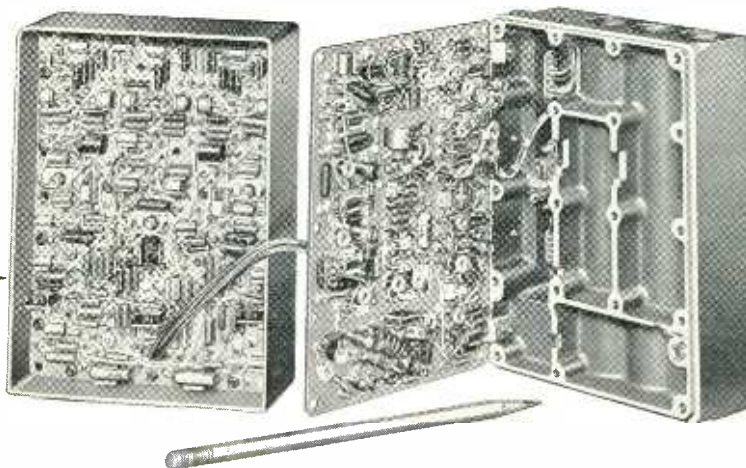
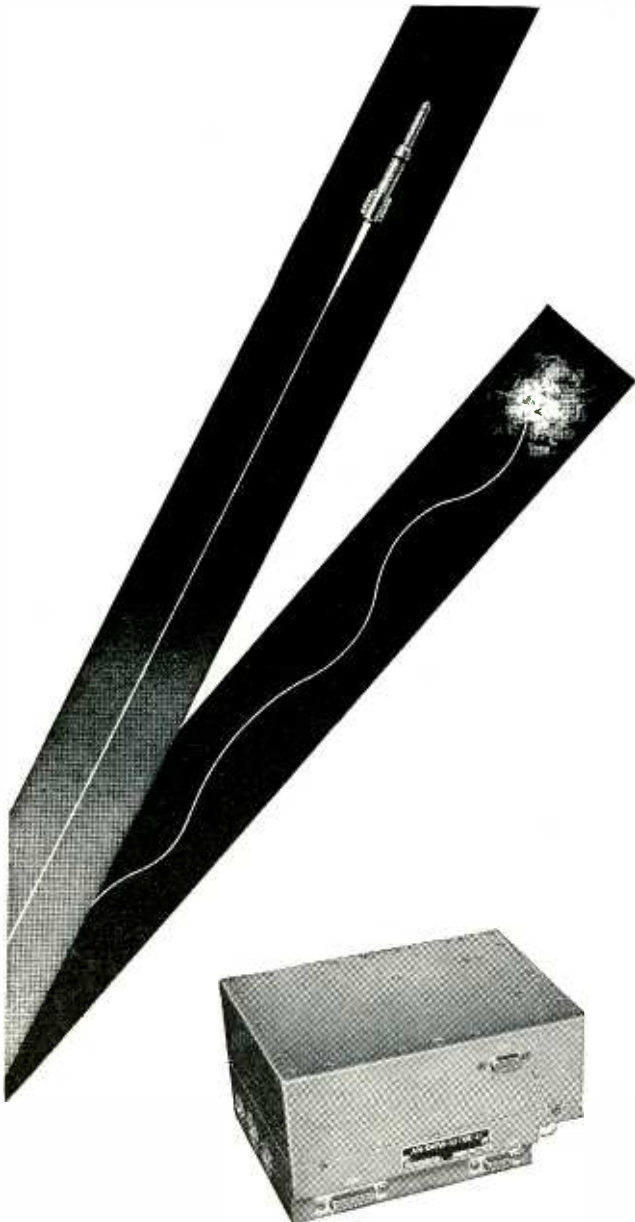

## RAMO-WOOLDRIDGE

P. O. BOX 90534, AIRPORT STATION - LOS ANGELES 45, CALIFORNIA  
a division of *Thompson Ramo Wooldridge Inc.*

# Radar Tracking Losses

Variation of chart described in previous article solves problems imposed by moving target indicator blind speeds where the target track offset is a variable

By **BUD M. COMPTON**  
Tech Rep division, Philco Corp.

and **FRED DUCHARM**,  
U. S. Air Force, Hamilton Air Force Base, Calif.

IN A PREVIOUS article (ELECTRONICS, p 62, May 22) a method was described for preparing a set of curves for graphical determination of blind speeds, blind scans and range at which a target on a passing course will pass through the blind speed. These curves were drawn for a typical L-band mti radar operating near an air traffic route.

Another useful form of these charts is shown in Fig. 1. Here the chart is plotted for a single blind speed of 164 knots and facilitates solutions of the variable track offset  $y$ . Figure 2 shows the geometry of a typical situation. From this geometry it can be shown that  $N$ , the number of blind scans or missed points, is determined by  $N = 4.5 \times 10^3$

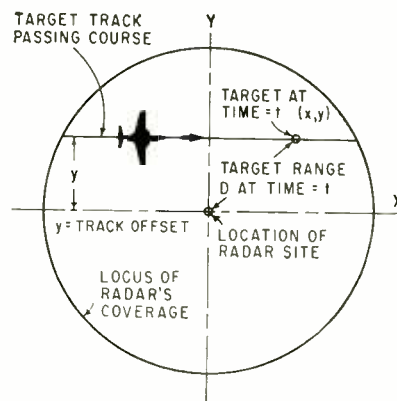

FIG. 2—Geometry formed by aircraft passing courses near typical radar site

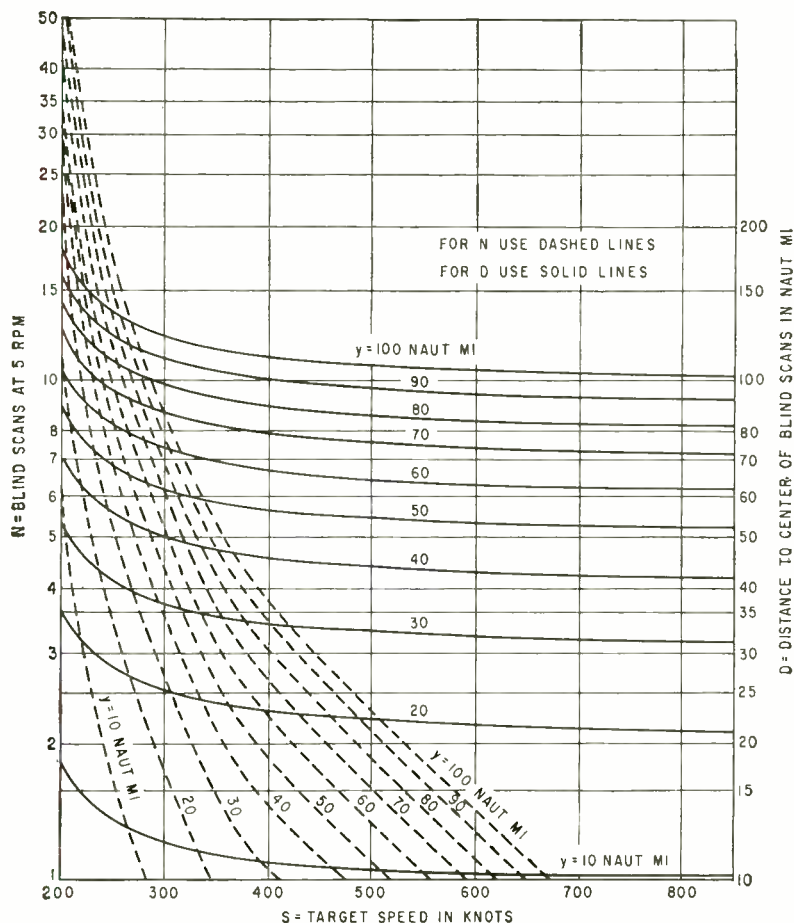

FIG. 1—Chart for determining blind scans and distances for blind speed  $V_b = 164$  knots

$Sy / (S^2 - V_b^2)^{3/2}$ , where  $S$  is the target speed,  $V_b$  the blind speed and  $y$  the track offset. Dashed lines in Fig. 1 are plots of  $N$ .

Solid lines are plots of the relation  $D = Sy / (S^2 - V_b^2)^{1/2}$ , where  $D$  is the distance to the center of blind scans. This chart, as in the previous article, is plotted for an L-band radar with a prf of 360 pps, and an antenna rotating at 5 rpm.

Charts of this type are required for every important blind speed in a given system.

A factor which was considered in plotting Fig. 1 is the range of speeds wherein a low ratio of mti signal to normal video signal results. In accordance with the velocity response of two-line mti radars and verified by flight tests, a range of 15 knots was determined. Thus, the radar is blind to targets whose radial speeds fall within  $\pm 7.5$  knots of its blind speeds. The number of blind scans varies only slightly with target range and size.



# Wide Bandwidth

with

True

Differential

Input

► Only Epsco Instrumentation Amplifiers give you all these features...

- WIDE BANDWIDTH . . . dc to 150 kc at gain of 100
- TRUE DIFFERENTIAL INPUT . . . true balance, low capacity
- HIGH COMMON MODE REJECTION . . . 200,000 to 1 dc . . . 50,000 to 1 ac
- HIGH GAIN . . . selectable gains of 100, 200, 500, 1000, 2000
- HIGH STABILITY . . . drift less than  $2\mu\text{v}$  per day; less than  $5\mu\text{v}$  long term cumulative drift
- LOW NOISE . . . less than  $3\mu\text{v}$  rms to 50 cps
- HIGH POWER OUTPUT . . .  $\pm 20$  volts, up to 40 ma
- 100,000 OHM INPUT IMPEDANCE
- FAST RISE TIME . . . 2.3  $\mu\text{sec}$ . for full scale step input at gain of 100
- WIDE DYNAMIC RANGE . . . unsaturating at twice nominal output
- NO ADJUSTMENTS OR CALIBRATIONS
- NO BATTERIES

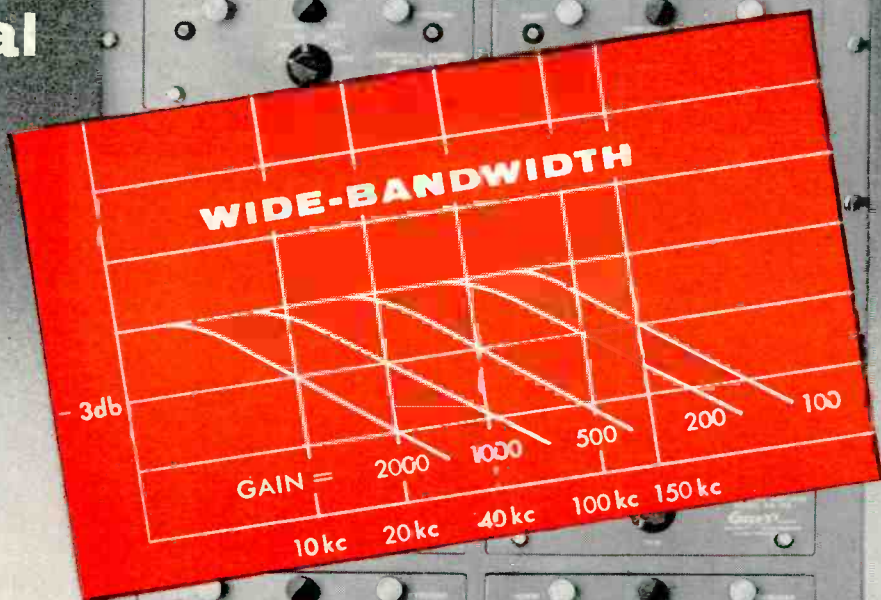

With the ever-increasing need for greater accuracy in dynamic instrumentation the demand for an expanding bandwidth in signal amplification becomes more and more urgent. Epsco Instrumentation Amplifiers not only meet the bandwidth challenge, but they also provide true differential input.

Available rack-mounted or in portable units. Write for Bulletin 105801 for complete technical information and options available.

**Epsco**   
First in data control

Epsco, Inc., Instruments & Equipment Division, 588 Commonwealth Avenue, Boston 15, Massachusetts





Sharp distinction between different densities makes electrostatic prints particularly useful for reconnaissance

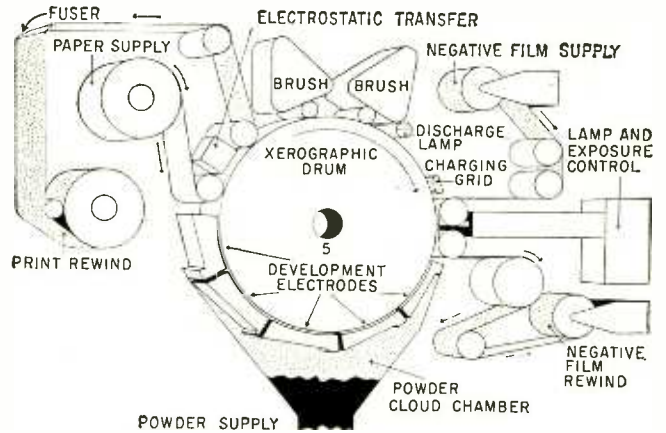

FIG. 1—Charged photosensitive selenium is used in machine to produce pictures continuously from roll of film negative

## Electrostatic Unit Prints Photos Dry

PROTOTYPE electrostatic printer makes inexpensive finished pictures in seconds from photographic negatives. The machine was developed by Haloid Xerox, Inc., for the U. S. Air Force.

The device produces finished, positive, continuous-tone pictures on white unsensitized paper at the rate of 20 ft/min, making a 9 by 9 inch print every 2½ sec.

Under combined sponsorship of the U. S. Air Force and Signal Corps, the machine was contracted for and technically monitored by the Aerial Reconnaissance Laboratory, Wright Air Development Center.

### Operation

The machine operates on the principles of xerography, making continuous-tone pictures in a machine in daylight and without chemicals or sensitized paper.

In one continuous cycle, the unit exposes, prints and finishes dry, positive pictures from a 500-ft roll of negative film up to 9 in. wide. With a simple adjustment, positive pictures can be made from positive film equally well. In this model, finished prints are the same size as the negatives. Prints could be enlarged or reduced with addition of a projection optical system.

The xerographic drum in Fig. 1 is coated with a thin layer of photosensitive selenium charged positively. The roll of negative film is

fed into moving contact with the rotating drum and exposed by a slit of light at the line of contact.

A finely dispersed (0.3-micron) charged black powder is sprayed against the drum. Portions of the drum shaded by dark areas of the film retain their electrical charge; portions covered by clear areas of the film are discharged. When negatives are printed, the charged dry powder is attracted to the uncharged areas on the drum, and repelled from the charged areas, making the latent image visible.

The powder image is brought in contact with a roll of plastic-coated white paper which is charged electrically to attract the powder from the drum. The powder is bonded tightly to the paper by briefly applying heat to soften the plastic. The image thus becomes permanent.

### Applications

The new machine is designed primarily for use in high-speed, high-volume printing from aerial film for mapping and reconnaissance purposes.

The finished prints may be viewed a few seconds after picture making begins and rapid modifications of contrast and exposure made continuously while the machine is running. A knob, calibrated to correspond to the various grades of conventional photographic papers, controls the amount of electrical

charge sprayed on the photosensitive drum. Thus modified exposures and contrasts are possible before substantial quantities of material have been processed and wasted, if adjustments were not correct.

Unlike conventional photographic emulsions, xerographic plates and drums are not affected by gamma and neutron radiation, except during the moment before exposure. In this moment, the xerographic surface is made sensitive by electrostatic charging, and is then processed so quickly that the prints are unaffected.

Prints having resolutions of 750 lines/in. can be made routinely; twice that has been attained.

Maximum density of the present xerographic pictures is not quite equal to that achieved on conventional photographic papers. However, it is anticipated that before broad acceptance is sought, further progress will be made.

## Manipulator Feels and Hears

FOUR-YEAR development program has produced an atomic manipulator that feels and hears. It will soon be able to see via three-dimensional closed-circuit television.

Developed by General Electric's General Engineering Laboratory,



first in  
Performance  
Reliability  
and Quality

# Kepeco

## TRANSISTORIZED V.R.P.S.\*

\*VOLTAGE  
REGULATED  
POWER  
SUPPLIES

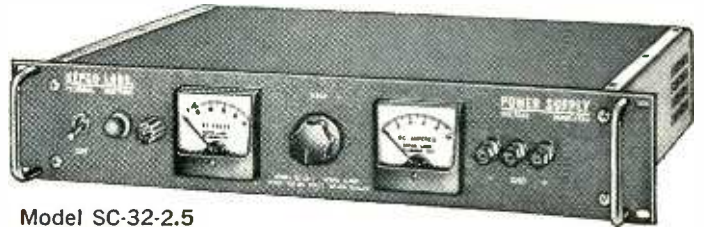

Model SC-32-2.5



Model  
SC-18-2M

0.1% REGULATION  
STABILITY

MODEL	DC OUTPUT VOLTS	DC OUTPUT AMPS.
SC-18-0.5	0-18	0-0.5
SC-18-1	0-18	0-1
SC-18-2	0-18	0-2
SC-18-4	0-18	0-4
SC-36-0.5	0-36	0-0.5
SC-36-1	0-36	0-1
SC-36-2	0-36	0-2
SC-3672-0.5	36-72	0-0.5
SC-3672-1	36-72	0-1

the most  
complete  
line of  
POWER  
SUPPLIES

0.01% REGULATION  
STABILITY

MODEL	DC OUTPUT VOLTS	DC OUTPUT AMPS.
SC-32-0.5	0-32	0-0.5
SC-32-1	0-32	0-1
SC-32-1.5	0-32	0-1.5
2SC-32-1.5	0-32	0-1.5
DUAL OUTPUT	0-32	0-1.5
SC-32-2.5	0-32	0-2.5
SC-32-5	0-32	0-5
SC-32-10	0-32	0-10
SC-32-15	0-32	0-15
SC-60-2	0-60	0-2
SC-60-5	0-60	0-5
2SC-100-0.2	0-100	0-0.2
DUAL OUTPUT	0-100	0-0.2
SC-150-1	0-150	0-1
SC-300-1	0-300	0-1

**Kepeco**

offers more than  
120 standard voltage  
regulated power supplies  
covering a wide range  
of transistor, tube  
and magnetic types.

For complete specifications,  
write for Brochure B-591



Model  
PSC-10-2

0.02% REGULATION  
STABILITY

COMPACT PACKAGE TYPE

MODEL	DC OUTPUT VOLTS	DC OUTPUT AMPS.
PSC- 5-2	0- 7.5	2
PSC-10-2	7.5-12.5	2
PSC-15-2	12.5-17.5	2
PSC-20-2	17.5-22.5	2
PSC-28-1	22.5-32.5	1
PSC-38-1	32.5-42.5	1



first in  
Performance  
Reliability  
and Quality

# Kepeco INC.

131-38 SANFORD AVENUE • FLUSHING 55, N.Y. • INDEPENDENCE 1-7000

*Don't get lost in a maze of wires!*

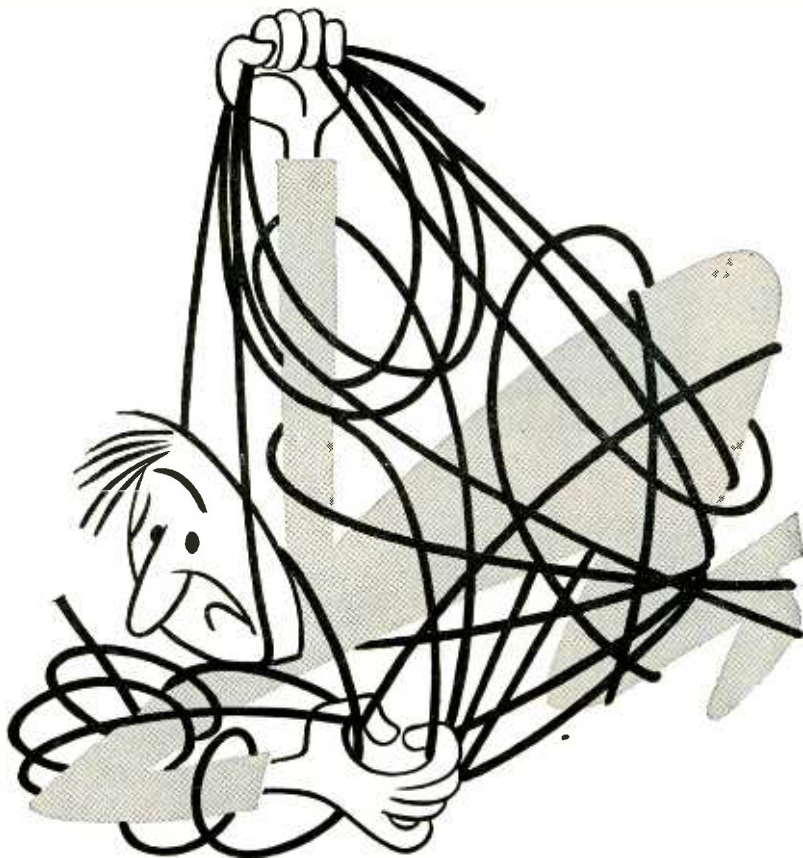

## Cut cost of assembly by as much as 65%, with printed circuits on TAYLOR copper-clad laminates

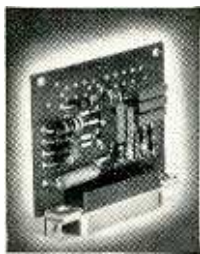

Conventional circuitry is a maze of wire and spaghetti. It is costly to assemble and unpredictable in performance. A printed circuit on TAYLOR rolled copper-clad laminate is a strong prefabricated part of known reliability. This quality is largely due to the new finish on the copper. Both solder and ink go on uniformly. The handling of one part alone can cut assembly costs as much as 65%.

And there is an important passalong benefit: field repairs, when necessary, can be made easier and more economically. Write TAYLOR FIBRE Co., Norristown 40, Pa., for complete details.

# Taylor

LAMINATED PLASTICS VULCANIZED FIBRE

CIRCLE 154 READERS SERVICE CARD

the manipulator is designed for work on nuclear aircraft machinery at the AEC National Reactor Testing Station, Idaho. The versatility and strength of the man-like machine eliminates need for a wide range of special tools and facilities.

The system is composed of five units—master, slave, electronic console and two hydraulic pump unit. Fifty-six servo loops carry signals between master and slave.

The master unit is mounted on a platform on wheels and can be raised or lowered, and rotated about a vertical axis with respect to the platform.

### Study Program

The research and development program involved an extensive study of human anatomy, to duplicate as much as possible the dexterity of the human hand and arm. The manipulator can bend its arms and fold and unfold its hands to manipulate objects of almost any shape. Using the jointed thumb and forefinger of each hand, it can hammer a nail, place one object inside another and unscrew a bolt.

Whatever the manipulator is handling, the operator feels too. For example, when it clutches a hammer, the operator in the master unit finds that he can close his fist only part way.

Ten basic motions were designed into each arm and hand. Compounded, they make possible a large range of movement, dictated by the master unit outside the danger area. Each slave hand and arm moves independently of the other.

The hand is approximately twice as strong as that of a man. With the slave arms extended one from the other the maximum distance of 9 ft, each slave hand can lift 75 pounds. Not fully extended, the hand can pick up more weight.

With his own arms and hands inside the master unit harness, the operator goes through motions desired of the manipulator. The manipulator duplicates the movement.

The forces encountered by the slave unit are reflected, or a portion of them are reflected, back to the master controls. The percentage of the forces encountered by the slave reflected to the master varies



according to the will of the operator. The ratios of force reflected back to the operator can be adjusted in increments of 3:1, 5:1, 10:1 and zero. Most work is performed so the operator feels only one-third the force exerted by the slave. These forces are reflected in such a manner that the muscular sensations the operator experiences are similar to those he would feel if he were to perform the task in person.

An analog computer determines the amount of force required by the manipulator to compensate the weight of the parts of master and slave. Thus, to the operator the manipulator appears to be weightless.

In addition to the force reflection, there is a spatial correspondence between master and slave.

Despite apparent complexity, a problem in any of the 56 servo loops can be traced to its source in less than 10 minutes. Because of modular-type design, there are very few variations in the parts, and replacement is simple.

It is believed that ultimately a system may be developed in which the slave manipulator is set in motion and controlled entirely by automatic programming.

## Clutter Computer Finds New Use

COMPUTER, originally developed for improving airborne radar operation, has been found effective as an aircraft navigational aid by Westinghouse.

In a moving aircraft, frequency of a radar signal hitting the ground is changed because of Doppler effect. Result in the radar system is unwanted noise or clutter.

A computer was designed to constantly determine approximate ground speed from air speed, wind speed and direction, and trigonometry. Knowing approximate ground speed, the computer calculates clutter frequency and filters it out for improved radar reception.

In the new application, the computer uses clutter frequency to compute actual ground speed. Hence, the total system uses the airborne fire-control radar for both Doppler navigation and fire control.

## NOW... first electrostatic generators for industrial use that can give several kilowatts at up to 600,000 volts dc

The complete line of "Sames" electrostatic generators—the first practical industrial electrostatic power supplies—are now available in the U.S. from Sorensen & Company. They supply from 50 to 600 kilovolts dc at substantial amounts of power (2400 watts for the 600 kv model).

The Sames generators (so-called from their manufacturer, Societe Anonyme de Machines Electrostatiques, Grenoble, France) are extremely compact and safe compared to transformer-rectifier-filter-type supplies in similar kilovolt ranges. The electrostatic generators are available in highly stabilized models supplying 50, 100, 150 and 600 kilovolts that are particularly suitable for electron-microscopy and many critical nuclear physics applications. Medium stability models with outputs of 50, 80, 100, 140, 150, 250, 300, and 600 kilovolts, have found wide application in Europe for testing cable insulation, alternator windings and other dielectrics, electrostatic flocking, painting and particle precipitation, electron and nuclear particle accelerators and similar applications.

Write for complete details on Sames electrostatic generators to Sorensen & Company, Richards Avenue, South Norwalk, Conn. S.36

## HIGH VOLTAGE

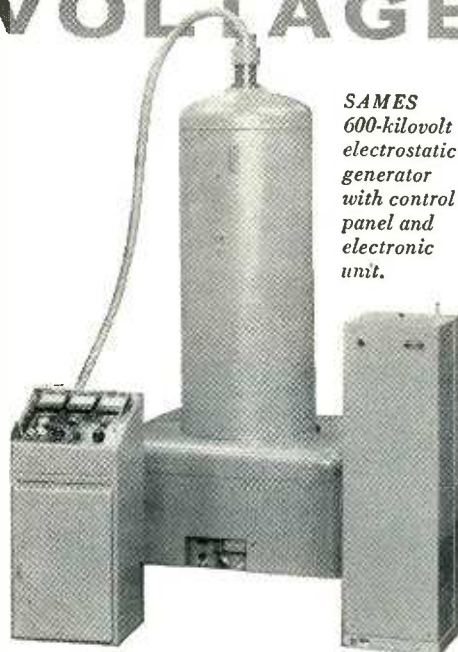

*SAMES  
600-kilovolt  
electrostatic  
generator  
with control  
panel and  
electronic  
unit.*

**SORENSEN & COMPANY, INC.**  
Richards Avenue, South Norwalk, Conn.

WIDEST LINE OF CONTROLLED-POWER  
EQUIPMENT FOR RESEARCH AND INDUSTRY

In Europe, contact Sorensen-Ardag, Zurich, Switzerland.  
In Western Canada, ARVA. In Eastern Canada, Bayly  
Engineering, Ltd. In Mexico, Electro Labs, S.A., Mexico City.



# V-Loop Antennas for Beacon Telemetry

TWO ANTENNA CONFIGURATIONS, designed to fulfill a need that exists for omnidirectional circularly-polarized broadband antennas, are shown in Fig. 1. These are beacon-telemetry antennas that will give horizon-and-down coverage over a wide frequency band. Mounted on the underside of an aircraft or missile, these antennas can be scaled to operate over a bandwidth of about 2 to 1 at any frequency from 20 mc to over 20 kmc.

## Coverage

Developed by Radiation Inc. of Melbourne, Florida and called Loop-Vee Antennas, these basic forms, designed for high power operation, may be used for both transmission and reception.

Although not designed for flush mounting, low weight and minimum projection of these antennas are a good trade-off with a flush mounted antenna which might attempt to give equivalent horizontally-polarized horizon coverage. One model is ideally suited to telemetry in the 2,250-mc band and beacon use in the S-Band.

The elevation pattern coverage of the grounded version, Fig. 1A, is about equivalent to grounded quarter-wave stub for vertical polarization, and the horizontally-polarized coverage is equivalent to that produced by a current loop above a

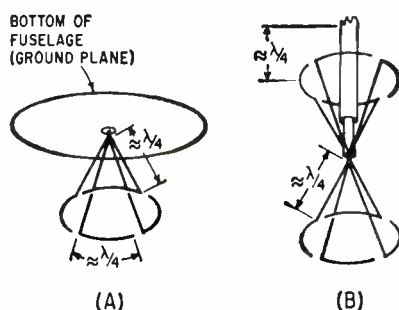

FIG. 1—Two basic forms of the circularly polarized, omnidirectional antennas illustrate the grounded version (A), and the balanced version, (B)

ground plane. At the design frequency, the relative phase of the two orthogonal components of the field is about 90 deg. when referred to the feed point, thus producing good circularity in the direction of maximum radiation.

The azimuth plane patterns are almost perfect circles for any polarization.

The impedance characteristic of Fig. 1A is equivalent to a disccone and Fig. 1B is equivalent to a biconical antenna. This accounts for the excellent broadband impedance characteristic of this type of antenna.

The vertically-polarized elevation pattern of the balanced antenna is equivalent to that produced by two in-phase current loops separated by slightly less than one-half wavelength.

## Patterns

A typical set of elevation patterns for the grounded antenna, mounted on a ground plane about four wavelengths in diameter is shown in Fig. 2. Free-space elevation patterns are shown in Fig. 3.

The driving point impedance of the grounded antenna is very close to 50 ohms resistance at the design frequency and the vswr can be maintained less than two over a bandwidth of about 2 to 1. The balanced configuration has a driving point impedance of about 100 ohms, but can be matched to a 50-ohm line by means of a quarter-wave matching section.

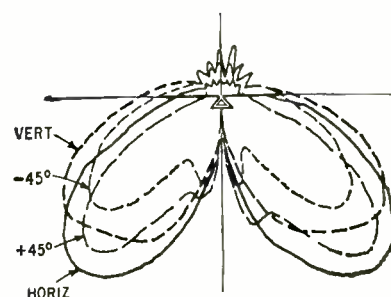

FIG. 2—Typical elevation patterns of the grounded antenna, taken on a ground plane about four wavelengths in diameter. These are voltage patterns

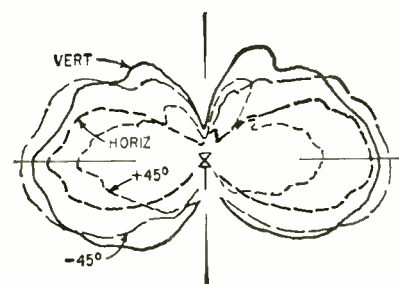

FIG. 3—Elevation patterns of a balanced antenna in free space. Irregularities are due to feed line reflections

The grounded antenna protrudes about one-quarter wavelength from the ground plane exclusive of the radome. The height of the balanced configuration is about one-quarter wavelength.

## Optimum Design

Obviously, the requirements for all applications are not the same as to pattern requirements, bandwidth, impedance characteristics, power capacity, size and shape of ground plane, and for best performance these antennas should be optimized for each application.

The balanced version may also be used with a ground plane.

## Thermoelectric Junction on the Market

AVAILABLE IN EXPERIMENTAL quantities from the manufacturer, Ohio Semiconductors, Inc., Columbus, the type TA-11 Thermo-cell is a ther-



Antenna is designed to give excellent impedance characteristics over a wide frequency band when mounted on the underside of an aircraft or missile



# your hook-up wire problems end here

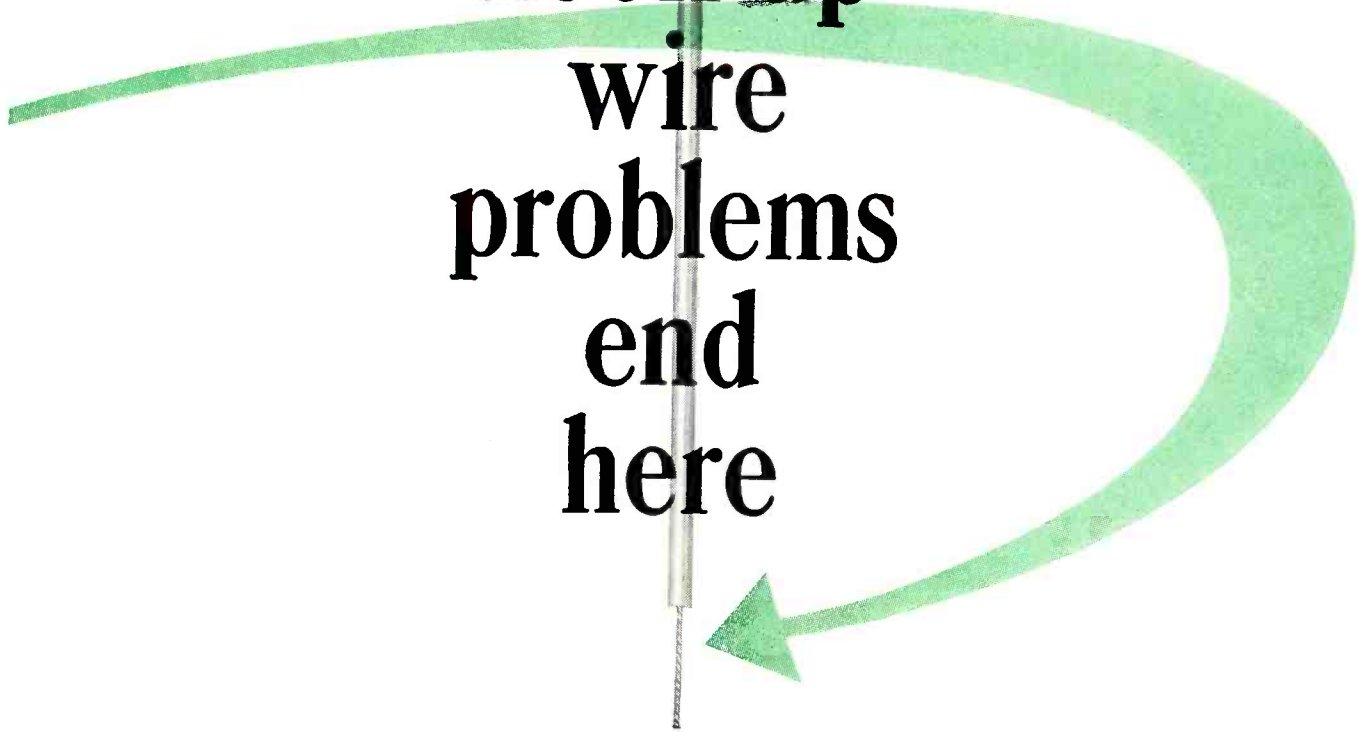

## PLASTICOTE® "THRIF-T-BOND" BONDED, TINNED HOOK-UP WIRE

What you get out of any length of wire or cable depends entirely upon what goes into it. We're not just talking about electrical properties, either. This new Plasticote "Thrif-T-Bond" Hook-Up Wire is a good example. A special overcoating process bonds the tinned strands together so they won't fray out, giving the user the workability of solid conductor wire with the flexibility of stranding... ideal for fine wire terminations in tight quarters, on all miniaturized components. The overcoating also eliminates the need for expensive induction heating equipment to bond wire during stripping operations... simplifying preparation, cutting labor costs, saving time. It's thinking like this that makes Chester Plasticote wire and cable a preferred brand in electronics... for electronics men know that Chester wire and cable is *custom engineered for the END result!*

CHESTER CABLE CORP., CHESTER, NEW YORK  
A SUBSIDIARY OF MIAMI COPPER COMPANY



Complete data on "Thrif-T-Bond" and other custom constructions is available on request, but the story of this wire begins with Chester facilities. Ask for this new booklet, too.

*Specify Chester Wire and Cable For All Your Electronic Equipment Needs*

Coaxial Cables • Hook-Up Wire • Multi-Conductor Cable • Appliance Wire • Audio Wire • Miniature Wire and Cable • High Voltage Wires • High Frequency Wires • Antenna Loop Wire • Annunciator Wire • Telephone Wires and Cables • Television Transmission Lines



Stokes high vacuum oven installed in dry box at Raytheon's Semiconductor Division. Vacuum gauges are on top of dry box.

**AT RAYTHEON**

## Transistor reliability improved with Stokes High Vacuum Ovens

Stokes High Vacuum Ovens are featured in an entirely new method of baking and processing transistors at the Semiconductor Division, Raytheon Manufacturing Co. at Newton, Mass. Chosen because they met the rigid requirements set by Raytheon engineers, these ovens assure improved transistor quality and uniformity, more stable electrical parameters and increased production.

Operating continuously 24 hours a day, the twelve Stokes ovens consistently maintain the conditions demanded by Raytheon's closely controlled drying technique. Yet only one operator per shift is required to attend six ovens.

If high vacuum is an important aspect of your present or planned process, Stokes' long experience in vacuum techniques, and in designing and manufacturing high vacuum equipment, can be of valuable aid. Your inquiry is invited.

The Stokes Model 236 Vacuum Baking Oven includes fully automatic instrumentation.

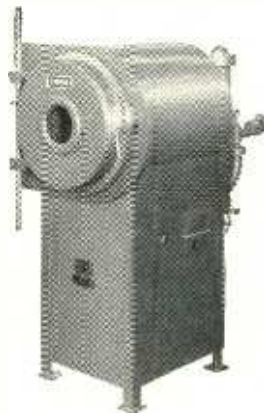

**STOKES**

Vacuum Equipment Division  
F. J. STOKES CORPORATION  
5500 Tabor Road, Philadelphia 20, Pa.

molectric junction designed to maintain a temperature either above or below the ambient. It can be used for cooling, heating, power generation and dynamic heat transfer in such applications as quartz crystal ovens and other critical electrical circuits.

At normal room temperatures and with an input power of two watts to the junction, it is possible to obtain a temperature difference of more than 40 C. The cold junction temperatures is  $-15\text{ C}$  with no external heat load.

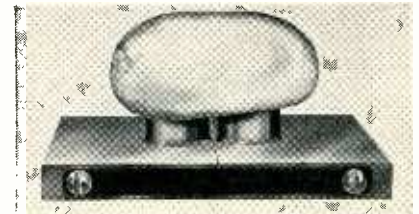

Frosted Thermo-cell being used as a Peltier cooler. Cold junction temperature is  $-35\text{ C}$  with power input of two watts

Typical specifications for the device are as follows: resistance,  $0.0025\text{ ohm}$ ; maximum current for heating and cooling applications,  $40\text{ amp}$ ; maximum hot junction temperature,  $150\text{ C}$ ; minimum cold junction temperature,  $-75\text{ C}$  and figure of merit (average of  $p$  and  $n$  type),  $2.25 \times 10^{-8}\text{ K}^{-1}$ .

Units may be connected in series or parallel for greater cooling or heating capacity.

## Heat-Dissipating Coil for Rotary Components

STANDARD ROTARY COMPONENTS such as servo motors and synchros can be operated at temperatures higher than their rated upper limits by use of a heat-dissipating coil. The coil, developed by Kearfott Co., Inc., is a finned aluminum unit that is clamped around the component's housing. Internal heat generated by continuous operation is conducted rapidly to the coil's fins where it is radiated into the air.

The coil consists of a deeply threaded short tube with an inside diameter slightly less than that of the component's housing diameter. The coil is slotted lengthwise to permit insertion of a spreader bar



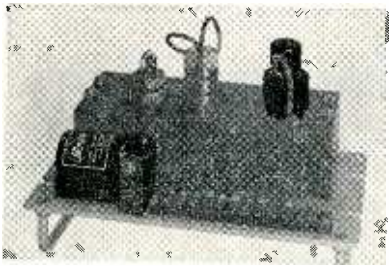

to spring the coil wide enough to insert the particular unit of interest. When the component is positioned properly within the coil, the spreader bar is removed, allowing the coil's spring tension to clamp the unit firmly. This puts the coil in intimate contact with the rotary component for efficient heat transfer.

The coil is available to fit standard 8, 10, 11, 15 and 18 rotary components.

## Helicopter Lays Cable at 100 Mph

DEVELOPMENT of a new cable by International Telephone and Telegraph Laboratories in cooperation with the Signal Corps has made it possible for a helicopter to lay the cable at speeds of 100 mph.



The telephone cable is made up of a twisted pair of polyethylene-insulated coaxial lines packed zig-zag fashion in a special package designed by Flight Refueling, Inc. Each package holds ten miles of cable. The cable can carry 96 simultaneous two-way conversations or 336 separate computer or teletypewriter links.

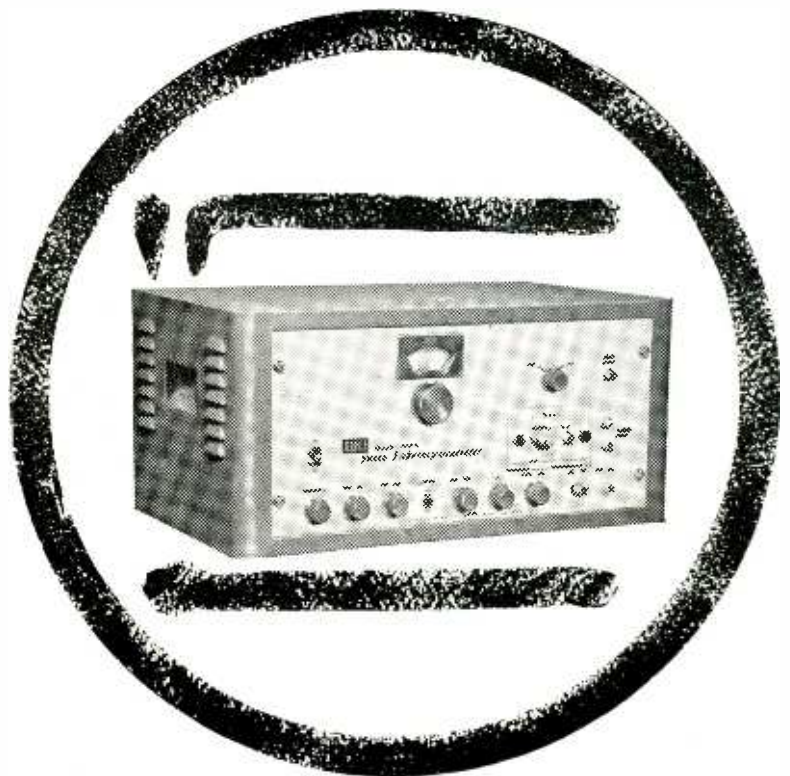

**JERROLD'S** versatile new

## 900A Sweep Generator Covers the Range of Three Regular Instruments!

It's the most versatile Sweep Generator in the electronics industry... this one instrument covers all your needs from 1/2 MC to 1200 MCS, for IF's, radar, video, telemetering and communications!

**Specifications:** In two ranges—0.5 MC to 400 MC and 275 MC to 1200 MC—the instrument supplies sweep signal with center at any frequency from 500 KC to 1000 MC and with sweep widths as broad as 400 MC and as narrow as 100 KC. The RF output carefully monitored by matched, crystal diodes feeding a two-stage, push-pull AGC amplifier—is flat within  $\pm 0.5$  db at full sweep width up to 800 MCS and  $\pm 1.5$  db from 800 MCS to 1200 MCS. When using sweep widths as narrow as 20 MCS flatness at any center frequency is approximately  $\pm 0.15$  db.

**\$126000**

**MODEL 900A IS NOW IN QUANTITY PRODUCTION!**

- **HIGH OUTPUT!** .25 volt RMS on VHF—  
.5 volt RMS on UHF!
- **WIDE SWEEP WIDTHS!** From 100 KC up  
to 400 MCS!
- **FLAT OUTPUT!** Flat to  $\pm .5$  db on  
widest sweep width!

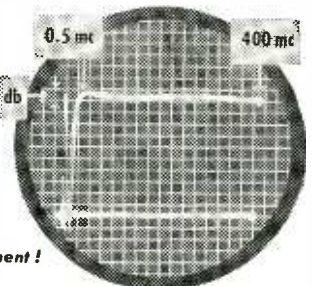

Write for on the spot demonstration of this versatile instrument!

**JERROLD ELECTRONICS CORPORATION**

Industrial Products Division Dept. TED 38, The Jerrold Building, Philadelphia 32, Pa.

Jerrold Electronics Corp., Ltd., Toronto, Canada

Export Representative: Rocke International, New York 16, N. Y.

# Instrument Finds Mica Waviness



Operator is shown using wavniness tester to grade mica

WAVINESS MEASURING instrument for nondestructive testing of mica flatness has been developed by American Research and Manufacturing Corp., Rockville, Md. It analyzes reflection of light rays from the mica surface to determine the amount of waviness in a sample or a specific defect.

Principal parts of the instrument

are shown in Fig. 1. The light gun projects a tight cone of light rays onto the mica. The reflection into the analyzer is rapidly chopped and its width measured. The signal

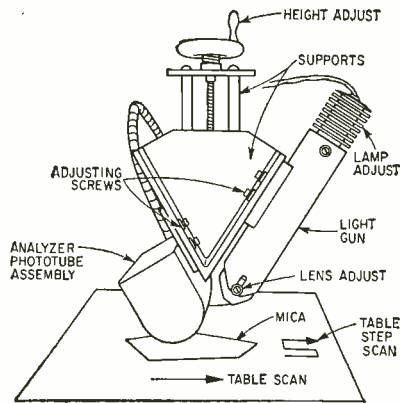

FIG. 1—Principal parts of wavniness tester

from the analyzer, indicating the amount of beam spreading or distortion, is amplified and displayed or recorded.

Findings can be displayed as waviness index numbers, or calibrated into units of measurement such as the radius of curvature of a defect. The tester will automatically traverse an area up to 8 inches square or can be manually controlled to traverse an irregular area.

A prototype has been delivered to the General Services Administration. Its development was monitored by NBS and ASTM. A model for production testing of mica is under consideration. The firm reports the instrument is also suitable for surface investigations of other materials, coatings, contours and corrosion.

# Automatically Winds Capacitors

AUTOMATIC WINDER for metalized capacitors will make 1 and 2 layer capacitors with a paper width of 40 to 60 millimeters, a paper length of 3 to 40 meters and a diameter of 8 to 35 mm.

The machine was developed and built at Standard Telephone et Radio, S. A., Zurich, Switzerland, an affiliate of International Telephone and Telegraph Corp., New York.

Capacitors are wound on a hard paper tube with an outside diameter of 6.5 mm. The magazine-loaded tubes are inserted into winding position, where they are friction driven by 3 cylinders triangularly positioned.

## Automatic Feed

The paper automatically enters the winding mechanism. After a few windings are made, the speed of the driving rolls is increased to 1 meter a second. When the prescribed length is reached, the winding speed slows to about 0.25 meters a second.

The papers are perforated by revolving combs, on the lower 4 of the group of 8 small rollers. After per-

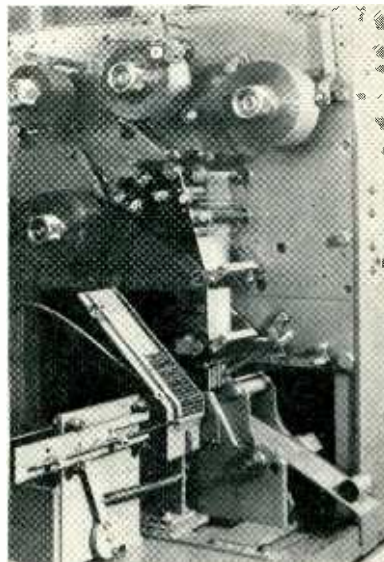

Paper is unrolled and wound at speed of 1 meter a second

foration, the paper rolls are blocked so that the papers are torn off at the perforations. The outer paper is glued in place and the capacitor ejected.

Regulation of the paper length (capacitor diameter) is handled by a sliding device. The machine stops automatically when a paper band

tears. Operation time is reported as  $\frac{1}{3}$  that of former methods. One operator surveys several machines.

# Electron Bombardment Welds Tough Metals

ELECTRON BOMBARDMENT apparatus for production welding of metals, including the reactive and refractory metals, is announced by High Vacuum Equipment Corp., Hingham, Mass. Welding is done in a vacuum by a focused beam of high velocity electrons drawing about 0.2 amp of current.

The emitter, a tungsten filament,



Fine adjustments in electron beam may be made during operation



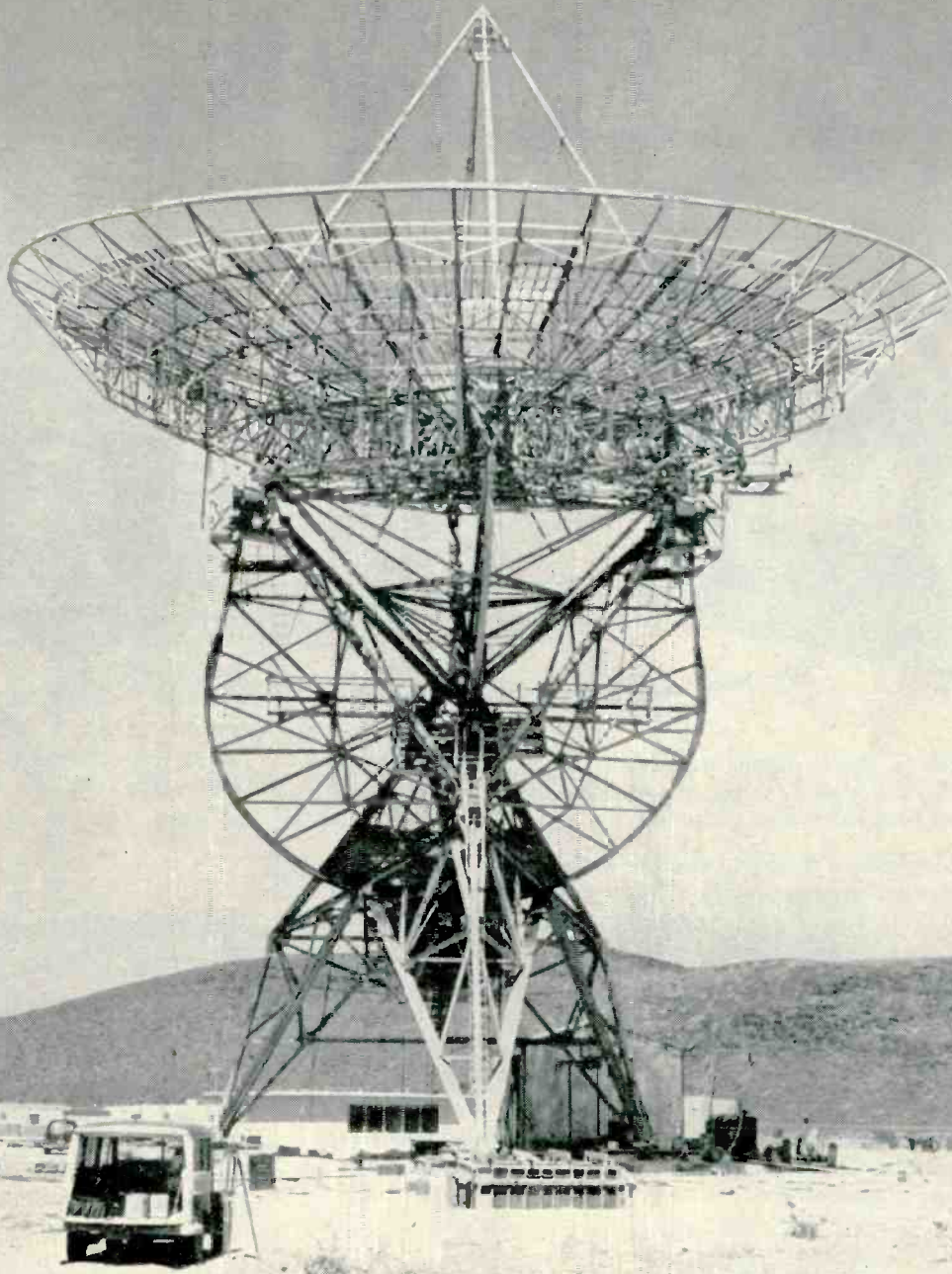

85' diameter tracking antenna, shown under construction. Reflector face surface is fabricated from aluminum. Pedestal, Polar Cage, Declination Cage and back up structure are of galvanized steel.

## New BLAW-KNOX 85' diameter tracking antenna for U.S. Lunar Probe Project

This newest Blaw-Knox 85' Tracking Antenna is part of the Space Probe Project of the Jet Propulsion Laboratory at Pasadena, Calif. It will be used to maintain communications with space vehicles at ranges up to 250,000 miles.

Its design is fully determinate. All structural members of the assembly are analyzed for stress and deflection before fabrication. Coupled with shop fabrication and field erection to rigidly accurate tolerances, it is capable of the highest gain, with a minimum of distortions or aberrations.

The entire drive system embodies such critical design requirements as infinitely variable movement with negligible creep or overrun for tracking. The slewing drives are capable of the extremely rapid acceleration and deceleration necessary to focus on targets.

Pioneering like this is the latest step in a long series of Blaw-Knox developments. Such milestones as the Guyed Vertical Radiator design in AM radio, the first radar antenna used to bounce signals off the moon, and the Tropospheric Scatter Antenna for over-the-horizon television have marked Blaw-Knox as a world leader in advanced design, fabrication and erection techniques.

Blaw-Knox welcomes the opportunity to translate your most advanced concepts into highly reliable operating equipment. Contact the Antenna Group.

**Antennas**—Rotating, Radio Telescopes, Radar, Tropospheric and Ionospheric Scatter.



**BLAW-KNOX COMPANY**  
Blaw-Knox Equipment Division

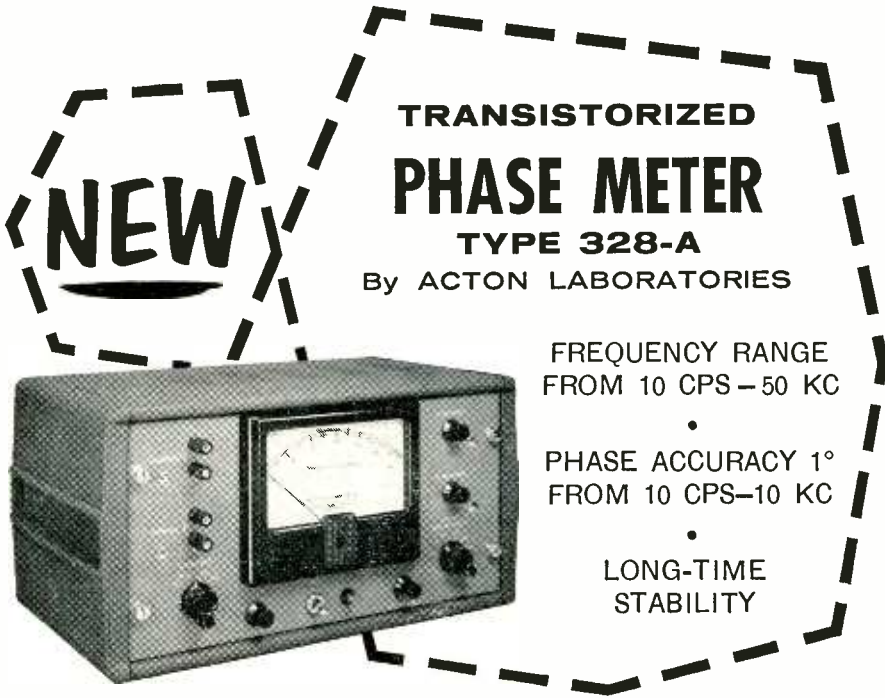

# TRANSISTORIZED PHASE METER

TYPE 328-A  
By ACTON LABORATORIES

FREQUENCY RANGE  
FROM 10 CPS - 50 KC

PHASE ACCURACY 1°  
FROM 10 CPS - 10 KC

LONG-TIME  
STABILITY

**FEATURING . . .** Direct reading from 0° to 360° in 6 ranges of 60° each (on a 5" meter scale) • Wide variety of applications • Recorder connection • Can operate from external 45 volt battery

Type 328-A is designed specifically to measure the phase angle in degrees between two sinusoidal or non-sinusoidal voltages within a frequency range from 10 cps to 50 kc. It is capable of handling a wide variety of applications in the field of audio facilities, supersonics, servo-mechanisms, geophysics, vibrations, acoustics, aerial navigation, electronic power, transformation, signalling, computing amplifiers and resolver systems.

Acton Laboratories' Type 328-A Phase Meter is extremely simple to operate. All controls are functional. Readings of phase angles are indicated directly on meter scale which has six full-scale ranges of 360°, 300°, 240°, 180°, 120°, and 60°. Phase angle, as measured by the 328-A is defined as the angular separation of the corresponding zero-axis crossings of the periodic signals being compared.

Available as Type 328-AR with a 19" panel for rack mounting.

## SPECIFICATIONS

Amplitude Range — .25 to 170 volts peak (1 volt min. below 500 cps)

Phase Accuracy — For input signals above 10 volts peak from 10° to 350°

Frequency	Phase Accuracy
10 cps — 10 kc	1°
10 kc — 30 kc	2°
30 kc — 50 kc	3°

Input Impedance — One megohm shunted by 20 mhf

Recorder Output — Maximum voltage at 360° is -2.0 volts. Internal output impedance is approximately 100,000 ohms

Power Supply — 105-125 volts, 60 cycles A.C. Total power consumption is approximately 20 watts.

Terminals are also provided for operating from an external 45 volt battery.

Dimensions — 15¾" W. x 8¾" H. x 10¾" D. (cabinet mounted)

Weight — 18 lbs.

Complete technical details on Type 328-A Phase Meter are available on request.

**ACTON LABORATORIES, INC.**  
517 MAIN STREET, ACTON, MASS. • COLONIAL 3-7756



is housed in an electron gun structure which is at 15,000 volts negative. The workpiece, acting as the anode, is at ground potential. Electrons, attracted to the work, quickly heat it to a molten state. The gun confines the electron beam to a small diameter.

Oxides, nitrides and carbides which may be present in the materials in the weld zone are ionized into positive ions and are attracted to the gun's grid. After the gun is turned off, the impurities fall off the grid or may be brushed off by the operator.

Maximum workpiece sizes are 10 inches diameter by 12 inches high on a turntable, 42 inches length with vertical setup, or 120 inches length with optional extension enclosures. Maximum outside diameter is 3.125 inches and maximum wall thickness is 0.375 inch. Operating vacuum is 0.01 to 0.1 micron.

## Ultrasonic Grinder Forms Mesa Diodes

By P. ZUK, Bell Telephone Laboratories, Inc., Allentown, Pa.

SMALL AREA JUNCTIONS must be formed in the manufacture of the 1N696 millimicrosecond computer diode to achieve low capacitance. A process combining solid state diffusion and ultrasonic cutting has been developed to make the diodes in large quantity and high uniformity.

Donor and acceptor centers are diffused into opposite sides of thin silicon slices. Slices are painted and stacked in the diffusion furnace to yield thousands of diffused wafers

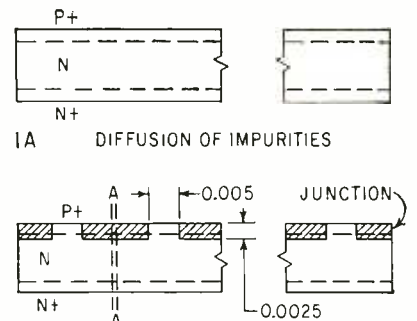

FIG. 1—Diffusion and cutting methods (not to scale)



simultaneously. A junction is formed at a uniform depth of 0.0015 inch. *N* type silicon is used and the resultant cross-section of a slice is shown in Fig. 1A. The *N+* and *P+* surfaces permit easy attachment of ohmic contacts.

Ultrasonic cutting is used to form the mesas controllably with a height of 0.0025 inch. The cutting tool is a cutting plate with a number of 0.005 inch diameter holes. When this is brought into contact with the silicon in the presence of a slurry, the shaded portions shown in Fig. 1B are removed, leaving hundreds of cylindrical mesas physically uniform and having a precisely located junction. A second cutter separates the mesas on larger-sized islands by a pass shown as A-A in Fig. 1B.

These processes have been used by the Western Electric Company at Laureldale, Pa., to produce high-speed diodes for military applications with a switching time of about 1 millimicrosecond and a zero bias capacitance of about 2.5  $\mu\mu\text{f}$ .

### Instrument Bearings Packed in "Blisters"



BLISTER PACKAGING of bearings avoids the possibility of contamination when 1 bearing is removed from a package of several bearings. A new package, developed by the Eclipse-Pioneer division, Bendix Aviation Corp., Teterboro, N. J., and Celanese Corp. of America, seals bearings individually in transparent acetate. An acetate cover strip and a coated lint-free paper board are heat sealed to the blister strip in 1 operation. The paper board stiffens the package, can be printed with the bearing identification and is perforated so that individual blisters can be torn off. The packaging machine is made by Packaging Industries, Ltd., Montclair, N. J.

## New Deutsch "Snap-In" Miniature Connectors make RELIABILITY a REALITY



Here's a snap-in miniature you can trust to do what it's supposed to do. The new Deutsch DS Series of quick-disconnect connectors—with insertable and removable contacts and crimp-type terminations—has been thoroughly tested and *proved* under extreme environmental conditions.

*Proven*  
Check these advantages against your design requirements



	DS FEATURES	YOUR DESIGN REQUIREMENTS
1 Pins and sockets	Easily insertable and removable	
2 Terminations	Crimp-type	
3 Contact retention	Withstands minimum of 25 lbs. pull	
4 Crimp strength	Greater than the wire itself	
5 Hand tools	Simple, fool-proof crimping, inserting and removal tools	
6 Interfacial seal	Continuous dielectric separation without voids; no bonding, reversion or shrinkage of inserts	
7 Environmental	Meets or exceeds MIL-C-26482 (ASG)	
8 Temperature	-100°F. to 300°F.	
9 Push-pull coupling	Positive ball-lock design; operates in direction of plug travel	
10 Contact size	Immediately available in #20 size; others to follow	
11 Shell size	Immediately available in 3, 7, 12, 19, 27, 37 and 61 contacts	
12 Interchangeability	Mates with existing Deutsch DM5000, DM6500 and DM9000 series	
13 Assembly	Delivered completely assembled except for insertion of contacts	

For complete technical information and test report, contact your Deutsch Representative or write us for Data File 5B.



**The Deutsch Company**  
7000 Avalon Boulevard • Los Angeles 3, Calif.

© THE DEUTSCH COMPANY, 1959

# On The Market

## Phase Detector precision instrument

AD-YU ELECTRONICS LAB., INC., 249 Terhune Ave., Passaic, N. J. A new precision phase detector for r-f and video frequencies is capable of measuring phase angle or time delay with an error of 0.05 deg or  $\pm 1$

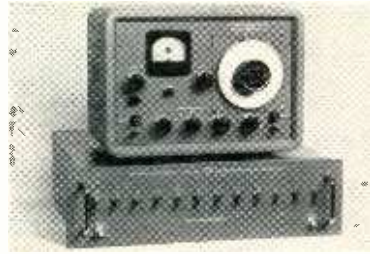

percent from 100 kc up to 15 mc. Essentially, it consists of an input cathode follower, two amplifier stages, a step variable delay line, a continuously variable delay line, a differential tuned amplifier, a balanced phase detector and a sensitive output indicator. **Circle 200 on Reader Service Card.**

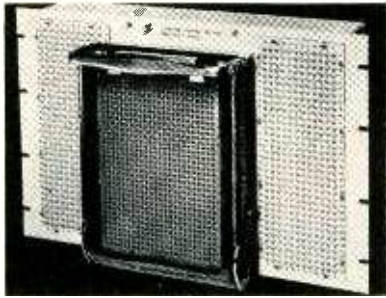

## Plugboard Panel compact unit

COMPUTER CONTROL Co., INC., 92 Broad St., Wellesley, Mass. Model PB-10 plugboard panel is designed to facilitate fast interchange of T-PAC circuit configuration. It consists of one panel-mounted AMP universal patchcord programming

system, containing 816 gold-plated contacts arranged in a 34 by 24 array. Each contact is brought out to a taper pin jack on the front terminal to permit convenient compatible wiring connections to the associated T-PAC terminals. Plugboard is center-mounted on a standard 19 by 12 $\frac{1}{4}$  in. rack panel. **Circle 201 on Reader Service Card.**

## Resistance Element metal-ceramic

CHICAGO TELEPHONE SUPPLY CORP., Elkhart, Ind. A new resistance element is produced by a process which fires a metal resistance path onto ceramic at temperatures exceeding 600 C. Because the element

is very stable to 500 C, it is extremely reliable at the elevated temperatures demanded in military requirements. Current data indicate a temperature coefficient under 250 ppm per deg C over a range of -63 C to +150 C. Resistance range, 10 ohms to 100 K ohms per square. **Circle 202 on Reader Service Card.**

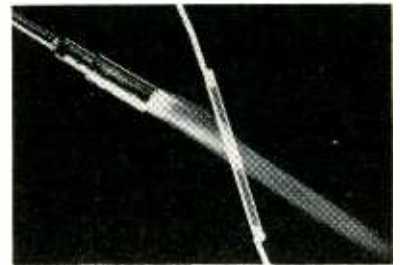

## Readout Tube numeral glow

NATIONAL UNION ELECTRIC CORP., Bloomington, Ill. The NUP102 Inditron is a 0-9 numeral glow readout tube. Operating characteristics are: anode voltage, 150 d-c minimum;



anode current, 2 ma nominal, with a 6 K ohms resistor minimum. It is slightly over 1 in. in diameter; seated height is 1 $\frac{1}{8}$  in.; numeral height,  $\frac{5}{8}$  in. It has a standard 13-pin base for which there is a commercially available socket. **Circle 203 on Reader Service Card.**

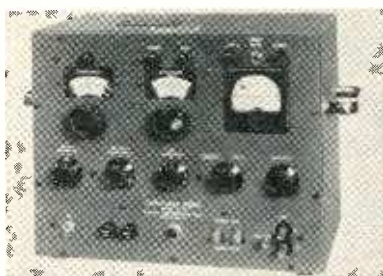

## Capacitance Bridge three-terminal

BOONTON ELECTRONICS CORP., 738 Speedwell Ave., Morris Plains, N. J. Model 74-CS8 accurately measures small values of direct or grounded capacitance. Capacitance measurement range is from 0.0002  $\mu\mu\text{f}$  to

11,000  $\mu\mu\text{f}$  with an accuracy of 0.25 percent pulse range factor. Differential capacitance measurement can be made with a readability of  $\pm 1$  ppm on nominal values above 200  $\mu\mu\text{f}$  and a conductance measurement of 0.01  $\mu\text{mho}$  to 1,000  $\mu\text{mhos}$  with a test frequency of 100 kc. A d-c voltage source is arranged so that



# First Digital Voltmeter With Mathematically Perfect Logic...



The first stepping switch voltmeter with mathematically perfect logic . . . and the first to be completely transistorized! It's the NLS V-34, the latest instrument to be developed by the originators of the digital voltmeter. The exclusive new digital logic of the NLS V-34 allows readings to be made without cycling stepping switches through all nine positions in each decade. For the first time, "needless nines" are eliminated . . . the result: longer switch life and shorter measuring time. Check the exclusive features listed below.

## "NO NEEDLESS NINES"

FOR FASTER MEASUREMENTS AND GREATEST RELIABILITY

**MATHEMATICALLY PERFECT LOGIC** — No numbers change that absolutely do not have to change. Stable measurements can be made of varying voltages.

**STEPPING SWITCHES SEALED IN OIL** — Each stepping switch is mounted in an individual oil-filled container. No manual lubrication needed. Oil bath extends life by factor of ten.

**PLUG-IN STEPPING SWITCH MODULES** — Stepping switches can be replaced as quickly as plugging in the meter.

**FIRST COMPLETELY TRANSISTORIZED DIGITAL VOLTMETER** — Even logic functions are performed by semi-conductors. Switch points reduced to one-half those required by "completely transistorized" competitive meters. Only the NLS V-34 is transistorized to the fullest possible extent.

### SPECIFICATIONS

Range to  $\pm 1000$  volts . . . Ratio to  $\pm .9999$  . . . 10 Megohm input impedance . . . 0.01% accuracy . . . Automatic range and polarity changing . . . five-digit model also available.

Write today for complete information on the NLS V-34



Originators of the Digital Voltmeter

**non-linear systems,  
inc.** DEL MAR (San Diego), CALIFORNIA

## COMPARISON CHART

The few steps required by the NLS V-34 to make a typical measurement (3rd column) are compared with the many required by competitive meters. Note the blue "needless nines" in the middle column.

NO. OF STEPS	COMPETITIVE METERS	NLS V-34
0	+ .8888	+ .8888
1	+ .8889	— .8888
2	+ .8880	— .9888
3	+ .8890	— .0888
4	+ .8800	— .1888
5	+ .8900	— .1988
6	+ .8000	— .1088
7	+ .9000	— .1188
8	+ .0000	— .1198
9	— .0000	— .1108
10	— .0001	— .1118
11	— .0002	— .1119
12	— .0003	— .1110
13	— .0004	— .1111
14	— .0005	
15	— .0006	
16	— .0007	
17	— .0008	
18	— .0009	
19	— .0019	
20	— .0029	
21	— .0039	
22	— .0049	
23	— .0059	
24	— .0069	
25	— .0079	
26	— .0089	
27	— .0099	
28	— .0199	
29	— .0299	
30	— .0399	
31	— .0499	
32	— .0599	
33	— .0699	
34	— .0799	
35	— .0899	
36	— .0999	
37	— .1999	
38	— .1099	
39	— .1199	
40	— .1109	
41	— .1119	
42	— .1110	
43	— .1111	



THE MEASUREMENT IS COMPLETED IN JUST 13 STEPS BY THE NLS V-34

**NLS — The Digital Voltmeter That Works...And Works...And Works!**

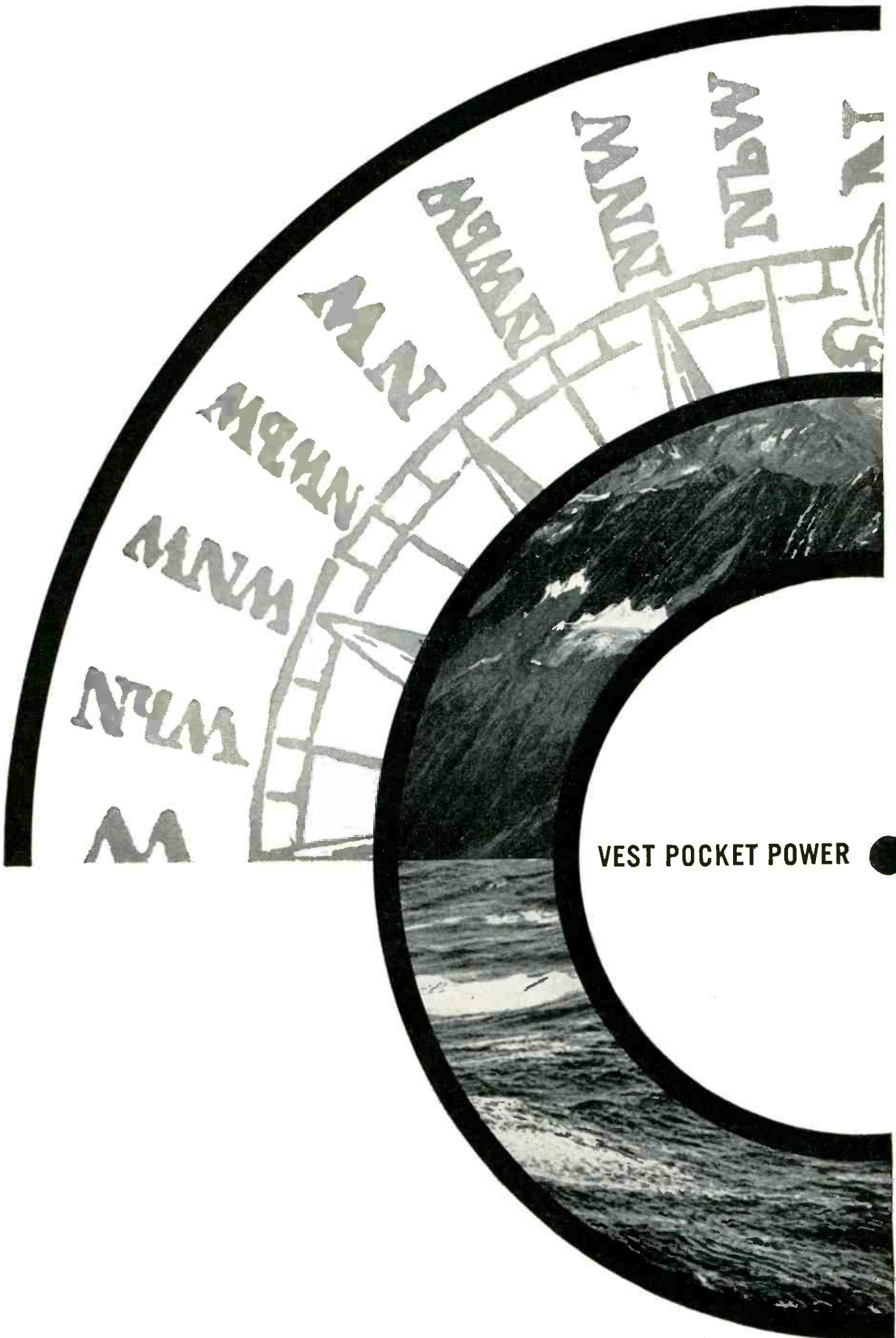

VEST POCKET POWER ●



*From vest-pocket nuclear generators for ocean, arctic and wilderness stations—or satellites and space systems—to portable power reactor systems meeting the large-scale requirements of military installations, the products of Martin's five-year nuclear development program are now making news... Developed under the direction of the AEC, the pint-sized 4-pound Martin SNAP III thermo-electric generator was recently singled out for commendation by the scientific community. Meanwhile, Martin is at work on a portable nuclear power plant, designed for transport by air, to provide power and heat for an Air Force installation at Sundance, Wyoming.*



*The Nuclear Division  
is one of the  
seven divisions  
of The Martin Company*

it can be applied as a bias to the component undergoing test. **Circle 204 on Reader Service Card.**

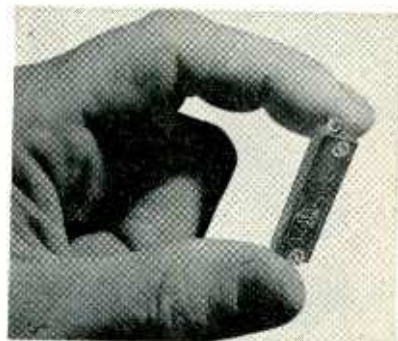

### **Miniature Pot trimmer type**

ATOHM ELECTRONICS, 7648 San Fernando Road, Sun Valley, Calif. The W-10 miniature pot provides high accuracy—once set it remains at ohm setting under a wide range of environmental conditions. The variable micrometer type adjustment gives a precise selection of resistance—from 10 ohms to 150,000 ohms. The high-temperature housing material withstands up to 500 F. Among unit's many features are all-welded internal connections; double connection—rotating and sliding for positive contact with wiper; Kel-F insulator provides moisture and dust barrier; ratio of mass to interior space is 9 to 1 for extra strength. **Circle 205 on Reader Service Card.**

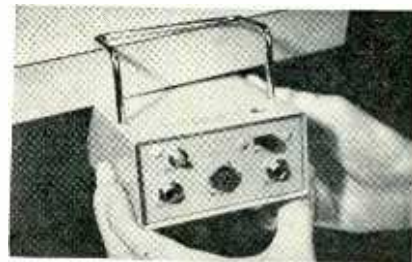

### **EEG Preamplifier transistorized**

LEVINTHAL ELECTRONIC PRODUCTS, INC., 760 Stanford Industrial Park, Palo Alto, Calif. The new preamplifier makes it possible to display electroencephalograph (EEG) signals on standard medical cardioscopes and electrocardiographs by increasing their sensitivity by a factor of 30. It features an exceptionally low

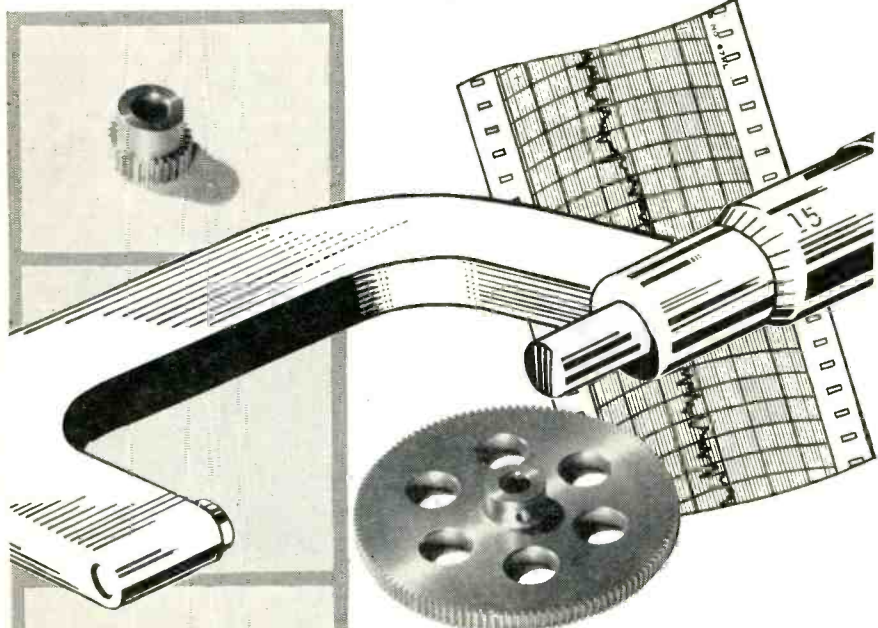

**YOU CAN ALWAYS DEPEND ON**

*Certified*

**APPCO PRECISION  
STOCK GEARS**

Precision gears of all types, pitches and sizes right out of stock. Each certified for accuracy . . . each meets or surpasses A. G. M. A. specifications.

APPCO Certified Precision Stock Gears are offered in 32, 48, 64, 72, 96 and 120 diametral pitches of  $14\frac{1}{2}^\circ$  and  $20^\circ$  pressure angles. Each gear is completely sealed on a shipping tray with a plastic cover . . . always "factory-fresh," free of dust, corrosion, and scratches.

APPCO Precision Gears are engineered and manufactured to allow for accurate assembly of precision units . . . held to tolerances that assure precise fits to standard instrument bearings, shafting, etc. according to accepted industry practice and A. G. M. A. specifications. For complete technical data and catalog write to Atlas Precision Products Co., Castor and Kensington Aves., Philadelphia 24, Pa.



Division of  
**PRUDENTIAL INDUSTRIES INC.**

noise level of  $1\mu\text{v}$  peak and an impressively high 60-cycle rejection of 1 million to 1. Unit has no operating controls—only a  $50\mu\text{v}$  calibrate button. Price, complete with cables, is \$325. Circle 206 on Reader Service Card.



**D-C Solenoid  
midget size**

GUARDIAN ELECTRIC MFG. CO., 1621 W. Walnut St., Chicago 12, Ill. The No. 22 d-c midget solenoid features plunger strokes adjustable from  $\frac{3}{8}$  in. to  $\frac{5}{8}$  in. with a maximum lift of 11 oz, continuous duty; 24 oz, intermittent duty. Overall dimensions are  $\frac{3}{4}$  in. high by  $1\frac{1}{8}$  in. long by  $\frac{3}{4}$  in. wide. Coil values range from 6 to 110 v, d-c only. Shipping weight is approximately 2.5 oz. Circle 207 on Reader Service Card.

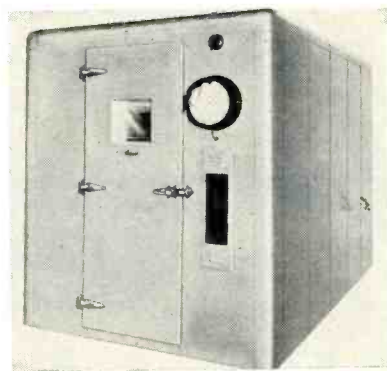

**Environmental Room  
portable unit**

ELECTRIC HOTPACK CO., INC., 5017A Cottman Ave., Philadelphia 35, Pa., has developed a new room designed to provide improved production and quality techniques involving electronic components and systems requiring closely controlled atmospheres for assembly or testing. It features atmospheres of heat to  $125\text{ C}$ , refrigeration to  $0\text{ C}$ , humidity from 20 to 98 percent, and is equipped with air filter, dehumidifier, and purifier. Work bench and storage



# LOW COST STANDARD BOBBIN CORES FOR COMPUTER APPLICATIONS

protected by **ARMAG\*** non-metallic armor

## FLUX RATINGS AVAILABLE IN EIA PREFERRED NUMBER SERIES FOR SIMPLIFIED DESIGN

### NEW STANDARD BOBBIN CORE SERIES:

... offers a decade progression of flux ratings with *guaranteed* switching times. *For the first time*, designers using magnetic core logic can select low cost bobbin cores on a *catalog basis*, with complete published specifications, in the same simplified way you select capacitors and resistors.

### NEW SPECIAL BOBBIN CORE SERIES:

... offers flux ratings in decade progression with switch time and noise ratio specified by the customer.

### DYNACOR CUSTOM SERIES:

... for special applications, the Custom Series continues to offer bobbin cores tailored to the most exacting customer specifications.

### ARMAG\* NON-METALLIC ARMOR:

... provides maximum protection for all DYNACOR

Bobbin Cores. Suitable for use with normal encapsulation techniques, ARMAG is available on both ceramic and stainless steel bobbins. *It costs no more than the polyester tape and nylon materials which it renders obsolete!*

### CHECK FEATURES — SEND FOR BULLETINS:

... Rigidly controlled 4-79 Molybdenum Permalloy Tape • Ceramic or Stainless Steel Bobbins • ARMAG\* Protective Jackets • 100% Tested to Performance Specifications • Maximum Uniformity in Production Quantities • Reliable Reproduction of Uniform Cores to Rigid Performance Specifications—on order after order—over long periods of time!

Write for Engineering Bulletins DN-1000A and DN-1003 for complete performance and specification data covering the wide range of Dynacor Standard, Special and Custom Bobbin Cores. Address your letter to Technical Literature Section.



\*TRADEMARK

# DYNACOR

A SUBSIDIARY OF  
**SPRAGUE**  
ELECTRIC COMPANY

DYNACOR, INC., 10431 METROPOLITAN AVENUE • KENSINGTON • MARYLAND

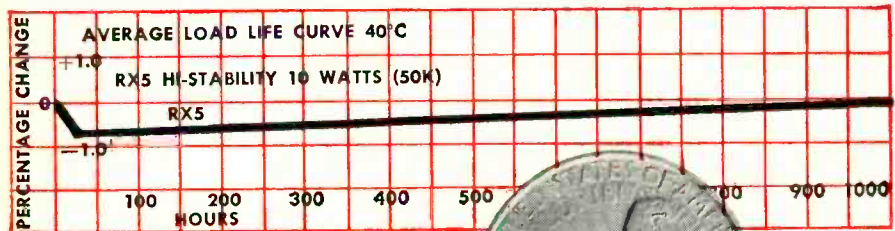

Now—under a dollar

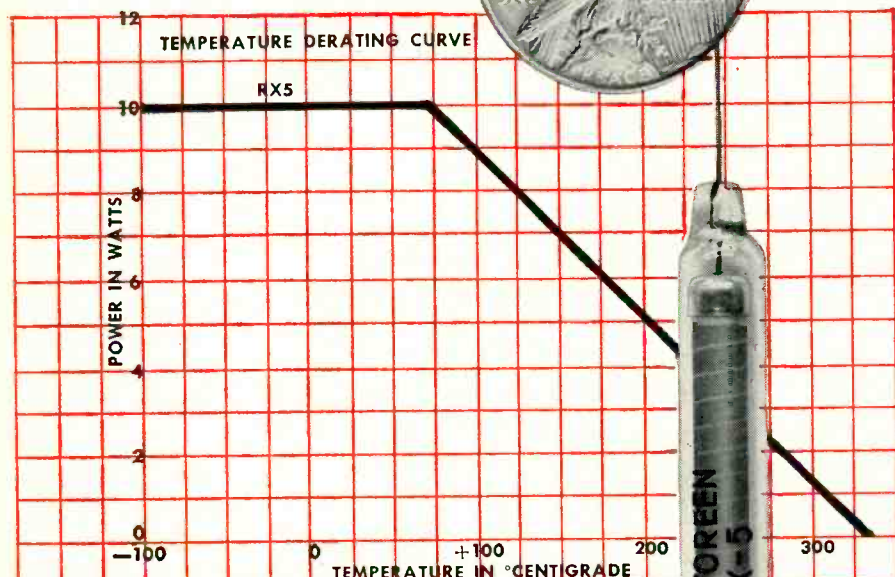

Now—the same  
**HIGH QUALITY**  
**VICTOREEN**  
*deposited carbon*  
*resistors at the new*  
**LOWER PRICE**



Victoreen Glass-Sealed Resistors have always been synonymous with the highest product quality. You get high power with high stability . . . absolute independence from unfavorable environments . . . closer production and inspection tolerances.

And now—because of new quality-volume production techniques—Victoreen can offer these superb components at highly competitive prices. New pricing structure, with large quantity discounts, brings prices down below a dollar. The trend is to Victoreen Deposited Carbon Resistors—get with it *now*. AA-9242



**Victoreen**

5806 Hough Avenue • Cleveland 3, Ohio

Export Department  
 135 Liberty Street, New York 6, N. Y.  
 Cable: TRILRUSH, New York

racks are built in. Sectionalized, prefabricated design permits assembly or disassembly of the entire room within a few hours. Circle 208 on Reader Service Card.



**Ultrasonic Analyzer**  
 100 cps to 525 kc

PANORAMIC RADIO PRODUCTS, INC., 514 S. Fulton Ave., Mt. Vernon, N. Y. Expanded frequency coverage is featured in the model SB-15 spectrum analyzer. It is designed for ultrasonic spectrum analyses, harmonic investigations, ultrasonic vibration and noise measurements, telemetering, monitoring, and attenuation measurements of filters and transmission lines—all in a complete unit 8 3/4 in. high. Advantages include: continuously calibrated sweep widths, from 200 kc to 1 kc; exceptional stability at reduced sweep widths; 100 cps resolution capability; continuously variable sweep rate from 1 cps to 60 cps. Circle 209 on Reader Service Card.

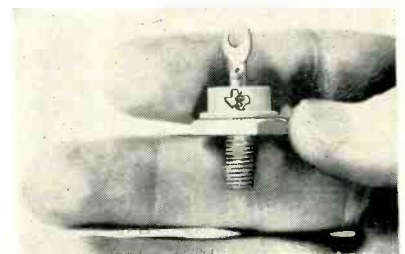

**Silicon Rectifiers**  
 heavy-duty

TEXAS INSTRUMENTS, INC., P. O. Box 312, Dallas, Texas, announces a complete line of heavy-duty diffused silicon stud-mounted rectifiers. They are rated at 50 and 30 amperes at a stud temperature of 150 C. The heavy-duty rectifiers feature recurrent piv's of 50 through 600 v in both the 50-ampere and 30-ampere series. Operating



# WE'RE LEARNING WHY TWO EARS ARE BETTER THAN ONE



Which speaker is making the sound? In echoless chamber at Bell Labs, Robert Hanson measures test subject's ability to localize sounds — observes how two ears operate in partnership. This and other tests may point the way to better telephone instruments.

In listening to stereophonic music, how is it that our ears and brain construct a picture of the entire orchestra with but two samples (the sounds from two speakers) to work with?

How is it that our ears and brain are able to pinpoint *one* voice in a roomful of talkers—to listen to it alone and ignore the rest?

What makes *two* ears better than one?

Bell Telephone Laboratories scientists are searching for the answers. For in finding them, better telephone instruments and better ways of transmitting sound will surely result.

Our hearing performs feats that no electronic system can yet duplicate. How? Laboratories scientists believe the secret lies in the way our two ears function in partnership and in the way

our neural network connects them with our brain. *The problem:* to discover what functions the network performs and to see whether electronic duplication might enhance understanding.

The work is under way. Electronic circuits that simulate the operation of nerve cells have already been created—and conceptual models of the neural network are being constructed.

Alexander Graham Bell's interest in deafness and hearing led to the invention of the telephone. Bell Laboratories' current explorations in binaural sound may well lead to important new advances in the transmission of speech and music.



**BELL TELEPHONE LABORATORIES**

World center of communications research and development

# NEW PRECISION VARIABLE RESISTOR with no sliding wiper

By



MFR 2



MFR 1

These Rotary Metallic Film Potentiometers are the perfection of years of research and development

*Super reliability is inherent through unique manufacturing techniques*

## FEATURES:

- Complete Hermetic Seal
- Infinite Resolution
- High Temperature Operation
- Long Life
- Low Torque
- Exceptionally High Accuracy
- Extremely Low Noise

A patented compression contact eliminates the wear or friction caused by usual wiper contacts. A precious metal capsule contact provides dependable long life operation. The deposited metal film resistance element is encased and hermetically sealed. The ultimate in craftsmanship is employed in the manufacture to produce a potentiometer unparalleled for performance. This new concept of design makes possible super reliability under the most severe environmental conditions such as those encountered in airborne, missile and satellite applications.

*Details will be sent upon request.*



## TECHNOLOGY INSTRUMENT CORP.

569 Main St.  
Acton, Mass.  
COlonial 3-7711

P. O. Box 3941  
No. Hollywood, Calif.  
POplar 5-8620

range is  $-65$  to  $+200$  C. The stud configuration of the case permits easy mounting of the unit to chassis or heat sink. Circle 210 on Reader Service Card.

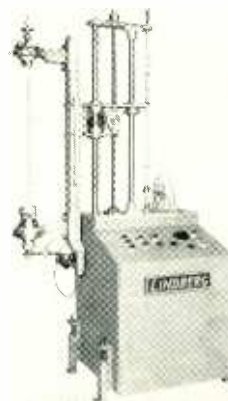

## Silicon Purifier fully automatic

LINDBERG ENGINEERING Co., 2450 W. Hubbard St., Chicago, Ill., offers a vertical floating zone scanner designed for accurate and precise production of ultra high purity semiconductor materials and metals. Mechanism allows easy material and seed centering since top and bottom holders are adjustable in both a horizontal and a vertical direction. Silicon up to 1 in. diameter and 24 in. long can be processed with the unit. Circle 211 on Reader Service Card.

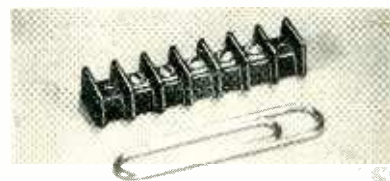

## Terminal Blocks subminiature

KULKA ELECTRIC CORP., 633-643 So. Fulton Ave., Mt. Vernon, N. Y. The tiny series 409 terminal blocks eliminate splicing, increase insulation, stop electrical leakage and shorts and generally simplify wiring work particularly in tight spots. Molded of high tensile strength Bakelite for commercial uses, they are available in other materials made in full compliance with latest electrical specifications or MIL-M-14. They are made with 1 to 21 terminals, depending on size. Units



# CDF Dilecto<sup>®</sup> paper-base laminates for the workhorse insulation jobs

For everyday mechanical-electrical parts that receive tough punishment and must have excellent physical and dielectric properties at low cost, the CDF phenolic paper-base line is outstanding.

**Economy.** CDF paper-base grades machine readily into intricate parts. Some are flame-retardant. Others are especially adaptable for punching. All are economical for the value delivered.

**Fabrication Facilities.** CDF has excellent and extensive plastics-fabrication facilities for turning out finished Dilecto parts to your specifications—better and more economically than you can do it yourself. Save the time and trouble of intricate fabrication by using CDF's specialized facilities.

See Sweet's, Electronics Buyers' Guide, and the other directories for the phone number of the CDF sales engineer nearest you. Or send us your print or problem direct, and we'll return a recommendation of the right Dilecto grade for your need.

CDF makes Di-Clad\* printed-circuit laminates, Diamond\* Vulcanized Fibre, CDF products of Teflon†, flexible insulating tapes, Dilecto\* laminated plastics, Celoron\* molded products, Micabond\* mica products, Spiral Tubing, Vycoid\*.

\*Trademark of Continental-Diamond Fibre Corporation  
†Du Pont trademark for its TFE-fluorocarbon resin



## CONTINENTAL-DIAMOND FIBRE

A SUBSIDIARY OF THE *Built* COMPANY • NEWARK 16, DEL.

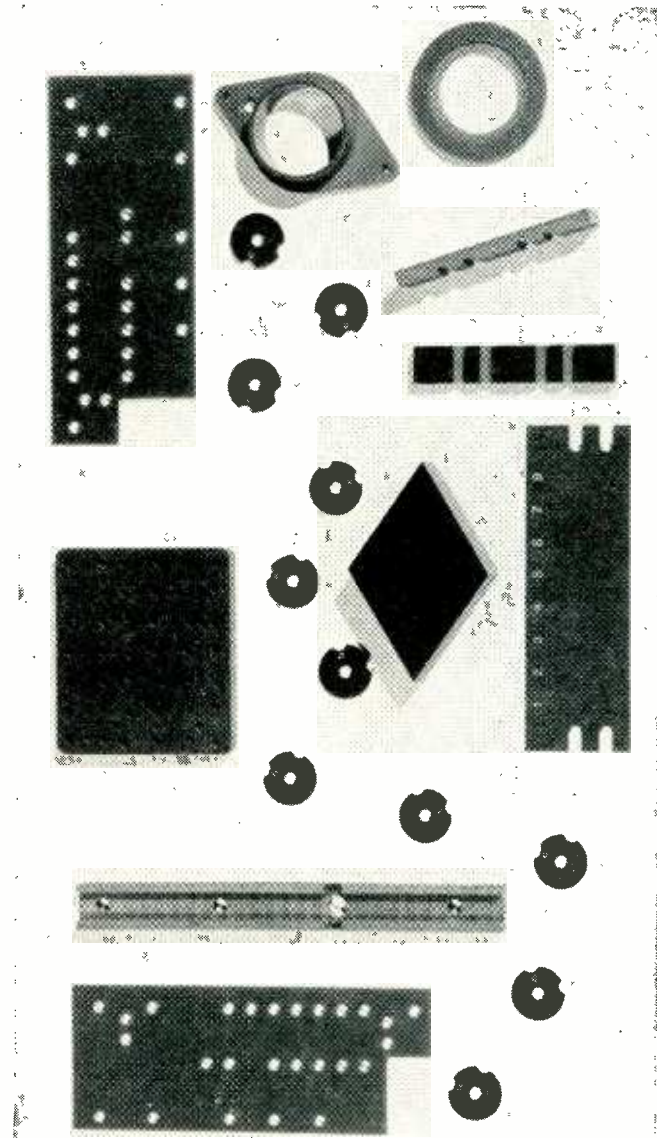

Fabricated by CDF. Near the presses that produced the Dilecto laminates, these paper-base parts were machined to close tolerances by CDF specialists . . . quickly, accurately, economically for the purchasers. This is a random selection from the five grades described in the table below.

Typical Property Values—Dilecto Paper-Base Laminates in Sheet Form

	X-13 (NEMA X)	XP-13 (NEMA P)	XX-13 (NEMA XX)	XX-13 FR (Fire-retardant) (NEMA XX)	XXXX-28 (NEMA XXXP)
ROCKWELL HARDNESS (M SCALE)	100	95	110	108	90
TENSILE STRENGTH 1w (1000 psi.)	20	12	16	17	12
FLEXURAL STRENGTH 1w (1000 psi.)	27	16	17	20	18
COMPRESSIVE STRENGTH (1000 psi.)	40	25	35	41	22
WATER ABSORPTION (% in 24 hrs.) 1/16" thickness	3.5	3.0	1.4	1.2	0.6
MAXIMUM CONTINUOUS OPERATING TEMPERATURE (°C.)	120	120	120	120	120
DIELECTRIC STRENGTH perp. to lam. (VPM)	800	800	650	700	800
DIELECTRIC STRENGTH parallel to lam. (Kv.)	50	50	60	70	75
DISSIPATION FACTOR at 1 mc, Cond. A	0.042	0.038	0.034	0.038	0.027
DIELECTRIC CONSTANT at 1 mc, Cond. A	5.5	4.6	4.7	4.8	3.6
ARC-RESISTANCE (seconds)	8	4	4	10	10
INSULATION RESISTANCE (megohms) ASTM D-257, Fig. 3	100	100	1,000	1,000	600,000
AIEE insulation class	A	A	A	A	A

# A VOLT IS A VOLT IS A VOLT

Or is it? Monitoring mag-amp regulated ground power-supplies with a conventional voltmeter is like trying to measure micro-inches with a yardstick.

Take this preflight checkout system for example: 115-volt, 400-cycle power is regulated to  $\pm 1\%$ , equal to  $\pm 1.15$  volts. But ordinary 2% meter error is  $\pm 3$  volts... less than half the accuracy you need.

Now, wire a standard 110-120 volt Beckman expanded scale voltmeter into the circuit. Result:  $\pm 0.3\%$  accuracy equal to  $\pm 0.345$  volt... better than twice the precision of regulated voltage. And one-tenth volt resolution makes reading easy... lets you take full advantage of the meter's drift-free accuracy.

What's more, there's no average-reading "fudge-factor" to contend with. Feed a Beckman AC meter anything from pure sine to square waves... *it always reads true rms.*

Helipot builds self-contained, panel-mounting Beckman expanded scale meters... AC or DC... in hundreds of models... commercial or ruggedized... in a wide variety of shapes, sizes and ranges. Color coding, special ranges and assemblies are yours for the asking.

Trade in your yardstick! Send for Data File A54.

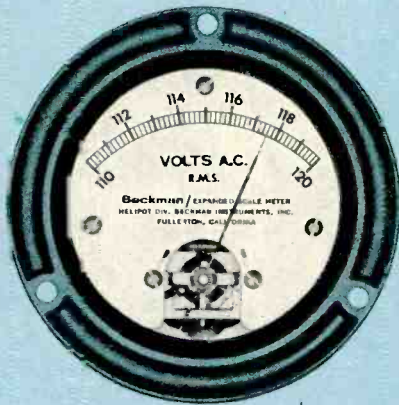

Beckman® Helipot®

Helipot Division of  
Beckman Instruments, Inc.  
Fullerton, California  
Engineering representatives  
in 29 cities

potentiometers  
dials: delay lines  
expanded scale meters  
rotating components  
breadboard parts

have two mounting holes and are also available with turret lugs. Circle 212 on Reader Service Card.

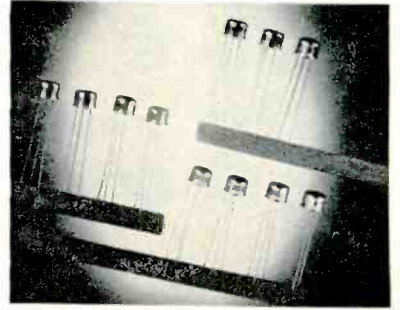

## Audio Transistors high reliability

MOTOROLA INC., 5005 E. McDowell Rd., Phoenix, Ariz. Types 2N-1191-93 are germanium *pnp* alloy junction transistors, designed for general purpose applications in the a-f range, including both amplifier and switching service. The internal construction and hermetically sealed industry standard AO-9 Package is designed to meet or exceed the mechanical and environmental requirements of MIL-T-19500A. Maximum ratings are: collector to base voltage, 40 v; collector to emitter voltage, 25 v; collector dissipation at 25 C ambient, 175 mw. Current gain ranges are tightly controlled with 2.5:1 or less spread. Circle 213 on Reader Service Card.

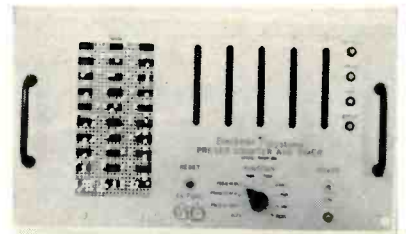

## Preset Counter and timer

BECKMAN SYSTEMS DIVISION, 325 No. Muller Ave., Anaheim, Calif. Model 5690-80 preset counter and timer is capable of measuring frequency of a sine wave input from 10 to 1,000,000 cps, and time intervals in milliseconds from 1 to 99,999. Used as a frequency measuring device, it counts pulses for 0.1, 1 or 10 sec and displays the total on a bank of 5 decimal counting units. The results are multiplied by 10, 1



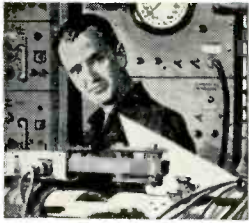

## PHILCO IS PEOPLE

From advanced research and development to mass production, installation and servicing of countless electronic products and systems, Philco is people. Here is a closely integrated organization of scientists, engineers, installation and service specialists, ready to meet any challenge for creation of military, industrial and consumer electronics systems.

## PHILCO IS FACILITIES

To assist this outstanding organization of skilled and dedicated people, Philco has amassed millions of dollars worth of intricate equipment in plants and laboratories from coast to coast. Philco facilities include: the world's most advanced research labs; environmental test facilities; specially equipped design and engineering labs, plus prototype and model shops; and the most advanced mass production facilities.



# PHILCO IS CAPACITY

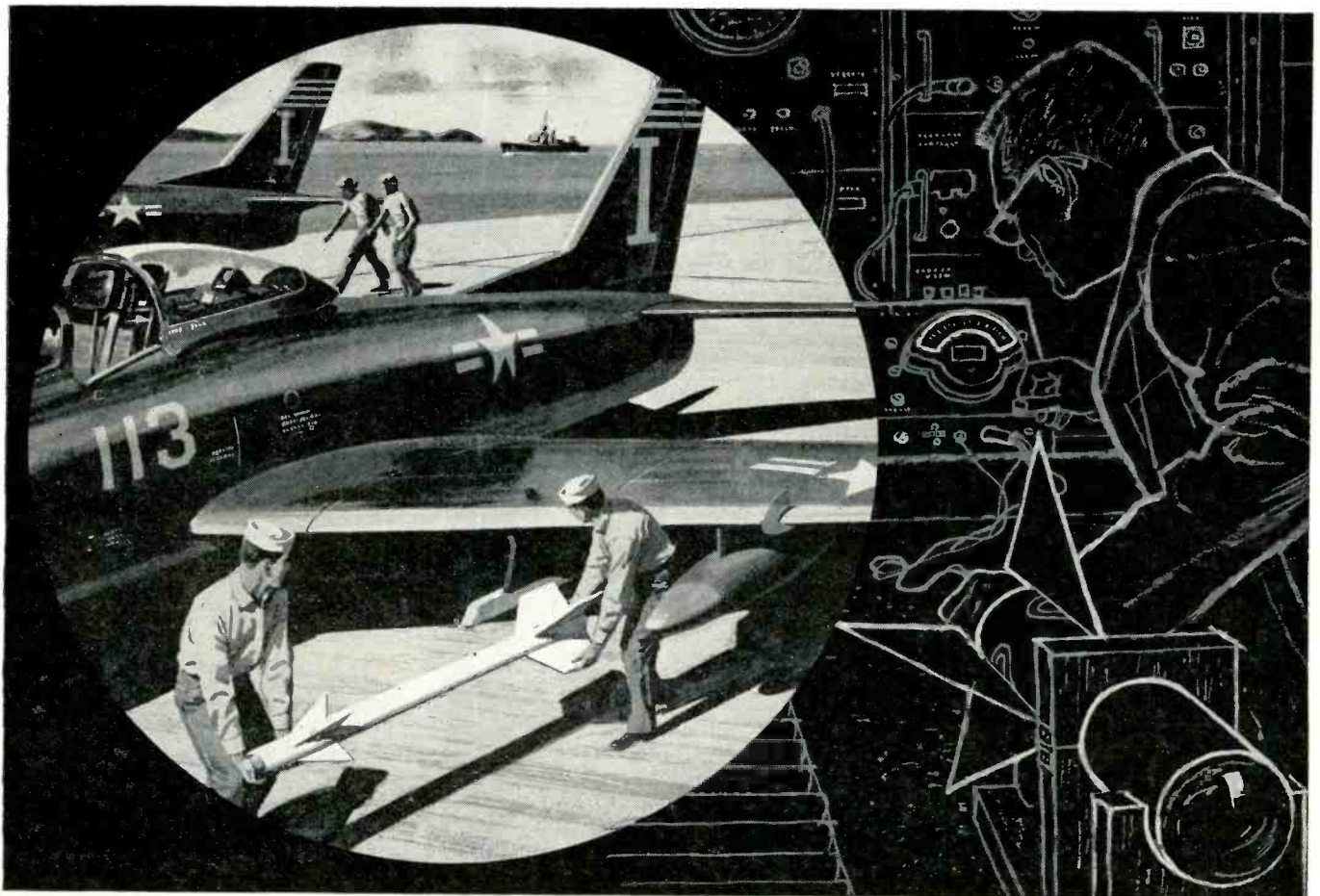

At Philco the world of tomorrow is *NOW!* Here are human resources, plus ultra-modern facilities, plus tremendous accumulated experience in research and development. Here too, are unlimited career opportunities in the fields of missiles and guidance, weapons systems, All-Transistor computers, infra-red, advanced radar techniques and communications systems. At Philco, versatility is the key to tremendous capacity in advanced technology. Make Philco your prime source for prime contracts from development to delivery.

**PHILCO**<sup>®</sup>  
GOVERNMENT & INDUSTRIAL DIVISION  
4700 Wissahickon Avenue  
Philadelphia 44, Pennsylvania



# THE *Specialized* ALLOY FOR GLASS HERMETIC SEALS



# RODAR®

... ASSURES  
*Permanently-Bonded*  
VACUUM-TIGHT SEALS!

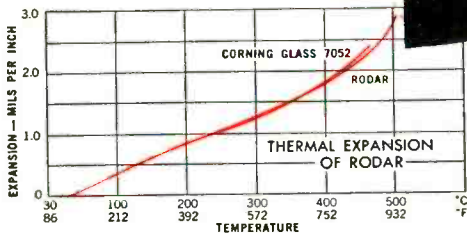

This precision alloy was developed for sealing metal to hard glass. Wilbur B. Driver Rodar is processed from melting to finished size in our own plant under the strictest controls to insure consistent analysis, temper, uniform grain size and conformance to customers' specifications. The superior stamping and sealing properties of Rodar make it the preferred sealing alloy.

Rodar produces a permanent, vacuum-tight seal with simple oxidation procedure and resists attack by mercury. Readily machined and fabricated, Rodar can be welded, soldered or brazed. Available in wire, strip and bar to your specifications.

## Another Special Alloy for a Specific Purpose

- PROPERTIES**
- Composition (Nominal)
    - Nickel . . . . . 29%
    - Cobalt . . . . . 17%
    - Manganese . . . 30%
    - Iron . . . . . Balance
  - Melting Point . . . 1450°C. (Approx.)
  - Specific Gravity . . . 8.36
  - Weight Per Cubic Inch . . . . . 302 lb.
  - Electrical Resistivity . . . 294 Ohms C.M.F.
  - Tensile Strength . . . . . 80,000 PSI
  - Hardness . . . . . 82 B Rockwell
  - Elongation . . . . . 30% (2" gauge length)

Temperature Range	Average Thermal Expansion, *Cm/Cm/°C x 10 <sup>-6</sup>
30° To 200 C.	4.33 To 5.30
30° To 300 C.	4.41 To 5.17
30° To 400 C.	4.54 To 5.08
30° To 450 C.	5.03 To 5.37
30° To 500 C.	5.71 To 6.21

\*As determined from cooling curves, after annealing in hydrogen for one hour at 900°C. and for 15 minutes at 1100°C.



**WILBUR B. DRIVER CO.**  
NEWARK 4, NEW JERSEY

IN CANADA: Canadian Wilbur B. Driver Co., Ltd., 54 Kemper Drive, Rexdale (Toronto)

or 0.1 to arrive at frequency in cps. Time interval is displayed on the decimal counting units. Unit has available 20 pairs of high-low limits which may be used to activate alarms should a reading go off-normal. Circle 214 on Reader Service Card.



## Resistance Bridge military-specified

INDUSTRIAL INSTRUMENTS, INC., 89 Commerce Road, Cedar Grove, N. J., has available a resistance bridge designed to military specifications. The ZM-4B/U is a Wheatstone bridge used primarily for determining line or cable faults and the type and approximate location of the fault. Full set-up instructions are attached to the inside of the lid for such tests as: ordinary resistance measurements, picking out grounded wires, Murray loop tests, simple and multiple Varley loop tests, Hilborn loop and open location checks on quadded cable or pairs. Circle 215 on Reader Service Card.

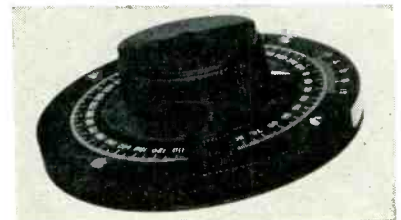

## Dial Assembly servo-mounted

THETA INSTRUMENT CORP., 48 Pine St., E. Paterson, N. J. A new dial assembly model permits mounting from the front panel of any equipment. Upon the rim of the dial assembly is a machine groove which



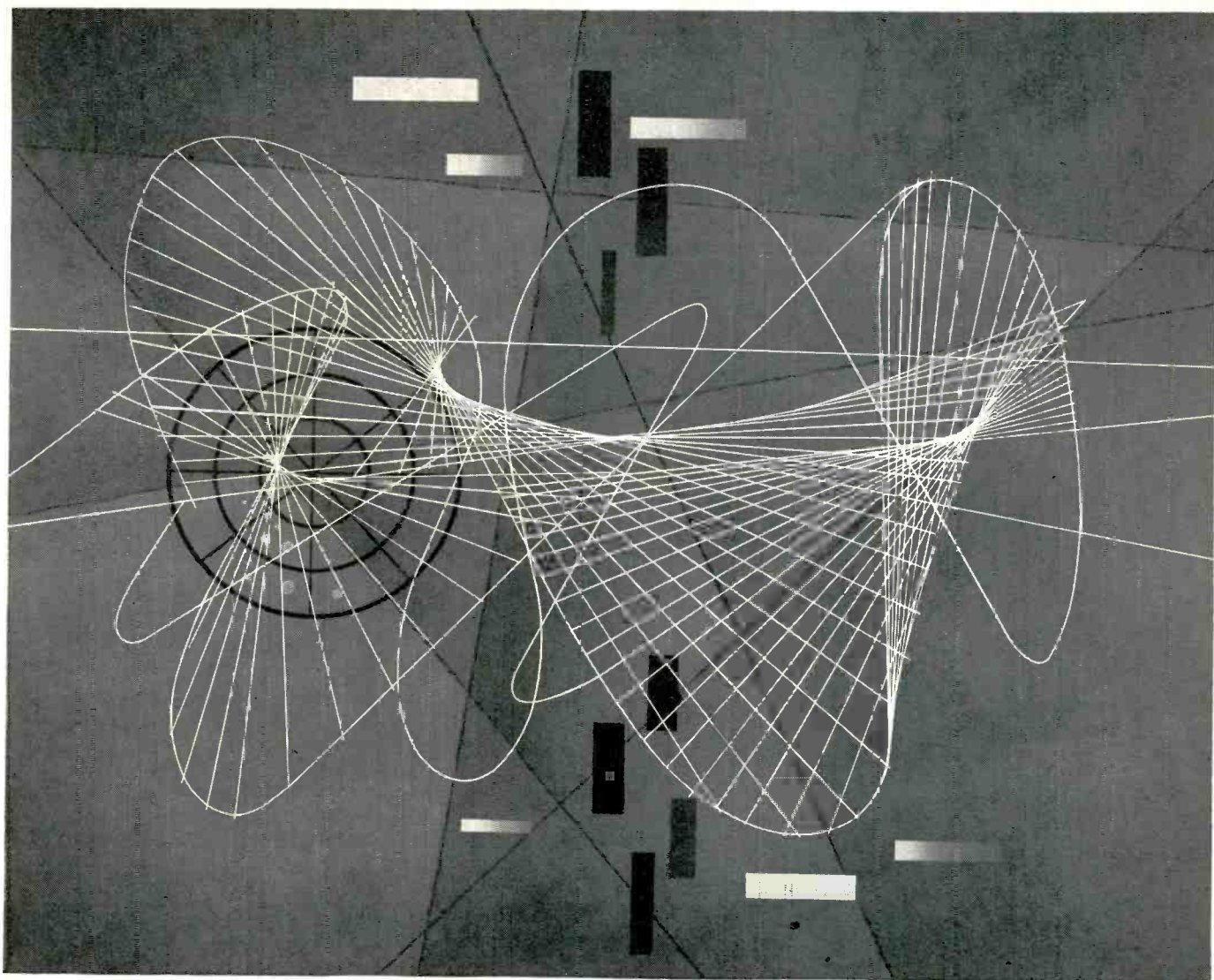

## WHEN A COMPANY OUTGROWS ITS NAME

As the domestic research organization of the world-wide International Telephone and Telegraph Corporation, we are carrying on our tradition of pioneering in electronics. As our engineering responsibilities have increased so our organization has grown. Today, in addition to our main laboratories in New Jersey, laboratories in Ft. Wayne, Chicago and in California are pursuing projects of great magnitude and importance.

You will find in our staff the same fine creative thinking and engineering imagination which brought distinction to our old names. Formerly Federal Telecommunication Laboratories and Farnsworth Electronics research laboratories, our names have been changed to identify us clearly with our parent company, and to reflect our expanded responsibilities and growth.

Electronic engineers will find here opportunity to express initiative and competence in such areas as long range radar systems, digital computer applications to data processing and communications, space technology, microwave tube research and missile systems instrumentation. We are continuing our work in air navigation and control, and in electronic systems . . . and making new contributions to electronic theory and techniques. In fact, it would be hard to find another research organization that offers the engineer such a wide scope of activities.

*Engineers interested in discussing professional positions with our staff are invited to write Mr. T. C. Allen, Manager, Professional Staff Relations.*

## ITT LABORATORIES

*A Division of International Telephone and Telegraph Corporation*

500 Washington Avenue, Nutley, New Jersey

Ft. Wayne, Indiana • Chicago, Illinois • Palo Alto, California • San Fernando, California



Thermal  
stability

+

Low noise

+

reliability

=



### low-noise, low-thermal Syncroverter\* choppers

In solving the above equation, Bristol has paved the way for new advances in low level switching. New performance standards are being established by these latest models of the external coil Syncroverter chopper.

For complete specifications, write:  
Aircraft Components Division, The Bristol Co.,  
152 Bristol Road, Waterbury 20, Conn.

\*T. M. Reg. U. S. Pat. Off.

9.1

**BRISTOL** FINE PRECISION INSTRUMENTS  
FOR SEVENTY YEARS

is used in the same manner as the mounting groove of a synchro. Conventional synchro clamps located on the equipment panel firmly hold the dial. Range is 360 deg continuous; accuracy, 0.1 deg; outside diameter, 5 in. It meets pertinent requirements of MIL-T-945A. Circle 216 on Reader Service Card.

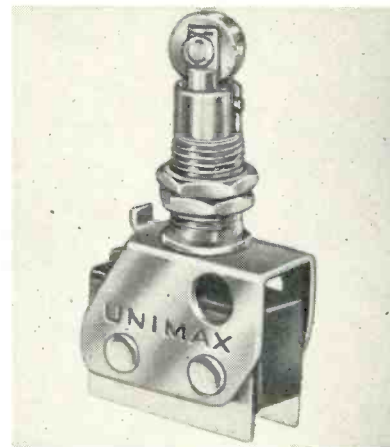

### Snap-Acting Switch subminiature

UNIMAX SWITCH DIVISION, The W. L. Maxson Corp., Ives Road, Wallingford, Conn. Type 1SR1-1 subminiature switch has an over-travel roller-plunger actuator. It is designed for use where operating force is applied by a cam, as in many types of automatic equipment. The stainless-steel roller provides long-wearing, low-friction bearing on the actuating cam and the spring plunger permits 0.031 in. over-travel. The plunger is keyed to keep the roller in line with the cam. Rated at 2.5 amperes, 30 v d-c, inductive; 5 amperes, 30 v d-c resistive; 5 amperes, 125/250 v a-c, the switch has spdt action. Circle 217 on Reader Service Card.

### Skived Teflon Tape four grades

CONTINENTAL - DIAMOND FIBRE CORP., Newark, Del., has available four grades of skived Teflon tape. Made by skiving Teflon billets, these tapes feature excellent electrical properties, resistance to all common chemicals, a low coefficient of friction and a surface to which nothing will stick. The tapes are designed primarily for high



temperature and high frequency wire and cable insulation. However they may also be used as stock from which gaskets, seals and miscellaneous small parts can be cut. Circle 218 on Reader Service Card.



### Electronic Switch transistorized

NAVIGATION COMPUTER CORP., 1621 Snyder Ave., Philadelphia 45, Pa. Model 129A transistorized electronic switch performs the following functions: (1) gating of pulse bursts, (2) standardizing pulses to the NAVOR system-Vk pulse, and (3) providing a one-shot gate circuit. The one-shot gate is used to generate an output signal the first time an input is applied, but not thereafter. A control flip-flop and a transistor gate can transmit or inhibit pulses in accordance with external "start" and "stop" signals. The output of this gate is standardized by a flip-flop to prevent any partial "one" outputs. Circle 219 on Reader Service Card.



### Relay solid-state

PENDAR, INC., 2660 S. La Cienga Blvd., Los Angeles 34, Calif. A new relay features no moving parts, yet snap action characteristics with a pick-up time of approximately 5  $\mu$ sec and drop-out time of approximately 30  $\mu$ sec. The 28 v d-c coil circuitry is completely isolated from the switching circuit and the unit responds to 18 v pick-up and 11 v drop-out. Production unit rated to

## HIGH SPEED alphanumeric PRINTER with integrated storage and programming electronics

prints up to

**48,000**

digits per minute

adaptable to all

digital data sources

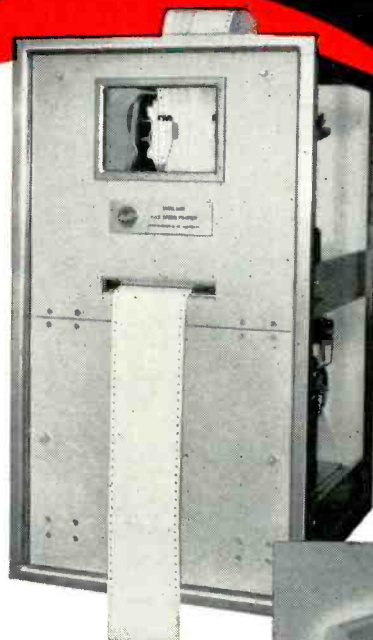

### SOLID STATE DESIGN MODEL 3260



A POTTER EXCLUSIVE:  
Stellite Type Fonts To Order.

## Check these features...

#### OPERATING SPEEDS

4 BIT DATA @ 20 lines/sec.  
6 BIT DATA @ 10 lines/sec.  
PAPER FEED TIME.....15 Ms  
SERIAL LOADING RATE 20 kcs

#### RELIABILITY

Solid state storage, transistorized hammer drive and paper feed... troublesome contacts and wiper arms eliminated by reluctance pickup. Digital logic throughout.

#### CUSTOM DESIGNS

Designs to meet MIL or Commercial Specs.

#### COMPATIBILITY

4 or 6 bit input data in parallel or serial-parallel form and in any coding system.

#### FLEXIBILITY

Self-synchronized or random (slaved) operating modes  
Tailored horizontal and/or vertical formats  
Modular construction permits wide variation of characteristics  
Accessible input/output command functions for maximum utility



The mark of  
Engineering Quality

### POTTER INSTRUMENT COMPANY, INC.

Sunnyside Boulevard, Plainview, N. Y.  
Overbrook 1-3200

Potter has career opportunities for qualified engineers who like a challenge, and the freedom to meet it.

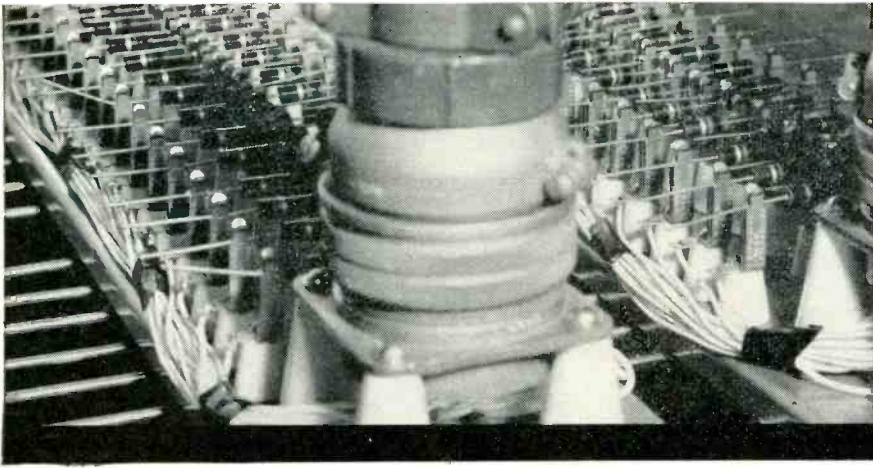

## Reliability Testing **AUTOMATED FOR YOU** at United States Testing Company

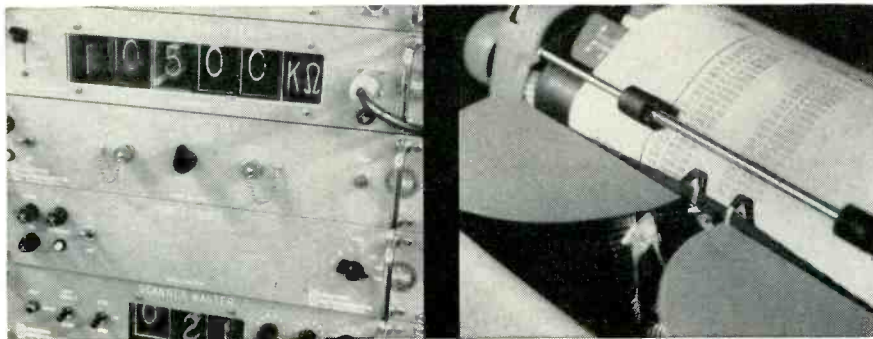

You can profit from the cost-saving, time-saving digital read-out system which automates Quality Assurance programs done by United States Testing Company. Now, under all environmental conditions, readings can be machine-recorded, error-free, every 3 seconds with accuracies of 0.1%. Reliability of resistors, capacitors, semi-conductors, transformers and other components...also systems...can be predicted quickly and economically...failures analyzed. Tests meet military, government and commercial specifications.

Complete environmental laboratory includes facilities for simulating high and low temperatures, humidity, altitude, immersion, salt spray, sand and dust, rain, fungus, vibration, shock and acceleration.

Save investment in laboratory equipment...free needed operating funds. Use United States Testing Company's extensive facilities. Detailed confidential reports at completion of project. Write for quotation. No obligation.

Complete facilities in the fields of chemistry, metals chemistry; metallurgy; physical testing of materials; engineering analysis of mechanical, electro-mechanical, and electronic devices; site inspection; package testing; psychometrics and certification services for product quality control.

### United States Testing Company, Inc.

1415 Park Avenue, Hoboken, N. J.



**FREE!**  
Send for facilities bulletin 5801.

**Branch Laboratories**

BOSTON · BROWNSVILLE · DALLAS  
DENVER · LOS ANGELES · MEMPHIS  
NEW YORK · PHILADELPHIA  
PROVIDENCE · TULSA

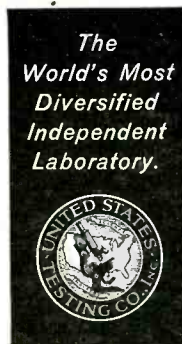

switch a-c or d-c from 10 mils to 10 amperes in the spst variety and 10 mils to ½ ampere in the dpst, all normally open contacts. Temperature range is -55 to +160 F. Circle 220 on Reader Service Card.



### Thickness Tester ultrasonic

BRANSON INSTRUMENTS, INC., 40 Brown House Road, Stamford, Conn. The new Audigage model 6 direct-reading ultrasonic gage weighs less than 5 lb—including batteries, probe, harness, cable and earphones. Completely self-contained it is used for nondestructive thickness measurement of most metals, glass, ceramics, and plastics from one side. Circle 221 on Reader Service Card.

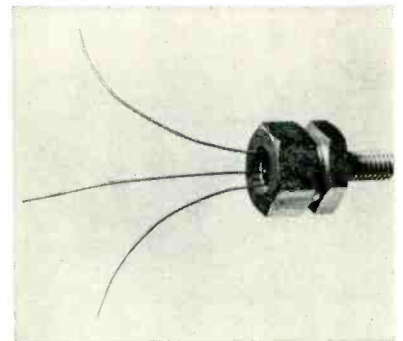

### Heat Sink stud-mounted

JADARO MACHINE PRODUCTS, 325 South Shiloh Road, Garland, Texas, has available an insulated stud mounted heat sink for medium power transistors. The 1101-A provides a practical and efficient means of heat sinking transistors in the JETEC 30 round welded packages. It can be easily attached to the transistor by the user, converting the transistor to a double ended



package. Firmly tightening the gland nut provides a good thermal and mechanical contact between the transistor and the heat sink. Circle 222 on Reader Service Card.

### Circuit Breaker thermal type

METALS & CONTROLS CORP., Attleboro, Mass. The Klixon D6760-5 thermal-type, three-phase circuit breaker is a new model in the D6760 series for applications on aircraft and missile ground support equipment where high voltage power is used. The -5 version is a modification of the basic design with greater electrical clearances between phases. This internal redesign eliminates the possibility of arcing between phases on short circuit interruption. Circle 223 on Reader Service Card.

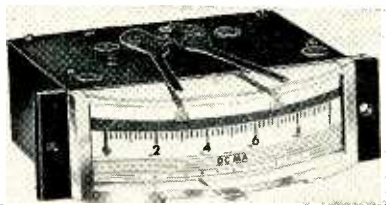

### Control Meter miniaturized

INTERNATIONAL INSTRUMENTS INC., New Haven, Conn., has developed a miniaturized control meter that operates without the use of contacts at the set points. As a result, movement of the pointer is not stopped at the set points, and the full scale range of the meter is available for readings at all times. Additional current is not required to insure proper contacting, and such difficulties as contact resistance, flutter, corrosion and spot welding are eliminated. Circle 224 on Reader Service Card.



### Digital Voltmeter medium speed

ELECTRO MEASUREMENTS, INC., 3540 Aero Court, San Diego 11, Calif.,

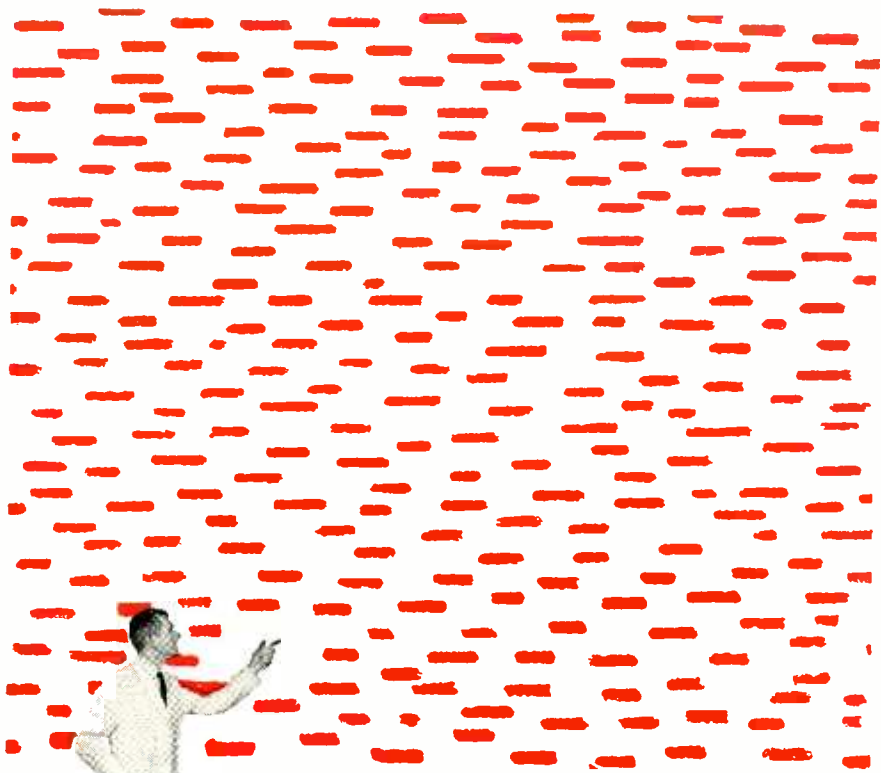

## How big is a dropout?

A dropout can be measured more than one way. Physically, the surface imperfection that causes a dropout is microscopic — often quite invisible to the naked eye. Financially, though, this molehill can become a mountain — may cost you thousands of dollars from a single error.

That's why our customers invariably demand perfection from our EP Audiotape, the extra precision magnetic recording tape. They just can't afford dropouts.

Audio Devices' battery of Automatic Certifiers is one of the unique means used to make sure EP Audiotape always meets customer specifications. The Automatic Certifier records and plays back every inch of the EP Audiotape under test. These tests can be so demanding that if the tape fails to reproduce just one test pulse out of the 40 million put on a single reel, the entire reel is rejected. There are no ifs, ands, or buts.

This is one of many special quality-control operations to which EP Audiotape is subjected. From raw material to hermetically sealed containers, every reel gets individual attention.

EP Audiotape quality is so well verified by instruments like the Automatic Certifier that every reel is guaranteed to be defect-free! For more information write for free Bulletin T112A. Write Dept. TE, Audio Devices, Inc., 444 Madison Avenue, New York 22, N. Y.

**TYPE EP audiotape** TRADE MARK

**AUDIO DEVICES, INC.**

444 Madison Ave., N. Y. 22, N. Y.

In Hollywood: 840 N. Fairfax Ave.

In Chicago: 5428 Milwaukee Ave.

Export Dept.: 13 East 40th St., N. Y., 16

Rectifier Division: 620 E. Dyer Rd., Santa Ana, Calif.



# ADVANCED DESIGN COMPONENTS



## New ULTRASONIC DELAY LINES

Low cost — Small size

Development engineers can now employ new concepts in existing and proposed applications. These Curtiss-Wright delay lines are extremely small, hermetically sealed and vibration proof. They are ideally suited for use in computers, coders and decoders, telemetering and navigational systems.

### SPECIFICATIONS

Delay range... .5 to 6000 microseconds  
Tolerance... . $\pm 0.1$  microsecond  
Signal to noise ratio... Greater than 10:1

Input & output impedance... 50-2000 ohms  
Carrier frequency... .100 kc-1 mc  
Delay to pulse rise time... Up to 800:1

### DIGITAL MOTORS

For high reliability applications

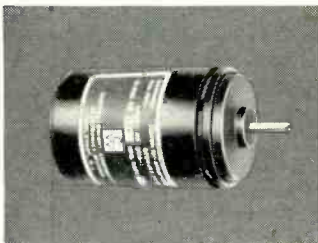

These stepping motors meet the requirements of assured reliability and long life for aircraft, missile and automation systems.

#### FEATURES

Dynamically balanced  
Bi-directional • Positive lock  
Simplicity of design  
High pulsing rate

### TIME DELAY RELAYS

For high vibration applications



"H" Series thermal time delay relays are designed to meet the high shock and vibration conditions of today's military applications.

#### FEATURES

Time delays from 3 to 180 seconds  
Temperature compensated  
Hermetically sealed • Miniature  
Meets rigid environmental specifications

WRITE FOR COMPLETE COMPONENTS CATALOG 159

ELECTRONICS DIVISION

# CURTISS-WRIGHT

CORPORATION • WEST CALDWELL, N. J.

is marketing an all-electronic digital voltmeter capable of making 50 measurements per sec. The new four-digit model 8409 features totally transistorized logic circuits;  $\pm 1$  digit accuracy; automatic polarity; automatic, manual and remote ranging; 1,000 meg-ohm input impedance; BCD and decimal output; direct printer operation; provision for external reference voltage; and modular construction throughout. **Circle 225 on Reader Service Card.**

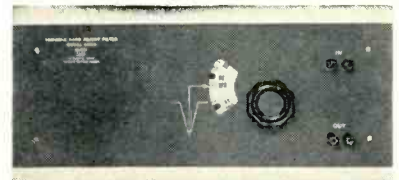

## Band Reject Filter direct-reading dial

ALLISON LABORATORIES, INC., 14185 Skyline Dr., La Puente, Calif. Model BE6 band elimination filter is designed to reject any one frequency between 20 and 20,000 cps, and allow all other frequencies between d-c and 100 kc to be passed. It can be used to eliminate one frequency in measuring circuits where hum is interfering with normal measurements, or the resonant response of an accelerometer prevents analysis of other frequencies present, or where it is desired to measure the distortion and hum present in an amplifier while eliminating the fundamental test frequency completely. **Circle 226 on Reader Service Card.**

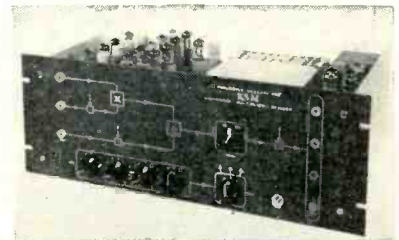

## Multiplier-Divider high precision

GEORGE A. PHILBRICK RESEARCHES, INC., 285 Columbus Ave., Boston 16, Mass. Model K5-M multiplier-divider is a precision analog computing component with improved long



there's  
only

buyers'  
guide

serving the  
electronics industry

and it's the . . .

ABC

electronics  
BUYERS' GUIDE

A McGRAW-HILL PUBLICATION

330 WEST 42nd ST. NEW YORK 36, N. Y.

ABD

# YOKE

## specialists

COMPLETE LINE for every Military and Special purpose . . . in PRODUCTION QUANTITIES . . . or CUSTOM DESIGNED to your specific requirement.

# syntronic

INSTRUMENTS, INC.

100 Industrial Road, Addison, Ill., Phone Kingswood 3-6444  
CIRCLE 84 READERS SERVICE CARD

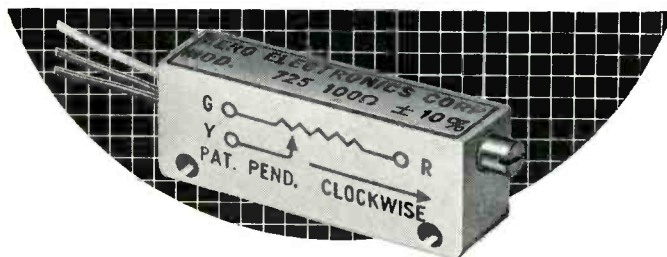
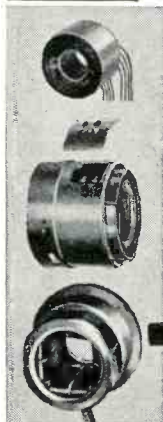

## AEROPOT

*miniature trimming potentiometer*

— utmost reliability in  
a stable, 5-watt unit

Aluminum case won't distort on uneven mounting surface . . . won't change resistance by compressing. Self-locking adjusting screw holds settings under high vibration and shock . . . rides at limits of wiper travel.

Excellent Resistance Stability — 30 ppm per degree C nominal from —65° to +175° C.

Moisture Resistant — Aeropot passes MIL-STD 202, Method 106, and many other Mil. Specs. Size: 1.25" L x .37" W x .5" H. One-inch mounting centers. Resistance values from 50 to 150,000 ohms. Write for complete data on Model 725.

**AERO ELECTRONICS CORP.**

1745 W. 134th Street, Gardena, Calif.

CIRCLE 85 READERS SERVICE CARD

ELECTRONICS — May 29, 1959

Advance Relays  
Automatic Electric  
Basson and Robinson  
Collins Electronics  
C. P. Clare  
Elgin Neomite  
E. M. S.  
Guardian Electric  
Kurman  
Leach Relays  
Monitor  
Phillips Control  
Potter & Brumfield  
R-B-M  
Div. Essex Wire  
Struthers Dunn  
Terado  
And Others

Now... Buy

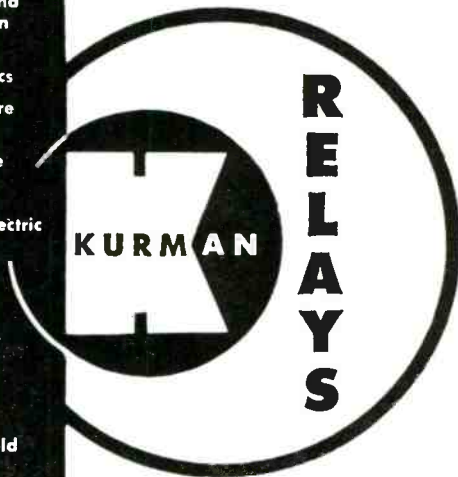

24 HOUR DELIVERY

from

**RELAY SALES**

Send for our Catalog C-9  
Phone West Chicago 1100  
TWX West Chicago, Ill. 3464-U  
Write P.O. Box 186-PM, West Chicago, Ill.



CIRCLE 86 READERS SERVICE CARD

## SERVO SYSTEM ANALYZERS AT WORK:

# POINT-to-POINT . . . NONSTOP!



### SERVOSCOPE®

plays a role from T square to Touchdown

SERVOSCOPE servo system analyzers are being used today in every phase of the aviation industry, from take-off on new ideas through autoflight and flight-training systems to radar traffic control. They have even invaded the ticket office where automatic, reservations-handling systems are being set up! Look at some of the areas where SERVOSCOPE plays a part!

— Aerophysics — Flight Test Instruments — In-Flight Instruments — Airborne Radar Seeker Servo Systems — Network Response — Computers and Servomechanisms — Autopilot and Damper Testing Simulating Rate Gyro — Frequency Response Characteristics of Components and System Loops of Autopilot and Aircraft Flight Controls — Antenna Servo Drive Tests — Aircraft Electronic Servo System Testing — Servo System Analyses in Servo Test Program (Flight Training) — Frequency Response on Electro-hydraulic Servo System — Testing of Radar Systems

A full line of five models provides a full range of essential features, such as: wide-range coverage (.001 to 100 cps); fast direct-setting and read-out; high-accuracy measuring of phase, transient response, and gain, and many other features.

The same features which make SERVOSCOPE play so many parts in the aviation field lead to wide use in Missiles, Instrumentation, Communication, Navigation, Electronic and Electrical Engineering, Education, Computers and in many others.

Acquaint us with your servo analysis problems. Specification and application data is available. Request TDS 1100-E.



## SERVO CORPORATION of AMERICA

20-20 Jericho Turnpike • New Hyde Park, L. I., New York

term stability. Based on a new all-electronic semiconductor network, it accepts three variable inputs,  $e_1$ ,  $e_2$ ,  $e_3$ , and provides as output  $e_1$ ,  $e_2/e_3$ . Accuracy as a multiplier, including drift, is better than  $\frac{1}{10}$  v in all four quadrants. A 3-digit decade provides an adjustable voltage which may be added to numerator, denominator or output, and which serves as an adjustable scale factor for operations involving only two variables. Circle 227 on Reader Service Card.



### Voltmeter expanded scale

MAGNAVOX CO., 2131 Bueter Rd., Ft. Wayne, Ind. A new expanded scale voltmeter features  $\pm 0.5$  percent or better accuracy, high input impedances of 1,000 to 1,700 ohms per v, scale expansions of 4 to 1 or greater, a-c and d-c models. Special scales can be provided. Both panel-mounted and cased units are available. No external power source is required. Circle 228 on Reader Service Card.



### Coax Terminations d-c to 10 kmc

WEINSCHEL ENGINEERING, 10503 Metropolitan Ave., Kensington, Md. The 50 ohm coaxial terminations, model 535, are now available with type TNC connectors (male or female) in addition to types N, C, SC and BNC. The film resistors used are artificially aged for maximum stability under pulse



## UNIQUE DESIGN ROTARY SWITCH— 5-SECOND WAFER REPLACEMENT

No Unsoldering or Disassembling ... No Wire Removing ...  
Simply Lift out Any Wafer & Replace Instantly ...  
Highly Reliable—Presently Supplied for Military Applications

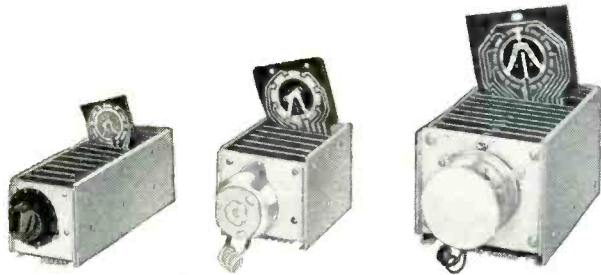

Reduces to seconds maintenance which otherwise could take a full day or more, saving valuable time. New design obsoletes old switches.

Switches are available in sizes approx. 2" x 2", 3" x 3" and 4" x 4" with lengths to accommodate up to 36 wafers. Virtually unlimited choice of switch circuit configurations. All connections are to a single bank of receptacles and are conveniently accessible from one side of the aluminum housing. Contacts are silver, gold or rhodium plated on a copper base. Wafers can be made to include printed circuitry and components in addition to their normal switching function.

Switches may be manually, motor or solenoid operated for use in any rotary selector switch application. Manufactured under Tabet U. S. Patent No. 2,841,660. Other U. S. and foreign patents pending. Write for details today.



CIRCLE 87 READERS SERVICE CARD

## MEET ROLLY CHAREST



Associate  
Editor  
electronics

### RESUME:

Charest, Roland J., Boston University, BS in Journalism. Formerly New England editor for electronics. Navy sonarman. Writer, reporter, editor for Lynn Item, Boston Globe, Boston Traveler. Won a New England Associated

Press (AP) award in 1955 for writing feature articles in the major city newspaper class.

### PRESENT OCCUPATION:

Rolly Charest supports Managing Editor Jack Carroll for editorial content accuracy and expediting putting each weekly issue to bed. Rolly reworks headlines for greater readability, is involved in makeup, and helps polish editorial content. Rolly's across-the-board background assures you accuracy in the face of journalistic pressures; articles in this week's issue that could be held over to the next deadline, but are not. The readers' interests come first!

### REFERENCES:

If you're not a subscriber, if your subscription is expiring, if you will miss exciting features "in-the-works" by electronics 26-man staff, fill in box on Reader Service Card. Easy to use. Postage is free.

electronics

A McGraw-Hill Publication • 330 W. 42nd St., New York 36

## universal transistor tester

\$59.50

MEASURES  $I_{ca}$ , ALPHA

MEASURES DIODE FORWARD  
AND REVERSE CURRENTS

TESTS FOR SHORT CIRCUITS

Battery-operated, portable model TT-1 provides quick, reliable measurements on both PNP and NPN transistor types of low, medium and high power. Universal panel receptacle and test leads accommodate all standard and special types. Dual scale on precision 50-microamp ammeter indicates transistor leakage and gain, diode forward and reverse currents. Ideal for laboratory, production or field test. Strong, shock-resistant case.



Write for  
complete specifications.

**REFLECTONE**

THE REFLECTONE CORP. • STAMFORD, CONN.  
CIRCLE 88 READERS SERVICE CARD

Advance  
Relays  
Automatic  
Electric  
Besson and  
Robinson  
Collins  
Electronics  
C. P. Clare  
Elgin  
Neomite  
E. M. S.  
Guardian Electric  
Kurman  
Leach  
Relays  
Monitor  
Phillips  
Control  
Potter  
& Brumfield  
R-B-M  
Div. Essex Wire  
Struthers  
Dunn  
Terado  
And Others

Now... Buy



24 HOUR DELIVERY

from

**RELAY SALES**

Send for our Catalog C-9  
Phone West Chicago 1100  
TWX West Chicago, Ill. 3464-U  
Write P.O. Box 186A, West Chicago, Ill.



CIRCLE 90 READERS SERVICE CARD

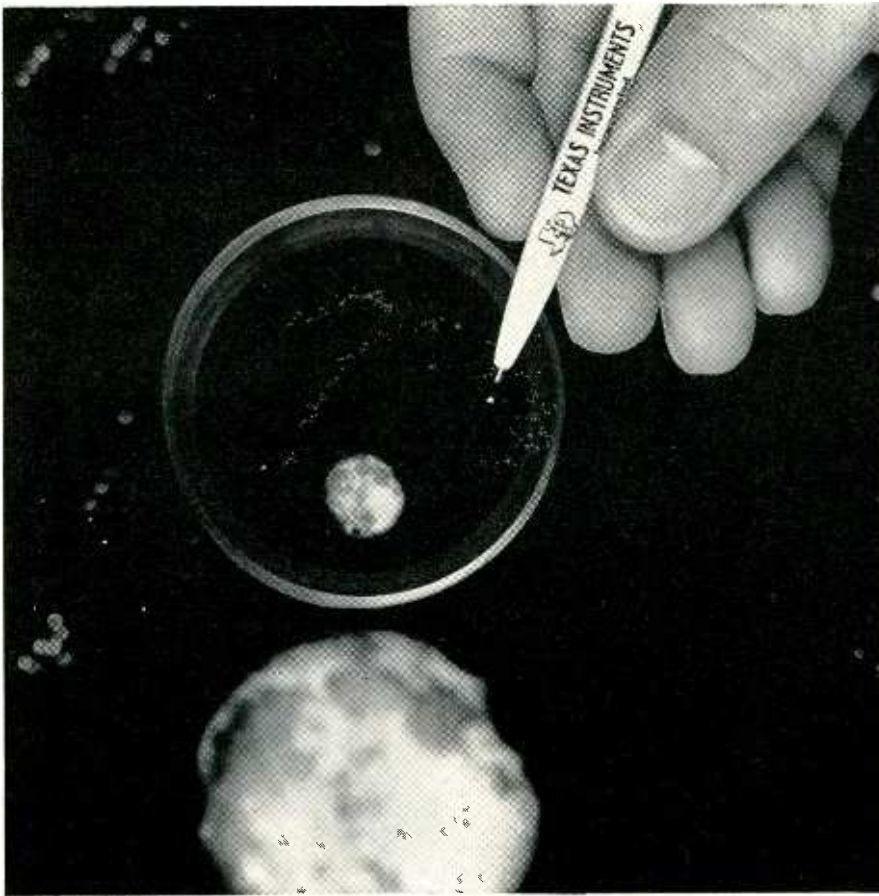

## FOLLOW THAT STAR!!

*It's always fair weather* in outer space... and that simplifies the task of star-tracking and satellite astronomy. But it still takes fantastic degrees of accuracy in all optical components of these systems to yield accurate data measured across *millions of light years*. Such accuracy is the normal product of Texas Instruments blue-chip craftsmen.

Texas Instruments — leading designer and producer of silicon, germanium, quartz and other optics for military and commercial uses — has first-hand familiarity with unusual materials suited to specific portions of the spectrum. In one of the nation's best equipped facilities, TI craftsmen grind, polish and coat precision optics with the accuracy needed to pinpoint stars at almost inconceivable distances. Whatever your requirements... prisms, lenses, windows... the TI optics team — backed by a full-time engineering service and high-speed computers — can meet your needs *in any quantity* from concept to completion. For detailed information on any phase of precision optics technology, contact SERVICE ENGINEERING:

TEXAS



OPTICS DEPARTMENT  
**INSTRUMENTS**  
 INCORPORATED  
 6000 LEMMON AVENUE  
 DALLAS 9, TEXAS

power, as well as humidity and temperature cycling. Frequency range is d-c to 10 kmc; 1 w average, 1 kw peak power. Individual vswr calibrations are supplied at d-c, 400, 1,000, 2,000, 4,000, 7,500 and 10,000 mc. Circle 229 on Reader Service Card.

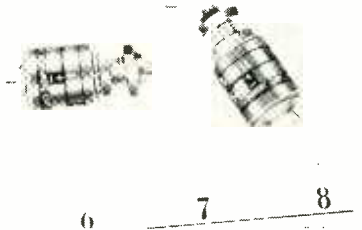

### Trimmer Pot hermetically sealed

MAUREY INSTRUMENT CORP., 7924 S. Exchange Ave., Chicago 17, Ill., announces the 50-M34 hermetically sealed trimmer potentiometer. A glass header soldered on the housing insures a perfect hermetic seal. The unit may be inserted in a  $\frac{1}{4}$  in. hole in the mounting panel and soldered in place. This trimmer pot is of rugged construction, has mechanical stops and the shaft may be locked in place. Resistance range is 25 ohms to 10,000 ohms. Circle 230 on Reader Service Card.

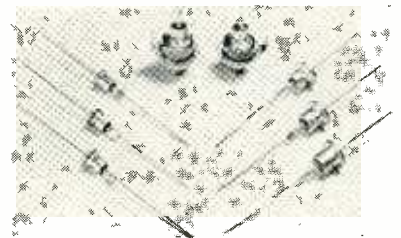

### Zener Diodes regulator type

ITT COMPONENTS DIVISION, 100 Kingsland Road, Clifton, N. J., announces a new complement of silicon zener regulator diodes. The carefully controlled characteristics of these components may be used in a variety of circuits in such applications as power supply voltage regulators, meter protectors, bias controls, etc. Four nominal basic power ratings are available: series B, 750 mw; series T, 1 w; series G, 3.5 w; and series K,



# Meet Bill Bushor and Sam Weber

Associate Editors, electronics  
FEATURE ARTICLE EXPERTS



## Resumés:

Bushor, William E., Lawrence Institute of Technology, BSEE, I. R. E. member. 9 years experience: U.S. Army (communications chief), Bell Aircraft (air-to-air missile), G. M. Research Labs, Sperry Gyroscope, etc. Member Society Technical Writers.

Weber, Samuel, Virginia Polytechnic Institute, BSEE, I. R. E. member. 10 years diverse engineering experience: U. S. Navy, Barlow Electrical Mfg. Co., Curtiss-Wright, etc. Primarily in communications, uhf and microwave components and design, jet engine test instrumentation.

## Present Occupations:

Bill Bushor is preparing a series to appear in 1959 on medical electronics comprising diagnostics, therapeutics, prosthetics, and clinical and operative aids.

Sam Weber is working on "Sophisticated Communications Methods" for the October 1959 issue. Report covers scatter systems, meteorburst transmission, satellite relays, carrier systems, etc.

## References:

If you're not a subscriber, if your subscription is expiring, if you will miss exciting features "in-the-works" by electronics 26-man staff, fill in box on Reader Service Card. Easy to use. Postage free.



# electronics

A McGraw-Hill Publication • 330 West 42nd Street, New York 36, N.Y.

Advance  
Relays  
Automatic  
Electric  
Besson and  
Robinson  
Collins  
Electronics  
C. P. Clare  
Elgin  
Neomite  
E. M. S.  
Guardian Electric  
Kurman  
Leach  
Relays  
Monitor  
Phillips  
Control  
Potter  
& Brumfield  
R-B-M  
Div. Essex Wire  
Struthers  
Dunn  
Terado  
And Others



Now... Buy



24 HOUR DELIVERY

from

**RELAY SALES**

Send for our Catalog C-9  
Phone West Chicago 1100  
TWX West Chicago, Ill. 3464-U  
Write P.O. Box 186A, West Chicago, Ill.

CIRCLE 92 READERS SERVICE CARD

## NETIC CO-NETIC MAGNETIC SHIELDING

Non-Shock Sensitive, Non-Retentive, No Periodic Annealing, Shaped to Your Application

Permanently unaffected by shock or vibration from usage, drilling, cutting, punching, bending, etc. For maximum effectiveness, all possible joints are heliarc welded. Sheds magnetic forces like a duck's back sheds water. Will not become magnetized.

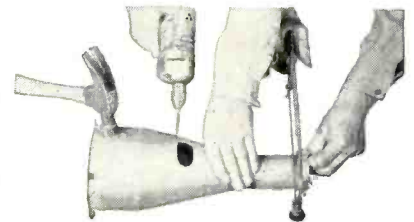

Permanently non-retentive — negligible residual magnetism. No periodic annealing required.

Provides simultaneous high and low intensity shielding as well as high and low frequency shielding or any one of them. Aids miniaturization by making possible placing components close together, even mounted on the shield itself. Can be furnished tinned, ready for soldering—without affecting shielding qualities. Available as raw material if desired for fabricating parts in your own plant.

Typical applications include tape container shields to protect broadcasting, military and automation tapes, cathode ray tube shields, photomultiplier tube shields, transformer shields, magnetron shielding, 7 & 9 pin tube shields, portable measuring chambers for simulated pressure, vacuum, altitude and non-pressurized testing of delicate instruments in laboratory or field, shields for motors, tape heads, submin. encap. uses.

**MAGNETIC SHIELD DIVISION PERFECTION MICA CO.**

1322 No. Elston Avenue • Chicago 22, Illinois

CIRCLE 94 READERS SERVICE CARD

announcing...

# PROLENE

INSULATED WIRE AND CABLE

## *A Significant Advance in High Heat Resistant Insulation*

Phalo Plastics Corporation, through their program of research and development now offer "Prolene" insulated wire and cable to mark an important step forward in high heat resistant insulation.

Super light (0.9) specific gravity "Prolene" is tougher and harder and displays greater crush resistance than the two basic types of polyethylene in general use.

"Prolene" has good inertness and moisture resistance. It also resists solvents, greases, oils and many of the common acids and chemicals.

Chart shows typical comparative melt points of low density polyethylene — "Phalene" and "Prolene".

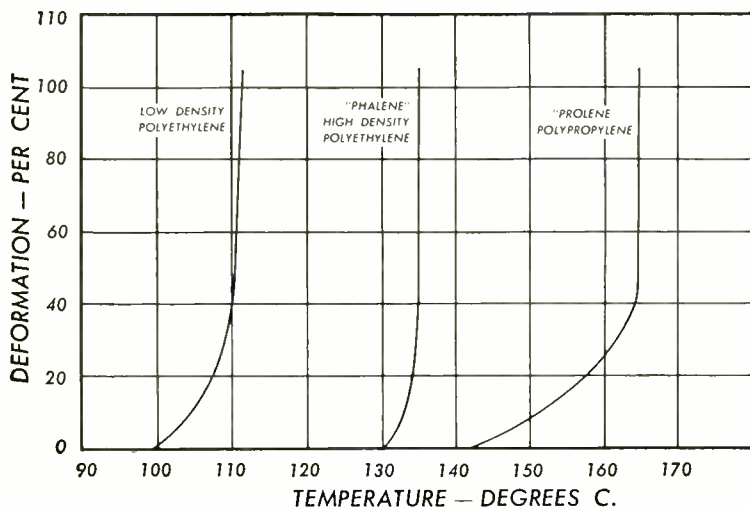

Ask for technical data on new "PROLENE"

**PHALO**

530-8 BOSTON TURNPIKE  
**PLASTICS CORPORATION**  
SHREWSBURY, MASSACHUSETTS



Representatives in Leading Cities Throughout The U S. A.

196-9

10 w; the first two on an axial pig-tail top hat package and the higher power devices in 10-32 stud-mounted cases. **Circle 231 on Reader Service Card.**

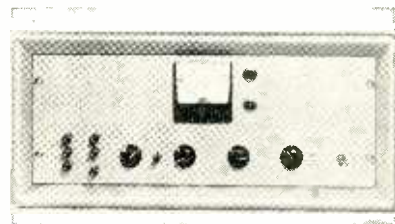

### Core Tester versatile unit

ARKAY ENGINEERING, INC., 225 Santa Monica Blvd., Santa Monica, Calif. Developed for use by both production and design engineers, the model RK-100 tests tape wound cores, ferrite cores and relays. The instrument monitors tolerances on core parameters, determines drive requirements, switching times and voltage and disturbance output. Parameters are read on a scope to plot families of curves for determination of coercive force, volts per turn and other data. **Circle 232 on Reader Service Card.**

### Transformers toroidal type

TRIAD TRANSFORMER CORP., 4055 Redwood Ave., Venice, Calif., has developed the TY series of transformers for transistor power supplies. They provide d-c output from mobile supplies of either 6, 12 or 28 v d-c. Units are epoxy molded, toroidal type transformers capable of exceeding the requirements for grade 5 class R units as specified in MIL-T-27A. **Circle 233 on Reader Service Card.**



### V-T Electrometer three types



THE VICTOREEN INSTRUMENT CO., 5806 Hough Ave., Cleveland 3, Ohio, announces a new line of vacuum



No quicker, more accurate way to get information on PRODUCTS and SERVICES than . . . .

**electronics  
BUYERS'  
GUIDE**

keep it  
at your  
fingertips!

ABC   **electronics  
BUYERS' GUIDE**  
A McGRAW-HILL PUBLICATION  
330 WEST 42nd ST. NEW YORK 36, N. Y.

Advance Relays  
Automatic Electric  
Besson and Robinson  
Collins Electronics  
C. P. Clare  
Elgin Neomite  
E. M. S.  
Guardian Electric  
Kurman  
Leach Relays  
Monitor  
Phillips Control  
Potter & Brumfield  
R-B-M  
Div. Essex Wire  
Struthers Dunn  
Terado  
And Others



*Now... Buy*



**24 HOUR DELIVERY**  
from  
**RELAY SALES**

Send for our Catalog C-9  
Phone West Chicago 1100  
TWX West Chicago, Ill. 3464-U  
Write P.O. Box 186A, West Chicago, Ill.

CIRCLE 96 READERS SERVICE CARD

# RESEARCH ENGINEERS

## Electronic and Electro-Mechanical

**COMMUNICATIONS & COUNTERMEASURES** To direct and supervise group of physicists, engineers and technicians in projects involving weapons systems, ranging, detection, atmospheric measurements, etc. Conversant with practical and theoretical implications of defensive or offensive systems.

**ULTRASONICS** To direct group of physicists, engineers and technicians in research and development of sonic and ultrasonic equipment for commercial and military applications, and encompassing all aspects of ultrasonic research. Requires qualities of leadership and compatibility with highly skilled scientific minds.

**SERVOS & CONTROLS** Will direct and supervise group of engineers, physicists and technicians in research and development in electro-mechanical devices, servos, industrial controls and instrumentation. Excellent opportunity in applied research in this field.

Degree required in engineering or science with a minimum of 5 years related experience. These positions are with the Research Division, at Quehanna, in the picturesque area of North-Central Pennsylvania, 40 miles from State College, home of Pennsylvania State University.

Send resume including salary requirements to: Mr. T. W. Cozine, Manager, Executive & Technical Placement, Curtiss-Wright Corporation, Dept. RD-72, Wood-Ridge, New Jersey.

*All replies confidential*

**CURTISS-WRIGHT**   
CORPORATION • WOOD-RIDGE, N.J.

# HEXSEALS®

*Modular  
(Explosion-Proof\*)*

## SWITCH and SHAFT SEALS

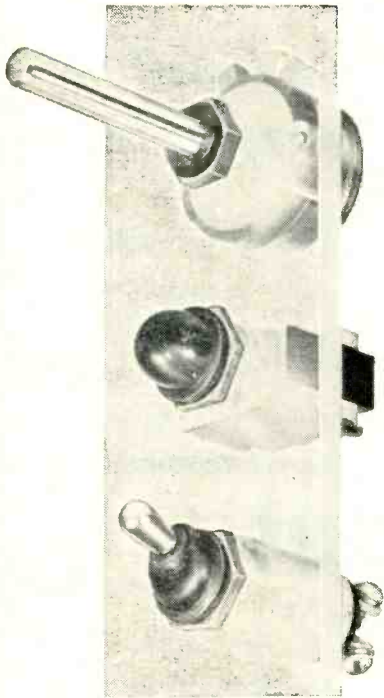

- Fit all industrial electrical controls.
- Meet Military Specifications:  
MIL-B-005423A (ASG),  
MIL-B-19257 (Ships),  
SCL-6303 (Sig. Corps),  
Paragraph 183.10-20,  
Part (B)  
U.S. Coast Guard.

\*DISCLAIMER: We cannot assume responsibility for explosion-proofing any equipment not entirely designed by APM, therefore no guarantee is made or implied.

Send for Catalog 359



**A.P.M. Corporation**

(AUTOMATIC and PRECISION MFG.)

252 Hawthorne Ave., Yonkers, N.Y.  
Yonkers 8-2010

Designers and Manufacturers of  
HIGH PRESSURE STATIC AND MOVABLE SEALS  
HEXSEALS® • SEELSKREWS® • SEELBOLTS® • SEELRIVETS®  
CIRCLE 186 READERS SERVICE CARD

tube electrometers for measuring low currents. Model VTE-O is a low-current measuring instrument covering a current range from  $10^{-8}$  to  $10^{-11}$  amperes. Model VTE-1 is identical except that it has a built-in bucking current supply. Model VTE-2 is a wide range and stable measuring device covering the current range of  $10^{-8}$  through  $2 \times 10^{-13}$  amperes full scale. Circle 234 on Reader Service Card.

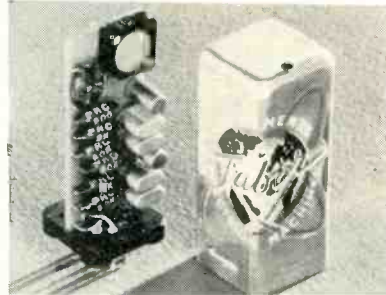

### Plug-In Amplifier transistorized

TABER INSTRUMENT CORP., North Tonawanda, N. Y. This plug-in transistor amplifier, designed for servo and audio applications, features good closed-loop gain stability from  $-60$  C to  $+150$  C. Open-loop gain is 90 db and closed-loop gain is variable from 2 to 1,000. Two external feedback resistors and an external bypass capacitor are required to select the desired gain and low frequency cut-off. Bandwidth is 5 cps to 50 kc. There is no significant increase in noise with vibration to 40 g at 60 cps. Circle 235 on Reader Service Card.

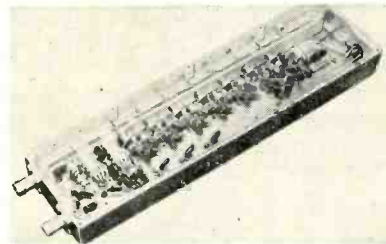

### I-F Amplifier low noise unit

LEL, INC., 380 Oak St., Copiague, N. Y. The IF-81 transistorized i-f amplifier is a low noise hybrid unit combining the low noise properties of a tube input circuit with the low

# D-C POWER

Precisely Regulated for  
Missile Testing and  
General Use

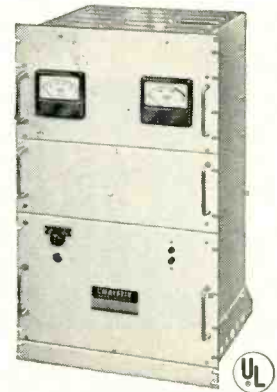

## SILICON POWER SUPPLIES

available in 30 standardized and militarized models from 30 to 1500 amps... 6 to 135 volts. CHRISTIE'S QUALITY CONTROL is approved by the A.E.C., leading aircraft and missile manufacturers.

Write For Bulletin AC-58-A

**CHRISTIE  
ELECTRIC CORP.**

3410 W. 67th Street  
Los Angeles 43, Calif.

CIRCLE 187 READERS SERVICE CARD

May 29, 1959 — ELECTRONICS



power requirements and ruggedness of transistors. Typical specifications are: center frequency, 30 or 60 mc; bandwidths available from 1 to 20 mc; gain 100 db and noise figures as low as 1 db. Circle 236 on Reader Service Card.

### Copper Wire aluminum clad

SYLVANIA ELECTRIC PRODUCTS INC., Warren, Pa., announces an aluminum clad copper wire designed for use in the production of high temperature magnet wire and a variety of electrical conductor applications in aircraft, missiles, and other high speed industrial equipment. The aluminum alloy measures approximately 40 percent of the cross-sectional area. At room temperature the conductivity of the new wire is close to 70 percent that of copper. Circle 237 on Reader Service Card.



### P-C Etcher laboratory model

CENTRE CIRCUITS, INC., P. O. Box 165, State College, Pa., announces a new, high-speed laboratory model pump spray etcher for printed circuitry. It features PVC and titanium construction throughout; variable spray nozzle pattern. Unit uses ferric chloride or chromic acid to etch sides simultaneously on boards up to 16 in. by 22 in. Capacity is 25 gallons; size, 48 in. by 25 in. by 36 in. Circle 238 on Reader Service Card.

### Test Set sweep frequency

JERROLD ELECTRONICS CORP., 15th & Lehigh Ave., Philadelphia 32, Pa. Model 1707 sweep frequency test set offers unusual versatility and highly accurate quantitative measure-



# CHICAGO STOCK PULSE TRANSFORMERS

Stocked for immediate delivery  
from your electronic parts distributor

Designed for Navy Preferred Circuits  
and other  
blocking oscillator applications

These CHICAGO ultra-miniature wound core pulse transformers are hermetically encapsulated 3 winding units. They are designed and built in accordance with MIL-T-27A and are characterized by extremely fast rise time, minimum droop, and high temperature stability. The leads are arranged so that they can be soldered directly in to the circuit or clipped and plugged into a standard 7-pin miniature tube socket. Each unit in the "PE" series weighs approximately .16 ounce.

CHICAGO Part No.	Nominal Pulse Width Microseconds	Rise Time Microseconds	Height	Width	Depth
PE-50	0.5.	.07	1/16"	1/16"	1/16"
PE-75	0.75	.07	1/16"	1/16"	1/16"
PE-100	1	.06	1/16"	1/16"	1/16"
PE-200	2	.05	1 1/16"	1 1/16"	3/4"
PE-500	2	.07	1 1/16"	1 1/16"	3/4"
PE-700	7	.1	1 1/16"	1 1/16"	3/4"

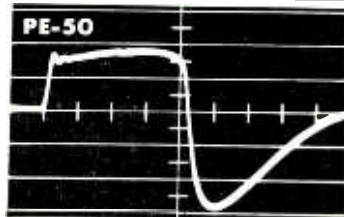

Data obtained through use of N.B.S. Preferred Circuit #46 as found in Navy Aeronautical Preferred Circuits Handbook.

Oscillograph pictures of pulses for all units and other technical data are available in Chicago Bulletin CT-45. Write for your free copy.

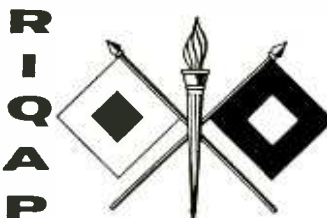

Since 1955, Chicago Standard Transformer Corporation has been operating continuously under RIQAP, the U.S. Army Signal Corps' Reduced Inspection Quality Assurance Plan. When you specify Chicago Standard transformers, delivery time is reduced and incoming inspection is at a minimum. You are assured of the highest quality units for military applications.

**CHICAGO STANDARD** Transformer Corporation  
3502 West Addison Street • Chicago 18, Illinois

# COUCH CVE TYPE RUGGED ROTARY RELAYS

Built to  
reach  
outer space . . .



*. . . and work all the way!*

Couch Rugged Rotary Relays were used in the Atlas 10B satellite launched from Cape Canaveral on December 18, 1958.

Couch relays were selected by Convair Astronautics because of their proven ability to perform in the most severe environments. Modern quality control techniques coupled with a simple rugged design provide the reliability needed for missiles.

Couch relays are available in wide variety . . . for switching dry circuits as well as circuits up to 10 amperes . . . for operation with voltages from 6 to 250 VDC . . . all under vibration up to 20 G's with no contact opening.

*May we have the opportunity of discussing your relay requirements?*

*Couch*

**ORDNANCE INC.**

A subsidiary of S. H. Couch, Inc.

3 Arlington Street

North Quincy, Mass.

ments of gain, loss and vswr, using sweep frequency techniques. The instrument is designed for laboratory or production test usage where accurate quantitative and comparative measurements are required in terms of dbm, power, voltage, and the db difference between two levels. Test set includes a crystal controlled marker generator, a precision sweep generator (flat within 5/100 of a db) and a voltage comparator. Circle 239 on Reader Service Card.



## Free Gyro for missile use

IRON FIREMAN MFG. CO., 2838 S.E. Ninth Ave., Portland 2, Ore., has in production a miniature free gyroscope weighing only 3½ lb and able to withstand vibration of 10 to 1,000 cps at 10 g and 1,000 to 2,000 cps at 20 g with 2-minute sweep cycles without the benefit of vibration isolators. Model N4100 is a cageable, 2-axis, free gyro designed especially for missile application. Circle 240 on Reader Service Card.

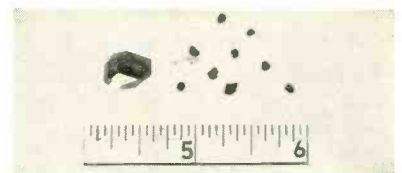

## Yttrium Iron Garnet single crystal

MICROWAVE CHEMICALS LABORATORY, INC., 282 Seventh Ave., New York 1, N. Y., offers single crystal YIG in all sizes up to 0.400 in. and weighing as much as two grams per crystal. These crystals have extremely narrow resonance line width, less than 5 oersteds at microwave frequencies. Their Curie point is 292 C + 1 C. Potential uses lie in the microwave device field, as parametric amplifiers, and as superior substitutes for conventional microwave ferrite single crystals. Single



crystal YIG has been successfully used as a Faraday-rotation type IR modulator. Circle 241 on Reader Service Card.

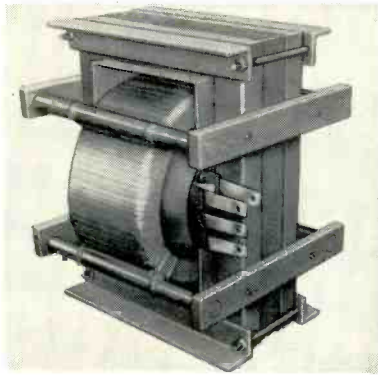

### Transformer compact design

NOTHELPER WINDING LABORATORIES, INC., P.O. Box 455, Trenton, N. J., has introduced a shell type Donut transformer. It is used for isolating high voltages in filaments, cascaded h-v power units, etc. The low cost of the unit is achieved by eliminating ceramic bushings, oil and tank. New transformer features a more compact design. For detailed information write directly to the company.

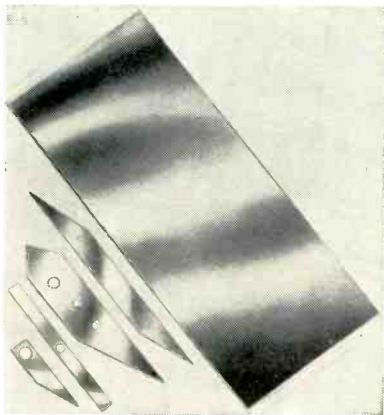

### Resistance Card metal film

FILMOHM CORP., 48 25th St., New York 10, N. Y., announces the metal film resistance card, a new highly stable microwave attenuator material. Base is a fine weave glass cloth impregnated with high temperature thermosetting resin which meets MIL-P-18177. Resistance material is a thin film of pure metals,

**15,000 hours at 55°C**  
**without servicing or oiling**  
*and still going strong!*

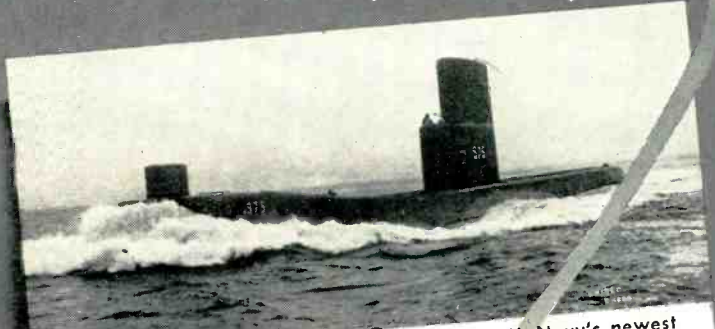

Air-Marine Motors go to sea on USS Seawolf, Navy's newest atomic-powered submarine.

## SEAWOLF'S VITAL ELECTRONIC EQUIPMENT COOLED BY AIR-MARINE MOTORS

**15,000**  
**10,000 HOURS UNDER THE SEA!**

When the U.S. Navy's atomic-powered submarine—miracle of modern engineering—churns through the waters at 50 fathoms down, its vital electronic equipment is constantly protected day and night by a battery of the most rugged blowers ever devised.

Incorporating into its design equipment never before mounted for undersea service, Navy engineers were confronted with a critical cooling problem, for the Seawolf was to stay submerged week after week and month after month. And such equipment must be dependably and constantly cooled.

Tough project? Not at all for Air-Marine. It's highly trained staff of engineers pooled their knowledge and promptly designed, to rigid Navy specifications, blowers that could run continuously toward a 10,000 hour life—more than a solid year—delivering uninterrupted cooling for the A-sub's vital installations.

Whatever your problem—small or large—this same experienced engineering staff is yours to command. Contact Air-Marine for your motor needs—for the best motors skill can produce—the finest money can buy.

115V 400CY 1PH 1-0MFD

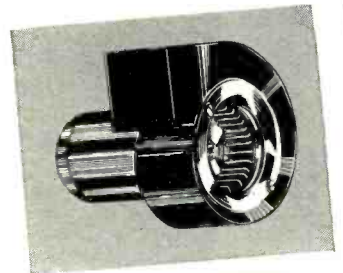
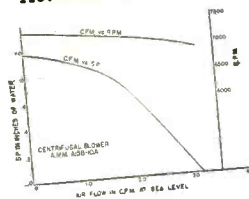

Air-Marine's Seawolf Motor



**air-marine motors, inc.**  
 Amityville, N. Y.  
 Los Angeles, Calif.

369 Bayview Avenue  
 West Coast Factory: 2221 Barry Ave.

Above is an air-marine motors advertisement which first appeared in July, 1957.

# MISSILE RELAYS

*with the reliability you've  
been looking for!*

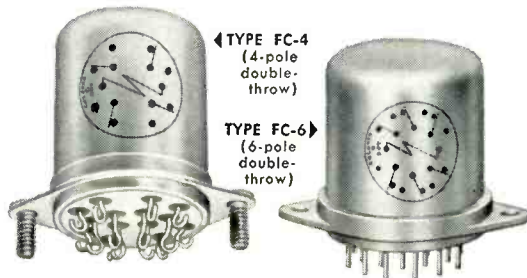

***Dunco means  
high reliability!***

Most relay troubles come from contamination, use of improper contact materials or unbalanced design.

To eliminate these, Struthers-Dunn installed a quarter of a million dollar environmental testing laboratory for determining exactly what is needed to insure missile relay reliability.

As a result, Dunco FC-6 and FC-4 relays are spotlessly clean, have a unique new contact material of outstanding dependability, and incorporate improved design that provides positive protection against vibration. Best proof of their performance is the fact that they play important parts in at least six vital missile programs.

**WRITE FOR  
DUNCO BULLETIN FC**



## STRUTHERS - DUNN

Makers of the World's Largest Assortment of Relays

PITMAN, NEW JERSEY



Sales Engineering Offices in: Atlanta • Boston • Buffalo • Chicago • Cincinnati • Cleveland • Dallas • Dayton • Detroit • Kansas City • Los Angeles • Montreal • New Orleans • New York • Pittsburgh • St. Louis • San Francisco • Seattle • Toronto

approximately 50 millionths of an inch thick, uniformly deposited on one surface of the plastic. A protective coating is provided over the metal film. Standard cards are 5 by 12 in., and 0.025, 0.032 or 0.062 thick. Circle 242 on Reader Service Card.

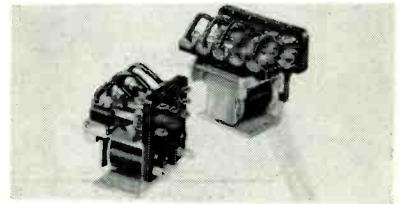

### Power Relay general purpose

COMAR ELECTRIC Co., 3349 Addison St., Chicago 18, Ill. Type U general purpose power relay is ruggedly built with single coil construction, employing box type magnetic field. Moveable contact springs are mounted on molded phenolic insulating bars, providing positive contact alignment. Contacts of  $\frac{1}{4}$  in. diameter are available in either silver or silver cadmium oxide, rated singly at 10 to 25 amperes, 110 v a-c, noninductive. Circle 243 on Reader Service Card.

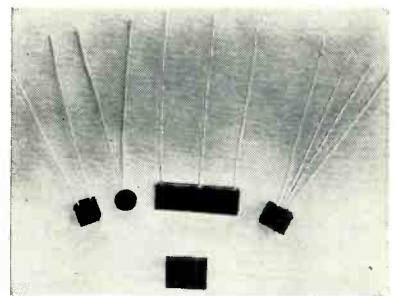

### Selenium Rectifiers miniature units

GENERAL INSTRUMENT CORP., Radio Receptor Division, 240 Wythe Ave., Brooklyn, N. Y., announces the ABC series of completely potted, low-cost selenium rectifiers. Line is available in a wide range of voltages and currents for use in half-wave, full-wave, single or three-phase rectifier circuits. Dimensions depend upon specific voltage and current requirements. Heading the list is type ABA, a 130 v rms, 20 ma rectifier rated with a resistive or inductive load



which, because of its tiny size and its ability to operate off the line, is ideally suited for rechargeable battery-operated appliances. Circle 244 on Reader Service Card.



### Ferrite Isolator high power

RAYTHEON MFG. Co., River Bldg. No. 2, Waltham 54, Mass. Model IUH1 ferrite isolator is designed to operate in the 500-700 mc region of the uhf band. It is 6½ in. high, 19 in. wide, 30 in. long and weighs 100 lb less transitions. Transitions from this reduced height guide to full height guide or to coax line can be supplied. Minimum transmit/receive isolation is 9 lb; maximum insertion loss is 1 db. Average power handling capacity is 10 kw without cooling; peak power is 10 megawatts. Circle 245 on Reader Service Card.

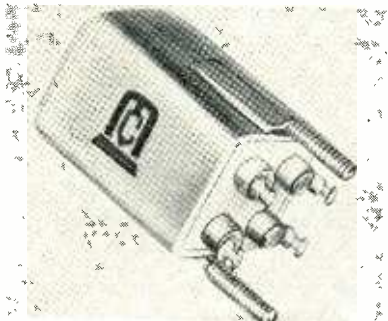

### Transformers seven new types

MICROTRAN Co., INC., 145 E. Mineola Ave., Valley Stream, N. Y., has added seven new subminiature transistor transformers to its catalog line. Units are available hermetically sealed, in MIL-AF case, round hermetic case, or in epoxy-molded construction. Size is slightly less than 1 cu in. with an approximate weight of 1 oz. Impedance ranges are designed to meet the requirements of many new transistors. Circle 246 on Reader Service Card.

# atlee CLIPS GAIN IN HOLDING POWER

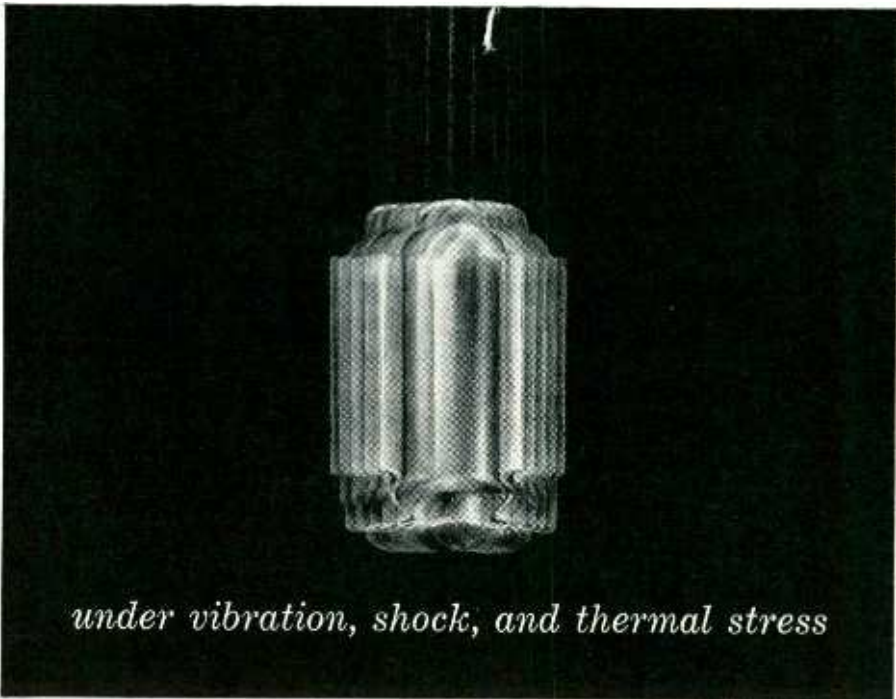

*under vibration, shock, and thermal stress*

**TESTS PROVE IT . . . tests conducted independently by some of the nation's most critical users of component holders.\***

*the TESTS:*

- vibration at 500 cps 90 G peak, and at 2,000 cps 65 G peak, for one minute
- 1,750 impact shocks at 200 G, perpendicular to and also along the axis of the holder
- 100 complete cycles of component insertion and withdrawal
- above tests repeated after 15 minutes exposure to temperature of 500°F.

*the RESULTS:*

- no visible shifting of the component in the holder
- no resonant frequencies developing under vibration
- temperature had no effect on dynamic holding power
- insertion-withdrawals had no effect on dynamic holding power
- force required to dislodge component *increased* during tests

*the REASONS:*

- severe vibration and shock cause the material of the holder to flex slightly, producing a closer "set" of the holder surfaces to the contours of the held component.

**atlee** component holders *start out* with a tighter-than-usual grip . . . because of proper contours, construction and materials. As environmental stresses increase, this holding power automatically increases to meet the greater demand . . . because the holders actually mold themselves to the components. Here is an equipment designer's dream come true: the greater the stress, the *greater* the security.

*DESIGN FOR RELIABILITY WITH atlee* — a complete line of superior heat-dissipating holders and shields of all types, plus the experience and skill to help you solve unusual problems of holding and cooling electronic components.

\* Names on request.

# ATLAS E-E CORPORATION

47 PROSPECT STREET • WOBURN, MASS.

**NEW**

# MINIATURE TRANSFORMERS

FOR  
*Transistor*

AND PRINTED  
CIRCUIT  
APPLICATIONS



Custom transformers for printed circuits are now available from ADC in five standard case sizes with terminals and inserts on 0.1" grid multiples. Audio, power, and ultrasonic transformers and inductors with maximum electrical performance for each size are being custom designed for transistor and vacuum tube circuitry. Raised mountings prevent moisture from being trapped. Available in Mumetal cases. They meet MIL-T-27-A Grade 5 Class R or S Life X, and can be designed to meet 500 and 2,000 cps vibration.

## TYPICAL RATINGS

Fig.	Description	Primary	Secondary	Maximum Level	Response (CPS)
1	Output	P-P collectors 100 ohms CT	400/150 ohms	+33 dbm (2w)	±2db 250-10,000 cps
2	Output	5000 ohms 5ma DC	50/250/500 ohms	+10 dbm (10mw)	±1db 100-10,000 cps
3	Output	P-P collectors 1000 ohms CT	4/B/16 ohms	+25 dbm (300mw)	±1db 250-10,000 cps
3	Interstage	Collector 5000 ohms 1ma DC	P-P bases 3000 ohms CT	+5 dbm	+1db 250-5,000 cps
4	Input	50/250/500 ohms	50,000 ohms	+2 dbm	+1db 250-10,000 cps
5	Output	P-P collectors 500 ohms CT	4/B/16 ohms	+20 dbm (100mw)	±1db 250-10,000 cps
5	Interstage	Collector 7500 ohms 1ma DC	P-P bases 5000 ohms CT	0 dbm	+1db 250-10,000 cps

Fig.	Description	Rating
3	Audio	200 mhs 1v 1000 cps 0 DC
5	Power	500 mhs 1v 400 cps 10ma DC

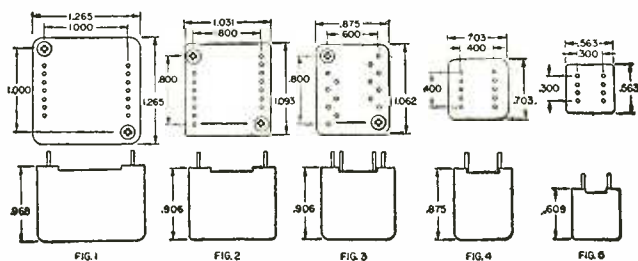

Fig.	Description	Rating
3	Low pass 600 ohms input 600 ohms output	+10dbm 1 cutoff 50kc Attenuation 18db per octave
3	High pass 10,000 ohms input 10,000 ohms output	+10dbm 1 cutoff 2kc Attenuation 18 db per octave

Fig.	Description	Primary	Secondary	VA	Regulation
4	Filament	1.5v 380-420 cps	6.3v .6a	4.0	10%
5	Dual filament	26v 380-420 cps	111.6v 5ma (2) 6v 5ma	?	2%

Note: Other combinations are available with 400 cps max. volt ampere ratings up to 15 for Fig. 1, 10 for Fig. 2, 6 for Fig. 3, 4 for Fig. 4, and 1 for Fig. 5



WRITE TODAY FOR COMPLETE INFORMATION



**AUDIO DEVELOPMENT COMPANY**  
2838-13th Avenue South • Minneapolis 7, Minnesota  
TRANSFORMERS • REACTORS • FILTERS • JACKS • PLUGS • JACK PANELS

## Literature of

### MATERIALS

**Reinforced Plastic Tapes.** Minnesota Mining and Mfg. Co., 900 Bush Ave., St. Paul 6, Minn., has available data sheets on fast curing, one-part epoxy resin systems in the form of Scotchply brand reinforced plastic tape for electrical applications. Circle 250 on Reader Service Card.

### COMPONENTS

**Precision Wirewound Potentiometers.** Maurey Instrument Corp., 7924 South Exchange Ave., Chicago 17, Ill. An illustrated catalog contains technical data on single-turn wirewound pots and resistance elements. Circle 251 on Reader Service Card.

**Wire Stranding Chart.** Alpha Wire Corp., 200 Varick St., New York 14, N. Y. Stranding chart ZK-4 makes it possible, through the use of a one-page reference, to rapidly determine available stranding combinations for various sizes of conductor wire. Circle 252 on Reader Service Card.

**Coax Attenuators.** Empire Devices Products Corp., Amsterdam, N. Y. A new 4-page, 2-color engineering catalog, A-259, presents a complete line of coaxial attenuators for use at microwave frequencies. Circle 253 on Reader Service Card.

**Power Connectors.** DeJur-Amsco Corp., 45-01 Northern Blvd., Long Island City 1, N. Y. An illustrated bulletin gives specifications, outline dimensions and general information on series 14 power connectors with closed ring entry contacts. Circle 254 on Reader Service Card.

**Hermetically Sealed Resistors.** Consolidated Resistance Co. of America, Inc., 44 Prospect St., Yonkers, N. Y. Series 200 resistors which are 0.01 percent accurate and 0.003 percent stable are de-



# the Week

scribed in engineering bulletin R-28. Circle 255 on Reader Service Card.

**Electronic Tubes.** Sperry Gyroscope Co., Electronic Tube Div., Great Neck, N. Y. A recent condensed catalog covers twt's and various types of klystrons. Circle 256 on Reader Service Card.

## EQUIPMENT

**Instruments.** John Fluke Mfg. Co., 1111 West Nickerson, Seattle, Wash. The 16-page instrument catalog C-59 gives illustrations of all the company's products with complete details, specifications and application for each unit. Circle 257 on Reader Service Card.

**Instrumentation Tape Recorder.** Precision Instrument Co., 1011 Commercial St., San Carlos, Calif. An eight-page two-color brochure describes the PS-200 transistorized magnetic tape instrumentation recorder. Circle 258 on Reader Service Card.

**Zener Voltage Tester.** Electronic Research Associates, Inc., 67 Factory Place, Cedar Grove, N. J. A recent catalog sheet provides full descriptive material on the new Zener voltage tester, model DT100. Circle 259 on Reader Service Card.

**Audio Frequency Amplifiers.** Cinema Engineering Division, Aero-ox Corp., Burbank, Calif. A 12-page brochure on audio frequency amplifiers contains charts, diagrams, and product pictures. Circle 260 on Reader Service Card.

## FACILITIES

**Electrical Connectors.** The Deutsch Co., Municipal Airport, Banning, Calif., has published a booklet illustrating and describing its facilities for the volume production of precision connectors for the critical demands of advanced military and industrial systems. Circle 261 on Reader Service Card.

SPECIALLY BUILT TO WITHSTAND SEVERE OPERATING CONDITIONS



# HARD GLASS TUBES



6094  
BEAM POWER AMPLIFIER



6384  
BEAM POWER AMPLIFIER



6754  
FULL-WAVE RECTIFIER

- Ideal for modern high-performance aircraft and missiles.

- Processing at higher vacuum and under the higher heat permitted by the hard glass reduces gas and contamination and provides greater operating stability at higher temperatures.

- Ceramic element separators prevent emission loss from high heat and vibration.

- Solid aluminum oxide heater-cathode insulator eliminates shorts, reduces leakage.

For complete line of tubes, write RED BANK DIVISION, BENDIX AVIATION CORPORATION, EATONTOWN, NEW JERSEY.

ELECTRICAL RATINGS*	6094 Beam Power Amplifier	6384 Beam Power Amplifier	6754 Full Wave Rectifier
Heater Voltage (AC or DC)**	6.3 volts	6.3 volts	6.3 volts
Heater Current	0.6 amp.	1.2 amp.	1.0 amp.
Plate Voltage (Maximum DC)	300 volts	750 volts	350 volts
Screen Voltage (Maximum DC)	275 volts	325 volts	—
Peak Plate Voltage (Max. Instantaneous)	550 volts	750 volts	—
Plate Dissipation (Absolute Max.)	14.0 watts	30 watts	—
Screen Dissipation (Absolute Max.)	2.0 watts	3.5 watts	—
Heater-Cathode Voltage (Max.)	±450 volts	±450 volts	±500 volts
Grid Resistance (Maximum)	0.1 Megohm	.1 Megohm	—
Grid Voltage (Maximum)	5.0 volts	0 volts	—
Grid Voltage (Minimum)	-200 volts	-200 volts	—
Cathode Warm-up Time	45 sec.	45 sec.	45 sec.

\*For greatest life expectancy, avoid designs which apply all maximums simultaneously.

\*\*Voltage should not fluctuate more than ±5%.

MECHANICAL DATA	6094	6384	6754
Base	Miniature	Octal	Miniature
Bulb	9-Pin	T-11	9-Pin
Maximum Over-all Length	T-6½	T-11	T-6½
Maximum Seated Height	2 7/8"	3 15/32"	2 3/4"
Maximum Diameter	2 7/8"	2 15/16"	2 3/4"
Mounting Position	Any	17/16"	7/8"
Maximum Altitude	80,000 ft.	80,000 ft.	80,000 ft.
Maximum Bulb Temperature	300°C	300°C	300°C
Maximum Impact Shock	500G	500G	500G
Maximum Vibrational Acceleration	50G	50G	50G

West Coast Sales and Service: 117 E. Providencia Ave., Burbank, Calif.  
Canadian Affiliate: Computing Devices of Canada, Ltd., P. O. Box 508, Ottawa 4, Ont.  
Export Sales & Service: Bendix International, 205 E. 42nd St., New York 17, N. Y.

Red Bank Division





## Edo Occupies New Building

IN COLLEGE POINT, L. I., N. Y., Edo Corporation, manufacturer of a diversified line of electronic equipment and aircraft components, has transferred engineering and administrative personnel to a recently completed \$500,000 building. The new two-story structure is directly across the street from the original plant, which continues to house Edo's extensive manufacturing and shop facilities.

Area of the new building is 30,000 sq ft, with electronic and mechanical engineering staffs housed on the second floor and the ground floor occupied by administrative, sales and accounting personnel. Its completion has released some 18,000 sq ft in the original plant for stepped-up production.

Edo Corporation was founded in 1925 by Earl Dodge Osborn, who is still active as chairman of the board, and whose initials gave the company its name. Originally the firm specialized in the design and production of aircraft floats and various hull-type configurations for aircraft. The company is still a leader in that line, but the bulk of its production today is in the electronic field, with special emphasis on sonar devices and navigation systems for ships and aircraft. In addition, for the U. S. Navy, Edo makes a number of classified devices for use in underwater detection, antisubmarine warfare and other special applications.



## Warriner Joins Sprague Electric

APPOINTMENT of Robert R. Warriner as military applications specialist at Sprague Electric Co.,

North Adams, Mass., is announced. He comes to Sprague from the Aerovox Corp. of New Bedford, Mass., where he was chief applications engineer for the past 10 years. Prior to that he was chief application engineer for the Solar Mfg. Corp., Los Angeles, Calif.

## Servo Corp. Hires Fitzgerald

APPOINTMENT of Joseph Fitzgerald as assistant manager of weapons sub-systems sales at Servo Corp. of America, New Hyde Park, N. Y., was recently announced. He was previously associated with Lewyt Mfg. Corp., where he was engaged in subcontract sales to the aircraft electronic industry.

## Appoint Evans Lab Manager

SANFORD EVANS was recently named manager of Dalmo Victor Company's Monterey, Calif., engineering laboratory. He replaces Frank McDonald who has resigned. McDonald will remain associated with the company on a consulting basis.

In addition to his new duties, Evans will remain the technical director of the laboratory.



## Brush Advances Whittemore

BRUSH INSTRUMENTS, Division of Clevite Corp., Cleveland, Ohio, has named William K. Whittemore manager of its eastern regional office at Arlington, Va. From the Arlington office, he will direct sales and service operation in Virginia, West Virginia, Maryland and Delaware.

Whittemore has been associated with Brush Instruments since 1950. After employment as sales engineer in the Washington office he was transferred to Cleveland where he served successively as project engineer, assistant to chief engineer, and most recently as sales engineer.

## Raytheon Picks Plant Manager

WILLIAM HYSLOP has been named manager of Raytheon Mfg. Company's receiving tube division plant at Quincy, Mass. He had been staff



FROM OUR GALLERY OF "DOUBTING THOMASES"

to querulous Thomas McHector McVector  
**GLUE WAS THE IDEAL AND  
PERFECT CONNECTOR!**

Trouble with McH. McV. was he didn't think ahead! To the day when the horse would be replaced by the automobile, the plane and the missile; and each, in turn, with its own needs for a new type of connector! Until an entirely new connector system had to be devised.

You have come to know this as the Varicon Connector system, the industry's synonym for "reliability" and whose limitless applications are limited only by your own imagination. Elco also provides you with the most complete line of printed circuit components, tube-sockets and shields.

Why not write for the Catalogs and Technical Bulletins relating to those components in which you are interested. Today?

**IF IT'S NEW... IF IT'S NEWS... IT'S FROM**

**ELCO** CORPORATION

"M" St. below Erie Ave., Phila. 24, Pa., CU 9-5500

Elco-Pacific: 2200 Centinella Avenue, West Los Angeles 64, Cal., GR 8-0671



**ELCO'S SERIES 5002**

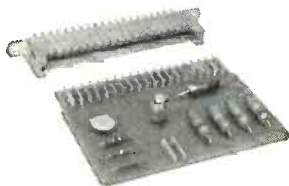

P. C. Varicon Connectors; sectional design, female part; for 1 to 44 contacts. Male member consists of contacts supplied on plastic strips. Bulletins 101A and Staking Bulletin TB001.

**ELCO'S  
SERIES 7001**



Subminiature P. C. Varicon Connectors; for maximum number of contacts in minimum space; plus all Varicon reliability, versatility factors. Bulletins 106A and TB001.

**ELCO'S SERIES 5301**



Board-to-board Printed Circuit Connectors. Contacts supplied in disposable plastic strips. Offers any number of contacts, spacing, location and board angulation. Bulletins 108A and TB001.

DON'T  
BE  
FOOLED  
BY  
LOOK-  
ALIKES

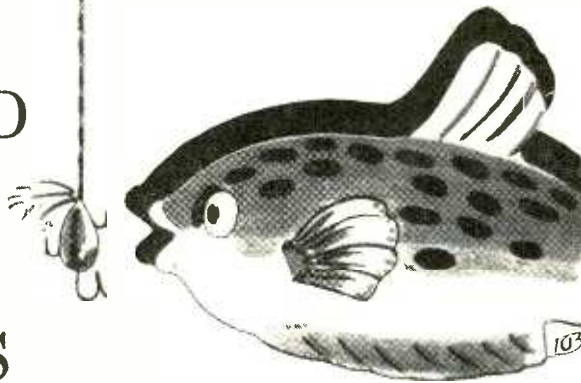

Adherence to tightest specifications by skilled assemblers—100% inspection for perfect construction—precision parts—closely controlled spacing guarantees **RELIABLE PERFORMANCE** in every **SUPERIOR** electron gun mount.

At your service for any type of electron gun mount. Samples, catalogs, prices available on request.



## Superior Electronics Corporation

208 Piaget Avenue, Clifton, New Jersey • GRegory 2-2500

CIRCLE 196 READERS SERVICE CARD

assistant to division manager George Loomis.

In his new post Hyslop will direct some 1,100 employees in the production of receiving tubes used in radios, television sets, and other electronic devices.



## Collins Radio Ups Landee

THE western division of Collins Radio Co., Burbank, Calif., announces that Robert W. Landee has been promoted from assistant director to director of research and development for airborne data communications.

Landee also has had broad experience in servos, indicators and radar transmitters and receivers, serving as program manager on various missile and radar systems.

## News of Reps

Precision Tube Co., Inc., North Wales, Pa., has announced the appointment of the **Vince E. Johnson** Co. of Seattle, Wash., as its sales rep in the states of Washington and Oregon.

**Fred Spellman Co.** of Manhasset, L. I., N. Y., is named sales rep in New York City and suburbs, Long Island, and northern New Jersey, for Elco Corp., Philadelphia, Pa.

Appointment of Shephard-Winters Co., Los Angeles, as southern Cali-

**TEMPERATURE  
CONTROL  
FOR  
COMPONENTS**

**BLILEY  
TYPE  
BCO-10**

For temperature stabilization of diodes, the new Bliley BCO-10 oven will hold  $\pm 1^\circ\text{C}$  with ambient temperature variation from  $-10^\circ\text{C}$  to  $+50^\circ\text{C}$ . Stability is better than  $\pm 4^\circ\text{C}$  from  $-55^\circ\text{C}$  to  $+70^\circ\text{C}$ .

Compact unit has multiple contacts (20 terminals) for mounting up to 10 diodes. Dimensions, less brackets, are  $1\frac{15}{32}'' \times 1\frac{1}{4}'' \times 1\frac{23}{32}''$ . Design features an hermetically sealed snap-action thermostat and non inductive heater winding to minimize noise and interference in low level circuitry.

Standard models are available for operation at  $50^\circ\text{C}$  or  $75^\circ\text{C}$  with 12.6 volt, 26.5 volt or 115 volt heaters as required.

*Request Bulletin 517 for Complete Information.*

**Bliley** **BLILEY ELECTRIC COMPANY**  
UNION STATION BUILDING • ERIE, PENNSYLVANIA



fornia and Arizona sales rep for the Shockley Transistor Corp., Palo Alto, Calif., is announced.

Recently appointed reps for H. H. Buggie, Inc., Toledo, Ohio, are:

**Carlson Electronic Sales Co.**, of Chicago, Ill., for the state of Illinois; **Winfield Electronics Co.** of North Miami, Fla., for the state of Florida; **Allen C. Craft, Jr.**, of Atlanta, Ga., for the state of Georgia; and the **Charles W. Kinsley Co.**, of Huntsville, Ala., for the state of Alabama.

Solid State Electronics Co., Van Nuys, Calif., has appointed the following six sales reps:

**G. H. Vaughan Co.**, of Pasadena, for California, New Mexico, Arizona and Colorado; **Industron Co.**, of New York, for New York, New Jersey and Philadelphia; **Walter C. Stemler & Associates, Inc.**, of Aberdeen, Md., for Maryland, Washington, D. C., Delaware, eastern Pennsylvania and Virginia; **Saunders & Co.** of Waltham, Mass., for Massachusetts, Connecticut, Rhode Island, Vermont, New Hampshire and Maine; **Specialized Equipment Corp.** of Atlanta, Ga., for Georgia, Florida, Tennessee, North Carolina, South Carolina and Alabama; and **Ohio Instrument Co.** of Dayton, Ohio, for Ohio, western Pennsylvania, Kentucky and West Virginia.

Hitemp Wires, Inc., Westbury, N. Y., announces the appointment of the **Par Company** as technical and sales reps for the state of Florida.

Appointment of the **Danco Corp.**, Fairview Village, Pa., as rep in the Middle Atlantic states has been announced by **Telemeter Magnetics, Inc.**, Los Angeles, Calif.

Mid-Eastern Electronics, Inc., Springfield, N. J., has appointed two West Coast sales rep organizations to handle its line of ultra high resistance measuring instruments, power supplies and special test equipment. The **George H. Vaughan Co.**, Pasadena, will cover southern California and Nevada, and **Eicher & Co.**, Seattle, will handle Washington, Oregon and Idaho.

# NEW WILEY BOOKS—PROFESSIONAL TOOLS

## 1. ELECTRONIC CIRCUIT THEORY DEVICES, MODELS & CIRCUITS

By HENRY J. ZIMMERMAN and SAMUEL J. MASON, M.I.T. Strongly emphasizes the model concept, with little description of specific devices. Treats the subject as generalized theory rather than covering many theories to meet different conditions. Transistor theory is integrated throughout. 1959. 564 pages. \$10.75

## 2. SOLID STATE MAGNETIC AND DIELECTRIC DEVICES

Edited by HAROLD W. KATZ, General Electric Co. with 14 contributors. Core of the book is the electrical description of matter. A coherent treatment of dielectric and magnetic properties of the solid state, with magnetization and polarization as a basic electric property. First part covers theory as a background for 7 chapters on specific devices. 1959. 542 pages. \$13.50

## 3. NONLINEAR PROBLEMS IN RANDOM THEORY

By NORBERT WIENER, M.I.T. The fascinating role of biological nonlinear processes in studying self-organizing systems and nonlinear coding processes in communication theory. Includes much of pertinent interest in electronics, and must be examined to be appreciated. A Technology Press Research Monograph. 1958. 131 pages. \$4.50

## 4. PHYSICAL LAWS & EFFECTS

By C. FRANK HIX, JR., and ROBERT P. ALLEY, General Electric Co. Lists unusual laws and effects for application in modern science and technology. Superbly cross-referenced: 1. alphabetical; 2. by physical scientific discipline; 3. by physical quantities. 1958. 291 pages. \$7.95

## 5. SAMPLED-DATA CONTROL SYSTEMS

By ELIAHU I. JURY, University of California. Develops basic methods of analysis and synthesis used in sampled-data systems and allied fields—circuits, networks, computers, and the general field of systems engineering. 1958. 453 pages. \$16.00

## 6. JUNCTION TRANSISTOR ELECTRONICS

By RICHARD B. HURLEY, University of California. An answer to the ever-growing need for a book on truly basic knowledge involved in characteristics and circuit applications of transistors. 1958. 473 pages. \$12.50

## 7. TOPICS IN ELECTROMAGNETIC THEORY

By DEAN A. WATKINS, Stanford University. Brings together material on theory and microwave electron tubes not previously published in book form. Using both field and circuit approach it gives a coherent treatment of topics of great current interest. 1958. 118 pages. \$6.50

## 8. NOISE IN ELECTRON DEVICES

Edited by LOUIS D. SMULLIN and HERMANN A. HAUS, M.I.T. with 6 contributors. Stresses basic processes and gives background for thorough understanding of such devices as masers and parametric amplifiers. Includes methods of designing low-noise tubes. A Technology Press Book, M.I.T. 1958. 413 pages. \$12.00

## 9. FUNDAMENTALS OF ADVANCED MISSILES

By RICHARD B. DOW, U.S. AIR FORCE. Principles involved in propulsion, aerodynamics, guidance and control of missiles and space vehicles. Applications are covered from point of view of theory, experiment, and actual examples. A Wiley Book in Space Technology. 1958. 567 pages. \$11.75

## AND . . .

10. THE ANALYSIS OF STRAIGHT LINE DATA: Forman S. Acton, \$9.00. 11. THEORY AND DESIGN OF MAGNETIC AMPLIFIERS: E. H. Frost-Smith, \$12.50. 12. PROGRESS IN SEMICONDUCTORS, VOL. III. Edited by Gibson, Burgess, Aigrain, \$8.50. 13. SEMICONDUCTOR ABSTRACTS: Battelle Memorial Institute. VOL. IV, 1956 ISSUE, Edited by E. Paskell, \$12.00

TRIAL ORDER

### JOHN WILEY & SONS, Inc.

440-4th Ave., New York 16, N. Y.

1 2 3 4 5 6 7 8 9 10 11 12 13

Send me copies of the books I've circled. Within 10 days I'll remit full price or return books postpaid.

Check here to save postage. Enclose full amount with order and we pay postage. Same return privilege.

Name .....

Street .....

City .....Zone .....

State .....



"at last...  
a dependable  
source for

## PRECISION RESISTORS!"

Save valuable production time—cut costs—on precision wire-wound resistors. Designed for use in critical applications, **PRECISE-OHM** resistors are immediately available in a wide variety of standard designs and ratings. For specialized applications, resistance values and tolerances may be varied to meet your specifications. Coordination is close—delivery cycles are fast—and PI offers complete flexibility to help you meet your production schedules!

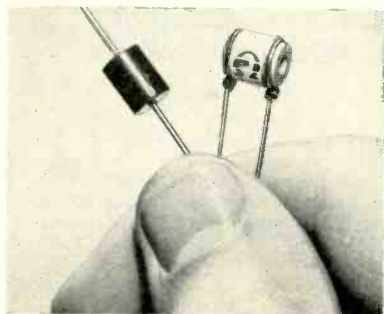

Types available in open or encapsulated styles, radial or axial leads, tolerances up to 1/50%. Next time your product design calls for a precision resistor . . . specify **PRECISE-OHM!**

Precision, Inc. also manufactures a complete line of Vitreous Enamel Resistors. Types include fixed, adjustable, multi-section, and pigtail units.

**Custom Manufacturing Facilities for Miniature Wire-Wound Components . . .**

- High Temperature Magnetic Coils
- Miniature Stators and Rotors
- Toroidal Reactors and Transformers
- Specialized Solenoids

**WRITE TODAY . . .**  
—for catalog, data sheets, and complete facilities brochure.

**precision, inc.**  
4748 France Ave. No. • Minneapolis, Minn.

CIRCLE 97 READERS SERVICE CARD

## COMMENT

### Crosby on Stereo

I would like to point out a correction in ("Recent Developments in Stereo Broadcasting," p 41, Apr. 3). On p 44 you mention a system of stereo transmission called the Harkins system. Harkins does not propose a system himself; he merely endorses my system. The transmission from KGLA in April 1958 used the sum-and-difference mixing amplifier, and subcarrier generator, developed by Crosby Laboratories Inc., in conjunction with the multiplex exciter developed by Harkins.

Harkins' contribution to that test was to provide a multiplex exciter so that a subcarrier could be applied with the standards I propose. I am sure that you will find that Red Harkins will agree with this. He indicated his endorsement of my system in a petition to the Federal Communications Commission on April 11, 1958.

Another point you missed in your article is that the system I developed is being experimentally broadcast by five stations who have the special FCC permits: WBAI, New York City; WJBR, Wilmington, Del.; WFDS, Baltimore; WFSM, Birmingham, Ala.; and WFMM, Minneapolis.

My contention is that the system I have proposed provides the optimum transmission efficiency, and is the only true stereo transmission system with no compromises in favor of a background music service, and with full 15-kc fidelity on both the transmitted channels—so that the listener obtains the same stereo performance he would obtain if he had the tape or disk directly reproduced in his home.

MURRAY G. CROSBY

CROSBY LABORATORIES  
SYOSSET, N. Y.

### Random Noise

I wish to make the following comments on your review of my book, *Principles and Applications of Random Noise Theory* (John Wiley & Sons, Inc., New York, 1958) which was published Apr. 10 (New Books, p 126). The review gives the impression of being written in haste and shows a lack

## FOR DEPENDABLE VIBRATION-PROOF TUBE SUPPORT

### MINI-SPRING®



Mini-Spring is the choice for positive holding action. Designed for "tight squeezes" that miniature electron tubes demand. Easy to install—no extra chassis piercing necessary. Specify Mini-Spring and be sure!

AVAILABLE IN QUANTITY AT YOUR LOCAL DISTRIBUTOR, OR WRITE FOR BULLETIN NO. 100. SPECIALS MADE TO YOUR ORDER.

THE **Staveland** COMPANY  
INCORPORATED

41-51 North Saxon Avenue, Bay Shore, N. Y.  
Distributor inquiries invited.

CIRCLE 199 READERS SERVICE CARD

## MEET TOM EMMA

Associate Editor, electronics  
FINANCE EXPERT



Thomas Emma, BA, Columbia, is a U.S. Naval Reserve officer who was formerly a technical writer with IT&T. Tom prepares "Financial Roundup"—a regular weekly business feature. In the coming months Tom will be concerned with radio communications, but he will be specifically involved with spectrum usage problems. To keep abreast of finance in electronics, turn to Tom's weekly coverage of latest developments. To subscribe or renew your subscription, fill in box on Reader Service Card. Easy to use. Postage free.

**ABC electronics ABC**

A McGraw-Hill Publication  
West 42nd Street, New York 36, N. Y.



# TELREX LABORATORIES

Designers and Manufacturers of

## COMMUNICATION ARRAYS FOR THE ARMED FORCES and Commercial Service

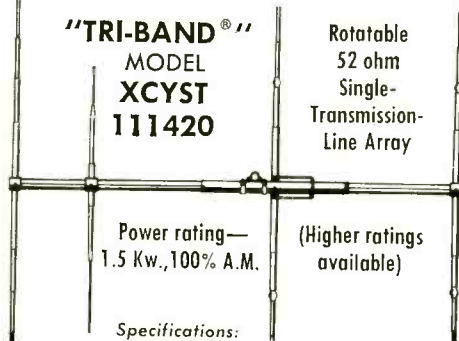

**Specifications:**  
Gain 11Mc.-8.0 db, F/B 24 db, E-Plane B-W 1/2 Power-66°  
Gain 14Mc.-8.4 db, F/B 24 db, E-Plane B-W 1/2 Power-60°  
Gain 20Mc.-8.6 db, F/B 24 db, E-Plane B-W 1/2 Power-56°  
Wind surface-13.36 sq. ft. Load at 100 mph.-423 lbs.  
Turning radius-23 ft. Container size-12"x12"x14"  
Antenna weight-160 lbs. Shipping weight 200 lbs.  
Antenna rated design with 1/2" radial ice-110 mph.

For information or  
to order, phone  
PRospect 5-7252  
or write  
Department SC.

ANTENNAS

SINCE  
1921

Communication and TV Antennas  
**telrex** LABORATORIES

ASBURY PARK 25, NEW JERSEY, U.S.A.

CIRCLE 65 READERS SERVICE CARD

• Telrex is equipped to design and supply to our specifications or yours, Broad-band or single frequency, fixed or rotary arrays for communications, FM, TV, scatter-propagation, etc.

• Consultants and suppliers to communication firms, universities, propagation laboratories and the Armed Forces.

Calibrated for easy assembly to specifications and center frequency of your choice. Custom Quality construction throughout. Suggested rotator for above - Telrex Model 500-RIS.

Also available: Over 172 off-the-shelf fixed or rotatable high-performance arrays. 7Mc. to 600Mc. Mono, Duo, Tri and Multi-band individually fed or single line feed, and medium to extra heavy duty rotator-indicator control systems, rotated masts, and towers.

## A Personal Invitation to ENGINEERS



from **ROBERT McCULLOCH**  
President

"If you would like to be a member of a select corps of Engineers, working for an interesting, growing company... in one of the country's most stimulating areas... I invite you to write to Temco. Temco's growth is sound and planned, its products are diversified and challenging, our facilities are modern. Every benefit, for you professionally and in good living for you and your family, is here. Below are some of the areas in which jobs are open now."

### SYSTEMS ANALYSIS & DESIGN

Graduate Electronics Engineer or Physicist to perform theoretical electronic system analysis and design of new projects in the missile and electronic system field. He will be responsible for analyzing the customer's requirements and establishing basic as well as overall design parameters to be followed throughout the development of the project. The System Design Engineer will consider the various operational aspects of the system, including environments as well as collateral and concurrent effectiveness when used with related systems.

### GUIDANCE DESIGN

Graduate Electronics Engineer or Physicist to perform design and development of circuits and components necessary to the optimum functioning of missile guidance systems. He will design transistorized pulse and video circuits for use in missile and other electronic system projects. He will be responsible for developing applicable circuitry, working from specified and/or general requirements laid down by the particular system concept as dictated by the needs of the customer. The field of emphasis will be in the development of radar techniques.

Write **BILL G. HICKEY**

Supervisor Technical Employment  
Room 505E, P. O. Box 6191

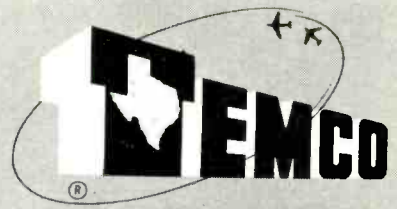

AIRCRAFT CORPORATION • DALLAS 22, TEXAS

Engineers! Designers!  
**THERE IS NO SUBSTITUTE  
FOR RELIABILITY!**

Specify -  
**PERFORMANCE  
PROVEN "MAG MOD"**

## MAGNETIC MODULATORS

Actual  
Size

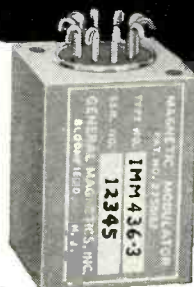

For complete specifications and application data on "Mag Mod" Miniature and Standard Components, call or write.

Miniaturized design permits engineers to employ these new components in transistorized printed circuit assemblies and wafer type structures. All models offer maximum reliability, fully ruggedized construction and conform to MIL-T-27A specifications.

- COMPLETE RELIABILITY
- INFINITE LIFE
- FASTER RESPONSE TIME
- NEGLIGIBLE HYSTERESIS
- EXTREME STABILITY (Ambient Temp. Range from -75° to +135°C)
- COMPACT SIZE
- LIGHTWEIGHT

Typical circuit applications for Magnetic Modulators are algebraic addition, subtraction, multiplying, raising to a power, controlling amplifier gains, mechanical chopper replacement in DC to fundamental frequency conversion, filtering and low signal level amplification.

### GENERAL MAGNETICS • INC

135 BLOOMFIELD AVENUE  
BLOOMFIELD, NEW JERSEY  
Telephone: Pilgrim 8-2400

CIRCLE 66 READERS SERVICE CARD

- REDUCE COSTS
- SIMPLIFY ASSEMBLY
- IMPROVE APPEARANCE with

# GRC DIE CAST ZINC ALLOY & MOLDED NYLON FASTENERS

now! **WASHER BASE WING NUTS**  
from **GRC STOCK**



Integral wide-diameter washer base eliminates need for separate washer. Cuts your cost, saves assembly time and labor. Specially suitable for use with bolt holes, adjusting slots, soft surfaces. Holds better because of greater seating area. 14 thread sizes— $\pm 6$  thru  $\pm 8$ ". GRC—world's most complete stock of standard and special wing nuts. Write today for new detailed catalog.

- Uniformly accurate
- High in quality
- Low in cost
- Wide range of stock styles, types, sizes and threads

Produced in one high speed automatic operation, GRC's exclusive methods assure uniformity, smooth, rustproof & corrosion resistant surfaces and the lowest possible cost. New kinds of fasteners never before available . . . modifications in stock fasteners for specified use . . . infinite variety in styles, types and sizes, have been made possible by GRC's special automatic die casting and molding machines.



Write, wire, phone **RIGHT NOW** for prices, your copy of **GRC's NEW DETAILED CATALOG**

World's Foremost  
Producer of  
Small Die Castings



**GRIES REPRODUCER CORP.**

151 Beechwood Ave., New Rochelle, N. Y. • New Rochelle 3-8600

CIRCLE 68 READERS SERVICE CARD



of study and examination.

All four books mentioned by the reviewer have in common elementary treatments of probability theory, general ideas of random processes, and (excepting Freeman) a review of Wiener optimum linear prediction and filter theory. Even here, however, there are strong differences in approach and emphasis. For example, in my book (unlike the others) the reader is not required to first study probability theory before taking up basic questions in random noise concerning power spectra and correlation functions. Considerable emphasis is given to the employment of ensemble averages and notation.

The four books are quite distinct as regards their various applications and advanced material, and what overlap that may exist among them is helpful to students. Without aiming to be critical of the other books, all three of which I recommend and use, I would like to point out a few of the important subjects discussed in my book which are not mentioned or hardly mentioned in the others:

1. A full treatment of Rice's representation of random noise and its application to various problems.

2. Demonstration of the widespread importance of exponential-cosine autocorrelation functions by analyzing many different physical sources of noise.

3. Many practical engineering details and an extensive mathematical analysis on statistical errors in measuring autocorrelation functions of exponential-cosine form.

4. Discussion of the important zero-crossing problem.

5. Useful advanced material on optimum time-variable filters not covered by Laning and Battin or by Davenport and Root.

6. Development of some analog computer techniques which extend the treatment given by Laning and Battin.

7. Discussion of measurement errors in nonlinear envelope detection and correlation of random noise.

Your reviewer apparently desires a highly abstract treatment for the subject, whereas my book is directed towards the student and practicing engineer.

JULIUS S. BENDAT

RAMO-WOOLDRIDGE  
LOS ANGELES

## CONSTANT VOLTAGE

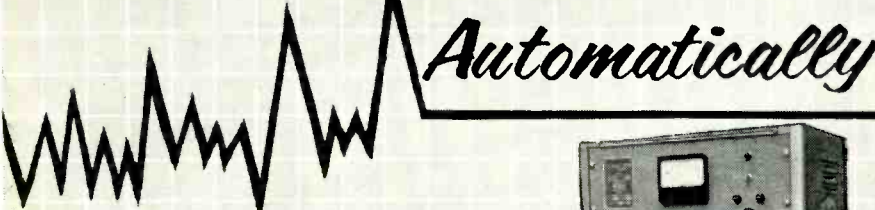

*Automatically*

*with the*



## SELENIVAC

THE ELECTRO-MECHANICAL AUTOMATIC VOLTAGE REGULATOR

ONLY THE SELENIVAC HAS ALL THESE FEATURES . . .

- No Waveform Distortion
- High Efficiency . . . Up to 99%
- No Effect on Power Factor
- Variable Input and Output Range
- Manual Control with Automatic Reset
- Sensitivity Can Be Varied
- Fast Response
- Virtually Maintenance-free

The SELENIVAC can be supplied to operate on 25, 50, 60 or 400 cycles . . . 1-, 2- or 3-phase. Capacity ratings: 1 KVA to 300 KVA. Voltage ratings: up to 600 volts

WRITE FOR COMPLETE INFORMATION

### AMERICAN RECTIFIER CORPORATION

95 Lafayette Street — New York 13, N. Y.  
Phone: WOrth 6-3350



## RESEARCH &amp; DEVELOPMENT

**ELECTRONIC  
ENGINEERS****Unusual Career Openings**

in RAPIDLY growing company for

**PROJECT ENGINEERS****SR. ENGINEERS & ENGRS.****BS-EE or PHYSICS**

Several years or more experience in circuitry and equipment design or applicable background—to work on UHF and VHF systems. Wide band knowledge desirable for challenging assignments on electronic countermeasures systems for military application and electronic instruments for commercial use.

Excellent salary range at all levels. Close association with acknowledged leaders who will aid your professional growth and develop your engineering abilities.

Profit Sharing Retirement Plan.  
Many other Benefits.



Call for interview  
J. V. Hicks  
OVerbrook 1-7100  
or send resume  
in confidence to:

**INSTRUMENTS FOR  
INDUSTRY, INC.**

101 New South Rd Hicksville, L. I.

**EXPERIENCED  
COMPUTER SERVICE  
ENGINEERS & TECHNICIANS**

If you're an electronic engineer or technician with service or maintenance experience on electronic digital computer systems, here's an opportunity for a stable, well paying position, with one of the nation's leading companies in digital computer system development.

You'll hold a responsible position in the maintenance of a large-scale business data processing system. Excellent opportunity to advance. Exceptional company stability, broad benefits.

Please submit resume immediately to:

**K. W. ROSS, Department K**  
**NATIONAL CASH REGISTER CO.**  
**DAYTON 9, OHIO**



**MANUFACTURERS'  
REPRESENTATIVES**  
IN THE ELECTRONIC INDUSTRY  
CONTRACT RATES GIVEN ON  
REQUEST. WRITE  
**ELECTRONICS**

**SAMUEL K. MACDONALD, INC.**

manufacturers representatives over 25 years  
1531 SPRUCE STREET, PHILA. 2, PA.

Territory:  
Pennsylvania • New Jersey  
Delaware • Maryland  
Virginia • West Virginia  
District of Columbia

Other Offices:  
Pittsburgh  
Baltimore  
Washington, D.C.

*Explore new  
areas at IBM in*

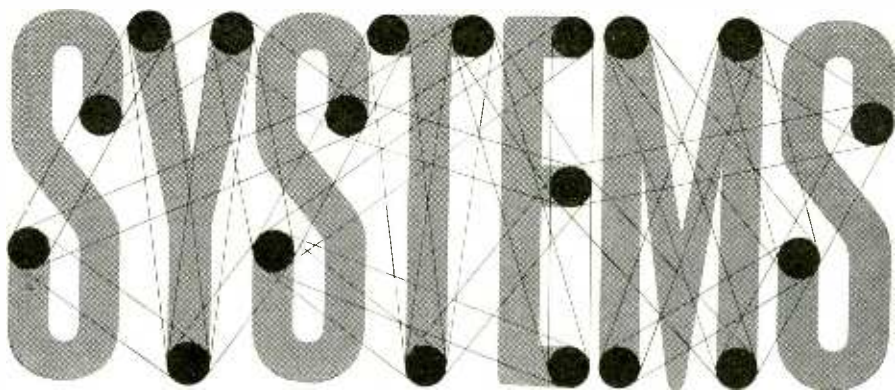

Electronic systems engineering covers the full spectrum of applied research and development at IBM. Currently, engineers and scientists concerned with broad systems problems in business, science, and government are working toward self-optimizing computers that may some day program themselves and arrive at the one best solution to a problem. Progress is being made in advanced studies for radically different data systems for terrestrial and stellar navigational problems. For problems like these, and many others, IBM needs people who want to convert challenges into careers.

You will enjoy unusual professional freedom, comprehensive education programs, the assistance of specialists of diverse disciplines, and a wealth of systems know-how. Working independently or as a member of a small team, your individual contributions are quickly recognized and rewarded.

**CAREERS AVAILABLE IN THESE AREAS...**

Applied mathematics & statistics	Inertial guidance
Circuit design & development	Information theory
Component engineering	Logical design
Computer analysis	Operations research
Cryogenics	Programming
Flight test analysis	Radar circuitry
Human factors	Theoretical physics
	Transistor device design

**Qualifications:** B.S., M.S., or Ph.D. in Electrical or Mechanical Engineering, Physics, or Mathematics —and proven ability to assume a high degree of technical responsibility in your sphere of interest.

For Details, write, outlining background and interest, to:

**Mr. R. E. Rodgers, Dept. 554E5**  
**International Business Machines Corp.**  
**590 Madison Avenue, New York 22, N. Y.**

**IBM**

INTERNATIONAL BUSINESS MACHINES CORPORATION

## ELECTRONICS ENGINEERS

Are invited to explore opportunities with a leading manufacturer of non-destructive testing systems and products for instrumentation and control. Requisites are BS level of education and 2-4-years experience in electronic circuit development. Suburban atmosphere with opportunity for advanced education under liberal company plan. Write or call

Robert C. Eichin  
Magnaflux Corporation  
7300 W. Lawrence Avenue  
Chicago 31, Illinois

## ELECTRONIC ENGINEER

Manufacturer of automatic temperature controls located in northwest suburb of Chicago is seeking a young man age 30 to 40, with college degree in Electronics or Electrical Engineering plus 3 to 4 years experience in design and development in the electronic field, with special emphasis on control systems or servo-mechanisms.

Exceptional opportunity for one desiring association with an electronic development program now in its infant stage. This is an AAA-1 company with modern facilities and complete employee benefits.

Give full information concerning education, experience, personal data and salary. All information given will be kept confidential and no employers contacted without permission.

Write To:

R. G. STECKEL  
The Powers Regulator Company  
3400 Oakton Street  
Skokie, Illinois

## CONTACTS



Actual Size

ORIGINAL  
DESIGN  
HAND-MADE  
CUFF LINKS

Sterling silver inlay  
inbedded and ground  
flush in black ceramic  
Set . . . . . \$6.50

(No COD's)

**Columbia Studio**

480 Seventh Avenue New York 18, N. Y.

If you are in need of flare type GLASS STEMS (soft or hard glass) or clear glass HERMETIC SEALS, for your EXPERIMENTAL work or a LIMITED PRODUCTION, in lots anywhere from 100 to 100,000 pieces. It is cheaper to buy from small manufacturer than to make in a large plant

WILLIAM CEPEK  
QUALITY PRODUCTS CO., 387 Charles St.  
Providence 4, R. I. Phone GASpee 1-8947

# SEARCHLIGHT SECTION

(Classified Advertising)

BUSINESS OPPORTUNITIES

EQUIPMENT - USED or RESALE

DISPLAYED

The advertising is \$24.75 per inch for all advertising other than on a contract basis. AN ADVERTISING INCH is measured 7/8" vert. on a column, 3 cols.—30 inches—to a page. EQUIPMENT WANTED or FOR SALE ADVERTISEMENTS acceptable only in Displayed Style.

Send NEW ADVERTISEMENTS or Inquiries to Classified Adv. Div. of Electronics, P. O. Box 12, N. Y. 36, N. Y.

The publisher cannot accept advertising in the Searchlight Section, which lists the names of the manufacturers of resistors, capacitors, rheostats, and potentiometers or other names designed to describe such products.

---RATES---

UNDISPLAYED

\$2.40 a line, minimum 3 lines. To figure advance payment count 5 average words as a line. BOX NUMBERS count as one line additional.

DISCOUNT of 10% if full payment is made in advance for four consecutive insertions.

### BUSINESS OPPORTUNITY

Reputable Italian Industrialist Desires to Contact American Electronics and Electrical Component Part Manufacturers Who Would Like Their Products Developed in Italy for the Common Market Countries. Principal Will Be in New York Early June 1959. Please Write: Mr. Carlo San Pietro, c/o United Mineral & Chemical Corp., 16 Hudson Street, New York 13, N. Y.

### OFFICIAL PROPOSAL

Bids: August 31, 1959.

### Ghana Broadcasting System External Broadcasting Project

Tenders are invited by the Crown Agents for Oversea Governments and Administrations acting for and on behalf of the Ghana Government for the supply of four 100 k.w. Short Wave Broadcasting Transmitters, Auxiliary Equipment and Aerial Arrays together with the necessary buildings to accommodate the equipment for installation near Accre. Tenderers must be prepared to supply staff for installation, operation and maintenance of equipment, and training of local staff.

Copies of the specifications, Drawings, Form of Tender and Conditions of Contract may be obtained from the Crown Agents, 4 Millbank, London, S.W. 1, by application quoting the reference Contract EE2 GHANA 1815 on payment of a deposit of £10.0.0. The deposit will be returned on receipt of a bona fide tender.

Tender documents will be available for issue as from the 29th May, 1959 and completed tenders must be delivered to the Crown Agents' Office not later than 1 p.m. on Monday 31st August, 1959.

The Ghana Government does not undertake to accept the lowest or any tender nor be responsible for, or pay for, expenses or losses which may be incurred by any tenderer in the preparation of his tender.

We are Distributors and carry Full Stock for Immediate Delivery

NEON and MINIATURE LAMPS  
Merkle-Korff Geared Motors in all speeds  
Wheeler Sound Powered Telephones  
Veeder Root Counters—Micro Switches  
Guardian Electric Relays & Solenoids  
Timing Devices by Industrial Timer Corp.  
Linemaster Footswitches—Etc.

**Potter & Brumfield, inc.**  
We have practically all types of Relays in large quantities, ready to deliver.—No waiting.  
See our large ad in March 13, 1959 issue page 314

**BLAN**  
EST. 1923

INCLUDE POSTAGE  
648 Dey St.  
New York 7  
N. Y.

WANTED

**ALLEN-BRADLEY  
RESISTORS  
and  
POTENTIOMETERS**

**LEGRI S. COMPANY**  
391 Riverdale Ave.  
YONKERS 5, NEW YORK

lab grade TEST EQUIPMENT for sale

standard brands—military surplus  
(new or professionally reconditioned)  
experienced problem solvers and budget-cutters

ENGINEERING ASSOCIATES  
434 Patterson Road Dayton 19, Ohio

Tropo Scatter Receiver

Two dual diversity REL 400-500 megacycle receivers with 75 kc band width, in excellent condition available subject to prior sale.

GIZMOS & SUCH  
STILL RIVER, MASSACHUSETTS



Antique

Polished Brass Telephone Lamp!  
Mouthpiece and receiver bakelite. Less shade and bulb—\$14.00.

All shipments FOB Simpson, Pa.  
TELEPHONE ENGINEERING CO.  
Dept. E-79 Simpson, Pa.

## PROFESSIONAL SERVICES

ERCO RADIO LABORATORIES, INC.

Radio Communications Equipment  
Engineering - Design - Development - Production  
Our 30th Year in Air to Ground  
Communication and Radio Beacons  
Garden City • Long Island • New York

TYPES AB; CD; EF—J—JJ—JJJ—JJJJ and G's  
**POTENTIOMETERS**

From stock in all values.

**LEGRI S COMPANY**

391 Riverdale Ave. Yonkers 5, N. Y.  
Phone YO 9-6000

Your Inquiries to Advertisers Will Have Special Value . . .

—for you—the advertiser—and the publisher, if you mention this publication. Advertisers value highly this evidence of the publication you read. Satisfied advertisers enable the publishers to secure more advertisers and—more advertisers mean more information on more products or better service—more value—to YOU.



# ELECTRONIC

WAR TERMINATION INVENTORIES

WRITE OR WIRE FOR INFORMATION ON OUR COMPLETE LINE OF SURPLUS ELECTRONIC COMPONENTS. ALL PRICES NET F.O.B. PASADENA, CALIFORNIA

## C&H.

### SALES CO.

2176-E East Colorado St.  
Pasadena 8, California  
RYan 1-7393

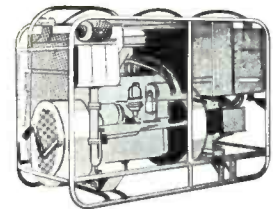

### POWER UNIT PU-104/U

5 KW 120/208 volt AC single or 3-phase permanent magnet type 400 cycle alternator. Alternator is driven by Hercules model ZXB 4-cylinder 4-cycle "L" head liquid cooled gasoline engine. This unit is complete with a control panel. Price \$495.00

### 400 CYCLE PM GENERATOR

115/200 volts A.C. 1- or 3-phase, 200 watts. 4,000 r.p.m. Approx. dimensions: 4 3/4" dia.; 3" long; 1/2" shaft, AN connector. \$75.00



### 400 CYCLE 1/3 PHASE GENERATOR

115 VAC. 3 KVA. Mfg. Bogue Elect. Mod. 2800S. External excitation 107 VDC. 1.1 amp. 3450 rpm 1" shaft. \$200.00

### MINNEAPOLIS-HONEYWELL RATE GYRO (Control Flight)



Part no. JG7005A, 115 volts A.C., 400 cycle, single phase potentiometer take off resistance 530 ohms. Speed 21,000 r.p.m. Angular momentum 2 1/2 million, CM<sup>2</sup>/sec. Weight 2 lbs. Dimensions 4-7/32 x 3-29/32 x 3-31/64. Price \$22.50

### VARIABLE SPEED BALL DISC INTEGRATORS

**No. 145**  
Forward & Reverse 2 1/4-0-2 1/4. Input shaft spline gear 12 teeth 9/32" dia. x 3/4" long. Output shaft 15/64" dia. x 15/32" long. Control shaft 11/32" x 3/8" long. Cast aluminum construction. Approx. size 3" x 3" x 2 3/4". \$17.50

**No. 146**  
Forward & Reverse 4-0-4. Input shaft 5/16" dia. x 3/4" long; Output shaft 15/64" dia. x 9/16" long. Control shaft 11/64" dia. x 11/16" long. Cast aluminum construction. Approx. size 4 1/2" x 4 1/2" x 4". (All Shafts Ball Bearing Supported) \$18.50 ea.



### SMALL DC MOTORS



(approx. size overall 3 3/4" x 1 1/4" dia.)

5067043 Delco 12 VDC PM 1" x 1" x 2", 10,000 rpm.	\$7.50
5067126 Delco PM, 27 VDC, 125 RPM, Governor Controlled	15.00 ea.
5069600 Delco PM 27.5 VDC 250 rpm	12.50
5069230 Delco PM 27.5 VDC 145 rpm	15.00
5068750 Delco 27.5 VDC 160 rpm w. brake	6.50
5068571 Delco PM 27.5 VDC 10,000 rpm (1x1x2")	5.00
5069790 Delco PM, 27 VDC, 100 RPM, Governor Controlled	15.00 ea.
5072735 Delco 27 VDC 200 rpm governor controlled.	15.00
5BA10A118 GE 24 VDC 110 rpm	10.00
5BA10AJ37 GE 27 VDC 250 rpm reversible	10.00
5BA10AJ52 27 VDC 145 rpm reversible	12.50
5BA10AJ50, G.E., 12 VDC, 140 rpm	15.00
5BA10FJ401B, G.E. 28 VDC, 215 rpm, 10 oz. in., .7 amp. contains brake	15.00
5BA10FJ421, G.E. 26 VDC, 4 rpm, reversible, 6 oz. in., .65 amp	15.00
S. S. FD6-21 Diehl 24 VDC PM 10,000 rpm. 1" x 1" x 2".	4.00

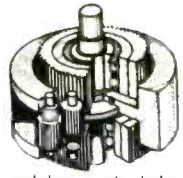

### SIMPLE DIFFERENTIAL WITH BALL-BEARING SUN GEARS

The 1:1 reverse ratio spur gears are 48-tooth, 32 pitch brass with 3/16" available face. On one side, the shaft is 23.64" dia. for 1/16" and has a pin hole, then increases in dia. to .377" for the remaining 3/16" of length. On the other side, the shaft is .377 dia. 1/4" lg. 2-13/16" dia. is required to clear the body. Stock no. A6-115.....each \$15.00

### 400 CYCLE, 3 PHASE GENERATOR

BY MASTER ELECTRIC Type AG, frame 364Y, 7.5 kw, 3428 rpm, pf .95. Star connected 120/208 3 phase 22 amps. Delta connected 120 volt single phase 66 amps. Self excited. Complete with control box, voltage regulator, AC voltmeter and frequency meter. Shaft 1" dia., 2" long; overall dim. of unit: 21"x18"x20". Price \$395.00 each



### SIMPLE DIFFERENTIAL WITH SPACED-OUT SUN GEARS

1:1 reverse ratio spur gears are aluminum, 3/32" face, 32 pitch, 32 tooth on one side, 48 tooth on the other. The body is 3/4" thick, but the sun gears are spaced out so that they are 1 1/2" apart. 1/4" dia. shaft on each side is 23/32" long. OA length 3 1/8". Requires 1-23/32" dia. to clear the body. Stock no. A6-149.....each \$4.50

### SYNCHROS SERVOS

1CT conf. Trans 90/55V 60 cy. \$34.50  
 1DG Diff. Gen. 90/90V 60 cy. 34.50  
 1F Syn. Mtr. 115/90V 60 cy. 34.50  
 1G Gen. 115V 60 cy. 34.50  
 1 HDG 37.50  
 1HCT 37.50  
 1HG 37.50  
 1SF Syn. Mtr. 115/90V 400 cy. 12.50  
 5CT Conf. Trans. 90/55V 60 cy. 34.50  
 5D Diff. Mtr. 90/90V 60 cy. 34.50  
 5DG Diff. Gen. 90/90V 60 cy. 34.50  
 5F Syn. Mtr. 115/90VAC 60 cy. 34.50  
 5G Syn. Gen. 115/90VAC 60 cy. 34.50  
 5HCT Cont. Trans. 90/55V 60 cy. 37.50  
 5SDG Diff. Gen. 90/90V 400 cy. 12.50  
 6DG Diff. Gen. 90/90V 60 cy. 25.00  
 6G Syn. Gen. 115/90VAC 60 cy. 34.50  
 7G Syn. Gen. 115/90VAC 60 cy. 42.50  
 7DG differential generator, 90/90 volts, 60 cycle 37.50  
 C56701 Type 1-1-4 Rep. 115V 60 cy. 20.00  
 C69405-2 Type 1-1 Transm. 115V 60 cy. 20.00  
 C69406 Syn. Transm. 115V 60 cy. 20.00  
 C69406-1 Type 1-1-2 Rep. 115V 60 cy. 20.00  
 C76166 Volt. Rec. 115V 60 cy. 10.00  
 C78248 Syn. Transm. 115V 60 cy. 12.50  
 C78249 Syn. Diff. 115V 60 cy. 5.00  
 C78410 Repeater 115V 60 cy. 20.00  
 C78863 Repeater 115V 60 cy. 7.50  
 C79331 Transm. Type 1-4 115V 60 cy. 20.00  
 E51 Bendix Autosyn Mtr. 22V 60 cy. 7.50  
 -03 Kollsman Autosyn Mtr. 32V 60 cy. 7.50  
 FPE-25-11 Diehl Servo 75/115 v 60 cy. 12.50  
 FPE 49-7 Diehl servo motor, 115 volts, 60 cycle, 10 watts 30.00  
 FPE-43-1 Resolver 400 cy. 19.50  
 FJE-43-9 Resolver 115V 400 cy. 15.00  
 F110-2A Kearfott Cont. Mfr. 17.50  
 F111-2A 20.00  
 F112-2D-B 22.50  
 F200-1-A Kearfott Cont. Trans. 15.00  
 F220-1 Kearfott Receiver 20.00  
 F235-1A Kearfott Resolver 20.00  
 AY201-2B 15.00  
 AY201-3B 12.50  
 AY201S-1B 15.00  
 AY221-34 10.00



### SIMPLE DIFFERENTIAL

1:1 reverse ratio, 60 teeth on large gear; 1/4" shaft. Size: 3" long with 1-15/16" dia. Stock no. A6-104.....each \$3.95

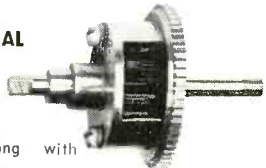

### DUAL SIMPLE DIFFERENTIAL

1:1 reverse ratio on both. Size: 3/4" long x 1-7/16" dia. Shaft size: 1/8" and 5/32". Stock no. A6-107.....each \$7.50

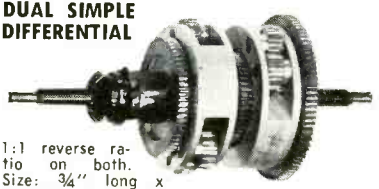

### SPERRY VERTICAL GYRO



Part #653265. Motor 115 volts, 3 phase, 400 cycle, 8 watts, 20,000 RPM. 3-minute runup, synchro pickoffs, roll 360°, pitch 85°. Synchro excitation 26 volts, 400 cycle, 150 m.a. Vertical accuracy ±1/2". Weight 3 1/2 lbs. Approx. dim. 5 3/4" L, 4 1/2" W, 4 1/2" H. Price \$35.00

### HONEYWELL VERTICAL GYRO MODEL JG7003A-1

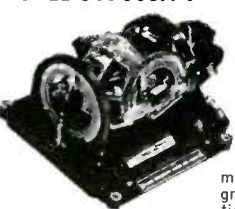

115 volts, 400 cycles, single phase, 35 watts. Pitch and roll potentiometer pickoffs 890 ohms, 40 volts max. AC or DC. Speed 20,000 rpm, ang. momentum 12,500,000 gm-cm<sup>2</sup>/sec. Erection system 27 VAC, 200 cycles, time 5 min. to 1/2". Weight 5.5 lbs. Price \$35.00 each





- Merck & Co., Inc. .... 77
- Motorola, Inc. .... 19
- Mycalex Corporation of America..... 39
  
- Navigation Computer Corp. .... 29
- Non-Linear Systems, Inc. .... 115
- North Electric Company ..... 22
  
- Ohmite Mfg. Co. .... 7
- Oster Mfg. Co., John ..... 20
  
- Parker Seal Company ..... 75
- Perfection Mica Co. .... 137
- Phalo Plastics Corporation ..... 138
- Philco Government & Industrial  
Division ..... 125
- Potter Instrument Company, Inc. .... 129
- Precision, Inc. .... 154
  
- Quality Products Co. .... 158
  
- Radiation, Inc. .... 17
- Radio Corporation of America... 4th Cover
- Radio Industries, Inc. .... 32
- Ramo-Wooldridge, a Division of  
Thompson Ramo Wooldridge, Inc... 99
- Raytheon Mfg. Co. .... 5
- Reflectone Corp. .... 135
- Relay Sales Inc..... 133, 135, 137, 139
  
- San Jose Chamber of Commerce..... 30
- Servo Corporation of America..... 134
- Simpson Electric Company ..... 76
- Sola Electric Co. .... 74
- Sorensen & Company, Inc. .... 105
- Sprague Electric Company..... 52, 53
- Staver Company ..... 154
- Stokes Corporation, F. J. .... 108
- Struthers-Dunn, Inc. .... 144
- Superior Electronics Corporation .... 152
- Superior Tube Company ..... 6
- Space Technology Laboratories, Inc... 15
- Sylvania Electric Products,  
Inc. .... 2, 35, 36, 37, 38, 50, 51
- Syntronic Instruments, Inc. .... 133

- Taylor Fibre Co. .... 104
- Technology Instruments Corp. .... 122
- Telrex Laboratories ..... 155

● See advertisement in the June, 1959 Mid-Month ELECTRONIC BUYERS' GUIDE for complete line of products or services.

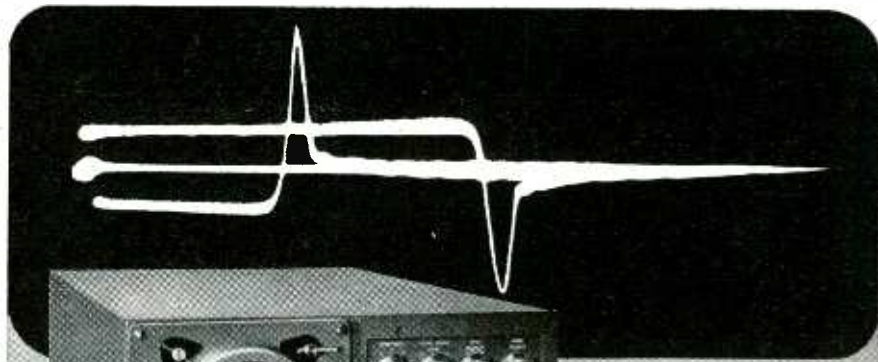

Typical display of recovery time of two diodes tested simultaneously.

2 FROM 1

**GET DUAL POSITION OPERATION FOR  
QUALITY CONTROL TESTING OF FAST  
RECOVERY DIODES WITH THE  
EG&G MILLI-MIKE OSCILLOSCOPE**

Now two operators can use the same EG&G Type 2236A Milli-Mike Oscilloscope at the same time. It's like getting **two** oscilloscopes—(EG&G Oscilloscopes)—for the price of one!

**TYPE 2236A PERFORMANCE DATA**

	Vertical (TW)	Horizontal
Sensibility	.054 v/trace width	0.30 v/trace width
Nominal Spot Size (trace width)	0.002 inch	
Deflection	27 v/inch (nominal)	150 v/inch
Frequency Response	DC to greater than 3,000 mc (-3db at approx. 2,000 mc)	
Input Impedance	50 or 100 ohms	
Writing Speed	3 x 10" trace widths/sec.	

The EG&G Milli-Mike Oscilloscope—one of a family of millimicrosecond instruments—is now being used to solve problems in measurement of high speed semiconductors, decay times of scintillators, discontinuities in transmission lines and as a synchroscope in high resolution radar systems. For information on this and other millimicrosecond pulse techniques, write to Application Engineering Group.



**EDGERTON, GERMESHAUSEN & GRIER, INC.**

160 BROOKLINE AVENUE, BOSTON 15, MASS. 1622 SOUTH "A" STREET, LAS VEGAS, NEV.

for maximum reliability

## PREVENT THERMAL RUNAWAY

Prevent excessive heat from causing "thermal runaway" in power diodes by maintaining collector junction temperatures at, or below, levels recommended by manufacturers, through the use of new Birtcher Diode Radiators. Cooling by conduction, convection and radiation, Birtcher Diode Radiators are inexpensive and easy to install in new or existing equipment. To fit all popularly used power diodes.



with NEW  
BIRTCHER  
**DIODE**  
**RADIATORS**

**B**

THE BIRTCHER CORPORATION

*industrial division*

4371 Valley Blvd. Los Angeles 32, California

Sales engineering representatives in principal cities.

CIRCLE 72 READERS SERVICE CARD

FOR CATALOG

and  
test data write:



- Temco Aircraft Corp. .... 155
- Texas Instruments  
Incorporated ..... 10, 79, 136
- Trans World Airlines (TWA)..... 54
- Transltron Electronic Corp. .... 31
- Trio Laboratories, Inc. .... 60

United States Testing Company, Inc., 130

- Victoreen Instrument Co. .... 120

Wiley & Sons, Inc., John ..... 153

Manufacturers' Representatives..... 157  
Professional Services ..... 158

### CLASSIFIED ADVERTISING

F. J. Eberle, Business Mgr.

EMPLOYMENT  
OPPORTUNITIES ..... 157, 158  
BUSINESS OPPORTUNITIES..... 158  
NOTICES  
Proposal ..... 158

EQUIPMENT  
(Used or Surplus New)  
For Sale ..... 158, 159

WANTED  
Equipment ..... 158

### ADVERTISERS INDEX

Blan ..... 158  
C & H Sales Company..... 159  
Engineering Associates ..... 158  
Gizmos & Such..... 158  
Instruments for Industry..... 157  
International Business Machines Corp... 157  
Legri S. Company..... 158  
Magnaflex Corporation ..... 158  
National Cash Register Company..... 157  
Powers Regulator Company..... 158  
Telephone Engineering Company..... 158

• See advertisement in the June, 1959 Mid-Month ELECTRONICS BUYERS GUIDE for complete line of products or services.

This index is published as a service. Every care is taken to make it accurate, but ELECTRONICS assumes no responsibilities for errors or omissions.

**ACE**  
**FABRICATED**  
**PLASTIC PARTS**  
**FAST SERVICE**  
**LOW COST**

- LUCITE
- PLEXIGLAS
- ACRYLIC
- ACETATE
- BUTYRATE
- CAST PHENOLIC
- EPOXY RESIN
- ETHYL CELLULOSE
- KEL-F
- LAMINATED BAKELITE
- NYLON
- POLYETHYLENE
- STYRENE COPOLYMERS
- TEFLON

- BALLS
- BOBBINS
- BUSHINGS
- COLLARS
- DETENTS
- FINIALS
- GROMMETS
- HANDLES
- KNOBS
- MECHANICAL
- CHECKS
- NAME PLATES
- PINS
- PLATES
- PLUGS
- RINGS
- SPACERS
- SPOOLS
- STANDS
- STRIPS

SIZES: 1/4" to 2 1/4" LENGTHS: 1/16" to 9"

Write, wire, phone for samples, prices and Bulletin F listing stock items. Send specifications or blueprints for prompt quotations on specials.

New e-x-p-a-n-d-e-d production facilities now give you ACE PRECISION on all types of screw machine centerless ground parts and special shapes... all colors... all materials.

## ACE PLASTIC COMPANY

91-33 Van Wyck Expwy., Jamaica 35, N. Y. JAMAICA 3-5500



# HERE'S WHY CALCULATING ENGINEERS USE KIN TEL DIGITAL VOLTMETERS

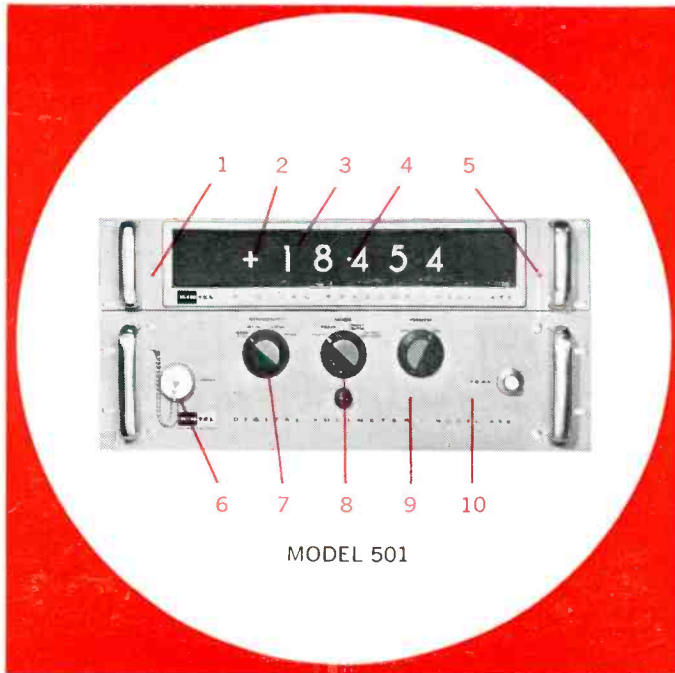

MODEL 501

1. **Single-Plane Readout**...no superimposed outlines of "off" digits...readout lamps have ten times longer life.
2. **Automatic Polarity Indication**...no lead switching.
3. **Ten Times Greater Resolution** at decade voltage points than other 4-digit voltmeters. A unique extra fifth digit in the left decade indicates "0" or "1" to provide 100% over-ranging.
4. **Automatic Ranging**...decimal point is automatically positioned for maximum resolution and accuracy.
5. **Remote Readout Mounting**...no electronic circuitry in readout allows easy remote mounting.
6. **Floating Input**...input may be floated above or below chassis ground...10 megohms input impedance...input connectors on front and rear.
7. **Adjustable Sensitivity**...control permits decreasing sensitivity to allow reading of noisy signals...greatly increases instrument usefulness.
8. **Built-in Printer Drive** for parallel input printers...control permits either automatic operation when voltmeter reaches null, or remote operation by external contact closure.
9. **Reliability**...transistor drive circuits provide "cushioned" DC drive for stepping switches for long, trouble-free operation.
10. **Accuracy**...measures DC from  $\pm 0.0001$  to  $\pm 1000.0$  volts...continuous, automatic calibration against internal standard cell provides 0.01%  $\pm 1$  digit (of reading) DC accuracy.

Price: \$2995

*These let you measure AC,  
increase sensitivity,  
measure ratios,  
scan multiple inputs*



#### AC CONVERTER

Price: \$850

The Model 452 AC converter can be added to the basic 501 DC digital voltmeter to permit 4-digit measurement of 0.001 to 999.9 volts AC, RMS, 30 to 10,000 cps. Accuracy is 0.2% of full scale and ranging is manual (auto-ranging models are available).



#### DC PREAMPLIFIER

Price: \$1475

The Model 459 differential DC preamplifier has a gain of  $-100$  which extends the DC sensitivity of KIN TEL digital voltmeters to 1 microvolt. Overall system accuracy when the 459 is used with a digital voltmeter is 0.15%  $\pm 5$  microvolts. Input resistance is greater than 5 megohms, and input and output circuits are completely floating and isolated from each other and chassis ground. Common mode rejection is 180 db for DC and 130 db for 60 cps with up to 1000 ohms input unbalance. Input can be floated up to  $\pm 250$  volts.

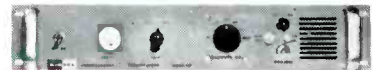

#### AC-DC PREAMPLIFIER

Price: \$1225

The Model 458 is a single-ended preamplifier with a gain of  $-100$  which extends the sensitivity of KIN TEL digital voltmeters to 1 microvolt DC, and 10 microvolts AC from 30 to 2000 cps. Overall system accuracy when the 458 is used with a digital voltmeter is 0.1%  $\pm 2$  microvolts for DC, and 0.25% of full scale for AC.



#### DVM & RATIOMETER

Price: \$3835

The Model 507A measures both DC voltages from  $\pm 0.0001$  to  $\pm 1000.0$  volts and DC/DC ratios from .0001:1 to 999.9:1. Ranging is automatic and accuracy is 0.01%  $\pm 1$  digit both for ratios and voltage. Any external reference between 1 and 100 volts may be used for ratio measurements.



#### INPUT SCANNER

The Model 453M master scanner automatically or manually scans up to 400 1-wire, 200 2-wire, or 100 4-wire inputs. Addition of a slave scanner (453S) permits scanning up to 1000 data points.

5725 Kearny Villa Road,  
San Diego 11, Calif.

Phone: BRowing 7-6700

Representatives in all major cities

**KIN TEL**  
A DIVISION OF  
**COHU**  
ELECTRONICS, INC.

Remarkable  
Cathode  
Advance...

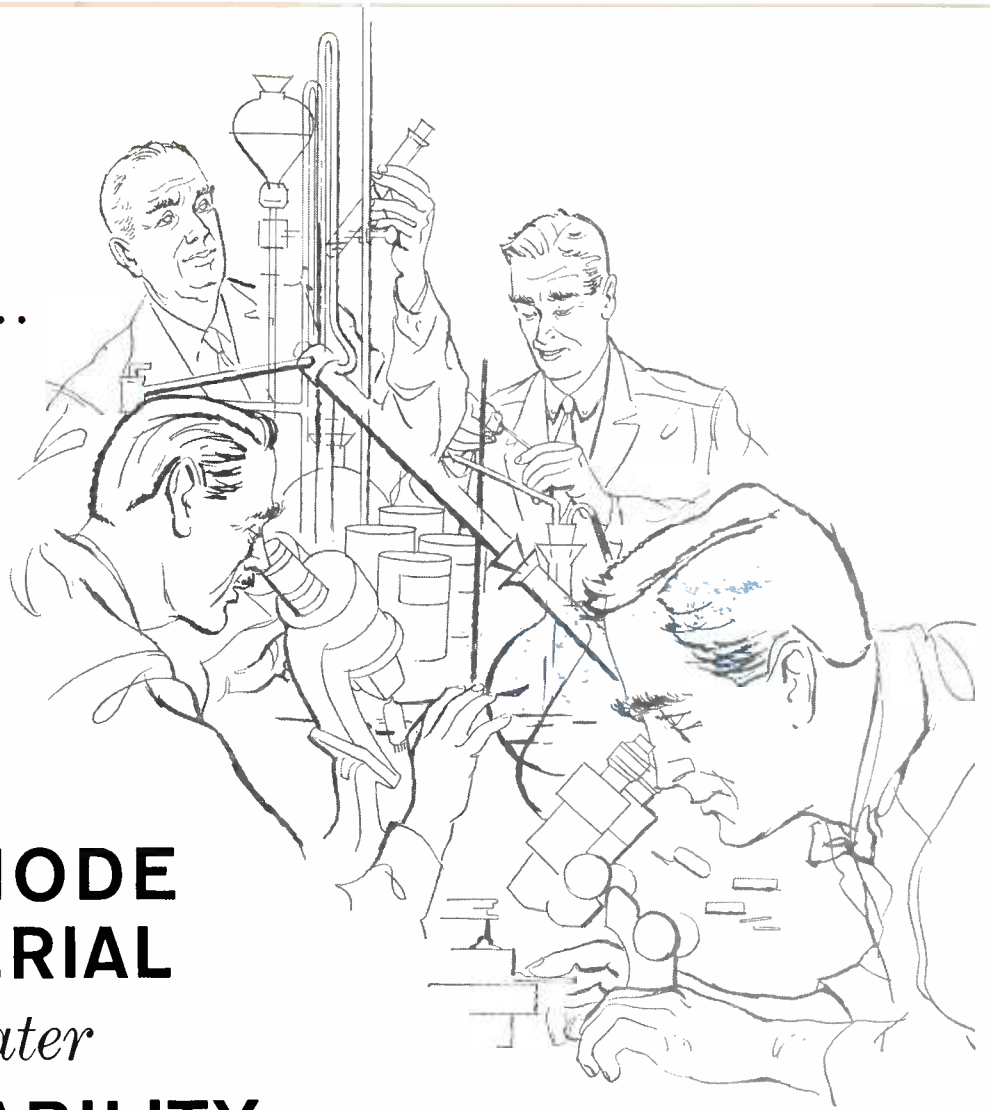
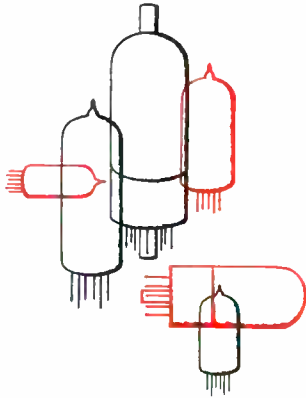

*vacuum-melted*  
**N-132 CATHODE  
BASE MATERIAL**  
*brings you greater*  
**TUBE RELIABILITY**

N-132 cathode base material, produced by a vacuum-melting process... an RCA development... is a new and extraordinary base composition for cathodes. N-132 makes possible substantial improvements in cathode uniformity, contributing significantly to the reliability and performance of Electron Tubes.

Vacuum-melting reduces the level of contaminants such as copper and sulphur. It also permits rigid controls to be placed on the presence of essential elements such as carbon, magnesium, manganese, silicon, and titanium. As a result, this process yields exceptional uniformity from one melt to another, therefore holding cathode characteristics within strict limits. In addition, the "process" reduces the deoxidizing agents usually employed in processing nickel "batches". This minimizes the possibility of gaseous contamination as the cathode material heats and ages, assuring long term, reliable performance in high impedance circuits.

RCA Tubes utilizing N-132 Cathode material can add a greater element of reliability to your circuits. Ask your RCA Representative—he'll be glad to prove the point.

**RCA FIELD OFFICES**

**EAST:** 744 Broad Street  
Newark 2, New Jersey  
HUboldt 5-3900

**MIDWEST:** Suite 1154  
Merchandise Mart Plaza  
Chicago 54, Illinois  
WHitehall 4-2900

**WEST:** 6355 E. Washington Blvd.  
Los Angeles 22, California  
RAYmond 3-8361



**RADIO CORPORATION OF AMERICA**

**Electron Tube Division**

**Harrison, N. J.**