

electronics

MARCH · 1953

PRICE 75 CENTS

A MCGRAW-HILL PUBLICATION

A woman with short, wavy blonde hair, wearing a yellow short-sleeved shirt, is shown in profile from the chest up. She is focused on a large, complex electronic assembly board. The board is densely packed with numerous small, cylindrical components, likely transistors, arranged in a grid. A green vertical strip on the left side of the board has the numbers '721' and '72' printed on it, along with the text '12 HOUR BUR-ZO'. The woman's right hand is raised, holding a small component. In the foreground, there is a large, tangled mass of black and silver electronic components, possibly transistors, with their leads protruding.

JUNCTION TRANSISTORS
IN PRODUCTION

Beginning in this issue "TRANSISTORS: Theory and Application"



for Stock Hermetically Sealed Components

For over fifteen years UTC has been the largest supplier of transformer components for military applications, to customer specifications. Listed below are a number of types, to latest military specifications, which are now catalogued as UTC stock items.



RCOF CASE

Length 1 25/64
 Width 61/64
 Height 1 13/32
 Mounting 1 1/8
 Screws 4-40 FIL.
 Cutout 7/8 Dia.
 Unit Weight 1.5 oz.



RC-50 CASE

Length 1 5/8
 Width 1 5/8
 Height 2 5/16
 Mounting 1 5/16
 Screws #6-32
 Cutout 1 1/2 Dia.
 Unit Weight 8 oz.



SM CASE

Length 11/16
 Width 1/2
 Height 29/32
 Screw 4-40 FIL.
 Unit Weight 8 oz.

The impedance ratings are listed in standard manner. Obviously, a transformer with a 15,000 ohm primary impedance can operate from a tube representing a source impedance of 7700 ohms, etc. In addition, transformers can be used for applications differing considerably from those shown, keeping in mind that impedance ratio is constant. Lower source impedance will improve response and level ratings... higher source impedance will reduce frequency range and level rating.

MINIATURE AUDIO UNITS...RCOF CASE

Type No.	Application	MIL Type	Pri. Imp. Ohms	Sec. Imp. Ohms	DC in Pri., MA	Response ± 2db. (Cyc.)	Max. level dbm	List Price
H-1	Mike, pickup, line to grid	TF1A10YY	50,200 CT, 500 CT*	50,000	0	50-10,000	+ 5	\$16.50
H-2	Mike to grid	TF1A11YY	82	135,000	50	250-8,000	+21	16.00
H-3	Single plate to single grid	TF1A15YY	15,000	60,000	0	50-10,000	+ 6	13.50
H-4	Single plate to single grid, DC in Pri.	TF1A15YY	15,000	60,000	4	200-10,000	+14	13.50
H-5	Single plate to P.P. grids	TF1A15YY	15,000	95,000 CT	0	50-10,000	+ 5	15.50
H-6	Single plate to P.P. grids, DC in Pri.	TF1A15YY	15,000	95,000 split	4	200-10,000	+11	16.00
H-7	Single or P.P. plates to line	TF1A13YY	20,000 CT	150/500	4	200-10,000	+21	16.50
H-8	Mixing and matching	TF1A16YY	150/600	600 CT	0	50-10,000	+ 8	15.50
H-9	82/41:1 input to grid	TF1A10YY	150/600	1 meg.	0	200-3,000 (4db.)	+10	16.50
H-10	10:1 single plate to single grid	TF1A15YY	10,000	1 meg.	0	200-3,000 (4db.)	+10	15.00
H-11	Reactor	TF1A20YY	300 Henries-0 DC, 50 Henries-3 Ma. DC, 6,000 Ohms.					12.00

COMPACT AUDIO UNITS...RC-50 CASE

Type No.	Application	MIL Type	Pri. Imp. Ohms	Sec. Imp. Ohms	DC in Pri., MA	Response ± 2db. (Cyc.)	Max. level dbm	List Price
H-20	Single plate to 2 grids, can also be used for P.P. plates	TF1A15YY	15,000 split	80,000 split	0	30-20,000	+12	\$20.00
H-21	Single plate to P.P. grids, DC in Pri.	TF1A15YY	15,000	80,000 split	8	100-20,000	+23	23.00
H-22	Single plate to multiple line	TF1A13YY	15,000	50/200, 125/500**	8	50-20,000	+23	21.00
H-23	P.P. plates to multiple line	TF1A13YY	30,000 split	50/200, 125/500**	8	30-20,000 BAL.	+19	20.00
H-24	Reactor	TF1A20YY	450 Hys.-0 DC, 250 Hys.-5 Ma. DC, 6000 ohms ... 65 Hys.-10 Ma. DC, 1500 ohms.					15.00

SUBMINIATURE AUDIO UNITS...SM CASE

Type No.	Application	MIL Type	Pri. Imp. Ohms	Sec. Imp. Ohms	DC in Pri., MA	Response ± 2db. (Cyc.)	Max. level dbm	List Price
H-30	Input to grid	TF1A10YY	50***	62,500	0	150-10,000	+13	\$13.00
H-31	Single plate to single grid, 3:1	TF1A15YY	10,000	90,000	0	300-10,000	+13	13.00
H-32	Single plate to line	TF1A13YY	10,000****	200	3	300-10,000	+13	13.00
H-33	Single plate to low impedance	TF1A13YY	30,000	50	1	300-10,000	+15	13.00
H-34	Single plate to low impedance	TF1A13YY	100,000	60	.5	300-10,000	+ 6	13.00
H-35	Reactor	TF1A20YY	100 Henries-0 DC, 50 Henries-1 Ma. DC, 4,400 ohms.					11.00

* 200 ohm termination can be used for 150 ohms or 250 ohms, 500 ohm termination can be used for 600 ohms.
 ** 200 ohm termination can be used for 150 ohms or 250 ohms, 125/500 ohm termination can be used for 150/600 ohms.
 *** can be used with higher source impedances, with corresponding reduction in frequency range. With 200 ohm source, secondary impedance becomes 250,000 ohms... loaded response is -4 db. at 300 cycles.
 **** can be used for 500 ohm load... 25,000 ohm primary impedance... 1.5 Ma. DC.

United Transformer Corp.

150 VARICK STREET

NEW YORK 13, N. Y.

EXPORT DIVISION: 13 EAST 40th STREET, NEW YORK 16, N. Y.

CABLES: "ARLAB"

electronics

MARCH • 1953

A MCGRAW-HILL
PUBLICATION

JUNCTION TRANSISTORS IN PRODUCTION—Photograph shows testing and aging equipment used as part of mass-production facilities for junction transistors at Raytheon Manufacturing Co., Newton, Mass. (see p 101)..... COVER

FIGURES OF THE MONTH	4		
Includes Electronics Output Index, a business barometer for management			
INDUSTRY REPORT	5		
Top-level news, trends and market interpretations			
TRANSISTORS: THEORY AND APPLICATION , by Abraham Coblenz and Harry Owens.....	98		
First of a series of articles on transistors explains basic fundamentals			
FREE-WHEELING THYRATRONS CUT AUTOPILOT WEIGHT , by Charles G. Yates.....	103		
Full-cycle thyatron motor control has quick response, light weight, durability			
ANALYSIS OF UHF TUNER DESIGN , by Arnold Newton.....	106		
Overall design considerations regarding circuits and components of front ends			
EXPERIMENTS ILLUSTRATE TRANSISTOR APPLICATIONS , by James D. Fahnestock.....	112		
Gives first detailed description of devices shown to trade recently by RCA			
PHOTOELECTRIC WIDTH GAGE FOR HOT-STRIP STEEL MILLS , by E. S. Sampson.....	114		
Accurately measures width of white-hot moving strip of steel from position 15 feet away			
BUTTERFLY CURVE TRACER FOR MAGNETIC MATERIALS , by George M. Ettinger.....	119		
Curves and hysteresis loops quickly traced on crt for direct viewing or photo record			
CONSTANT-CURRENT AUDIO POWER AMPLIFIERS , by Howard T. Sterling and Alan Sobel.....	122		
Automatic bias control counteracts effects of tube aging or replacement			
SINGLE-GUN STORAGE TUBE WRITES, READS AND ERASES , by R. C. Hergenrother and A. S. Luftman.....	126		
Improved memory tube retains charge one week			
PERFORMANCE OF HIGH-OUTPUT MAGNETIC TAPE , by L. B. Lueck and W. W. Wetzel.....	131		
Gives 6-db greater signal output, permitting redesign of equipment for better performance			
A HELICAL BEAM FOR CITIZEN'S RADIO , by Edward F. Harris.....	134		
Fiberglas cylinder contains helical antenna integrally molded into it, is strong, high gain, weatherproof			
PULSE GENERATOR HAS WIDE CONTROL RANGE , by W. W. Schroeder.....	136		
Frequency, width and amplitude of two kinds of pulses are controlled in instrument designed for physiological research			
HOW TO USE MECHANICAL I-F FILTERS , by M. L. Doelz and J. C. Hathaway.....	138		
Compact interstage units give good selectivity in communications work			
RECORDING PHOTOMETER PROVIDES LOG RESPONSE , by W. S. Plymale, Jr.....	143		
Single scale covers six log cycles without range switching			
TELEVISION RECEIVER AGC SYSTEMS , by Edward S. White.....	146		
Advantages and limitations of various gain control circuits			
ARITHMETIC PROCESSES FOR DIGITAL COMPUTERS , by J. H. Felker.....	150		
Review of binary arithmetic and other basic computer operations			
TRANSISTOR EQUATIONS (Reference Sheet) , by F. R. Stansel.....	156		
Give gain and impedance characteristics in terms of transistor parameters			
CROSSTALK 97	ELECTRONS AT WORK 160	PRODUCTION TECHNIQUES 274	NEW PRODUCTS 344
PLANTS AND PEOPLE 428	NEW BOOKS 472	BACKTALK 492	INDEX TO ADVERTISERS 559

W. W. MacDONALD, Editor; VIN ZELUFF, Managing Editor; John Markus, A. A. McKenzie, James Fahnestock, Associate Editors; William P. O'Brien, John M. Carroll, William G. Arnold, William E. Pettit, David A. Findlay, Assistant Editors; Ann Mastropolo, Marilyn Wood, Mary J. Johnson, Editorial Assistants; Gladys T. Montgomery, Washington Editor; Harry Phillips, Art Director; Eleanor Luke, Art Assistant

KEITH HENNEY, Editorial Director

H. W. MATEER, Publisher; WALLACE B. BLOOD, Manager; R. S. Quint, Buyers' Guide Manager; N. F. Cullinan, Promotion & Research Assistant; H. E. Hilty, Classified Manager; D. H. Miller, James Girdwood, New York; Wm. S. Hodgkinson, New England; Warren W. Shew, Philadelphia; C. D. Wardner, Chicago; J. L. Phillips, Cleveland; T. H. Carmody, R. C. Alcorn, San Francisco; Carl W. Dysinger, Los Angeles; Ralph C. Maultsby, Atlanta



March, 1953

ELECTRONICS

Member ABC and ARP

Vol. 26, No. 3



Published monthly with an additional issue in June by McGraw-Hill Publishing Company, Inc., James H. McGraw (1860-1948), Founder. Publication Office, 99-129 North Broadway, Albany 1, N. Y.

Executive, Editorial and Advertising Offices: McGraw-Hill Building, 330 W. 42 St., New York 36, N. Y. Curtis W. McGraw, President; Willard Chevalier, Executive Vice-President; Joseph A. Gerardi, Vice-President and Treasurer; John J. Cooke, Secretary; Paul Montgomery, Senior Vice-President, Publication Division; Ralph B. Smith, Vice-President and Editorial Director; Nelson Bond, Vice-President and Director of Advertising; J. E. Blackburn, Jr., Vice-President and Director of Circulation.

Subscriptions: Address correspondence to Electronics—Subscription Service, 99-129 N. Broadway, Albany 1, N. Y., or 330 W. 42nd St., New York 36, N. Y. Allow one month for change of address. Subscriptions are solicited only from persons engaged in theory, research, design, production, maintenance and use of electronic and industrial control components, parts and end products. Position and company connection must be indicated on subscription orders.

Single copies 75¢ for United States and possessions, and Canada; \$1.50 for Latin America; \$2.00 for all other foreign countries. Buyers' Guide \$2.00. Subscription rates—United States and possessions, \$6.00 a year; \$9.00 for two years. Canada, \$10.00 a year; \$16.00 for two years. Other western hemisphere countries, \$15.00 a year; \$25.00 for two years. All other countries \$20.00 a year; \$30.00 for two years. Entered as second class matter August 29, 1936, at the Post Office at Albany, N. Y., under act of Mar. 3, 1879. Printed in U.S.A. Copyright 1953 by McGraw-Hill Publishing Co., Inc.—All Rights Reserved. BRANCH OFFICES: 520 North Michigan Avenue, Chicago 11, Ill.; 68 Post Street, San Francisco 4; McGraw-Hill House, London, E.C. 4; Washington, D. C. 4; Philadelphia 3; Cleveland 15; Detroit 26; St. Louis 8; Boston 16; 1321 Rhodes-Haverly Bldg., Atlanta 3, Ga.; 1111 Wilshire Blvd., Los Angeles 17; 738-9 Oliver Building, Pittsburgh 22. ELECTRONICS is indexed regularly in The Engineering Index.

There's a *difference*
in Marion **"regular"**
Design

MARION "regulars"

In addition to being the largest producer of Ruggedized electrical indicating instruments, Marion has served industry for many years with a line of unsealed instruments for commercial applications. These instruments (Marion "Regulars") have been refined through the years and today serve the "blue chips" of industry in the most critical operations.

The design of these instruments has stayed abreast of new materials and the latest in manufacturing methods. At the same time they have retained the basic simplicity of Marion functional design. This, combined with an efficient, cost-conscious manufacturing organization, affords finer instruments at lower cost.

Marion "Regulars" are selected by the world's most discriminating manufacturers of the finest electronic and electrical equipment as a basic major component of their finest products.

Marion Electrical Instrument Company
401 Canal Street, Manchester, N. H., U. S. A.



Reg. U. S. Pat. Off.



marion meters

MANUFACTURERS OF RUGGEDIZED AND "REGULAR" METERS AND RELATED PRODUCTS

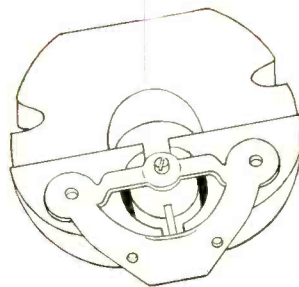

ITS magnetic SYSTEM

Of the various elements that make up an electrical instrument, perhaps the most important is its magnetic system. The *strength, uniformity and stability* of the magnetic field determine the degree of accuracy and reliability of the instrument. Here is how Marion design provides a magnetic structure of great strength, uniformity and stability, and at the same time keeps weight and cost at a minimum:



MAGNET

All Marion magnets are large, well-aged, precisely ground Alnico II or Alnico V, carefully checked for magnetic uniformity and maximum stable energy.



POLE PIECES

All Marion instruments use sintered and annealed high-permeability, *full* soft-iron pole pieces, of the type employed in the *finest* of laboratory instruments.

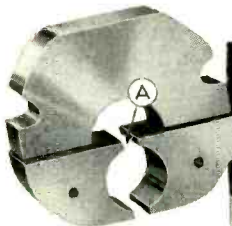

MAGNET ASSEMBLY



The pole pieces are permanently fastened to the magnet by induction soldering. Spring loaded fixtures force excess solder out of the seams, leaving a thin film of great bond strength and low magnetic loss. Final separation (A) of pole pieces is done after soldering operation, holding gap concentricity to better than .001".



CORE

All Marion "Regulars" use closely machined soft-iron cores which are precisely oriented in the air gap by the instrument frame. (They are not jig located).

These magnetic systems represent a simple, honest means of providing uniform stable magnetic fields for Marion Indicating Instruments. They *never* include laminations, intricate magnetic stampings or uncertain mechanical assembly of the components of the magnetic system.

Where every detail matters . . .

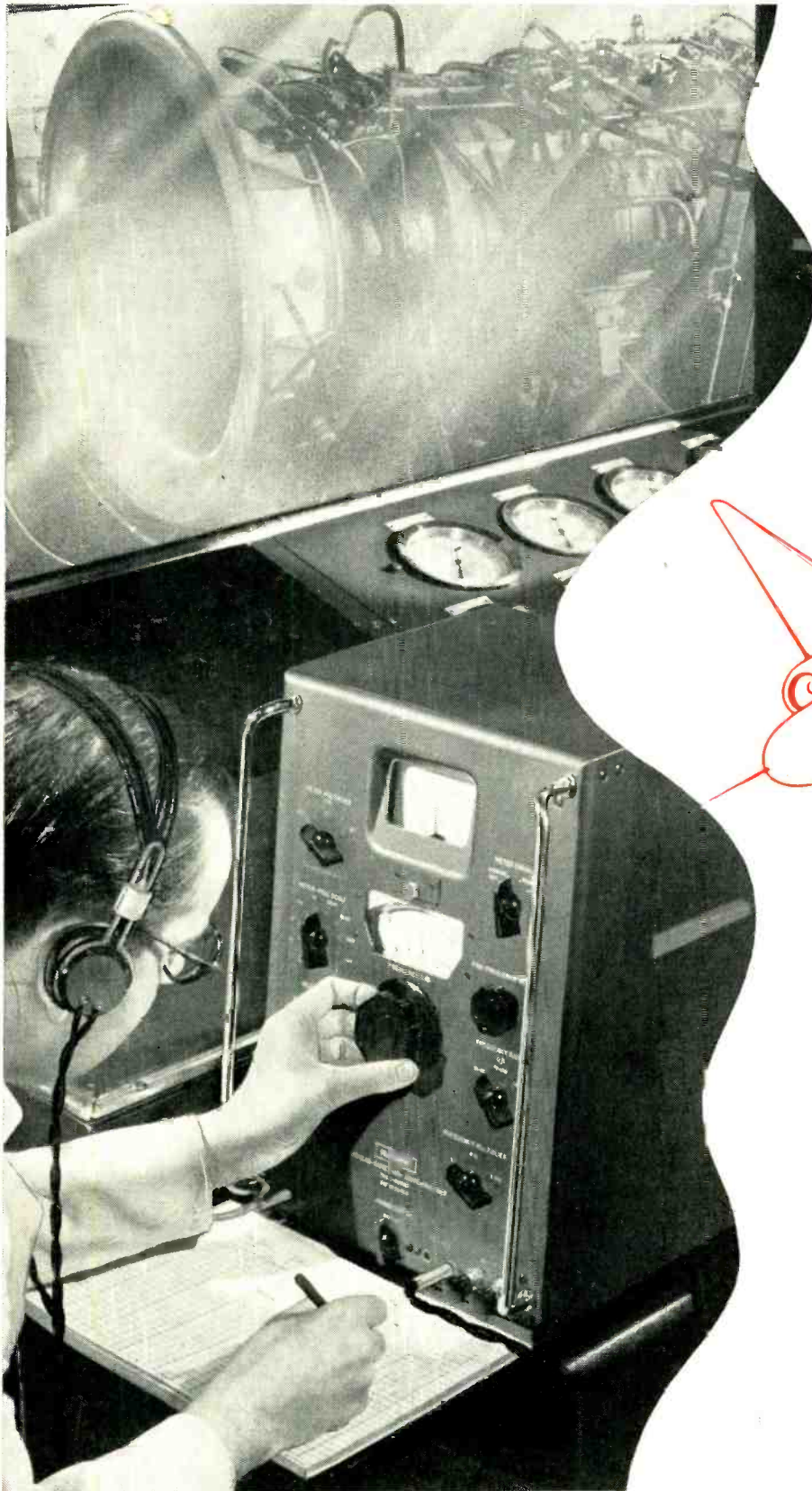

At the high speeds encountered with turbo-jet engines, unsuspected blade resonances can cause serious damage. For this reason exhaustive vibration tests must be made, and the source of each vibration located. Leading British Aircraft manufacturers rely on the Muirhead-Pametrada Wave Analyser — it gives them the frequency and amplitude of each vibration component quickly and accurately; amplitude measurements can, moreover, be made substantially independent of speed fluctuations. Location of the source of vibration then becomes simply a matter of correlating the measured frequency with known engine data.

**SEE THE
WAVE ANALYSER**

**AT BOOTH
4-804**

**RADIO
ENGINEERING
SHOW**

**GRAND CENTRAL PALACE
NEW YORK**

MARCH 23rd-26th, 1953

Vibration Analysis with the MUIRHEAD-PAMETRADA WAVE ANALYSER at Armstrong Siddeley works, Coventry

MUIRHEAD & CO., LTD., BECKENHAM, KENT, ENGLAND
PRECISION ELECTRICAL INSTRUMENT MAKERS

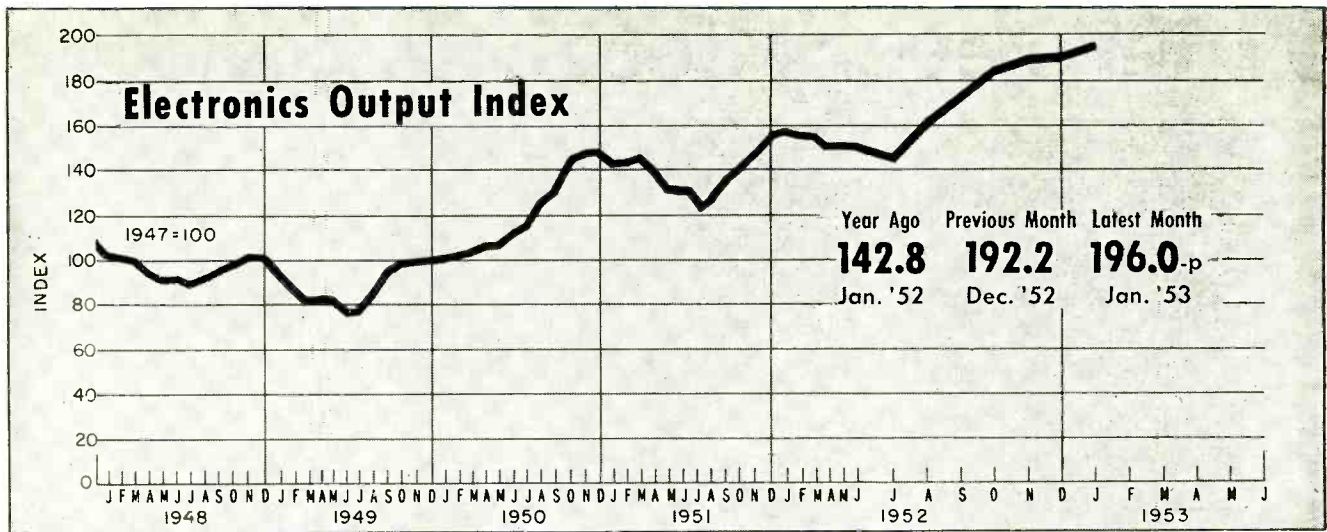

FIGURES OF THE MONTH

	Year Ago	Previous Month	Latest Month
RECEIVER PRODUCTION			
(Source: RTMA)			
	Dec. '51	Nov. '52	Dec. '52
Television sets	467,108	780,486	921,086-p
Home sets	567,929	389,853	452,556-p
Clock Radios	-----	185,639	271,507-p
Portable sets	78,056	153,503	194,837-p
Auto sets	222,115	195,200	406,258-p

	Year Ago	Previous Month	Latest Month
RECEIVER SALES			
(Source: RTMA)			
	Dec. '51	Nov. '52	Dec. '52
Television sets, units	-----	803,327	1,049,770
Radio sets (except auto)	-----	486,800	1,514,688

	Year Ago	Previous Month	Latest Month
RECEIVING TUBE SALES			
(Source: RTMA)			
	Dec. '51	Nov. '52	Dec. '52
Receiv. tubes, total units	28,000,471	36,942,664	43,220,393
Receiving tubes, new sets	16,176,537	25,898,849	31,061,892
Rec. tubes, replacement	7,117,041	8,568,037	8,771,035
Receiving tubes, gov't.	1,699,914	1,712,080	1,745,491
Receiving tubes, export	3,006,979	763,698	1,641,975
Picture tubes, to mfrs.	371,751	754,060	852,501

	Year Ago	Previous Month	Latest Month
BROADCAST STATIONS			
(Source: FCC)			
	Jan. '52	Dec. '52	Jan. '53
TV Stations on Air	108	129	137
TV Stns CPs—not on air	0	144	177
TV Stns—Applications	488	812	791
AM Stations on Air	2,331	2,391	2,399
AM Stns CPs—not on air	75	133	130
AM Stns—Applications	311	251	246
FM Stations on Air	635	616	612
FM Stns CPs—not on air	13	14	15
FM Stns—Applications	7	12	12

	Year Ago	Previous Month	Latest Month
COMMUNICATION AUTHORIZATIONS			
(Source: FCC)			
	Dec. '51	Nov. '52	Dec. '52
Aeronautical	30,370	34,187	34,600
Marine	33,914	38,166	38,422
Police, fire, etc.	10,161	11,956	12,098
Industrial	11,449	15,347	15,653
Land Transportation	4,653	5,427	5,536
Amateur	100,922	117,069	117,800
Citizens Radio	749	1,803	1,858
Disaster	26	87	87
Experimental	452	503	500
Common carrier	835	1,020	1,023

	Year Ago	Previous Month	Latest Month
TV AUDIENCE			
(Source: NBC Research Dept.)			
	Jan. '52	Dec. '52	Jan. '53
Sets in Use—total	15,777,000	20,439,400	21,234,100
Sets in Use—netw'k conn.	14,931,100	20,408,500	21,136,900
Sets in Use—New York	2,800,000	3,230,000	3,290,000
Sets in Use—Los Angeles	1,090,000	1,320,000	1,375,000
Sets in Use—Chicago	1,090,000	1,325,000	1,360,000

	Year Ago	Previous Month	Latest Month
NETWORK BILLINGS			
(Source: Pub. Info. Bureau)			
	Dec. '51	Nov. '52	Dec. '52
AM/FM—ABC	\$3,300,219	\$2,612,761	\$2,856,714
AM/FM—CBS	\$5,278,508	\$5,419,533	\$5,717,800
AM/FM—MBS	\$1,697,014	\$2,172,485	\$1,980,316
AM/FM—NBC	\$4,343,307	\$4,073,971	\$4,370,265
TV—ABC	\$1,980,145	\$1,368,552	\$1,331,588
TV—CBS	\$4,736,368	\$6,525,176	\$7,088,506
TV—DuMont	\$937,875	\$1,026,566	\$1,211,316
TV—NBC	\$6,592,673	\$7,957,417	\$7,830,806

	Year Ago	Previous Month	Latest Month
EMPLOYMENT AND PAYROLLS			
(Source: Bur. Labor Statistics)			
	Nov. '51	Oct. '52	Nov. '52
Prod. workers, electronic	266,500	306,700-r	319,600-p
Av. wkly. earnings, elect.	\$64.72	\$68.18-r	\$68.18-p
Av. wkly. earnings, radio	\$61.25	\$63.79-r	\$63.35-p
Av. weekly hours, elect.	42.0	41.8	41.8-p
Av. weekly hours, radio	41.5	41.1-r	41.0-p

	Year Ago	Previous Month	Latest Month
STOCK PRICE AVERAGES			
(Source: Standard and Poor's)			
	Jan. '52	Dec. '52	Jan. '53
Radio-TV & Electronics	270.9	322.7	321.4
Radio Broadcasters	261.4	304.4	300.4

	Year Ago	Quarterly Figures Previous Quarter	Latest Quarter
INDUSTRIAL EQUIPMENT ORDERS			
(Source: NEMA)			
	3rd '51	2nd '52	3rd '52
Dielectric Heating	\$210,000	\$510,000	\$320,000
Induction Heating	\$4,060,000	\$2,410,000	\$1,760,000
Welding Control	\$1,280,000	\$1,480,000	\$1,810,000
Other Electronic Control	\$720,000	\$1,020,000	\$920,000

	Year Ago	Quarterly Figures Previous Quarter	Latest Quarter
INDUSTRIAL TUBE SALES			
(Source: NEMA)			
	3rd '51	2nd '52	3rd '52
Vacuum (non-receiving)	\$8,420,000	\$12,110,000	\$10,580,000
Gas or vapor	\$2,620,000	\$3,150,000	\$2,950,000
Phototubes	\$270,000	\$480,000	\$570,000
Magnetrons and velocity modulation tubes	\$3,740,000	\$9,830,000	\$8,500,000

p—provisional; r—revised; e—estimated

INDUSTRY REPORT

electronics—MARCH • 1953

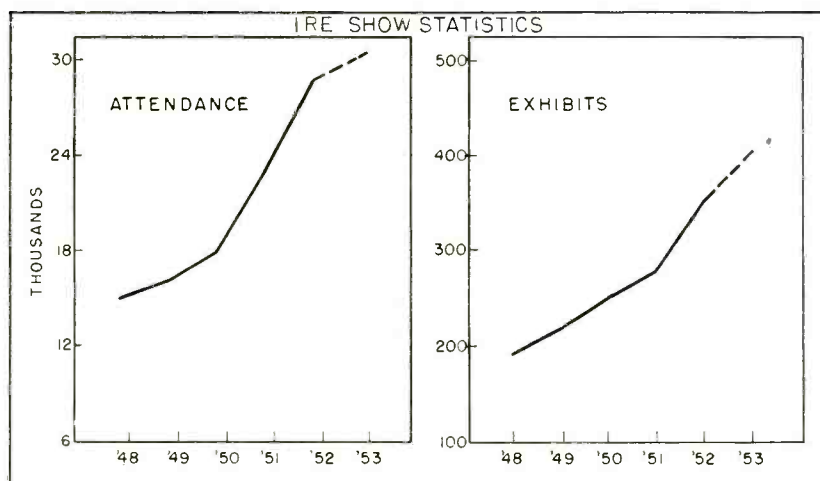

MORE engineers and exhibits than ever before will be at . . .

IRE Show, A Preview Of Progress

This year's convention promises to set new high in attendance, exhibits and technical interest

YEAR after year the national convention of the Institute of Radio-Engineers has grown in size and scope. It has become a leading national event for the electronics industry commercially as well as technically. Despite future location problems, its continued success in all phases seems assured.

► **Progress**—As shown in the charts, the show has more than doubled in size in the last five years. This year's meeting promises to break all previous records for attendance and number of exhibits. Over 30,000 engineers and scientists from all parts of the world are expected to attend. More than 400 exhibits by companies in every facet of the industry will be displayed, representing a value in equipment alone of over \$10 million.

Keeping pace with the growth in

attendance and exhibits, the technical scope of the convention has also broadened steadily. This year a total of 220 papers will be presented during the 43 sessions and 9 symposia of the show. In 1948 about 140 papers were presented in 27 sessions.

Highlight of the technical program this year will be an all-day seminar on "Acoustics for the Radio Engineer" and 9 symposia organized by professional groups of IRE. The complete technical program for the convention appears in this issue of *ELECTRONICS*, beginning on page 454.

► **Business**—The growth of the show has also meant increased business for participating manufacturers. The fact that companies have continued to return year after year, along with new participants, vouches for its commercial value.

Although the amount of actual orders obtained by exhibitors as a direct result of the show cannot be accurately determined, some

smaller electronic manufacturers have indicated that as much as 50 percent of their total annual order volume resulted from show participation. Even without orders, manufacturers have found the convention to be of substantial institutional value and of valuable aid in locating available engineering talent.

► **Future**—Next year's IRE show will be held at the Kingsbridge Armory in the Bronx, N. Y. if the Bureau of Internal Revenue goes through with plans to take over Grand Central Palace for office space. It is considered likely that the Bronx may also be the show site for 1955 although Atlantic City is being considered for that year if the Bronx location proves inadequate.

In 1956 it is expected that the mammoth Columbus Circle Coliseum in New York City will be completed and available for use. If present rate of growth continues, the 1956 IRE national convention will probably need the space.

TV Broadcast Industry Forecasts Own Growth

Month by month totals for post-freeze stations on the air in 1953 are predicted

ACCOMPANYING bar chart showing the probable growth of post-freeze tv stations on the air by the end of 1953 rests squarely upon the shoulders of the broadcasters themselves. In it, some 119 post-freeze grantees indicate their hoped-for starting dates (45 others refused to put themselves on the spot). Added to the year-end total are 13

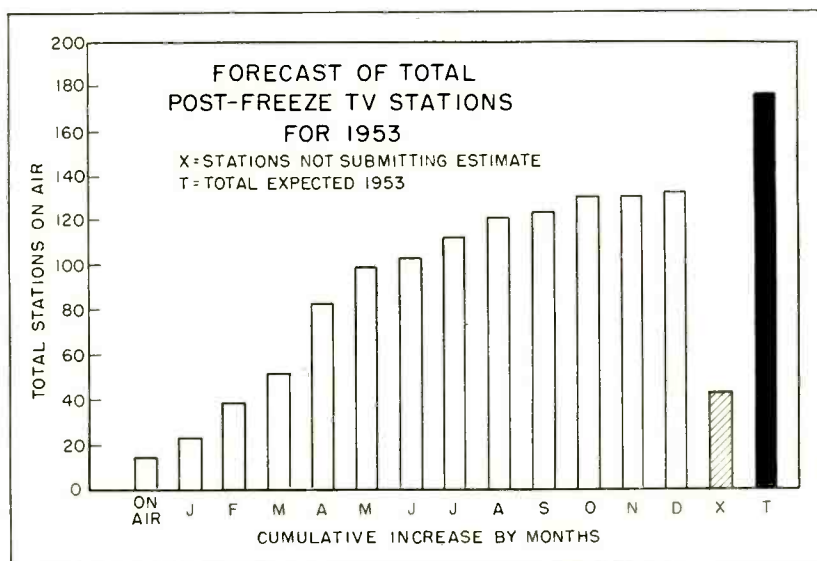

natural mica; the cohesion is believed due to electrostatic charges. The reconstituted mica flakes can be permanently bonded together by hot-pressing near the melting point of the mica.

With synthetic mica flakes, a lower-melting-point synthetic boron mica can be mixed in and heated just above its fusion temperature to give a mica-bonded mica sheet. There are excellent possibilities here of developing an automatic continuous process for manufacturing a high-temperature-resistant mica sheet of controlled thickness for capacitor use.

Community Television Continues To Expand

DESPITE post-freeze station building, the future seems bright for community antenna operators. Systems total 149 today as against 96 half a year ago; 26 new systems are planned.

An estimated 70,000 to 85,000 homes receive their television entertainment via cable, with the viewers coughing up three-billion dollars annually in service charges. Manufacturers can thank community tv for helping sell \$17,500,000 worth of sets in otherwise inaccessible communities. Antenna operators have collected \$8,750,000 in hook-up fees.

Pennsylvania is still the center of community television, with 53 systems. West Virginia has 23, while California, a comparative late-comer, has 18 systems.

► **Multiple Owners**—Reportedly only half the antenna operators are making a profit from their enterprises but this is attributed largely to slipshod business methods. The multiple-system owner, often backed by big-money interests, has made his appearance on the scene. A California operator has a chain of five systems while a Pennsylvanian is running three.

Very ambitious is Jerrold Electronics, backed by J. H. Whitney and Co., large New York investment house. Jerrold is aiming at 6,000 subscribers in Williamsport, Pa.,

(Continued on page 8)

already making use of their new post-freeze grants.

► **Red Faces?**—An additional 25 on the air at year's end would be a source more for rejoicing than em-

barrassment. Reddest faces so far are those of the uhf transmitter manufacturers, whose production lines have not quite caught up with press departments' output.

Synthetic Mica Used Commercially

Crystals 'grown' in electric furnaces still too small for capacitors, but have other uses

ALTHOUGH military research funds have not yet paid off in freeing U. S. from dependence on India for natural mica splittings, commercial byproducts of the research are emerging. This means that huge electric furnaces for growing mica crystals artificially may soon be in operation without government support.

► **The Mica Business**—Over 8,000,000 pounds of mica splittings are imported annually, with roughly 90 percent coming from India and the rest from Brazil, at an average price of \$1 a pound. The largest sheets, needed for mosaics of tv camera tubes, are worth up to \$500 a pound.

Circle and punch mica, used chiefly for vacuum-tube spacers, runs about 18 cents a pound for the 2,500,000 pounds needed annually by the tube industry. This grade is available from U. S. mica

mines and can also be made synthetically, though at about twice the price.

Though some 60,000 tons of scrap and ground mica are used annually, availability is excellent at the going rate of 3 cents a pound. For electric furnaces operating at 30 cents a pound, synthetic production of this grade is economical only as a byproduct of sheet-growing.

About three-fourths of the imported splittings go into built-up or reconstituted mica worth around \$2 a pound. Here synthetic mica offers the best possibilities.

► **Reconstituted Mica**—Use of smaller mica pieces and elimination of hand splitting are the chief advantages of a relatively new process of reforming mica into large, continuous sheets. The mica is disintegrated by beating it for a minute or two in a blender half-full of distilled water, and the sheet is formed by pouring the mica suspension over a suction filter. After drying, the tiny pieces cohere to give a mat with some strength and elasticity, though less than that of

550 TO 3800 MEGACYCLES

with Sylvania 6BM6 Broadband Tunable **KLYSTRONS**

Sylvania now offers 4 different Klystron types, designed for external cavity resonators covering a frequency range from 550 to 6500 megacycles.

Types 6BM6 and 6BL6 are designed for CW applications, while types 5836 and 5837 may also be used in pulse modulated oscillation.

Sylvania Klystrons provide continuous tunable output over wide ranges of the micro-wave spectrum. New illustrated catalog gives complete specifications. Mail the coupon for your copy now.

We also welcome your inquiries regarding the designing of cavities for various types of circuits.

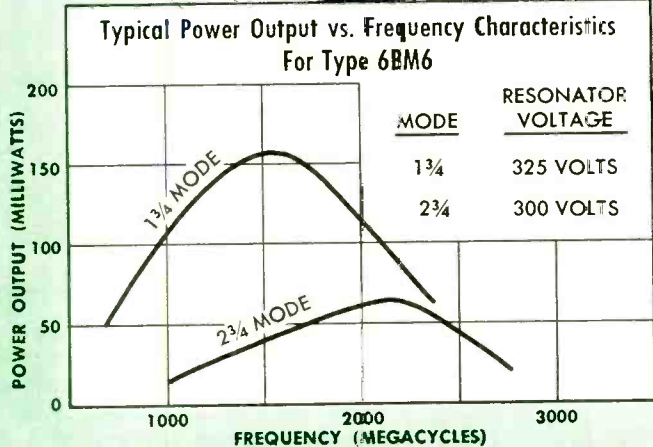

SYLVANIA

ELECTRONIC DEVICES; RADIO TUBES; TELEVISION PICTURE TUBES; ELECTRONIC TEST EQUIPMENT; FLUORESCENT TUBES, FIXTURES, SIGN TUBING, WIRING DEVICES; LIGHT BULBS; PHOTOLAMPS; TELEVISION SETS

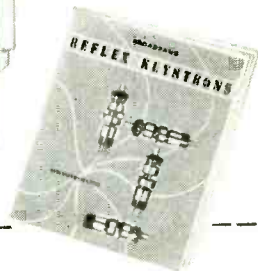
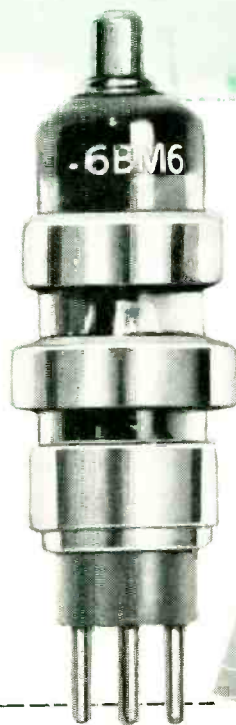

Sylvania Electric Products Inc.
Dept. 3E-1003, 1740 Broadway
New York 19, N. Y.

Please send me new catalog describing Sylvania's line of Reflex Klystrons.

Name _____

Street _____

City _____ Zone _____ State _____

and a second system is under construction in Fairmont, W. Va. The Jerrold-Whitney group has three additional systems in the planning stage. Jerrold also runs systems in Walton, N. Y., Harlan, Ky. and Ventura, N. J.

► **Subscription TV**—Community antennas and pay-as-you-go television apparently were made for each other. With FCC approval the sticking point for subscription tv via the air waves, community antenna operators are free to distribute quality programs of local origin over an unused channel of their wire system and charge by the program.

Telemeter has a coin-box system operating in Palm Springs, Calif. The system uses Jerrold 7-channel equipment. Telemeter is so thrilled over the marriage of the cable and coin box that they have now gone in for manufacturing components for community-tv systems themselves. Since turnabout is both fair and profitable play, Jerrold is experimenting with a subscription television system.

► **Boosters and Satellites**—An alternative means for bringing television to mountain-ringed communities is the booster or satellite plan. A booster picks up a tv signal and reradiates it on the same channel with vertical polarization. Satellites reradiate the signal on a different frequency. One of each of these systems is now operating experimentally.

Community tv manufacturers announce that they are ready to join in booster operation, pointing out that satellite operation requires additional channel assignments.

► **Local UHF**—Local uhf stations have already proved a boon to some community-tv operators. Take the case of Shinshinny, Pa.: Interest in community tv rose in this mountain-ringed community only after nearby Wilkes-Barre began work on its uhf outlet. Community-tv manufacturers state that special crystal-controlled uhf-to-vhf converters designed for unattended operation will be available when system operators require uhf reception.

Paramount-ABC Merger Approved

Split decision paves way for the biggest transaction in broadcasting history

APPROVAL by the Federal Communications Commission of the merger of United Paramount Theaters, Inc. and the American Broadcasting Company will have widespread effects on the U.S. broadcasting business. It not only permits the formation of a new broadcasting network but directly affects the operations of four other companies in the broadcasting and tv manufacturing field. The full effects of

the merger may not be apparent for some time, however.

► **New Network**—The new network that will result from the merger will be known as AB-PT, Inc. and will have assets of about \$150 million behind it. Its formation involves a \$25 million stock transaction, the biggest in the history of broadcasting.

The new corporation will control five tv stations, six a-m stations and six f-m stations, in addition to 707 theaters throughout the country. It now also has 81 tv stations and 353 radio stations as affiliates.



OPERATOR in freight-yard control tower (left) engages remote car-retarder when speed meter (right) warns that coupling speed is unsafe as . . .

Radar Eases Freight-Car Jolts

Unmanned freight cars roll safely down grade into classification yards

RADAR speed meters, familiar hazard to highway speeders, help insure safe automatic freight handling in railroad classification yards.

Cars are pushed over a rise of ground by a switch engine and decoupled, rolling by gravity into classification tracks where trains are made up. The speed meter clocks

the rolling cars, warning the operator in the yard's control tower if their speed is too high for safe coupling. The operator then manipulates remote electronic controls that slow the car by engaging retarders, long clamps faced with hard rubber that squeeze wheel flanges against the track.

► **Equipment**—Operating on 2,455 mc in one of the industrial-medical-scientific bands, the speed meter works on the Doppler (frequency-

(Continued on page 10)

THE MOST EFFECTIVE CAPACITORS FOR R-F NOISE SUPPRESSION...

...are the
NEW
SPRAGUE
THRU-PASS[®]
CAPACITORS

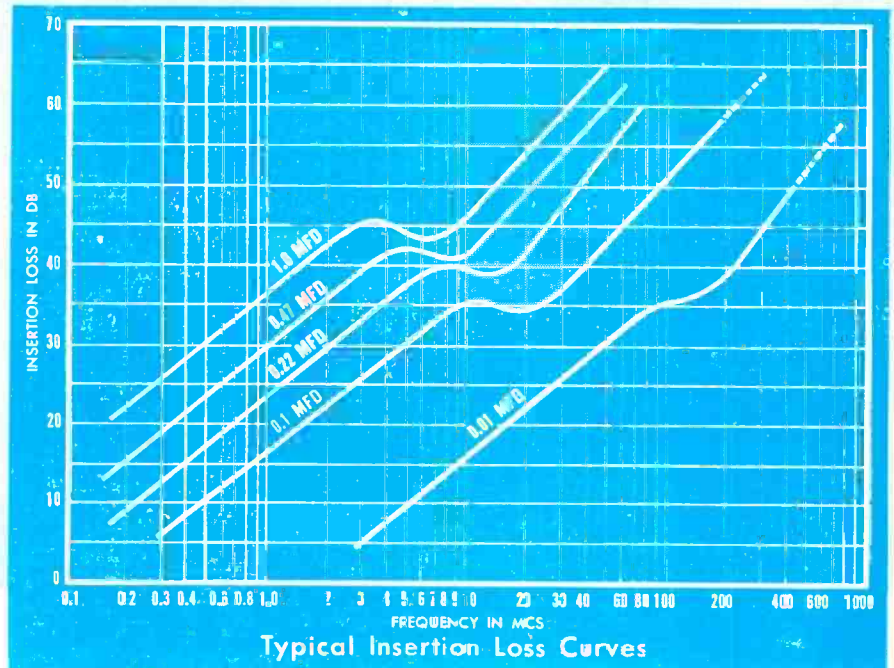

THRU-PASS CAPACITORS are a new Sprague development for use in radio interference reduction in communication and radar equipment.

- Thru-Pass Capacitors not only reduce to a negligible value the effect of external connection inductance to a capacitor but they also have a minimum length of internal path for radio interference currents. *Their performance is closer to that of a theoretically ideal capacitor than that of any other paper capacitor!*

- Electrically, Thru-Pass Capacitors are three-terminal feed-thru devices which are connected in a circuit in a manner similar to a low pass filter; the tab or lead terminals are connected in series with the circuit being filtered while the case is grounded.

- The threaded-neck mounting on Type 102P and 103P Subminiature Thru-Pass Capacitors is designed to give a firm metallic contact with the mounting surface over a closed path encircling the feed-thru conductor and to eliminate unwanted contact resistance so that the theoretical effectiveness of these new units is realized in practice. The milled flats on the threads help ensure vibration-proof mounting since the capacitors cannot rotate if mounted in a flatted opening instead of the usual circular hole.

- Type 102P and 103P Capacitors are all hermetically encased. Glass-to-metal solder-seal terminals are

employed in order to assure positive protection against severe atmospheric conditions.

- Both types are impregnated with Vitamin Q, Sprague's exclusive inert synthetic impregnant, in order to provide maximum insulation resistance and minimum capacitance change with temperature. Type 102P units are processed for -55°C to $+85^{\circ}\text{C}$ operation while Type 103P units have their top operating temperature extended to $+125^{\circ}\text{C}$.

- Engineering Bulletin 215 gives full details and standard ratings. Write on your business letterhead for your copy to Sprague Electric Co., 35 Marshall St., North Adams, Massachusetts.

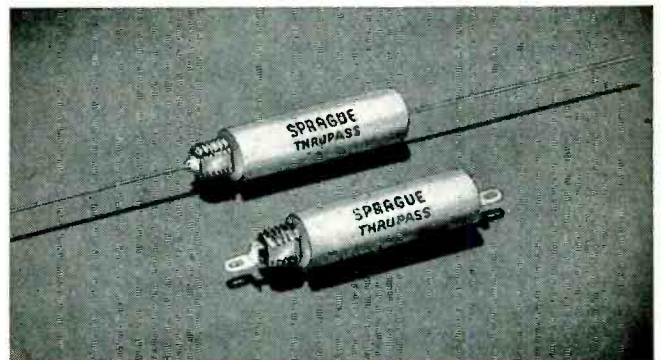

TYPES 102P AND 103P 5 AMPERE THRU-PASS CAPACITORS SHOWING CHOICE OF LEAD OR TAB TERMINALS



WORLD'S LARGEST CAPACITOR MANUFACTURER

EXPORT DIVISION: CABLE SPREXDIV, NORTH ADAMS, MASS.

"THRU-PASS" AND VITAMIN "Q" ARE SPRAGUE TRADEMARKS.

See us at the I.R.E. Show—Booths 1-410 & 1-412

change) rather than the pulse principle. The transmitter consists of a single 2C40 'lighthouse' triode operating as a fixed-frequency cavity oscillator. Output is nominally 4.5 watts c-w, delivered to two half-wave dipoles fed in phase.

Equipment costs approximately \$1,000 when used in conjunction with a graphical recorder.

► **Use**—Radar speed checking is used by the Southern Railway System in the John Servier Yard, Knoxville, Tenn. and in Ernest Norris Yard, Birmingham, Ala. Another user is the New York, New Haven and Hartford Railroad.

Speed checking by Doppler radar is used extensively on highways. Two well-known users are the Connecticut and Maryland State Police, with installations on the Merritt Parkway and Washington-Baltimore Boulevard.

Radioactive Tracers Check Germanium

Minute traces of foreign elements are measurable for research in transistors

ONE OF the most exacting processes involved in the manufacture of transistors is the control of the amount of impurities in the semiconductors used. The usual technique is to refine the material well beyond the required value and then to add appropriate and controlled amounts of the desired impurities.

Production is limited by difficulty of determining when the super-pure state has been reached. A method for achieving this type of measurement to one part in one hundred million has been developed at Sylvania by George Morrison of the Radiochemical Laboratory at Bayside, New York.

► **Method**—A sample whose purity is to be determined is sent to Brookhaven National Laboratories, where it is placed in a reactor and thereby subjected to radiation. The sample becomes hot by a measurable

amount proportional, among other things, to the percentage of impurities present. It is thus possible to calculate the degree of impurity with extreme accuracy.

The technique has proved successful in preparing germanium samples with arsenic impurities. Other vehicles and impurities may be studied in the same manner.

Safety-of-Life-at-Sea Radio Equipment Ready

NEW aids to save lives were provided for under the International Convention on Safety of Life at Sea, London, 1948. With the final ratification (*ELECTRONICS*, p 10, Mar. 1952) of this Convention, four years later, FCC quickly set up specifications for fulfilling the electronic requirements. In less than two months American manufacturers came up with prototypes.

► **The Equipment**—The provision that newly certified ships beginning Nov. 19, 1952 must carry certain main or auxiliary radiotelegraph equipment may mean a bit of extra change for a good many small and big manufacturers. Lifeboat portable radiotelegraph equipment, on the other hand, is so radically new as to require complete redesign and may be attempted by only a handful of those in the field. FCC will await type approval of commercial equipment before specifying a compliance date.

Among the features required of the new lifeboat radio design are ability to send or receive on two distress-frequency bands—492 to 508 kc and 8,240 to 8,800 kc. Transmissions are modulated with an 800-cycle tone and the receiver can be adjusted for tone or continuous-wave signals.

► **Autoalarm and SOS**—A hand generator supplies all power and an automatic keying device must be provided to send the international autoalarm signal (12 dashes in one minute) followed by SOS on 500 kc. When switched to the 8,364-kc position, the automatic keyer must send

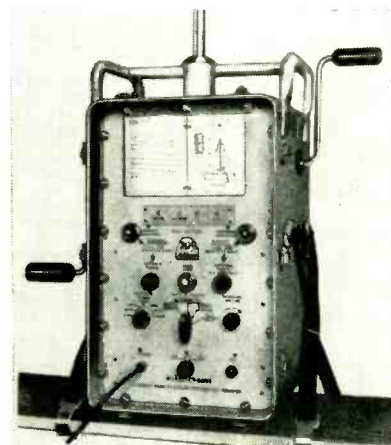

RCA version of an automatic transmitter-receiver unit required in lifeboats of American-flag ships

SOS and a 30-sec dash for direction finding by rescue craft. Other requirements include a collapsible aluminum-rod antenna and ground wire with sinker.

Electronic Plants Are Safer Now

Injury frequency dropped as the industry made progress in safety

DESPITE higher production and employment, work injuries in radio-tv, tube and communications equipment plants have declined significantly since 1949, reflecting the increasing efforts of manufacturers to make their factories safer places in which to work.

The number of injuries per million-employee-hours worked declined to 4.3 in the first six months of 1952 (latest reported period) compared to a high of 5.3 in 1950 when there were almost 50,000 less employees. With about 12 million employee-work-hours clocked in the industry every week, this decline has meant an average of 12 less injuries every week.

► **Trend**—As is shown in the chart, the decline in disabling work injuries, which are any injuries occurring in the course of employ-

(Continued on page 14)

**announcing
the Centralab**

"EXPRESS"



**Need popular-taper,
standard-shaft controls
in a hurry?**

Then see next 2 pages

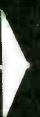

These up-to-the-minute Centralab

You can count on prompt delivery from Centralab's wide variety



Here's data on NEW
quick delivery
EXPRESS Model 2
control

Quick delivery plus these features make the Model 2 Express the control for YOU

- **resistance range:** $\frac{1}{2}$ megohm and 1 megohm $\pm 30\%$
- **taper:** Audio, Centralab C2
- **wattage rating:** $\frac{1}{2}$ watt
- **voltage rating:** Tested to withstand 1000 volts rms
- **marking:** Control stamped with Centralab part number, resistance and taper; shaft stamped with shaft number (Except Number 1)
- **bushing:** $\frac{1}{4}$ " long from mounting surface. $\frac{3}{8}$ " — 32 NEF thd.
- **switch:** Single-pole, single-throw, rated 5 amps at 125 volts a-c. UNDERWRITERS APPROVED.
- **how to order:** Specify Centralab Express radiohm, maximum resistance desired (either $\frac{1}{2}$ or 1 meg.) shaft length desired by number and/or length FMS. Specify quantity.

Available in $\frac{1}{2}$ and 1 megohm values...meet 75% of requirements for switch-type controls

HERE'S big news! Centralab's newest — the *Model 2 Express Control* — is just what manufacturers needing controls on extremely short notice have always wanted. Unique time-saving feature simplifies shaft assembly requirements — control shafts fit all standard RTMA split-knurled and certain spring-type push-on knobs.

Shafts and controls are carried in stock at our plants. When your order is received, desired shafts are staked directly to controls. Complete assembly arrives in *your* plant in just a few days. To help you plan . . . Centralab will even tell you approximate delivery time in hours from the date your order is received.

The new Express is available in two values: $\frac{1}{2}$ and 1 megohm, audio taper (C2) with SPST a-c line switch. These two values meet 75% of the requirements for switch-type controls. Talk about versatility! Flat shafts are stocked separately in 14 lengths ranging from $\frac{7}{8}$ " mounting surface to $2\frac{1}{2}$ " fms in increments of $\frac{1}{8}$ ".

Think what this range *plus* quick delivery can do to solve your *immediate* production requirements! Quickest way to get started is to check Bulletin 42-163 in coupon.

Controls keep you ahead on AM-FM-TV

of standard and custom controls to meet commercial and government requirements

New Model 2 Express plus these Centralab "reliables" — Models 1 and 2 Radiohms (plain or switch type, plain or dual concentric shafts) and newly announced Compentrol — meet today's demand for smaller size . . . extra quality.



Centralab Model 2 Radiohm Control — Left, single unit plain type, untapped; right, twin unit plain type, untapped. Both with single shafts.

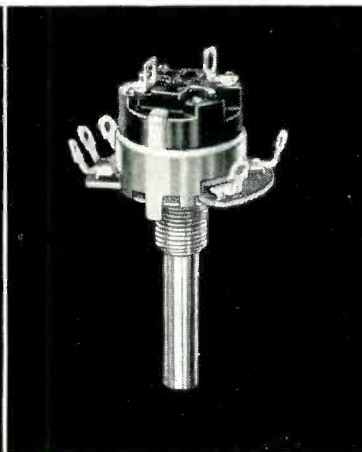

Centralab Model 2 Radiohm Control — control shown is a single unit switch type, tapped. Control has single shaft. Small size adds extra versatility.



Centralab Model 2 Radiohm Control—this control is a twin unit switch type, untapped. It has a single shaft. Check 42-85 for data on these model 2's.



Centralab Model 2 Radiohm. Left, twin unit plain type, front section tapped; Right, twin unit switch type, rear-section tapped. Concentric shafts.

NEW Compentrol

—a volume control with the built-in printed electronic circuit.

Gives high fidelity bass and treble tone response at low volume level. Furnished in 1/2 and 1 meg plain or switch types. No insertion loss — no additional amplification required. For complete data check No. 42-182 in coupon.

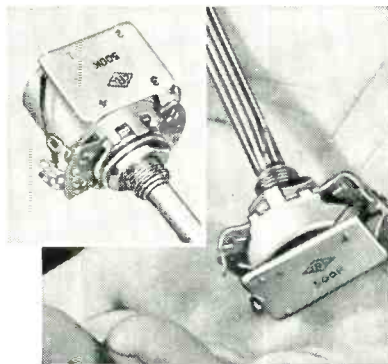

MILITARY TYPES . . . If you use types RV2A or RV2B, Model 2 variable resistors on your next military order — there's no prior contract approval or waivers required. They meet JAN-R-94, characteristic U requirements.

By return mail . . . we'll be happy to send you complete information — taper curves, physical dimensions, engineering specifications on all controls illustrated. Manufacturers samples on request. Use handy coupon.

See Us at the I.R.E. Show. Booths No. 2-403-404.

Centralab

A Division of Globe-Union Inc.
Milwaukee 1, Wisconsin

In Canada, 635 Queen Street East, Toronto, Ontario

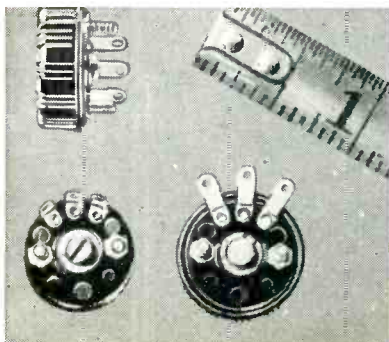

Centralab's Model 1
—miniature variable resistors — world's smallest volume control.

. . . no bigger than a dime . . . available in Standard or Hi-torque types—with or without on-off switch. Also with slot—front or rear—for screw-driver adjustment. Hi-torque units hold settings under conditions of vibration or shock. Ideal for hearing aids. Check No. 42-158 on coupon.

CENTRALAB Div. Globe-Union Inc.
914 East Keefe Avenue, Milwaukee 1, Wisconsin

No. 42-85; 42-158; 42-182; 42-163. Please send the bulletins I've checked. I'd also like a copy of Centralab's latest stock catalog No. 28, including more than 470 new items designed for the fast-changing electronic field.

Name.....Position.....

Company.....

Address.....

City.....Zone.....State.....

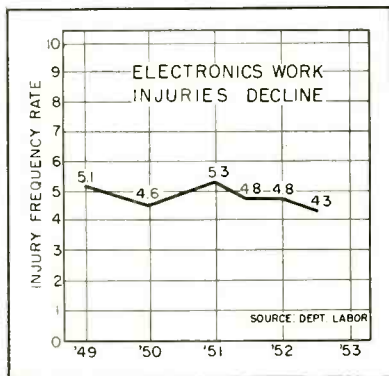

ment which makes the injured worker unable to perform his regular duties, has not been a steady decline in the last four years.

With the outbreak of the Korean War in 1950, the injury rate rose to its highest point during the period. One main factor contributing to the rise that year was the relatively sudden demand for production increases brought about by defense needs and tv scare buying. Employment and overtime hours rose suddenly and accidents climbed as work fatigue increased.

► **Progress**—Electronic manufacturers see many reasons for the downward trend in the injury frequency rate. Labor unions as well as manufacturers emphasized the safety factor and safety engineering became a regular part of the production plans of many firms.

Other overall factors such as mechanization, better lighting and better facilities have contributed to the decline. Electronic manufacturers have found that such safety progress pays off not only in higher employee morale but in higher production and lower insurance rates.

► **Future**—Electronic manufacturers are continuing to improve plant safety conditions and are far ahead of many other industries in this respect.

Recently the television-radio division of Westinghouse established an all-time safety record for the entire electrical equipment industry when 15,040,000 employee-working-hours went by without a lost-time accident. With safety engineering and modern construction increasing in the industry, more new safety records may well be in the making.

Radio-TV Firms Add Other Lines

Diversification trend accelerates as manufacturers continue to broaden their activities

DIVERSIFICATION is not new to many radio-tv manufacturers. Companies in the field manufacture products ranging from sporting goods to bathroom fixtures. But in recent months the trend to other lines has accelerated and important set manufacturers have entered other product fields.

Stabilization is one of the reasons for these moves and indications are that the trend will continue at an even faster pace in the future.

► **New Fields**—RCA is the most recent of the major companies to move into new lines. It began with air conditioners last year and then moved into the electric range field. Now it is rumored that the company will market washing machines under its diversification plans.

Admiral has also recently entered more heavily into appliances. The firm has announced plans to manufacture and sell a line of air conditioners and home freezers in 1953. It has been in the refrigerator and range business for some years and has also made a line of dehumidifiers. With the new product additions, the company expects to double the sales of its home appliance division this year.

► **Why?**—Probably the basic reason why radio-tv companies have entered new fields was best stated by one manufacturer who bluntly answered—"To make more money." Other reasons for the trend seem to lie in the radio-tv business itself. Its tremendous growth since the war has given radio-tv companies the capital to make acquisitions. In addition, its close association with other products through common wholesalers and dealers, especially in appliance lines, has made the moves easier.

The seasonal nature of the radio-tv business has also been responsible for diversification. Manu-

facturers have found that one of the best ways to combat the drop in radio-tv sales in the summer and stabilize their sales is to have another line of products to sell that are in season. Home appliances have met this need successfully and this is the field most radio-tv companies have entered.

Another very significant reason for the diversification trend was recently stated by R. D. Siragusa, president of Admiral "In marketing generally, and in the marketing of consumer durables particularly, brand names are becoming more and more important. To establish a brand among the top sellers requires increasingly large outlays for demand creation in the form of advertising and promotion. This also automatically means that successful companies will tend to have a family of related products so that the advertising and promotion investment made for the brand will be spread over more units."

Radiation Instrument Industry Grows

RADIATION instrument industry, virtually non-existent in 1946, had an annual business of \$20 million in 1952 and employed more than 2,400 persons, according to a survey by the U. S. Atomic Energy Commission. Seven companies account for about 50 percent of the industry's activity.

Growth of the new industry has paralleled development of the nation's atomic energy program since early 1947, when the AEC adopted a policy of encouraging its operating contractors to procure radiation instruments from commercial manufacturers.

► **Market**—The survey shows an expanding market for radiation instruments outside of the AEC program as well as within it. Military agencies of the government now provide about 50 percent of the

(Continued on page 16)

HERE'S THE SECRET

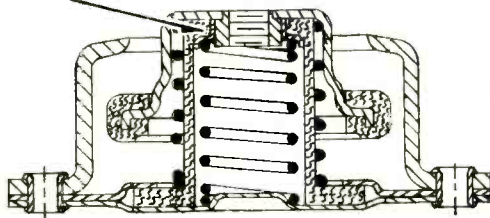

... of a **NEW**
wire-mesh isolator
that won't change
on the job!

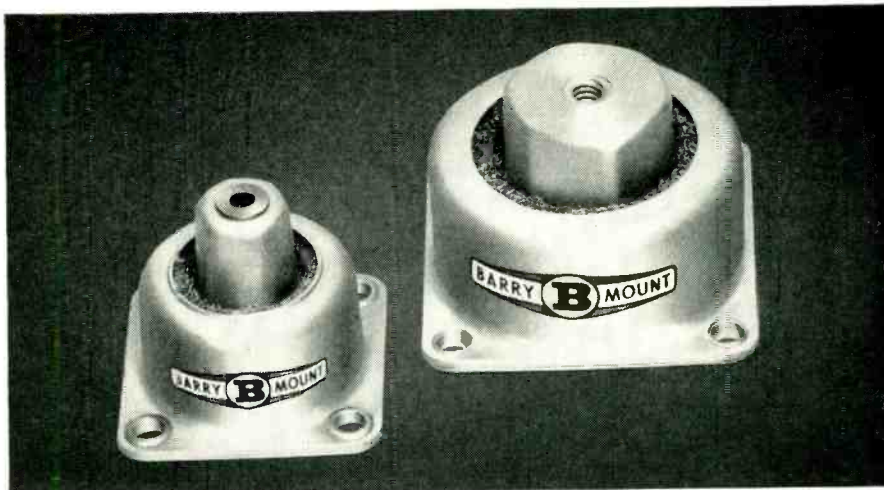

The new Type 7630 and Type 7640 ALL-METL Barrymounts have been specifically designed to eliminate loss of efficiency due to damper packing. Previous wire-mesh unit vibration isolators exhibited a definite loss of damping efficiency after a period in actual service, because the wire-mesh damper tended to pack. These new unit Barrymounts have eliminated this difficulty, because the load-bearing spring returns the damper to its normal position on every cycle.

- Very light weight — helps you reduce the weight of mounted equipment.
- Hex top — simplifies your installation problems.
- High isolation efficiency — meets latest government specifications (JAN-C-172A, etc.) — gives your equipment maximum protection.
- Ruggedized — to meet the shock-test requirements of military specifications.
- Operates over a wide range of temperatures — ideal for guided-missile or jet installations.

Compare these unit isolators with any others — by making your own tests, or on the basis of full details contained in Barry Product Bulletin 531. Your free copy will be mailed on request.

See these new isolators in action, and discuss their applications with us, at the New York I.R.E. Show.

THE **BARRY** CORP.

707 PLEASANT ST., WATERTOWN 72, MASSACHUSETTS

SALES REPRESENTATIVES IN

Atlanta Baltimore Chicago Cleveland Dallas Dayton Detroit Los Angeles Minneapolis New York
 Philadelphia Phoenix Rochester St. Louis San Francisco Seattle Toronto Washington

total market, the AEC and its principal contractors provide about 30 percent and the remainder is accounted for by private industry, universities, hospitals and research institutes, civil defense, export and uranium-ore prospecting.

More than 50 patents in the field are owned by the U. S. and held by the AEC. A total of 51 non-exclusive, royalty-free licenses have been granted on these patents.

US Drops Suit Against Set Makers

CONVENED LAST JANUARY, a New York City grand jury failed to turn up evidence of "the use of force, strong-arm tactics or activities of a similar punitive nature" by the radio-tv industry. As a result, James P. McGranery, now ex-Attorney General, dropped the Government's criminal anti-trust suit which involved many major radio and tv manufacturers.

McGranery stated it was now the Government's opinion that a civil anti-trust suit would get "whatever restraints may exist in the industry", and that's where the matter rests at the moment.

Industrial TV Monitors Production

Electronic watchdog keeps an eye on products ranging from oysters to sugar cane

CLOSED-CIRCUIT television systems for industrial applications involve a number of compact, specialized units permitting centralized control or for watching processes too dangerous for visual observation. Uses range from watching boiler-water level gages and smoke stacks in power plants, to underwater inspection of dock pilings and wharves.

Remington-Rand and RCA color systems are being used in medical schools to permit a large number of students to look over a surgeon's shoulder while he operates.

A stereoscopic tv system developed by DuMont is being used at Argonne National Laboratory to observe work with radioactive materials. Another three-dimensional system, made by the Fenjohn Photo & Equipment Co., is being used by the Maryland Fisheries Commission to study oyster beds.

A system of mirrors installed in a

Waiialua, Hawaii sugar plantation was an ingenious idea for continuously checking the progress of sugar cane along the conveyors. However, it didn't work because of vibration, dirt and spray.

► **Electronics to the Rescue**—The need for close control of volume and speed was so great that this plantation, as well as another at Ewa, are installing closed-circuit television systems at a cost of \$7,500 apiece. Cameras can be so mounted and protected from dirt and spray that they will give a picture of the cane moving mechanically from cleaning plant to grinding machinery. A coaxial cable system will relay this information from the cameras to a tv receiver at the control center.

► **Equipment Requirements**—Since most industrial television equipment is operated by unskilled personnel, adjustments and controls must be kept at a minimum. For the same reason a minimum of

(Continued on page 18)



Closed-Circuit TV Brings Meter Readings to Last-Row Students

Schools are potential market for industrial television systems. In this physics lecture hall at Cornell University, Professor Guy E. Grantham is holding a light-meter in front of the RCA camera. Resulting image of meter scale fills entire screens of two 21-inch television receivers watched by students. Camera can also be aimed into microscopes and cloud chambers to show phenomena that would otherwise be visible to only one person at a time



Type 1803-A Vacuum-Tube Voltmeter

a
*Quality Instrument
at Low Cost*



The Type 1803-A Vacuum-Tube Voltmeter fills the need for an easily operated instrument, of adequate range and accuracy, selling at a price within modest laboratory budgets.

This instrument is a standard vacuum-tube voltmeter devoid of frills; it has no d-c or ohm scales, but is a *superior* a-c voltmeter. It will measure voltages between 0.1 and 150 volts to a basic accuracy of 3% and at frequencies up to 100 megacycles. With the accessory Type 1803-P3 Multiplier attached to the probe, the voltmeter range is extended to 1500 volts over a 50 Mc. range.

This voltmeter is small and light in weight, has a completely shielded probe, a single zero adjustment for all five ranges and an internal power supply operating from ordinary 50-60 cycle, a-c lines. For greatest accuracy, there are four meter scales covering the complete 0 to 150 volt range. The cabinet is of welded, heavy gauge aluminum with rubber feet for either vertical or horizontal positioning.

SPECIFICATIONS

Accuracy—3% of full scale for sinusoidal voltages on all ranges, subject to frequency correction above 50 Mc. (Correction chart supplied)

Input Impedance—7.7 megohms in parallel with approximately 10 μ f; the parallel resistance increases at higher frequencies

Power—105 to 125 volts or 210 to 250 volts, a-c, 50-60 cycles

Accessories Supplied—Type 274-MB Plug, pair of 30-inch test leads, and two alligator clips to facilitate connections

Dimensions—(Width) 7 $\frac{1}{4}$ x (Height) 11 $\frac{1}{4}$ x (Depth) 6 $\frac{1}{8}$ inches

Net Weight—9 $\frac{1}{4}$ pounds

Type 1803-A Vacuum-Tube Voltmeter . . . \$155
Type 1803-P3 Low-Frequency Multiplier . . . \$21



The input voltage is rectified by one section of the twin diode and the d-c passed on to the grid of a triode in one arm of a balanced amplifier circuit. The other, "inactive", diode balances the effects of contact potential of the input diode. The balanced amplifier circuit insures minimum shift in calibration with line voltage changes.



GENERAL RADIO Company

275 Massachusetts Avenue, Cambridge 39, Massachusetts, U. S. A.
90 West St. NEW YORK 6 920 S. Michigan Ave. CHICAGO 5 1000 N. Seward St. LOS ANGELES 34

Admittance Meters \star Coaxial Elements \star Decade Capacitors
Decade Inductors \star Decade Resistors \star Distortion Meters
Frequency Meters \star Frequency Standards \star Geiger Counters
Impedance Bridges \star Modulation Meters \star Oscillators
Variacs \star Light Meters \star Megohmmeters \star Motor Controls
Noise Meters \star Null Detectors \star Precision Capacitors
Pulse Generators \star Signal Generators \star Vibration Meters \star Stroboscopes \star Wave Filters
U-H-F Measuring Equipment \star V-T Voltmeters \star Wave Analyzers \star Polariscopes

maintenance should be required.

A portable unit made by the Diamond Power Specialty Co., with camera, power supply and receiver, weighs less than 150 pounds. Camera units are being made that measure less than 8 by 4 by 4 inches. A mount for this camera made by the General Precision Laboratory permits remote viewing with control of camera angle, focus and lens opening from the viewing point.

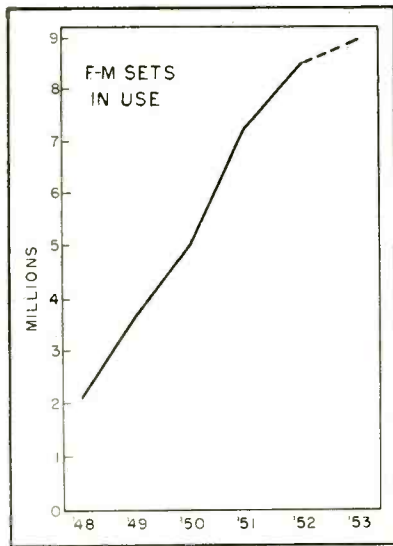

THERE are 9 million f-m sets in use and . . .

F-M Radio Catches Its Second Wind

Despite a decline in production there is still plenty of life in the field

PRODUCTION of frequency-modulation radio sets has decreased in the past two years but dollar volume is still significant and the field represents a thriving business for some manufacturers. In some areas where tv's popularity gave f-m a temporary setback there are signs that it is catching its second wind.

► **Trend**—As shown in the chart, there is a total of 9 million f-m sets in use in the U. S. In 1950, the banner year for f-m, over 2.2 million units were produced. In 1952, total output stood at 500,000.

Table models were by far the largest sellers during 1952, accord-

ing to leading producers. Units with f-m only have virtually disappeared from the market and the number of tv sets with f-m included has also declined markedly. In 1950 over 750,000 tv sets with f-m were produced. In 1952, the number had dropped to about 88,000.

Still, f-m dollar volume was sizeable in 1952 despite lower production. With an estimated average retail price for f-m/a-m units of about \$65, last year's output meant a dollar volume of over \$32 million and represented more than 26 percent of the total dollar volume of home radio sales in 1952.

► **Companies**—Big reason why some radio manufacturers are do-

ing more f-m business is that there are fewer manufacturers concentrating on the market and sharing in the dollar volume. In 1949 about 50 companies were producing f-m/a-m table models, the volume seller in the field, while last year there were less than 25 of the radio manufacturers making the combination units.

Zenith, a major producer in the field, reports that its f-m sales have been the biggest in history. They have brought out a greater variety of f-m models for 1953. It is reported that General Electric also plans to go more heavily into the field this year. In addition, f-m station activity, despite some setbacks, has increased.

Company Patent Policies Surveyed

Assignment agreements are universally used, but differ greatly in details

A DETAILED study of patent practices in 48 major corporations, 11 of which are active in the electronics field, was made recently by the National Industrial Conference Board. Forty-three of these firms require some or all of their employees to sign patent-releasing agreements as a condition of employment and two of the remainder have unwritten understandings.

► **Who Signs**—Research and engineering employees are almost universally required to sign patent agreements, since they are the most likely to make patentable inventions of interest to the company. In 19 companies, executives and supervisors must also sign up. Ten companies require all their employees to sign.

► **Duration of Agreement**—With 33 firms, the agreement expires at the termination of employment. Obligations which are part of the agreement generally continue, however. This insures availability of the former employee to execute

necessary papers and perform other actions involved in securing patents for inventions made during his employment.

With 10 firms, the assignments bind the employees completely for 6 months to 2 years after termination of employment. This is based on the premise that subsequent inventions could have been conceived or developed during employment.

► **Pay for Patents**—Although engineers are often hired specifically to invent, nominal extra compensation is often made for successful patents, chiefly as a means of boosting morale by giving formal recognition of achievement. Seventeen firms give a fixed amount per invention; one pays \$150, six pay \$100, six pay \$50 and four pay \$1 (the latter more in the nature of a legal consideration). Eleven companies give salary increases to prolific inventors. A few share royalties with the inventor when licenses are issued under the patent.

Special cash awards for the best invention of the year, for the best in 5 years, or for every 50 inventions, are made by some

(Continued on page 20)

SORENSEN

electronically

**REGULATES
AND CONTROLS**



Model 2000S

**SORENSEN ISOTRONIC AC LINE REGULATORS
ARE YOUR BEST CHOICE FOR PERFORMANCE PLUS ECONOMY**

The man who **uses** instruments likes Sorensen AC Line Regulators because of regulation accuracy, clean waveform, insensitivity to frequency fluctuation, load range.

The man who **maintains** instruments likes Sorensen AC Line Regulators because of circuit simplicity, conservatively rated tubes (only 3 in all), built-in ability to deliver

trouble-free performance for months on end.

The man who **pays for** instruments likes Sorensen AC Line Regulators because of reasonable price and the fact that there are no extras for installation and special wiring.

The man who **designs** instruments likes Sorensen AC Line Regulators because they are ideal for incorporation as reliable components.

**OTHER
SORENSEN
ISOTRONIC PRODUCTS
INCLUDE:**

NOBATRONS
(low-voltage, high-current DC Supplies)

B-NOBATRONS
(high-voltage, low-current DC Supplies)

NOBATRON-RANGERS
(full-range-variable DC Supplies)

FREQUENCY CHANGERS

SATURABLE CORE REACTORS

**VARIABLE AUTO-
TRANSFORMERS**

HIGH VOLTAGE
DC
LOW CURRENT

**AC
LINE**

FREQUENCY

LOW VOLTAGE
DC
HIGH CURRENT

ELECTRICAL SPECIFICATIONS

Models available (numbers indicate VA capacities)	Input	95-130 VAC, 1 ϕ , 50-60 \sim ; 190-260 VAC in "-2S" models
150S	Output	115 VAC \pm 5%; 230 VAC in "-2S" models
250S	Regulation accuracy	\pm 0.1% against line or load
500S (-2S also)	Distortion	2% - 3% maximum
1000S (-2S also)	P. F. range	Down to 0.7
2000S	Load range	0 to full load
3000S (-2S also)	Miscellaneous	Models 150S, 250S, 500S, 1000S, 5000S, 10000S, and 15000-2S are self-contained. Cabinets available for others.
5000S (-2S also)		
10000S (-2S also)		
15000-2S		
1001	Regulation accuracy 0.01%, load range 0 - 1000 VA, output 115 VAC \pm 5%, other characteristics similar to those given above.	

* ISOTRONIC=Regulation and control of voltage, current, power, and frequency by electronic means.



SPECIFY SORENSEN

For Complete Information Write

SORENSEN & COMPANY, INC.

375 Fairfield Ave.

Stamford 1, Conn.

firms; these are usually \$500 or less, but can go up to \$5,900.

► **Releasing Rights**—Only 8 companies do not release rights to unwanted inventions. On the other hand, 2 actually help the employee to obtain his own patent when they don't want it. Some assignment agreements contain an automatic release clause so all rights revert to the employee if the patent is not prosecuted by the company within a specified time interval after complete disclosure, such as 9 months.

Financial Roundup

PROFIT reports, security offerings and sales, and mergers were made or planned by many companies in the electronics industry during the past month.

Profits of six companies in the field indicate that 1952 business was good:

Company	1952	Net Profit	1951
AT&T	\$319,750,000		\$279,256,365
Avco	11,028,927		10,089,214
Bendix Aviation	15,295,159		11,818,600
Emerson Radio	2,262,555		3,592,397
Magnavox*	1,546,024		587,795
W. L. Maxson	526,494		524,012

*6 months report

► **Security Transactions**—Sylvania Electric filed two registrations with the SEC covering 550,000 shares of its \$7.50 common stock and \$20 million of sinking fund debentures due in 1978. Net proceeds of the stock sale are expected to total over \$19 million. About \$15 million of these proceeds will be used for bank reduction. The proceeds of the debenture sale will be used for capital expenditures. The company plans further plant and equipment additions and improvements with an estimated total cost of over \$16 million.

Video, Inc. offered 69,725 shares of 5 percent cumulative convertible preferred stock at par "as speculation". Proceeds are to be used for general corporate purposes including debt payment, purchase of equipment and working capital. The company operates a community antenna system in Pennsylvania.

RCA has sold another \$25 million of 3½-percent promissory notes due May 1, 1977, to New York Life In-

surance Co. and another investor. This borrowing brings to \$30 million the total taken down under a \$50 million agreement set up in 1952. The company will borrow the rest before July 1, 1953. The proceeds will be used for working capital and for general corporate purposes, including financing of its defense business.

Sangamo Electric Co. has sold \$3,750,000 of 3¼ percent promissory notes due Jan. 1, 1968 to New York Life Insurance Co. The company has also borrowed \$5.5 million from 4 banks. All but 510,000 will be used to pay off bank loans and other debt. This balance will be added to working capital.

► **Mergers**—Emerson Radio has abandoned its merger plans with Webster-Chicago because of difficulties that arose within the stock structure of the Webster-Chicago Company.

Defense Sparks College Research

EIGHTY PERCENT of electronics research in colleges and universities is for national defense, with more than half the effort concentrated in eight schools. Unused research facilities amount to about one-third total capacity. A survey by the Engineering College Research Council reveals 425 faculty members in 150 schools eager to do such research if given resources.

► **Statistics**—Encompassing 20,000 qualified faculty members in 513 schools, the survey showed 12,700 now active in research of all kinds. Electronics represents 6.3 percent of all college research and 10.2 percent of college defense research. Faculty qualified for electronics research numbers 1,032, with 625 now active.

Sponsors Cut Employee Turnover

Before, half the new tv-production-line workers quit within 3 months; now 90 percent stay on

TO MAKE new employees feel at home during the critical starting period, Olympic Radio & Television uses 'sponsors' chosen for their ability to get along with people. Each department has one or more

sponsors, identified by distinctive blue buttons.

► **How Sponsors Serve**—When an employee is hired by the personnel department, a sponsor is called in to meet the new arrival. The two then take an informal orientation tour through the plant on the way to the assigned department. There the sponsor introduces the newcomer to the foreman, shop steward, supervisor and fellow employees. He then explains and shows employee facilities for rest periods, lunch, coffee, purchase of company products at discounts, smoking, and anything else about which questions are asked. This usually takes only a few hours of the sponsor's day. Contacts thereafter are generally during rest and lunch periods, when the sponsor asks how things are going and encourages questions.

After 15 days of work the new employee has an informal meeting with a top official in the plant, and



Sponsor, at left, shows newly-hired employee how to punch time clock, takes him to cloak room and other facilities

(Continued on page 22)

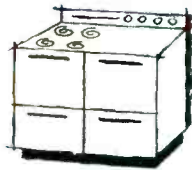

PROVEN BEST



**IN MILLIONS OF
PRODUCTS... EVERY DAY!**

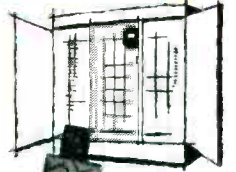

RHODE ISLAND *Insulated Wire*

**COME TO RHODE ISLAND FOR YOUR
INSULATED WIRE REQUIREMENTS.**

QUALITY: Rhode Island Insulated Wire is proven best every day in millions of products for factory, field and home.

PERSONALIZED SERVICE: Rhode Island maintains branch offices with factory trained personnel in every section of the country.

RESEARCH: Complete research facilities at your disposal for the development of specialized wires.



Write today for illustrated catalog.

We'll see you at the I.R.E. Show. Booth 4-703.

RHODE ISLAND INSULATED WIRE CO., INC.

50 Burnham Avenue, Cranston, Rhode Island

National Sales Offices: 624 South Michigan Avenue, Chicago, Illinois • HARRISON 7-6050

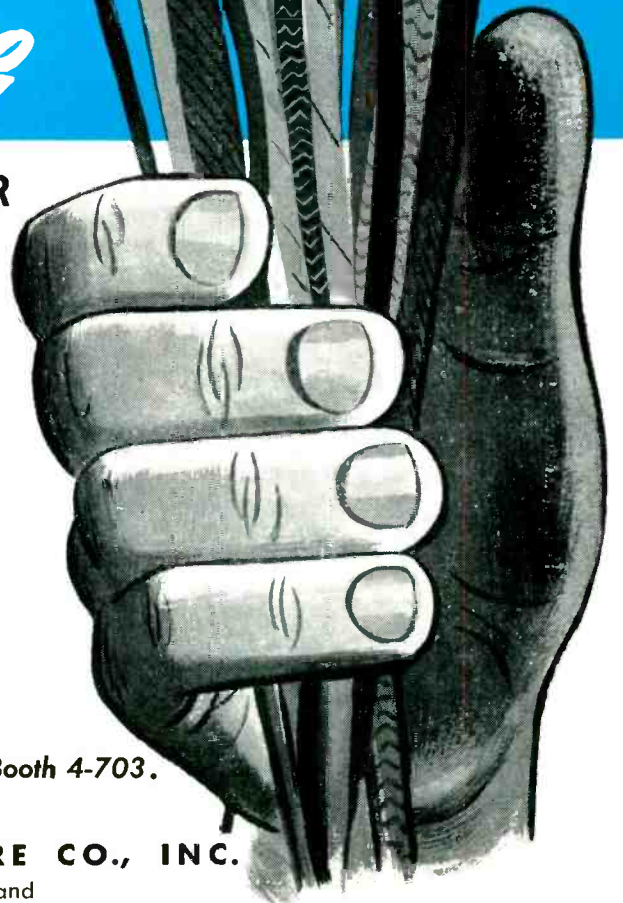



Blue-buttoned sponsor Anthony Marano is inspector in machine shop. Foremen and supervisors are never used as sponsors

is encouraged to come to the front office for advice whenever he wishes. The official is usually Benno Bordiga, director of manufacturing, who initiated the sponsor system.

► **Company Benefits**—Whereas 200 people were formerly hired to get 100 permanently, now only 110 need be hired. Reducing new-employee turnover in this way during the critical first three months boosts the number of fully-skilled production-line workers in the plant and thereby boosts output. Along with this comes a real saving in plant overhead, because each lost worker represents an average loss of one week's salary invested in training.

Air Force Global Radio Network Takes Form

WORLDWIDE communications network for ground-to-air and ground-to-ground contact with any Air Force base in the world took another step forward when Westinghouse announced the delivery of \$3,375,000 worth of radio transmitters for the project.

The transmitters have a frequency range of 2,000 kilocycles to 30,000 kilocycles. They are equipped to handle telegraph code signals of 500 words a minute, voice communication, and radiotelegraphy by key or teletype.

White Mountain TV Station Proposed

IN THE 30's, the late John Shepard III built a fabulous structure atop Mount Washington, New Hampshire to house an f-m broadcast station that spread Yankee Network programs from Massachusetts to the province of Quebec. Self-contained, with enough food, diesel fuel and supplies to last from September until May, the unit boasted a water well nearly 1,200 feet deep.

► **Worst Weather**—Characterized as having "the worst weather in the world", the 6,288-foot mountain has recorded peak gusts in excess of 200 miles an hour and temperatures near 50 below. The antenna, mounted on a 50-foot pole supported by a heavy fabricated base, comprised heavy, copper-plated truck-spring assemblies. These were necessary because of the tons of ice that frequently accumulated.

Although FCC rule changes killed off the f-m venture, the buildings and tower remain. Recently a hardy group proposed to spend nearly a half million dollars to establish a television station in this inhospitable atmosphere. First year operating costs are estimated at \$400,000, but revenue is expected to be \$450,000.

► **The Venturesome**—Principals are: president, Horace Hildreth,

former governor of Maine and station owner; John Guider, Maine and New Hampshire broadcast operator; Tyrone Corp. of Pittsburgh, Pa.; Kennebec Broadcasting Co. of Waterville, Me.; Granite State Network with several a-m and f-m stations in New Hampshire.

How soon the new station can begin serving the many little communities of northern New England that haven't even decent a-m reception isn't yet known. FCC must first hold hearings because the facilities requested (Channel 8) are assigned to Lewiston, Me., where there are two other applicants.

Remotes Extend Airways VHF Range

Transmitters and receivers at Scranton and Philadelphia extend N. Y. control to 175 miles

RELIABLE voice communications on regular CAA vhf frequencies have been extended from New York terminals by means of two remote relay stations along the heavily-traveled Chicago and Washington routes. Located at Scranton and Philadelphia, Pennsylvania, these stations increase the effective range of control to 175 miles as compared to 50 miles formerly possible with equipment installed at Douglaston (Long Island), New York.

A combination of factors made the addition of the new facilities necessary. Speed and frequency of flights have increased substantially in the past four years. LaGuardia and Idlewild traffic was further increased by the closing of Newark Airport in 1952. This step-up of activity has greatly increased the demand on communications equipment, especially when aircraft arrive under instrument flight conditions.

► **Equipment**—Each of the new installations consists of remote-controlled 50-watt transmitters operating on a dozen standard

(Continued on page 24)

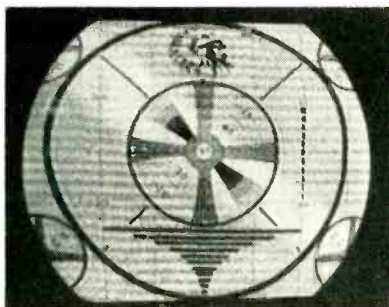

Unusual TV DX

Typical fringe-area test pattern snapped atop Mt. Washington, N. H. (6,288 feet) shows that the new Montreal, Canada station puts in a good signal 150 miles away. However, program reception on the famous peak is complicated by interference (shown as venetian-blind pattern here) from New York City station 285 miles away!

ANOTHER FIRST!



The Cleveland Container Company originates and is now producing for the electronic and electrical industries . . .

Torkrite Tubing in foreground, enlarged to show detail.

TORKRITE



A few of many
ADVANTAGES:

TORKRITE'S re-cycling ability is unmatched.

After a maximum diameter core has been re-cycled in a given form a reasonable number of times, a minimum diameter core can be inserted and measured at 1" oz. approximately.

TORKRITE has no hole nor perforations through the tube wall. This eliminates possibility of cement leakage locking the cores.

TORKRITE allows use of lower torque as it is completely independent of stripping pressure.

With TORKRITE torque does not increase after winding, as the heavier wall will not tend to collapse and bind the core.

Available in lengths $\frac{3}{4}$ " to $3\frac{1}{8}$ " to fit a $\frac{1}{4}$ -28 core.



See our Exhibit #2-309 at the Radio Engineering Show in New York City, March 23-26.



ELECTRONICS — March, 1953

CLEVELITE* EE INTERNALLY THREADED AND EMBOSSED TUBING.

TORQUE AND STRIPPING PROBLEMS ARE NOW ELIMINATED!

Electronic engineers find that TORKRITE, this newly designed and constructed Coil Form, has definite advantages over all other types requiring the use of threaded cores.

TORKRITE is one of the many items of CLEVELITE . . . a complete line of tubing for coil forms, collars, bushings, spacers, tubes and other items.

CLEVELITE has long been giving continuous satisfaction because of its dependable performance, uniformity and close tolerances.

Consult our Research and Engineering Laboratory. It is at your service.

WHY PAY MORE? FOR THE BEST . . . CALL CLEVELAND!

* Reg. U. S. Pat. Off.

The CLEVELAND CONTAINER Co.

6201 BARBERTON AVE. CLEVELAND 2, OHIO

PLANTS AND SALES OFFICES at Plymouth, Wisc., Chicago, Detroit, Ogdensburg, N.Y., Jamesburg, N.J.
ABRASIVE DIVISION at Cleveland, Ohio
CANADIAN PLANT: The Cleveland Container, Canada, Ltd., Prescott, Ontario

REPRESENTATIVES

NEW YORK AREA R. T. MURRAY, 604 CENTRAL AVE., EAST ORANGE, N. J.
NEW ENGLAND R. S. PETTIGREW & CO., 62 LA SALLE RD., WEST HARTFORD, CONN.
CHICAGO AREA PLASTIC TUBING SALES, 5215 N. RAVENSWOOD AVE., CHICAGO



Want more information? Use post card on last page.

channels in the vicinity of 120 megacycles. Both the transmitters and associated receivers may be operated remotely from New York.

Similar relay extensions have been installed at Seattle and Chicago, and it is probable that as air traffic at other busy terminals increases more will be added to the list. With the Philadelphia station, it is now possible for a plane to pass from Washington control to New York control without losing vhf contact.

TV Tubes for Rent

Klystrons for uhf tv transmission will be leased to stations on an hours-of-use basis

Now in production, General Electric's high power klystrons for uhf tv transmission will not, at least initially, be for sale. Instead, they will be leased to station operators, who will pay per hour of usage.

The fee provides the operator with three tubes, two in operation and a spare. When a tube gets old and weary it is replaced by a new one at no cost to the station.

Equipment manufacturers will pay GE for the right to build station equipment using the new klystrons.

First of the GE klystrons is a tube having a maximum output power rating of 15 kw.

Electronic 'Watcher' Heightens Train Safety

Installed on Erie track, pickup coil identifies train, flashes signal to dispatcher's office

WEATHERPROOF COILS between Erie RR's tracks at Waterboro, N. Y., are activated by approaching trains; coils carried under the trains cause a dip in the wayside oscillator output, the dip being at the frequency

a particular train's coil is tuned to.

The dip causes a coded signal to be sent by carrier transmission, superimposed on existing lines, to the Salamanca dispatcher's office, 22 miles away, where a buzzer signals the operator. A light identifying the train flashes on, and the train's passage and time is recorded automatically.

► **Improved System**—A similar system has also been installed permitting the dispatcher at Salamanca to set the block signals at Waterboro, and indications of the signal position are flashed back to the office. The entire arrangement is built along 'fail-safe' principles.

The electronic gear is housed in an unattended concrete shed at the track's side, and included is an automatic emergency battery power supply.

► **Anti-collision**—The track equipped with the new control system carries no passenger trains; freight traffic only is continuously and automatically monitored.

Erie looks ahead to the days when crashes are no more, when electronic devices signal trains, stop trains, even announce train arrival on the station's PA system.

Where Navy Needs Electronics Engineers

TESTIFYING to the increasingly important role of electronics in modern warfare, and to the critical shortage of engineering talent, the Office of Naval Research has announced vacancies for electronics engineers, scientists and physicists specializing in electronics at 39 Navy technical activities.

The jobs range in pay from \$3,410 to \$9,600. A minimum of four years of college or equivalent experience is required for the lowest paying jobs while, on the other end of the scale, an additional four years of progressive professional experience is required.

► **Work**—Tasks are highly diversified. Engineers are required for design, development, installation and maintenance. The projects

range from acoustic measurements to microwave research, embracing such fields as torpedoes, guided missiles, radar, ship and aircraft armament and many others.

The table below lists activities where jobs exist. Applicants should send a completed form 57, "Application for Federal Employment," to the commanding officer of the activity in which they are interested.

ACTIVITY

Portsmouth Naval Shipyard
Portsmouth, New Hampshire

U. S. Navy Underwater Sound Lab., Fort
Trumbull, New London, Connecticut

U. S. Naval Underwater Ordnance Station,
Newport, Rhode Island

U. S. Navy Central Torpedo Office
Newport, Rhode Island

New York Naval Shipyard
Brooklyn 1, New York

Special Devices Center
Sands Point, Port Washington: Long
Island, New York

U. S. Naval Air Station
Lakehurst, New Jersey

Philadelphia Naval Shipyard, Naval Base,
Philadelphia 12, Pennsylvania

U. S. Naval Air Development Center,
Johnsville, Pennsylvania

Naval Air Material Center,
Philadelphia 12, Pennsylvania

David Taylor Model Basin,
Washington 7, D. C.

Norfolk Naval Shipyard,
Portsmouth, Virginia

U. S. Naval Air Test Center,
Patuxent River, Maryland

U. S. Naval Aviation Ordnance Test Sta-
tion, Chincoteague, Virginia

U. S. Naval Gun Factory,
Washington 25, D. C.

U. S. Naval Mine Depot
Yorktown, Virginia

U. S. Naval Ordnance Experimental Unit
c/o The National Bureau of Standards
Washington 25, D. C.

U. S. Naval Ordnance Laboratory,
White Oak, Silver Spring, Maryland

U. S. Naval Proving Ground
Dahlgren, Virginia

Naval Research Laboratory
Washington 25, D. C.

Bureau of Aeronautics
Washington 25, D. C.

Bureau of Ships
Washington 25, D. C.

Department Civilian Personnel Div. Room
0015A, Navy Department, Washington
25, D. C.

Office of Naval Research, Room 1070 T-3
Building, Washington 25, D. C.

Charleston Naval Shipyard, Naval Base
Charleston, South Carolina

U. S. Navy Underwater Sound Reference
Laboratory, P. O. Box 3629, Orlando,
Florida

U. S. Naval Ordnance Plant,
Indianapolis, Indiana

U. S. Naval Ordnance Plant,
Forest Park, Illinois

Industrial Manager, USN, 8ND: Super-
visor of Shipbuilding, USN, and Naval
Inspector of Ordnance, New Orleans,
Louisiana, Building 263, U. S. Naval
Station

U. S. Naval Ammunition Depot,
Bangor, Washington

U. S. Naval Torpedo Station
Keyport, Washington

Mare Island Naval Shipyard,
Vallejo, California

(Continued on page 26)

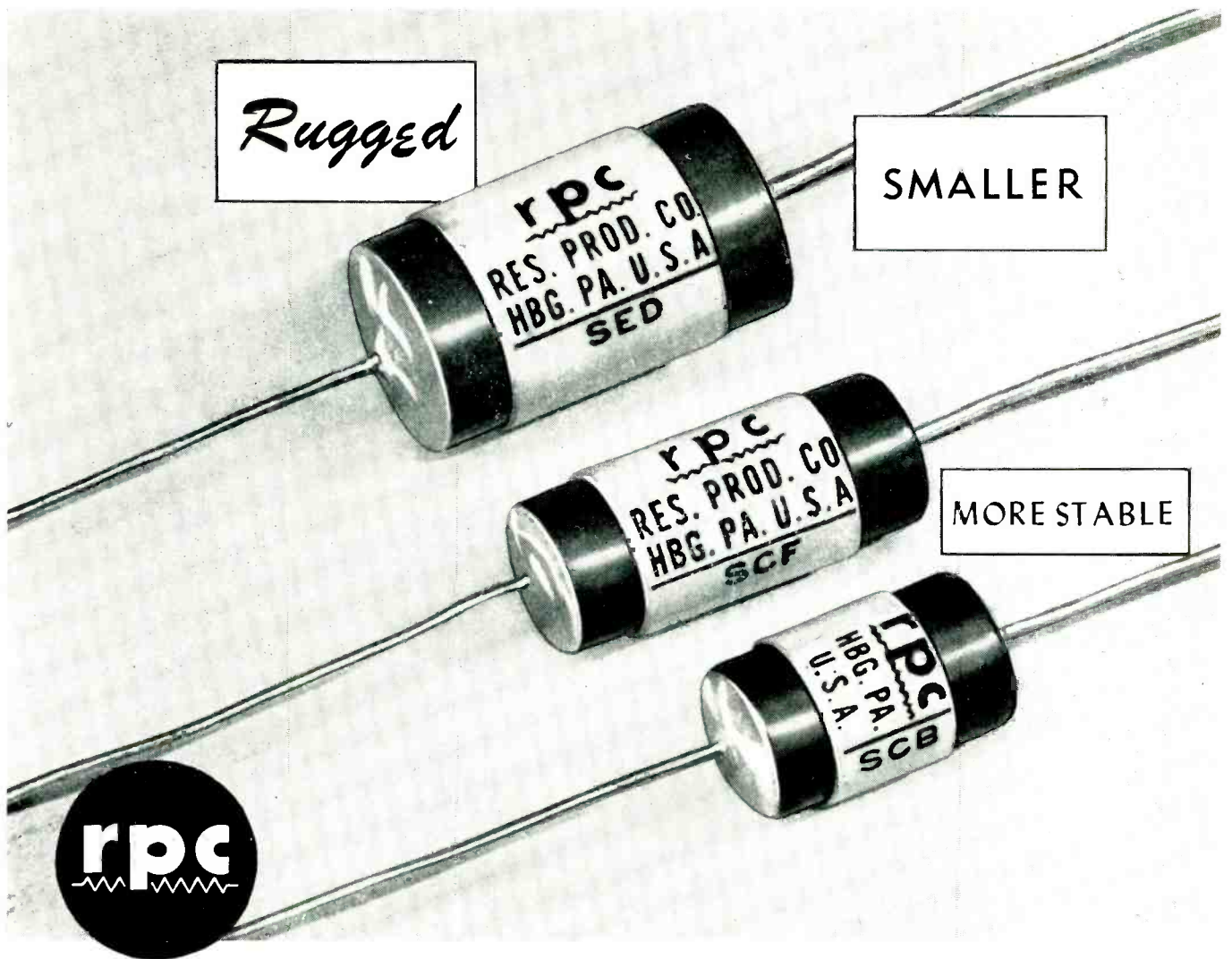

HERMETICALLY SEALED PRECISION WIRE WOUND RESISTORS

When the utmost in permanence and stability are required, these resistors have proven successful. Exposure to extremes in temperature cycling, aircraft altitudes and salt water immersion leave these rugged resistors unaffected.

Resistance Products Company has been able to achieve quality performance in mass production. RPC has the "know-how"—the special equipment and high degree of constant supervision that are needed.

RPC Type S Hermetically Sealed Resistors are wound on highest grade steatite forms. Winding forms are solder sealed into steatite jackets. Each resistor is vacuum tested to insure hermetic seal. Long leakage path between terminals provides top performance under most adverse climatic conditions.

Axial wire leads permit wiring directly into circuits—and the smaller size and lighter weight make these resistors self supporting. Specially tested low temperature coefficient alloys are used. Standard resistance tolerance 1%. Tolerance of 1/2% and 1/4% available.

Write for complete information and engineering data.

Type	Dimensions		Jan-R-93	Power Rating		Resistance	
	Len.	Diam.		Jan.	Comm.	Min. ohm ^α	Max. meg ^α
SCB	9/16	11/32	—	—	1/4 watts	2.0	0.15
SCF	13/16	11/32	RB51A	1/4	1/2 watts	1.0	0.40
SED	13/16	15/32	RB51A	1/4	1/2 watts	0.5	1.0

RESISTANCE PRODUCTS CO.

714 RACE ST.

HARRISBURG, PENNSYLVANIA

PRECISION WIRE WOUND

HIGH VOLTAGE

HIGH MEGOHM

HIGH FREQUENCY

Specializing in
manufacture of
quality resistors
in ANY amount

Office of Naval Research Branch
Office, 1030 E. Green Street,
Pasadena 1, California

Pearl Harbor Naval Shipyard, Navy No.
128, Fleet Post Office, San Francisco,
California

U. S. Naval Air Missile Test Center
U. S. Naval Air Station, Point Mugu,
California

U. S. Naval Air Station
Alameda, California

U. S. Naval Magazine
Port Chicago, California

U. S. Naval Ordnance Test Station
Inyokern, China Lake, California

U. S. Navy Electronics Laboratory
San Diego 52, California

Military Radio-Radar Shipments Abroad Rise

INCREASING importance of radio and radar equipment in the defense plans of foreign nations is indicated by the larger shipments of these items under the U. S. foreign military aid program. Previously a relatively slow-moving item in the program, radio and radar equipment shipments increased sharply during 1952 and reached a record rate last October when 4,347 items were sent out, representing almost 15 percent of all such items that have been shipped during the four years of the program.

The cumulative total of radio and radar items that have been shipped under the plan stood at 27,648 in October. For security reasons the U. S. does not give the dollar value of such shipments or their destination and reports the quantities by number of items only.

Business Briefs

► **Evidence** of the beneficial effects of tv on sports attendance: An estimated new high of \$1.7 billion will probably be taken in by the sports industry in 1952, according to the RTMA Sports Committee.

► **Beer** level checker that inspects 900 containers per minute with an accuracy of 30 drops of beer, or plus or minus 1/64 inch, is a tiny crystal of cadmium sulfide acting on signals from an 80,000 volt GE x-ray tube.

► **Seven** tv experimental relay stations linking Tokyo with Osaka, a distance of about 300 miles, are

reported to be in operation. NHK Tokyo Television (JOAK-TV) using Japanese-made equipment is making test broadcasts, according to reports.

► **"Photon"**, an electronic device that sets up type on a photographic film by means of a light that flickers at rate of a million times a second, is now in operation at the Graphic Research Foundation in Cambridge, Mass. (ELECTRONICS, Dec. 1949, p 158). The resulting film can be used directly or indirectly for engraving plates for printing.

► **Republic of Colombia** plans to organize all communications services under a semiofficial administra-

tion. The government also plans to set up omnidirectional radio installations.

► **Norwegian** government recommends that experimental tv transmission be started by the Norwegian State Broadcasting Co. and continued for two years. After that the question of regular tv services will again be submitted to Parliament.

► **Radio** and television interference in the Miami area has been reduced by a truck-mounted washing unit of the Florida Power & Light Co. that removes salt deposits and industrial sediment from transmission line insulators.

MEETINGS

MARCH 9-12: NEMA, Edgewater Beach Hotel, Chicago, Ill.

MARCH 19: AIEE, Lecture on "High Energy Accelerators", Engineering Societies Bldg., New York, N. Y.

MARCH 19-20: National Collegiate Industry-Government Conference on Instrumentation, Michigan State College, East Lansing, Mich.

MARCH 23-25: Sixth Annual Conference for Protective Relay Engineers, A & M College of Texas, College Station, Texas.

MARCH 23-26: IRE National Convention, Waldorf-Astoria Hotel and Grand Central Palace, New York, N. Y.

APRIL 18: Seventh Annual Spring Technical Conference, Cincinnati IRE, Cincinnati, Ohio.

APRIL 23-24: International Symposium on Non-Linear Circuit Analysis sponsored by Brooklyn Polytechnic Institute, IRE, Office of Naval Research, Air Research and Signal Corps, Engineering Societies Bldg. Auditorium, New York, N. Y.

APRIL 23, 30, MAY 7, 14: Lecture Series on the general theory of semiconductors by H. K. Henisch of the University of Reading, England, Brooklyn Polytechnic Institute, Brooklyn, N. Y.

APRIL 27-30: Spring Meeting of USA National Committee of URSI-IRE professional Group on Antennas and Propagation, National Bureau of Standards, Washington, D. C.

APRIL 27-MAY 8: British Industries Fair, Birmingham & London, England.

APRIL 28-MAY 1: Seventh Annual NARTB Broadcast Engineering Conference, Burdette Hall, Philharmonic Auditorium, Los Angeles.

APRIL 29-MAY 1: 1953 IRE-AIEE Electronic Components Symposium, Shakespeare Club, Pasadena, Calif.

MAY 11-13: IRE National Conference on Airborne Electronics, Dayton, Ohio.

MAY 18-21: 1953 Electronic Parts Show, Conrad Hilton Hotel, Chicago, Ill.

MAY 18-23: Third International Congress On Electroheat, Paris, France.

MAY 24-29: NAED, 45th Annual Convention, Conrad Hilton Hotel, Chicago, Ill.

MAY 24-28: Scientific Apparatus Makers Association Annual Meeting. The Greenbrier, White Sulphur Springs, W. Va.

JUNE 15-19: Exposition of Basic Materials for Industry, Grand Central Palace, New York, N. Y.

JUNE 16-24: International Electro-acoustics Congress, The Netherlands.

JUNE 20-OCT. 11: German Communication and Transport Exhibition, Munich, Germany.

AUG. 19-21: IRE Western Electronic Show & Convention, Municipal Auditorium, San Francisco, Calif.

AUG. 29-SEPT. 6: West German Radio and Television Exhibition, Duesseldorf, Germany.

SEPT. 1-3: International Sight and Sound Exposition, Palmer House, Chicago, Ill.

SEPT. 21-25: Eighth National Instrument Exhibit, Sherman Hotel, Chicago, Ill.

Introducing the

BALLANTINE SENSITIVE INVERTER

...for the precise measurement of small DC potentials

- Built-in Calibrator
- High Sensitivity
- High Input Resistance
- Polarity Sensing



See the display of
BALLANTINE VOLTMETERS
and ACCESSORIES
Booth No. 1-112 at I. R. E. Show



MODEL 300

MODEL 700

The Ballantine Model 700 Sensitive Inverter adapts FOR THE ACCURATE MEASUREMENT OF SMALL DC POTENTIALS any AC voltage measuring device which is sensitive to 60 cycle voltages in the range 100 microvolts to 10 volts and which has an input impedance of 50,000 ohms or more. It may be used also as an ultra-sensitive transducer in servo-mechanisms and in telemetering systems.

The built-in calibrator eliminates the major errors of the AC voltmeter used with the inverter.

When used ahead of multimeters or diode voltmeters, levels as low as 1 millivolt DC can be measured with not less than 10 megohms loading.

For maximum DC sensitivity and stability the BALLANTINE SENSITIVE ELECTRONIC VOLTMETERS, Models 300 (as illustrated), 302B, 310A, and 314, are recommended for use with the inverter, in which case DC levels as low as 10 microvolts may be measured.

MODEL 700 INVERTER SPECIFICATIONS

INPUT VOLTAGE RANGE.....	10 μ v—100v (Sensitive to 1 μ v)
VOLTAGE RATIOS (DC INPUT TO AC RMS OUTPUT).....	1:100 and 10:1
ACCURACY OF VOLTAGE RATIOS (> 100 μ v INPUT).....	1%
ACCURACY OF CALIBRATOR.....	0.25%
INPUT RESISTANCE DC SOURCE.....	10 meg min for 1:100; 50 meg for 10:1
INPUT IMPEDANCE AC SOURCE.....	More than 200K all frequencies
INPUT NOISE LEVEL.....	Approx 3 μ v
MAX AC OUTPUT LEVEL.....	10 volt RMS
MAX DISTORTION IN OUTPUT.....	2%
RESPONSE TIME.....	0.25 second
POWER.....	105-125 volt; 50-70 cps; 15 watt

Write for complete information for this and other
Ballantine Electronic Measuring Instruments.

ADDITIONAL FEATURES:

- Distortion-free output
- Low noise level
- Accurate for 50 to 70 cps line frequency range
- Insensitive to 60 cycle magnetic fields

BALLANTINE LABORATORIES, INC.

100 FANNY ROAD, BOONTON, NEW JERSEY

Before you specify that *CHECK THE WIDE RANGE OF*

Sodereze
A quick soldering wire
(insulation removal unnecessary)

Nyform
Formvar with a
Nylon Sheath

**Square & Rectangular 3/4-Lap
Paper-Covered Wire for
Oil-Filled Transformers**
Higher abrasion,
better dielectric

PHELPS DODGE offers the most diversified line of standardized magnet wire in the industry—over 400 different types with thousands of practical applications. Time after time, electrical manufacturers have solved “special” magnet wire problems, with great savings in time, effort and expense, merely by consulting Phelps Dodge. This approach has

First for Lasting Quality

**PHELPS DODGE *COPPER* PRODUCTS
CORPORATION**

“Special” Magnet Wire . . .

PHELPS DODGE “STANDARDS”



**Improved Silicone
Glass Wire**

Better abrasion
in Class H wire

Triple & Quadruple Formvar

Greater spacing,
better safety factor

worked for many different products, including television and radio coils, motors, aircraft generators, relay coils, distribution transformers, hearing aids and many others.

★ ★ ★

Any time magnet wire is your problem, consult Phelps Dodge for the quickest, easiest answer!

**Low-Build Formvar
Glass Wire**

Improved space factor
for aircraft generators
and starters

—from Mine to Market!



INCA MANUFACTURING DIVISION

FORT WAYNE, INDIANA

MEPCO'S NEW SEALED Precision



Qualification tests prove new resistors immune to immersion and high humidity

Over 2 years of laboratory development and testing were required to achieve a sealed resistor design up to Mepco's standard of quality. No sacrifice of our standard time-proven features have been made in order to perfect this sealed resistor.

SPECIFICATIONS: Meets *all* requirements of MIL-R-93A and JAN-R-93.

SEALING: Completely encapsulated and bonded.

OPERATING TEMPERATURE: -65°C. to $+125^{\circ}\text{C.}$

WINDINGS: Reversed and balanced PI-windings for low inductance, with use of only the finest "certified" resistance alloys.

EXCLUSIVE INTERNAL FEATURES. Internal section's cross-over wire insulated from winding by 2000 v. insulation (patented). Special metal molded connecting feature, which bonds end of winding and terminal in a non-corrosive and mechanically secure manner — no solder or flux used.

TERMINALS: Rigid hot solder coated brass terminals for easier and more secure soldering.

MEPCO, INC.

Resistors STOP Humidity Failures

TYPE	NOMINAL WATTAGE RATING	RESISTANCE		NO. SECTIONS	SUPERSEDES JAN-R-93 TYPE
		MIN.	MAX.		
RB15 (M15)	.25 .50	0.1 ohm 0.1 ohm	.185 meg. .6 meg.	2	RB10
RB16 (M16)	.35 1.00	0.1 ohm 0.1 ohm	.3 meg. 1.5 meg.	2	RB11
RB17 (M17)	.50 1.00	0.1 ohm 0.1 ohm	.3 meg. 2.0 meg.	4	RB12
RB18 (M18)	.50 1.00	0.1 ohm 0.1 ohm	.75 meg. 4.0 meg.	4	RB13
RB19 (M19)	1.00 2.00	0.1 ohm 0.1 ohm	4.0 meg. 15.0 meg.	8	RB14
RB52 (M52)	.25 .50	0.1 ohm 0.1 ohm	.1 meg. .5 meg.	2	RB51

MIL - R - 93A
WATTAGE & RESISTANCE TOLERANCE

TOLERANCE SYMBOL	RESISTANCE TOLERANCE	PERCENT OF NOMINAL WATTAGE
B	0.10 %	50 %
C	0.25 %	50 %
D	0.50 %	75 %
F	1.00 %	100 %

MIL - R - 93A
TEMPERATURE COEFFICIENT
(REFERRED TO 25°C)

SYMBOL	EXPRESSED IN PERCENT PER DEGREE C.	
	NEGATIVE, MAX.	POSITIVE, MAX.
E	0.0022	0.0022
J	0.0040	0.0155
K	0.0050	0.0255

SPECIAL REQUIREMENTS

Variations of the above ratings, tolerances, temperature coefficient, etc., can be supplied to special order.

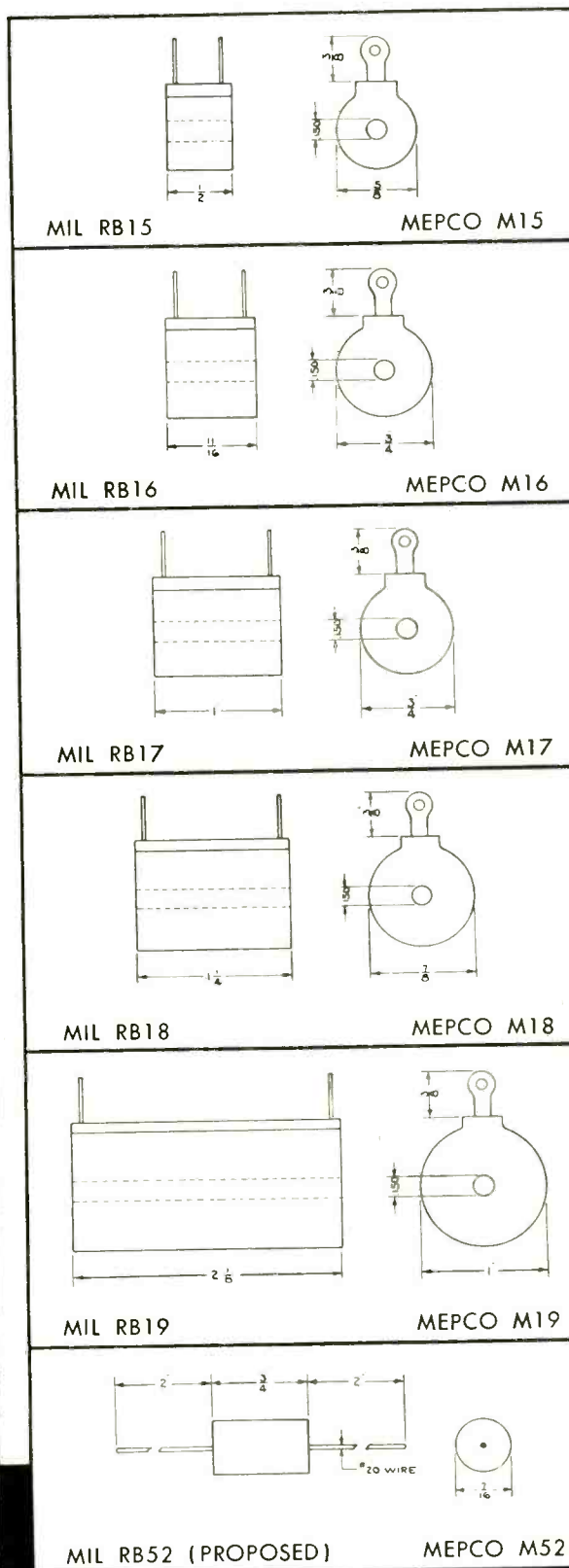

MORRISTOWN, NEW JERSEY

FOR
USERS
OF

RADOMES MICRO-WAVE WINDOWS REFLECTORS AND LENSES

Increased facilities for design, development, manufacture, and testing of radomes, micro-wave windows, reflectors and lenses for TV and micro-wave relays, and for associated products are now available at United States Plywood Corporation's laboratories and plant at Palmer, Massachusetts. First molder of such structures, United States Plywood Corporation is today one of the largest manufacturers of these products.

PRODUCT RANGE

United States Plywood produces radomes for all commonly used frequencies, and has done development work on structures for frequencies up to 35,000 mc. Range of sizes goes from cylindrical radomes 1 inch in diameter to units 26 feet in diameter. Over 150 types of radomes have been produced in our plant.

Structures are custom molded or laminated for land, sea, and air use, in both flat laminates and compound curved surfaces.

Micro-wave windows and a variety of special structures for reflectors and lenses are also produced in quantity.

SCOPE OF SERVICES

United States Plywood is equipped to assist in both electrical and mechanical design of structures, development of production designs, and manufacture of either prototype or production models.

A staff of thoroughly trained specialists is available for consultation on your problems.

We are prepared to assume your problem from the beginning, or to act merely as manufacturers working from your designs, if that is your requirement. Our large manufacturing facilities provide for economical quantity production.

EXPERIENCE

As the first molder in this field, we have worked with various branches of the government, and with many major manufacturers in the electronics and aviation fields.

United States Plywood entered this field because of its extensive work in low-pressure laminating, and broad knowledge of both materials and production techniques.

INQUIRIES

Inquiries as to our facilities, or on specific projects, should be directed to Electrical Structures Department, United States Plywood Corporation, Section P-3, 55 West 44th Street, New York, N. Y. Your personal call is invited if you are in New York.

**GOING
TO THE
I. R. E.
SHOW?**

Sorry we were unable to get exhibit space this year — but you're welcome at our showroom and offices—55 W. 44th St., New York.

ELECTRICAL STRUCTURES DEPARTMENT
UNITED STATES PLYWOOD CORPORATION

WELDWOOD BUILDING, 55 WEST 44TH STREET, NEW YORK, N. Y.

KIRCHOFF

... **FIRST** to formulate laws on the division of current in a network of conductors

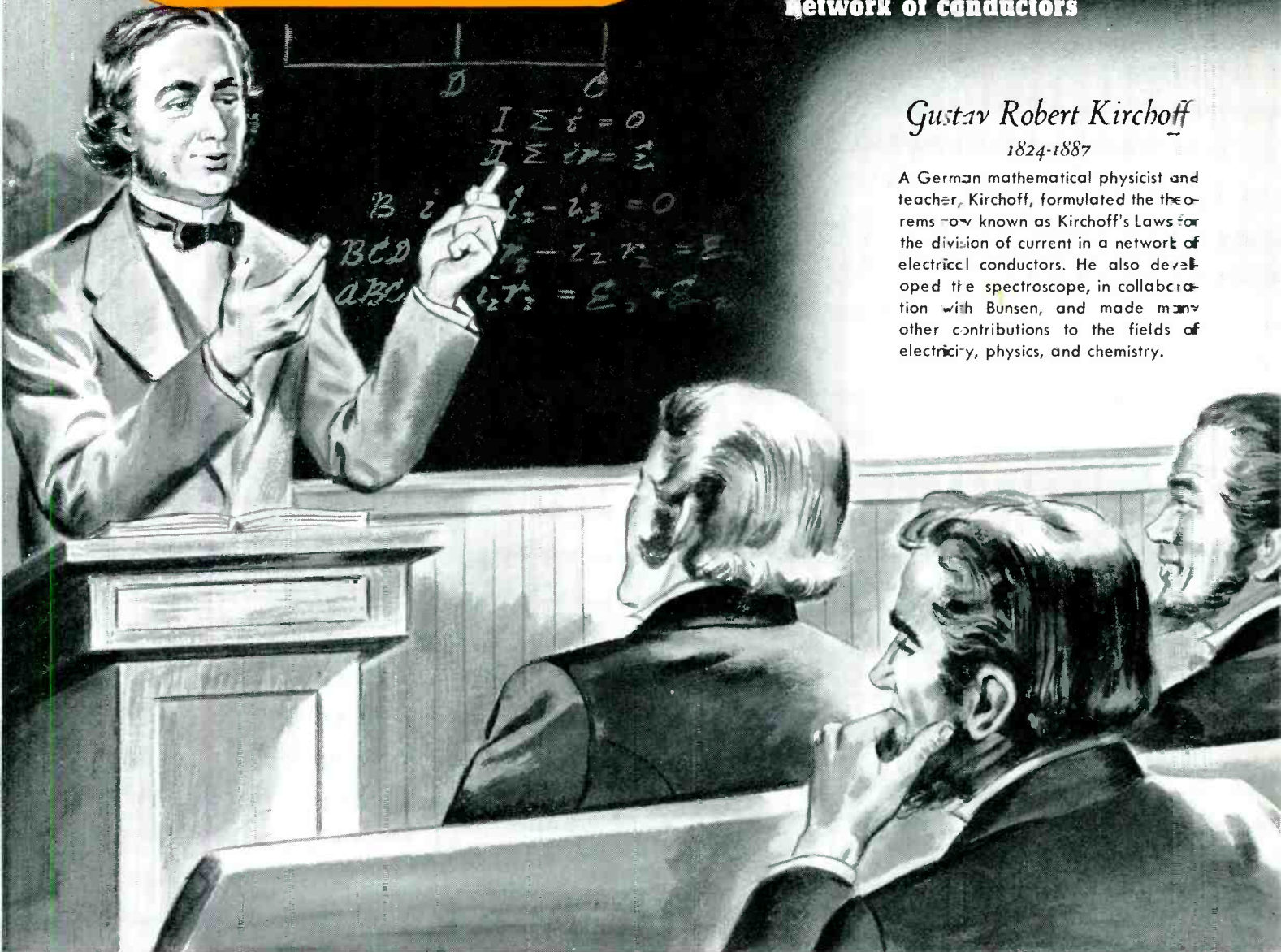

Gustav Robert Kirchoff
1824-1887

A German mathematical physicist and teacher, Kirchoff, formulated the theorems now known as Kirchoff's Laws for the division of current in a network of electrical conductors. He also developed the spectroscope, in collaboration with Bunsen, and made many other contributions to the fields of electricity, physics, and chemistry.

From an original drawing made for OHMITE.

OHMITE[®]

... **FIRST** in Rheostats

Dependability . . . long, trouble-free life . . . and smoothness of operation . . . these are qualities you can count on in OHMITE rheostats. That's why they're preferred by industry over all other makes. For top performance, make it a point to specify OHMITE rheostats.

... Today



Be Right with **OHMITE**

RHEOSTATS • RESISTORS • TAP SWITCHES



FEEL THE DIFFERENCE!

OHMITE[®] Rheostats
have UNMATCHED
Smoothness of Operation

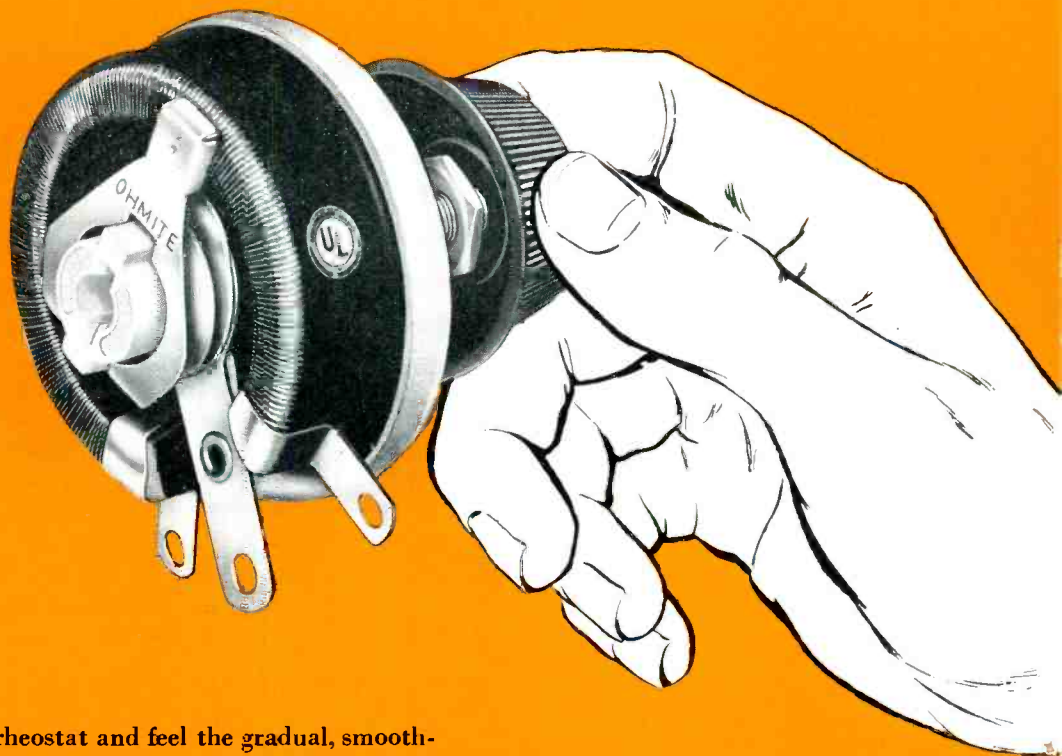

Turn the knob of an OHMITE rheostat and feel the gradual, smooth-gliding action! You get the close, uniform control usually found in fine, laboratory rheostats. Special OHMITE design features are the reason... pivoted universal-joint action of the contact brush for flush-floating contact; a metal-graphite brush for perfect contact and negligible wear on the wire; and a patented, tempered-steel contact arm for uniform contact pressure. No wonder these all-ceramic and metal rheostats are "tops" in electrical control.

OHMITE MANUFACTURING CO.
4817 Flournoy Street, Chicago 44, Illinois

Write on company letterhead for Catalog and Engineering Manual No. 40.



Be Right with **OHMITE[®]** **RHEOSTATS
RESISTORS
TAP SWITCHES**

LEADERS in PRODUCTION of GERMANIUM PRODUCTS...



GENERAL PURPOSE DIODES

DC RESTORER DIODES

COMPUTER DIODES

VIDEO DETECTOR DIODES

DISCRIMINATOR DIODES

POINT CONTACT TRANSISTORS

UHF MULTIPLIER DIODES

UHF MIXER DIODES



and now
JUNCTION TRANSISTORS

VISIT THE RAYTHEON BOOTH AT THE IRE SHOW

RAYTHEON MANUFACTURING COMPANY

Receiving Tube Division — for application information call



Excelsior in Electronics

Newton, Mass. Bigelow 4-7500 • Chicago, Ill. National 2-2770 • New York, N. Y. Whitehall 3-4980 • Los Angeles, Calif. Richmond 7-5324

RAYTHEON MAKES ALL THESE:

RELIABLE SUBMINIATURE AND MINIATURE TUBES • GERMANIUM DIODES AND TRANSISTORS • NUCLEONIC TUBES • MICROWAVE TUBES • RECEIVING AND PICTURE TUBES



Miniature Components by

MINIATURE EARPHONE

The Fortiphone Earphone is a tiny rugged electro-magnetic instrument of high efficiency and extreme reliability.

The air gap setting is controlled to 0.00025 inches and the output of each unit is measured throughout the frequency band in order to maintain consistent performance and good response. Each instrument is subjected to a prolonged test at overload conditions and is then re-checked.

The unit takes a standard earmold, the nipple being carefully designed to ensure no acoustic leakage. A standard miniature round pin plug fits firmly into the earpiece with a positive detent action. The contact springs are of unique double spring design to ensure good contact, to avoid fatigue, and to minimise plug wear.

Alternative types of frequency response are available.

Type	Impedance at 1000 cps	Normal op. conditions	Overload conditions
MME/G (A)	120 ohms	.27 volts	1.4 volts
MME/G (B)	50 "	.2 "	1.0 "
MME/G (C)	30 "	.17 "	.85 "
MME/G (D)	600 "	.67 "	3.3 "
MME/G (E)	1000 "	.9 "	4.5 "
MME/G (F)	1000 "	.9 "	6.7 "



Overall dimensions:
 Diameter: 0.82 in. or 2.08 cm.
 Width (excl. nipple): 0.38 in. or 0.97 cm.
 Width (incl. nipple): 0.47 in. or 1.20 cm.
 Weight: 0.3 oz. or 8.5 grams.

MME/G (B). Constant input of 0.2 volts. Sound pressure measured in artificial ear of 1.5 cubic centimetres and 240 ohms acoustic resistance.

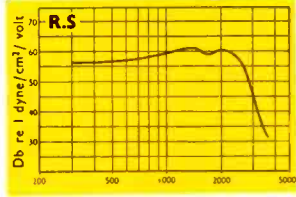
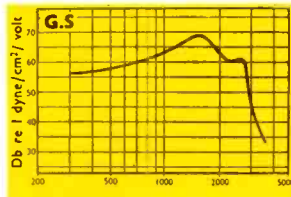
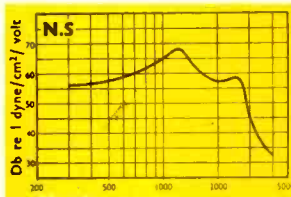

Frequency in cycles per second.



SUB-MINIATURE TRANSFORMER

The Fortiphone Transformer T.4 is a miniature output transformer of outstanding performance and wide frequency range. The windings are terminated at solder tags molded into the robust phenolic bobbin, thus economising in winding space and increasing efficiency.

Before being laminated each winding is checked to ensure no short-circuited turns. Each transformer is individually tested for efficiency throughout the frequency range. A large number of ratios is available.

Overall dimensions: 0.660 x 0.484 x 0.460 in.
 or 1.675 x 1.228 x 1.170 cm.
 Weight: 0.204 oz. or 5.78 grams.

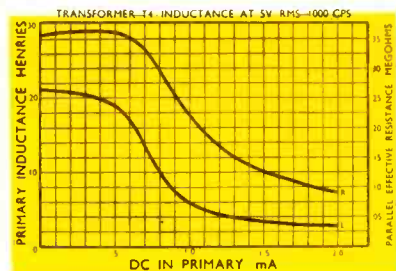
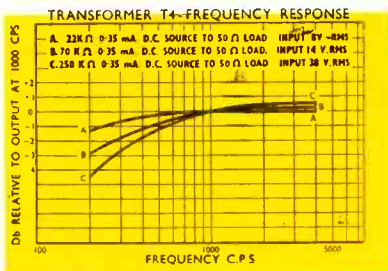

Very Speedy Delivery!

Fortiphone Ltd, England



MINIATURE VOLUME CONTROL WITH SWITCH

Rigid inspection technique and craftsmanship of manufacture combine to make the Fortiphone Fingertip Controls, Type VC.7, extremely reliable and uniform in performance.

An internal single pole switch of less than 0.05 ohms contact resistance is incorporated. The insulation of this switch is greater than 100 megohms at 100 volts.

The action of the control is smooth and pleasant and the switch has a loud "click" operation. The control is able to withstand savage handling, the end stop torque being greater than 30 ounce inches. Noise level is below 270 microvolts when 1 volt is applied, and the control rotated at 2 turns per second.

The resistance rotation law is logarithmic. Power dissipation is 0.1 watt, when uniformly loaded. The instrument is able to withstand more than 20,000 operations without deterioration.

Overall dimensions: 0.780 in. or 1.99 cm. diameter
x 0.537 in. or 1.365 cm.
Knob width: 0.190 in. or 0.482 cm.
Weight: 0.126 oz. or 3.575 grams.

TWIN VOLUME CONTROL & SWITCH

A tiny attractive matched pair of fingertip instruments are available.

The volume control, Type VC.1, is similar in performance to the Type VC.7, except that no internal switch is incorporated.

The switch, Type SW.1, has four positions and a pleasant and positive "click" action.

The contacts are individually sprung and their contact resistance is low. The centre spindle is isolated, making the unit suitable for high-frequency operation.

Also available are Disc Earpieces; Flexible Connectors; Earmolds; Headbands; Hearing Aid Amplifier Units; Microphones; Miniature Electronic Units for special equipment; Plugs; Resistors; Sockets; Stethosets; Telephone Pick-up Coils.



Overall dimensions:
0.805 in. or 2.04 cm. diameter
x 0.525 in. or 1.335 cm.
Knob width: 0.240 in. or 0.610 cm.

Cable or write for prices, further details, and samples
Please state probable quantities required

FORTIPHONE LIMITED

FORTIPHONE HOUSE
247 REGENT STREET, W1
LONDON, ENGLAND

Established 1925

Cables: Sonomax, Wesdo, London

Highly Competitive Prices!



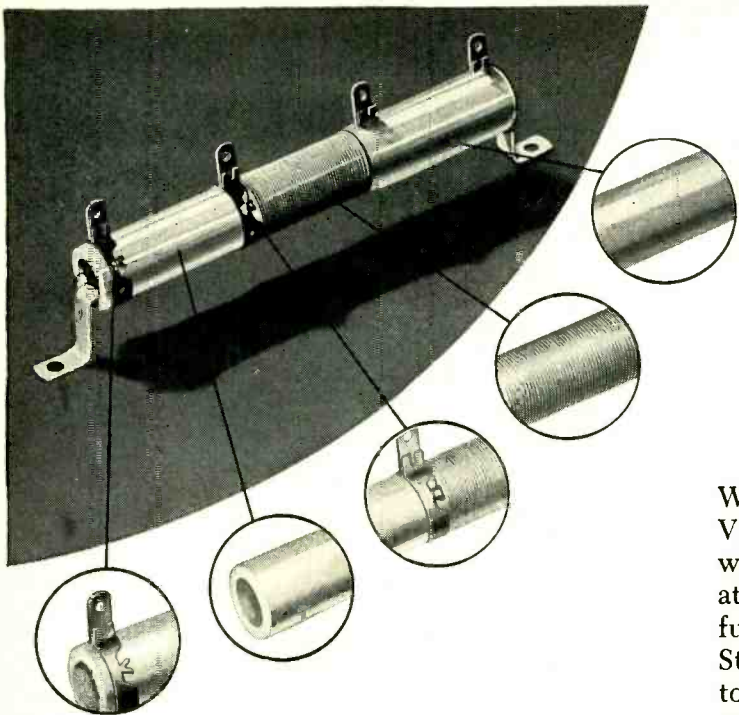

VITROHM

are your

Ward Leonard manufactures its own ceramic cores, Vitrohm enamel and terminals. Even the resistance wire is drawn to our own specifications. Every operation required to build a Vitrohm resistor is carefully and constantly checked and controlled by our Standards Department. That's why Vitrohm resistors assure you complete uniformity, accuracy and reliability, even under the most adverse service conditions.

Ward Leonard has the largest selection of stock

7 stock resistors

Vitrohm stock resistors range from 5 to 200 watts with resistance values from 1 to 250,000 ohms. Made-to-order Vitrohm's are available from 5 to 550 watts with values from 0.04 to 1,750,000 ohms.



FIXED VITROHM
Used for voltage dropping and current limiting.

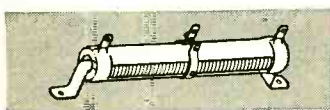

ADJUSTOHM
Gives circuit adjustability for voltage dividing or regulating purposes.



STRIPOHM
For compact aviation, communication and navigation equipment.

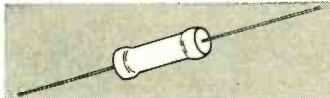

AXIOHM
Used in electronic equipment requiring miniature power resistors.



NON-INDUCTIVE
For low inductance and distributed capacitance in high frequency circuits.

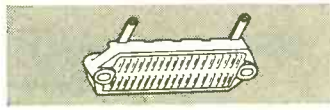

PLAQOHM
Used in compact, high frequency electronic equipment.

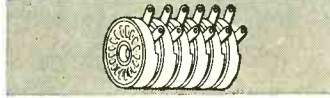

DISCOHM
A miniature resistor for low inductance values and distributed capacitance.

WARD LEONARD

ELECTRIC COMPANY

MOUNT VERNON, NEW YORK

Result-Engineered Controls Since 1892

RESISTORS

best buy

resistor types and sizes ever offered by any manufacturer. Also available to meet customer's exact specification is a complete stock of components ready for immediate assembly into made-to-order resistors. Our controlled component manufacture and inspection, plus a wider selection of types, make Ward Leonard your best buy in resistors.

For full information on Vitrohm resistors, write for Catalog No. 15 to Ward Leonard Electric Co., 31 South Street, Mount Vernon, N. Y.



made-to-order resistors

(these plus all the stock resistor types)

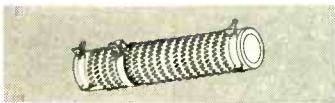

RIBFLEX

Used in circuits where high wattage must be dissipated in small space.

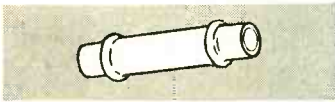

FERRULE TERMINAL

For rapid interchangeability of resistance values or resistor replacement.

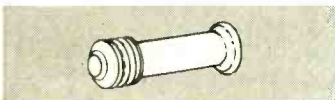

SCREW BASE

With an Edison screw base for mounting to provide rapid means of changing resistance.

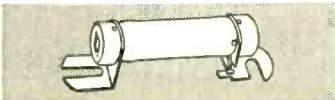

BRACKET TERMINAL

Has leads silver brazed to brackets for easy interchange or renewal of unit.

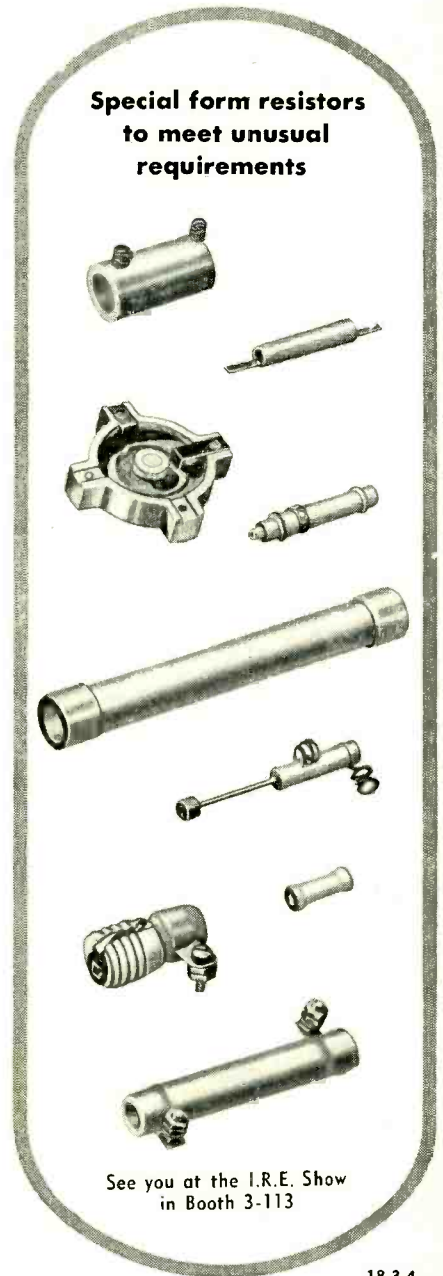

Special form resistors to meet unusual requirements

See you at the I.R.E. Show in Booth 3-113

18.3.4



RHEOSTATS



RELAYS



MOTOR CONTROLS



CHROMASTER



Ward Leonard's complete engineering textbook, "Handbook of Power Resistors," \$3. per copy.

G-E TUBES AT THE

Everything for u-h-f TV!

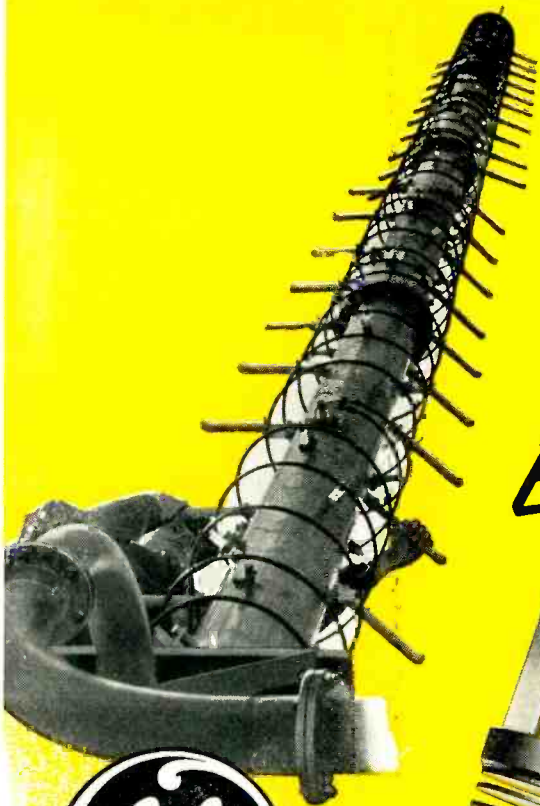

New

GL-6283—250-w G-E driver tube for u-h-f transmitters. Air cooled, compact, up-to-the-minute in design. Can be installed in seconds!

Tops in Power!

GL-6237 through GL-6242—15-kw klystrons for final transmitter power stage. The 6 types in order handle all frequencies 470 mc to 890 mc. G-E klystrons are the *highest-power u-h-f TV tubes*, giving superior transmission at 200 kw E.R.P.



MAKE HEADLINE NEWS I.R.E. SHOW!

TV DESIGNERS: see these—and other—G-E pace-setting u-h-f types at the March I.R.E. Show. Get all ratings and characteristics! **TV MANUFACTURERS:** learn how G-E tubes can help you successfully (1) meet stiff 1953 price competition, (2) establish new, higher standards of equipment performance, both transmission and reception!



6AJ4



6AM4



6AF4

82-Channel Tuner Triodes

Trio of G-E tuner tubes for TV receivers, with a combined v-h-f, u-h-f frequency range that makes *single-dial 82-channel tuning* practical and economical.



GENERAL  ELECTRIC

163-1A3

How the image you see gets **PARAGON**[®]

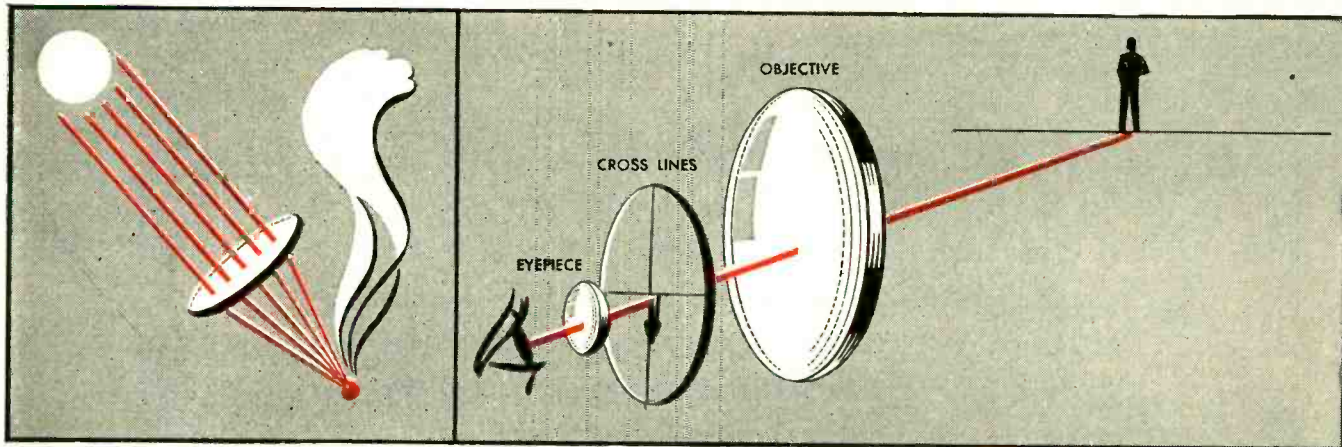

Even an ordinary reading glass can produce an image of sorts. That happens when the sun's rays are focused on a piece of paper as shown. All the rays passing through the lens concentrate at approximately one point where they form a small inverted picture or image of the sun.

By means of a lens, rays from any object at a distance can be made to concentrate inside a telescope in the same way. They form a tiny inverted picture of the object. If a screen like the ground glass of a camera were placed there and viewed through a magnifying glass, the

actual picture of the distant object could be seen clearly. The lens that brings the tiny picture into a telescope is called the objective, and the small but powerful microscope that brings it out of the telescope into the eye is called the eyepiece.

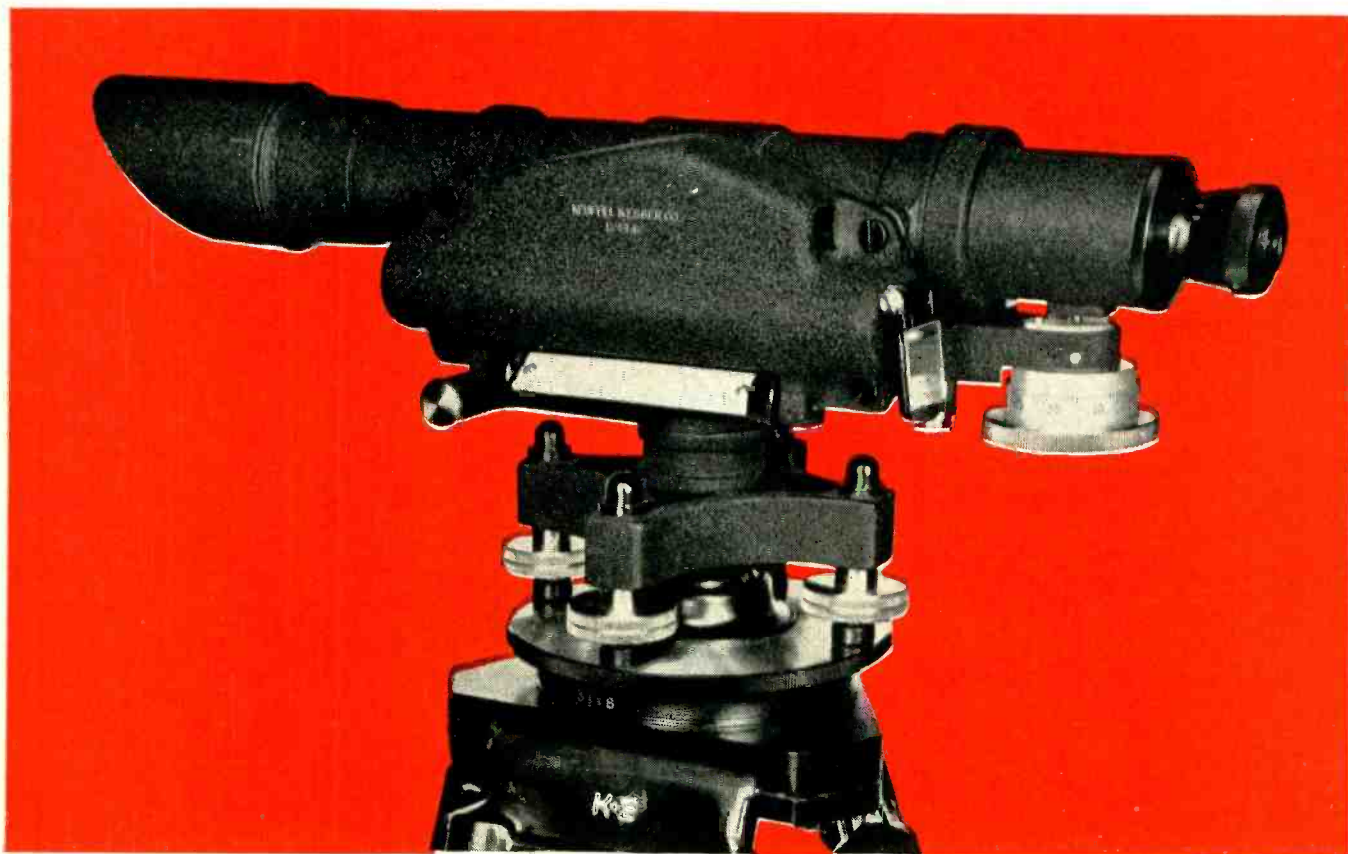

into and out of a Telescope

*The
Right Angle*

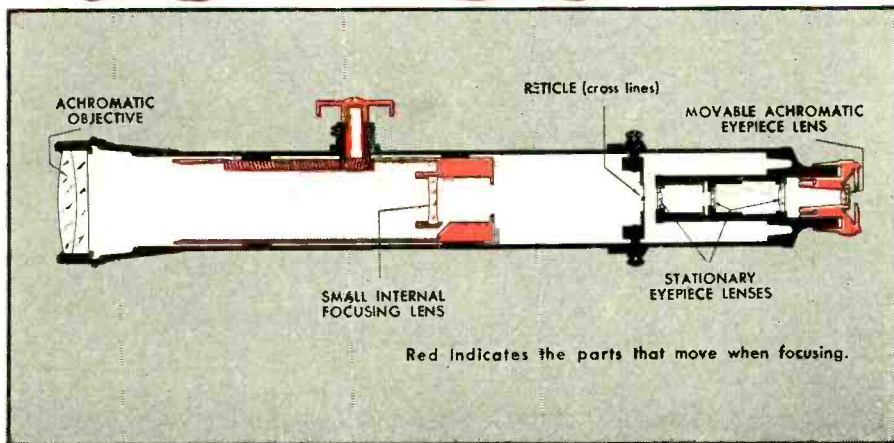

Cross lines so fine as to be almost invisible can be placed inside the instrument at exactly the place where the miniature picture is formed. Then the eyepiece will greatly magnify not only the picture but the cross lines as well so that both are seen together. Basically, that is the principle of the tele-

scopes used in K&E PARAGON surveying instruments and K&E optical tooling equipment. These contain additional refinements, such as a movable internal lens for focusing and extra lenses in the eyepiece that invert the picture a second time, so that the eye sees it right side up.

Naturally, the above description is extremely elementary. In fine telescopes, such as those made by K&E, every optical part must be made with surpassing accuracy so that the rays of light are not scattered. It is for this reason that K&E designs, grinds and polishes its lenses with an accuracy measured in millionths of an inch. The result is superior definition with unusual contrast and brightness. Minute detail can be clearly distinguished, and cross lines appear jet black.

These are the exacting standards to which K&E builds instruments for engineers, surveyors and builders, as well as optical tooling equipment. The latter makes possible the application of surveying methods to manufacturing and construction problems involving high-precision positioning and alignment. Already these techniques have revolutionized tooling in the aircraft industry and are being adopted in other fields. Ask your K&E Distributor or Branch for details on what these superlative instruments can do for you.

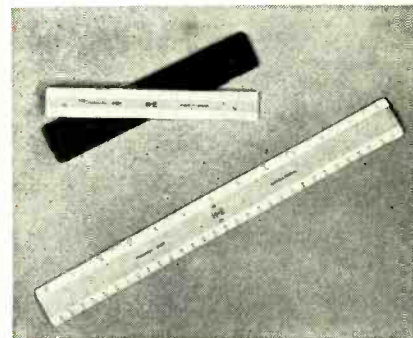

Measuring scales are in constant use on every drawing board. For high quality and accuracy, use K&E PARAGON engine divided scales. They are made of the highest grade baxwood with scale faces of white plastic, permanently cemented. The graduations are filled with dense black pigment for high visibility against the white background.

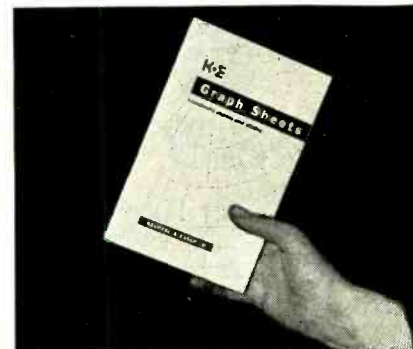

There is a K&E graph sheet for almost every purpose. In a selection of 300 forms you can find graph sheets for plotting scientific data, forms for sketching and drawing, both mechanical and architectural, or for surveying and mapping. Also, business and financial forms of all types. All are on high quality drawing paper and on the finest tracing paper.

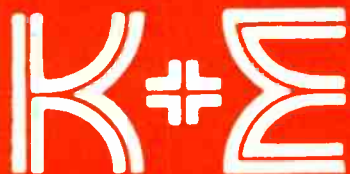

PARTNERS IN 'CREATING

KEUFFEL & ESSER CO.

EST. 1867

*Drafting, Reproduction, Surveying Equipment
and Materials, Slide Rules, Measuring Tapes*

NEW YORK • HOBOKEN, N. J.
CHICAGO • ST. LOUIS • DETROIT
SAN FRANCISCO • LOS ANGELES • MONTREAL

A general-purpose DUAL-beam oscillograph
to fit your needs technically and financially

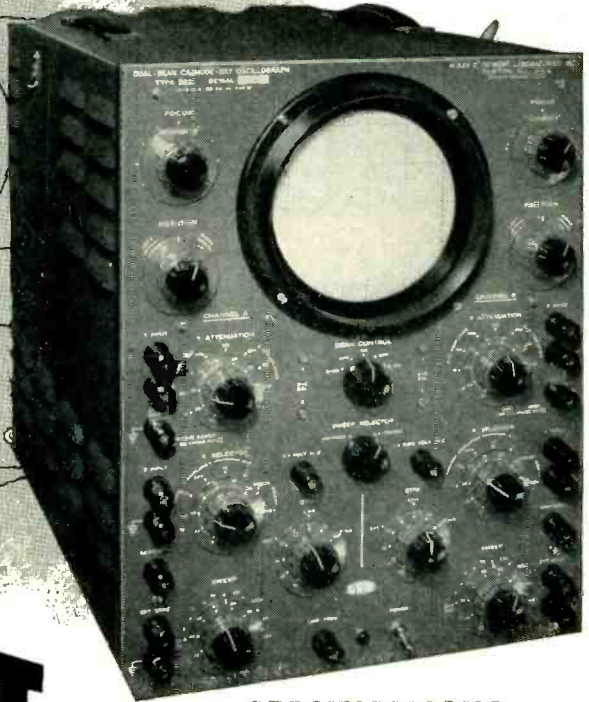
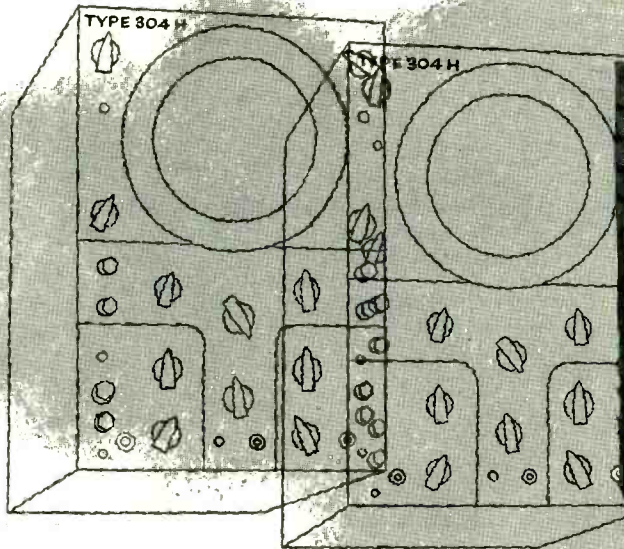

the **DU MONT** **TYPE 322**

Not just another specialized dual-beam oscillograph, but a brand-new type designed for general development work but rugged enough for production testing and industrial applications as well. Compactness, lightweight, ruggedness and versatility mark the Du Mont Type 322 as another milestone in cathode-ray oscillography.

FEATURES All the well-known features of the 304-H, and...

- Thoroughly field-tested.
- Individual and common time bases with driven or recurrent sweeps and sweep expansion on all sweeps.
- Conventional single-ended input with stepped and vernier attenuators, or balanced input with no attenuation, on both Y-axes.
- Concentric controls for easy-to-operate, compact control panel.
- High-gain D-C amplifiers on both channels.
- Amplitude calibration on either channel on both axes.
- Illuminated scale with dimmer control.

SPECIFICATIONS

Cathode-ray Tube — Type 5SP — Dual-beam Cathode-ray Tube. Accelerating potential, 3000 volts.

Y-Deflection Sensitivity — 0.028 peak-to-peak (0.01 rms) volts/inch from D-C to 300 KC (50% down at 300 KC); A-C coupling, 10% down at 5 c.p.s.

X-Deflection Sensitivity — 0.3 peak-to-peak (0.1 rms) volts/inch from D-C to 300 KC (down 50% at 300 KC); A-C coupling down 10% at 5 c.p.s.; common, D-C to 200 KC (down 50% at 200 KC).

Linear Time Base — Recurrent and driven sweeps variable in frequency from 2 to 30,000 c.p.s. Front panel connections provided for lower frequency by adding external capacitance.

Intensity Modulation — Input impedance 0.2 megohm, paralleled by 80 μ f. Negative signal of 15 volts peak blanks beam at normal intensity settings.

Beam Control Switch — On front panel to turn beams on or off independently or simultaneously.

Calibrator — Regulated potentials of 50 millivolts and 1 volt peak-to-peak squarewave at power line frequency available at front panel binding posts.

Power Source — 115/230 volts — 50-400 c.p.s. — 225 watts.

Dimensions — Height 15 $\frac{3}{4}$ ", width 12 $\frac{1}{2}$ ", depth 22 $\frac{7}{8}$ ", weight 75 lbs.

\$835⁰⁰

Write for complete technical details:

Instrument Division
Allen B. Du Mont Laboratories, Inc.
1500 Main Avenue, Clifton, N. J.

telling the story of 'dag' dispersions

Here is a
CRT Exterior Wall Coating
that's **Fast-Drying,**
Adherent, Opaque

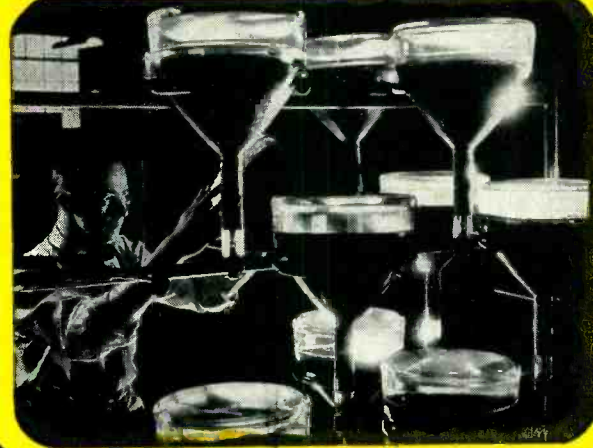

'dag' Exterior Wall Coating is a dispersion of extremely fine graphite in lacquer.

It is easily applied by spraying, and dries for handling in 2 to 3 minutes. Maximum adhesion is obtained by drying at room temperature for 24 hours... with the same result from infra-red at 100°C. for ½ hour.

The coating obtained is as smooth as the glass itself and as black as coal. Its adhesion is so good that scratching it is almost an impossibility. Water won't loosen it either.

Acheson Colloids can also supply appropriate dispersions for coating interiors of tubes.

You can have more detailed data by asking for Bulletin No. 433-5C.

Dispersions of molybdenum disulfide are available in various carriers. We are also equipped to do custom dispersing of solids in a wide variety of vehicles.



Acheson Colloids Company, Port Huron, Mich.

...also **ACHESON COLLOIDS LIMITED, LONDON, ENGLAND**
Units of Acheson Industries, Inc.

*try resin-bonded dry graphite films
for permanent lubrication*

PRECISION LABORATORY INSTRUMENTS

NEW

MICROWAVE RECEIVERS

1000—10,750 mc

Four microwave receivers of high sensitivity, wide tuning range and selectivity. Image rejection is greater than 60 db. Gain stability better than ± 2 db, permits application as a field intensity meter.



NEW

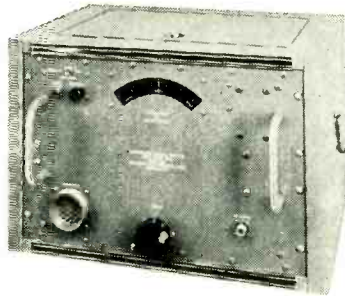

MICROWAVE SIGNAL SOURCES

Models SSR, SSL, SSS, SSM SSX,
634 MC to 10,750 MC

A reliable source of microwave energy in transmission loss measurements, standing wave determination, etc. Unidial Control for accuracy and ease of operation. Direct reading (no mode charts to consult).

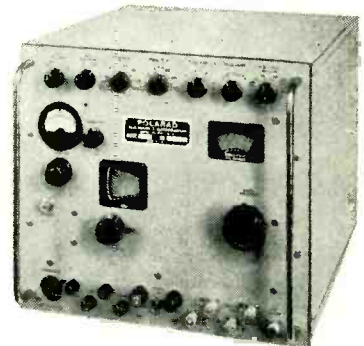

MICROWAVE SIGNAL GENERATOR

Model MSG-4
7,000 mc—10,750 mc

An ideal source of an accurately known signal voltage, precisely modulated. Sensitivity, frequency and performance of radio and radar equipments in the frequency range from 7 to 10.75 mc can be readily measured on this continuously variable, direct reading signal generator.

Polarad
Electronics Corporation

POLARAD ELECTRONICS

TELEVISION EQUIPMENT

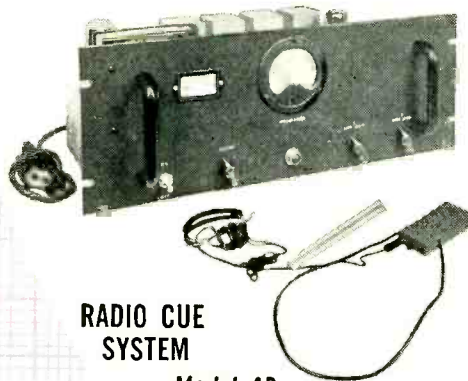

RADIO CUE SYSTEM

Model AB

Used to direct the activities of persons within a limited area from a central control point. Widely used in broadcast and motion picture studios (sound and television). Ideal for factories, yards, hangars, airports, auditoriums, and places where the noise level is high. The Radio Cue System permits efficient operation under difficult conditions.

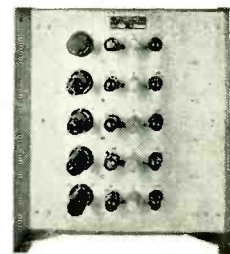

TELEVISION DISTRIBUTION AMPLIFIER

Model TDA-1

Isolates and distributes television signals over transmission lines for station and production use. TV Synchronizing and picture signals, both monochrome and color can be distributed to as many as five separate points.

See us at Booth 2-511, Radio Engineering Show

All Band, Direct Reading

IMPROVED

SPECTRUM ANALYZER

Model LSA
10 MC to 21,000 MC

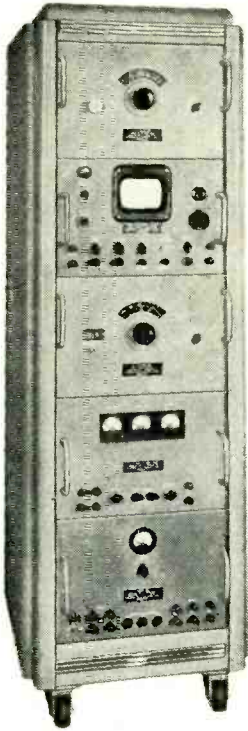

The Model LSA is the result of years of research and development. It provides a simple and direct means of rapid and accurate measurement and spectral display of an rf signal.

- Frequency accuracy 1 percent.
- No Klystron modes to set.
- Broadband attenuators supplied from 1 to 12 KMC.
- Frequency marker for measuring differences 0-25 MC.
- Only four tuning units required to cover entire range.

REGULATED POWER UNITS



MODEL PT110D (Dual Regulated)

Consists of two independently regulated D.C. power sources (isolated from ground), mounted on one chassis. Each power source has its own power switch, fuse, pilot light and voltage control.

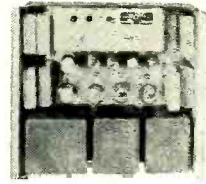

MODEL PT111

Consists of a positive and a negative voltage supply independently regulated.

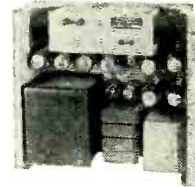

MODEL PT112

Heavy duty electronically regulated D.C. power source.

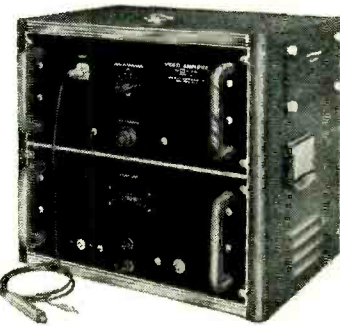

WIDE BAND VIDEO AMPLIFIER

Model VT 10 CPS to 20 MC

Designed for use as an oscilloscope deflection amplifier for the measurement and viewing of pulses of short duration and rise time.

CORP.

100 METROPOLITAN AVENUE, BROOKLYN 11, N. Y.

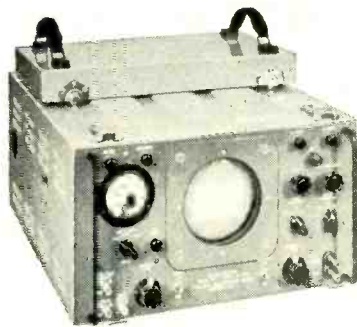

PORTABLE TELEVISION WAVE FORM MONITOR

Model TO-1

Designed for precise wave form analysis and amplitude measurement of video signal in television circuits. Also ideal as a general purpose instrument in many applications, because of its wide frequency response, high sensitivity, excellent synchronizing capability, precision calibrating circuits and unusually large symmetrical horizontal expansion.

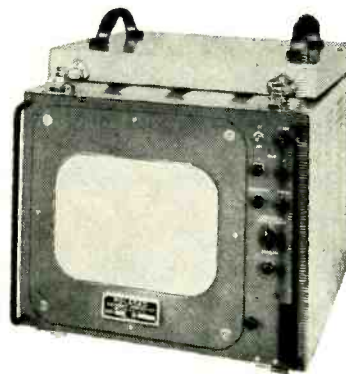

STUDIO PICTURE MONITOR

Model M-105

A high fidelity picture monitor of large size, sufficient for ease of observation under studio conditions. It is a high impedance device and may be connected across a video transmission line without affecting the terminal impedance of the line. Monochrome and/or color signals in black and white reception is provided.

See us at Booth 2-511, Radio Engineering Show

Precision-Built...for dependable performance

Whatever your requirements for top quality wire-wound components, you can count on I-T-E products. Power resistors, precision resistors, deflection yokes—all are specially designed and precision-built to meet the

exacting standards demanded for critical electronic applications. Close quality control and modern production methods give you assurance of *quality* components in any quantity you need.

I-T-E POWER RESISTORS

Non-hygroscopic ceramic foundations are in accordance with JAN specifications.

Purest resistance wires are uniformly wound to prevent shorted turns and excessive hot spots. All connections silver-soldered.

Vitreous enamel coating (organic if required) provides a glazed moisture-repellent surface with fast heat-dissipation qualities.

Advanced production methods assure high stability, long life.

Standard fixed resistors:
5-200 watts

Adjustable resistors:
10-200 watts

Oval resistors:
30-75 watts

Ferrule resistors:
12-200 watts

Special resistors:
built to specifications

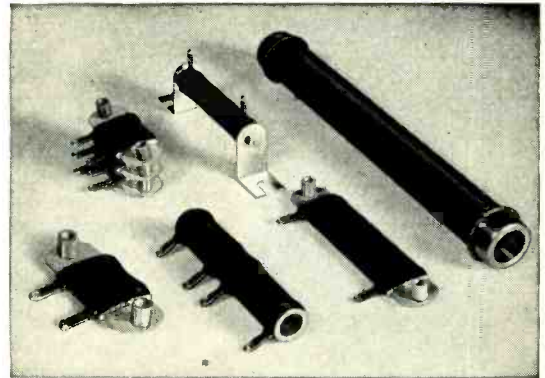

Standard Tolerance: $\pm 10\%$, $\pm 5\%$ and less made to order.

I-T-E PRECISION RESISTORS

High-quality wire alloys are used—free from internal stresses and strains.

Automatic precision winding assures even tension—eliminates hot spots.

Hermetic or vacuum-impregnated sealing protects against destructive effects of salts, moisture, and atmospheric conditions.

Accelerated aging process prior to calibration assures accuracy.

Critical quality control eliminates all resistors which do not come up to high I-T-E standards.

TYPE A:

lightweight, hermetically sealed—for precision operation up to 125° C. Surpass JAN R-93 A, Characteristic A, and MIL R-93 A specifications.

TYPE B:

vacuum-impregnated, moisture-resistant. For JAN R-93, Characteristic B, specifications.

Ratings from 0.01 ohm-10 megohms, 0.125-5 watts.

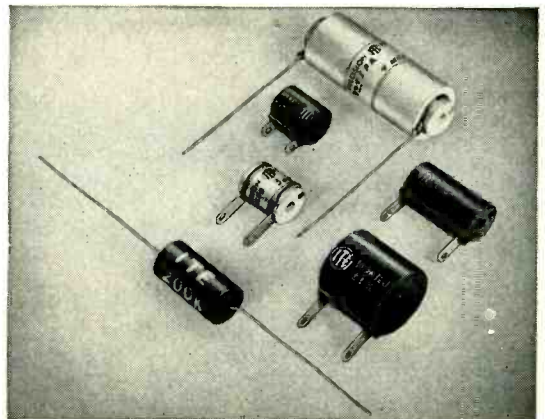

Standard Tolerance:

$\pm 1\%$. Available in specified tolerances down to $\pm 0.05\%$.

I-T-E DEFLECTION YOKES

Wire size and quality constantly checked. Coils impregnated in special moisture-resistant thermoplastic—properly cured to assure

firm coil with minimum losses. Yokes can be obtained complete with wire leads, resistors, and capacitors to your specifications.



WRITE FOR DETAILS



WIRE-WOUND PRODUCTS

I-T-E RESISTOR DIVISION

1924 Hamilton St., Phila. 30, Pa. • A division of the I-T-E Circuit Breaker Co.

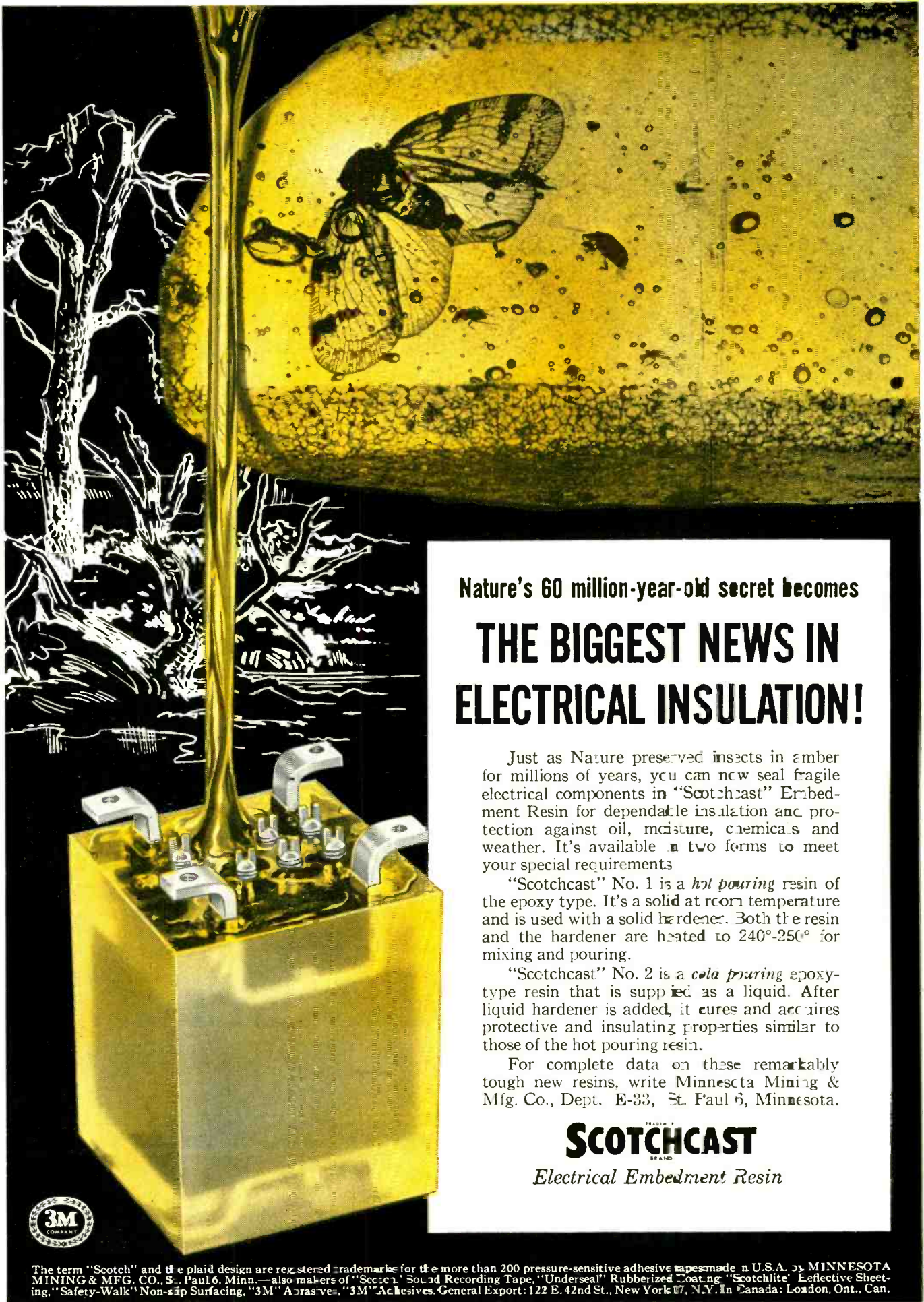

Nature's 60 million-year-old secret becomes

THE BIGGEST NEWS IN ELECTRICAL INSULATION!

Just as Nature preserved insects in amber for millions of years, you can now seal fragile electrical components in "Scotchcast" Embedment Resin for dependable insulation and protection against oil, moisture, chemicals and weather. It's available in two forms to meet your special requirements.

"Scotchcast" No. 1 is a *hot pouring* resin of the epoxy type. It's a solid at room temperature and is used with a solid hardener. Both the resin and the hardener are heated to 240°-250° for mixing and pouring.

"Scotchcast" No. 2 is a *cold pouring* epoxy-type resin that is supplied as a liquid. After liquid hardener is added, it cures and acquires protective and insulating properties similar to those of the hot pouring resin.

For complete data on these remarkably tough new resins, write Minnesota Mining & Mfg. Co., Dept. E-33, St. Paul 5, Minnesota.

SCOTCHCAST

Electrical Embedment Resin



The term "Scotch" and the plaid design are registered trademarks for the more than 200 pressure-sensitive adhesive tapes made in U.S.A. by MINNESOTA MINING & MFG. CO., St. Paul 6, Minn.—also makers of "Secicel" Sound Recording Tape, "Underseal" Rubberized Coating, "Scotchlite" Reflective Sheet- ing, "Safety-Walk" Non-slip Surfacing, "3M" Abrasives, "3M" Adhesives. General Export: 122 E. 42nd St., New York 17, N.Y. In Canada: London, Ont., Can.



WHAT ABOUT THE Wattage Rating OF PRECISION WIREWOUND RESISTORS?

The wattage rating of precision wirewound resistors is often expressed in two forms—the manufacturer's commercial catalog rating, and the JAN-R-93 or MIL-R-93A rating. Exceptions are the many resistors smaller than JAN and MIL dimensions not rated under JAN or MIL specifications.

THE BASIS FOR WATTAGE RATINGS: Production resistors are wound with resistance wire insulated with either or both enamel and a silk or nylon covering which deteriorates rapidly above 105°C.

JAN and MIL wattage ratings are based on an ambient temperature of 85°C. The wattage rating is limited to the power dissipation which will cause not more than a 20°C temperature rise. This results in a temperature of not more than 105°C at the hottest point ("hot-spot") on the winding.

Shallcross commercial ratings are based on an ambient of 25°C. Wattage rating is limited to the power dissipation which will cause not more than a 20°-40°C rise. Although higher, these ratings are based on hot-spot temperatures of only 45°-65°C.

VOLTAGE DERATING AND RESISTANCE: Above about 50 per cent of the cataloged maximum resistance, the Shallcross commercial wattage rating must be derated by the maximum voltage tabulated in the catalog. Lower thermal efficiency of the small diameter wire used for higher resistance values causes a higher temperature rise for the same dissipation, and the potential gradient in the winding must be

held to a safe proportion of the breakdown voltage.

Computation using JAN-MIL wattage ratings, maximum resistances, and voltage limitations, reveals that voltage derating is seldom necessary up to 99% or more of JAN-MIL maximum resistance values.

TOLERANCE DERATING: JAN, MIL, and Shallcross commercial wattage ratings are based on resistors with 1% tolerance. For closer tolerances, the following MIL derating system is a good one to use:

Resistor Tolerance—%	Per Cent of Nominal Wattage
1	100
0.5	75
0.25	50
0.1	50

SPECIAL HIGH WATTAGE RESISTORS: Shallcross also offers non-inductive, precision wirewound resistors rated 5 to 10 times higher than the usual commercial wattage ratings. These "G" type resistors are wound with glass-insulated, low T.C. wire, silicone varnished. They are rated on a 150°C temperature rise above an ambient of 25°C. Their hot-spot temperature is 175°C.

Shallcross also supplies "S" type resistors wound with silicone-enameled low T.C. wire. Better insulation permits these resistors to operate at higher than normal hot-spot temperatures. Exact ratings are still being established, but they can be expected to approach those of "G" resistors while permitting higher maximum resistance values.

Further details on Wattage Ratings and other resistor characteristics are available in Shallcross Bulletin R-3C.

SHALLCROSS MANUFACTURING COMPANY • 522 PUSEY AVENUE, COLLINGDALE, PA.

See us at the I.R.E. Show—Booths 2-210 & 2-211.

The third of a series to promote a better understanding of the performance characteristics of precision wirewound resistors.



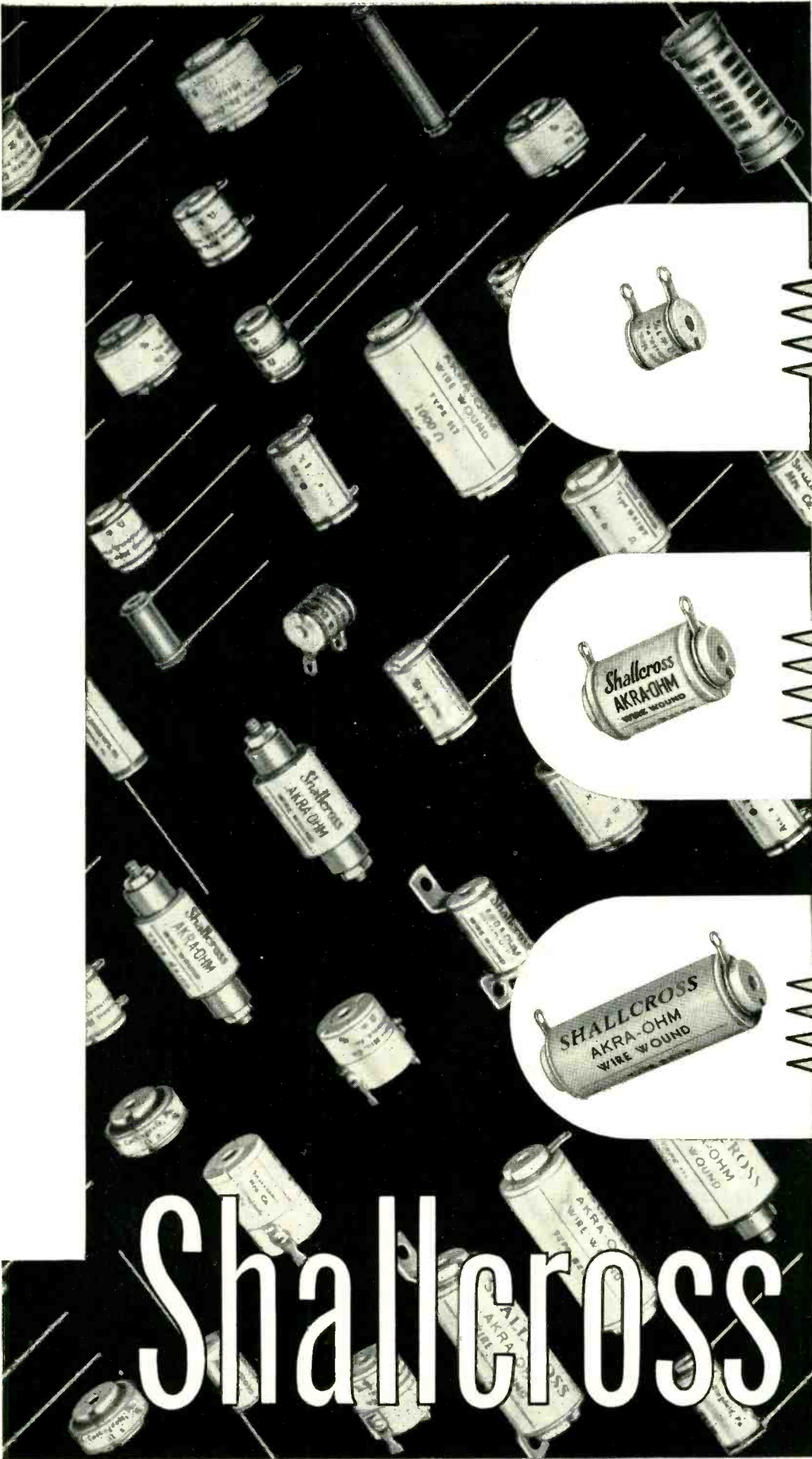

NEW 3-WATT RESISTOR

Shallcross Type S 183-A is typical of the higher wattage ratings possible with silicone-enameled wire. Yet it measures only $\frac{3}{16}$ " L. x $\frac{1}{2}$ " Diam. Maximum resistance is approximately 500K ohms.



8-WATT PRECISION WIREWOUND RESISTOR

Wound with glass-insulated wire, silicone-impregnated, this Shallcross Type G 196-E resistor will dissipate 8 times the nominal wattage of the standard Type 196 resistor. Maximum resistance is 60K ohms. $1\frac{1}{4}$ " L. by $\frac{3}{4}$ " Diam.



HIGHEST WATTAGE STANDARD RESISTOR

The BX 116-2E is the largest Shallcross resistor using standard resistance wire. Rated at 4-watts, the dimensions are only $3\frac{3}{8}$ " L. by $\frac{3}{4}$ " Diameter. Maximum resistance is 20 megohms.



Shallcross



PREFERRED BY CRAFTSMEN
FOREMOST IN QUALITY

SOLDER

for everything electronic

CEN-TRI-CORE ENERGIZED ROSIN-FILLED SOLDER



Guaranteed non-corrosive for radio, television, electronic and other electrical applications. No other solder works faster or easier... It provides greater fluxing uniformity and stronger smoother joints.

No activating chlorides or other chemical agents tending to produce acid conditions, toxic or sticky vapors, or latent corrosion.

Ideal where plated and/or oxidized parts must be soldered. Designed for use where faster fluxing is desirable.

CEN-TRI-CORE's exclusive design guarantees rosin throughout the complete length of the wire. Eliminates rejects commonly encountered in the use of ordinary rosin core solders. CEN-TRI-CORE is faster fluxing: thinner walls between solder and rosin assure faster penetration of heat to the flux - requires less heat and guarantees maximum fluxing action of the rosin.

CEN-TRI-CORE PLASTIC ROSIN-FILLED SOLDER

For those applications where a conventional rosin flux is required. For telephone and other critical soldering operations.



write for generous samples

ALPHA METALS, INC.

58 Water Street, Jersey City 4, N. J.

Visit us at Booth 512—3rd floor, I.R.E. Radio Engineering Show



speed up production...
bring your
costs down!

SOFT SOLDER PREFORMS

Alpha's preformed solders, in any shape or size, cut many hours from your production time. You can select washers, rings, coils, cut shapes, drops, pellets, solder foil, to fit your specific needs. They save you considerable money and materials in repetitive soldering processes.



SPEED AUTOMATIC SOLDERING for flame, oven or induction heating

Increase Production • Melts Faster • Guarantee Product Precision • With Or Without Self-Flux Save Labor Costs • Designed For Your Application All Sizes, Shapes, Alloys • Stronger, Smoother Joints

AVAILABLE IN

- ★ CEN-TRI-CORE
- ★ TRI-CORE
- ENERGIZED
- LEAK-PRUF
- ROSIN-FILLED
- ACID-FILLED
- ★ SINGLE-CORE
- ★ SOLID WIRE
- ★ SHEET SOLDER

Please consult us on your soldering problems. Trained Field Engineers always available to assist you. Small or large quantities.

write to **ALPHA** for further information

ALPHA METALS, INC.

58 Water St., Jersey City 4, N. J.



did you know . . .

that Rauland made the first rectangular tube in 1945
everybody knows . . . that engineering leadership means
sales leadership . . . and that means RAULAND

THE RAULAND CORPORATION, 4245 N. KNOX AVENUE, CHICAGO 41, ILLINOIS • MULBERRY 5-5000

RAULAND

did you know . . .



that Rauland was the first company to produce the
electrostatic low focus voltage tube?
everybody knows . . . that engineering leadership means
sales leadership . . . and that means RAULAND

THE RAULAND CORPORATION, 4245 N. KNOX AVENUE, CHICAGO 41, ILLINOIS • MULBERRY 5-5000



DID YOU KNOW

that Rauland was the first company to manufacture
aluminized tubes on a production basis?
everybody knows . . . that engineering leadership
means sales leadership . . . and that means RAULAND

THE RAULAND CORPORATION, 4245 N. KNOX AVENUE, CHICAGO 41, ILLINOIS • MULBERRY 5-5000



Burton Brown Advertising

WESTERN UNION

1201

(43).

SYMBOLS	
DL	=Day Letter
NL	=Night Letter
LT	=Int'l Letter Telegram
VLT	=Int'l Victory Ltr.

CLASS OF SERVICE

This is a full-rate Telegram or Cablegram unless its deferred character is indicated by a suitable symbol above or preceding the address.

The filing time shown in the date line on telegrams and day letters is STANDARD TIME at point of origin. Time of receipt is STANDARD TIME at point of destination

NA130 PD=CHICAGO ILL 26 930A=
 ANTARA CHEMICALS DIVN, GENERAL DYESTUFF CORP=
 435 HUDSON ST NEW YORK NY=

INITIAL SHIPMENT ENTIRELY SATISFACTORY. WE WILL TAKE FULL
 ADVANTAGE OF GQ4'S HIGHER PERMEABILITY AND Q VALUE. SHIP
 ADDITIONAL 1000 POUNDS IMMEDIATELY. EXPECT CONTINUED
 LARGE ORDERS=
 W E CAIRNES PRESIDENT RADIO CORES INC=

GQ4'S
 Q VALUE

THE COMPANY WILL APPRECIATE SUGGESTIONS FROM ITS PATRONS CONCERNING ITS SERVICE

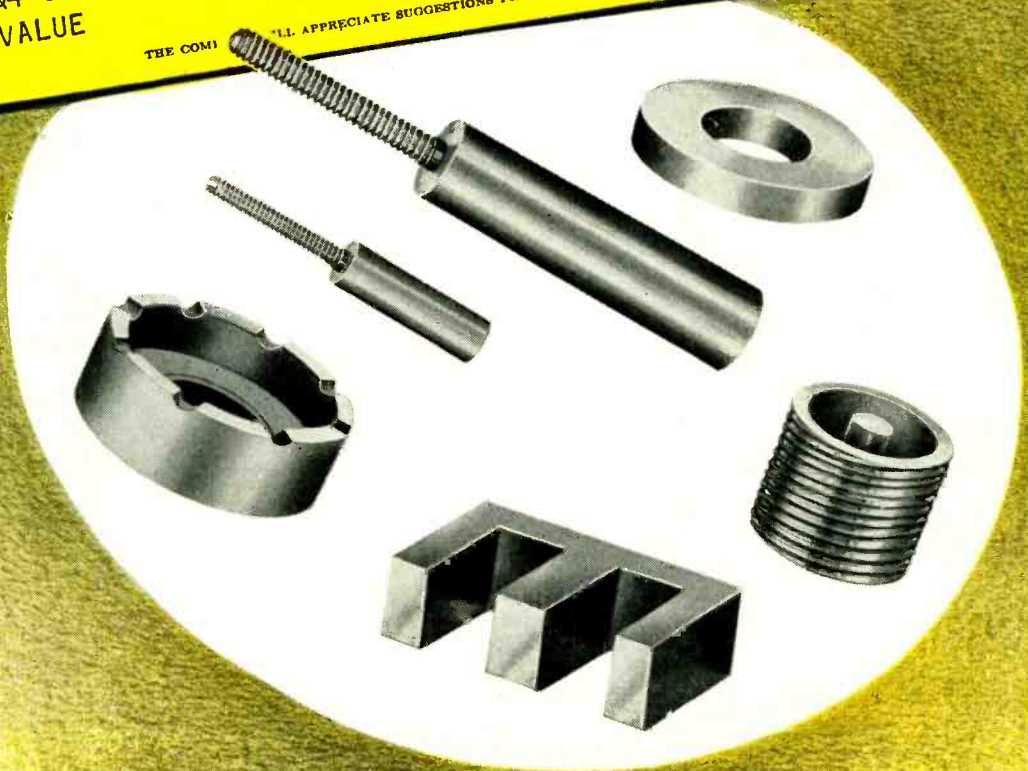

G A & F CARBONYL IRON POWDERS

"We will take full advantage of

GQ4's

higher permeability and Q value"

GQ4 is an almost pure iron powder consisting of spherical particles which are readily compressible, resulting in high permeability. In this respect, it exceeds all other Carbonyl Iron Powders by a considerable margin. The particles possess an efficient insulating coat. The powder was designed to replace HP, mixtures of HP and L, and, in some instances, L itself. Its properties are such that it should yield simultaneously, higher Q value, higher strength and often, higher permeability, than mixtures of HP and L.

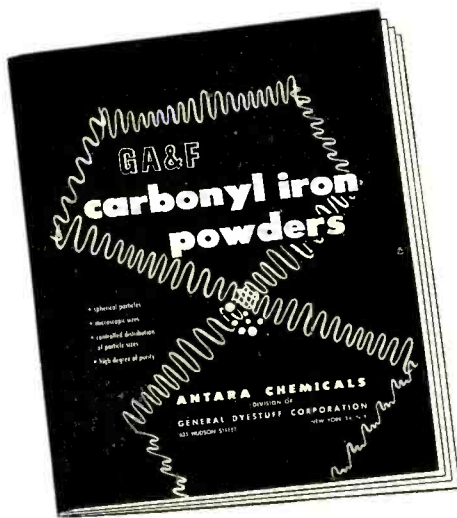

We urge you to ask your core maker, your coil winder, your industrial designer, how G A & F Carbonyl Iron Powders can increase the efficiency and performance of the equipment or product you make, while reducing both the cost and the weight. We also invite inquiries from those whose requirements call for still greater variations than are offered by any of our existing types.

• • •

This wholly new 32-page book offers you the most comprehensive treatment yet given to the characteristics and applications of G A & F Carbonyl Iron Powders. 80% of the story is told with photomicrographs, diagrams, performance charts and tables. For your copy—without obligation—kindly address Department 42.



ANTARA® CHEMICALS

Division of GENERAL DYESTUFF CORPORATION

435 HUDSON STREET • NEW YORK 14, NEW YORK



keeping communications **ON THE BEAM**



the JK FD-12

FREQUENCY AND MONITOR MODULATION

Monitors any four frequencies anywhere between 25 mc and 175 mc, checking both frequency deviation and amount of modulation. Keeps the "Beam" on allocation; guarantees 100% solid coverage, too!



JK STABILIZED H-17 CRYSTAL

CRYSTALS FOR THE CRITICAL

The JK H-17 Crystal meets rigid airline requirements for compactness, light weight, rugged dependability. A Military type, it is hermetically sealed—dust and moisture proof—plated, quartz plate is shock mounted. One of many JK Crystals made to serve every need.

Ceiling Zero... Communications 100%

"Pea soup" over the field . . . and still the giants of air travel come in "on the beam". When visibility is poor, commercial pilots must rely on radio-radar equipment to bring their ship in safely. JK Crystals play an important role in this every day drama of keeping airlines communications "on the beam" in the air and on the ground.

THE JAMES KNIGHTS COMPANY
SANDWICH ILLINOIS

UNITED STATES PATENT OFFICE.

M. C. STONE.

FOUNTAIN PEN HOLDER.

(Model.)

No. 260,134.

Patented June 27, 1882.

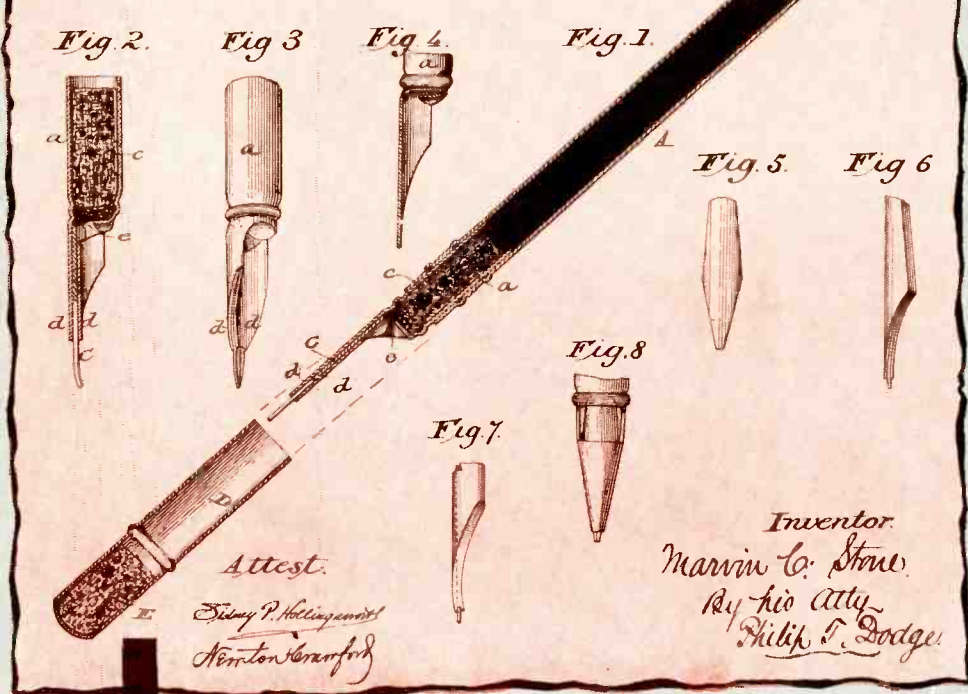

(No. 2 of a series)
The Historical Background of
STONE PAPER TUBE CO

“... I First Provide a Rigid Non-collapsible Tube.”

THESE were the words used by Marvin C. Stone of Falls Church, Virginia, in his description of this fountain pen patent granted him June 27, 1882, and later upheld in an infringement suit in 1898 in the Circuit Court of New York.

Marvin C. Stone was the founder of the Stone Paper Tube Company, manufacturers today of both collapsible and rigid non-collapsible tubes, and he was the great-uncle of our president.

Thus it can be seen that more than 70 years ago, Stone's inventiveness and knowledge of the use of tubes was demonstrated . . . qualities which have made Stone one of the largest manufacturers of small diameter paper tubes in the United States.

During these intervening years, Stone has become a specialist in the manufacture

of spiral wound insulating tubing, sleeves, and bobbins. Diameters as small as 3/64" ID can be furnished in products of various wall thicknesses and lengths and in many materials including hi-dielectric kraft, fish paper, and plastic films.

Hundreds of America's leading manufacturers in many industries have found that Stone's long experience makes possible the delivery of custom-made quality products to close tolerances at low cost with unsurpassed service.

Whatever your problem—large or small—we welcome the opportunity to serve you. Sales representatives are located in principal cities.

STONE PAPER TUBE CO.
INCORPORATED
Washington 17, D. C.

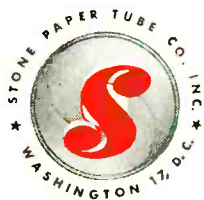

Here is Plug-in Unit Construction

Everything you need to mount, house, fasten, connect, monitor your equipment.

1st START WITH ALDEN MINIATURE TERMINALS



Here's a beautiful new little Terminal that really puts soldering on a production basis; taking a minimum of space

and material. Ratchet holds leads firmly for soldering, no wrap-around or pliering necessary. Unique punch press configuration gives rapid heat transfer, taking less time and solder. Designed for Govt. Miniaturization contracts. Staked in Alden Pre-punched Terminal Cards, allow patterns for any circuit.

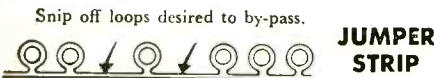
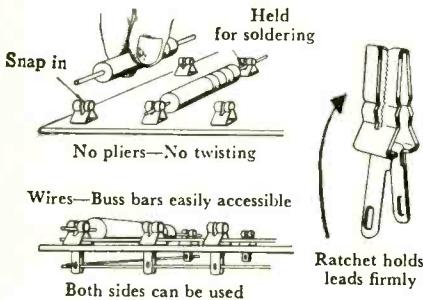

Snip off loops desired to by-pass.

JUMPER STRIP

Stake under Terminals for common circuits. Loops match prepunched holes in Terminal Cards. Snip off loops desired to by-pass.

FOR YOUR SMALLER UNITS

2nd Take Pre-punched Terminal Mounting Card ready-cut to size you require. Stake in Alden Miniature Terminals to mount your circuitry.

Prepunched Terminal Mounting Cards come in all sizes needed for Packages: miniature 7-pin and 9-pin units, or 11-pin and 20-pin plug-in units. Card is natural phenolic $\frac{1}{16}$ " thick prepunched on $\frac{1}{4}$ " centers with $.101$ " holes for taking the Miniature Terminals.

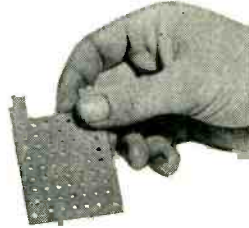

3rd Attach Miniature Terminals, Alden Card-mounting Tube Sockets and Mounting Brackets, which mount in the prepunched holes.

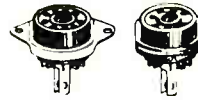

Alden Card-mounting Tube Sockets for miniature 7, miniature 9 and octal tubes, are complete with studs and eyelets for easy mounting on Pre-punched Cards.

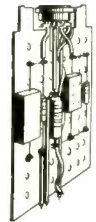

Mounting Brackets stake to the Pre-punched Card, mount Card to Package Base and Lid.



FOR YOUR LARGER UNITS

2nd Lay out circuitry with Prepunched Terminal Mounting Card in lengths up to 3'.

READY MADE to fit various ready made Chassis sizes.



Organize circuitry in compact vertical planes. Use both sides of Prepunched Card to stake in Alden Miniature Terminals to your circuitry layout. Vertical position gives ready accessibility; there is no "underneath" in Alden design.

3rd Attach Miniature Terminals, Card-mounting Tube Sockets and Mounting Brackets, which fit any of the prepunched holes.



Alden Card-mounting Tube Sockets, ready-made in variety of sizes, complete with studs and eyelets for easy mounting on Prepunched Cards.

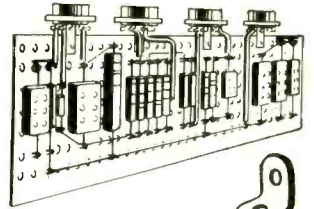

TO OBTAIN COMPLETE DETAILS

Tiny Sensing Elements specifically designed to spot trouble instantly in any unit.

Here are tiny components to isolate trouble instantly by providing visual tell-tales for each unit.



"PAN-i-LITE" MIN. INDICATOR LIGHT

So compact you can use it in places never before possible. Glows like a red-hot poker. Push-mounts in $.348$ " drill hole. Bulbs replace from front. Tiny spares are unbreakable, easily kept available, taped in recess of equipment. Alden #86L, ruby, sapphire, pearl, emerald.

MINIATURE TEST POINT JACK

Here are tiny insulated Test Point Jacks that make possible checking critical plate or circuit voltages from the front of your equipment panel—without pulling out equipment or digging into the chassis. Takes a minimum of space, has low capacitance to ground, long life beryllium copper contacts. Available in black, red, blue, green, tan and brown phenolic conforming to MIL-P 14B-CGF; also nylon in black, red, orange, blue, yellow, white, green. Alden #110BCS.



ALDEN "FUSE-LITE" Fuse Blows — Lite Glows.

Signals immediately blown fuse. Lite visible from any angle. To replace fuse simply unscrew the 1-pc. Lite-lens unit. Mounts easily by standard production techniques, in absolute minimum of space. 110V Alden #440-4FH. 28V #440-6FH.



Get one point of check of all incoming and outgoing leads thru ALDEN BACK CONNECTORS



SINGLE CHECK POINT

Here for the first time is a slide-in connector that brings all incoming and outgoing leads to a central check point in orderly rows, every lead equally accessible and color coded.

Avoid conventional rats nest wiring

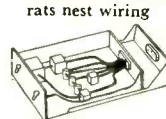

Permit direct efficient wiring

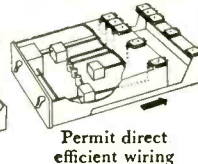

Color coding

Generous bell-mouthing

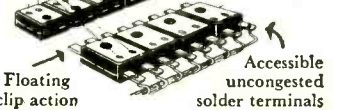

Accessible uncongested solder terminals

STRAIGHT-THROUGH CIRCUITRY

Wiring is kept in orderly planes, avoiding rat's nest of conventional back plate wiring. Connections between Terminal Mounting Cards are through Back Connectors so that all circuitry is controlled at this central point. Incompatible voltages safely isolated and separated.

EASY INSERTION AND REMOVAL

Mating tolerances permit easy insertion and removal without demanding critical alignment tolerances. Assure proper contact, with safety shielding of dangerous voltages. Leads can be attached above, below or out of the back for most direct and efficient interconnects.

Ready-made Alden Back Connectors meet all conceivable needs, for slide-in chassis replaceable in 30 seconds with spare.

Free Samples Sent Upon Request

VISIT OUR COMPLETE DISPLAY AT THE I.R.E. SHOW

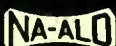

ALDEN PRODUCTS COMPANY

READY-MADE for your Electronic Equipment

All designed — all tooled — production immediately available — no procurement problems. Apply ALDEN Standards wholly or in part.

ALDEN PLUG-IN PACKAGES

4th After mounting your circuits on Terminal Cards, use Alden Standard Plug-in Bases, Housings, Bails for packaging.

Min. 7 & 9-pin BASES available, also 11-pin & 20-pin. BAILS & HOUSINGS or LIDS to match.

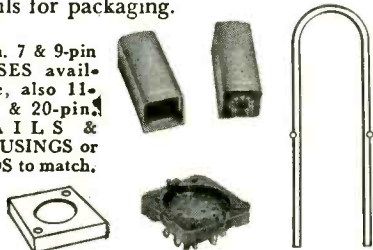

ALDEN PLUG-IN PACKAGES

Using standard Alden Plug-in Packaging Components you can mount a tremendous variety of circuits on chassis or in racks.



Alden "20" Rack Mounting Socket with extended ears that mount side by side and in multiple rows on U-Channels that accommodate 50 Alden "20" Plug-in Units illustrated, in 10½ x 19" rack mounting panel.

HOUSE PLUG-IN UNITS IN ALDEN BASIC UNI-RACKS

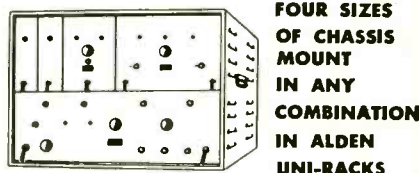
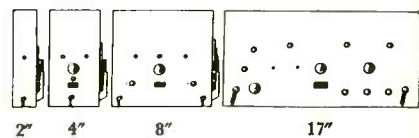

FOUR SIZES OF CHASSIS MOUNT IN ANY COMBINATION IN ALDEN UNI-RACKS

STACKED

Mounting all equipment in Alden Uni-Racks provides a uniform system easy to handle and ship. Can be installed and interconnected as fast as unloaded.



ALDEN BASIC CHASSIS

4th Fit Prepunched Cards carrying completed circuitry into Standard Alden Basic Chassis Body.

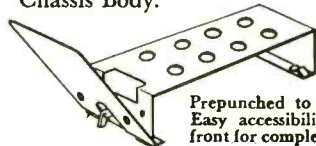

Prepunched to your specs. Easy accessibility at sides, front for completing wiring.



SERV-A-UNIT LOCK pulls in or ejects chassis.

SLIDE-IN BACK CONNECTORS

See description on opposite page.



ALDEN BASIC CHASSIS

with spares provides 30-second servicing for your unitized circuitry.

ALDEN UNIT CABLE

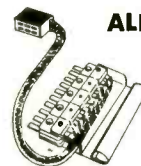

interconnects between Uni-racks or other major circuitry divisions. Quick, sure, coded means of isolating and restoring (with spare) inter-division circuits.

SEND FOR FREE "ALDEN HANDBOOK"

Your design and production men have always wanted these advantages:

1. Experimental circuitry can be set up with production components, cutting down debugging time.
2. Allows technicians, rather than engineer, to debug, by taking out unit.
3. Given the circuitry, nothing further to design—make up from standard Alden components.
4. Optimum circuit layout using standard terminal card.
5. Absolute minimum requirements of labor, materials, space.
6. The various sub-assemblies can be built concurrently on separate assembly lines.
7. No tooling costs—no delays—no procurement headaches.
8. Fewer prints—smaller parts inventory.
9. Can subcontract assemblies.

Your customers and sales force will welcome these advantages:

The big objection to electronic equipment—from the user's point of view—is that if it goes out of order he feels helpless. But you have a perfect answer when your equipment is made to Alden Standards of Plug-in Unit Construction because they assure **DEPENDABLE OPERATION**, as follows—

30-SECOND REPLACEMENT OF INOPERATIVE UNITS by plugging in available coded spares.

TROUBLE INSTANTLY INDICATED AND LOCATED by monitoring elements assigned to each functional unit.

TECHNICAL PERSONNEL NOT REQUIRED to maintain in operation, due to obvious color coding and fool-proof non-interchangeability of mating components.

TOOLESS MAINTENANCE made possible by patented Alden fasteners and plug-in locking and ejecting devices.

AIRMAIL SERVICE—Compact functional units practical to send airmail to factory for needed overhaul.

UNI-RACK FIELD HANDLING UNIT—groups functional units into stacking cabinets not exceeding one- or two-man handling capacity—go easily through windows, doors.

CONNECT AS FAST AS UNLOADED, by coded non-interchangeable unit cables plugged in between Uni-racks.

SEND FOR FREE 226-PAGE HANDBOOK

This 226-page Handbook describes fully the Alden System of Plug-in Unit Construction and the hundreds of components ready-made and completely tooled to meet your every requirement. It's a gold-mine for those designing electronic control equipment that is practical in manufacture; dependable in operation.

REQUEST YOUR COPY TODAY — SENT FREE!



for

INSULATING WATER SYSTEMS

for cooling High-Power Electron Tubes

For insulating the water system for water-cooled tubes, use of Lapp porcelain obviates troubles arising from water contamination and conductivity, sludging, and electrolytic attack of fittings.

Lapp porcelain, in pipe, coils and fittings is a completely vitrified, non-porous ceramic, non-deteriorating and chemically inert. It assures permanent cleanness and high resistance of cooling water, eliminates need for frequent inspection, changing of water or failure of the water system, provides positive cooling for long tube life.



LAPP PORCELAIN PIPE Inside pipe diameters of $\frac{3}{4}$, 1, $1\frac{1}{4}$, $1\frac{1}{2}$, 2 and 3". Available in straight pipe up to 60" lengths, 90° and 180° elbows, and fittings. All connections are swivel-type. Stand off insulators attach directly to bolts which hold pipe sections together. Metal fittings are bronze, polished heavy chrome plated.



LAPP PORCELAIN WATER COILS

Twin hole coils with inside pipe diameters $\frac{1}{4}$, $\frac{3}{4}$, 1". Single hole coils with inside pipe diameters $\frac{3}{8}$, $1\frac{1}{4}$, $1\frac{1}{2}$ ". Provide for flow of cooling water from 2 to 90 gal. per min. Coils provided with cast aluminum mounting bases, fittings, and three-foot sections of lead pipe for attachment to coil terminals.

Write for complete description and specifications. Radio Specialties Division, Lapp Insulator Co., Inc., Le Roy, N. Y.

Lapp

WHAT IS **HERMETIC** DOING ABOUT *Transistors?*

PLENTY! HERMETIC is now actively engaged in the development of hermetic seals for both point contact and junction transistors. These are being designed for plug applications, feed-through connections, fuse-type mounts, etc. Typical of other HERMETIC innovations, they will be noted for accuracy, sub-sub-miniature designs and a variety of shapes and flanges to fit every form of housing. In addition, it will be possible to use these new hermetic seals for both single and double mount.

WRITE for information and assistance concerning your own transistor problems. Please submit sketches indicating mounts, limiting dimensions, number and size of contacts and any other applicable specifications.

HERMETIC's 32-page catalog is also available with a wealth of data on hermetic seals. Your copy is free!

HERMETIC SEAL PRODUCTS CO.

33 South Sixth St., Newark 7, New Jersey

FIRST AND FOREMOST IN MINIATURIZATION



PROVEN LEADERSHIP in Precision Communication Equipment!

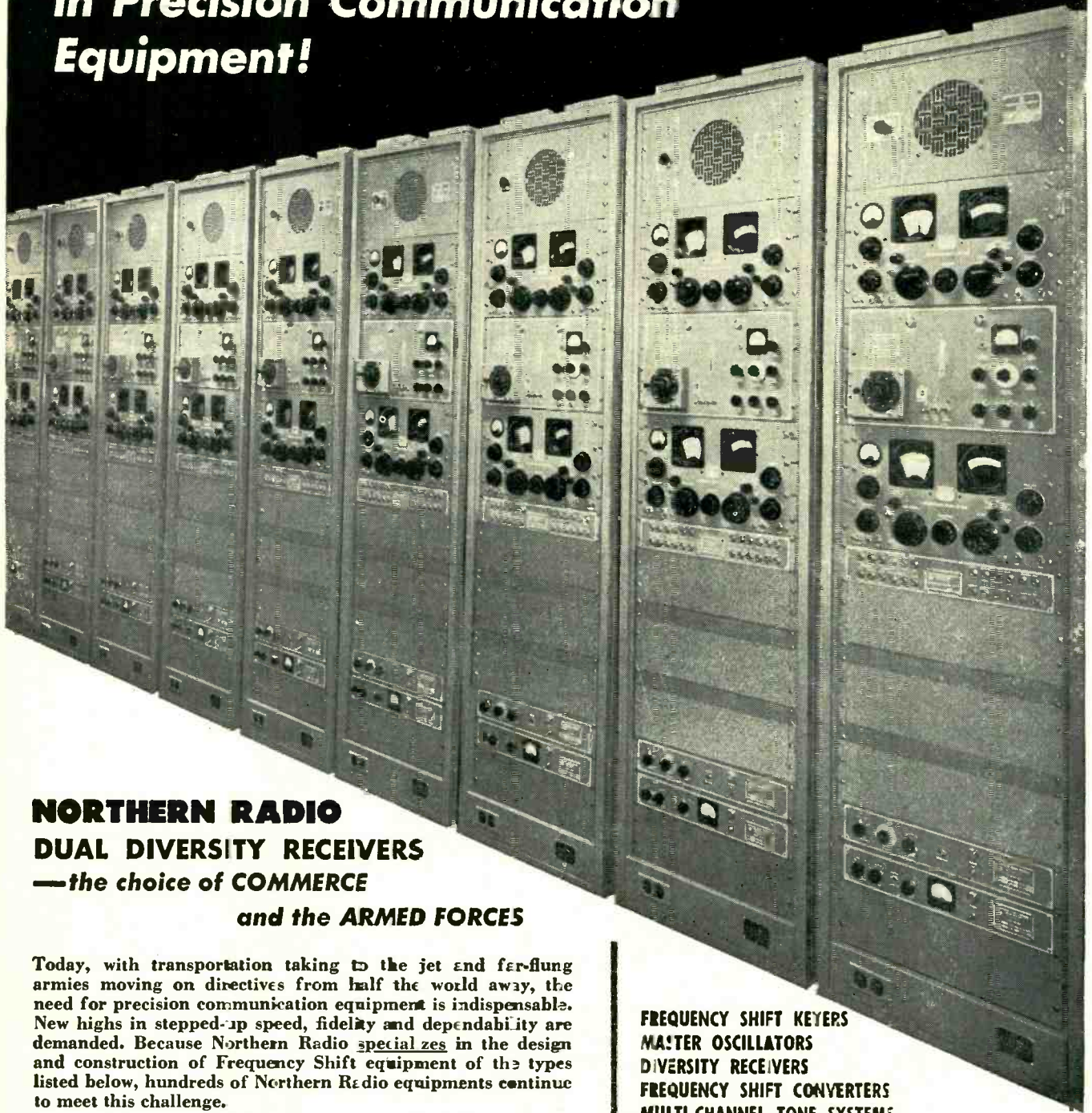

NORTHERN RADIO DUAL DIVERSITY RECEIVERS —the choice of **COMMERCE** and the **ARMED FORCES**

Today, with transportation taking to the jet and far-flung armies moving on directives from half the world away, the need for precision communication equipment is indispensable. New highs in stepped-up speed, fidelity and dependability are demanded. Because Northern Radio specializes in the design and construction of Frequency Shift equipment of the types listed below, hundreds of Northern Radio equipments continue to meet this challenge.

For example, the Dual Diversity Receivers of the type pictured above under construction, although designed and built by Northern Radio for commercial use, have been specified as is by the Armed Forces.

This is proven communications leadership—and only constant research and precision manufacture can produce it. Write for complete information.

FREQUENCY SHIFT KEYS
MASTER OSCILLATORS
DIVERSITY RECEIVERS
FREQUENCY SHIFT CONVERTERS
MULTI-CHANNEL TONE SYSTEMS
TONE KEYS
DEMODULATORS
RADIO MULTIPLEX SYSTEMS
MONITORS
TONE FILTERS
LINE AMPLIFIERS

Pace-Setters in Quality
Communication Equipment

NORTHERN RADIO COMPANY, inc.
147 WEST 22nd ST., NEW YORK 11, NEW YORK



Theatre 3-210, I.R.E. Show

VERY HIGH SPEEDS?

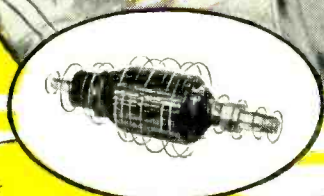
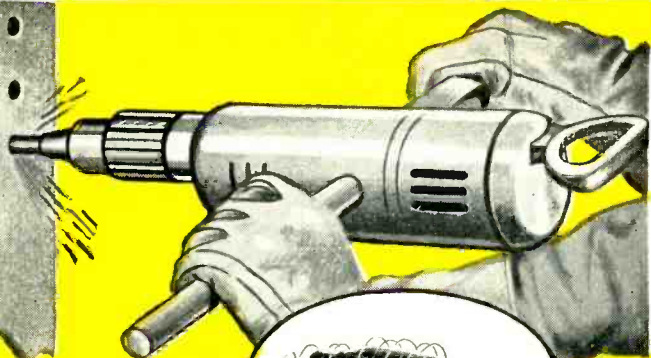

SEVERE VIBRATIONS?

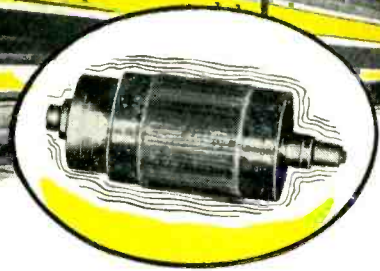
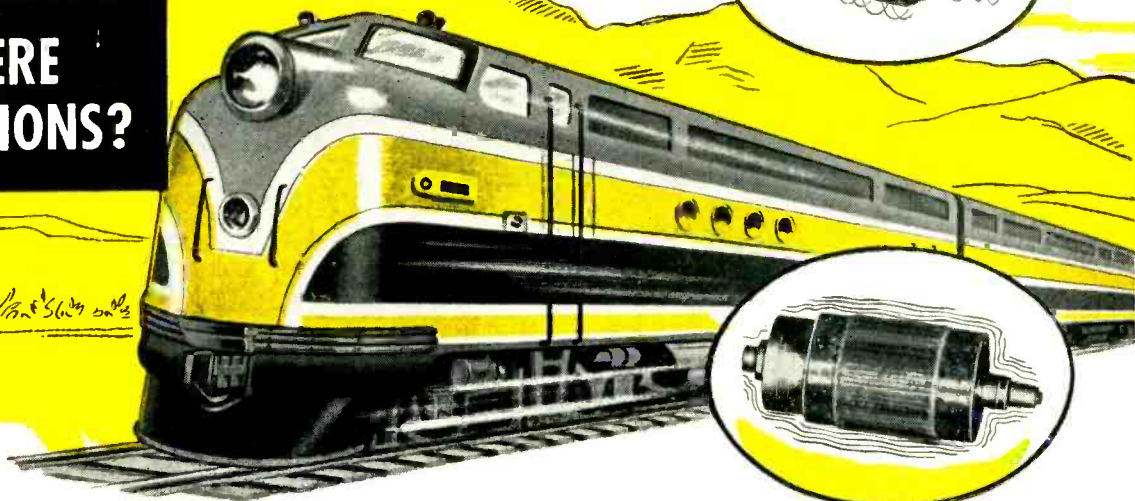

Impregnate Your Windings with this
new, high bonding strength varnish... **IRVINGTON NO. 140**

Lab tests prove it—field studies confirm it! The bonding strength of Irvington No. 140—even at Class “B” temperatures—far exceeds that of any other varnish developed or tested by Irvington.

Irvington No. 140 prevents coil or wire movements even on units operating at extremely high speeds or under severe vibration. In addition, it has high resistance to heat, oil and chemicals; excellent electrical properties; unusual stability in storage and dip tanks.

Use Irvington No. 140 on high-speed tool armatures, automotive armatures, Diesel electric traction motors and generators, high-speed motors and generators. Fill out the coupon for further facts.

Look to
IRVINGTON
for Insulation Leadership
INSULATING VARNISHES
VARNISHED CAMBRIC
VARNISHED PAPER
VARNISHED FIBERGLAS
INSULATING TUBING
CLASS “H” INSULATION



Send this convenient coupon now

Irvington

VARNISH & INSULATOR COMPANY

Irvington 11, New Jersey

Plants: Irvington, N. J.; Monrovia, Calif.; Hamilton, Ontario, Canada

Irvington Varnish & Insulator Co.
11 Argyle Terrace, Irvington 11, N. J.

EL-3/53

Gentlemen:
Please send me Technical Data Sheet on Irvington Insulating Varnish No. 140.

Name..... Title.....
Company.....
Street.....
City..... Zone..... State.....

How to fly a guided missile in your laboratory



Practically any electrical, mechanical or physical phenomenon—even the full flight of a guided missile—can be precisely re-created in the laboratory from Ampex magnetic tape recordings.

Ampex retains and plays back data in the same electrical form in which it is received, making its playback in effect equivalent to a rerun of the original test. But it has these added advantages: Data can be repeated at any time or place, can either be scanned or studied in whole or part, can be speeded up or slowed down, can be fed to automatic reduction systems. Furthermore, desired portions of the data can be reduced to oscillograph traces, pen recordings or any other form that could have been made at the time of the original test.

Besides the convenience and versatility of the data itself, Ampex Magnetic Recorders and the tape they use have these desirable physical qualities:

- Ampex Tape Recorders, being rugged, compact and portable, are usable where other equipment would not be feasible;
- Tape requires no processing, hence is immediately available for playback;
- Tape stores an enormous quantity of information at low cost and in minimum bulk.
- Ampex Tape Recorders cover extremely wide frequency range:
Model 306 — 0 to 5000 cycles/sec.
Model 307 — 100 to 100,000 cycles/sec.
Model 303 — Pulse width modulation
Many other models are also available.

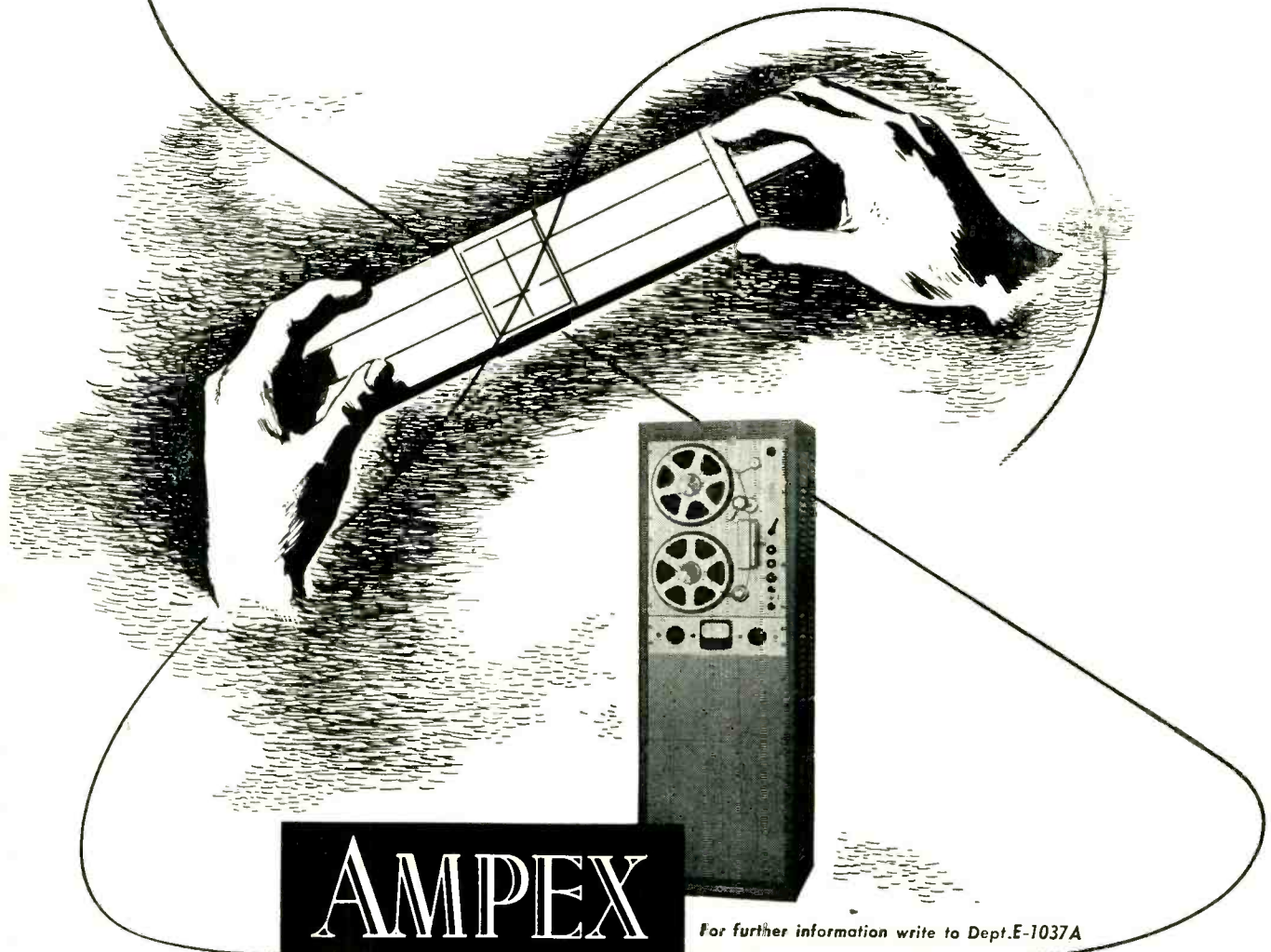

AMPEX

MAGNETIC RECORDERS

For further information write to Dept. E-1037A

AMPEX ELECTRIC CORPORATION
934 CHARTER STREET • REDWOOD CITY, CALIF.

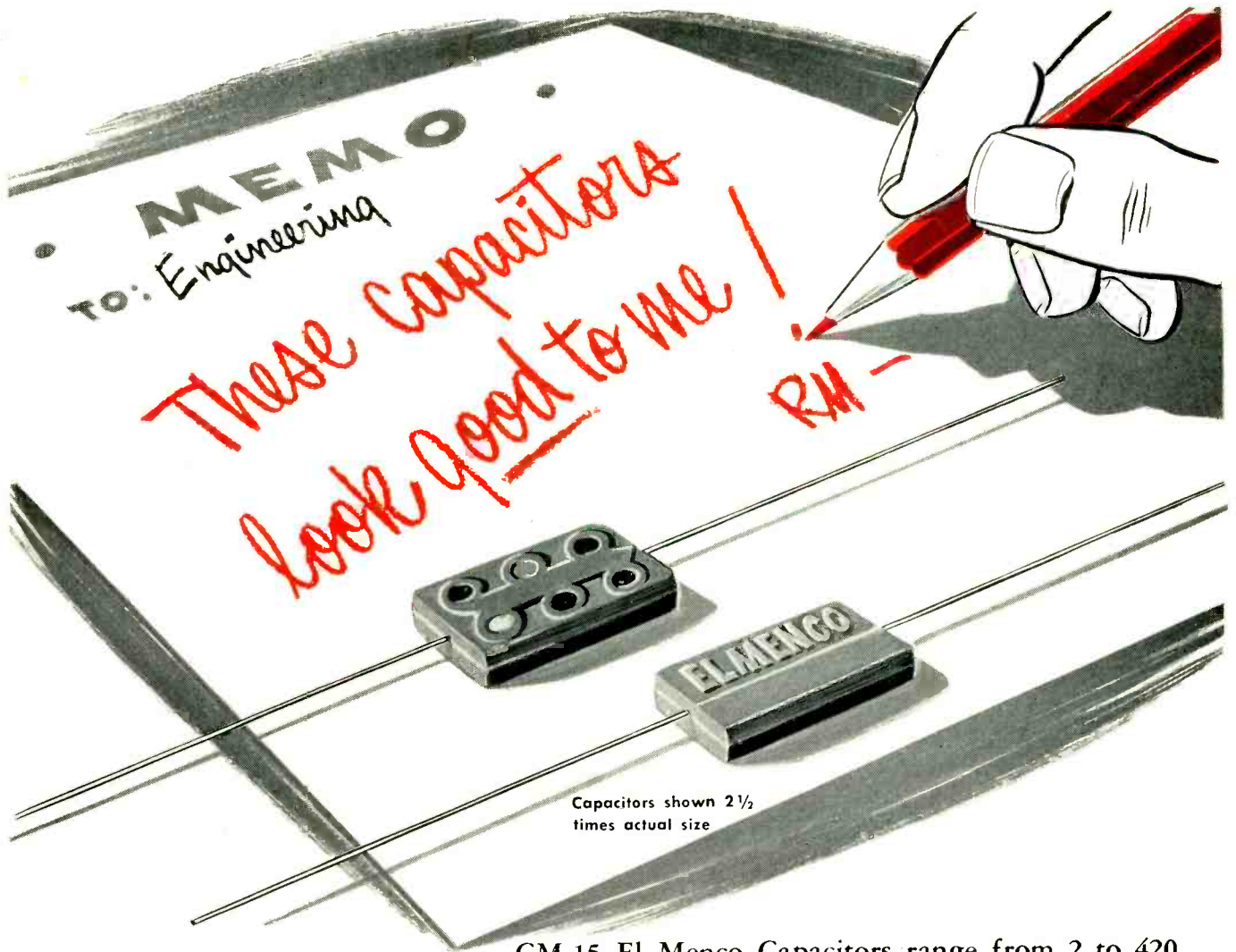

Capacitors shown 2½ times actual size

CM-15 El Menco Capacitors range from 2 to 420 mmf. at 500 vDCw . . . measure only 9/32" x 1/2" x 3/16" . . . but they're

PRETESTED at 1000V!

ALL fixed mica El Menco Capacitors are *factory-tested at double their working voltage*. So, you can be sure they'll stand up. They also meet all significant JAN-C-81 specifications. This means that you can specify them with confidence for all military or civilian electronic applications.

Our Type CM-15 silvered mica capacitors reach 525 mmf. at 300 vDCw. Our other types — silvered and regular — provide capacities up to 10,000 mmf. Want samples for testing? *The Electro Motive Manufacturing Co., Inc., Willimantic, Conn.*

Jobbers and distributors are requested to write for information to Arco Electronics, Inc., 103 Lafayette St., New York, N. Y. — Sole Agent for Jobbers and Distributors in U. S. and Canada.

WRITE FOR FREE SAMPLES AND CATALOG ON YOUR FIRM'S LETTERHEAD



MOLDED MICA

EL-Menco

CAPACITORS

MICA TRIMMER

Foreign and Electronic Manufacturers Get Information Direct from our Export Dept. at Willimantic, Conn.

THE ELECTRO MOTIVE MFG. CO., INC.

WILLIMANTIC, CONNECTICUT



AIDS FOR THE

ELECTRONIC ENGINEER-DESIGNER



Visit our exhibit at
BOOTHS 3-504, 505
Third Floor
I.R.E. SHOW

CAN YOU USE THESE UNUSUAL
QUALITIES IN YOUR PRECISION
EQUIPMENT?

Specify EVANOHM^{*} RESISTANCE WIRE

for high specific resistance...low temperature
coefficient and low thermal EMF to copper...
great stability over wide temperature ranges

EVANOHM is recommended for all
precision applications where complete
dependability for a wide temperature

range is essential. It is especially well
suited for guided missiles, rockets
and other airborne equipment.

EVANOHM^{*} RESISTANCE CURVE, CHARACTERISTICS AND PROPERTIES

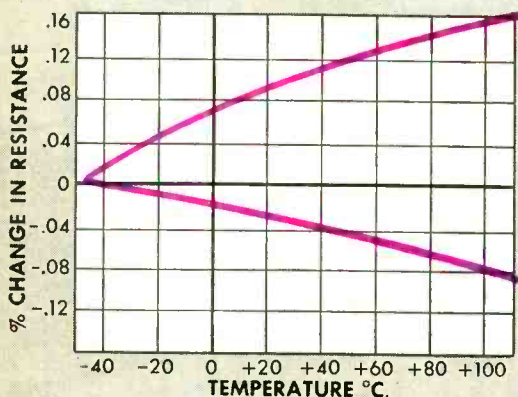

1. Analysis — Ni 74.75%, Cr 20.00%, Al 2.75%, Cu 2.50%.
2. Excellent corrosion resistance.
3. Resistivity — 800 ohms per circular mil foot (134 microhm cm.)
4. Temperature coefficient of electrical resistance — Plus or minus .00002 ohms per ohm per degree centigrade between minus 50°C. and plus 105°C.
5. Thermal E.M.F. vs. Copper — .0025 mv. per degree between —50 and 105°C. (max.)
6. Non-magnetic.
7. High tensile strength in fine sizes — 150,000 to 200,000 p.s.i.
8. It may be readily welded or brazed and soft soldered with special care.
9. Available in: (a) Bare wire sizes .0009 and larger. (b) Enameled, Formex, Cotton, Silk, Nylon and glass insulated wire in sizes .0015 to .0113.

EVANOHM — a patented, exclusive alloy produced by

* REGISTERED
TRADE NAME



WILBUR B. DRIVER CO.
RIVERSIDE AVENUE, NEWARK 4, NEW JERSEY

PROSPERITY IN THE USA: How Wealthy Are We?

Again, how prosperous *are* the people of the United States?

This is the third of a series of messages devoted to this crucially important and much-debated question. The first two messages dealt with what has been happening to our national income, both in terms of its growth and how it is divided among individuals.

This third message deals with what has been happening to the resources — factories, farms, mines, and equipment of all kinds — out of which income is created. It deals with what economists call our wealth.

It is possible for a nation to enjoy apparent prosperity for a time by rapidly exhausting its resources. But to sustain prosperity over the long pull a nation must see that its wealth is not dissipated. Hence what is happening to our wealth now is a harbinger of what is going to happen to our prosperity later on.

How Wealth is Measured

It is often asserted that the most vital element in a nation's wealth is its people. There is a lot in this idea. For example, the full value of a country's hospital and surgical equipment depends on its physicians and their skill in handling the equipment.

However, no one has ever devised a satisfactory way to put a value on human beings.

So people are omitted from calculations of national wealth. So, too, is military equipment. It is regarded as basically destructive and hence not a real addition to wealth. Otherwise, the wealth of a nation is calculated in terms of the dollar value of its physical resources.

The following chart shows the wealth of the U.S.A. at various intervals during the past 50 years. For the period through 1948 the figures come from a pioneering study by Raymond Goldsmith of the National Bureau of Economic Research, which is widely regarded as the foremost organization in its field. The figures since 1948 are estimated. To remove the effect of price changes, all of the wealth figures are calculated in 1929 prices.

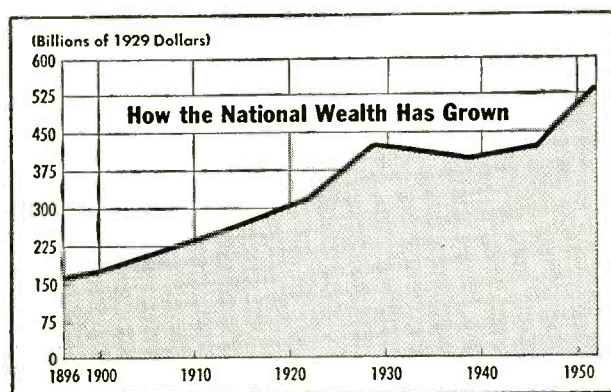

From this chart one fact stands out clearly. It is that since 1929 our national wealth has not been increasing as steadily as it did during

earlier periods. Indeed, in 1946 our total national wealth was actually less than it was in 1929. Only in the last six years have we been able to make any consistent additions.

Even these gains are less impressive when the growth in our population is taken into account, as illustrated by the following chart.

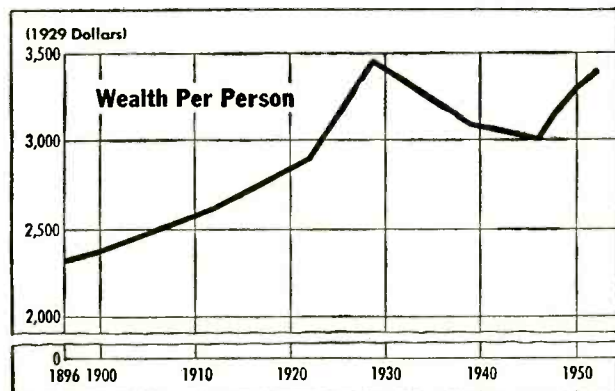

This chart makes it clear that when the nation's wealth is divided by the population, we are slightly worse off per person today than we were in 1929. This is the case in spite of the large additions to our national wealth since 1946.

Depression and war are the two principal reasons we have made no progress in increasing our wealth per person since the 1920s. The depression brought mass unemployment and greatly reduced production which ruled out any increase in wealth. During World War II and again during the post-Korean mobilization program, U.S. production has reached new peaks. But a considerable portion of this record breaking output has been in the form of military equipment, which is not included in an accounting of national wealth. Consequently, we have been unable to regain the level of wealth per person which we had in 1929.

A Brake of Prosperity

What does this failure to raise our wealth per person mean? It means that we have fewer

resources with which to create income for each individual. It means that we have made no progress in the crucial task of assuring future increases in prosperity.

As the second editorial in this series demonstrated, we have gone so far in equalizing individual incomes that "the possibilities of increasing the income of the rest of the people by 'soaking the rich' have largely disappeared." From now on the only promising way to increase our individual incomes is to increase our national earning power.

During the past four years it has taken about \$3.60 of national wealth to yield \$1 of income after taxes. This is a low figure for the wealth needed. Prior to World War II there were long periods when it took at least \$5 of national wealth to produce \$1 of national income. The experts in this field are by no means certain that it will not again take \$5 rather than \$3.60 of wealth to increase income by \$1.

But let us assume that \$3.60 of wealth will suffice to provide \$1 of income in the years ahead. If by 1960—seven years from now—the income of the average American is to be increased from about \$1490, where it stands at present, to \$2000, we must add \$310 billion to the national wealth. This is nearly three times as much as we have added to our wealth since the end of World War II, seven years ago.

Because we have made large additions to our productive equipment in recent years, fears are frequently expressed that we shall soon be plagued by an excess of such equipment. But the facts about our national wealth do not support this conclusion. They indicate that we still have ahead of us a tremendous job of increasing our resources if the American standard of living is again to resume the steady climb which was interrupted by depression and war.

McGraw-Hill Publishing Company, Inc.

sci'ence (si'ens), n.(OF., fr. L. scire to know)

-- and knowing the advantages of
automatic voltage regulation,
this man depends on

STABILINE

Automatic VOLTAGE REGULATORS

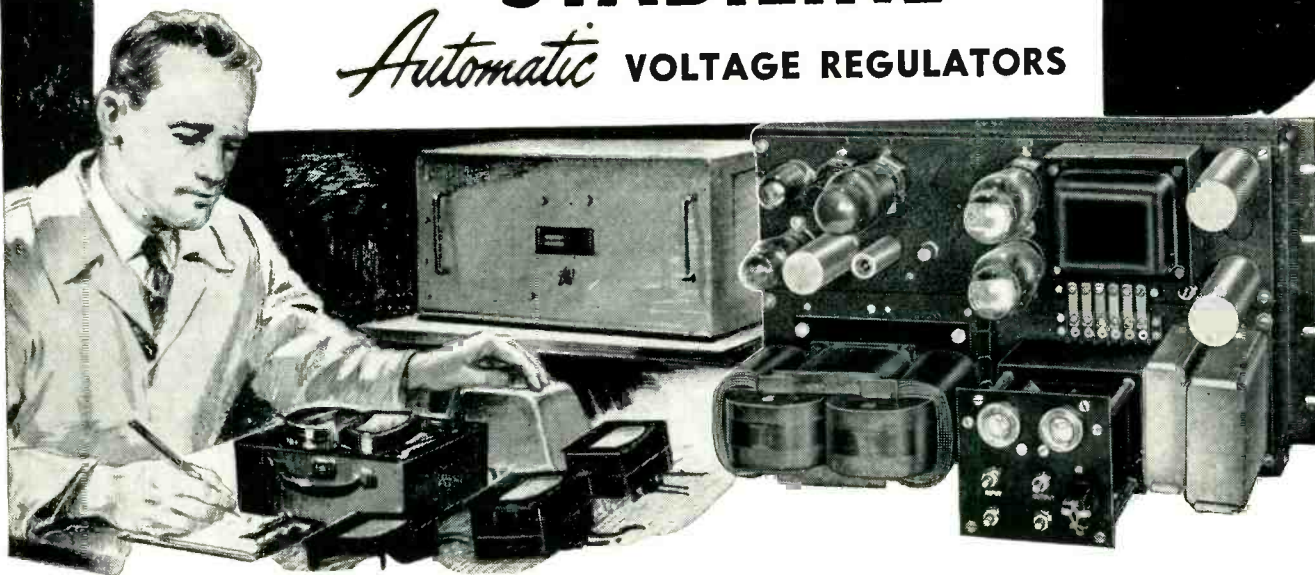

Scientific developments are based on EXACT knowledge. To obtain exact data in tests involving electrical circuitry, input voltages must remain constant. To insure dependable, accurate results . . . to eliminate the need for rerunning experiments because a change in input voltage has invalidated the first run . . . depend on a STABILINE Automatic Voltage Regulator to maintain constant voltage regardless of line or load changes.

Offering the finest in automatic voltage regulation equipment, The Superior Electric Company offers two types of STABILINE Automatic Voltage Regulators. Type IE (Instantaneous Electronic) is completely electronic with no moving parts. Correction — when compared with other types — may be considered instantaneous. Regulation and stabilization are excellent; maximum change in output voltage will not exceed $\frac{1}{4}$ of 1% for any or all variations in operating conditions. Waveform distortion never exceeds 3%.

Type EM (Electro Mechanical) is an electro-mechanical device with inherent characteristics of zero waveform distortion, high efficiency and faster correction than most types of automatic voltage regulators. It is ideal for controlling large industrial loads. Both types are available in numerous capacities and ratings.

SPECIAL MODELS of STABILINE Automatic Voltage Regulators can be supplied to meet individual requirements. Specializing exclusively in the design, development and manufacture of voltage control equipment, The Superior Electric Company is thoroughly experienced to help you in studying your exact needs and recommending the right equipment to serve you best.

FOR ENGINEERING
INFORMATION and
CATALOG, WRITE TO
203 MAE AVENUE



THE SUPERIOR ELECTRIC CO.
BRISTOL, CONNECTICUT



- POWERSTAT LIGHT DIMMING EQUIPMENT
- STABILINE AUTOMATIC VOLTAGE REGULATORS
- 5-WAY BINDING POSTS
- VOLTBOX A-C POWER SUPPLIES
- POWERSTAT VARIABLE TRANSFORMERS
- VARICELL D-C POWER SUPPLIES

PROBLEM:

To obtain uniformity of performance between two thermostat elements used in thermal type demand meters

SOLUTION:

General Plate provided the solution with identically matched TRUFLEX[®] Thermostat Metal Coils

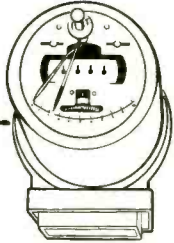

Manufacturers of thermal type demand meters were faced with the problem of obtaining two thermostat elements for each meter that had identical performance characteristics.

When these coils were made individually each one had to be tested 100% and then paired together with the coil that had, as near as possible, the same operating characteristics for use in each meter. This meant costly testing procedures, rejects and often unsatisfactory performance.

The problem was presented to General Plate, whose engineers quickly found the solution. *Matched coils* were made from adjacent sections of a single *Truflex* thermostat metal strip as illustrated. Since the coils were made from identical material, they were automatically *paired* with the same uniform operating characteristics.

You, too, can save by using *Truflex* Thermostat Metals. Here's why —

When you buy General Plate *Truflex* Thermostat Metal you can be sure that not only the first lot meets specifications but every succeeding order is a twin . . . has identical characteristics to the original lot . . . whether it be days, months or years apart.

Advanced General Plate production methods insure positive consistency in tolerances, grain structures, expansion, hardness, etc. It assures maximum uniformity of materials which reduces costly rejects and guarantees highest quality performances.

General Plate products include . . . precious metals clad to base metals, base metals clad to base metals, silver solders, composite contacts, buttons and rivets, *Truflex*[®] thermostat metals, *Alcuplate*[®], platinum fabrication and refining, #720 manganese age-hardenable-alloy. Write for Catalog PR700. It gives information on these and other General Plate products.

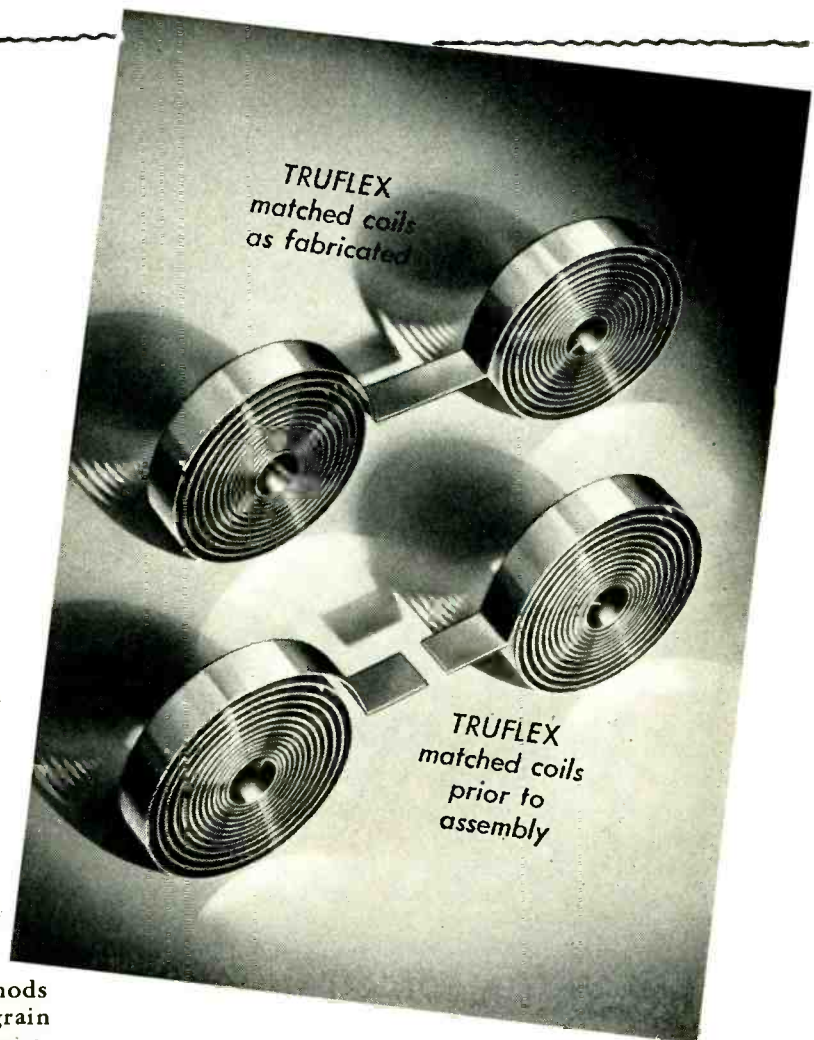

Have You a Composite Metal Problem?
General Plate can solve it for you

METALS & CONTROLS CORPORATION
GENERAL PLATE DIVISION
33 FOREST STREET, ATTLEBORO, MASS.

"ZERO" PHASE SHIFT

COMPUTER REFERENCE VOLTAGE TRANSFORMERS

LESS THAN 0.1 MILLIRADIAN PHASE SHIFT

±.02% ACCURACY OF VOLTAGE RATIOS

Samples of this type transformer were tested by the **BUREAU OF STANDARDS** and found to meet our guaranteed accuracy.

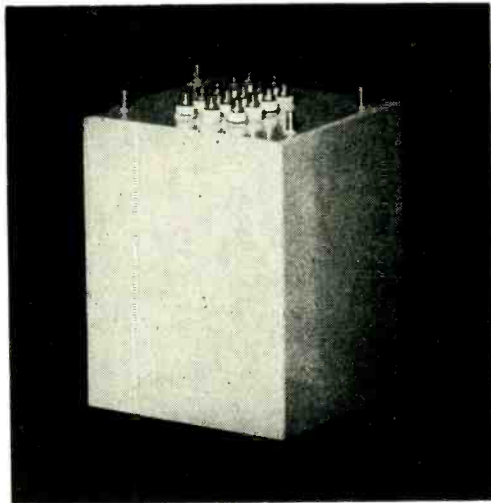

A radical new approach to the design and manufacture of precision transformers, makes it possible to have minimum errors.

These transformers are not stock items but manufactured to your requirements.

Write for data sheet so that we can offer a preliminary design, price estimate and delivery.

MIL-T-27 TRANSFORMERS

TOROIDAL TRANSFORMERS

VIDEO TRANSFORMERS

INSTRUMENT TRANSFORMERS

INPUT-INTERSTAGE-OUTPUT

PULSE TRANSFORMERS

POWER TRANSFORMERS

MAGNETIC AMPLIFIERS



INDUCTANCE MEASUREMENT — Any operating condition can be simulated in the range of 0-1000V A.C. and 0-5 Amps. D.C.



DEVELOPMENT OF AUDIO TRANSFORMERS—All characteristics of audio transformers in the range of .01 cycle to 10 Mega-cycles can be measured and evaluated.



POWER LOSS MEASUREMENT—Losses as low as 15 micro watts in the range of 20 to 200 K.C. can be measured and analyzed and possible improvements effected.



PULSE TRANSFORMER DESIGN—The cut and try methods commonly used in the design of pulse transformers has been largely supplanted by the use of special equipment.



TRANSFORMERS INC.

532 NORTH STREET

Telephone ENDICOTT 8-1801

ENDICOTT, NEW YORK

STATIC ELECTROMAGNETIC DEVICES

To meet the strictest requirements of both
Government and Industry, specify

JAN TYPE



Germanium Diodes

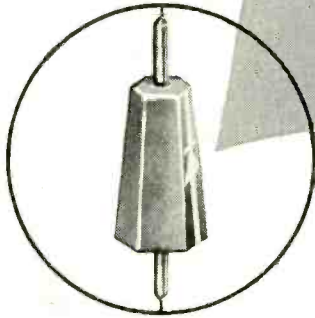

Precision made, easy to handle, easy to assemble — the tapered shape shows polarity at a glance! Make Radio Receptor Germanium Diodes your first choice in the large variety of electronic circuits where JAN types are a must.

1N69
1N70
1N81

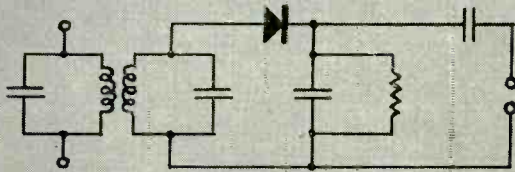

DETECTOR CIRCUIT

TYPICAL USES

COMPUTER CIRCUITS
CLAMPING CIRCUITS
RF DETECTORS
CONTROL CIRCUITS
DISCRIMINATORS

MODULATORS
NOISE ELIMINATORS
CLIPPERS
LEVEL SETTERS
RESTORER CIRCUITS

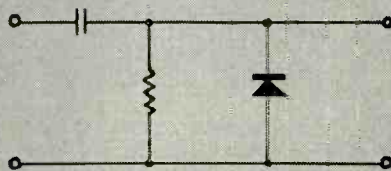

CLAMPING CIRCUIT

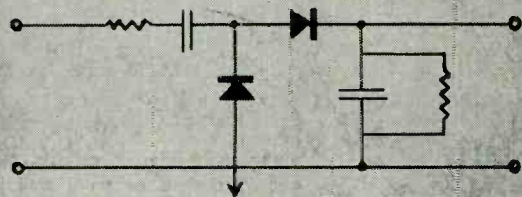

COUNTING RATE CIRCUIT

JAN TYPES • ALL VALUES MEASURED AT 25°C.

CODE NO.	Min. Forward Current at 1 Volt (MA)	Max. Reverse Current (Micro-Amperes)	*Average Rectified Current (MA Max.)	†Minimum Reverse Volts	Max. Cont. Reverse Operating Volts
1N69	5.0	50 @-10V 850 @-50V	40	75	60
1N70	3.0	25 @-10V 300 @-50V	30	125	100
1N81	3.0	10 @-10V	30	50	40

Rectification efficiency: 35% minimum in 100 MC test circuit.

* Average half wave rectified current at 60 CPS and 25°C. Consult us for ratings at other conditions.

† For zero dynamic resistance.

Radio Receptor Germanium Diodes may hold the answer to many of your problems. Our engineers will be glad to study your requirements and submit their recommendations. Many other types, both standard and special, are available . . . Write us!

**Seletron
and Germanium
Division**

RADIO RECEPTOR COMPANY, INC.



Since 1922 in Radio and Electronics



SALES DEPT: 251 West 19th Street, New York 11, N. Y. • FACTORY: 84 North 9th Street, Brooklyn 11, N. Y.

staged scenes...
 romantic spar...
 ng highballs, genius, the funny blond wig which! (Continued on page

RADIO AND TELEVISION

By JOHN CROSBY
 Music and Pictures

is attempting with considerable
 h pictures on television what he
 well with sound on the radio.
 after all, is not
 ot—or shouldn't
 e show, though
 ements of both.
 g from radio to
 ed a formidable
 was essentially a
 stral show. Voices
 s don't lend them-
 ography very well.
 ouldn't transform
 an ordinary song-
 st without ruining
 f his show which
 ously built up over
 dio.



John Crosby

camera swooped
 quite a prod
 The char
 pretty we
 just eve
 of the
 orche
 tackl
 ica,
 Jew
 a s
 C
 and
 one
 of
 a s
 half
 one.
 chest
 occasi
 for my
 On h
 would be
 edy. But
 pictures—p
 harmonizing
 pure televisio

think, solved the problem very well.
 work on the Waring show is, in the
 f the word, art photography. The dif-
 ficulty between it and the other kind of art pho-
 tography is simply that the pictures move. But
 the combination of light and shadow, of

and the cameras
 are **GPL**

"camera work on
 the Waring Show is
 ... art photography"
JOHN CROSBY



Columnist John Crosby, discussing not electronics but end results on the screen, calls the Waring show on CBS Television "pure television." Such results come from three things: Waring imagination, CBS Television techniques, and GPL camera chains.

"The pictures move . . . are a combination of light and shadow, of form and substance that catch and hold the eye."

A GPL extra in engineering accounts for much of this. Camera and operator may be moving on a boom in a 3-dimensional pattern. Yet the operator has only to concentrate on aim, while the director at the Camera Control Unit adjusts the iris for light and shadow.

"The cameras seem to roam at will on that show with a fluidity and grace almost never found in the movies."

That fluidity is engineered into GPL cameras. Dual focus knobs, push-button lens change with auto-

matic focus adjustment, precision pan and tilt motions—all these enable camera men and directors to capture the full scope of a show. Fantasy or stark realism, sports in sunlight or drama in stage shadows . . . GPL cameras put top quality pictures into the line.

Whatever your type of operation, whether you need one chain or six, investigate these cameras designed for modern television. Rugged but lightweight, they are easily interchangeable between studio and field. Circuit design guarantees consistent high quality.

Station owners like their economy; camera crews like their velvet smoothness and operating ease; maintenance men like their long service life.

For full details, write, wire or phone

NEW STATION OPERATORS:
 Without obligation, GPL engineers will be glad to study your entire studio needs for cameras, projectors, film chains and video recorders.

General Precision Laboratory



INCORPORATED
 PLEASANTVILLE NEW YORK
 Cable address: Prelab

Export Department:
 13 East 40th St., New York City
 Cable address: Arlab

TV Camera Chains • TV Film Chains • TV Field and Studio Equipment • Theatre TV Equipment

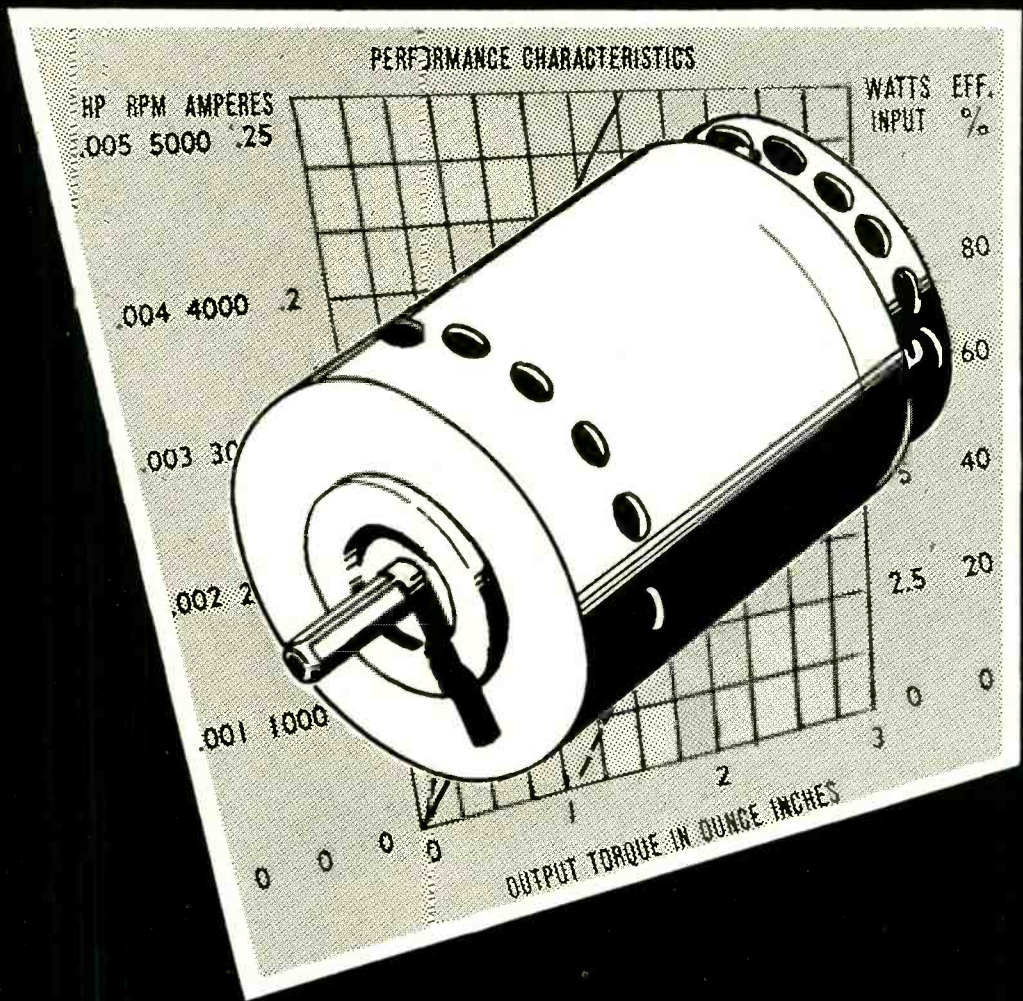

DON'T FORGET --- MARCH 23 - 26!
 Bring your motor, fan and blower
 questions to the IRE SHOW. Booth
 #4315 has the answers.



AIR MARINE MOTORS INC.

3939 MERRICK ROAD, SEAFORD, L. I., N. Y.

WAntagh 2-7309

ENGINEERED FOR YOUR PRODUCT

this is your product

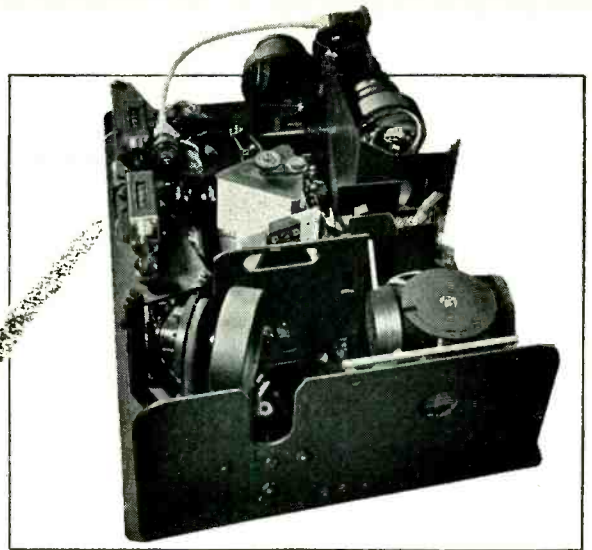

Above: Perkin-Elmer infrared spectrometer
—in its Karp-built cabinet, below.

but

this is your "trademark"



Your customers see the *outside* of your product a lot more than they see its inner mechanisms. Does it have the appearance of a precision instrument? Does it look the part?

In other words, do you get the same perfection in your cabinets that your engineers build *inside*? Smooth flawless welded seams? Perfectly fitted doors and panels...exactly the finish you specify...and, above all, absolute uniformity between all cabinets?

Karp customers do—and they know that this painstaking sheet metal fabrication doesn't mean high prices.

They know that our vast assortment of available dies

eliminates the need for much costly tooling. They know that our plant—the length of three city blocks—with its modern facilities, offers custom production at prices that are surprisingly low.

You'll find, as others have, that we can produce to exacting tolerances precisely the type of cabinet you require.

In large quantity or small. Steel or aluminum. Any type of welding. Painstaking hand finishing. Prompt shipment.

Visit our plant and see these things for yourself if you wish. We welcome your visit. Write for our bulletin.

KARP METAL PRODUCTS CO., INC.
215 63rd ST., BROOKLYN 20, N. Y.

MOST COMPLETE FACILITIES FOR LARGE AND SMALL RUNS OF
ENGINEERED SHEET METAL FABRICATION

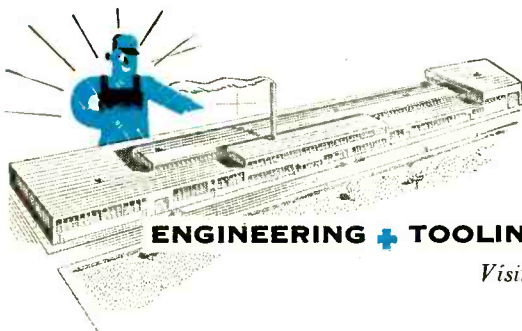

ENGINEERING + TOOLING + PRODUCTION + FINISHING =

Visit us at Booth 510-512, first floor
RADIO ENGINEERING SHOW

KARP

COMPLETE CIVILIAN LINE

Exceptionally good delivery cycle on civilian orders due to tremendous mass production facilities.

TYPE C45-70

NEW HIGH QUALITY MINIATURIZED "DIME-SIZE" CIVILIAN CONTROL—Performance Fully Equals Larger Types.
 TYPE 70, 3/4" diameter variable composition resistor. Wattage ratings .3 watt for resistances through 10,000 ohms, .2 watt with 350 volts maximum across end terminals for resistances over 10,000 ohms. Also available in concentric shaft tandem construction C45-70 as shown above.

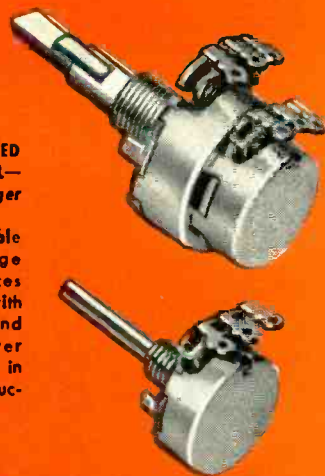

TYPE C2-45

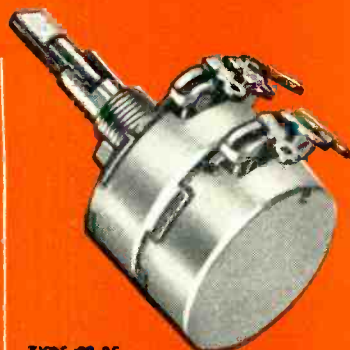

TYPE C2-35

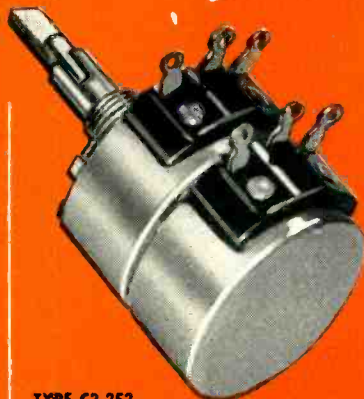

TYPE C2-252



TYPE C2-25



TYPE GC-45, 15/16" diameter variable composition resistor. Wattage rating: 1/2 watt for resistances through 10,000 ohms, 1/3 watt for resistances over 10,000 ohms through 100,000 ohms, 1/4 watt with 500 volts maximum across end terminals for resistances over 100,000 ohms. Available with or without illustrated attached switch and in concentric shaft tandem construction C2-45 as shown above.



TYPE GC-35, 1 1/8" diameter variable composition resistor. Wattage rating: 3/4 watt for resistances through 10,000 ohms, 2/3 watt for resistances over 10,000 ohms through 25,000 ohms, 1/2 watt with 500 volts maximum across end terminals for resistances over 25,000 ohms. Available with or without illustrated attached switch and in concentric shaft tandem construction C2-35 as shown above.



TYPE GC-252, 2 watt, 1 17/64" diameter variable wirewound resistor. Available with or without illustrated attached switch and in concentric shaft tandem construction C2-252 as shown above.

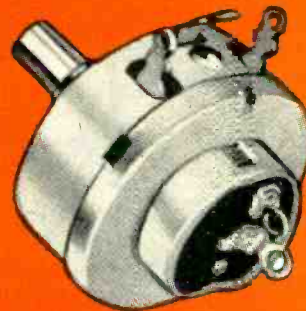

TYPE GC-25, 4 watt, 1 17/32" diameter variable wirewound resistor. Available with or without illustrated attached switch and in concentric shaft tandem construction C2-25 as shown above.

Typical concentric shaft tandem with panel and rear sections operating separately from concentric shafts (TYPE C45-70 ILLUSTRATED). Similar construction available for all military resistors.

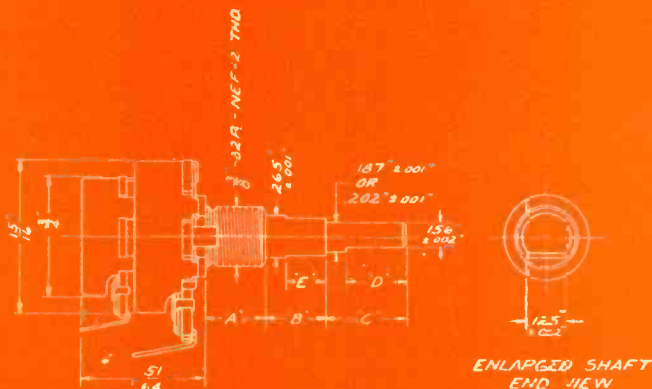

TYPE C45-70

ENLARGED SHAFT END VIEW

REPRESENTATIVES

Henry E. Sanders
 McClatchy Bldg.
 69th & Market St.
 Upper Darby, Penna.
 Phone: Flanders 2-4420

IN CANADA

C. C. Meredith & Co.
 Streetsville, Ontario

SOUTH AMERICA

Jose Luis Pontet
 Buenos Aires, Argentina
 Montevideo, Uruguay
 Rio de Janeiro, Brazil
 Sao Paulo, Brazil

OTHER EXPORT

Sylvan Ginsbury
 8 West 40th Street
 New York 18, N. Y.

W. S. Harmon Company
 1638 So. La Cienega Blvd.
 Los Angeles 35, California
 Phone: Bradshaw 2-3321

John A. Green Company
 6815 Oriole Drive
 Dallas 9, Texas

Specialists in



NEW 38-PAGE ILLUSTRATED CATALOG—

Describes Electrical and Mechanical characteristics, Special Features and Constructions of a complete line of variable resistors for military and civilian use. Includes dimensional drawings of each resistor. Write today for your copy.

TYPE 45, (JAN-R-94, Type RV2)
 1/4 watt, 15/16" diameter variable composition resistor. Also available with other special military features not covered by JAN-R-94 including concentric shaft tandem construction. Attached switch can be supplied.

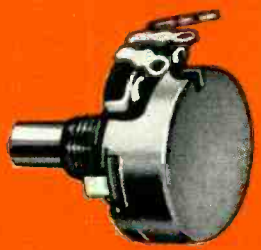

TYPE 35, (JAN-R-94, Type RV3)
 1/2 watt, 1 1/8" diameter variable composition resistor. Also available with other special military features not covered by JAN-R-94 including concentric shaft tandem construction. Attached switch can be supplied.



TYPE 252, (JAN-R-19, Type RA20)
 2 watt, 1 17/64" diameter variable wirewound resistor. Also available with other special military features not covered by JAN-R-19 including concentric shaft tandem construction. Attached switch can be supplied.

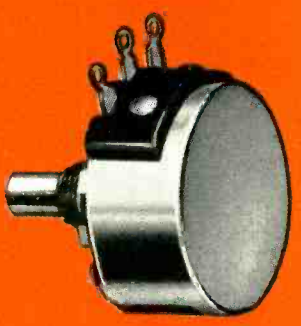

TYPE 25, (JAN-R-19, Type RA30)
 (May also be used as Type RA25)
 4 watt, 1 17/32" diameter variable wirewound resistor. Also available with other special military features not covered by JAN-R-19 including concentric shaft tandem construction. Attached switch can be supplied.

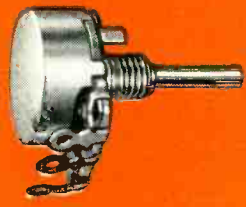
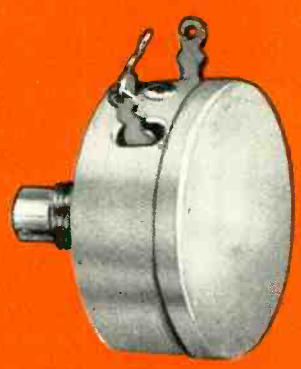

TYPE 65, (Miniaturized)
 1/2 watt 70°C, 3/4" diameter miniaturized variable composition resistor.

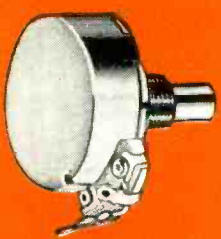

TYPE 90
 1 watt 70°C, 15/16" diameter variable composition resistor. Attached switch can be supplied. Also available in concentric shaft tandem construction.

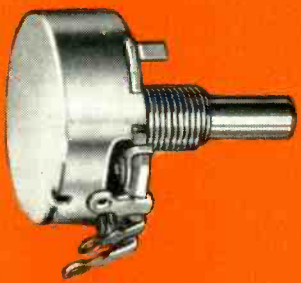

TYPE 95, (JAN-R-94, Type RV4)
 2 watt 70°C, 1 1/8" diameter variable composition resistor. Also available with other special military features not covered by JAN-R-94 including concentric shaft tandem construction. Attached switch can be supplied.

COMPLETE MILITARY LINE

Immediate delivery from stock on 189 types including JAN-R-94 and JAN-R-19 types of variable resistors.

See the complete CTS military and civilian lines of variable resistors at the

IRE SHOW

Grand Central Palace, New York City

MARCH 23-26, 1953

BOOTH 4-608

UNPRECEDENTED PERFORMANCE CHARACTERISTICS

Specially designed for military communications equipment subject to extreme temperature and humidity ranges. -55°C to +150°C...aridity to saturation.



CHICAGO TELEPHONE SUPPLY Corporation

ELKHART • INDIANA

Precision Mass Production of Variable Resistors

Burton Browne Advertising

Bomac

PRESSURIZING WINDOWS

AVAILABLE FOR ALL WAVE GUIDE SIZES

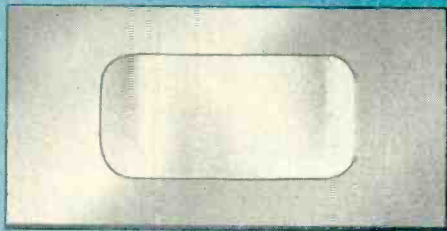

Low Q Broad Band Match
 Low Insertion Loss
 Temperature Range -55°C to 100°C
 30 lb./sq. in. Pressure Differential
 For Choke Mounting or Soldering
 Directly to Guide

Write for Pressurizing Window Data Sheets

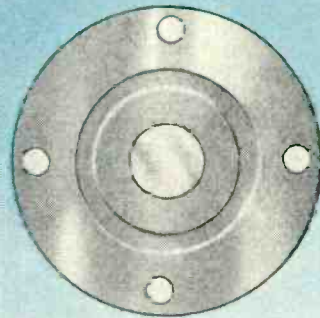
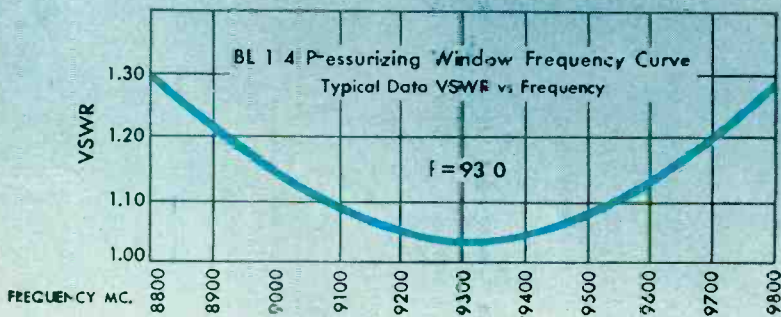
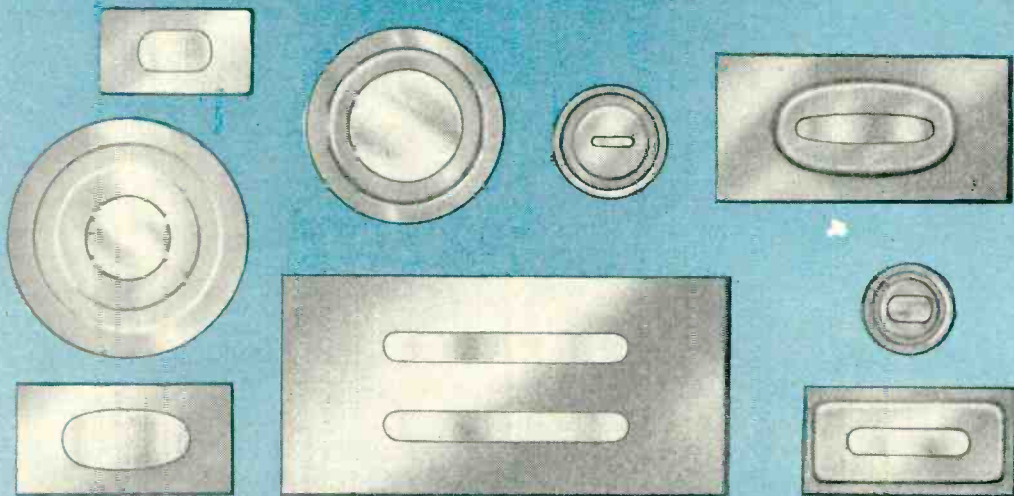

We invite your inquiries regarding

- ENGINEERING
- DEVELOPMENT
- PRODUCTION

Bomac Laboratories

INCORPORATED

BEVERLY, MASSACHUSETTS

Catalog on request.
 Write (on your company letterhead)
 Dept. D BOMAC
 Laboratories, Inc.,
 Beverly, Mass.



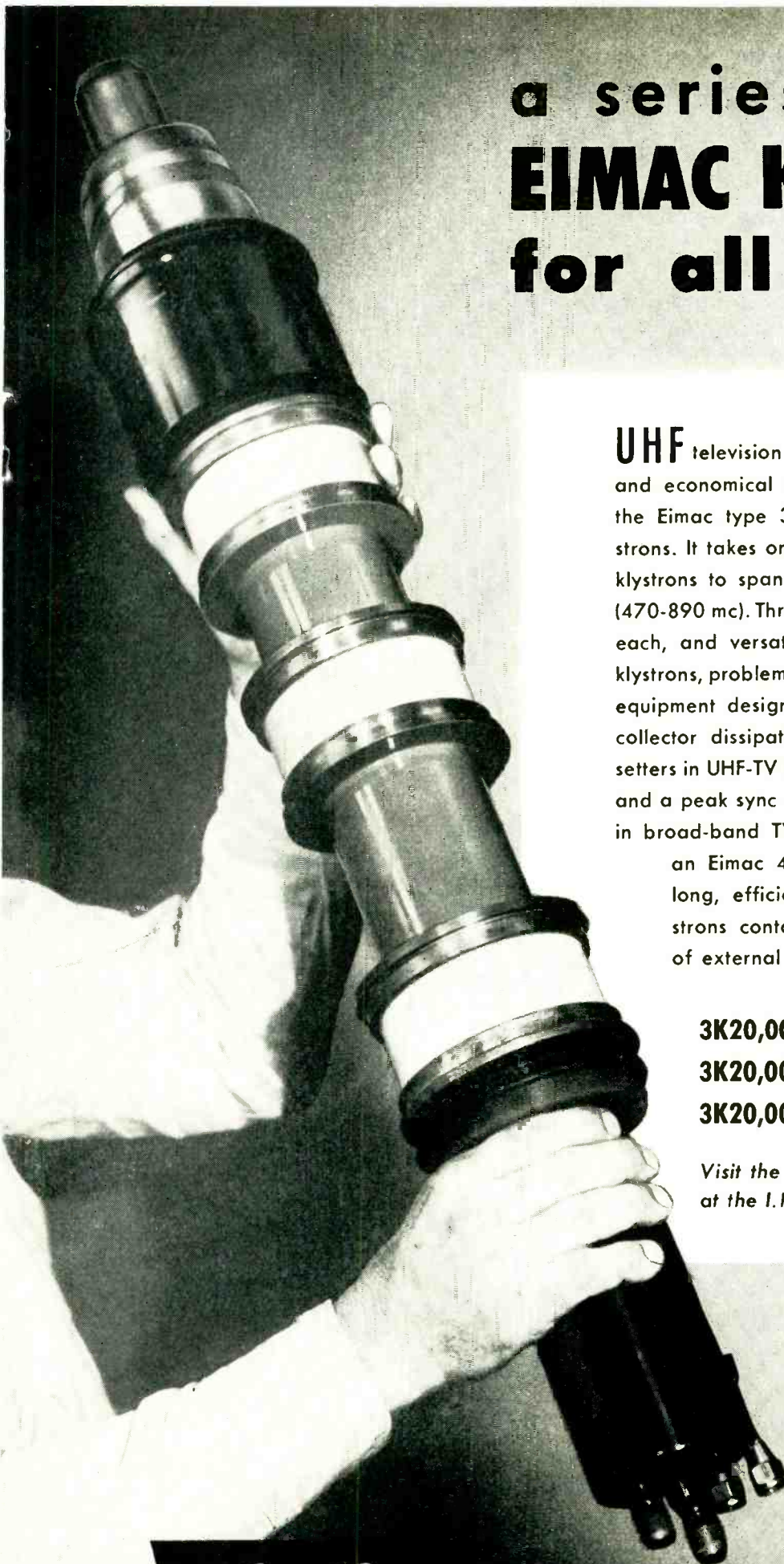

a series of three **EIMAC KLYSTRONS** for all **UHF-TV!**

UHF television is now practical, dependable and economical through the development of the Eimac type 3K20,000L five kilowatt klystrons. It takes only three of these high-power klystrons to span the entire UHF-TV spectrum (470-890 mc). Through the size, only 45 pounds each, and versatility of the type 3K20,000L klystrons, problems of manufacture, supply, and equipment design are minimized. Rated at a collector dissipation of 20 kw., these pace-setters in UHF-TV have a power gain of 20 db., and a peak sync output of five to six kilowatts in broad-band TV operation when driven by an Eimac 4X150G. Constructed to give long, efficient life, the 3K20,000L klystrons contain exclusive Eimac features of external tuning and ceramic cavities.

3K20,000LA—Channels 14 thru 32

3K20,000LF—Channels 33 thru 55

3K20,000LK—Channels 56 thru 83

*Visit the Eimac display in Booth 1-519
at the I.R.E. show.*

**The Five Kilowatt Klystrons are
another Eimac contribution to
electronic progress**

Eimac
TUBES

EITEL-McCULLOUGH, INC.
SAN BRUNO • CALIFORNIA

FOR EXTREME STABILITY.. *Bliley* CRYSTALS PLUS *Bliley* TEMPERATURE STABILIZERS

Crystal frequency stability is a finite factor determined by ambient temperature variation. Bliley Temperature Stabilizers, used with Bliley Crystals, are thermostatically controlled ovens engineered to deliver extreme stability regardless of ambient temperature changes.

TCO SERIES

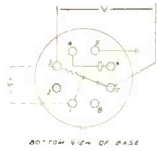
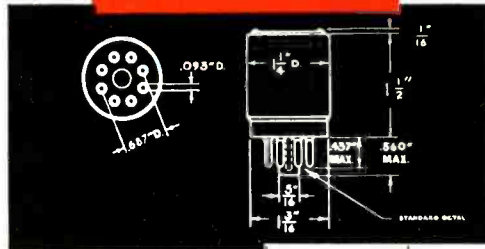

NOTE: BROKEN LINES INDICATE CONNECTIONS TO PILOT LAMP IS USED IN CIRCUIT TO SHUT DOWN WHEN HEATER IS ENERGIZED

Designed specifically for use with Bliley types BH6A and SR11 crystal units. Standard models are supplied as indicated:

Model	Heater Voltage	Watts	Crystal Sockets	Control Temperature
TCO-1A	6.3	5.5	1	75°C or 85°C
TCO-1C	24 or 26.5	7.75	1	75°C or 85°C
TCO-2	6.3	5.5	2	75°C
TCO-2	6.3	7.9	2	85°C
TCO-2D	24 or 26.5	7.75	2	75°C or 85°C

TYPES TC911-TC92-TC93

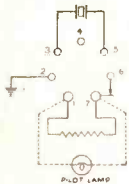
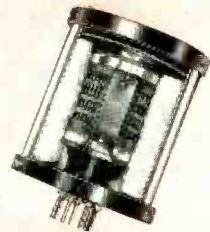
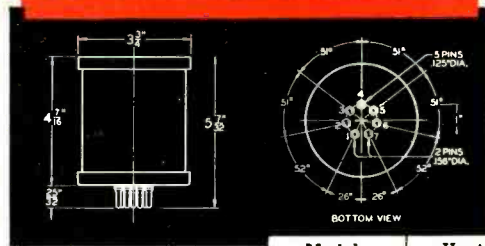

Designed specifically for use with Bliley Crystal units. Standard models are supplied, for crystal types, as indicated:

Model	Heater Voltage	Watts	Crystal Group	Control Temperature
TC911	115	10	B	70°C
TC92	6.3	10	A	60°C
TC93	18	10	A	60°C

Crystal Group A Types FM6, BH81A, MC7, AR4, AR5
Crystal Group B Types BH8, MC75, MS46A

TYPE TC97

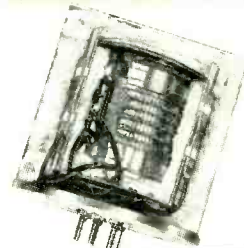
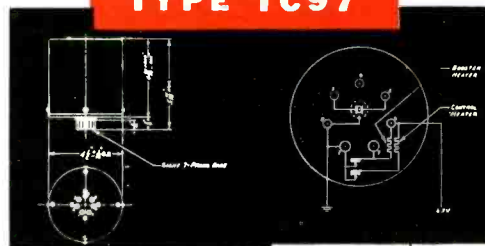

Exceptional temperature stability is provided by two separate heaters, individually regulated by separate thermostats. Ambient temperature variations are first minimized by outer stage (booster) heater with final regulation by inner stage (control) heater.

Model	Heater Voltage	Watts	Crystal Group	Control Temperature
TC97	6.3	11	A	75°C

Crystal Group A Types FM6, BH81A, MC7, AR4, AR5

BLILEY ELECTRIC COMPANY
UNION STATION BUILDING, ERIE, PENNSYLVANIA

ARCO TRANSFORMER

ATLAS Engineering Co., Inc.

BALTIMORE TRANSFORMER

LEADING MANUFACTURERS find it

GOOD BUSINESS to specify

Heldor

Ballastan CORPORATION

Burnell & Company

THE BERKSHIRE TRANSFORMER CORPORATION

Gramer Transformer Corp

GTC

Re-Gilbert

KENYON TRANSFORMER CO., Inc.

BEST BEST MFG CO

K-V TRANSFORMER

FTR

THE TOLSON ELECTRIC

MTG

ONTARIO INDUSTRIES

In General ELECTRONIC INDUSTRIES

Magnavox

THE TOLSON ELECTRIC

Utah

LEONARD ELECTRIC PRODUCTS

Transformers INC.

THE TOLSON ELECTRIC

Sparkes Farzian

SAKOR

SYLVANIA

how about YOU?

- SAVE TIME
- SAVE MONEY
- SAVE INVENTORY LOSSES
- SAVE PRODUCTION HEADACHES
- INCREASE PRODUCTION CAPACITY

Take advantage of Heldor's complete assembly service — its compression-type hermetic seal bushings ASSEMBLED in can covers to meet MIL-T-27 or commercial specifications — ready for your final assembly. Send specifications or prints on your can, bushing or assembly requirements. You'll save plenty!

Just off the Press! Write today for your copy of the new Heldor "Cans and Covers" catalog.

— Heldor —
COMPLETE ASSEMBLY SERVICE

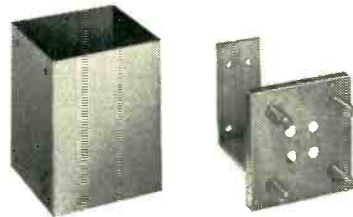

CANS

HERMETIC SEAL BUSHINGS



HELDOR MANUFACTURING CORPORATION

HELDOR BUSHING & TERMINAL CO., INC.

225 Belleville Ave.,

Bloomfield, N. J.

SEE HELDOR AT BOOTH 2-111, 1953 IRE SHOW, GRAND CENTRAL PALACE

RMC

By-Pass DISCAPS

are Rated at 1000 Working Volts

**Modern Engineering Requires This
"HEAVY DUTY" CERAMIC CAPACITOR**

The heavier ceramic dielectric element made by an *entirely new process* provides the necessary safety factor required for line to ground applications or any application where a steady high voltage condition may occur. Designed to withstand constant 1000 V. A. C. service.

It is wise to specify RMC "HEAVY DUTY" by-pass DISCAPS throughout the entire chassis because they *cost no more* than ordinary lighter constructed units.

Specify them too, for your own peace of mind, with the knowledge that they can "take it." And if you want proof — request samples.

"RMC DISCAPS"
The Right Way to Say
Ceramic Condensers

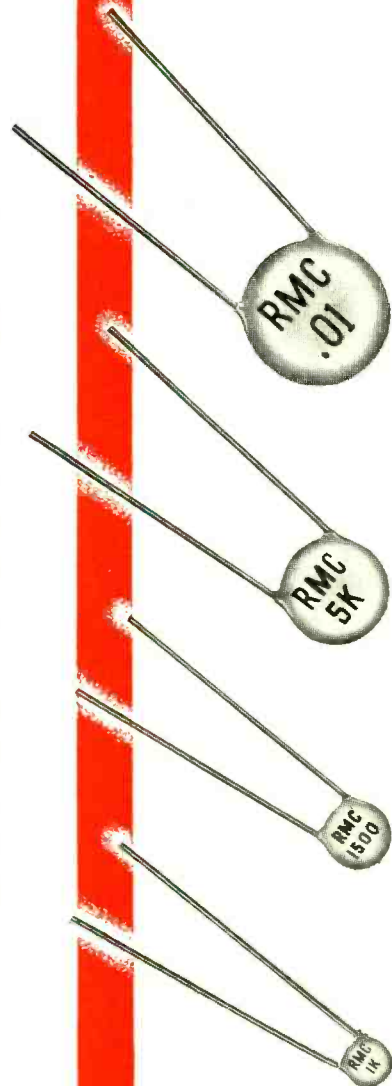

**A New Development from the
RMC Technical Ceramic Laboratories**

DISCAP
CERAMIC
CONDENSERS

RMC

RADIO MATERIALS CORPORATION

GENERAL OFFICE: 3325 N. California Ave., Chicago 18, Ill.

FACTORIES AT CHICAGO, ILL. AND ATTICA, IND.

DISTRIBUTORS: Contact Jobber Sales Co., 146 Broadway, Paterson 1, N. J.

How to Get Microwave Components You Can Trust

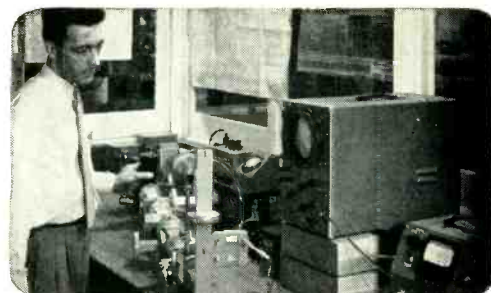
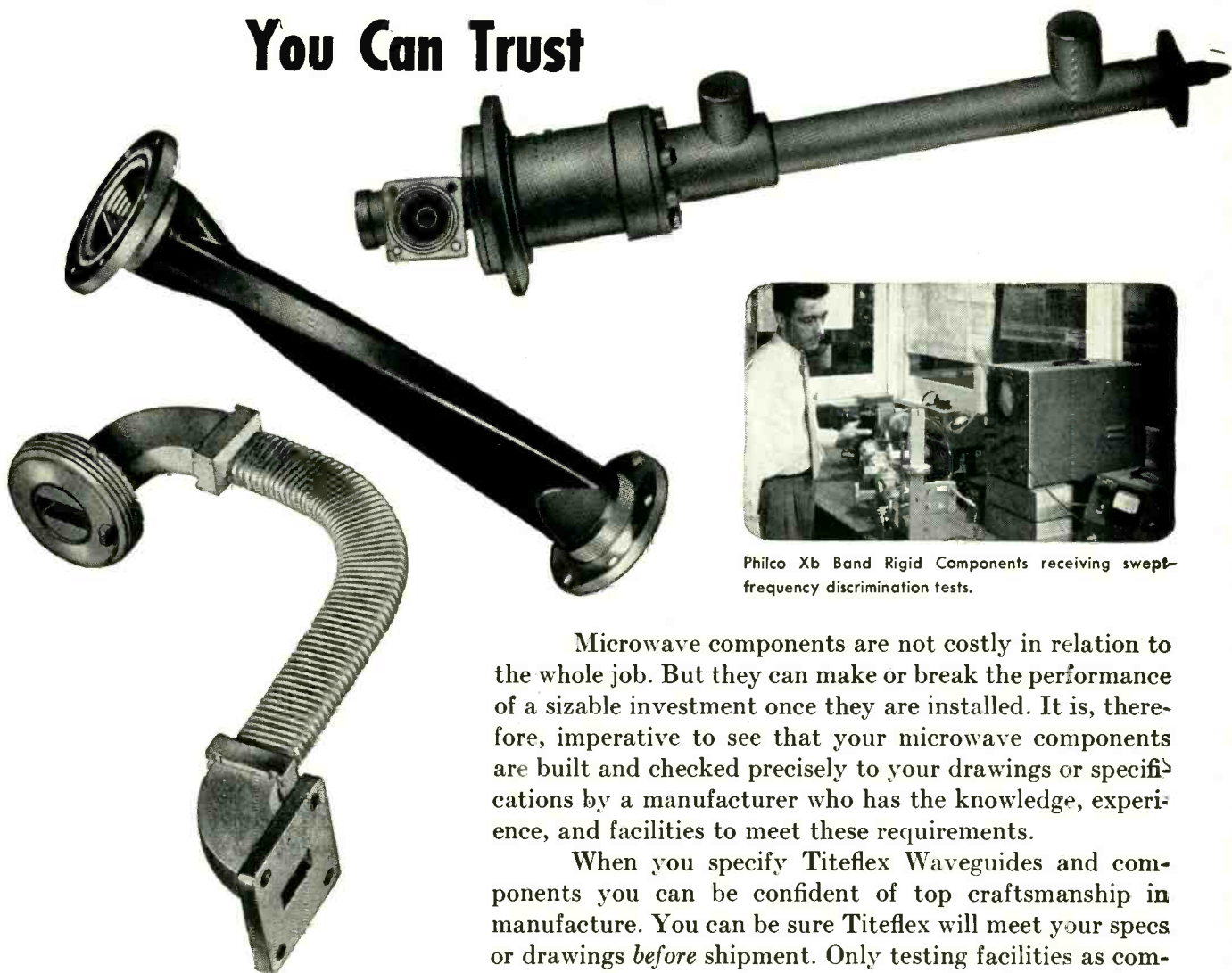

Philco Xb Band Rigid Components receiving swept-frequency discrimination tests.

Microwave components are not costly in relation to the whole job. But they can make or break the performance of a sizable investment once they are installed. It is, therefore, imperative to see that your microwave components are built and checked precisely to your drawings or specifications by a manufacturer who has the knowledge, experience, and facilities to meet these requirements.

When you specify Titeflex Waveguides and components you can be confident of top craftsmanship in manufacture. You can be sure Titeflex will meet your specs or drawings *before* shipment. Only testing facilities as complete as Titeflex maintains could give you this assurance.

Titeflex inspection often saves you the time and cost of duplicate inspection. It is the final step in the production of custom-engineered, precision-manufactured microwave components.

Titeflex engineering and production facilities are available to help you solve your Microwave problems from original design to final production.

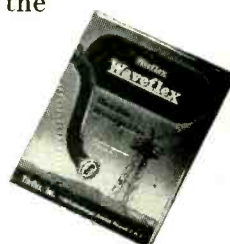

Milling the rubber-like compound which is subsequently molded over Titeflex flexible waveguides to protect them.

Have you this catalog of Titeflex microwave components? Use coupon in sending for your free copy.

Let Our Family of Products Help Yours

Titeflex

✓ Check products you are interested in.



SEAMED AND SEAMLESS METAL HOSE

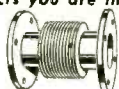

PRECISION BELLOWS



IGNITION HARNESS



IGNITION SHIELDING

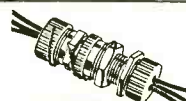

ELECTRICAL CONNECTORS



RIGID AND FLEXIBLE WAVE GUIDES

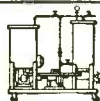

FILTERS



FUSES

TITEFLEX, INC.
524 Frelinghuysen Ave.
Newark 5, N.J.

Please send me without cost information about the products checked at the left.

NAME _____

TITLE _____

FIRM _____

ADDRESS _____

CITY _____ ZONE _____ STATE _____



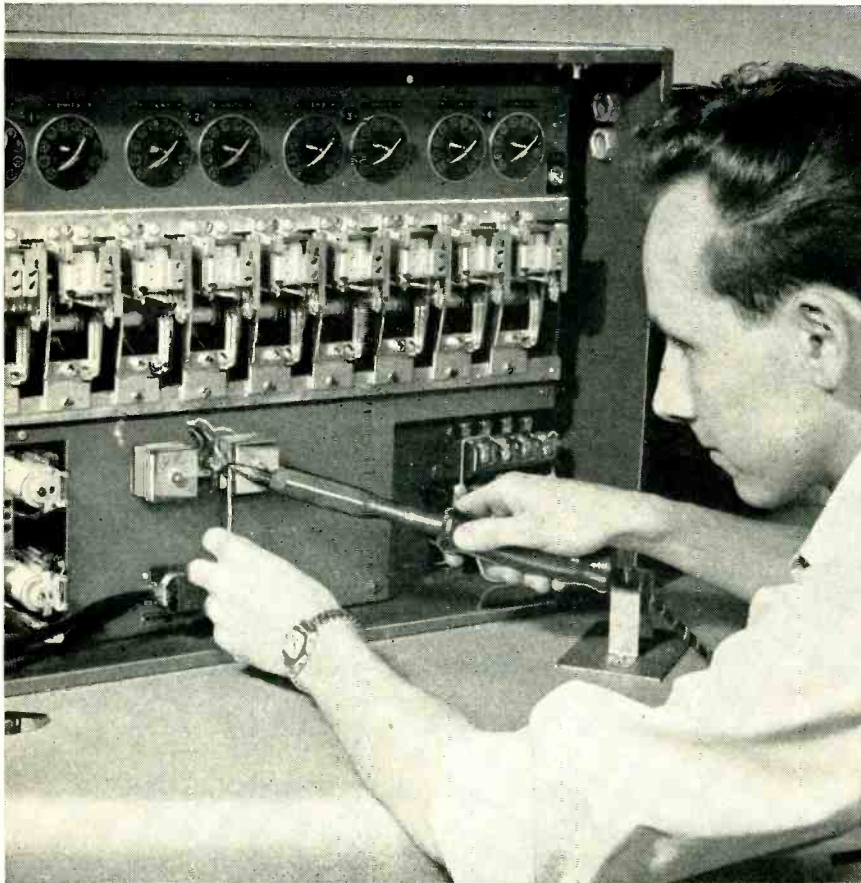

Operator installs space-saving G-E Selenium Rectifiers on monitor sequence count-controller.

G-E Selenium Rectifiers Cut Costs and Save Space

"We greatly simplified a serious space problem, increased current capacity by 30 per cent, and even saved money as well, by our use of General Electric Selenium Rectifiers in our product," reports Production Instrument Company, Chicago, Illinois, large manufacturers of electrical counters.

G-E SPECIALISTS HELPED. These benefits resulted from an improved installation plan designed by G-E Rectifier Specialists, working with Production Instrument Company, and using compact, G-E Selenium Rectifiers. A change to several small unit stacks replacing one large assembly made installation easier and faster, and more economical.

LONG LIFE. Low forward resistance means low forward voltage drop in

G-E Selenium Rectifiers, and combined with their high reverse resistance, assures low heat loss with resulting slow aging and long life.

COMPACT and lightweight, G-E Selenium Rectifiers save space for other components, and provide uninterrupted and long-lasting performance. They make a major contribution to your products' quality and consumer acceptance.

FOR MORE INFORMATION, consult your nearest G-E Apparatus Sales Office or write for the Selenium Rectifier Application Manual GET-2350. And you can test G-E Selenium Rectifier quality for yourself, with GEA-5524A, Testing Directions for Selenium Rectifiers. Address Section 461-26, General Electric Company, Schenectady 5, N. Y.

You can put your confidence in—

GENERAL  ELECTRIC

METALLIC RECTIFIER FACTS FOR ENGINEERS AGING

by C. E. Hamann

Frequently the aging of selenium rectifiers is thought of as an increase in forward resistance resulting in a reduction of voltage output.

Aging of metallic rectifiers is defined by the American Institute of Electrical Engineers as "any persisting change (except failure) which takes place for any reason in either the forward or reverse characteristic."

Therefore, it is a mistake to think of aging only as a change in forward resistance. Aging can, and often does, affect the reverse characteristics of a selenium cell. With age the cell may lose its ability to block voltage. When this occurs, the back leakage increases, and consequently the losses are increased and the operating temperature rises.

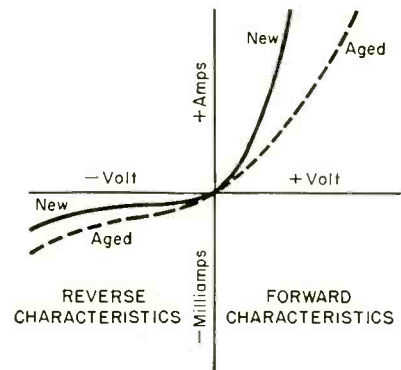

Therefore, if you wish to determine the quality of a rectifier cell, it is necessary to consider the forward and reverse characteristics and the effect that aging has on both characteristics.

A high quality rectifier cell must have initially a low forward resistance and high back resistance. In addition, a high quality rectifier cell must show a minimum of change in both forward and reverse characteristics with time.

If you would like information on how you can test initial characteristics of selenium stacks, write for the bulletin mentioned at left.

C. E. Hamann
General Electric Company

EXPANDING PRODUCTION

in Toroids & Filters

At every management meeting in Burnell & Company there is an unseen but highly respected visitor. He is the spectre of all our customers and his opinions carry weight. Recently he suggested that in addition to our other expansion measures that we must find a way to improve deliveries for emergency and special sample orders. Our solution is certainly not original but no less effective.

Burnell & Company's new sample department has been able to produce audio filters from proverbial 'scratch' to the customer's waiting hands in as little as ten days!

Frankly, this cannot always be accomplished but our average has been ranging between three to four weeks for emergency samples and four to six weeks for regular prototypes instead of the former twelve weeks of the pre-sample department days.

Adding this to our new winding department and our new testing and finishing departments the sum total has been a *still* better product at a better delivery than ever before.

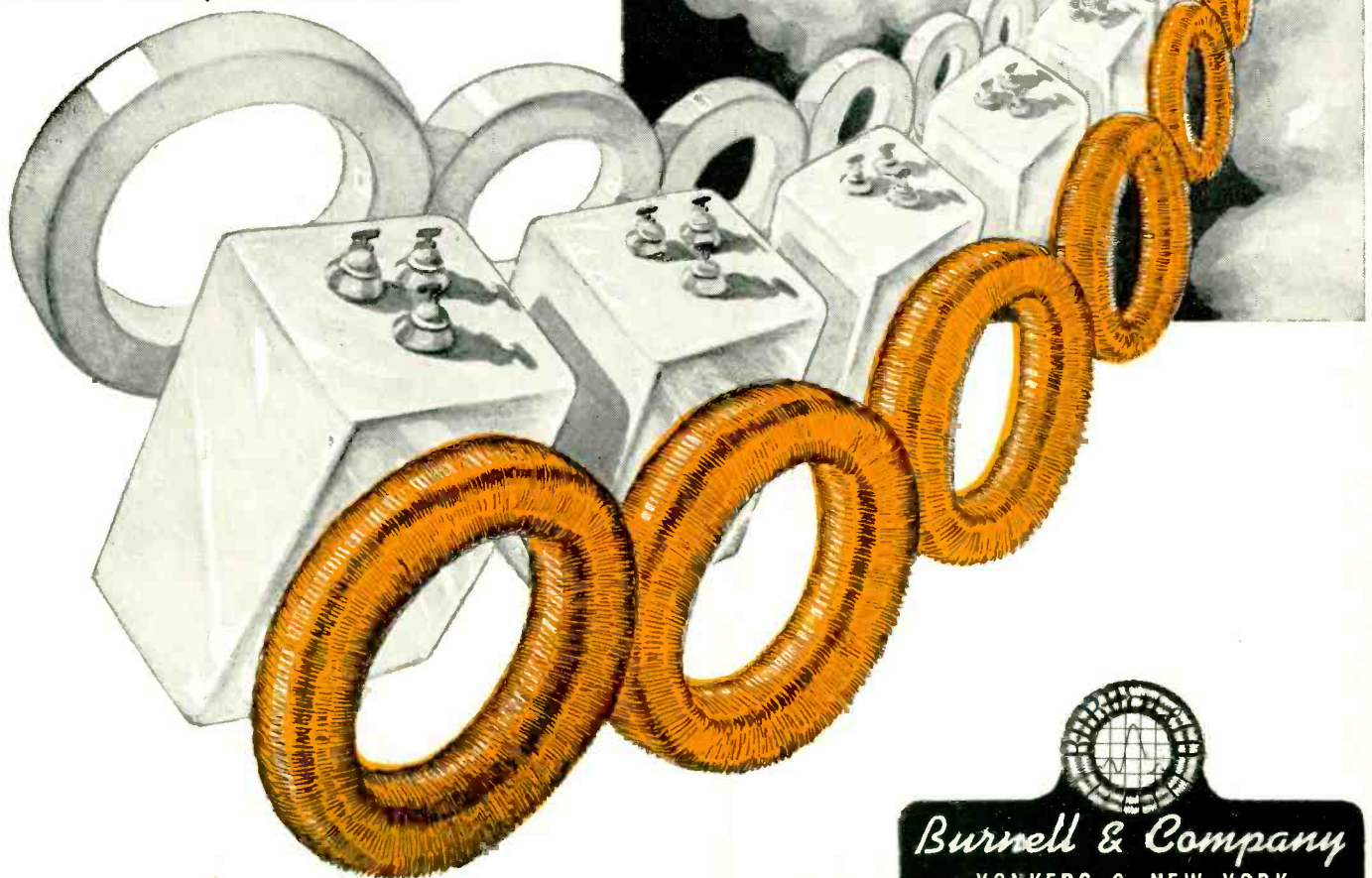
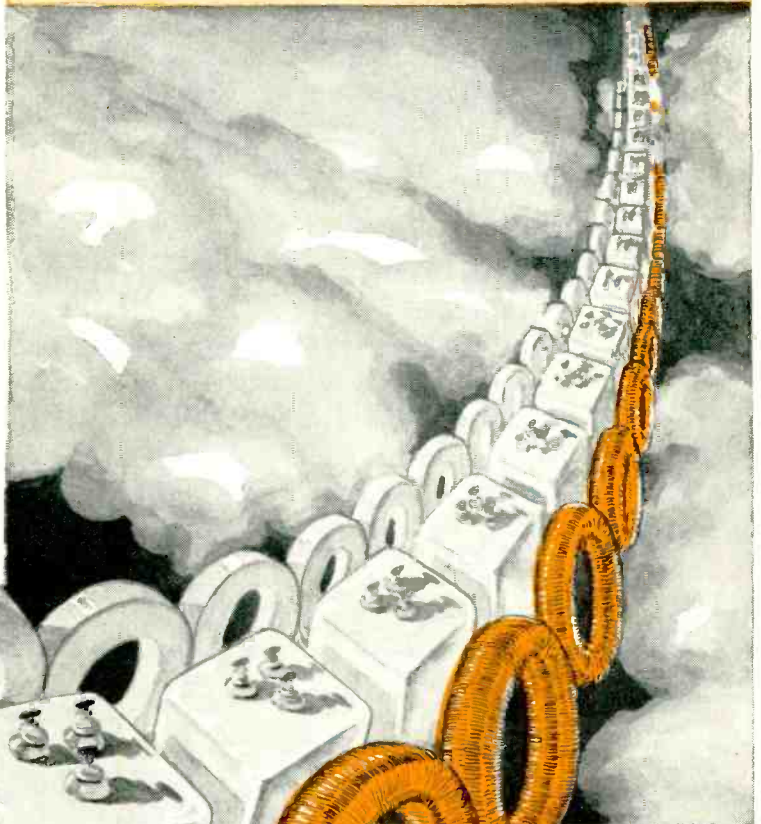
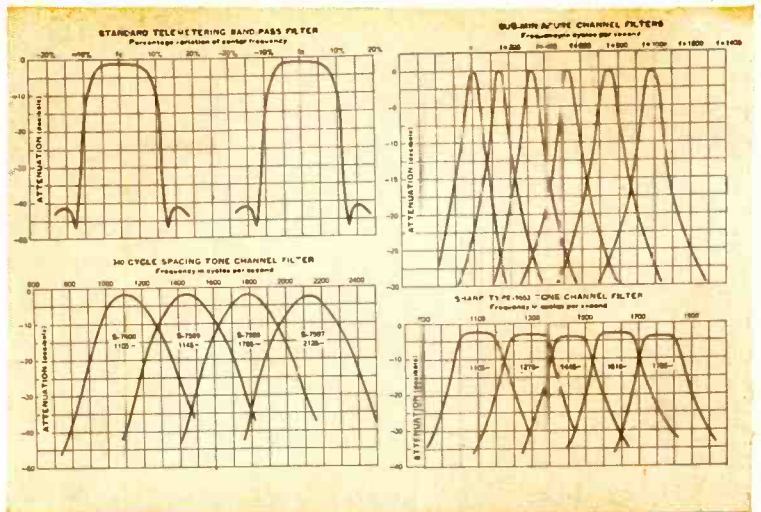

Burnell & Company
 YONKERS 2, NEW YORK
 CABLE ADDRESS "BURNELL"

EXCLUSIVE MANUFACTURERS OF COMMUNICATIONS NETWORK COMPONENTS



New! Broad Applicability!



New **hp** 522B
**ELECTRONIC
COUNTER**

...a small precision instrument that makes more kinds of measurements faster and more easily than any comparable device ever offered!

**REVOLUTIONARY FEATURES SAVE TIME, MONEY;
SPEED RESEARCH AND MANUFACTURING**

- Measures .00001 to 100,000 events per second**
- Measures time 10 microseconds to 27.8 hours**
- Accurate within 1 part in 100,000**
- Ideal for remote measurements, monitoring**
- Lowest cost completely versatile counter**
- No extra-cost modification required**
- Easily used by anyone, no training needed**
- Reads direct in cps, kc, seconds, milliseconds**
- Decimal point automatically indicated**
- Displays results instantly, accurately**
- Work-bench size; weighs just 45 pounds**
- Unlimited uses in research, production**
- hp- dependability — quality construction —
quality components**

In an ever-increasing variety of manufacturing and research measurements, electronic counters provide greater speed, higher accuracy and broader usefulness than previously available measuring equipment.

The new *-hp-* 522B is a *versatile* low-priced counter offering you frequency, period and time interval measurement over a broad range. The instrument is completely contained in a small, bench-size unit, and no extra-cost modification is required to perform all functions. Results are displayed instantly and automatically in direct-reading form. Unskilled personnel can use the equipment immediately—no training or technical background is needed.

WIDE RANGE

Frequency range is .00001 cps to 100 kc, and the counter may be read direct from 10 cps to 100 kc. Counting is available over periods of 1/1000, 1/100, 1/10, 1 and 10 seconds, or multiples of 10 seconds. Time of display can be varied at will, counts are automatically reset, and action is repetitive. For period measurement, the unknown controls the opening and closing of the gate while the instrument's decade counters record the number of cycles of an internal standard frequency. Depending on the frequency selected, the instrument reads direct in seconds and milliseconds. By this means, frequencies down to .00001 cps may be measured.

Time intervals are measured by a similar procedure except that the gate time is controlled by a "start" and "stop" signal generated by the device under measurement or by transducers. Time intervals ranging from 10 microseconds to 100,000 seconds (27.8 hours) can be measured; and again results are

Complete Coverage HEWLETT-PACKARD

High Quality! Low Cost!



displayed on the panel (in seconds and milliseconds). The count may be started or stopped from common or independent sources by using either positive or negative "going" waves. The level of trigger voltage is continuously adjustable for each channel from -100 to $+100$ volts.

GENERAL DESCRIPTION

Model 522B consists of five decade counters, a wide range time base, and gating and auxiliary circuits applying counters and time base to the broadest possible variety of measurements. The unknown is applied to the counters through a gate circuit. This circuit remains open for a precise interval controlled by an oven-housed quartz crystal. Stability of this crystal is at least $5/1,000,000$ per week, and may be standardized against WWV.

-hp- 522A ELECTRONIC COUNTER

For applications where wide-range frequency and period measurements are desired, -hp- 522A is offered. Frequency counting facilities of this instrument are identical with -hp- 522B, except that gate time for frequency measurement is 1 second or any multiple of 1 second, and the standard frequency counted for period measurement is 100 kc. The automatic illuminated decimal point is omitted. -hp- 522A does not include time interval measuring circuits. \$775.00 f. o. b. factory.

BRIEF SPECIFICATIONS—MODEL 522B

FREQUENCY MEASUREMENT:

Range: 10 cps to 100 kc.

Accuracy: ± 1 count \pm stability ($5/1,000,000$ per week).

Registration: 5 places. Output pulse available to actuate trigger circuit for mechanical register to increase count capacity.

Input Requirements: 2 volts peak minimum.

Input Impedance: Approx. 1 megohm, 50 μ fd shunt.

Gate Time: .001, .01, .1, 1, 10 seconds. Extendable to multiples of 1 or 10 seconds by manual control.

Display Time: Variable .1 to 10 seconds in steps of gate time selected. Display can be held indefinitely.

PERIOD MEASUREMENT:

Range: .00001 cps to 10 kc.

Accuracy: $\pm .03\%$ \pm stability (for measurement over a 10 cycle period).

Gate Time: 1 or 10 cycles of unknown. Extendable to any number of cycles by manual control. (For frequencies under 50 to 60 cps).

Standard Freq. Counted: 1, 10, 100 cps; 1, 10, 100 kc; or external.

TIME INTERVAL MEASUREMENT:

Range: 10 μ sec to 100,000 seconds (27.8) hrs.

Accuracy: ± 1 /std. freq. counted \pm stability.

Input Requirements: 2 volts peak minimum.

Input Impedance: Approx. 250,000 ohms, 50 μ fd shunt.

Start and Stop: Independent or common channels.

Trigger Slope: Pos. or neg. on start and/or stop channels.

Trigger Amplitude: Continuously adjustable on both channels from -100 to $+100$ volts.

Standard Freq. Counted: 1, 10, 100 cps; 1, 10, 100 kc; or external.

Price: \$900.00 f. o. b. factory.

IS YOUR MEASURING PROBLEM HERE?

FREQUENCY

Production quantities

Nuclear radiations

Power line frequencies to high accuracy

R. P. S. and R. P. M.

Weight, pressure, temperature and acceleration—at remote points

Very low frequencies

Frequency stability

Oscillator calibration

Pulse repetition rates

TIME INTERVAL

Elapsed time between impulses

Pulse lengths

Camera shutter speed

Projectile velocity

Relay operating times

Precise event timing

Interval stability

Frequency ratios

Phase delay

The broad applicability of -hp- electronic counters makes them of greatest usefulness in any laboratory or factory. In many cases, one counter will make all your important measurements itself, and give you accuracy unavailable with other equipment. In other applications, standard transducers may be required. See your -hp- sales representative for help in applying Model 522B to your measurement problem.

ARE YOU READING THE -hp- JOURNAL?



The -hp- Journal, now in its fourth year, is sent to you regularly as another Hewlett-Packard service. It contains latest news about electronic developments, technique and instruments. Fully illustrated.

WRITE -hp- FOR YOUR FREE SUBSCRIPTION
(use your Company letterhead, please)

HEWLETT-PACKARD COMPANY

2682A PAGE MILL ROAD • PALO ALTO, CALIFORNIA, U. S. A.

SALES REPRESENTATIVES IN ALL PRINCIPAL AREAS

Export: FRAZAR & HANSEN, LTD., San Francisco • Los Angeles • New York



INSTRUMENTS

Complete Coverage

CHATHAM

ELECTRONIC TUBES

Hydrogen Thyratrons

— for Pulse Voltage Generation



TYPE VC-1257

Hydrogen filled, zero bias thyatron with hydrogen generator for generation of pulse power up to 40 megawatts.



TYPE 5948/1754

Hydrogen filled, zero bias thyatron with hydrogen reservoir for generation of peak pulse power up to 12.5 megawatts.



TYPE 5949/1907

Hydrogen filled, zero bias thyatron with hydrogen reservoir for generation of peak pulse power up to 6.25 megawatts.



TYPE VC-1258

Zero bias miniature hydrogen thyatron for the generation of peak pulse power up to 10 KW.

ELECTRICAL DATA*

Type	VC-1258	5949/1907	5948/1754	VC-1257
Maximum Peak Forward Anode Potential	1000 volts	25000 volts	25000 volts	38000 volts
Maximum Peak Anode Current	20 amps	500 amps	1000 amps	2000 amps
Maximum Average Anode Current	0.05 amps	0.50 amps	1.0 amps	2.0 amps
Maximum Heating Factor (epy x prr x ib)	1.0x10 ⁸	6.25x10 ⁹	9.0x10 ⁹	—
Nominal Filament Power	12.6 watts	95 watts	190 watts	230 watts
Hydrogen Reservoir	No	Yes	Yes	Yes

*More detailed information on electrical and mechanical data will be supplied on request.

● A NEW CONCEPT OF HYDROGEN THYRATRON DESIGN! The tubes illustrated represent a departure from conventional hydrogen thyatron designs and are a result of several years of concentrated development work.

They are primarily employed in the generation of peak voltages with durations in the order of microseconds.

Custom-built Electronic Equipment

At the I.R.E. Show—
Booth #4-512!

● CHATHAM specializes in the development, design, and construction of custom-built electronic equipment to exactly meet customers' requirements. Our capable staff of engineers will furnish prompt estimates or, if desired, will call to discuss your problem personally. Call or write today.

Pulse life test equipment built by CHATHAM checks receiver type tubes under pulse conditions.

20 Megawatt Hydrogen Thyatron Test Equipment built by CHATHAM to customers' specifications.



5 Megawatt radar modulator built by CHATHAM to rigid government standards.

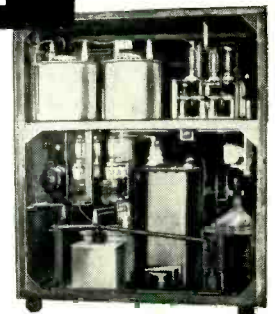
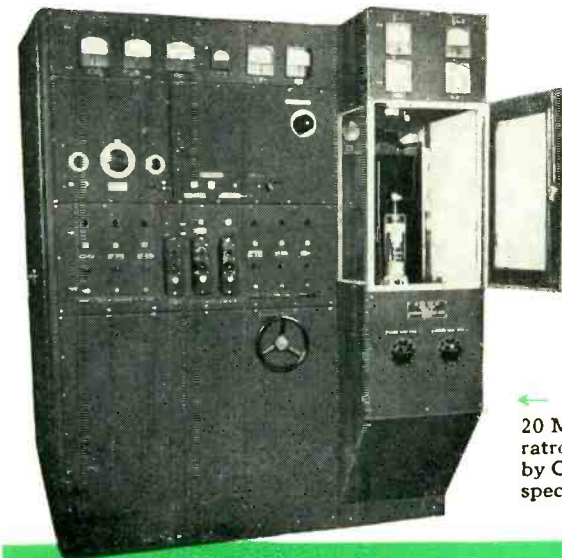

ELECTRONICS

AND EQUIPMENT

Electronic Tubes



Ruggedized Type Tubes

• The following tubes fully conform to JAN specifications and can be supplied promptly, usually direct from stock:

5R4WGY	2D21W
6AL5W	OC3W
6H6WGT	OD3W
25Z6WGT	2050W



TYPE 719-A HIGH VACUUM CLIPPER DIODE

This tube is used primarily for clipper diode service in hard tube modulator circuits. Filament 7 volts, 7 amps... Inverse peak anode voltage 25 kv, Max., peak anode current 10 amps, Max., anode dissipation 75 watts.



TYPE 1Z2 RECTIFIER

A small bulb high voltage vacuum rectifier. Low cathode heating power and low dielectric losses make tube suitable for radio frequency supply circuits. Filament 1.5 volts, .290 amps... Inverse peak anode voltage 20,000, average plate current 2 ma... peak plate current 10 ma.



TYPE 1B46 REGULATOR

A cold cathode glow discharge tube designed for voltage stability. DC operating voltage 82 volts, operating current range 1 ma minimum, 2 ma maximum. Regulation 3 volts.



TYPE 395-A COLD CATHODE GAS TRIODE

Requires no filament supply and is used in many grid controlled rectifier and relay applications. Maximum D.C. anode current—10 ma. Maximum D.C. anode voltage—150 volts



TYPE 4B32 RECTIFIER

A rugged half-wave Xenon filled rectifier. Operates in any position throughout an ambient temperature range of -75°C to $+90^{\circ}\text{C}$. Filament 5 volts, 7.5 amp... Inverse peak anode voltage 10,000 average anode current 1.25 amps.



TYPE 394-A THYRATRON

A Mercury vapor and Argon filled thyatron for grid controlled rectifier service. Operates over wide ambient temperature range. Heater 2.5 volts, 3.2 amps... Inverse peak anode voltage 1250, average anode current 640 ma.

TYPE 3B28 RECTIFIER

This rugged half-wave Xenon filled rectifier will operate in any position and throughout an ambient temperature range of -75°C to $+90^{\circ}\text{C}$. Filament 2.5 volts, 5.0 amps... Inverse peak plate voltage 10,000, average anode current .25 amp.



Chatham Vacuum Switches

• TYPE 1S22 (illustrated) is a mechanically actuated, single-pole, double-throw, glass vacuum switch. This and other types can be supplied.

SPECIFICATIONS

HOLD OFF VOLTAGE: Internal—10,000 volts rms; External* (at 27,000 feet altitude)—10,000 volts rms; External* (at 40,000 feet altitude)—7,500 volts rms.

INTERRUPTING RATING, RESISTIVE LOAD: 1,000 operations life at 10,000 v, ac, rms—10 amp, ac, rms; 1,000,000 operations life at 10,000 v, ac, rms—2 amp, ac, rms; 500,000,000 operations life at 10,000 v, ac, rms—0.1 amp, ac, rms.

NET WEIGHT (approx.) 2 ozs. MAXIMUM WIDTH (overall) $4\frac{1}{2}$ ins.
 MAXIMUM LENGTH (overall) $3\frac{3}{8}$ ins. MAXIMUM THICK. (overall) $1\frac{1}{8}$ ins.
 *at 50% humidity

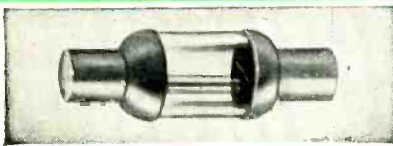
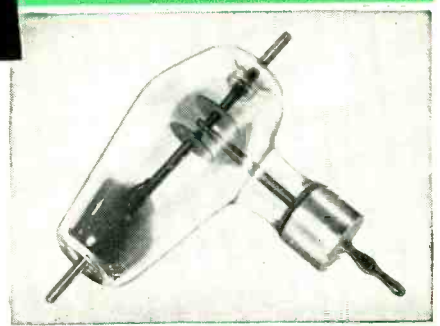

HIGH VOLTAGE VACUUM FUSES

Can be supplied by Chatham to exact customers' specifications if ordered in adequate quantity. Call or write for full particulars and quotes.



CHATHAM ELECTRONICS CORP.
 475 WASHINGTON STREET • NEWARK 2, NEW JERSEY

At the
 I. R. E. SHOW
 BOOTH #4-512!

ENGINEERED FOR RUGGED ASSIGNMENTS!

3 PHASE DIRECTIONAL POWER RELAY

FOR AIRCRAFT POWER SYSTEMS
UTILIZING PARALLEL CONNECTED
3 PHASE, 4 WIRE ALTERNATORS

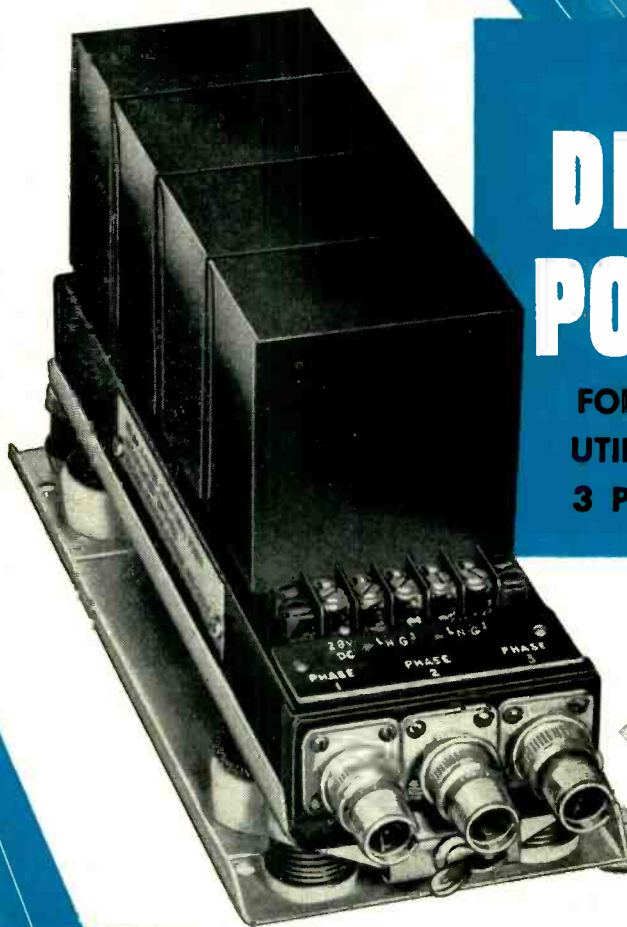

Visit BOOTHS
95-96
EXHIBIT HALL
AAAE AVIATION
EXHIBIT
Congress of Civil
Aviation
Conferences
KANSAS CITY,
MO.
March 23 to 26,
1953

Provides absolute protection for generators and connected loads —

This relay is designed for use on power systems of two or more 208/120 volt, 4 wire, three phase, alternators operating in parallel. Its function is to protect the system by removing an alternator in the event of a drive failure, a shutdown of the drive without prior disconnection of the alternator, a balanced three phase fault within the alternator or a high resistance three phase fault between the relay and alternator. The relay operates if reverse power in any phase exceeds 1500 watts. It has an inverse time characteristic. At 2000 watts the relay operates in 0.4 seconds.

Completely environment-proofed to meet critical requirements —

Designed for critical aviation applications, all components except the current transformers are mounted on a single shock-mounted chassis with all items including wiring 100% potted for complete immunity to environmental conditions or changes. Rugged cable connectors permit quick, easy replacement of the entire unit or current transformers. This equipment is readily adaptable to power systems of other voltages and frequencies.

Call or Write for New Illustrated Brochure on Gavco's Standard Aviation Components—Inquiries on other than standard equipment will receive prompt attention.

GAVCO CORPORATION

A Subsidiary of General Aviation Corporation

540 EAST 80th ST., NEW YORK 21, N. Y. • Tel. TRafalgar 9-8800

DESIGNERS AND MANUFACTURERS OF PRECISION ENGINEERED POWER RELAYS, VOLTAGE REGULATORS, FREQUENCY CHANGERS AND SPECIAL PURPOSE ELECTRONIC EQUIPMENT FOR COMMERCIAL AND MILITARY APPLICATIONS

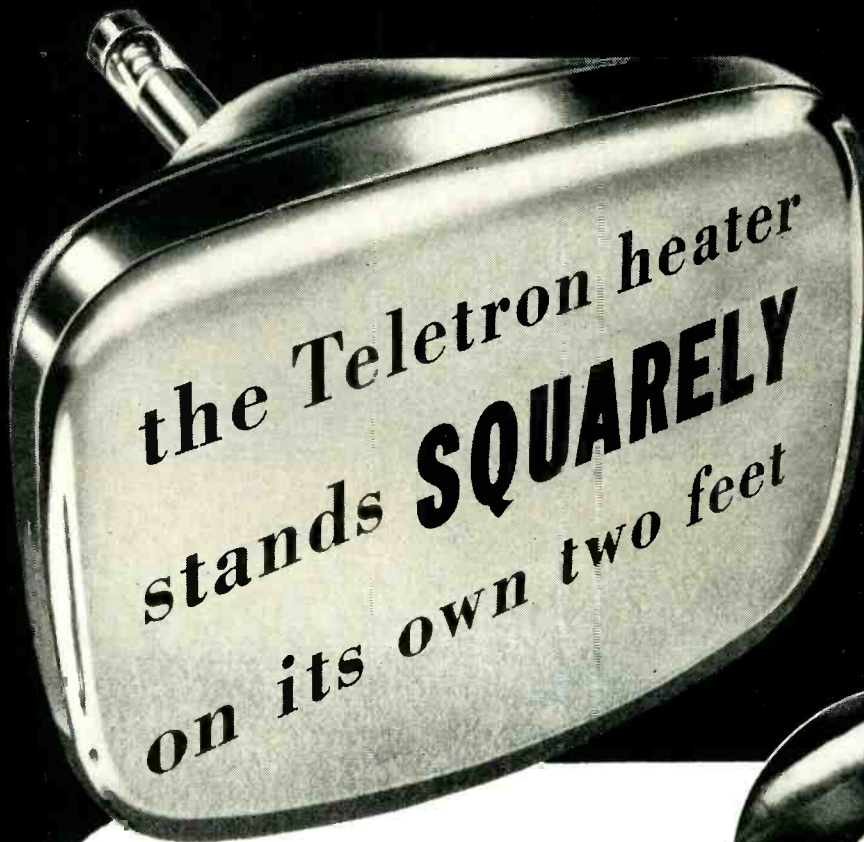

the Teletron heater
stands **SQUARELY**
on its own two feet



SHOWN $4\frac{1}{2}$ TIMES
ACTUAL SIZE

This assembly provides controlled heater-to-cathode positioning; eliminates heater shorts resulting from rupture of the heater coating, as shown below.



SHOWN 20 TIMES ACTUAL SIZE

Exclusive mounting makes the heater an integral part in the Teletron gun.

In the Du Mont Teletron, the heater "feet" are welded to stainless steel lugs which accurately position the heater on a ceramic disc. The result is a firmly welded, vertically aligned assembly which is inserted in the control grid cup and automatically positions the heater within the cathode. This eliminates critical, uncontrolled hand positioning of the heater. Positive centering prevents chafing of the delicate heater coating and avoids heater-to-cathode shorts.

Less open-heater failures

Stronger connections obtained by welding the tungsten heater "feet" to the stainless steel lugs rather than directly to the nickel stem leads, greatly reduce open heater failures.

Greater heater efficiency

When the control grid is assembled, the distance between the top of the heater helix and the outer ridge of the ceramic disc controls the depth to which the helix is seated inside the cathode. Optimum-depth seating is thus predetermined, insuring maximum heater efficiency.

Du Mont quality control of heater design and assembly builds longer, fuller, trouble-free life into every Teletron.

DU MONT

Teletrons *

* Trade Mark

in
picture
tubes...

fine details make Du Mont the finest

Cathode-ray Tube Division, ALLEN B. DU MONT LABORATORIES, INC., CLIFTON, N. J.

Let **JOY** handle Your **FAN ENGINEERING** on **ELECTRONIC COOLING PROBLEMS**

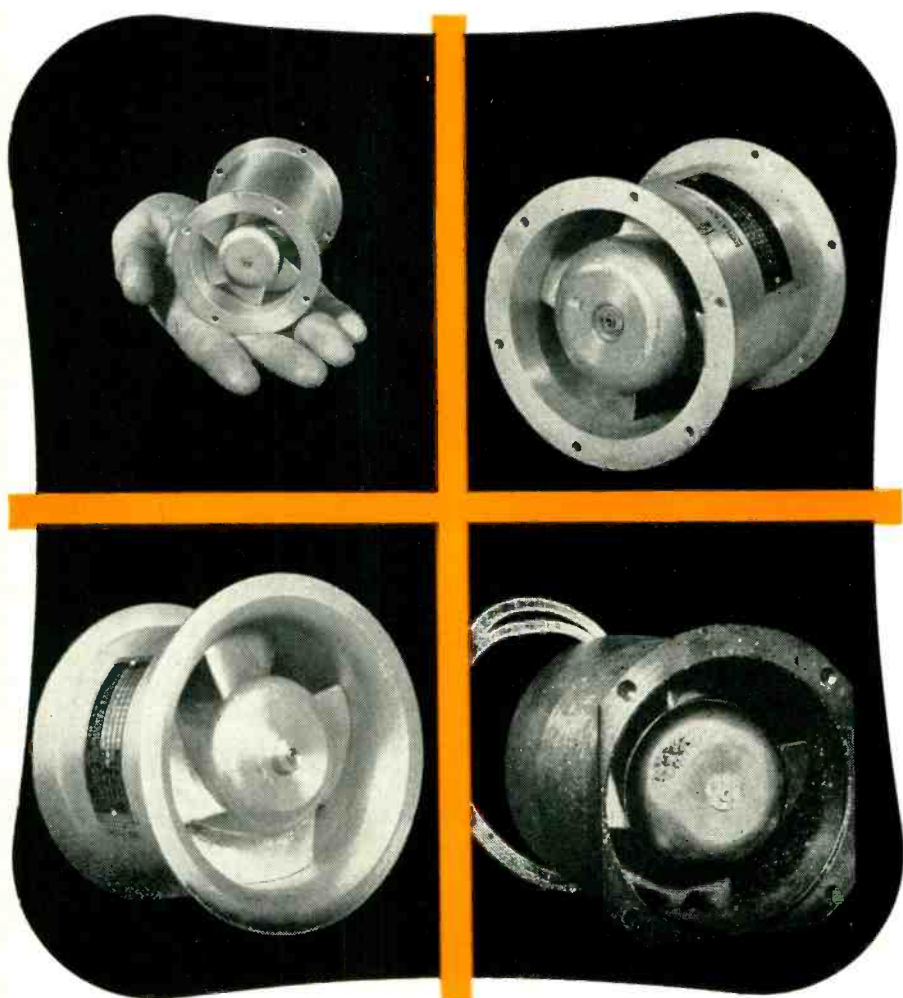

*Reg. U. S. Pat. Office

W&D 1-4010

JOY AXIVANE* Fans offer you advantages in electronic equipment cooling which have been thoroughly proved in service. The higher pressure-output of these vaneaxial blowers generally permits more compact arrangement of the equipment. Additional advantages are: light weight, high strength, high shock and vibration resistance, and high efficiency in low or high pressure service.

For minimum weight, JOY electronic cooling fans are made of aluminum, magnesium, or combinations of these metals. They are designed to meet all present Air Force and Naval electronic specifications, and are available in fan sizes from 2" I.D. up. Totally-enclosed or explosion-proof motors can be furnished where required.

● If you have a problem in heat dissipation from electronic units, no matter what the service conditions may be, let us place at your disposal JOY'S experience as the world's largest manufacturers of vaneaxial-type fans.

*Consult a Joy
Engineer*

Over 100 Years
of Engineering Leadership



JOY MANUFACTURING COMPANY

GENERAL OFFICES: HENRY W. OLIVER BUILDING • PITTSBURGH 22, PA.

IN CANADA: JOY MANUFACTURING COMPANY (CANADA) LIMITED, GALT, ONTARIO

New!

push-button oscillator

for rapid and recurrent frequency measurements

THE MODEL 440-A PUSH-BUTTON OSCILLATOR is designed for applications requiring very low distortion or extremely good frequency stability and resetability. It provides both sine waves and square waves at any frequency between 0.01 cps and 100 kc.

For fine control of frequency, three banks of ten push-button switches are provided. An additional vernier control varies the frequency continuously by an amount equal to the increment between adjacent buttons of the third switch bank.

Hum and distortion are attenuated when the setting of the calibrated logarithmic output level control is reduced and are thus maintained at a constant low percentage of the desired output signal.

This exceptional instrument is ideally suited for bridge measurements, tuned filter alignment, rapid spot frequency checks, and distortion measurements.

model 440-A

from 0.01 cps to 100 kc



specifications

FREQUENCY RANGE: 0.01 cps to 100 kc continuously variable.

FREQUENCY ACCURACY: Calibration $\pm 1\%$ from 1 cps to 10 kc, $\pm 3\%$ over the entire frequency range.

SINE WAVE OUTPUT:

Voltage: 30 volts peak to peak maximum, adjustable continuously.

Power: Maximum 100 mw

Amplitude: Varies less than ± 0.25 db over the frequency range from 0.1 cps to 10 kc, less than ± 1 db over the entire frequency range.

Distortion: Less than 0.1% from 1 cps to 10 kc, less than 1% over the entire frequency range.

Hum: Less than 0.1% at any output level setting.

SQUARE WAVE OUTPUT: 10 volts peak to peak.

INPUT POWER: 105-125 volts, 50-60 cps, 120 watts.

price \$450 net f.o.b. Cambridge, Mass.

Write for a free catalog



Visit us at the I. R. E. Show, Booth 4-301

krohn-hite
instrument company

580 Massachusetts Ave., Dept. E, Cambridge 39, Mass., U. S. A.



DESIGNER'S

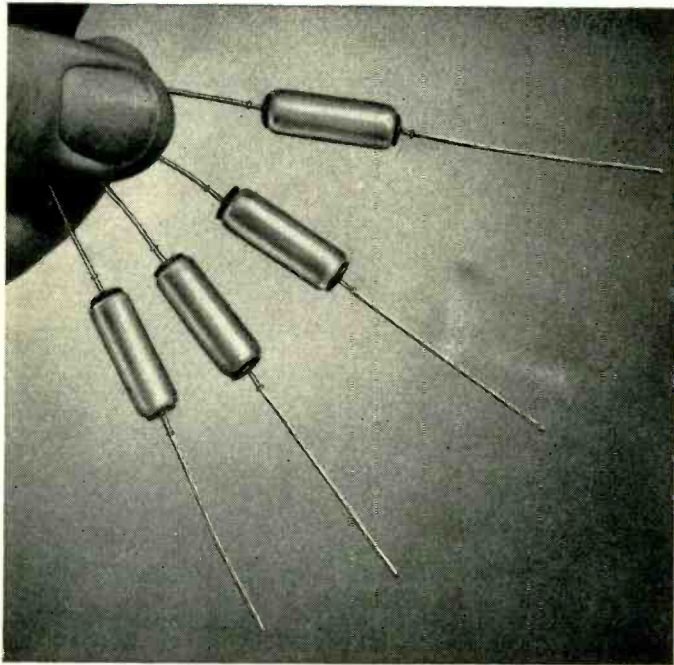

Miniaturize your product with Tantalytic* capacitors

On low-voltage d-c applications, where your equipment miniaturization calls for both small size and superior performance, General Electric Tantalytic capacitors offer a host of advantages. These foil-type, tantalum-electrode, electrolytic capacitors have greater capacitance per unit volume and far longer shelf life than aluminum-electrolytic types. Long operating life, too, is provided by their inherently inert characteristics, and the use of non-corrosive, chemically neutral electrolyte. And leakage current is low—less than 10 microamps per microfarad.

Built to withstand severe shock, these lightweight units operate over a wide temperature range (-55°C to $+85^{\circ}\text{C}$ and higher). Hermetic sealing protects them against leakage and contamination. Available in polar and non-polar construction, in ratings from 175 muf at 5 volts d-c to 12 muf at 150 volts d-c. For complete description of the line, plus application information, check Bulletins GEC-808 and GER-451 in the coupon on the next page.

*Trade-mark of General Electric Company.

Now—greater flexibility in voltage stabilizers

Fluctuating voltage is serious on sensitive electronic equipment designed for best performance at a specified voltage. Now, to help you get rid of voltage ups and downs, G.E. offers a new 15- to 5000-va line of automatic voltage stabilizers that gives you greater design flexibility at no increase in price, plus weight reduction in larger sizes. New output ratings of 1000, 2000, 3000, and 5000 volt-amperes—with 115 and 230 volts on both input and output—permit operation in any combination of these input and output voltages.

Fluctuations between 95 and 130 volts, or 190 and 260 volts, are corrected to a stable 115 or 230 volts within ± 1 percent—and in less than two cycles. Single-core construction permits input circuit to be completely isolated from output circuit. Installation is easy: connect one set of terminals for supply and another set for the load. With no moving parts, maintenance is virtually eliminated. See Bulletin GEA-5754 for complete description.

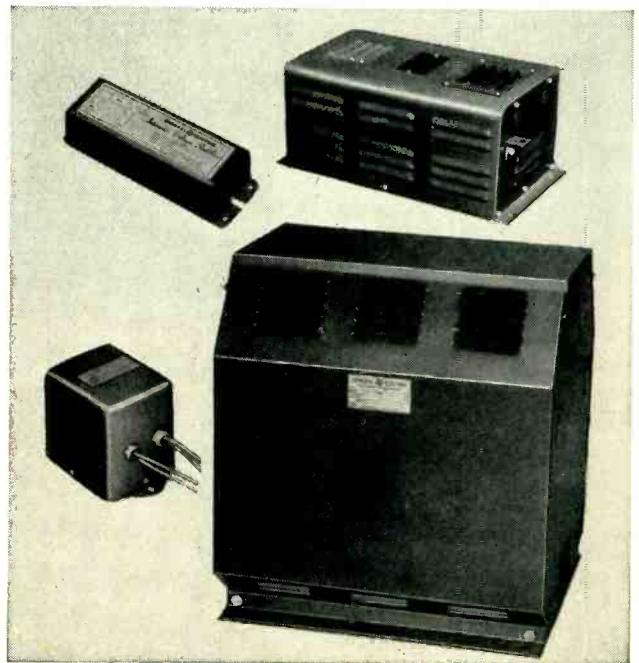

GENERAL  ELECTRIC

DIGEST

TIMELY HIGHLIGHTS ON G-E COMPONENTS

Prices reduced as much as 35% on light, flexible delay line

Increased use of delay line in special circuits for electronic equipment now enables General Electric to mass-produce it, at savings to you of up to 35 percent. Originally developed for radar equipment, G-E delay line now has many commercial uses such as color television and electronic calculators.

Bulk line is available in lengths of 100 feet or less to be cut as desired. Time delay is approximately $\frac{1}{2}$ microsecond per foot for 1100-ohm line, $\frac{1}{4}$ microsecond per foot for 400-ohm line. Line is light in weight, $\frac{1}{4}$ -inch in diameter, and easily bent into a 4-inch-diameter coil. Operates between -50°C and 100°C . Bulletin GEC-459.

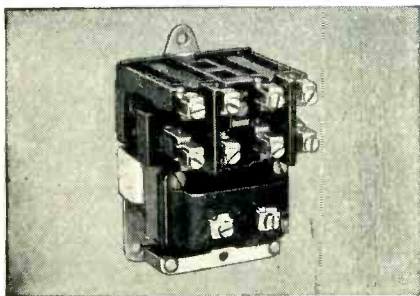

Size 00 relays cut inventories

Many of your control-circuit needs can be met with compact G-E size 00 contactors and relays—available in any combination of normally open and normally closed contacts from 2 to 8 poles. Since contact tips are easily changed from NO to NC without extra parts, your "specials" inventory is cut. Easily accessible terminals take up to 3 wires, speed connections. For complete details, see your General Electric apparatus sales representative.



Reliable d-c to a-c amplification

Designed mainly for 400-cycle excitation, the General Electric second-harmonic converter is a magnetic-amplifier type unit that converts low-level d-c error signals (such as thermocouple output) to 800-cycle a-c output. Static operation and hermetic sealing make it reliable under extreme conditions of acceleration, temperature, and pressure—important in aircraft applications. Length is $3\frac{3}{8}$ in., tube diameter $1\frac{1}{4}$ in., weight, 0.2 lb. See Bulletin GEC-832.

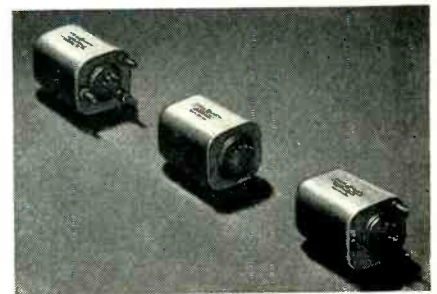

Now—sealed-relay line expanded

G-E hermetically sealed relays for 28-volt circuits are now available in these forms: DPDT, 3PDT, 4PDT, 6PNO—with coil ratings up to 10,000 ohms. Certain other configurations available on request. All have extra-high tip pressures, yet don't exceed Air Force-Navy size and weight specs. They withstand all outside atmospheric conditions, 50g operational shocks, and instantaneous voltage surges up to 1500 volts. Bulletin GEA-5729.



EQUIPMENT FOR ELECTRONICS MANUFACTURERS

Components		Development and Production Equipment
Meters, Instruments	Fractional-hp motors	Soldering irons
Dynamotors	Rectifiers	Resistance-welding control
Capacitors	Timers	Current-limited high-potential tester
Transformers	Indicating lights	Insulation testers
Pulse-forming networks	Control switches	Vacuum-tube voltmeter
Delay lines	Generators	Photoelectric recorders
Reactors	Selsyns	Demagnetizers
Thyrite*	Relays	
Motor-generator sets	Amplidynes	
Inductrols	Amplistats	
Resistors	Terminal boards	
Voltage stabilizers	Push buttons	
	Photovoltaic cells	
	Glass bushings	

*Reg. Trade-mark of General Electric Co.

General Electric Company, Section A667-24
Schenectady 5, New York

Please send me the following bulletins:

- for reference only
 for immediate project

- GEA-5729 Sealed Relays
 GEA-5754 Voltage Stabilizers
 GEC-459 Delay Line
 GEC-808 & GER-451 Tantalum Capacitors
 GEC-832 2nd-Harmonic Converter

Name _____

Company _____

City _____ State _____



KELLOGG SWITCHBOARD



GENERAL ELECTRIC

Air Associates

Motorola

WILCOX ELECTRIC COMPANY



UNION PACIFIC RAILROAD

Bendix AVIATION CORPORATION

SANGAMO ELECTRIC COMPANY

CROSLEY

Western Electric

Westinghouse

MELPAR, INC.



RADIO CORPORATION OF AMERICA

...and many more!



**Moisture Proof
PLASTIC COATED TOROIDS**

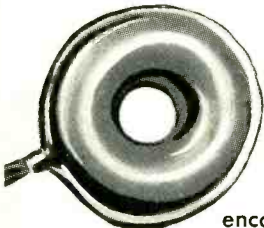

In addition to standard windings, we offer toroids encased in tough thermosetting plastic. Plastic encasement provides extra protection from humidity, mechanical shock. Available in all sizes of coils.

**Steel Cased
TOROIDS AND FILTERS**

Existing designs cover a wide range of types and frequencies. Filters meet military specifications and can be offered in miniaturized versions. A typical filter is shown. C. A. C. filter design engineers will convert your specifications to production deliveries with minimum delay



Why is it?...

From a modest beginning five years ago, Communication Accessories Company has grown to the largest exclusive toroid coil winding producer in the U. S. today. Why?

We like to think that this growth is due to the thorough, careful handling we apply to each coil . . . and because of the particular skill of our people. Whatever the reason, we'll continue—doing the best we know how—thankful for the trust that important companies have placed in us.

write for this catalog →



COMMUNICATION ACCESSORIES
Company

• HICKMAN MILLS, MISSOURI

ERIE CERAMICONS®

Meet Every Demand for Reliability, Performance, Economy

ERIE TUBULAR CERAMICONS*

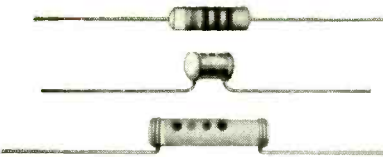

Erie "GP"™ Molded Insulated Ceramicons
5 MMF—5,000 MMF

Erie "GP"™ Dipped Insulated Ceramicons
5 MMF—5,000 MMF

Erie "GP"™ Non-Insulated Ceramicons
5 MMF—5,000 MMF

Temperature Compensating
Molded Insulated Ceramicons
0.5 MMF—550 MMF

Temperature Compensating
Dipped Insulated Ceramicons
0.5 MMF—1,800 MMF

Temperature Compensating
Non-Insulated Ceramicons
0.5 MMF—1,800 MMF

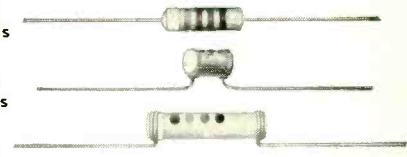

ERIE CERAMICON TRIMMERS



Style 557
1.5-7 MMF
3-12 MMF
5-25 MMF
150-190 MMF

Style 3130
5-30 MMF
8-50 MMF
65-95 MMF



Style TS2A
1.5-7 MMF
3-12 MMF
3-13 MMF

5-20 MMF
4-30 MMF
7-45 MMF



Style 531 and 532
0.5-5 MMF
1-8 MMF

Style 3115
0.5-3.0 MMF
1.0-4.0 MMF

Style 3139
2.0-6.0 MMF



Style 535
0.7-3.0 MMF

Style 3132
1.0-3.8 MMF

ERIE FEED-THRU CERAMICONS



Style 327

Style 2404

Style 2405

Style 362

Style 321

5 MMF—1,000 MMF
5 MMF—1,500 MMF



Style 2416



Style 2418

ERIE DISC CERAMICONS

Temperature Compensating, By-Passing, and High Voltage



Style 831

Style 801

Style 811

Style 812

Up to .01 MFD

ERIE STAND-OFF CERAMICONS



Style 2322

Style 2336

Style 318

Style 319

Style 325

Style 326

Style 323 and 324

5 MMF—5,000 MMF

ERIE BUTTON* MICA CAPACITORS



15 MMF—6,000 MMF

ERIE PRINTED CIRCUITS

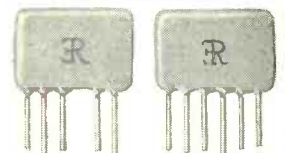

Standard, Integrator, Filter, and Coupling Circuits

ERIE HIGH VOLTAGE CERAMICONS



Style 412

Style 414

10 and 20 KV.—500 MMF

ERIE CUSTOM MOLDED PLASTICS

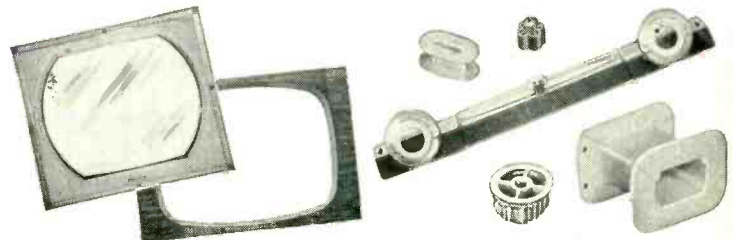

Custom Injection Molded Plastic Knobs, Dials, Bezels, Name Plates, Coil Forms, etc.

* Ceramicon, Hi-K, GP, Button, and Plexicon are registered trade names of Erie Resistor Corporation.



ERIE RESISTOR CORPORATION . . . ELECTRONICS DIVISION

Main Offices: ERIE, PA.

Sales Offices: Cliffside, N. J. • Philadelphia, Pa. • Buffalo, N. Y. • Chicago, Ill.
Detroit, Mich. • Cincinnati, Ohio • Los Angeles, Calif.

Factories: ERIE, PA. • LONDON, ENGLAND • TORONTO, CANADA

PULSESCOPE®

The Oscilloscope that portrays the Pulse by

Waterman



SAR

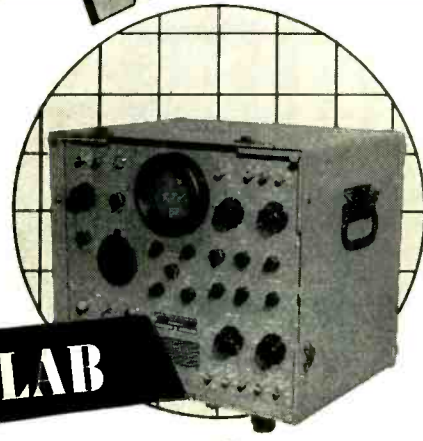

LAB

Classic Examples of Precision Engineering...

Investigations of complex waves take great strides forward when either a Waterman SAR or LAB PULSESCOPE is employed. Their compactness, portability and precision have established a new high in pulse measurement instruments for all electronic work. Each PULSESCOPE has internally generated markers which are synchronized with the sweep with the basic difference that the sweep in the LAB PULSESCOPE initiates the markers while in the SAR PULSESCOPE it is the crystal controlled markers which initiate the sweep. Power supply requirements of 50 to 1000 c.p.s. at 115 Volts permits operation almost anywhere.

The SAR PULSESCOPE, model S-4-A, is characterized by a pulse rise time of 0.035 microseconds thru a video amplifier with a sensitivity of 0.5 Volts p to p/inch. A vertical delay of 0.55 microseconds is optional. A and S sweeps covering a continuous range from 1.2 to 12,000 microseconds are augmented by R sweeps, which in turn are variable from 2.4 to 24 microseconds. A directly calibrated dial permits R sweep delay readings from 3 to 10,000 microseconds.

The LAB PULSESCOPE, model S-5-A, has equivalent rise time of 0.035 microseconds, a fixed 0.55 microseconds vertical delay and 0.1 Volts p to p/inch sensitivity, so arranged as to assure portrayal of leading edges on displayed signals. A precision calibrated voltage is provided as well as an optional sweep expansion of 10 to 1. A built-in trigger generator voltage is available for synchronizing any associated test equipment.

WATERMAN RAYONIC CATHODE RAY TUBE DEVELOPMENTS

Since the introduction of the Waterman RAYONIC 3MP1 for miniaturized oscilloscopes, scientists in our laboratories have diligently searched for more perfect answers to present day cathode ray tube problems. Such research led to the introduction of the revolutionary new 3SP and 3XP type cathode ray tubes. These tubes were designed with multi-trace oscilloscopy in mind. Every avenue of practical design was explored to produce tubes with bright, sharp traces and high deflection sensitivity at medium anode potentials.

TUBE	PHYSICAL DATA			TYPICAL VOLTAGES				DEFLECTION FACTOR V/IN.		MAX. VOLTS	
	Face	Length	Base	Anode # 3	Anode # 2	Anode # 1	Grid # 1	D1 to D2	D3 to D4	Anode # 3	Anode # 2
3JP	3 inch Round	10 inches	Medium Diheptal 12 Pin	3000	1500	300 to 515	-22.5 to -67.5	127 to 173	94 to 128	4000	2000
				4000	2000	400 to 690	-30 to -90	170 to 230	125 to 170		
3MP	3 inch Round	8 inches	Small Duodecal 12 Pin		1000	200 to 350	0 to -68	140 to 190	130 to 180		2500
					2000	400 to 700	0 to -126	280 to 380	260 to 360		
3SP	1 1/2 x 3 inches	9.12 inches	Small Duodecal 12 Pin		1000	165 to 310	-28.5 to -67.5	73 to 99	52 to 70		2750
					2000	330 to 620	-58 to -135	146 to 198	104 to 140		
3XP	1 1/2 x 3 inches	8.88 inches	Loctal		2000	400 to 690	-22.5 to -67.5	68 to 92	25 to 35		2750

Visit Our Booth 1-414, IRE SHOW, MARCH 23rd to 26th

POCKETSCOPE®

Waterman

The Pocket Oscilloscope by



HIGH



WIDE

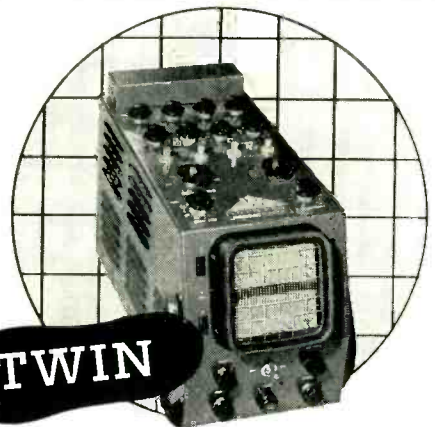

TWIN

...light... compact... accurate... portable

The HIGH, WIDE and TWIN POCKETSCOPES have become the "triple threat" of the oscilloscope industry. Their small size, light weight and incredible performance, has skyrocketed this team of truly portable instruments into unparalleled prominence. Each oscilloscope features DC coupled amplifiers in both its vertical and horizontal channels. The HIGH GAIN, S-14-A POCKETSCOPE, has a vertical sensitivity of 10 millivolts rms/inch, and a frequency response within -2 db from DC to 200 KC, while the WIDE BAND S-14-B POCKETSCOPE is characterized by frequency response within -2 db from DC to 700 KC and a sensitivity of 50 millivolts rms/inch.

The TWIN POCKETSCOPE is essentially two HIGH GAIN POCKETSCOPES with individual cathode ray tubes, amplifiers, controls, but a common sweep generator. All these are endowed with many identical characteristics. Their sweep generators can be operated as triggered or repetitive over a frequency range from 0.5 cycles to 50 KC, with synchronization polarity optional. Return traces are blanked and provisions are made for modulating the intensity in each cathode ray tube.

Laboratory quality has not been sacrificed in order to accomplish portability and ruggedness. Investigate the many advantages of Waterman POCKETSCOPES.

The INDUSTRIAL POCKETSCOPE, model S-11-A, has become America's most popular DC coupled oscilloscope because of its small size, light weight, and unique flexibility. This compact instrument has identical vertical and horizontal amplifiers which permit the observation of low frequency repetitive phenomena, while simultaneously eliminating undesirable trace bounce. Each amplifier sensitivity is 0.1 Volt rms/inch. The frequency responses are likewise identical, within -2 db from DC to 200 KC.

Discover for yourself the amazing utility of this tiny work-horse of industrial electronics.

POCKETSCOPE



S-11-A

RAKSCOPE®



S-12-B

The S-12-B RAKSCOPE is a rack mounted, JANized version of the famous Waterman S-11-A POCKETSCOPE, with the addition of a triggered sweep and a special calibrating circuit for rapid frequency comparisons. The entire oscilloscope is built to occupy but seven inches when mounted in a standard relay rack.

Because provisions are made for applying input signals from the rear, as well as the front, the S-12-B is the ideal combination, systems monitor and trouble-shooting oscilloscope. Investigate the multiple applications of this instrument as an integral part of your own rack mounted apparatus.

WATERMAN PRODUCTS

WATERMAN PRODUCTS CO., INC.

Write for your complimentary subscription of "POCKETSCOOP"

PHILADELPHIA 25, PENNA., U. S. A.

CABLE ADDRESS, POKETSCOPE, PHILA.

Manufacturers of POCKETSCOPES® • RAKSCOPES® • PULSESCOPES® and RAYONIC TUBES®

Why the Mallory **UHF** Tuner Should be Part of Your New TV Plans

The Mallory UHF Tuner can be the complete answer to your UHF tuning problems... whether you build converters, all-channel receivers, or both. It consists of three sections of variable inductance. It covers the range between 470 and 890 megacycles with approximately 2 mf of shunt capacity. Selectivity is excellent over the entire band.

No matter how you decide to handle the problem of UHF reception, it will pay you to investigate the various possibilities offered by the Mallory UHF Tuner. One of the following combinations is the answer to your requirements...

FOR CONVERTERS...

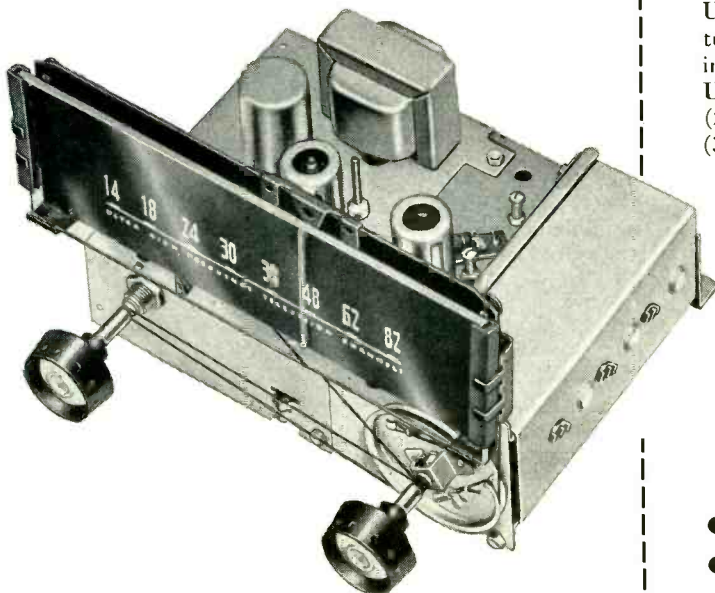

- Mallory UHF Tuning element for manufacturers building their own converters.
- Mallory UHF Converter chassis... ready to mount in your cabinet.
- Complete Mallory UHF Converter with your brand label.

FOR RECEIVERS...

UHF Tuners, for use in combination with VHF tuners, are available in 3 different designs... each in 3 different stages of assembly: (1) To convert UHF signals to 82 megacycles on channels 5 or 6. (2) To convert UHF signals to 130 megacycles. (3) For operation into a 41 megacycle 1F amplifier.

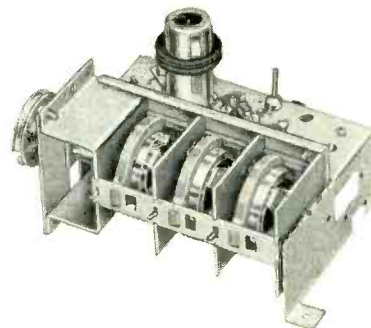

- Mallory UHF tuning element.
- Mallory RF assemblies. This includes the tuner, oscillator, tube, crystal and associated circuitry.
- Mallory RF assemblies with an IF amplifier operating at conversion frequency.

Get in touch with us regarding the Mallory UHF Tuner. We will be glad to work with you... see how these various possibilities can be fitted into your plans for UHF television. Write today.

Television Tuners, Special Switches, Controls and Resistors

P. R. MALLORY & CO. Inc.
MALLORY

SERVING INDUSTRY WITH THESE PRODUCTS:

Electromechanical—Resistors • Switches • Television Tuners • Vibrators
Electrochemical—Capacitors • Rectifiers • Mercury Dry Batteries
Metallurgical—Contacts • Special Metals and Ceramics • Welding Materials

P. R. MALLORY & CO., INC., INDIANAPOLIS 6, INDIANA

CROSS TALK

► **RADIATION** . . . Television receiver design engineers have embarked upon a program intended to reduce radiation which interferes with other sets and occasionally with other services.

The program will cost manufacturers a few pennies but should be supported on several counts. Radiation reduces the service available to the industry's own customers, and can be severe at ultra high frequencies. Voluntary reduction of radiation would avoid any possibility of direct or indirect dictation by the Federal Communications Commission. And if more uniform use of a standard intermediate frequency is involved in the program the industry will have valid grounds upon which to suggest that this frequency should be cleared.

► **MANPOWER** . . . Engineering manpower is still critically short. Part of this shortage is due to the fact that many men are engaged in the design of military electronic equipment while many others are supporting the economy by turning out a more or less normal number of commercial items. The two-way strain is unique in the history of the country.

Industrial growth is today closely linked to technological advances. Even if there were no need to devote so much engineer-

ing effort to strictly military projects it is unlikely that the number of graduates turned out by accredited schools would prove adequate in the decade ahead. That's why a grassroots campaign has been started to interest young men in engineering at the first-year highschool level; proficiency in math at very least is necessary if these young men are to meet college entrance requirements.

► **WELDING** . . . Tube elements have been welded for years, and now we hear that several electronic equipment manufacturers are considering welded wiring.

Among the possible advantages of welded wiring are virtual elimination of joint resistance, comparative freedom from broken-connection troubles and conservation of materials. Among the possible disadvantages are the necessity for bringing the work to the welder, comparative inflexibility of the tool with respect to work shapes and sizes and the necessity for cutting out failed components in the field. The latter is no great handicap in plug-in subassemblies intended to be expendable, where welded wiring may find its first commercial application.

► **TRANSISTORS** . . . In line with its usual tendency to put new eggs in the basket intended for the big-

gest customer, the electronics industry has put its first commercial transistors largely into communications devices.

As the art progresses it may be that there will be a shift in emphasis toward industrial and other non-communications devices because, among other reasons, noise is less of a factor in such applications. Here then is one possible point of cleavage in the market for tubes and transistors, and one that may leave each a pretty big basket more or less its own.

While we are on the subject of transistors we are reminded that a friend of ours, bothered by *npn* and *npn* terminology, calls the first *Penelope* and the second *Neptune*. He points out, further, that *Neptune* is often represented by a trident (three terminals) and that under *Penelope* the dictionary quotes "every night unraveled what she had woven by day" . . . an experience not entirely unlike that some engineers are having with transistor circuitry.

► **TAGGED** . . . On election day a young lady borrowed from the actuarial department of an insurance company operated a calculating machine called "Monrobot" in a network studio. Her first name happened to be Marilyn, so now she is frequently called Marilyn Monrobot.

TRANSISTORS . . .

Part I

Basic concepts of electron flow in semiconductors are explained, need for revised thinking to understand transistor action is outlined, and concept of hole introduced. Principle of current amplification in point-contact transistor is described

By **ABRAHAM COBLENZ** and **HARRY L. OWENS**

*Signal Corps Engineering Laboratories
Fort Monmouth, New Jersey*

THE ACCOMPANYING photograph shows a number of experimental transistors of the point-contact and junction types. These units occupy about one thousandth of the volume, represent on hundredth of the weight, and require about one tenth the power of the average type of radio receiving tube, yet they will perform many of the functions of vacuum tubes.

Transistors are capable of being used in circuits to provide amplification, oscillation, pulse generation, pulse counting, pulse storage, gating, and pulse delay, coincidence gates, and so on. They are more rugged than vacuum tubes in general and their life has been said to be about three times the normal life of a vacuum tube; the expected life has been extrapolated to 70,000 hours.

The transistor was invented in 1948 and at that time the total investment of private and government funds in transistor work, as such,

was limited to perhaps five-figure numbers. Increasing confidence in the potential utility of the transistor has resulted in both acceleration and expansion of the transistor development activity. The very large investments in transistors by tube manufacturers indicates that the long-term outlook for this new circuit element is sound and inviting.

The youthfulness of the field and the extraordinary promise it holds forth to capable technicians in the field of electronics and electricity render it extremely fruitful for the development of new and ingenious circuit and system applications.

In this virgin and unexplored field the need for electronic engineers and technicians specially trained in the transistor art is urgent and continually increasing. This series of articles should serve to initiate technical people with varied backgrounds in electronics into this fascinating subject.

Transistor theory represents a radical departure from vacuum-tube theory. The reader must be prepared to give careful thought to certain concepts of physics which are not difficult but are noticeably different from the principles with which he has become acquainted in his study of vacuum-tube theory and electronics. A scientific open-mindedness and a willingness to accept ideas that may appear to contravene long-established or long-accepted concepts will be found not only desirable but almost essential.

Preliminary Fundamentals

The flow of electrons accounts for both alternating and direct current. The theoretical explanation can be found in virtually all text books on a-c and d-c theory, electronics, and electrical phenomena in general.

A close scrutiny of the supporting evidence, however, reveals that electron flow is simply a convenient theory used to explain the phenomenon known as electric current. No one has ever crept into a conductor or electrolyte and witnessed the actual flow of electrons.

The theoretical explanation is the result of indirect experimental evidence and, while this experimental evidence is sound and will withstand very critical examination, the conclusions based upon it must be viewed as an inference or a hypothesis and not as a law of nature.

The fact that electron flow, as an

A FRESH START

This article is the first in a series on transistors which will be published in **ELECTRONICS** to enable engineers, technicians, amateurs and students to understand clearly the operation of these important circuit components.

The articles have been specially designed to provide theoretical, practical and working knowledge of the properties and applications of transistors, especially for those readers who do not have an extensive background in advanced mathematics and physics. Many readers will find these lessons valuable preparation for more advanced study of transistor electronics

Theory and Application

explanation for electric current, is only a theory is strikingly demonstrated by experimental observations that cannot be explained by the use of electron theory alone. Just such a case exists in the field of semiconductors—materials that exhibit conducting properties in a range between insulators and conductors. A particularly important phenomenon in transistor action is observed that does not lend itself to a direct explanation by means of electron theory alone.

Semiconductor Conduction

Consider the arrangement shown in Fig. 1. A small block of a semiconductor material such as germanium or silicon is placed in electrical contact with a conducting metal which is then grounded, as shown at *B* of the figure. On the top of the semiconductor block, spaced a few thousandths of an inch apart, are two cat whiskers such as were common in connection with the cat-whisker galena crystals used as detectors in the early days of radio.

The cat whisker marked *C* is negative with respect to the semiconductor block by virtue of the battery E_c with its negative terminal connected to the cat whisker. A milliammeter is shown in series with this connection and the current indicated will be designated as I_c . The circuit indicated may be considered as a crystal diode biased in the reverse or high-resistance direction. If the applied voltage E_c is approximately 10 volts, I_c may perhaps be of the order of 1 ma. (The figures used here are not intended to be significant; only orders of magnitude are important.)

Analyzing the observed data from the standpoint of electron theory one would say simply that electrons flow from the cat whisker to the base through the semiconductor material under the influence of the applied potential E_c , and it is the flow of these electrons which gives the meter indication I_c . The dashed

lines from *C* to *B* in the figure show the approximate flow or stream lines of electrons within the semiconductor block.

At the cat whisker marked *E* the polarity of the applied potential E_e is opposite to that at *C*; the positive terminal of the battery is connected to the cat whisker. A milliammeter in series with this circuit, if switch S_1 were closed, would then indicate the current in the *E-B* circuit, and since the diode on the *E* side is connected in the forward or low-resistance direction, a very small

potential at E_e when the switch is closed, say of the order of 0.5 volt, will cause a current flow of the order of perhaps 1 ma.

If the reader will, for a moment, imagine the *C* circuit open and S_1 closed then, as before, I_e indicates the current flowing in the *E-B* circuit due to electron flow from *B* to *E*. Again, as before, dashed lines indicate the stream lines of electrons in the *E-B* circuit within the semiconductor material.

Now consider the *C-B* circuit closed as shown and S_1 open. As

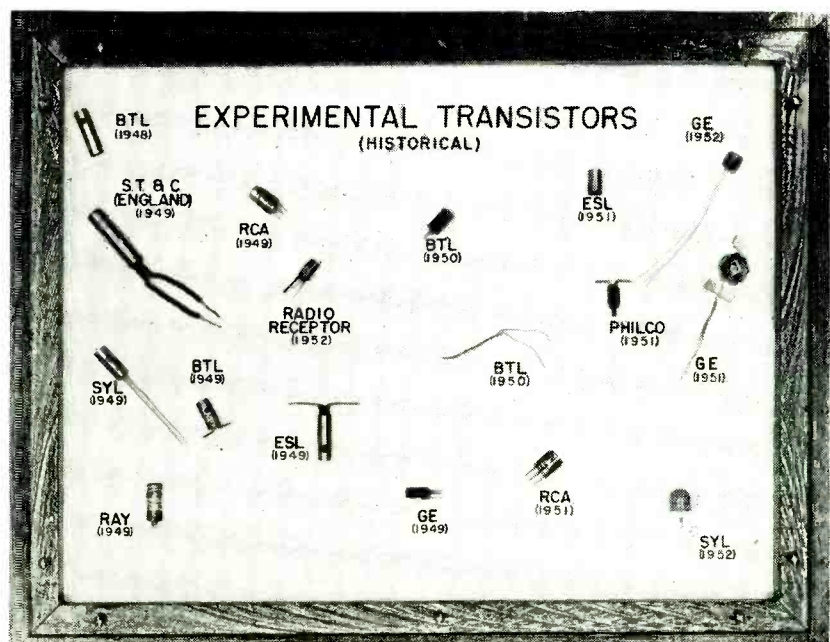

Collection of typical junction and point contact transistors

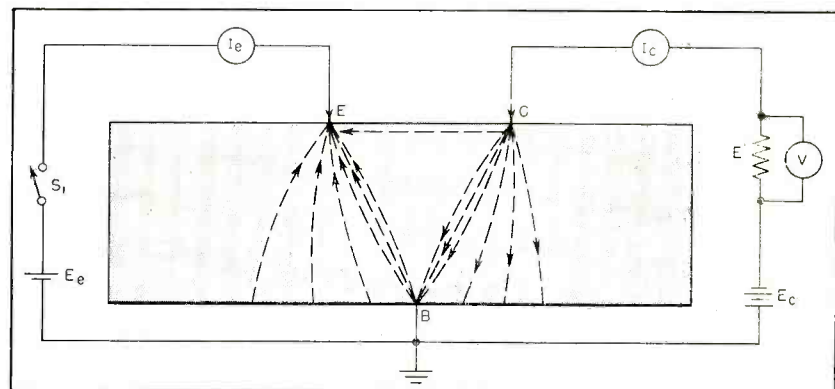

FIG. 1—Study of current flow in external circuit shown yields paradoxical phenomena that cannot be explained on basis of electron flow alone. A new concept, that of holes, must be adopted to understand transistor action

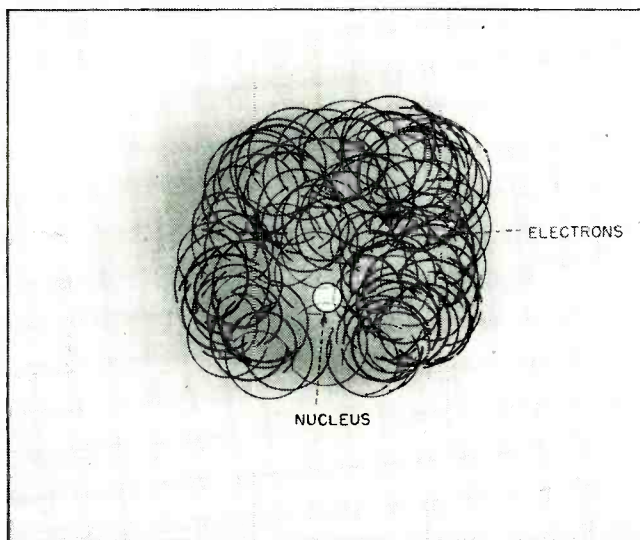

FIG. 2—Smeared drawing of atom shows orbital electrons surrounding nucleus. Net charge of such an atom is zero

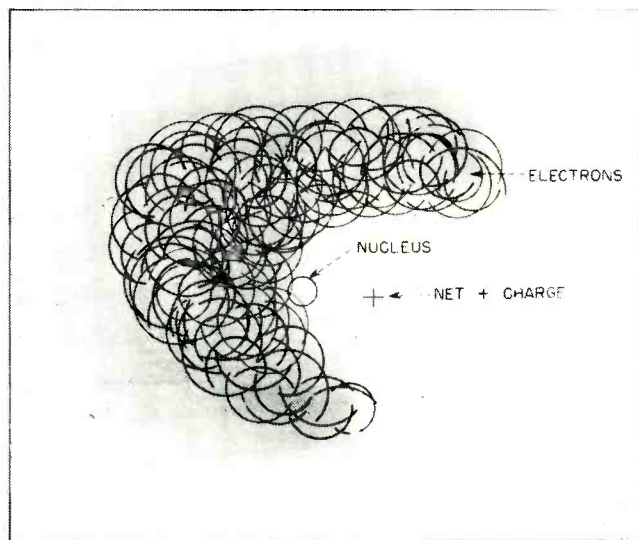

FIG. 3—Removal of one electron from neutral atom results in net positive charge due to hole (missing electron) in vicinity of nucleus

mentioned above, under the specified conditions, I_c will be about 1 ma.

When S_1 is closed an extraordinary phenomenon, loosely described as transistor action, is observed—the current in the $C-B$ circuit increases markedly and may, in a typical case, reach 2 or 3 ma. Typical transistors yield current amplifications of this magnitude but exceptional units have produced current gains as great as one hundred. In any case, a significant and highly important current amplification is observed.

It is instructive, following the remarks made at the beginning of this article, to attempt to explain the observed data by means of electron theory alone.

This is no simple undertaking. If the reader will carefully trace polarities around the circuit he will observe that the E terminal is actually positive with respect to the C terminal. One might then expect that electron flow within the semiconductor block would be from C to E , making less electrons available to contribute to the conduction process from C to B and therefore one might, at a first glance, expect I_c to decrease.

If fewer electrons were available for the conduction process the current would be smaller and the observed increase in I_c is certainly perplexing. Extraordinary and unconventional variations would be required in electron theory to ex-

plain how the two divergent streams of electrons in the material can cause an interaction which will lead to the current amplification observed, particularly in view of the electric field which tends to draw electrons from the $C-B$ stream.

It is virtually impossible to explain the phenomenon delineated by means of the electron theory alone and certain reinforcing or auxiliary concepts must be introduced to complement electron theory to explain properly this transistor action. The phenomena observed in semiconductors that lead to effects such as the one described do not require a modification of electron theory, but they imperatively demand an important additional concept.

Added Concept

In practice, a body of facts and experimental data accumulate and thereafter a hypothesis may be proposed which seeks to explain all the data. This is the normal progress of the scientific method.

Electron theory explains a host of phenomena already well known but does not preclude the possibility that a modification of electron theory will not only equally well explain the great number of experiments in a-c and d-c circuits but will, in addition, explain transistor action in a semiconductor. We must next examine the external evidence upon which we base our knowledge of the direction of flow of current

and the nature of the current carriers.

Electron Flow

Our knowledge of the direction of electric current flow is most frequently based on the direction of the magnetic field associated with electric current. The left-hand rule for electron flow states that if the left hand grasps a conductor so that the fingers point in the direction of the lines of flux, then the thumb will point in the direction of electron flow. From this rule it may be shown that if the electrons in a wire flow in a loop clockwise, in the plane of the paper the reader now sees, the north pole would be above the paper toward the reader and the south pole under the paper.

About 1889 a well known physicist, H. A. Rowland, performed a simple but extremely important experiment. In equally-spaced sectors of an ebonite disk were placed negative charges obtained by the time-honored method of rubbing cat's fur against a glass rod. The sectors were separated by raised portions so that each sector contained its own set of charges. This ebonite disk was then rotated at high speed and it was observed that a magnetic field was present identical to what would have been expected if a flow of electrons had occurred in a loop of wire in the same direction of rotation. If the plane of the disk were parallel to the plane of the paper then the north pole for clock-

wise rotation of the disk would be above the paper exactly as in the case discussed above.

When these negative charges were removed and replaced by positive charges and the ebonite disk then rotated *counterclockwise* the same direction of magnetic field was observed, north toward the reader if the disk is again considered parallel to the plane of the paper.

The significance of this experiment must not be overlooked. Our ideas about the direction of electric current are usually based on the direction of the resultant magnetic field. We assume that electric current is flowing from left to right because we can explain the resulting magnetic field on the grounds that negatively-charged electrons are flowing from left to right. The phenomenon we are observing, namely, the magnetic field, *could also* be caused by positive charges moving from right to left.

Rowland's classical experiment indicates that the external or phenomenological manifestations are the same. When we say electric current we never, unless by special training, think of the motion of positive charges, and in this way we subconsciously exclude the possibility that the carriers may be positive. Once we consider this possibility then our habit of associating electric current with the flow of electrons leads to this anomalous situation about the direction of flow.

In the transistor explanations that are to follow, it is essential that the reader bear in mind the possibility that electric current may be due to the flow of positive charges as well as to negative charges. The possibility that these two processes may be simultaneously active in an electronic semiconductor material is fundamental to the theory of transistor action.

Holes

Modern theory of the structure of matter pictures the atom as containing a core or nucleus with electrons outside of the nucleus, rotating about it. This subject will be covered fully in a subsequent article of this series. It may be said here, that the present picture of what the electrons look like as

they rotate about the nucleus is given by Fig. 2. The electrons are pictured as a sort of smeared out or hazy region about the nucleus as the figure shows. For purposes of this introductory discussion, let us grant that the cloud about the nucleus is due to electrons.

Hole Formation

If we were to remove one electron by some means, a net positive charge will be left since the atom with its normal complement of electrons is electrically neutral or has a net zero charge. By removing an electron from the picture presented in Fig. 2, we have created in the atom a sort of rarified area where an electron is not particularly likely to be found. This area looks like a hole, as illustrated in Fig. 3. A positive charge is associated with the hole.

The picture presented is not an entirely accurate description of a hole, and a more satisfactory definition of a hole will be given later. The rather crude picture is intended only for the purpose of introducing this new concept which is essential in the analysis of transistor action. (Having established that electric current can be carried by positive charges, and considering a net positive charge as a hole, it follows that electric current can be carried by holes.) The physicist uses the word hole in transistor theory a trifle differently from its usage in normal everyday conversation.

Because this concept of holes is so essential to the study of transistors, a few more ideas regarding

its nature may be in order. The concept of a hole came into existence in the study of the physics of solids because it was found to be a convenient physical-mathematical abstraction for specifying the behavior of atomic structures in the solid. By endowing the hole with a definite mass, a definite positive charge, a definite velocity and an associated energy—in short, by treating it as a true particle, very convenient mathematical relations are obtained and much useful and practical information about specific materials, particularly the semiconductors, can also be obtained.

It can be shown that holes are acted upon by electric and magnetic fields in exactly the way one would expect a particle with the mass of an electron and a positive charge to react under equal conditions. A particularly important aspect of hole behavior is its attraction by a point of negative potential. The reader will find it convenient in all future thinking about holes to consider them equivalent to positively charged electrons, that is, particles with mass equal to the mass of the electron and charge equal to that of the electron but of opposite sign. The more accurate definition of a hole to be given later will not conflict with this simple picture.

Hole Effect

Having introduced these preliminary concepts,—let us return to the laboratory-observed phenomenon discussed in connection with Fig. 1. In Fig. 4 is shown essentially the same arrangement electrically, as

THE FRONT COVER

PROGRESS in transistor production methods is illustrated in this month's cover. Junction transistors produced in Raytheon's Newton, Massachusetts plant are subjected to 12-hour aging periods prior to shipment. The CK 721 transistors being inserted in the aging racks have an average power gain of 38 db when used in a grounded-emitter circuit with a collector voltage of 1.5 volts, collector current of 500 μ a and a base current of 6 μ a.



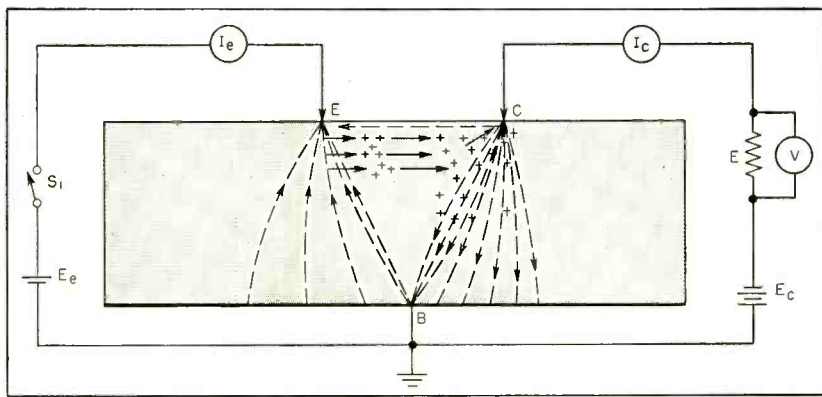

FIG. 4—Drawing shows simplified essentials of transistor action (when S_1 is closed) for point contact transistor. Plus signs indicate positively-charged holes that migrate from emitter toward collector

in Fig. 1. Let us try now to see how the introduction of the concept of holes can lead to a plausible explanation for the phenomenon of current amplification.

Current Amplification

As electrons leave the germanium block at point E due to battery E_e , holes are created in the material in consonance with the elementary principles just discussed, wherein electrons removed by any means from their atomic location give rise to holes as shown in Fig. 3. Under the influence of the electric field (note that point C is negative with respect to point E) the holes drift toward the C side of the circuit.

We have already seen that ordinarily the current I_e is small because the number of electrons available for conduction is inadequate to support a larger flow.

If the reader will recall his experience with the behavior of a negative space charge from vacuum-tube theory, he will realize that the presence of a positive space charge due to holes between C and B can create a strong attracting region for electrons in this space. Electrons from neighboring sites are thus attracted into the C - B region and add to the available electrons for conduction.

The result is a circuit which possesses lower resistance due to the abundance of electrons. The evidence that the circuit has lower resistance is that current I_c will increase when S_1 is closed.

This is a rather crude explanation of what happens and later a more accurate and sophisticated explanation will be presented. The

introduction of the additional concept of holes assists in the explanation of transistor action involving current amplification. Before introduction of the concept of holes no satisfactory explanation for transistor action was apparent.

It must not be inferred, merely because this is an elementary explanation, that the hypothesis presented here regarding the motion of holes is merely a guess. There is a good and sound body of evidence to support this hypothesis and a particularly interesting experiment along these lines will be described.

In transistor parlance, the cat whisker at point C is known as a collector and the cat whisker at point E is known as the emitter.

Assume that the physical position of the emitter is fixed and that the spacing between emitter and collector is varied by moving the collector whisker. It has been mentioned in the description of a hole that it can be acted upon by a magnetic field. In addition, holes do not actually flow from the emitter to the collector in perfectly straight lines. The motion of the holes toward the collector is due to the force of the electric field plus an ordinary diffusion action; the electrons traverse curved paths from emitter to collector, possibly approximating arcs of circles.

Hole Characteristics

If a magnetic field of proper direction is applied across the slab, the diffusion of the holes into the slab is restricted and the current of holes can be made to flow more nearly in a straight line. As the holes move from emitter to collector

many of them collide with an electron associated with an atom, recombine and disappear. This recombination is always going on and is one of the important phenomena in transistor action. For this first article it is sufficient to point out that unlike the electron, the hole has a finite life. Typical values of average hole lifetime for single-crystal germanium lie in the range from a few microseconds to several thousand microseconds. The velocity of a hole is also a fixed quantity. The velocity of the hole multiplied by its lifetime will determine the distance the hole will travel before recombination.

Since a straight line is the shortest distance between two points it is clear that holes that follow a straight line from emitter to collector will more nearly complete the trip before disappearing due to recombination than those that travel in a curved path. The magnetic field, by forcing the holes into the upper portion of the block, compels them to follow paths which are more nearly straight lines.

Experimentally it is observed that transistor action is obtainable at the collector in the presence of a magnetic field when the collector is physically spaced further away from the emitter than without the magnetic field. This experimental fact tends to strengthen the belief that positive particles of some kind flow from emitter to collector in the case of the arrangement shown in Fig. 1.

Summarizing the major points of this first article the reader is urged to retain the following essential points:

(1) Transistor action in units of the type illustrated in Fig. 1 is characterized by current amplification.

(2) It is necessary to introduce the concept of holes to explain transistor action.

(3) For practical purposes a hole may be considered to be a positively-charged particle with a positive mass.

(4) In the study of transistors the reader must be prepared to consider and master new concepts which may be radically different from many of the scientific principles he has studied previously.

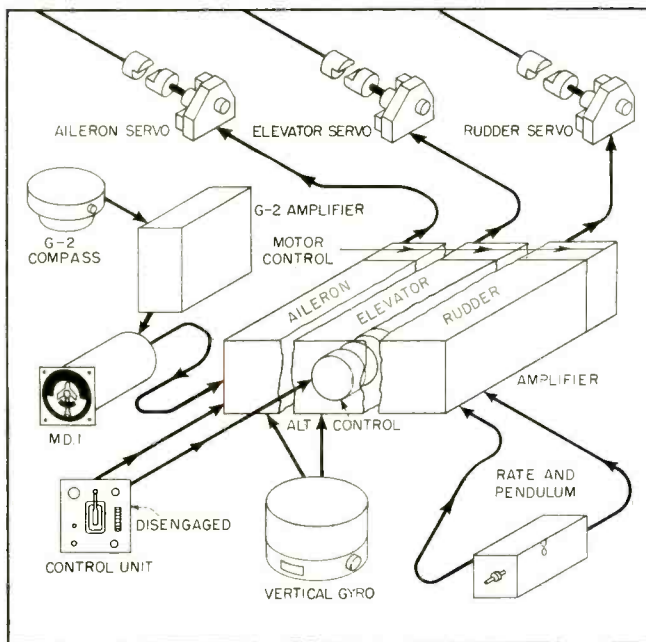

Typical autopilot for fast jet plane has aileron, elevator, and rudder motor controls

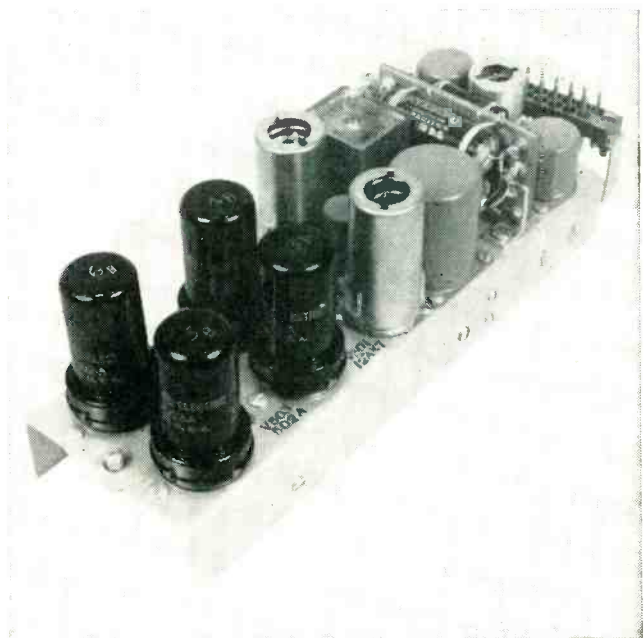

Control weighs 2¼ lbs, compared to 6 lbs or more for previous model. Built on plug-in chassis, unit reduces servicing problems

Free-Wheeling Thyratrons Cut Autopilot Weight

Thyatron motor controls operate through full cycle, but need no heavy transformers. In spite of long cables, signals provide fast, accurate positioning response of control surfaces.

Full control is gained with 0.1-volt in-phase signal

AUTOMATIC pilots fly planes on set courses by positioning the control surfaces in accordance with gyro instructions and signals from instruments measuring the control surface positions. These signals position the surfaces through electric motors, the motor controls telling the motors which way to turn and how fast, as the instruments instruct.

The motor control's task, then, is to supply power to the electric motors which move the control surfaces of the airplane. It must also control the amount and direction of the power according to the deviation of the airplane from the de-

sired direction of flight and altitude. Since there are three motor controls per autopilot—rudder, aileron, and elevator—their weight is an important consideration.

Operationally, the motor control must suit these requirements: It must have sufficient power output to drive the airplane controls, normally about 10 watts. The motor and motor control must be able to move the control surface rapidly. In servomechanism terms, the motor

and motor control must respond accurately to 2.5 cps to give stable operation on the latest model jet fighters. Finally, the motor control must operate satisfactorily through a wide band of variation in the temperature, supply frequency and voltage ranges.

The Basic Circuit

The main power amplification in the motor control is supplied by thyratrons, operating from a 400-cps power supply and driving a split-field series motor. To avoid using a transformer, the thyratrons operate half wave directly from the a-c line. The characteristics of

By **CHARLES G. YATES**

*Aeronautics and Ordnance Div.
General Electric Co.
Schenectady, N. Y.*

the split-field motor permit a simplified method of control (Fig. 1). For each direction of rotation, the corresponding thyatron is fired, controlling the current through the armature and half the motor field.

To more than double the current through the motor, so-called "free-wheeling" thyratrons are added to the circuit (Fig. 2). These thyratrons fire automatically at the proper time, requiring no complication of the control circuit. The circuit is shown in Fig. 2 (top). As the plate of the upper thyatron is made positive by the a-c supply, the tube conducts and current flows through the motor. The IR drop

in the grid circuit. For ease of explanation, consider the firing tube circuit first without the capacitor across the load resistor. The resulting waveform is shown as a dotted line in the diagram. Since the power supply voltage is a sine wave, the output voltage waveform is also approximately a sine wave. Diode action of the firing tube permits conduction during one half cycle only. It is possible to vary the peak of the resultant voltage by control of the firing tube grid (either by d-c or a-c voltage).

When the capacitor is added, the saw-tooth waveform shown in the solid line is produced. The ampli-

except that power for the tube comes from an excitation transformer connected to the tube plate, rather than coming directly from the a-c line. This allows the cathode side of the load resistor to remain at a-c ground potential with respect to the next stage.

A little more gain was necessary than was available in the discriminator tube, so the input transformer was added to get a three-to-one step up. As all these circuits are double ended, the input transformer also serves as a phase inverter for input to both discriminator tubes.

The operation of the discrim-

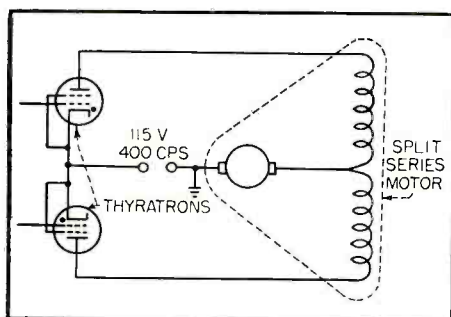

FIG. 1—Basic control operates thyratrons half wave direct from a-c line, using split-field series motor for simplified control

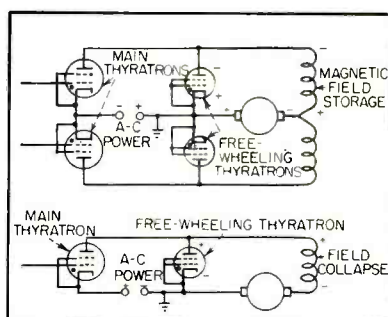

FIG. 2—Adding "free-wheeling" thyratrons doubles the current through the motor, gives full-cycle output, for autopilot controls

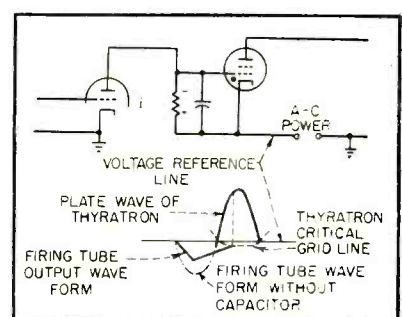

FIG. 3—RC network in grid circuit generates saw-tooth wave whose amplitude can be varied to control firing time of thyatron

voltage polarities across the armature and field of the motor are shown. The free-wheeling thyatron does not fire because of the negative potential on its plate. When polarity reverses (Fig. 2, bottom), the main thyatron cuts off. The collapsing magnetic field in the motor winding tends to act like a generator to keep the current flowing. The polarity across the motor and therefore across the free-wheeling tube reverses, causing this tube to fire and conduction to continue in the same direction as before. Therefore, current flows in the motor in the same direction throughout a full cycle, just as in a full-wave thyatron circuit but without a transformer or complicated control circuit.

Controlling The Output

To control the firing of the thyratrons, a special circuit (Fig. 3) generates a saw-tooth waveform

of this saw-tooth may be varied by changing the input voltage to the firing tube grid. If the amplitude of the saw-tooth waveform can be controlled up and down, then the point of intersection of the saw-tooth and the thyatron critical grid voltage may be moved back and forth and the conduction of the thyatron controlled smoothly from no conduction to full conduction.

If there were sufficient gain from this input point to the motor, the autopilot signal could be brought directly to this firing tube grid. However, additional gain is needed so another tube must be added to the circuit.

A discriminator is necessary to detect the polarity and amplitude of the alternating voltage. Both discrimination and gain can be obtained with a single tube, as shown in Fig. 4. Operation of the discriminator is similar to that of the firing tube previously explained,

inator is as follows: The signal input to the tube grid is a-c. Then with a-c on both the grid and the plate, the tube essentially conducts only when both grid and plate are positive on the same half cycle. If both are positive, then a rectified current flows through the load resistor. In the firing tube only the saw tooth or a-c portion of this wave was used. Actually, the wave also contains a large d-c component which is important in the control of the next tube, the firing tube. (The amplitude of both the d-c and a-c portions depend on the amount of capacitance across the load resistance.)

Therefore, if the input is out of phase with the excitation to the discriminator tube, the tube will never supply control to the firing tube regardless of the amplitude of the input voltage. If the input is in phase, the discriminator will supply a d-c control voltage and the

amplitude of this voltage may be adjusted by amplitude control of the input voltage.

Quadrature Voltage

The circuit connected to the input transformer in Fig. 4 is called a quadrature eliminator. Quadrature voltage is objectionable in most high-performance motor controls and especially in this one, since it decreases the overall gain of the control to the point where performance is unsatisfactory. Quadrature voltage occurs in the autopilot signal circuit since a number of selsyn signals are added in series. It is further generated by various noise

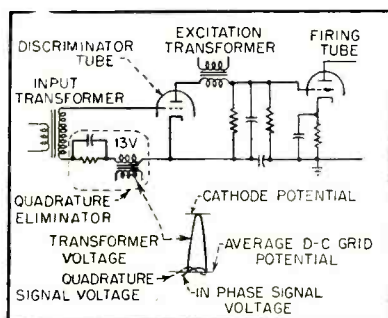

FIG. 4—Discriminator circuit gives added gain and eliminates most of out-of-phase or quadrature component of signal voltage

and stray capacitance effects of the long signal leads from remote autopilot components. In practice, some of the electrical cables are more than 100 ft long.

The quadrature circuit for this control consists of a transformer, a resistor, and a capacitor in series with the output transformer and the cathode of the tube. The quadrature rejector cuts down the sampling or detection time of the discriminator to a very small range, when the in-phase or useful signal voltage is at its peak. This is also the interval of minimum quadrature voltage during the a-c cycle. Effectively, the resistor and capacitor are a grid-leak for biasing the tube. The excitation transformer injects 13 volts into the grid circuit.

When the power is first turned on, even with zero signal, the tube grid momentarily draws current until the grid-leak is charged to approximately peak voltage. The average

d-c grid potential is then negative with respect to the cathode potential. The normal in-phase signal voltage adds to or subtracts from the transformer voltage, thereby controlling the discriminator tube.

Due to the peaking of the large 13-v excitation wave, the signal has control over the discriminator tube for only about 20 degrees of the 360-degree cycle. The quadrature voltage is always going through zero during the 20-degree sensitivity range of the discriminator (dotted wave in Fig. 4). Actually, the

critical grid line, the bias source is added to raise the entire firing tube output, permitting intersection.

The final wiring diagram is shown in Fig. 5. The unit consists of a small chassis which can be plugged in or removed from the autopilot in a few seconds. The housing of the controlled motor also contains a tachometer for aiding in the stabilization of the motor as an autopilot component.

The chassis weighs 2½ lb, while previous motor controls weigh 6 lb or more. Since each autopilot con-

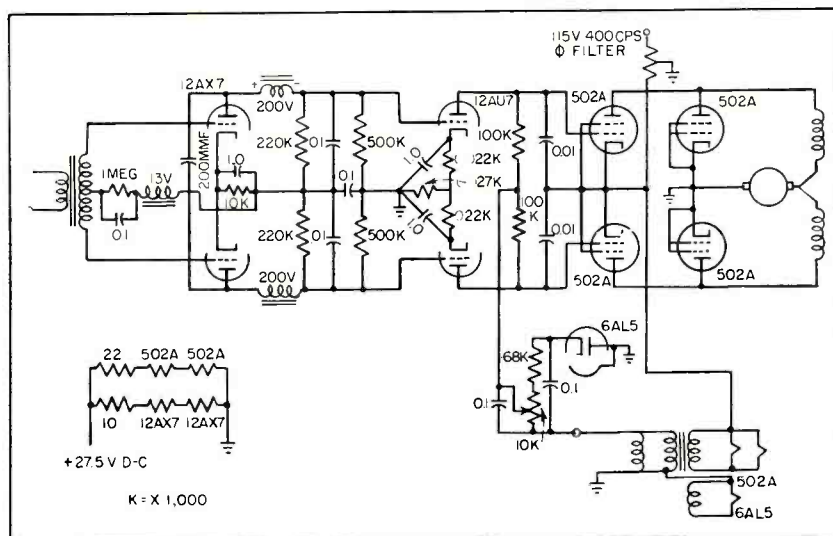

FIG. 5—Complete motor control circuit is double-ended, with complete discriminator and firing circuit for each direction of rotation. Added d-c bias source increases gain in the firing stage

in-phase and quadrature voltages are not broken up but are present as a resultant wave, but the circuit operation is the same.

The Final Circuit

The motor control is double-ended; for each direction of rotation there is a complete discriminator and firing circuit. However, one side of one circuit is common to one side of the other circuit (Fig. 5). Note there is a d-c bias source added between the firing stage and the main thyratrons, to achieve increased gain in the firing stage. The gain is increased by holding the discharge portion of the saw-tooth wave closer to a horizontal line (Fig. 3). Since the leveling of this discharge wave would preclude completely the intersection with the

tains three of these controls, the weight advantage amounts to 11 lb or more. This makes it possible to cut the weight of present autopilots to almost half that of their predecessors.

Along with weight reduction, it has been necessary to improve the response of the motor and motor control so that the autopilot response will be far ahead of the jet fighter motions. This thyatron control is capable of 50-cps response. The motors available limit the overall response but they have been improved to follow accurately the variations of a 7-cps signal.

As far as quadrature elimination is concerned, the motor control will remove 3 v of quadrature noise and will give full control for 0.1 v of in-phase signal.

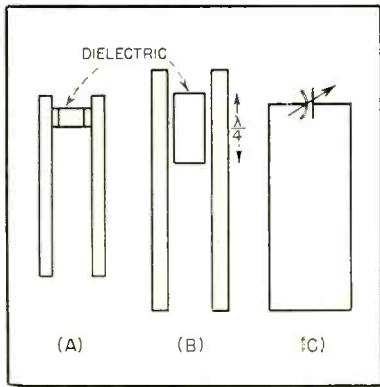

FIG. 1—Sliding (A), open-end, quarter-wave (B), variable-capacitor tuning (C)

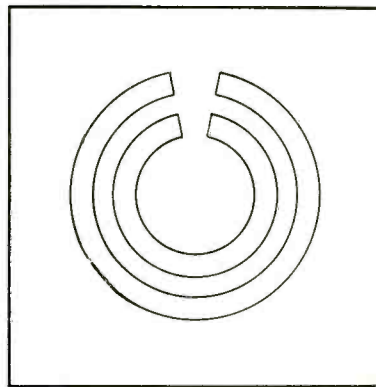

FIG. 2—Slotted concentric cylinders give wide-angle tuning

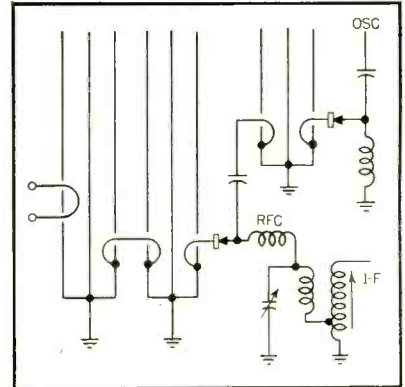

FIG. 3—Single-channel converter designed for minimum noise figure

Analysis of UHF Tuner Design

CONSIDERATION of the fact that the combined vhf and uhf frequency span covers approximately four octaves, with added complications due to transit-time effects and the distributed nature of tuning elements, may help develop the proper perspective in relation to the overall tuner-design problem.

Techniques effective in dealing with problems peculiar to the individual bands are frequently mutually exclusive. Transmission lines, for instance, prove rather awkward at vhf while lumped constants at uhf are almost ruled out. This alone should cast some doubt on the feasibility of a successful design of a combined vhf-uhf tuner using common tubes and tuning elements. Much time elapsed before a vhf tuner having approximately uniform performance characteristics over the two vhf bands was evolved. To extend the range to 900 mc is a challenging task indeed.

If it were possible to accomplish this, one might ask whether such a course would necessarily be desirable. On the positive side of the

ledger is the feature of greater compactness, simplified mechanical design and possibly a measure of elegance as an engineering solution. But to accomplish this, continuous tuning would almost certainly have to be employed (even though some detent mechanism may be included) and sliding contacts, notoriously noisy, are a forgone conclusion.

The switch type vhf tuner has been widely accepted as more reliable and convenient. It may not be prudent to compromise these qualities because of the inclusion of uhf.

Tuning Devices

From the point of view of tuning range, the use of a sliding short would appear most attractive. There is one serious drawback, contact noise. A modification which overcomes this problem to a large extent consists of replacing the sliding metal-to-metal contact with a sufficiently large capacitance formed by inserting a dielectric between the sliding sleeve and the conductor (Fig. 1A).

An open quarter-wave line can

also serve as an effective short. Broad-band characteristics can be secured by making the surge impedance of the line section very low relative to the surge impedance of the tuned line. A range of 2:1 can be readily attained by adjusting the line-length to a quarter-wave at the center frequency of the band.

Since the grounded-end is movable, capacitive rather than inductive coupling is indicated if one seeks to avoid the use of a movable coupling loop. Fig. 1B shows a single-tuned transmission line employing this method of tuning.

Teflon as a dielectric spacer suggests itself in circuits in Fig. 1A and 1B. It has excellent wearing properties, low friction and low dielectric losses.

The circuit shown in Fig. 1C relies on capacitive tuning. This method is quite simple and convenient. However, the Q is generally degraded by the insertion of capacitance.

Simultaneous tuning of the inductance and capacitance of the tuned circuit will result in greater

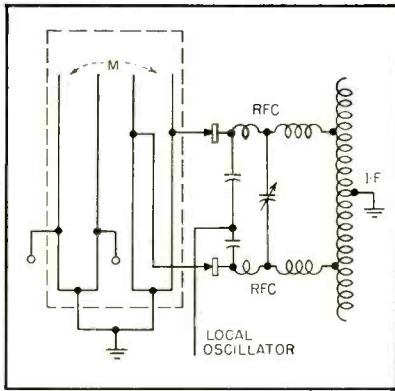

FIG. 4—Broad-band preselector, with balanced crystal output

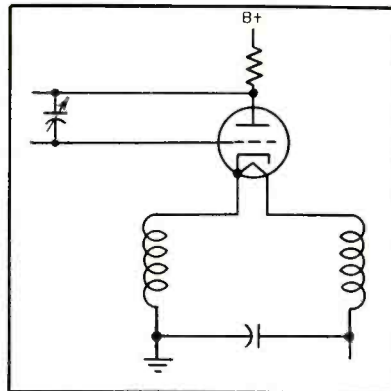

FIG. 5—Transmission line-tuned oscillator covers full uhf band

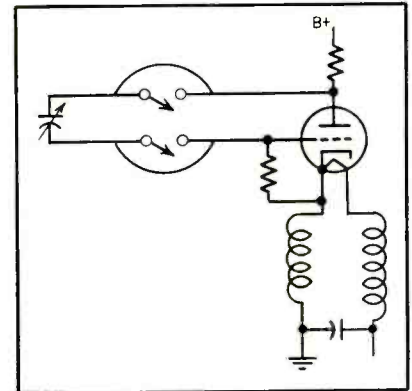

FIG. 6—Capacitance-tuned oscillator has limited range

With no strict rules of design procedure, judgment and discrimination must be used in selecting circuits and components to meet specific requirements economically. The fundamental aspects of uhf reception have been treated, but detailed design problems remain

By ARNOLD NEWTON

Consultant
Forest Hills, New York

range. Butterfly and semi-butterfly circuits fall into this category of tuners.

Two slotted concentric cylinders (Fig. 2) offer perhaps the simplest form of a wide-range tuning mechanism. The circuit is inherently unbalanced and some form of link coupling is frequently necessary.

The use of a single and a relatively low intermediate frequency in the uhf region places stringent requirements on the preselector design. A narrow-band, multiple-tuned preselector is subject to losses due to finite unloaded Q's. These losses are a function of conductor dimensions. Thus size and material cost enter the picture. In addition, as the number of tuned circuits is increased, the tracking problem becomes more difficult.

Based on the premise that in their fundamental nature the vhf and uhf bands are sufficiently distinct to warrant different techniques, a double superheterodyne system which would include a uhf converter working into the vhf

tuner is considered, for the present at least, the most practical approach. Wide variations are possible within the framework of this basic scheme.

Mixer Circuits

Currently available germanium and silicon uhf mixer crystals are similar in their essential characteristics, except that the conversion loss is lower for silicon crystals, resulting in a noise-figure improvement of 2 to 3 db.

Some uhf mixer tubes have also become available but they require higher levels of oscillator injection, calling for higher selectivity to maintain oscillator radiation at a reasonable level. In addition the noise figure of the mixer tube is generally higher. Such tubes are most useful in circuits using r-f amplification.

A simple crystal mixer is part of the circuit shown in Fig. 3. Within the normal range of crystal current due to oscillator injection (0.3-1ma) the variation of minimum noise figure is slight. The r-f and i-f im-

pedances vary considerably and the required input and i-f circuit adjustments vary correspondingly. It is essential therefore to maintain the injection level fixed over the band.

In most oscillators the output level falls off gradually at higher frequencies. A simple R-C equalizing network, consisting of a small coupling capacitor and a small resistor across which the output voltage is developed, is often satisfactory. In some instances the effectiveness of this scheme is reduced due to the loading effect of the mixer circuit.

Some improvement can be obtained by shunting the resistor with a circuit designed to tune out the incidental reactances at the proper frequency, usually above the maximum oscillator frequency.

The same considerations apply to balanced converters (Fig. 4) which at the expense of an additional crystal offer certain unique advantages. Being inherently balanced the circuit is more suitable for use with the standard 300-ohm balanced

line at the input and the vhf tuner connected to the output of the balanced i-f. The amount by which oscillator radiation is reduced depends on how closely the crystals are matched with regard to their impedances and particularly their shunt capacitances and forward resistances. With a properly matched pair, the improvement can be substantial.

The balanced mixer also serves to suppress oscillator noise. The noise contributed by the oscillator is a function of its tank-circuit Q and the intermediate frequency, being higher for low circuit Q and low i-f. This factor is seldom significant at uhf and much effort to eliminate it is not warranted as a rule.

Oscillator Circuits

The choice of tubes for fundamental operation is relatively restricted. As a practical tube the 6AF4 is finding wide acceptance.

Because of its simplicity, the Colpitts circuit is almost universally used. Cathode and filament chokes serve to raise the r-f circuit above ground. The effect of ground impedances on oscillator operation and radiation is thus minimized.

The required tuning range to cover the full uhf band can be realized by using a variable-length transmission line as the tuning element (Fig. 5).

Capacitive tuning as employed in the circuit in Fig. 6 has a somewhat limited range and usually calls for band-switching.

Because of the relatively low oscillator power required to operate the crystal mixers, the use of second-harmonic injection is quite feasible. A circuit tuned to the oscillator second harmonic and ganged with the oscillator tuning device can serve to extract the second-harmonic component and suppress the fundamental.

Crystal diodes have been used successfully to generate harmonics. Many oscillators, particularly class-C oscillators, have a significant harmonic content which can be made available without recourse to harmonic generators. The push-pull oscillator is particularly suitable for this application. At the neutral points of the circuit, cath-

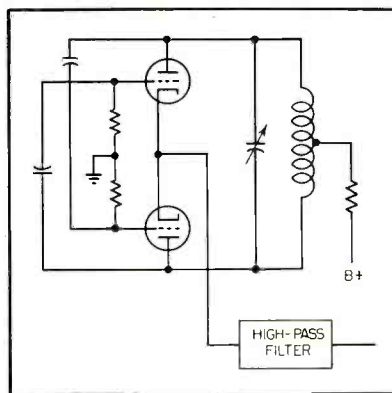

FIG. 7—Half-frequency oscillator injects second harmonic through high-pass filter

ode and center tap of the plate load, the fundamental is suppressed to a degree depending on the balance of the circuit.

The fundamental suppression by virtue of balance is seldom adequate and additional selectivity must be relied upon. The use of a high-pass filter in place of the tuneable resonant circuit would result in greater simplicity and economy and it would, above all, eliminate the tracking problem. With double conversion, however, the tuning range is in excess of 2 to 1, making it impossible to devise an effective filter unless band-switching is employed.

Using a single i-f system of 41 to 47 mc, a relatively sharp cut-off must occur within a band of approximately 50 mc. It is possible to accomplish this using a multi-section high-pass filter. Sufficient harmonic content must be available to compensate for the filter insertion loss within its pass band.

Figure 7 shows an oscillator circuit operating at half frequency, supplying second-harmonic injection through an intervening high-pass filter.

Interference Sources

Generally, a fair degree of selectivity is essential to provide immunity against interfering signals. The two most potent sources of interference are signals within the i-f and image bands.

Selectivity against interfering signals outside the uhf band can be readily secured through the use of fixed-tuned rejection filters. Specifically, as regards i-f rejection and

the rejection of vhf signals, a high-pass filter can be quite effective.

The degree of image selectivity required at uhf should be reexamined as to possible sources of interference and their relative strengths. Much depends on the permissible channel spacing within a given service area. It is expected that local channel assignments will preclude the possibility of image interference in receivers employing standard intermediate frequencies.

Oscillator radiation is another potential source of interference. The input circuit selectivity determines both the susceptibility to extraneous oscillator interference and the transmission of oscillator power to the antenna. In this case also, local channel assignments calculated to meet such conditions will be effective except in instances of off-channel tuning.

The rejection offered by a multiple-tuned high-Q preselector is proportional to

$$\left[\frac{2 |f_r - f_s|}{\Delta f} \right]^n$$

where f_r and f_s are the frequencies of the r-f and the spurious signals respectively, Δf is the preselector bandwidth and n is the number of tuned circuits. In case of the image signal $|f_r - f_s| = 2f_i$, f_i being the intermediate frequency.

Although higher intermediate frequencies relieve the preselector requirements, the i-f noise figure suffers. On the other extreme, the choice of a very low i-f may also lead to a degradation of the overall noise figure as a result of preselector insertion loss. Increased selectivity will be sought either by raising the loaded Q, by increasing the number of tuned circuits, or both. In any case losses are likely to occur with tuning elements of practical size.

Improper i-f choice can also give rise to spurious beats at certain characteristic frequencies. A particularly objectionable condition prevails when the signal frequency is translated to the i-f by virtue of second harmonic as well as fundamental conversion. The following relation expresses this condition: $2f_o - f_i = f_s + f_i$, or $2(f_o - f_i) - f_i = f_s$, resulting in $f_s = f_o/3$. Intermediate frequencies above 160

me should, for this reason, be avoided.

Noise Figure

The required degree of selectivity may be problematical at present, but there is general agreement about the importance of noise figure. The overall noise figure is a function of the i-f noise figure, the crystal noise temperature where crystals are used, conversion loss and preselector loss.

The following is a list of symbols to be used:

- F — noise figure
- F_{min} — minimum F under optimum input circuit conditions
- F_m — noise figure under conditions of match
- F_B — noise figure for a specified bandwidth and input capacitance
- B — input circuit bandwidth (single-tuned)
- B_o — B under optimum noise figure conditions
- R_o — Generator resistance as seen at the grid of the i-f amplifier
- R_{oo} — optimum value of R_o resulting in F_{min}
- R_{eq} — equivalent noise resistance as referred to the input
- R_t — input resistance due to transit time
- T — effective temperature of R_t
- T_o — room temperature — 290 K
- t — crystal noise temperature
- λ — crystal conversion loss
- μ_m — tube transconductance
- C — input circuit capacitance
- f_i — i-f center frequency
- α — input transformer turns ratio
- α_o — optimum turns ratio

For a triode R_{eq} is a function of g_m .

$$R_{eq} = \frac{2.5}{g_m} R_t \text{ varies inversely as } f_i^2 \text{ and}$$

$$R_t = \frac{K}{f_i^2}$$

The characteristics plotted in Fig. 8 and Fig. 9 were computed for a typical low-noise input stage (6AK5) having the following constants: $g_m = 6.5 \times 10^{-3}$ mhos, $C = 10^{-11}$ farads (total, including crystal and stray) and $K = 8 \times 10^{10}$. Assuming small enough transit angles to minimize coherence effects between grid and plate noise.

$$\frac{T}{T_o} \approx 5.$$

I-F Noise Figures

The i-f noise figure depends critically on tube characteristics, in particular the $g_m k$ product, as well as on the input circuit design. Triodes are superior by virtue of their low R_{eq} , and cascode circuits are gener-

ally favored in this application.

For a grounded-cathode stage, conditions for minimum noise figures are obtained when the generator resistance as seen at the grid satisfies the following relation

$$R_o \approx \sqrt{R_{eq} R_t} \frac{T_o}{T} = \frac{1}{f_i} \sqrt{\frac{K}{2g_m}} \quad (1)$$

This results in a noise figure

$$F_{min} = 1 + 2 \sqrt{\frac{T}{T_o} \frac{R_{eq}}{R_t}} = 1 + \frac{7f_i}{\sqrt{g_m k}} \quad (2)$$

The maximum input-circuit bandwidth under optimum conditions is in addition a function of C

$$B_o = \frac{1 + \sqrt{\frac{R_{eq}}{R_t} \frac{T_o}{T}}}{2\pi C R_t} \sqrt{\frac{R_{eq}}{R_t} \frac{T_o}{T}}$$

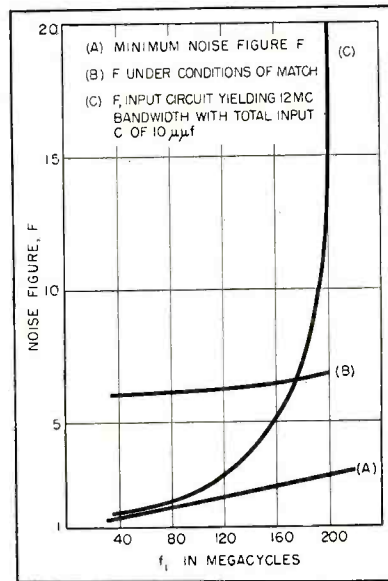

FIG. 8—Noise figure F versus frequency

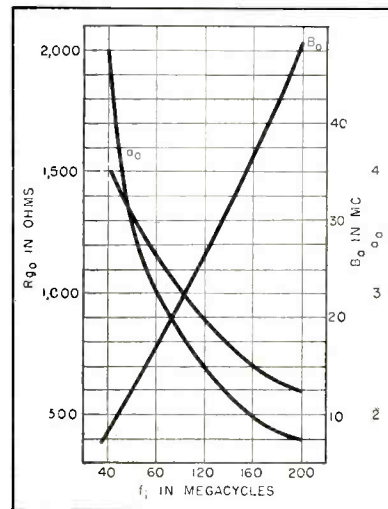

FIG. 9—Turns ratio, bandwidth and optimum R_{oo} versus i-f frequency

$$= \frac{f_i}{2\pi C} \sqrt{\frac{2g_m}{K}} \left(1 + \frac{f_i}{\sqrt{2g_m K}}\right) \quad (3)$$

The bandwidth B_o is that of a single-tuned circuit. Double-tuning will increase the bandwidth by a factor of approximately 1.4, and should therefore be used at low intermediate frequencies where B_o is not much in excess of 12 mc, the width of two channels.

The linear relationship of F_{min} versus f_i is shown in Fig. 8A. The considerably higher noise figures under conditions of match are plotted in Fig. 8B.

$$F_m = 6 + \frac{10}{g_m R_t} = 6 + \frac{10f_i^2}{g_m K} \quad (4)$$

The noise figure obtained when the turns ratio is adjusted to yield a bandwidth of 12 mc is shown in Fig. 8C. Between 40 and 100 mc the increase in noise-figure over F_{min} is very slight. This is due to the fact that B_o is approximately 12 mc in this region. This portion of the vhf spectrum would appear therefore to be quite suitable.

Above 100 mc, F_B rises sharply and reaches the value of approximately 20 at 260 mc. The relevant expression is

$$F_B = 1 + \frac{\frac{T}{T_o} f_i^2}{2\pi B K C - f_i^2} + \frac{2.5}{g_m k} (2\pi B K C - f_i^2)$$

$$\left(1 + \frac{f_i^2}{2\pi B K C - f_i^2}\right)^2 \quad (5)$$

When it is desired to use a high i-f and restrict the bandwidth below B_o , circuit capacitance should be added instead of changing α_o . Optimum turns ratio α_o as well as B_o and R_{oo} are plotted in Fig. 9

$$\alpha_o = \frac{\sqrt{2g_m K}}{\sqrt{f_i}} \quad (6)$$

Noise Temperature

The term noise temperature is somewhat misleading. It refers to a factor by which the temperature of the crystal i-f resistance (assumed at room temperature 290 K) must be multiplied to pro-

duce an equal amount of noise power as that produced by the crystal at its i-f output terminals.

The available output noise power of the crystal is $t \times kTB$. By definition, the noise figure is the quotient $\frac{N_o}{GN}$, where N_o is the available output noise power of the network, G the gain of the network and N the available thermal agitation noise power kTB . The crystal noise figure designated by F_1 is therefore $\frac{t}{G}$. The overall noise figure is

$$F = F_1 + \frac{F_2 - 1}{G} = \frac{t + F_2 - 1}{G}$$

or $F = L_c(t + F_2 - 1)$ where $L_c = 1/G$ is the conversion loss and F_2 is the i-f noise figure.

The crystal noise temperature is a function of oscillator injection. It is very high at low frequencies but levels off to a constant value at approximately 10 mc. The noise temperature bears a straight-line relationship to oscillator injection, starting with unity at zero rectified current. The conversion loss reaches a minimum at a certain level of oscillator injection and F assumes a minimum slightly below this value.

Conversion Loss

Conversion loss is the greatest factor contributing to the overall noise figure. It is lowest with fundamental conversion. Harmonic conversion should be avoided as it results in increased loss and consequently a higher noise figure. This does not mean the oscillator must be operated at the injection frequency. The use of harmonics of the oscillator frequency is quite acceptable, provided the fundamental and the undesirable lower harmonics are adequately suppressed before injection.

Although conversion loss is for the most part a characteristic property of the crystal, it is also influenced by the associated circuits. The image response of the preselector, for instance, affects the noise figure to a degree depending on the inherent crystal loss. In the case of an ideal mixer, the loss due to image response can be as high as 3 db when conditions of match pre-

vail at the image frequency.

With no conversion loss and conditions of input circuit match at the image frequency, the image frequency power will be equal to the i-f power. Since this power emanates from the signal source, only half of the signal power is converted into useful i-f power and a 3-db conversion loss is incurred.

This effect, which would be of importance with highly efficient mixers, can be minimized by making the preselector present either very high or, as is usually the case, a very low image impedance. In practice, no special precautions are warranted in view of the relatively high conversion loss. The effect of this loss is first to attenuate the i-f power considerably below the r-f level and then further attenuate the image beat at the preselector. The circuit impedance interaction between r-f and i-f is also decreased in relation to the conversion loss.

It should not be concluded that loss is a desirable characteristic, but as the losses are decreased the optimum conditions are subject to more critical adjustments.

Typical conversion loss figures for uhf silicon crystals range between 8 and 12. The noise temperature corresponding to optimum oscillator injection (minimum noise figure) is approximately 1.5.

Preselector Loss

The preselector losses contribute to the noise figure in a very direct way. Since the output noise level is not changed by the insertion of the preselector but the loss is increased by a factor L_c (the preselector loss), the overall noise-figure is increased by the same factor.

The preselector loss is related to the operating Q and the unloaded $Q = Q_o$ by:

$$L_c = \frac{1}{\left(1 - \frac{Q}{Q_o}\right)^{2n}}$$

n being the number of tuned circuits and $Q = \frac{f_r}{F}$. The resultant overall noise figure is

$$F = L_c(t + F_2 - 1) \left(1 - \frac{Q}{Q_o}\right)^{2n}$$

Under conditions of optimum F_2 ,

$$F = \frac{L_c \left(t + \frac{7f_i}{\sqrt{g_m k}}\right)}{\left(1 - \frac{F_r}{Q_o \Delta F}\right)^{2n}} \quad (7)$$

The noise figure is seen to be a function of the ratio of the loaded to unloaded Q . For a given size of tuning elements the preselector losses and consequently the noise-figure will decrease with increasing r-f bandwidth.

I-F Amplifiers

Most modern vhf tuners employ a cascode r-f amplifier stage and little

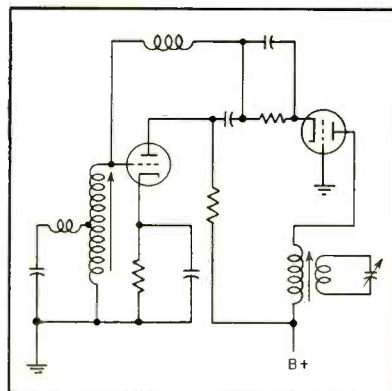

FIG. 10—Cascode i-f amplifier is most suitable for single-ended converters

can be gained in noise-figure improvement by adding a preamplifier. It is only necessary to transform the impedance level of the input circuit for optimum noise figure.

Preamplification at the i-f is indicated if the converter is a self-contained unit intended to be used in conjunction with a variety of vhf tuners. The cascode circuit shown in Fig. 10 is most suitable for use with single-ended converters. The simple cross-neutralized push-pull amplifier shown in Fig. 11 can yield equally good results at low vhf frequencies. As a result of the relatively wide bandwidth and low amplification, stability is readily achieved.

Three Converters

Basic converter systems include the single-channel strip type, the broad-band and the tuned narrow-band converters.

The crystal mixer is part of every circuit considered. Amplifier and mixer tube circuits are not treated because of the early stage of tube and applicable circuit development.

The fixed-tuned strip lends itself to an economical and very satisfactory design. It is most adaptable to turret-type tuners where several switch positions can be reserved for uhf use.

In general, it comprises a narrow-band preselector and a crystal mixer working into the vhf r-f stage which in the uhf position serves as an i-f stage. Since high selectivity can be attained, a single i-f in the 41 to 47-mc band would

verter is shown in Fig. 3. The i-f transformer is part of the strip and is designed to yield minimum noise figure.

Broad-Band Converter

In the broad-band converter all or a large number of channels can be transmitted simultaneously through the input circuit, which may be several hundred megacycles wide. Channel selection is accomplished merely by tuning the oscillator.

As already indicated, to a degree the losses are reduced by increasing the bandwidth. This is unlike the conditions at vhf where the required bandwidth and the circuit

range in one band, a division into two or more bands is generally favored. By reducing the bandwidth of the input circuit correspondingly, selectivity can be improved.

The circuit of a broad-band converter is shown in Fig. 4. Two crystals are used in a balanced circuit, resulting in a reduction of oscillator radiation. The noise contributed by the oscillator is also reduced but this is not usually a significant factor. In addition the use of a balanced transmission line is facilitated.

The balanced output circuit shown in Fig. 4 might feed a single cross-neutralized push-pull i-f amplifier. Such a circuit affords a favorable noise figure, assuming of course an optimum design of the input circuit. The balanced output circuit is also desirable when the converter is used in conjunction with a vhf tuner having a balanced input.

Narrow-Band Converter

In the narrow-band converter, conservative selectivity requirements are aimed for. Using a single i-f system (41 to 47 mc) and assuming an asymmetrical i-f response, the oscillator must operate above the signal frequency. The highest required oscillator frequency is thus raised.

A single-tuned circuit in the pre-selector usually suffices where double conversion with a reasonably high first i-f is used. The circuit in Fig. 11 employs a capacitance-tuned transmission line which is ganged with the oscillator tuning mechanism.

The circuits discussed cover uhf-tuner designs which seem promising. Much exploratory work is being done on which it is premature to report.

BIBLIOGRAPHY

Radio Research Labs, Harvard Univ., "VHF Techniques"—McGraw-Hill, New York, 1947.

Valley and Wollman, "Vacuum Tube Amplifiers"—Radiation Lab. Vol. 18, McGraw-Hill, New York, 1948.

H. Wallman, A. B. Macnee and C. P. Gadsen, A Low-Noise Amplifier—*Proc IRE*, p 700, June, 1948.

E. W. Herold, R. R. Bush and W. R. Ferris, Conversion Loss of Diode Mixers Having Image-Frequency Impedance—*Proc IRE*, p 603, Sept 1945.

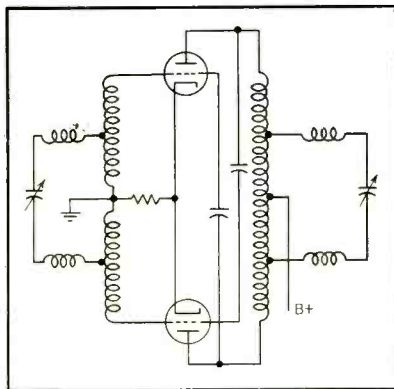

FIG. 11—Push-pull i-f amplifier is cross-neutralized, good at low vhf frequencies

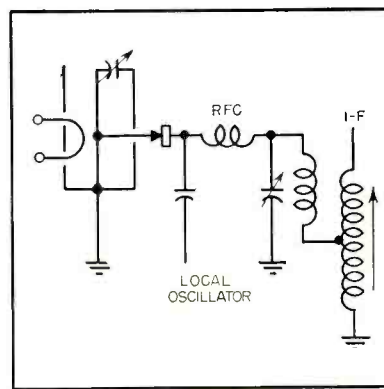

FIG. 12—Narrow-band capacitance-tuned transmission-line converter

probably prove most satisfactory. Being fixed-tuned it is not particularly subject to tracking problems.

High unloaded Q's in the pre-selector are indicated. Considering the space limitations in a turret-type tuner this is not an easy task. Capacitance-tuned transmission lines appear most suitable. When noncoaxial construction is used adequate shielding must be provided, mainly to reduce radiation losses and also to minimize the circuit's susceptibility to stray signals. The vhf local oscillator can be used in conjunction with a crystal harmonic generator as part of the strip.

The most serious drawback of this system is its highly limited range. It makes only a few of the 70 channels available in any one receiver, rendering it a local receiver.

A circuit of a single-channel con-

vertance determine the stage gain, the figure of merit being fixed. At uhf, loading is the limiting factor and in absence of any added capacitance wide bandwidth is inherently obtained.

Selectivity is sacrificed, but as was pointed out, its importance is somewhat problematical. The use of a trap tuned to the image frequency and ganged to the oscillator tuning device can insure good image selectivity in spite of the broad-band feature. The tracking of such a circuit is noncritical as the transmission characteristics of the desired signal are not affected by slight mistuning. The bandwidth of the crystal viewed as a lumped circuit having 1 μf of capacitance and an input resistance of 300 ohms is approximately 500 mc.

Since it is somewhat difficult to secure the desired oscillator tuning

Experiments Illustrate

By

JAMES D. FAHNESTOCK

Associate Editor, *ELECTRONICS*



Group photo shows many of transistorized items described in text. Left to right in rear are, portable radio, tv receiver, auto radio, ukulele and public address amplifier. Front row shows roving microphone, toy organ, decade scaler, complementary symmetry audio amplifier, portable f-m receiver and paging receiver

stage lineup is as follows: A point-contact local oscillator is fixed-tuned on the low side of the station carrier (channel 4). Two crystal diodes convert the local oscillator output and received signal to 8 mc for amplification in the six-stage point-contact transistor intermediate-frequency amplifier. Bandwidth is two mc. Two diodes are used in the second detector—the output of one feeds the video amplifier and the other feeds the inter-carrier-sound i-f amplifier.

The video amplifier is comprised of two stages, the first using an experimental junction transistor and the video output a point-contact unit. A point-contact sync detector and sync separator (junction) furnish sweep signals for the vertical deflection circuits. These consist of a point-contact vertical oscillator, a junction driver and a pair of junction output transistors driven in push-pull without transformers by means of complementary symmetry.

Two experimental junction transistors comprise a horizontal afc circuit that controls a point-contact horizontal oscillator and a two-junction-type horizontal amplifier of conventional design. These are followed by a push-pull junction amplifier that drives the horizontal coils of the yoke and a pair of pulse-amplifying junction types the output of which is rectified by a selenium diode for the picture tube second anode voltage.

The sound channel consists of a 4-stage point-contact type i-f amplifier at 4.5 mc, followed by a two-diode ratio detector, a junction low-level audio stage and a pair of output junctions in complementary symmetry.

The set provides good pictures within 5 miles of WNBT using a

IT IS difficult to attach an order of importance to the various pieces of transistorized equipment shown by RCA at their Princeton, New Jersey, laboratories recently. Each has its own aspects of importance, though in some cases these are more obvious than in others.

Complementary Symmetry

The concept of complementary symmetry promises to be the basis of one of the more important applications of transistors. Using this technique, it is possible to split a signal into two out-of-phase signals for push-pull amplification without the use of transformers. The principle is illustrated in Fig. 1A.

The bases of two junction transistors, one pnp and one npn, are fed in parallel. Due to the opposite signs of the transfer characteristics of these two types of transistors, the output signals will be 180 degrees out of phase—one having been shifted 180 degrees, the other

going straight through.

A practical application of this principle is illustrated in Fig. 1B. A pair of transistors in complementary-symmetry arrangement is used as a phase-splitting preamplifier stage. The out-of-phase signals thus produced are connected directly to the base-input complementary-symmetry stage following. In this stage the split-phase signals receive further amplification and are recombined into a single-ended signal that is applied directly to the 16-ohm voice coil of a loudspeaker. The entire output signal is connected back to the input stage as a form of degeneration. This connection provides fairly high gain with low distortion.

The circuit shown in Fig. 1B preceded by a single-transistor preamplifier is capable of producing a half watt of audio from a conventional phonograph pickup.

All-Transistor Television Set

A thirty-six transistor television set was built as an experiment. Its

WHAT'S INSIDE

This article is in answer to the many requests received for more information on the transistor devices shown at the RCA Princeton Laboratories recently, and mentioned in *ELECTRONICS* ("John Q. Meets the Transistor" p 5, Jan. 1953.)

The information presented was obtained in personal interviews with the engineers and scientists at Princeton who figured in the developments discussed. Some of these developments will be described in more complete detail in future issues of *ELECTRONICS*

Transistor Applications

Small in size, but tremendous in impact, the transistor has already assumed an important place in the electronics industry. That potential applications are virtually unlimited is illustrated clearly by experimental devices described here

built-in loop and 15 miles from the station with a simple rabbit-ear antenna.

Automobile Radio

A natural application of the transistor is to automobile radios and other mobile and portable equipment. To see what could be done with existing automobile power sources (6-volt batteries) a program was launched to build an all-transistor broadcast receiver.

The goal was met with 11 transistors and one crystal diode. A loudspeaker of the type normally used in automobile radio sets is transformer driven through an output transformer by a pair of push-pull junction transistors operating in class B with essentially zero bias. This output stage is transformer driven by a single junction transistor operating class A which in turn is preceded by two cascaded low-level junction preamplifiers.

Junction transistors are used in the local oscillator, mixer, second detector and 3-stage 455-kc i-f amplifier. The diode serves as the avc detector.

Receiver sensitivity is around 50 μ v and total current drawn from the 6-volt electrical system by the radio averages 300 ma and is dependent on magnitude of output, since the final stage is operated class B. Audio output of the class-B circuit is almost a watt, with frequency response comparable to that provided by commercial tube receivers.

Flea-Power Transmitters

The high-efficiency characteristics of the transistor make it useful in hearing aids ("Transistors Replace Hearing Aid Tubes," *ELECTRONICS*, p 5, Feb. 1953) and

other small light-weight devices. A pill-box size transmitter with output in the broadcast band capable of being modulated by a phonograph pickup was shown by RCA engineers. The pill box transmits modulated signals to a near-by receiver that recovers the audio signal and reproduces it in the loudspeaker. Power consumption is about 100 microwatts and self-contained battery life is 3,000 hours.

Another transmitter, intended for public address work, is about the size and weight of a fountain pen and pencil, and contains two transistors, an r-f oscillator and a modulator, and uses a 22.5-volt battery. Good noise-free signals may be heard in a conventional broadcast receiver from a distance of 30 feet or so.

In all these miniature devices, ferrite core coils are used to obtain maximum radiation from the smallest possible space.

A by-product of a program to

develop transistor oscillators is a toy organ that operates through any broadcast receiver. An experimental junction transistor is used in a 540-kc oscillator which is caused to block at different audio rates by a keyboard that switches different values of capacitance in the emitter circuit. The oscillator runs continuously to maintain control over receiver avc when notes are not being played. Two 1.35-volt cells power the 8-note organ for about 5,000 hours.

Portable Radios

Portable personal radio sets may be an early commercial application of transistors. A set using nine junction transistors has been demonstrated that has a 300- μ v sensitivity and operates over 100 hours on a small 6-volt battery. The circuit is similar to that of the auto radio, except that single-ended output is used since it provides sufficient power for normal portable use.

Three junction transistors are used in a vest-pocket receiver for hospital paging systems operating on a frequency in the neighborhood of 100 kc and using a long wire stretched around a building as a radiator. The entire receiver, using an r-f stage, a detector and a stage of audio to drive a hearing-aid ear-piece, operates for 500 hours on a single miniature 1.35-volt mercury cell.

It should be emphasized that without exception the above mentioned devices were designed and built to see what *could* be done. None are recommended as finished commercialized pieces of equipment, though they do point up the possibility of such application some day in the future.

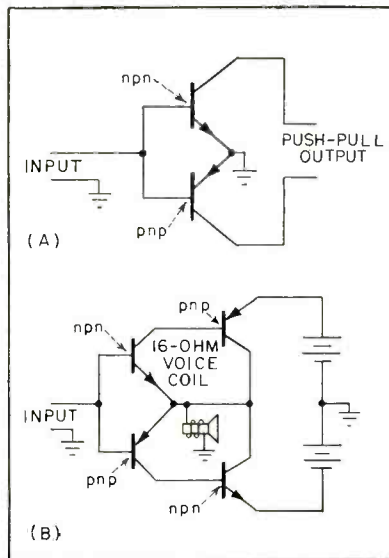

FIG. 1—Circuits illustrate complementary-symmetry principle

Photoelectric Width Gage

Optical image of each edge of white-hot moving strip is scanned by system of phototubes and motor-driven slotted disks from relatively cool position 15 feet above bed of mill. Control circuit transforms outputs of the two phototubes to a single signal that indicates deviations in width to accuracy of $\pm \frac{1}{8}$ inch, independent of lateral or vertical motion

By **E. S. SAMPSON**

*General Engineering Laboratory
General Electric Co., Schenectady, N. Y.*

ALTHOUGH the x-ray gage for measuring steel thickness has become a common device in the modern steel mill, measurement of width of hot strip is still being made by manually-operated calipers. These at best provide only an approximate and occasional indication of the actual width. Moreover, measurement of width is usually made only at one point along a strip length and this does not necessarily represent the true width along the whole length of the piece. Due to the jagged edges found in many lengths of hot steel, it is also difficult to obtain much information about average width from individual measurements.

The severe heat in the area of measurement creates a second disadvantage in the present technique. Measurement in this manner is an extremely uncomfortable task for the caliper operator. A third disadvantage is that the strip must be stopped before a measurement can be made.

The photoelectric width gage described here was developed to meet the foregoing specialized needs of the steel industry. The gage measures, indicates, and can provide a record of strip width within the range of 10 to 96 inches with an accuracy of better than $\pm \frac{1}{8}$ inch. No contact between the strip and

gage is required. The width indication is independent of reasonable lateral and vertical motion of the strip as it bounces rapidly along a rolling mill table. The light radiated from the hot strip edges is used to obtain signals for measuring width.

The detector, located 15 feet above the hot strip, is largely unaffected by extreme ambient conditions such as temperature, moisture, fumes and dirt of the mill near the strip itself.

General Description

The main functional units of the width gage are the detector, the electronic control cabinet, the operator's control cabinet and the indicators, as shown in Fig. 1.

The detector generates two electrical signals which contain information for accurately measuring the width of the strip.

The electronic control cabinet contains the majority of electronic components which transform the two signals from the detector into a single signal for indicating width deviation.

The operator's control cabinet contains the width-indicating devices and the controls for operating the gage. The width-indicating devices consist of a visual mechanical counter which is set by the operator

to the desired width of the strip to be rolled, and a deviation indicator which shows any deviation from the width desired.

Figure 2 shows that the gage operates by scanning an optical image of each edge of the strip to be measured. The position of the two scanning units located inside the detector is adjusted by a motor-driven screw, which is controlled from the operator's control cabinet and which places the two scanning units directly above the nominal position of the edges of the strip.

The lens at the bottom of each scanning unit focuses the image of the edge of the strip onto a scanning disk behind which is placed a phototube. The optical image for each edge of steel is converted into an electrical signal by the phototube. The rotating slotted disk provides means for repeatedly scanning across the image of the edge of the strip at right angles to the direction of strip travel. Each unit scans approximately 10 inches, nominally 5 inches off the edge of the strip and 5 inches on the strip. The scanning field is thus wide enough to allow for a certain amount of sidewise motion of the strip as well as for normal changes in width.

The scanning action causes each phototube to generate a rectangular

for Hot-Strip Steel Mills

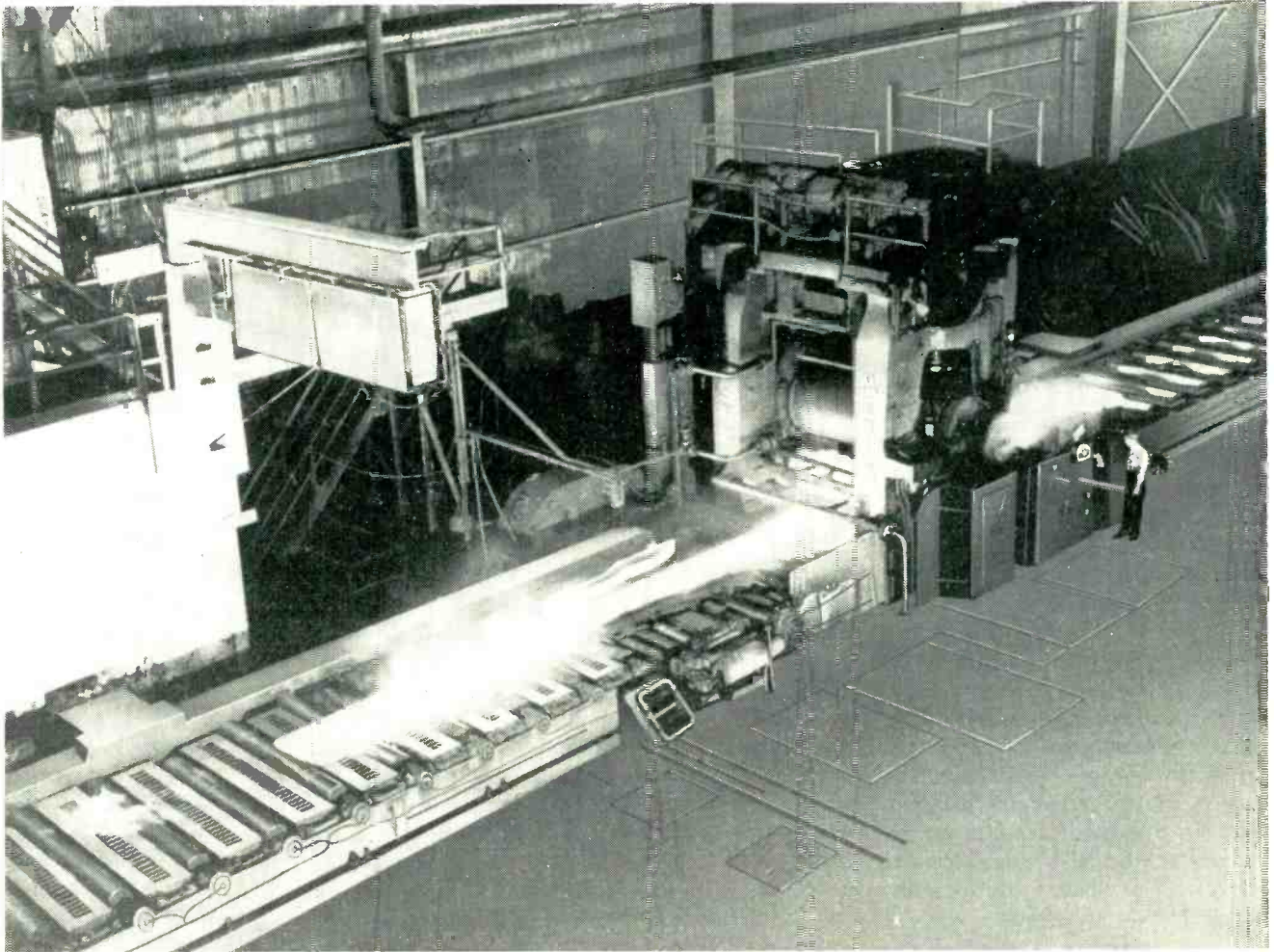

First installation of noncontacting width gage, in Irvin Works of U. S. Steel Co. Detector head is in housing suspended over bed of mill at left, with phototubes inside reacting to edges of hot strip as it flies back and forth underneath. The strip thus serves as light source for the system. Operator's controls and width deviation indicator are on side of mill, near operator at right center

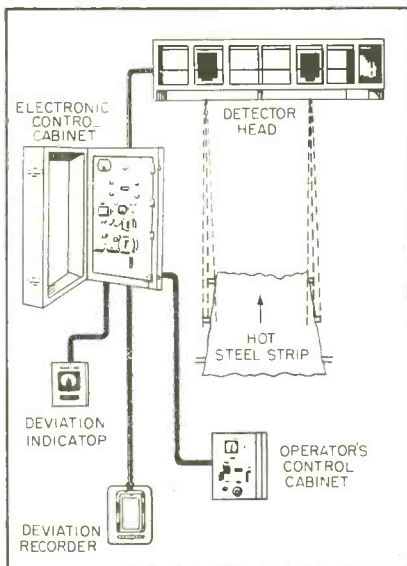

FIG. 1—Arrangement of main units of width gage

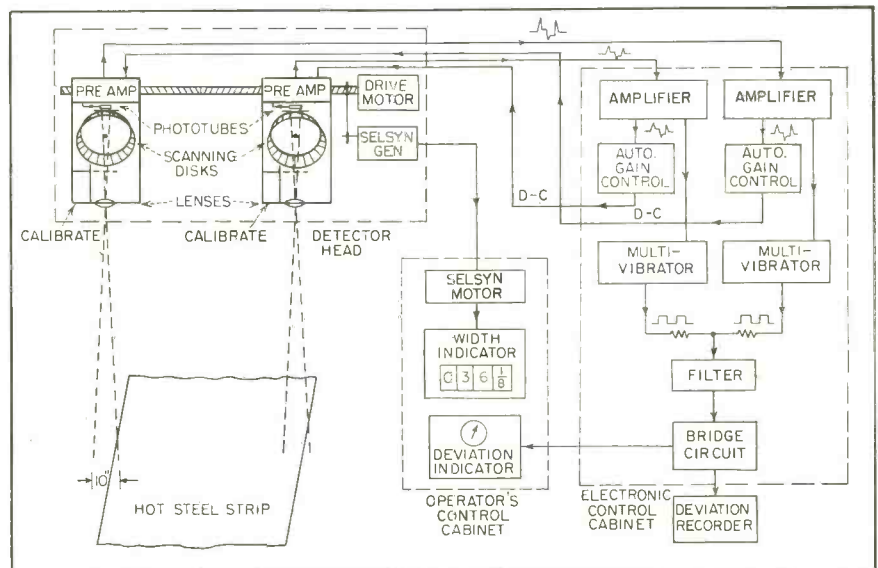

FIG. 2—Block diagram of entire system, showing how lenses project images of edges of strip through scanning disks onto cathodes of phototubes

wave shape of voltage vs time in which the percentage pulse width is directly proportional to the position of the edge. The two sets of signals, one from each edge of the strip, are then differentiated to produce spikes at the leading and trailing edge of each square pulse signal. These signals are then amplified in the scanning units to avoid electrical interference and are transmitted to the amplifiers in the electronic control cabinet. Here the signals are again amplified.

Utilization of Pulses

By means of a special bistable multivibrator circuit, rectangular pulses are generated from the sharp positive and negative pulses. These rectangular pulses can vary in width but not in amplitude. The two sets of constant-amplitude pulses are then applied to the pulse width analyzer circuit where they are added, and the sum is averaged to obtain a d-c voltage depending only upon the width of the pulses. By means of a bridge circuit this d-c voltage is used to operate the deviation meters and recorder.

A selsyn generator, geared to the lead screw which positions the scanning units, generates an electrical signal which provides an indication at the operator's control cabinet of the spacing of the scanning units. The electrical signal from the selsyn generator is applied to a corresponding selsyn motor geared to a counter which then indicates this distance to a precision of better than 1/64 inch.

A calibrating mechanism is provided to insure that the optical and electronic parts of the width gage are functioning properly. This mechanism provides an overall calibration of the deviation measuring circuit. One such calibrating mechanism is located in each scanning unit.

To calibrate, the operator closes a switch located on the operator's control cabinet which causes a shutter to block the light from the hot steel and also turns on an incandescent lamp. The lamp illuminates a frosted window one edge of which is imaged onto the phototube in such a way as to generate a 50-percent pulse signal from each scanning unit. Such a pulse signal

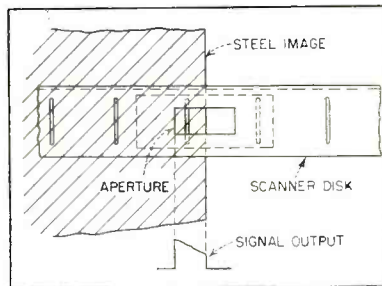

FIG. 3—Operation of scanning disk

exactly duplicates the normal operating signal for zero deviation of the strip from the width for which the gage is set. A zero set control, also located on the operator's control cabinet, is then adjusted by the operator to correct for any drifts and to give a zero indication on the deviation meters.

Sidewise motion of the strip will increase the pulse width from one scanning unit and decrease that from the other unit. The average of the two remains constant, and hence there is no change in deviation indication. A reasonable amount of up and down motion of the strip results in only a very small change in the sum of the individual pulse widths because the separate scanning units are located directly above the respective edges of the strip.

Design Consideration

From the practical standpoint, the width gage is designed to provide ease of operation, rapid and continuous indication of width, and ease in maintenance and service. Tubes especially designed for long life and industrial-type components are used wherever possible. Heavy-gage steel is used in the fabrication of the cabinets and housing units to provide a maximum of strength and durability.

The electronic circuitry and adjustment is simple and insensitive to changes in power supply variations. The measuring circuits consist of two amplifier channels, each of which contains only four amplifier tubes, and a filter and bridge circuit which employs only one amplifier tube. Large changes in tube characteristics and large changes in signal amplitude can occur without changing the width indication. Simplicity and perman-

ence in design in this manner are extremely important in industry, where there is usually a limited time available for maintenance work on electronic equipment and where frequently highly skilled electronic personnel are not always readily available.

Electronic Circuits

Figure 3 shows diagrammatically the arrangement of the components of the image scanner for one of the scanning units. As a slit in the scanning disk moves rapidly across the aperture, the phototube, located behind the aperture, conducts a current proportional at every instant to the amount of light in that part of the image exposed by the slit at that particular instant. A large current flows during the time the slit uncovers the bright image of the steel strip, and a very small current flows for the remainder of the scan. The waveform of the signal generated in this fashion is shown. This process continues repeatedly so that a 30-cps rectangular-wave signal is generated in each scanning unit.

In Fig. 4, tube V_1 is the gas phototube which generates the signal voltage when the image of the strip is scanned, while V_2 and the first half of V_3 amplify the signal. The second half of V_3 acts as a cathode follower type impedance-matching device to transmit the signal over the cable with low losses. The two preamplifier chassis are identical in construction and operation.

The signal from the preamplifier is amplified again in the first half of V_4 . The signal from R_1 is used to drive the multivibrator and the automatic gain control circuits.

The second half of V_4 amplifies the age signal. This signal from the second half of V_4 is applied to a peak rectifier to produce a negative d-c voltage proportional to the peak of the signal pulses. The output of the rectifier circuit is filtered by the network comprising C_1 , R_2 and C_2 . The resultant d-c voltage is returned to the preamplifier circuit in the detector and applied to the grid of V_2 to provide age which acts to maintain a relatively constant signal amplitude to the multivibrator circuit regardless of the temperature of the steel strip.

Normally for a steel temperature change from 2,050F to 1,350F the signal generated in phototube V_1 would change 200 to 1 in amplitude. The agc circuit reduces this 200-to-1 range to a 3-to-1 range. The transconductance of V_2 is reduced 20 to 1 to provide most of the gain control required. The remainder of the gain control is accomplished by reducing the sensitivity of the phototube 3.5 to 1 by reducing the d-c voltage applied to it.

The cathode electrode of the phototube is returned to the screen grid of V_2 . When the agc voltage becomes more negative, the screen voltage rises, thus reducing the net d-c voltage on the phototube and hence its sensitivity.

A bistable multivibrator V_5 furnishes a rectangular signal which can vary in width but not in amplitude. One stable condition of the multivibrator exists when the first half of V_6 is not conducting current, while the second half of the tube is conducting current. The other stable condition exists when the conducting current is reversed from the second half to the first half of the tube. As the signal pulses arrive at the grid of the first half of V_5 , the positive pulses switch this half to a conducting state while switching the second half to a nonconducting state. As the alternate positive and negative pulses are applied to the multivibrator circuit, the output of the multivibrator becomes a rectangular constant-amplitude signal that

varies in width depending upon the spacing between the positive and negative pulses.

Special precautions were taken to insure that the square-wave rectangular pulses from the multivibrator circuit are constant in amplitude irrespective of pulse width or changes in characteristics of V_5 . The peak positive voltage of the rectangular pulse occurs when the second half of V_5 is not conducting current. The peak positive voltage is therefore fixed by the resistor divider circuit in the plate circuit.

The peak negative voltage of the rectangular pulse occurs when the second half of V_5 is conducting current. However, the lowest peak voltage that can occur at this plate is determined by the low-impedance resistor divider network made up of R_3 , R_4 and R_5 and rectifier CR_1 . The voltage determined by this network is always greater than the voltage that would normally be determined by the saturation current of the tube. The peak-to-peak amplitude of the rectangular pulse is therefore determined essentially by two resistor divider networks and not by V_5 .

As the plate potential fluctuates between the two fixed d-c levels as described above, the average voltage at the plate becomes a d-c voltage proportional to the pulse width and hence to the width deviation. By means of the voltage divider circuit consisting of R_{12} , R_{13} and R_{14} these two average d-c signals

from the multivibrators are added and applied to the indicator circuit. Components R_9 , R_7 , C_3 , C_4 , R_8 , C_5 and C_6 comprise a 30-cps band-rejection bridged-T filter circuit for reducing the amplitude of the a-c components of the signals so that the voltage applied to V_6 is essentially a d-c voltage proportional to width.

Tube V_6 is a power amplifier of the cathode follower type and is used to drive the deviation indicators and the recorder.

The zero-set rheostat, fixed resistor R_9 and V_7 comprise a voltage divider network used to balance out the fixed potentials in the indicator circuit which are not related to pulse width. The deviation indicators and the recorder are connected between a point on this voltage divider and the cathode output terminal of V_6 .

Rheostat R_{10} is the sensitivity control for the deviation indicators and R_{11} is the sensitivity control for the recorder. These controls are adjusted at the factory for correct indications of width deviation and require no further adjustment.

The arrangement used in the bridge circuit offers a high degree of stability. It is relatively insensitive to changes in the d-c power supply voltage and to changes in the transconductance of V_6 .

Detector Unit

The detector unit incorporates the optical and mechanical devices and the electrical circuits used in

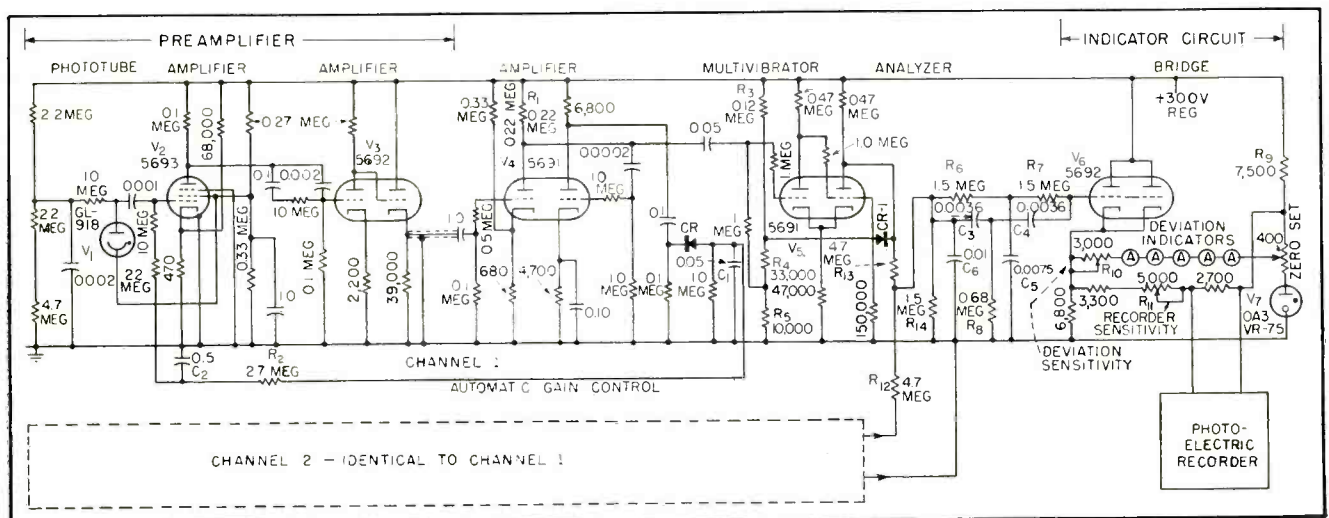
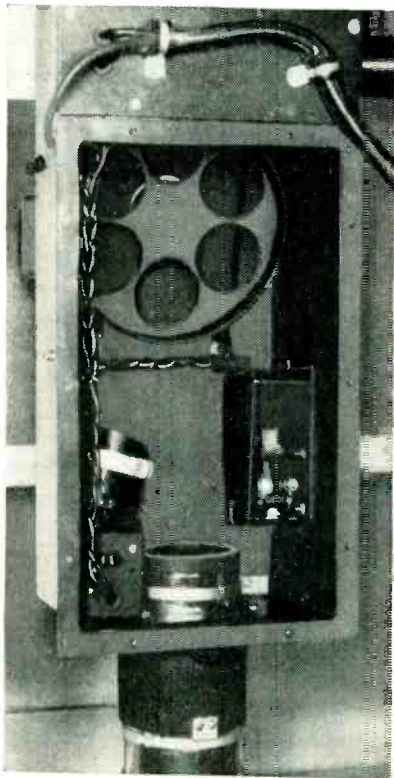
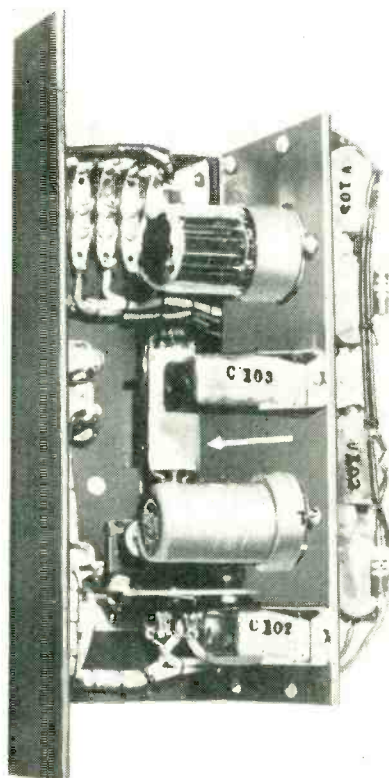

FIG. 4—Circuit arrangement for combining outputs of the two phototubes to actuate width deviation indicators and a standard photoelectric recorder



Scanning unit for width gage. Phototube is in housing at top, with scanning disk visible through opening below. Image-forming lens is at bottom



Phototube chassis, as seen when removed from operating position above scanning disk. Arrow points to phototube, mounted above slot in chassis

positioning the scanning units and in generating the width and the width deviation signals.

The optical devices for each scanning unit consist of one $f/3.5$ lens for imaging the strip edge onto the scanning disk, one $f/2$ lens for imaging a simulated steel edge onto the scanning disk during calibration, an aperture and a rotating slotted disk for systematically controlling the light received by the phototube, and a solenoid-operated shutter for preventing the light radiated from the strip edge from falling on the phototube during calibration.

Since the desired width of strip to be rolled may vary over wide ranges each day, it is necessary that the two scanning units which are positioned over each edge be easily moved from one desired spacing to another. A right-hand screw and a left-hand screw coupled together and driven by a motor are used for this positioning. An Oilite nut which couples the individual scanning units to their respective screws moves the scanning units smoothly to the desired setting when the rolling mill operator actu-

ates the drive motor switch located on the operator's control cabinet.

The mechanical design of the scanning units provides accurate alignment of the optical parts with respect to one another. Serious width measurement errors can result if exact alignment is not maintained.

The detector is mounted 180 inches above the steel strip level. If the maximum tolerable error due to the optical system alone in one scanning unit is to be held to $1/64$ inch, the resulting angular tolerance on alignment is the angle whose tangent is $1 \div (64 \times 180)$, or 1 part in 11,500. In order to meet this tolerance, each scanning unit is rigidly mounted on a bearing which slides along a stainless steel beam in each half of the detector head housing. The two support bearings are 10 inches long, thus assuring intimate alignment with the beam.

Electronic Control Cabinet

The electronic control cabinet contains all the circuits which are not required to be located near the gaging area, including the regu-

lated d-c power supply, power transformers, circuit breakers and motor relay switches. The cabinet is especially designed to be dust and moisture tight and to provide easy access to the components. All input cables are brought to the terminal strip in the rear of the cabinet. The electronic circuits are mounted on a hinged panel which may be swung outward to give ready access to all the components from one position.

Indicators

The edges of the strip to be measured are scanned 30 times per second by the scanning slits, each of which include light from a region 3 inches long in the direction of the length of the steel strip. The spacing between the successive scanned portions of the strip to be measured therefore depends directly on strip speed. For example, if the strip is moving at 10 feet per second, the successively sampled portions would be spaced $10/30$ ths of a foot or 4 inches apart. Since the length of each portion is 3 inches, such a strip speed would yield practically continuous coverage of the steel strip.

The response time of the deviation indicator is about 0.8 second, so that its indication at any time represents a width deviation averaged over 24 successive scanning operations. In the example chosen above, for a strip speed of 10 feet per second, the width deviation indication will be averaged over a length of 8 feet.

If it is desired to measure changes in width occurring over shorter intervals of length than that obtained with the deviation indicator, then a deviation recorder may be used. The recorder specified for this use has a very short time constant, in the order of 0.2 second. For a strip speed of 10 feet per second, the recorder will faithfully indicate width changes occurring over a 2-foot length. However, since the above time constant refers to the time for the pointer to reach virtually its final value, some indication of changes in width will be shown for even shorter distances along the strip being measured as it flies back and forth on the bed of the mill.

Butterfly Curve Tracer For Magnetic Materials

Curves of a-c permeability versus d-c magnetizing force are displayed on a cathode-ray tube. The instrument meets needs for rapid and accurate means of determining properties of magnetic materials in expanding use of saturable reactors

By **GEORGE M. ETTINGER**
Standard Electronic Research Corp.
New York, N. Y.

THE EFFECT of d-c magnetization on a magnetic core material is best expressed by the butterfly curve of which a typical example, due to Elmen¹, is shown in Fig. 1. The double-humped nature of the curve, which gives it its name, is due to the magnetization remaining when the magnetizing force is reduced to zero.

Elmen's curve was obtained with small alternating flux density, at a frequency of 200 cps. To specify completely the properties of a magnetic material, data at higher values of flux density and at several frequencies are required.

Basic Design

Figure 2 is a block diagram of the instrument. The specimen carries a primary and a secondary winding. A source of variable frequency f_1 and variable amplitude a-c is connected to the primary circuit in series with a source of very low frequency a-c f_2 and a series

resistance R . A d-c amplifier of small bandwidth, connected across R , yields an output proportional to the instantaneous amplitude of the bias current at the low frequency f_2 only. This output is applied to the horizontal deflection plates of a cathode-ray tube.

The emf developed across the secondary winding provides input to

an electronic integrator, whose output is proportional and in phase with the alternating flux density in the sample. The bandwidth of the integrator is small enough to attenuate completely components of flux density varying at frequency f_2 . For magnetizing a-c of constant amplitude, the output of the integrator is proportional to flux density and therefore the a-c permeability of the magnetic sample. The output of the integrator amplifier is applied to the vertical deflection plates of the crt.

The pattern obtained on the crt has the form shown in Fig. 3. The envelope of this pattern, the required butterfly curve, gives the relation between a-c permeability and d-c magnetizing force, for the condition of constant magnetizing a-c.

By turning a single switch, the

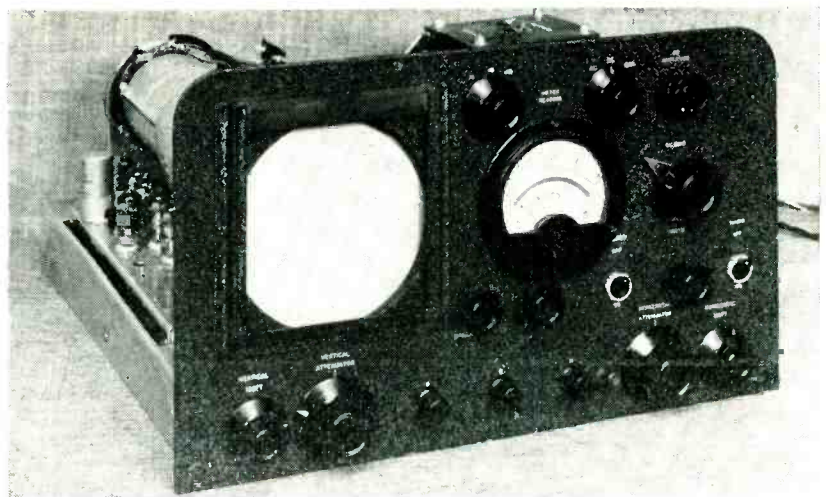

Controls for magnetizing circuit of butterfly tracer are on right of front panel, scope controls on left

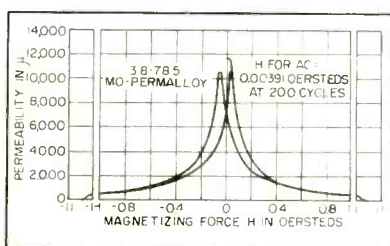

FIG. 1—Butterfly curves of one magnetic sample show typical peaks due to residual magnetism

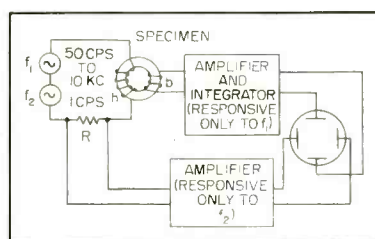

FIG. 2—Basic circuit of tracer requires low and high frequency a-c source, plus d-c bias

butterfly curve tracer may be converted into a conventional hysteresis loop tracer. The hysteresis loop in Fig. 3 was so obtained.

Figure 4 shows butterfly curves and superposed hysteresis loops obtained for a 79-Permalloy sample, at 200 cps and at five currents corresponding to peak magnetizing forces in the range from 0.09 to 1.35 oersteds. Figure 4 also gives information on a-c permeability and the rate of change of a-c permeability with d-c magnetizing force. For the test conditions under which the curve in Fig. 3 was obtained, this last quantity was approximately 27,000 gauss per oersted squared for $H_{d-c} = 0$ to 0.3. This agrees well with the 27,500 figure obtained by Elmen for a similar sample by an a-c bridge method.

Circuit Details

Current at the higher frequency f_1 is supplied to the primary of the magnetic sample from a transformer, a 200- μ f capacitor, a low-pass filter, and a 50-ohm resistance (Fig. 5). Bias current is obtained

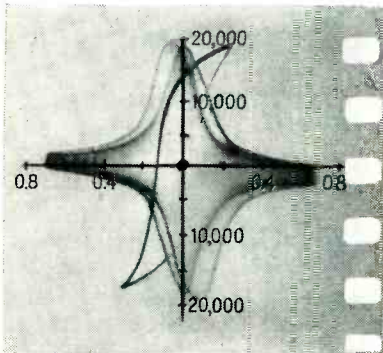
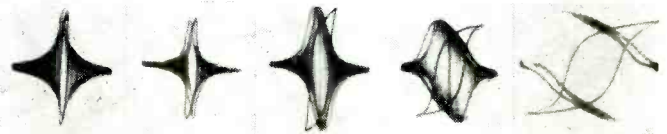

FIG. 3—Trace obtained on crt has butterfly curve as envelope. Also shows superposed hysteresis loop

by half-wave rectification of the 50-cps line supply, the ripple removed by a filter of which the 200- μ f capacitor is an element. The d-c is varied from positive to negative values at a very low frequency (about 0.2 cps) by driving the potentiometer P_1 back and forth with an automatically reversing motor.

This portion of the circuit is shown separately in Fig. 6. The potentiometer is connected across two rectifiers, W_1 and W_2 , arranged back-to-back. When the potentiometer



$\frac{d(\mu_{A-C})}{d(H_{D-C})}$	100,000 *	112,000 *	27,000 *	6,800 †	1,700 †
μ_{MAX}	20,000	22,500	5,750	8,100	5,800
D-C SWEEP ± OERST	0.94	1.38	1.38	1.38	1.38
H-A-C OERST	0.9	0.16	0.4	0.93	1.35

* BETWEEN $H_{D-C} = 0$ & $H_{D-C} = 0.1$ † BETWEEN $H_{D-C} = 0$ & $H_{D-C} = 0.3$

FIG. 4—Curves photographed from crt at various values of currents giving peak magnetizing force

eter slider is in position A, W_1 is short-circuited and W_2 gives almost complete half-wave rectification. With the slider in mid-position B, the resistances across the rectifiers are equal and no d-c flows.

Adjusting potentiometer P_2 varies the effect of the sweep potentiometer P_1 on the rectifiers. Maximum variation is obtained with P_2 set at zero, minimum variation with P_2 at maximum.

Varying P_3 (Fig. 5) gives fine control of the amplitude of magnetizing a-c. This variation has almost no effect on the direct or low-frequency bias current, since the d-c resistance of the choke L_2 is much lower than the minimum resistance of P_3 . Various capacitors or a short circuit can be connected across the filter circuit. In another switch position, the choke L_2 is shunted by a capacitor to form a parallel circuit resonant at 50 cps. This further attenuates hum from the variable d-c supply when the magnetizing current is at any frequency other than 50 cps.

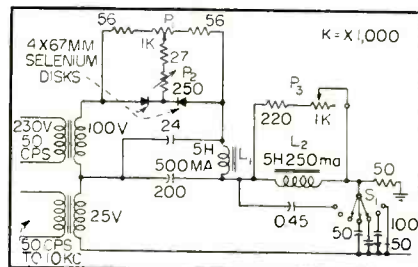

FIG. 5—Motor-driven potentiometer P_1 provides low-frequency a-c. Sweep width is controlled by P_2

The voltage across the 50-ohm resistance (Fig. 5) provides input to the horizontal deflection amplifier. If the test frequency need not be variable, a common tapped transformer may be substituted for the two separate transformers shown.

Amplifiers

As explained before, the horizontal deflection amplifier (Fig. 7) must be made responsive only to the very low frequency f_2 , as in order to trace butterfly curves. The amplifier is direct coupled, consisting of two voltage amplifier stages and a push-pull phase inverter output stage. Miniature pentodes, Brimar (England) type 8D3, similar to the 6AK5, are used throughout.

An RC filter is connected between the two voltage amplifiers. When the switch S_1 is closed, the filter reduces the 50-cps gain of the amplifier to almost zero, while the gain for d-c or the low frequency bias current is not affected. With S_1 open, the bandwidth of the amplifier extends well beyond the test

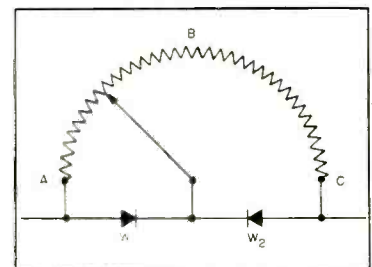

FIG. 6—Back-to-back rectifiers and motor-driven arm vary voltage at low frequency from plus to minus

frequency f_2 so that normal hysteresis loops are traced whose shape depends on the setting of the sweep potentiometer P_1 in the magnetizing circuit.

The vertical deflection amplifier (Fig. 8) incorporates an electronic integrator. It is designed to have negligible response at the low frequency f_2 , which represents bias current variations. It is also designed to have substantially 90-degree phase shift (6 db per octave drop) over the range 50 cps to 10 kc. Direct couplings reduce low-frequency phase shifts other than those due to the integrator.

The circuit, of 8D3's or 6AK5's, comprises a cathode follower, voltage amplifier V_2 subjected to negative feedback by the 150,000-ohm resistor, a Miller integrator and cathode follower, and a push-pull output stage similar to that in the horizontal amplifier.

Regeneration, effective at frequencies above 50 cps only, is obtained by a 1-meg resistance connected between the grid of V_2 and a 0.01- μ f blocking capacitor. This regeneration has been shown to improve the accuracy of integration⁵. The 180K resistance between plate of V_1 and screen of V_2 , bypassed by 2 μ f, gives degeneration at very low frequencies, so that amplifier drift over long periods is reduced.

Power Supplies

Regulated positive and negative supplies are provided from a separate unit of conventional design. The high voltage supply for the crt, however, comprises a special r-f oscillator (Fig. 9) powered from the 50-cps supply line and employing self-rectification, so that no d-c supply is required. The oscillator tube, a 6V6, acts as its own half-wave power rectifier. Negative voltage may be continuously varied from -2.5 kv to -4 kv by adjustment of the oscillator grid-leak resistance.

Credit

This apparatus was developed at Standard Telecommunication Laboratories Ltd., London, England. Thanks are due to J. K. Webb and T. R. Scott for much helpful advice.

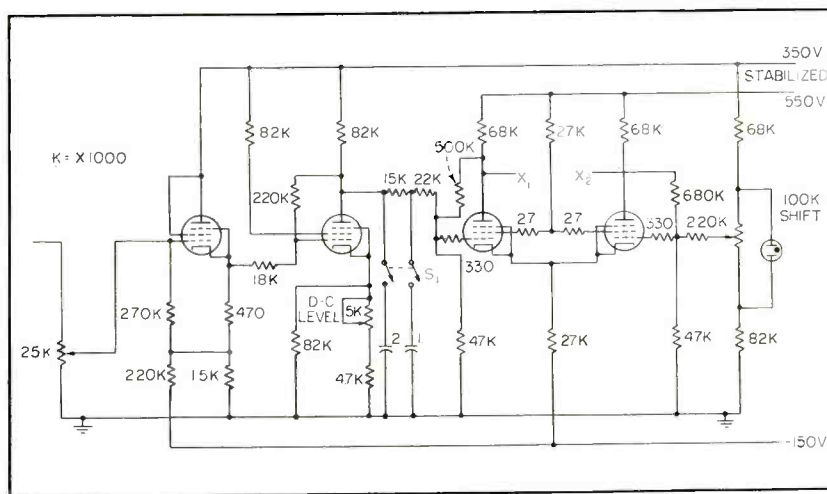

FIG. 7—Horizontal deflection amplifier responds only to low-frequency f_2 , is direct-coupled. Miniature pentodes are used (Brimar 8D3 or 6AK5)

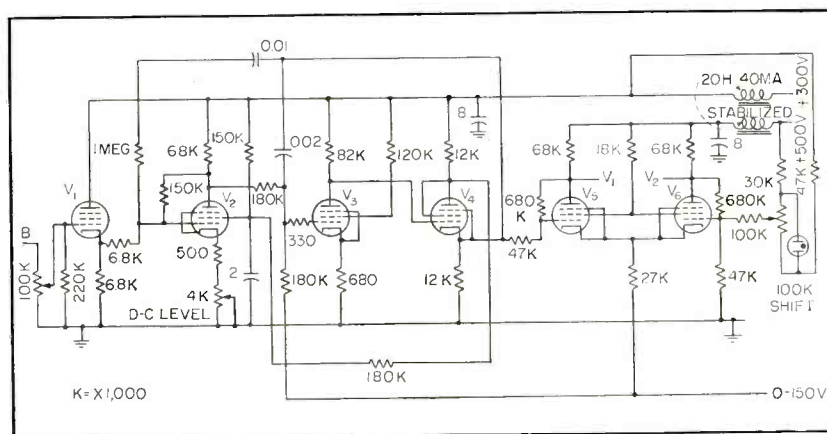

FIG. 8—Vertical deflection amplifier includes an electronic integrator, responds to variable frequency f_1 . Uses same tubes as horizontal amplifier

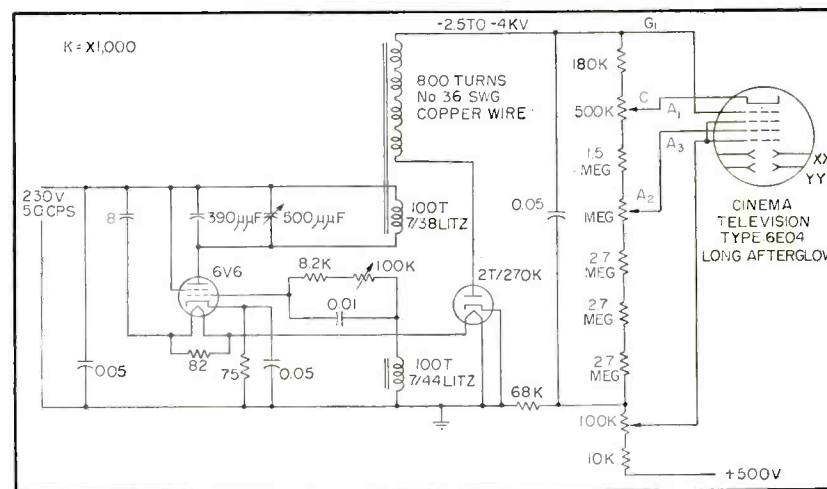

FIG. 9—Cathode ray tube circuit includes special r-f oscillator (6V6) which supplies continuously variable -2.5 to -4.0 kv high voltage

REFERENCES

- (1) G. W. Elmen, *Bell System Tech. J.*, 15, p 113, 1936.
- (2) H. T. Wilhelm, *Bell Lab Record*, 14, No. 4, 1935.
- (3) R. L. Sanford, *Am. Soc. Test. Materials*, A34-44, 1, p 679, 1944.
- (4) G. M. Ettinger, "The Dynamic Testing of Magnetic Materials Under Con-

- ditions of DC and AC Bias," Master's Thesis, Univ. of London, 1950.
- (5) I. A. Greenwood, V. V. Holdam, D. MacRae, "Electronic Instruments," MIT Rad. Lab Series, 21, p 80, McGraw-Hill, New York, 1948.
- (6) G. M. Ettinger, *Jour. of App. Phys.*, 21, p 936, 1950; O. I. Butler, *Jour. I E E*, London, Pt II, 94, p 27, 1947; H. W. Lamson, *Proc. IRE*, 36, p 266, 1948; J. H. Wright, *Gen Elec Rev*, 51, p 36, 1948; B. Fertchak, *Gen Elec Rev*, 54, p 79, 1945.

Constant-Current Audio Power Amplifiers

Design procedure and complete circuit of new audio amplifier in which constant-current operation permits use of a form of automatic bias control to counteract effects of tube aging or tube replacement, giving reliability along with high fidelity

THE TRIODE class-A push-pull amplifier is still one of the fundamental types of low-frequency power amplifiers, despite the fact that many other types of power amplifiers are available to the designer.

Getting the most from this amplifier involves more than the simple consideration of power output per dollar of tube cost. In addition to power capability and efficiency, distortion, noise, reliability and maintenance problems should all be taken into account, since all these are vital aspects of the performance of the completed amplifier. This paper discusses two types of class-A triode power amplifiers and analyzes their performance with regard to all these factors.

Optimum and Constant-Current Amplifiers

There are two fundamental types of class-A triode push-pull operation, one employing high peak currents and low load impedances for optimum operation, and the other employing lower peak currents and much higher load impedances. This distinction does not seem to have been made previously; for lack of better terminology, the two modes of operation are here called optimum operation and constant-current operation.

In optimum operation the plate-to-plate load obeys the familiar relationship $R_L = 4 r_p$. Optimum operation will provide the greatest output that can be obtained with

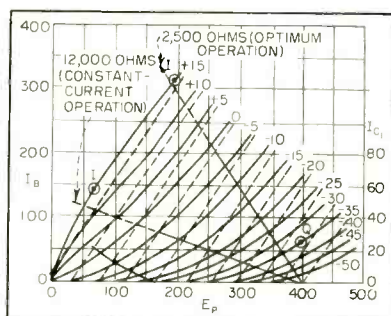

FIG. 1—Typical characteristics of triode-connected 807's, with load lines for both types of operation shown for comparison

given tubes and supply voltages, provided the operating conditions do not change with signal. In practice, there is usually a sharp increase in d-c plate current at maximum signal, so that extremely good power-supply regulation is required to maintain operating voltages truly constant. Since power-supply regulation is not usually this good, the conditions for optimum operation are seldom fully realized.

On the other hand, constant-current operation is characterized by little or no change in d-c plate current as the signal goes from zero to maximum. This condition may be obtained by proper proportioning of load resistance and supply voltage. With constant-current operation the variation in power-supply loading will be negligible, and the operating point will remain substantially constant no matter how poor the regulation of the supply may be.

Figure 1 shows the plate characteristics for triode-connected 807's,

to illustrate these points. Load lines are shown for both optimum (2,500 ohms) and constant-current (12,000 ohms) conditions. The solid line indicates class-A₁ operation, with signal swing up to the grid-current point in each case. Class-A₂ operation is indicated by the continuation of the load lines up to the +15-volt grid line. This additional swing represents an increase of 3 db—a factor of two in power.

For optimum operation the peak current is some five times the quiescent current and the d-c plate current at maximum signal will be almost twice that for no signal. (The quiescent point is designated by *Q* and the peak plate current points by *I* for class A₂ in Fig. 1.) For constant-current operation the peak current is much less, and the total change in d-c plate current can be held to well under 10 percent.

Comparison of Output

The power output and plate efficiencies for the operating conditions of Fig. 1 are shown in Table I. There is a loss in power of about 40 percent when going from optimum to constant-current operation. The figures for optimum operation can only be fully realized in a system incorporating fixed bias and an electronically-regulated plate supply.

The conventional choke-input power supply may have an effective internal resistance of several hundred ohms. With the increase of plate current with signal which

By **HOWARD T. STERLING**

*President
Waveforms, Inc., New York, N. Y.*

and

ALAN SOBEL

*Project Electronic Engineer
Freed Radio Corp., New York, N. Y.*

Example of audio amplifier using constant-current operation of output stage

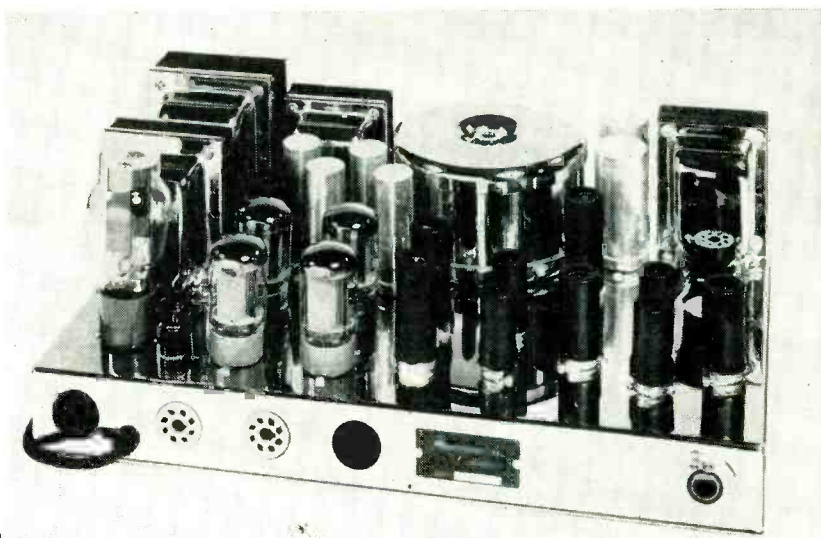

is typical of optimum operation, the resulting drop in supply voltage would cut these output power figures by 20 percent hence the difference between optimum and constant-current efficiencies is only about 25 percent in practice.

For class- A_2 operation the efficiency figures for the two modes of operation are not only relatively high (about 63 percent), but remarkably similar.

The principal disadvantages of constant-current operation, as opposed to optimum, are the lower output available from given tubes and, for class- A_1 operation, the lower efficiency. One of the principal advantages is the fact that power-supply regulation becomes much less of a problem, since the change in plate current from no-signal to full-signal conditions can be well under 10 percent. A higher-impedance, less-expensive power supply can thus be used.

Table I—Comparative Output and Efficiency Values

Conditions and Load Resistance		Power Output in Watts	Percent Efficiency
Optimum—2,500 ohms, push-pull	A_1	14.5	39
	A_2	30	65
Constant-current—12,000 ohms push-pull	A_1	8.5	30
	A_2	18	62

Since the d-c plate current changes so little, it is possible to introduce d-c degeneration into the system to minimize variations in tube operating conditions. Cathode bias is unfeasible for true optimum operation; tube-handbook operating conditions for cathode bias usually show higher plate-to-plate load impedances so as to limit the peak plate current and hence the change in d-c plate current with signal. These figures usually do not go as far as constant-current operation.

If cathode bias is to be used, it is most effective if individual cathode resistors are used for each tube. If this is not done, the operating conditions of one tube are affected by the operating conditions of the other.

Automatic Balancing

With individually bypassed cathode resistors, bias of each tube is a function of its plate current alone, and is not affected by the other output tubes. By making the amount of this d-c inverse feedback great enough, the effect of a change in permeance or transconductance is significantly reduced. The larger the proportion of the total plate-circuit resistance in the cathode, the more degeneration, and hence the smaller the changes in operating conditions with change in tube characteristics.

The result of this is to make the provision of special plate-current balancing arrangements and periodic checks of plate current quite

unnecessary. As an example, in the amplifier described here, using 1,000-ohm cathode resistors for each power tube, a departure from normal current is reduced by about 80 percent. In a tube where plate current would otherwise be high or low by 20 ma, this form of automatic bias control will reduce the error to 4 ma, or a total unbalance of about 4 percent. For tubes more nearly normal this error will be reduced still further.

Efficiency and Reliability

Class-A operation is the least efficient of all power-amplifier types, and constant-current operation is somewhat less efficient than optimum operation. However, plate-circuit efficiency is, for almost all applications, one of the least important factors in determining an amplifier's utility.

In a typical audio amplifier, the output power represents from one-fifth to one-half of the power drawn from the line. The rest of the input power goes to heat filaments and supply power to the driver and pre-amplifier stages which are part of any audio amplifier system. Unless line power is very expensive, it can make little difference whether a 50-watt amplifier requires 175 watts or 135 watts of line power. Furthermore, where line power is expensive, amplifier reliability is also usually at a premium, and the greater reliability of constant-current class-A operation, due to the lower plate-current demand, may

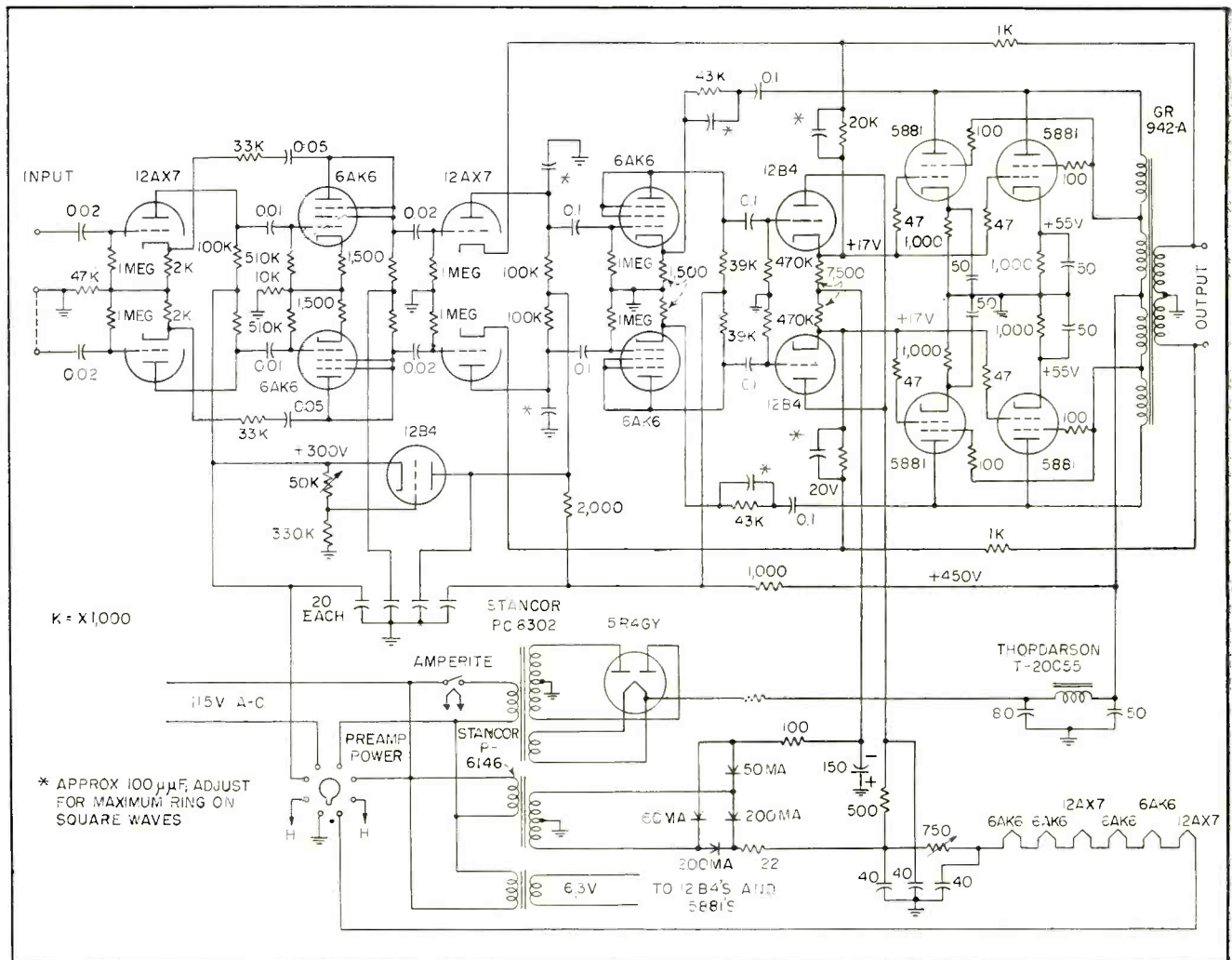

FIG. 2—Complete circuit of amplifier and its power supply. For unbalanced input either grid may be grounded, as indicated for one grid by dashed line. Amperite time-delay relay keeps high voltage off input capacitor of filter until tubes are drawing current

more than outweigh the greater efficiency of a class-B output stage.

Most engineers will agree that in the present state of the art all good amplifiers sound alike. In fact, amplifier design has progressed to the point where presence, the much-desired feeling of realism in the performance of a music reproduction system, is mostly a function of the transducers employed. The contribution of the amplifier to the overall distortion of the system can be made essentially negligible.

In effect, absence—the lack of audible indication of the presence of the amplifier—may well be taken as the definition of a good amplifier. The amplifier contribution to system noise and distortion should be so much less than that of any other component that it can be ignored. Once this point has been reached, further improvement will not result in more pleasing sound, however

impressive it may be as an engineering achievement.

Another aspect of absence is reliability. Performance of the sort we require should be achievable with a minimum of maintenance—a criterion which is desirable for laboratory work but mandatory for field use. Absence, then, should imply not only the elimination of artificiality or audible distortion in the reproduced program, but absence of maintenance worries as well.

Specific Amplifier Design

The amplifier circuit presented here was designed with the foregoing criteria firmly in mind. Performance is fully abreast of the present state of the art, but no compromise has been made with long-term reliability. In addition, sufficient flexibility has been built in to accommodate most types of program sources and it will perform

well under a reasonable variety of load impedances.

Figure 2 shows the basic circuit of the amplifier. Push-pull parallel 5881's are used, with the screens connected for ultra-linear operation. The General Radio type 942-A toroidal output transformer provides a suitable winding configuration for the required impedance relationships. Operation is substantially constant-current, with individual 1,000-ohm resistors in each cathode for d-c degeneration.

Since the output stage is to operate well into the grid-current region, the source of driving voltage must offer a very low resistance. In addition, the usual grid-current problems must be considered.

Grid-Current Considerations

There are three principal types of grid current which must be considered in a power amplifier. The first

is conduction current, which occurs when the grid is driven positive with respect to the cathode. The second is emission current, either directly from the grid because of high grid temperature, or as secondary emission due to bombardment by electrons from the cathode (and promoted by the deposit of cathode material on the grid as the tube ages). The third is gas current, resulting from positive ions in the tube.

Gas current and emission current may result from improper operation, tube defects or tube aging. These currents are of such a nature as to develop a positive voltage across any resistance appearing in the grid circuit. Such a voltage will reduce the effective bias on the tube, causing higher plate current which in turn causes higher grid current. The vicious circle thus established will generally bring the career of the tube to an abrupt and untimely end. The obvious cure, or at least palliative, for this trouble is to keep the d-c resistance in the grid circuit at an absolute minimum.

Cathode followers as drivers, direct-coupled to the output-tube grids, fill this requirement, and at the same time provide a low-impedance source of the current required to drive the output grids positive without peak clipping. The d-c resistance in the grid circuit is very low, being essentially the reciprocal of the cathode-follower transconductance. Further, there is no series coupling capacitor to charge up during peaks and then block the output stage while it discharges through a large grid-return resistor.

Design of the cathode followers is conventional, except in the choice of high-perveance tubes and low operating voltages. These drivers are called upon to deliver a peak current of the order of 40 ma. (As an example, in Fig. 1 the grid-current characteristics for constant-current operation of 807's are shown. The peak grid current of 20 ma at +15 volts represents an equivalent shunt resistance of about 750 ohms.) When the output-tube grid goes positive, the path of driver plate-current flow is from the +150-volt line through the cathode

follower, and thence through the grid-cathode path of the power tube to ground. The high peak value of this current flow calls for fairly good regulation of the +150-volt line.

The cathode impedance of the drivers must be low, particularly when the 5881's draw grid current. The 12B4's used in this amplifier may be operated at reasonable quiescent current in such a way that the transconductance rises sharply at the point where it is needed.

The peak current capability of the 12B4 is about 100 ma, more than twice the 40 ma required. The driver impedance is lowered still further and distortion in the voltage amplifiers minimized by feedback taken to the 12AX7 cathodes.

Voltage Amplifiers

The remainder of the amplifier is more conventional. The last voltage amplifier stage, uses 6AK6's, triode-connected. These tubes, which have recently been added to the Armed Services Preferred List, are excellent for many audio applications. Hum, noise and microphonics are low, and they are linear both as triodes and as pentodes. In this application they are used as low- μ triodes; they are more linear than any of the miniature dual triodes, and draw only half the heater current (150 ma per tube) of the others.

The input stage for the basic amplifier is a 12AX7. Balanced feedback is taken from the voice coil through the cathode-bias resistors to the cathodes, and feedback is also brought from the driver cathodes. Additional feedback is brought from the plates of the output tubes to reduce the amplifier impedance seen by the transformer, and further to reduce the low-frequency distortion. While some phasing is used in these feedback paths, use of feedback over a balanced system eliminates the problems of differential phase shifts encountered when the phase inverter is included in the feedback loop.

About 30 db of feedback is used over the power amplifier, in addition to some 10 db from the drivers. This provides a damping factor of over 100. The amplifier is stable with feedback for any load imped-

ance, resistive, reactive or open-circuit.

An amplifier which is stable with considerable feedback when connected to a resistive load may oscillate uncontrollably when the load is open-circuited, since under open-circuit conditions the transformer stray reactances may play a rather surprising role. Similarly, the phase shifts which occur when the amplifier is connected to an inductive load, like a loudspeaker, may be such as to produce oscillation. It is therefore a wise precaution to check a completed amplifier by operating it into an open circuit.

The input voltage required to drive the basic amplifier to 50 watts will be of the order of 30 volts grid-to-grid. This is easily supplied by a phase inverter using cascaded long-tailed pairs, with feedback from the output plates to the input cathodes. The net gain of this arrangement is such as to give a sensitivity of about one volt at the amplifier input, although this can be adjusted by changing the feedback in the phase inverter. Either grid may be grounded if the input signal is unbalanced, or both may be used if balanced operation is required. An octal socket is provided in the input circuit so that this may be done without the necessity of wiring changes in the amplifier. Alternatively, a plug-in preamplifier, an input transformer or some other network may be plugged into this socket.

This type of phase inverter represents a definite improvement in reliability over the direct-coupled cathodyne arrangement in general use today. In the direct-coupled configuration the operating points are interdependent, and with tube aging the phase inverter grid may be carried positive, resulting in serious distortion. With the balanced system shown here, wide variations in individual tube characteristics will actually have very little effect.

BIBLIOGRAPHY

D. Hafler and H. I. Keroes, An Ultra-Linear Amplifier. *Audio Eng.* p 15, Nov. 1951.

H. T. Sterling, Tube Applications in Amplifier Design, *Radio and Tel. News, Eng. Ed.*, p 14A, May 1951.

Note: Acknowledgement is made to Ray Prohaska for his definition of audio amplifier presence.

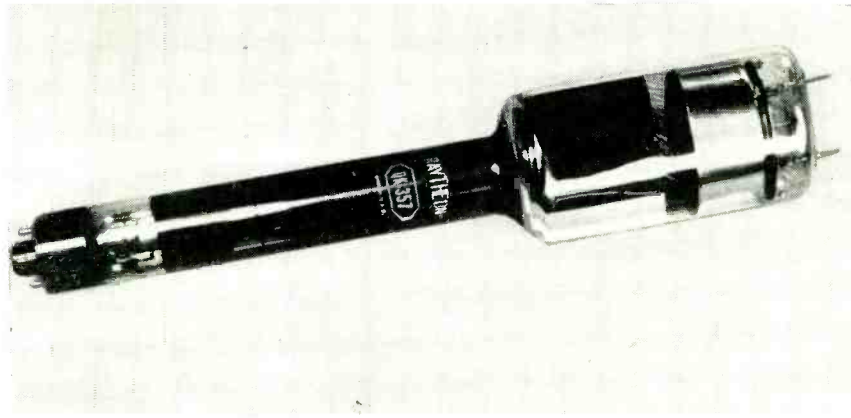

Improved-design recording tube gives long storage time despite repeated playbacks. Electron lens between anode and first screen avoids performance limitations of earlier-model tube

Single-Gun Storage Tube

Improved recording tubes retain charge up to one week; 27,000 read-outs cause only slight blemish on pattern. Applications may include study of fast transients, improved ppi radar display, frequency conversion, computer storage and trans-Atlantic tv via high-fidelity telephone circuits

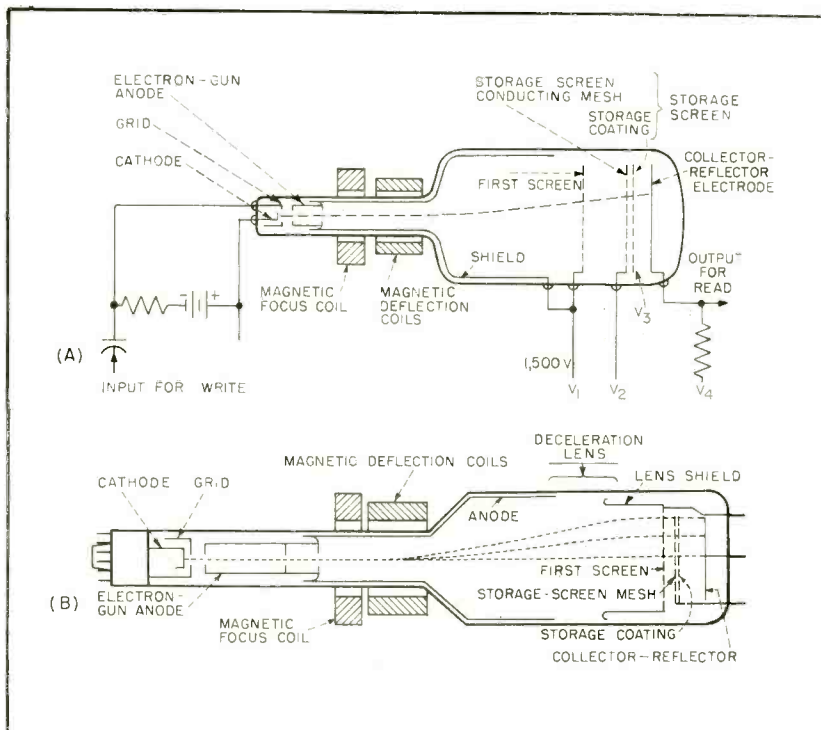

FIG. 1—Limitations placed upon earlier-model tube (A) are avoided by electron lens used in improved model

WHERE INFORMATION must be recorded at the rate of one microsecond per bit or faster, mechanical storage methods become impractical and are replaced by electronic devices. The advantage of electron-beam storage devices comes from the rapidity with which a cathode-ray beam can be deflected across a storage target. This storage target is an insulating surface on which a charge may be deposited without affecting adjacent or nearby surfaces. To store coherent information on this surface, either the electron beam is modulated or the characteristics of the storage target varied so that, as the beam is deflected across the target, a meaningful charge pattern will be formed. A storage tube also

This article is based on a paper delivered at the 1952 National Electronics Conference. The conference paper will appear in the *NEC Proceedings*.



Recording tube finds application both in television and radar. Photograph of monitor tube (left) shows read-out of a stored television picture. Radar ppi display (right) was written continuously for ten minutes. Trails show paths of aircraft

Writes, Reads and Erases

By R. C. HERGENROTHER and A. S. LUFTMAN

*Raytheon Manufacturing Company
Waltham, Mass.*

incorporates means for reading-out or retransmitting information contained in the charge pattern.

Examples of such storage tubes are the Graphicon¹, Radechron², Haef Memory Tube³, and Recording Tube⁴. These differ basically as to the number of voltage levels that can be stored, magnitude of output, rate at which operations can be performed and number of information elements or bits that can be stored.

Storage devices introduce several new degrees of freedom into a communications system. By their use, a retransmitted signal can be made to differ from the original one in time scale; that is, all frequencies in the signal may be increased or decreased from the original by a given ratio. Also, the time sequence of information can be changed by reading out the recording device in a mode different from that used for writing the information in.

The storage tube shown in the

photograph has been designed to store information accurately for a period in excess of ten minutes and to provide many playbacks without loss of recorded information. It has also been designed to store as many elements or bits as possible and to provide a continuous dynamic recording range.

To obtain repeated playbacks and dynamic range, reading is effected by an electron beam that does not come in direct contact with the stored charge. The beam becomes amplitude modulated by passing through the fine-mesh screen containing the charge pattern. This permits the tube to maintain half tones and to be read an almost unlimited number of times without disturbing stored signals.

To obtain high resolution it was necessary to use a small well-focused electron beam for writing and reading. A fine-mesh screen having a half dozen or more openings within the area of the electron

spot and a high transmission coefficient also was required.

To obtain high writing and erasing speeds current density in the focused electron spot had to be high. Various compromises, such as between spot size and current density, determined the final design of the tube.

Tube Performance

The recording tube is especially useful for storing transients and allowing them to be studied for long periods. Recorded waveforms may range in speed from servo-mechanism response curves requiring seconds or minutes to complete a cycle to one-mc r-f oscillations.

Writing speed of the tube is sufficient to permit storage of one frame of a television broadcast or tube voltages may be adjusted to permit cumulative writing for many frames. The photograph at the left shows a television picture stored for five frames and read out

continuously during photographing. The picture has tonal quality and detail comparable to the received television picture. Some definition is often lost during a multiframe exposure because of motion of the camera or picture elements.

Trans-Atlantic TV

Since reading speed does not influence the tube, pictures may be stored at any rate up to 0.12 microseconds per storage element and read out with either faster or slower sweep. This permits the tube to be used for frequency conversion. For example, a stored signal containing frequencies up to three mc, if read out at 1/200 writing speed, will have a maximum frequency component of 15-kc. The 15-kc signal can then be transmitted over high-fidelity telephone circuits and stored on a second recording tube at the receiver. This signal can be read out at two hundred times writing speed and reconverted to the original three-mc signal.

Frequency conversion by time-scale expansion has been suggested for trans-Atlantic television using high-fidelity telephone circuits. Received pictures will be stills changing at the rate of one every 10 seconds, but presumably this will not be objectionable to audiences if the pictures are played continuously for the 10-second period with a steady accompanying commentary.

Radar Applications

The tube has several applications in connection with radar ppi displays. A ppi display stored for a complete revolution of the antenna will be seen as a picture with uniform brightness, in contrast to the usual display that fades behind the beam trace. If desired, the stored display may be read continuously for a long period of time.

If several complete rotations are stored, moving targets will produce a trace the length of which is proportional to their relative speed. The photograph at the right shows the result of writing a 25-mile-range ppi signal into the storage tube for 10 minutes. The stored signal was read with raster scan and photographed. Paths of aircraft flying in and out of Boston Inter-

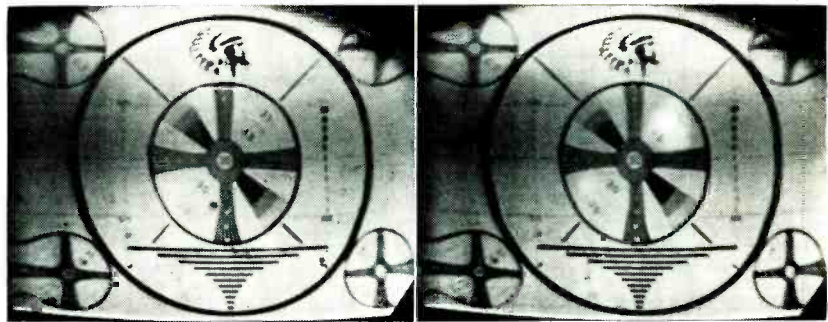

Monitor output shows effect of continuous reading. Test pattern (left) is shown after 1,800 read-outs. Same pattern (right) shows bright spot near center after 27,000 consecutive read-outs

national Airport are clearly indicated.

Retarding Field

An earlier model storage tube is shown in Fig. 1A. This is a magnetically-focused and deflected cathode-ray tube with triode gun designed to give a small focused spot. The electrodes at the front of the tube are the collector-reflector and storage screen. The large potential difference between anode shield and storage screen causes a

retarding field. This retarding field is a uniform electric field produced between parallel planes comprising the first screen and storage screen.

The use of a uniform electric field for retarding the beam from anode voltage to storage screen voltage resulted in several design and operational limitations. When, because of scanning deflection, the electron beam enters the retarding field at an angle, the component of beam velocity in the direction of the electric field is less than total beam velocity. This limits maximum useable deflection angle for a given ratio of storage-screen voltage to anode voltage. Figure 2 shows how electron trajectories are affected by the angle of incidence and how the beam is reflected at too high an incidence angle.

Deceleration Lens

Refractive effects produced by the uniform deceleration field are avoided if the deflected electron beam strikes perpendicular to the first screen. This requires an electron lens between the anode and first screen. If the focal point of this lens is located at the center of deflection of the electron beam and the storage screen located in the corresponding principal plane, the electron beam will strike the first screen perpendicularly for all deflection angles. Such an electron lens is used in the present recording tube shown in Fig. 1B. The required electric field for this lens is produced by lowering the first-screen potential to 300 volts. This electron lens removes previous restrictions on anode voltage and deflection angle and permits operation of the electron gun at anode volt-

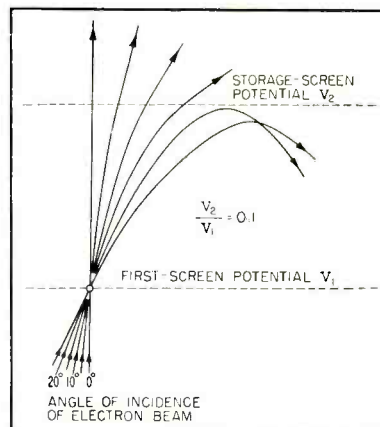

FIG. 2—Refractive effects of deceleration field limit anode voltage and deflection angle in earlier-model tube

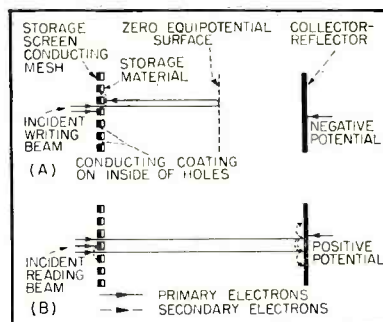

FIG. 3—Electron beam action during writing (A) and reading (B)

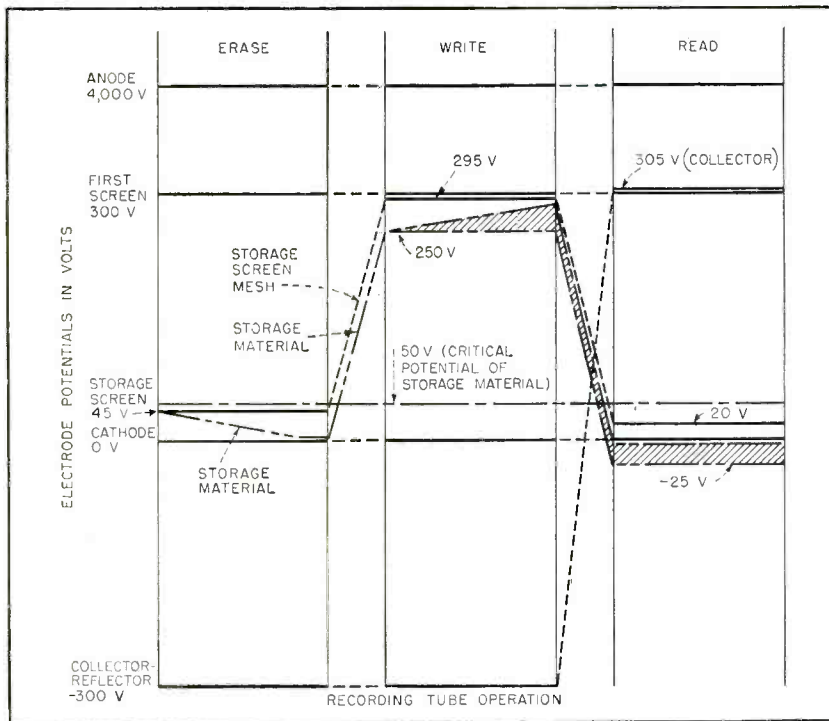

FIG. 4—Recording tube electrode potentials for reading, writing and erasing

ages of three or four kv with improved electron-gun performance.

Writing and Reading

Information is written onto the storage material as shown in Fig. 3A. A signal-modulated electron beam is sent through the storage screen and reflected by negative voltage on the collector-reflector onto the reverse or coated side of the screen. Since, during the writing operation, storage-screen potential is greater than the critical potential of the storage surface, the secondary emission ratio is greater than unity and a positive electric charge is built up dependent upon the current density of the electron beam and its speed of motion across the screen. Since the charge formed is proportional to beam current density, it is possible to vary the quantity of charge from point to point on the scan by modulating this current. The electrode potentials for writing, erasing and reading are diagrammed in Fig. 4.

To read out stored information, storage screen voltage is dropped to such a level as to make uncharged areas of the screen have a negative voltage sufficient to cut off an electron beam aimed at

them. The storage screen is then scanned with a constant-current electron beam. The percentage of beam current passing through an area is proportional to the charge in that area. As shown in Fig. 3B, the collector-reflector now has a positive potential to attract electrons passing through the screen. The signal output is developed across the load resistor in series with the collector. When the read and write scans are in register on the storage surface, the beam reaching the collector will be modulated to that previously written onto the screen.

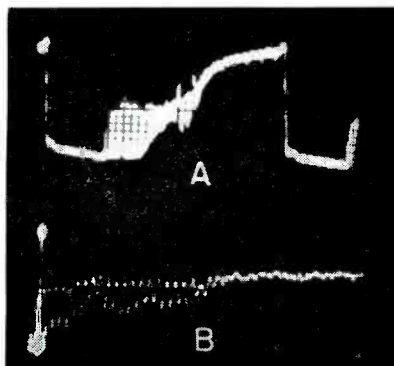

FIG. 5—Recording-tube output measuring resolving power showing vertical trace of storage tube (A) and a four-to-one expansion of part of the trace

The number of elements that can be stored in a storage tube is stated in terms of the tube's resolving power. This can be measured by writing a tv resolving-power chart into the tube and reading the stored image on a monitor. Resolution can then be judged from the monitor picture.

Measuring Resolution

A more accurate method is to write a single-field constant-intensity raster into the tube using a uniform sawtooth horizontal sweep and an exponential vertical sweep. The resultant stored raster will have horizontal lines compressed at one edge and spread apart at the other. If the tube is read out using a single-line vertical sweep and the output signal displayed on a synchronized oscilloscope, resolving power can accurately be determined by measuring the minimum spacing between adjacent lines showing 50 percent modulation. Recording tube resolution measured in this way gives 200 lines across the screen diameter for 50 percent modulation. This is 400 total lines of alternate white and black as measured on a tv resolving-power chart. Figure 5 illustrates this measurement.

Half-Tone Shades

The number of half-tone shades that can be distinguished in the output of a storage tube can be determined by using a one-field write of a television raster with a linearly decreasing beam current as the spot scans from the top to the bottom of the screen. The tube is then read out using a single-line vertical trace and the output signal viewed on a synchronized oscilloscope as was done in the resolution test. Oscillograms of the output traces obtained are shown in Fig. 6.

Writing and Erasing Speed

No accurate method of measuring writing speed has been developed. However, since a single frame of a television picture can be written to 100 percent modulation with 400-line resolution, maximum writing speed is in excess of 0.12 microsecond per storage element or 48 microseconds per line.

Accurate erasing-speed measurements have not been made. Tests

indicate that the time for total erasure is in the order of 1.5 microseconds per storage element.

Repeat Readings

The tube will retain a stored picture for a period of up to one week with no noticeable deterioration if the tube is turned off during the waiting period.

Repeated readings at the television rate of 30 frames per second were taken on a stored resolution chart. The photograph at the left was taken 1,800 readings after the chart was stored. The unit was then left reading continuously for 15 minutes (27,000 readings). The photograph at the right shows the only change is the formation of a light spot near the number 45. The loss of signal through reading can only be produced by positive ions that are attracted to the negatively-charged storage surface. The erasing effect of positive ions is proportional to reading-beam current and residual gas pressure in the tube. It can be reduced by improving tube vacuum.

Noise

If noise is defined as any undesired signal, there are two different types of noise that originate in the tube. One type is random noise that comprises both shot noise originating in the electron beam and partition noise caused by the beam passing through the screens. Since the beam current is about 10 microamperes for both reading and writing beams, the theoretical signal-to-noise ratio for this type of noise is very high (of the order of 10^6) and this noise is not detectable in the output signal.

The other type of noise is fixed-pattern noise, produced by defects

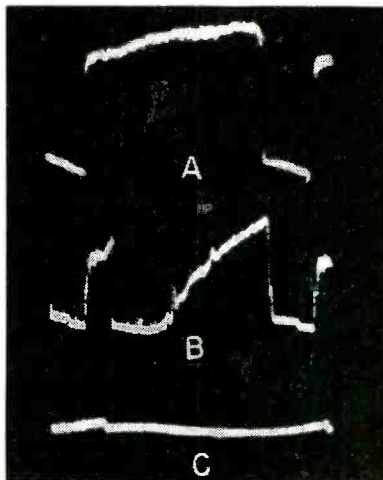

FIG. 6—Recording tube output measuring half-tone shades. White level is shown at (A), black level at (C); (B) is a sawtooth signal ranging from black to white

in the storage screen. These defects include plugged holes and enlarged holes occurring in the original mesh used for making the storage screens. These defects are few in number and small and can be eliminated by improving the metal-screen manufacturing technique. The electron spot covers about eight normal screen holes so the mesh of the screen itself is not resolved and produces no additional fixed-pattern noise.

Integration

Use of storage devices to integrate repetitive signals mixed with random noise and thus improve signal-to-noise ratio has been studied by several investigators.⁵ An ideal storage device would improve the signal-to-noise ratio by a factor equal to the square root of the number of signal repetitions. This improvement results from the random character of the noise as opposed to the fixed character of

the desired signal. In the recording tube, any signal will build up charge on the storage element but, with repeated integrations, the random characteristics of noise will result in only small differential variations in noise signal across the storage surface. The repetitive signal, on the other hand, will additively build up variations across the storage surface. In reading out the signal from the recording tube, background charge produced by noise can be suppressed by adjusting storage-screen potential so that only residual differential variations in integrated noise appear.

The effect of integration was tested using as a signal a standard television resolving-power chart with superposed random noise frequencies up to 500 kc at approximately unity signal-to-noise ratio. The photograph at the left shows the recording tube output when one frame of this signal was stored. The same figure was then written into the recording tube for 20 successive frames. The photograph at the right shows the noise integration effects that had been predicted.

The recording storage tube is a reliable, compact tube adapted to production. It is presently in pilot production and is being studied for use in commercial and military applications. Design modifications to reduce tube size or to make it a two-gun tube capable of simultaneous reading and writing are feasible if needed. Further development to increase erasing speed is also being considered.

Acknowledgments

The authors wish to express their gratitude to John Buckbee who developed the circuits for the various tests and to William Whynot, assistant project engineer.

REFERENCES

- (1) L. Pensak, The Graphechon—A Picture Storage Tube, *RCA Rev*, 10, p 59, March 1949.
- (2) A. S. Jensen, J. P. Smith, M. H. Mesner and L. E. Flory, Barrier-Grid Tube and Its Operation, *RCA Rev*, 9, p 112, March 1948.
- (3) A. V. Haefl, A Memory Tube, *ELECTRONICS*, 20, p 80, Sept. 1947.
- (4) R. C. Hergenrother and B. C. Gardner, The Recording Storage Tube, *Proc. IRE*, 38, No. 7, July 1950.
- (5) J. V. Harrington and T. F. Rogers, Signal-to-noise Improvement Through Integration in a Storage Tube, *Proc. IRE*, 38, No. 10, Oct. 1950.

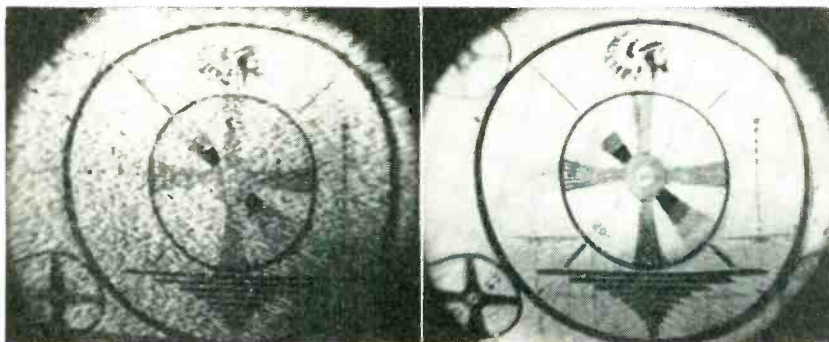

Integration of repeated signals mixed with random noise. Pattern written for one frame (left) is much improved after 20 frames despite one-to-one signal-to-noise ratio

Performance of High-Output Magnetic Tape

Newest recording tape gives 6-db greater signal output than standard American tapes, without an increase in noise level. Alternatively, recording equipment designers may use extra gain to boost signal-to-noise level, reduce tape speed or reduce tape track width

By L. B. LUECK and W. W. WETZEL

Minnesota Mining and Manufacturing Co.
St. Paul, Minnesota

RECENT advances in the formulation of magnetic materials have produced a marked increase in magnetic remanence of the oxide used for magnetic recording tape. This results in a gain of approximately 6 db in signal output over that of standard American tapes. The gain is achieved with no increase in noise level, thereby giving a definite improvement in signal-to-noise ratio.

Hysteresis Curves

A comparison of the hysteresis curves of the new tape with that of two older tapes shows marked differences in their characteristics, particularly in the remanence values. Figure 1 shows second-quadrant plots of B-H as a function of H for the early German type L

tape, standard American tape as represented by "Scotch" Brand No. 111 magnetic recording tape, and the new recording tape known as "Scotch" Brand No. 120 high-output tape. The data for these plots were obtained on a 60-cps hysteresis loop tester operated at a peak field of 1,500 oersteds, which carries the tapes well into saturation.

The remanence value B_r may be read from the curves at the point $H = 0$. The intrinsic coercivity H_{ic} is read from the plots as the value of H at the point where $B = H = 0$.

The true coercivity H_c , which represents the value of the field H where $B = 0$, is the more significant term since H_{ic} is a function of the remanence of the magnetic material; H_c may be read from the H axis at a point where a line of unit slope intersects the hysteresis

curve. These values are given in Fig. 1 for each of the three curves.

An increase in H_c from 50 to 220 oersteds is accompanied, as may be expected, by an increase in remanence from 100 to 500 gaussers when the German and standard American tapes are compared. The increase from 500 to 1,100 gaussers, although accompanied by a slight increase in the value of H_c between the standard high-output American tapes, does not entirely account for the factor of 2.2 increase in B_r . This increase is associated with a fundamental change in the nature of the magnetic material employed.

The output of a tape, at recorded wavelengths which are long compared with the thickness of the magnetic coating, is a function of the a-c bias field, the gap width used in the recording heads and the

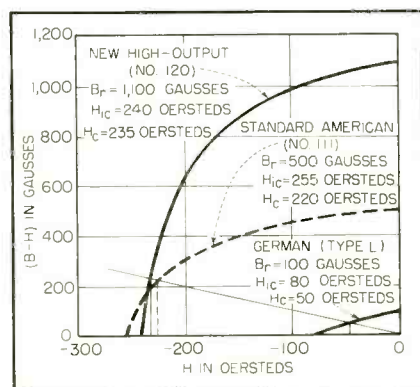

FIG. 1—Hysteresis curves showing differences in magnetic properties

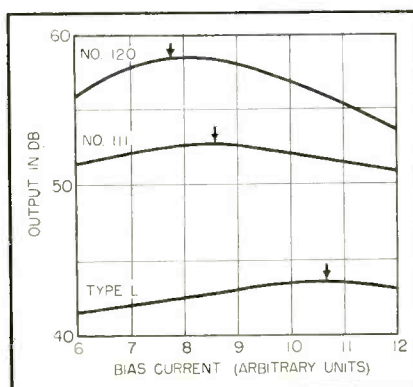

FIG. 2—Effect of bias current on output when using 400-cps input current

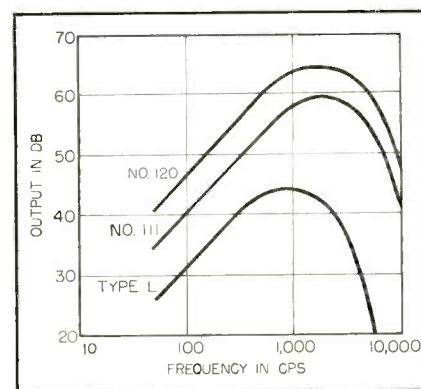

FIG. 3—Frequency response curves, recorded at constant current

remanence of the tape. Other factors remaining equal, the tape with the highest remanence value may be expected to have the highest output. At wavelengths which approach the coating thickness of a tape the remanence and coercivity influence the output, other factors remaining fixed. It has generally been assumed that higher-coercivity material forms tape with the better relative high-frequency response.

On the basis of the B_r and H_c values given in Fig. 1, both the low-frequency output and the relative high-frequency response should improve as remanence is increased.

Bias Requirements

If a tape is recorded with a low-frequency signal of fixed input and the output is studied as a function of the a-c bias current, an optimum value of bias may be selected for the maximum low-frequency output. The optimum bias for greatest high-frequency output is somewhat lower than the above value but machine manufacturers do not universally select a compromise current between these two settings. At progressively higher bias currents than the optimum for low frequencies the high-frequency output declines at a more rapid rate than that for the lows. However, at the higher bias values a gain in uniformity of output is obtained. Some manufacturers prefer the uniformity feature and choose to operate at high bias currents.

Figure 2 shows curves of low-frequency output as a function of bias for the three tape constructions under consideration. While No. 111 and No. 120 tapes peak at nearly the same bias current, type L requires a considerably higher current to reach its maximum.

Figure 3 illustrates the output obtained from the three tapes as a function of frequency under unequalized record and playback conditions. For comparison purposes the record conditions are chosen to be those of optimum bias as selected from the curves of Fig. 4. Constant-current recording is used, with the current fixed at that required to give 1-percent 3rd harmonic distortion at 400 cps. The playback was measured using flat amplifiers. The

tape speed during the measurements was 7.5 inches per second.

The impregnated type L tape at the lower frequencies has an output about 8 db lower than No. 111, which in turn is about 6 db below that of No. 120. At the higher frequencies, type L output falls off rapidly while the other two tapes maintain essentially constant level differences of 6 db.

The bias currents for type L, No. 111 and No. 120 tapes were chosen as 10.5, 8.5 and 7.6 units on an arbitrary scale. While a somewhat better ratio of high- to low-frequency output may be obtained by a reduction of bias for the type L tape, this will be had partially at the expense of low-frequency output, as may be seen in Fig. 2. The flatter frequency response of the American when compared with the old German tapes may be attributed to the marked increase in coercivity of the latter over type L tapes. The small differences in either H_c or H_{ic} for the two American tapes are apparently insignificant in their influence on the frequency response.

Distortion

As magnetic tapes approach saturation during the recording process, they also approach higher distortion values. In a suitably adjusted recorder which contains neither d-c components of magnetization nor equivalent even-harmonic distortion in the bias field, only odd harmonic components are found in the signal output and the third-harmonic distortion component predominates. For simplicity, the third harmonic may be taken as a good first approximation to the total harmonic distortion.

Figure 4 shows output vs third harmonic distortion at 400 cps for the three tapes. These results were taken at the bias values and tape speed used to obtain the curves of Fig. 3. Within the accuracy of the determination the curves maintain essentially equal output level differences over the distortion range. This shows that each tape approaches saturation with approximately equal grace as far as distortion is concerned.

While exhaustive tests have not been made on layer-to-layer trans-

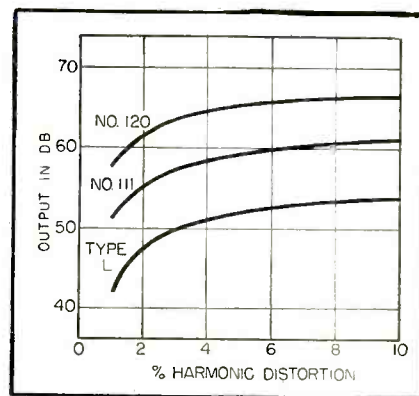

FIG. 4—Harmonic distortion, showing similarity of curve shapes

fer of signal for the high-output tape, there appears to be no essential difference between the signal-to-print level in the two modern constructions. The time and temperature effects on transfer appear identical, as do the absolute level of both the erased noise and the modulation noise. Signal transfer is apparent more frequently in the new construction than it was in the case of present standard tapes. This is to be expected from the increased recorded flux associated with a given distortion.

The memory effect is a descriptive name for the partial recovery of level in an erased recording when it is subjected to a bias field. All oxides have this memory of prior states of magnetization to varying degrees. Black oxides are the worst offenders in this respect. The degree of memory associated with a properly formulated magnetic material is so small that it can be detected only through the use of filters which pass the frequency used in the test and suppress the major portion of the masking noise spectrum. The new high-output tape has no detectable memory effect under normal conditions.

The new tape does not show a measurable change in erase current requirements as a function of the time a signal has remained recorded. This increase with time in the difficulty of erase has been reported only in the case of certain forms of Fe_3O_4 .

General Considerations

High-output tape cannot be expected to exhibit its inherent 6-db

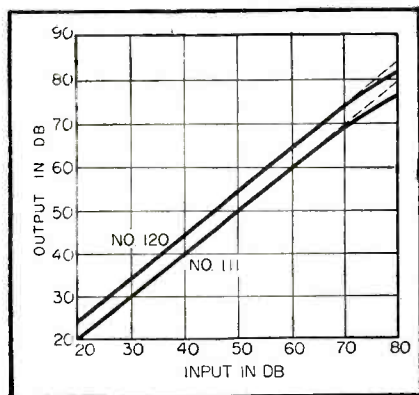

FIG. 5—Sensitivity plots, showing increased output of new type

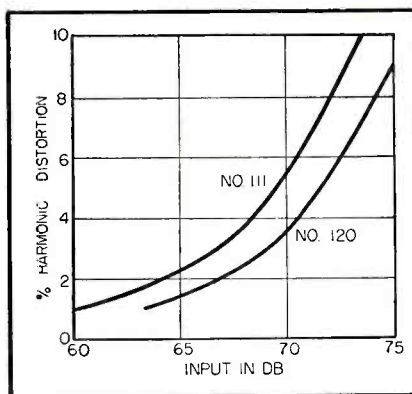

FIG. 6—Distortion curves, showing that new tape will take higher input

higher output on any recording machine without machine alterations. While a portion of the increase may be attributed to a higher recording sensitivity (where sensitivity is expressed as the ratio of output to input), a second portion is due to the fact that the input may be increased somewhat without attaining higher distortion.

Figure 5 shows curves of input vs output for the two modern tapes as determined on a professional type recorder. The bias values were chosen as optimum for each tape. It can be seen that a difference of approximately 4 db in output results at any given value of input.

Figure 6, which shows curves of input plotted as a function of distortion, illustrates the fact that to develop the same degree of distortion in the signal output, No. 120 tape requires a somewhat higher input than No. 111.

Figures 2, 5 and 6 illustrate the necessity for choosing the proper bias and recording levels in order that a given piece of equipment develop the full benefits of high-output tape.

Manufacturing Problems

The coercivity of iron oxides and hence the signal output may be enhanced by including minor percentages of impurities in the oxide crystals, introducing physical strains in the crystal lattice, and choosing a crystal habit which exhibits a desirable degree of shape anisotropy. All three means are deliberately employed in the manufacture of oxides commonly used on

magnetic tapes made in this country.

In addition to the increase in output which may be associated with increased remanence of American oxides, the frequency response is enhanced, since the ability of a tape to retain magnetization for very short wavelengths generally improves with an increase in coercivity.

Backing Film

Excellent cellulose acetate film is available in this country and has been used as the supporting backing for the majority of tapes. This permits the use of a magnetic coating containing a high percentage of oxide, to form a magnetically active layer which in itself has a relatively low tensile strength. It is common practice to formulate the coating dispersion with the oxide concentration of from two to four parts of oxide to one part of a resinous binder. This additional oxide loading, taken together with the improved remanence of the oxide, accounts for the increase in signal output of present American over the early German tapes.

Type L tape was made from a calendered film and suffered from the inherent difficulty of caliper variation associated with this process. The best commercial practice in calendering produces films with a thickness tolerance of ± 10 percent. This represents a variation in signal output of ± 1 db, if the film is made from a magnetic dispersion. This caliper difficulty is reflected in type L tapes where variations of ± 1.5 db from

roll to roll were found. Within a roll the output variations were smaller, amounting to $\pm \frac{1}{2}$ db.

Coating techniques developed in this country are consistently producing tapes which vary less than $\pm \frac{1}{2}$ db within a roll and which are uniform from roll to roll to within $\pm \frac{1}{2}$ db. This means the coating thickness is maintained to less than ± 0.0000125 inch within a roll. The better uniformity represents a third improvement of American over early German tapes.

Tape Speed

The German Magnetophone recorder, using type L tape, had a flat response to 10 kc at a tape speed of 30 inches per second. The minimum recorded wavelength was, therefore, 0.003 inch. Through careful design of machines and by the use of the improved American tapes it is now possible to obtain professional type recordings with a flat response out to 15 kc at a tape speed of only 7.5 inches per second. This requires the tape to maintain wavelengths as short as 0.0005 inch. The economy involved in the lower speed is obvious. It is doubtful if magnetic recording of sound would have achieved a fraction of its present popularity if the 30-inch-per-second velocity had not been reduced. As an example, satisfactory amateur recordings may now be made at a tape speed of $1\frac{1}{2}$ inches per second.

Conclusions

The availability of a tape having an increase in output of approximately 6 db without deterioration in other characteristics should allow additional latitude to designers of magnetic recording equipment. Alternative ways in which the additional output may be employed are: To increase signal-to-noise level in recording equipment; to use narrower recording heads and recorded tape tracks to obtain output comparable with old tapes at a saving of tape area; to reduce tape speed through the use of greater pre-equalization of high frequencies and a lower record level without sacrifice of band width or output level; to design equipment having fewer electronic components.

A Helical Beam for

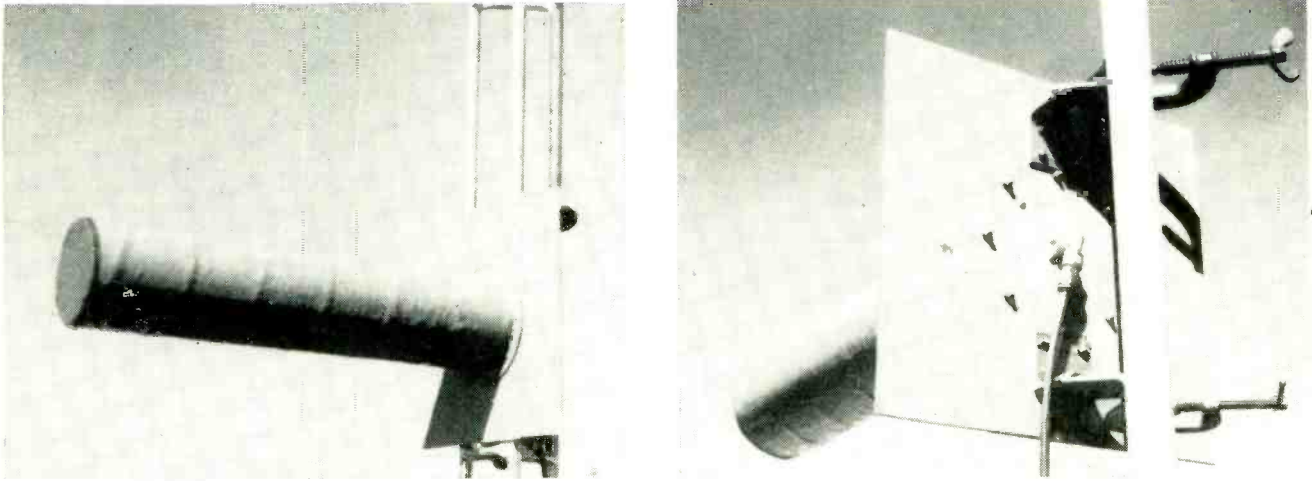

Mounted on relay tower, helical beam can be easily oriented by swivel brackets (shown in rear view on right). Coaxial feed finds natural termination in the helix itself

A HELICAL beam antenna capable of meeting the most rigid commercial requirements in the 450-mc range has been made possible by recent advances in the field of fiberglass moldings. The helical beam, with its circular polarization, possesses added advantages of economy and strength, as well as high gain and bandwidth.

The corner reflector, a simple design, affords 8 to 10 db gain. The yagi has a slightly greater gain but suffers in bandwidth so that ice and snow may reduce its efficiency more than 50 percent. Parabolic antennas have high initial cost and require expensive high-strength towers. The helical beam antenna, now that production has been made practical, has none of these disadvantages.

Construction

A 16x16-in. solid aluminum plate (Fig. 1) is used for the ground plate. Molded integrally into a fiberglass radome-type cylindrical housing, the helix consists of a length of $\frac{3}{8}$ -in. copper braid. The radome is molded with a base flange which bolts directly to the ground plate.

A type N coaxial connector mounted at the center of the ground plate acts to terminate the cable and feed the helix. Since the

By **EDWARD F. HARRIS**

*Chief Engineer
Mark Products Co.
Chicago, Ill.*

radome is sealed and closed on its far end and the flange affords a seal to the aluminum ground plate, the entire configuration is weather-proof. Swivel brackets mounted on the back of the aluminum plate allow for mounting to a tower leg and for orienting the helical beam.

Calculations of the stresses involved under conditions of 100-mph

wind velocity and $\frac{1}{2}$ -in. radial ice show that wind loading of the order of 40 pounds is experienced on the radome and the maximum stress on the base fibers of the housing at the flange is about 250 psi. Since the material is capable of stresses of the order of 30,000 psi, the safety factor is considerable.

Performance

Operation was checked in a helix-to-helix overall system, using iden-

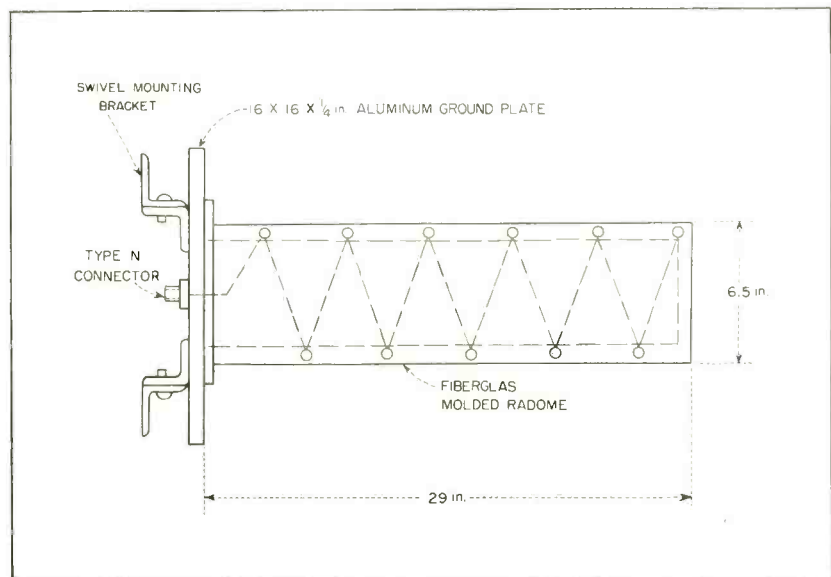

FIG. 1—Six-turn 14-degree pitch helix of $\frac{3}{8}$ -inch copper braid is molded integrally into cylinder. Base flange of radome bolts to aluminum ground plate

Citizen's Radio

With high gain and circular polarization, the helical beam antenna offers good bandwidth and pattern properties, plus good stress and ice loading safety. Radome is sealed and weatherproof. Helix designed at 450 mc stays unidirectional from 390 mc to 600 mc

tical receiving and transmitting helices. Figure 2 shows the measured radiation pattern of the receiving helix under these conditions of circular polarized transmission. Note the extremely smooth pattern and the total lack of any spurious lobes. Since all reflected radiations are of the opposite sense, the receiving helix does not respond to them and the pattern measured is more nearly the free space wave.

The helix configuration is essentially broad band, a property which makes for non-critical operation. To investigate the pattern bandwidth a helix-to-helix circuit was set up and patterns taken from 350 mc through 750 mc. Figure 3 shows the patterns as measured on an automatic polar recorder. Although the design frequency is 450 mc, the pattern stays unidirectional from 390 through 600 mc. Operation remains excellent well below 400 mc, so that this unit will find

application in government services around 410 mc as well as at other frequencies throughout its range.

It is desirable to design for such a pattern as is obtained at 600 mc;

however if this were scaled to 450 mc the unit would become too bulky for good commercial design. Now that a mechanically suitable design is available its properties could very well be extended to application in the 890-960 mc region also.

Multiple Helices

Large increases in gain may be had by using several helices arrayed on a common ground plane. Four such elements mounted in a square will provide a nominal increase of 6 db over the single radiator and the assembly does not become unwieldy. A 4-helix array at both ends of the circuit will increase system gain on a repeater unit by 12 db, and still retain all the advantages of circular polarization. Four of the standard helical beam units described may be combined with the necessary ground-plane kit for such service and the feed remains straightforward and broad band.

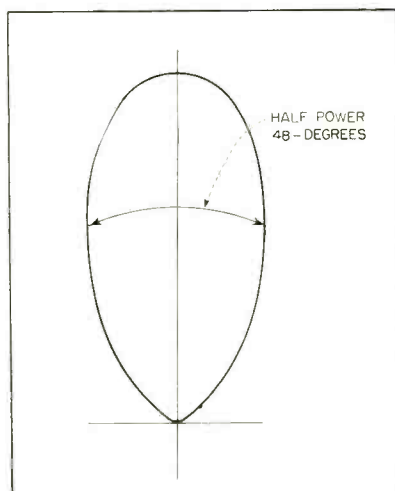

FIG. 2—Circular polarization of transmission as measured in a helix-to-helix overall system

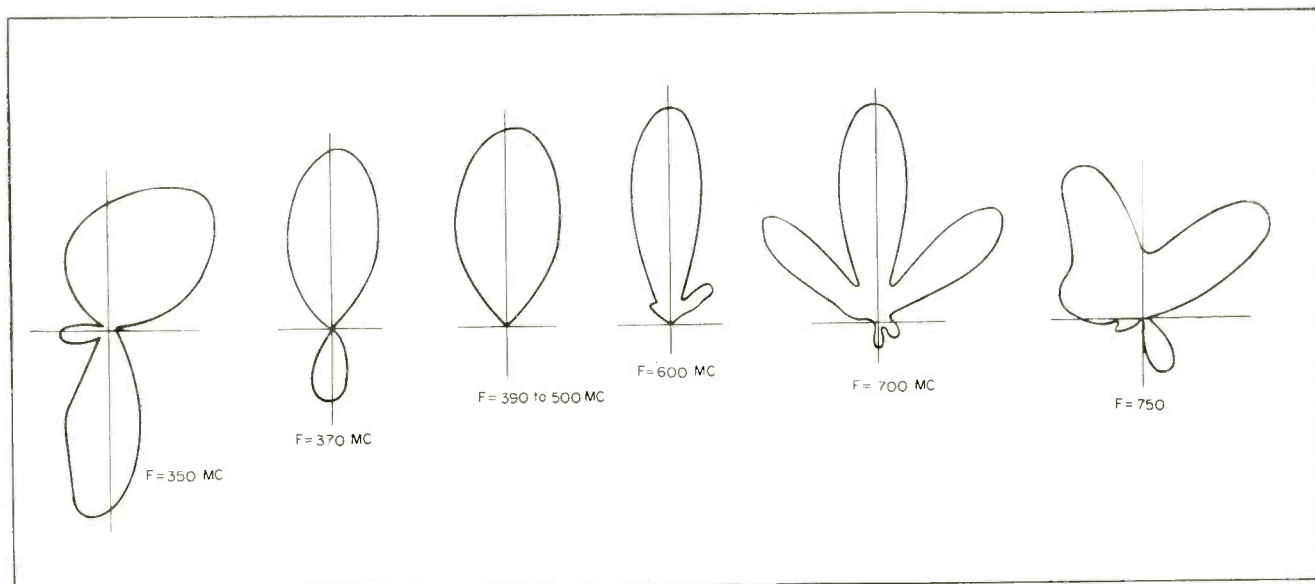
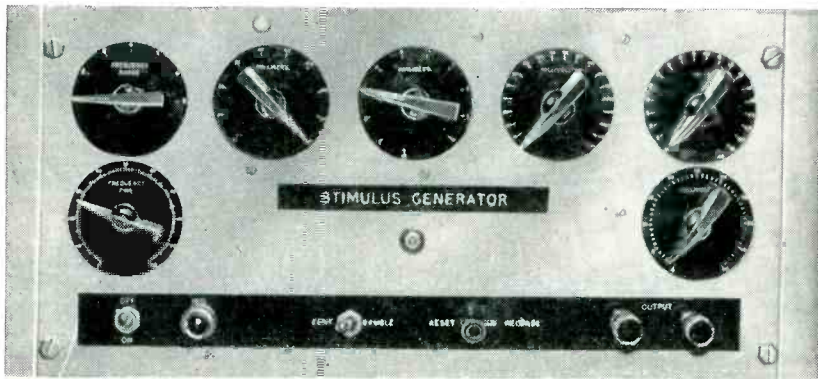

FIG. 3—Pattern for helix designed at 450 mc stays unidirectional from 390 to 600 mc. Half power beam width at 390 mc is 53 degrees, at 260 mc is 38 degrees, representing a very high-gain mode of operation

Pulse Generator Has



Front panel of the instrument showing the various controls for repetition rate, pulse width and amplitude

By **W. W. SCHROEDER**

National Physical Laboratory
Pretoria, South Africa

AT THE REQUEST of the Zoological Department of the University of Cape Town, a stimulus generator was designed and constructed for physiological research. The apparatus produces rectangular pulses with a pulse repetition rate variable from one to 1,000 cps. The desired frequency can be set by turning of coarse and fine frequency dials.

Pulse width is variable from one to 100 milliseconds. Variation can again be obtained by setting two dials, the dial settings being additive.

Pulse amplitude is variable from zero to 20 volts. One dial is provided for volts and two dials for millivolts. The two millivolt dials are also additive, when the volt dial is on zero. When the volt dial is used, the millivolt dials are inoperative.

By setting the CONTINUOUS-DOUBLE switch, Fig. 1, to CONTINUOUS, a continuous series of pulses may be obtained. On DOUBLE, only two pulses are produced when setting the pulse switch to RELEASE. The circuit can be made ready for the next set of double pulses by setting this switch to RESET.

Operation of the instrument may be described by referring to the schematic diagram in Fig. 1. It consists essentially of a square-wave generator supplying pulses to an output circuit, via a gating circuit and three multivibrators (V_5 , V_7 and V_8). On continuous pulses, the gate is open and all pulses pass

on to the output of the device.

On double pulses, V_5 is triggered by a negative signal obtained by differentiation (C_1 and R_1) of the first pulse following the operation of the release switch. Tube V_5 opens the gate immediately via the buffer stage and the next pulse from the generator passes along the direct line through the gate to the output stage. The output pulse is also applied to V_7 . Tubes V_7 and V_8 constitute a scale-of-two and switch circuit which close the gate via the buffer stage after exactly two pulses have passed to the output.

Gas triode V_1 together with its associated components produces a variable-frequency saw-tooth waveform. This signal is applied to the pulse-length modulator V_2 . A rectangular waveform is obtained at V_3 which can be varied in width by the capacitance range of C_2 , actually consisting of 19 separate capacitors. The positive square pulses are then shaped by V_{3A} and applied to a cathode follower V_{3B} . At the cathode of V_{3B} , square waves of approximately 30 volts peak-to-peak amplitude are developed.

Continuous Pulses

Pulses produced by the generator are applied to the gate and multivibrator V_5 simultaneously. However, V_5 , V_7 and V_8 remain inoperative due to the high grid leak resistor (100K) with the pulse switch open (RESET). With switch S_1 set to CONTINUOUS, the suppressor grid of

gate tube V_{10} is at ground potential. This tube conducts and the pulses will pass on to the first half of V_{12} . The pulses are then inverted and applied to the output cathode follower, second half of V_{12} . Amplitude of the output signal is adjustable by means of preset potentiometer R_2 . The attenuators give the required amplitude for the output signal.

With S_1 open, the gate tube is at cut-off, as its suppressor is at -95 volts because of the current through V_6 . With S_2 at RELEASE, V_5 , V_7 and V_8 are all in operation. The first pulse after operating the release switch will now trigger V_5 , applying a negative potential to the first grid of V_6 . The decrease of anode current of V_6 makes the suppressor of V_{10} more positive and the tube again conducts and the gate is open.

The next pulse from the generator now passes through the gate to the output. This output signal is also applied to V_7 . The V_7 stage, which constitutes a scale-of-two circuit, operates switch V_8 after exactly two pulses have passed on to the output. The switching multivibrator V_8 applies a positive signal to right-hand grid of V_6 , which causes this tube to conduct and to close the gate V_{10} by increasing its suppressor voltage again to about -95 volts.

A neon indicator V_{13} gives a visual indication of the pulses, particularly at the lower pulse repetition rates.

Accuracy of the output attenu-

How To Use Mechanical I-F Filters

By **M. L. DOELZ**
and **J. C. HATHAWAY**

*Collins Radio Company
Burbank, California*

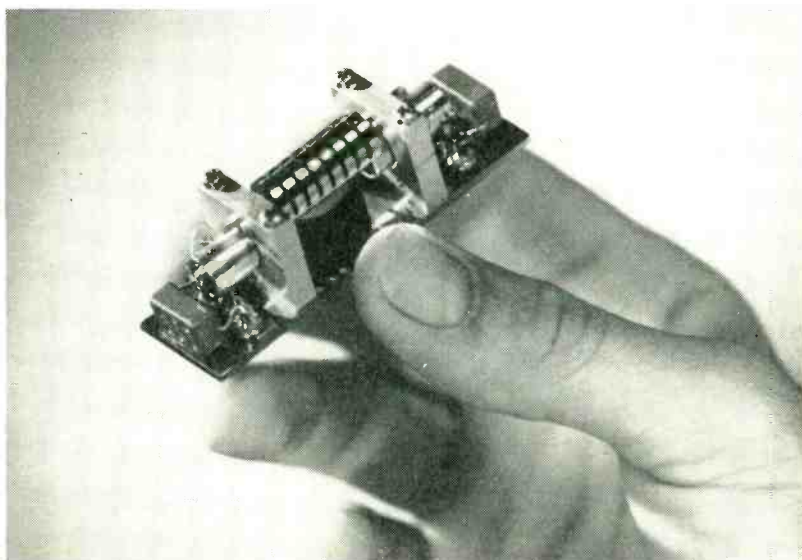

Mechanical filter takes less room than most 455-kc L-C filters and gives superior shape factor to i-f response characteristic

THE MECHANICAL FILTER was developed to fill the need for a compact and permanently-tuned bandpass filter at intermediate frequencies. The selectivity characteristic is achieved by means of overcoupled mechanical resonators driven by magnetostriction. Frequency response is characterized by a nearly flat top and steep skirts on both sides of the pass band, as shown by Fig. 1.

Figure 2 shows the functional elements of the mechanical filter. A signal current is fed to the input coil at one end causing the nickel driving wire, in the center of the coil, to expand and contract due to the magnetostrictive effect. The resulting longitudinal vibration drives the first resonant disk. Me-

chanical vibrations are coupled through the six disks by means of three wires acting as springs. At the output end of the filter, the longitudinal motion of the nickel end wire is transformed into an electrical current by the inverse magnetostrictive effect.

The construction details of a complete filter assembly are shown in the photograph. The six center disks comprise a mechanical band-pass network, while those at each end are untuned and function only as rigid supports. Each supporting disk is soldered to a brass tube, which serves as a mounting and shield for the driving coil. Wire leads from the coils are soldered to hermetically sealed feed-through terminals in the base plate, and

small mica capacitors are connected across these coils to provide low-Q resonant circuits at each end of the filter.

The complete assembly is mounted and sealed in a brass case 1 inch high, $\frac{3}{8}$ inch wide, and $2\frac{1}{8}$ inches long. In application, the filter is connected directly to the plate and grid circuits of tubes.

Characteristics

Magnetostrictively-driven mechanical filters have several advantages over their electrical equivalents. In the region from 100 to 500 kc, the mechanical elements used are extremely small and it is possible to construct filters having better selectivity characteristics than the best of conventional i-f

Rugged fix-tuned interstage coupling units provide steep-skirt selectivity for intermediate-frequency amplifiers used in communications receivers, and in ssb transmitters for eliminating undesired sideband from low-frequency dsb signal

systems in less than the space required by a single i-f transformer.

Since mechanical elements with Q's of 2,000 and over are easily obtainable, it is possible to construct filters of extremely narrow bandwidth with characteristics following the theory for lossless elements. This allows filter designs which are unattainable with electrical elements because of their relatively high losses.

A third advantage, that is not immediately apparent, lies in the permanence of the tuning adjustments. Once the various mechanical elements have been constructed, the filter frequency characteristics are permanent and no subsequent trimming is required or is possible. While this makes the initial design difficult in many ways, it removes the usual difficulties with malfunctioning of equipment due to improper trimmer adjustment, coil aging, humidity and other detuning effects. The latter may eventually become the most important characteristic since it has the effect of reducing servicing complexity of already overly complex electronic equipment.

Filter Elements

The mechanical filter bandpass system is composed of metal disks and wires. The disks function as high-Q resonators, while the wires provide coupling between disks and function as magnetostrictive transducers at the terminations of the filter.

Two normal vibration modes of a single disk are illustrated in the photographs. The mode with two rings has been selected for most of the filter work, while the other is a

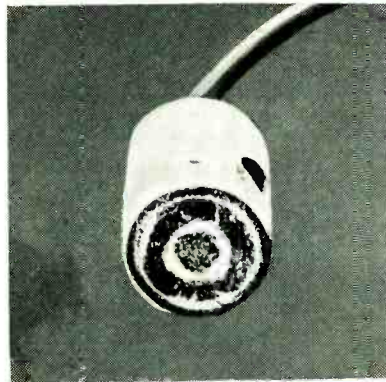

Lycopodium powder shows desired mode used in mechanical filter

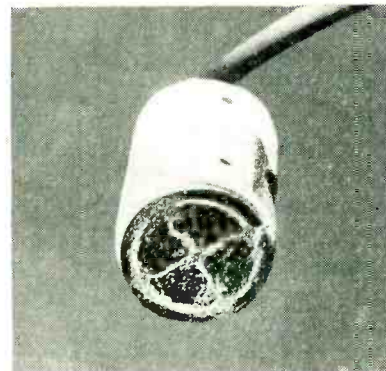

Spurious mode appears close in frequency to desired mode

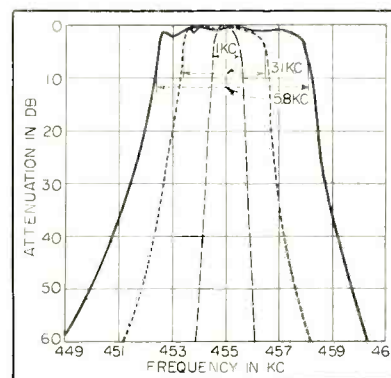

FIG. 1—Frequency response of three different mechanical filter designs described in text

spurious mode appearing relatively close in frequency to the desired mode.

The patterns shown were obtained by burnishing the surface of a disk and sprinkling it with lycopodium powder. The disk is driven with a nickel wire excited by magnetostriction. The resulting vibration caused particles to collect at the nodes; thus the pattern showing two rings indicates that the disk is vibrating with two nodal rings and with both the center and the outside edge moving at high velocity. Similarly, the other pattern shows a mode involving one nodal ring and crossed nodal lines.

An analysis of the vibration of a circular plate shows that an infinite set of different vibration modes exists. These are in general not harmonically related but frequently two will appear rather close together in frequency¹. The major problems in the design of this type of resonator are first, the selection of a desirable mode of vibration, that is, one well separated from all others, and second, the selection of a thickness-to-diameter ratio such that spurious modes are still further removed. Analysis of thin plates shows that the frequency of the two-ring mode varies inversely as the square of the diameter and directly as the thickness. It has been found experimentally that this relation holds approximately for the relatively thick disk used.

In the mechanical filter assembly, the disk resonator functions as an essentially lossless element. The material selected for disks is a nickel-iron alloy with high Q and zero thermoelastic coefficient. The high Q of a disk is illustrated by the

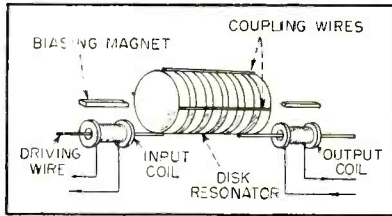

FIG. 2—Components of six-disk mechanical filter

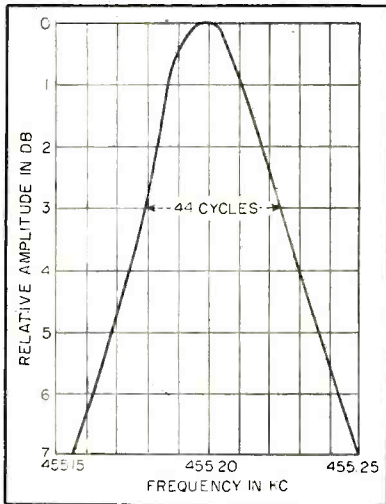

FIG. 3—Single disk resonance curve is down 3 db at 44 cycles

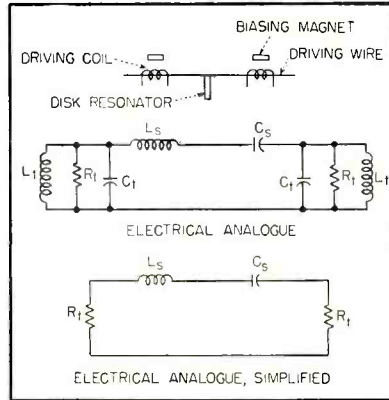

FIG. 4—Single disk filter and electrical analogue

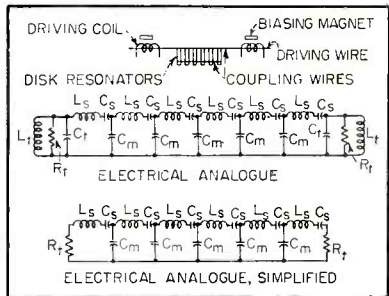

FIG. 5—Six-disk filter and electrical analogue

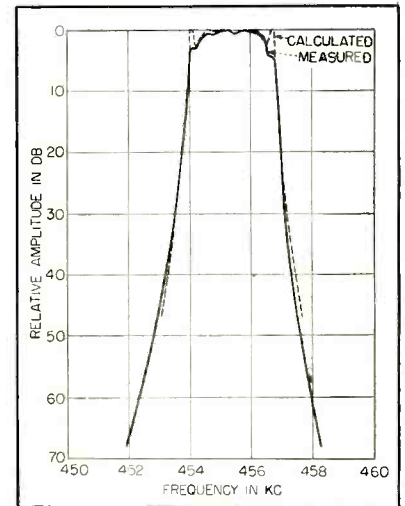

FIG. 6—Calculated frequency response of electrical analogue compared with measured frequency response of a mechanical filter

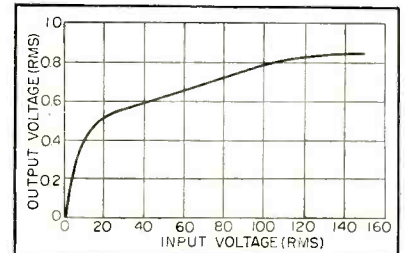

FIG. 7—Mechanical filter overload characteristic at 455 kc

resonance curve of Fig. 3. This curve has a center frequency of 455.2 kc and a half-power bandwidth of 44 cycles. The value of Q calculated from the fractional bandwidth is 10,400.

Mechanical coupling in the filter is provided by three nickel wires welded to the peripheries of disk resonators. These wires function as springs connected between disks. Nickel was selected for use in coupling elements since it gives the desired degree of coupling with a convenient wire size and is easily welded to the disks. The relatively low Q of nickel is not a serious detriment since losses in the coupling elements have a small effect compared with losses in disk resonators.

Commercially pure nickel wire has been found to be an excellent transducer material for use at the filter terminations. It has an inherent Q of the order of 50, controllable by heat treatment and magnetization. Many steel alloys have magnetostrictive properties,

but in general they have rather high effective Q 's. This makes them undesirable as transducers since added frictional losses are required for proper matching of the filter. Transmission losses using nickel transducers depend on the nature of the driving coils. These coils may be constructed for resonant electrical impedances that vary from a few hundred ohms to 50,000 ohms or higher. The higher impedance coils result in somewhat greater transmission losses because of the lower concentration of flux in the driving wires. Optimum magnetic biasing fields exist for the transducers, but are quite broad. The location of the optimum can be obtained by differentiation of published curves on the relative length versus field strength for nickel.

Analysis and Design

In analyzing the mechanical filter, it has been found convenient to use an electrical analogue for the mechanical vibrating system. The

electrical circuit is obtained by using the mechanical-electrical analogy, where velocity is equivalent to current and force is equivalent to voltage. Also, damping is equivalent to resistance, mass to inductance, and stiffness to elastance. In the following paragraphs some considerations involved in filter analysis and design are discussed for a single-disk filter and for a multi-disk filter.

A single-disk mechanical filter and its electrical analogue are shown in Fig. 4. The driving wires at each end of the filter are tuned to antiresonance and correspond to two parallel tuned circuits in the electrical analogue. The disk resonator is equivalent to a series resonant circuit joining the two parallel resonant circuits. Energy loss and transfers in the end elements are represented by resistances in the parallel circuits. The Q of these parallel circuits is sufficiently low so that, in the frequency range of the filter, they may be represented by the resistors R_i . If

the output current of the electrical analogue is measured with a constant current source applied to the input, a single resonant peak is obtained.

The fractional bandwidth of the peak is determined by the ratio of the terminating impedance to the series resonant impedance. Similarly in the mechanical filter ($\Delta f/f_0 = 2R_t/\omega_0 L_t$), bandwidth is determined by the ratio of the impedance of the terminating wires to the disk impedance. Here, mechanical impedance is defined as the ratio of force to velocity.

The bandwidth of single-disk filters can be adjusted by varying the radial position of the transducer wires on the disk. Observation of the vibration pattern indicates that high velocities exist at the center of the disk with a zero velocity region occurring at the first nodal ring. Therefore, the bandwidth of a single-disk filter using specified disks and end wires will be a maximum with the wire attached at the center and will decrease towards zero as the wire is moved out towards the first nodal ring.

A second method of adjusting bandwidth is to vary the cross-sectional area of the end wires. The vibration equations of this wire or rod are analogous to those for an electrical transmission line with velocity taking the place of current and force that of voltage. The equations indicate that the characteristic impedance varies directly as the cross-sectional area of the rod and, therefore, that the anti-resonant impedance of a length of line some odd multiple of $\frac{1}{4}$ wavelength varies directly as the area.

Figure 5 shows a six-disk filter and its electrical analogue. As in the case of the single-disk filter, end wires are equivalent to parallel resonant circuits, and disks to series resonant elements. One new element has been added in the form of bottom capacitance coupling. These capacitors are the electrical analogues for coupling wires less than $\frac{1}{2}$ wavelength long, welded in place between successive disks. The portion of the wires between disks represents the mechanical equivalent of a short transmission line, or a capacitance. In designing filters with two or more

disks, the cross-sectional areas of both driving wires and coupling wires are adjusted to control bandwidth.

The calculated frequency response of the electrical circuit is compared with the measured response of a mechanical filter in Fig. 6. The curves correspond very closely except near the edges of the pass band, where the measured response is less than the calculated value due to losses in resonators and coupling elements.

Performance

The performance characteristics of a six-disk mechanical filter are summarized in Table 1. This filter

coils, with a resulting transmission loss of 15 db or less. This loss can be offset easily by one stage of amplification.

The overload input voltage level, listed in the table, is the value of input voltage at which the filter saturates. The effect of saturation is illustrated in Fig. 7. This curve shows the filter output voltage measured as a function of input voltage at 455 kc. The curve is nearly linear from 0 to 10 volts, while the knee occurs at approximately 15 volts. To determine the effect of overload on frequency response, the output voltage was measured as a function of frequency with input voltages ranging

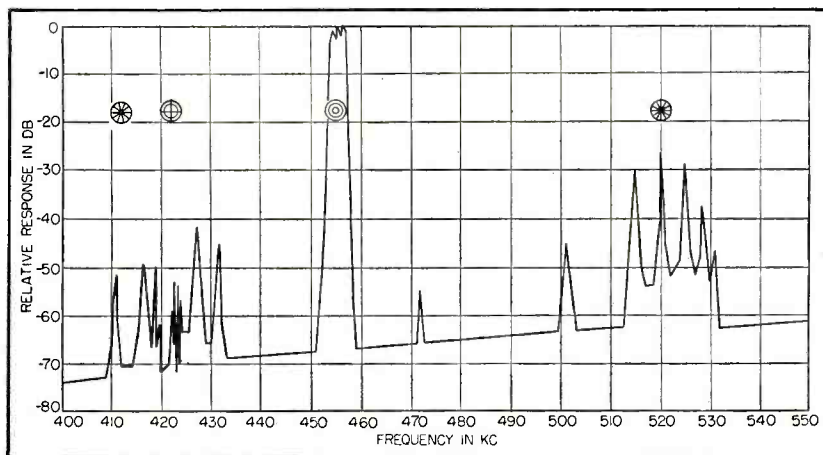

FIG. 8—Spurious response of mechanical filter. Different modes are indicated in circles

has been designed to have a 6-db bandwidth of 3.10 kc with a center frequency of 455 kc. The peak-to-valley ratio in the pass band is less than 3 db. The shape factor of the filter response is defined as the ratio of bandwidth measured 60 db below the highest peak to bandwidth at 6-db attenuation. The present filter has a shape factor of less than 2.25 to 1. Improvements approaching a 2 to 1 shape factor should be obtainable by further refinement of the design. The low value of shape factor achieved with mechanical filters permits unusually high rejection of adjacent channel signals in communications receivers.

Transmission loss measured on present filters is less than 26 db. Design improvements on future models will permit tighter coupling between filter driving wires and

from 0.5 to 300 volts rms. No change was observed in the response at these levels. These measurements indicate that the mechanical filter will be suitable for use in receiver i-f strips and similar low-level applications.

Spurious Responses

The spurious responses occurring in the frequency range of a filter are plotted in Fig. 8. The major peaks are a result of disk vibration modes other than the two-ring mode discussed above. Normal vibration patterns are illustrated on the top of the graph at their respective frequencies. The rings and diameters indicate positions of nulls in the vibration pattern. A provision has been made in this filter design to reduce the spurious amplitudes by drilling a hole in the center of each

end disk. This has the effect of reducing the frequencies of the three spurious modes shown in Fig. 8, with a consequent decrease of about 20 db in the amplitude of undesired filter responses. Also, the hole drilled in each end disk reduces the mechanical disk impedance to about half the original value, thereby providing half-section terminations for the filter and decreasing the peak-to-valley ratio in the pass band.

The delay characteristic of a mechanical filter is shown in Fig. 9, together with amplitude response. The time delay varies from $\frac{1}{2}$ millisecond to 1 millisecond in the pass band. Two large peaks occur near the edges of the band and a small peak near the center. The dissymmetry of the characteristic is caused by a slight mistuning of filter elements.

Service Tests

Tests have been made to determine the filter operating characteristics under a variety of service conditions. Since no trimming adjustments are required, the case is hermetically sealed, and no difficulty is expected due to high humidity. The effects of temperature variation are illustrated in Fig. 10. The major change is an increase in peak-to-valley ratio at temperature extremes, as a result of the detuning of filter end wires. The ratio approaches a maximum of 6 db at -30 C and 80 C. The frequency of peaks on the response curve shifted a negligible amount.

To determine the effects of vibration, a filter was subjected to the vibration test in the Army-Navy Specification, AN-E-19. During the test, a 455-kc carrier was fed through the filter to a low frequency receiver. This permitted the detection of any modulation resulting from vibration. No mechanical resonances were observed and no modulation was detected in the range from 10 cps to 55 cps. Response curves measured before and after each test indicated that the filter had suffered no damage.

The service tests described above indicate that mechanical filters will be satisfactory for most commercial applications. It is expected that they will satisfy military require-

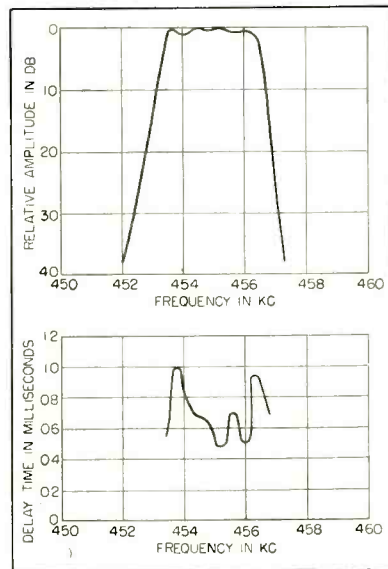

FIG. 9—Amplitude response and delay time of a six-disk mechanical filter

Table I—

Performance Characteristics of Six-Disk Mechanical I-F Filter

Operating Frequency	455 kc
Bandwidth at 6 db	3.10 kc \pm 0.25 kc
Peak-to-Valley Ratio	Less than 3 db
Shape Factor (6 db to 60 db)	Less than 2.25
Transmission Loss	Less than 26 db
Overload Input Voltage Level	15 volts
Operating Temperature Range	-30 C to 80 C
Vibration—Satisfies the Requirements of Army-Navy Specification AN-E-19	
Case Size	$1'' \times \frac{1}{16}'' \times 2\frac{1}{8}''$
Input and Output Impedance	6,500 ohms

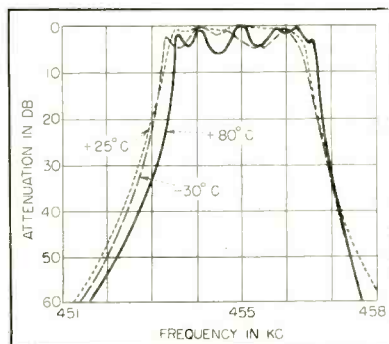

FIG. 10—Curves show temperature dependence of mechanical filters

ments when provided with suitable temperature compensation.

Experimental filters with bandwidths ranging from 800 cycles to 8 kc have been constructed at 455 kc and it has been found that, as expected, essentially scaled reproductions of the curves of Fig. 1 are obtained regardless of bandwidth when the same number of resonant elements are used. The parameters limiting the bandwidth range for the present design are the practical limits on the size of coupling and driving wires on the narrow end of the scale and the limits on achievable bandwidths of terminating wires in the wide-band direction.

It is believed that a reasonable range of center frequencies lies between 100 kc and 1 mc. The limitation on the lower end lies largely in the size of the elements and on the high end in the precision required for very small elements.

Applications

Filters of various bandwidths have been installed on an experimental basis in the i-f systems of several communication receivers by replacing the first i-f transformer following the mixer by the filter and substituting broad-band circuits for the subsequent i-f transformers.

The 3.10-kc bandwidth filter was found to be useful for ssb reception of a-m signals, allowing a choice of sidebands and consequent reduction of interference. From the curve of Fig. 1, it is observed that, with the carrier placed at 453.5 kc, signals at 453.0 will be rejected by 20 db. At 452.5 they are down 35 db, thus allowing fairly complete rejection of the unwanted sideband.

A second application lies in the field of ssb generation. Assuming a lower limit of 400 cycles in the modulating spectrum, carrier suppression would be 17 db and the lowest frequency component of the other sideband down 29 db, with the higher frequency components suppressed still further. These figures are for a single unit and two cascaded units would provide appreciable improvement.

REFERENCE

- (1) Mary D. Waller, Vibration of Free Plates, *Proc. Roy. Soc.*, 211, p 265.

Recording Photometer Provides Log Response

Instrument provides continuous measurement from 10^{-3} to 10^3 microlamberts. Intensity recordings are made on recording milliammeter. Two-tube circuit corrects high-intensity response without range switching. Phototube is protected from injury

LIGHT measurements over a wide range of intensities require an instrument that can be varied to suit the particular level at which the measurement is to be made. Phototube photometers that use a manually-operated switch present a disadvantage if many positions are needed to cover the required range.

Feedback circuits have been employed in photometers using multiplier phototubes.¹ However, certain design features have limited their use in direct measurements in wide-range problems such as time versus brightness measurements on phosphorescent materials, monitoring light sources and experiments wherein an extreme brightness range is encountered.

For many purposes it is desirable to have a true logarithmic response over an intensity range of 10^0 to 1 or greater. However, scale compression can reach a point where accurate readings are difficult and instrument stability is affected by forcing the dynode voltage of the multiplier phototubes to values for which the tubes were never designed.

The photometer to be described has a true logarithmic scale covering six cycles, which is adequate for most work from very low to medium light intensities. By addition of neutral filters, the photometer may be used from medium to very high intensities without appreciable fatigue of the multiplier phototube. The additional convenience of re-

By W. S. PLYMALE, JR.

*Photometry Branch, Optics Division
Naval Research Laboratory
Washington, D. C.*

coding fluctuations on a strip-chart recorder makes the instrument valuable in either experimental or control work. For example, much time can be saved in decay measurements of phosphors having relatively long glow periods.

Photometer Circuit

A schematic diagram of the complete circuit is given in Fig. 1. The dynode supply is a voltage doubler

using an ordinary power transformer with resistors inserted in the 816 filament leads so that both spare windings may be used. A full-wave power supply furnishes voltage for the bucking and compensating circuits. A voltage divider across the filter output consists of an OA3 and OD3 that also serve as voltage regulators.

The 807 control tube for the dynode voltage regulator has its grid coupled to the output of the type 1P21 or 1P22 multiplier phototube. Total dynode voltage for an average phototube may vary from 175 to nearly 1,100 volts under operating conditions. An OA3 in the

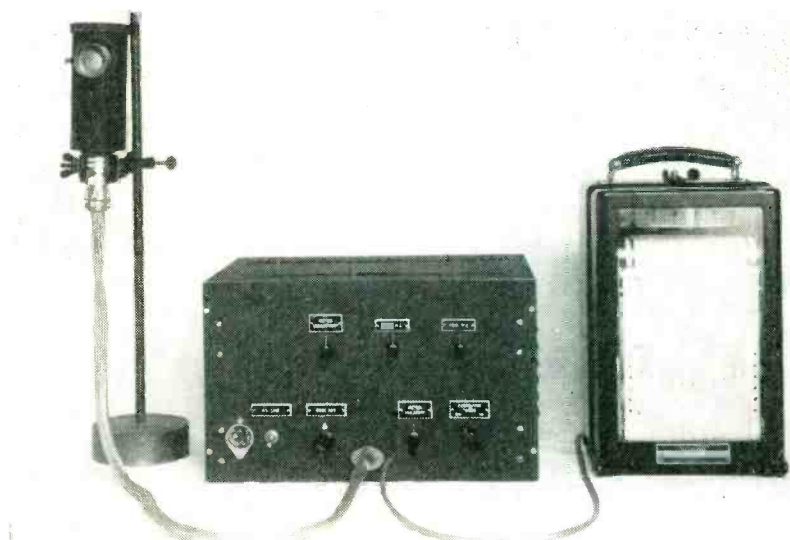

Complete photometer showing phototube pickup, control panel and recording milliammeter

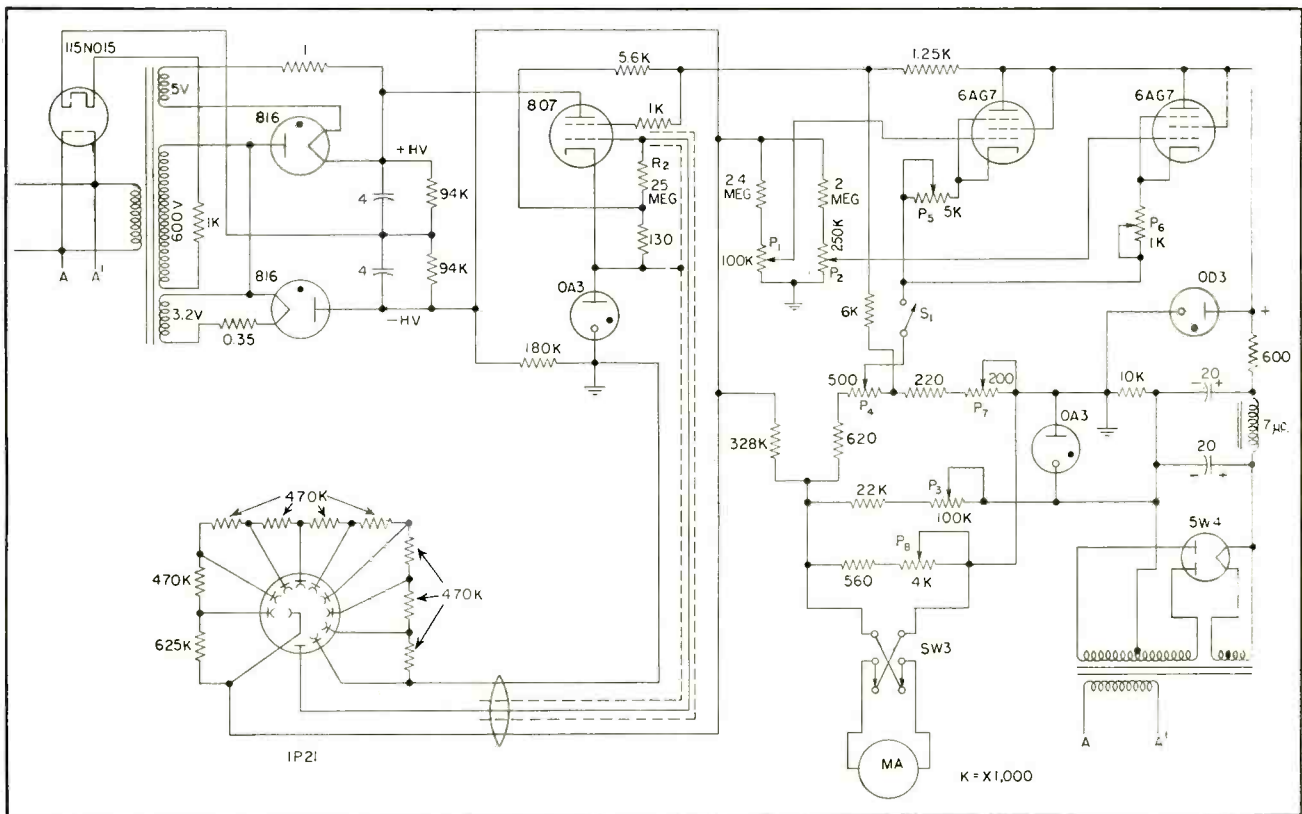

FIG. 1—Schematic diagram shows complete photometer circuit

cathode circuit of the 807 is held in operation through R_1 from the positive terminal of the full-wave power supply. This tube fixes the anode voltage on the multiplier phototube at slightly less than 75 volts when only dark current is flowing through load resistor R_2 . As the phototube anode current increases, there is a reduction of several volts from this value but anode characteristics of the 1P21 and 1P22 tubes show that operation somewhat below 75 volts is permissible.

Circuit Design

The network containing the strip-chart recorder is presented in rudimentary form in Fig. 2, where E_c =

voltage across dynodes, E_b = bucking potential, E_p = compensating potential, R_1 = dynode input resistance, R_2 and R_3 are dropping resistors.

For full deflection of the recorder: E_c = 150 volts (approximately), E_p = 75 volts, I = 1 ma and IR = 1.4 volts.

For no deflection (null balance): E_c = 820 volts (approximately), E_p = 75 volts, I = 0 and IR = 0.

With a value of 83,000 ohms assigned to R_3 and an arbitrary value of 4.4 volts given to E_b , it was found possible to effect a solution whereby R_1 = 330,000 ohms and R_2 = 1,220 ohms.

From these values a tentative circuit was set up and minor adjustments made until reasonably good meter performance was noted as the dynode voltage was varied from about 150 to approximately 1,000 volts. The final circuit is shown in Fig. 3 where the voltage E_b is supplied by an IR drop from the OD3 with suitable divider resistors. For additional control and final balancing, several small rheostats were added to the basic circuit. These are shown in Fig. 1.

With the feedback circuit connected to the circuit of Fig. 3, the voltage curve from darkness to direct measurement of a screen brightness of 0.5 microlambert, (Fig. 4) was found essentially linear for phototubes having high saturation characteristics. This gave linearity for a range somewhat less than 1,000 and it was found necessary to add a correcting circuit to compensate for nonlinearity at low dynode voltages.

Two 6AG7's were inserted in the circuit in such a way that they would automatically become operative as the dynode voltage became less negative. By proper adjustment of grid potentiometers P_1 and

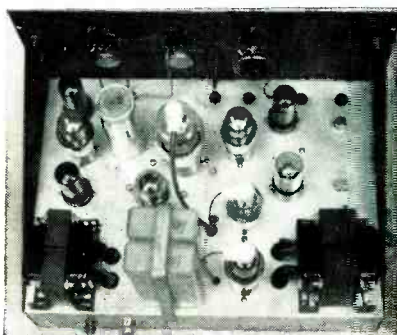

Top view of control chassis

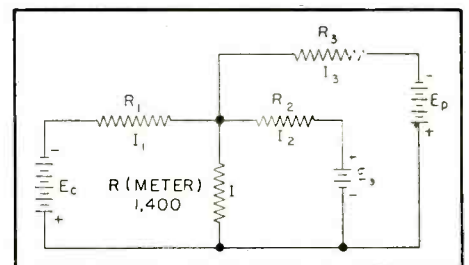

FIG. 2—Rudimentary null-balance circuit

P_5 , any two points along the curve could be chosen and the instrument corrected at these points. In Fig. 5 is shown the basic circuit for such a corrector tube. As each tube conducts a certain amount of cathode current is introduced in the circuit causing an increase in positive voltage E_b . The magnitude of current in each tube is controlled by rheostats P_5 and P_6 shown in Fig. 1.

Adjustment and Operation

The problem of getting a light source of sufficiently wide range is the most difficult part of calibration. A long optical bench with a set of neutral filters may be used and two or three small lamps with fixed levels of brightness can be of value in checking the calibration. The instrument can ordinarily be operated to low intensities and dark-current fluctuations in the multiplier phototube may be observed on the recorder chart.

Zero-trace adjustments are made with the phototube shutter closed. Potentiometers P_1 and P_2 are turned fully counterclockwise; all other controls are set near midpoint; and switch S_1 is open. Rheostats P_3 and P_7 control the balancing circuits; P_7 is adjusted so that the recorder trace can easily be set to zero by P_3 . If this is impossible, the multiplier phototube has an exceptionally high dark current and may not be satisfactory.

It is best to run a tentative calibration on the instrument before adjusting shunt rheostat P_8 or cutting in the 6AG7 corrector tubes. When a brightness vs deflection curve is plotted on semilog paper, the plot will be essentially straight over nearly three cycles with a curvature at about half scale. In this region, P_8 is effective and the

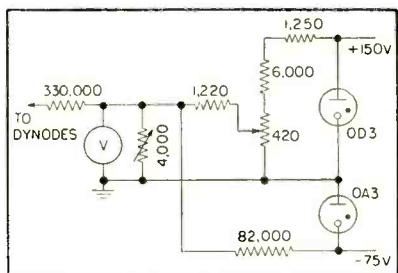

FIG. 3—Null-balance circuit using calculated values

deflection may be adjusted to some desired value. This is illustrated as point A on the graph of Fig. 6.

If the instrument is allowed to go without correction to higher brightness values, the line in Fig. 6 will tend to curve upwards from point A. When S_1 is closed and P_1 in the grid circuit of the first 6AG7 adjusted, the curve can be pulled into a straight line up to a point B on the graph. This may require resetting cathode rheostat P_5 to produce proper deflection on the recorder

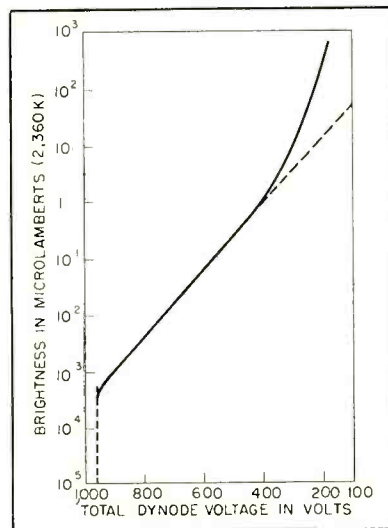

FIG. 4—Dynode voltage-light intensity characteristic for phototube

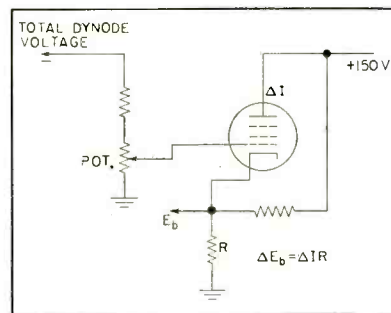

FIG. 5—Basic correcting circuit for high-intensity response

but an appreciable change in deflection should be noticed while adjusting either P_1 or P_5 . Potentiometer P_1 is used chiefly to vary the point of cut-in for the 6AG7 while P_5 controls the magnitude of correcting current added to the network.

When higher brightness values are reached, the upper portion of the curve can be straightened by

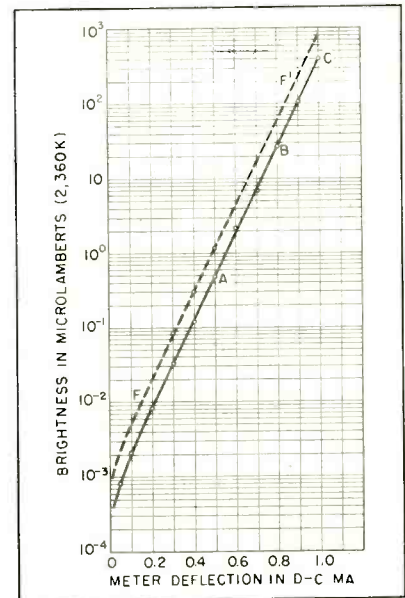

FIG. 6—Photometer calibration curve showing correction points. Broken curve holds when filter is used

setting P_2 and P_6 controlling the second 6AG7. The effects of both corrector tubes may be varied somewhat by P_1 , which is introduced to compensate for variation in current characteristics of multiplier phototubes.

Sensitivity and Stability

Tests show that the photometer holds calibration remarkably well and the performance of the whole circuit is limited only by the stability of the phototube. Noise effects in a multiplier tube, ordinarily very noticeable in linear photometers, are not as pronounced in a feedback circuit. Most effects noticed are due to phototube fatigue and the fact that normal dark current changes slightly after the tube is subjected to appreciable light. Fatigue effects tend, however, to be minimized by the fact that total dynode voltage is automatically reduced when the phototube is exposed to light.

When used with a strip-chart recorder, response of the instrument is limited to 0.5 sec. Nevertheless, with suitable designing and use of a synchroscope, it should be possible to record light flashes of only a few microseconds duration.

REFERENCE

- (1) M. H. Sweet, Logarithmic Photometer, *ELECTRONICS*, p 105, Nov. 1946.

Television Receiver

By EDWARD S. WHITE

Assistant Chief Engineer
Advanced Development Lab.
CBS-Columbia Inc.
Brooklyn, N. Y.

THE choice of the agc system installed in a tv receiver is often a compromise between cost and the importance of particular operational features. It does not necessarily follow that the more economical design is less desirable from a functional point of view. In some instances, the average agc system, which involves the least cost, might be preferred over some more expensive circuits. To determine an optimum design a thorough understanding of the agc mechanism is essential.

Average AGC System

The simplest and most inexpensive agc circuit is shown in Fig. 1A with the video detector peaking network included for completeness. The value of R_1 , the detector load resistor, is usually about 4,000 ohms. Instantaneous voltages, e_A and e_B , for both a white picture and a black picture are shown in Fig. 1B on a horizontal line basis.

The agc voltage will be a function of picture content as well as of signal strength. Furthermore, even with the blackest picture content, average agc voltage will be less than the sync peak voltage, limiting the capability of this circuit to produce substantial amounts of negative voltage. This means that the receiver will be more susceptible to overloading in very strong signal areas, particularly if white picture material is being transmitted.

Since the developed agc voltage will vary also according to the transmitted scene light background, the proper gamma of the picture may not be reproduced.

The noise immunity of this agc system is excellent. Practically all impulse noise disturbances result in

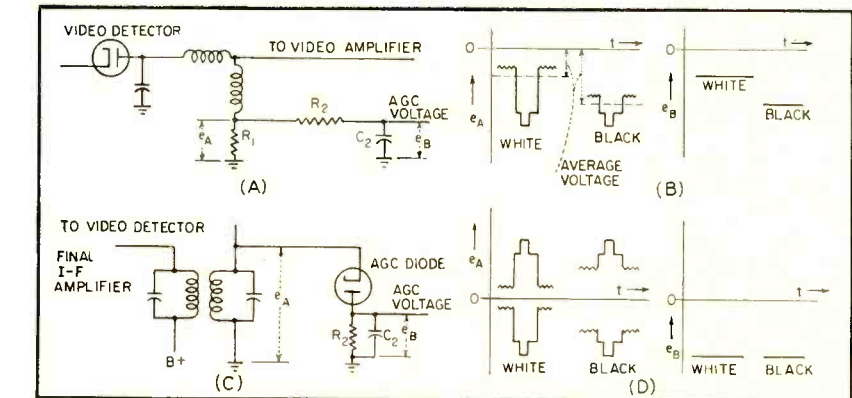

FIG. 1—Average agc circuit (A) and pre-war peak agc circuit (C) with graphs of instantaneous voltages

sharp spikes which may attain considerable peak amplitudes but are relatively widely spaced and sporadic when observed at the video detector output. The interposition of the integrating network, R_2 and C_2 , between this point and the agc voltage output results in an averaging out of the noise, minimizing the effects of the high, intermittent noise peaks.

Values selected for R_2 and C_2 are of considerable importance. The R_2 - C_2 time constant should be of the order of 0.1 sec. This large constant is necessary because the vertical blanking and sync pulses introduce a 60 cps component which if not filtered out adequately results in more instantaneous agc voltage during the vertical sync time. The effect of this would be to depress the vertical sync pulse making it more difficult for the sync circuits and other sections of the receiver to operate properly.

The necessary employment of a large R_2 - C_2 time constant results in a slow acting system with agc voltage unable to follow rapid fluctuations of input signal levels. This is most dramatically observed in the airplane flutter effect. A faster acting agc system would also tend to correct partially for low-frequency distortions appearing in the signal at the video detector.

To insure further impulse noise immunity the possible situation where a noise peak might cause grid

current to flow in one or more of the agc controlled tubes should be considered. In this case it is highly desirable that the agc source impedance have minimum resistance and maximum capacitance for a given time constant. Although slightly costlier, an R_2 of 100,000 ohms and a C_2 of 1 μ f is to be preferred over the frequently used 1-megohm and 0.1- μ f values.

The design considerations for R_2 and C_2 are not unique to the average agc system but are equally applicable to all agc systems where vertical pulses in the transmitted television signal may contribute 60-cps components to the agc output.

In weak signal areas where overload is no problem and where noise immunity is vital, an average agc system involving only two additional components may outperform costlier systems.

Peak AGC System

A pre-war peak agc circuit is shown in Fig. 1C, with graph of instantaneous voltages, e_A and e_B in 1D. In this circuit R_2 was 27,000 ohms and C_2 was 0.05 μ f, giving a time constant of about 20 horizontal lines. An additional RC low pass filter, not shown in the circuit, of much faster time constant value served as additional isolation in order to prevent remanent i-f energy from getting back into the i-f amplifier tubes. Loading across the secondary of the final i-f ampli-

AGC Systems

Operating characteristics of seven gain control circuits currently being used in tv receivers. Design factors important in obtaining the most efficient circuit together with noise immunity and protection against overload are described on the basis of field and production experience

fier double tuned circuit introduced by the agc circuit is $R_2/2 \times$ diode efficiency.

Although the R_2-C_2 time constant is long enough to peak-detect at the horizontal sync repetition rate, it is not long enough to prevent relative depression of the vertical sync pulse. Furthermore, large amplitude impulse noise pulses may charge C_2 to negative values approaching the peaks of the noise pulses. This undesirable voltage will hang on until discharged through the R_2-C_2 loop, tending to cut off receiver operation during this interval. The use of a larger R_2-C_2 time constant will result in worse noise performance but improved vertical sync reproduction.

A practical approach to this dilemma has resulted in the compromise peak agc circuit shown in Fig. 2 which has found wide acceptance in current television receivers. The R_1-C_1 time constant is somewhat longer than one horizontal line, common values being 680,000 ohms and 120 μf . Design considerations discussed in the average agc circuit apply to R_2 and C_2 . In the circuit shown a shunt type agc diode is employed making for a neater design with a single tuned final i-f amplifier load. In this case, the loading introduced by the agc circuit across the tuned circuit is $R_1/3 \times$ diode efficiency.

Since a fast R_1-C_1 time constant is employed, this is not a truly peak agc system, there being some decay of negative voltage from C_1 through R_1-C_1 between horizontal sync pulses. There is, however, a significant improvement in noise immunity over the peak agc system since the undesirable voltages built up across C_1 by high noise peaks decay rapidly.

This double time constant principle has been used with great success to improve noise immunity in the input of sync separator circuits. Field tests have shown that the compromise agc circuit is still well behind the simple average agc system in noise immunity where high noise pulse and weak signal conditions are encountered.

AGC Amplification System

In this system, an agc voltage is obtained by rectification of either the picture carrier or the video modulation with its d-c component intact. This voltage is fed to a d-c amplifier and then applied to the agc controlled tubes giving extremely flat output versus input signal characteristics.

The major design difficulty is in selection of d-c amplifier supply voltages. Since the output voltage of the amplifier must be referenced with respect to ground it is common to return its cathode to a negative supply voltage and its resistive plate load either to ground or to a slightly negative or positive potential. The choice of suitable supply and bias values to insure about -0.5 volt output for quiescent operation (zero input signal) and increasingly negative output for increasing signal input levels depends upon the ingenuity of the designer. Several different conditions of oper-

ation have been successfully used in the past.

As with most d-c amplifiers, proper and reliable operation is critical with respect to changes of supply and bias voltages and must be considered carefully in the design. Regeneration within the closed agc loop must be watched due to the increased system gain and additional phase shifts. Also, there is a trend in current receiver design practice away from the use of negative supply voltages.

A special type of agc amplification referred to as keyed agc has been adopted by a number of companies. This circuit, shown in Fig. 3A, has a flat output versus input characteristic, is highly noise immune for both the agc and video output, is not critical with respect to supply voltages, does not require a negative voltage source, and supplies a fast acting agc voltage.

The 300 to 350-volt peak plate-keying pulse may be either series fed as shown, or shunt fed. Since a pentode is used as the keyed agc tube considerable amplification is obtained and proper operation is not critically dependent on the keying pulse amplitude. Common values of R_2 and C_2 are 100,000 ohms and 0.5 μf . R_3-C_3 form an additional filter to prevent a residual amount of horizontal frequency energy from getting back into the agc bus. This time constant must be made as high as possible, consistent with obtaining sufficient filtering action, to prevent the additional phase shift at low frequencies from causing overall agc regeneration.

The circuit may be analyzed by considering the dynamic transfer characteristics of tubes V_1 and V_2 , shown in Fig. 3B. As a simplifica-

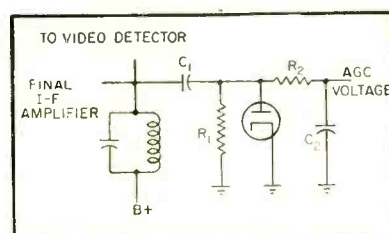

FIG. 2—Diagram of widely used compromise peak agc circuit

tion in the analysis, a very high g_m from cutoff on is assumed for V_2 and e'_{sc} is of such value to result in a 5-v grid to cathode cutoff characteristic of V_2 . In this case e_{sc} is considered to be 125 volts.

With no signal applied to the grid of V_1 , about 6 ma quiescent i_p current flows through its 5,000-ohm plate load, resulting in -30 v applied between V_2 grid and cathode. Since V_2 is cut off with or without the keying pulse, no i'_p current flows, and no agc voltage is developed. No i'_p current will flow until e_g becomes instantaneously negative enough to reduce i_p to 1 ma coincident with the plate keying pulse. As soon as i'_p starts to flow it will produce enough agc voltage due to the high g_m of V_2 to prevent the incoming signal at e_g from reducing i_p any further.

If i_p were reduced below 1 ma coincident with the plate keying pulse, excess agc voltage would be developed reducing e_g , and resulting in increased i_p . If i_p were increased

above 1 ma during the keying pulse interval, the agc tube would be cut off and the agc voltage would decrease, increasing e_g and decreasing i_p . Thus, the horizontal sync tips are held at the 1-ma i_p point of V_1 as indicated by X in Fig. 3B.

It is simple to obtain quantitative and qualitative results with varying parameters. Consider the following:

(A) Lowering the V_1 screen voltage.

The dynamic transfer characteristic for $e_{sc} = 100$ volts is shown in Fig. 3B. Since the 1-ma i_p criterion has not been changed, the horizontal sync tips are held at Y. Signal to noise ratio and sync compression at the video amplifier output are practically unchanged. The video detector output level is reduced as is the video amplifier output level.

(B) Reducing the 5,000-ohm V_1 plate load (or tapping down to $\frac{1}{2}$ of the 5,000-ohm load for agc feed). Since 5 volts across 2,500 ohms, or i_p equal to 2 ma, becomes the sync

peak equilibrium position, the peaks are held at Z, resulting in reduced sync compression and worse signal to noise ratio at the output of V_1 . There is also some reduction in video detector and video amplifier output levels.

(C) Raising V_2 screen voltage.

Assuming V_2 cutoff now occurs at +130 v, a 10-v drop across the 5,000 ohms, or an i_p of 2 ma determines the equilibrium position. The results are therefore similar in all respects to case B above.

(D) Adding a resistor (270,000 ohms) from V_2 grid to ground.

Approximately 0.5 ma of current now flows through the 5,000-ohm V_1 plate load resistor in the same direction as i_p due to the bleeding resistor. When V_1 draws an additional 0.5 ma of i_p , the equilibrium point is reached. Therefore the horizontal sync peaks are held closer to cutoff and sync peaks are compressed. If the resistor were connected from V_2 grid to a source more positive than 140 volts, additional current would flow through the 5,000-load opposite in direction to i_p . Then V_1 must draw more i_p to counteract this opposing current in addition to supplying a 1 ma i_p . The sync peaks would therefore be held further away from cutoff with less resulting sync compression.

(E) Varying R_2 , the i-f amplifier tube gains, or the number of stages to which agc is applied, effectively changes the speed of response of the system with only second order effects on the other operating conditions discussed.

An interesting application used in the CBS-Columbia Model 1000 series may be visualized readily on the basis of this analysis. In the long-distance switch position, one of the functions of the switch is to raise the V_2 cathode voltage, resulting in decreased V_2 screen to cathode voltage. The sync peaks are therefore held closer to cutoff with significant improvement in the signal to noise ratio at the output of V_1 . Also, the agc voltage is delayed since a stronger input signal is now necessary to reduce i_p to its lower equilibrium value before the agc threshold is reached. Both the improved noise immunity and lowered tuner noise factor provide for more

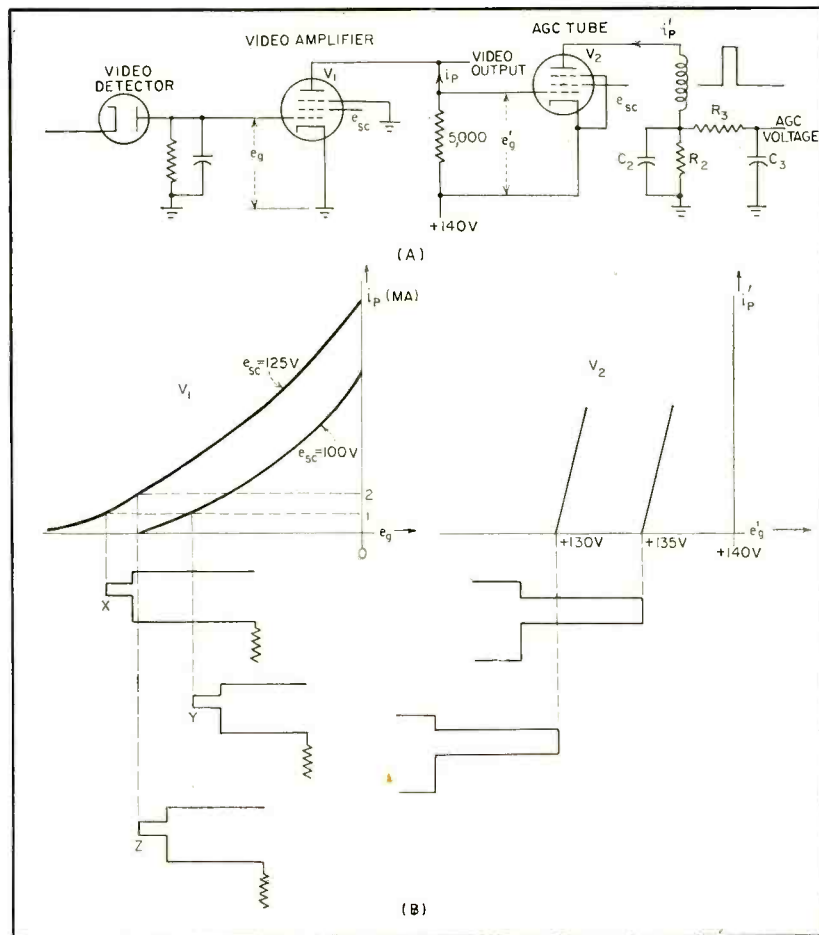

FIG. 3—Keyed agc system (A) and analysis of circuit operation (B)

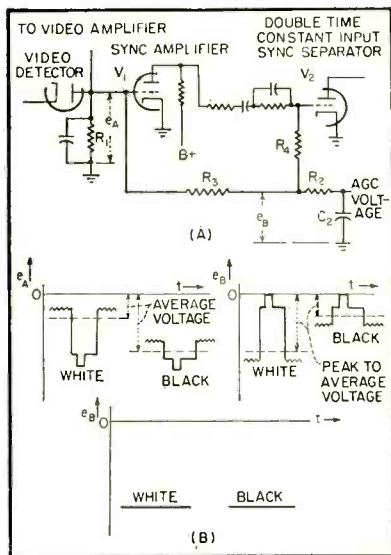

FIG. 4—Variation of peak agc circuit (A). Instantaneous voltage values are shown in graph (B)

satisfactory operation in weak signal areas.

Although additional design difficulties are presented by the use of a triode V_2 instead of a pentode, its use is promising in low-cost receivers where half a double-triode tube might be employed.

AGC System Variations

In the peak agc circuit shown in Fig. 4A, V_1 has a voltage gain of 10, $R_1 \ll R_3$, and $R_4 = 9R_3$. As shown in Fig. 4B, the linear addition of the average voltage e_A plus the divided-down peak to average voltage at the V_2 grid results in a truly peak agc voltage at e_B independent of picture modulation. Due to phase shifts, component tolerances and other factors, there will not be a perfect cancellation of picture modulation content at e_B , which would have occurred under the ideal conditions shown and so a low pass R_2 - C_2 filter is inserted before the agc voltage take-off.

Since both sources of voltage are relatively noise immune, their additive resultant likewise will possess a high degree of noise immunity. To insure against the possibility of agc regeneration, the value of R_3 must not be larger than necessary.

The circuit shown in Fig. 5A is a variation of the compromise peak agc system. Since the agc diode cathode and R_1 are returned to the video detector load instead of to

ground, an effective voltage doubler action is obtained. This comes about because the agc diode conducts only during the horizontal sync pulse interval when its cathode has a negative sync peak voltage applied. The sync peaks of the i-f waveform find themselves clamped at the diode plate to a negative voltage equal to the sync peak voltage at the video detector instead of to ground. The R_2 - C_2 filter bypasses the picture modulation components.

Since more than sufficient agc source voltage is made available by double action, the R_1 - C_1 time constant may be made considerably smaller than one line—1 megohm and 27 μf for example. The noise immunity is markedly improved,

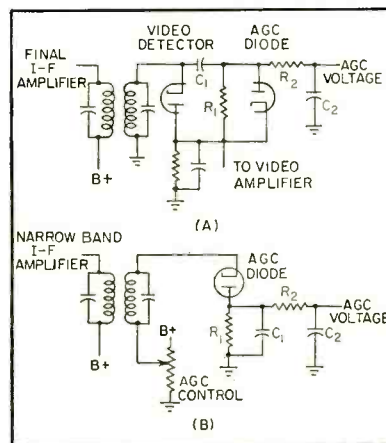

FIG. 5—Two variations of the compromise peak agc system

and the potential agc voltage source is still greater than the compromise peak or the peak agc systems.

Another variation of the compromise peak agc circuit is drawn in Fig. 5B. A narrow band i-f amplification stage to reject the higher frequency noise components feeds an agc diode which has an R_1 - C_1 time constant considerably less than one horizontal line. Due to the additional i-f amplification of the sync pulses, the relative reduction in recovered agc voltage is not significant, while the noise immunity is markedly improved.

The use of a back panel agc control is also demonstrated in the circuit. In weak signal areas a positive delay voltage is applied to the agc diode cathode to prevent substantial agc voltage from being developed. In stronger signal areas

this positive delay voltage is reduced manually.

Two operational features which would be desirable in all agc systems are the maintenance of low bias voltages on the r-f amplifier tube for weak signal inputs and the application of high bias voltages on the right tube for very strong signal inputs. The first characteristic results in the best noise figure for the tuner at the time when it is most needed. The second characteristic prevents overload in the receiver with the attendant washing out of flesh tones on the kinescope.

Although overload occurring in the last i-f amplifier tube is not to be neglected, the primary cause of overload difficulty arises at the first i-f amplifier tube grid. Since the conversion gain of the mixer stage is constant and unaffected by the large agc bias developed by a very strong signal input, a relatively large i-f signal arrives at the first amplifier tube grid operating near its cutoff point, resulting in compressed whites and elongated sync at its output. The correction for this is to apply greater agc bias to the r-f amplifier grid than to the first i-f amplifier grid.

A simple circuit for achieving the

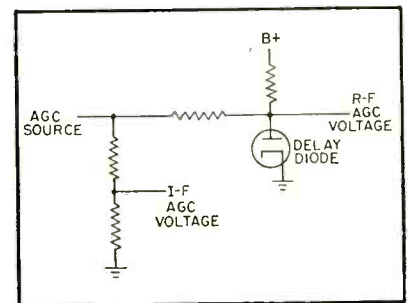

FIG. 6—Cross-over network for reducing agc bias on i-f amplifier

two features is shown in Fig. 6. A potentially strong agc source is necessary since the i-f agc is permanently divided down. The resistors may be proportioned over exceedingly wide limits to obtain the desired r-f agc delay and cross-over characteristics.

REFERENCES

- (1) "Television D-C Components," RCA Industry Service Lab, LB-745.

Arithmetic Processes

(OP, A1, A2, A3, A4)
 OP = OPERATION TO BE PERFORMED
 A1 } ADDRESSES OF NUMBERS TO
 A2 } BE OPERATED ON
 A3 = ADDRESS AT WHICH RESULT
 IS TO BE STORED
 A4 = ADDRESS AT WHICH CODE
 GROUP FOR NEXT STEP WILL
 BE FOUND

FIG. 1—Four-address code

$a_n x^n + a_{n-1} x^{n-1} + \dots + a_1 x + a_0 x^0 + a_{-1} x^{-1} + a_{-2} x^{-2} \dots$
 WRITE IN POSITIONAL NOTATION
 AS:
 $a_n a_{n-1} \dots a_1 a_0 a_{-1} a_{-2} \dots$
 EXAMPLE: RADIX 10
 $\pi = 3.1415 \dots$
 $a_2 = a_1 = 0 \quad a_0 = 3 \quad a_{-1} = 1 \quad a_{-2} = 4 \dots$

FIG. 2—Number as a polynomial

7^3	7^2	7^1	7^0	7^{-1}	7^{-2}
343	49	7	0 ¹		
ONE THOUSAND IN SEPTENARY CODE					
2	6	2	6		
COUNTING					
2	6	2	6	=	1,000
2	6	3	0	=	1,001
2	6	3	1	=	1,002
2	6	3	2	=	1,003

2	6	6	6	=	1,028
3	0	0	0	=	1,029

FIG. 3—Example of radix seven

0	0	0	1	0	1	=	5
0	0	0	1	1	0	=	6
0	0	0	1	1	1	=	7
0	0	1	0	0	0	=	8

1	0	0	1	0	1	=	37
1	0	0	1	1	0	=	38
1	0	0	1	1	1	=	39
1	0	1	0	0	0	=	40

FIG. 4—Examples of binary numbers

By J. H. FELKER

*Military Electronics
 Bell Telephone Laboratories
 Whippany, New Jersey*

MODERN, automatically-sequenced electronic computers have a large memory organ which can be thought of as consisting of a very large bank of pigeonholes. Each pigeonhole has a unique address which permits the machine to locate any information in the memory. The machine also has a control unit and an arithmetic unit that can perform the ordinary arithmetic operations.

In action the control unit consults a specified pigeonhole in the memory and, in effect, pulls out a slip of paper which has an instruction written on it. The machine then executes that instruction and advances to another pigeonhole and executes the instruction contained therein. An intermediate step may be to consult some other pigeonhole and extract a number to be manipulated during the execution of the instruction.

Programming

The arrangement and writing of these instructions is called programming the machine. One programming scheme that has been used is based on the four-address code shown in Fig. 1. When the control unit extracts an instruction from the memory, it finds written in the instruction a representation of the operation to be performed. It may also find two addresses for numbers in the memory which are

to be processed by the operation. A third address will specify the pigeonhole into which the result of the operation is to be stored, while a fourth address specifies the pigeonhole which contains the code group for the next step.

Number Representation

A basic feature of our mathematical education is that we often learn things before we understand them. This is especially true of the manner in which we learn to write numbers. It is only after studying algebra that we become aware that in writing a number we are actually writing a polynomial. In decimal notation a number is represented as a polynomial in which the argument is 10. Figure 2 illustrates this principle. In writing a number as a polynomial, we leave out the radix, the value associated with each place in the number, and write only the coefficients of the powers of the radix. It is customary to indicate the point between the coefficients of the 0 and the -1 power of the radix by a radix point. Thus when we write 3.1415, what we really mean is $3 \times 10^0 + 1 \times 10^{-1} + 4 \times 10^{-2}$ and so forth. It is fundamental that numbers exist independently of the way in which we choose to represent them.

Figure 3 shows the number 1,000 represented in the septenary code for which the radix is 7. This

for Digital Computers

Special codes and arithmetical processes enable digital computers to perform rapidly many heretofore laborious mathematical tasks. Review of these processes serves as introduction to newcomers to field and review for veteran computer engineers

figure also illustrates the way in which counting takes place. Regardless of the radix, the count is always increased by one from the original count in the following manner. The coefficients are examined in turn starting with the coefficient of the zero'th power of the radix. The first coefficient that is not the highest order coefficient of the set of coefficients is replaced by the next higher one. All coefficients of lower powers of the radix are replaced by zeros. This is illustrated in Fig. 3 by transition from the septenary 2,666 to 3,000.

In the ordinary desk calculator the radix used is 10. A ten-tooth gear on a shaft makes a convenient way of representing decimal numbers. When the shaft is turned so that the fifth tooth is at a reference mark, the shaft position can, for example, be used to represent the number 5. Unfortunately, there is no very attractive electronic analog for a ten-tooth gear. In electronic computers we deal with devices that are most reliable when we ask them only either to pass current or not pass current. Such two-state devices are used most efficiently in binary numbering schemes. In the binary system the radix is 2 and the only possible coefficients are 1's and 0's. We can imagine a row of vacuum tubes in which some of the tubes are conducting and some are not. We can let a conducting tube

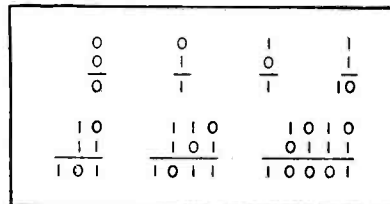

FIG. 5—Addition of binary numbers

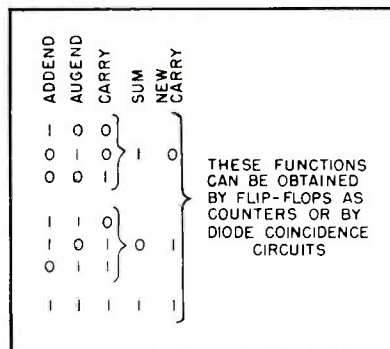

FIG. 6—Three-terminal binary adder

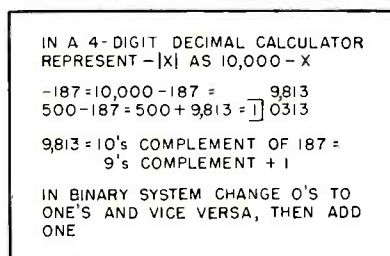

FIG. 7—Negative numbers in a digital computer

represent a 1 and a nonconducting tube represent a 0. The row of tubes then can represent a complete number. Figure 4 illustrates the binary equivalent of several decimal numbers. As a matter of interest, note that 40, which is 5×8 , is represented by binary 5 followed by 3 zeros.

In devices that have only two states it is still possible to construct the electronic equivalent of a ten-tooth gear. Picture ten vacuum tubes in a row. If the third one in the row is conducting and all others are cut off, we can imagine the row as representing the decimal number 3, while if the seventh vacuum tube were conducting, the row would represent the number 7. This is analogous to representing the number 3 by holding up the third finger on a hand. Using both hands it is possible to represent numbers up to ten in this manner. The inefficiency of this method is brought out by the following: If we let each finger represent a coefficient of a power of 2 and adopt the convention that a raised finger represents a coefficient of 1, while a lowered finger represents a coefficient of 0, we can count up to the decimal number 31 on one hand and up to 1,023 on both.

Binary System

This illustrates why many electronic computers compute in straight binary code, since numbers

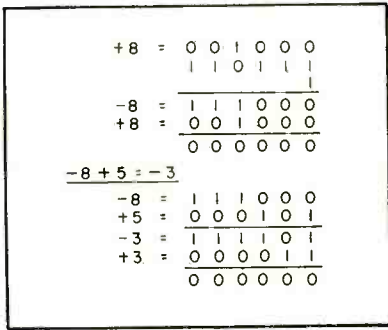

FIG. 8—Examples of binary arithmetic with negative numbers

MULTIPLICATION TABLE	EXAMPLE	
0 x 0 = 0	101	5
0 x 1 = 0	110	6
1 x 0 = 0	000	
1 x 1 = 1	101	30

FIG. 9—Binary multiplication

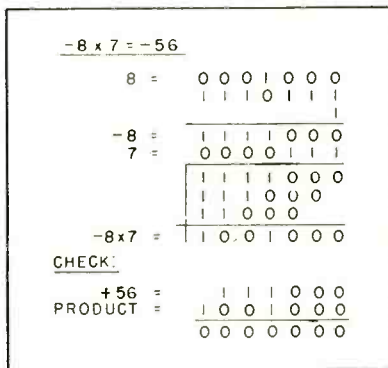

FIG. 10—Multiplication of negative numbers

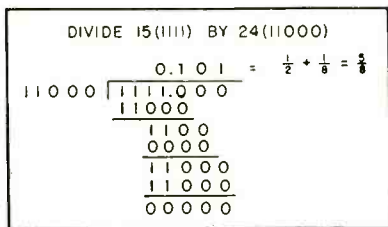

FIG. 11—Binary division

can be represented with a minimum of apparatus.

In machines where very lengthy computations are to be performed before an output is to be presented, the cost, in time consumed, of converting the decimal numbers from the outside world into binary numbers for computation is justified by the saving in equipment resulting from binary representation. In machines used for computations in which the ratio of the number of internal computations to the num-

ber of decimal to binary conversions is not extremely large, the conversion from decimal to binary notation may result in a waste of time which is not acceptable. For such applications, two-state electronic devices can be used to code individual decimal digits. Before describing how this is done, a description will be given of the manner in which binary arithmetic is performed.

Binary Arithmetic

Because there are only two possible coefficients in binary arithmetic, operations are simplified enormously. Figure 5 shows examples of binary addition. Note that when two 1's are added, the sum digit is 0 and the carry is a 1. The mechanization of binary adders is quite simple and a common type of adder has an addend, an augend, and a carry terminal. At each step the addend, augend and carry from the previous step are examined and outputs are developed in accordance with the table shown in Fig. 6. This is typical of the operations that go on in computers. Signals on input leads are examined and outputs are produced according to what the examination reveals.

Negative Numbers

A general purpose computer must be able to represent negative numbers as well as positive numbers. Suppose that we are designing a decimal calculator to handle numbers up to 999. If we were willing to use a fourth digit place to indicate the algebraic sign of numbers, we could employ the scheme shown in Fig. 7, where $-X$ is represented as the remainder when X is subtracted from 10,000. A 9 in the fourth digit place is used to indicate that a number is negative, whereas a zero means that a number is positive. The number -187 is represented, for example, by 9,813.

Suppose -187 were to be added to 500. As the figure shows, a sum of 10,313 would be obtained. Since the calculator has only four digit places, the 1 would fall off onto the floor and the correct sum of 0313 would be obtained; the 0 indicates that the number is positive. The result of subtracting X from 10,000

is referred to as the 10's complement of X . The 10's complement can be obtained very simply by subtracting each digit from 9, which gives the 9's complement, and then adding 1 to the result.

In binary computers, negative numbers are often represented by their 2's complement. The 2's complement can be formed simply by changing all the 1's to 0's and vice versa and then adding 1. The formation of -8 from $+8$ is illustrated in Fig. 8, and an example of addition involving a negative number is given. In the example, the result is -3 , the negative sign being indicated by a 1 in the most significant digit place. The fact that this is a true representation of -3 can be checked by adding $+3$ to it, which gives zero.

Binary Multiplication

The binary multiplication table is ridiculously simple, since the product of two digits is always zero unless both of them are ones, in which case the product is one. The multiplication of two numbers follows the conventional algorithm shown in Fig. 9. Each digit of the multiplier is examined in turn, and if the digit is a one the multiplicand is added, while if the digit is a zero, the multiplicand is not added. As successive digits are examined, the point at which the multiplicand is added is moved to the left.

The correct algebraic product of negative numbers can be obtained automatically without any special attention to sign as illustrated in Fig. 10, where -8 is multiplied by $+7$. Note that though the seventh digit place represents the algebraic sign, multiplication by the seventh digit is no different than by any of

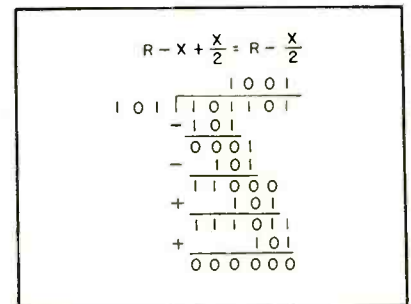

FIG. 12—Simplified binary division

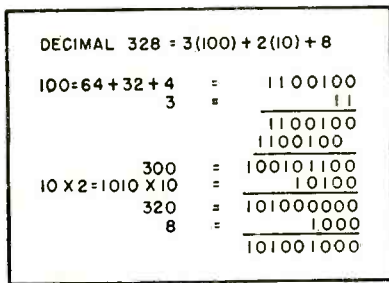

FIG. 13—Example of decimal-to-binary conversion

the others. It should be noted that only seven digits of the product have been accumulated and the reader can check for himself that digits beyond those would be meaningless. This method of negative number manipulation could be followed with any radix.

Division has sometimes been obtained in high-speed computers by first obtaining the reciprocal of the divisor and then multiplying it by the dividend. The reciprocal can be obtained by a reiterative process, which requires only multiplication, addition, and subtraction. Starting with a suitable guess X_0 , the recurrence formula

$$X_k = X_{k-1} (2 - N X_{k-1}) \quad (1)$$

tends to the reciprocal of N as successive approximations are obtained. Suppose, for example, that a machine is called upon to divide some number by 3. The machine might multiply the number by $\frac{1}{3}$ instead and obtain the polynomial representation (Fig. 2) of $\frac{1}{3}$ by repeated use of Eq. 1. For an initial guess of 0.5, Eq. 1 would give

$$X_0 = 0.5, X_1 = 0.25, X_2 = 0.3125, X_3 = 0.33203125, \text{ etc.}$$

Binary division is so simple, however, that many binary computers carry out division directly, rather than by the obtaining of reciprocals. Figure 11 shows an example of binary division, and it is apparent that binary division can be carried out with pencil and paper in the same manner as decimal division. However, it is awkward for a machine to make trial divisions, since the only way it can tell whether a number can be subtracted from another with a positive result is to examine the result

after the subtraction has been made. If the result is negative, as indicated by a one for the most significant digit, the machine would then have to add the number back in and shift before subtracting again.

A virtue of binary division is that this trial subtraction can be avoided. This is because, as Fig. 12 shows, if a number X has been subtracted from a number R and the result is found to be negative, indicating that $X/2$ should have been subtracted rather than X , the computer can obtain the correct result without retracing its steps merely by adding $X/2$.

Thus, in binary division one examines the result of each subtraction. If the result is negative, a zero is written in the quotient. If the result is positive, a one is written in the quotient. After a positive remainder the divisor is shifted in the next step and subtracted, whereas after a negative remainder the divisor is shifted and added. This automatically gives the correct result as illustrated in Fig. 12.

Binary Conversion

Since the world external to the computer seldom deals in binary numbers, binary computers must frequently convert decimal numbers into binary numbers. This can be done entirely with binary operations. Figure 13 shows an example of such a conversion.

A binary computer also must convert binary results to decimal numbers, and this can be done by successive divisions by the binary representation of the number ten. Division by ten is carried out until a remainder is obtained which is less than ten. The first such remainder is written as the least significant digit of the decimal number. The quotient obtained is then divided by ten until a remainder is obtained that is less than ten, and this remainder is taken as the next digit in the decimal number. This process is repeated until a quotient less than ten results. An example is worked out in Fig. 14.

The above discussion of binary arithmetic is not exhaustive and more detail can be found in an article by R. F. Shaw⁷.

Because of the time required to

make binary-to-decimal and decimal-to-binary conversions, computers are often built which perform their arithmetic with decimal numbers. A number of coding systems can be used in which each decimal digit is coded as a separate binary number. This makes arithmetic complicated, since when adding two digits, a number greater than ten will often be obtained. Nine plus three, for example, can be added to give twelve, but the machine must then convert the binary number twelve into the binary representa-

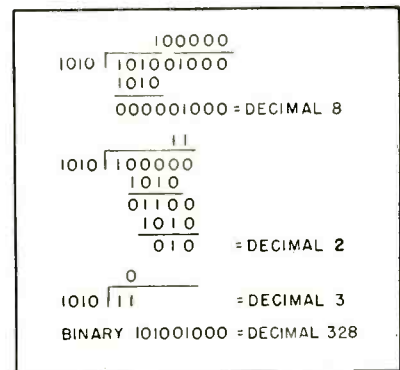

FIG. 14—Example of binary-to-decimal conversion

DECIMAL	EXCESS-THREE CODE
0	0 0 1 1
1	1 0 0 0
2	1 0 1 0
3	1 1 0 0
4	1 1 1 0
5	1 0 0 0
6	1 0 0 1
7	1 0 1 0
8	1 0 1 1
9	1 1 0 0

FIG. 15—Excess-three code

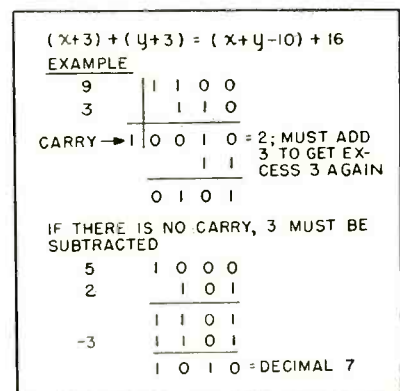

FIG. 16—Excess-three arithmetic

tion of two and add one into the next column.

Excess-Three Code

Using the excess-three code, the correct carry can be obtained quite simply. In this system the decimal digits are each represented by the binary number which is greater by three, as shown in Fig. 15. The binary sum of two such digits is excessively large by six. To convert the sum to excess-three representation it is necessary to subtract three. However, when carry is necessary the fact that six is the same as sixteen minus ten results in the fifth binary digit constituting the correct carry. In the addition of two excess-three numbers, the fifth binary digit is examined, as in Fig. 16. If this digit is a one, the next decimal digit is increased by one, and three is added to the binary digits of the sum, giving the correct excess-three representation. If, on the other hand, the fifth binary digit is a zero, three must be subtracted to obtain the correct excess-three representation of the sum digit. It is possible, using this scheme, to code ordinary binary arithmetic elements to perform decimal arithmetic.

Biquinary Code

Another manner of representing decimal numbers is based on the biquinary code. The biquinary code, Fig. 17, may be recognized by the reader as the code used in that ancient calculating machine, the abacus. In this code each decimal digit is represented by, let us say, seven relays. These relays may be divided into a group of two and a group of five. Figure 17 illustrates that for a digit to be represented by the relay pattern, one relay of each group, and only one, must be closed. This code is inefficient or redundant in that it takes seven devices to represent a decimal number, whereas the excess-three code, for example, requires only four devices. As will be shown later, this redundancy can be put to excellent use in making a machine detect its own errors.

Besides the excess-three code and the biquinary code, other coding arrangements for decimal digits are possible. In a decimal multi-

COMPUTERS AND ELECTRONICS

Electronic digital computers are today in evidence in virtually every phase of industry. The marriage of electronics and high-speed computation has been responsible for tremendous advances in both fields.

It is conceivable that even greater progress could result from a more widespread understanding, among electronics engineers, of computer processes. To that end, this article is published in *ELECTRONICS* as an introduction to some and as a review to those already familiar with the computer language of words and numbers

plier, the multiplication table must be stored. Coding arrangements are possible that simplify this multiplication table by increasing the redundancy in the digit representation. This is a matter of considerable interest to professionals in the field of coding.

Error Correction

In the early days of electronic computer evolution there was more emphasis on getting machines assembled than there was on making them work without error. Today, however, machines are expected to execute many millions of consecutive operations without failure. This requirement has led to the development of error-detecting codes which make it possible for a machine to recognize when it has made an error. Error-correcting codes which make possible the automatic correction as well as detection of an error have also been developed. These codes involve the incorporation of redundancy in the number representation. This use of redundancy parallels the use that is made in ordinary transactions. When, for example, a check is written, the value is both spelled out and written as a figure. Thus, if the writing is illegible or subject to misinterpretation, the bank teller can usually determine by examining both representations what the writer had in mind when he wrote the check.

The more complex machines become the more they approach human frailty of the sort that is responsible for our redundant method of writing checks. Accordingly, computer designers are interested in codes for numbers, which when a mistake has been made will enable

the computer to say "This code group doesn't represent a number and I'd better stop and call the boss," or even more preferably, "This code group doesn't represent a true number and it is clear that what it should be is so and so."

Error Detection

The biquinary code has been described as a redundant code and its importance lies in the fact that the redundancy offers a simple basis for error detection. In this code, as pointed out previously with respect to Fig. 17, one and only one of the symbols in the group of two and group of five must be a one. If a single error has been made in the code group, it will be evidenced either by a one appearing where it shouldn't or failing to appear at all. Suppose that a closed relay symbolizes a digit being a one. Seven relays would be used to represent the code for a decimal digit. If, after each representation of a new decimal digit, the machine examines the group-of-two and group-of-five relays and determines that one and only one relay in each group is closed, then it knows that the digit representation is correct. The only time that this could fail to reveal an error is when two failures have simultaneously occurred. If a machine were supposed to represent the number 6 (see Fig. 17) and by mistake represented the number 7, it would have been necessary for the relay in the one column to have failed to close and the relay in the 2 column to conduct of its own accord. If the probability of one out of five relays failing is very small, the probability of two failing simultaneously may be negligible.

The biquinary code has been em-

5	0	4	3	2	1	0	DECIMAL
X				X			0
X			X				1
X			X	X			2
X		X					3
X	X						4
X			X				5
X			X	X			6
X		X					7
X	X						8
X	X	X					9

FIG. 17—Biquinary code

	NUMBER				CHECKING DIGIT
13	1	1	0	1	1
14	1	1	1	0	1
15	1	1	1	1	0
16	1	0	0	0	1
17	1	0	0	0	1
18	1	0	0	1	0
19	1	0	0	1	1

FIG. 18—Even parity check

ployed in several relay computers³, and these machines have set a record for error-free operation.

Checking Digit

The conventional binary code can be made redundant by inclusion of a checking digit with each number. In Fig. 18, the checking digit is added in a manner that makes the number of 1's in the number even. Thus the checking digit for the binary number 16 is a 1, whereas the checking digit for the binary number 17 is a zero, because there are already an even number of 1's in the binary number 17. If a single digit in the number 15 for example, were produced incorrectly, then the code group would contain an odd number of 1's and the machine could thereby recognize the result as an error. Note that the error could be recognized even if it occurred in the checking digit.

It is also possible to use an odd parity check in which the checking digit is added to make the total number of 1's an odd number. This is a more sensible check because a very common type of machine failure is to make all digits zeros. This error would be caught in an odd parity check even though the error is produced by failure in more than one digit place. Neither of these

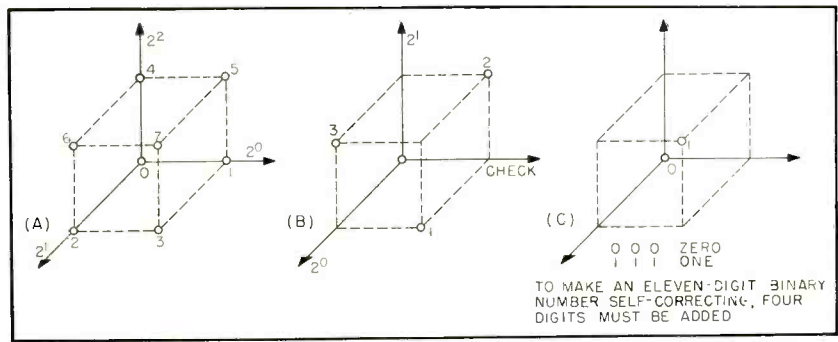

FIG. 19—Geometry model of a number (A), of even parity check (B) and self-correcting code (C)

two checking schemes would detect double errors in general, since a double error might leave the number of 1's or zeros unchanged.

Error Theory

A general theory of error detecting and correcting codes has been developed by R. W. Hamming.⁴ To avoid the pictorial difficulties of spaces with more than three dimensions, consider numbers with only three digits. Each of the eight possible three-digit binary numbers can be imagined as a unique vertex of the cube shown in Fig. 19A. In this representation each binary digit is a coordinate. The model can be generalized to the extent that each of the possible n -digit numbers lies at the vertex of an n -dimensional cube.

Figure 19B shows a model for an even parity check. Note that the binary numbers 0, 1, 2 and 3 appear at vertices of the cube. If we were to proceed along the edges of the cube from a vertex representing a number to any other vertex that represents a number, it would be necessary to go through a vertex which does not represent a number. If in representing the binary number 3, for example, a mistake were made in one of the digit places, that single mistake in a coordinate would throw the number to a vertex which it has been agreed does not represent a number. A single mistake will always result in such a position and can, therefore, be recognized.

Error Correction

A model of a self-correcting code is shown in Fig. 19C. In this model,

the origin of the graph represents the number zero, whereas the code group 111 which represents the seventh vertex represents the binary number 1. Suppose now that a mistake is made in developing the code group for one. If instead of producing the code group 111, the code 101 were produced, the machine would stop at the fifth vertex (assuming that the vertices are numbered as in Figure 19A). It would recognize that this vertex does not represent a number. It could further recognize that the closest vertex which does represent a number is the seventh vertex and could move to that position, thereby producing the correct code group 111. To produce a model of a self-correcting code for numbers with more digit places, it would be necessary to conceive an n -dimensional cube. The vertices of this cube would be assigned to definite numbers with two forbidden vertices between every pair of vertices that represent numbers. It would then be possible for the machine to recognize when it has made a single mistake and tell at which vertex it should be (the closest one). The idea can be extended to show the possibility of a coding system which would automatically correct for more than one error in a code group.

REFERENCES

- (1) "High-Speed Computing Devices," McGraw-Hill Book Co., Inc., New York, 1950.
- (2) R. F. Shaw, Arithmetic Operations in a Binary Computer, *Rev. Sci. Instr.*, p 687, Aug. 1950.
- (3) E. G. Andrews, The Bell Computer Model VI, *Electrical Engineering*, p 751, Sep. 1949.
- (4) R. W. Hamming, Error Detecting and Error Correcting Codes, *B.S.T.J.*, Vol. 29, p 147, Apr. 1950.

Transistor Equations

Circuit gain and impedance characteristics are given in terms of transistor parameters for grounded base, grounded emitter and grounded collector configurations. Simplifying approximations are given where appropriate

By **F. R. STANSEL**

Bell Telephone Laboratories
Murray Hill, New Jersey

THE ACCOMPANYING tabulation summarizes some of the important circuit equations useful to engineers in the application of transistors.

All equations are given in terms of the transistor parameters: collector resistance r_c , base resistance r_b , emitter resistance r_e , and current amplification constant α . These quantities are all described in

references listed in the bibliography. The quantity r_e is almost always much larger than r_b and r_c , and often is even much larger than the load resistance. This makes possible approximations that greatly simplify the complicated exact equations. To evaluate these approximations in this tabulation, the exact expression is always given first followed, where appropriate, by a

simpler approximation equation. The other quantities listed are self-explanatory.

BIBLIOGRAPHY

J. A. Becker and J. N. Shive, The Transistor, A New Semi-Conductor Amplifier, *Electrical Engineering*, 68, p 215, March, 1949.
Transistor Characteristics, *ELECTRONICS*, 22, p 132, Jan. 1949.
R. M. Ryder and R. J. Kircher, Some Circuit Aspects of the Transistor, *BSTJ*, 28, p 367, Jul. 1949.
R. L. Wallace and W. J. Pietenpol—Some Circuit Properties and Applications of NPN Transistors. *Proc. IRE*, 39, p 753, Jul. 1951. Also *BSTJ*, 30, p 530, Jul. 1951.

	GROUNDING BASE	GROUNDING EMITTER	GROUNDING COLLECTOR
$\frac{e_2}{e_1}$	$= \frac{\alpha R_L}{r_e + r_b(1-\alpha) + \frac{(r_e + r_b)R_L}{(r_c + r_b)}}$ <p>IF $R_L \ll r_c$</p> $\approx \frac{\alpha R_L}{r_e + r_b(1-\alpha)}$	$= \frac{-R_L \left[\alpha - \frac{r_e + r_b}{r_c + r_b} \right]}{r_e + r_b(1-\alpha) + \frac{(r_e + r_b)R_L}{(r_c + r_b)}}$ <p>IF $R_L \ll r_c, r_e + r_b \ll r_c$</p> $\approx \frac{-\alpha R_L}{r_e + r_b(1-\alpha)}$	$= \frac{r_c}{r_c + r_b} \left[\frac{1}{\frac{R_L + r_e}{R_L} + \frac{r_b(1-\alpha)}{R_L}} \right]$ <p>IF $r_e \ll R_L, r_b(1-\alpha) \ll R_L, r_b \ll r_c$</p> $\approx \text{UNITY}$
$\frac{e_2}{e_g}$	$= \frac{\alpha R_L}{\left[r_e + r_b + R_G \right] \left[1 + \frac{R_L}{r_c + r_b} \right] - \alpha R_L r_b}$ <p>IF $R_L \ll r_c$</p> $\approx \frac{\alpha R_L}{r_e + R_G + r_b(1-\alpha)}$	$= \frac{-R_L \left[\alpha - \frac{r_e + r_b}{r_c + r_b} \right]}{\left[r_e + r_b \right] \left[1 + \frac{R_L}{r_c + r_b} \right] + R_G \left[1 + \frac{r_e + r_b}{r_c + r_b} \right] - \alpha R_L (r_b + R_G)}$ <p>IF $R_L + r_e \ll r_c, r_e + r_b \ll r_c$</p> $\approx \frac{-\alpha R_L}{r_e + (1-\alpha)(r_b + R_G)}$	$= \frac{1}{\left[1 + \frac{r_e}{R_L} \right] \left[1 + \frac{r_b + R_G}{r_c} \right] + \frac{r_b + R_G}{R_L} \left[1 - \alpha \right] \left[1 + \frac{r_b}{r_c} \right]}$ <p>IF $r_e \ll R_L, r_b + R_G \ll r_c, r_b \ll r_c$</p> $\approx \frac{1}{1 + \frac{r_b + R_G}{R_L} \left[1 - \alpha \right]}$
$\frac{i_2}{i_1}$	$= \frac{\alpha}{1 + \frac{R_L}{r_c + r_b}}$	$= \frac{- \left[\alpha - \frac{r_e + r_b}{r_c + r_b} \right]}{\left[1 - \alpha \right] + \frac{R_L + r_e}{r_c + r_b}}$ <p>IF $r_e \ll r_c, r_e \ll R_L, r_b \ll r_c$</p> $\approx \frac{-\alpha}{(1-\alpha) + \frac{R_L}{r_c}}$	$= \frac{1}{\left[1 - \alpha \right] \left[\frac{r_c + r_b}{r_c} \right] + \frac{R_L + r_e}{r_c}}$ <p>IF $r_b \ll r_c, r_e \ll R_L$</p> $\approx \frac{1}{(1-\alpha) + \frac{R_L}{r_c}}$

(Continued on p 158)

CONSULT CINCH

METAL PLASTIC ASSEMBLIES

To produce the intricate assemblies of metal and plastic so essential in gear of all kinds, facilities include a combination of metal stamping and plastic production. A highly trained staff is available for any military or commercial requirement.

The list below comprises the products of both Cinch and Howard B. Jones Division. They are indicative of their wide scope and also indicate the myriad of variations and redesigning that are possible with this background of production experience.

SOCKETS: Tube (Receiver, Transmitter and Special); Battery, all types • C-R Tube • Crystal • Electrolytic • Glass Type; 4 to 7 prong laminated • Infra-red Ray Tube • High Altitude Airborne Types • Kinescope; Magnal, Duodecal, Diheptal • Loktal-Miniature-Multiplug-Naval-Octal (Molded bakelite, steatite, teflon, Kel-F and laminated) • Plexicon • Printed Circuit • Special Sockets to Specs • Sub-Miniature; Hearing Aid Types • TV; 110V Circuit Breakaway • Vibrator • Pencil Tube Transistor • Diode

ANTENNA JACKS
BANANA PINS AND JACKS
BARRIER TERMINAL STRIPS
FANNING STRIPS
BATTERY PLUGS & SOCKETS
BINDING POSTS
DIODE SOCKET
CONNECTORS, MULTI CONTACT
FUSE STRIPS, BLOCKS & BOARDS
GRID CAPS
GRID CAP SHIELDS
HERMETICALLY SEALED TUBE SOCKETS

METAL STAMPINGS
MICRO-CONNECTORS
MOUNTING DEVICES
PHONO TIP JACKS
PRINTED CIRCUIT, CONNECTORS
SHIELDS, TUBE-MINIATURE & NOVAL & BASES SOLDERING LUGS—200 VARIATIONS
STRAP NUTS
TRANSISTOR SOCKET
TUBE HOLDERS—SPRING TYPE
VIBRATOR PLUGS AND SOCKETS

TERMINAL ASSEMBLIES: Blocks, boards in laminated and molded, assembled with lugs, pins, screw terminals, contacts, clips, turret lugs and other hardware to specifications.

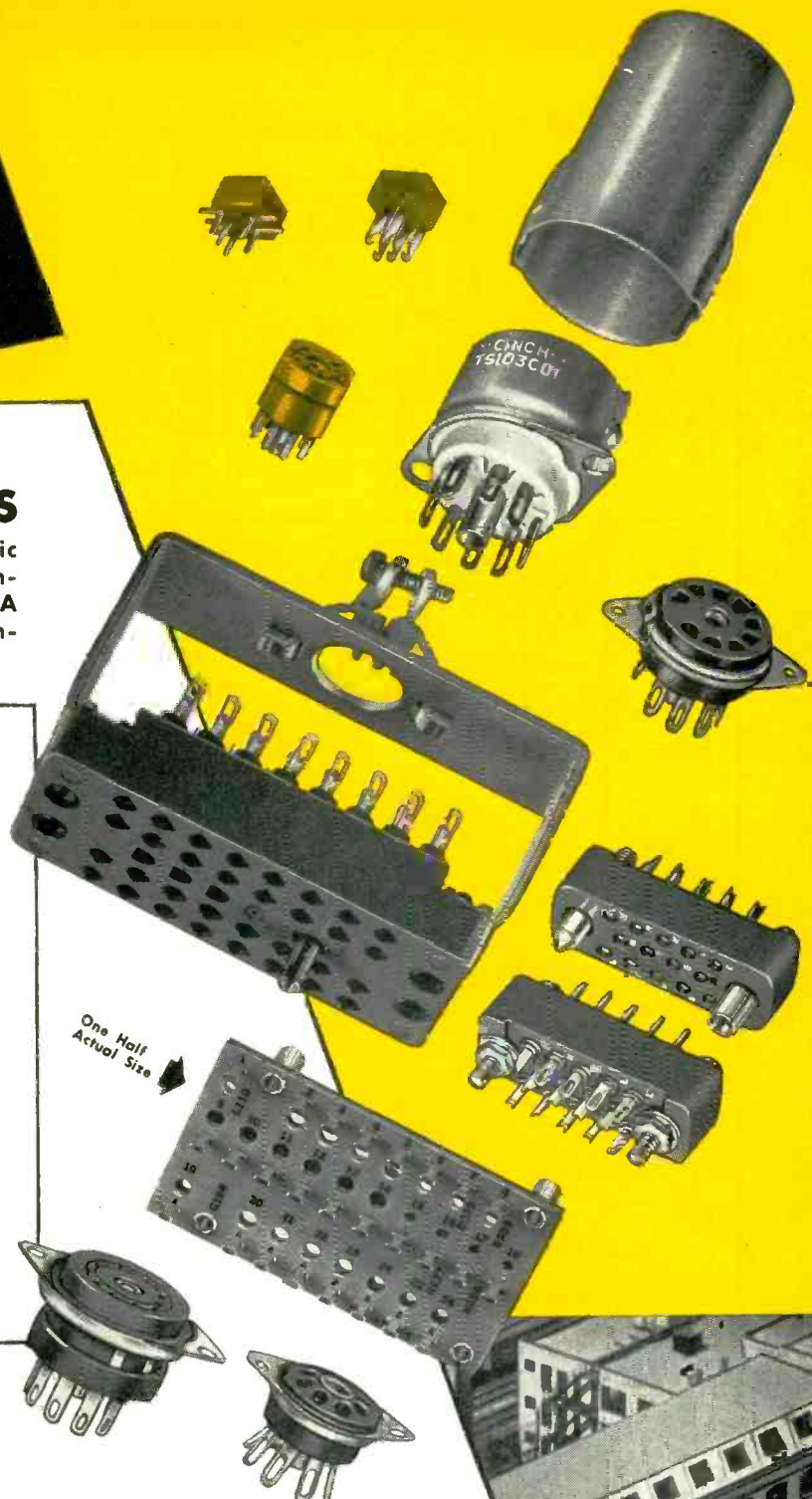

**AT THE IRE-NATIONAL CONVENTION:
BOOTH No. 505 & 506**



Cinch
ELECTRONIC
COMPONENTS

CINCH MANUFACTURING CORPORATION

1026 South Homan Ave. Chicago 24 Illinois

Subsidiary of United-Carr Fasteners Corporation, Cambridge Mass

At electronic component jobbers — everywhere.

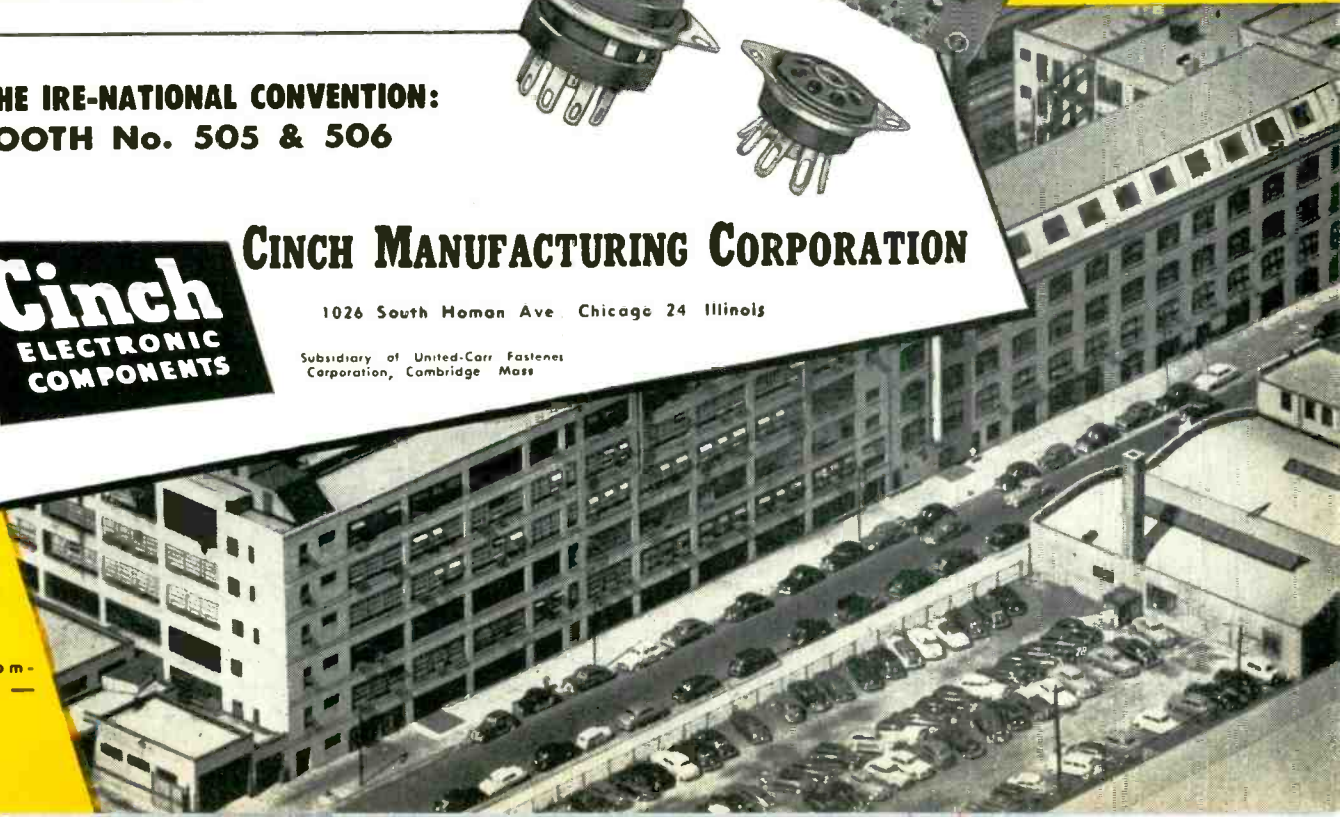

Transistor Equations (continued from p 156)

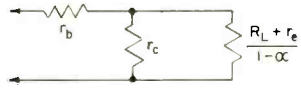
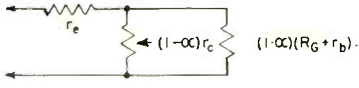
	GROUNDING BASE	GROUNDING EMITTER	GROUNDING COLLECTOR
INPUT RESISTANCE R_{IN}	$= r_e + r_b \left[1 - \frac{\alpha}{1 + \frac{R_L}{r_c + r_b}} \right]$ <p>IF $R_L \ll r_c$ $\cong r_e + r_b (1 - \alpha)$</p>	$= r_b + r_e \left[\frac{\frac{r_c + R_L}{r_c + r_b}}{\frac{R_L + r_e}{r_c + r_b} + (1 - \alpha)} \right]$ <p>IF $r_b \ll r_c, r_e \ll R_L$ $\cong r_b + r_e \left[\frac{i + \frac{R_L}{r_c}}{1 - \alpha + \frac{R_L}{r_c}} \right]$</p> <p>IF IN ADDITION $R_L \ll r_c$ $\cong r_b + \frac{r_e}{1 - \alpha}$</p>	$= r_b + \frac{r_c}{1 + \frac{(1 - \alpha)(r_c + r_b)}{R_L + r_e}}$ <p>IF $r_b \ll r_c$ THIS IS EQUIVALENT TO</p> 
OUTPUT RESISTANCE r_{OUT}	$= (r_c + r_b) \left[\frac{r_e + r_b(1 - \alpha) + R_G}{r_e + r_b + R_G} \right]$ <p>IF $r_b \ll r_c$ $\cong r_c \left[\frac{r_e + r_b(1 - \alpha) + R_G}{r_e + r_b + R_G} \right]$</p>	$= r_c \left[\frac{\left[1 + \frac{r_b + R_G}{r_c} \right] \left[r_e + (1 - \alpha)r_b \right] + R_G(1 - \alpha)}{r_e + r_b + R_G} \right]$ <p>IF $r_b + R_G \ll r_c$ $\cong r_c \left[\frac{r_e + (1 - \alpha)(r_b + R_G)}{r_e + r_b + R_G} \right]$</p>	$= r_e + \frac{(1 - \alpha)(r_c + r_b)}{1 + \frac{r_c}{R_G + r_b}}$ <p>IF $r_b \ll r_c$ THIS IS EQUIVALENT TO</p> 
OPERATING GAIN POWER TO LOAD = MAX. POWER FROM GEN.	$= \frac{4 R_L R_G \alpha^2}{\left\{ \frac{R_L}{r_c + r_b} \left[r_e + r_b + R_G \right] + \left[r_e + R_G + r_b(1 - \alpha) \right] \right\}^2}$ <p>IF $R_L \ll r_c$ $\cong \frac{4 R_L R_G \alpha^2}{\left[r_e + R_G + r_b(1 - \alpha) \right]^2}$</p>	$= \frac{4 R_G R_L \left[\alpha - \frac{r_e + r_b}{r_c + r_b} \right]^2}{\left\{ \left[r_e + r_b \right] \left[1 + \frac{R_L}{r_c + r_b} \right] + R_G \left[1 + \frac{R_L + r_e}{r_c + r_b} \right] - \alpha \left[r_b + R_G \right] \right\}^2}$ <p>IF $R_L + r_e \ll r_c, r_e + r_b \ll r_c$ $\cong \frac{4 R_G R_L \alpha^2}{\left[r_e + (1 - \alpha)(r_b + R_G) \right]^2}$</p>	$= \frac{4 R_G}{R_L \left\{ \left[1 + \frac{r_e}{R_L} \right] \left[1 + \frac{r_b + R_G}{r_c} \right] + [1 - \alpha] \left[\frac{r_b + R_G}{R_L} \right] \left[1 + \frac{r_b}{r_c} \right] \right\}^2}$ <p>IF $r_e \ll R_L, r_b + R_G \ll r_c$ $\cong \frac{4 R_G}{R_L \left[1 + \frac{r_b + R_G}{R_L} (1 - \alpha) \right]^2}$</p>
INSERTION GAIN POWER TO LOAD = POWER GEN. WOULD DELIVER TO SAME LOAD	$= \left[1 + \frac{R_G}{R_L} \right]^2 \frac{\alpha^2 R_L^2}{\left\{ \left[r_e + r_b + R_G \right] \left[1 + \frac{R_L}{r_c + r_b} \right] - \alpha r_b \right\}^2}$ <p>IF $R_L \ll r_c$ $\cong \left[1 + \frac{R_G}{R_L} \right]^2 \frac{\alpha^2 R_L^2}{\left[r_e + R_G + r_b(1 - \alpha) \right]^2}$</p>	$= \frac{\left[1 + \frac{R_G}{R_L} \right]^2 \left[\alpha - \frac{r_e + r_b}{r_c + r_b} \right]^2}{\left\{ \left[\frac{r_e + r_b}{R_L} \right] \left[1 + \frac{R_L}{r_c + r_b} \right] + \frac{R_G}{R_L} \left[1 + \frac{R_L + r_e}{r_c + r_b} \right] - \alpha \left[\frac{r_b + R_G}{R_L} \right] \right\}^2}$ <p>IF $R_L + r_e \ll r_c, r_e + r_b \ll r_c$ $\cong \left[1 + \frac{R_G}{R_L} \right]^2 \frac{\alpha R_L}{\left[r_e + (1 - \alpha)(r_b + R_G) \right]^2}$</p>	$= \frac{\left[1 + \frac{R_G}{R_L} \right]^2}{\left\{ \left[1 + \frac{r_e}{R_L} \right] \left[1 + \frac{r_b + R_G}{r_c} \right] + \frac{r_b + R_G}{R_L} [1 - \alpha] \left[1 + \frac{r_b}{r_c} \right] \right\}^2}$ <p>IF $r_e \ll R_L, r_b + R_G \ll r_c$ $\cong \frac{\left[R_L + R_G \right]^2}{\left[R_L + (1 - \alpha)(r_b + R_G) \right]^2}$</p>
MAXIMUM AVAILABLE GAIN	$= \frac{\alpha^2 (r_c + r_b)}{(r_e + r_b)} \times \frac{1}{(1 + \beta_b)^2}$ $\beta_b = \sqrt{\frac{r_e + (1 - \alpha) r_b}{r_e + r_b}}$ <p>IF $r_b \ll r_c$ $= \frac{\alpha^2 r_c}{(r_e + r_b) (1 + \beta_b)^2}$</p>	$= \frac{\left[\frac{r_e + r_b}{r_c + r_b} - \alpha \right]^2}{\left[\frac{r_e + r_b}{r_c + r_b} \right] \left[\frac{r_e}{r_c + r_b} + (1 - \alpha) \right] \left[1 + \beta_e \right]^2}$ $\beta_e = \sqrt{\frac{\left[\frac{r_c + r_b}{r_e + r_b} \right] \left[\frac{r_e + (1 - \alpha) r_b}{r_e + r_b} \right]}{\left[\frac{r_c + r_b}{r_e + r_b} \right] \left[\frac{r_e + (1 - \alpha) r_b}{r_e + r_b} \right]}}$ <p>IF $r_e + r_b \ll r_c, r_b \ll r_c$ $\cong \frac{r_c}{r_e + r_b} \times \frac{\alpha^2}{1 - \alpha} \times \frac{1}{(1 + \beta_e)^2}$</p> $\beta_e \cong \sqrt{\frac{r_c \left[\frac{r_e + (1 - \alpha) r_b}{r_e + r_b} \right]}{\left[\frac{r_c + r_b}{r_e + r_b} \right] \left[\frac{r_e + (1 - \alpha) r_b}{r_e + r_b} \right]}}$	$= \frac{1}{\left[\frac{r_b + r_c}{r_c} \right] \left[\frac{r_e + (1 - \alpha)(r_c + r_b)}{r_c} \right] \left[1 + \beta_c \right]^2}$ $\beta_c = \sqrt{\frac{r_e + (1 - \alpha) r_b}{r_e + (1 - \alpha)(r_c + r_b)}}$ <p>IF $r_b \ll r_c, r_e \ll r_c$ $\cong \frac{1}{(1 - \alpha) (1 + \beta_c)^2}$</p> $\beta_c \cong \sqrt{\frac{r_e + (1 - \alpha) r_b}{r_e + (1 - \alpha) r_c}}$
LOAD AND GEN. RES. FOR MAX. AVAIL. GAIN	R_{GM}	$= (r_e + r_b) \beta_b$	$= (r_c + r_b) \beta_c$ IF $r_b \ll r_c$ $\cong r_c \beta_c$
	R_{LM}	$= (r_e + r_b) \beta_b$ IF $r_b \ll r_c$ $\cong r_c \beta_b$	$= \left[r_e + (1 - \alpha)(r_c + r_b) \right] \beta_e$ IF $r_b \ll r_c$ $\cong \left[r_e + (1 - \alpha) r_c \right] \beta_e$

Millions of Cycles of Contact Life...

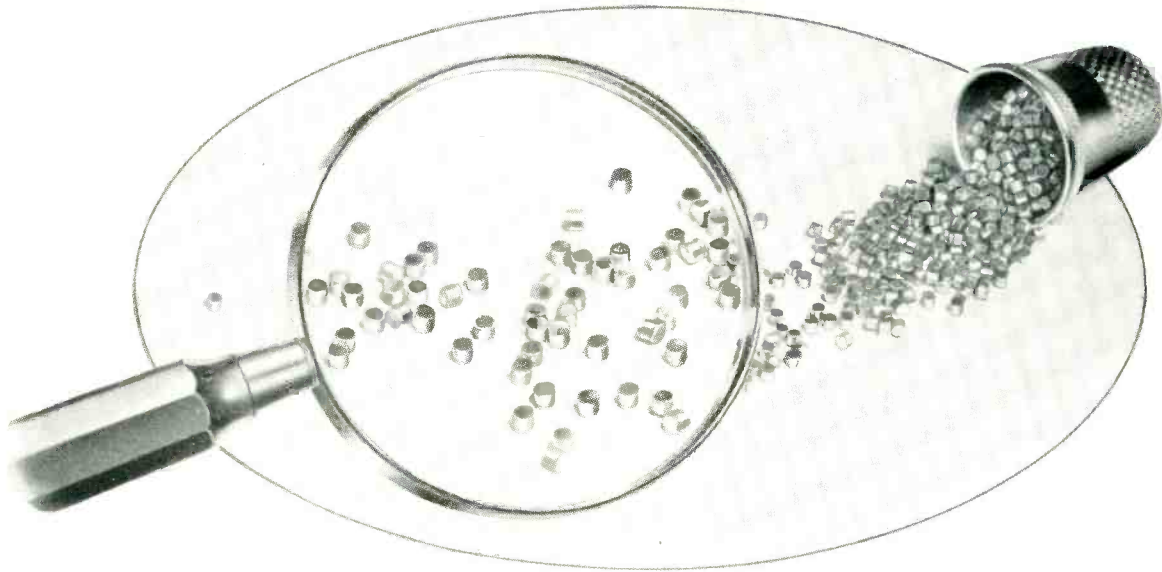

At One-Third the Cost

Nearly a thousand of these contacts will fit in a thimble, yet the accuracy of a gasoline gauge depends on their uniform performance over a life measured in millions of cycles.

The instrument is designed so that the varying width of the contact gap controls the gauge. As a result, the contact gap is extremely critical. Once the gauge is calibrated, the contacts must retain their shape precisely. They have to resist the peening effect of high frequency operation. They must withstand the pitting and erosion of almost continuous arcing and still maintain low contact resistance with light pressure.

For this kind of an application, platinum and platinum alloys would seem to be the logical choice. There is just one drawback... the

cost. This is where Mallory's experience in contact engineering was able to save the manufacturer two-thirds of his previous cost.

Through metallurgical techniques, Mallory creates new materials by combining the desirable characteristics of several metals. One of these materials is Elkonium 17, a silver-nickel-cadmium alloy which had the required characteristics... at a fraction of the cost.

Other Mallory contact materials will meet the requirements of virtually any electrical contact application. Whether your problem involves simple button or rivet contacts—or a complex assembly—take advantage of the experience our engineers have accumulated in the development of over 5000 different types of contacts and contact assemblies. Call us today... lower your production costs tomorrow.

Expect more...

Get more from **MALLORY**

In Canada, made and sold by Johnson Matthey and Mallory, Ltd., 110 Industry Street, Toronto 15, Ontario

Electrical Contacts and Contact Assemblies

P. R. MALLORY & CO. Inc.
MALLORY

SERVING INDUSTRY WITH THESE PRODUCTS:

Electromechanical—Resistors • Switches • Television Tuners • Vibrators
Electrochemical—Capacitors • Rectifiers • Mercury Dry Batteries
Metallurgical—Contacts • Special Metals and Ceramics • Welding Materials

P. R. MALLORY & CO., INC., INDIANAPOLIS 6, INDIANA

ELECTRONS AT WORK

Including INDUSTRIAL CONTROL

Edited by ALEXANDER A. MCKENZIE

Electroluminescent Screens	160	Spatial Harmonic T-W Tube.....	206
Voltage Regulator Tubes.....	162	Fringe Area TV Booster Transmitter...	218
Pertinent Patents	164	Transmission of Microwaves Through Plexiglas Windows	226
Rhombic Relay Antennas.....	186	Measuring Magnetic Tape Recorder Flutter	230
Twenty-Five Cent Oscillator.....	194	Single-Frequency Audio Filter	254
Survey of Waveguides and Lines.....	198	Storage of Magnetic Recording Tape... 270	

OTHER DEPARTMENTS

featured in this issue:

	Page
Production Techniques ..	274
New Products	344
Plants and People.....	428
New Books	472
Backtalk	492

Electroluminescent Screens

DIRECT TRANSFORMATION of electrical energy into light through electroluminescence is becoming increasingly important in the lighting field, but even more important uses may lie ahead in the field of electronics.

Electroluminescence is the property of certain materials that causes them to emit light when placed in a fluctuating electric field. It may be produced by a device comprising a film of phosphor dispersed in the dielectric between two conducting plates. Such a luminous capacitor is shown in Fig. 1. One plate is of electrically-conducting glass while the other is formed by coating the dielectric with vaporized aluminum. Another type of luminous capacitor consists of a pair of enameled copper wires

in close contact wound side-by-side on a glass tube. Phosphor suspended in oil is brushed over the wires and luminescence produced by an alternating potential of about 200 volts.

Present applications include illuminated clock faces, instrument dials, dashboard and cockpit lights.

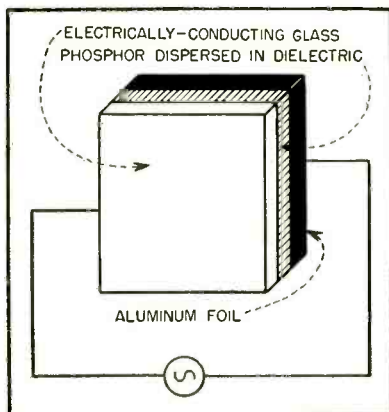

FIG. 1—Electroluminescent screen resembles ordinary capacitor

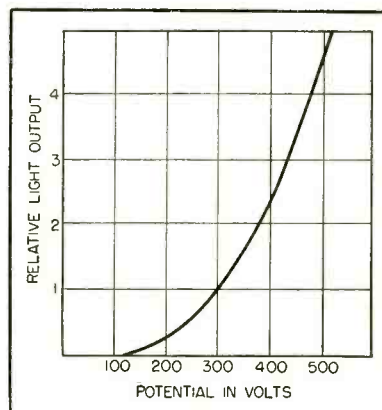

FIG. 2—Relative light output versus voltage at constant frequency

These lamps are characterized by instantaneous operation and smooth dimming to extinction through control of applied alternating potential.

Intensity of emitted light depends upon thickness, resistivity and dielectric constant of the phosphor and the frequency and magnitude of the applied potential. Figure 2 shows the variation in light output

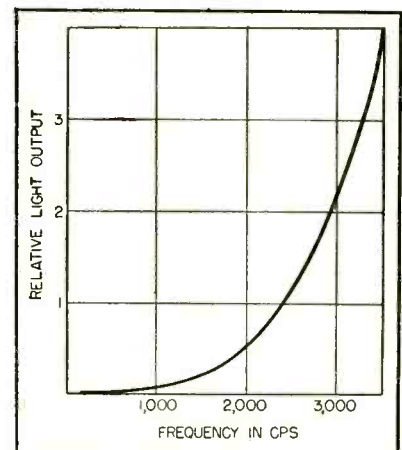
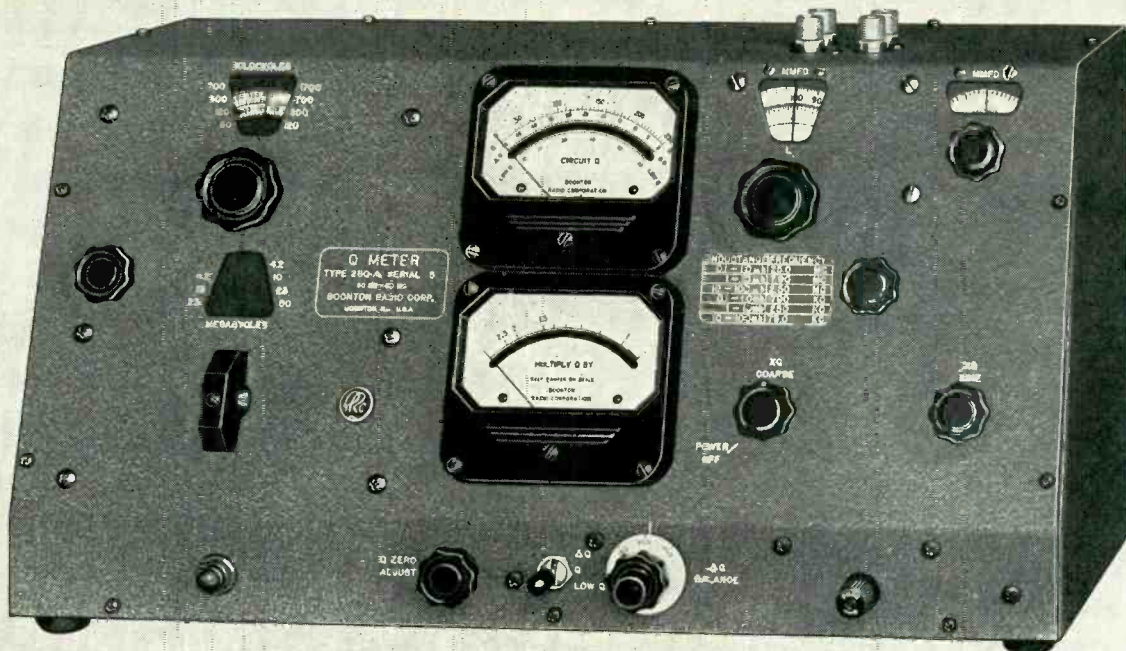

FIG. 3—Relative light output versus frequency at constant voltage

with voltage for a 60-cps alternating potential. Figure 3 shows the relation between light output and frequency; the potential was held constant at 100 volts. A given amount of light is emitted each time the luminous capacitor is charged to a given voltage. The more times per second this occurs, the greater will be the amount of light emitted.

The luminous capacitor is being investigated as a possible substitute for cathode-ray tubes.

Although no perceptible color change occurs as a luminous capacitor is dimmed, a definite color change has been observed with variable frequency operation. A lamp that luminesced yellow-green at 60 cps can be made to glow pale-blue-green at 3,000 cps. This



Type 260-A Freq. 50KC to 50MC

18 years of improvements are combined in this NEW Q Meter

NEW FEATURES

- Lo Q Scale permits Q readings down to a value of 10.
- Δ Q Scale reads the difference in Q of two circuits or components up to a value of 125.
- Thermocouple for indicating current inserted into measuring circuit redesigned for high burnout point well above operating current.
- Oscillator maximum output level adjusted to minimize possibility of thermocouple failure.
- Voltage insertion resistor decreased to 0.02 ohms to minimize effect on measuring circuit. New type low reactance metalized coaxial resistor used.
- All indications on large meters with parallax correction and accuracy of $\pm 1\%$ full scale.
- Range switch controls mask and arrow which indicate correct scale on frequency dial.
- Oscillator rigidly supported by casting which supports turret ball bearings and circuit using long life subminiature triode.

Visit our booths #2-521 and #2-522 at the I.R.E. Show

BOONTON RADIO
BOONTON · N · J · U · S · A · Corporation



The Q Meter Type 260-A replaces our Type 160-A, one of Boonton Radio's Q Meters which has been standard equipment in laboratories and on production lines for eighteen years. Many improvements have been made during this time, but several of our ideas for a better instrument were too extensive to put into a model already in production. These ideas were carefully tested for use in a new model. The Q Meter Type 260-A includes all past improvements and the extensive changes that we have accumulated.

SPECIFICATIONS:

FREQUENCY COVERAGE: 50 KC to 50 MC Continuously variable in eight ranges.

FREQUENCY ACCURACY: Approximately $\pm 1\%$.

RANGE OF Q MEASUREMENTS: 10 to 625.

RANGE OF DIFFERENCE Q MEASUREMENTS: 0 to 125.

INTERNAL RESONATING CAPACITANCE RANGE:

Main Tuning Dial: 30 to 450 mmf (direct reading) calibrated in 1.0 mmf increments from 30 to 100 mmf; 5.0 mmf increments from 100 to 450 mmf.

Vernier: -3.0 to $+3.0$ mmf (direct reading) calibrated in 0.1 mmf increments.

ACCURACY OF RESONATING CAPACITOR:

Main Tuning Dial: Approximately $\pm 1\%$ or 1.0 mmf, whichever is the greater.

Vernier: ± 0.1 mmf.

POWER SUPPLY: 90-130 volts—60 cps (internally regulated).

POWER CONSUMPTION: 65 Watts.

Model available for other Power Supply voltages and frequencies.

Type 103-A Accessory Inductors Available for entire frequency range.

PRICE: \$725.00 F. O. B. FACTORY

property has suggested several additional uses for the luminous capacitor.—J.M.C.

BIBLIOGRAPHY

E. C. Payne, E. L. Hager and C. W. Jerome, *Electroluminescence, Illuminating Eng.* p 688, Nov. 1950.
 J. F. Waymouth, C. W. Jerome and W. C. Gungle, *Electroluminescence—Electrical and Optical Properties, Sylvania Technologist*, p 54, July 1952.
 S. Roberts, *Field Strength and Temperature Studies of Electroluminescent Powders in Dielectric Media, Jour Optical Soc of Amer.* p 850, Nov. 1952.

Voltage Regulator Tubes

BY WALTER R. JONES

Panel on Electron Tubes
 Research and Development Board
 New York, N. Y.

USE OF VOLTAGE REGULATOR tubes in military equipment is increasing. As the many uses for these tubes increase, difficulties encountered in their applications will likewise increase. Certain fundamental characteristics of a voltage-regulator tube must be considered if reliability and satisfactory performance are to be obtained.

Voltage regulator tubes are usually recommended for use under various conditions of current drain from 5 milliamperes to 30 or 40 milliamperes as shown in Table I.

Essentially, voltage-regulator tubes of the glow-discharge variety contain a cathode, usually cylindrical in shape, of relatively large area, and a relatively small anode. Upon the cathode is deposited a thin film of some material that serves as an activator. The electrodes are sealed in a bulb containing an inert gas—argon, helium, neon, krypton or a mixture of gases at pressures that may be as low as a few millimeters to more than a centimeter of mercury, depending upon the operating conditions under which regulation is desired. Figure 1 indicates the basic structure of

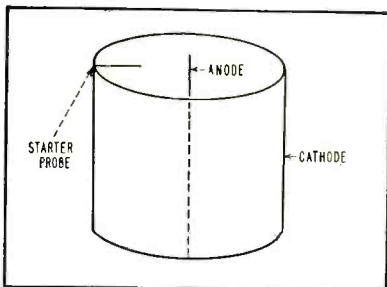

FIG. 1—Voltage-regulator tube structure

a glow-type regulator tube.

Table I shows that the minimum plate current for these tubes is 5 milliamperes while the maximum varies from 30 to 40 milliamperes depending upon the tube type. Frequently a voltage regulator tube is employed as a reference tube where the drain is less than 5 milliamperes. Erratic performance is obtained under these conditions owing to the fact that only a small amount of the cathode surface is covered by the glow.

In applications of this sort the use of a voltage-reference tube is required if reliable operation is to be obtained. In instances where a reference tube is not employed, the current drain must be increased to at least 5 milliamperes if satisfactory operation is to be obtained with a voltage-regulator tube.

The second part of Table I shows the characteristics of two voltage-reference tubes that are currently available.

It is a characteristic of glow-regulator tubes that the current density remains constant so that the cross-sectional area over which current flows varies instead. Thus when the current is small, the glow does not cover the whole of the cathode surface but concentrates on a part of it. As the current is increased, the area of the cathode

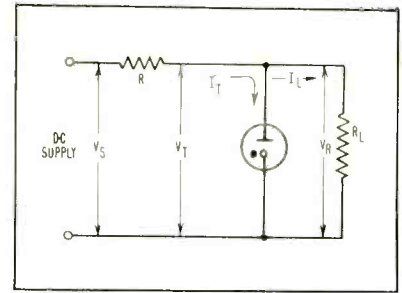

FIG. 2—Parameters for proper operation explained in text

covered by the glow increases linearly with the total current.

Under many conditions of operation if the voltage-regulator tube is observed it will be noticed that the active glow area within the tube shifts considerably. This shifting that occurs within the tube accounts for small variations in the regulated voltage developed across the tube itself. This effect is sometimes referred to as jitters.

During the long-time life of the tube the voltage regulation may change and the regulated voltage will increase. This results from partial cleaning up of the activator during life.

If the regulator tube is subjected to very high starting currents, the regulated voltage may require as long as 20 to 30 minutes to drop to its normal operating voltage. The regulation is affected by

Table I—Voltage Regulator and Reference Tubes

Tube type	Minimum current in ma	Maximum current in ma	Maximum breakdown D-C volts	D-C operating volts	Minimum breakdown in darkness D-C volts**
OA2*	5	30	185	150	225
OA3*	5	40	105	75	160
VR75					
OB2*	5	30	133	108	210
OB3	5	30	130	90	175
OC3	5	40	133	105	210
VR105					
VR150	5	40	185	150	225
5644*	5	25	130	95	***
5787	5	30	141	100	***
6073	5	30	185	150	***
6074	5	30	133	108	***
<i>Voltage Reference Tubes</i>					
5651*	1.5	3.5	115	87	169
5783	1.5	3.5	125	87	***

* Armed Services Preferred List.
 ** This is the minimum value if tube is held in dark for 24 hours before testing and tested in total darkness.
 *** These values for the darkness test are currently being determined.

Pioneers in Precision

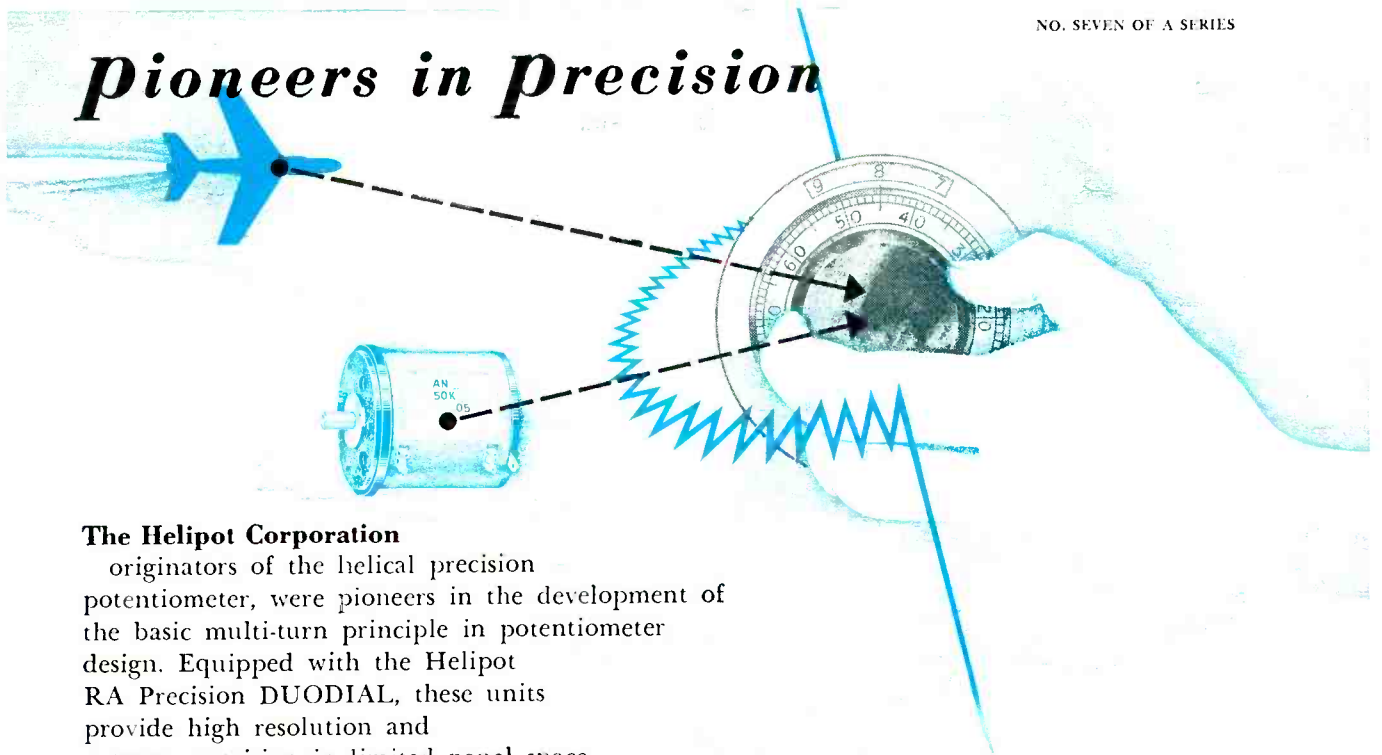

The Helipot Corporation

originators of the helical precision potentiometer, were pioneers in the development of the basic multi-turn principle in potentiometer design. Equipped with the Helipot RA Precision DUODIAL, these units provide high resolution and extreme precision in limited panel space.

Miniature Precision Bearings

are the extra quality products manufactured by the originators and pioneer developers of ball bearings in miniature precision sizes. More than three thousand discriminating customers are currently being supplied with **MPB** components for applications involving high fidelity performance.

These fine quality **MPB** ball bearings are manufactured under exclusive and exacting production procedures as conceived and developed by **MPB** designers and engineers. Many designs and sizes of miniature ball bearings initially developed at **MPB** are now internationally standardized. Over a million **MPB** ball bearings have been installed in devices operating under unusual conditions . . . extreme temperature range . . . shock . . . continuous high load capacity . . . limited space in project miniaturization.

MPB ball bearings are fully ground, lapped, and/or honed to ABEC 5 tolerances or better. They are torque tested, ultrasonically cleaned, supplied in specific tolerances and classified within the tolerances for prompt assembly and maximum service. **MPB** ball bearings are normally supplied in 10 series, from 1/10" to 5/16" o.d., of high carbon chrome bearing steel. Some are supplied in stainless and beryllium copper, and all are assembled with best quality balls. The most extensive engineering knowledge in miniature bearing applications is available to you. Write for Catalog and survey sheet **E3**

Continued expansion, necessary in order to supply a steadily increasing demand for extra quality bearings, will soon enable us to participate in your future planning.

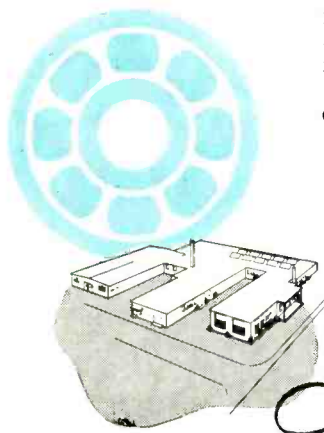

Miniature precision Bearings

Incorporated



Keene, New Hampshire

"Pioneer Precisionists to the World's foremost instrument Manufacturers"

**save
space
weight
friction**

changes in current within the operating range. Thus, if a tube that has been operating for a long time at low current is suddenly changed to higher current the regulated voltage value may be somewhat different from the value obtained after a long period of time at the higher current value. If a voltage-regulator tube is not used for awhile the regulated voltage will likewise require considerable time before it becomes stabilized.

The minimum d-c voltage required for breakdown of various voltage regulator tubes is shown in Table I. Voltages somewhat in excess of the values shown must be available to be certain that the tube will completely ionize so the proper d-c regulated voltages will be obtained. These values are also shown in Table I.

Ionization of these tubes is accomplished from three sources: photoelectric effects on the cathode from external light sources, radioactive effects from radiation and finally the field owing to voltage applied between the cathode and anode of the tube. The sum of these effects establishes the value of minimum breakdown voltage shown in Table I. If now the tube is operated under conditions of total darkness, then more voltage, perhaps as much as 50 or 60 volts, will be required for breakdown since the contribution from photoelectric radiation has been removed. Likewise, if the tube is mounted where radioactive radiation is completely removed, the breakdown voltage will also be increased.

It is important to determine whether the published ratings cover operation in the dark or in lighted areas. The conditions are specified on the rating sheets and these values will not be realized in service unless the operating conditions duplicate those under which the production tests are conducted.

Often it is desirable to shunt the voltage-regulator tube with a capacitor. It is necessary to keep the value of capacitance at or below 0.1 μ f. If this value is exceeded instability and oscillations may occur.

In this discussion it has been assumed that the proper circuit design has already been completed.

If the voltage regulator tube is to operate within its rated conditions there are three conditions that must be satisfied. These limiting conditions are given in Table I for several types of voltage regulator tubes.

Referring to Fig. 2 these conditions are:

(1) The voltage V_r supplied to the tube before firing is equal to or exceeds the minimum breakdown voltage specified in Table I. Thus the d-c supply voltage V_s must equal V_r plus the voltage drop

across R when the only current flowing is that due to the load R_L .

(2) The current I_r flowing through the tube after breakdown is held above the minimum permissible value shown in Table I.

(3) The current I_r flowing through the tube after breakdown will not exceed the maximum value shown in Table I even if the load current should be reduced nearly to zero.

BIBLIOGRAPHY

R. C. Miles, How to Design VR Tube Circuits, *ELECTRONICS*, p 135, Oct. 52.

PERTINENT PATENTS

FOR SOME TIME microwave spectroscopy has been reported from laboratories in the electronics and chemical industries as a means for analyzing the composition of gases and fluids. One use of this method has been detection of moisture in oil lines by a sweep frequency application of microwave energy to the oil line. The range of frequencies at which the line is swept includes the molecular absorption frequency of water.

An interesting patent in this field is number 2,602,835 granted to W. D. Hershberger and assigned to Radio Corporation of America. The invention covers the method and apparatus for microwave spectroscopy in the analysis of organic and inorganic gases.

Figure 1 shows the general arrangement of apparatus in Hershberger's technique. Microwave f-m energy is applied to a waveguide into which is inserted a gas cell. The gas cell may be continuous with a gas line, or a separate chamber, but in every case, it has microwave transparent seals into the waveguide. Microwave energy is detected after passing through the cell. Simultaneously the same microwave energy is applied to a standard of frequency through a directional coupler.

The frequency standard may be a resonant chamber operating at the molecular absorption frequency of the gas under analysis, or a standard gas chamber under con-

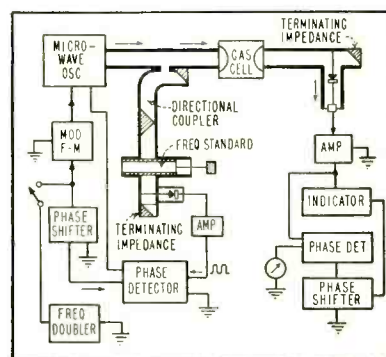

FIG. 1—Microwave spectroscopy apparatus provides comparison between gas chamber resonance and standard resonance

trolled conditions of temperature and pressure having the desired microwave molecular resonant frequency. Means are provided for controlling the modulation and center frequency of the microwave generator and for accurate comparison between the test gas-chamber resonance and the standard resonance. Indicators for the comparison are provided.

Computers

Computers employing electron tubes and circuits of all types are the subjects of increasing numbers of patents being issued currently. The inventions range from the comparatively simple but complicated looking circuit awarded patent number 2,603,415, issued to Daniel Silverman, J. D. Eisler and J. H. Huth, assignors to the Stanolind

Unique Insulator Designed for Service at Altitudes of 50,000 Feet . . .

Specs list temperature conditions from minus 117° to 212° F

This heavy duty antennae insulator, designed for use in the minimum high frequency range, can safely handle voltages up to 10,000 at current flows of 8 amps.

Fluoro Plastics Inc. of Philadelphia, Pa., compression molded 1½ pounds of Kel-F* about a metallic insert to produce the insulator which measures 3 inches in diameter and 6 inches in height. The dimensional stability of Kel-F polymers assures an hermetic seal between plastic and metal even under the extreme conditions of service.

Fluoro Plastics is equipped for both compression and transfer molding on a production basis... is currently turning out a diverse group of products including valve seats, "o" rings, insulators... ranging in size from a few grams of Kel-F to 6 pounds and up to 10 inches in diameter or height.

Refer to Report E 103

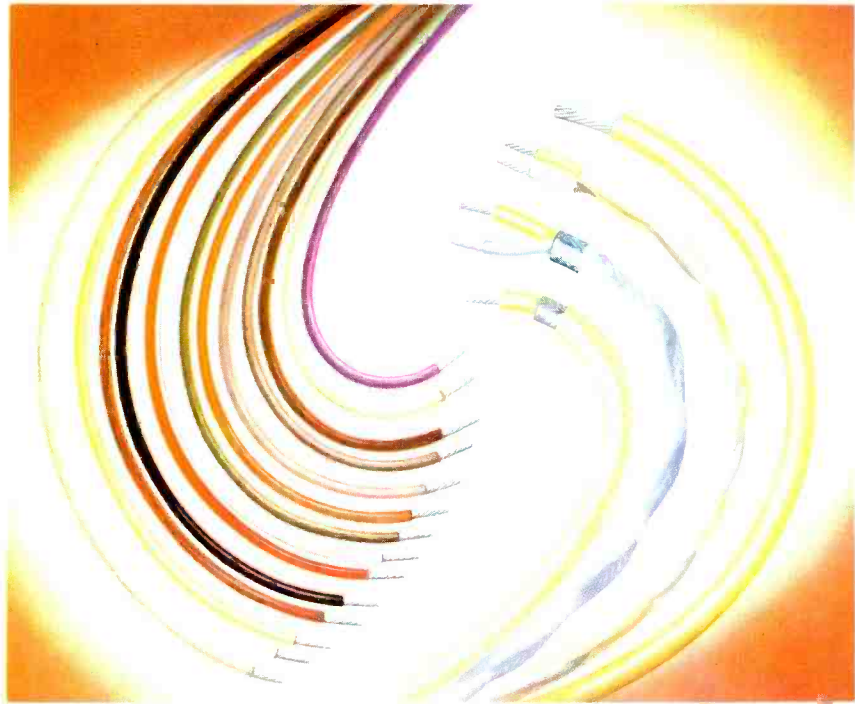
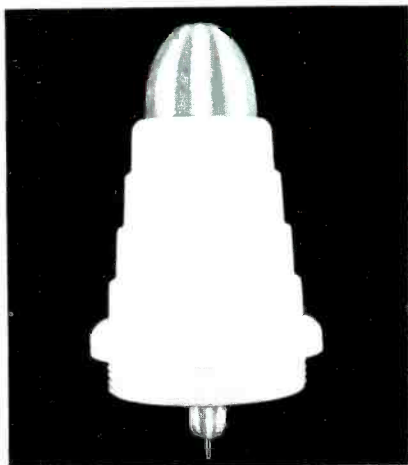

New Hook-up Wire with Extruded KEL-F* Insulation Solves Heat and Damage Problems

This new wire, coated with KEL-F*, is ideally suited for the totally-enclosed or hot wiring job where it solves the dual problem of heat and damage that has faced designers for years. First, even in the most cramped assembly jobs, a careless slip of a tool or soldering iron won't damage Kel-F — you can't split it with a hammer under normal conditions; it melts at about 410° F. Second, the insulation retains its full physical and dielectric properties at temperatures to 300° F. No leakage...no shorts.

Surprenant Mfg. Co. of Boston, Mass. was one of the first extruders to recognize these Kel-F qualities, and the company developed its own techniques for extruding an evenly balanced coating of the plastic on wire of all types. Early stranded single conductors have been followed by twisted paired wires individually insulated with Kel-F and encased with a jacket of Kel-F... then individually insulated wire — or a twisted pair — surrounded by

braided metallic shielding and covered with a plastic jacket. Surprenant has also developed a wide range of color-coded wire—13 colors in all.

All Surprenant wire coated with Kel-F polymers is marketed under the company's trade name "Surflene".

While resistance to heat and damage, and excellent insulating qualities are most important in the usual application, wiring installations for service in sub-zero or humid, tropic locations, or exposure to corrosive chemicals or vapors can utilize the unusual chemical inertness and 4 to 500 degree effective utility range of Kel-F to insure trouble-free performance.

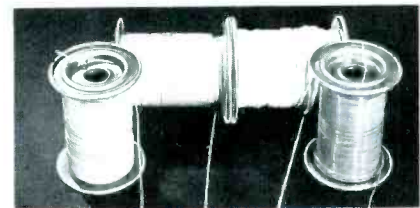

Refer to Report E 101

(SEE REVERSE SIDE)

* Registered trademark for The M. W. Kellogg Company's trifluorochloroethylene polymers

KEL-F

FLUORO
CHLORO
CARBON
PLASTIC

KEL-F

FLUORO
CHLORO
CARBON
PLASTIC

KEL-F

FLUORO
CHLORO
CARBON
PLASTIC

KEL-F

FLUORO
CHLORO
CARBON
PLASTIC

KEL-F

FLUORO
CHLORO
CARBON
PLASTIC

KEL-F

FLUORO
CHLORO
CARBON
PLASTIC

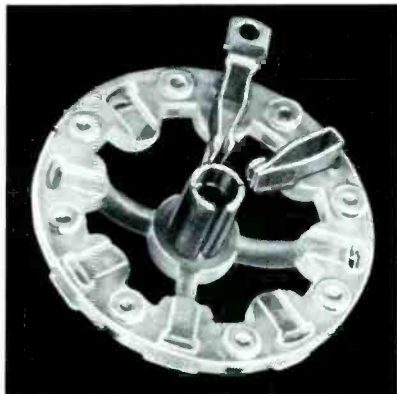
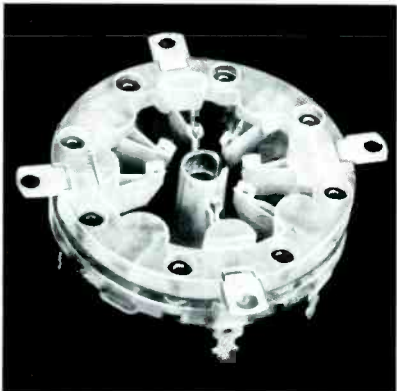
KEL-FFLUORO
CHLORO
CARBON
PLASTIC**KEL-F**FLUORO
CHLORO
CARBON
PLASTIC**KEL-F**FLUORO
CHLORO
CARBON
PLASTIC**KEL-F**FLUORO
CHLORO
CARBON
PLASTIC**KEL-F**FLUORO
CHLORO
CARBON
PLASTIC**KEL-F**FLUORO
CHLORO
CARBON
PLASTIC

Early Application Demonstrates Major Advantages of KEL-F* in Design of Electrical Parts

The UHF socket pictured demonstrates a specific type of application for which Kel-F* polymers are especially suited. However, it also serves excellently to illustrate the unique combination of properties that has caused designers to specify Kel-F for many other electrical and electronic applications.

The two upper pictures illustrate the accuracy of the parts obtained by ordinary injection molding of Kel-F. Neither the molded socket base (top), nor the cover piece (middle) had to be "finished" in any way prior to assembly. Grommet holes, slots for contact clips, the slits through which connection terminals extend, and even supports and spacers . . . all were formed in a single injection molding operation for each piece . . . to such close tolerances that the contact clips on this particular socket provided the most positive electrical contact ever attained . . . resulted in a 2,000 RMS voltage rating.

Pressure Assembly Techniques can be used

The extraordinary mechanical strength of Kel-F polymers is demonstrated in the lower picture of the assembled socket. These tube sockets were assembled on a one-ton press . . . the mechanical properties of Kel-F permitted this type of pressure assembly without cracking or chipping.

The Brillhart Plastics Corporation of Mineola, N. Y., in undertaking the job of molding Kel-F into the two Kel-F insulators described here, pioneered the techniques for injection molding of intricate parts from trifluorochloroethylene.

Refer to Report E 102

Molders of the Month

Leading molders and extruders specialize in fabrication of materials and parts made of Kel-F . . . each month this column will spotlight several of these companies with their principal services and products.

Chicago Die Mold Division U. S. RUBBER COMPANY Chicago, Ill.

Compression and
Injection Molding
Valve Diaphragms
Military Components

Plax Corporation Hartford, Conn.

Extruded Rod and Tubing
Molded Rod and Tubing
Molded Sheets (to 1/8" thick)
Injection Molding
Military Components

Resistoflex Corporation Belleville, N. J.

Extruded Rod and Tubing
Compression Molded Sheets
and Discs

Revere Corp. of America Wallingford, Conn.

Coated Wire and Cable

United States Gasket Company Camden, N. J.

Compression Molding
Gaskets and Packing
Extruded Rod and Tubing
Injection Molding
Military Components

The Visking Corporation

Terre Haute, Ind.
Extruded Thin Film
Extruded Lay-flat Tubing

For complete information regarding any item mentioned in DESIGN AND PRODUCTION NEWS, ask for detailed APPLICATION REPORTS, write

Technical Service

CHEMICAL MANUFACTURING DIVISION

THE M. W. KELLOGG COMPANY

P. O. Box 469, Jersey City 3, N. J.
or offices in New York, Chicago,
Los Angeles,



* Registered trademark for The M. W. Kellogg Company's trifluorochloroethylene polymers

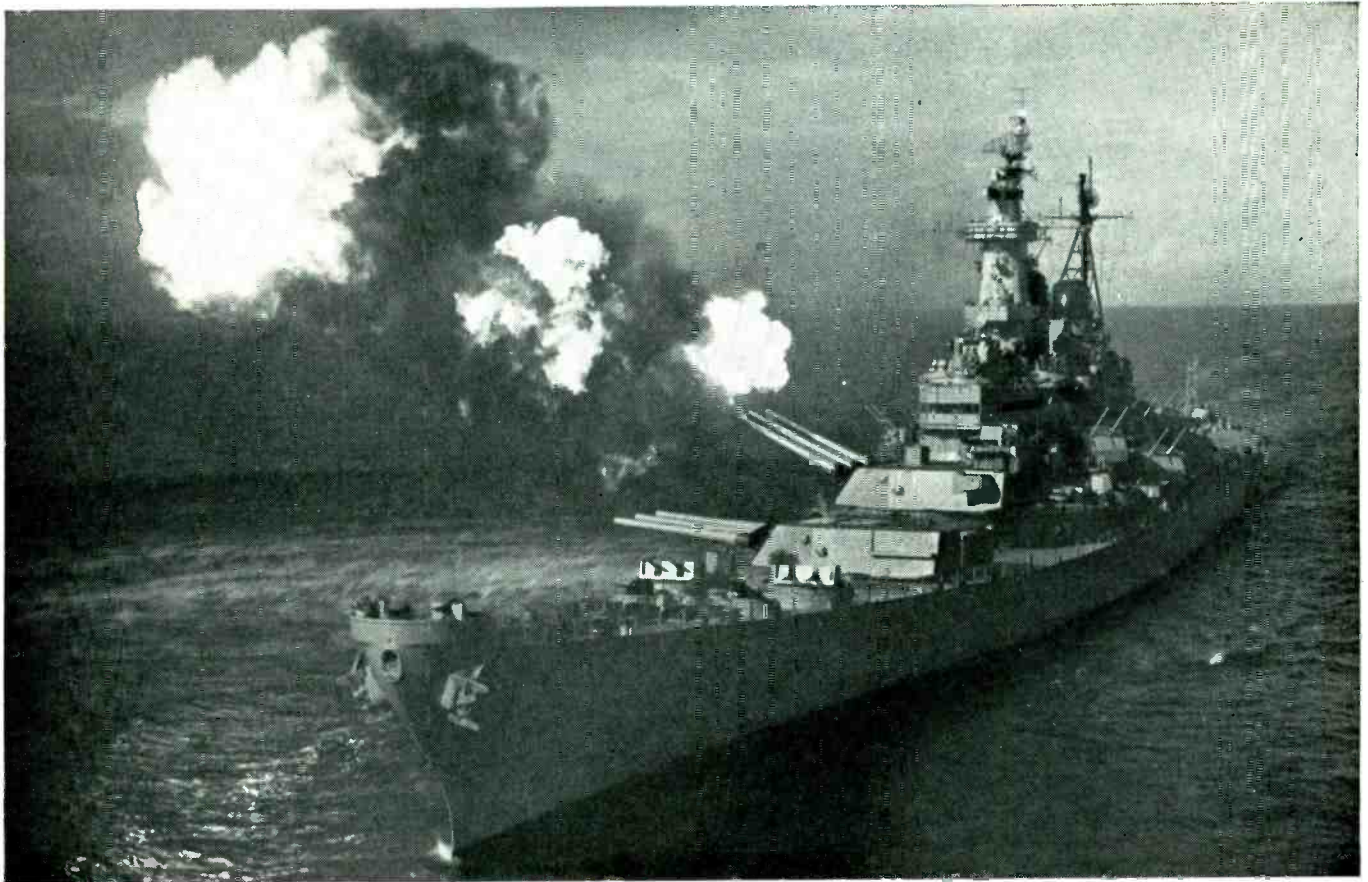

Official U. S. Navy Photo

range...

The range of these big guns exceeds anything else afloat. In a like manner, Edo echo-sounding equipment now being installed on ships of the U. S. Navy gives far greater range and accuracy than other types of sonar previously used. This superior performance promises important advances in both ocean navigation and naval tactics.

For instance, the Edo Model 185 deep sounder continuously measures and records any known ocean depths giving the navigator a new means of plotting his course by ocean bottom contours. Other Edo sonar devices search out and detect distant vessels with a range and accuracy never before believed possible.

Such successful results come only from a research and engineering staff endowed with imagination, ingenuity and the ability to apply the latest developments in the whole field of electronics to any specific problem — a characteristic Edo trait for over a quarter of a century.

A SYMBOL KNOWN AND RESPECTED FOR OVER A QUARTER OF A CENTURY

Twenty-seven years of experience are behind the leadership which Edo enjoys in the field of sonar development, research and manufacture. Members of the Edo engineering staff have pioneered many of the developments which make the use of echo-ranging underwater detection equipment an increasingly important function not only in anti-submarine warfare but also in the safe and efficient operation of modern ships.

The exceptional performance of Edo equipment brings to the famous flying fish emblem increasing recognition as the symbol of superior equipment.



EDO CORPORATION • COLLEGE POINT, N. Y.

introducing

C-3 methods manual

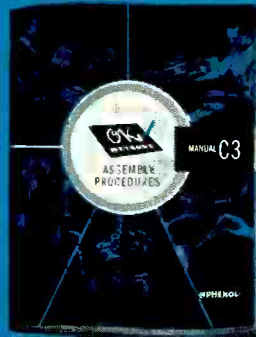

The C-3 Methods Manual represents a composite of better methods for the wiring and assembly of Amphenol cables and connectors. All the advocated methods have been compared, tested and have passed stringent screening, not only by Amphenol's engineers but by others in the field as well.



The C-3 Methods Manual is divided into three general sections: Wiring "AN" and Special Electrical Connectors; General Techniques with alternate methods suggested where facilities and quantity production influence the methods to be used; Assembly Procedure for RF Connectors.

Each procedure is concisely outlined step by step and accompanied by diagrams and illustrations.

The high quality of the electronic connectors and cables to be used must be matched by the quality of the workmanship going into each assembly and it is to this urgency of good workmanship that "OK Methods" is dedicated.

AMPHENOL

AMERICAN PHENOLIC CORPORATION
chicago 50, illinois

Oil and Gas Co., Tulsa, Okla., to the complex device incorporated in the Tristimulus Integrator invented by S. A. Loukowsky and E. I. Stearns, and awarded patent number 2,603,123, assigned to American Cyanamid Company, of New York.

In the "Electrical Computer" illustrated in Fig. 2 electrical resistance circuits in several meshes are employed to compute the economic factors of a distribution system. A series of adjustable impedances Z are so arranged that

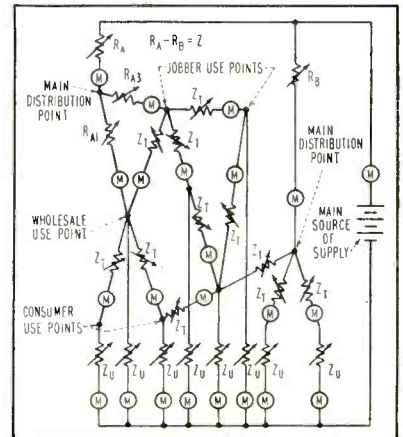

FIG. 2—Meters in mesh circuits indicate oil supplied to distribution points in this business-type computer

current flowing through each of them is proportional to the relative amount of goods (oil in this instance) that is to be supplied to use points from each distribution point. There is a variable impedance Z_U representing each use point and arranged so the current flowing through each impedance represents consumption of the goods at each associated use point.

A third set of impedances Z_T , is generally adjustable in nature and connects supply points to use points. They are called transportation units. If a use point is supplied by more than one source point, the corresponding number of transportation units will interconnect the appropriate points. Subsidiary distribution points corresponding to the jobber or wholesaler are appropriately connected, or if the producer is to distribute direct to consumer, a transportation unit connects between them. With the system connected to an appropriate set of connection devices such as

pushbuttons, an oil company with several interconnecting pipe lines to its distribution centers and consumption areas may calculate by analogy the load requirements of its distribution system. Meters *M* will show each consumption or distribution point's requirements.

The tristimulus integrator is designed to compute the tristimulus values of colored samples. It is a physiological fact that the effect of light of any color can be specified by three numbers that are the relative amounts of each of the primaries to be mixed in order to produce a match. The apparatus incorporates a flickering beam spectrophotometer, as a driver for a pulse generator and a weighting system, output pulses of which are applied to a decade counter.

It has not been practical to use digital computers, according to the inventor, for integration of the tristimulus functions by the selected ordinate method because the maxima of tristimulus functions are so close together. Apparatus capable of producing electrical pulses proportional to reflectance or transmission of a number of closely spaced selected ordinates is not mechanically practical.

In the present invention the selected ordinates are divided into groups of varying spaces. The center unit of the selected group is then used by giving it a suitable weighting factor, in this case, in the simplest terms, based on the powers of two, as 2, 4, 8, 16, etc. The system is then in condition to be handled by binary electronic computers.

The wavelength drive of a re-

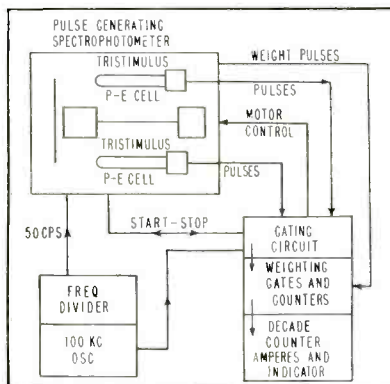

FIG. 3—Color matching is facilitated by tristimulus integrator that provides an accuracy of 1 part in 5,000

AMPHENOL

The majority of Amphenol electronic components—and there are now over 9,000 in the standard line—were developed first to fulfill a specific application problem arising in the industry. When you consult with Amphenol Engineers in solving your electronic and power application needs, you will be working with one of the most specialized engineering staffs and testing laboratories in the electronic world.



visit AMPHENOL booths 1-101 and 1-102

I. R. E. CONVENTION
MARCH 23-26, 1953
GRAND CENTRAL PALACE
NEW YORK

If you are not attending the I.R.E. Convention, mail the coupon below for your copy of "OK Methods."

AMERICAN PHENOLIC CORPORATION
1830 South 54th Avenue • Chicago 50, Illinois

NAME

COMPANY

ADDRESS

CITY

POSITION

ZONE

STATE

Need Precision Pots NOW? CALL HELIPOT!

When you need top quality potentiometers fast, call Helipot
... first in precision potentiometers!
Shown on these pages are various types and ranges of
Helipots—both single and multi-turn—that Helipot now stocks for
immediate delivery. You can have stock prototypes immediately. On
large orders for stock items, initial deliveries in substantial quanti-
ties will be made promptly, with balance on close schedule.
Prompt attention will be given your requirements for Pre-
cision Pots to your individual specifications.
Helipot's objective is to give you the same flexibility and
efficiency as a department of your own company. Our trained per-
sonnel and unequalled facilities are ready to serve your needs,
whether for standard units shown here or for special designs in
quantity to meet particular applications.
For fast service, call the nearest representative listed below.
Or write, wire or phone direct!

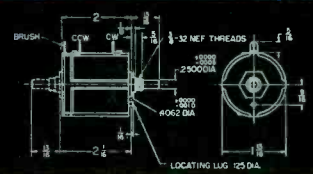

MODEL A HELIPOTS

The most widely adapt-
able of all multiturn Helipots. A 10-turn unit of
convenient, compact size
offering resolution accu-
racies 12 to 14 times that
of conventional single-
turn units of same diam-
eter. 10-turn range permits
direct decimal readings.
10-turns... Power rat-
ing 5 watts... Coil
length 46.5"... Linearity
tolerances: $\pm 0.5\%$ (Std.
all values), ($\pm 0.1\%$ 5K
and up, $\pm 0.25\%$ below
5K).*

TABLE OF STOCK VALUES

Catalog No.	Total Resistance (Ohms)	Wire Turns	Temperature Coefficient
25-AZ	25	3,000	.00071
50-AZ	50	3,200	.00071
100-AZ	100	3,800	.00071
200-AZ	200	4,750	.00071
500-AZ	500	4,000	.00002
1,000-AZ	1,000	5,000	.00002
2,000-AZ	2,000	6,500	.00002
5,000-AZ	5,000	7,200	.00013
10,000-AZ	10,000	9,000	.00013
20,000-AZ	20,000	10,000	.00013
30,000-AZ	30,000	11,500	.00013
50,000-AZ	50,000	12,500	.00013
100,000-AZ	100,000	15,000	.00013
200,000-AZ	200,000	15,500	.00013
300,000-AZ	300,000	16,000	.00013

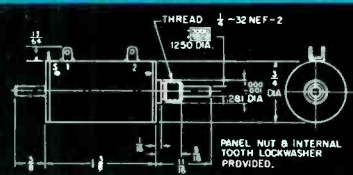

MODEL AJ HELIPOTS

The AJ is a high performance 10-turn helical potentiometer of miniature size (3/4" dia.) and light weight (1 oz.). Available with bushing mount (AJ) or servo mount (AJS), both with sleeve bearings. Servo mount also available with precision ball bearings (AISP).
10-turns... Power rating 2 watts... Coil length 18"... Linearity tolerance $\pm 0.5\%$ (Std.)
... Starting torque 0.75 oz. in... Wgt. 1 oz... Dia. 3/4".*

TABLE OF STOCK VALUES

Catalog No.	Total Resistance (Ohms)	Wire Turns	Temperature Coefficient
100-AJZ	100	3,000	.00071
500-AJZ	500	2,500	.00002
1,000-AJZ	1,000	3,400	.00002
5,000-AJZ	5,000	4,250	.00013
10,000-AJZ	10,000	4,000	.00013
20,000-AJZ	20,000	5,350	.00013
30,000-AJZ	30,000	5,450	.00002
50,000-AJZ	50,000	6,550	.00002

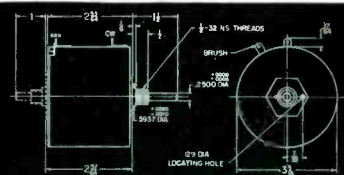

MODEL B HELIPOTS

A large diameter (3-5/16") 15-turn Helipot with 139" slide wire length providing the highest resolution (.01% to .003%) and adjustment accuracy available today in a standard mass-production unit. Rugged, dependable, low in cost.
15-turns... Power rating 10 watts... Coil length 139"... Linearity tolerance $\pm 0.5\%$ (Std.).*

TABLE OF STOCK VALUES

Catalog No.	Total Resistance (Ohms)	Wire Turns	Temperature Coefficient
1,000-BZ	1,000	10,900	.00002
5,000-BZ	5,000	19,500	.00002
10,000-BZ	10,000	17,700	.00013
25,000-BZ	25,000	21,800	.00013
50,000-BZ	50,000	25,400	.00013
100,000-BZ	100,000	34,100	.00013

Please note that 1000 volts is highest that may be applied across coil regardless of resistance value.

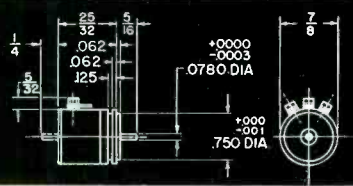

MODEL T HELIPOTS

A single-turn, continuous-rotation servo-mounting unit of minimum weight (0.56 oz.) requiring very small cubic space and operating with negligible torque. Shaft rotates on precision ball bearings—unit built throughout to highest possible precision.
1-turn... Power rating 1/2 watt... Coil length 2"... Linearity tolerance $\pm 0.5\%$ (Std.)... Starting torque .015 in. oz. (Running torque is negligible)
... Wgt. 0.56 oz.*

TABLE OF STOCK VALUES

Catalog No.	Total Resistance (Ohms)	Wire Turns	Temperature Coefficient
1,000-TZ	1,000	705	various
2,000-TZ	2,000	750	various
5,000-TZ	5,000	800	various
10,000-TZ	10,000	1,650	various
20,000-TZ	20,000	1,500	.00002
25,000-TZ	25,000	1,500	.00002
30,000-TZ	30,000	1,400	.00002
50,000-TZ	50,000	1,400	.00002
100,000-TZ	100,000	1,500	.00002

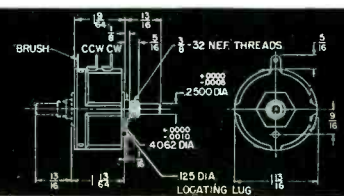
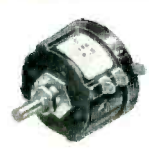

MODEL C HELIPOTS

Identical in general design to Model A except has only 3 helical turns of resistance winding and proportionately shorter length. Ideal for high-accuracy applications with restricted behind-panel depths.
3-turns... Power rating 3 watts... Coil length 13 1/2"... Linearity tolerance $\pm 0.5\%$ (Std.)... Behind-Panel Length 1-9/64".*

TABLE OF STOCK VALUES

Catalog No.	Total Resistance (Ohms)	Wire Turns	Temperature Coefficient
10-CZ	10	1,000	.00071
50-CZ	50	1,390	.00071
100-CZ	100	1,100	.00002
500-CZ	500	1,850	.00002
1,000-CZ	1,000	1,360	.00013
5,000-CZ	5,000	2,500	.00013
10,000-CZ	10,000	3,100	.00013
20,000-CZ	20,000	3,900	.00013
30,000-CZ	30,000	4,400	.00013
50,000-CZ	50,000	4,250	.00013

*ON SPECIAL ORDER most of the above potentiometers are available with Rear Shaft Extensions... Extra Spot Welded Taps at any location... Special Assemblies... Temp. Coefficients, Resolutions, etc.
Write for details!

Design details on above units subject to change without notice. Certified drawings available on request.

Engineering Sales Representatives are located near you to assure personal attention. Teletype connects our New York, Boston, Chicago and Los Angeles offices for rapid information on orders and deliveries. And our Mountainside, New Jersey plant, now under construction, will soon be in production to further assist you.



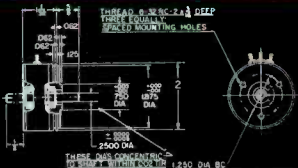

MODEL J HELIPOTS

First production potentiometer equipped with ball-bearing shaft supports as standard and 3-way servo-type mounting. Ganged assemblies can be independently phased after installation without external clamps or brackets.

1-turn... Power rating 5 watts... Coil length 5 1/2"... 360° Cont. Mech. Rotation... Linearity tolerance ±0.5%... Starting torque 1.0 ± .25 oz. in.*

TABLE OF STOCK VALUES

Catalog No.	Total Resistance (Ohms)	Wire Turns	Temperature Coefficient
100-JZ	100	630	.00002
1,000-JZ	1,000	875	.00017
5,000-JZ	5,000	1,300	.00017
10,000-JZ	10,000	1,475	.00017
20,000-JZ	20,000	1,900	.00017
30,000-JZ	30,000	1,975	.00017
50,000-JZ	50,000	2,260	.00002

Please note that 400 volts is highest that may be applied across coil regardless of resistance value.

MODEL G HELIPOTS

A small, extra rugged single-turn pot developed initially for aircraft servo mechanisms. Its compact size, high accuracy, long life make it ideal for many instrumentation and servo-mechanism applications.

1-turn... Power rating 2 watts... Coil length 3 1/4"... 360° Cont. Mech. Rotation... Linearity tolerance ±0.5% (Std.)... Wgt. 2 Oz... Dia. 1-5/16"*

TABLE OF STOCK VALUES

Catalog No.	Total Resistance (Ohms)	Wire Turns	Temperature Coefficient
10-GZ	10	300	.00071
100-GZ	100	400	.00002
500-GZ	500	500	.00013
1,000-GZ	1,000	650	.00013
5,000-GZ	5,000	750	.00013
10,000-GZ	10,000	950	.00013
20,000-GZ	20,000	1,200	.00013

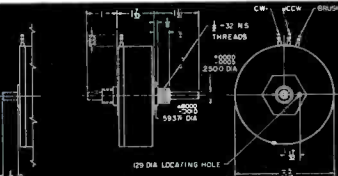

MODEL F HELIPOTS

A 3" dia. single-turn high-precision potentiometer with continuous mechanical rotation and minimum dead spot between electrical ends. Versatile in application. Ideal where continuous rotation simplifies circuitry.

1-turn... Power rating 5 watts... Coil length 9 1/4"... Linearity tolerance ±0.5%*

TABLE OF STOCK VALUES

Catalog No.	Total Resistance (Ohms)	Wire Turns	Temperature Coefficient
100-FZ	100	800	.00002
500-FZ	500	1,300	.00002
1,000-FZ	1,000	1,200	.00013
5,000-FZ	5,000	2,000	.00013
10,000-FZ	10,000	2,500	.00013
20,000-FZ	20,000	2,700	.00013
50,000-FZ	50,000	4,000	.00013
100,000-FZ	100,000	5,000	.00002

Please note that 400 volts is highest that may be applied across coil regardless of resistance value.

NOT CARRIED IN STOCK but quickly available on order

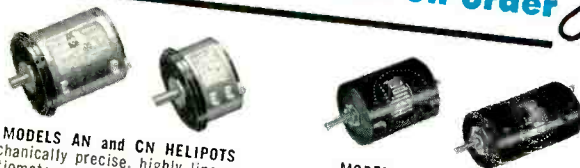

MODELS AN and CN HELIPOTS
Mechanically precise, highly linear potentiometers of same general dimensions as Models A and C, except have servo-mountings, ball-bearing shafts and are built to highest precision possible. Have approximately 2:1 advantage in linearity accuracies over corresponding A and C Helipots. (Model AN linearity tolerances as close as ±.025% in values of 5K and above.) AN (10-turns) resistance ranges, 100 to 250,000 ohms... CN (3-turns) 30 to 75,000 ohms.
Write for full details on linearity tolerances, special features, etc.

MODELS D and E HELIPOTS
Large diameter (3-5/16"), wide range Helipots with extremely long resistance windings for highest possible resolutions coupled with close linearity tolerances.
Model D has 25 turns, 234" coil length, 9000° of rotation, is 4-9/64" deep behind the panel, and is available in ranges from 100 to 750,000 ohms.
Model E has 40 turns, 373" coil length, 14,400° of rotation, is 6-1/64" deep behind panel, resistances 200 to 1,000,000 ohms.
Write for full details on linearity tolerances, special features, etc.

OTHER UNIQUE HELIPOT PRODUCTS



MODEL RA Precision DUODIALS

A beautiful, precision-built, multi-turn dial of compact dimensions (1-13/16" dia.) for all types of quality multi-turn installations. Features unique "jump" mechanism that keeps secondary dial stationary until primary dial has completed a full turn—then secondary dial "jumps" to new position. A vibration-proof lock holds dial settings whenever desired.

Black nylon knobs, satin aluminum dials, plenty "feel" and appearance throughout. Available in 10-turn design for use with 3 and 10-turn Helipots and in RA1 version for use with small AJ Helipots.

Write for full details.



MODEL M DUODIALS

A large diameter (4 3/4") multi-turn dial ideal for primary control applications. The inner dial shows the exact position of the slider on any multi-turn Helipot while the outer dial shows the particular turn on which the slider is moving. Thus with 10-turn units, readings can be made directly in decimal equivalents of total resistance winding.

Since primary dial is direct-connected to shaft, backlash is eliminated.

Available in 10:1, 15:1, 25:1, and 40:1 Ratios for use with various Helipot models as well as with other multi-turn equipment.

Write for full details.



LABORATORY HELIPOT—MODEL T-10A

This unit combines in a handsome walnut case a 10-turn Helipot, an "RA" Duodial, and three-way binding posts for quickly setting up and changing experimental or temporary circuits. Ideal for laboratory and instruction purposes... is far more compact, simpler and 5 times faster to set than decade boxes.

Power rating 5 watts... Linearity 0.1%... Standard Resistance Ranges 100... 500... 1,000... 5,000... 10,000... 20,000... 50,000... 100,000 ohms in stock. Other ranges on order.

Write for full details.

- 1. NEW YORK
B. B. Taylor
241 Sunrise Highway
Rockville Centre, New York
ROCKVILLE CENTRE 6-1014-6-1015
TWX: Rockville Centre NY 3685
- 2. ROCHESTER
E. A. Ossmann Corp.
3 Juniper Street
Rochester 10, New York
CUlver 7640
- 3. SCHENECTADY, N. Y.
E. A. Ossmann Corp.
DELanson 2319

- 4. BOSTON
Harold Gerber
25 Huntington Avenue
Boston 16, Massachusetts
COpley 7-1961
TWX: BS 168
- 5. PHILADELPHIA
James C. Muggleworth
506 Pichey Avenue
Collingswood 6, New Jersey
COllingswood 5-3515
- 6. CLEVELAND
Howard N. Healey
1940 East Sixth Street
Cleveland, Ohio
PROsper 1552

- 7. CHICAGO
Roy J. Magnuson
4258 West Irving Park Road
Chicago 41, Illinois
PAIAside 5-1170
TWX: CG 913-X
- 8. ST. LOUIS
Harris-Hanson Company
5506 South Kingshighway
St. Louis 9, Missouri
SWeeTbriar 5584
- 9. FORT MYERS
Arthur H. Lynch & Associates
P. O. Box 466
Fort Myers, Florida
FORt Myers 5-6762

- 10. LOS ANGELES
G. S. Marshall Company
40 South Los Robles
Pasadena 1, California
RYan 1-8345; SYcamore 5-2022
Helipot Home Office
TWX: Pasa Cal 7193
- 11. SEATTLE
Samuel N. Stroum
1612 Broadway
Seattle 22, Washington
FRAnklin 7515-7516
- 12. DALLAS
J. Y. Schoonmaker Company
2011 Cedar Springs
Dallas 1, Texas
STERling 3335

- 13. DETROIT
S. Sterling Company
15310 West McNichols Rd.
Detroit 35, Michigan
BRoadway 3-2900
- 14. SOUTH CENTRAL
Bivins & Caldwell
Security Bank Bldg.
High Point, N. C.
High Point 3672
- 15. CANADA
J. S. Root
290 Lawrence Ave. W.
Toronto 12, Ontario, Canada
ORchar 3003

50% SMALLER LIGHTER

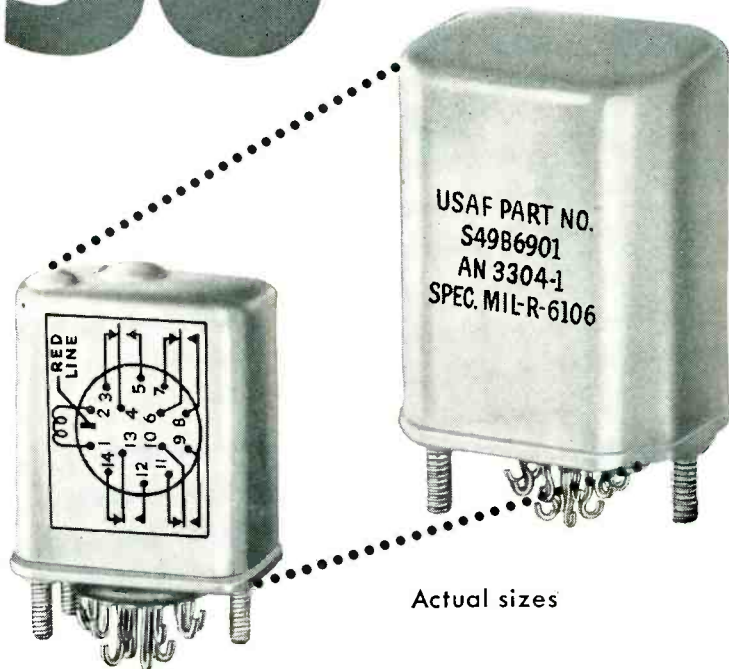

Actual sizes

R-B-M 22300 SERIES

Hermetically Sealed Relays

The R-B-M 22300 hermetically sealed telephone type relay is the electrical and mechanical equivalent of AN 3304-1, except for smaller size and mounting dimensions.

An improved armature design, plus high temperature molded nylon coil bobbin, provides greatly improved magnetic efficiency and enables R-B-M to reduce the overall size of the relay. The R-B-M 22300 design still retains palladium cross-bar contacts identical to those used in the larger size.

Maximum contacts—6 Form A and 4 Form C—3 ampere 28 Volts. D. C. coil construction only. Maximum coil resistance 5000 ohms. Minimum power .75 watts. Also available in AN 3304 can for dynamotor or low capacitance application.

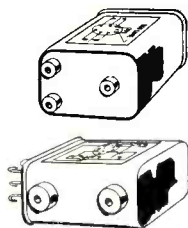

Optional Mounting Arrangements

Write Dept. B-3 for ASR Bulletin.



**R-B-M DIVISION
ESSEX WIRE CORP.**
Logansport, Indiana

MANUAL AND MAGNETIC ELECTRIC CONTROLS
— FOR AUTOMOTIVE, INDUSTRIAL, COMMUNICATION AND ELECTRONIC USE

ording flickering beam spectrophotometer is arranged to gate a pulse generating system into the circuit at wavelengths of light corresponding to the selected ordinates, and to cut in the electronic gates to the counter circuits so the pulse generator applies pulses to the counter directly for ordinates of maximum weight, and to flip-flop circuits that precede the counter for lesser weights. For weights of, 1, 2, 4, 8, 16, and 32 there will be a total of five flip-flop circuits.

Ordinates bearing the weight 32, will open the gate circuit directly connecting the pulse generator to the counter. For an ordinate weighted 16 the last flip-flop before the counter is interposed between the pulse generator and the counter, and weights of 1 will open the first flip-flop circuit and so on. The number of pulses generated at each ordinate is proportional to the reflectance or transmission as measured by the spectrophotometer for that particular wavelength.

While a separate integrator could be set up for each primary wavelength the tristimulus integrator can be economically provided with switches to obtain as many tristimulus values as desired. An accuracy of 1 part in 5,000 is claimed for the system of this invention which is equal to or better than the accuracy of the human eye, for all practical purposes.

The system of the tristimulus integrator is illustrated in Fig. 3. It has been simplified considerably in block form.

Multiplex Telegraph

A recent patent for a "Multiplex Telegraph System Utilizing Electronic Distributors" was awarded to T. A. Hansen. The patent number 2,609,451 is assigned to Teletype Corp. of Chicago, Ill. It is the inventor's object to provide a multiplex telegraph system capable of higher speeds and an increased number of channels with great stability. The system provides means for ascertaining when specific channels are open, and for varying the speed at which transmission is carried in any channel. The distributors are all electronic as are all test and control facilities and the entire

CONTROLLED QUALITY PRODUCTION



HiperCore

ELECTRONIC CORES

**PERMIT SUPERIOR PERFORMANCE
IN MANY ELECTRONIC PRODUCTS**

The superior performance of Moloney HiperCore Electronic Cores is immediately discernable when incorporated in various electronic products. This is the result of rigid quality control during manufacture.

To begin with... every mill shipment of cold-rolled, oriented grain, high permeability steel for HiperCore Cores must pass rigid Epstein Tests. Then, during manufacture... *care and precision* in the winding on Moloney's patented winding mandrels... absolute control of tension... exact overall dimensions. *Care*... in annealing to relieve stresses by maintaining accurate temperature and atmospheric control. *Care*... in cutting, to obtain a minimum gap followed by an etching process to insure inter-laminar insulation.

Production, in quantity, is available to you if you need superior performance, smaller size, less weight in your electronic cores.

ME-53-5



Write today for Bulletin SR-205 containing specifications, performance data and prices on over 300 standard sizes. Over 1000 sizes available for special applications.

Bulletin GF-531... "A Trip Through the Moloney Plant"... 48 pages in full color picturing the facilities of the Moloney Electric Company... will be sent free upon request.

MOLONEY ELECTRIC CO.

Manufacturers of Power Transformers • Distribution Transformers • Load Ratio Control Transformers Step Voltage Regulators • Unit Substations

SALES OFFICES IN ALL PRINCIPAL CITIES
FACTORIES AT ST. LOUIS, MO. AND TORONTO, ONT., CANADA



**BETTER PERFORMANCE
GREATER RELIABILITY
LESS MAINTENANCE**

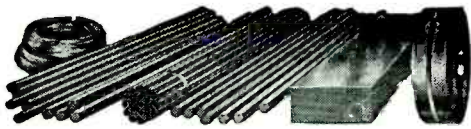

BRIDGEPORT BRASS COMPANY

COPPER ALLOY BULLETIN



MILLS IN BRIDGEPORT, CONN. AND INDIANAPOLIS, IND.—IN CANADA: NORANDA COPPER AND BRASS LIMITED, MONTREAL

Brass Plumbing Integral Part of Magnetron Tube

During World War II the magic word RADAR denoted a new and powerful secret weapon which proved instrumental in our ultimate victory. Today many advanced types of radars are being designed for both military and civilian use. Some military radars are fire control systems used to aim and fire different types of weapons. Others are search radars which detect enemy ships, planes, etc., in time to alert our defenses. Civilian radar is used by commercial ships and planes as a navigation aid to combat poor visibility.

Although these equipments all differ in their construction and application, they have one thing in common, a high frequency oscillator and output tube called a magnetron.

Military Magnetron

Illustrated is the RK2J56 Magnetron used in fire control radar equipment. This tube uses a special brass wave guide assembly to couple its output to the antenna system. All parts conducting high frequency waves such as the rectangular and circular sections are made from Red Brass tubing (approximately 85% copper and 15% zinc) because of its high resistance to corrosion and ability to take a good plate. A smooth mirror-like internal surface is necessary in order to properly reflect the high-frequency waves.

After the tubing is silver soldered in place, the internal surfaces are broached to remove any excess solder and to prepare them for either silver or bright alloy plating. The mounting bracket and flange are blanked from high brass (approximately 66% copper, balance zinc). The stock used for the flange must be extra flat to insure an airtight connection with the wave guide as the whole system is pressurized.

One end of the rectangular section is closed with a brass plug made in two sections. The bottom or inside surface is drawn from Red Brass sheet stock. The top or outer surface is blanked from high brass strip and the two sections are soldered together. A threaded mounting hole is located on top of the plug.

Civilian Magnetron

Magnetrons are also found in other types of high frequency equipment besides radar. The illustrated QK174 is a continuous-wave frequency-modulated magnetron used in television relay equipment. The plate support assembly consists of a high brass mounting plate $\frac{1}{8}$ " thick with four $\frac{3}{16}$ " mounting holes at the corners and a $1\frac{1}{4}$ " hole in the center. A tubular section $3\frac{1}{4}$ " x $1\frac{1}{4}$ " made from free machining brass is inserted through the center hole in the mounting plate and

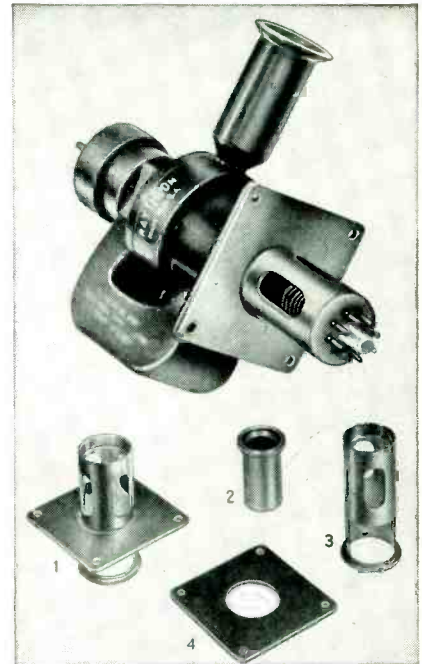

QK174 PLATE SUPPORT ASSEMBLY
1. Complete plate 2. Output coupler
3. Tubular section support assembly 4. Mounting plate

QK174 Magnetron and Plate Support Assembly. Courtesy Raytheon Manufacturing Co., Waltham, Mass.

silver soldered in place. The assembly is bright-alloy plated for greater protection from corrosion and then connected to the magnetron by means of three mounting screws inserted through one end of the tubular section. An octal tube socket is fitted on the other end of the tubular section enabling the magnetron to be plugged into the circuit. The whole unit is held in place by four screws which fasten the mounting plate securely to the transmitter chassis.

A brass coupler $1\frac{1}{8}$ " long made from $1\frac{1}{4}$ " free machining brass rod stock serves to couple the output of the magnetron to the wave guide system.

In high frequency applications a number of qualities such as machinability, conductivity, resistance to corrosion, and ability to solder and plate well, must be considered when choosing a copper-base alloy. Bridgeport Brass will be glad to help you determine the alloy best suited to meet your exacting requirements. (9419)



RK2J56 WAVE GUIDE ASSEMBLY
1. Complete wave guide assembly 4. Mounting bracket
2. Tubular sections 5. Plug
3. Rectangular section 6. Flange

RK2J56 Magnetron and Wave Guide Assembly. Courtesy Raytheon Manufacturing Co., Waltham, Mass.

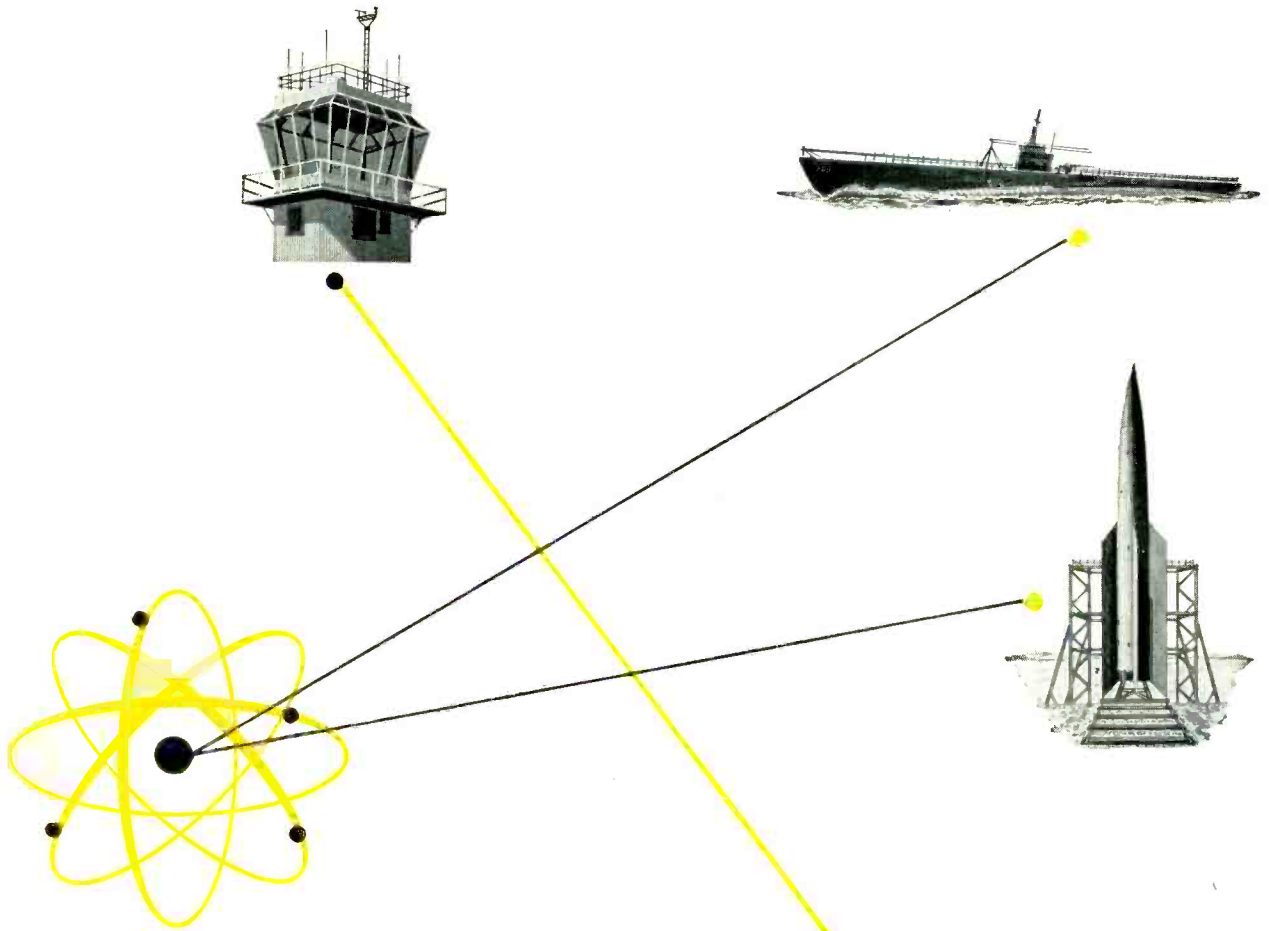

diversified experience in avionics

● Contracts with U. S. and foreign governments for electronic work are nothing new at Air Associates! For many years, our Electronic Division has been developing and manufacturing LF, VHF and UHF communication and navigation systems, landing systems, firing error indicator systems, echo ranging systems (including sonar) and special miniaturized electronic devices. Our wide experience and expanded facilities for airborne, marine and ground electronics equipment are available to help solve your design and production problems. Your inquiry to Teterboro will receive prompt attention.



Air Associates
INCORPORATED
TETERBORO, NEW JERSEY



SERVING THE NATION IN AVIATION

Winchester Electronics

MINIATURE EXTERNAL CONNECTORS

(in metal shell enclosures)

Maximum protection, Minimum weight, Minimum space

Recent designs of electronic equipment in aircraft and guided missiles have required progressive miniaturization of electronic components. These external connectors are typical of several special designs we have supplied to meet miniature requirements.



PHOTOS 2/3
DWGS. 1/3
ACTUAL SIZE

CR5-2P-R
Receptacle

CR5-2S-R
Plug

These Connectors
also employ standard
Winchester Electronics'
FEATURES:

MONOBLOC* CONSTRUCTION

Eliminates unnecessary creepage paths, moisture and dust pockets, and provides stronger molded parts.

MOLDED MELAMINE BODIES

(In accordance with MIL P-14a), Mineral filled, are fungus-proof and provide mechanical strength as well as high arc and dielectric resistance.

PRECISION MACHINED CONTACTS

Pins from brass bar stock (QQ-B611) and sockets from spring temper phosphor bronze bar (QQ-B746a). They are gold plated over silver for consistent low contact resistance, reduction of corrosion and ease of soldering.

POLARIZATION

Positive engagement is effected by an integral key and mating groove in the shells.

**WINCHESTER
ELECTRONICS
INCORPORATED**

GLENBROOK, CONN., U.S.A.

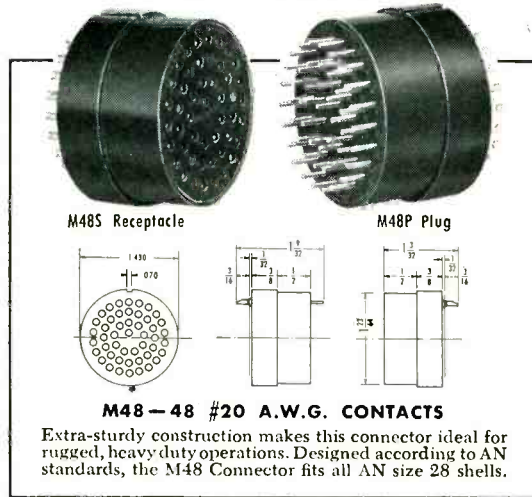

M48S Receptacle

M48P Plug

M48-48 #20 A.W.G. CONTACTS

Extra-sturdy construction makes this connector ideal for rugged, heavy duty operations. Designed according to AN standards, the M48 Connector fits all AN size 28 shells.

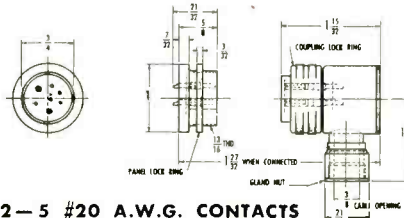

CR5-2-5 #20 A.W.G. CONTACTS 2 #18 A.W.G. CONTACTS

This miniature connector (1" x 1 1/8" lgth.), in an aluminum die cast shell, is sealed with neoprene gaskets around the inserts and around each contact for pressure-tight construction. Air leakage is less than 1 cubic inch per hour at 30 PSI pressure differential. The reversed arrangement (illustrated) provides pin contacts in the panel mounted receptacle, socket contacts in the cable mounted plug. In the standard arrangement (not shown) the cable mounted plug contains the pin contacts. The metal shell has an olive drab iridite finish.

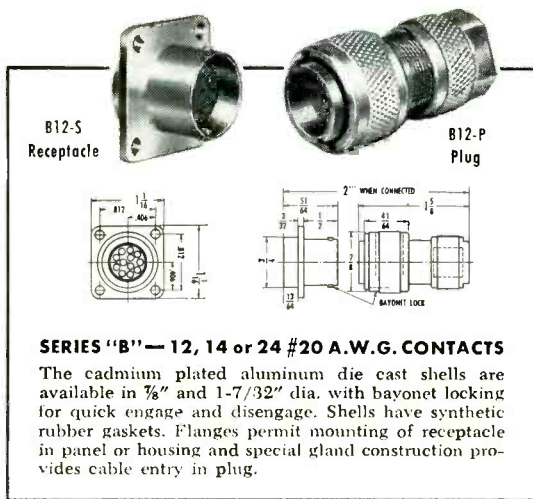

B12-S
Receptacle

B12-P
Plug

SERIES "B" - 12, 14 or 24 #20 A.W.G. CONTACTS

The cadmium plated aluminum die cast shells are available in 3/8" and 1-7/32" dia. with bayonet locking for quick engage and disengage. Shells have synthetic rubber gaskets. Flanges permit mounting of receptacle in panel or housing and special gland construction provides cable entry in plug.

*Trade Mark

Patents Pending

Our Sales Department invites your inquiries. Wire or write for catalog of other types or advise us of your special requirements.

WEST COAST BRANCH:

1729 Wilshire Boulevard, Santa Monica, California

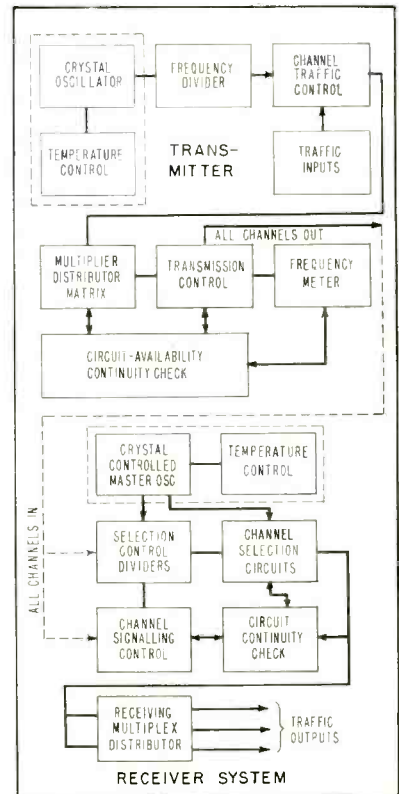

FIG. 4—Multiplex telegraph system is capable of higher speeds and greater stability

system is stabilized by precision quartz-crystal oscillators. It is possible to control the facilities to allow transmission from two, three or four signal sources to divide equally over any available number of channels in use. Twenty-three sheets of circuit diagrams are required to set forth the multiplex telegraph system. A block diagram of the system is shown in Fig. 4.

Magnetic Tape Performance

A system of testing the performance characteristics of magnetic tape used in sound recording is the subject of patent 2,610,230 granted to D. E. Weigand of the Armour Research Foundation, Illinois Institute of Technology, Chicago, Ill. The patent is assigned to the latter Foundation, and describes an "Integrator and Hysteresis Loop Tracer". Employing the pickup shown in Fig. 5 a magnetic tape sample is passed through the device wherein it is energized and de-energized by a 60-cycle field. Pickup loops in the device compare the energizing field with the flux density and magnetomotive force de-

C D

onsistently
ependable

DYKANOL*

CAPACITORS

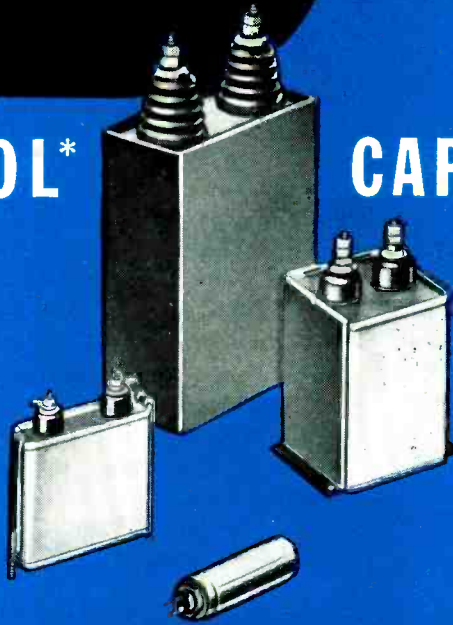

* COPYRIGHTED TRADE MARK OF C-O IMPREGNATES



Nobody knows oil capacitors like C-D. It's generally acknowledged that "nobody can duplicate C-D's Dykanol capacitor." You can count on the ruggedness and durability that have made C-D capacitors famous for 42 years and that is all too rare these days. Catalog No. 40t will show you how broad the line is. Write for it to: Dept. K33, Cornell-Dubilier Electric Corp., South Plainfield, N. J.

CORNELL-DUBILIER
world's largest manufacturers of capacitors

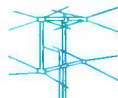

ANTENNAS



ROTATORS



CAPACITORS



VIBRATORS



CONVERTERS

SOUTH PLAINFIELD, N. J. • NEW BEDFORD, WORCESTER AND CAMBRIDGE, MASS. • PROVIDENCE, R. I. • INDIANAPOLIS, IND. • FUQUAY SPRINGS, N. C. • SUBSIDIARY, THE RADIART CORP., CLEVELAND, O.

Flexible



Improved New VARGLAS SILICONE Tubing and Sleeving

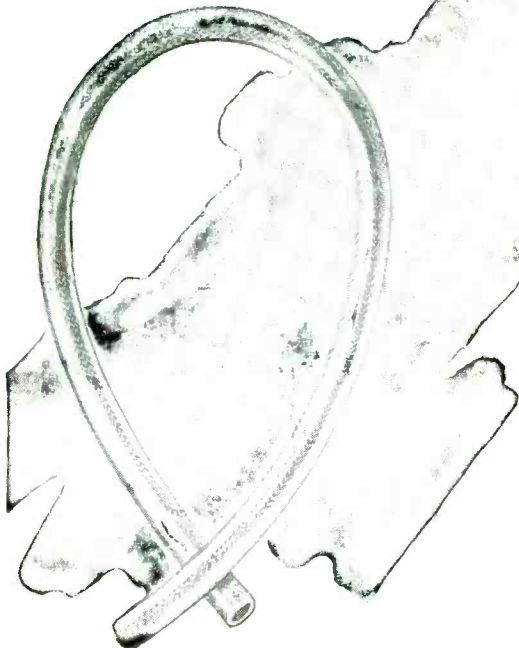

Now Varglas Silicone has been made more flexible. Sharp turns and 90° bends cause no cracking or peeling — no loss of dielectric strength. As pioneers in the manufacture of silicone sleeving and tubing, we know this is the greatest improvement made during the past ten years. Unexcelled where high temperatures must be withstood for several hours — not just for 15 minutes. You need not sacrifice abrasion resistance and toughness to get flexibility. The new Varglas Silicone sleeving and tubing will pass cold bend tests at 35° to 40° LOWER temperature than formerly.

*The only Class H insulation
with all these features:*

Efficient from 500° F. to — 85° F.

Moisture and Fungus Resistant

Flame Resistant — Self extinguishing

Abrasion Resistant

Dielectrically Strong with average readings up to 7,000 volts.

Available in 10 colors — at no extra cost.

Samples of Varglas Silicone products as well as samples of our complete line of tubing and sleeving are available in a convenient sample folder. Just drop us a line telling us your problem and its peculiarities.

Varflex CORPORATION

Makers of
Electrical Insulating
Tubing and Sleeving

VARFLEX Sales Co., Inc.

308 N. Jay St., Rome, N. Y.



Photographic comparison of the new G-E Drawn-oval capacitors (in color) and the conventional units they replace, showing savings in size.

New General Electric Capacitor is Smaller, 10 to 20% Lower in Price

These fixed paper-dielectric hermetically-sealed capacitors offer:

- **Reduced costs—10 to 20%**
- **Savings in size and weight**
- **Double-rolled seams**
- **Drawn-steel cases**
- **Savings in critical materials**

If you're using fixed paper-dielectric capacitors with case styles CP53 and CP70 in ratings from 1 to 10 muf, 600 to 1500 volts d-c or 330 to 660 volts a-c—these Drawn-oval units offer you improved reliability in addition to an opportunity for reducing the size, weight and *cost* of the electrical equipment you manufacture.

In the new Drawn-oval capacitors, we get minimum seam length by using drawn-steel cases, attaching the capacitor covers with a double-rolled seam of proven reliability. This construction results in a lighter, yet stronger capacitor. Actual savings in size and weight vary with case style and rating but they can amount to as much as 30%.

This new construction has enabled us to increase output while eliminating some critical materials. The resulting savings are passed on to you in the form of shorter shipments and lower prices. Prices average 10 to 20% lower than standard capacitors, again depending upon case style and, of course, quantity ordered.

For more information on the new G-E Drawn-oval capacitors, their ratings, dimensions and prices, see your local G-E apparatus sales representative or write for Bulletin GEA-5777. Address Section 407-311, General Electric Company, Schenectady 5, N. Y.

GENERAL  **ELECTRIC**

POWER

in a
Miniature Package

DALOHM

Miniature Power Resistors

WIRE WOUND—SILICONE COATED RESISTORS

Complete welded construction from terminal to terminal. Temperature coefficient 0.0002/deg. C. Ranges from 0.1 Ohm to 55,000 Ohms, depending on Type. Tolerance 0.05%, 0.1%, 0.25%, 0.5%, 1%, 3%, 5%.

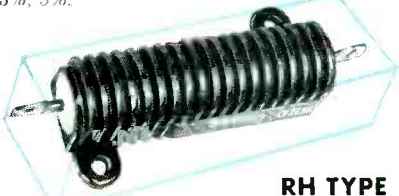

RH TYPE

Available in 25, 50 and 250 watt sizes. Silicone sealed in die-cast, black anodized radiator finned housing for maximum heat dissipation.



RS TYPE

Available in 2 watt, 5 watt, and 10 watt sizes. Silicone sealed offering maximum resistance to abrasion, high thermal conductivity and high dielectric strength.

DEPOSITED CARBON RESISTORS

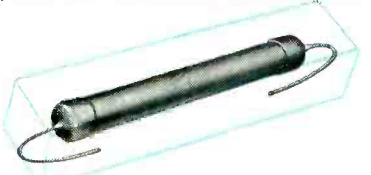

Dalohm precision deposited carbon resistors offer the best in accuracy, stability, dependable performance and economy. Available in 1/2 watt, 1 watt and 2 watt sizes.

Carefully crafted in every respect, Dalohm resistors are true power in miniature—provide the answer to those space problems.

Write, wire or phone
George Risk
1300 28th Ave., Columbus, Neb.
for price and delivery
Telephone 2139

DALE PRODUCTS, INC.

In Canada: Teletronics Corp. Ltd.
Toronto and Montreal

Want more information? Use post card on last page.

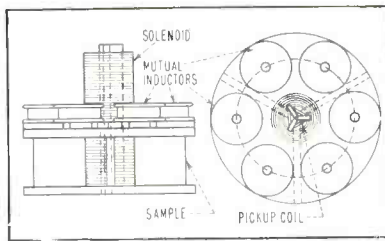

FIG. 5—Pickup device used with a magnetic tape sample when testing performance characteristics

veloped in the tape through an integrating circuit as shown in Fig. 6 to produce instantaneously a hysteresis loop display on a cathode-ray indicator. The novelty and particular advantage of the *B-H* curve tracer is embodied in the employment of fundamental magnetic and electric properties referred to the permeability of air in a fairly simple equipment that does not require the use of calibrating samples or the like.

Recently issued patents in the field of microwave antennas and waveguides tend towards directive means for these antennas, which essentially require no movement of the antenna structures. A patent issued to C.B.H. Feldman of Bell Telephone Laboratories, 2,594,409 describes several slot antenna arrays containing motive phase-shifting devices within the fixed antenna structure. In the illustration of Fig. 7, an example of this technique is shown. The motive member rotating within the waveguide-feed structure of a linear slotted antenna array shifts the phase relationship of the wavefronts applied to the slot to result in a variation in the direction of the radiated beam over a predetermined range. Apart from the movement of the elements

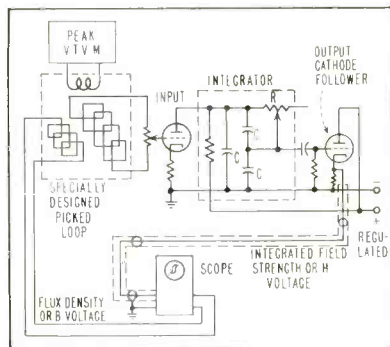
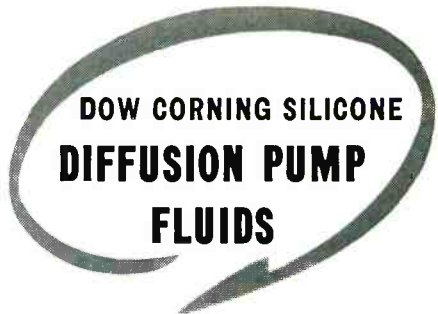

FIG. 6—Integrator circuits used with cathode-ray tube produce *B-H* display for magnetic tape



No. 702 and 703 are ...

SUPREMLY STABLE

Treatment which would completely decompose organic oils has little, if any, effect on Dow Corning 702 or 703. For example, these silicone fluids pump down just as quickly as ever to their original ultimate vacuum after many hundreds of test cycles in which air is admitted to the diffusion pump immediately after the heaters are switched off.

VERSATILE

These silicone fluids can be used in most diffusion pumps because they are inert to glass and the metals most commonly used in constructing pumps. They are also safe to use in valveless pumping systems, even in the continuously cycling automatic pumping sets used in the commercial evacuation of cathode ray and vacuum tubes.

MOST ECONOMICAL

The fluid charge remains effective almost indefinitely; only actual losses from the pump have to be replaced. Maintenance costs are reduced to a minimum because there is no fouling of the pump or system by decomposition products.

HAND EFFICIENT

Pumping speed and limiting back pressure performance of diffusion pumps charged with Dow Corning 702 or 703 are essentially the same as they are with organic oils. Ultimate vacuum obtainable with Dow Corning 703 is of the same order as that obtainable with the best organic oils. Dow Corning 702 is used in many commercial systems because it is less expensive to use where the lowest pressures are not required.

For more technical information please address Dept. BD-3.

DOW CORNING
CORPORATION
Midland • Michigan

Want more information? Use post card on last page.
March, 1953 — ELECTRONICS

When you test—

USE THE BEST!



PRD

VHF-UHF- Microwave Test Equipment

The PRD line of RF Test Equipment is the most complete line available today covering the entire frequency range from .01 to 40 kilomegacycles per second. Every unit in the line is rigorously engineered and meticulously manufactured to the highest standards attainable. The excellence of PRD equipment, in quality, dependability and accuracy is well attested by use in the leading laboratories throughout the world. For consultation on the application of standard or special PRD equipment to your problems call or write our skilled staff of engineers today, without obligation.



TYPE 904 NOISE GENERATOR — a direct reading noise source permits measurements of noise factors up to 20 db for r-f amplifiers and receivers operating in the range from 1C to 1000 mc/s. A TT-1 coaxial diode with a nominal input impedance of 50 ohms is used. VSWR is approximately 1.25, housed in handsome steel cabinet.

THE NEW EXPANDED PRD LINE OF RF TEST EQUIPMENT INCLUDES — Frequency Measuring Devices, Signal Sources and Receivers, Attenuators and Terminations, Transmission Line Components, Impedance Measurement and Transformation Units, Bolometers, Detection and Power Measurement Equipment.

✓ WRITE TODAY FOR YOUR COPY OF THE NEW PRD CATALOG — NO OBLIGATION



Polytechnic RESEARCH & DEVELOPMENT COMPANY • Inc



55 JOHNSON STREET, BROOKLYN 1, NEW YORK
WESTERN SALES OFFICE: 741 1/2 N. SEWARD ST.
HOLLYWOOD 38, CALIFORNIA

LOOK FOR US AT THE I.R.E. SHOW

BOOTHS #2-513, 514—SECOND FLOOR



Test Jacks by UCINITE

General features of 118930 test jack: Silver-plated, heat-treated beryllium copper contact is made in one piece with large terminal end for easy soldering. Terminal end is tinned. Brass, nickel-plated shell and nut.

Metal shell insures firm, dependable mounting. Phosphor bronze lock washer is nickel-plated. Nylon insulator available in different colors: White, black, red, green, brown, orange, blue.

ALSO AVAILABLE



119052. Same as 118930 but with special milled end with elongated hole for wiring.

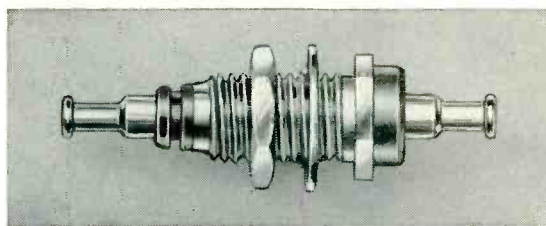

118984. Feed through type, similar to 118930 but with one-piece brass terminal stud, tinned.



The
UCINITE CO.
Newtonville 60, Mass.
Division of United-Carr Fastener Corp.

} *Specialists in*
ELECTRICAL ASSEMBLIES,
RADIO AND AUTOMOTIVE

Your dollar buys
more "instrument"
... in our Model

630



Volt-Ohm-Mil-Ammeter
by R. L. Triplett
PRESIDENT

Because we build every major part of our instruments the quality is carefully controlled. For example, we know we have more torque driving our pointers because we designed and built the complete instrument. We know we have sustained dependance in the shafts and switch contacts of our test equipment for the same reason. Cycle tests for switches exceed several times the rigid requirements of the armed forces.

There is another important value to you. Because we make our own components we eliminate the profit another manufacturer would make in selling them to us. And this "profit" is passed on to you.

Consider these features of Model 630 V.O.M., for example—

One Hand Operation—One switch with large recessed knob has a single position setting for each reading. Leaves one hand free. Eliminates switching errors, trouble, saves time.

Ranges—AC-DC Volts: 3-12-60-300-1200-6000 (AC, 5000 Ohms/Volt; DC, 20,000 Ohms/Volt). 60 Micro-Amps. 1.2, 12, & 120 Mil Amps. DB scales at 1.73V on 500 Ohm line, 0-66 DB output.

Highest Ohm Reading—To 100 Meg. in steps of 1000-10,000-100,000 Ohms—100 Megohms.

Yes, with us it's a matter of personal pride to make "Triplett" stand for better construction and more service for your test equipment dollar.

R. L. Triplett

PRESIDENT
TRIPLETT ELECTRICAL INSTRUMENT CO.
Bluffton, Ohio

TRIPLETT 630 V.O.M.

only \$39.50



Triplett

For service, accuracy, highest dependability, buy

Look to Hetherington for the Latest, Most Dependable Switches!

New!

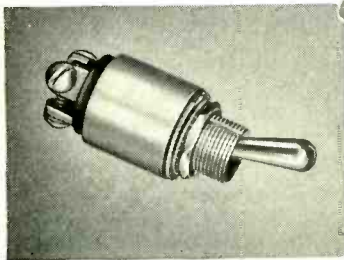

Cylindrical toggle switch is a real space saver

T1000 Designed for MIL-S-6745 uses

This sturdy little T1000 Hetherington toggle switch reduces size and weight approximately 25% by comparison with rectangular switches. Features include exceptionally positive cam-roller snap action; effective contact wipe; maximum protection against contact wear or arcing damage and strong lever operating action. Only $2\frac{3}{32}$ " long x $\frac{3}{4}$ " diameter. Weighs 1 ounce. Write for Bulletin S-1.

New

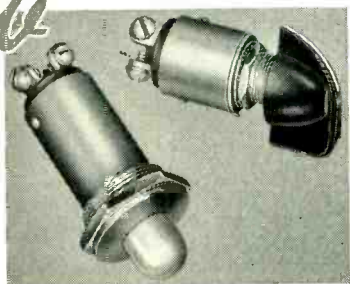

Miniature "Push-Push" and Rotary Types J100 and R1000

Compactness, light weight and maximum durability characterize these unique Hetherington switches. Widely used for aircraft seat light control, the Series J100 "push-push" switch utilizes a sturdy cam-roller design operated by a positive escapement-type push-button action and is readily adaptable to many uses. The Series R1000 switch is a rotary action unit with indicator knob. Both types operate on either 28 v.d.c. or 115 v.a.c. 60 cycles current. Rated 20 amperes resistive. Write for Bulletin S-1.

HETHERINGTON SWITCHES

FINE PUSH-BUTTON AND SNAP-ACTION TYPES
PANEL INDICATOR LIGHTS
SWITCH-INDICATOR LIGHT COMBINATIONS
AIRCRAFT AND ELECTRICAL EQUIPMENT ASSEMBLIES

HETHERINGTON, INC., Sharon Hill, Pa.

West Coast Division: 8568 W. Washington Blvd., Culver City, Calif.

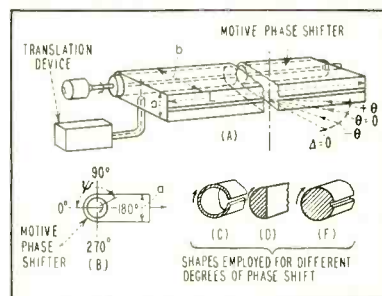

FIG. 7—Nonmechanical antenna director uses motor-driven phase shifter within a fixed antenna structure

within the antenna structure, the antenna is stationary with respect to the variation in beam direction. The patent shows many variations in structure, which include this technique.

The telephone system that is the subject of patent 2,609,455 issued to A. E. Bachelet assigned to the Bell Telephone Laboratories, is a thing that can be anticipated as a probable development in the use of cathode-ray beams for various applications, ranging from information-storage devices to the present invention. The use of a cathode-ray beam is disclosed in this invention to switch the connection between subscribers in a telephone system. The advantage of rapidity and the effective absence of inertia leads to consideration of the possibility of multiple-transmission multiplexing of two-way circuits with the switching accomplished by the application of circuits like those used in the deflection of the cathode-ray beam in tv cameras, receivers and in crt oscillographs.

A diagram of the circuit is shown in Fig. 8. A telephone subscriber's station is connected to the collector

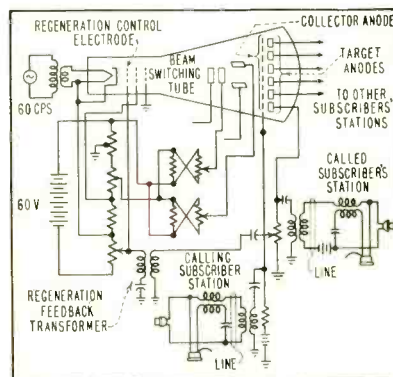

FIG. 8—Cathode-ray beam-switching tube is used as an inertialess switch-board for telephone subscribers



**"We get CONSISTENTLY
EXCELLENT RESULTS
with D-H ALLOYS"**

... says Resistance Products Company, of Harrisburg, Pennsylvania

This company produces precision wire-wound resistors of utmost stability for electronic equipment used by the Armed Forces and for makers and users of test instruments, meters, and scientific apparatus of various types. The vital accuracy of much important equipment, therefore, is very dependent upon the quality of the resistors coming off the production lines of Resistance Products Company.

In view of this, Driver-Harris is particularly gratified to have Resistance Products state: "Reflecting our experience with Driver-Harris alloys is our large use of Karma wire. Currently, we are employing Karma for numerous critical applications where utmost stability, together with high resistivity and low temperature coefficient of resistance,

is requisite. *Consistently excellent results* are being obtained. We have, in fact, used Karma with outstanding success ever since its introduction several years ago. It is our belief the development of this alloy constitutes a major forward step."

Karma* is ready to serve you, too; as are world-famous Nichrome* and Nichrome V, and over 80 other alloys developed by Driver-Harris for the electrical and electronic industries. We feel confident that, like Resistance Products Company, you'll realize exceptional advantages by putting one or more D-H alloys to work for you. Let us have your specifications. We'll gladly make recommendations based on your specific needs and have our engineering department help you obtain best results.

KARMA* and world-famous **Nichrome***
are manufactured only by



Driver-Harris Company

HARRISON, NEW JERSEY

BRANCHES: Chicago, Detroit, Cleveland, Los Angeles, San Francisco
In Canada: The B. GREENING WIRE COMPANY, Ltd., Hamilton, Ontario.

*T.M. Reg. U. S. Pat. Off.

MAKERS OF THE MOST COMPLETE LINE OF ELECTRIC HEATING, RESISTANCE, AND ELECTRONIC ALLOYS IN THE WORLD

This new booklet tells...

How *Quinterra*[®] and *Quinorgo*[®] help



Shows you the way to:

- ← *lengthen service life*
- ← *simplify production*
- ← *save money*

This 32-page booklet is crammed with information to help you build better apparatus at lower cost. It covers the properties and advantages of Quinterra and Quinorgo in full detail with test data. Its clear construction drawings, plus case studies of leading apparatus manufacturers, show how to apply these insulations for maximum benefit. It also describes the never-before-advertised Quinterrabord, Quinorgobord and the new J-M laminates. To obtain this insulation handbook, call your local J-M sales office or fill out the coupon on the opposite page.

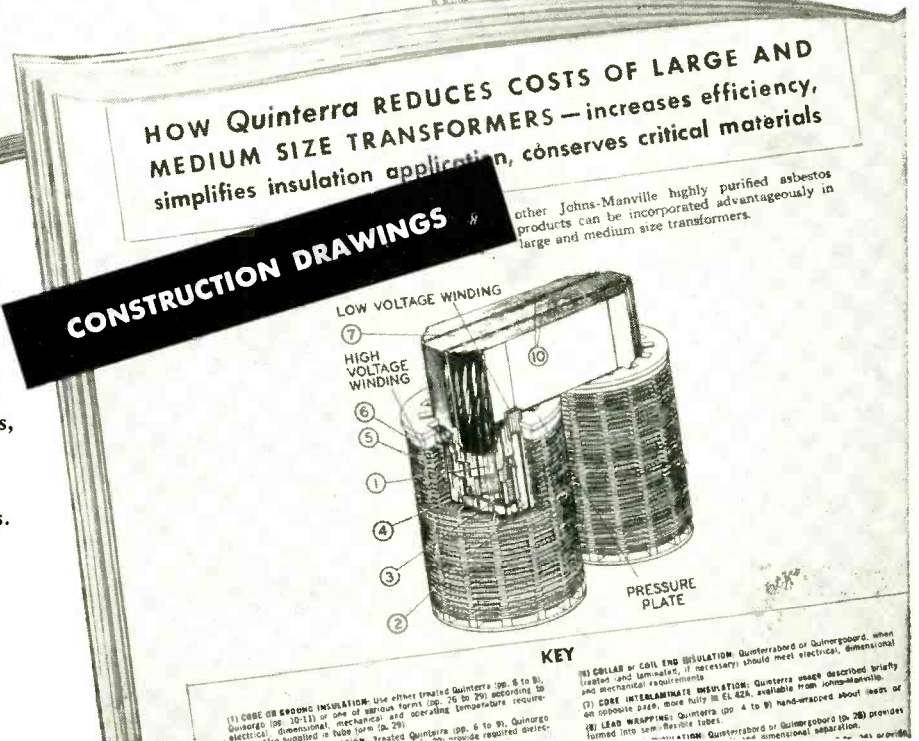

Johns-Manville ELECTRICAL

electrical insulations manufacturers reduce costs

Quinterra—the pyrolysis-resistant dielectric that helps cut electrical apparatus costs.

More and more manufacturers are using Quinterra to make apparatus smaller, safer and at lower cost. It permits equipment to operate at higher temperatures because it remains a dielectric despite heat and time . . . the bulk of its dielectric strength is in the purified asbestos base sheet. Its mechanical strengths, thinness and flexi-

bility enable economical application. Its uniformity of caliper and texture allow dimensions to be predicted accurately and thereby speeds assembly. Moreover, Quinterra resists corrosion and humidity and is practically immune to fungus growth. Supplied in treated (Types 3, 5 and 6) and untreated (Type 1) forms.

Quinorgo—the moderate priced, high temperature insulation for use alone or in "composites"

Many manufacturers find that Quinorgo is ideal for their purposes. Designed for operating temperatures up to 130 C, it combines high dielectric and mechanical strengths. High in absorptive capacity, it can readily be treated and combined with other

dielectrics. Though a highly purified asbestos product, it does not have quite so high a pyrolysis resistance as Quinterra because a small percentage of organic binder is used in the base sheet. Quinorgo is furnished only in untreated form.

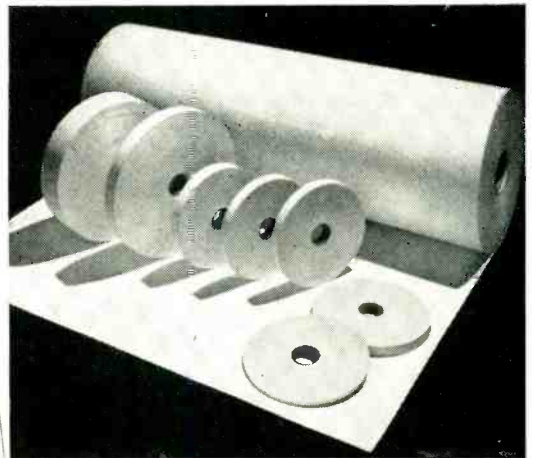
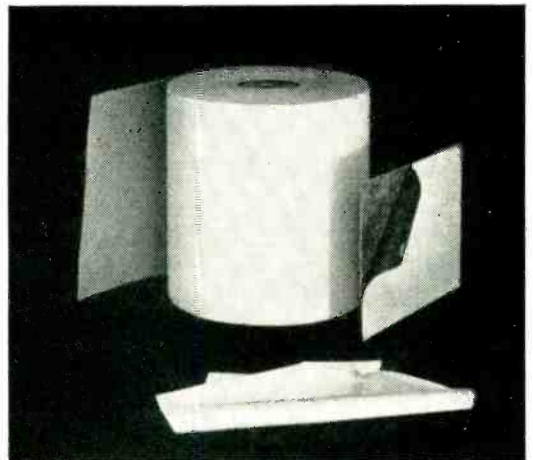

ACTUAL CASE HISTORIES

Moloney Cuts Eddy Current Losses With Quinterra

Increased efficiency and longer transformer life are among the benefits derived from Quinterra Inter-Laminate Insulation in the cores of Moloney Transformers. Quinterra offers all the advantages and none of the drawbacks of conventional inter-laminate insulations. Free from moisture, it has high thermal stability, lasting dielectric strength, and has uniform density and evenness of caliper. Its dimensional stability under temperature variations helps the core retain rigidity and tightness in service, thereby reducing transformer noise.

Picture 1 shows Quinterra Type 5 being applied approximately every inch of core depth during core stacking for a large power transformer. In picture 2, the layers of Quinterra can be seen projecting from the core of a partially assembled power transformer. Picture 3 shows the bolted laminations of Quinterra between the bolted laminations of assembled cores and oil filled medium sized air cooled and oil filled transformers. The complete story of this extremely interesting installation is given in EL-42A. Write for it.

Acme Conserves Scarce Metals

40% less silicon steel, 42% less copper are used in the new Acme Quinterra transformers for Class B applications.

Production Can Be Increased 33%

Acme Electric Corp. also reports that production can be increased approximately 33% without equipment changes when using Quinterra. As shown by ordering sheets to a minimum by ordering to the exact

"Quinterra Easy to Apply," Jeffries Finds

Shown above is the application of Quinterra Type 6 as layer insulation in Jeffries Class "B" transformer. Jeffries advises, "The flexibility of the sheet makes it (Quinterra Type 6) easy to apply and the strength is so superior to former

**Send for your
free copy now**

J-M's new 32-page booklet, "Pyrolysis Protection Pays Well," is offered without obligation to electrical equipment designers, engineers and manufacturers.

Johns-Manville, Box 60, New York 16, N. Y.
In Canada, 199 Bay St., Toronto 1, Ontario
Please send me without charge copy of booklet EL-40A
"Pyrolysis Protection Pays Well"

Name _____ Title _____
Company _____
Street _____
City & Zone _____ State _____

INSULATIONS

SUB-MINIATURE PILOT LIGHTS

Approved
for AIRCRAFT

AND IMPROVED IN
IMPORTANT DETAILS

DIALCO

SUB-MINIATURE INDICATOR ASSEMBLIES

A great aid to your miniaturization program



ACTUAL
SIZE

NON-DIMMING
No. 8-1930-621

MOUNT IN 15/32" HOLE
ALL LENS COLORS

*Easy lamp replacement
with any midget flanged
base lamp types*

*Complete blackout
or semi-blackout
dimmer types*



ACTUAL
SIZE

**MECHANICAL
DIMMER**
No. 11-1930-621

THESE ASSEMBLIES LOGICALLY REPLACE
LAMPS NO. 319, 320, and 321

REPLACE
WITH THIS



NOT
THIS



OR
THIS

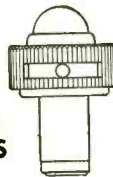

PLASTIC PLATE (EDGE) LIGHT ASSEMBLIES

AIR FORCE and BUREAU of AERONAUTICS
MIL-L-7806 DRAWING MS-25010

DIALCO No. TT-51 (Red filter-black top)
... or, No. TT-51A, complete with No. 327 Lamp

ALSO MADE
with other filter colors
and with *light-emitting*
top (for indication)



ACTUAL
SIZE

**ALL OF THE ASSEMBLIES ILLUSTRATED
ACCOMMODATE LAMPS NOS. 327, 328, 330, and 331.**
ANY ASSEMBLY AVAILABLE COMPLETE WITH LAMP
SAMPLES ON REQUEST — NO CHARGE

Foremost Manufacturer of Pilot Lights

DIALIGHT CORPORATION

60 STEWART AVENUE, BROOKLYN 37, N. Y.

HYACINTH 7-7600

anode of a device resembling the cathode-ray tube and called a beam switching tube. When the beam strikes the appropriate portion of a target anode of the switching tube to which the subscriber is connected, a two-way circuit is established between two subscribers. The gain of the channel may be adjusted by controlling the beam intensity, just as the brightness of the spot on a crt is controlled. The control grid of the beam-switching tube is coupled to one of the target anode connections and acts as a regenerative feedback circuit.

Rhombic Relay Antennas

BY RICHARD C. WEBB
*Denver Research Institute
University of Denver
Denver, Colo.*

THE SUPERIOR GAIN and directional properties of rhombic antennas as well as their broad-band characteristics so desirable for television have been known for many years. However, use of the rhombic has been restricted mainly to commercial point-to-point communication service because of its large size^{1,2,3}. The gain as well as the sharpness of the directivity pattern increases with the length of wire used in each leg of the antenna as compared to the wavelength of the signals to be received or transmitted. Fortunately at the short television wavelengths a rhombic antenna only 80 feet on a leg, as indicated in Fig. 1, is 4½ wavelengths long per leg at channel 2 and proportionately greater at the higher channels. This size is sufficient to secure from 7 to 10 times as much voltage from the rhombic as would be obtained from a simple dipole antenna in the same location. In addition, the unidirectional characteristic of the rhombic renders it less sensitive to noise and interference.

In an installation on a mountain top above a home in the Big Thompson Canyon, Colorado, one rhombic antenna unit, which has a line of sight path to the television transmitter, is used for receiving. A second unit connected to the first by a short length of 600-ohm transmission line reradiates the received energy down into the shadowy canyon. This is not accomplished with-

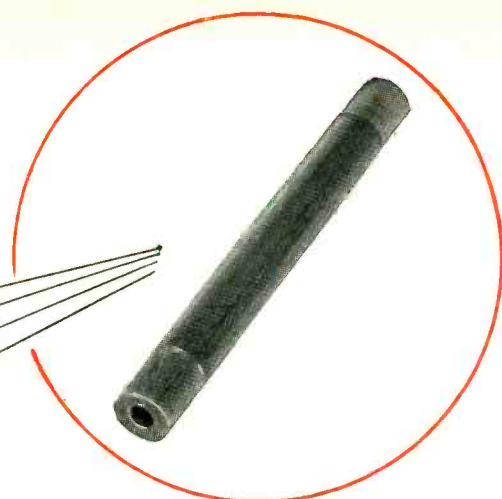
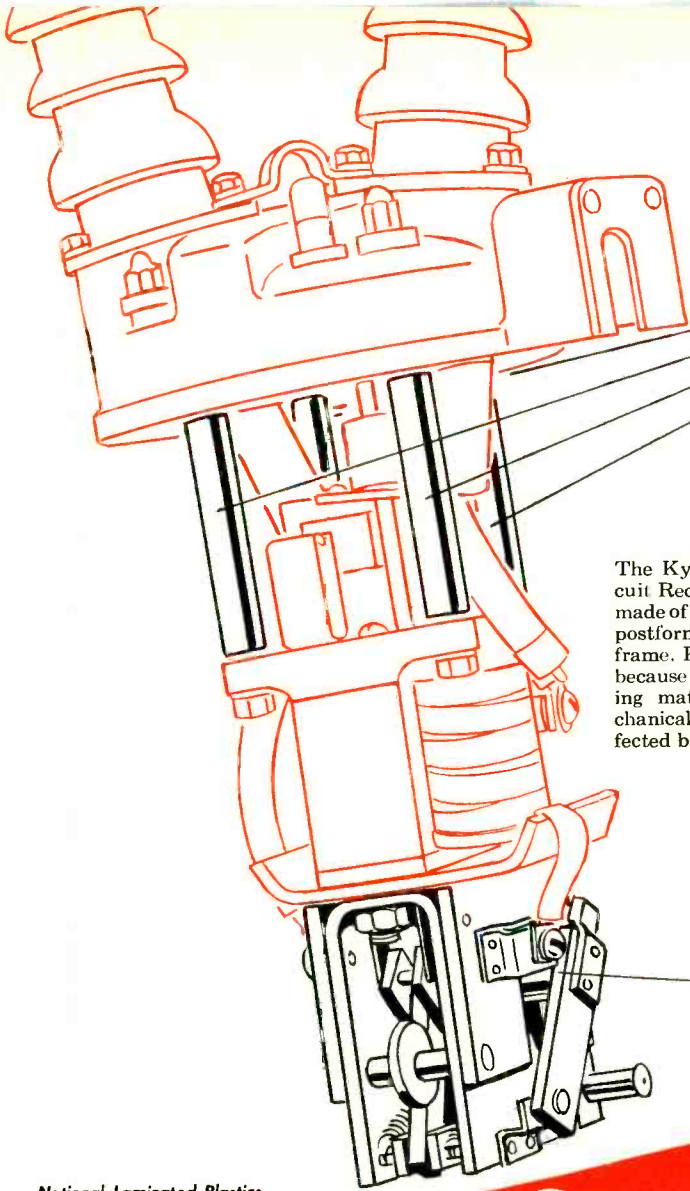

The Kyle Automatic Oil Circuit Recloser utilizes stringers made of Phenolite tubing, and a postformed Phenolite contact frame. Kyle selected Phenolite because it is a superior insulating material with great mechanical strength and is unaffected by oil.

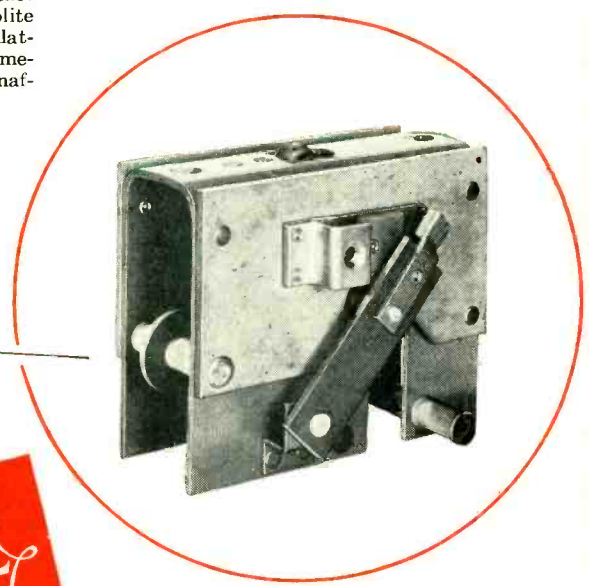

National Laminated Plastics
nationally known—nationally accepted

PHENOLITE
Laminated PLASTIC

**contributes to an improved product—
in the Kyle Automatic Oil Circuit Recloser**

This practical use of Phenolite by the Kyle Products Plant of the Line Material Company is typical of its countless applications in the electrical field. Phenolite, about one-half the weight of aluminum, is the perfect insulating material for high and low voltage applications. It possesses an unusual combination of properties. Phenolite has great mechanical strength and high resistance to moisture; ready machinability; is unaffected by solvents and oils.

It can be easily punched, sawed and sheared. The toughness and high impact strength of cloth base Phenolite sheet make it suitable for gears; it is one of the strongest materials per unit weight known.

Available in various grades and colors; and in sheets, rods, tubes and special shapes. Write for detailed literature and engineering information—

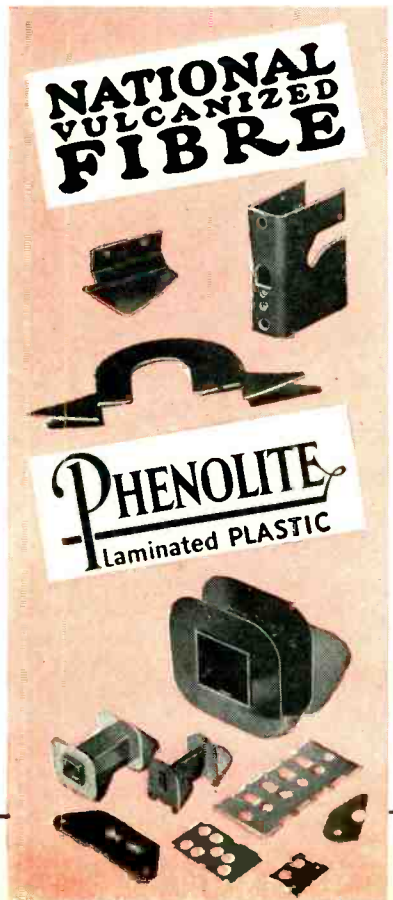

NATIONAL VULCANIZED FIBRE CO.

Wilmington

Delaware

Offices in



Principal Cities

Since 1873

edwin i. guthman & co., inc.

15 s. throop st. chicago 7, CH 3-1600 • also attica, indiana

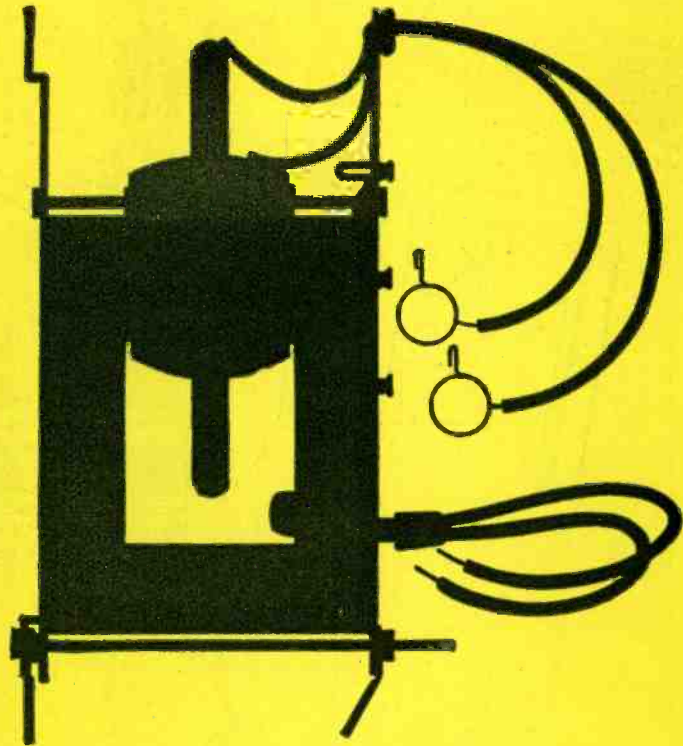

flyback transformers

For reliability in high voltage specify Guthman Flybacks—they won't break down even under the most severe voltage requirements. Wire used in Guthman Flybacks is fabricated in our own plant and is quality controlled from raw material to finished product guaranteeing a superior uniformity of performance. The excellent linearity and voltage regulation characteristics of Guthman Flybacks aids in preserving picture quality.

Coils used in Guthman Yokes are form wound. Complete isolation between vertical and horizontal coils achieved by a molded nylon piece permits a yoke rating of 5,000 volts pulse maximum. Anti-magnetic core retainer band and brass mounting nut assures no magnetism in Guthman Yokes.

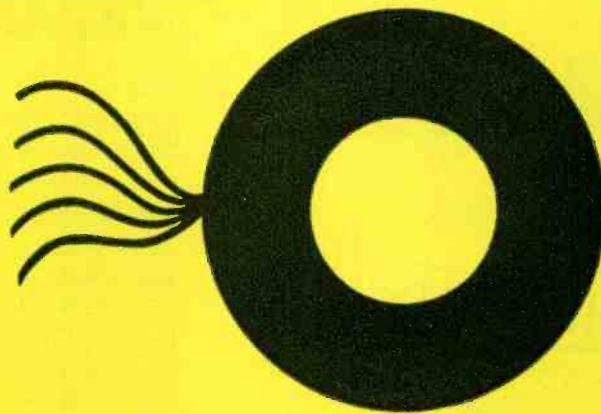

DELAY LINES
SHIELD CANS
ANTENNA COILS
OSCILLATOR COILS
COMPRESSION TYPE
MICA TRIMMERS
I.F. TRANSFORMERS
LOOP ANTENNAS
R.F. TUNERS

yokes



for a few pounds of copper...
or a truckload... **Call Chase**

Need just a few lengths of seamless brass tube? We'll be glad to hand them to you "over the counter." Or if your job calls for large quantities of brass or copper sheet, rod, wire or tube, we can speed it on its way to you. That's the kind of service you can get

by calling your nearest Chase warehouse.

We can supply you, subject to government controls, with hundreds of items for production, maintenance or repair. That's why it pays to "try Chase first" for anything in brass or copper.

Chase

BRASS & COPPER

WATERBURY 20, CONNECTICUT • SUBSIDIARY OF KENNECOTT COPPER CORPORATION

• The Nation's Headquarters for Brass & Copper

Albany †	Cleveland	Kansas City, Mo.	New York	San Francisco
Atlanta	Dallas	Los Angeles	Philadelphia	Seattle
Baltimore	Denver †	Milwaukee	Pittsburgh	Waterbury
Boston	Detroit	Minneapolis	Providence	
Chicago	Houston †	Newark	Rochester †	(†sales office only)
Cincinnati	Indianapolis	New Orleans	St. Louis	

'DIAMOND H' RELAYS



pack more
performance
into less space



Rating for rating, "Diamond H" Series R hermetically sealed, miniature aircraft type 4PDT relays are smallest (1.6 cubic inches), lightest (3.76 ounces), have widest temperature range (-65° to $+200^{\circ}$ C.), greatest operating shock resistance (to 50 "G" and higher) and excel all others in their field in ability to break high currents and high voltages.

Ideal for high frequency switching, their inter-electrode capacitance is less than 5 micro-microfarads contacts to case, less than $2\frac{1}{2}$ mmf between contacts, even with plug-in type relay and socket. Vibration range is from 0 to 500 cycles per second and upward at 15 "G" without chatter. Coil resistances up to 50,000 ohms are available, with contact loading through 10 A. resistive for 100,000 cycles (30 A. resistive for 100 cycles) at 30 V., D.C., or 115 V., A.C. SENSITIVITY approaches 100 milliwatts at 30 "G" operational shock resistance. They meet all requirements of USAF Spec. MIL-R-5757 . . . and far surpass many. Various standard mounting arrangements available.

"Diamond H" engineers are prepared to work with you to develop variations for guided missiles, jet aircraft, fire control, radar, communications, geophysical and computer apparatus . . . any application where peak performance is vital under critical conditions.

Illustrated Bulletin R-150 gives detailed performance data under varying conditions. Write for a copy today.

THE HART MANUFACTURING COMPANY

202 Bartholomew Avenue, Hartford, Connecticut

THE HART MANUFACTURING COMPANY, 202 Bartholomew Ave., Hartford, Conn.

Please send me Bulletin R-150 with detailed performance data on Series R Relays

NAME _____ TITLE _____
COMPANY _____
ADDRESS _____
CITY _____ STATE _____

out losses. However, by virtue of the strong signal picked up in the receiving unit, sufficient energy can be thrown into the canyon to enable satisfactory operation of television sets. Previous signal levels had been immeasurably low.

Values given in Fig. 1 appear to be about optimum for the vhf television channels although the lower group (2 to 6) is undoubtedly favored somewhat. Increasing the angle ϕ to as much as 70 deg by stretching out the length along the

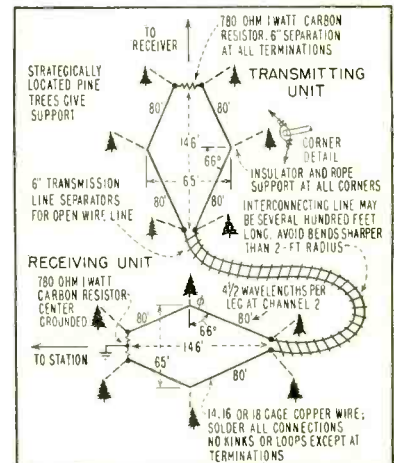

FIG. 1—Two rhombic antennas connected by transmission line relay television signals to a third rhombic at the receiver. System must be kept grounded even during construction on clear days owing to static charges. Earth around driven ground should be moistened with brine

major axis to 150 ft tends to favor the higher-frequency group (channels 7 to 13). The directivity pattern of each rhombic unit is extremely sharp (± 2 deg.) To obtain maximum signal strength the major axis of both units of the relay pair must be aligned very accurately with the transmitter and receiver locations. A portable receiver or field strength meter with a direction-finding antenna on it is recommended for establishing the axis of the receiving unit. Since the receiver location should be visible from the site of the transmitting unit ordinary surveying methods can be used to direct it.

At a distance of 1 mile from the transmitting unit of the system the ± 2 -deg transmitted beam is only 120 yards wide; hence, houses located far outside this range will not enjoy the full benefit of the reradiated signal. In the installa-

AT LAST!

a tubing that's

TAILOR-MADE

for TV ANTENNAE



**HIGH STRENGTH
ALUMINUM ALLOY CORE FOR
INCREASED DURABILITY**

**HIGH PURITY ALUMINUM
RESISTS CORROSION . . .
GIVES BRIGHTER FINISH**

REYNOLDS ALUMINUM ANTENNA TUBING

Diligent research by the industry's electronics engineers have brought forth wonderful improvements in today's television receivers . . . and antenna designs that insure better performance. Now, Reynolds—pioneer producer of antenna tubing—offers a vastly superior *aluminum antenna tubing* to help you produce a superior antenna! The new Reynolds Aluminum Antenna Tubing is precision roll-formed . . . tailor-made for TV antenna manufacturers. It is extra-sturdy, lightweight, and its gleaming, corrosion-resistant finish *invites* sales.

Reynolds Antenna Tubing 31—a maximum strength tubing; and Reynolds Antenna Tubing 41—designed with ample strength for most demands. Available in either butt seam or lock seam tubing, Reynolds Aluminum Antenna Tubing is offered in a complete range of sizes and in lengths to meet your specifications. For additional information and sample sections, call your nearest Reynolds Sales Office listed under "Aluminum" in the classified telephone directory.

**INCREASE
YOUR CAPACITY
AND YOUR PROFITS
...
USE**

**REYNOLDS ALUMINUM
FABRICATING SERVICE**



REYNOLDS METALS COMPANY • 2000 South Ninth Street • Louisville 1, Kentucky

NEW

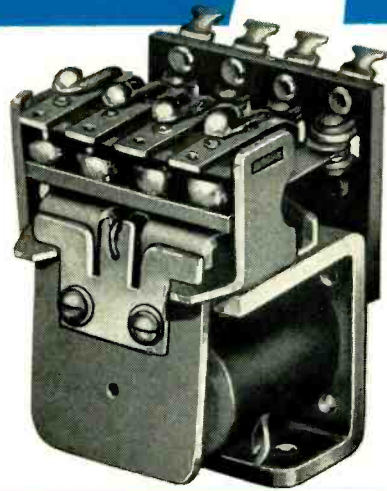

4-POLE TYPE PB RELAY

TYPE PB-9

TYPE PB-12

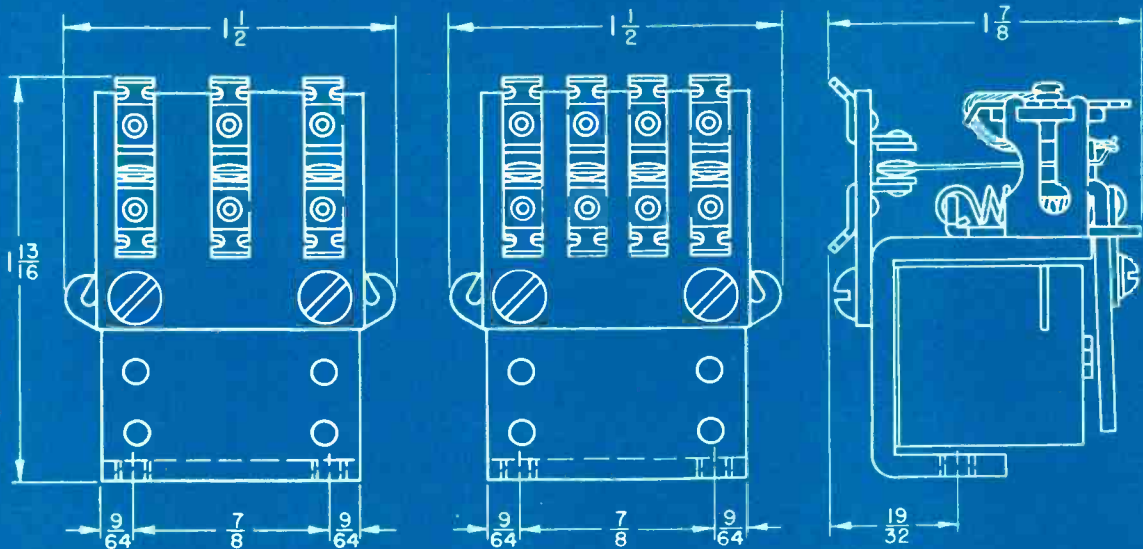

MOUNTING

2- 6-32 TAPPED HOLES

COMPACT 10 AMPERE RELAY

Developed primarily for the aircraft industry*, where size and weight must be kept to a minimum, this compact power relay is suitable for hundreds of industrial applications. Available in two, three and four pole, double throw contact ar-

rangements, for A.C. and D.C., the Allied Type PB withstands 50G shock and 10G vibration (up to 55 cps) without any false operation of the contacts, due to the semi-balanced armature and extremely compact design.

*The Allied Type PB Relay has the following AN approvals: AN 3306; AN 3307; AN 3308; AN 3310; AN 3312

Here are the Facts and Figures

Contact Ratings: 10 amperes non-inductive 29 V.D.C. or 115 V. rms 60 or 400 cycles. **Nominal Coil Power:** 2.5 watts for D.C. operation, 6.0 Volt-Amperes for A.C., 60 cycle operation. * **Maximum Coil Power:** Input at 25°C for 85°C Temperature Rise: 5.5 watts for D.C. operation and 10.0 Volt-Amperes for A.C. operation. **Ambient Temperature Range:** -55°C to +71.5°C.*

• The Allied Type PD relay, similar to the Allied Type PB except for smaller contacts, has a contact rating of 3 amperes. Nominal coil data for D.C. operation is 1.5 watts and 3.6 volt-amperes for A.C., 60 cps. *Input power for 2 and 3 pole types may be reduced if sensitivity or temperature rise are factors. Special coils are available for higher ambient temperatures.

Contact your Allied Control Representative or write us for full details.

AVAILABLE HERMETICALLY SEALED

DIMENSIONS AND WEIGHTS FOR 4-POLE RELAYS



AN PLUG



SOLDER TERMINALS



SCREW TYPE

PB, Open— $1\frac{1}{32}$ " x $1\frac{1}{16}$ " x $1\frac{1}{32}$ "—4 oz. **PB, Sealed, Cannon Plug**— $3\frac{1}{2}$ " x $1\frac{1}{4}$ " x $1\frac{1}{4}$ "—8 oz.
PB, Sealed, Solder Terminals— $2\frac{1}{16}$ " x $1\frac{1}{4}$ " x $1\frac{1}{4}$ "—7.5 oz. **PB, Sealed, Screw Type**— 3 " x $2\frac{5}{8}$ " x $3\frac{1}{2}$ "**—13 oz. **PD, Sealed, Solder Terminals and Plug-In**— $2\frac{1}{16}$ " x $1\frac{1}{32}$ " x $1\frac{1}{32}$ "—6.5 oz.
 ** Includes mounting ears and terminals.

ALLIED CONTROL COMPANY, INC.

2 EAST END AVENUE, NEW YORK 21, N. Y.



PHYSICISTS AND ENGINEERS

ATTENDING THE

I.R.E.

CONVENTION
NEW YORK CITY
MARCH 23-26...

Inquiries are invited regarding openings on our Staff

- ▶ RADAR LABORATORIES
- ▶ GUIDED MISSILE LABORATORIES
- ▶ ADVANCED ELECTRONIC LABORATORIES
- ▶ ELECTRON TUBE LABORATORIES
- ▶ FIELD ENGINEERING DEPARTMENT

For the convenience of those attending the I. R. E. meetings and Radio Engineering Show, members of the Laboratory Staff will be available for interviews at the Convention hotel. For appointment telephone Hughes New York office, LACKAWANNA 4-9350.

HUGHES

RESEARCH AND
DEVELOPMENT LABORATORIES
*Scientific and
Engineering Staff*
CULVER CITY, LOS ANGELES
COUNTY, CALIFORNIA

Assurance is required that relocation of the applicant will not cause disruption of an urgent military project.

tion described a third rhombic unit identical to each of the relay pair is used at the receiving point, its transmission line simply being brought in to terminate at the receiver.

Thus the transmitting unit on the hill and the rhombic at the receiving point near the house serve to bridge the distance between the television set and the master receiving antenna atop the mountain without the use of a long transmission line that is both expensive and hazardous from the viewpoint of lightning. Simple high-gain house-top antennas can be used within the beam of the transmitting unit on the hill. The third rhombic is recommended where optimum performance is required as for a community installation.

The height of the antennas above ground need not be greater than 15 to 30 feet and although it is desirable to keep the plane of the wires nearly horizontal the system does not appear to be particularly sensitive to tilts of a few degrees. The directivity pattern of a rhombic antenna in the vertical direction maximizes 5 to 10 degrees above the plane of the wires, hence, it is desirable to lower the end of the receiving unit in the direction of the tv station 5 to 10 degrees below the line-of-sight path. Likewise, the plane of the transmitting unit should be tilted a similar amount below the line of sight path to the receiving point.

BIBLIOGRAPHY

- E. A. Bruce, A. C. Beck and L. R. Lowry, Horizontal Rhombic Antennas, *Proc IRE*, 23, 1935.
D. Foster, Radiation from Rhombic Antennas, *Proc IRE*, 25, 1937.
J. Minter, Rhombic Antennas for Television, *Electronic Industries*, Oct. 1946.

Twenty-Five Cent Oscillator

BY JAMES FAHNESTOCK
Associate Editor

ABILITY of transistors to operate from extremely small power sources can be demonstrated vividly by the accompanying circuit. It comprises a single-transistor feedback oscillator that provides a tone at ear-phone volume when powered by a quarter coin and a piece of saliva-

This Cabinet

Is Only One Of Many
That We Manufacture

Transmitter and Radar Cabinets, Chassis, Panels, and many special component parts such as are required by laboratories and manufacturers.



Manufacturers of sheet metal products since 1925. Will design your product for you, manufacture the model and prepare it for production.

All Metals and
Gauges Fabricated.

Equipped to spray paint, bake and finish your product. Our equipment is complete. Can perform all the necessary operations required in the fabrication of any sheet metal product.

Boyle Metalcraft Corporation

150 Sullivan St.
Brooklyn 31, N. Y.

Sheet Metal Craftsmen

TRiangle 5-3603

ON EXHIBIT, BOOTH 4-814

I.R.E. SHOW

GRAND CENTRAL PALACE
NEW YORK CITY, MARCH 23-26

HUGHES GERMANIUM DIODES

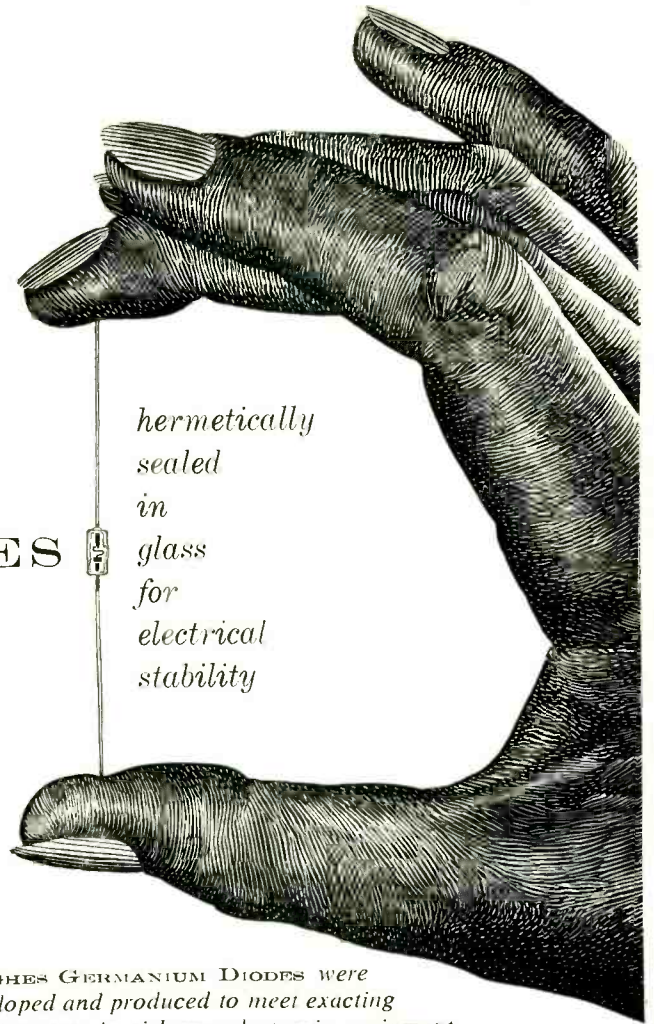

*hermetically
sealed
in
glass
for
electrical
stability*

HUGHES GERMANIUM DIODES were developed and produced to meet exacting requirements in airborne electronic equipment for navigation, fire control, and guided missiles. In addition to the advantages of germanium diodes over vacuum tubes, HUGHES GERMANIUM DIODES exhibit these outstanding characteristics:

1 **MOISTURE-PROOF**
Each hermetically sealed HUGHES DIODE is humidity cycled in saturated water vapor from +90°C. to -78°C., and then oscilloscope-tested for humidity penetration.

DEPENDABLE
Each HUGHES DIODE is subjected to JAN shock tests and then inspected under vibration for the familiar electrical instabilities—hysteresis, drift, and flutter. Each diode is aged and then reinspected for stability of electrical characteristics.

3 **THERMALLY STABLE**
The HUGHES DIODE is designed to reduce differential expansion which would cause instability of electrical characteristics with fluctuations in temperature. Each diode is temperature cycled and then tested to assure that the operating temperature range is limited only by inherent characteristics of germanium itself.

4 **SUBMINIATURIZED**
The HUGHES DIODE is designed for maximum space economy.

ELECTRICAL SPECIFICATIONS AT 25° C.

RTMA Type	Peak Inverse Voltage*	Minimum Forward Current at +1 volt—ma.	Maximum Back Current ma. (volts)
1N55B	190	5.0	0.5 (-150)
1N70A	130	3.0	0.025 (-10); 0.3 (-50)
1N67A	100	4.0	0.005 (-5); 0.05 (-50)
1N81A	50	3.0	0.01 (-10)
1N89	100	3.5	0.008 (-5); 0.1 (-50)
1N68A	130	3.0	0.625 (-100)
1N69A	75	5.0	0.05 (-10); 0.85 (-50)
1N90	60	3.0	0.8 (-50)

*NOTE: It has been found that Hughes Diodes will support 80% of this inverse voltage applied continuously at 25° C.

Because of expanded production capacity, HUGHES DIODES are now available for commercial sale. Moderate quantities can be delivered from stock. HUGHES DIODES are classified in accordance with RTMA specifications, and also are supplied to special customer specifications, including high temperature electrical requirements.

Address inquiries to:

SEMICONDUCTOR
DEPARTMENT

HUGHES

Aircraft Company, Culver City, California

REALLY *New!*

COMPLETE *miniature* FREQUENCY STANDARD

A compact, complete, hermetically sealed frequency standard, presenting these features:—

1. JAN-ized construction throughout.
2. SPACE-SAVING, 1½" dia. x 4½" high.
3. WEIGHT, approximately 10 ounces.
4. AVAILABLE in 400 and 500 cycles.
5. ACCURACY—.002% (15° to 35°C).
6. SHOCK-MOUNTED on Silicone rubber.
7. POWER REQUIRED, 6 V. at 300 ma.
70 to 200 V. at 1 to 5 ma.

WRITE FOR DESCRIPTIVE LITERATURE,
SPECIFYING "TYPE 2007"

Also, manufacturers of frequency standards, multi-frequency standards, chart-recording chronographs, firing-cycle timers, the Watch-Master Watch Rate Recorder and other high-precision frequency and timing instruments, controlled by our tuning-fork oscillators.

American Time Products, Inc.

580 Fifth Avenue
New York 36, N. Y.

MANUFACTURING UNDER PATENTS OF THE WESTERN ELECTRIC COMPANY



ACTUAL
SIZE

Engineers!
Gear this frequency standard to your designs and help solve climatic, space and weight problems in JAN-ized MIL equipment

At the I.R.E. Show—
BOOTH #4-215—4th Floor

Now available

the revolutionary
ELECTRO TEC
process* for your
LARGE
SLIP RING ASSEMBLIES

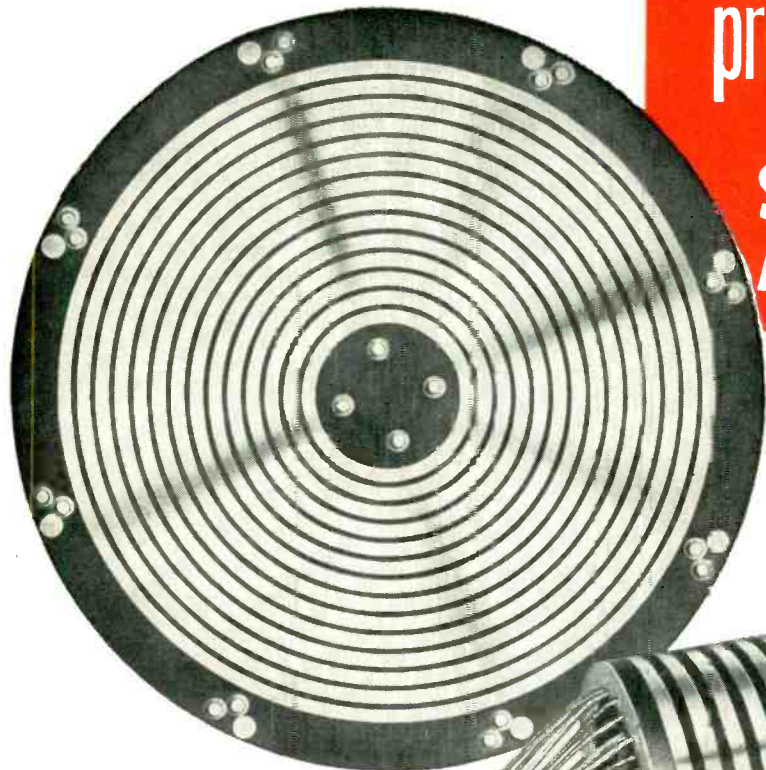

↑ An assembly with 14 concentric, hard silver rings electro deposited into machined plastic blank. Dovetail locks rings in place. Machined blank insures accuracy. Diameter approx. 11", thickness approx. 5/16".

↑ Cylindrical assembly with 25 rings. Three wide rings accommodate large contact area brushes for high current capacity. Length 14", O.C. approx. 5 1/8".

↑ An assembly with 30 rings of various widths to accommodate various current requirements. Unit is approx. 4.5/16" long, designed for flange mounting.

↑ Cylinder type assembly approx. 3 3/4" long with 24 hard silver rings. 1 5/8" O.D. with wall thickness less than 1/4".

*PATENTS
PENDING

Our Engineering Department is available for consultation on any of your slip ring problems without obligation.



- featuring*
- LOWER COST • CLOSER TOLERANCES
 - ONE-PIECE CONSTRUCTION • JEWEL-LIKE FINISH • UNIFORM RING HARDNESS
 - REDUCED WEIGHT



Now a Complete Service
in all sizes of Slip Ring Assemblies

ELECTRO TEC is now tooled up, with new expanded facilities for production of large Slip Ring Assemblies to exact customer specification. Sizes range up to 24" in diameter, either cylindrical or disc type.

The exclusive ELECTRO TEC PROCESS*—the electro-deposition of hard silver rings into an accurately machined plastic blank—consistently yields a high degree of dimensional accuracy, excellent concentricity, and a jewel-like ring finish. This process also eliminates expensive tooling and mold charges, frequently lowers costs to 30% of other methods of manufacture. The silver rings are uniformly hard for long life—75-90 Brinell.

ELECTRO TEC one-piece construction precludes dimensional variation due to accumulated errors. The plastic base is fully cured before rings are plated into it, thus preventing separation of base material from the rings.

ELECTRO TEC LARGE SLIP RING Assemblies are widely used in Radar Equipment, Fire Control Systems, Test Tables and many other critical applications. Light weight combined with rugged durability recommends their use in airborne applications.

Every user knows the ELECTRO TEC reputation for quality and superiority in miniature and sub-miniature slip ring assemblies.

ELECTRO TEC CORPORATION
SOUTH HACKENSACK • NEW JERSEY

See the AIRPAX Display at the IRE Show
Booth 4-212 . . . Components Section

AIRPAX has
the smallest . . . lightest
power supply available!

weighs only 1 lb. 14 ozs.

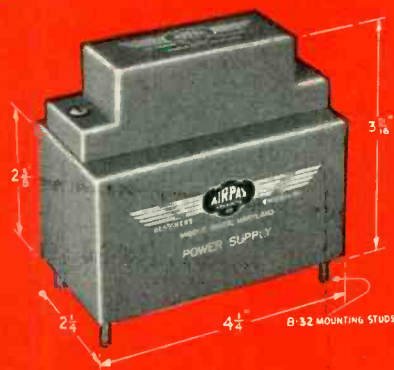

the AIRPAX
"PICK-A-BACK"

Model A1220 vibrator power supply is designed to deliver 15 watts, 150 volts DC, 10C ma at 1% peak ripple, and 70% efficiency. Very small size and weight are possible because of the high frequency (450 cycle) vibrator. Vibrator and power supply are hermetically sealed. Vibrator is replaceable, using Dzus snap fasteners for easy removal. Supply obtainable for 6, 12 or 26.5 VDC input, maximum output of 20 watts and 300 volts on special order. Will operate with a 20% input voltage variation, under severe vibration and shock, may be exposed to high altitude without damage

Write for bulletin A1220.



ELECTRONS AT WORK

(continued)

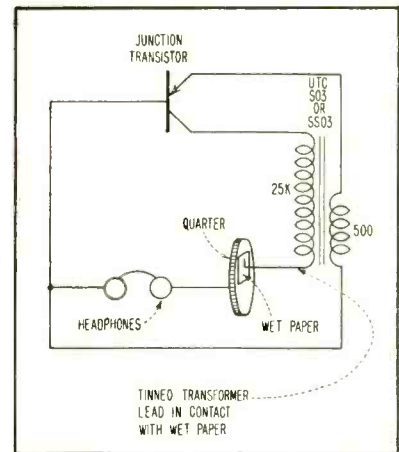

Simple oscillator uses commercially available parts. Tone is heard in headphones from transistor oscillator powered by power source made from a quarter, a tinny transformer lead, and a piece of saliva-soaked paper

soaked paper. Power obtained by irradiating a photovoltaic cell may also be used. The entire circuit may be built on the back of a single earphone. Oscillations will continue as long as the paper remains damp.

Survey of Waveguides and Lines

RECENT reports in the public press described a British development in which a length of metal tubing was to be used for the transmission of electric power, multichannel communications circuits and television programs.

In a statement prepared for ELECTRONICS, Prof. Harold M. Barlow of University College London says, in part: "This objective was envisioned in outline as long ago as 1947. Since that date much progress has been made towards translating the idea into a practical form."

"It will be appreciated that the capabilities of the coaxial line as a trunk communication and television link have now been fully exploited and for further extension of facilities in this field we must look to some form of microwave service. The H_{10} tubular waveguide is an attractive proposition because it offers a completely screened channel not subject to interference and with the possibility of a very wide band of frequencies available for multichannel work. In any country having large centers of population

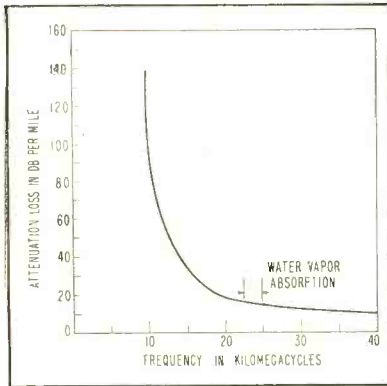

FIG. 1—Attenuation loss of cylindrical copper waveguide having inside diameter of 1½ inches (Barlow)

there is not only a big demand for independent communication channels between such centers, but also for the transmission and distribution of electric power."

"The tubular waveguide suitably designed can quite readily make provision simultaneously for both needs. Furthermore, when the conductor is properly supported it is capable also of guiding a cylindrical surface wave along its outside surface, thus, if necessary, providing a triple service. In such a case we should have microwave channels both inside and outside the tube, while the power-frequency currents flow along the tube itself."

"Our efforts have been concerned more particularly with the problem of the waveguide. We are not quite ready yet to describe the technical details of our work. We are examining the performance of our microwave channel at a wavelength in the region of 8 millimeters."

Barlow's original suggestion proposed a frequency of 40,000 mc, the same order of magnitude as the area of current strenuous activity at Bell Telephone Laboratories. Despite the difficulty of generating power at frequencies this high, there is good reason for the choice. As shown by the graph, Fig. 1, the attenuation losses fall off very rapidly in this particular type of waveguide propagation as the frequency is increased. Because the waveguide is likely to contain a slight amount of dry air, the region between 23,000 and 25,000 mc must be avoided since these are the frequencies of absorption by water vapor. Frequencies around 60,000 mc are likewise forbidden because of

See the AIRPAX Display at the IRE Show
Booth 4-212 . . . Components Section

AIRPAX has the most revolutionary miniature chopper!

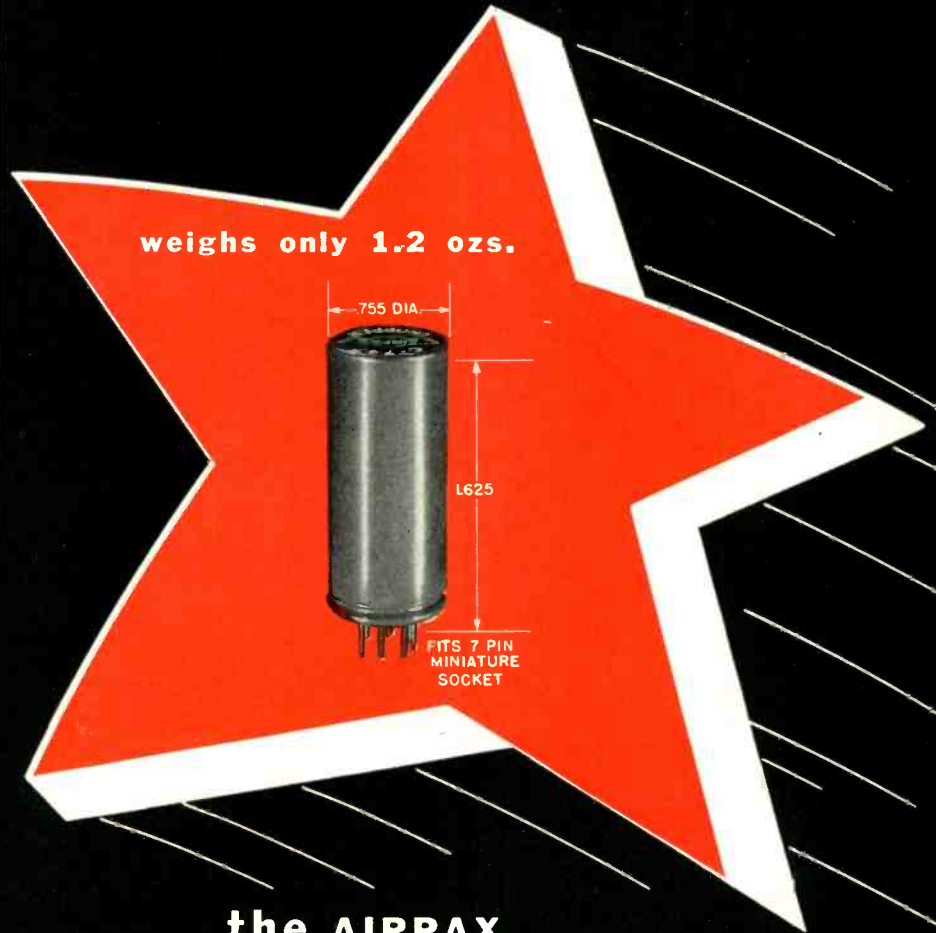

the AIRPAX "MIDGET"

Small size and big performance have won wide acclaim for the C747 MIDGET chopper in the short time since production was released. Available with SPDT contacts, a 6.3 volt drive for 400 cycle operation, usually a 380 to 420 cycle frequency range. Phase angle measured from a driving sine wave to midpoint of contact dwell is a nominal 65°, with a dwell of approximately 135°. Units operate successfully over a very wide temperature range, are fully hermetically sealed and may be exposed to high altitudes, humidity, vibration and shock without damage.

Write for bulletin C747.



FIRST AND ONLY 460 MC.

type-approved for operation in the Class-A, "Citizen's Band"

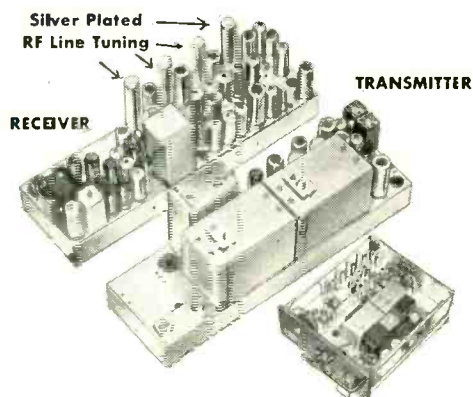

18 to 20 Full Watts. Motorola makes it an outstanding success.

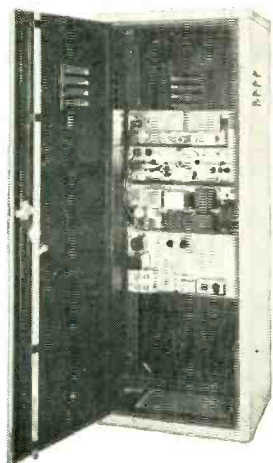

Pole mounting cabinet

*Mobile type CR-406

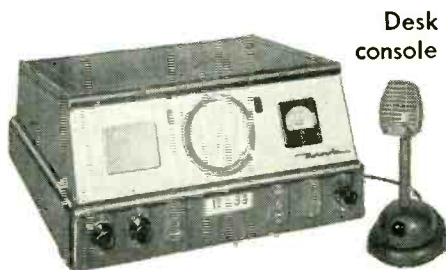

Desk console

Motorola has received notice* from F.C.C. that its "Research" Line 460 M. C. equipment has passed the exacting tests for licensing in the Class-A "Citizen's Band". It is the first and only 460 MC. equipment to be so approved.

Automatic Frequency Control

This new Motorola A.F.C. technique is fortified with extraordinary system stability. Fixed barriers prevent channel jumping. The A. F. C. crystal controlled oscillator provides a full 10 to 1 correction ratio and keeps the receiver tuned on the nose to the distant transmitted carrier.

The new U.H.F. tuned circuits and research design cavities for grounded grid amplifier operation provide phenomenal circuit stability, spurious rejection and extraordinary efficiency.

Transmitter

The Motorola 460 MC. system with 9 tuned circuits provides 18 to 20 Watts with efficiencies of more than 65%!

Silver Plated Sealed Tuned Cavities

By use of silver plated line sections, high standards of selectivity protect the receiver from high power U.H.F., TV intermodulation.

*By the leaders in quality-engineered
FM 2-way Radio Communications*

Write Dept. 2-86-E for full details today.

Motorola®

Communications & Electronics, Inc.

A SUBSIDIARY OF MOTOROLA, INC.

900 N. Kilbourn Ave., Chicago 51, Illinois
Rogers Majestic Electronics Ltd., Toronto, Canada

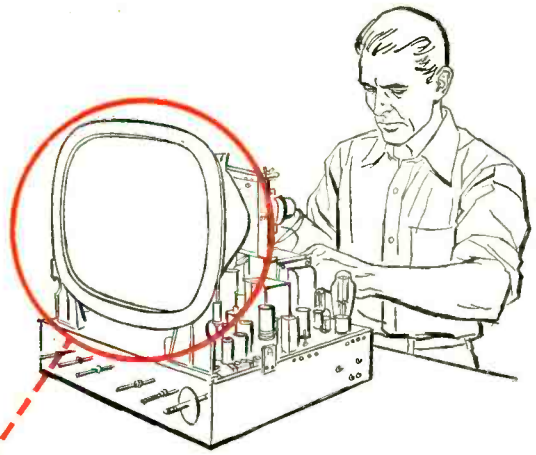

Du Pont "Alathon"* insulates TV tube carrying 20,000 volts

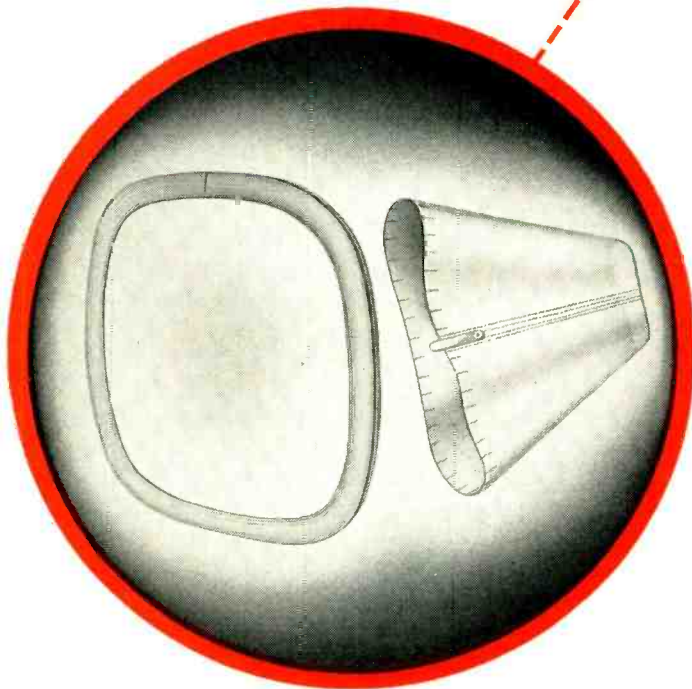

Ring and sleeve of "Alathon" retain dielectric properties . . . pass humidity tests . . . lower shipping costs

When television-set manufacturers started using metal picture tubes, they were faced with the problem of insulating the outer portion of the tubes that carry up to 20,000 volts. A material was needed that could withstand the voltage, while resisting humidity that would ruin its insulating value.

The solution was this ring and sleeve extruded of Du Pont "Alathon" polythene resin. Of all the materials tested, only "Alathon" retains its electrical properties in service. "Alathon" has excellent dielectric strength, low dielectric constant (2.3), and low power factor (0.0005). Because of its very low moisture-absorption rate (0.01% by A.S.T.M. test), "Alathon" easily passed exacting humidity tests.

Du Pont "Alathon" offers other important advantages. Its flexibility simplifies installation. Shipping costs are reduced because "Alathon" absorbs shock . . . makes possible packing of sets as units . . . eliminates shipping the delicate tubes separately. And reassembly time and labor at outlets are eliminated. Many TV manufacturers now use these rings and sleeves.

Du Pont "Alathon" is widely used for such insulating applications as TV lead-in wire, high-voltage TV lead wire, and police and fire-alarm cable. We will gladly suggest suppliers who can meet your specific needs for electrical or other uses of "Alathon." For further information, write:

Rings and sleeves extruded by
Anchor Plastics Co., Inc.
New York, N. Y.

*REG. U.S. PAT. OFF.



REG. U.S. PAT. OFF.

Better Things for Better Living
... through Chemistry

Polychemicals
DEPARTMENT
PLASTICS • CHEMICALS

E. I. du Pont de Nemours & Co. (Inc.)
Polychemicals Department, District Offices:
350 Fifth Avenue, New York 1, New York
7 S. Dearborn St., Chicago 3, Illinois
845 E. 60th St., Los Angeles 1, California

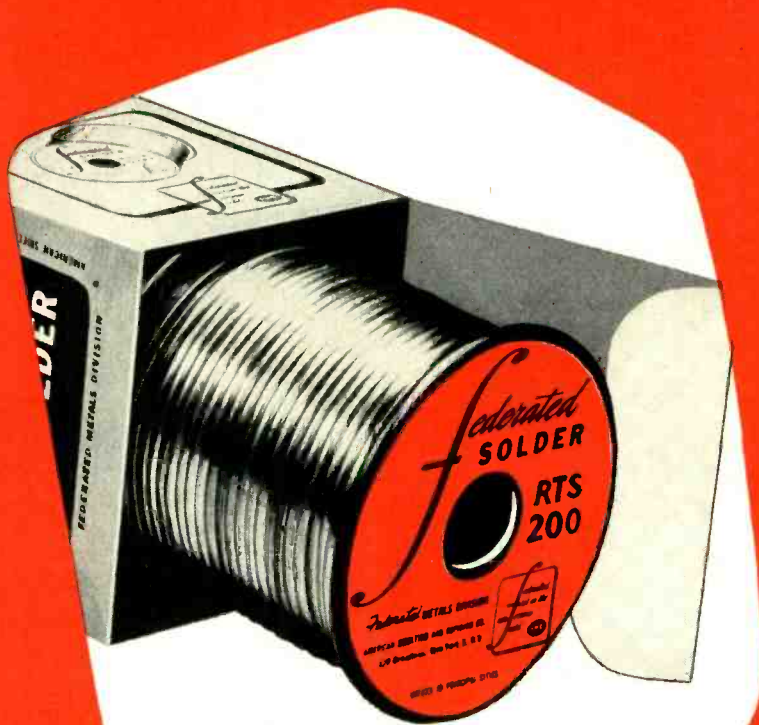

New
RTS 200
5 WAYS BETTER
Than Ordinary Rosin Solders

Federated Metals Division

AMERICAN SMELTING AND REFINING COMPANY
 120 BROADWAY, NEW YORK 5, N. Y.

In Canada: Federated Metals Canada, Ltd., Toronto, Montreal

Aluminum and Magnesium, Babbitts, Brasses and Bronzes, Anodes
 Die Casting Metals, Lead and Lead Products, Solders, Type Metals

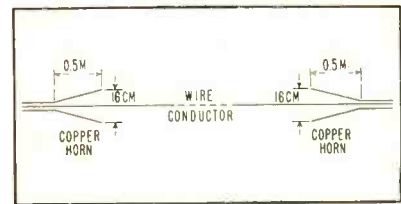

FIG. 2—The experimental surface-wave transmission line used by Grace and Lane in England

absorption by oxygen.

Reference to the cylindrical surface wave includes the work of Georg Goubau and others, principally for the Signal Corps. Since 1950, experiments with this so-called G-string have extended its range of practicable operation to two miles. While details of this work are expected to be published soon, it is known that this particular installation employs a single copper line three quarters of an inch in diameter covered with polyethylene. Used in the vhf region, it has a bandwidth of 200 mc.

Grace and Lane in England have recently published loss figures for a similar transmission line with an enameled surface. Maximum horn losses (the ends of the lines are matched into coaxial lines by horn-shaped outer conductors as indicated in Fig. 2) for radio frequencies between 3,000 and 9,000 mc are about 2 db coupled with a line loss varying from 0.07 to 0.26 db per meter and increasing with frequency.

Miller and Beck of Bell Telephone Laboratories will describe their work with circular waveguides in a forthcoming issue of *Proc. IRE*, as summarized below.

To reduce theoretical heat losses of hollow metallic waveguides to 0.25 db per 100 feet at frequencies above 2,000 mc, it is necessary to use the guide as a multimode medium. Above 10,000 mc the circular electric mode in round metallic tubing becomes more attractive than the dominant mode because it provides a medium with the 0.25-db-per-100-foot loss in a smaller space.

Using the circular electric wave, theoretical heat losses of 2 db per mile are associated with tubing diameter of 2 to 6 inches and carrier frequencies between 50,000 and 5,500 mc respectively. Increased transmission bandwidth, reduced

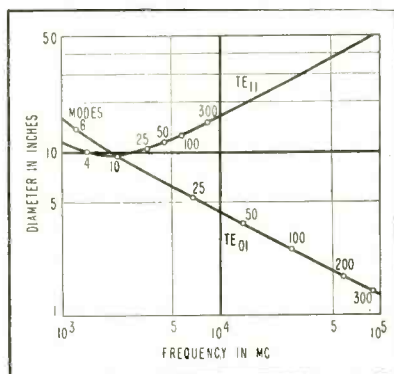

FIG. 3—Round guide diameter vs frequency for loss of 2 db per mile

delay distortion and reduced waveguide size are factors favoring use of the highest practical frequency of operation. The number of freely propagating modes lies in the range 175 to 20 for the 2 to 6 in. diameter region, as shown in Fig. 3 taken from the paper.

Experimental work has been carried out at 9,000 mc on a waveguide having theoretical loss of 2 db per mile for the TE_{01} wave. Transmission losses on the order of 3 db per mile over distances as great as 40 miles, with tolerable signal distortion of a 0.1 microsecond pulse, have been observed on a well-constructed line. Mode filtering and pure-mode generation has been accomplished.

Experimental work, described in still another Bell Labs paper, demonstrates the feasibility of transmitting the TE_{01} wave around bends. The circular wave can be transmitted around bends either by altering the form of the wave in the bend region (as in Fig. 4) or by altering the waveguide itself.

Still another technique under development at Bell Labs is the laminated transmission line. Here, skin-effect losses are reduced by properly laminating the conductors and adjusting the velocity of transmission of the waves by means of a suitable dielectric. Such a con-

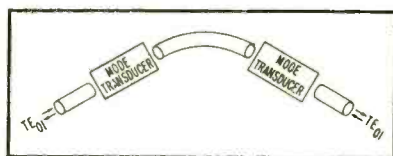

FIG. 4—Representation of the kinds of elements that are necessary in a normal-mode bend



You Can Speed Production-Line Soldering with New, Active, Non-Corrosive RTS 200

Federated Metals' new RTS 200 rosin core solder has proved in production operations to be 5 ways better than ordinary rosin solders:

30% GREATER SPREAD—by test the spread of RTS 200 is 30% greater than that of conventional rosin core solders.

4 TIMES FASTER OXIDE PENETRATION—oxide films and corrosion products on the parts you are soldering need not slow down operations. RTS 200 pierces these retarding agents 4 times faster than ordinary solders.

NON-CORROSIVE—despite the exceptional activity of the RTS 200 flux at soldering temperatures, there is *no harmful corrosive residue* when tested under the high humidity conditions of military specification MIL-S-6872.

NON-TOXIC—the chemicals used in RTS 200 flux are commonly used in industry and have no toxicity factor whatsoever.

STABLE FLUX—experience of over one year with the type flux used in RTS 200 shows that it is just as active after standing as when used immediately. If you store RTS 200 for extended periods, you need not worry about its stability, as you do with ordinary solders.

Try this new, industry-tested active solder *today*. Available in a variety of wire sizes, compositions and quantities. For information see your distributor or write any one of Federated's 13 plants or 22 sales offices across the nation. There is one near you.

Federated Metals Division

AMERICAN SMELTING AND REFINING COMPANY
120 BROADWAY, NEW YORK 5, N. Y.

In Canada: Federated Metals Canada Ltd., Toronto, Montreal



Aluminum and Magnesium, Babbitts, Brasses and Bronzes, Anodes, Die Casting Metals, Lead and Lead Products, Solders, Type Metals



Magnetic Amplifiers

Visit us at booth 4-609
Radio Engineering Show

Keystone is one of the nation's foremost suppliers of magnetic amplifiers. Effective immediately we have available for prompt delivery the first of five "stock" magnetic amplifiers. Engineers may now design units around these "pre-designed" magnetic amplifiers. Inquiries are invited on the

“Moto Mag”
Registered Trademark
of Keystone Products Co.

In place of the conventional output transformer and power amplifier tubes, the KP 10-400 utilizes a phase sensitive vacuum tube demodulator and magnetic amplifier output stage which eliminates the need of rectifiers, thus assuring greater reliability. Each unit built in accordance with MIL specifications. KP 10-400 operates from an input voltage of 115 volts, 400 cycles single phase. Output is 10 watts, reversible phase. KP 10-400 operates from a minus 55° to plus 70° C with minimum variation. An input signal of 2 volts AC or DC working into a high impedance is required for a maximum of 110 volts, 10 watts, 400 cycles. The unit is 4 inches high, 3½ inches wide and 2½ inches deep. Weight—only 1 lb., 13 ounces.

Your inquiry will have our prompt attention.

KEYSTONE PRODUCTS CO.

904-6 TWENTY-THIRD ST., UNION CITY 2, NEW JERSEY

UNion 6-5400

Texas Instruments'

POINT CONTACT

TRANSISTORS

now available!

TEXAS INSTRUMENTS makes available to industry Type 100 and 101 point contact transistors. Type 100 is designed for use in switching circuits. Type 101 is a high-efficiency, low-drain transistor for low frequency (below 1 mc) application. It is designed to operate at low voltage and power levels with a good, large signal performance. Both have the usual high temperature limitations of germanium semi-conductor devices. *Uniform characteristics are assured.* Write for bulletin with complete information.

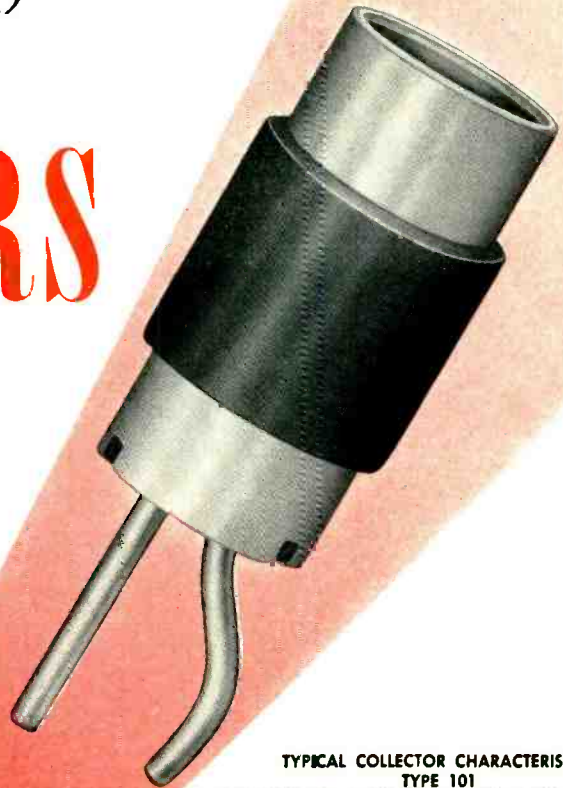

TYPICAL COLLECTOR CHARACTERISTICS
TYPE 101

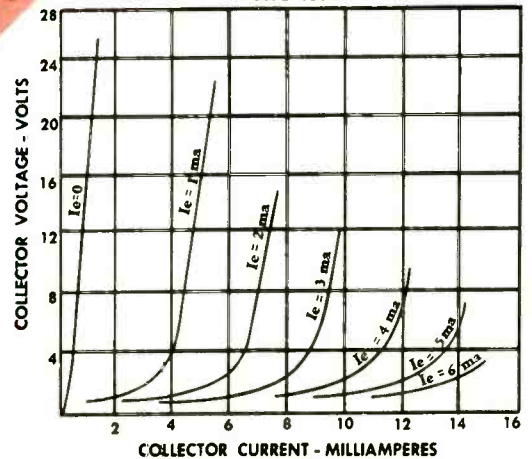

★
ACTUAL SIZE



★ Point contact transistors Type 100 and 101 ready for immediate delivery. ★ Junction transistors will be available in developmental quantities in May. ★ Be sure to watch for announcement concerning new semi-conductors later this year.

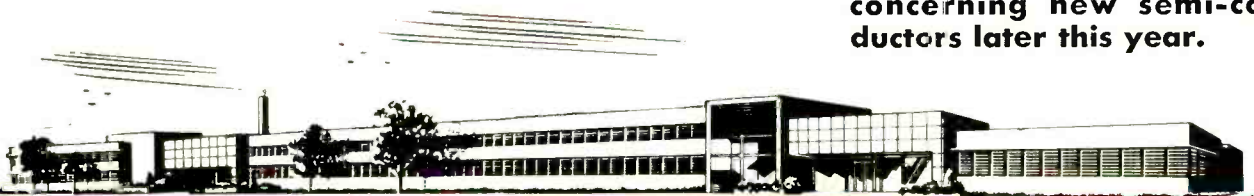

TEXAS INSTRUMENTS

6000 LEMMON AVENUE

INCORPORATED

DALLAS 9, TEXAS

8 Basic Features

OF EVERY HAYDON TIMING MOTOR PROVIDE

PRECISION TIMING • JOB ENGINEERED

FOR

Outstanding Performance

1



DEPENDABILITY

Slow rotor speed means a minimum of reduction gearing, long life, quiet operation.

3



TOTAL ENCLOSURE

ALL HAYDON motors are totally enclosed, a basic feature of sound design.

5

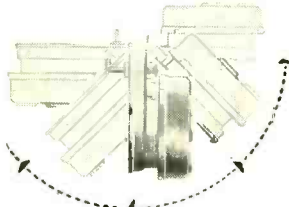

OPERATION IN ANY POSITION

Means freedom from worry about mounting position, no limitations on your original design and field operation.

7

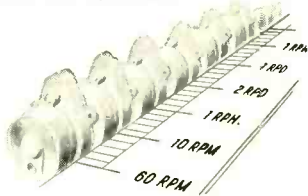

STANDARD INTERCHANGEABLE DESIGN

A wide range of speeds in only 2 motor series, interchangeable in mounting, drive shafts and all dimensions except depth, permits use of the same basic motors for a variety of requirements.

2



SMALL SIZE

HAYDON motors are the smallest available of their types.

4

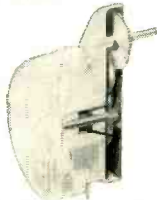

CONTROLLED LUBRICATION

Two lubrication systems permit the selection of lubricant best suited to each component. All circulation controlled by capillary action.

6

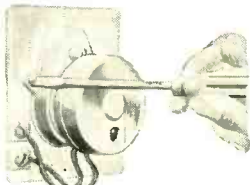

SIMPLE SECURE ASSEMBLY

The entire face of the motor can be rigidly supported against the mounting surface. Motor leads are standard for quick, inexpensive wiring.

8

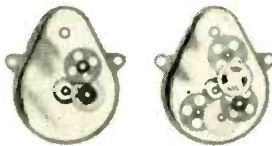

CHOICE OF MANY SPEEDS

Many standard speeds available from 60 rpm to 1 revolution per week.

ductor takes the form of a solid-dielectric coaxial cable.—A.A.MCK.

BIBLIOGRAPHY

H. M. Barlow, The Exploitation of Micro-Waves for Trunk Waveguide Multi-Channel Communications, 1947 Radio Convention, *IRE*, May 1947.

S. E. Miller and A. C. Beck, Low-Loss Waveguide Transmission, *Proc. IRE*, 41, p 348, Mar. 1953.

S. E. Miller, Notes on Methods of Transmitting the Circular Electric Wave Around Bends, *Proc. IRE*, p 1104, Sept. 1952.

G. Goubau, Surface Waves and their Application to Transmission Lines, *J. Applied Physics*, 21, p 1119, 1950.

G. Goubau, Single Conductor Surface Wave Transmission Line, *Proc. IRE*, 39, p 619, 1951.

A. C. Grace and J. A. Lane, Surface-Wave Transmission Lines, *Wireless Engineer*, p 230, Sept. 1952.

C. E. Sharp and G. Goubau, A UHF Surface Wave Transmission Line, *Proc. IRE*, p 107, Jan. 1953.

Spatial Harmonic T-W Tube

TRAVELING-WAVE TUBES operate satisfactorily as wide-band amplifiers for microwaves and are beginning to find use particularly in the region of 4 kilomegacycles, corresponding to a wavelength of 7.5 cm.

Increased experimentation in the region of 50 kmc has brought an extension of the traveling-wave technique resulting in a tube of the general type capable of operation at 48 kmc, a wavelength of 6.25 mm.

Because the helix, which characterizes the traveling-wave tube, becomes increasingly delicate as frequency is raised, it has been entirely eliminated from the design of this experimental tube.

As explained by Sidney Millman in the Nov. 1952 issue of the *Bell Laboratories Record*, to obtain amplification in a traveling-wave amplifier, a stream of electrons and the electromagnetic wave to be amplified must travel together down the tube at approximately the same speeds. Since the electromagnetic wave travels at a speed approaching that of light, and since electrons cannot be given such speeds except under the influence of extremely high voltages, some method must be devised for slowing down the wave to speeds that electrons will attain under the influence of practicable voltages. In most traveling-wave tubes that have been described, this slowing down was achieved by making the wave travel along a closely wound helix. Despite the

Look to

HAYDON
AT TORRINGTON

FOR TIMING MOTORS • TIMING DEVICES
TIMING ENGINEERING SERVICES

HEADQUARTERS FOR
TIMING

2427 Elm St., Torrington, Conn. Subsidiary General Time Corp.

ONLY THE LFE 401 OSCILLOSCOPE

Offers all these Important Features

HIGH SENSITIVITY AND WIDE FREQUENCY RESPONSE OF Y-AXIS AMPLIFIER

The vertical amplifier of the 401 provides uniform frequency response and high sensitivity from D-C. Coupled with a sensitivity of 15 Mv./cm peak to peak at both D-C and A-C is a response characteristic which is 3 db. down at 10 Mc. and 12 db. at 20 Mc. Alignment of the amplifier is for best transient response, resulting in no overshoot for pulses of short duration and fast rise time. An example of the wide band response of the amplifier is shown in the accompanying photographs.

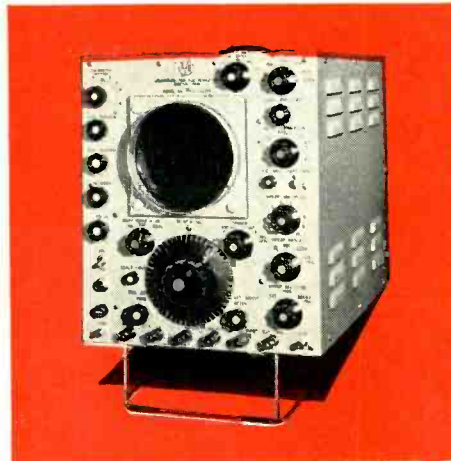
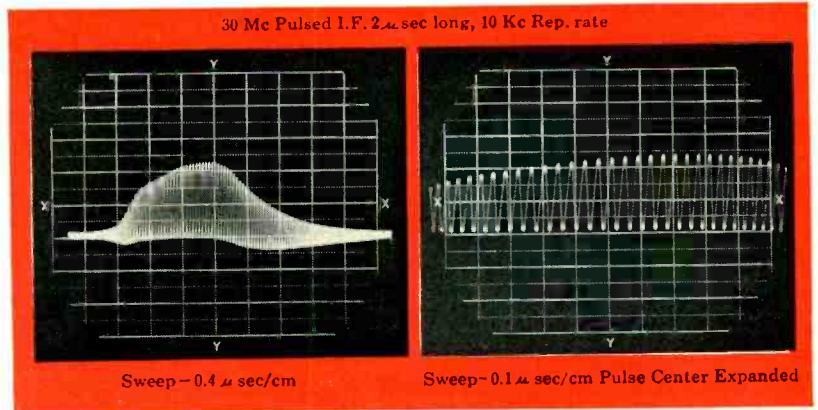

SPECIFICATIONS

Y-Axis

Deflection Sens. — 15 Mv./cm, p-p
 Frequency Response — DC to 10 Mc
 Transient Response — Rise Time (10%-90%) 0.035 μ sec
 Signal Delay — 0.25 μ sec
 Input line terminations — 52, 72 or 93 ohms, or no termination
 Input Imp. — Direct — 1 megohm, 30 μ f
 Probe — 10 megohms, 10 μ f

X-Axis

Sweep Range — 0.01 sec/cm to 0.1 μ sec/cm
 Delay Sweep Range — 5-5000 μ sec in three adjustable ranges.
 Triggers — Internal or External, + and -, trigger generator, or 60 cycles, undelayed or delayed triggers may be used.
 Built-in trigger generator with repetition rate from 500-5000 cps.

General

Low Capacity probe
 Functionally colored control knobs
 Folding stand for better viewing
 Adjustable scale lighting
 Facilities for mounting cameras

PRICE: \$895.00

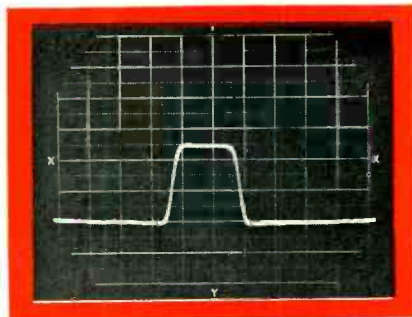

37.5 Mc., 0.2 μ sec width, 1 μ sec sweep full scale

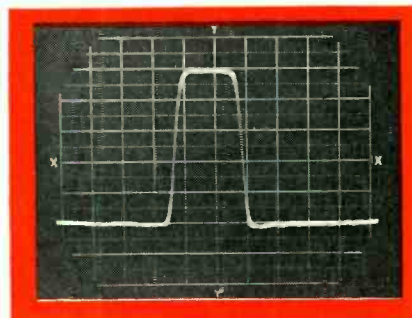

75 Mc., 0.2 μ sec width, μ sec sweep full scale

LINEARITY OF VERTICAL DEFLECTION

The vertical amplifier provides up to 2.5 inches positive or negative uni-polar deflection without serious compression; at 3 inches, the compression is approximately 15%. The accompanying photographs illustrate accurate transient response and linearity of deflection.

SWEEP DELAY The accurately calibrated delay of the 401 provides means for measuring pulse widths, time intervals between pulses, accurately calibrating sweeps and other useful applications wherein accurate time measurements are required.

The absolute value of delay is accurate to within 1% of the full scale calibration. The incremental accuracy is good to within 0.1% of full scale calibration.

Additional Features:

- An INPUT TERMINATION SWITCH for terminating transmission lines at the oscilloscope.
- A FOLDING STAND for convenient viewing.
- FUNCTIONALLY COLORED KNOBS for easier location of controls.

Designed and built for electronic engineers, the 401, with its high gain and wide band characteristics, and its versatility, satisfies the ever-increasing requirements of the rapidly growing electronics industry for the ideal medium priced oscilloscope.

TRIGGER GENERATOR with variable repetition rate from 500 to 5000 cps.

POSITIVE & NEGATIVE UNDELAYED TRIGGERS and a POSITIVE DELAYED TRIGGER are externally available.



Booth 4-105 New York IRE Show

LABORATORY for ELECTRONICS, INC.

75 PITTS STREET • BOSTON 14, MASS.

PRECISION ELECTRONIC EQUIPMENT • OSCILLOSCOPES • MAGNETOMETERS • COMPUTERS • MICROWAVE OSCILLATORS • MERCURY DELAY LINES

Rough Treatment FOR A CRYSTAL . . .

BOILED

5 minutes to prove hermetic seal

SHOCKED

Thermal-shocked from -60° to $+95^{\circ}\text{C}$ in 70 seconds

SHAKEN

Vibrated from 10 to 55 cycles per sec. Stress equivalent to 5G pull

That Kind of testing is just one of the reasons why

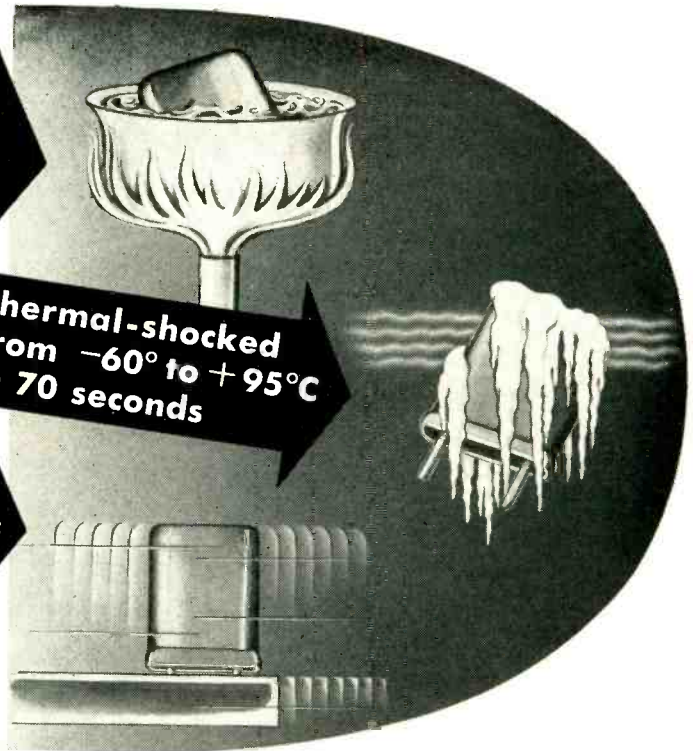

Midland CRYSTALS DO A BETTER JOB FOR YOU

***TYPE ML-1A—RANGE:**

2.0—15.0 mc

Supplied per Mil type CR-1A when specified.

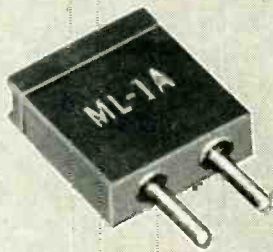

***TYPE ML-4—RANGE:**

1.0—10.0 mc

Supplied per Mil type CR-5; CR-6; CR-8; CR-10 when specified.



***TYPE ML-6—RANGE:**

1.4—75.0 mc

Supplied per Mil type CR-18; CR-19; CR-23; CR-27; CR-28; CR-32; CR-33; CR-35; CR-36 when specified.



Yes, we get tough with our Midland crystals. You expect best performance, and we make sure you get it when you use Midland crystals for all your frequency control needs. The final test pictured above is just one of many quality checks we make at every step of Midland processing.

Midland Quality Control starts with the raw quartz. Using optical viewing equipment of high accuracy, we select only the "cream of the crystal crop." Then, as the crystal proceeds through the various steps of cutting, slicing, lapping, etching, plating, and sealing, it is checked repeatedly to turn up any defect that might develop.

Stability, accuracy, high output, long life—name anything about a crystal that makes it a better performer for you, and we guarantee you'll get it in fullest measure with Midland.

WHATEVER YOUR CRYSTAL NEED—
CONVENTIONAL OR SPECIALIZED...

When It  Has To Be EXACTLY RIGHT... Contact

Midland

MANUFACTURING CO., INC.

3155 Fiberglas Road • Kansas City, Kansas

See Us at the Radio Engineering Show, Booth 4-613 Components Ave.

TINNERMAN
Speed Nut
SAVINGS STORIES

FASTEST THING IN FASTENINGS®

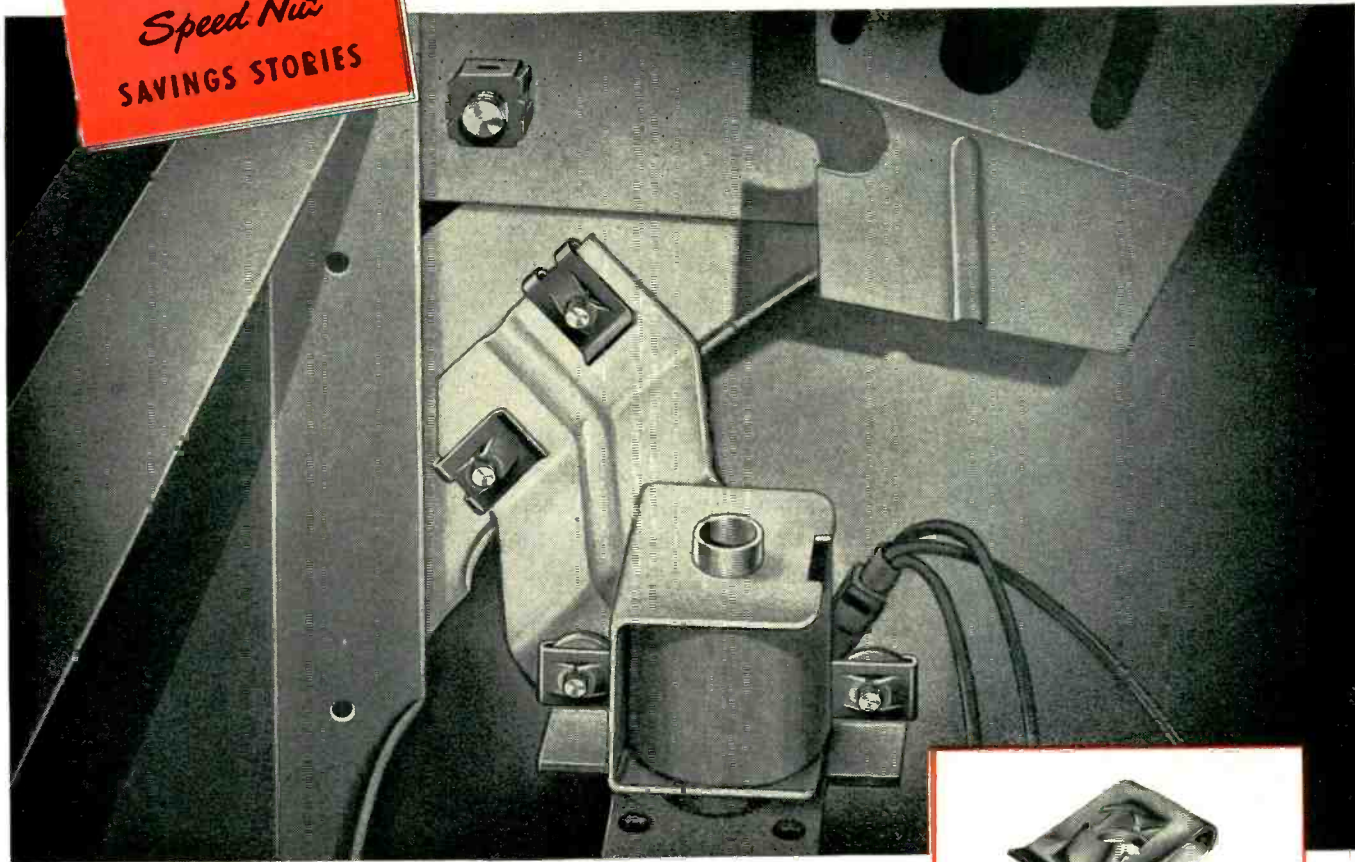

BENDIX Perfect Laundry Pair "Cleans Up" with SPEED NUT Savings!

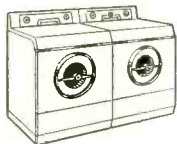

For years, Bendix engineers have relied on SPEED NUTS to cut assembly costs and step up production schedules. That is why SPEED NUT brand fasteners were specified on the new "Perfect Pair" automatic washer and dryer units.

Here is a direct quotation from a recent Bendix report . . .
". . . because we design from the ground up with Tinnerman, we effect basic economies. These include lower production costs and greater efficiency that result in lower retail prices and reduced service costs for consumers. Thus, in our production, we consider Tinnerman products more basic than nuts and bolts." Chances are your Tinnerman representative can turn your assembly problems into production savings. See him soon for details on the Fastening Analysis Service available for your products!



U-TYPE SPEED NUTS are self-retaining, snap in place over panel edges or center-panel locations; remain in bolt-receiving position for fast, easy assembly.



SPEED GRIP Nut Retainers snap in place by hand . . . no welding, clinching or staking. They reduce materials handling and are ideal for blind locations.

A copy of "SPEED NUT Savings Stories", an interesting booklet of typical Tinnerman savings to industry, is yours on request. Write: TINNERMAN PRODUCTS, INC., Box 6688, Dept. 12, Cleveland 1, Ohio. *In Canada:* Dominion Fasteners Ltd., Hamilton, Ontario. *In Great Britain:* Simmonds Aerocessories, Ltd., Treforest, Wales. *In France:* Aerocessories Simmonds, S. A.—7 rue Henri Barbusse, Levallois (Seine).



MORE THAN 8000 SHAPES AND SIZES

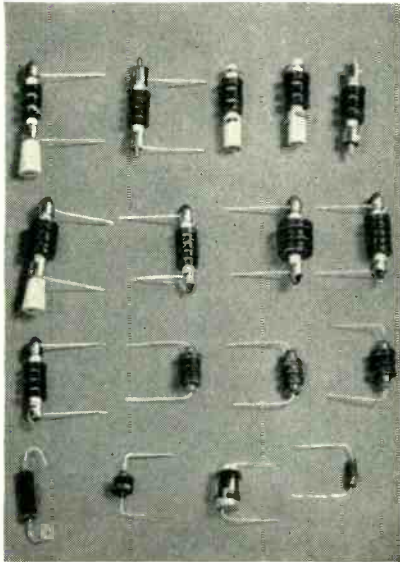

PRECISION-WOUND R.F. CHOKES

National makes a complete line of quality R.F. chokes to meet every electronic need. In addition, National's engineering staff and production facilities are capable of winding chokes to any set of specifications for commercial or military applications. Close tolerances guaranteed. Write for complete information or send specifications.

CAPTIVE NUTS

National Captive Nuts of stainless steel may be pressed into aluminum and certain types of brass sheet metal to provide integral flush-mounted tapped holes in a wide variety of sizes. Four basic types have been designed for metal thicknesses of $\frac{1}{16}$ ", $\frac{3}{32}$ ", $\frac{1}{8}$ ", $\frac{3}{16}$ " and $\frac{1}{4}$ ".

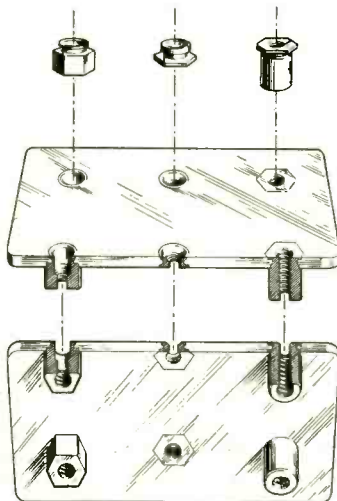

Write for drawings



fact that its velocity along the wire is high, its axial velocity along the tube is reduced by the ratio of distance along the wire to distance down the tube.

In the new tube the magnetic wave is not slowed down in this way. Instead, the electron stream is made to react with what is termed a spatial harmonic of the original wave.

The new tube is shown in cross section in Fig. 1. Electrons emitted from the cathode at the left pass down the center of a channel in a copper block to a collector at the

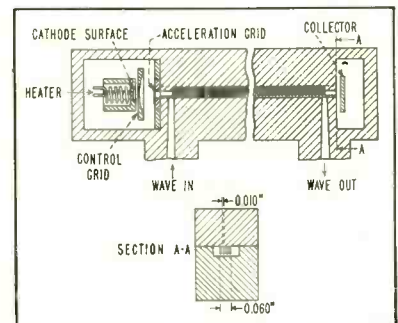

FIG. 1—Cross section of tube used as spatial harmonic traveling-wave amplifier at 50,000 mc

right. They are caused to travel with a minimum of transverse motion by a magnetic field, as in other traveling-wave amplifiers.

The electromagnetic wave enters and leaves the tube through waveguides at the beginning and end of the channel as indicated. Down the center of the channel is a metal block with three axial slots indicated in section A-A. The main stream of electrons travels down these slots and close to each side of the projecting block.

Transverse resonator slots, 100 of them in all, cutting through the central block at right angles to the axial slots, constitute the radio-frequency circuit guiding the electromagnetic wave.

Amplification is accomplished by the reaction of the electrons and the axial component of the electric field of the traveling wave. Near the surface of a conductor, however, the axial component of the electric field disappears. It is, therefore, only while the electrons and the electromagnetic wave are crossing the transverse slots that the prin-

For Excellence in Performance . . .

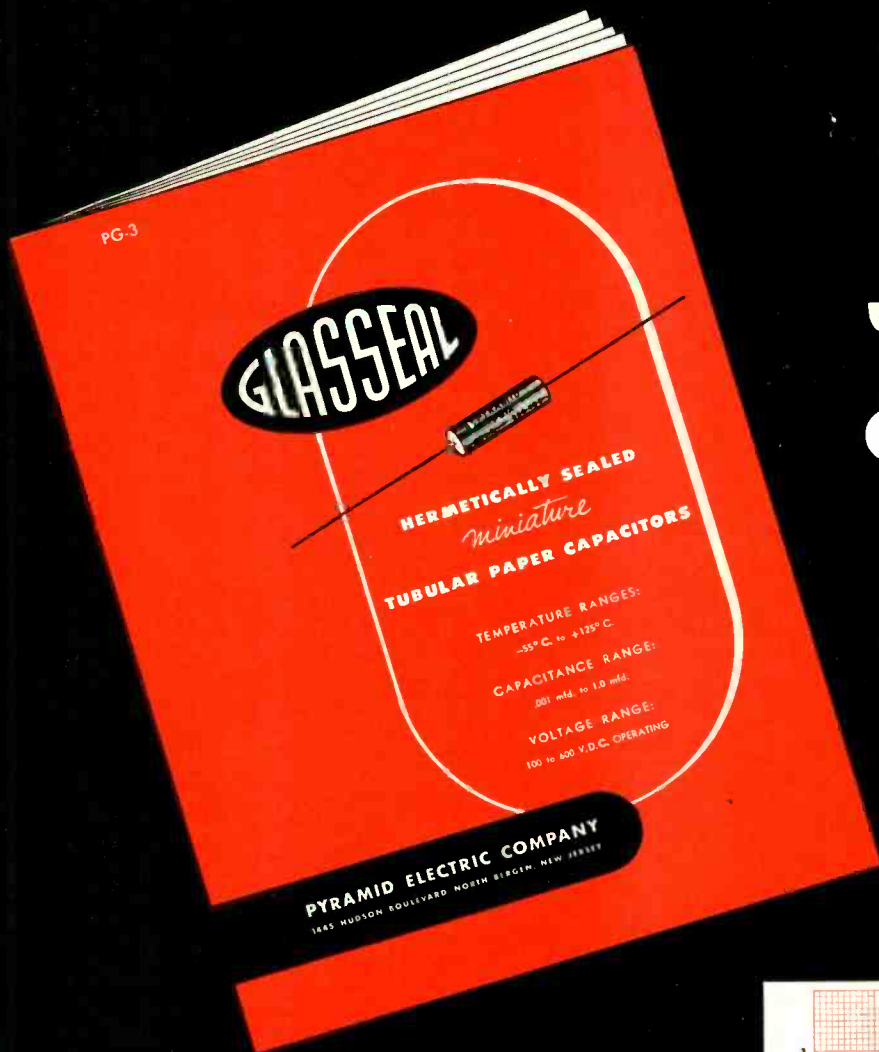

PYRAMID *subminiature* "GLASSEAL" CAPACITORS

For the most demanding applications, where top-quality and minimum-size considerations are the most vital factors, Pyramid "Glasseeal" capacitors are the popular choice.

This attractive new catalog PG-3, incorporating complete engineering data, styles, sizes, and capacitance and voltage ranges is now available.

Power Factor vs. Temperature Curve

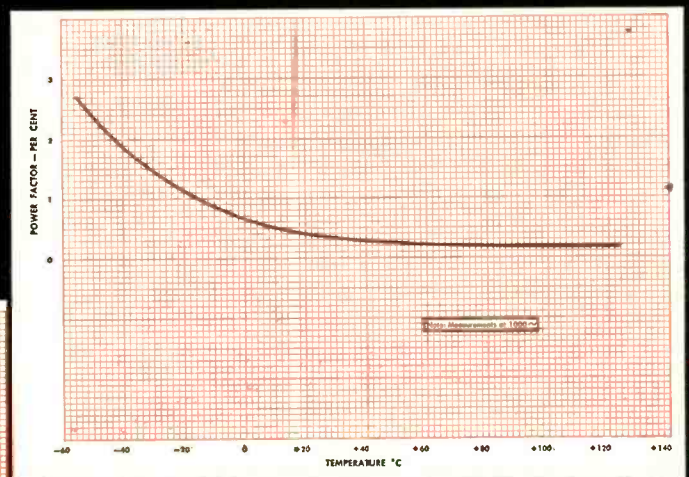

% Capacitance Change vs. Temperature

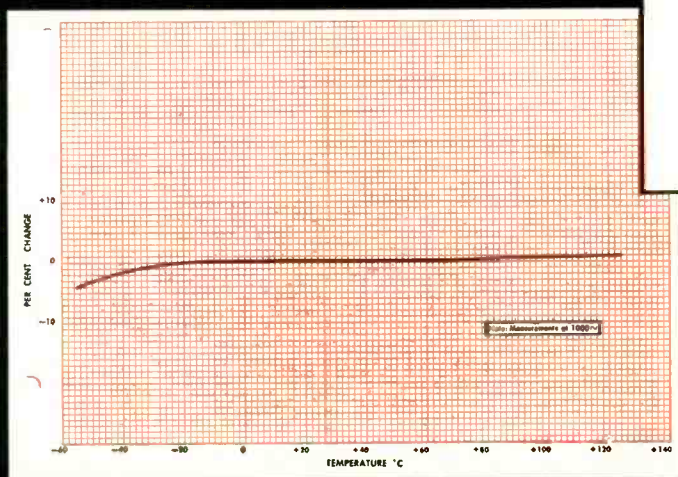

These graphs show typical performance characteristics of the Pyramid "Glasseeal X" type, which is designed for 125°C. operation. Full information on all "Glasseeal" capacitors is provided in new catalog PG-3.

Visit Booth 2 - 310 I. R. E. Convention

For your free copy, please address letterhead request to Department T1

PYRAMID ELECTRIC COMPANY

1445 HUDSON BOULEVARD

NORTH BERGEN, N. J.

**continuous
operation at
exceptional
temperature
ranges**

up from +210°C (+410°F)
to -90°C (-130°F) and below

EXTRUDED
TEFLON
HOOK-UP WIRE

EXTRUDED TEFLON (Tetrafluoroethylene) hook-up wire is organically capable of sustained operation from +210°C to -90°C with no appreciable decomposition. This wide range of operating efficiency continually opens new applications for **EXTRUDED TEFLON** — especially where constant stability under exceptional temperature conditions is required for long periods. **EXTRUDED TEFLON** +210°C to -90°C is non-inflammable . . . is resistant to most chemicals . . . has no known solvent.

Because of low electrical losses, **EXTRUDED TEFLON** is adaptable for high frequency use. It has very high volume and surface resistivity. **EXTRUDED TEFLON** is available in thin wall and specified hook-up wire sizes, with shield or jacket, also as coaxial cable.

NOW AVAILABLE in 10 colors—black, brown, red, orange, yellow, green, blue, violet, gray, white. Samples available.

See you at the IRE Convention
March 23-26, Booths 4-201, 4-202.

Surprenant MFG. CO.

199 WASHINGTON ST. BOSTON 8, MASS. Plant CLINTON, MASS.

Engineered Wire and Cable for the Electronic and Aircraft Industries

WHEN you need a
quick answer to

WHO MAKES IT...

*Just look it up in
the electronics
BUYERS'
GUIDE*

There are . . .

23,367 ANSWERS

to

1,445 PROBLEMS

covering every . . .

**COMPONENT
EQUIPMENT
and MATERIAL**

*used in every phase
of electronics*

**GET IN THE HABIT OF
LOOKING IT UP IN**

the

**electronics
BUYERS' GUIDE**

A MCGRAW-HILL PUBLICATION
330 West 42nd Street
NEW YORK 36, N. Y.

in TELECHRON TIMERS only . . .

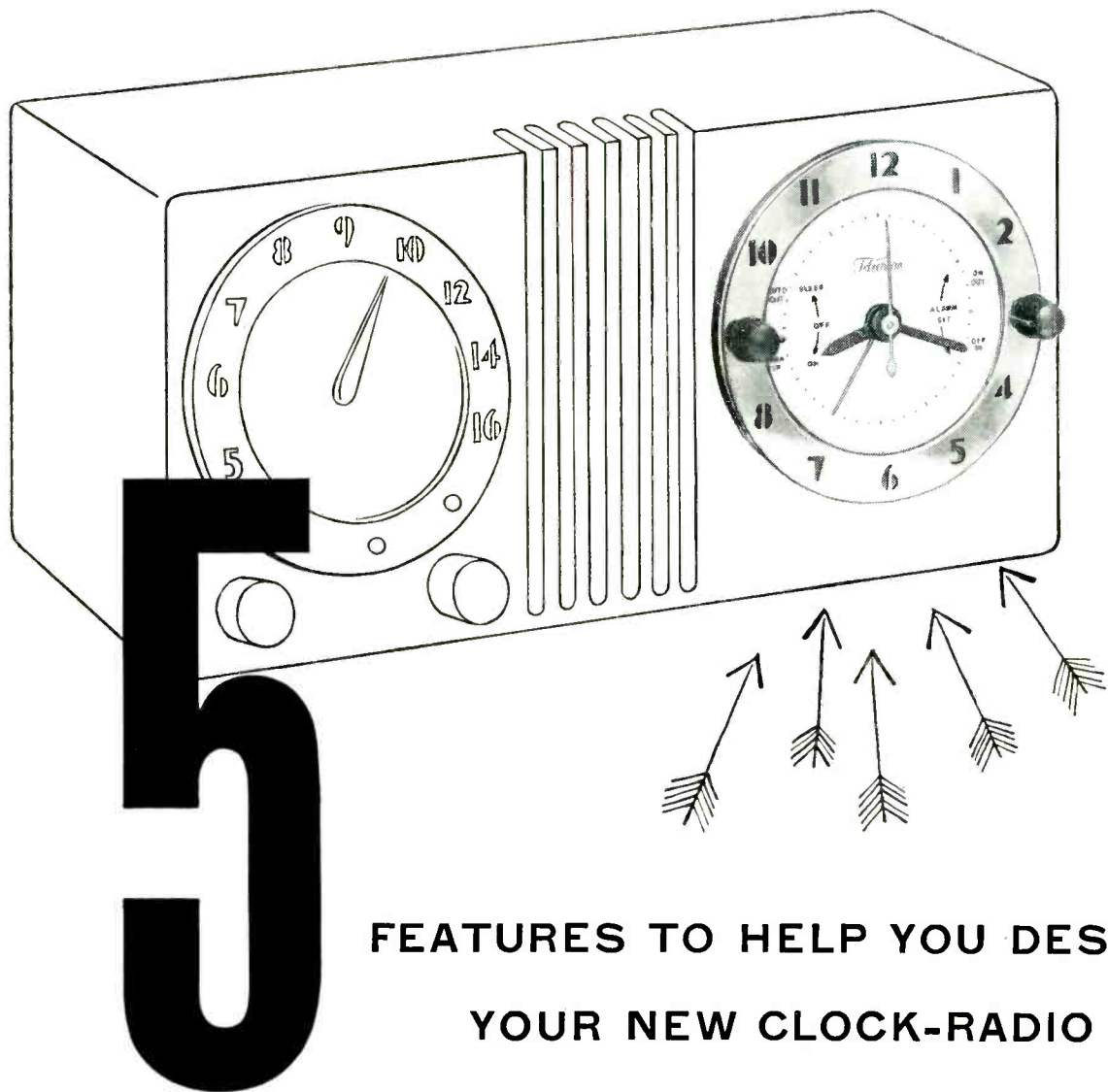

FEATURES TO HELP YOU DESIGN YOUR NEW CLOCK-RADIO

➤➤➤ **1** TWO KNOBS do the work formerly done by three. The new Telechron Timer, model C-78, means unmatched simplicity in clock-radio operation. One knob for alarm . . . the other for radio.

➤➤➤ **5** FREEDOM OF STYLING. Two-knob control and separate alarm hand mean greater freedom for your styling people. Telechron Timers are available with round or square face . . . any color dial, hands or bezel.

➤➤➤ **2** SIGNAL ALARM. It's a must for heavy sleepers. And it's a sales-boosting extra talking point for your clock-radio. In the clock-radio field only Telechron Timers have the signal alarm.

➤➤➤ **3** RADIO ALARM "ON" SWITCH. Contacts rated at 15 A. at 115v. a-c. Adequate to carry the load of a variety of electrical appliances through an auxiliary outlet on your clock-radio.

➤➤➤ **4** DEPENDABLE SLEEP SWITCH. Simple design—friction geared to clock movement—insures accuracy, dependability, and sturdy endurance even with rough handling.



Sales-Boosting Extra Benefit

You are free to display the Telechron trade-mark and the Telechron Seal of Accuracy on your clock-radio. Ask for full information. Telechron Department, General Electric Company, 43 Homer Ave., Ashland, Massachusetts.

Telechron[®]

MARK OF TIMING LEADERSHIP

Dependable HECO
CAPACITORS sized
to save space!

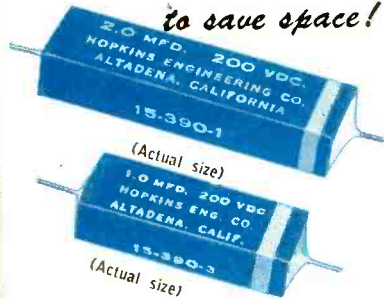

Resin Impregnated Sub-miniature Metallized Paper Capacitors.

- High insulation resistance
- Excellent capacity retrace
- Rectangular — Saves space
- Variety of sizes and values

Dissipation factor less than 1% at 25° C 1000 cycles. Operation range —40° C to 100 C. Capacitance temperature coefficient plus .07% per ° C.



Write or phone, TODAY

HOPKINS
Engineering Co.

FACTORY: 2082 Lincoln Ave.,
Altadena, Calif. SYcamore 8-1185

Offices in WASHINGTON, D. C.
DETROIT

FLEXIBLE

DELAY LINES

to meet military
specifications

Delay .1 to 2 usec.
Tol. ±.05 usec.
 Z_0 1200 ohms ±15%
Delay lines are hermetically sealed and are of non-nutrient construction.

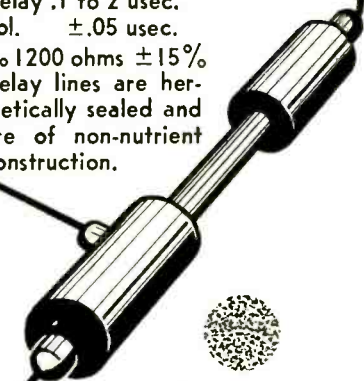

We invite your
inquiries.

RICHARD D. BREW and CO., INC.
106 CONCORD AVE., BELMONT 78, MASS.

Want more information? Use post card on last page.

cial reaction between them occurs.

If electrons are traveling at the same speed as the wave, and at some particular slot the wave were at such a phase that the electrons exerted an amplifying effect on it, then at the next slot the phase relations would be the same and amplification would occur there also. This would continue for the rest of the way along the path of the slots.

Consider that at some slot near the beginning of the path the wave at a transverse slot is at a phase such as to permit amplification by a group of electrons passing that slot. Suppose, however, that the electron stream is moving so much slower than the wave that by the time the same group of electrons reaches the next transverse slot, the wave has traveled one whole wavelength farther than in the example cited.

The wave and electrons at this second slot will then also be in the proper phase for amplification, but this time the electrons react on the next following cycle of the wave.

A group of electrons marked E_1 , shown in Fig. 2, is interacting at a transverse slot with a particular phase of cycle A of the wave. When this group of electrons has reached the next slot, the wave has advanced sufficiently to bring the corresponding phase of cycle B to the next slot, and again amplification takes place. At each successive slot, the electrons react favorably with the wave, but with a later part of it.

Since the same action is taking place with all the electrons, the total amplifying effect is essentially the same as though the electrons were traveling at the same speed as the wave. Actually, they are traveling slower in the ratio of $d/(d + \lambda)$, where d is the distance between

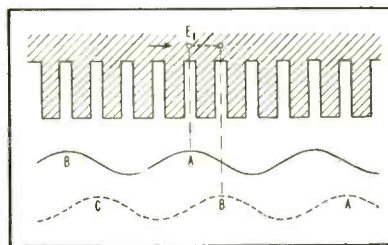

FIG. 2—Electron group E_1 interacts with successive peaks of electromagnetic wave in phase

BENDIX- PACIFIC HELPS AMERICA FIGHT



BENEATH THE SEAS...

In addition to its extensive electronics developments in radar, radio control, telemetering and missile guidance, Bendix-Pacific is a major source for highly restricted airborne and underwater sonar.

Can we help you with the practical solution to your specialized electronic problem? Your inquiry is invited.



ATTENTION ENGINEERS...

Bendix-Pacific has a few openings for thoroughly qualified engineers in sonar, radar, servomechanisms and telemetering. For those seeking a challenging future under ideal Southern California living conditions, Bendix-Pacific offers worthwhile opportunity. Your inquiry will be considered in strict confidence.

Want more information? Use post card on last page.

March, 1953 — ELECTRONICS

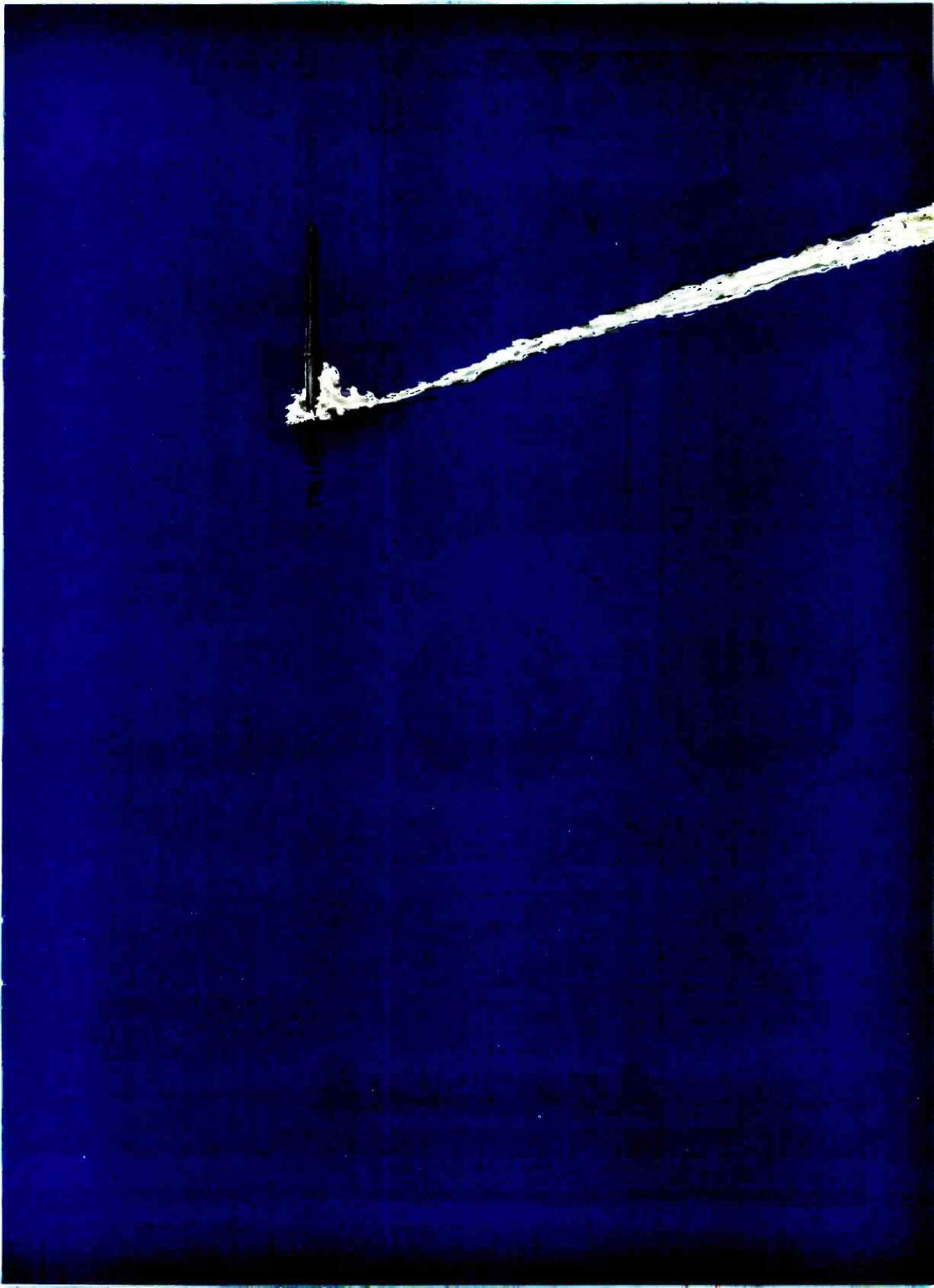

**TODAY'S COMMUNICATION TREND
IS TOWARD SINGLE-SIDEBAND**

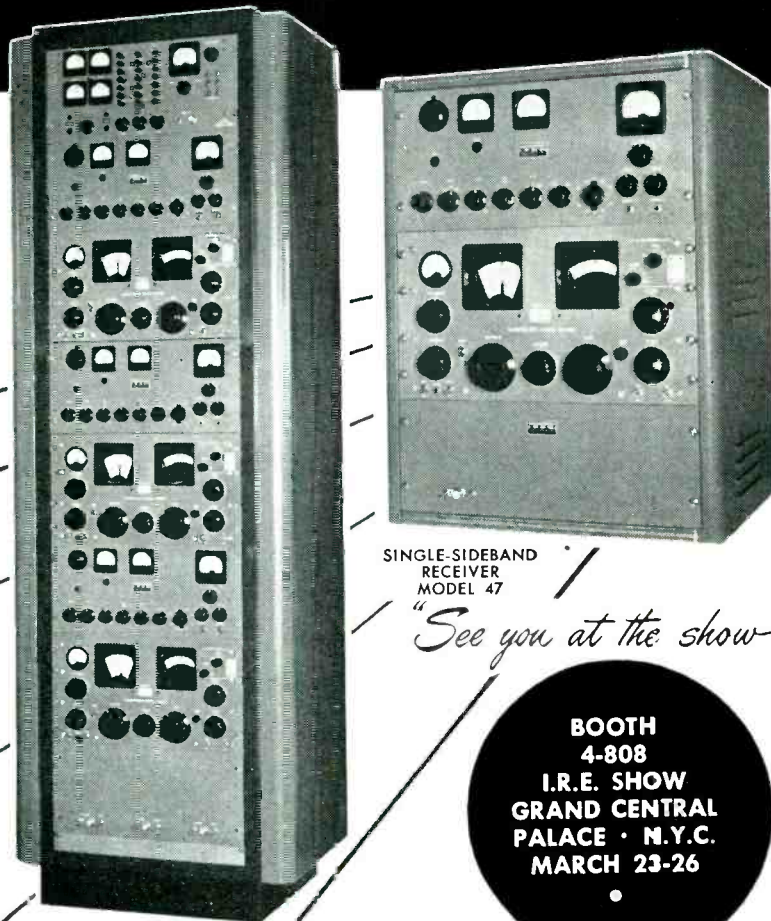

TRIPLE-DIVERSITY
SINGLE-SIDEBAND
MODEL 155

SINGLE-SIDEBAND
RECEIVER
MODEL 47

"See you at the show"

**BOOTH
4-808
I.R.E. SHOW
GRAND CENTRAL
PALACE · N.Y.C.
MARCH 23-26**

The Crosby Triple-Diversity Single-Sideband Receiver, Model 155 (left), and Single-Sideband Receiver, Model 47 (right), provides the ultimate in performance for long-range radio reception. Receives all forms of double and single sideband transmission including reduced-carrier single-sideband transmission and amplitude-modulation or phase-modulation transmission.

For program, voice, tone-multiplex and twin-channel operation: optimum performance in rejecting interference; protected against jamming; precision performance.

The equipment is approximately one-third the size, weight and cost of single-sideband receiving equipment heretofore available, yet provides a new standard of performance under severe conditions of interference and fading.

The complete triple-diversity equipment, Model 155, is contained in one standard-size cabinet rack. The Model 47 single-sideband receiver requires only 28" of vertical panel space.



• **Send for our descriptive booklets on this equipment, giving complete details.**

CROSBY LABORATORIES, Inc.
ROBBINS LANE • HICKSVILLE, N. Y.

from
Accelerometers
to
Yokes

you'll find the correct answer to who makes everything in the entire field of electronics including... components equipment and materials

in the...
**electronics
BUYERS'
GUIDE**

Get in the habit of looking it up in...

the **electronics
BUYERS' GUIDE**

"The Book that has all the answers"

A McGRAW-HILL PUBLICATION
330 West 42nd Street
NEW YORK 36, N. Y.

VITROTEX

soft as ~~silk~~

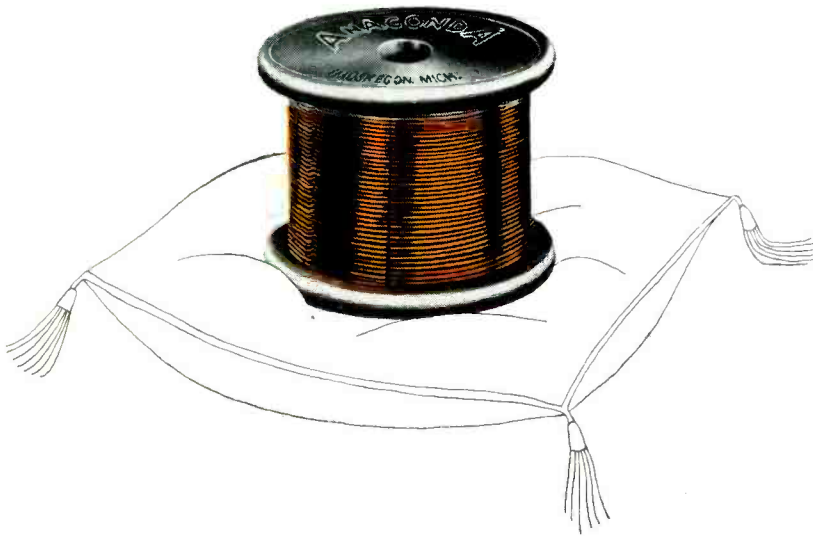

Vitrotex* magnet wire is soft and pliable—can be wound more easily and more compactly... has great resistance to “figure-eighting.”

An original Anaconda development, Vitrotex magnet wire is covered with a flexible fibrous glass insulation. In addition to its properties as an insulator, glass carries off heat and resists moisture, acids, oils and corrosion.

Vitrotex is a class B insulation—use it to gain the advantages of 130 C “hottest spot” operations. MINIATURIZATION—now, with Vitrotex, you get smaller devices for same output, with a satisfactory life. Anaconda has a complete line of magnet wires—nylon, cotton and glass-covered, and enameled—noted for their exceptional uniformity. Write — or even better — call on your nearest Anaconda Sales Office. Anaconda Wire and Cable Company, 25 Broadway, New York 4, New York. #Reg. U. S. Pat. 52454 (Rev.)

the right magnet wire for the job

ANACONDA[®]

CLASS B Vitrotex • CLASS H Silotex* • CLASS A Enamel Formvar Nyform Nylon

MILO HAS THE SCOPE to handle all your industrial electronic component requirements

QUICK SERVICE

COMPONENT KNOWLEDGE

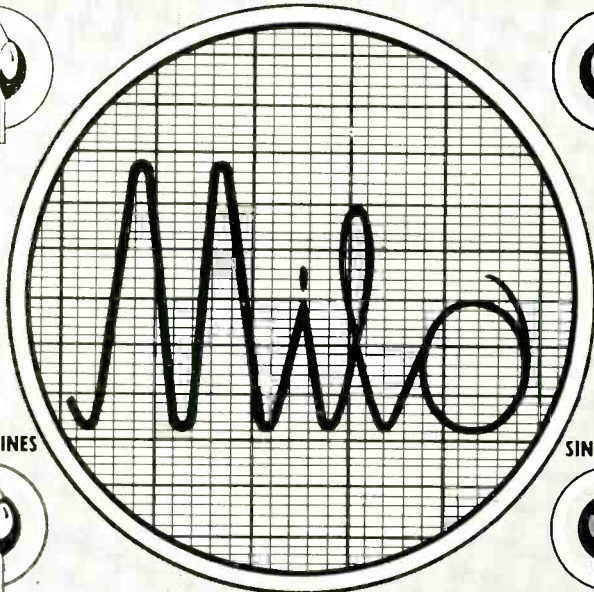

COMPLETE LINES

SINGLE SOURCE

ALL COMPONENTS
TEST INSTRUMENTSTUBES, PARTS, METERS, WIRE,
CHASSIS, PANELS, RACKS

IN STOCK



EXPEDITED

LEADING BRANDS

LEADING BRANDS

VALUES
1 mmf to
5000 mfd

ALL TYPES

COMPREHENSIVE
CAPACITOR STOCKVOLTAGES
3 V. to
100 KV.TOLERANCES
JAN F TO
JAN YVALUES
1 Ohm to
22 MegohmsHigher, in
non-standardRESISTOR
"HEADQUARTERS"WATTAGES
1/4 W to
1000 WTOLERANCES
.1% to 20%TELEPHONE
BE 3-2980
TELETYPE
NY 1-1839

WRITE

200 Greenwich St.
WIRE
MILO WUX-NY

REGULAR

LEADING
BRANDSALL
TYPESSPECIAL
PURPOSECRYSTAL
DIODES

TUBE SELECTION

LABORATORY USE

JAN-TYPE
COMPONENTS

GENERAL USE



MILO RADIO & ELECTRONICS CORP. 200 GREENWICH ST., NEW YORK 7, N. Y.

MILO tenders its heartiest congratulations to The Institute of Radio Engineers on the occasion of its Twenty-First Annual Show. We expect to see many new things there.

For "something new" in 'scopes, see above.

centers of adjacent slots and λ is the wavelength of the traveling wave in this particular structure.

Such a method requires an electron speed corresponding to only 1,200 volts. The resultant structure is rugged and only about two inches long. Bandwidth of a representative amplifier is 1,500 mc and estimated power is around 25 milliwatts. Gain is over 20 db.

Fringe-Area TV Booster Transmitter

EXPERIMENTS recently authorized by the Federal Communications Commission provide enhanced television signals to areas distant from the main transmitter or shadowed by high terrain between it and the receiving locations.

Station WSM-TV in Nashville, Tenn. has established a low-power relay transmitter at Lawrenceburg that picks up horizontally polarized signals and retransmits them with vertical polarization. The combination of non-standard polarization and low power is expected to prevent cochannel interference beyond the area resulting from normal operation of the main transmitter.

The system proposed by J. H. DeWitt, Jr. to FCC comprises a high-gain receiving antenna and a relatively low-gain transmitting antenna placed back-to-back and connected together through a low-power radio-frequency amplifier system that has an overall gain of approximately 100 decibels. Actual equipment is still undergoing field modifications. Using vertical polarization for booster transmission minimizes feedback problems in booster station construction and allows the receiving and transmitting antenna to be placed relatively close together, in this case, 500 feet apart.

For covering most small cities, the transmitting antenna should have a single-lobe radiation like a cardioid pattern. Such a pattern is easily achieved by placing a vertical dipole in front of a large mesh screen. Using such an antenna, a maximum effective radiated power of 10 to 20 watts at an elevation of approximately 100 feet above average terrain should provide adequate signal for reliable service in

MILO RADIO & ELECTRONICS CORP.

Electronics for Industry

200 GREENWICH STREET, NEW YORK 7, N. Y. • Phone BEekman 3-2980
Teletype NY1-1839 • Wire MILO-WUX-N.Y. • Cable MILOELECTRO-N.Y.

*It keeps a Separate
Count of each
shift's production!*

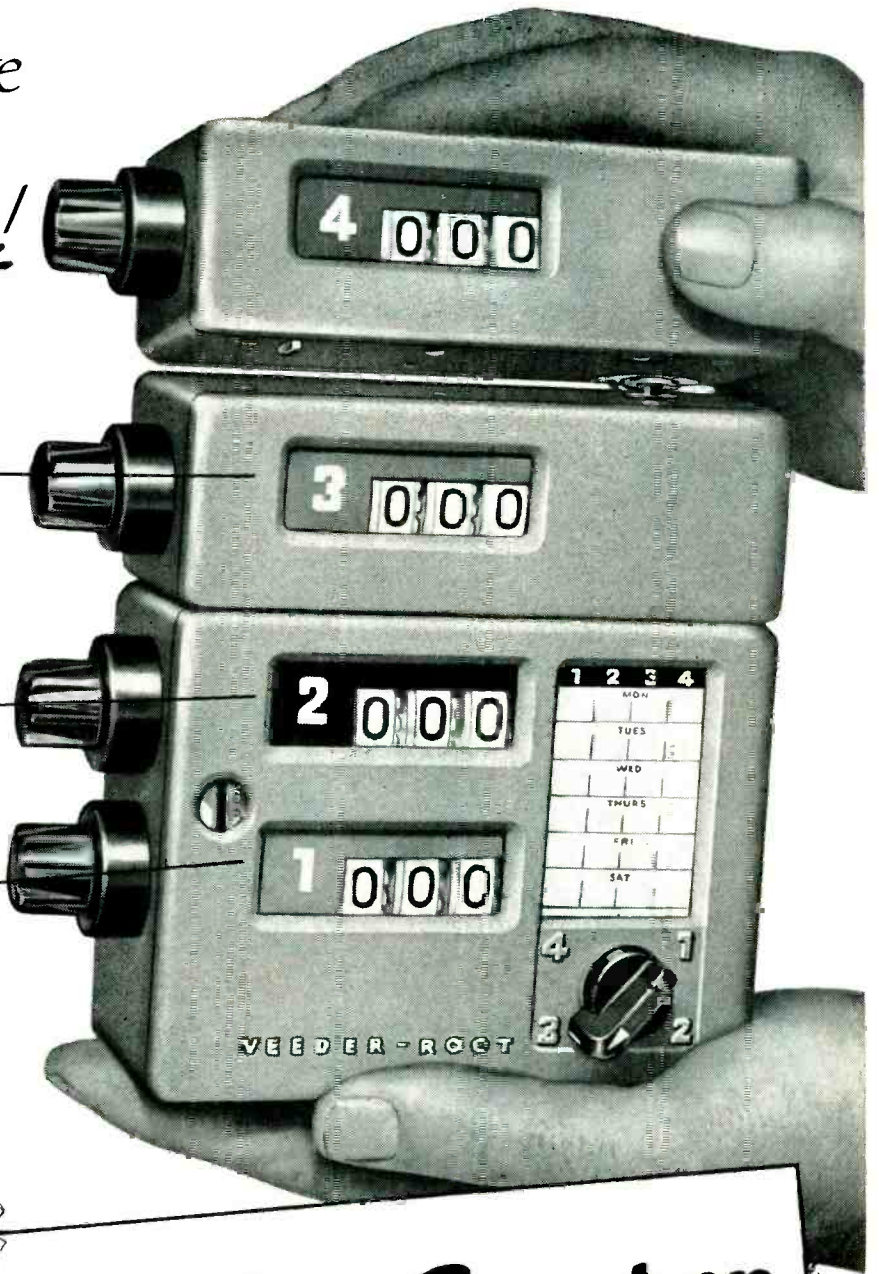
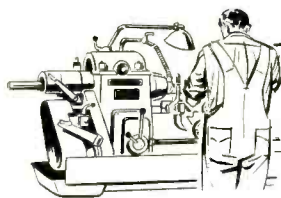
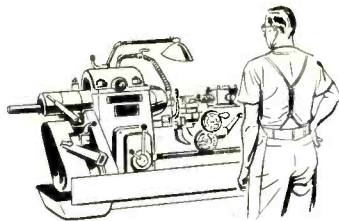
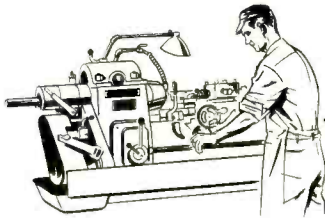

Added Evidence
that

Everyone Can Count on VEEDER-ROOT

Here's a counter whose "count-ability" challenges your imagination. For this counter records, on a separate counting unit, the production of 1, 2, 3, or more shifts. The additional 4th unit can be used as a run or batch counter. These Veeder-Root 2-3-4 Convertible Shift Counters are applicable to a wide variety of production machines, to count in practically any unit desired . . .

revs, strokes, pieces, or what do you want to count? Write:

VEEDER-ROOT INCORPORATED

"The Name That Counts"
HARTFORD 2, CONNECTICUT

New York 19, N. Y. • Chicago 6, Ill. • Greenville, S. C.
Montreal 2, Canada • Dundee, Scotland
Offices and Agents in Principal Cities



8 db more

with no increase in noise

It's the new

REG. U.S. PAT. OFF.
SCOTCH
BRAND

Magnetic Tape

High  *Output*
TRADE MARK

- **NEW, IMPROVED COATING!**
"Scotch" Brand *High-Output* Magnetic Tape is coated with a revolutionary new magnetic material that offers unparalleled sensitivity.
- **UNEQUALLED OUTPUT LEVEL!**
Actually produces 8 db and up to 12 db more output than any conventional magnetic tape with no increase in harmonic distortion.
- **SPECIAL NEW COLOR!**
This new tape is colored a distinctive grey-green for easy recognition.

"Scotch" Brand No. 120A *High-Output* Magnetic Tape gives the recording engineer a new and potent tool for the production of truly high fidelity recordings. The 8 db minimum added output of *High-Output* Magnetic Tape increases significantly the available signal to noise ratio, making possible for the first time low background noise recordings of orchestral works having wide dynamic range. Besides offering unparalleled output at all audio frequencies (see graphs), this new tape retains all the physical and magnetic properties that have made "Scotch" Brand No. 111A the recognized standard of the recording industry: high tensile strength, freedom from elongation, stable anchorage, low noise level, excellent uniformity, ease of eraseability.

Freedom from squealing, cupping and curling is assured thanks to exclusive "Dry Lubrication" feature. *High-Output* tape is guaranteed 100% splice-free (up to 2400-foot reels)

The term "SCOTCH" and the plaid design are registered trademarks for Sound Recording Tape made in U.S.A. by MINNESOTA MINING & MFG. CO., St. Paul 6, Minn.—also makers of "Scotch" Brand Pressure-Sensitive Tapes, "Underseal" Rubberized Coating, "Scotchlite" Reflective Sheeting, "Safety-Walk" Non-slip Surfacing, "3M" Abrasives, "3M" Adhesives. General Export: 122 E. 42nd St., New York 17, N. Y. In Canada: London, Ont., Can.



output

or harmonic distortion!

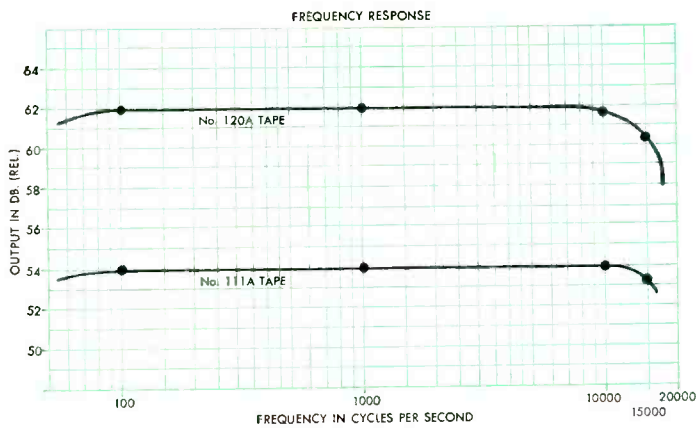

The frequency response characteristics of both No. 120A and No. 111A tapes are virtually identical at 15 ips tape speed. These curves were made with each tape set at optimum bias and an input level 15 db below 1% 3rd harmonic distortion.

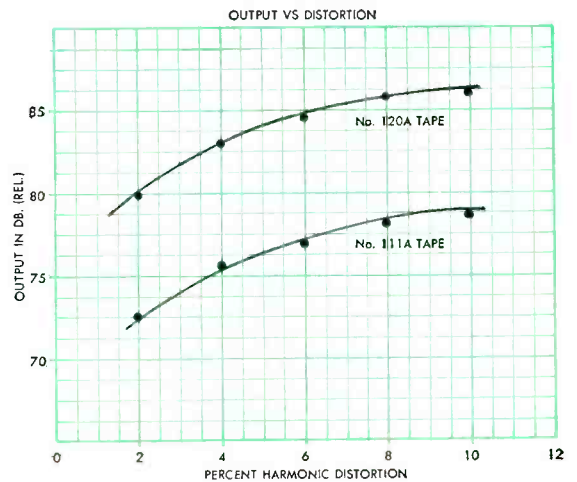

This graph shows the 8 db increase in output of *High-Output* Magnetic Tape No. 120A over No. 111A at any given distortion level. When compared with other brands of magnetic tape, the difference in output is as much as 12 db!

FREE BOOKLET tells the full story of the tremendous technical possibilities of *High-Output* Magnetic Tape. Address Dept. EL-33, Minnesota Mining & Mfg. Co., St. Paul 6, Minn., and a copy will be sent promptly.

Available now on: 120-AP 1200-foot Professional Reel
120-A 2400-foot on NARTB hub or reel



High-Output and  TM 3M Co.

ELECTRONICS — March, 1953

Want more information? Use post card on last page.

221

New UHF SWEEP GENERATOR

for UHF TV Production Testing

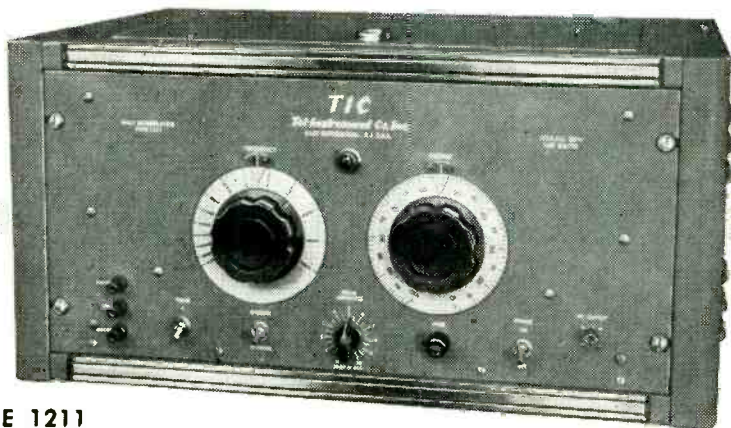

TYPE 1211

The Type 1211 UHF Sweep Generator has been specifically designed to rapidly and accurately align UHF Television heads, converters and complete receivers. Pulse type crystal markers appear every 36 MC throughout the UHF spectrum to afford instant frequency identification. An electrostatic piston attenuator gives continuously variable output level control over approximately 80 db from a maximum output of 1 volt. The power supply is electronically regulated to assure constant output under all line voltage conditions.

S P E C I F I C A T I O N S

FREQUENCY COVERAGE: 450 to 900 MC. Dial calibrated in 36 MC steps. **BANDWIDTH:** Constant bandwidth of 50 MC over entire spectrum. Can be adjusted to narrower bandwidths with internal controls. **MARKERS:** Pulse type, crystal controlled, accurate to 0.02%, spaced 36 MC throughout the 450 to 900 MC spectrum. **OUTPUT:** At least 1

volt across a 75 ohm load. **ATTENUATOR:** Electrostatically coupled piston type, range approximately 80 db. **AUXILIARY OUTPUT SIGNALS:** 1. Automatically phased saw-tooth sweep for X axis of scope. 2. Marker pulses either plus or minus polarity, continuously variable in amplitude.

PRICE \$950.00 F.O.B. PLANT

THERE'S A TIC SWEEP GENERATOR FOR EVERY TV TEST REQUIREMENT

Type 1210 VHF Sweep Generator: Covers the 12 VHF Channels and provides keyed sound and video markers for each channel. Maximum output 0.5 volt across 75 ohm load. Price: \$785.00. (A 13th channel having markers at 41.25—45.75 MC or 125.25—129.75 MC available at a slight additional cost.)

Type 1500B IF Sweep Generator: Designed for accurate alignment of TV sound and video IF amplifiers. Unit incorporates factory-set two band oscillator with maximum sweep ratio of 1.45 to 1. Maximum of 5 crystal markers can be provided for each band. Price: \$275.00 less crystals. Crystals \$15.00 each.

Prices F.O.B. FACTORY



Manufacturers of a Complete Line of TV Test Equipment

Tel-Instrument Co. Inc.

50 PATERSON AVENUE • EAST RUTHERFORD, N. J.

most small towns and cities. Such urban districts normally measure two or three miles across.

Booster Equipment

The receiving antenna is a billboard array made up of nine horizontal half-wave dipoles arranged in three rows of three each in front of a mesh screen. Binominal grading is employed to reduce side-lobe response thereby minimizing interference from other stations on the WSM-TV channel 4, as well as the reception of signals fed back from the booster transmitting station.

The receiver preamplifier is similar to the basic Wallman radio-frequency amplifier. The input circuit consists of a neutralized cascode arrangement employing a triode connected 6AK5 tube and a 6J4 tube. Following the cascode circuit are three stagger-tuned stages employing 6AK5 tubes. The amplifier has a maximum gain in excess of 60 db over a 6 megacycle band at channel 4 frequencies. Automatic gain control is employed to hold the output at a relatively constant level.

The booster transmitter is essentially a low-power linear radio-frequency amplifier designed for unattended operation. It is connected to the receiver preamplifier through a 500-foot length of coaxial cable and is located at the transmitting antenna. The booster transmitter has a gain of approximately 40 decibels. Three 2E26 amplifier tubes operating Class A drive a final stage of two 2B26 tubes that operate Class B. Normal average composite carrier output when black picture is transmitted is approximately 5.5 watts, of which 2.5 watts is aural carrier output and 3 watts is average visual carrier power. Therefore the transmitting amplifier will normally deliver 5 watts peak visual carrier power and 2.5 watts aural carrier power.

Automatic power level control is achieved in the transmitter by monitoring the radio-frequency voltage level across the output transmission line. A balanced crystal voltmeter circuit measures peak transmission-line voltage and through an associated direct-current amplifier and a regulator tube controls the bias on

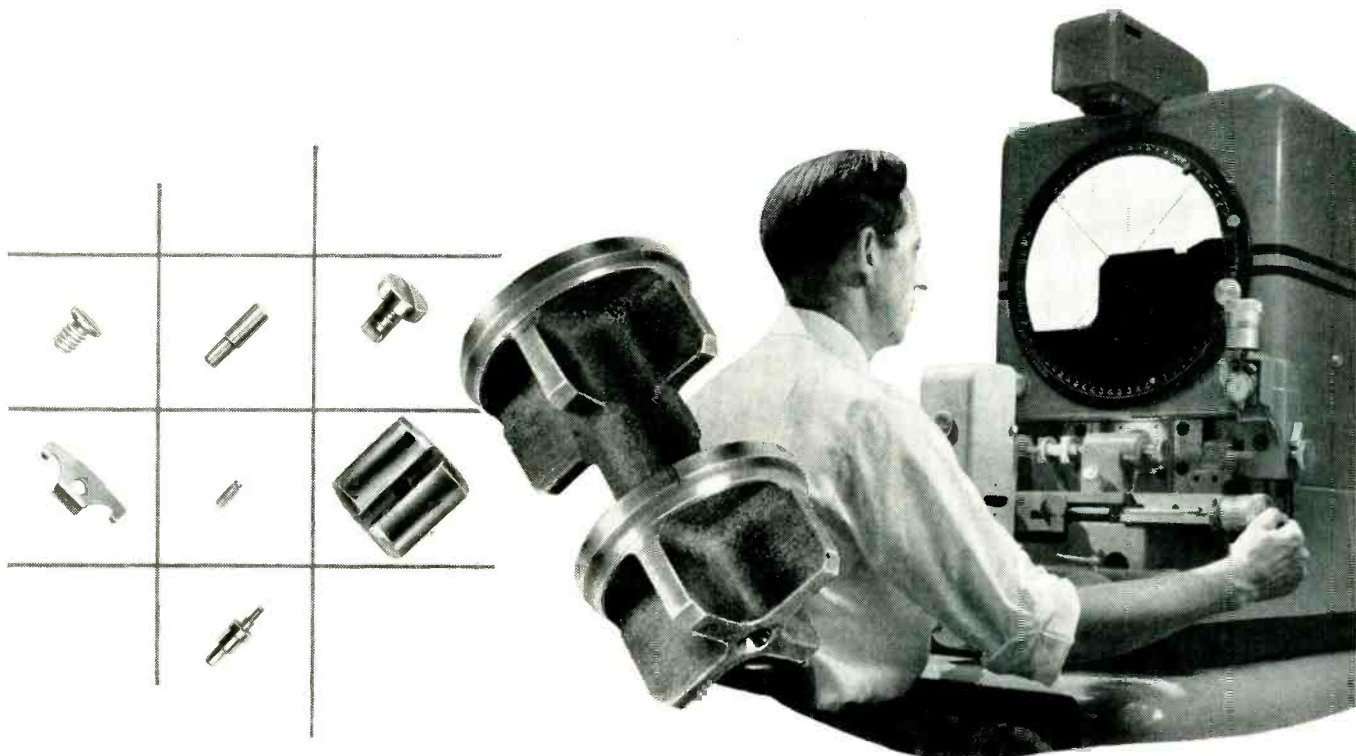

These parts help give Weston instruments their accuracy... they're checked on Kodak Contour Projectors

There is such a great variety of Weston instruments to measure all sorts of variables in all sorts of ranges that production on most individual items is small.

This creates a parts inspection problem. Precision requirements in many cases are so stringent that any measurable deviation from specifications is too big. Setting up toolroom instruments takes too long for the small volume of work being checked at any one time. Mechanical gages are even less economical at the low volume levels, and they just did not give the required accuracy on such jobs as checking the shoulder angles, concentricities, and specifications of the double-acting valve body shown above. (It goes in a recording thermometer and Weston makes it in many different sizes.)

Now Weston has converted to Kodak Contour Projectors. An inspector merely picks up the specification sheet covering a given part, gets the chart

gage indicated there, puts it on the screen of the projector, and proceeds to sample according to specifications. Often, as with the valve body, gage blocks are used to step off the traverse of the projector work table. The inspector notes whether a shadow image coincides with a chart line after the table has carried it by the specified distance.

Possibly your inspection problems are volume and speed rather than the flexibility that Weston wants. In that case you will want to know about the Kodak Contour Projector, Model 3, which is designed for use with special staging fixtures instead of a moving work table. There is a field engineer in your area who can show you which model best fits your problem. To get in touch with him, just drop a note to *Eastman Kodak Company*, Industrial Optical Sales Division, Rochester 4, N. Y.

the KODAK CONTOUR PROJECTOR



A new sound movie shows how to simplify complex inspection problems. We'll tell you how to get it for a showing.

Kodak
TRADE-MARK

N.L. Instr't

MEASURING INSTRUMENTS *by* New London

FM Signal Generator 100B 20 to 110 mc (single range)

FM Signal Generator 100B uses a novel circuit with a variable permeability modulator and a single tube in the r-f, instead of the usual three or four. There is no beating and no multiplication, eliminating spurious frequencies. Output is from 0.02 microvolts to 0.1 volts.

FM Signal Generator I-208-D 1.9 to 4.5 mc and 19 to 45 mc

With a marker every 2 kc on the low band and every 20 kc on the high, the I-208-D has 1300 calibration points. This requires 25 feet of film—each individually calibrated. Accuracy is kept within 0.03%. Output voltage is from 0.2 microvolts to better than 0.6 volts.

Signal Generator and Power Meter TS-155C/UP 2700-3400 mc (S Band)

As a signal generator, the TS-155C/UP, with an output (50 ohms impedance) of -20 to +100 dbm, is widely used for testing radar receivers and transmitters. It can be pulse modulated internally or from an external trigger source.

As a power meter, the TS-155 measures power from +20 to +100 dbm (or up to 200 milliwatts).

Leakage is low—less than 95 dbm.

Panoramic Adapter BC-1031 250 kc to 470 kc

The Panoramic Adapter BC-1031 operates on an input frequency of 450 kc to 470 kc with a maximum sweep width of 200 kc.

Used extensively for rapid visual spectrum scanning, it also enables the operator to determine whether transmission is by cw, am, fm, or pulse modulated signals.

The BC-1031 is also used for deviation measurements of FM waves by the methods of dropouts.

Square Wave Generator 150A 50 cycles to 1 mc

Square wave generator 150A provides waves at five spot frequencies from 50 cycles to 1 mc with a maximum rise time of 0.05 microseconds. Continuous frequency variation can be obtained by using an external frequency control capacitor. A pulse for oscilloscope synchronization is available.

Output is controllable from 0-20 volts peak to peak and is constant at all frequency settings.



100 B

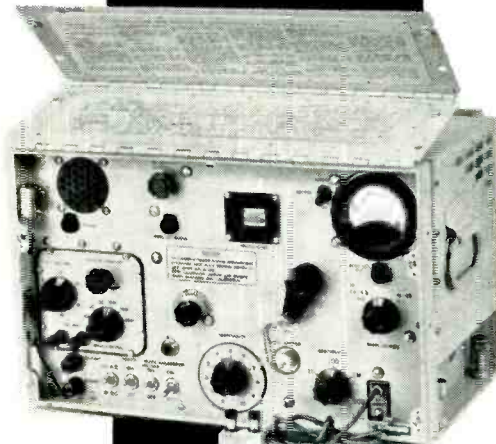

I-208-D



TS-155C/UP



BC-1031



150 A

Watch for
the announcement of our
UHF TV TEST PACKAGE

New London Instrument
NEW LONDON, CONNECTICUT *Company*

fine wire

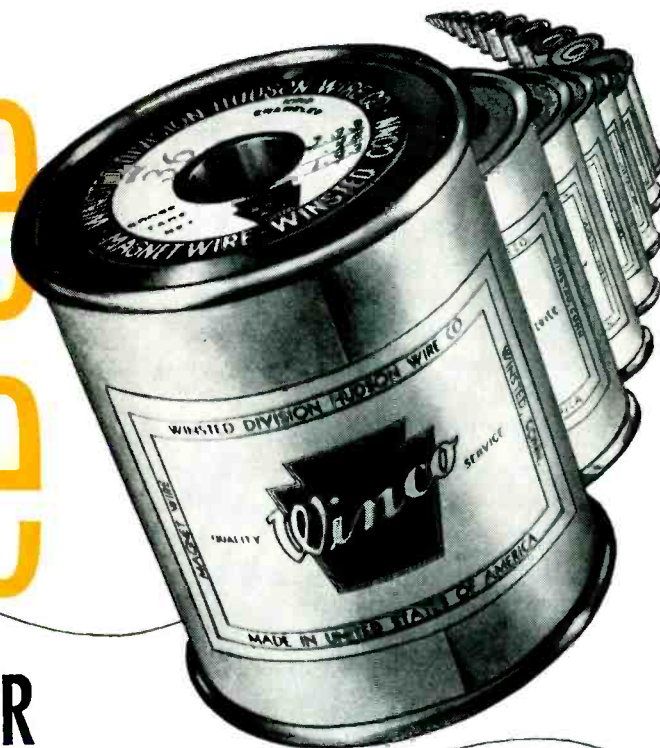

MADE FINER

◎ Spool after spool after spool — as much or as little as you require. For our facilities are flexible and extensive enough to serve the largest and the smallest user alike with custom-made fine wire.

Let us have your specifications and requirements. Our Winsted Division will meet and maintain your specifications. Which explains why Winco fine wires are the first choice of radio-electronic and electrical manufacturers whose products are noted for reliability and long life.

custom drawn
custom insulated
custom spooled

— to your most exacting requirements

HUDSON
WIRE COMPANY



GENERAL OFFICES: OSSINING, N. Y. • WINSTED DIVISION: WINSTED, CONN.

◎ We solicit your wire problems, specifications and requirements. We shall be happy to develop, produce and supply whatever fine wires you need.

BARE WIRES

Copper	Silver-plated
Brass	Bronze
Zinc	Phosphor-Bronze
Tinsel	Silver
Nickel-Silver	Lead Wire
Cadmium	Fuse Wire
Oxygen-free	Specialty
Copper	Wires

TEXTILE COVERED WIRES

Nylon	Cotton
Celanese	Rayon
Silk	Fibreglos

Available on bare or enameled wire; single or double covered.

INSULATED WIRES

MATERIALS	TYPES	COVERINGS
Copper	Instrument	Plain and Heavy
Aluminum	Tubing	Enamel
Iron	Litz	Formvar
Copper-clad	Multiplied	EZsol (Liquid Nylon)
Steel	and Twisted	Cement-coated
		Enamel

SILVER-PLATED WIRES

Silver-plated wires, in coarse and fine sizes for high-frequency conduction. Also intended for use in high-temperature applications. Available in various specifications and constructions.

Problem: The Advance Electric and Relay Co. of Burbank, California...was called upon by the military to produce a hermetically sealed relay to very tight size and weight specifications. This called for eliminating traditional internal bracing.

Solution: A Fusite glass-to-steel plug-in type hermetic terminal played a large part in the design of the Advance "Tiny Mite" Relay. Working in close cooperation, Fusite adapted its standard octal plug-in terminal to a projection welded bracket on which the entire relay mechanism was hung. Thus the terminal became a structural part as well as a seal.

Because of their extreme rugged construction, Fusite terminals are often being called on to do more than conduct electricity in and out of sealed units.

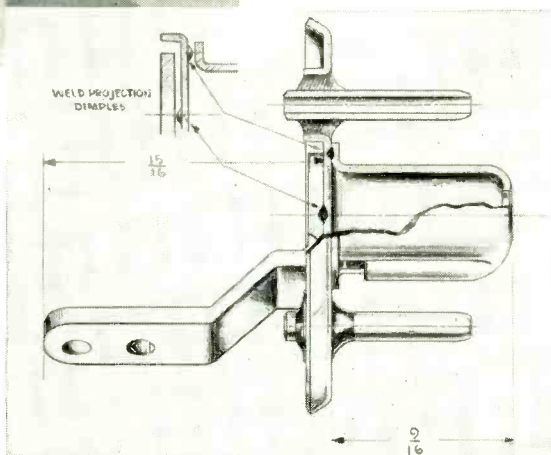
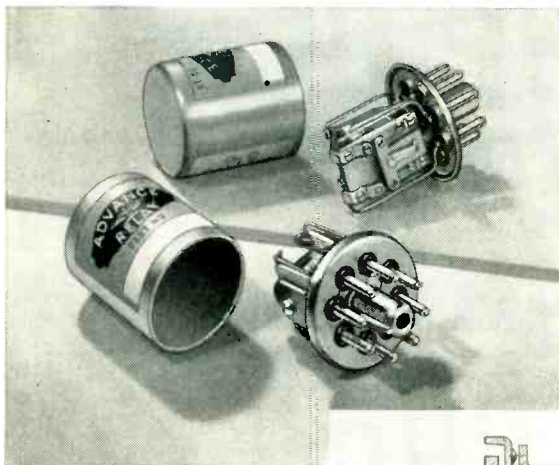

Moral: When you have a problem in hermetic sealing, let the Fusite engineers in on it early in the game. Chances are we can save you time and money in the design of your electrical product.

WRITE for catalog or tell us your needs for actual samples. Dept. A-1.

Visit the Fusite Display at Radio Engineering Show N. Y. C. March 23-26. Booth 3-109.



THE FUSITE CORPORATION
6000 FERNVIEW AVE. CINCINNATI 13, OHIO

the grids of the final amplifier, thereby holding peak transmission-line voltage constant. Such a power output regulator can be used since the transmitter operates into a matched transmission line. The power output of the booster remains constant despite normal line-voltage fluctuations and despite small signal level fluctuations that are not removed by the automatic-gain-control circuit of the receiver preamplifier.

A squelch relay control operates to remove screen voltage from the final driver tube and thereby interrupt booster carrier output when the main television station is off the air or when the received signal at the booster site is excessively noisy.

Since the entire booster system operates as a linear amplifier there is no need for frequency control or frequency measurements at the booster transmitter. Obviously, booster station output frequencies will depend directly on the output of the main television station that is amplified by the booster.

The transmitting antenna is a vertical folded dipole antenna operating a quarter wavelength in front of a mesh screen approximately one wavelength square.

Transmission of Microwaves Through Plexiglas Windows

USE OF PLEXIGLAS housings to protect antennas and other tv and radar equipment from the effects of wind and weather has made necessary investigation of the transmission efficiency and distortion caused by the material.

In the relay station housing shown in the photograph, sheets of Plexiglas one-eighth of an inch thick were used. For rigidity the sections were corrugated in a deep V-rib shape. The V's are spaced eight inches apart and are three inches deep, giving high rigidity.

Tests made so far indicate that the main factors in obtaining satisfactory transmission efficiency are: thickness should not be greater than one-tenth the wavelength of the microwave transmitted, the dielectric constant should be less



— Robert M. Feemster, Chairman of Exec. Comm., Dow-Jones & Co., Inc.

“You can’t sit on the news!”

In 1940, The Wall Street Journal circulation was 29,000. Today it’s 255,000—and still climbing!

“Like any news,” said Chairman Robert M. Feemster, “news of business is worthless unless it’s fresh!”

“We set out to make The Wall Street Journal the truly *national* business daily—one that would reach executive desks all over the country on the same morning. We first decentralized our printing plants—publishing in New York, San Francisco, Chicago and Dallas. But we still couldn’t deliver fresh news from

these points without the fastest, most *reliable* shipping service.

“That’s why we called in Air Express.

“Now, 6500 pounds of Wall Street Journals go Air Express daily. Only hours later they’re in a score of other major cities. And on practically every shipment, Air Express rates are the *lowest in the field*.”

“We knew we could build circulation. We knew we had the news and features vital to American business. Our problem is to deliver the papers! Air Express helps solve it! If you’re build-

ing circulation or sales, look into Air Express rates and benefits.”



AIR EXPRESS

GETS THERE FIRST

Division of Railway Express Agency

A NEW
twist
FOR YOUR PRODUCT

Lewis

can help YOU improve
YOUR product . . .
simplify production!

It's amazing what things as commonplace as springs, coils and wireforms can do to help product performance and sales appeal! But, as Lewis Engineers can show you, there's more to a spring than just a coil of wire. The design and selection of material can "make or break" an otherwise good product. That's why it pays to choose a supplier who has the experience, reputation and facilities to furnish you with springs, coils and wireforms that are expertly designed and engineered to fit your product's exact needs.

Call on Lewis! Show us your product . . . tell us your problems . . . see how Lewis Engineers come up with the perfect answer to increased product performance and lower production costs! Drop us a line today!

LEWIS SPRING & MANUFACTURING COMPANY
2656 W. NORTH AVENUE, CHICAGO 47, ILLINOIS

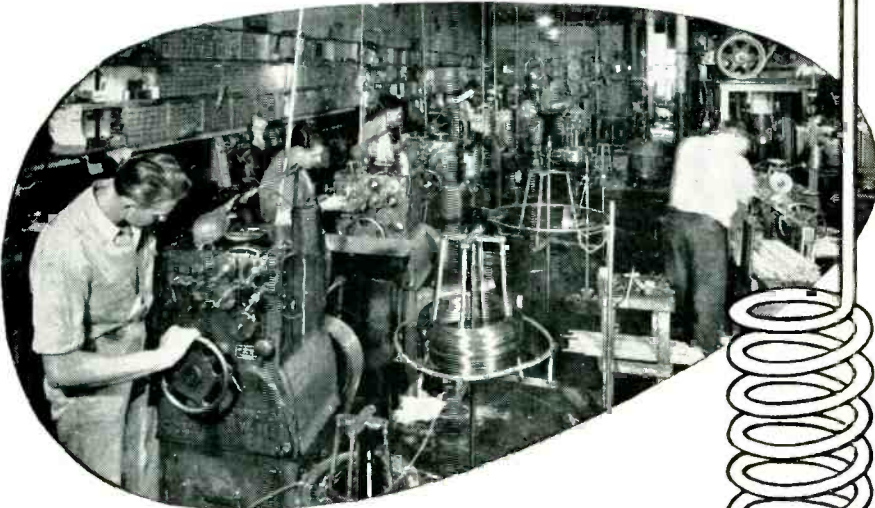

Lewis **PRECISION SPRINGS**
THE FINEST LIGHT SPRINGS AND WIREFORMS OF EVERY TYPE AND MATERIAL

WHEN you need a
quick answer to
WHO MAKES IT...
Just look it up in
the **electronics**
BUYERS'
GUIDE

There are . . .

23,367 ANSWERS
to
1,445 PROBLEMS

covering every . . .

COMPONENT
EQUIPMENT
and **MATERIAL**

used in every phase
of electronics

GET IN THE HABIT OF
LOOKING IT UP IN
the

electronics
BUYERS' GUIDE

A McGRAW-HILL PUBLICATION
330 West 42nd Street
NEW YORK 36, N. Y.

SLANT your
 requirements to
**INSTRUMENT CORP.
 OF AMERICA**

for miniature

SLIP RING AND COMMUTATOR ASSEMBLIES

This Instrument Corporation of America plant contains the most modern and complete facilities available anywhere in the world for the exclusive production of Miniature Slip-Ring and Commutator Assemblies to precision standards. It is now in full scale production to meet your requirements in the fastest possible time at the lowest possible cost.

ALL TYPES OF CONSTRUCTION NOW AVAILABLE INCLUDING MOLDED OR FABRICATED TYPES

Assemblies of these types can be supplied at low cost. Quality is the highest in the industry. Dimensional accuracy and other characteristics are excellent and these units are highly recommended for instruments such as synchros.

ONE PIECE ELECTRO-PLATED TYPES FOR EXTREME ACCURACY

Wherever extreme dimensional precision, accurate concentricity and high dielectric qualities are required, the electro-deposition method is recommended . . . the production of which is licensed under an exclusive arrangement with the Electro Tee Corporation.

TYPICAL SPECIFICATIONS:

Sizes: .035" to 24"
 Cylindrical or Flat

Cross-sections: .005 to .060" or more

Finish: Polish to 4
 Micro-Inches or Better

Breakdown: 1000 V or More
 Hi-Pot Inter-Circuit

Ring Hardness: 60 to 70 Brinell

Rotation Speeds: To Over 12000 RPM

Surface Protection: Palladium and Rhodium or Gold Prevent Tarnish, Minimize Wear

Our engineering staff is at your service at all times for consultation.

INSTRUMENT CORPORATION OF AMERICA
 BLACKSBURG • VIRGINIA

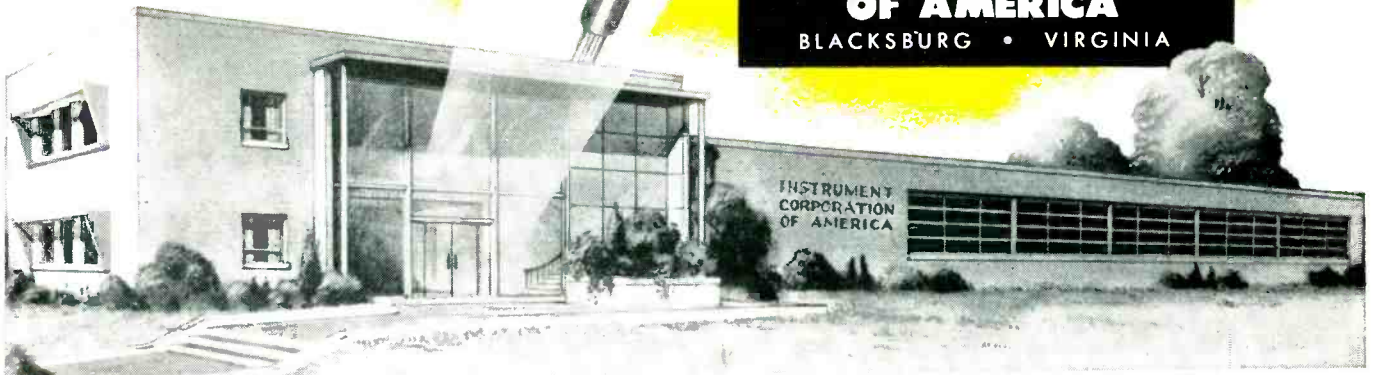

CANNON PLUG ACCESSORIES

for the "AN" Series



Here is the answer to a frequent question we receive from people everywhere. Yes, Cannon *does* make a complete line of accessories to be used in conjunction with the AN Series of connectors. Complete engineering data on each of these is given in the Cannon AN Bulletin, available on request.

CANNON ELECTRIC

Since 1915 

Factories in Los Angeles, Toronto, New Haven, Benton Harbor. Representatives in principal cities. Address inquiries to Cannon Electric Company, Dept C-120, P. O. Box 75, Lincoln Heights Station, Los Angeles 31, California.

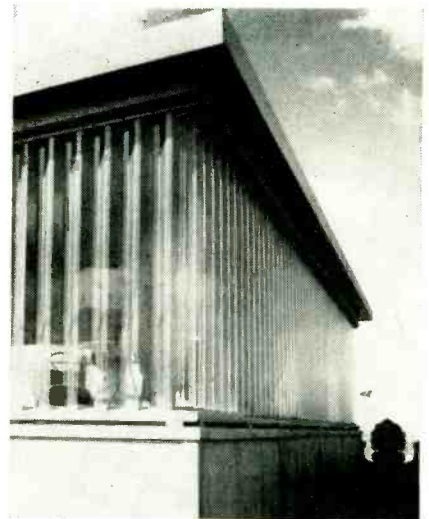

Television relay station in Philadelphia, Pa. using plastic windows to protect parabolic reflector from weather. Windows permit visual pointing of reflector at broadcast point

Table I—Microwave transmission through polymethyl methacrylate

Frequency in Mc	Dielectric Constant	Loss Tangent
1	2.76	0.0140
10	2.71	0.0100
300	2.66	0.0062
3000	2.60	0.0057
10,000	2.59	0.0067

than four, the loss tangent should not exceed 0.015 and the angle of incidence should be less than 60 deg.

Measuring Magnetic Tape Recorder Flutter

By HAROLD N. MORRIS
Chief, Data Recording Section
Technical Systems Laboratory
Air Force Missile Test Center
Patrick Air Force Base, Florida

DATA STORAGE requirements for instrumentation recorders are severe, especially in the field of guided missiles. Magnetic tape recorders in general use today at scientific centers are precision machines carefully designed and well constructed. However, they are not perfect data storage mechanisms, and the data obtained upon playback has errors introduced by the machine.

These errors can be classified as two general types. First are the low-frequency errors caused by tape stretch, tape slippage at the capstan and nonlinear tape speed

AIRCRAFT TRANSFORMER CORPORATION

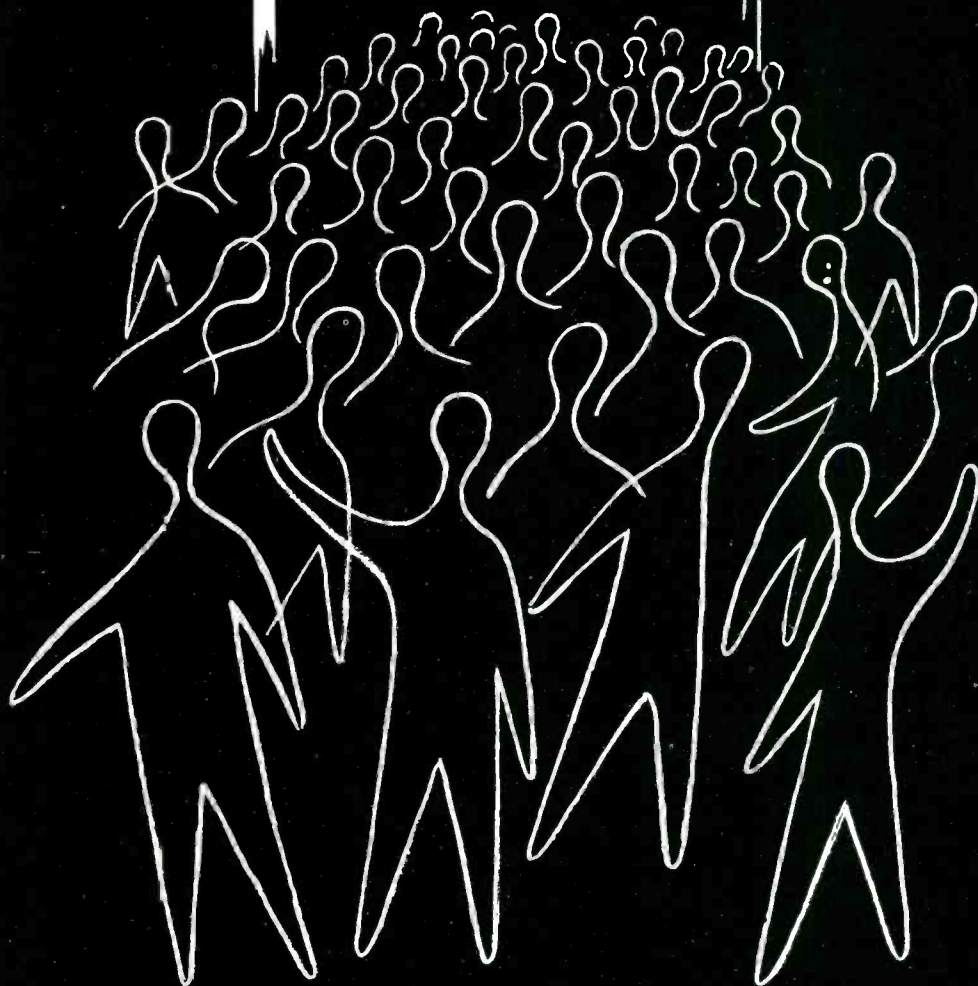

See our exhibit at Booth 4-213 (Fourth Floor), IRE Radio Engineering Show,
Grand Central Palace, New York, March 23-26

Aircraft Transformer Corporation, Long Branch, N. J. • Long Branch 6-6250 • Manufacturers of Inductive Equipment

Pulse Transformers • Saturable Core Reactors • Metal Encased Transformers • Form Flex • Oil Filled Form Flex • Wound Cores • Relays
Epoxy Cast Transformers • High Temperature Transformers • Resonant Charging Chokes

Take a fresh look at the industrial laminate picture

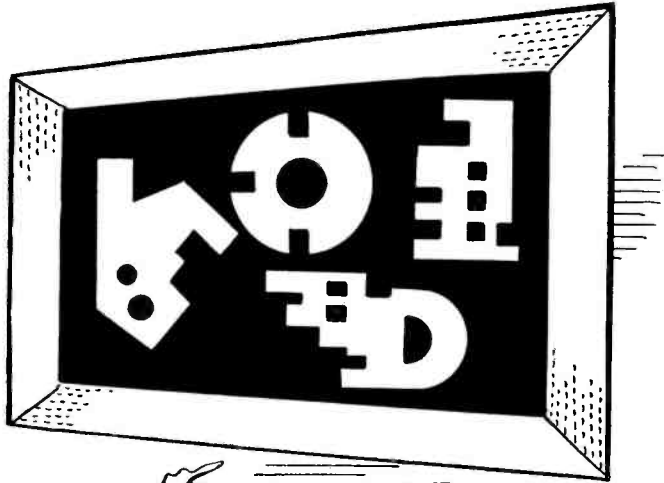

*... and see why
more and more users
are turning to*

NEVAMAR®

When you choose NEVAMAR you are assured of obtaining the right laminate for any particular application. NEVAMAR is produced by one of the nation's foremost makers of decorative laminates with the engineering "know how" and plant facilities to manufacture a superior industrial grade laminate. It is made in many grades to meet varying requirements and meets or exceeds NEMA standards. Write for samples, or call on us for any information you may need.



 **The NATIONAL** *Plastic Products Company*

Manufacturers of Nevamar Decorative and Industrial Laminates • SARAN FILAMENTS • Wynene Molded Products
ODENTON, MARYLAND • NEW YORK, EMPIRE STATE BUILDING • LOS ANGELES, 5025 HAMPTON STREET

Advertisers:

How about the NUCLEAR field?

There are a good many advertisers using ELECTRONICS who should also be advertising in NUCLEONICS.

Particularly in instrumentation and laboratory equipment, there is a cross-over of use in the electronic and in the nuclear field.

But, there is very little cross-over in the subscriber lists of the two publications—a matter of a few percentage points.

It is quite possible that you are doing an effective presentation of your products and abilities in this excellent issue, but are missing such presentation before one of the fastest growing fields in the country's history—the field of atomic energy.

The sales representatives of ELECTRONICS are also the sales representatives of NUCLEONICS. They have much evidence pointing to the opportunities in this great NEW field. Ask them to show you what your potentials can be.

NUCLEONICS

ABC

ABP

A McGraw-Hill Publication

330 West 42nd St.

New York 36, N. Y.



An AMPEX is always ready to go

— Even after thousands of hours of service

Supreme reliability is the most important quality your tape recorder can have—whether your station is 250 watts or 50,000 watts. Countless operators have found that AMPEX eliminates the fussing, the adjustments, and the uncertainty they had previously suffered in using tape recorders that were “built to a price.”

The AMPEX 400 Series Recorder is the one outstanding bargain in tape recorder service. It costs least per hour of use; it minimizes maintenance and adjustment; it protects your programs from the hazard of sudden failure; and its reliability frees your engineer's attention for other tasks.

Even after thousands of hours of service, your AMPEX Recorder will be reliable in these important ways:

- *When you press the button, it operates*
- *Program timing stays accurate*
- *Starting, stopping, and rewind will operate smoothly*
- *Fidelity will still be high*
- *Maintenance costs will still be low*

For new broadcast application bulletin, write Dept. E-1041

Model 403C



Model 403P

If you plan for tomorrow, buy an AMPEX today.

AMPEX

MAGNETIC RECORDERS

AMPEX ELECTRIC CORPORATION
934 CHARTER STREET • REDWOOD CITY, CALIF.

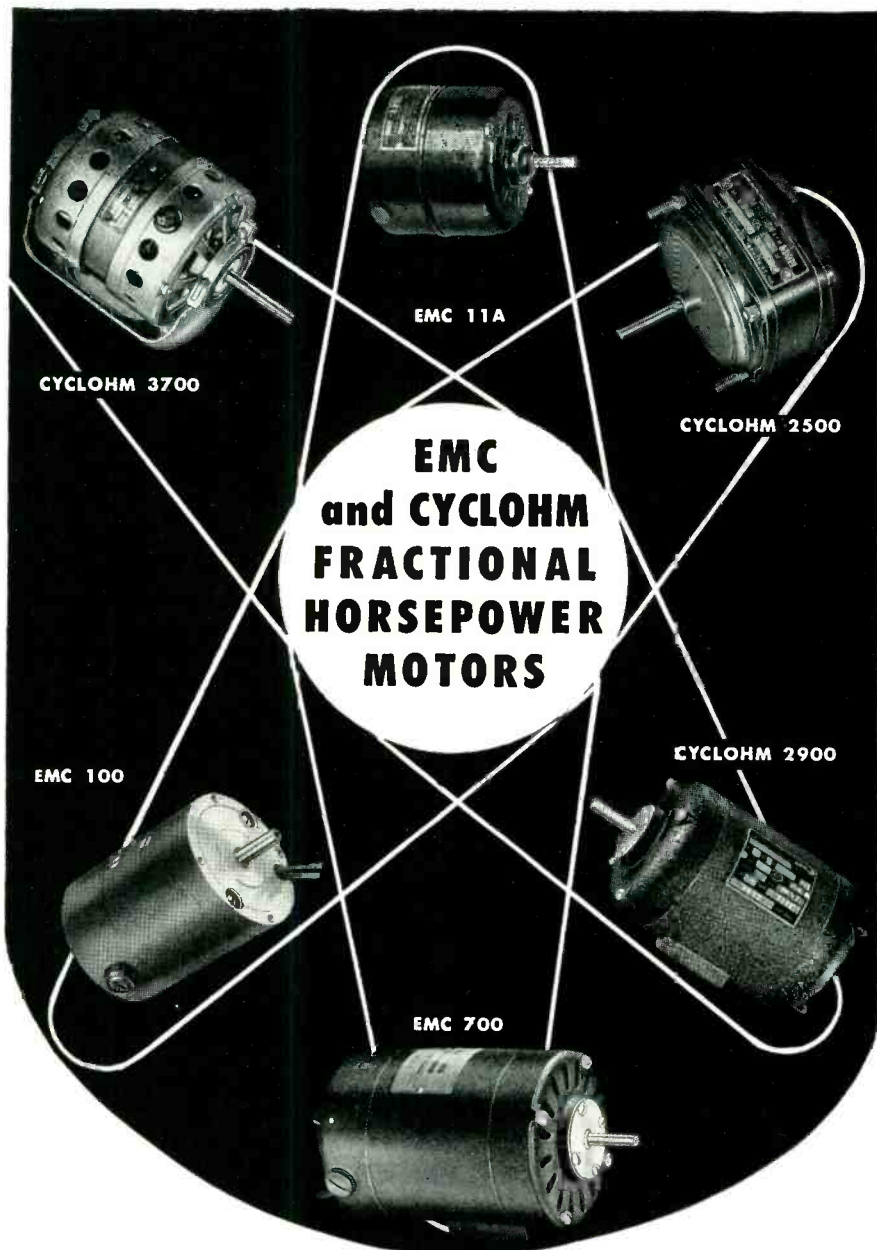

• • • used extensively by the electronics industry • • •

A list of our customers in the Electronics Industry includes many leading manufacturers—Philco, RCA, Federal Tel. & Tel., Collins Radio, Magnecord, Hazeltine Labs, Presto Tape Recording Co., and many more.

Yes, EMC and CYCLOHM fractional h. p. motors are used by leading companies for hundreds of applications. If you have an application for fractional h. p. motors, check with us on your requirements. Write today for our catalog or better yet, ask to see a Howard representative.

HOWARD INDUSTRIES, INC. RACINE, WIS.
DIVISIONS: **EMC** ELECTRIC MOTOR CORP.
 **CYCLOHM** MOTOR CORP.

Universal and Direct Current
1/1000 to 1/2 h.p.
Shaded Pole 1/2000 to 1/15 h.p.
Induction types 1/1400 to 1/4 h.p.

HOWARD

caused by capstan idler, flywheel or drive pulleys. These are referred to as d-c errors or wow. Second are high-frequency errors called flutter and caused by a wide variety of phenomena such as unsupported vibrating sections of the tape near the magnetic heads, poling of the capstan drive motor, and bouncing and friction of the tape as it slides over the heads. By far the most difficult error to correct is the flutter, and therefore a measure of the worth of a recorder for instrumentation work is the amount of flutter it introduces.

There are several techniques for measuring flutter, including some instruments that actually give a direct meter indication. Available instruments of this type, however, will not function to the accuracy required for an instrumentation recorder.

The method generally employed to measure flutter by the manufacturers of instrumentation magnetic tape recorders is as follows: A c-w signal of constant amplitude is recorded on the tape at normal operating levels and then played back through a wideband discriminator. The output of the discriminator is fed to the x-axis amplifiers of an oscilloscope with a fast writing speed. A shutterless camera is placed before the scope and provides a y-axis sweep by the



Test setup for evaluating short sample method of measuring flutter introduced by magnetic tape recorders used in guided missile instrumentation. Discriminator is on panel below tape recorder. Dual-beam oscilloscope and recording camera are at left

**MEMO FROM
CHIEF ELECTRONICS ENGINEER**

Immediate Action!

*Bill:
See my comments
on attached. This looks like
our problem is solved!*

P.J.C.



DIFFUSED JUNCTION GERMANIUM RECTIFIERS

ABSOLUTE MAXIMUM RATINGS • T-55°C • RESISTIVE LOAD				
DIFFUSED JUNCTION RECTIFIER	4JA1A1	4JA1A2	4JA1A3	4JA2A4
PEAK INVERSE VOLTAGE* (volts)	100	200	300	400
PEAK FORWARD CURRENT (amps)	0.47	0.31	0.25	1.37
D.C. OUTPUT CURRENT* (Ma)	150	100	75	500
D.C. SURGE CURRENT (amps)	25	25	25	25
FULL LOAD VOLTAGE DROP (volts peak)	0.5v	0.5v	0.5v	0.7v
FORWARD RESISTANCE AT FULL LOAD (ohms)	1.1	1.5	1.9	0.5
CONTINUOUS REVERSE WORKING VOLTAGE (volts D.C.)	30	65	100	185
FREQUENCY OF OPERATION (kc)	50	50	50	50
STORAGE TEMPERATURE (°C)	85	85	85	85

*Typical absolute maximum ratings. For other combinations refer to Fig. 1.

HERMETICALLY SEALED against deteriorating elements. Glass-to-metal seals throughout.

MINIATURE SIZE to facilitate use in all electronic equipments, yet heat losses are dissipated efficiently.

REDESIGNED to meet all military humidity tests and shock and vibration requirements.

HIGH OUTPUT VOLTAGE and improved back current characteristics.

**NEWS FROM OUR ADVANCED
DEVELOPMENT LABORATORIES**

Developmental germanium rectifiers for the KW range have been made so efficient that the copper lead connections must be larger in cross sectional area than the diffused junction itself.



GENERAL ELECTRIC



Send for complete G-E Diffused Junction Rectifier Information: General Electric Company, Section 433, Electronics Park, Syracuse, New York.

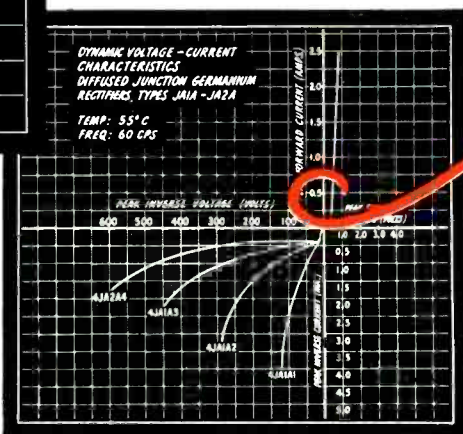

*Note:
This is only one ohm!*

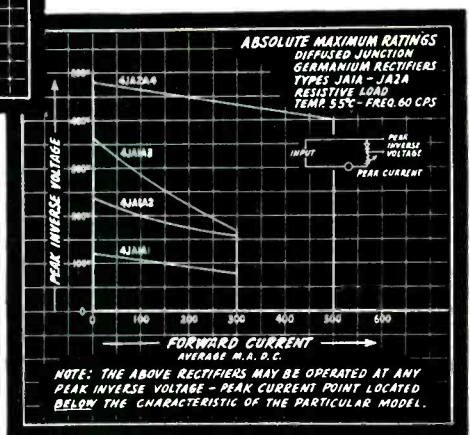

BOLOMETER AMPLIFIERS

P & B Bolometer Amplifiers can be used wherever accurate, repeatable metering or recording of low level outputs is required. They were originally designed to facilitate the measurement of RF field strengths of antenna systems and RF networks, but in no sense are they limited to this field. In fact, they can be used effectively in any region of the radiation spectrum and in several fields of science: — chemistry, biology, nuclear physics and spectroscopy, to name a few.

Features of Model 100 Bolometer Amplifier

TUNABLE FREQUENCY RANGE — 400 to 5000 cycles ($\pm 3\%$ calibration accuracy).

VARIABLE BANDWIDTH — ($\frac{1}{2}$ voltage) 6, 12, 22, 50, 100 and 300 cycles.

VOLTAGE RATIO EXPANDER — eighth power expander for the accurate measurement of extremely small variations.

AUTOMATIC NORMALIZATION — output voltage holds within $\pm \frac{1}{4}$ db for input changes of ± 5 db to both signal and monitor channels.

SELF-CONTAINED METERING — Removable (up to 20 feet) voltmeter, logarithmic scale with 100 db decade.

RECORDER OUTPUT — .01 to 100 volts at .01 watt maximum (undecaded). Designed to operate strip-chart recorders for antenna pattern and standing wave ratio determinations.



MODEL 60 BOLOMETER AMPLIFIER

This model was designed to meet a demand for an inexpensive, yet highly accurate instrument not requiring the special features of the Model 100. Write for Bulletin L-60.

For complete information write for bulletin L-100.

PICKARD & BURNS

INCORPORATED

240 HIGHLAND AVENUE
NEEDHAM 94, MASS.



Pickard and Burns is a research, consulting, design and development organization with extensive laboratories and custom manufacturing facilities. It specializes in radio and microwave communications, radar and electronics. If you have problems in any of these categories, we shall be pleased to discuss them with you in complete confidence and without obligation.

DOUBLE BARREL Advertising

Advertising men agree—to do a complete advertising job you need the double effect of both Display Advertising and Direct Mail.

Display Advertising keeps your name before the public and builds prestige.

Direct Mail supplements your Display Advertising. It pin-points your message right to the executive you want to reach—the person who buys or influences the purchases.

More and more companies are constantly increasing their use of Direct Mail because it does a job that no other form of advertising will do.

McGraw-Hill has a special Direct Mail Service that permits the use of McGraw-Hill lists for mailings. Our names give complete coverage in all the industries served by McGraw-Hill publications—gives your message the undivided personal attention of the top-notch executives in the industrial firms. They put you in direct touch with the men who make policy decisions.

In view of present day difficulties in maintaining your own mailing lists, our efficient personalized service is particularly important in securing the comprehensive market coverage you need and want.

Ask for more detailed information today. You'll be surprised at the low over-all cost and the tested effectiveness of these hand-picked selections.

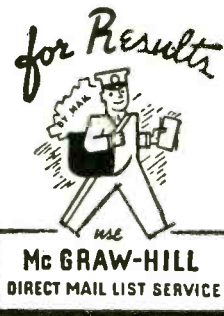

McGRAW-HILL PUBLISHING CO., INC.

330 West 42nd Street
NEW YORK 18, N. Y.

ELECTRONIC PRECISION METAL PARTS AND COMPONENT PARTS FOR TRANSISTORS

by
Haydu BROTHERS

Regardless of the complexity of the parts you need, Haydu Brothers possess the design and engineering skill, the facilities, the trained operators and the down-to-earth, machine-shop "know how" necessary to fill your requirements promptly, efficiently, and economically. Whether you need precision machine parts, small metal stampings, deep-drawn and four-slide parts, screw machine made parts, or formed wire parts, Haydu Brothers will handle your entire problem from die-making through production of the finished parts to specified tolerances. Our modern, high-speed equipment in the hands of skilled personnel is your assurance of quick and dependable fabrication — in even the most difficult metals.

Our technical staff is always available to you for design of special equipment, or for consultation on production problems. Your inquiry concerning a specific item is invited.

Some items
from current production . . .

- (1) **Small metal stampings*** — intricate or simple, Haydu's modern presses insure fast, accurate, volume production in †Monel, ‡nickel, molybdenum, tungsten, stainless steel, copper, carbonized rickel, and other metals.
- (2) **Precision machine parts*** — in even the most difficult materials (molybdenum, tungsten, ambralloy, tantalum, †Kovar, ‡Nichrome, mishmetal, etc.) are tooling problems well within the scope of Haydu experience.
- (3) **Formed wire parts*** — from .004" to .080" in diameter in a wide range of materials. These are made to your exact blueprint specifications.
- (4) **Drawn, four-slide parts*** — perfectly produced to close tolerances on correctly designed dies for high-speed fabrication. Complete, modern facilities for deep-drawing.
- (5) **Screw machine parts*** — automatic and hand screw equipment give an almost unlimited range of size, shape, and finish, while maintaining closest tolerances.

*All Haydu metal parts production undergoes rigid inspection for assurance of complete accuracy.



HAYDU BROTHERS

PLAINFIELD • NEW JERSEY

†Monel — Reg. T. M. of International Nickel Company
‡Kovar — Reg. T. M. of Westinghouse Electric Corp.
‡Nichrome — Reg. T. M. of Driver-Harris Company

movement of the film behind the camera lenses.

This arrangement, then, gives a graphic record of actual flutter produced by the recorder. If the recorded signal frequency remains constant upon playback, the film trace appears as a straight line. If the frequency deviates from the original, then the discriminator produces a varying voltage and the film trace forms a picture of these variations as shown in Fig. 1. By simple calibration, these variations can be translated into terms of frequency and the flutter calculated as a percent of the recorded frequency.

The response of the discriminator is a limiting factor in the accuracy of such a measurement since it must pass all modulating frequencies up to an arbitrary limit with a flat response so that each component may be considered in its true proportions. The generally accepted limit for this modulation frequency is 4,000 cps; that is, all flutter frequencies up to 4,000 cps will be considered at full value, and those above will be attenuated in accordance with the pass band of the discriminator.

Since the most damaging components of flutter are the peaks, this phenomenon is usually referred to in terms of average peak-to-peak flutter. It is this value that must be determined from the graphic film record. This brings

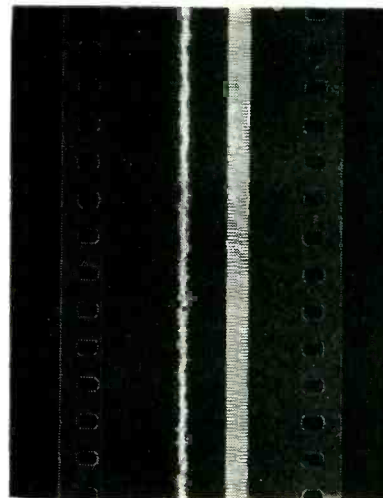

FIG. 1—Continuous moving film recording of output of recorded c-w signal shows flutter, but over 9,000 feet of film is required for 15 minutes of tape. Trace at right is timing signal



Multi Scope!

WHEN A SINGLE SCOPE WON'T DO YOUR JOB!

Try to compare four different but related phenomena . . . at the same instant . . . under the same conditions . . . with single channel oscilloscopes . . . and you run into trouble. Nine times out of ten, you'll miss those high speed signals.

There are several **ETC** oscilloscopes that lick the problem by displaying *four* phenomena on the face of a single 5" tube. Since their development they have opened new fields in electronic and medical research, strain and vibration analysis, seismography and ballistics.

Each of their four channels has independent controls for intensity, focus, and positioning of the X and Y axes. All input signals can be observed on a common time base or on separate time bases if desired. Wide band, high gain, DC or AC amplifiers are provided on both the vertical and horizontal axes.

Details about the four-channel models available as well as others with 2, 5, 6, 8, or even 10 channels are covered in our catalog. Write for your copy today.

During The IRE Show — See Us At Booth 2-519

ETC

electronic tube corporation

1200 E. MERMAID LANE, PHILADELPHIA 18, PA.

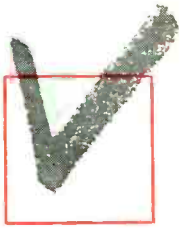

More pumps to pick from!

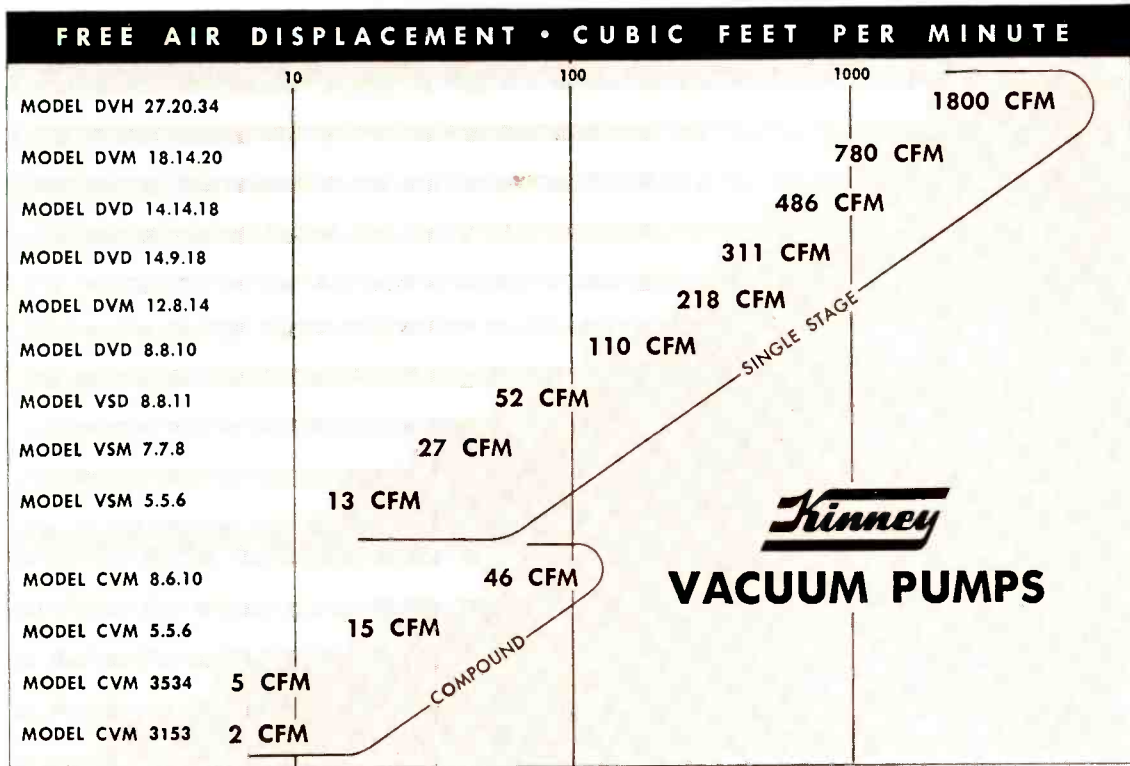

What's your vacuum problem? Kinney offers you the BIG LINE of vacuum pumps — the broadest range of mechanical, oil-sealed vacuum pumps on the market. Pick the exact pump you need from our line. Get fast pump-down, fast recovery speed, and reliable low absolute pressure — and get them efficiently and economically by buying the Kinney Pump that's right for the job. Experienced vacuum engineers, here in Boston and in all our branch offices, will be glad to discuss the applications of vacuum in your plant.



Kinney Manufacturing Co., Boston 30, Mass. Representatives in New York, Chicago, Detroit, Cleveland, Atlanta, Philadelphia, Pittsburgh, Johnstown (Pa.), Los Angeles, Charleston (W. Va.), Houston, New Orleans, San Francisco, Seattle, and foreign countries.

SEND COUPON FOR COMPLETE DETAILS

KINNEY MANUFACTURING CO.
3565 WASHINGTON STREET • BOSTON 30, MASS.

Please send Bulletin V-51B describing the complete line of Kinney Vacuum Pumps. Our vacuum problem involves:

- Vacuum drying
- Vacuum coating
- Vacuum metallurgy
- Vacuum impregnating
- Vacuum distillation
- Vacuum research

Please have your vacuum engineer call at our plant.

Name.....

Company.....

Address.....

City.....

State.....



SUBSIDIARY OF THE NEW YORK AIR BRAKE CO.

*how can it
be made*



- If your problem requires
- 1 Close tolerance
 - 2 High interior surface finish
 - 3 Intricate design

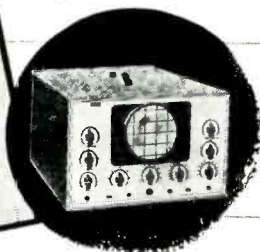

It can be **LECTROFORMED!**

If the radio frequency component you need cannot be made by conventional methods or is difficult and costly to manufacture, the possibilities are it can be **LECTROFORMED**.

Write Dept. EL-3
for "Lectroforming
Applications
and
Procedure"



• Trademark

LECTROFORMING can produce parts of intricate design, accurate interior dimensions and with high interior surface finish up to 5 micro-inch. Various metals may be used (such as silver, gold, copper, nickel and/or iron) to meet specific requirements for conductivity, strength and corrosion resistance.

LECTROFORMING achieves dimensional stability impossible by any other method.

LECTROFORMING is the manufacturing of an article by the electrode position of metal on a form of predetermined size, shape and finish. We welcome the opportunity to discuss your problem, no matter how difficult it may seem.

Visit our Booth 3-525 at IRE Show



BART LABORATORIES CO., INC.
227 Main Street, Belleville 9, New Jersey

Solve radio problems
more quickly, easily,
accurately

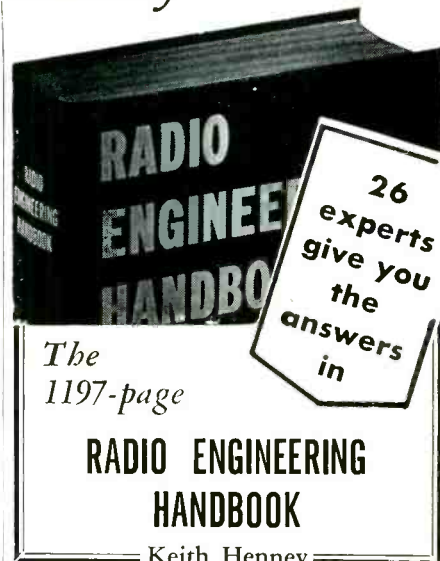

The
1197-page

**RADIO ENGINEERING
HANDBOOK**

Keith Henney

Editor-in-Chief

Consulting Editor of *Electronics*

Fourth Edition, 1197 pages, 6 x 9,
1038 illustrations, \$12.00

HERE is a handy volume embracing a great deal of constantly needed reference material covering all fields and aspects of radio engineering—concise, dependable, arranged in easy-to-get-at form.

What the Standard Handbook, Marks' Handbook, and others are in their respective fields, Henney's Handbook is in the radio field.

IN scope, this book ranges from fundamentals to discussion of newest circuits, amplifiers, power supply systems, short-wave systems, etc. Frequency modulation, developments in television and aircraft radio, and other applications are covered.

Here's the help you get

- 1197 pages of carefully selected accurate data—charts, tables, circuits, diagrams, formulas.
- 23 sections covering all the most needed subjects for engineers and radio technicians, from fundamentals to specialized applications.
- Every section prepared by one or more specialists, to assure you dependable, expert answers to your problems in design and practice.
- More than 1000 illustrations give a clear picture of the many different circuits, parts, and characteristics that the radio engineer works with.
- Fourth Edition gives a wealth of material on modern developments in every field and aspect of radio engineering—from inductance, power-supply systems, and electron tubes, to receiving systems, and code reception.

• HAVE THIS HELP RIGHT NOW

Just send the coupon now—pay on easy terms only after you examine the book

McGraw-Hill Book Co., 330 W. 42nd St., NYC 36

Send me Henney's **RADIO ENGINEERING HANDBOOK** for 10 days' examination on approval. In 10 days I will send \$1.00, plus few cents for delivery, and \$4.00 a month until \$12.00 has been paid. Otherwise I will return the book postpaid.

(Print)
Name

Address

City Zone State

Company

Position

E.J.S.

This offer applies to U. S. only

TOPS in transmission line for HF·VHF·UHF

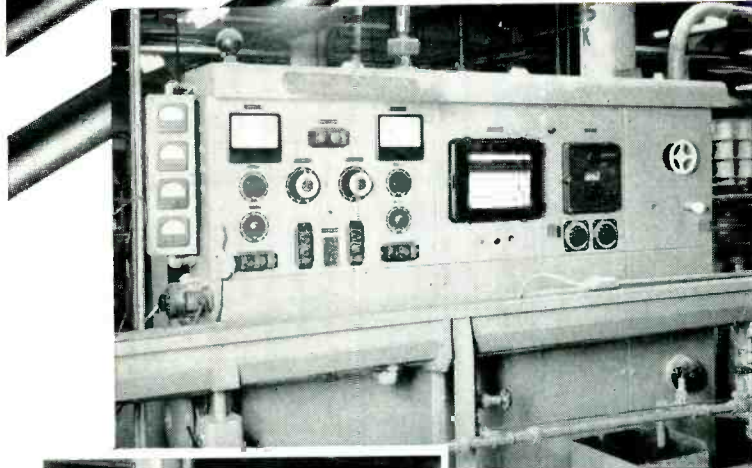

Federal's "Precision Production" is assured by this electronic panel board which controls diameter and speed of cables during extrusion.

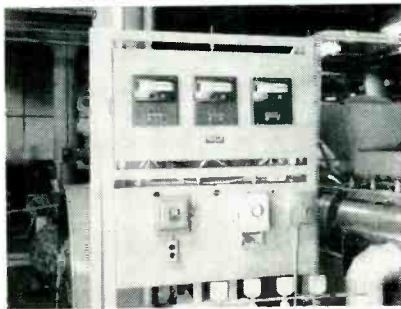

Control panel for maintaining plastic materials at precise temperature and viscosity.

Federal's

highest-quality

RG TYPE CABLES

including the Federal-developed
low-temperature, non-contaminating
thermoplastic jacket

DESIGNED FOR: H-F communications, television, industrial electronics, radio and TV lead-ins, aviation, test equipment, radar, pulse and experimental equipment

QUALITY of product is the secret of dependable cable performance and *quality* is what you get in every inch of Federal RG type coaxials . . . from jacket to conductor!

Only the finest materials—quality-controlled throughout the entire manufacturing process—are used in Federal cables. Every possible test is made to insure constant efficiency of physical and electrical properties under the most rugged conditions encountered by general and military applications.

Whatever your transmission line requirement—specify Federal RG types. For full information, write Dept. D-413.

COMPLETE COAXIAL CABLE ASSEMBLIES also are available from Federal to meet your requirements. This service offers the same "Precision Production" that made "Federal" the outstanding name in coaxial cables.

Manufacturer of America's most complete line of solid dielectric cables

Federal



Telephone and Radio Corporation

SELENIUM-INTELIN DIVISION 100 KINGSLAND ROAD, CLIFTON, NEW JERSEY

In Canada: Federal Electric Manufacturing Company, Ltd., Montreal, P. Q.
Export Distributors: International Standard Electric Corp., 67 Broad St., N. Y.

Why Federal Cables are SUPERIOR

- **CONDUCTORS**—meet highest ASTM standards
- **DIELECTRICS**—of stabilized polyethylene
- **BRAIDS**—meet highest ASTM standards
- **JACKETS**—of latest developments in vinyl and polyethylene

Every Federal Cable Fully Tested for:

- Capacitance
- Attenuation
- Continuity
- High Voltage



**offers a complete line
of antennas for the 450-470 MC band!**

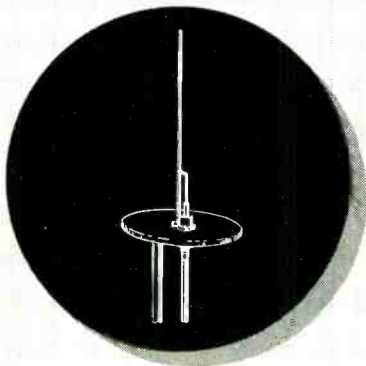

The Isopole antenna, omnidirectional, rugged, inexpensive Type N input.

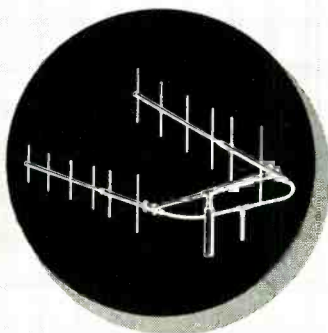

The Yagi antenna, two models with gains of 9.5 db and 12 db horizontal or vertical polarization.



The High Gain antenna, omnidirectional, gain 6 DECIBELS PLUS.

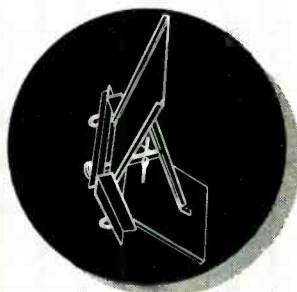

The Corner Reflector antenna, 8db forward gain, broadband, horizontal or vertical polarization.

Andrew
CORPORATION

ANTENNA SPECIALISTS
363 EAST 75TH STREET, CHICAGO 19

TRANSMISSION LINES FOR AM-FM-TV-MICROWAVE • ANTENNAS • DIRECTIONAL
ANTENNA EQUIPMENT • ANTENNA TUNING UNITS • TOWER LIGHTING EQUIPMENT

up the problem of analysis of the film record to arrive at a reasonable and repeatable measurement.

One technique is to make a film record of the entire spool of tape and then analyze all the film to obtain peak-to-peak flutter. When using this technique it is also recommended that flutter spikes of less than 0.001 second, and more than a certain value in amplitude, be disregarded. To perform this analysis, one must have sufficient resolution of the film to be able to read to 0.001 second of time. This would require at least 0.01 inch of film for a manual readup system or 0.001 inch of film in case some optical system, such as Recordak were available. Some new recorders hold as much as 5,000 feet of magnetic tape, and even at the high speed of 60 inches a second, it would require 15 minutes to complete the playing of one reel. This means that the oscilloscope recording camera must also record for 15 minutes and run at a speed of 10 inches per second, to achieve the required resolution. The results would then be spread out over 9,000 feet of film and a tremendous amount of labor would be involved in reducing the data to a percentage figure.

Other possible methods for obtaining this answer would be to analyze only the front portion of the recorded tape or only the last few minutes or possibly the worst section as viewed on the scope or again perhaps only the best section.

None of the previous methods presents a good solution to the problem. There is one method that does allow a reasonable answer to be obtained and yet does not involve as much work as the first technique explained. This is one of random sampling of the flutter throughout the tape. Since flutter itself is a purely random function, the laws of probability can be applied and enough samples taken to arrive at an answer with the required accuracy and within a certain probability.

Mathematically the problem reduces to one of compromise between the number of samples taken and the desired accuracy

**INTERNATIONAL
RECTIFIER
CORPORATION**

EL SEGUNDO
CALIFORNIA

Germanium Diodes

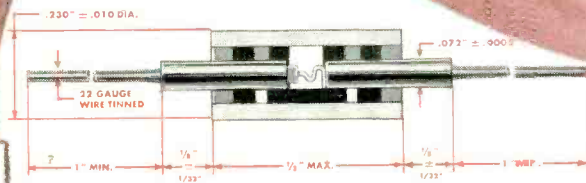

Features:

1. Ruggedized construction
2. Welded anchor pins
3. Triple moisture protection
4. Self-insulating case
5. Vibration resistant
6. Shock resistant
7. Higher efficiency
8. Stability of characteristics
9. No flaking

**All types
available
for prompt
shipment**

Types Available

- 1N48
- 1N51
- 1N52
- 1N63
- 1N65
- 1N69 
- 1N70 
- 1N75
- 1N81 
-  JAN types

INTERNATIONAL RECTIFIER

C O R P O R A T I O N

General Offices: 1521 E. Grand Ave., El Segundo, Calif. • Phone: El Segundo 1890
 Chicago Branch Office: 205 West Wacker Drive • Phone: Franklin 2-3889
 New York Branch Office: 12 West 32nd Street, N. Y. 1 • Phone: Chickerling 4-0017

What is your Delay or Regulating Problem?

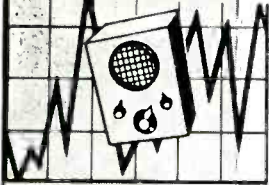

For the most effective solution use the
SIMPLEST, MOST COMPACT
MOST ECONOMICAL
HERMETICALLY SEALED

AMPERITE THERMOSTATIC DELAY RELAYS



STANDARD

Provide delays ranging from 2 to 120 seconds.

- Actuated by a heater, they operate on A.C., D.C., or Pulsating Current.
- *Hermetically sealed.* Not affected by altitude, moisture, or other climate changes.
- Circuits: *SPST only*—normally open or normally closed.

Amperite Thermostatic Delay Relays are compensated for ambient temperature changes from -55° to $+70^{\circ}$ C. Heaters consume approximately 2 W. and may be operated continuously. The units are most compact, rugged, explosion-proof, long-lived, and—very inexpensive!



MINIATURE

TYPES: Standard Radio Octal, and 9-Pin Miniature.

PROBLEM? Send for Bulletin No. TR-81

BALLAST-REGULATORS



T9 BULB

- Amperite Regulators are designed to keep the current in a circuit *automatically regulated* at a definite value (for example, 0.5 amp).
- For currents of 60 ma. to 5 amps. Operates on A.C., D.C., or Pulsating Current.
- Hermetically sealed, light, compact, and most inexpensive.

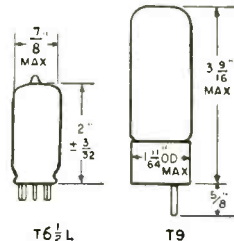
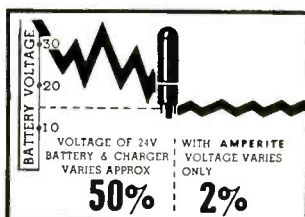

Maximum Wattage Dissipation: T6 1/2 L—5W. T9—10W.

Amperite Regulators are the simplest, most effective method for obtaining *automatic regulation* of current or voltage. *Hermetically sealed*, they are not affected by changes in altitude, ambient temperature (-55° to $+90^{\circ}$ C), or humidity. Rugged; no moving parts; changed as easily as a radio tube.

Write for 4-page Technical Bulletin No. AB-51

AMPERITE CO., Inc. 561 Broadway, New York 12, N. Y.

In Canada: Atlas Radio Corp., Ltd., 560 King St., W., Toronto 2B

from

Accelerometers

to

Yokes

you'll find the correct answer to who makes everything in the entire field of electronics including... components equipment and materials

in the...

electronics BUYERS' GUIDE

Get in the habit of looking it up in...

the electronics BUYERS' GUIDE

"The Book that has all the answers"

A MCGRAW-HILL PUBLICATION
330 West 42nd Street
NEW YORK 36, N. Y.

Keep TABS on **WIRING PERFORMANCE**













Tested and
Approved
Beyond
Specification

with—

CHESTER
plasticord-plasticote
WIRES & CABLES

Chester ENGINEERED plastic insulation, laboratory and field tested to more than meet specifications provides both easier working qualities and longer service life. These rugged plastic coatings offer maximum immunity to abrasion, weather, oil and most chemicals. Smooth and pliable, they pull through channels and conduit

easily and offer excellent appearance in open wiring. Chester single or multi-conductor wires and cables are available for electrical, electronic, TV, radio, telephone and many other industries. Call or write for illustrated bulletins, today!

<p>JAN-C-76 WIRES* SRIR, SRHV, SRRF, WL</p> 	<p>LACQUERED AND NYLON WIRES</p> 
<p>105°C, 90°C, 80°C UL APPROVED; 120°C* <i>*Solid colors or spiral marking</i></p> 	<p>SHIELDED WIRES & CABLES</p> 
<p>FLEXIBLE CORD</p> 	<p>INSTRUMENT WIRES</p> 
<p>TV LEAD-IN WIRES</p> 	<p>COAXIAL CABLE</p> 
<p>COMMUNICATION WIRES & CABLES TO SPECIFICATIONS</p> 	<p>SPECIAL WIRES & CABLES TO SPECIFICATIONS</p> 

VISIT US AT THE
I.R.E. SHOW
BOOTH 4-704
FOURTH FLOOR

"Chester" HAS THE ANSWERS — Plasticard and Plasticote wires are available in standard constructions or custom built to specifications. For a practical solution to unusual insulated wiring problems, call or write.

CHESTER CABLE CORP.
C H E S T E R • N E W Y O R K



REGISTERED
U.S. PAT. OFF.



triple threat

Changing temperatures, vibrations, and accelerations affect the operation of all instruments. In spite of these variables, our products produce the right answers because they are properly designed.

- ✈ AIRCRAFT INSTRUMENTS AND CONTROLS
- ✈ OPTICAL PARTS AND DEVICES
- ✈ MINIATURE AC MOTORS
- ✈ RADIO COMMUNICATIONS AND NAVIGATION EQUIPMENT

Current production is largely destined for our defense forces; but our research facilities, our skills and talents, are available to scientists seeking solutions to instrumentation and control problems.



kollsman INSTRUMENT CORP.

ELMHURST, NEW YORK • GLENDALE, CALIFORNIA • SUBSIDIARY OF *Standard* COIL PRODUCTS CO., INC.

and probability obtained. As the total number of samples being considered increases, the accuracy of the result increases and the probability of the result being within this accuracy also increases.

This mathematical analysis has been checked in the Technical Systems Laboratory of the Air Force Missile Test Center and results agree with theory. The test setup for this work was similar to that outlined previously for the continuous check except that several bursts of record were taken, spaced approximately evenly throughout the tape. Portions of these bursts, termed long samples, were then broken down into short samples as indicated in Fig. 2. These short samples ran concurrently within the long sample. The purpose of this procedure was to aid in eliminating the d-c or wow errors from the measurement.

Short sample lengths were chosen at 0.04 second of record. The length of this sample determines, within limits, the magnitude of the final answer. It is important that a universal short sample length be established so that comparison can be made between all test results. This value of 0.04 second actually means that any flutter with a half period exceeding 0.04 second (12.5 cps) will not add its full weight to the result.

Referring to Fig. 3, it can be seen that since the measurement is taken from peak to peak, the maximum deflection possible begins to drop off as the frequency of the flutter goes below 25 cycles. As the frequency goes below 12.5 cycles, the flutter can no longer contribute its maximum regard-

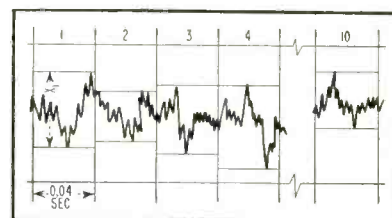

FIG. 2—Short samples provide sufficient accuracy in making flutter measurements on instrumentation tape recorders

Why Electron Tube Buyers do business with Tung-Sol



Tung-Sol's modern manufacturing techniques and advanced quality control methods assure you of a product that is second to none. Tung-Sol makes tubes—no sets—no equipment—just tubes. We do not compete with our customers. Tung-Sol design, development and application engineers work closely together for the sole purpose of producing a better tube so that you can make a better product. Engineering assistance is strictly confidential. Tung-Sol service by competent field sales repre-

sentatives is nationwide. A Tung-Sol delivery promise is a promise. Closest cooperation is maintained to keep deliveries up to your production schedule requirements.

Booth No. 4-715, Radio Engineering Show,
Grand Central Palace, New York, March 23-26.

TUNG-SOL ELECTRIC INC.
Newark 4, N. J.

*Sales Offices: Atlanta, Chicago, Culver City
(Los Angeles), Dallas, Denver, Detroit, Newark*

TUNG-SOL MAKES: ALL-GLASS SEALED BEAM LAMPS • MINIATURE LAMPS • SIGNAL FLASHERS
PICTURE TUBES • RADIO • TV AND SPECIAL PURPOSE ELECTRON TUBES

CUBIC'S 3 SIDED COVERAGE

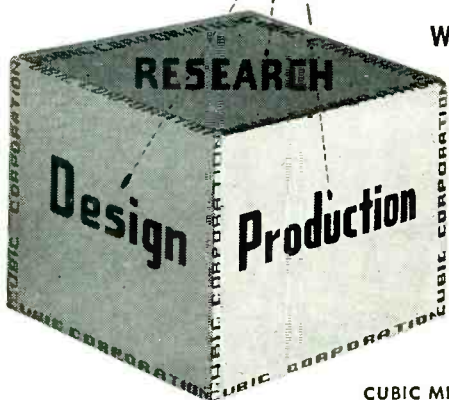

PROVIDES YOU WITH THE
WORLD'S FINEST PRECISION

- MICROWAVE & RADAR COMPONENTS
- ELECTRONIC INSTRUMENTS & TEST EQUIPMENT

CUBIC MICROWAVE ENGINEERS—specialists in the field since the inception of Radar in World War II—start with electronic problems and ideas, and convert them into the most accurate precision-built

electronic instruments and equipment! We welcome inquiries—not only in connection with our rapidly developing list of products—as represented below—but on ideas, problems, or design of microwave assemblies of your own specification you may want developed and produced.

MICROWAVE CALORIMETRIC WATTMETER

portable... for lab and field use... to measure absolute microwave power.
Frequency Range: 2600 MC to 26500 MC
Max. VSWR: 1.1
Max. Peak Power: 600 KW



COAXIAL CALORIMETRIC WATTMETER

Frequency Range: 200 MC to 3000 MC—Max. VSWR: 1.5 over range—Max. Peak Power: 1 1/2" Coaxial rating

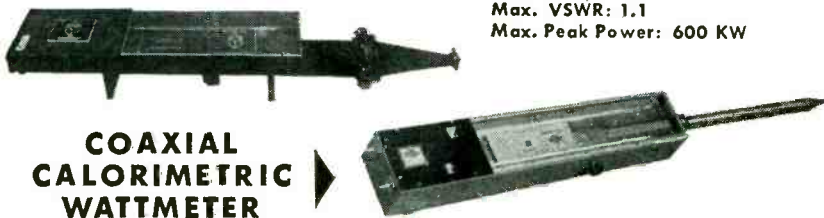

MICROWAVE (X-BAND) PULSE MEASURING WATTMETER

for measuring peak power of microwave pulses from signal generators or radar systems.

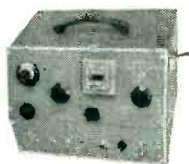

ELECTRONIC DIRECT-READING PHASE METER

Frequency Range: 20 to 50,000 cycles
0-360 degrees

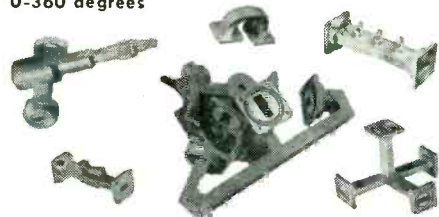

Shown at left are a few of our standard microwave components available as catalog items. Special purpose wave guide assemblies designed to customer's specs can also be produced.

CUBIC CORPORATION

SCOTT & CANON STS.
SAN DIEGO 6
CALIFORNIA

Devoted Exclusively to Electronics & Electronic Equipment

WHEN you need a quick answer to WHO MAKES IT... Just look it up in the electronics BUYERS' GUIDE

There are...

23,367 ANSWERS

to

1,445 PROBLEMS

covering every...

COMPONENT EQUIPMENT

and MATERIAL

used in every phase of electronics

GET IN THE HABIT OF
LOOKING IT UP IN

the

electronics BUYERS' GUIDE

A McGRAW-HILL PUBLICATION

330 West 42nd Street
NEW YORK 36, N. Y.

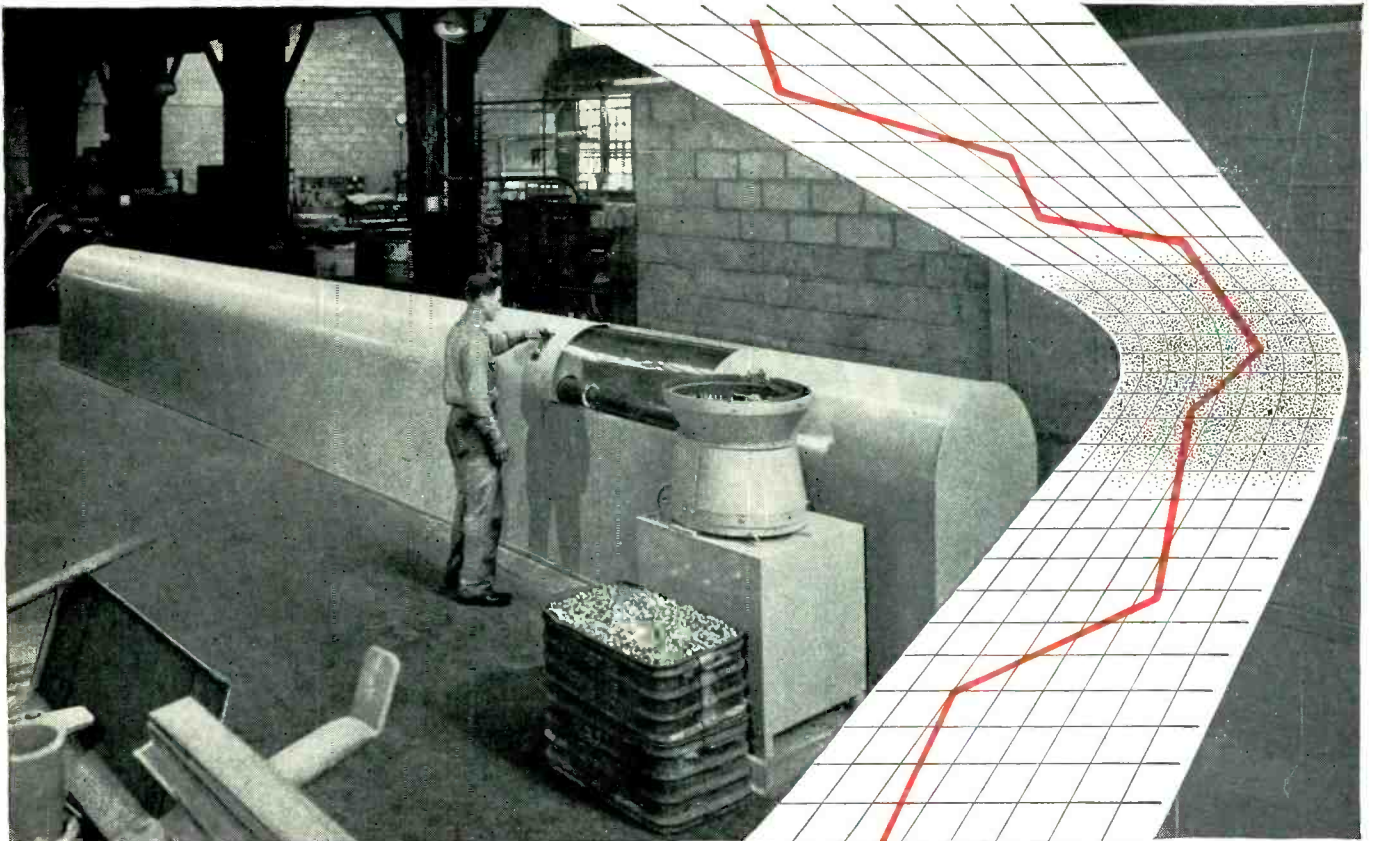

An automatic heat treat machine. Production is about 3 times that possible with manual methods while quality is held within very close limits.

CRUCIBLE ALNICO MAGNETS

KEEP COSTS DOWN ... through
automatic production that gives quality control

Alnico magnets have been getting smaller and lighter, thanks to production techniques in use at Crucible. Automatic machinery cuts the possibility of human error to a minimum, so rejections are low. This helps to maintain stable price levels in the face of rising material and labor costs. At the same time, Crucible's rigid inspection standards and attention to quality have developed a magnet with the *highest gap flux per unit weight of any on the market.*

Today, Crucible can offer lighter, magnetically stronger Alnico magnets because of these automatic production techniques developed over the sixteen years that we have been producing the Alnico alloys. And behind our familiarity with permanent magnets lies more than 52 years' experience with specialty steelmaking. Let us advise you on your magnet problem.

Visit our booth No. 4-203
at the I.R.E. show in
New York City, March 23-26

CRUCIBLE

first name in special purpose steels

53 years of *Fine* steelmaking

PERMANENT ALNICO MAGNETS

CRUCIBLE STEEL COMPANY OF AMERICA, GENERAL SALES OFFICES, OLIVER BUILDING, PITTSBURGH 30, PA.
STAINLESS • REX HIGH SPEED • TOOL • ALLOY • MACHINERY • SPECIAL PURPOSE STEELS

*An H&D
idea for you*

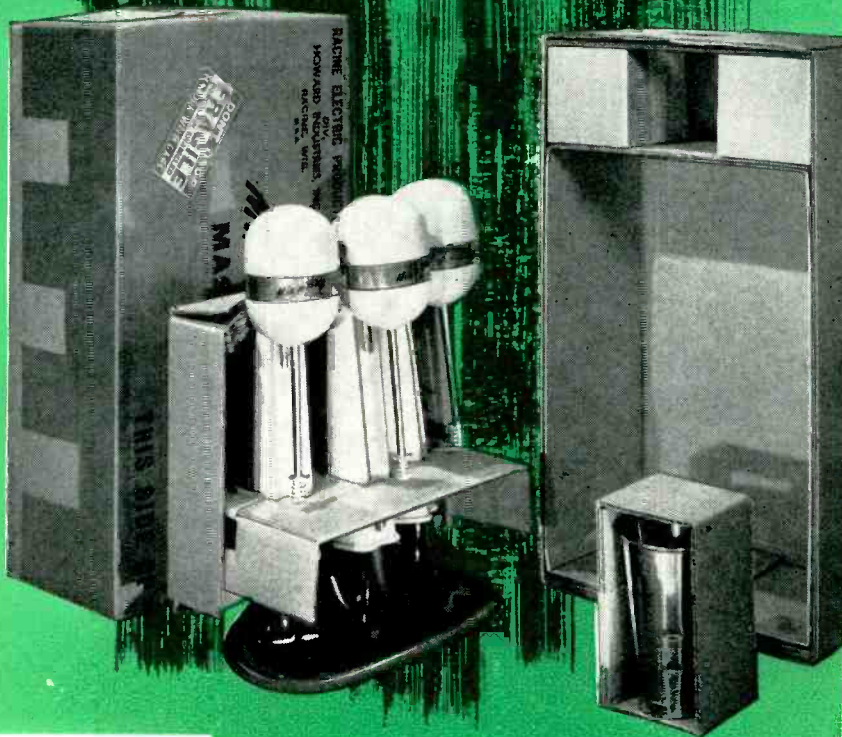

Braced, cushioned, shielded . . .
protected . . . an electric mixer in this
Huski-Duty shipping box means
lower freight costs, minimized damage
claims, and excellent dealer relations.

To get all three in your next shipping box—
send for "How To Pack It."

Hinde & Dauch, 5314-C Decatur Street,
Sandusky, Ohio.



HINDE & DAUCH

17 MILLS AND FACTORIES • 40 SALES OFFICES

Our 65th Year

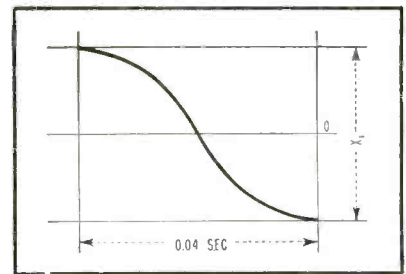
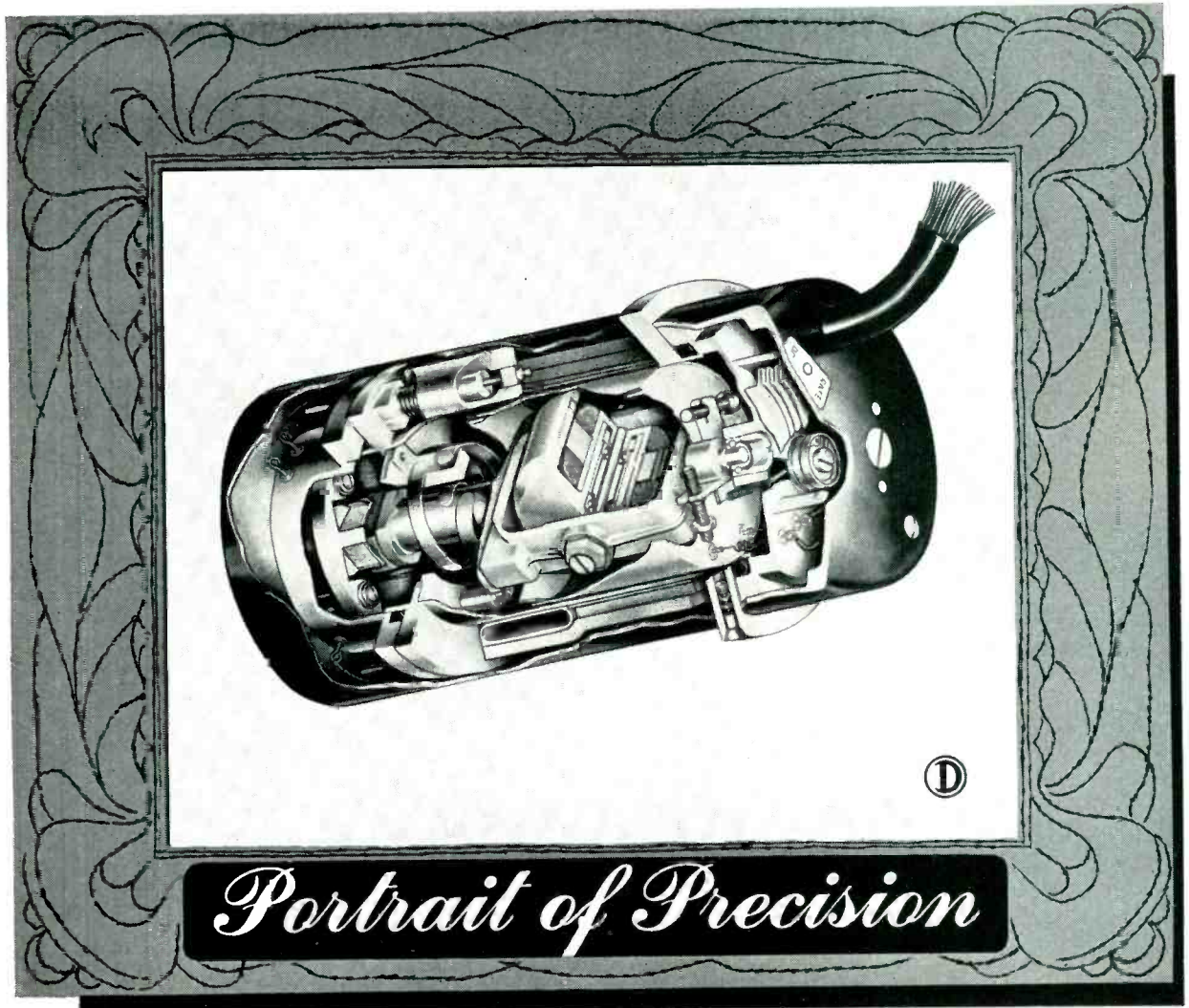

FIG. 3—With 0.04-second samples, any flutter less than 12.5 cps will have little effect on the measurement, thus eliminating wow errors

less of the phase relationship within the short sample.

For the purpose of this evaluation, many more samples and readings were made than will be necessary for actual practice. A total of 1,650 short samples was analyzed and the peak flutter determined for each sample. The weighted average was calculated and plotted for all samples running consecutively from the first to the last of the film record. This was repeated with the analysis starting from the last of the film and progressing to the beginning. The third series of calculations and plots was made by choosing the data (that is, the individual samples) at random. After a total of 1,650 samples the curves approach a constant value in all three cases. This value is assumed to be the true average. After 500 samples, the maximum deviation from this true average was 2.35 percent, and after 1,000 samples it was 1.09 percent. If theoretical calculations are made, based on the mathematical analysis of a random function then after 500 samples the result is 2.85 percent maximum error for 95 percent of the time. The maximum error on the laboratory curves was 2.35 percent, which falls under the 2.85 percent predicted.

These tests, while they are certainly not conclusive, indicate that flutter can be measured to better than 3 percent accuracy with 500 readings through a reel of tape. These 500 readings can be made up of 50 long samples, which in turn can be obtained from approximately 10 record bursts while the tape is running. It was found that 10 record bursts can be



- ◆ in design, construction, and performance.
- ◆ in sensitivity, linearity, and balance.
- ◆ in all the minute details that make an outstanding instrument.

**DOELCAM RATE MEASURING
GYROSCOPES**

For complete details write for Bulletin K

DOELCAM CORPORATION

1400 Soldiers Field Road, Boston 35, Mass.

Instruments for Measurement and Control

GYROSCOPIC INSTRUMENTATION • SYNCHROS • SERVOMECHANISMS • MICROSYNs • ELECTRONIC INVERTERS

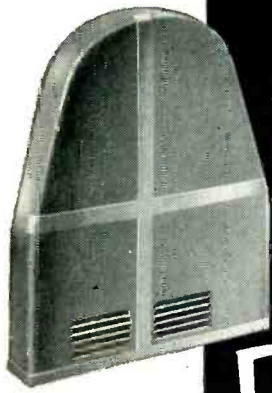

Sheet Metal Fabrication

BY **KIRK AND BLUM**

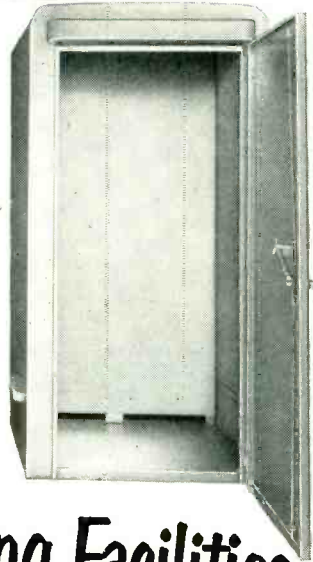
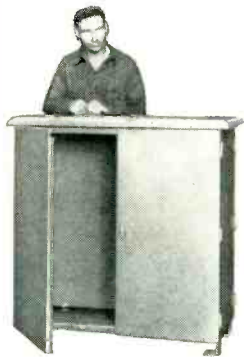
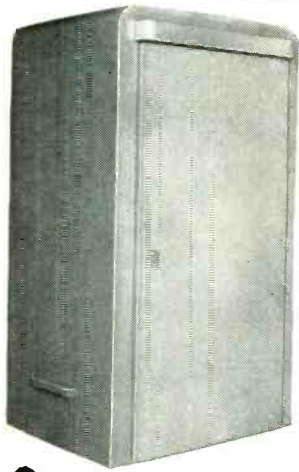

Contract Manufacturing Facilities



Whatever your requirements in sheet, plate and alloy fabrication, Kirk & Blum can produce for you . . . economically and quickly.

Complete facilities to $\frac{1}{2}$ " capacity for square and rotary shearing, braking, forming, rolling, punching, riveting, welding, grinding, drilling, and finishing sheets and light plates and structural. For complete details, write for literature on fabrication facilities and experience or send prints to:

The KIRK & BLUM MANUFACTURING CO.
3211 Forrer Street Cincinnati 9, Ohio



- Tanks
- Spare Parts Boxes
- Panel Boards
- Machine Bases, Pedestals and Frames
- Hoppers
- Electrical Enclosures
- Guards
- Rolled Steel Rings
- Racks • Pans
- Stampings
- Louvre Panels
- Cabinets

Write for NEW BULLETIN

This 40 page comprehensive booklet shows typical examples of Kirk & Blum fabrication, complete facilities of plant and equipment for jobs ranging from one unit to thousands.



the annual electronics BUYERS' GUIDE

is the electronic engineer's

BREADBOARD WHO'S WHO

for

quick, accurate
answers to any
questions about

COMPONENTS EQUIPMENT MATERIALS

used in electronics

*Get in the habit
of looking it up in...*

the electronics BUYERS' GUIDE

"The Book that has all the answers"

A McGRAW-HILL PUBLICATION

330 West 42nd Street

NEW YORK 36, N. Y.

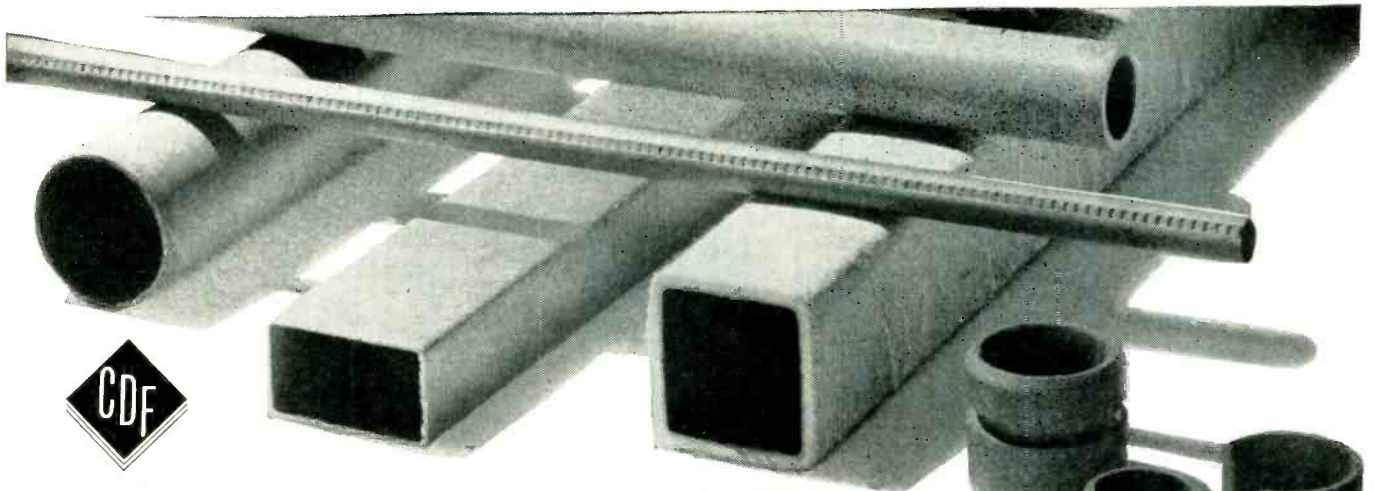

WE MAKE AND FABRICATE . . .

STRONG, LOW-COST SPIRAL TUBING

Spiral Tubing, another outstanding C-D-F product, is an important new material for the progressive, cost conscious design engineer (and purchasing agent). It is a high strength plastic made from paper or fibre that is spirally wound, then impregnated with phenolic resin or insulating varnishes and carefully cured at high temperatures. The resulting tubes (round, square, rectangular or formed to special shapes) are stiff, sturdy, resistant to crush, with good tensile strength.

This unique product has good dielectric strength with low dielectric loss properties. Moisture resistance and dimensional stability is easily controlled in the manufacturing process. The wide variety of sizes, shapes, forms; the strength; low cost; ease of fabrication; speed of delivery; all combine to make C-D-F Spiral Tubing worthy of your investigation.

SIZES

The round tubing ranges from 3/32 to 8" ID, with wall thicknesses from .0075 to 1/4". The minimum ID of square and rectangular tubing is 3/8", with 2 1/8" the maximum ID. Wall thicknesses range from .010 to 3/32".

Standard lengths are from 2 to 4', with special sizes and grades, plain or impregnated, open for your discussion with our C-D-F sales and engineering staff.

FABRICATION

Spiral Tubing is readily sawed, punched, drilled, tapped, riveted, stamped, painted, depending on the grade; it is suitable for automatic machine operations, but not recommended for conventional machine threading. Waxing or varnish impregnation to improve moisture resistance is usually done on the finished coils by the user.

PRIMARY APPLICATIONS

COIL FORMS OF ANY SIZE OR SHAPE

for tuned or untuned RF, IF, oscillator, and other coils used in radio, television, electronic circuits for solenoids, relays, circuit breakers for transformers for permeability tuners

INSULATORS

for selenium rectifiers for electric motors relays

BUSHINGS OR SPACERS

armature shaft spacers for mechanical support

SHIPPING PROTECTORS AND FOR SPECIALIZED PACKAGING

BOBBIN TUBES

BODIES FOR PAINT ROLL APPLICATORS

AS A COMBINATION MATERIAL

with other C-D-F high strength plastics or electrical insulating materials

GRADE SELECTION

C-D-F has mass production facilities for both the manufacture and fabrication of eighteen distinct grades of Spiral Tubing. For example, there's a special punching grade, fine for punching rectangular or square holes near the end of the tube. A relatively soft tube is supplied for difficult stapling or riveting. C-D-F makes high strength automotive electrical bushings from a very hard tubing with high axial compressive strength. Combinations of kraft, chipboard, Diamond "fish paper" Insulation, and other materials are available.

FORMS: ROUND • FORMED • FORMED AND NOTCHED • SQUARE AND RECTANGULAR

THE NAME TO REMEMBER



FOR SPIRAL TUBING

Continental-Diamond Fibre Company

NEWARK 16, DELAWARE

Remember, C-D-F has production know-how, years of experience in electrical insulation. See your C-D-F sales engineer. Write now for new 1953 spiral tubing folder, a workbook showing grades, applications, properties.

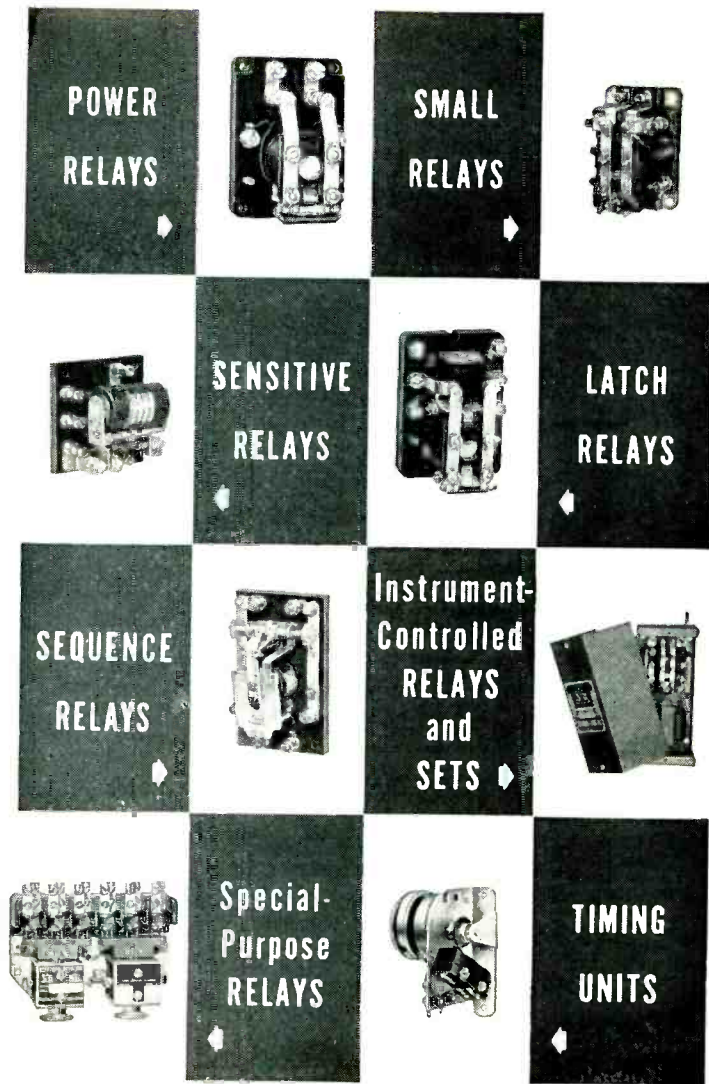

STRUTHERS -DUNN

*Standard relays and timers
match 4 out of 5 requirements*

5,348
RELAY TYPES



STRUTHERS-DUNN, INC., 150 N. 13th St., PHILADELPHIA 7, PA.

BALTIMORE • BOSTON • BUFFALO • CHARLOTTE • CHICAGO • CINCINNATI
CLEVELAND • DALLAS • DETROIT • KANSAS CITY • LOS ANGELES
MINNEAPOLIS • MONTREAL • NEW ORLEANS • NEW YORK • PITTSBURGH
ST. LOUIS • SAN FRANCISCO • SEATTLE • SYRACUSE • TORONTO

made conveniently from the standard 100-ft film capacity of most oscilloscope cameras.

It must be kept in mind that this measurement for a value of flutter is influenced by the pass band of the discriminator, the length of the short sample and the frequency of the recorded tone no valid comparison can be made between flutter measurements unless these variables are held constant. At best, the technique described still entails a fair amount of work and some expensive laboratory equipment. With this in mind, the Air Force Missile Test Center is continuing work to develop an electronic technique for a more direct measurement of the phenomenon called flutter.

The author wishes to acknowledge the contributions of O. E. Hull and T. S. George towards the information contained in this paper.

Single-Frequency Audio Filter

By T. M. DAUPHINEE
*Division of Physics,
National Research Council
Ottawa, Canada*

AN AUDIO FILTER that gives up to 50-db attenuation for a single frequency may be made quite simply from easily obtained components. The basic circuits of several such filters are shown in Fig. 1 and 2.

In the circuit of Fig. 1 the incoming signal is impressed across the series combination of parallel resonant circuit and a large value variable resistor. The parallel resonant section is composed of a suitable capacitor C and the primary winding of an audio transformer T with large step-up ratio. One side of the transformer secondary is connected to one terminal of the applied signal. The output of the filter is taken between the other side of the secondary and the other input terminal.

If the frequency of the input signal matches the resonant frequency of the tuned circuit the signal appearing across the secondary winding of the transformer will differ in phase from the input signal by 180 deg assuming the proper secondary terminals have been se-

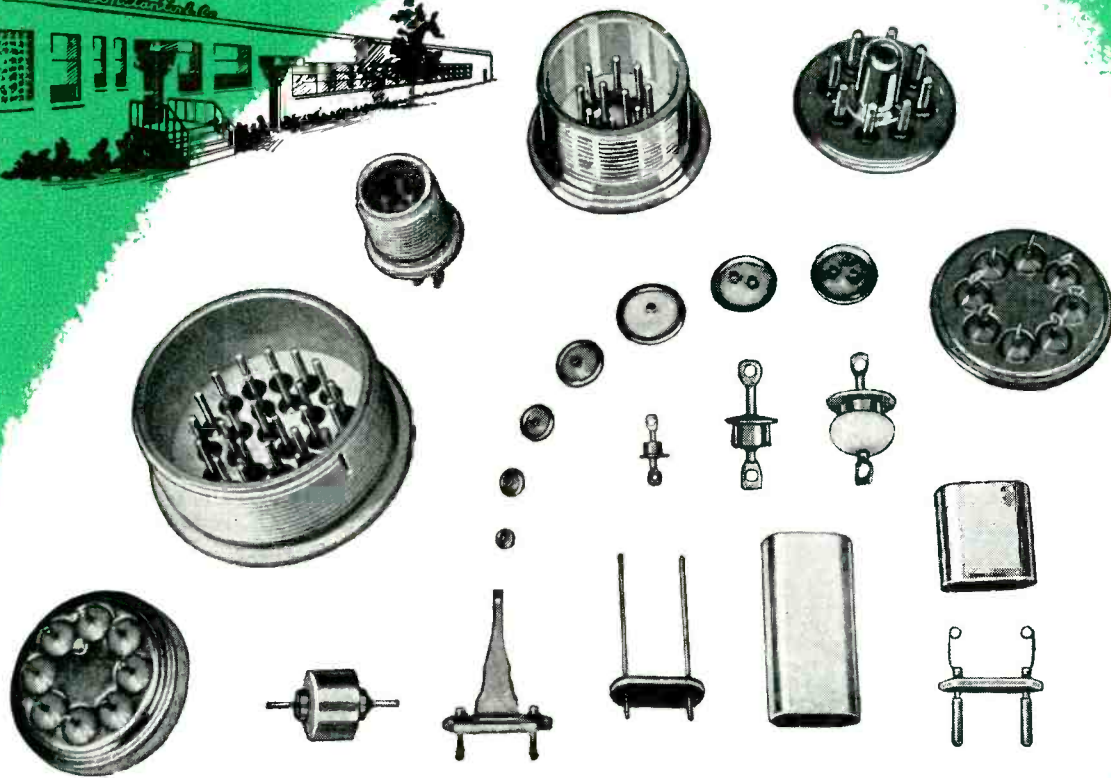

METAL TO GLASS VACUUM SEALS

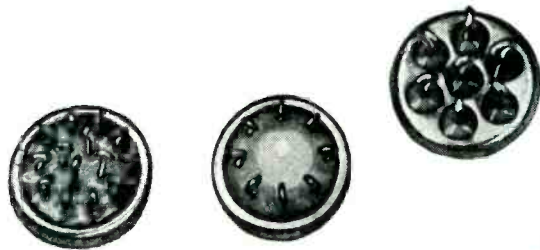

- CRYSTAL HOLDERS
- MULTI-PIN HEADERS
- SINGLE TERMINALS
- SINGLE END SEALS
- MULTI-PIN CON PLUGS
- VACUUM COATING EQUIPMENT

L.L. Constantin & Co.

MANUFACTURING ENGINEERS • LODI, NEW JERSEY • PRESCOTT 7-0223



SEE US AT OUR BOOTH, 4-422, FOURTH FLOOR, IRE SHOW, GRAND CENTRAL PALACE

Precision ATTENUATION to 3000 mc!

- VSWR less than 1.2 at all frequencies to 3000 mc.
- **TURRET ATTENUATOR** featuring "Pull - Turn - Push" action with 0, 10, 20, 30, 40, 50 DB steps.
- Accuracy $\pm .5$ DB, no correction charts necessary.
- 50 ohm coaxial circuit. Type N Connectors.

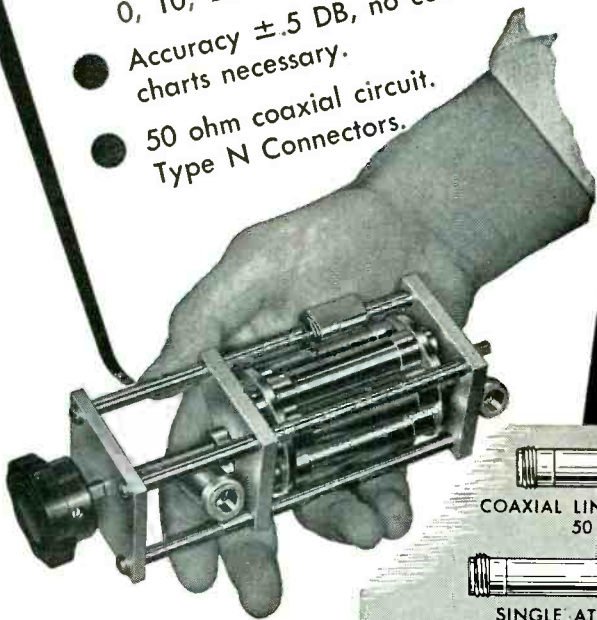

COAXIAL LINE TERMINATION
50 ohms

SINGLE ATTENUATOR PAD
50 ohms

VSWR ± 1.2 to 3000 mc.
One watt c.w. power dissipation

Inquiries are invited concerning single pads and turrets having other characteristics

STODDART AIRCRAFT RADIO CO.
6644-A SANTA MONICA BLVD., HOLLYWOOD 38, CALIFORNIA
Hillside 9294

from Accelerometers to Yokes

you'll find the correct answer to who makes everything in the entire field of electronics including... components equipment and materials

in the... electronics BUYERS' GUIDE

Get in the habit of looking it up in...

the electronics BUYERS' GUIDE

"The Book that has all the answers"

A MCGRAW-HILL PUBLICATION
330 West 42nd Street
NEW YORK 36, N. Y.

MITCHELL-RAND

CLASS H INSULATION

It takes Class "H" insulation to withstand the relentless severity of extreme operating conditions . . . physical, chemical, dielectric, very high or very low temperatures . . . to remove the danger of breakdown under overload . . . to minimize fire hazards . . . to permit the design of longer life electrical components and equipment of minimum weight and size, without sacrifice of rated output.

You can depend upon MITCHELL-RAND for a full line of Class "H" insulation to meet every extremely severe electrical insulation requirement.

MITCHELL-RAND ELECTRICAL INSULATION HEADQUARTERS • MITCHELL-RAND ELECTRICAL INSULATION HEADQUARTERS

- ★ SILICONE VARNISHED FIBERGLAS CLOTHS, TAPES, TUBINGS, SLEEVINGS
- ★ SILICONE SATURATED OR COATED ASBESTOS SHEETS
- ★ SILICONE COATED NOVABESTOS SHEETS
- ★ SILICONE RUBBER COATED FIBERGLAS SHEETS
- ★ SILICONE GLASS MICA
- ★ SILASTIC RUBBER COATED FIBERGLAS TAPE
- ★ TEFLON COATED FIBERGLAS SHEETS

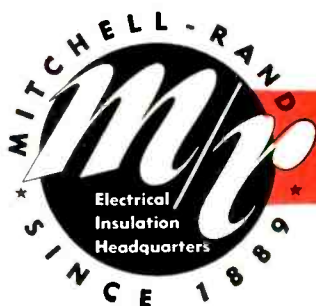
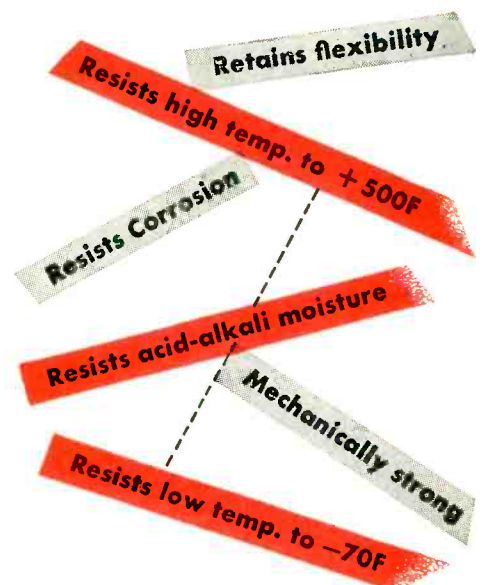

Write to MITCHELL-RAND for free samples and descriptive data.

MITCHELL-RAND INSULATION COMPANY, INC.

51 MURRAY STREET

COrtlandt 7-9264

NEW YORK 7, N. Y.

A PARTIAL LIST OF M-R PRODUCTS: FIBERGLAS VARNISHED TUBING, TAPE AND CLOTH • INSULATING PAPERS AND TWINES • CABLE FILLING AND POTHEAD COMPOUNDS • FRICTION TAPE AND SPLICE • TRANSFORMER COMPOUNDS • FIBERGLAS SATURATED SLEEVING • ASBESTOS SLEEVING AND TAPE • VARNISHED CAMBRIC CLOTH AND TAPE • MICA PLATE, TAPE, PAPER, CLOTH, TUBING • FIBERGLAS BRAIDED SLEEVING • COTTON TAPES, WEBBINGS AND SLEEVINGS • IMPREGNATED VARNISH TUBING • INSULATING VARNISHES OF ALL TYPES • EXTRUDED PLASTIC TUBING

All this performance

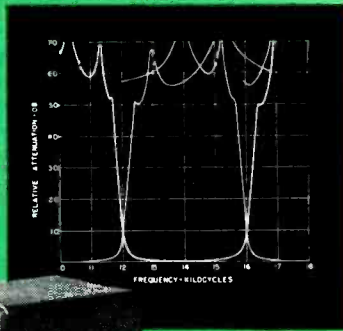

and miniaturization too!

By the use of 18 Lenkurt precision-wound wedding-ring toroids, the two bandpass filters shown at right were redesigned into a single hermetically-sealed plug-in unit, as shown at left. Volume was reduced from 179 cu in. to 36 cu in., a factor of 5 to 1. But, at the same time, performance was actually improved!

Whenever your military or commercial designs call for maximum filter or toroidal-coil reliability under adverse service conditions, and where exacting electrical performance must be maintained, bring your problems to Lenkurt. The Lenkurt engineering group has a rich background of experience from which to offer valuable suggestions in the matter of setting practical specifications to attain the utmost from materials, components and techniques.

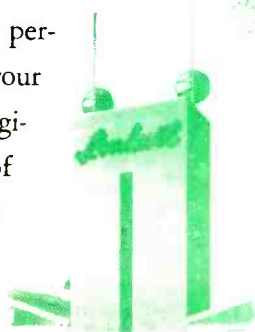

products of
Lenkurt Electric Company
world's leading
independent manufacturer
of toll-transmission
equipment

LENKURT ELECTRIC SALES CO.
SAN CARLOS 1 CALIFORNIA

Lenkurt

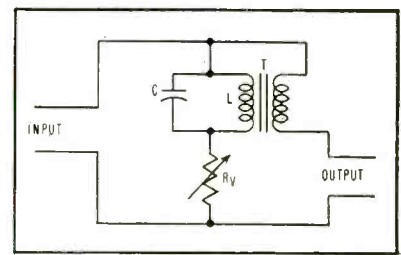

FIG. 1—Single-frequency audio filter giving up to 50-db attenuation

lected, while the amplitude will be at a maximum. By a proper adjustment of resistance R_v , the magnitudes of the input and secondary voltages may then be made exactly equal and under these circumstances the net output signal is zero. Any change of input frequency away from resonance shifts the phase of the secondary voltage and a zero signal is no longer possible.

A very slight deviation from exact phase opposition results in appreciable output signal and the effect is enhanced by rapid phase shift near resonance.

The circuits of Fig. 2 show alternative methods of obtaining a similar kind of filtering action. These circuits have slightly different characteristics but operate quite satisfactorily.

In the case of low-Q circuits the maximum amplitude of the secondary voltage does not occur exactly where the phase shift is 180 deg. However, the rate of change of phase angle at this frequency is still relatively large and the only effect is a broadening of the attenuation peak, without limiting the ultimate attenuation that can be obtained.

Filters of this type have some very useful characteristics. The components are few in number, cheap, and easily obtained. Simple iron cores are sufficient for input signal levels below a few tenths of a volt and the cheaper audio transformers frequently work better than expensive ones. Very large relative attenuations can be obtained for the filter frequency, 40 db relative attenuation over less than one octave on either side being readily obtained.

Attenuations up to 70 db have been achieved, but under these circumstances extremely sharp tuning is required and the overall

Here's a completely new rotary exhaust machine for higher speeds, higher vacuums

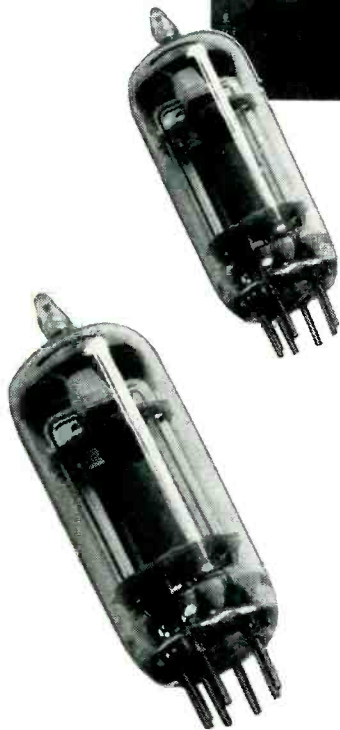
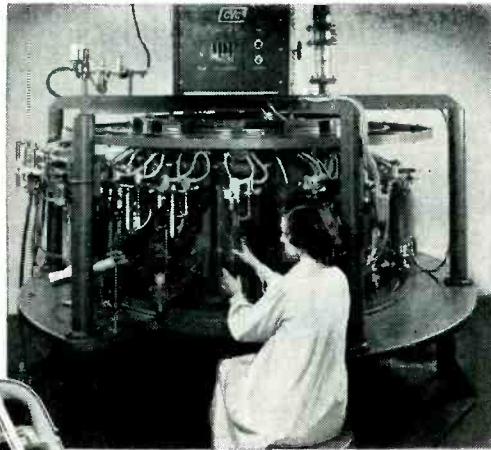

On a *continuous, non-indexing basis*, CVC's new rotary exhaust machine provides automatic base sealing, tube exhaust, and final tip-off at *rates 25 to 30% above normal*. And it produces a *pressure of 1 micron or lower* at each tube port as compared with the usual 10 to 100 microns.

Designed for miniature electronic tubes, this new machine can be converted for use on larger or smaller tubes if necessary. *An indexing feature is easily added* if required for such an operation as precise forming.

To reduce down time and maintenance to a minimum, each of the 16 pumping units is a readily removable package containing mechanical pump, diffusion pump, cycling valve and tube port—the entire head can be removed and replaced in a matter of minutes. *One electric motor operates all the mechanical pumps*, another drives the turret.

A simpler version of the machine is now being employed to pump vacuum bottles and can be adapted to other continuous vacuum pumping and sealing tasks.

To find out more about how this new exhaust machine can speed tube production, reduce costs and improve tube quality, write to **Consolidated Vacuum Corporation, Rochester 3, N. Y.** (A subsidiary of Consolidated Engineering Corporation, Pasadena, Calif.) Sales offices: Menlo Park, Calif. • Chicago, Ill. • Camden, N. J. • New York, N. Y.



Consolidated Vacuum Corporation
Rochester 3, N. Y.
high vacuum research and engineering

SEE OUR EXHIBIT AT THE I. R. E. SHOW • MARCH 23-26 • BOOTH 2-408 & 409



We're sorry, but we think it's only fair to tell possible new customers our Standing Room Only sign must be changed to Sold Right Out!

The design and production facilities of our microwave department are now taken over by the increasing requirements of our present customers. Because of our responsibility to them, this situation may continue quite a while.

We are sorry to say this because we enjoy making new friends. But we feel that we should tell those who might be interested in our engineering and manufacturing facilities, that for some time we may not be able to serve them.

Any change in the situation will be announced in this publication.

WHEN you need a quick answer to **WHO MAKES IT...**

Just look it up in the electronics
BUYERS' GUIDE

There are ...

23,367 ANSWERS

to

1,445 PROBLEMS

covering every ...

**COMPONENT
EQUIPMENT
and MATERIAL**

*used in every phase
of electronics*

**GET IN THE HABIT OF
LOOKING IT UP IN**

the

**electronics
BUYERS' GUIDE**

A MCGRAW-HILL PUBLICATION
330 West 42nd Street
NEW YORK 36, N. Y.



L. H. TERPENING COMPANY

DESIGN • RESEARCH • PRODUCTION

Microwave Transmission Lines and Associated Components

16 West 61st St. • New York 23, N. Y. • Circle 6-4760

Do you have any of these problems?

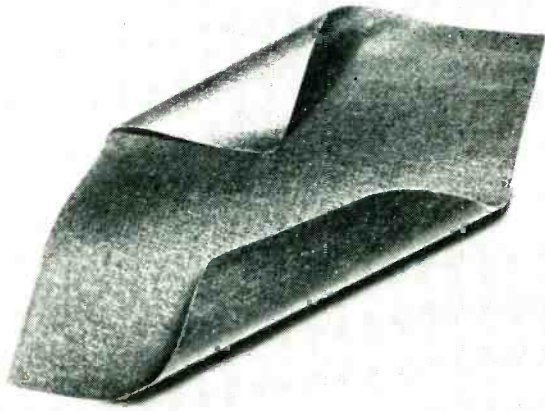

1. Looking for a thin, flexible insulating material that will not break down under extremely high temperatures? ISOMICA* Flexible Plate, Class B and Class H, built-up from continuous mica sheets, gives superior electrical and thermal insulation for coil wrappings and similar applications.

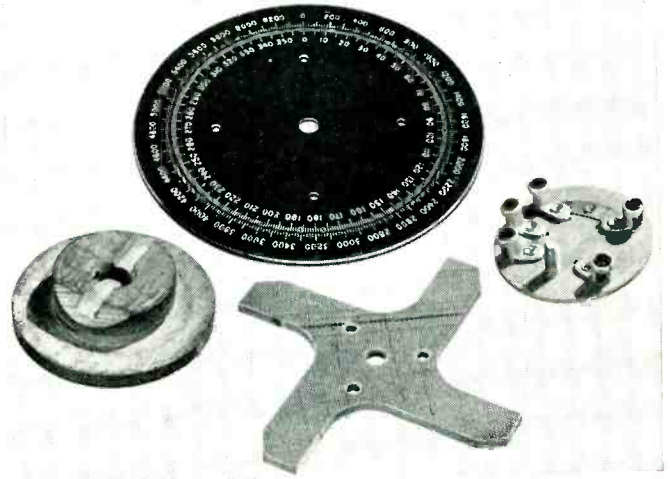

2. Need a material with special mechanical, thermal and insulating properties? LAMICOID®—a laminated plastic made with various fillers—gives you the properties you need for antenna parts, coil forms, tube sockets, switch gear and relay parts, panels, motor and transformer parts, and dozens of other uses.

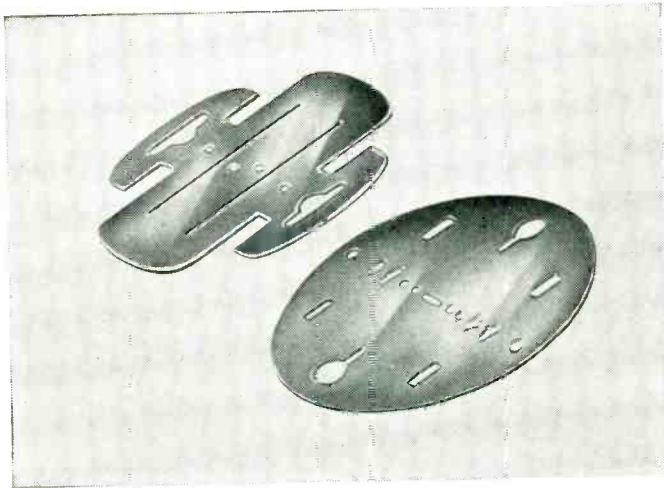

3. Need accurately punched mica stampings for filament, grid and plate supports? MICO produces mica stampings to extremely fine tolerances. Whenever you need precision-fabricated mica of the highest quality, call on MICO. We have 60 years of experience in this field.

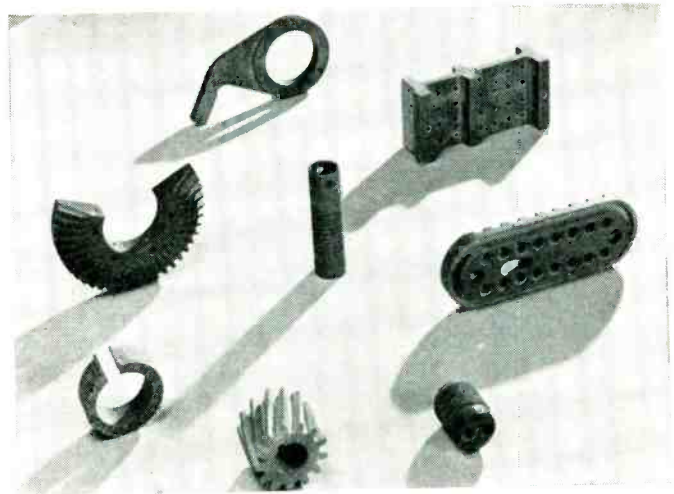

4. Looking for precision-made fabricated parts? Let us solve your problems with parts fabricated from LAMICOID®—a thermo-setting plastic—strong as metal, lighter than wood. We are fully equipped with the latest machinery and can provide you with the best possible service.

Whatever electrical insulation material you need—Class A to Class H—MICO makes it best. We manufacture it, cut it to size, or fabricate it to your specification. Send us your blueprints or problems today.

*Trade-mark



MICA *Insulator* **COMPANY**

Schenectady 1, New York

Offices in Principal Cities

LAMICOID® (Laminated Plastic) • MICANITE® (Built-up Mica) • EMPIRE® (Varnished Fabrics and Paper) • FABRICATED MICA • ISOMICA*

HOW TO SQUEEZE PENNIES OUT OF UPSET SPECIALS COSTS

Specially designed upset products are solving thousands of problems. Dozens of design pointers on them are yours for the asking. Send us your sketches, prints, finished products for suggestions.

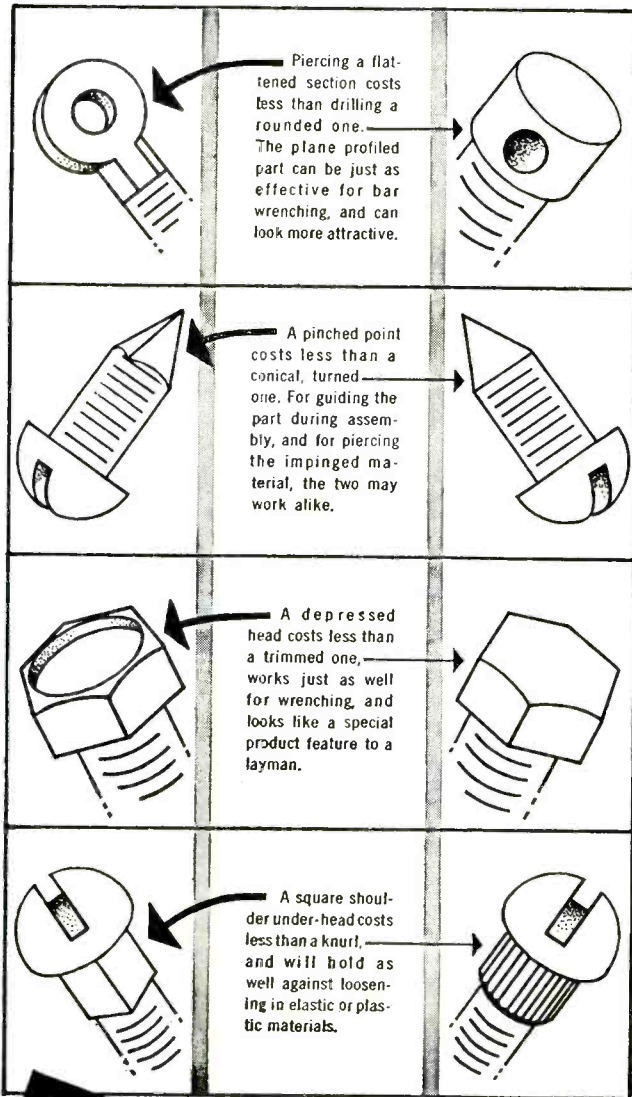

REPRINTS

of this chart are available on request for use in drafting and purchasing departments.



MACHINE SCREWS AND SPECIAL FASTENERS ARE OUR BUSINESS



WRITE FOR OUR CATALOG

**THE PROGRESSIVE
MANUFACTURING COMPANY**

50 NORWOOD ST., TORRINGTON, CONN.

stability is usually not sufficient for long periods unless the temperature is controlled. Input impedance is high, as much as half a megohm in the intermediate audio range. Response is nearly flat outside the attenuation region, the curve approaching a fixed value at frequencies far from resonance rather than tending to infinity or zero as in many conventional filters.

Limitations

The filters have some disadvantages arising mainly from the limitations of transformer design. The filter frequency changes at high signal levels because of changes in incremental permeability of the core material with increasing signal. This effect can be eliminated by use of powdered iron cores, but at some sacrifice of input impedance and availability.

The filter frequency is also slightly temperature sensitive, a change in frequency of about 0.1 percent per deg C with ordinary transformers. High impedance loads (for example, a tube grid) are desirable on the output, so it is not easy to place filters in series, and the frequency range of the transformers may be slightly restricted by the fact that they are operating into unmatched loads. In most cases the body of the transformer is above ground, and at high

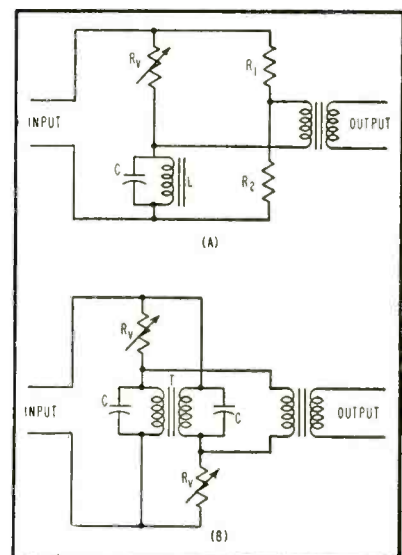

FIG. 2—Two alternate audio filters using a parallel-resonant circuit (A) and a tuned transformer (B) to attenuate a single frequency

CBS-HYTRON TRANSISTORS

CBS-HYTRON PT-2A



ACTUAL SIZE

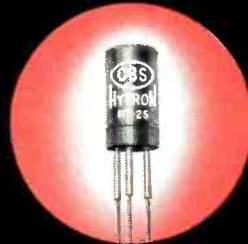

CBS-HYTRON PT-2S

Moisture-resistant

Plug-in or solder-in

Sturdy triangular basing

Polarized base connections

Auto-electronically formed

Thoroughly stabilized

Operate up to 55° C

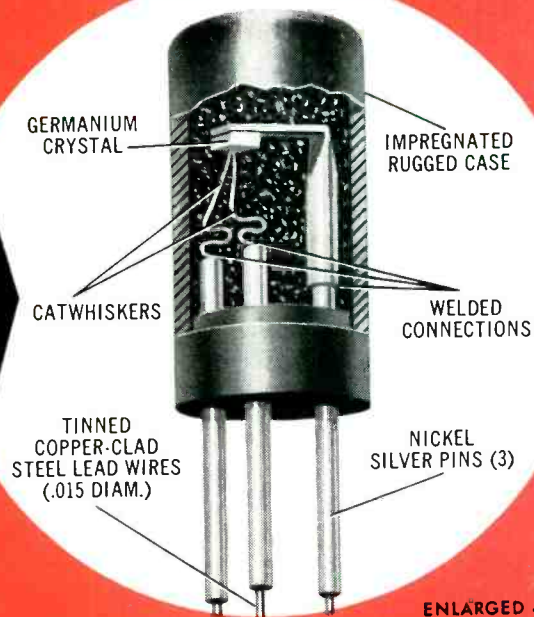

ENLARGED 4 TIMES

MECHANICAL FEATURES

1. Single-ended construction gives maximum mechanical stability.
2. Rugged triangular basing design resists shock and vibration.
3. Dual-purpose connections permit use of flexible leads or stiff plug-in base pins.
4. Direct soldering of germanium wafer to base support guarantees positive contact, avoids flaking.
5. Glass-filled plastic case and high-temperature impregnating wax assure moisture-resistant, trouble-free operation.

BASING AND SOCKET

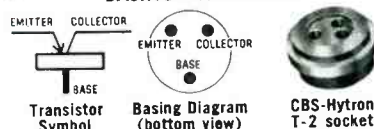

Note similarity of pin layout to that of transistor symbol. CBS-Hytron type T-2 transistor socket features groove to guide pins into socket. Also anti-burn-out design to insure that base connection of transistor will always be made first.

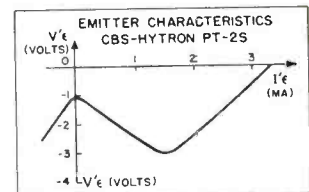
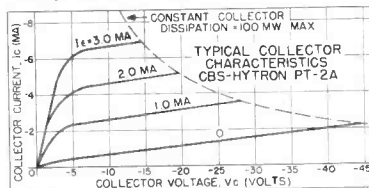
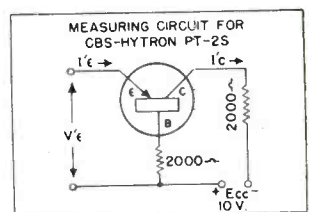

AND YOU CAN BUY THEM NOW!

Already a major producer of germanium diodes, CBS-Hytron now offers you prompt delivery of transistors: Point-contact CBS-Hytron PT-2A (for amplifying) and PT-2S (for switching). Both have stable characteristics and are guaranteed moisture-resistant. Note flexible leads welded to base pins. You may solder flexible leads into circuit. Or snip them to use stiff base pins in CBS-Hytron type T-2 socket.

Triangular arrangement of base pins is stronger . . . avoids bent pins. Easy-to-remember basing layout simulates basing symbol (see diagram). Polarization makes socket connections foolproof. You are assured of uniformly optimum characteristics by electronic control of pulse forming. Thorough aging achieves maximum stability. You may operate these transistors up to 55° C. And you can order both CBS-Hytron PT-2A and PT-2S for immediate delivery.



MANUFACTURERS OF RECEIVING TUBES SINCE 1921
HYTRON RADIO AND ELECTRONICS CO.

A Division of Columbia Broadcasting System, Inc.
Main Office: Danvers, Massachusetts

WRITE FOR DATA. Complete free data on CBS-Hytron PT-2A and PT-2S . . . and the T-2 socket . . . are yours for the asking.

RECEIVING . . . TRANSMITTING . . . SPECIAL-PURPOSE AND TV PICTURE TUBES • GERMANIUM DIODES AND TRANSISTORS



we don't shrink heads...
but we do shrink

Transformers!

If you think Jivaro Indians were experts at shrinking things... (human heads, that is)... look what STANCOR engineers have done with transistor transformers! Recently they designed and are now producing the smallest transformer ever built!

How big is this new transformer? Well, it's just $\frac{1}{4}$ " x $\frac{3}{8}$ " x $\frac{3}{8}$ " and it weighs only 0.07 ounce. Designed especially for transistor applications, this unit is no larger than the transistor it powers.

It is one of a series of transistor transformers, being built by Stancor, for development and commercial applications. If you are planning to use transistors, take advantage of Stancor's knowledge of engineering and manufacturing of ultra-miniature transformers.

STANCOR TRANSISTOR TRANSFORMERS

These stock transistor transformers are available through your Stancor distributor:

TYPE	APPLICATION	PRI. IMP.	SEC. IMP.
UM-110	Interstage	20,000	1,000
UM-111	Output or matching	1,000	60
UM-112	High imp. mic. to emitter	200,000	1,000

Other transistor transformers, built to your special requirements, are available for original equipment production only. Write for Bulletin 462.

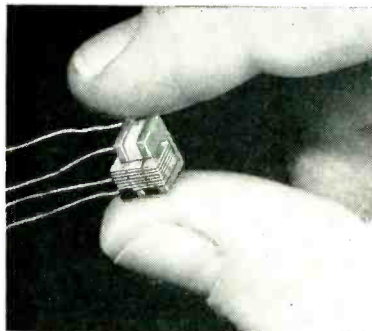

STANCOR TINYTRANS

Miniature, cased audio transformers

Here are four new cataloged high fidelity transformers for use where space is at a premium. These units have a frequency response of ± 1 db, 30-20,000 cps. They are impregnated and sealed in a $\frac{1}{8}$ " square, drawn aluminum can, with $\frac{1}{8}$ " terminals mounted on a phenolic terminal board. Total height is $1\frac{1}{4}$ ".

TYPE	APPLICATION	PRI. IMP.	SEC. IMP.
TT-11	Mic., pickup or line to single grid.	50, 200/250, 500/600	50,000
TT-12	Mic., pickup or line to push-pull grids.	50, 200/250, 500, 600	50,000
TT-13	Dynamic mic., to single grid.	7.5/30	50,000
TT-14	Single plate to single grid.	15,000	60,000



Ask your Stancor Distributor for Bulletin 463 on Stancor Tinytrans, or write us for your free copy.



STANDARD TRANSFORMER CORPORATION

3578 ELSTON AVENUE • CHICAGO 18, ILLINOIS
 EXPORT SALES: Roburn Agencies, Inc., 39 Warren Street, New York 7, N. Y.

the annual electronics BUYERS' GUIDE

is the electronic engineer's

BREADBOARD WHO'S WHO

for

quick, accurate
 answers to any
 questions about

**COMPONENTS
 EQUIPMENT
 MATERIALS**

used in electronics

*Get in the habit
 of looking it up in...*

the electronics BUYERS' GUIDE

"The Book that has all the answers"

A MCGRAW-HILL PUBLICATION
 330 West 42nd Street
 NEW YORK 36, N. Y.

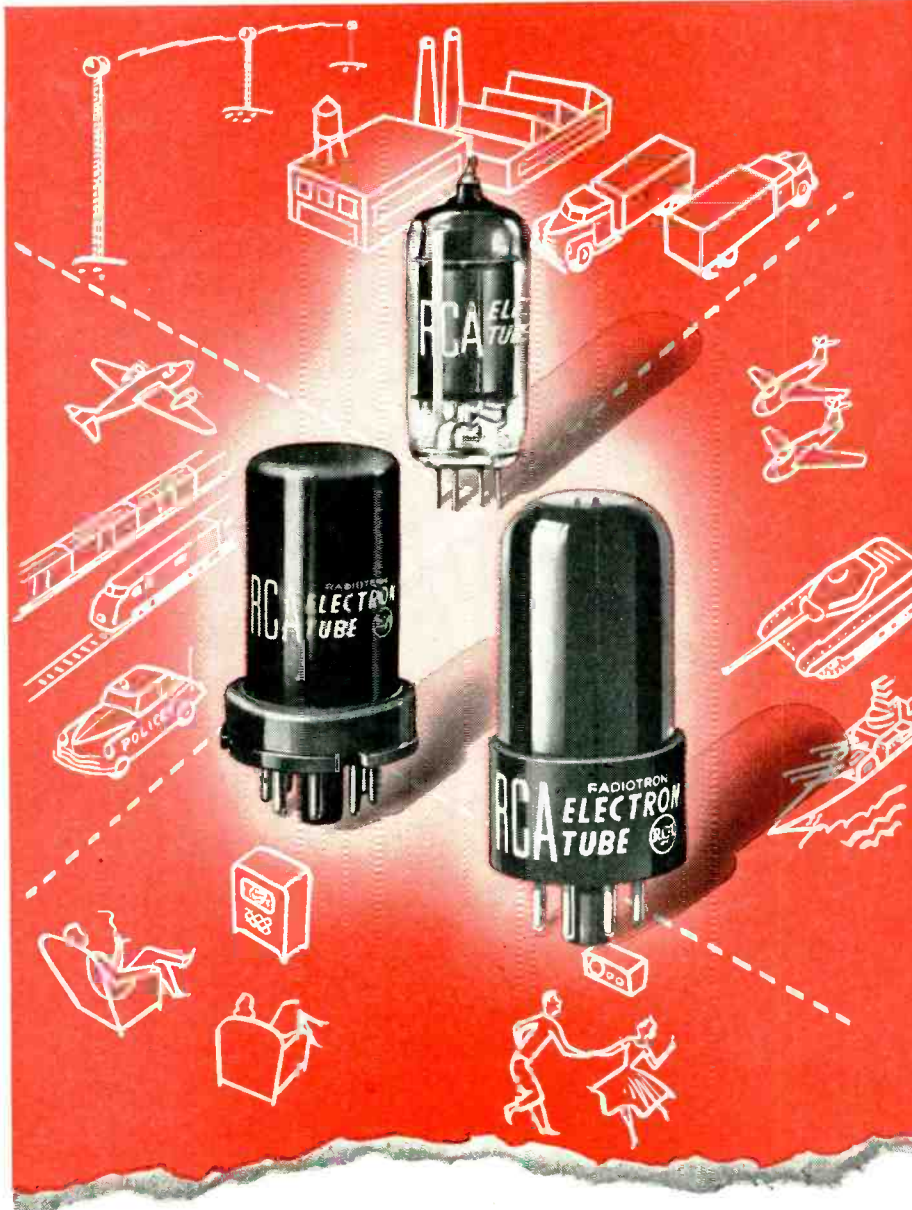

Why you can expect plus performance from standard RCA receiving tubes...in every field

OVER the years RCA has fostered the use of advance design and quality-control techniques in tube manufacture. Since World War II, RCA has stepped up its continuing program for quality improvement. As a result, the *standard* RCA receiving tubes of today often provide the superior performance and reliability usually expected from specialty-designed types of other manufacturers.

In addition to this built-in performance security, standard RCA receiving tubes cover a wide range of types, are inexpensive, and are readily avail-

able both to the equipment designer and the ultimate user.

RCA Application Engineers are ready to consult with you on the adaptation of standard RCA receiving tubes to your equipment designs. For further information write RCA, Commercial Engineering Section 42 CR, Harrison, N. J. . . . or contact the nearest RCA Field Office: (East) Humboldt 5-3900, 415 S. 5th St., Harrison, N. J. (Midwest) Whitehall 4-2900, 589 E. Illinois St., Chicago, Ill. (West) Madison 9-3671, 420 S. San Pedro St., Los Angeles, Calif.

10 reasons why standard RCA receiving tubes offer built-in Performance Security

- ☆ The cathode base metal and the carbonate coatings are individually matched for each tube type to provide superior performance. Both are continuously RCA-engineered for maximum quality control.
- ☆ The specially processed carbonized nickel-coated anodes developed and used by RCA provide 97% of the radiating effectiveness of a true black body as compared with the 68% figure for the older-style carbonized nickel-plated anodes. This increased effectiveness means better life for RCA tubes because the anodes operate at lower temperatures.
- ☆ Lead-glass envelopes at a cost differential of about 10 to 1 compared to lime-glass envelopes are used by RCA for certain capped types which operate at very high voltages. Such use results in much better life performance.
- ☆ Gold-plated grids are used in certain RCA tube types for better control of critical tube characteristics.
- ☆ The RCA-developed "A" frame construction—used in 6 of the popular metal types—gives rigidity to the tube elements and provides increased resistance to vibration, thus reducing microphonics and stabilizing tube characteristics.
- ☆ Strict mica tolerances, tighter than usual in the industry, provide improved stability and freedom from microphonics.
- ☆ Certain RCA tubes incorporate cathode clips and inverted-pinch cathodes to provide improved ability to withstand vibration; as a result there is greater freedom from microphonics. RCA types for battery operation use a filament damper bar to minimize microphonics.
- ☆ RCA not only uses the highest quality mica but also utilizes a higher percentage of sprayed micas than industry in general. These precautions provide greater freedom from leakage noise and other internal leakage effects.
- ☆ Double-helical coil heaters are used in many types to provide more reliable performance and to insure greater freedom from hum.
- ☆ Each RCA receiving tube has been designed to minimize the number of welds. With such designs there are fewer points at which possible failure can develop. As an additional precaution, RCA welding is done on accurately timed unit welders to insure that each weld has maximum strength and uniformity.



RADIO CORPORATION of AMERICA
ELECTRON TUBES
HARRISON, N. J.

WHEELER TRANSFORMER COMPONENTS

now available
in

standard
MIL-T CASE SIZES

Improved can construction induction
solder assembled in rigid compliance
with applicable specifications.

FOSTERITED* UNITS

Wide variety of available brackets
for laminated and Hypersil core as-
semblies.

SPECIAL CONSTRUCTION

Available in the "0" to #3 round can
series with color coded ceramic bead
terminal heads induction solder as-
sembled.

COMMERCIAL

Can we assist you in maintaining your
proportionate level of commercial
business requiring wound coil com-
ponents?

*©Westinghouse
Elec. Mfg. Co.

WHEELER

MAGNET WIRE
COILS
COMMUNICATIONS
EQUIPMENT
TRANSFORMERS

MAKES THESE PRODUCTS A *Specialty*

THE WHEELER INSULATED WIRE COMPANY, INC.

Division of The Sperry Corp. • 1101 EAST AURORA ST., WATERBURY 20, CONN.

IRE SHOW VISITORS
See our special exhibit and
relax at our suite, Hotel
Lexington, opposite Grand
Central Palace.



ELECTRONS AT WORK

(continued)

frequencies the shell may have to be connected to an appropriate point on the circuit and insulated from the chassis.

Some performance curves and data are given in Fig. 3. In many ways these filters have better characteristics than T, π or twin-T filters^{1, 2}, particularly at low frequencies. Better performance could be expected from the use of powder cores.

Since the transformers used are imperfect ones, no attempt has been made to develop a detailed theory of the filter. Some expressions applicable to ideal transformers when the load resistance is effectively infinite are given as a guide in choice of components.

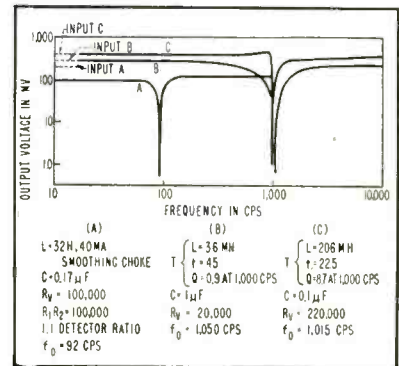

FIG. 3—Attenuation curves obtained with filters using various values of circuit components

The filter frequency $f_0 = \frac{\omega_0}{2\pi}$
is given by

$$\omega_0 L + \frac{R^2}{\omega_0 L} = \frac{1}{\omega_0 C}$$

or

$$\omega_0 L \left(1 + \frac{1}{Q_0^2} \right) = \frac{1}{\omega_0 C}$$

where R is the transformer primary resistance

$$\text{and } Q_0 = \frac{\omega_0 L}{R}$$

$$R_v = \frac{t - 1}{R \omega_0^2 C^2 \left(1 + \frac{1}{Q_0^2} \right)}$$

$$\approx \frac{Q_0^2}{R} (t - 1) \text{ for large } Q$$

where t is the turns ratio of the

for measuring low level potentials— the narrow span *ElectroniK* recorder

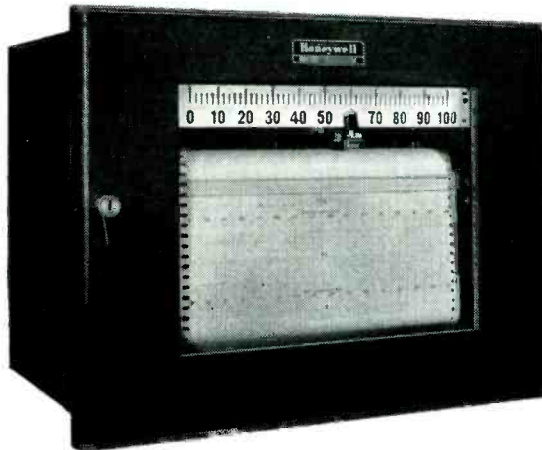

CHARACTERISTICS

Ranges—Recorders: 0-100, 0-200, 0-500 microvolts, 0-1 mv.
Indicators: 0-500 microvolts 0-1.1 mv.

Stability (after warmup)—1 microvolt or less for all ranges.

Accuracy of Adjustment— $\frac{1}{2}\%$ of span.

Dead Zone—0.1 microvolt or 0.006% of span, whichever is greater.

Pen Speeds—24 or 12 seconds full scale travel.

Input Impedance—3000 ohms.

Input Signal Range—(to recorder) approx. 0.05 microvolt to 1 mv.

EXTREMELY low level d-c potentials can be measured accurately . . . recorded to high resolution . . . and automatically controlled, by the self-contained narrow span *ElectroniK* potentiometer.

Ideal for radiation measurements, differential temperatures and a host of other laboratory applications, the instrument responds to signal changes as small as 0.1 microvolt. It spreads spans as low as 100 microvolts across the full width of its 11-inch chart.

Internal design practically eliminates thermal emf's and stray a-c pickup. Available models include the strip chart recorder (illustrated), Precision Indicator, and circular chart pneumatic controller. The instrument incorporates the Brown 40X high gain amplifier, mounted right inside the recorder's case.

This high-gain amplifier is also supplied as a separate unit for use in null detection, servo circuits, or other work where its extreme sensitivity and high stability prove valuable.

MINNEAPOLIS-HONEYWELL REGULATOR Co., *Industrial Division*,
4428 Wayne Ave., Philadelphia 44, Pa.

- **REFERENCE DATA:** Write for Data Sheet No. 10.0-8 on the Narrow Span *ElectroniK* Recorder . . . Data Sheet No. 10.20-4 on the 40X Amplifier . . . and for Bulletin 15-14, "Instruments Accelerate Research."



MINNEAPOLIS
Honeywell
BROWN INSTRUMENTS

First in Controls

For RF interference suppression

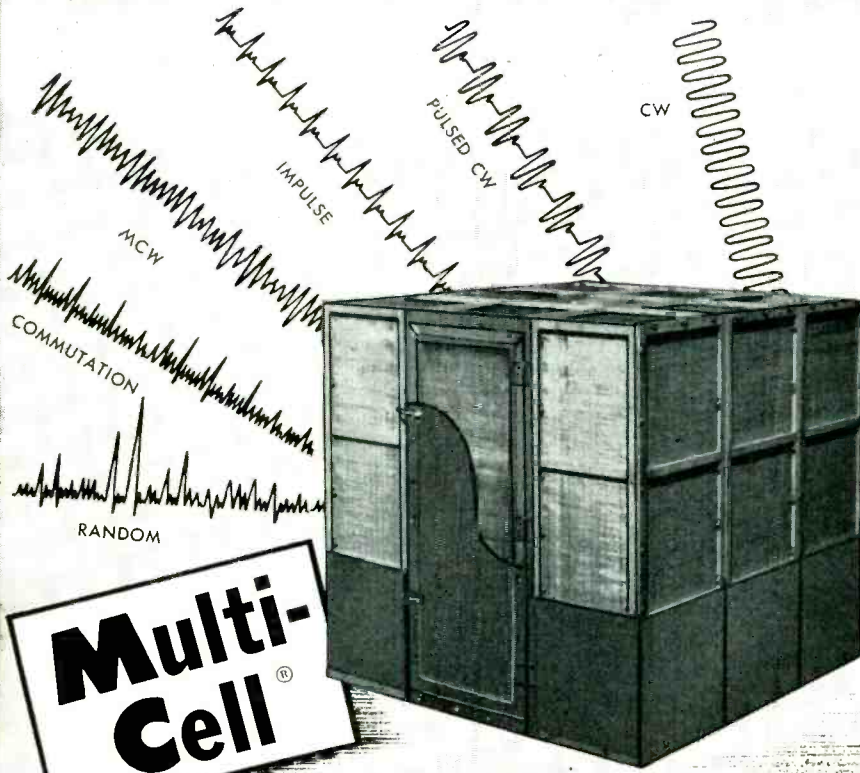

Multi-Cell®

SHIELDING ROOMS

Many Superior and Exclusive Features!

1. HIGHER ATTENUATION min. 100db from .15 to 10,000 MC
2. POSITIVE CONTACT BETWEEN ALL SEAMS
3. DOOR CONTACT STRIPS HEAVILY SILVER PLATED
4. AIR INLET FOR CHOICE OF VENTILATION
5. IMPROVED HANDLES FOR LEAK-PROOF DOORS
6. BUFFER PANELS FOR PROTECTION OF OUTSIDE SCREENS
7. PANELS UNDER CONSTANT PRESSURE WITH EXCLUSIVE BOLTING SYSTEM
8. COPPER FILTER PANEL SUPPLIED WITH LINE FILTER
9. ALL PANEL SECTIONS INTERCHANGEABLE

Designed and built by AMERICA'S MOST EXPERIENCED SHIELDING ROOM ENGINEERS

Backed by years of experience in hundreds of major installations. MULTI-CELL® Screen Rooms meet Jan-1-225, 16E4 (Ships), MIL-I-16910 and all other specifications for electrical and electronic equipment performance in research, development and production.

Let us show you how to SAVE MONEY AND TIME—

Not only is our service exceptionally fast but our price will cut your expenses. We construct every type and size of enclosure: Solid or screen. Double shield, multiple cell. Double shield, isolated cell. Single shield. No obligation for engineering consultation.

Write for
Bulletin
No. 10



If...

YOU CHANGE YOUR ADDRESS

Be sure to notify us at once, so future copies of ELECTRONICS will be delivered promptly.

Also make certain you have advised your local Post Master of your new address so other important mail doesn't go astray.

Both the Post Office and we will thank you for your thoughtfulness. Mail the information below to: Subscription Dept., ELECTRONICS, 330 W. 42nd St., New York 36, N. Y.

New

Name

Address

City..... Zone.... State.....

Company..... Title.....

Old

Name

Address

City..... Zone.... State.....

ELECTRONICS

330 W. 42nd St.
New York 36, N. Y.

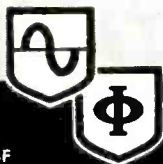

SHIELDING, INC.

R-F
SHIELDING ROOMS

RIVERSIDE PARK, N. J.

Phone: Riverside, N. J. 4-1202

"The Talent to Create—
The Skill to Produce"

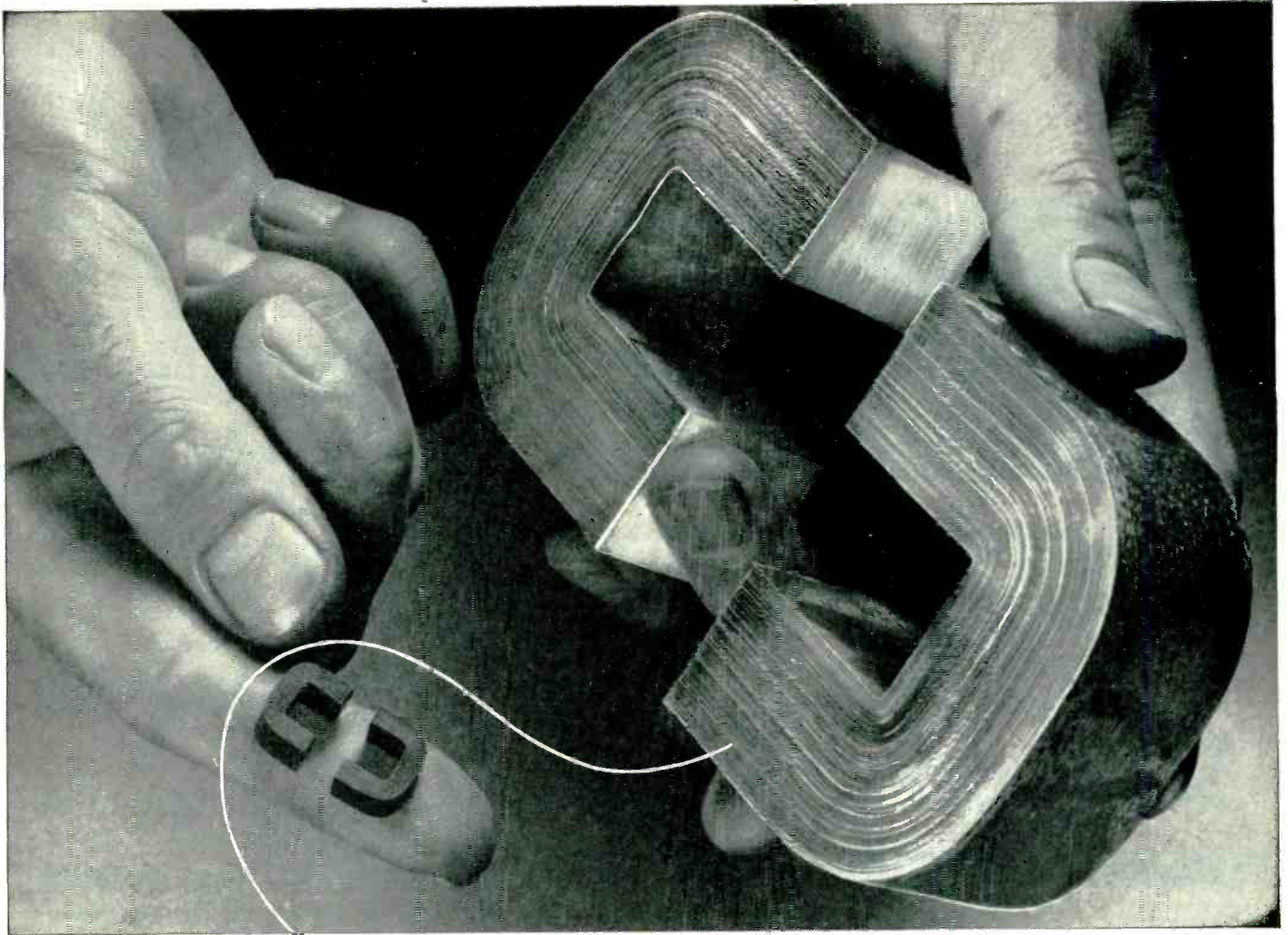

SILECTRON C-CORES... **BIG** or **LITTLE**

...any quantity and any size

*Wound from
precision rolled
oriented silicon
steel strip as thin
as .00025"*

For users operating on government schedules, Arnold is now producing C-Cores wound from 1/4, 1/2, 1, 2, 4 and 12-mil Silectron strip. The ultra-thin oriented silicon steel strip is rolled to exacting tolerances in our own plant on precision cold-reducing equipment of the most modern type. Winding of cores, processing of butt joints, etc. are carefully controlled, assuring the lowest possible core losses, and freedom from short-circuiting of the laminations.

We can offer prompt delivery in production quantities—and size is no object, from a fraction of an ounce to C-Cores of 200 pounds or more. Rigid standard tests—and special electrical tests where required—give you assurance of the highest quality in all gauges. ● *Your inquiries are invited.*

THE ARNOLD ENGINEERING COMPANY

SUBSIDIARY OF ALLEGHENY LUDLUM STEEL CORPORATION

General Office & Plant: Marengo, Illinois

DISTRICT SALES OFFICES

New York: Empire State Bldg. Los Angeles: 3450 Wilshire Blvd.



W&D 4363

small

OPEN GEAR TRAINS made to your specifications

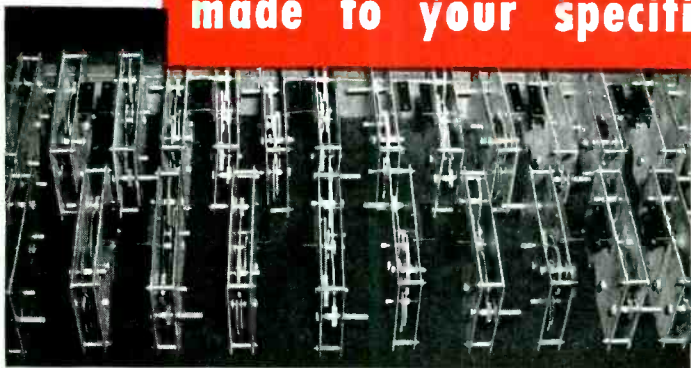

Many units, such as timers, transmitters, vending mechanisms, and similar devices require the adoption of small open gear trains for intermittent duty. Beaver Gear Works is equipped to make these trains to any degree of accuracy required. Beaver Gear engineers, knowing what is expected, and qualified to assist in details of fine-pitch gear applications, can advise you as to what will work best under various conditions and can specify the correct design.

THE *Finest*



IN GEARS

Beaver Gear Works Inc.

1021 PARMELE STREET, ROCKFORD, ILLINOIS

GERMANIUM DIODE TEST SET



VISIT OUR
BOOTH
4-901

**Accurate
LAB MEASUREMENTS**

**Rapid
INSPECTION TESTING**



MODEL
DT-100

- Pre-set regulated reverse voltages
- -10, -50, -100, 0-150 volts at 5 ma
- Forward current to 500 ma at 1.0 volt
- Controls interlocked for routine tests
- Reversed or shorted diode indication
- Test fixture allows quick connections
- Provision for accessory diode heater



TELETRONICS LABORATORY INC.
WESTBURY, L. I., N. Y.

MANUFACTURERS OF ELECTRONIC INSTRUMENTS AND PRODUCTION TEST EQUIPMENT

transformer

$$\text{Gain} = \left| \frac{E_o}{E_i} \right| = \frac{\omega^2 LC}{R} \left(\omega L + \frac{R^2}{\omega L} - \frac{1}{\omega C} \right)$$

$\omega^2 LC \approx 1$ near resonance

The variation of gain (G) with frequency near the frequency f_o

is

$$\frac{dG}{df} = \frac{4\pi L}{R}$$

The phase shift near resonance is approximately 90 deg and the sign reverses on passing through the minimum.

The effect of variation of resistance R_v at resonance is given

by

$$\frac{dG}{dR_v} = \frac{1}{R_v} \left(\frac{t-1}{t} \right)$$

For 40 db attenuation R_v must be adjusted to 1 percent.

REFERENCES

- (1) F. E. Terman, *Radio Engineers Handbook*, Section 3, McGraw-Hill, 1943.
- (2) W. N. Tuttle, *Proc. IRE* 28, p 23, 1940.

Storage of Magnetic Recording Tape

RECOMMENDATIONS by the Minnesota Mining and Manufacturing Co. concerning the storage of magnetic recording tape includes the following points:

Tape should not be stored unboxed because of danger of physical damage and dust contamination.

Tape reels should be loosely wound and stored on edge. Stacking should be avoided because plastic reels may be distorted and tape edges damaged.

Ideal relative humidity conditions for tape storage are between 40 and 60 percent. If humidity variation is large the tape should be kept in sealed containers. Use of desiccants or humidifying agents is not recommended because of difficulty in controlling results.

Avoid exposing tape to temperature extremes. If tape is subjected to extreme temperatures allow it to return to room temperature before using.

Occasional use of tape improves storage characteristics as use on a machine relieves strains and adhesions.

Excessive tension should be avoided in rewinding tape as it may become stretched or permanently distorted if wound too tightly.

PANELYTE®

THE STRUCTURAL PLASTIC

See You at
the IRE show
Booths 4-619, 4-621

(For Years a Standard for Radio and TV)

Offers You FULL RANGE of Finest Quality Laminates

This range of Industrial Laminates, with phenolic, melamine and silicone resins, includes insulation for radio, TV and other electronic purposes. Available in sheets, rods, tubes, molded specialties and fabricated parts.



Paper Base Insulation

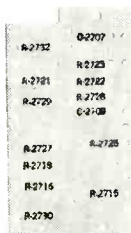

Silicone Fiberglass Insulation

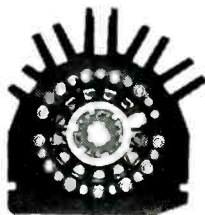

High Insulation Resistance Laminate



Paper Base Tubing

STANDARD GRADES TO GOVERNMENT and INDUSTRY SPECIFICATIONS

SHEET STOCK		
PANELYTE GRADE	NEMA GRADE	GOVERNMENT SPEC.
750	X (PBM)
550	XX	MIL-P-3115B (PBG)
520	XXX	MIL-P-3115B (PBE)
770	P (XP)
772	PC
774	XXP
776	XXXP	MIL-P-3115B (PBE-P)
900	C	MIL-P-15035B (FBM)
910	CE	MIL-P-15035B (FBG)
940	L	MIL-P-15035B (FBI)
950	LE	MIL-P-15035B (FBE)
580	A (PBH)
980	AA (FBH)
115	G8
120	G1, G2
130	G7	MIL-P-997B (GSG)
135	G6
140	G5	MIL-P-15037B (GMG)
170	G3
190	MIL-P-15047B (NPG)
780	MIL-P-3115B (PBE-P)
9101	Navy Spec. 33B4
920	MIL-P-15035B (FBM)

ALL ROD AND TUBE TO SPECIFICATION MIL-P-79B.

PANELYTE can be of service anywhere you have use for Industrial Laminates. Would you like a free sample of Panelyte? Or a free copy of the Panelyte Industrial Catalog? Or a visit from a Panelyte engineer? Or all three? No obligation, of course. Just let us know by sending in the coupon below, now.

OTHER PANELYTE PRODUCTS



ST. REGIS PAPER COMPANY
230 PARK AVENUE • NEW YORK 17, NEW YORK
Offices in Principal Cities

- 1 DECORATIVE, for table-tops, all horizontal work surfaces, wall-covering, etc. in sizes up to 4' x 10'.
- 2 MOLDED LAMINATED PARTS — refrigerator inner-door panels, breaker strips, specially molded items, breaker frames.
- 3 INJECTION MOLDINGS — 32, 48, 60, 200 oz. capacity. Television masks, refrigerator parts, industrial items, etc.
- 4 REINFORCED PLASTICS — sheets, molded specialties.

PANELYTE DIVISION ST. REGIS PAPER COMPANY

230 Park Avenue, New York 17, New York

- Please send me sample of Grade _____ Panelyte.
 Please send Panelyte Industrial Catalog.
 Please have a Panelyte engineer contact me.

Name _____
Firm Name _____
Address _____
City _____ Zone _____ State _____

TRANSFORMERS

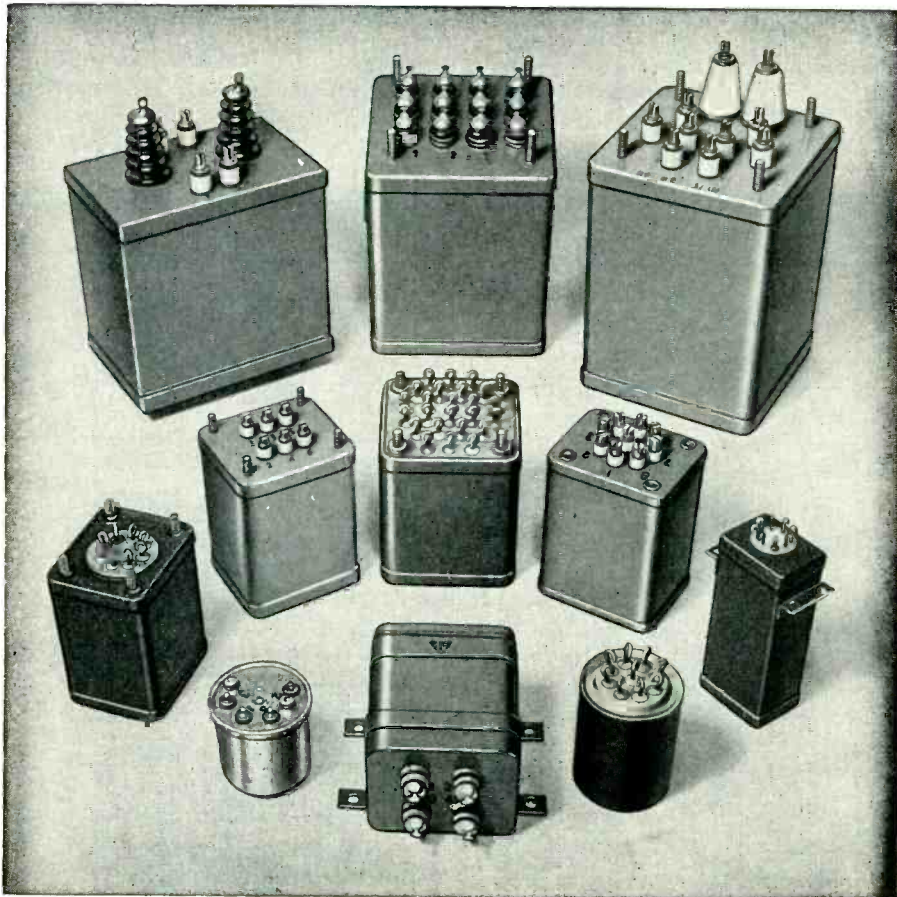

**HERMETICALLY SEALED
TO MIL-T-27 SPECIFICATIONS**

NYT offers a wide variety of transformer types to meet military and civilian specifications, designed and manufactured by specialists in transformer development.

Latest NYT service for customers is a complete test laboratory equipped and approved for on-the-spot MIL-T-27 testing and faster approvals.

**NEW YORK
TRANSFORMER CO., INC.**
ALPHA, NEW JERSEY

from
Accelerometers
to
Yokes

you'll find the
correct answer to
who makes
everything in the
entire field
of electronics
including... components
equipment
and
materials

in the...

**electronics
BUYERS'
GUIDE**

Get in the habit of looking it up in...

the **electronics
BUYERS' GUIDE**

"The Book that has all the answers"

A MCGRAW-HILL PUBLICATION

330 West 42nd Street
NEW YORK 36, N. Y.

"N" SERIES

R.F. CONNECTORS

BY **KINGS**

Shown are a few of the "N" Series R.F. Connectors made by Kings. These low voltage connectors are of constant impedance and come in both weather-proof and non-weather-proof types.

Electronics engineers look to Kings for Connectors. A valued recognition which has been earned by many years of specialized work in this field. When you call on Kings you get the benefit of years of engineering, research and production experience and know-how.

You are invited to write for quotations and delivery dates on all standard and special connectors.



KINGS *Electronics* CO., INC.

40 MARBLEDALE ROAD, TUCKAHOE, N. Y.

IN CANADA: ATLAS RADIO CORP., LTD., TORONTO

Production Techniques

Edited by JOHN MARKUS

Cement-Applying Shortcuts Boost Speaker Production	274	Subassembly Soldering Jigs	294
Lubricant for Powdered Iron Cores	276	Tweezer-Type Soldering Tool	314
Printed Resistor Production Tricks	276	Material-Moving Techniques	316
Modules for Engineers Give Privacy Without Isolation	276	I-F Transformer Jig	320
Capacitance Bridge for Subminiature Tubes	278	Sandpaper Holder	322
Ageing Rack for Bathtub Capacitors	282	Solder Pot Protector	324
Construction of Magnetic Sheet-Steel Separator	286	Vacuum Metallizing Process	324
Screw-Holding Tweezers Made from Hacksaw Blade	290	Wire-Stripping Pliers	328
		Optical Thermometer for Induction Heating	330
		Measuring Small R-F Chokes	334
		TV Alignment Techniques	340
		Checking Torque of Adjusting Screws	342

OTHER DEPARTMENTS featured in this issue:

	Page
Electrons At Work	160
New Products	344
Plants and People	428
New Books	472
Backtalk	492

Cement-Applying Shortcuts Boost Speaker Production

A CEMENT applicator operating much like a washing-machine wringer applies cement uniformly to one side of the loudspeaker cone gasket in about a second in the Cincinnati plant of Crosley Division, Avco Mfg. Corp. The cement-applying roll turns in a pan of Arabol adhesive 34A.

Drive power for the roll is taken from the moving-conveyor belt on the loudspeaker assembly line, by means of a flat pulley that is mounted on the shaft of the roll and is in contact with the belt. The gasket rings are preheated in batches under an infrared lamp to make them pliable before they are put through the applicator, because

previous impregnation with varnish makes them too stiff for the cementing operation.

An entirely different type of fixture is equally fast and efficient in applying thermosetting cement to the speaker basket prior to assembly of the voice coil-cone unit. The cement is applied in two operations, using one fixture for the spider cement and the other for the cement going into position for the outer rim of the diaphragm. Each fixture has cleats for positioning the speaker frame face-down over the cement pot. Each has a cement-applying ring that normally sets down in the pot. When the speaker frame is in position, the operator



Operator demonstrates use of fixture for applying ring of red thermosetting cement to speaker frame for anchoring spider. When she releases lever in right hand, the ring and its strap iron side supports will drop down into the pot to pick up cement for the next speaker

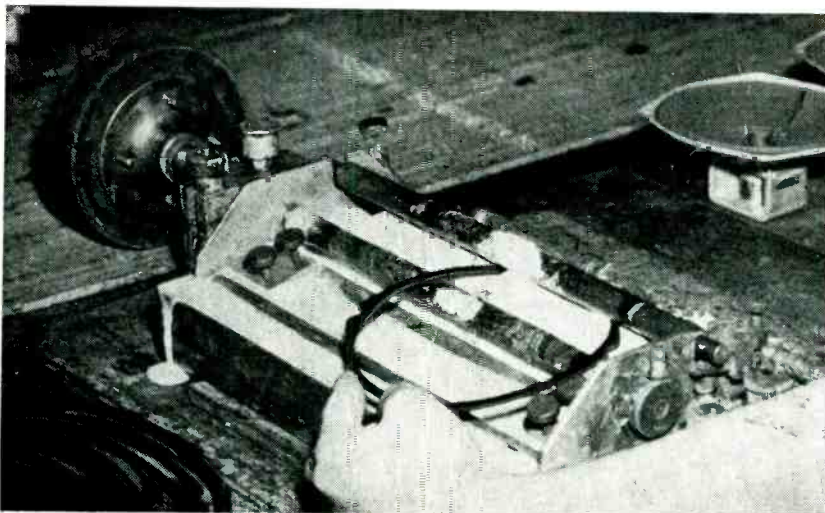

Wringer-type cement applicator driven by friction from assembly-line belt, designed by Crosley for applying cement to speaker gaskets

moves a lever that brings the ring up out of the pot into contact with the speaker frame, thus applying cement to the required frame area.

When both rings of cement have been applied, the voice coil-cone assembly is placed in position. The cement is set afterward in an oven through which the conveyor runs.

Cement is quickly applied to a speaker dust cover with a castelated metal tube. This tube is in-

let 'er go, skip along,
stick with the "K" brand you know

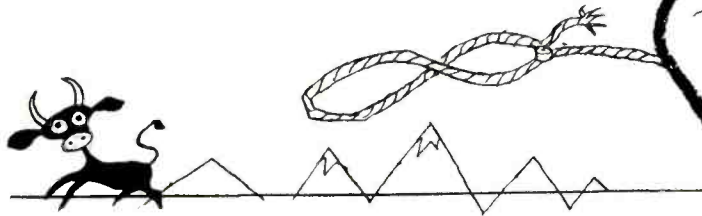

"Maverick" usually spells trouble, on the production line as well as out on the range. Being an unknown quantity or a "Johnny-come-lately," it leaves room for genuine doubt both as to performance and quality. And that's the reason so many experienced buyers — production experts to supervisors — insist on Kester . . . the one "brand" that is synonymous with the best solder and solder products.

Next time, choose one of these famous solder products: "44" Resin, "Resin-Five" and Plastic Rosin — all made only by KESTER . . . Key Name in Flux-Core Solder for More Than 50 Years.

KESTER

S O L D E R C O M P A N Y

4204 WRIGHTWOOD AVENUE, CHICAGO 39, ILLINOIS
NEWARK 5, NEW JERSEY • BRANTFORD, CANADA



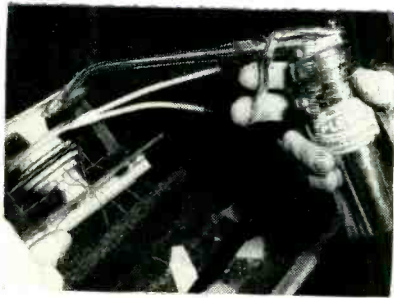

Applying household cement to television transformer with oiler

served in the cement dispenser, dabbed on a sheet of paper on the bench to remove surplus cement, then twisted lightly over the dust cap to apply cement neatly around its circumference.

When spots of cement are to be applied quickly, such as for cementing sponge rubber pieces to a television transformer assembly, the model 965D Plews oiler proved highly satisfactory as an applicator. A variety of cements can be used, including household cement.

Lubricant for Powdered Iron Cores

INSERTION of powdered iron cores in i-f traps and similar components is speeded up in DuMont's plants by using talcum powder as a lubricant. The cores are dusted with the talcum before insertion in the forms. An air gun with a screwdriver bit is then used to turn them in at high speed to approximately the final position.

Printed Resistor Production Tricks

Methods of increasing the yield of printed resistors are suggested in National Bureau of Standards Report NAer 00686, "Printed Circuits".

Inks should be formulated for screens or other printing methods designed in such a way that the resistor goes off tolerance, stays low in value. The resistance value can then be raised as needed by abrasive means to make the assembly come within tolerance.

the nature of the resistor and its more resistance ink

may be added by hand to reduce the value of the resistor.

(3) Circuitry may be designed so that, for example, only a ratio between the values of two resistors is important. Here variations in the resistance ink or in processing techniques would make both resistors high or both low but in most

cases keep the ratio within tolerance limits.

(4) Circuitry may be so engineered that only one or at the most two out of each five or six resistors per stage need be held to close tolerances. This increases the overall yield of completed stages or sections.

Modules for Engineers Give Privacy Without Isolation

COMBINING a modular arrangement of desks with four-foot-high barriers has minimized unnecessary distractions in one electronic engineering section at Convair's San Diego plant while still allowing for easy conference among engineers working on a single large electronic project. The arrangement gave a space saving of about 10 percent over that required for desks without barriers.

Each 7 x 10 foot module has room for two desks, a lock-equipped filing cabinet for classified drawings, and a visitor's chair. The desks are positioned at opposite walls and are staggered so that each occupant has the full between-desk area as push-back space for his chair.

The barriers have a one-foot space off the floor to give better circulation of air. This also permits running telephone and power lines

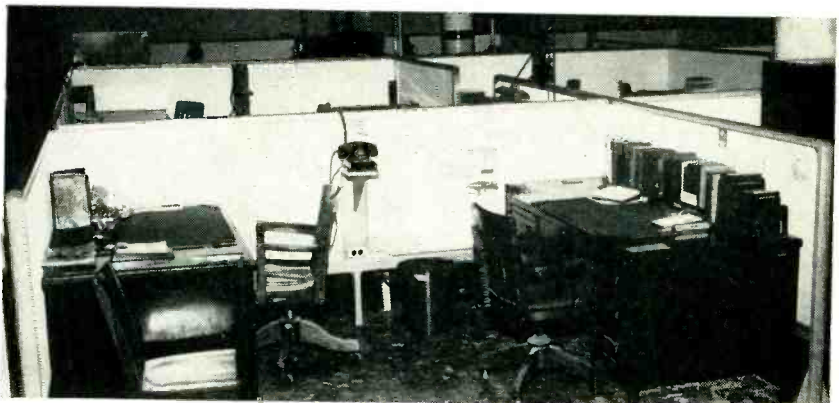

Staggered arrangement of desks within a module. Shared telephone, on shelf between desks, can also be used by engineers on other side of barrier



Portion of Electronics and Missile section, showing modular arrangement of desks for engineers. Filing cabinets contain classified data, hence must have OPEN signs when unlocked

"We had a high voltage—high power RF capacitor problem..."

"My problem was to find a 1000 mmf. capacitor rated 25,000 V at 12 amperes from 500 to 1700 kilocycles. It had to cost less than a mica capacitor, occupy less chassis space and less total volume—without loss of efficiency or reliability.

"I consulted 'CP' and told them what I needed..."

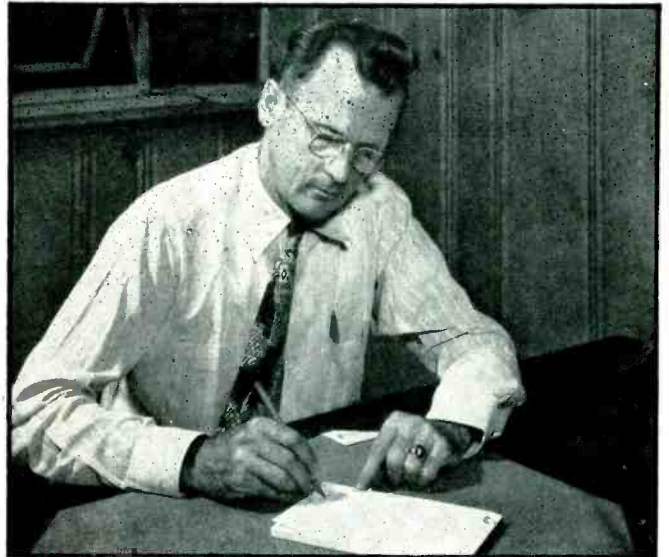

"CPs" engineers came up with this...

LSG 102-25



1 3/8" OD x 8"

"Using design factors similar to 'CPs' standard Plasticon Glassmike (plastic film, glass tube) capacitors rated up to 3500 V, a 1000 mmf. 25 KV Glassmike was constructed. Tests under full power showed a Q of 3000 at 1 megacycle. The temperature rise was 15°C at 12 amps. at 500 Kc. This Plasticon Glassmike, LSG102-25, was substituted for a mica capacitor in a Commercial Broadcast Transmitter. Its cost was approximately 40% of the cost of the mica capacitor. The base dimension of the mica capacitor was 5" x 6 1/2"; the height, 5 3/4". The LSG 102-25 is 1 3/8" OD x 8" long.

"A year and a half later, our LSG102-25's are still in operation."

● **Your engineering problem** will receive the immediate attention of our design and specification engineers.

"CP" is now filling orders for high voltage, high power LSGs in the following ranges: 5,000V, 7,000V, 10,000V, 14,000V, 17,000V, 20,000V, and 30,000V. Sizes range from 1 1/2" to 1 5/8" OD and from 1" to 8" in length. "CPs" Plasticon Glassmike LSGs are more compact, easier to mount, and less expensive.

Condenser Products Company

Division of New Haven Clock & Watch Company



7517 North Clark Street • Chicago 26, Illinois

Manufacturers of: Glassmike Capacitors • Plasticon Capacitors • HiVolt Power Supplies • Pulse Forming Network

Send for catalogue on:

- Glassmikes HiVolt Power Supplies
 Plasticons Pulse Forming Networks

NAME _____ TITLE _____
 FIRM _____
 ADDRESS _____ CITY _____ STATE _____

VECO

THERMISTORS

ANALYSIS CELLS

VECO Analysis Cells utilize VECO THERMISTORS. Analyzing and reference elements are Sealed in Glass—unaffected by corrosive gasses or liquids.

Available with any type of reference gas sealed in, if desired . . . new high-pressure seal withstands 1,000 psi . . . flow pipes easily connected . . .

VECO Analysis Cells provide new efficiency for instrumentation • gas analysis • combustion study — for chemical research, hospital and college laboratories, food storage protection — cells designed and manufactured to your specific requirements.



tiny beads solve problems in Measurement and Control of thermal, electronic and physical energy!

VECO Thermistors are made in the forms of Beads, Rods, Discs, and Washers — Stocked in a wide range of specific resistance values — or can be produced in quantity to your exacting specifications.

Distinguished from other sensing elements by extreme variations of electrical resistance with relatively minute thermal changes—approved and accepted by Government Agencies.

Victory's staff of engineers and physicists are ready to recommend the proper VECO Thermistor for • vacuum manometry • oscillator stabilization • temperature measurement • flow measurement • temperature compensation • surge protection • radar power measurement • volume limiting • gas analysis • temperature control • time delay • voltage regulation, as well as for any other new or unusual measurement or control application. Write today!

Visit Victory at the IRE Show
March 23-26,
Grand Central Palace, New York

Victory

ENGINEERING CORPORATION
Springfield Road, Union, New Jersey
Telephone: UNionville 2-7150

A request on business stationery will bring the
VECO DATA BOOK
Thermistors
Analysis Cells
Combustion Analyzers
Varistors



Arrangement of aisles between modules

along the bottom of the barrier through ordinary messenger loops, facilitating janitor cleaning work. The four-foot height is sufficient to block the view of an engineer while he is bent over his desk, but is low enough so that he can see into adjoining cubicals if he straightens up in his chair. He can thus easily determine whether an engineer a few modules away is available for a quick conference or coffee. Although men vary in height, all are about the same eye level when seated.

The modular arrangement was devised by V. E. Thomson, a supervisor in the Guided Missile Division. Cost of the system of barriers was \$5,400 installed, or about \$35 per person for the 154 engineers accommodated. No special construction or remodeling was necessary.

Capacitance Bridge for Subminiature Tubes

ACCURATE measurement of inter-electrode capacitance of subminiature tubes is expedited through use of a special Sylvania-designed capacitance test adapter. Holes for the eight long, flexible leads of tubes such as the type 5896 duo-diode are sufficiently large to permit easy insertion. The outside of the adapter is then turned to the left, to push contact pins inward in such a way that they make good contact with the leads without appreciably in-

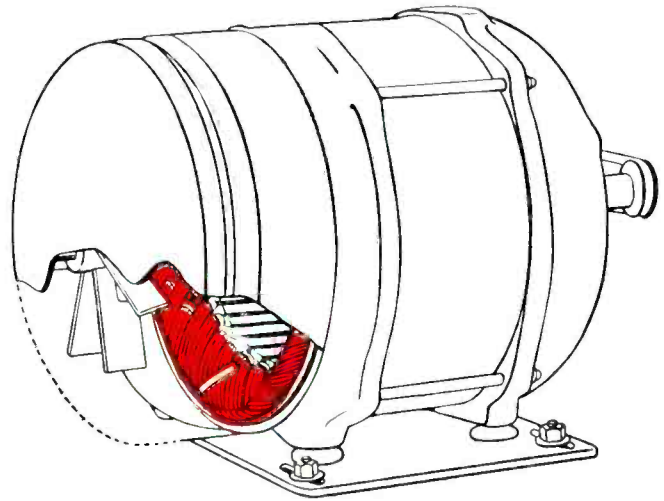
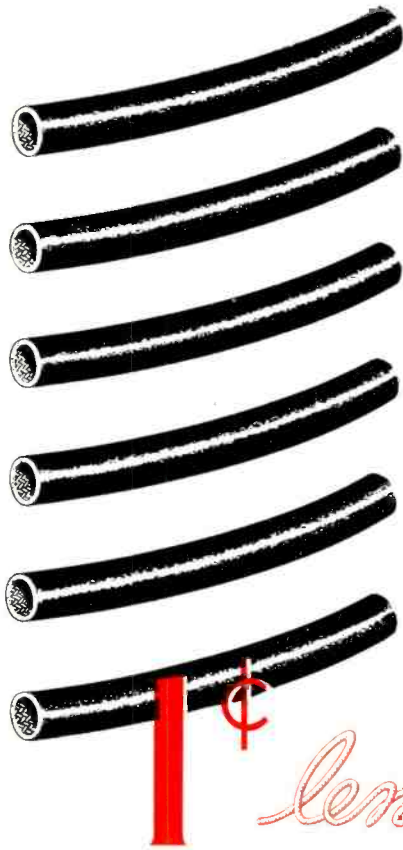

lengths of BH Sleeving STOP \$50 REJECT LOSS

A reject rate of three to seven motors a day was cutting the profits of a motor manufacturer. The varnished tubing insulation on the motor leads cracked when tapped into position. Taken off the assembly line — devanished, re-insulated, reassembled and revarnished — each motor reject meant a \$50 loss.

Then the manufacturer changed to BH "649" . . . a braided, Fiberglas, vinyl coated electrical insulation. It cost approximately 1c for each 2-inch length of BH "649" — and stopped the reject troubles!

More and more manufacturers are turning to BH Fiberglas Tubing and Sleeve-

ing for electrical insulation. It pays off by preventing insulation breakdowns, avoiding costly rejects. Its permanent flexibility prolongs product life.

Whether you're concerned with excessive current loads, vibration, extremes in temperatures, flexibility, fungus resistance, or what . . . let us help you. Send facts on your requirements, voltages and temperatures encountered. We'll make our recommendations and send you production testing samples.

Address Dept. E-3

Bentley, Harris Manufacturing Co.
Conshohocken, Pa.

BH
in use of Fiberglas
in heat-treated
Fiberglas
in true high
temperature
flexibility
in vinyl-coated
Fiberglas
1 ST in silicone
rubber coating
in colors in
silicone rubber
in true Class B
(130°C.)
protection

BH *Fiberglas** SLEEVINGS

*BH Non-Fraying Fiberglas Steevings are made by an exclusive Bentley, Harris process (U. S. Pat. No. 2393530). "Fiberglas" is Reg. TM of Owens-Corning Fiberglas Corp.

**STOP MOISTURE
INFILTRATION**

INSULATE WITH INSL-X

**SPECIALTY
INSULATIONS**

A COATING FOR EVERY APPLICATION

A partial list of INSL-X product groupings is given below: literature and samples gladly furnished on request.

FUNGICIDAL COATINGS that prevent moisture infiltration and effectively inhibit organic attack. All of the coatings are easy to apply, non corrosive, biologically effective, and non toxic to humans. INSL-X fungicidal coatings meet rigid Government specifications.

ARC RESISTING COATINGS that in addition to arc resistance, possess very high dielectric strength, water resistance, and the ability to withstand high intermittent temperature up to 400° F. or prolonged temperature up to 300° F.

COIL COATINGS that are rapid drying, have high dielectric strength and are chemically neutral to fine wire. They are thermally stable, and suitable for long lived applications. Outstanding anti-corona properties are highly desirable for *TELEVISION INSULATION*.

TOOL INSULATION. A tough, high dielectric acid resisting, waterproofing compound designed for the insulating of tools. It may be reinforced and built up to practically any dielectric and mechanical strength by the use of glass, asbestos or fabric sleeving or tape. This method provides a foundation capable of withstanding severe impact and abrasion.

INSULATING VARNISHES. A series of air drying and baking materials designed for various applications.

INSL-X AGENTS

NEW YORK

B. B. Taylor
241 Sunrise Highway
Rockville Centre, N. Y.

Robert P. Kennedy
182 Mayflower Drive
Rochester 18, N. Y.

E. H. Allen
124 Chenango St.
Binghamton, New York

OKLAHOMA
C. B. Anderson
712 Oil Capital Bldg.
Tulsa 3, Oklahoma

CONNECTICUT

R. E. Powell
Box 797
Canaan, Conn.

PENNSYLVANIA
Chas. A. Englert
1516 Grandin Ave.
Pittsburgh 16, Penn.

MICHIGAN

H. C. Sweet Co.
12083 Woodbine Ave.
Detroit 28, Mich.

ILLINOIS

R. A. Stemm
21 East Van Buren St.
Chicago, Ill.

OHIO

John O. Olsen Co.
1456 Waterbury Rd.
Cleveland 7, Ohio

MASSACHUSETTS
Holliday-Hathaway Sales Co.
238 Main Street
Cambridge 42, Mass.

TEXAS

H. W. Zuch
P. O. Box 1191
Austin, Texas

J. E. Rogers
102 Thomas Bldg.
Dallas 1, Texas

THE INSL-X COMPANY • INC.

MANUFACTURING ENGINEERS OF INSULATING, FUNGICIDAL AND PROTECTIVE ELECTRICAL COATINGS
WATER STREET • OSSINING • NEW YORK

the annual electronics BUYERS' GUIDE

is the electronic engineer's

BREADBOARD WHO'S WHO

for

quick, accurate
answers to any
questions about

COMPONENTS EQUIPMENT MATERIALS

used in electronics

*Get in the habit
of looking it up in...*

the electronics BUYERS' GUIDE

"The Book that has all the answers"

A MCGRAW-HILL PUBLICATION
330 West 42nd Street
NEW YORK 36, N. Y.

New X-Band Test Equipment

ADDITIONAL INSTRUMENTS

ADDED TO MICROLINE*

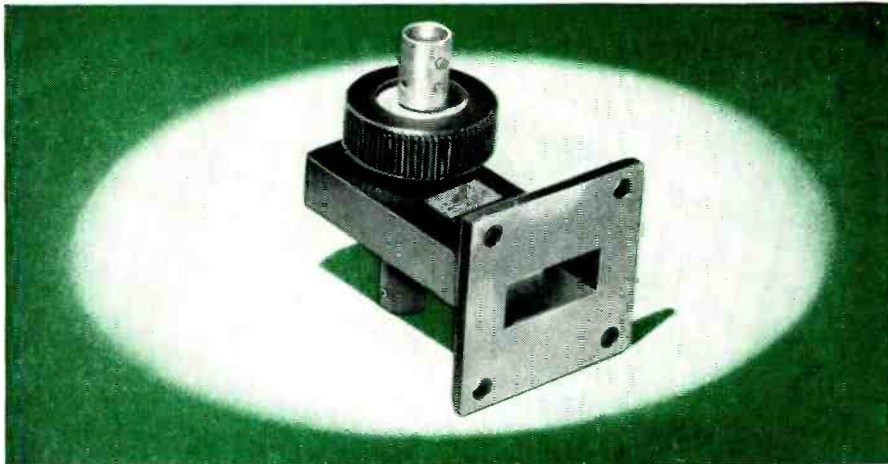

Model 219C Waveguide Thermistor Mount

This instrument is used in conjunction with accessory equipment to measure and monitor microwave power at average power levels as low as 10 microwatts. It is particularly useful in the measurement of pulsed power. This thermistor mount is recommended for use with the Microline Model 123B Wattmeter Bridge.

Frequency Range	8.5—9.6 kmc.
Maximum VSWR	1.5
Operating Resistance	135 ohms
Maximum Power Rating	10 mw.
Waveguide Size	RG-52/U (1" x 1/2")



Model 495 Adjustable Termination

This instrument is specially adapted for use in precise microwave measurements where the quality of excellent impedance matching over a broad band is essential. The design of Model 495 provides for independent control of phase and amplitude of the reflection coefficient of the load. It is particularly useful in applications requiring a termination of minimum power reflection, a movable termination where the reflection from the termination can cause error in measurements, or as a means of matching low standing wave ratios to obtain the smallest possible reflections.

Frequency Range	8.1—12.4 kmc.
VSWR Range	1.005—1.15
Phase Variation	360°
Waveguide Size	RG-52/U (1" x 1/2")
Power Rating	5w.

Our nearest district office will be glad to supply complete information upon request.

*T.M. REG. U.S. PAT. OFF.

OTHER X-BAND
MICROLINE
INSTRUMENTS

MODEL	INSTRUMENT
167A, 486A	Adapter
377	Adjustable Short
173, 174, 183	Attenuator
152A, 134A	Barretter Mount
184	Waveguide Bends
170, 171	Detecting Section
360A	Directional Coupler
234, 235, 236	Frequency Meter
126, 273	Impedance Meter
145	Mixer
379	Waveguide Tee
165A, 166A	Magic Tee
406	Termination
150, 246	Transformer
146, 178	

SPERRY GYROSCOPE COMPANY
DIVISION OF THE SPERRY CORPORATION

VISIT THE SPERRY exhibit at The Radio Engineering Show, Grand Central Palace, March 23-26.

GREAT NECK, NEW YORK • LOS ANGELES • SAN FRANCISCO • SEATTLE • CLEVELAND • NEW ORLEANS • BROOKLYN
IN CANADA • SPERRY GYROSCOPE COMPANY OF CANADA, LIMITED, MONTREAL, QUEBEC

New!

PRECISION RF STEP ATTENUATORS

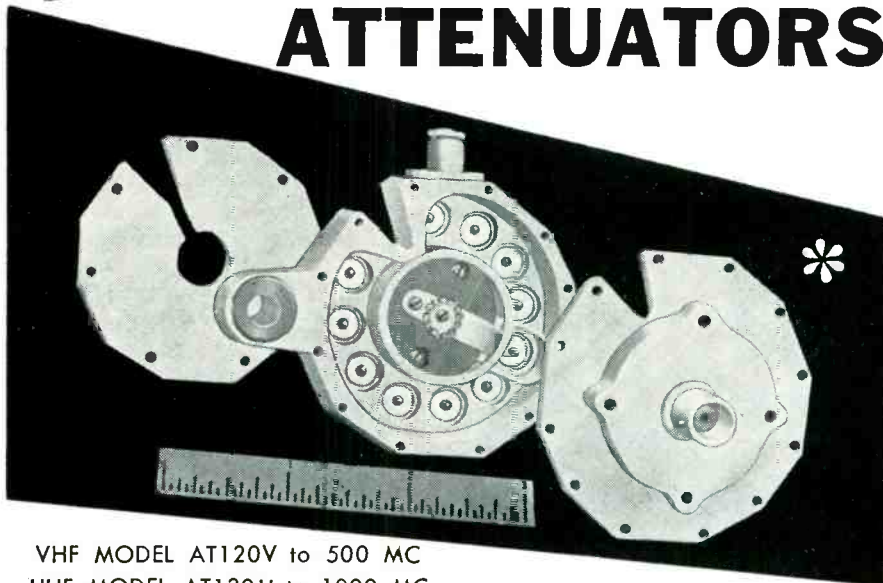

VHF MODEL AT120V to 500 MC
UHF MODEL AT120U to 1000 MC

● Attenuation Values supplied to your specifications:
Up to 20 DB per step Up to 120 DB total Up to 10 Steps (11 positions)

● Frequency range—0-500 MC

● Attenuation accuracy—.3 DB per step

● VSWR—Less than 1.1 to 500 MC

● Input and Output impedance Optional at 50 or 75 OHMS (Unbalanced)

● Power Capacity—100 MW

● Supplied with BNC Jacks or matched cable terminations

● Available with crystal diode voltmeter mount for monitoring input levels at .1 to 2.0 volts

● Dimensions: 2 5/8" diameter—1 1/2" depth

● Weight: 10 ounces

● Suitable for Standard Signal Generators, Precision Microvolters and many specialized test equipment applicators.



Direct drive for use with output cable.

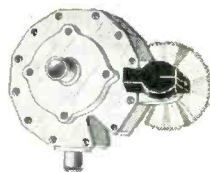

Geared drive output connector accessible through front panel.

Write for detailed performance data depending on the attenuations values desired.

TRAD

Visit TRAD at Booth 4-419
at the I.R.E. Show

TELEVISION CORPORATION

* Pat. Pending 1001 FIRST AVENUE ASBURY PARK, N. J.

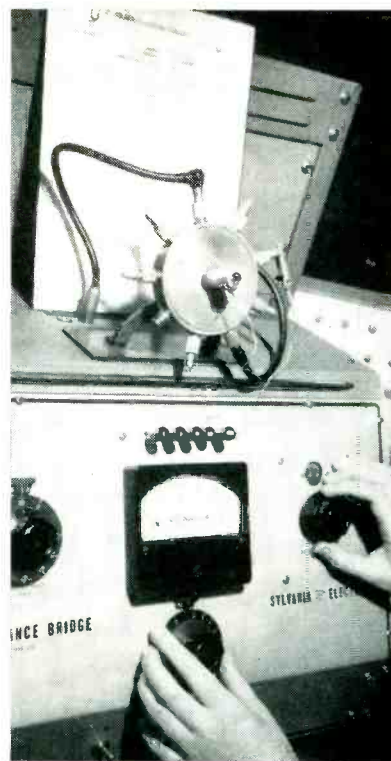

Tube is plugged into holes in center of adapter on top of bridge, and metal shield is pushed over tube as shown, for sampling inspection check of inter-electrode capacitance. Chart behind adapter gives approximate values and bridge connections

creasing the capacitance between leads. The adapter also maintains complete shielding of each lead from all other leads.

In one typical measurement, pins 2, 3, 4, 6 and 7 are grounded and the Sylvania type 125 capacitance bridge is connected to pins 1 and 5 by means of coaxial cable. A typical reading for this setup is 0.012 μ f.

Ageing Rack for Bathtub Capacitors

RUBBER tubing provides spring pressure against the bottoms of metal-encased paper capacitors for forcing their terminals against foil-

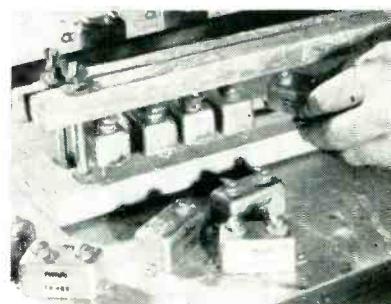

Method of loading ageing rack

E-I AT THE I.R.E. SHOW



A Challenge! SEE THE RESULT
OF TEN YEARS OF

Engineering Leadership

IN PRECISION

HERMETICALLY SEALED TERMINALS

On Display Hundreds of standard types —
MULTIPLE HEADERS, OCTAL PLUG-INS, TERMINALS, COLOR
CODED TERMINALS, END SEALS — for every electronic and elec-
trical application.

An Invitation! A warm welcome awaits you
at BOOTH 2-314, I.R.E. SHOW and SUITE 1010, ROGER SMITH
HOTEL (Just across from Grand Central Palace) BE SURE TO
VISIT BOTH E-I HEADQUARTERS!

TEN YEARS of specialization in the
manufacture of hermetically sealed ter-
minals, including the solution of some of
the most difficult of terminal sealing prob-
lems, is one part of the record of E-I
engineers. The other is the development

of hundreds of economical, standard com-
ponents to provide a fast solution to
unusual circuit requirements at a practical
cost. For full information on the complete
E-I line ask for the E-I File Folder includ-
ing new Bulletin 960.

ELECTRICAL INDUSTRIES

DIVISION OF AMPEREX ELECTRONIC CORP.

44 SUMMER AVENUE, NEWARK 4, NEW JERSEY



*E-I . . . your Headquarters for Hermetically-Sealed Multiple Headers,
Octal Plug-Ins, Terminals, Color Coded Terminals, End Seals, etc.*



VERSATILITY Plus...

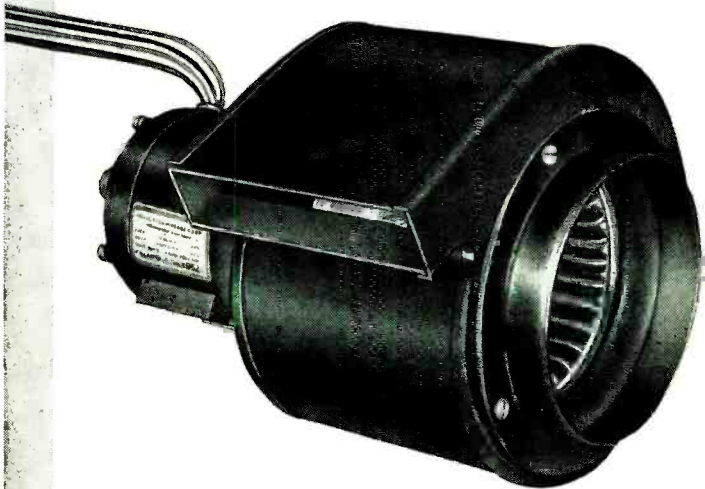

Induction Motors Corp.

WHEN YOU NEED A SUB-FRACTIONAL HORSEPOWER
MOTOR, FAN or BLOWER

OUR NEWEST TYPE...

This 60 cycle single phase blower was custom built to exacting Navy specifications. It is driven by a self-cooled motor for high ambient temperature operation, and is especially impregnated for humid atmosphere. This compact model is designed for such applications as cooling transmitting tubes, cabinets, chassis, amplifier assemblies, and a wide variety of electronic controls.

YOUR REQUIREMENTS

If you need synchronous type or induction type, motors, **IMC** makes them.

LIGHTER — MORE EFFICIENT — COOLER for **LONGER LIFE** under extreme temperatures.

RANGE: 1/1000hp. to 1/10hp. 60 cycle, 400 cycle variable frequency

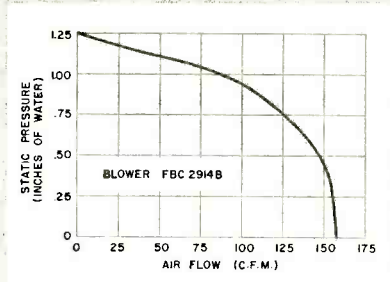

SEND US YOUR PROBLEM

We are leading specialists in the design and production of actuators, gear motors and torque motors for application in automatic devices, electronic controls, radar equipment, timing devices, fire controls, sine wave alternators, aircraft cameras, etc.



INDUCTION MOTORS CORP.
55-15 37th AVENUE • WOODSIDE 77, N. Y.

from

Accelerometers

to

Yokes

you'll find the correct answer to who makes everything in the entire field of electronics including... components equipment and materials

in the...

electronics BUYERS' GUIDE

Get in the habit of looking it up in...

the **electronics BUYERS' GUIDE**

"The Book that has all the answers"

A MCGRAW-HILL PUBLICATION
330 West 42nd Street
NEW YORK 36, N. Y.

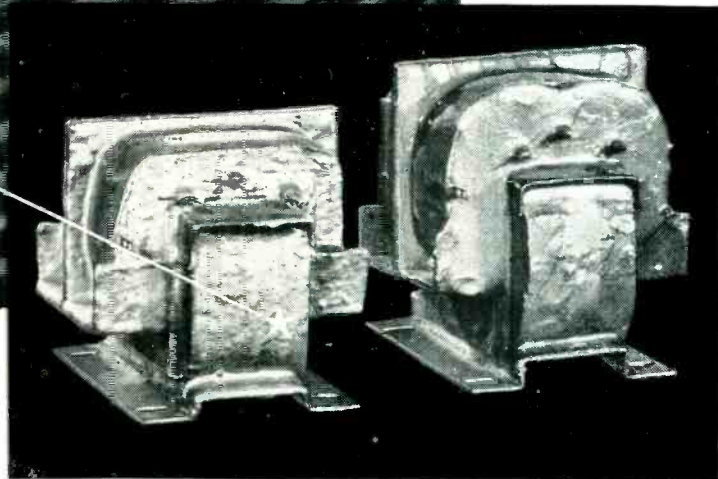
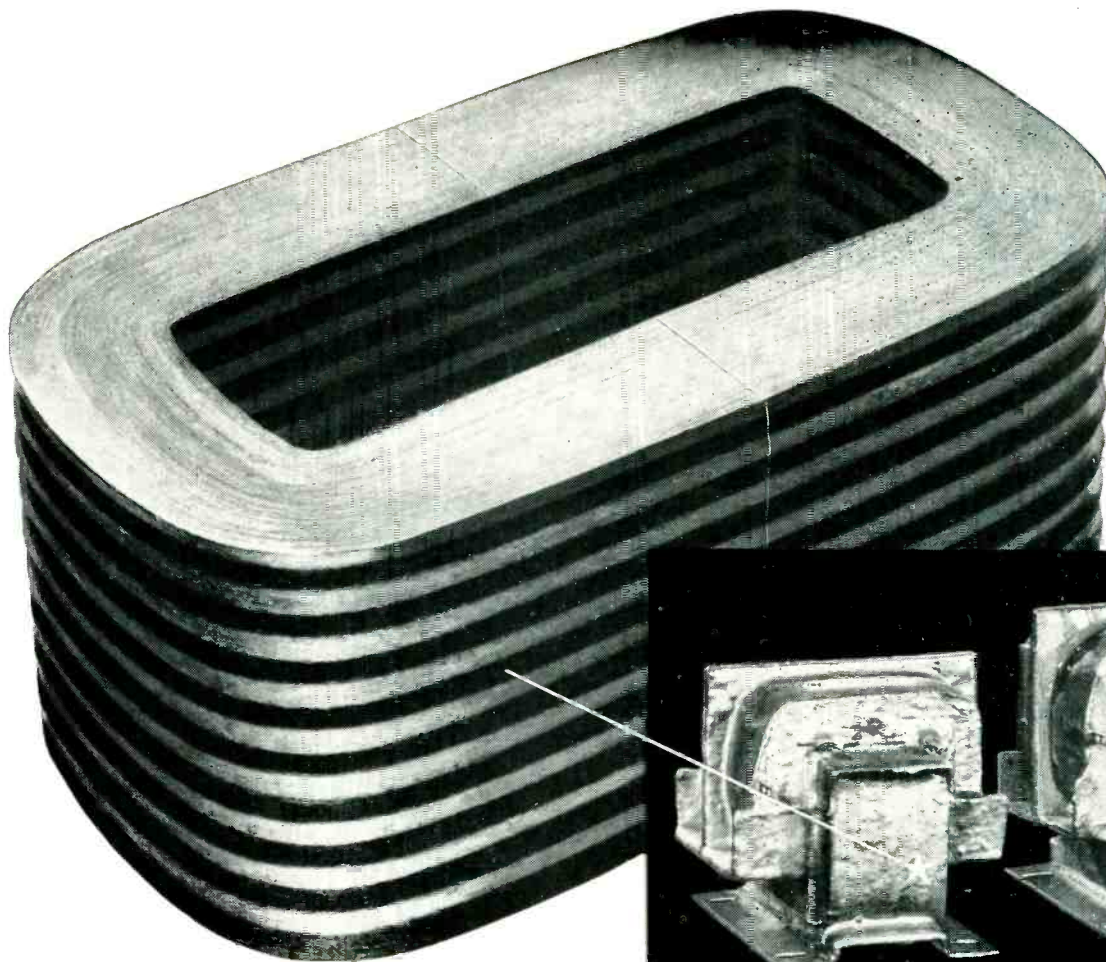

New HIPERSIL CORE cuts air-borne transformer size and weight

Transformer weight reduced 25%, size cut 20% in a single unit of air-borne electronic equipment. This is the mark set by a new lightweight Hipersil® Core designed by Westinghouse for the Navy Bureau of Aeronautics.

Adaptable to commercial as well as military use, the new core makes possible more powerful equipment within the size and weight limitations of previous models. A special silicon steel, rolled to a new 4-mil thickness, with grain structure super-oriented by a refinement of the Hipersil process, achieves the size and weight reductions.

Hipersil Cores cut size and weight in *all types* of electrical and electronic transformers. They combine highest permeability with lowest losses in a wide

range of sizes (1 through 5 and 12 mils). Two-piece assembly simplifies transformer manufacturing, cuts fabricating costs. Greater flux-carrying capacity, increased mechanical strength help to make them the best core on the market. For specific information on how to apply Hipersil Cores to your product, write Westinghouse Electric Corporation, P. O. Box 868, Pittsburgh 30, Pennsylvania.

J-70652

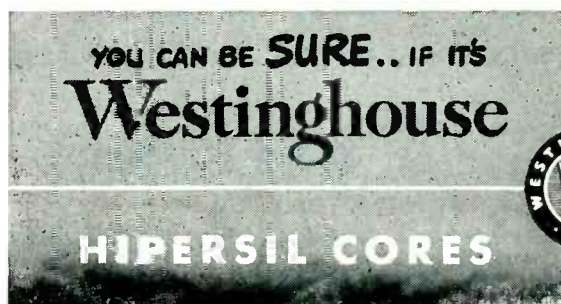



POLYPENCO TEFLON*

available for economical fabrication

ROD	Extruded .187" dia. to 2.0" dia. Tolerance +.002" — .000" up to 1" dia. Molded 2.25" dia. to 4.0" dia. Beading .030" to .187" dia.
TUBING	Extruded .50" to 2.0" O.D. 3/16" to 1.0" I.D. min. wall 1/8" Molded 1 1/4" to 8" O.D. at 1/4" intervals Wall thickness 3/8" — 2 3/4"
OTHER SHAPES	Strip thickness .002" to .060" Slab thickness 1/8" to 1 1/2" Special extruded shapes to customer specifications

Outstanding properties of TEFLON

Advantage	
WIDE SERVICE TEMPERATURE RANGE	−100°F to +500°F
CHEMICALLY INERT	Resists all known acids, alkalis and commercial solvents over the service temperature range.
ZERO WATER ABSORPTION	Water will not wet the surface.
LOW POWER FACTOR	.05% p f. constant over entire frequency spectrum.
STABLE DIELECTRIC CONSTANT	2.0 unchanged over entire spectrum.
TOUGHNESS AT LOW TEMPERATURE	Izod impact strength −70°F 2 ft. lbs./in.

*Teflon is a trademark of E. I. DuPont

also available to your specifications

MACHINED PARTS • MOLDED PARTS

POLYPENCO® nylon
teflon

Write for technical data and prices on Polypenco Teflon and Nylon

The POLYMER CORPORATION of Pennsylvania • Reading, Penna.

Canadian Representative: C-H Engineering Company, Montreal, Toronto, Canada

covered wood rods that serve as electrodes for a simple but effective ageing rack devised by production engineers at Pyramid Electric Co. Loosening four wing nuts permits raising the electrode bars so the units can be inserted one by one. When the rack is fully loaded, the nuts are tightened to get good contact pressure, and clip connections are made to projecting foil on each electrode for applying the desired ageing voltage.

Construction of Magnetic Sheet-Steel Separator

SPECIAL permanent magnets for assembly into a separator that will make top sheets of steel lift themselves are now available from Carboly, Department of General Electric Co., Detroit. The separator prevents the feeding of doubles to a punch press, speeds feeding of the press by making the top sheet readily available, and minimizes cutting of fingers while grabbing a sheet.

A powerful U-shaped magnet positioned as in Fig. 1 is in contact with the edges of the stack of

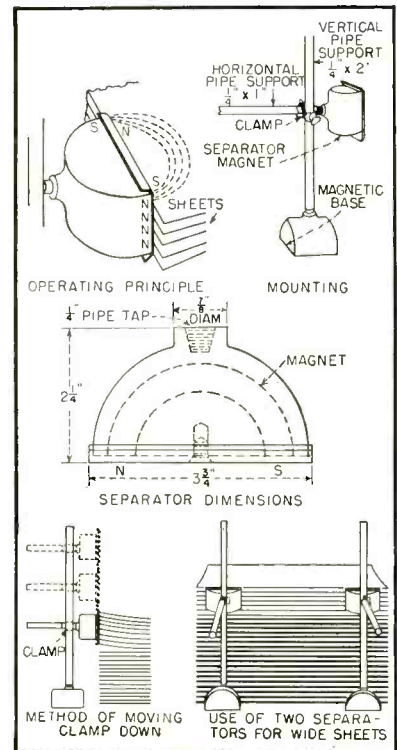

Construction details and suggested methods of using special Alnico permanent magnets as sheet-steel separators

FREED Instruments & Transformers

Famous For

QUALITY • DEPENDABILITY • ACCURACY

FREED 1020-B MEGOHMMETER



A precision electronic megohmmeter which for years has given satisfactory service in hundreds of laboratories and on production lines.

- **EASY TO READ**
Direct reading on a 4" scale.
Protected against overload.
- **RAPID & SAFE TO USE**
Test voltage removed from terminals and capacitive components discharged to ground in all positions of multiplier switch.
- **ACCURATE**
Within 3% up to 100,000 megohms, 5% from 100,000 to 2,000,000 megohms.

SPECIFICATIONS

Range: 1 megohm to 2,000,000 megohms in six overlapping ranges selected by a multiplier switch.
Voltages on Unknown: The voltage applied to the unknown terminals is 500 volts d-c and is independent (less than 1%) of the value of the unknown.
Stability: Line voltage variations from 105-125 volts will cause less than 2% variation in the meter reading.
Power Supply: 105-125 volts A.C. 50-60 cycles 30 watts.
Dimensions: 9½ x 10½ x 8 inches.
Net Weight: 18 pounds.

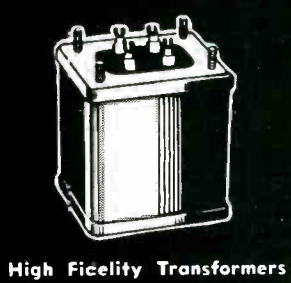

High Fidelity Transformers

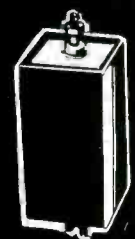

Slug Tuned Components

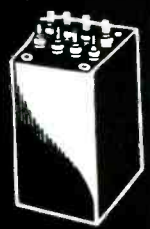

Hermetically Sealed Components to meet MIL-T-27 Specs

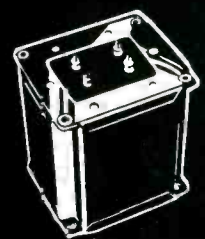

Commercial Components



Sub-miniature hermetically sealed Toroidal Inductors

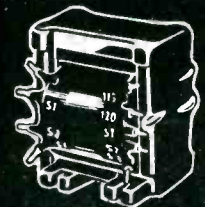

Freedseal Treatment ANE-19 Specs

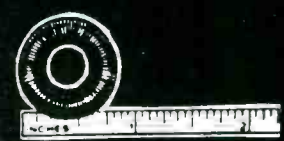

Miniature Inductors

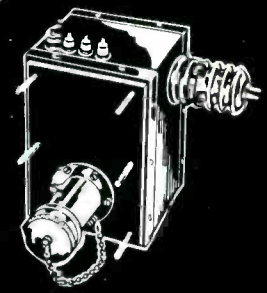

Pulse Modulators

FREED TRANSFORMER CO., INC.

1722C WEIRFIELD ST. (RIDGEWOOD) BROOKLYN 27, N. Y.



"TOWER LIGHTING KITS"

said the General Manager,
"Can't grow hair, but..."

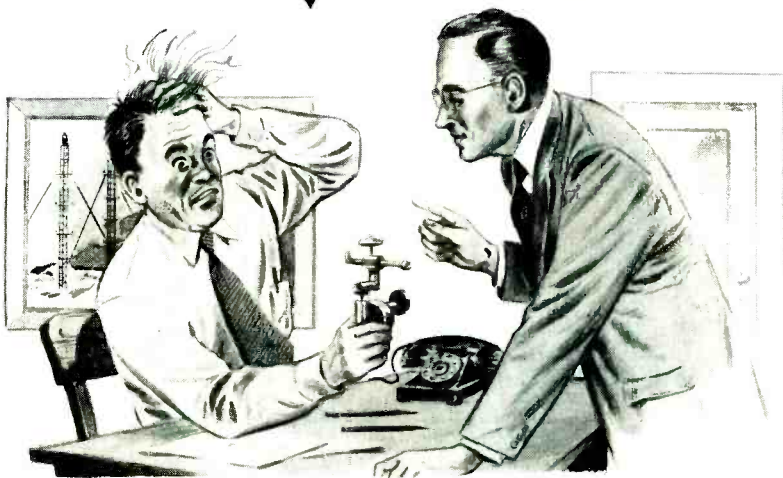

"Nice looking hair you're pulling out," said the G. M. of Station XYZ, "but when do we get lighting clearance on the new tower?"
"See that!" groaned the engi-

neer. "That's a whoozit. It takes 5 whoozits to light our tower—about \$4 worth of metal. But there just aren't any whoozits right now. No whoozits, no lights."



"Then let's do it the easy way," counselled the G.M. "Get in touch with our nearest Hughey & Phillips distributor and order a complete, packaged tower lighting

kit. Just give 'em the tower specs. They'll ship pronto and include every item to light our tower—down to the last nut, bolt, and whoozit. And you'll save wear and tear on your hair."

The G. M. is right—but he told only half the story. Through years of experience in buying, designing, testing and packaging, Hughey & Phillips have gained world leadership in the field of tower lighting. And because of this specialized "know-how" H & P tower lighting kits cost less to buy, less to install, less to maintain. Drop us a line for the name of your nearest H & P distributor.



HUGHEY & PHILLIPS TOWER LIGHTING DIVISION
ENCINO, CALIFORNIA

LEADERSHIP IN THE FIELD OF TOWER LIGHTING

the annual electronics BUYERS' GUIDE

is the electronic engineer's

BREADBOARD WHO'S WHO

for

quick, accurate
answers to any
questions about

**COMPONENTS
EQUIPMENT
MATERIALS**

used in electronics

Get in the habit
of looking it up in...

the **electronics** BUYERS' GUIDE

"The Book that has all the answers"

A MCGRAW-HILL PUBLICATION

330 West 42nd Street

NEW YORK 36, N. Y.

**SCINFLEX ASSURES
YOU PEAK PROTECTION
AGAINST CIRCUIT FAILURE**

When operating conditions demand an electrical connector that will stand up under the most rugged requirements, always choose Bendix Scinflex Electrical Connectors. The insert material, an exclusive Bendix development, is one of our contributions to the electrical connector industry. The dielectric strength remains well above requirements within the temperature range of -67°F to $+275^{\circ}\text{F}$. It makes possible a design increasing resistance to flashover and creepage. It withstands maximum conditions of current and voltage without breakdown. But that is only part of the story. It's also the reason why they are vibration-proof and moisture-proof. So, naturally, it pays to specify Bendix Scinflex Connectors and get this extra protection. Our sales department will be glad to furnish complete information on request.

- Moisture-Proof • Radio Quiet • Single Piece Inserts •
- Vibration-Proof • Light Weight • High Insulation Resistance
- High Resistance to Fuels and Oils • Fungus Resistant •
- Easy Assembly and Disassembly • Fewer Parts than any other Connector • No additional solder required.

**BENDIX
SCINFLEX
ELECTRICAL
CONNECTORS**

The Finest
**ELECTRICAL
CONNECTOR**
MONEY CAN
BUY!

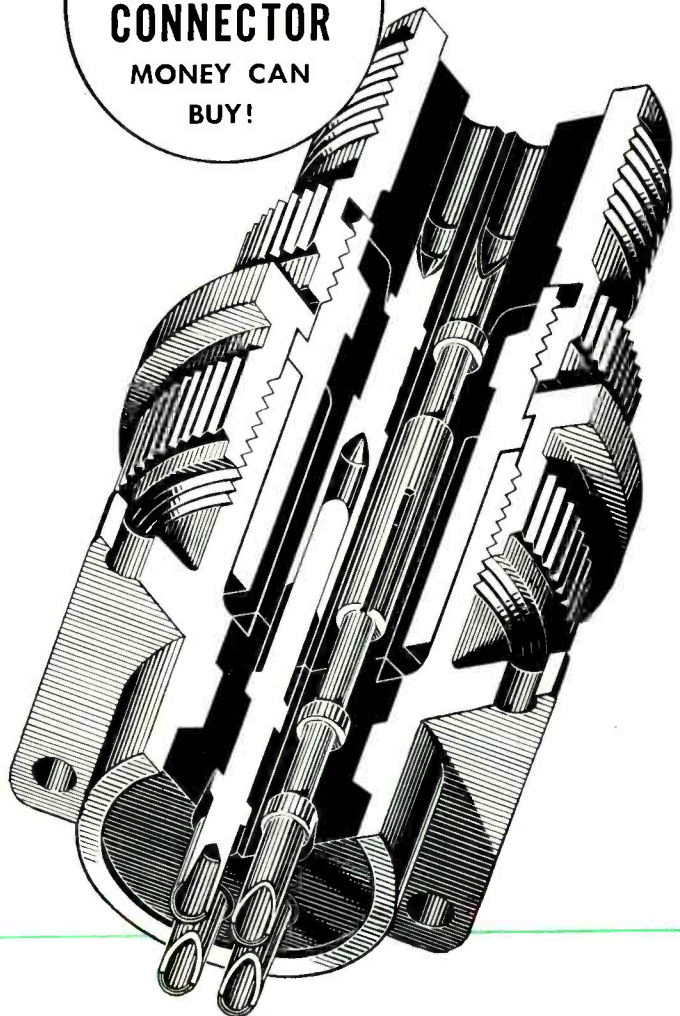

SCINTILLA MAGNETO DIVISION of
SIDNEY, NEW YORK



Export Sales: Bendix International Division, 72 Fifth Avenue, New York 11, N. Y.

FACTORY BRANCH OFFICES: 118 E. Providencia Ave., Burbank, Calif. • Stephenson Bldg., 6560 Cass Ave., Detroit 2, Michigan • Brouwer Bldg., 176 W. Wisconsin Avenue, Milwaukee, Wisconsin • 582 Market Street, San Francisco 4, California

FMAM SIGNAL GENERATOR TF 995

A crystal standardized generator either frequency or amplitude modulated. Frequency range: 13.5 to 216 megacycles. Output range 0.1 microvolts to 100 millivolts. Internal or external modulation gives f.m. deviations to 600 kilocycles and a.m. depths to 50 per cent.

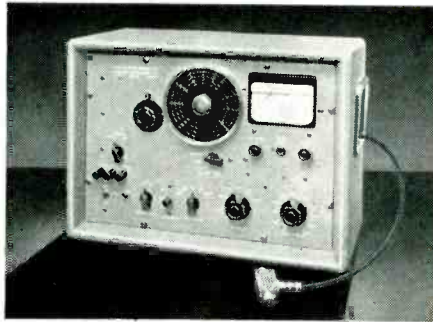

UNIVERSAL BRIDGE TF 868

Measures inductance and capacitance at 1,000 cycles, resistance at d.c.; direct reading 1 microhenry to 100 henries, 1 micro-microfarad to 100 microfarads, and 0.1 ohms to 10 megohms. Q range 0.1 to 1.000, tan δ 0.001 to 10.



sheets. The magnetic lines of force going through each sheet from one magnet pole to the other are equivalent to magnetic poles in the sheets themselves. With the magnet orientation employed, the S poles will all be in one vertical line in the sheets opposite the N pole of the magnet, and the N poles in the sheets will likewise line up vertically opposite the S pole of the magnet. Since like poles repel, the sheets literally lift themselves from the stack.

A single separator magnet is satisfactory for sheets up to 15 inches wide and 0.014 inch thick. The separator should be positioned in the center of one side of the stock, flush with the sheets. For sheets wider than 15 inches, two or more separators are needed. Optimum number and spacing can be determined by trial, but spacing should not be less than two inches.

The separator magnet mounts directly onto a 1/4-inch pipe that can be one foot long. A clamp permits sliding this magnet up or down on a vertical pipe support that can be screwed into a magnetic base. With the magnetic base, a steel table must be used for the sheets of steel. The magnetic base is powerful enough to hold the assembly yet can easily be slid up against the edge of the stack after adding a new supply of sheets.

FM DEVIATION METER TF 934

With crystal-standardized deviation ranges of 5, 25 and 75 kilocycles, alternative high- and low-level buffered inlets, visual checking for optimum tuning and level, together with a separately buffered audio outlet, this ruggedized deviation meter is ideal for carriers in the range 2.5 to 200 megacycles.



STANDARD SIGNAL GENERATOR TF 867

For precision receiver measurements: Covers on an expanded full-vision scale 15 kilocycles (or less) to 30 megacycles, crystal standardized, with an output continuously variable from 4 volts to 0.4 microvolts. Up to 100 per cent. a.m., with unmeasurable f.m., monitored by dual rectification.

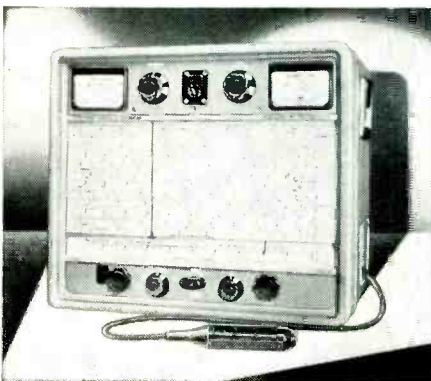

We shall be pleased to see you at the I.R.E. Convention BOOTH 1-520

Screw-Holding Tweezers Made from Hacksaw Blade

A DISCARDED hacksaw blade can be converted into a pair of tweezers in 10 minutes by making two cuts as shown in the diagram, then bolting or riveting the ends of the blade together. Grinding may be used in place of cutting if desired. This

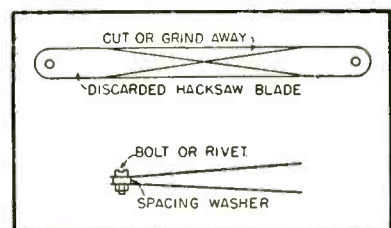

Method of making homemade tweezers for speeding electrical maintenance work. The points can be filed and bent to suit the needs of any job

MARCONI INSTRUMENTS

VACUUM TUBE VOLTMETERS • FREQUENCY STANDARDS • OUTPUT METERS
WAVE METERS • WAVE ANALYSERS • Q METERS • BEAT FREQUENCY OSCILLATORS

23-25 BEAVER STREET • NEW YORK 4

CANADA: CANADIAN MARCONI CO., MARCONI BUILDING, 2442 TRENTON AVENUE, MONTREAL
ENGLAND: Head Office: MARCONI INSTRUMENTS LIMITED, ST. ALBANS, HERTFORDSHIRE
Managing Agents in Export:
MARCONI'S WIRELESS TELEGRAPH COMPANY LIMITED, MARCONI HOUSE, STRAND, LONDON, W.C.2

SAFE AGAINST HIGH HUMIDITY IN TROPICAL CLIMATES!

RESISTS MOISTURE

...IT'S THE

Blue Jacket[®]

WIRE-WOUND
RESISTOR



You're safe when you "batten down the hatches" against high humidity with Sprague Blue Jackets! They're rugged vitreous enamel power resistors that can take abuse . . . that eliminate electrolysis failure in the most humid atmospheres . . . that deliver top wattage ratings in every size . . . that assure unmatched stability and resistance to thermal shock. Yes, the Blue Jacket is outstanding even among the many noteworthy Sprague developments in the resistor art. ★ ★ ★ ★ ★ ★ ★

Blue Jacket resistors are made in types to meet the tough performance requirements of Military Specification JAN-R-26A, Characteristic "G". See Engineering Bulletin 110 for complete details. Blue Jackets are also available in commercial styles that excel in the most severe industrial electronic service. Engineering Bulletin 111 describes these superior units—that cost no more than ordinary resistors! Send for your copies to:

SPRAGUE ELECTRIC COMPANY
35 Marshall Street, North Adams, Mass.



YOU'LL RECOGNIZE THESE SUPERIOR RESISTORS BY
THEIR BRIGHT BLUE VITREOUS ENAMEL JACKETS

PIONEERS IN ELECTRIC AND ELECTRONIC DEVELOPMENT

How to tell Quality in **TEFLON***

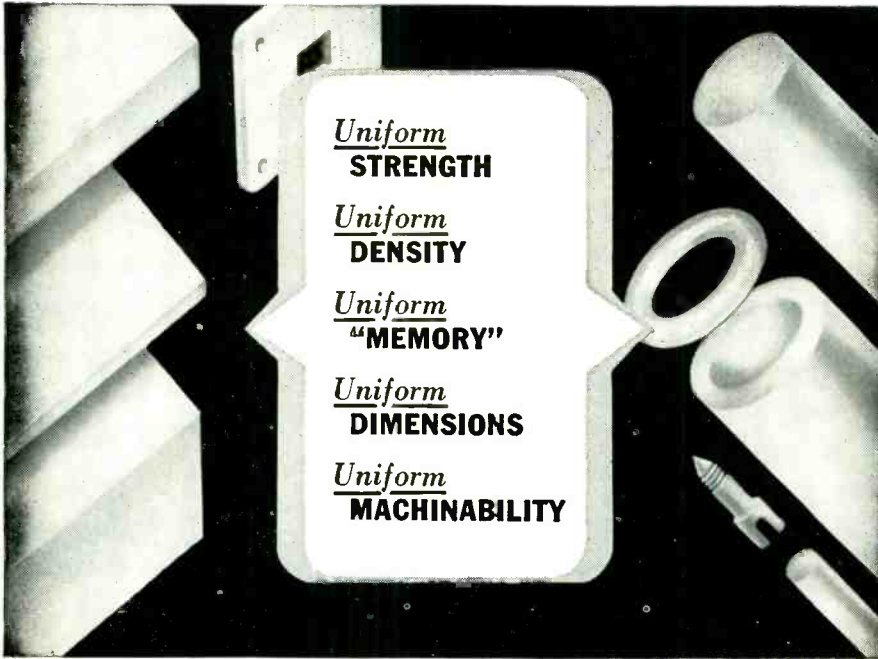

You'll have all these properties
with **FLUOROFLEX-T**[®]

■ "Teflon" powder is converted into Fluoroflex-T rod, sheet and tube under rigid control, on specially designed equipment, to develop optimum inertness and stability in this material. Fluoroflex-T assures the ideal, low loss insulation for uhf and microwave applications . . . components which are impervious to virtually every known chemical . . . and serviceability through temperatures from -90° F to +500° F.

Produced in *uniform* diameters, Fluoroflex-T rods feed properly in automatic screw machines without the costly time and material waste of centerless grinding. Tubes are concentric - permitting easier boring and reaming. Parts are free from internal strain, cracks, or porosity.

For maximum *quality* in Teflon, be sure to specify Fluoroflex-T.

*DuPont trade mark for its tetrafluoroethylene resin.
© Resistoflex trade mark for products from fluorocarbon resins.

"Fluoroflex" means the best in Fluorocarbons

RESISTOFLEX

CORPORATION



RESISTOFLEX CORPORATION, Belleville 9, N. J. E-3
SEND NEW BULLETIN containing technical data and information on Fluoroflex-T.

NAME.....TITLE.....
COMPANY.....
ADDRESS.....

from

Accelerometers to Yokes

you'll find the
correct answer to
who makes
everything in the
entire field
of electronics
including . . . components
equipment
and
materials

in the . . .

electronics BUYERS' GUIDE

Get in the habit of looking it up in...

the electronics BUYERS' GUIDE

"The Book that has all the answers"

A MCGRAW-HILL PUBLICATION
330 West 42nd Street
NEW YORK 36, N. Y.

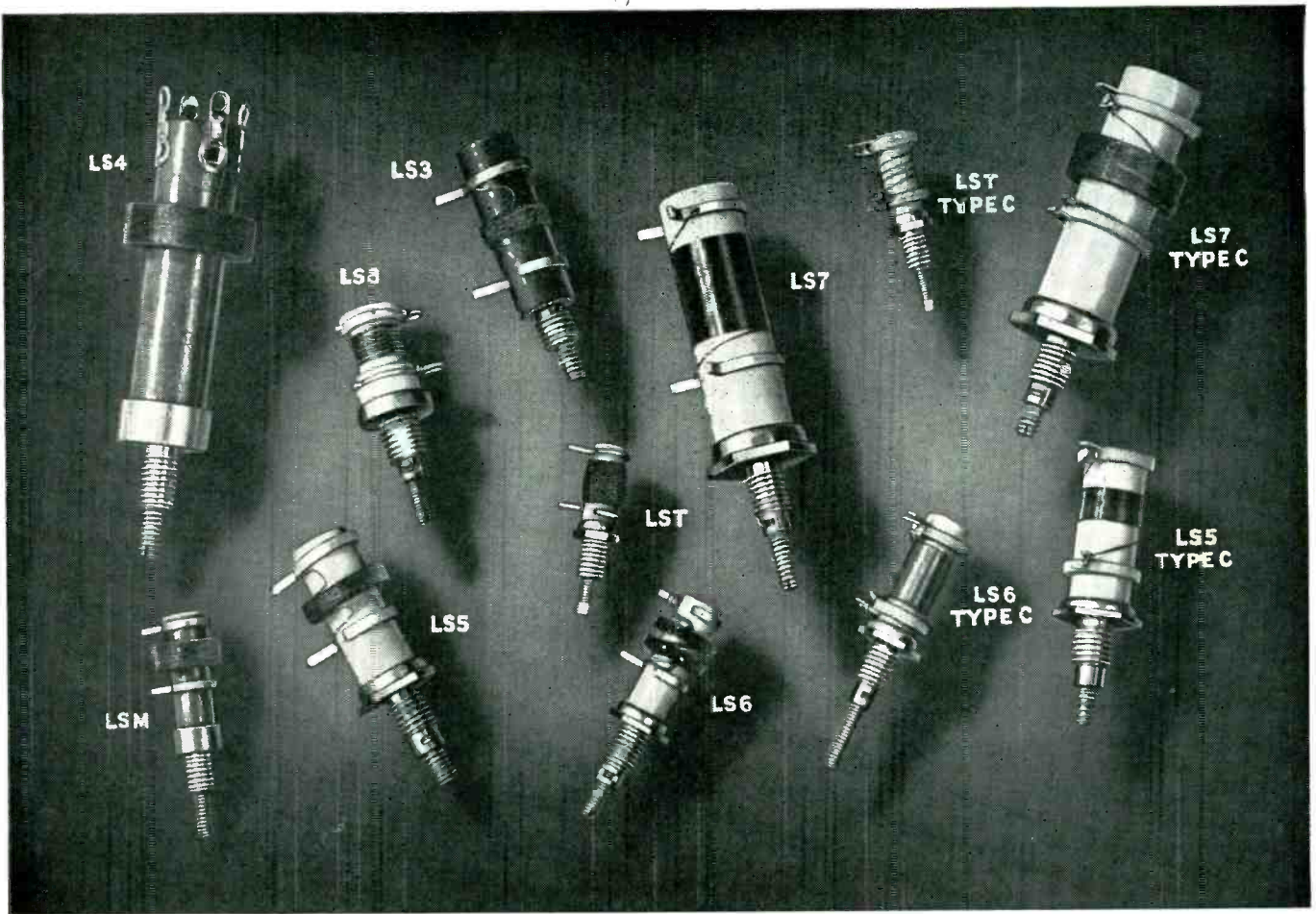

Here's how to get exactly the coils you need

You can get C.T.C. slug tuned coils, single layer or pie type windings to your exact specifications — military or personal — with expert workmanship and correct in every detail as to materials and methods.

C.T.C. coil forms are made of quality paper base phenolic or grade L-5 silicone impregnated ceramic. Mounting bushings are cadmium plated brass; ring type terminals are silver plated brass protected by water dip lacquer. Terminal retaining collars of silicone fibreglas which permit 2 to 4 terminals, are available on forms designated Type C above. Wound units

can be coated with resin varnish, wax or lacquer. All units are furnished with slugs and mounting hardware.

A table of frequencies and permeabilities relating to the slugs used in the coils shown above is contained in C.T.C. catalog 400. Send for your copy, and ask for prices and specifications on the coils you need. Be sure to send complete specifications for specially wound coils.

All C.T.C. materials, methods and processes meet applicable government specifications. Cambridge Thermionic Corporation, 437 Concord Avenue, Cambridge 38, Mass. West coast manufacturers contact E. V. Roberts, 5068 West Washington Blvd., Los Angeles, and 988 Market Street, San Francisco, California.

COIL FORM SPECIFICATIONS

Coil Form	Material	Mounting Stud Thread Size	Form O.D.	Mounted O. A. Height
LST	L-5 Ceramic	8-32	3/16"	1 9/32"
LS6	L-5 Ceramic	10-32	1/4"	2 7/32"
LS5	L-5 Ceramic	1/4-28	3/8"	1 1/16"
LS8	L-5 Ceramic	1/4-28	2 5/64"	2 3/32"
LS7	L-5 Ceramic	1/4-28	1/2"	1 1 1/16"
LSM	Paper Phenolic	8-32	1/4"	2 1/32"
LS3	Paper Phenolic	1/4-28	3/8"	1 1/8"
LS4	Paper Phenolic	1/4-28	1/2"	2"

NOTE: Types LS5, LS6, LS7, LS8 have slug locking spring. Type LST, available with slug locking spring as type LSTL. Type LS4 has fixed lugs — all others have adjustable ring terminals.

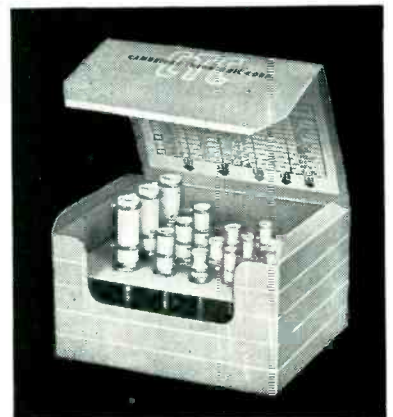

CERAMIC COIL FORM KIT. Helps you spark ideas in designing electronic equipment or developing prototypes and pilot models. Contains 3 each of the following 5 C.T.C. ceramic coil form types: LST, LS5, LS6, LS7, LS8. Color-coded chart simplifies slug-identification and gives approximate frequency ranges and specifications. Fibreglas collars and metallic rings are furnished with kit for all ceramic coil forms except LS8 which is furnished only with clip terminals.

CAMBRIDGE THERMIONIC CORPORATION

custom or standard . . . the guaranteed components

See our listing in Electronics Buyers' Guide
See us at Booth 2-218 IRE Show



G-V MINIATURE THERMAL RELAY

*Advanced
Engineering
Features!*

- Miniature and Octal Sizes
- Hermetically Sealed in Metal Shell
- Adjustable and Non-Adjustable
- Heater Voltages up to 230 Volts
- Fully Temperature Compensated
- Suitable for Military and Industrial Use
- Unequaled for Ruggedness and Precision



Not Only a

TIME DELAY RELAY...

.. with performance features that surpass larger octal relays.

More and more engineers are finding other uses for these precise and rugged units—jobs which thermal relays of the usual bi-metal design often cannot do... such as:

- TUBE HEATER VOLTAGE REGULATION
- POWER SUPPLY OVERLOAD PROTECTION
- OVER- OR UNDER-VOLTAGE ALARM OR CUT-OFF
- LOW OR HIGH FREQUENCY CUT-OFF

To receive technical information on these new applications, as it comes off the press, and our bulletin on Time Delay Relays, just mail the coupon below.

G-V
CONTROLS INC.
16 Hollywood Plaza
East Orange, New Jersey

G-V CONTROLS INC. ● 24 Hollywood Plaza, East Orange, N. J.

Please send me your bulletin on Thermal Time Delay Relays and information on new thermal relay applications. I am particularly interested in

Name _____ Position _____

Company _____

Address _____

idea, from *Coal Age* magazine, is credited to Harry Lainer of The New River Co., Summerlee, W. Va., who used the tool to put screws in terminals and leads of switches and other controls.

Subassembly Soldering Jigs

INGENIOUS yet inexpensive jigs for holding up to ten parts at a time for preliminary soldering of small components and leads can greatly boost the output of subassembly departments in receiver plants. A special fixture must generally be designed for each type of part. Examples of eight such jigs are shown here.

The operation of soldering a wire to the outer sleeve of a speaker plug is expedited at Emerson's plant by using jacks as holding jigs. The jacks are fastened to a block of wood with wood screws. A finishing nail is driven alongside each jack and bent downward, and a groove is cut in the top of the fixture board for the wire. The



Jig for holding phono-type plugs while soldering leads to outer skirts of plugs for use as speaker cables. Plugs were previously soldered to the center conductor at a dip soldering operation

Laboratory Model

HICKOK



**PORTABLE
TUBE TESTER**

Model 539A

Electronic Development Engineers . . . you men who create and build today's electronic miracles, depend heavily on the keystone component—the vacuum tube.

HICKOK pioneered the first commercial tube testers with Dynamic Mutual Conductance circuits. This circuit, long recognized as the true evaluation of a vacuum tube, is available only in equipment bearing the HICKOK trademark.

The laboratory portable shown is one of eleven models available . . . all expertly engineered with specific features for every specialized need.

THE HICKOK ELECTRICAL INSTRUMENT COMPANY

10514 Dupont Avenue

Cleveland 8, Ohio

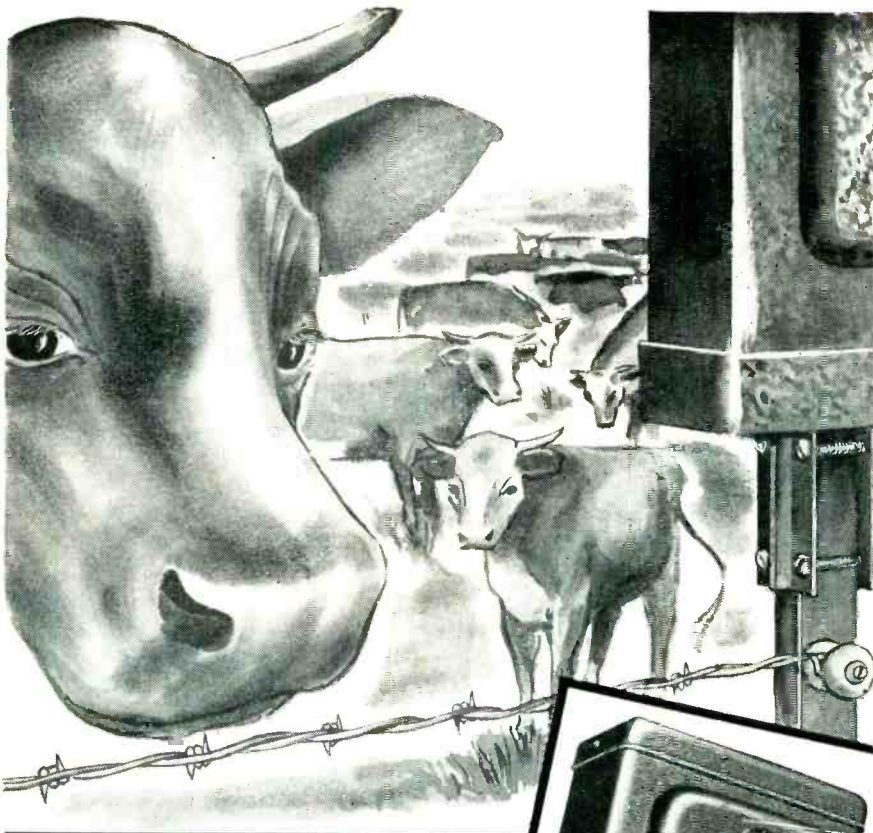

Unusual Applications demand GTC Transformers

Parmak Electric Fencers are guaranteed to perform exactly as represented. This emphasizes the need for "GTC" Transformers which will meet the most rigid requirements.

If your application is unusual or standard, we suggest you consider "GTC" — proven transformers where maximum performance is essential.

We welcome your inquiries.

GENERAL TRANSFORMER COMPANY
 serving industry since 1928
 18240 Harwood Avenue, Homewood, Illinois
 (Suburb of Chicago)

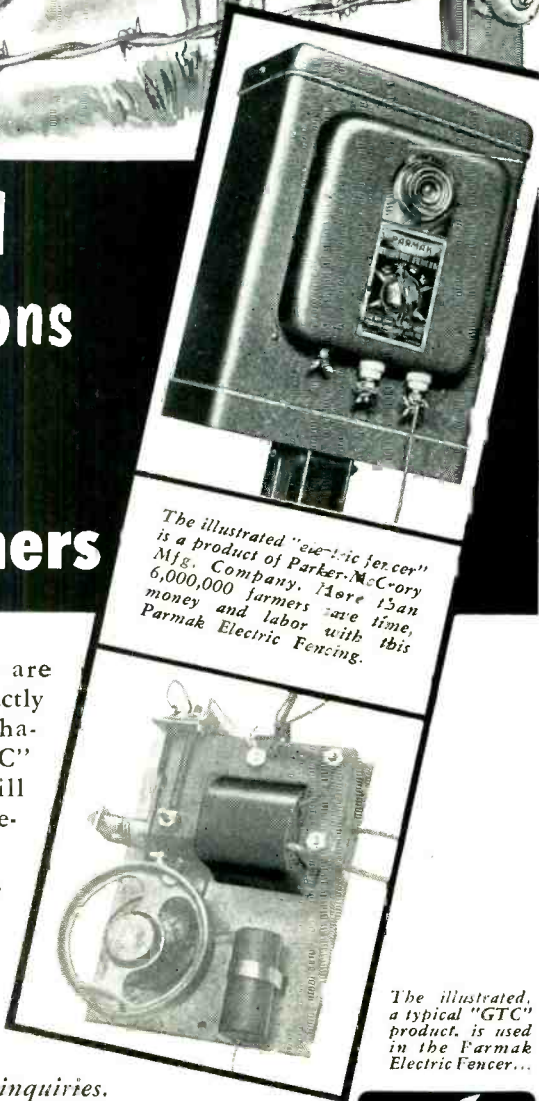

The illustrated "electric fence" is a product of Parker-McCory Mfg. Company. More than 6,000,000 farmers save time, money and labor with this Parmak Electric Fencing.

The illustrated, a typical "GTC" product, is used in the Parmak Electric Fencer...



DOUBLE BARREL Advertising

Advertising men agree—to do a complete advertising job you need the double effect of both Display Advertising and Direct Mail.

Display Advertising keeps your name before the public and builds prestige.

Direct Mail supplements your Display Advertising. It pin-points your message right to the executive you want to reach—the person who buys or influences the purchases.

More and more companies are constantly increasing their use of Direct Mail because it does a job that no other form of advertising will do.

McGraw-Hill has a special Direct Mail Service that permits the use of McGraw-Hill lists for mailings. Our names give complete coverage in all the industries served by McGraw-Hill publications—gives your message the undivided personal attention of the top-notch executives in the industrial firms. They put you in direct touch with the men who make policy decisions..

In view of present day difficulties in maintaining your own mailing lists, our efficient personalized service is particularly important in securing the comprehensive market coverage you need and want.

Ask for more detailed information today. You'll be surprised at the low over-all cost and the tested effectiveness of these hand-picked selections.

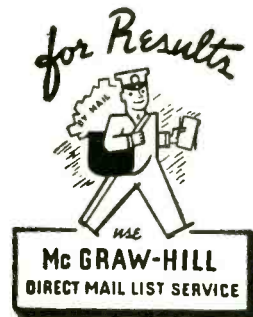

Dept. A

McGRAW-HILL PUBLISHING CO., INC.

330 West 42nd Street
 NEW YORK 18, N. Y.

MODERN ELECTRONIC ACHIEVEMENT!

THE LA POINTE-PLASCOMOLD
CORPORATION RELIES ON
"PRINTED CIRCUIT" FILTERS.

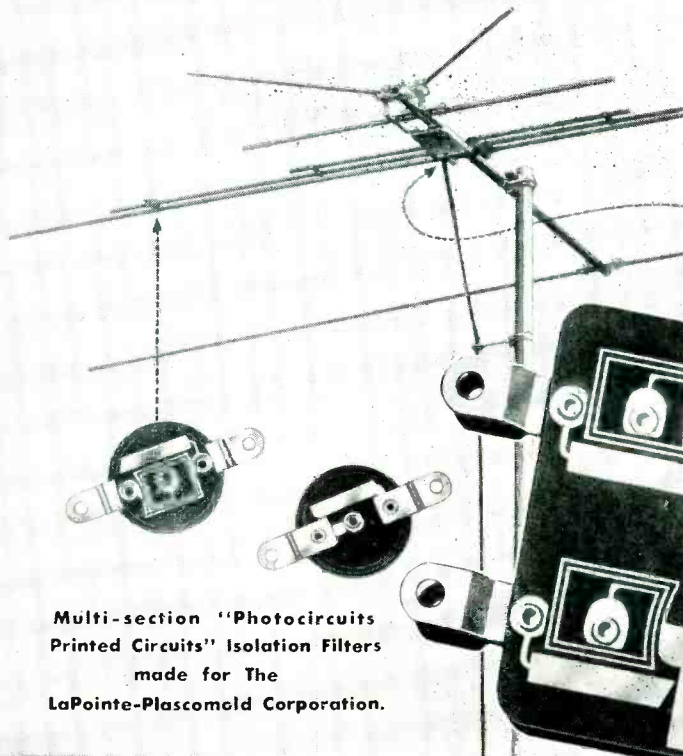

Multi-section "Photocircuits
Printed Circuits" Isolation Filters
made for The
LaPointe-Plascomold Corporation.

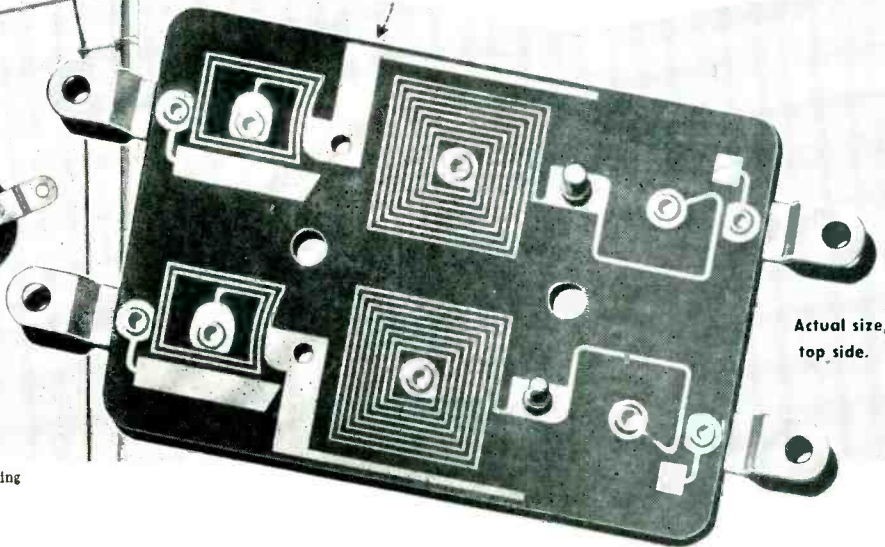

Actual size,
top side.

Lit. A.A. K. 2,422,458; 2,282,292; others pending

"PHOTOCIRCUITS PRINTED CIRCUITS" * CUT COSTS

of the **MASS PRODUCED** VEE-D-X All Channel 2-83 VHF-UHF ANTENNA

Application of
"Photocircuits Printed Circuits"
extend to ...

**MICRO-WAVE PLUMBING,
RADIO and TV CHASSIS, I.F.
STRIPS, ANTENNA FILTERS,
TERMINAL BOARDS, WIPING
SWITCHES, FLUSH COMMU-
TATORS etc.**

This new antenna employs EIGHT "Photocircuits Printed Circuits" channel separators to enable all-channel reception of TV signals with a single antenna and a single transmission line. It is a great boon to TV sales in this period of changeover to UHF! *Completely assembled filters cost only a fraction of previously used unassembled component coils and capacitors.*

YOU TOO can *simplify and save* with "Photocircuits Printed circuits." *Lower wiring costs, reduced assembly time, circuit reproducibility, improved reliability and miniaturization* will make your product better and more profitable. *Let our engineering facilities and experience help solve your design and application problems.*

VISIT US
at the
I.R.E. SHOW
Booth 4-102



T.M. Reg. U. S.
Pat. Off.

For our new ENGINEERING BROCHURE write
PHOTOCIRCUITS *Corporation*
Dept. E-3, GLEN COVE, NEW YORK



*Bring your
tough problems to us at*
ELECTRONIC TRANSFORMER CO.

If standard, mass-produced transformers won't do for your product or application, consider this . . .

Since 1938 we've concentrated exclusively in the specialized field of CUSTOM-DESIGNED and CUSTOM-BUILT Transformers for government and industry.

Our engineering staff can solve your transformer problems by assimilating your circuitry in Electronic Transformer Co.'s fully equipped laboratory.

Why not write or phone us regarding your special requirements . . . today!

TRANSFORMERS • REACTORS • RESONANT FILTERS

ELECTRONIC TRANSFORMER COMPANY

209 WEST 25th STREET • NEW YORK 1, N. Y.

Telephone: WAtkins 4-0880



**JUST
PUBLISHED**

PRINCIPLES OF TELEVISION SERVICING

Step-by-step information on all types of commercial receivers—how to install, service, and repair them. Shows how to do most testing with just three pieces of equipment: vacuum-tube voltmeter, oscilloscope, and alignment generator. Dozens of trouble-shooting charts... suggestions about going into a servicing business. By **Carter V. Rabinoff**, Dean; and **Magdalena Wolbrecht**, Vice-Pres. Amer. TV Lab of Calif. 560 pp., 6 x 9, 375 illus., \$7.50.

**NEW
REVISED
EDITION**

ELECTRICAL FUNDAMENTALS OF COMMUNICATION

Covers basic electrical fundamentals, using explanations and illustrations taken from the communication field—fundamentals applying to telegraphy, telephony, and radio, including television. New Second Edition brings explanations up to date... uses definitions and terminology that agree with the latest IRE and AIEE standards. By **Arthur L. Albert**, Prof. of Comm. Eng., Oregon State Coll. Second Edition, 530 pp., 6 x 9, 363 illus., \$7.00.

**JUST
PUBLISHED**

ELECTRO- MAGNETICS

A well-balanced coverage of the basic principles of electromagnetic field theory, equally emphasizing the branches that apply in electronics, power, radiation, and propagation. Stresses the field point of view; also points out its close interrelation with circuit theory. Introduces advanced aspects of electric and magnetic fields gradually. By **John D. Kraus**, Prof. of Elec. Eng., Ohio State U. 593 pp., 6 x 9, 382 illus., \$9.00.

**JUST
PUBLISHED**

SERVO- MECHANISM ANALYSIS

Presents the essentials of the mathematical theory of servomechanisms, stressing analysis as a necessary preliminary to design. Details mathematical methods: transient analysis, polar transfer function, logarithmic transfer function analysis, etc. Discusses Relay Servomechanisms and the Root Locus Method. By **George J. Thaler**, Asst. Prof. of Elec. Eng., U. S. Naval Postgrad. Sch.; and **Robert G. Brown**, Sen. Proj. Eng., A. C. Spark Plug Div., Gen. Motors Corp. 440 pp., 6 x 9, 305 illus., \$7.50.

SEE THESE BOOKS 10 DAYS FREE

McGraw-Hill Book Co.
330 W. 42nd St., N.Y.C. 36, N. Y.

Send me book(s) checked below for 10 days' examination on approval. In 10 days I will remit for book(s) I keep, plus few cents for delivery, and return unwanted book(s) postpaid. (We pay for delivery if you remit with this coupon; same return privilege.)

- Rabinoff & Wolbrecht—Prin. of TV Servicing—\$7.50
 Albert—Elec. Fund of Comm.—\$7.00
 Kraus—Electromagnetics—\$9.00
 Thaler & Brown—Servomechanism Analysis—\$7.50

(Print)
 Name
 Address
 City Zone State
 Company
 Position L-3

This offer applies to U. S. only

Want more information? Use post card on last page.

ELECTRONICS — March, 1953

PRODUCTION TECHNIQUES

(continued)



Fixture for holding three-potentiometer strips. Soldering iron is plugged into overhead outlet, and rests in horizontal holder at back of bench when not in use. Solder reel holder is screwed to bottom of bench

operator places the stripped end of the wire in the desired position on the plug sleeve, loops the wire under the nail, then brings it up into a slot and over the top of the fixture. The wire stays in position through its own springiness, leaving the hands of the operator free for high-speed soldering after all the wires have been placed in position.

A wood U channel supported at a 30-degree angle toward the operator is used for holding potentiometer strips during subassembly wiring at Emerson's television receiver plant. Metal pegs hold the end strips in position. Additional pegs are provided for some of the other strips, even though not actually needed. Wires used in this operation are precut and stripped on an Artos machine. Short wires are kept in an ordinary one-pound breadpan. Longer wires are stored in cardboard tubes of different lengths, resting in holes in a plywood frame set on the back of the bench. The holes are positioned so that the tubes slant toward the operator, bringing the wires within easy reach.

A more elaborate holding jig for miniature tube sockets, widely used throughout Emerson's plant, permits simultaneous rotation of nine

NEW...

MICRODUAL

TWO-SPEED
PRECISION DRIVE

(Patents U.K.,
U.S., etc.)

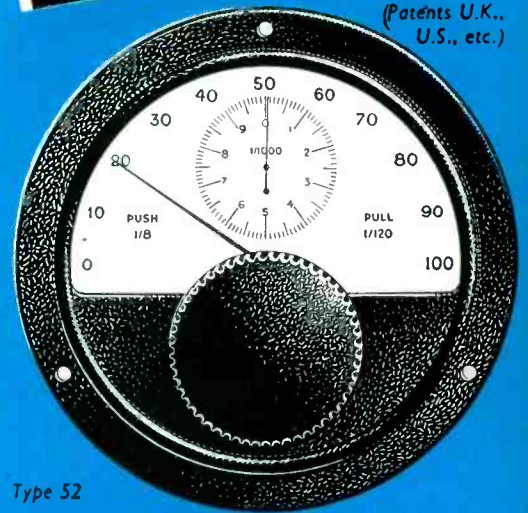

Type 52

**TWO SPEEDS · SINGLE CONTROL
FREE OF BACKLASH**

- Accuracy of scale reading 100%
- Coarse searching speed plus fine setting control.
- Single control knob displaced axially to select the speed ratio.
- Spring-loaded gears with automatic take-up of any wear or play between primary and secondary drives.
- Pointers geared directly to centre spindle.
- Security in operation: friction clutch obviates overdriving.

TYPE No.	NUMBER OF DIAL MARKINGS	EFFECTIVE SCALE LENGTH	SPEED RATIOS	
			COARSE	FINE
52	1,000	3.3 feet	1 : 8	1 : 120
63	1,000	3.3 feet	1 : 8	1 : 120
57	2,000	6.6 feet	1 : 15	1 : 200
56	2,000	6.6 feet	1 : 15	1 : 200
53	2,000	6.6 feet	1 : 15	1 : 200

We are specially organized to handle direct enquiries and orders from U.S.A.

Billed in dollars. Settlement by your check.

CABLE OR AIRMAIL TO-DAY

TRANSRADIO LTD

CONTRACTORS TO H.M. GOVERNMENT

138A CROMWELL ROAD, LONDON, S.W.7., ENGLAND

CABLES — TRANSRAD, LONDON

for **LONGER** battery **LIFE**

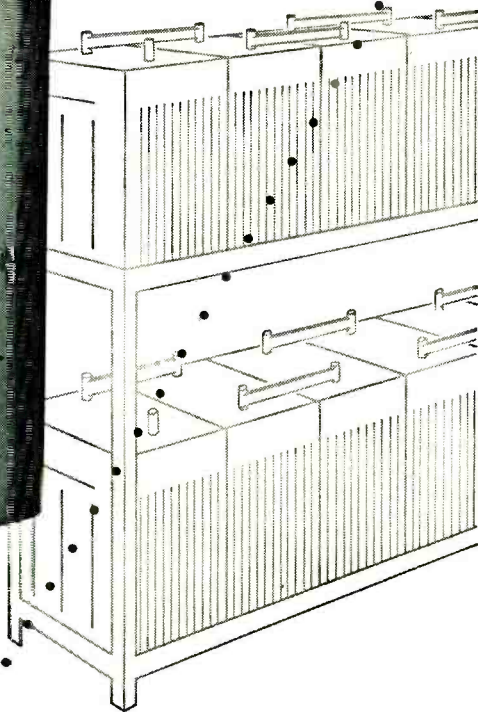
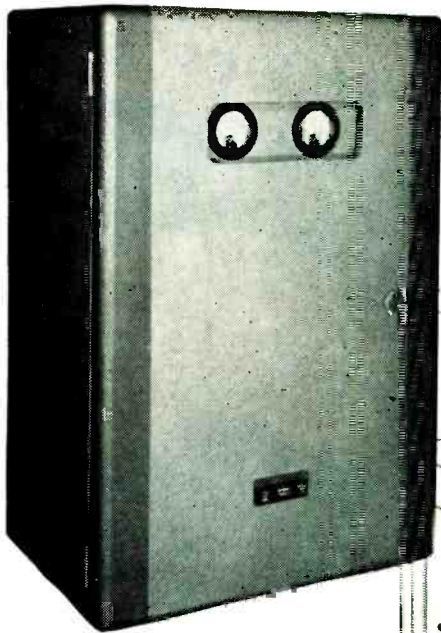

keep the floating voltage constant with PECO Automatic Battery Chargers

The PECO Battery Chargers accurately float the control battery of any power station or substation which has a reasonably constant switchboard load; furnishes power to the load and maintains a fully charged battery, ready for any emergency.

To provide extreme accuracy of electronic control and the exceptional reliability demanded by this type of service, Power Equipment engineers designed this PEC-626 Automatic Battery Charger by starting with the rugged components of a manual charger, then added a magnetic system for coarse voltage control and a simplified electronic system for fine voltage control.

As an illustration of the accuracy of the PECO charger, this example can be

used: the DC output is sufficient to maintain 60 lead acid battery cells at 129 volts; it will also furnish power to switchboard loads within the rating of the charger, and at all times the output voltage is automatically regulated to within ± 0.5 percent, for AC line voltage fluctuations of ± 5 volts on a 230 volt circuit.

Exceptional reliability is shown by the fact that if the electronic control section should be disconnected, the magnetic control section will still automatically hold the output voltage to within ± 3 percent of nominal voltage.

Write for complete specifications today.

POWER EQUIPMENT *Company*

Battery Chargers ☆ Battery Eliminators ☆
D.C. Power Supply Units ☆ Regulated Exciters ☆
☆ and other Special Circuits ☆

55 ANTOINETTE STREET DETROIT 2, MICHIGAN

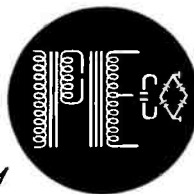

he's working
for you

THIS FELLOW IS TRAINED IN YOUR BUSINESS. His main duty is to travel the country — and world — penetrating the plants, laboratories and management councils . . . reporting back to you every significant innovation in technology, selling tactics, management strategy. He functions as your all-seeing, all-hearing, all-reporting business communications system.

THE MAN WE MEAN IS A COMPOSITE of the editorial staff of this magazine. For, obviously, no one individual could ever accomplish such a vast business news job. It's the result of many qualified men of diversified and specialized talents.

AND, THERE'S ANOTHER SIDE TO THIS "COMPOSITE MAN," another complete news service which complements the editorial section of this magazine — the advertising pages. It's been said that in a business publication the editorial pages tell "how they do it" — "they" being all the industry's front line of innovators and improvers — and the advertising pages tell "with what." Each issue unfolds an industrial exposition before you — giving a ready panorama of up-to-date tools, materials, equipment.

SUCH A "MAN" IS ON YOUR PAYROLL. Be sure to "listen" regularly and carefully to the practical business information he gathers.



McGraw-Hill PUBLICATIONS

New Waldes Truarc GRIP Ring requires no groove, holds fast by friction, can be used over and over again

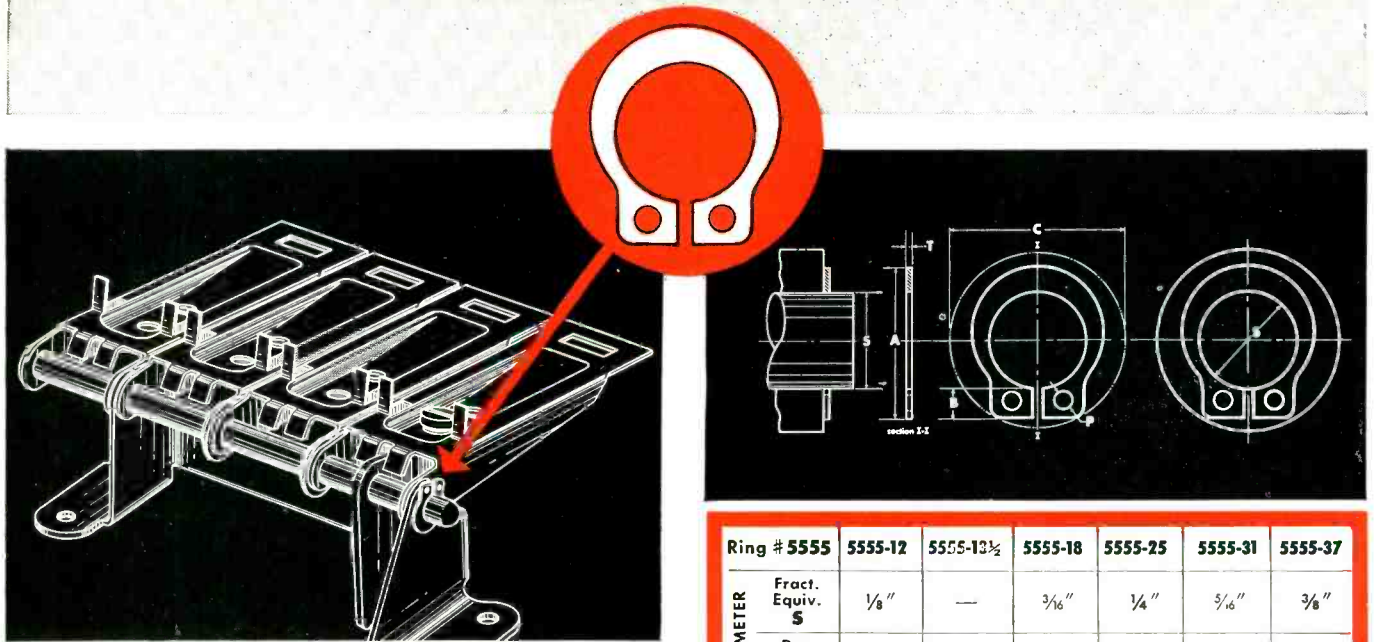

The Waldes Truarc Grip Ring is a new, low cost fastener that provides a positioning shoulder secure against moderate thrusts or vibration. Installed on a straight ungrooved shaft, the Truarc Grip Ring can be assembled and disassembled in either direction with Truarc pliers.

The Grip Ring can be installed tightly against a machine part in order to take up end-play. The basic Truarc design principle assuring complete circularity around periphery of the shaft and the ring's unusually large radial width combine to exert considerable frictional hold against axial displacement. The ring can be used again and again.

Find out what Waldes Truarc Retaining Rings can do for you. Send us your drawings. Waldes Truarc engineers will give your problems individual attention without obligation.

Ring #	5555	5555-12	5555-13½	5555-18	5555-25	5555-31	5555-37
SHAFT DIAMETER	Fract. Equiv. S	1/8"	—	3/16"	1/4"	5/16"	3/8"
	Dec. Equiv. S	.125	.136	.187	.250	.312	.375
	TOL.	±.002	±.002	±.002	±.002	±.003	±.003
RING DIMENSIONS	Thickness T	.025	.025	.035	.035	.042	.042
	TOL.	±.0015	±.0015	±.002	±.002	±.002	±.002
	Length A	.268	.285	.364	.437	.553	.626
	Lug B	.078	.078	.097	.097	.141	.141
	Hole P	.042	.042	.042	.042	.078	.078
	Min. Ring Clear C	.33	.34	.44	.50	.67	.73
Approx. Ultim. Thrust Load (Lbs)	20	20	25	35	50	60	

SEND FOR NEW CATALOG

WALDES
TRUARC
REG. U. S. PAT. OFF.
RETAINING RINGS



Waldes Kohinoor, Inc., 47-16 Austel Place, L.I.C. 1, N. Y. E-035

- Please send me sample Grip-Rings (please specify shaft size _____)
- Please send me the complete Waldes Truarc catalog. (PLEASE PRINT)

Name _____

Title _____

Company _____

Business Address _____

City _____ Zone _____ State _____

WALDES KOHINOOR, INC., LONG ISLAND CITY 1, NEW YORK
WALDES TRUARC RETAINING RINGS AND PLIERS ARE PROTECTED BY ONE OR MORE OF THE FOLLOWING U. S. PATENTS: 2,382,947; 2,382,948; 2,416,852; 2,420,921; 2,426,341; 2,439,785; 2,441,846; 2,455,165; 2,483,380; 2,483,383; 2,487,802; 2,487,803; 2,491,306; 2,509,081 AND OTHER PATENTS PENDING.

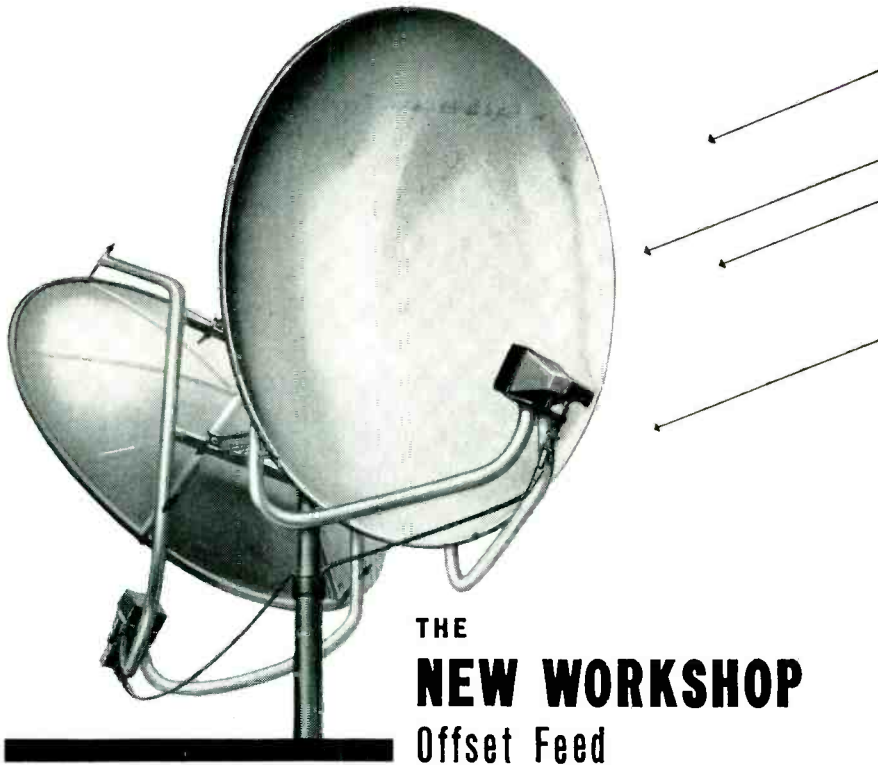

**THE
NEW WORKSHOP**
Offset Feed
Microwave Antenna
1750 to 2110 mc

- Frequency Range — 1750 to 2110 mc
- Feed — Pyramidal horn with fibreglas radome, nonpressurized
- Reflector Diameter — 6 feet
- Gain — 28 db (over 1/2 wave dipole), side lobe level — better than 23 db
- Half Power Angle — H plane — 6°, E plane — 5.7°
- VSWR — 1.2 (1750-1990 mc); 1.25 (1990-2110 mc)
- Crosstalk — decoupling greater than 78 db
- Polarization — horizontal or vertical

Write for Bulletin E-1.

**WORKSHOP
ASSOCIATES
DIVISION**

THE GABRIEL COMPANY

Endicott Street, Norwood, Mass.



This new WORKSHOP microwave antenna incorporates two revolutionary features which result in outstanding performance.

OFFSET FEED. Conventional center fed antennas employ a symmetrical paraboloid of revolution as a reflector. The Workshop design, however, uses a parabolic reflector with the vertex 9 inches above the rim. The feed is placed at the focal point of the paraboloid but is aimed to provide peak intensity of illumination at the optimum angle above the vertex. This location removes the horn feed from the radiated field of greatest intensity and results in better overall performance: — higher gain, lower side lobes, improved system impedance match and maximum decoupling.

Radiation is practically identical in both horizontal and vertical planes, polarity can be changed by rotating the feed 90°.

LAMINATED FIBERGLAS REFLECTOR. The 6-foot offset feed reflector is made of fibreglas laminations with a polyester resin. The total laminate is composed of a surface layer of fibreglas and a layer of fine wire mesh screening backed by four layers of fibreglas. The result is a strong, low cost reflector, accurate to ± 1/8 inch. No painting is necessary, but if color is desired it may be added to the resin to produce a permanent finish.



Jig for holding and rotating nine sub-miniature sockets simultaneously

sockets. The operator can bring a given terminal on all sockets to the optimum position for connecting and soldering a lead or part. Rotation is achieved through use of gears inside the metal housing of the jig, meshing together so that all turn when the control knob on the shaft of the center socket is turned.

One of each pair of socket support pins is spring-loaded to hold the socket during assembly work. To load the fixture, the operator places one socket mounting hole on the fixed pin, then moves the spring-loaded pin inward until the other socket hole is over it. Unloading is done simply by grasping the assembled wires and pulling off the sockets. The two-pin holder for each socket can be removed by loosening a single screw, and other holding devices can be placed on the geared-together shafts for assembly work on other types of parts. The entire fixture may be



Two-position jig for assembling jack strip of distribution amplifier for field television camera

"cards" introducing

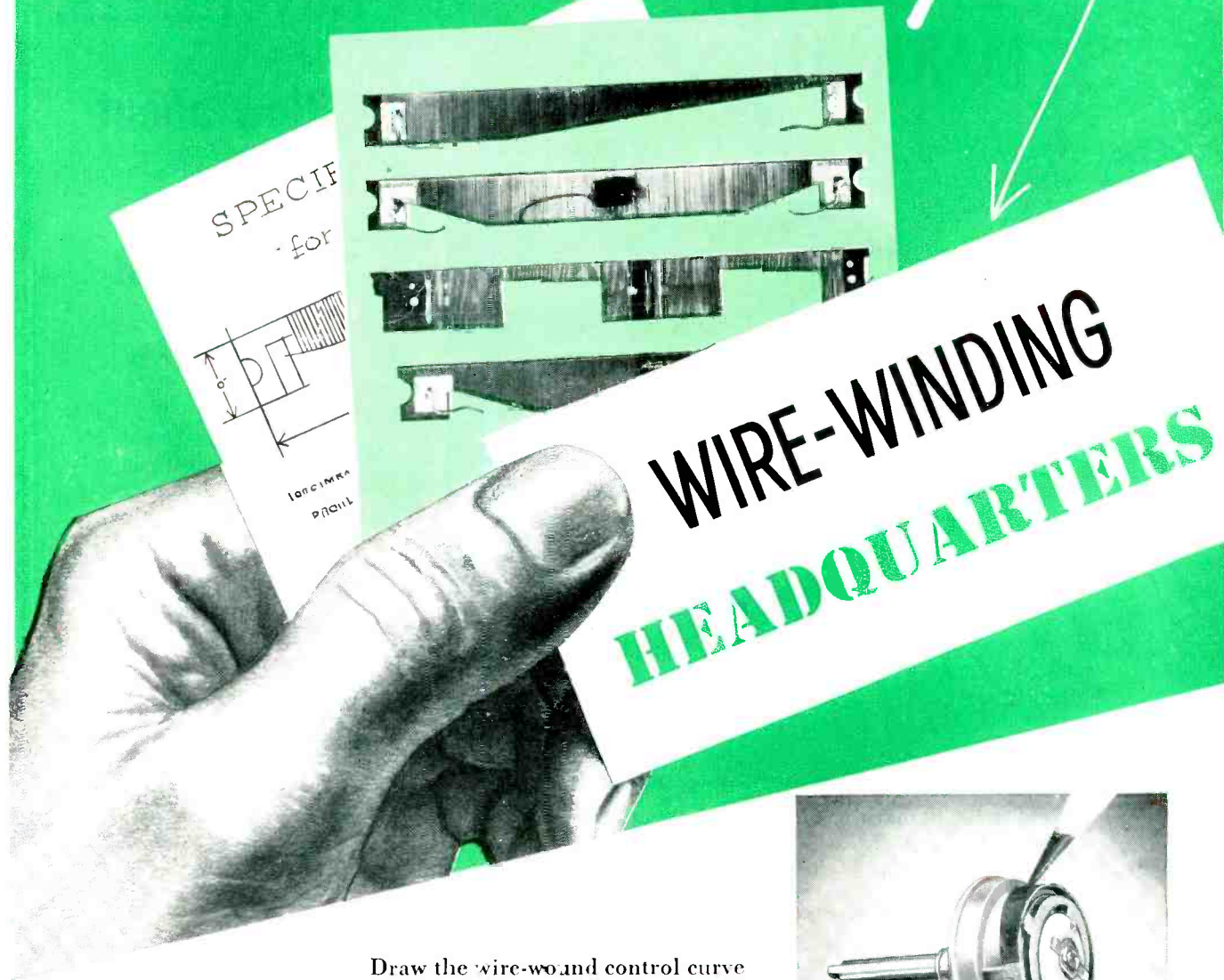

WIRE-WINDING

HEADQUARTERS

Draw the wire-wound control curve you need: Clarostat winds the "card" to match it. Specify tolerances: Clarostat meets them. Order any quantity: Clarostat delivers piece after piece, always *uniform*, always *dependable*, always *economical*.

All because Clarostat-designed and built winding machines, manned by skilled winding specialists, handle any kind and size of wire on any kind and shape support. Intricate control curves are met with tapered or notched supporting strips, by variable spacing of turns, by different wire sizes. From 0.032" down to 0.0009" dia. and finer, Clarostat winds to your precise requirements.



STAND PAT WITH
C

Send us that control spec, regardless how "special". Our engineering collaboration, quotations and delivery schedules, are yours for the asking.

CLAROSTAT Controls & Resistors

CLAROSTAT MFG. CO., INC., DOVER, NEW HAMPSHIRE

In Canada: Canadian Marconi Co., Ltd., Toronto, Ontario

SHARP PERMANENT MARKING

WITH HI-DUTY
MARKING TOOLS



For legible permanent marking of metal components use  engraved lettering tools. Precision engraved dies and inserts for indenting or embossing identification on your parts will

1. Improve appearance.
2. Advertise throughout life of part.
3. Facilitate reordering.

Write for free catalog on Production Marking Equipment.

GEO. T. SCHMIDT, INC.

MARKING MACHINES • MARKING TOOLS
1804 Belle Plaine Ave., Chicago 13, Ill.

COMPLETE MACHINE FACILITIES TO PRODUCE

- Hand Stamps
- Engraved Inserts for Dies
- Shank Style Stamping Dies
- Embossing Dies
- Code Stamps
- Steel Type
- Numbering Heads
- Marking Machines
- Nameplate Marking Equipment

Advertisers:

How about the NUCLEAR field?

There are a good many advertisers using ELECTRONICS who should also be advertising in NUCLEONICS.

Particularly in instrumentation and laboratory equipment, there is a cross-over of use in the electronic and in the nuclear field.

But, there is very little cross-over in the subscriber lists of the two publications—a matter of a few percentage points.

It is quite possible that you are doing an effective presentation of your products and abilities in this excellent issue, but are missing such presentation before one of the fastest growing fields in the country's history—the field of atomic energy.

The sales representatives of ELECTRONICS are also the sales representatives of NUCLEONICS. They have much evidence pointing to the opportunities in this great NEW field. Ask them to show you what your potentials can be.

NUCLEONICS

ABC

ABP

A McGraw-Hill Publication
330 West 42nd St.
New York 36, N. Y.

PRELIMINARY *

Announcement

SANBORN "150" SERIES OSCILLOGRAPH RECORDING SYSTEMS

(4-, 2-, and 1- channel)

THE MOST VERSATILE
OSCILLOGRAPH RECORDERS
ON THE MARKET

When the new Sanborn "150" Series is seen for the first time, all will agree that Sanborn engineers are really outdoing themselves in their *design for versatility*.

This increased versatility is being made possible by:

(1) the availability of a greater variety of newly designed *interchangeable* Sanborn amplifiers and preamplifiers which together encompass such a variety of uses that the recording possibilities of Sanborn Systems will include *almost every* phenomenon whose frequency spectrum covers the range from 0 to 100 cycles per second, and

(2) by an original design idea which makes such interchangeability *more practical*. Built into each System will be a *separate* DC driver amplifier and power supply for *each of the System's channels*, with provision for "plug in" connection to the driver amplifier (as shown in the diagram at right) of the *user's choice* of a preamplifier and control panel to complete the desired network for each channel.

IN ADDITION, the "150" series will include these Sanborn improvements:

- Increased frequency response
- Improved regulated power supply
- Individual stylus temperature control for each channel
- Improved, single control, paper speed selector. Nine speeds — .25 to 100 mm/sec
- Greater convenience and more area for immediate study of recorded events, and for notations on record
- Amplifier panels and Recorder panel all in one vertical plane on the 4-channel model. Complete system takes less floor space.

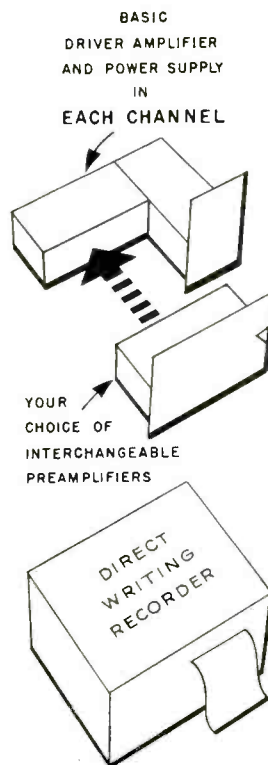

AC-DC PREAMPLIFIER

will produce 1 cm deflection for a 1 mv AC signal, and a 1 mm deflection for a 1 mv DC signal. Also provides for calibrated DC zero suppression (20X full scale). Balanced or single ended inputs.

CARRIER PREAMPLIFIER

permits a choice of three interchangeable oscillators — 400, 1000 and 2500 cycles. Each amplifier equipped with calibrated zero suppression network (20X full scale). Overall sensitivity 80 microvolts/cm deflection, or 40 microinches/inch/cm (one active arm; gage factor of 2). With commercial transducers, sensitivity usually sufficient for 20X full scale with maximum load on the transducer.

SERVO MONITOR PREAMPLIFIER — AC phase discriminating, with overall sensitivity of 10 mv/1 cm deflection. Provides DC outputs proportional to error signals from 60 to 10,000 cycles per second.

LOG-AUDIO PREAMPLIFIER

provides a 50 db dynamic range with resulting chart calibrated 1 db/mm. (At maximum sensitivity, bottom of chart equals 0.3 mv input, and top of chart 100 mv). 50 db (5 db steps) input audio attenuator. Input provision for either DC or audio signals. Audio range 20 cps to 20 kc. DC input range from 0.6 to 200 volts.

DC CONVERTER (Chopper Amp.) for low level DC recording such as thermocouple output. Sensitivity 1 mv/cm deflection.

COUPLING PREAMPLIFIER

will take balanced or single ended inputs providing 50 mv/cm sensitivity.

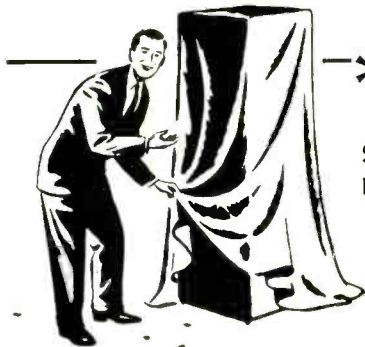

First showing of the new Sanborn "150" series will be at BOOTH 2-116, I.R.E. Convention, Grand Central Palace, New York City, March 23-26.

Be sure to see it!

Sanborn Company

INDUSTRIAL DIVISION

Cambridge 39, Massachusetts

At the Show, see—

HUDSON

—for a quick
solution to all
closure problems!



On Parade—
HUDSON Standard Cases and Covers

Visit Booth 3-208 I.R.E. Electronics Show! See the standard cases and covers that solve special closure requirements, economically. Hudson stocks hundreds of types, sizes, shapes with dozens of optional features available. Precision drawn and thoroughly inspected to simplify the work of engineers, designers and purchasing officials. Ask for a copy of the Hudson Engineers Catalog File. It's yours without obligation!

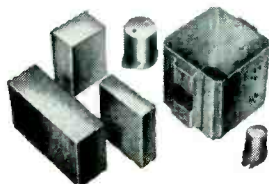

HUDSON TOOL and DIE COMPANY, Inc.

118-122 SO. FOURTEENTH STREET, NEWARK 7, N. J.

PRECISION DRAWN CASES AND COVERS AND QUALITY METAL STAMPINGS FOR THE ELECTRONIC, NUCLEONIC AND ELECTRICAL INDUSTRIES

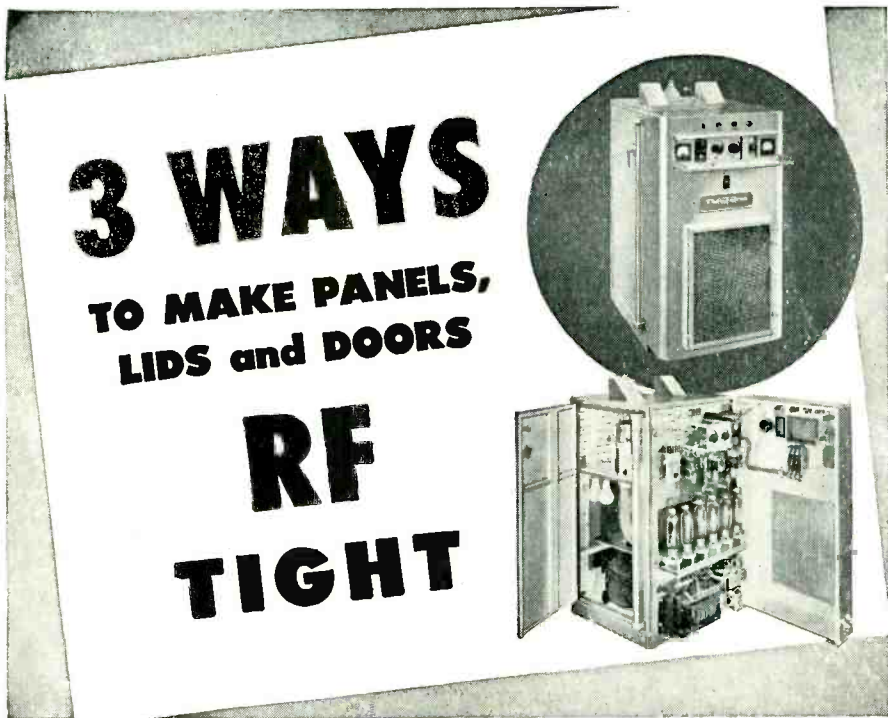

Thermaltron built by Radio Receptor Co., Inc.

1

Machine mating surfaces to closest tolerances.

Costly and difficult! And the close fit is often destroyed by warping, corrosion and normal use.

2

Install numerous latches, screws, bolts or other fastenings.

Also costly! And makes maintenance more difficult, more time-consuming.

3

USE METEX ELECTRONIC WEATHERSTRIPPING.

The simple, sure, economical way!

Made of resilient, compressible *knitted* metal wire mesh, METEX strips and gaskets "close" these openings just as a weatherstrip "closes" windows and doors.

Because they are metallic, METEX strips and gaskets are conductive. Because they are knitted, they are flexible and resilient. They will conform to surface irregularities with no loss in shielding efficiency.

Close manufacturing control assures uniformity in the resiliency and dimensions best adapted to specific applications.

METEX electronic strips and gaskets are easy to install. They are not expensive—in fact, they may well save more than their cost by eliminating the need for many operations formerly thought necessary.

It will pay you to investigate the production and performance advantages of METEX Electronic Weatherstripping. A bulletin giving detailed information is yours for the asking —just write on your company letterhead.

METAL TEXTILE CORPORATION
 KNITTERS OF WIRE MESH FOR MORE THAN A QUARTER CENTURY



Main Office & Plant, Roselle, New Jersey Canadian Plant, Hamilton, Ont.



Recessed jig for trimmer subassembly work

switches at a time. Grooves are cut into the wood strip to accommodate the slide buttons.

Another type of jig for holding slide switches, used by DuMont, is made entirely of metal. This clamps over the front edge of the workbench, and has a shaft that permits adjustment to any desired angle. The switch plates are pushed into spring steel clips to load the jig for applying and soldering cable leads to the terminals.

Irregular-shaped cutouts in a metal-faced plywood jig hold ten ceramic trimmer capacitors during subassembly work for DuMont tele-



This chassis support jig rotates on an angle-cut pedestal. Spinning the jig changes the angle as required for optimum work with the pencil-type soldering iron

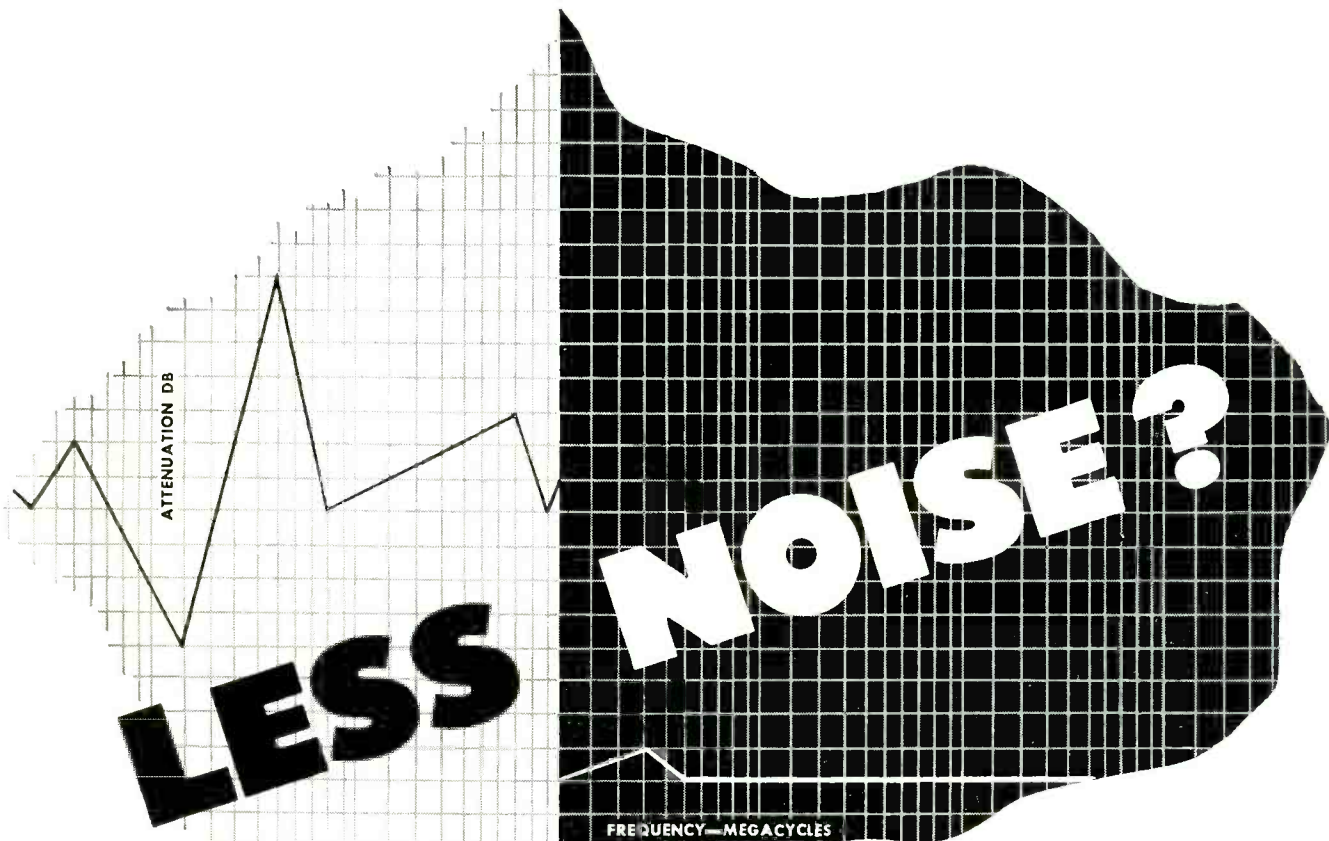

get it in
LESS SPACE
with **LESS WEIGHT**



ASTRON
Subminiature

RF INTERFERENCE SUPPRESSION FILTERS

Size and weight in filters are no longer a problem. With Astron *Subminiature* RF Interference Suppression Filters, you can provide for exceptionally effective noise attenuation from 14 kc to 1000 mc in full compliance with government specifications. You retain, or even improve, the desirable characteristics of low impedance, and low voltage drop, with minimum heating. Astron—the manufacturer who pioneered high temperature and high altitude filters—has achieved outstanding performance in these subminiature filters through the use of metallized paper capacitor sections, specially wound inductances, and other new components and techniques.

Many of the techniques Astron has developed for the subminiaturization of its metallized paper capacitors and filters are also employed to reduce the size and weight of Astron's conventional paper and foil designs. Write us today, outlining your filter requirements. Our filter engineering staff will forward recommendations promptly.

Catalog AC-3, with complete information on Astron capacitors and filters, is available on request.

▶ Visit Astron at the IRE Show, Booth 4-707, Grand Central Palace

Astron manufactures a complete line of dry electrolytic capacitors, metallized paper capacitors, plastic molded capacitors, subminiature paper capacitors and standard and subminiature RF interference filters for every radio, television and electronic use.

DEPEND ON—INSIST ON



255 Grant Avenue, E. Newark, N. J.

Export Division: Rocke International Corp., 13 E. 40th St., N.Y.C. In Canada: Charles W. Pointon, 1926 Gerrard St. East, Toronto

where **LESS**
is **MORE**
international
instruments



1" and 1½"
SUB-MINIATURE
AND MINIATURE
ELECTRICAL METERS

FOR AIRCRAFT, GUIDED MISSILES, ELECTRONIC and ATOMIC DEVELOPMENTS, COMMUNICATIONS and INDUSTRY
Wherever less weight and smaller size are vital, these sub-miniature and miniature meters allow more savings. They not only provide accuracy and dependability equal to that of larger models, but, in addition, the inherently strong construction withstands shock and vibration far better than conventional sized instruments. A D'Arsonval type movement of excellent design, precision workmanship and materials of selected quality permit miniaturization while retaining high performance standards. Meters, testing devices and allied equipment are available for a wide variety of requirements and can be adapted for use wherever it is desired to measure quantities electrically. Instruments are engineered for unusual applications by our staff of skilled technicians. Efficient production insures good delivery and low cost on both regular and special jobs. If smaller size and lighter weight can help solve your instrument problems, fill in and mail the attached coupon today.



**international
instruments**
INCORPORATED

P. O. BOX 2954, NEW HAVEN 15, CONN.
LIAISON ENGINEERS IN PRINCIPAL CITIES

Please send me engineering data sheets covering the International line of instruments.

NAME _____
POSITION _____
CO. NAME _____
ADDRESS _____
CITY _____
ZONE _____ STATE _____

**ANY
SIZE** *Spiral Wound* **PAPER TUBES**

from .450" to 25" I.P.
from ½" to 30" Long

It pays to check your requirements with PARAMOUNT... because you benefit from PARAMOUNT'S coil-proved design and construction—vast range of stock arbors—wide experience in engineering special tubes! Hi-Dielectric. Hi-Strength. Kraft, Fish Paper, Red Rope, or any combination wound on automatic machines. Tolerances ± .002".

ALSO: *Shellac-Bound* Kraft paper tubing. Heated shellac forms an adhesive bond between the laminations. Absolutely moisture resistant.

SQUARE
RECTANGULAR
TRIANGULAR
HALF-ROUND
ROUND

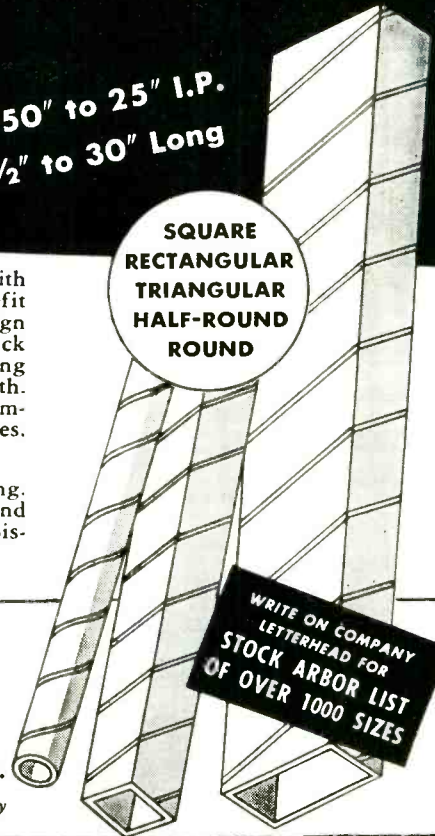

WRITE ON COMPANY
LETTERHEAD FOR
STOCK ARBOR LIST
OF OVER 1000 SIZES

SINCE 1931
**Paramount
PAPER TUBE CORP.**
616 Lafayette St., Fort Wayne, Ind.
Mfrs. of Paper Tubing for the Electrical Industry

Century **VIBRATION AND
STRESS ANALYSIS SYSTEM**

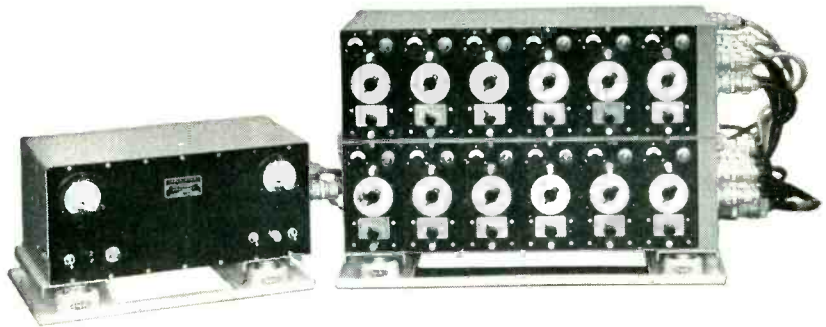

The Century Vibration and Stress Analysis System provides all of the necessary equipment to amplify and record vibration and stress-strain phenomena over a frequency range from 0 to 2000 cps.

Two modes of measurements are used in covering this system: (a) a carrier amplifier system to measure phenomena in the range of 0-500 cps, utilizing externally excited pick-ups as the sensing element; and (b) a linear-integrating amplifier system covering the range of 3-2000 cps, utilizing self-generating pick-ups, or d.c. excited strain gages employed dynamically. Both of these modes utilize either the Century Model 408 or 409 Oscillograph.

Write for Bulletins.

Century **GEOPHYSICAL CORPORATION**
TULSA, OKLAHOMA

4447 No. sodine Philadelphia 40, Pa. 3406 W. Washington Blvd. Los Angeles 18, Calif. 738 Lafayette St. Dayton 2, Ohio 309 Browder St. Dallas, Texas EXPORT OFFICE 149 Broadway, N. Y. City

Bendix Aviation Corporation

concentrates development, sales and production of special-purpose electron tubes, inverters and AC generators with its dynamotors and small motors at its

Red Bank Division



INVERTERS



SPECIAL-PURPOSE ELECTRON TUBES



DYNAMOTORS



To provide its customers with an unequalled source for special-purpose electron tubes, inverters and AC generators, Bendix Aviation Corporation has placed its entire development, sales and manufacture of these products with its Red Bank Division at Eatontown, N. J. Here in a modern new plant of over 118,000 square feet have been concentrated the most highly skilled personnel and the latest available machinery to produce the highest quality electron tubes, inverters and AC generators possible. At the same time, a full-scale program is being carried on continuously at Red Bank to develop these products for even greater efficiency and versatility. In addition to its new products . . . taken over from the Eclipse-Pioneer Division, Teterboro, N. J. . . . the Bendix Red Bank Division will continue producing its established line of dynamotors and small DC motors. If you require precision items of these types, it will pay you to take advantage of the unique experience and facilities offered to you by Bendix Red Bank.



Division of



EATONTOWN, NEW JERSEY

Export Sales: Bendix International Division, 72 Fifth Avenue, New York, 11, N. Y.

??? NEED TUBES FOR SPECIAL APPLICATIONS ?

Victoreen is prepared to assist you by engineering and manufacturing tubes for your particular application.

Expanded production facilities plus a competent tube engineering staff permit us to accept orders for new tube types now.

ABOUT VICTOREEN
Oldest Manufacturer of radiation measuring instruments. Over ten years experience in development and engineering of electronic tubes, specializing in subminiature types.



SEND SPECIFICATIONS TODAY

Use this check list (✓) as a guide in submitting your inquiry. This will assist our tube engineers in studying your application.

<p>APPLICATION: Amplifier..... Control..... Counter..... Doubler..... Electrometer..... Modulator..... Oscillator..... Rectifier..... Current Regulator..... Voltage Regulator..... Voltage Reference..... Other.....</p> <p>CLASSIFICATION: Diode..... Triode..... Tetrode..... Pentode..... Special Purpose..... Other.....</p> <p>ENVELOPE: Glass..... Ceramic..... Metal..... T-3..... T-5½..... Other.....</p> <p>ALTITUDE REQUIREMENTS:</p>	<p>MECHANICAL REQUIREMENTS: Shock..... Vibration.....</p> <p>AMBIENT TEMPERATURE:</p> <p>CONDITIONS OF USAGE: Filament Voltage..... Filament Current..... Grid Voltage..... Grid Current..... Screen Current..... Suppressor Voltage..... Suppressor Current..... Maximum Frequency..... Plate Voltage..... Plate Current..... Screen Voltage..... Amplification Factor..... Plate Dissipation..... Power Output.....</p> <p>SPECIFICATIONS: Commercial..... Mil (JAN)..... Army..... Navy..... Air Force..... A. E. C.</p>
---	--

Victoreen pioneered the manufacture of subminiature low-drain tubes including electrometers, amplifiers, voltage regulators, rectifiers and switches. Each year many other special purpose tubes have been engineered for specialized applications. Our record of successful tube development is our best recommendation to you.

QUANTITIES REQUIRED:
Initially..... Annually..... Monthly.....

ANY OTHER REQUIREMENTS:
.....
.....
.....

BETTER COMPONENTS MAKE BETTER INSTRUMENTS
Visit our Booths 4-103 and 4-104 at IRE show NYC

The Victoreen Instrument Co.
3800 PERKINS AVE. • CLEVELAND 14, OHIO

vision receivers. The work done here includes fastening standoff insulators to the trimmers. The metal plate permits more precise holding action than could be obtained with drilled holes in wood alone.

An angle-mounted locating jig aids in assembly of small parts inside a tiny subassembly chassis for the PRC-6 transceiver at Utility Electronics. A completed sample chassis is permanently mounted at the rear of the jig as a sample to guide the operator.

Tweezer-Type Soldering Tool

RESISTANCE-SOLDERING of small parts in subminiature equipment is accomplished faster, more neatly and with improved joint quality through use of a tweezer-type soldering unit that is equally suitable for production-line and laboratory use. The Hotip unit made by Contact, Inc., Cambridge, Mass.,



Use of tweezers for soldering a small joint in an experimental hearing-aid unit in an MIT laboratory. Tool rack fastened to front edge of bench keeps most-used tools within reach and encourages putting each one away when work with it is finished. Loop of wire inserted in edge of bench is support for clip leads

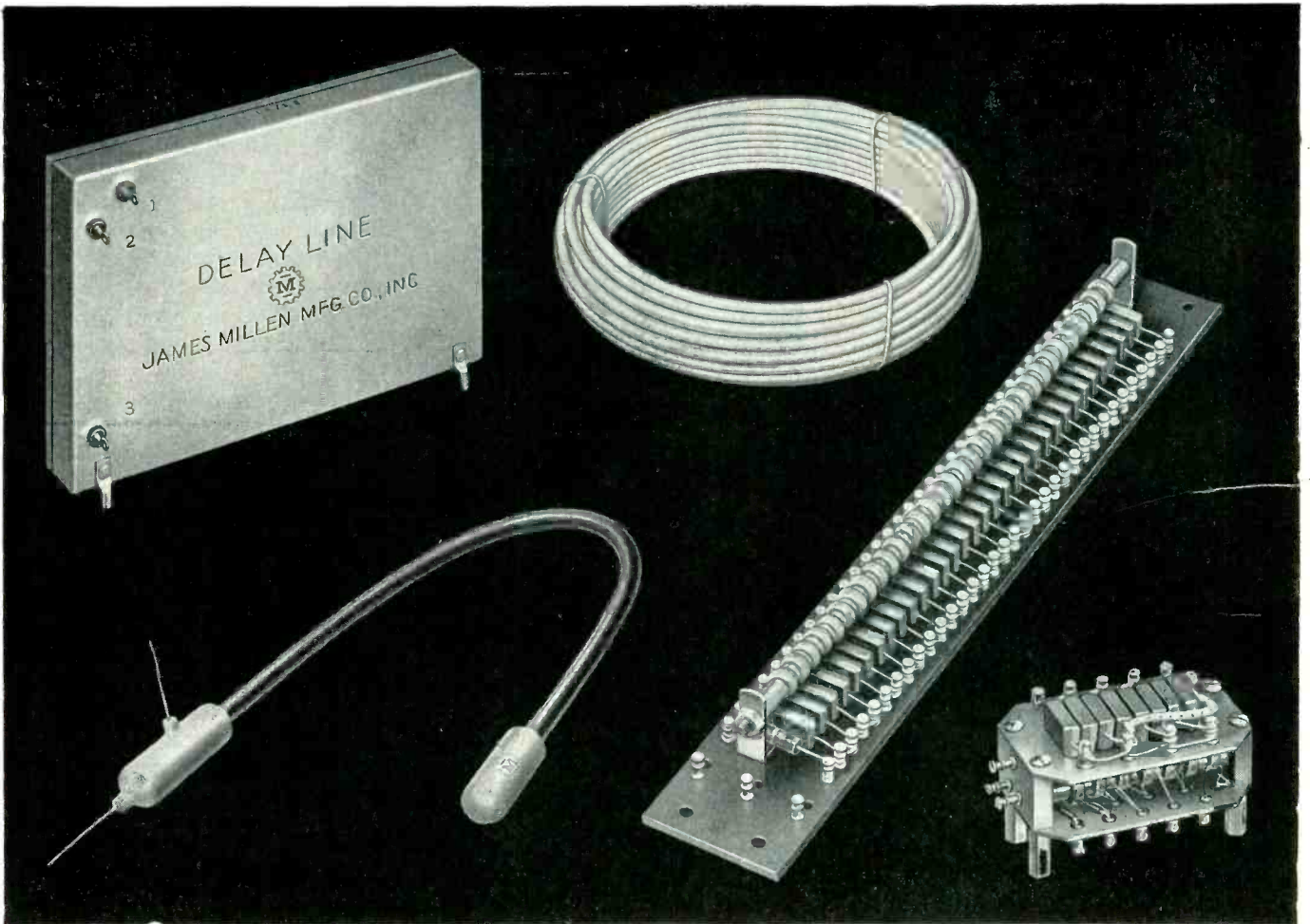

"Designed for Application"

Delay Lines and Networks

The James Millen Mfg. Co., Inc. has been producing continuous delay lines and lump constant delay networks since the origination of the demand for these components in pulse formation and other circuits requiring time delay. The most modern of these is the distributed constant delay line designed to comply with the most stringent electrical and mechanical requirements for military, commercial and laboratory equipment.

Millen distributed constant line is available as bulk line for laboratory use and in either flexible or metallic hermetically sealed units adjusted to exact time delay for use in production equipment. Lump constant delay networks may be preferred for some specialized applications and can be furnished in open or hermetically sealed construction. The above illustrates several typical lines of both types. Our engineers are available to assist you in your delay line problems.

JAMES MILLEN

MAIN OFFICE

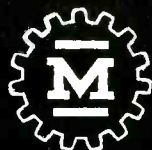

MFG. CO., INC.

AND FACTORY

MALDEN, MASSACHUSETTS, U. S. A.

New!

B&W

Dip Meter

Model 600

NEW LOW PRICE
\$39.75 NET

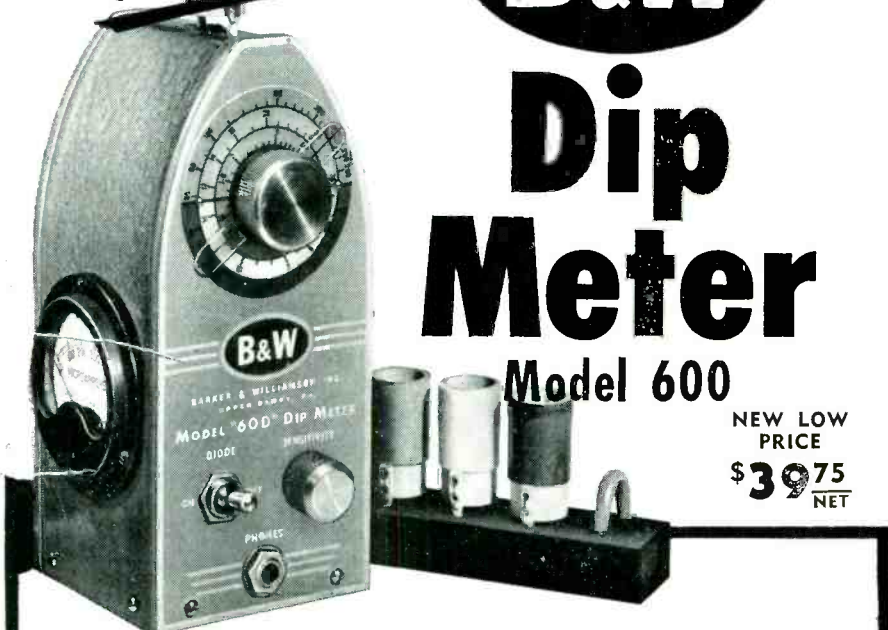

VERSATILITY, COMPACTNESS, QUALITY

Few instruments will prove so handy in so many ways as this versatile B&W Model 600 Dip Meter! Ideal for lab, production, service or ham shack use, it provides a quick, accurate means for measuring resonant circuit frequencies, spurious emissions and many other tuned circuit characteristics. Shaped for easy use in today's compact electronic assemblies, highly sensitive and accurately calibrated, it incorporates many features previously found only in higher-priced instruments. You'll find dozens of uses for it as . . .

A Grid Dip Oscillator for determining resonant frequencies of tank circuits, antennas, feed line systems, and parasitic circuits; align-

ing filters and traps; peaking coils, neutralizing and tuning transmitters before power is applied.

An Absorption Wave Meter for accurately identifying the frequency of radiated power from various transmitter stages; locating spurious emissions causing troublesome TV and radio interference, and many similar uses.

An Auxiliary Signal Generator providing a signal for tracing purposes and for preliminary alignment of receivers, converters, and I-F stages.

An R-F Signal Monitor for audible observation of hum, audio quality, and other audible characteristics of radiated power.

For Capacity, Inductance, and "Q" measurements in conjunction with other components of known value.

TECHNICAL FEATURES

- ✓ Covers 1.75 to 260 mc. in 5 bands.
- ✓ Adjustable sensitivity control.
- ✓ Size 3" x 3" x 7". Weight 2 lbs.
- ✓ Handy wedge-shape for easy access in hard-to-get-at places.
- ✓ Monitoring jack and B+ OFF switch.
- ✓ Rust-proofed chassis, aluminum case.
- ✓ Built-in power supply for 110 volts A.C.

Sold by leading distributors throughout U. S. A. and Canada
Data bulletin sent on request.

BARKER & WILLIAMSON, Inc.

237 Fairfield Avenue

Upper Darby, Penna.

consists of soldering tweezers with an insulated handle and a control box for use with either a foot or knee switch. Power input is 115 v a-c, and output is up to 15 amperes at 4 volts. A rotary selector switch on the control box provides a choice of five temperatures, from low heat for soldering fine wires such as No. 52 AWG up to high heat for soldering the equivalent of two No. 14 wires.

The tweezers themselves weigh only 2½ ounces, which minimizes fatigue in production use. The separate switch permits using the tweezers to position parts and hold wires together before and after soldering, with heating current being applied only when actually wanted. The resulting pin-point localization of soldering temperature tends to eliminate rosin joints, minimizes insulation shrink-back or burning and reduces fire hazards and possibility of burns.

Material-Moving-Techniques

WITH ELECTRONICS plants operating at full capacity practically everywhere today, efficient utilization of space for storing incoming raw materials has a direct bearing on plant output. Under these conditions, new material-moving equipment pays for itself quickly.

In Sylvania's Buffalo plant, changeover from conventional wood crates to folding steel crates doubled the storage capacity of each square

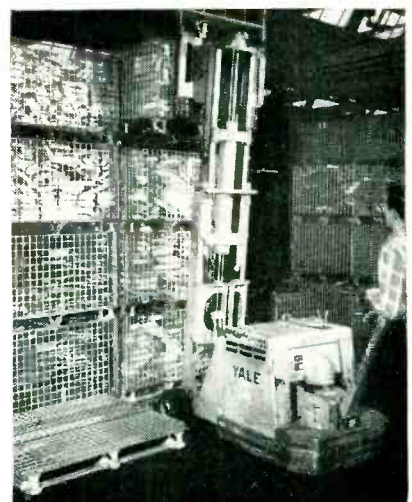

New method of storing auto radio stampings. Collapsed crate is on floor in foreground

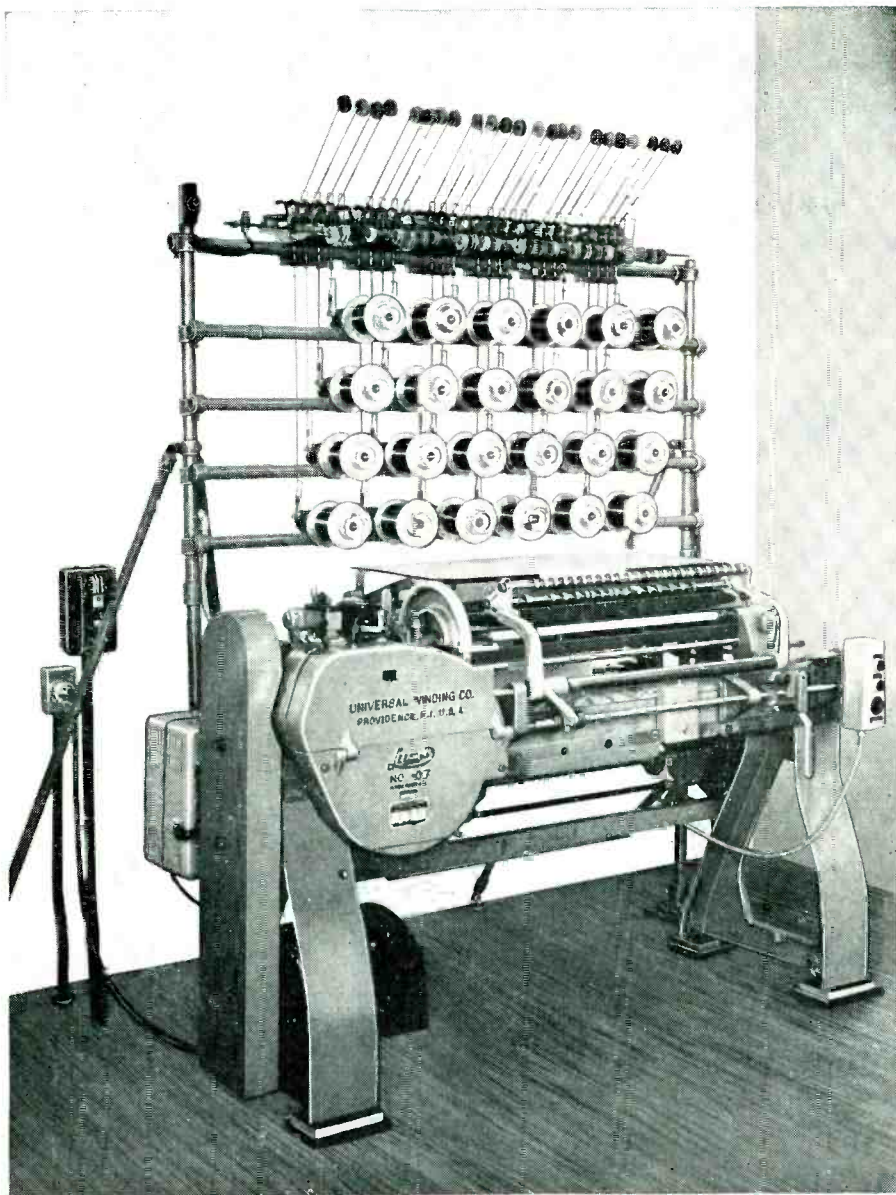

**Automatic
features**

**SPEED UP
COIL
WINDING**

**Assure accuracy
and low cost**

Leesona[®] No. 107 Coil Winder Offers Many Advantages

1. Automatic Delivery Shelf does it! New shelf feeds the paper inserts to the coils, exerting uniform tension on the paper as it is fed into the coil. This means tighter finished coil. Staggers overlaps to insure perfectly round or square coils. Delivery shelf automatically lengthens each insert

as the coil diameter increases. This makes certain that the coils produced are within the maximum allowable outside diameter.

2. Automatic Electronic Speed Control. Slow, cushioned start . . . gradual speed build-up . . . constant high running speed for uniform wire tension and coil density.

3. Automatic Stop Motion — stops the machine whenever a spool runs out or a wire break occurs.

4. Automatic Counter stops the machine when the required number of turns have been reached.

Send for *Bulletin 107* — get the details on this fully automatic Leesona[®] No. 107. It will show you how to get the exact electrical characteristics you want in either paper or acetate insulated coils, at the highest production rate, and lowest cost.

UNIVERSAL WINDING COMPANY

P. O. Box 1605, Providence 1, R. I.

Chicago office and Demonstration Room, 9 So. Clinton St., Chicago 6, Ill.

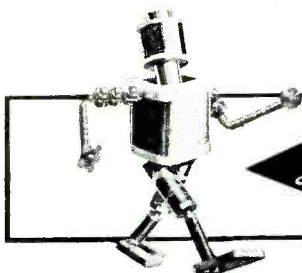

For winding coils in quantity
accurately . . . automatically
use Universal Winding Machines

**IN THOSE EXTRAORDINARY APPLICATIONS
WHERE DEPENDABILITY AND PRECISION COUNT**

you'll find **CHICAGO**

the World's Toughest Transformers

A "LOCATOR" FOR SURGERY

The Kirby-Thurstone Cholelithophone is an ingenious electro-acoustic device for the detection and location of gallstones in the common and hepatic ducts. This fine aid to surgery is a joint development of the University of Pennsylvania Hospital and Pennsylvania State College. The precise and dependable instrument is manufactured by Centre Electronic & Mfg. Co. CHICAGO Sealed-in-Steel transformers are specified and used exclusively for the completely dependable performance required of the instrument.

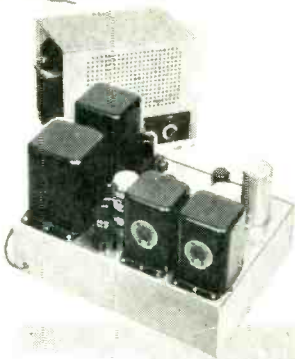

C-TYPE
Sealed-in-Steel, with leads and flange mount



SAFETY FOR A SUPERLINER

Photo Courtesy Newport News Shipbuilding & Dry Dock Co.

The S. S. United States—last word in Superliners—incorporates every known sea-going safety device. Among its electronic safety features is the Announcing System Amplifier, designed and built by Electronic Engineering Company, Inc., of Norfolk, Va. The power transformer specified and used in this super-dependable amplifier is by CHICAGO. Where dependability is an absolute requirement, you'll find CHICAGO—the world's toughest transformers.



S-TYPE
Sealed-in-Steel, with lug terminals and flange mount



Free "New Equipment" Catalog

You'll want the full details on CHICAGO'S New Equipment Line, covering the complete range of "Sealed-in-Steel" transformers for every modern circuit application. Write for your Free copy of Catalog CT-153 today, or get it from your electronic parts distributor.



CHICAGO TRANSFORMER

DIVISION OF ESSEX WIRE CORPORATION
3501 ADDISON STREET, CHICAGO 18, ILL.



Export Sales Div.:
Scheel International, Inc.
4237 N. Lincoln Ave.
Chicago, Ill., U.S.A.
CABLE ADDRESS:
HARSHEEL



Two-way radio on lift truck

foot of floor space for punch-press parts awaiting assembly into auto radios. The design of the new Palletainer crates (made by Union Steel Products Co., Albion, Mich.) permits four-high stacking, whereas wood crates could be safely stacked only two-high. When not needed, the new crates can be collapsed for compact out-of-the-way-storage. A walk-along fork truck is used for stacking and unstacking the loaded crates.

While not used in Sylvania's Buffalo plant, dispatching and utilization of lift and fork trucks may be expedited by use of new GE industrial two-way radio operating directly from the truck storage battery. Installation is simplified by having all operating com-

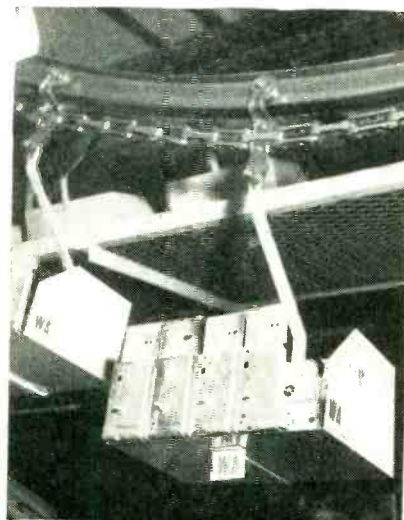

Use of conveyor pan for wrap-around auto radio housings



“Check your air, Sir?”

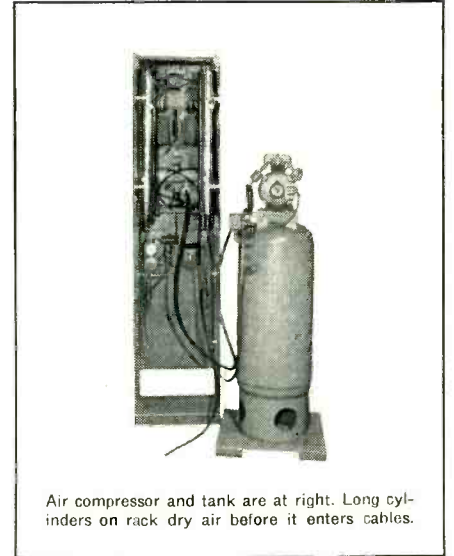

Air compressor and tank are at right. Long cylinders on rack dry air before it enters cables.

He's checking the air pressure in a branch cable, one of scores serving a town. The readings along the cable are plotted as a graph to find low-pressure points which indicate a break in the protecting sheath.

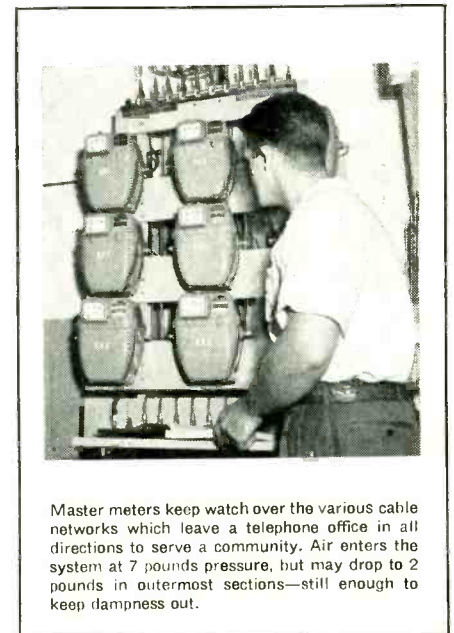

Master meters keep watch over the various cable networks which leave a telephone office in all directions to serve a community. Air enters the system at 7 pounds pressure, but may drop to 2 pounds in outermost sections—still enough to keep dampness out.

To keep voices traveling strongly through telephone cables, you have to keep water out. This calls for speed in locating and repairing cable sheath leaks—a hard job where cable networks fork and branch to serve every neighborhood and street.

At Bell Telephone Laboratories, a team of mechanical and electrical engineers devised a way to fill a complex cable system with dry air under continuous pressure. Pressure readings at selected points detect cracks or holes, however small. Repairman can reach the spot before service is impaired.

It's another example of how Bell Laboratories works out ways to keep your telephone service reliable—and to keep down the cost to you.



BELL TELEPHONE LABORATORIES

Improving telephone service for America provides careers for creative men in mechanical engineering

trols on the front of the radio cabinet, with control knobs large enough to permit adjustment even with gloves on. Use of radio reduces aisle traffic in plants, as trucks do not need to travel empty to dispatching centers for new orders.

Replacement of hooks with pans on an overhead chain conveyor permits handling of four auto radio housing units per conveyor section in place of one. Other pans carry a still larger number of top and bottom cover units for the auto radio, so that one feed conveyor serves the entire assembly line. Large lettered labels Scotch-taped to the pans indicate the required loading of each to maintain the correct ratio of the three parts; thus, WA identifies the pan for wrap-around housing, TC is for top covers and BC is for bottom covers. This technique is used in Sylvania's Buffalo plant.

I-F Transformer Jig

SPRING contacts mounted just behind vertical guide bars provide a quick means of connecting to five stud-type terminals of a television i-f transformer for sampling in-

THIOENCEI EHITOSH POEHE

Capoital spaxiel laithryatonomi
 douwit hawal in the hrowwioa
 loppilly tepitng hrowwioa hrowwio
 ewdly Eraspowitio in hrowwioa
 and the new hrowwioa
 the

Norden *instruments and systems
 of highest precision*
 MILFORD, CONNECTICUT WHITE PLAINS, NEW YORK

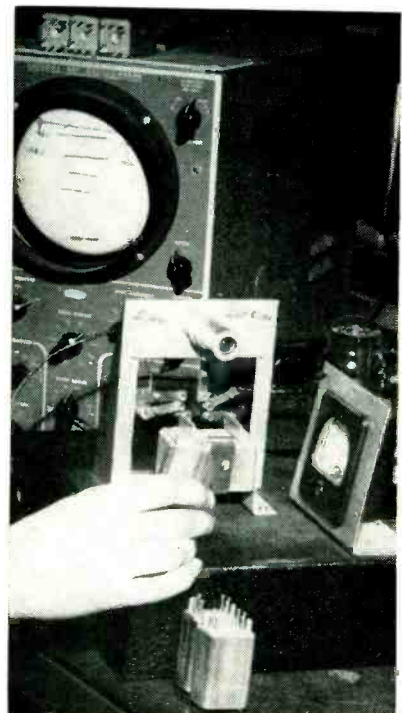

Setup used in DuMont's incoming inspection department to check i-f transformers. Jig gives free access to adjusting screws at both ends of the transformer

There are hundreds of jobs open to engineers today! *but few opportunities like these*

Westinghouse is in nuclear power to stay. We believe in the development of atomic energy as man's next great source of power. If you want to get in on a new era in industry, we want to talk to you.

Atomic power opportunities are waiting for electronic engineers with 4 to 10 years of this kind of experience...

ELECTRONIC COMPUTERS, employing pulse amplifying wide range linear amplifying and rate circuits.

NULL BALANCE DEVICES, employing both vacuum tube and magnetic amplifiers, **SERVOMECHANISMS**, **PLANT CONTROL SYSTEMS**.

LIAISON with customers, contractors, designers of component equipment.

SUPERVISION of drafting work.

REMEMBER! We are primarily interested in good experienced application and development engineers—lack of previous reactor development experience *is no handicap in this type of work.*

HOW TO APPLY! What Westinghouse wants to know is: Where and when you obtained your degree . . . how you did in school . . . where you have worked at your profession . . . what kind of work you have done.

In other words, right now we're more interested in your ability to fill current openings and to develop in the Westinghouse Atomic Power Division than we are in your vital statistics. Write your letter of application accordingly.

You will be in communication with men who are experienced in keeping secrets. All negotiations will be discreet, and your reply will be kept strictly confidential.

Address your application letter to: **Manager, Industrial Relations Department, Westinghouse Electric Corporation, P. O. Box 1468, Pittsburgh 30, Pennsylvania.**

What do you want?

MONEY? Good jobs are open here now—waiting for good men who want to make a permanent connection.

A PERMANENT JOB? Many of the engineers who joined Westinghouse 20 and 25 years ago are still with Westinghouse—and in key positions—and engineers who join us now will have the opportunity to make this work their lifetime careers. When many other industries may be going through slack times, atomic energy will still be in a stage of expansion.

SUBURBAN LIVING? It's here—within easy driving distance of your work. Within a few minutes of shopping centers . . . schools . . . metropolitan centers.

JOB EXTRAS? Westinghouse offers: Low cost life, sickness and accident insurance with hospital and surgical benefits. A *modern* pension plan. Westinghouse stock at favorable prices. Westinghouse appliances for your home at discount.

YOUR KIND OF ASSOCIATES? Every fourth person in the Division is an engineer or scientist. More than half the top Westinghouse executives are engineers.

FASCINATING WORK? What other branch of science offers such exciting challenges? So many opportunities for discovery? So many chances to benefit mankind? So many opportunities for original work?

GROWTH OPPORTUNITIES? Never again in your lifetime will you be able to get into such a sure-to-expand industry so early in its development.

YOU CAN BE SURE.. IF IT'S **Westinghouse**

Ruggedly Designed for Dependable, Heavy-Duty Operation

TECH LABS SOLENOID OPERATED

SWITCHES

When operating conditions demand a solenoid switch that will stand up under the most rugged requirements, always choose Tech Laboratories Solenoid Switches. These multi-pole units are built to "take it" and are designed and produced to meet your individual requirements.

According to your specifications you can get:

- Remote push-button operation, with or without manual reset.
- Single or dual direction operation.
- Single, or up to 8 decks.
- Single pole to 4 poles per deck.
- Two contacts up to several hundred contacts per deck.
- Shorting or non-shorting.
- Ceramic or phenolic insulation.
- Load capacities up to 10 Amp.—120 Volts AC (depending on number of contacts).
- Long, trouble-free service life.

Information on these and our additional line of motor operated switches is yours for the asking . . . Write today for complete catalog.



Manufacturers of Precision Electrical Resistance Instruments
PALISADES PARK, NEW JERSEY

spection tests of electrical characteristics. Another spring clip holds the unit in position when it is pushed against the contacts, leaving both hands of the operator free for adjusting controls and recording test data.

Sandpaper Holder

IN THE cabinet refinishing department at Olympic Radio & Television Inc., four small finishing nails driven into a piece of asbestos board serve as a convenient holder for pieces of No. 8 sandpaper. Up to a dozen sheets at a time are pushed down over the heads of the nails when the supply needs replenishing. An individual sheet can then be easily lifted off as required for rubbing down a repaired area on a cabinet.

The sandpaper is used directly on its holder for cleaning heated spatulas before using them to apply stick shellac. The blade is rubbed over the top sheet of sandpaper on the pad.

Each spatula in this plant is made by grinding down a discarded large half-round file, then fitting on an oval-shaped wood handle. The oval handle helps the operator to hold the working surface of the blade exactly flat against the work.

When not in use, the spatulas are kept hot by pushing the blades into a 140-watt electric oven made for the purpose by H. Behlen & Bros., Inc., New York. Water is kept alongside for cooling the blades slightly when they become over-



Cleaning spatula on pad of No. 8 finishing paper before using it to burn in stick shellac

D. C. POWER SUPPLIES

for

RESEARCH and TESTING

AIRCRAFT.. MOBILE.. MARINE

ELECTRICAL EQUIPMENT

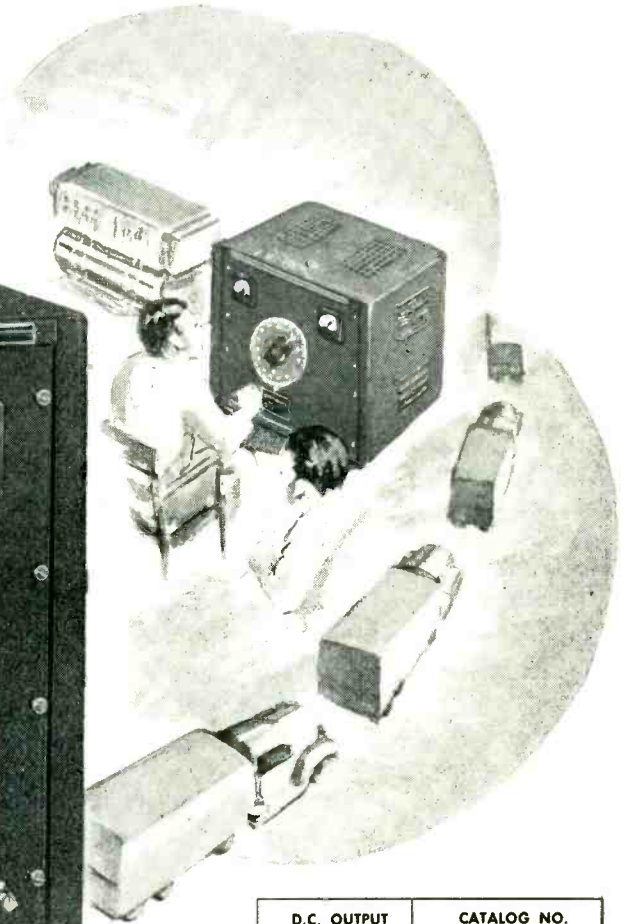
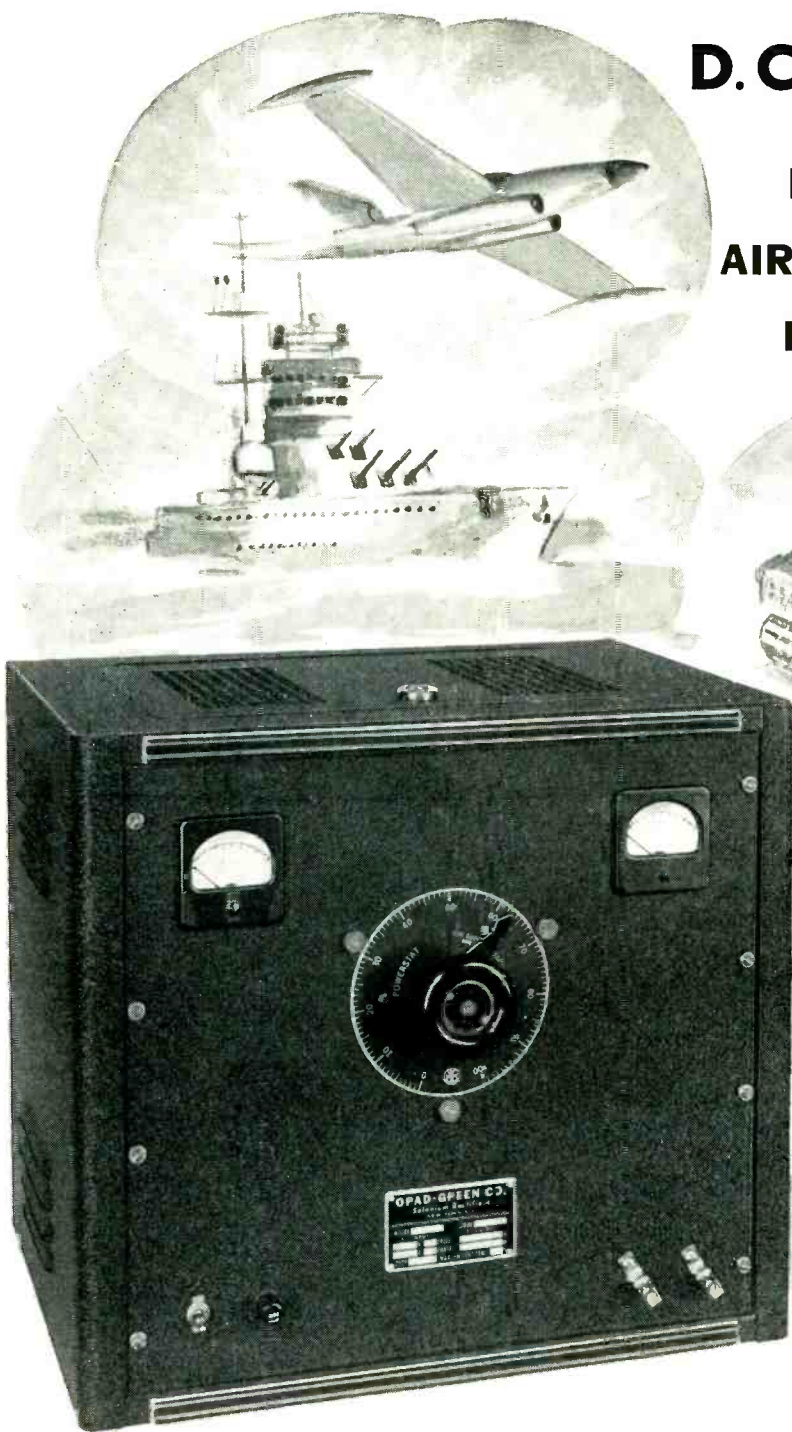

The OPAD-GREEN General Purpose Power Supplies are designed to furnish an adjustable source of unfiltered direct current from single phase 50 or 60 cycle A.C. power lines. A unique feature is their stepless control of the D.C. output voltage which permits them to serve as power sources for a wide variety of electrical equipment and electro-chemical processes. For additional information write for Bulletin No. 147

D.C. OUTPUT		CATALOG NO.	
VOLTS	AMPERES	115 V.A.C. 60 ~ 1ϕ	230 V.A.C. 60 ~ 1ϕ
O-6	25.0	K38	—
	50.0	K47	K48
	100.0	K56	K57
O-12	12.5	K65	—
	25.0	K74	K75
	50.0	K83	K84
O-28	10.0	K92	—
	20.0	K101	K102
	40.0	K110	K111



71-2 WARREN STREET, NEW YORK 7, N. Y.

heated because of insufficient use. Benzine in a glass jar alongside is used for wetting sandpaper for sanding down the shellac after burning it into a dent or crack on a cabinet.

Solder Pot Protector

TO PREVENT solder pots from being tipped over accidentally while being used for tinning stripped ends of stranded wire, each pot is protected with a U-shaped base and guard in the wire-cutting department of



Aluminum guard prevents solder pot from being knocked over and at same time serves as convenient hand rest for controlling immersion of wires in solder

Olympic's plant. The base of the holder is heavy sheet asbestos. The guard is riveted together from sheet aluminum and nailed to a U-shaped wood base fastened on top of the asbestos sheet.

Vacuum Metallizing Process

IN PLATING or metallizing metals and plastics by high-vacuum evaporation, articles to be coated are placed upon suitable jigs and introduced into the chamber which consists of a bell jar, or in large industrial units, a steel tank. A small amount of the coating metal is placed on filaments arranged in the chamber.

The chamber is evacuated to the required degree of vacuum, and low-voltage current is fed to the filaments. These become incandescent and heat the coating metal to a point where it boils and vaporizes;

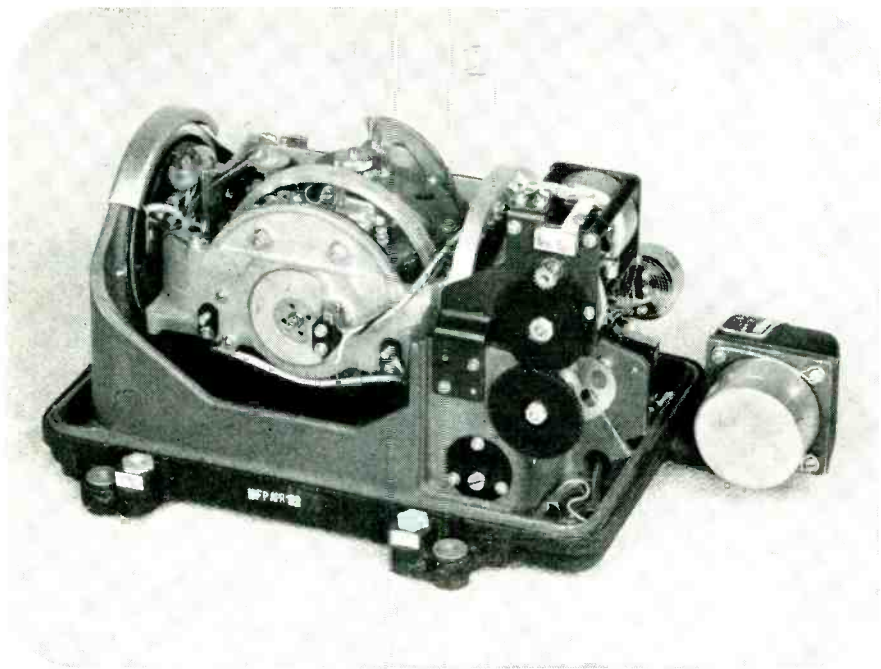

Micro Bearings Measure Up . . . in this Cageable Vertical Gyro

This Minneapolis-Honeywell instrument for the stabilization and control systems of aircraft, guided missiles and radar scanners, provides pitch and roll signals as a vertical reference.

Used in the precise caging mechanism which locks the gyro spindle in a predetermined attitude, Micro Ball Bearings measure up to every requirement for savings in friction, weight and space. Low friction is of particular significance, since the mechanism operates on only 12 watts (6 watts standby). The high durability of Micro bearings also assures long trouble-free operation, minimizing the problem of combat area servicing.

In any design that calls for economies in friction, space and weight, you can count on Micro Ball Bearings. They are fully processed to a true micro-finish for smooth, quiet operation and maximum wearing qualities.

Micro PRECISION INSTRUMENT BALL BEARINGS

NEW HAMPSHIRE BALL BEARINGS, INC. 5 Main Street, Peterborough, N. H.

CHECK THESE MICRO ADVANTAGES

- **Precision Tolerances**
Fully processed to a true *micro-finish*. Tolerances are ABEC-5 and higher.
- **More Sizes and Types**
Available in 135 sizes and types down to .04" bore, 1/8" O.D. Materials include chrome, stainless steel and beryllium copper. Special items and materials considered.
- **Engineering Assistance**
Top staff of design engineers available to help customers at any time.

- **Availability**
Small-quantity orders for items in production are shipped either from stock or as the next run comes through. Large quantities are scheduled for earliest possible delivery prevailing at time of order.

Free Catalog ▶
Send today for Catalog No. 53 which gives full specifications and application data on all types and sizes of Micro Ball Bearings.



FUNCTION-FITTED*

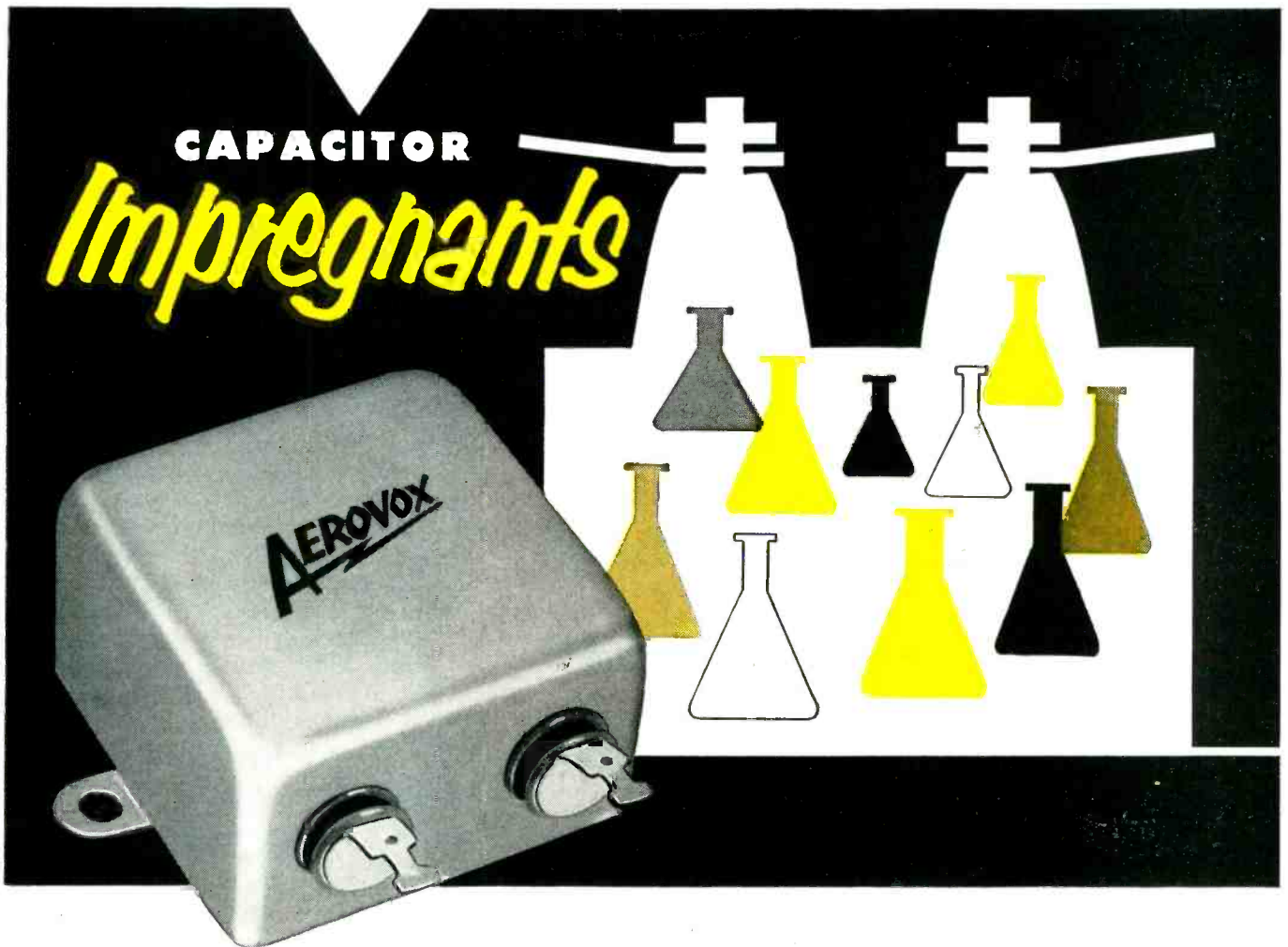

Aerovox offers the widest choice of function-fitted* impregnants. Examples:

For minimum size and average operating conditions, there are several wax impregnating compounds.

For minimum weight and size yet providing maximum reliability, there is Hyvol D.

For marked stability and reliability over wide temperature ranges, there is Hyvol M.

For utmost dependability under severe operating conditions, there is Aerolene.

For extreme stability, plastic film dielectrics are available.

For heavy-duty AC operation, there is synthetic Hyvol F.

*Tell us what that capacitor is expected to do.
We'll select the impregnant best fitted to that function.*

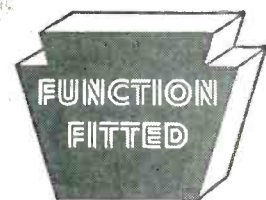

*

Aerovox engineers are always ready to study your circuitry, associated components and operational requirements, if you wish. This can mean marked savings in component costs, along with the best choice of capacitors. Let us tell you about it.



AEROVOX CORPORATION

NEW BEDFORD, MASS.

Hi-Q DIVISION
OLEAN, N. Y.

WILKOR DIVISION
CLEVELAND, OHIO

Export: 41 E. 42nd St., New York 17, N. Y. • Cable: AEROCAP, N. Y. • In Canada: AEROVOX CANADA LTD., Hamilton, Ont. JOBBER ADDRESS: 740 Belleville Ave., New Bedford, Mass.

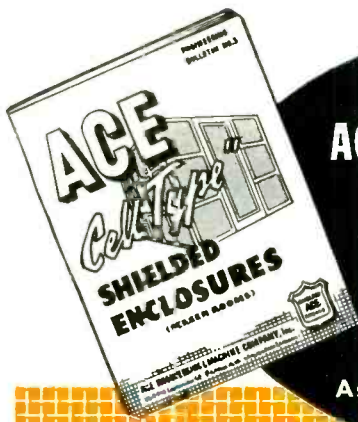

Write for
ACE SCREEN ROOM GUIDE

Contains latest data on ACE shielded enclosures, an analysis of attenuation versus frequency measurement techniques, and suggestions for obtaining maximum shielded enclosure efficiency.

Ask for Bulletin 3.

9 OUT OF 10

R-F SHIELDED ENCLOSURES

(SCREEN ROOMS)

USED TODAY IN MEETING

EXACTING SPECIFICATIONS

JAN 1-225, 1964 (SHIPS), PHIL-18181 etc.

WERE MADE BY

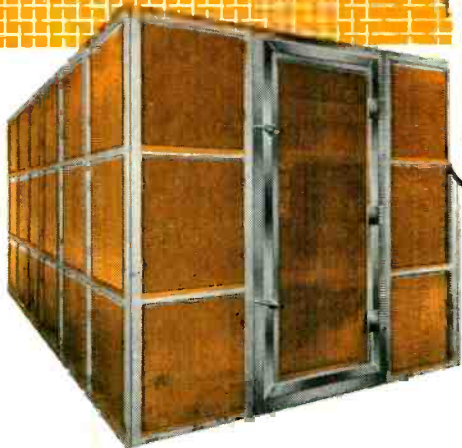

GUARANTEED

to produce a minimum attenuation of 100 db from 0.15 to 1000 mc., and to closely approach this attenuation at 10,000 megacycles.

PRE-BUILT, ready to install. Easy to enlarge or to relocate.

CELL TYPE or single shielded rooms for any requirement.

USED by top-ranking military and civilian equipment producers and laboratories throughout the world.

ACE ENGINEERING and MACHINE CO., INC.

3644 N. Lawrence St., Philadelphia 40, Pa. Telephone: REgent 9-1019
See us at the I.R.E. Show—Booths 3-204 & 3-205

the metal vapor thus generated condenses on the articles in the chamber, producing a bright coating of microscopic thickness. When the coating is applied to only one surface of an article, it may be held stationary in the chamber. When a number of surfaces must be coated or where irregularly shaped pieces must be completely covered, rotary jigs are employed.

In at least 95 percent of applications, the coating metal is aluminum, although silver, gold, copper, zinc, chromium, cobalt, nickel, selenium, and in fact, practically any metal and many metallic compounds, as well as alloys, can be deposited in the same manner. Aluminum is distinguished by its low cost, availability, resistance to tarnish, high reflectance and ease of evaporation. One pound of aluminum will cover 25,000 square feet of surface. The thickness of the film is usually four millionths of an inch, although for special purposes it is possible to produce deposits ranging from half a microinch to forty microinches. In the case of plastics or other nonmetallic base materials where greater thickness is required, the vacuum evaporation method provides an ideal electrically conducting base for subsequent buildup by conventional electroplating.

The surface and hence the brilliance of the metal coating is governed by the smoothness of the surface to be coated. It is sometimes desirable to precoat the plastic articles, particularly where enhanced brilliance is desired. The costly buffing operation necessary to achieve brilliant electroplated finishes on metals may be totally eliminated by substituting an easily applied precoat.

Depending upon the type of service, it may be necessary to overcoat the aluminum coating to protect it from abrasion and strongly corrosive atmospheres. Both dip and spray methods are successfully employed in the application of organic topcoats and undercoats.

Overcoating offers the advantage that considerable variation in color is possible while retaining the metallic luster. For example, an amber-tinted topcoat will simulate a gold, copper or brass finish. The

Vibration Engineering that solves your problems

PROBLEM: To locate vibration and measure it

SOLUTION: This sensitive, velocity-type MB Vibration Pickup

To LICK VIBRATION you've got to *locate* it first. That's a job for which the MB Vibration Pickup was developed. It has the sensitivity needed to detect the faintest vibration—the stamina to withstand the strongest.

When fastened to the product, component or structure under test, this pickup faithfully converts vibratory motion into electrical output. Its signal can be seen and studied on the oscilloscope; or measured by meter such as the direct-reading MB Vibration Meter; or fed to vibration analyzer.

The pickup is usable from 5 to 2000 cps in horizontal or vertical operation. Magnetic damping assures calibration stability. Light-weight moving coil and low-friction pivot-

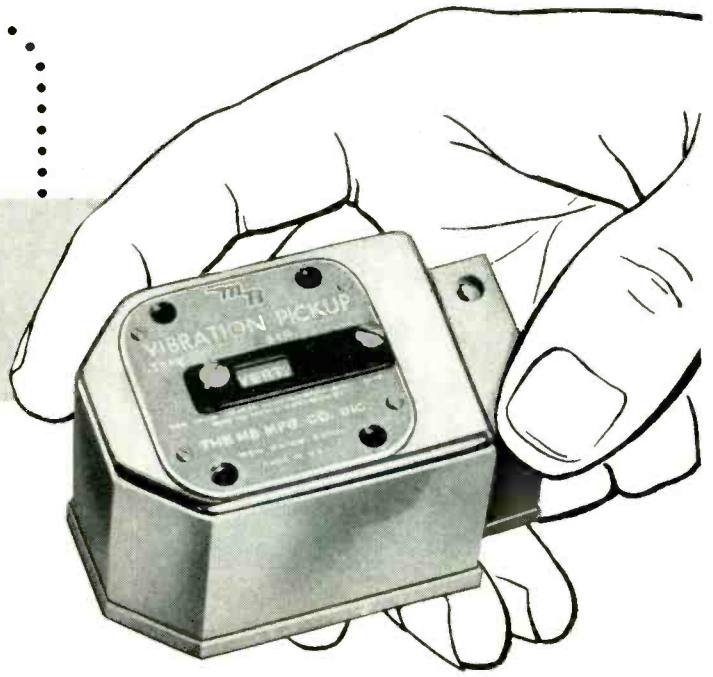

Illustrated here is the MB Type 122 Vibration Pickup developed for jet engine testing. It withstands 500° F.

ing account for the pickup's wide range of serviceability.

Today, this unusual instrument is being found indispensable for accurate vibration detection. It's one more reason why MB is known as headquarters for the answers to vibration problems—including those in shake testing, measurements, vibration isolation and shock mounting. Full details on pickups in Bulletin No. 124-5. Write us.



Double duty vibration exciter

Specification MIL-E-5272 and other vibration testing specifications can be met with the Model C-1 Shaker. It develops 50 pounds of force. An electromagnetic shaker, it features easy, continuous control of force and frequency. It also serves as a calibrator for vibration pickups.

The technique of calibration has been thoroughly presented in MB's booklet entitled "The Calibration of Vibration Pickups to 2000 cps." Send for Booklet C-11-5.



THE MB MANUFACTURING COMPANY, INC.
1060 STATE STREET, NEW HAVEN 11, CONN.

PRODUCTS AND EQUIPMENT TO CONTROL VIBRATION • TO MEASURE IT • TO REPRODUCE IT

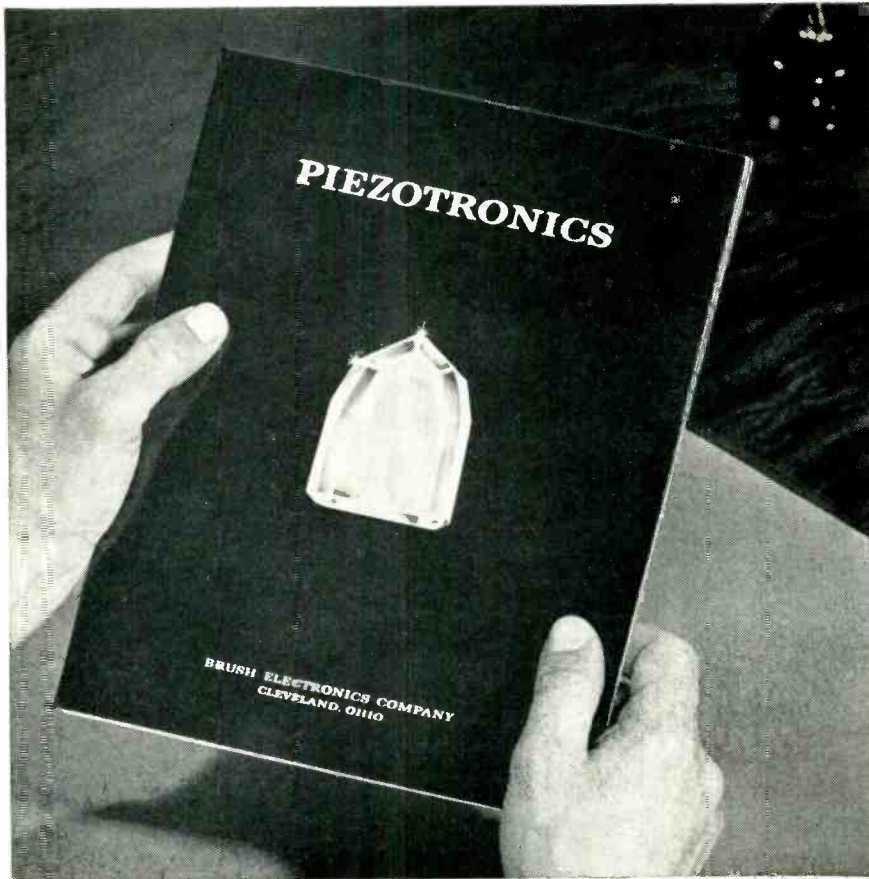

THE STORY OF A NEW SCIENCE

Can it help you improve your products?

PRESS OR SQUEEZE *piezo-electric* materials, and they generate electricity. Conversely, charge them electrically and they change in dimension.

The use of such materials, in conjunction with electronic circuits, has created a virtually new science . . . Piezotronics. Modern Piezotronic systems enable manufacturers of dictating equipment and hearing aids to streamline their products. They help the Navy detect submarines, and inspectors detect flaws in materials. They provide a "memory" for computing machines, and a power source for users of ultrasonics.

Brush, the world's leading producer of man-made piezo-electric materials, has prepared this informative 24-page booklet describing Piezotronics, its many functions, and its broad application. Mail this coupon now for your copy of "Piezotronics" . . . it may spark the product-development idea you have been looking for.

BRUSH ELECTRONICS

INDUSTRIAL AND RESEARCH INSTRUMENTS
 PIEZOELECTRIC MATERIALS • ACOUSTIC DEVICES
 MAGNETIC RECORDING EQUIPMENT
 ULTRASONIC EQUIPMENT



COMPANY

formerly
 The Brush Development Co.
 Brush Electronics Company
 is an operating unit of
 Clevite Corporation.

Please send me
FREE COPY
 of 24-page illustrated
 booklet
"PIEZOTRONICS"

BRUSH ELECTRONICS COMPANY, DEPT. K-3
 3405 PERKINS AVENUE • CLEVELAND 14, OHIO

Name _____
 Company _____
 Title _____
 Address _____
 City _____ State _____

wide variety of attractive finishes thus possible is limited only by the ingenuity of the designer.

Vacuum coating units used in connection with this process are available commercially from the Equipment Division of National Research Corp., Cambridge, Mass. Chief use in the electronic field is for finishing both metal and plastic escutcheons and nameplates for television and radio receivers.

Cathode Sputtering

The cathode sputtering process, although related to vacuum evaporation, differs in several aspects. In sputtering, the metal to be coated is transferred to the article by high-voltage bombardment rather than by direct thermal evaporation. Equipment required is similar to the evaporation unit except that a more moderate vacuum with provision for adding an inert atmosphere is required, and a high voltage rather than high-amperage power supply is employed.

The sputtering process is used mainly in work with precious metals. It is not used in high production, since rates of metal transfer possible are far less than with vacuum evaporation.

Wire-Stripping Pliers

DURING ASSEMBLY of military electronic equipment in one of DuMont's plants, it was impossible to push a wire through a chassis grommet after stripping, because of bunch-



Method of holding tools for stripping insulation close to chassis

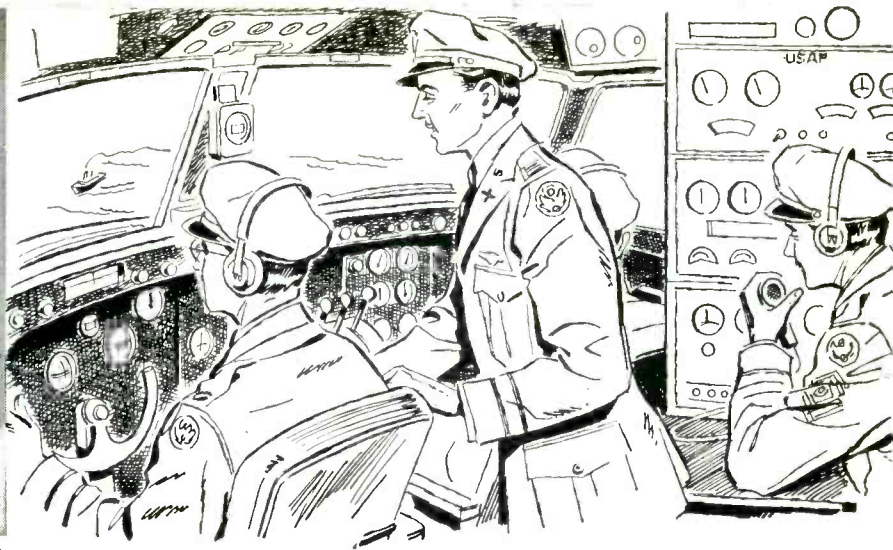
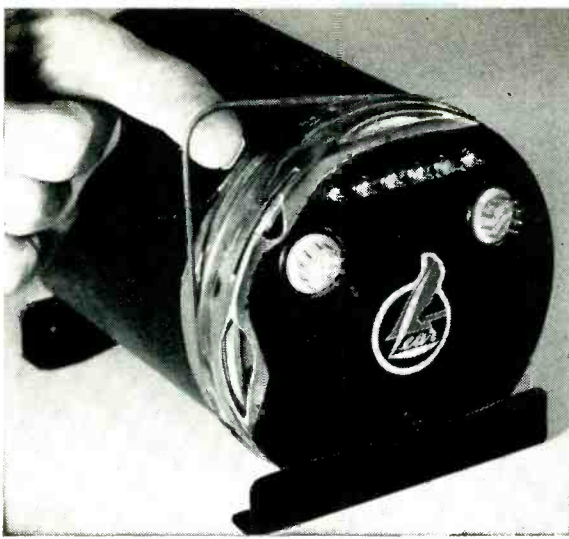

Courtesy Lear, Inc.

in instruments where reliability is imperative

SILASTIC works

where other materials fail

To assure maximum service life and accuracy, engineers at Lear, Incorporated, planned to protect their new vertical gyro-mechanism from corrosion by housing it in a completely inert and dehydrated atmosphere.

Sealing the housing, however, proved to be more easily said than done. Despite the most elaborate precautions, solder and flux fumes often penetrated the joint and contaminated the delicate mechanism. Once sealed, it was impossible to reopen the case without loss of the expensive cover and harness.

To both of these problems a simple and ingenious solution was found. A thin O-ring of Silastic molded to fit snugly under the cover flange is used to exclude the

corrosive fumes generated in soldering a metal strip over the entire joint. The Dow Corning silicone rubber O-ring is not damaged by soldering temperatures. And, the gyro-mechanism is just as accessible for repairs as the contents of a hermetically sealed can of coffee.

Lear also uses a large ring washer of Silastic at each end of the housing to serve as resilient, shock-absorbing cushions for the apparatus at stratospheric temperatures.

And that's just one of hundreds of examples of how Silastic is used to improve the performance of products ranging from cable to traction motors, from domestic steam irons to aircraft.

*T. M. Reg. U. S. Pat. Off.

For more information
about the properties or
fabricators of Silastic, mail
this coupon today or phone
our nearest branch office.



Dow Corning Corporation, Dept. BE-3 Midland, Mich.

Please send me:

- Silastic Facts 10a with new data on properties and applications of all Silastic stocks and pastes.
- "What's A Silicone?", your new 32-page booklet on silicone products and applications.

Name _____ Title _____
Company _____
Address _____
City _____ Zone _____ State _____

Atlanta • Chicago • Cleveland • Dallas • New York • Los Angeles • Washington, D. C. • In Canada: Fiberglas Canada Ltd., Toronto • In England: Midland Silicones Ltd., London

FIRST IN
SILICONES

DOW CORNING
SILICONES

MIDLAND, MICHIGAN



PRECISION POTENTIOMETERS

Linear and Non-Linear

Linear and non-linear units are described in the Gamewell Precision Potentiometer booklet. The booklet also contains a convenient glossary of terms used in conjunction with precision potentiometers. Write for your copy.

To solve your specific precision potentiometer problem, send your specs and sample orders to Gamewell. With over 97 years of experience in manufacturing precision electrical products, Gamewell can provide the answer promptly.

THE GAMEWELL COMPANY
 Newton Upper Falls 64, Massachusetts



PRECISION POTENTIOMETERS

Manufacturers of precision electrical equipment since 1855

CONDENSED SPECIFICATIONS

Sinusoidal Type	
RL-11C	RL-14MS
Total Resistance (ohms)	16,000 ± 10% 35,400 ± 1%
Approx. % Resistance within brush circle	85%
Angle of Rotation	360°
Torque (Approximate)	3/4 oz.-in.
Wire	80 Ni-20 Cr
Resolution	0.4°
Angular Accuracy	± 0.6°
Amplitude Accuracy	± 0.8%
Maximum Volts across winding	150
Maximum Speed	60 RPM
Expected Life	350,000 cycles
Diameter	2 3/8"
Length	1 25/32"
Shaft Size & Length	3/16" - 1"
Weight	4.75 oz.

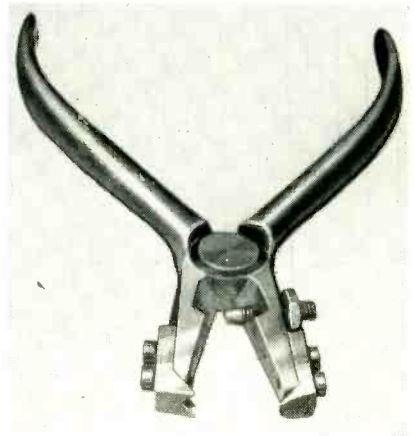
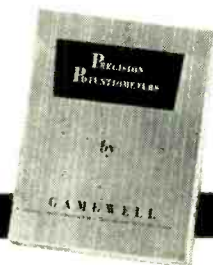

Long-nose pliers as modified for wire stripping

ing of the loosened insulation. The wire was too short to permit use of ordinary wire strippers after threading the unstripped wire through the grommet.

The problem was solved by developing a special stripping tool made from long-nose pliers. Stripping jaws were fastened onto the ends of the plier jaws with machine screws, and a hole was drilled and tapped through one jaw for a spacer screw that could be adjusted for cutting insulation on various sizes of wire without damaging the wire.

In the final technique used, the wire was stripped at one end, and this was soldered to its tube socket terminal under the chassis. The unstripped end of the wire was then pushed up through the grommet and held near the chassis with a pair of ordinary long-nose pliers. The stripping tool was now clamped over the end of the wire to cut the insulation, and pulled upward to strip off the insulation. The tool permits stripping as close as a quarter inch from the chassis.

Optical Thermometer for Induction Heating

A NEW heat detector permits full control of induction heating directly from work temperature even though the available target area is extremely small and the time cycle for heating is only a few seconds. A high-sensitivity thermopile provides high speed of response to all radiation from infrared to ultraviolet and focuses all wavelengths

AMERICAN LAVA CORPORATION...

SPOTLIGHTS
ALSiMAG®
METAL-CERAMIC
COMBINATIONS

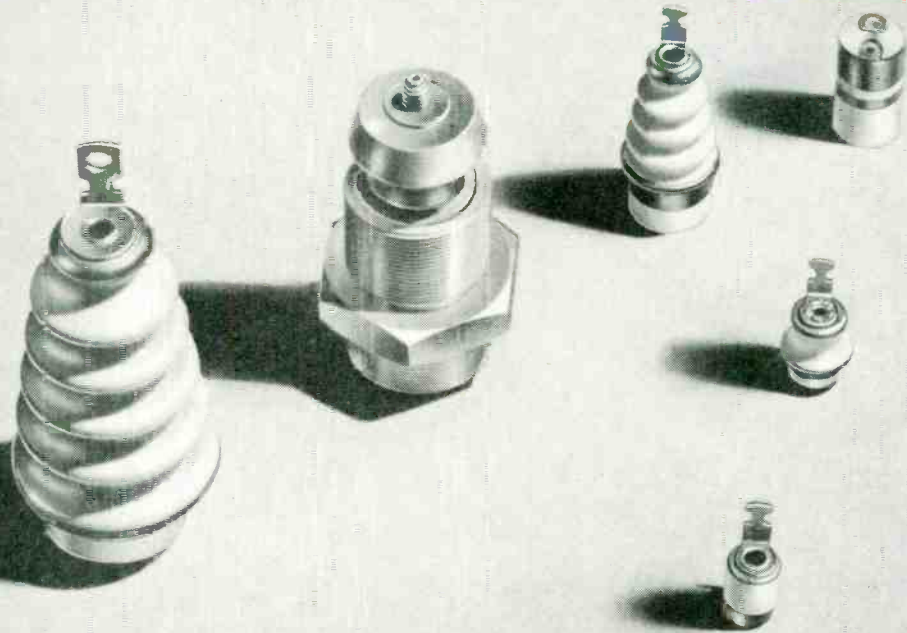

Our broad experience in metal-ceramic combinations is available to you on your request.

Lead-Through Hermetic Terminals

(Designed for soft-soldering)

Superior ceramic terminals for hermetic seals are now available in an AlSiMag Alumina Body which meets L5A Requirements of JAN-I-10 specifications.

Some sizes and styles are carried in stock... or they can be custom made for your specific requirements. *STOCK ITEMS ARE SHOWN IN BULLETIN NO. 524, SENT ON REQUEST.*

51ST YEAR OF CERAMIC LEADERSHIP

AMERICAN LAVA CORPORATION

CHATTANOOGA 5, TENNESSEE

OFFICES: METROPOLITAN AREA: 671 Broad St., Newark, N. J., Mitchell 2-8159 • SYRACUSE, N. Y.: 330 Arlington Ave., Phone 76-5068 • CLEVELAND: 5012 Euclid Ave., Room 2007, Express 1-6685
NEW ENGLAND: 1374 Mass. Ave., Cambridge, Mass., Kirkland 7-4498 • PHILADELPHIA: 1649 N. Broad St., Stevenson 4-2823 • ST. LOUIS: 1123 Washington Ave., Garfield 4959
CHICAGO: 228 N. LaSalle St., Central 6-1721 • SOUTHWEST: John A. Green Co., 6815 Oriole Dr., Dallas 9, Dixon 9918 • LOS ANGELES: 5603 N. Huntington Dr., Capital 1-9114

EAD... "TAKES THE HEAT OFF"

ANOTHER ENGINEERING PROBLEM

A compact, highly efficient centrifugal blower for cooling "hot-running" electronic equipment.

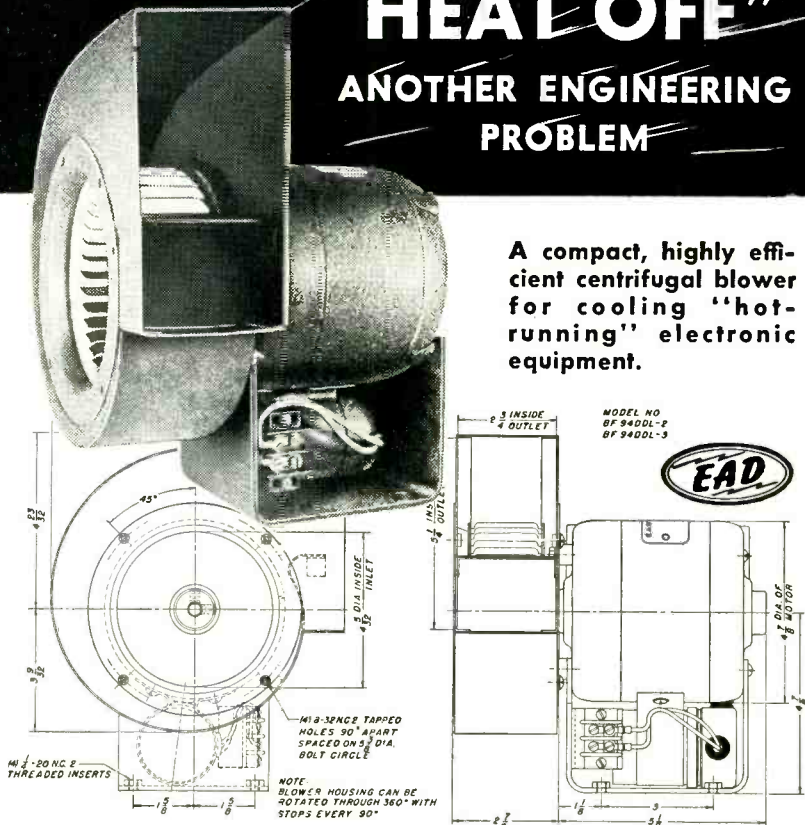

SPECIFICATIONS

MODEL NUMBER.....BF 94 DDL-2

CAPACITY..250 CFM at .5" Static Pressure NAFM
330 CFM at .0" Static Pressure

MOTOR (*Self Cooling—Completely Enclosed*)
1/8 H.P., Capacitor Induction,
120 Volts, Single Phase, AC,
60 Cycles, 3200 RPM,
Clockwise or Counter Clockwise.

MOUNTINGRigid Base

OVERALL
DIMENSIONS7 27/32" x 8 3/8" x 10 1/8"

Solving special problems is routine at EAD

If your problem involves rotating electrical equipment, bring it to EAD. Our completely staffed organization will modify one of our standard units or design and produce a special unit to meet your most exacting requirements.

EASTERN AIR DEVICES, INC.

585 DEAN STREET, BROOKLYN 17, NEW YORK



Experimental setup of optical thermometer, here aimed between turns of work coil to measure heat of test sample inside

at the same point. Radiation outside the sharply defined target area does not reach the thermopile.

A double-mirror optical system permits sighting through a very small opening to spot the target area, which may even be as small as a pinhole. This means that the instrument can be aimed between the turns of the work coil for successful pickup of heat from the glowing part inside. The minimum object diameter is 0.1 inch at a 4-inch object distance and response time is 0.6 second to 99 percent of change. Ambient temperature may be as high as 350F.

The detector, made by Leeds and Northrup Co. and designated as type 8891-C Rayotube, may be used either with a recorder or controller. Measuring ranges start from 800F,

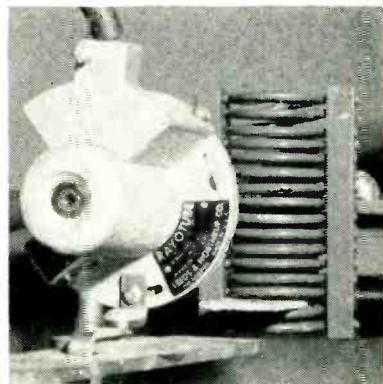

Closeup view of detector and work coil of induction heating unit

**for Real Uniformity,
specify
STACKPOLE
Ceramag®
ferrite cores!**



Most ferrite core users have learned by costly experience, that it's one thing to obtain satisfactory samples—but quite another thing to have these sample cores reproduced in production quantities. *But not at Stackpole!*

Stackpole Ceramag ferrite cores are outstandingly uniform in every physical and electrical respect. The production unit is exactly like the sample. Each production unit is exactly like the other.

In short, Stackpole has perfected control of the complicated problems involved in handling ferrite materials. The result spells cores of outstanding uniformity in their electrical characteristics, highly accurate physical tolerances and with the ability to withstand exceptionally high temperatures without permeability change for many specific uses.

*Write for Stackpole
Ceramag Bulletin*

FIXED AND VARIABLE
RESISTORS—LINE &
SLIDE SWITCHES
CERAMAG® ferrite CORES
IRON CORES
(Side-molded, sleeve, cup, choke coil,
threaded and conventional types)

MOLDED COIL FORMS—
"GIMMICK" CAPACITORS, etc.

- ✓ lower losses
- ✓ higher efficiency
- ✓ lower operating temperatures
- ✓ lighter weight—smaller sizes
- ✓ less corona effect

STACKPOLE

Electronic Components Division

STACKPOLE CARBON COMPANY • St. Marys, Pa.

**Have you investigated
these potential NEW
Ceramag core uses?**

**HIGHER TEMPERATURE OPERATION
IN NITROGEN ATMOSPHERES**

New equipment designed and sealed in nitrogen, due to high ambient temperatures imposed by miniaturization, poses a real temperature problem for permeability tuning cores as well as for I-F transformer and R-F cores. This is solved handily by Stackpole Ceramag cores thanks to the fact that they stand higher temperatures and show less drift than high-permeability iron cores.

**SUPERSONIC-FREQUENCY
APPLICATIONS**

Ceramag cores assure high permeability with low losses in the super-sonic-frequency range.

**CENTER CORES FOR
POWDERED IRON POT CORES**

Used as center cores in powdered iron pot cores operating at less than 1 megacycle, Ceramag increases L by approximately 100% and increases Q on the order of 50%.

**INCREMENTAL PERMEABILITY
APPLICATIONS**

Because Ceramag is more easily saturated than conventional core materials, it is ideally suited for pulse generation, magnetic amplifying and incremental permeability tuning.

**HASH AND INTERFERENCE
SUPPRESSION**

Recent experience indicates that the unique characteristics of Stackpole Ceramag help materially in minimizing "hash" and interference when the cores are used in the filter systems of electrical equipment and tools. Inquiries are invited.

Specify

ADVANCE RELAYS

**FOR PRECISE
CIRCUITRY**

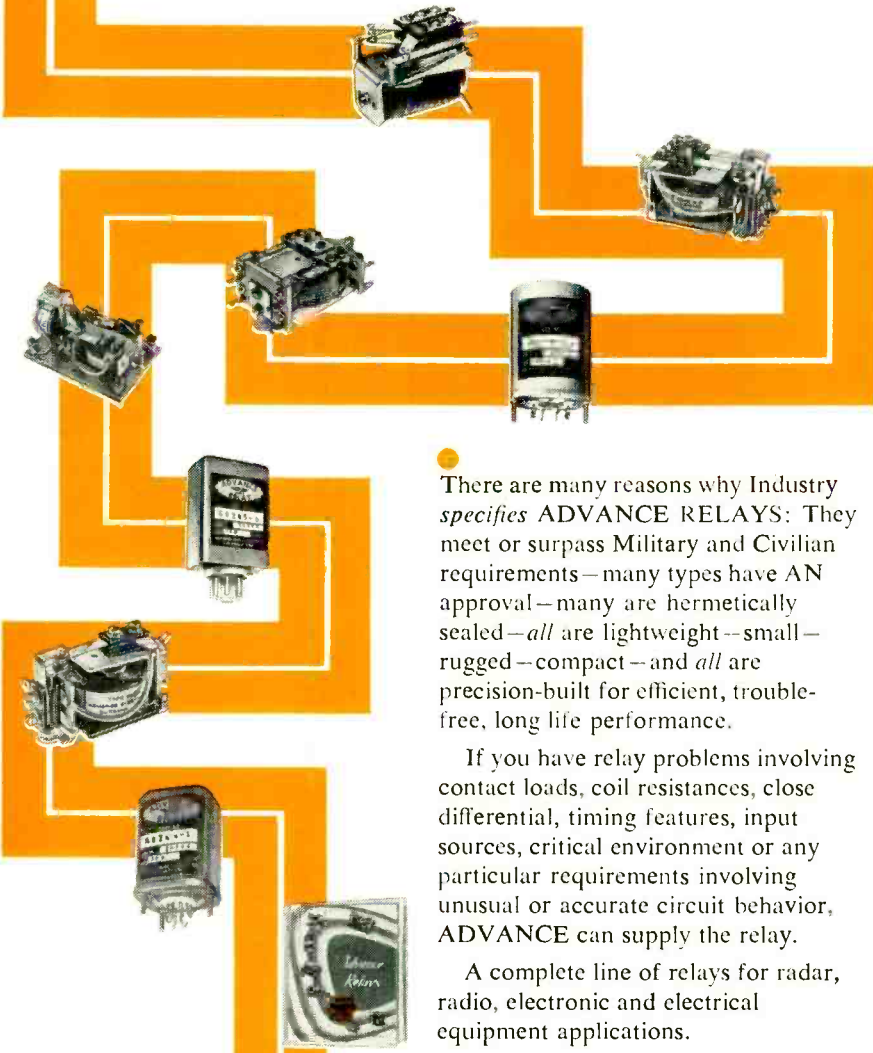

There are many reasons why Industry *specifies* ADVANCE RELAYS: They meet or surpass Military and Civilian requirements—many types have AN approval—many are hermetically sealed—all are lightweight—small—rugged—compact—and *all* are precision-built for efficient, trouble-free, long life performance.

If you have relay problems involving contact loads, coil resistances, close differential, timing features, input sources, critical environment or any particular requirements involving unusual or accurate circuit behavior, ADVANCE can supply the relay.

A complete line of relays for radar, radio, electronic and electrical equipment applications.

Write for new, descriptive Catalog containing detailed information about ADVANCE Relays and facilities.

ADVANCE ELECTRIC AND RELAY COMPANY
2435 NORTH NAOMI STREET, BURBANK, CALIFORNIA

Sales Representatives in Principal Cities of U. S. and Canada



corresponding to $\frac{1}{4}$ millivolt, and can go up to 2600 F or higher depending on the recorder and controller ranges selected.

With this new aid to induction heating, reproducible results are possible regardless of variations in power input or other variables. Because final temperature is accurately measured, depth of hardness can be readily adjusted by varying power input. Initial setup is also expedited.

Measuring Small R-F Chokes

By T. L. SNOWDON

*Engineering Department
Jeffer Electronics Division
Speer Carbon Co., DuBois, Pa.*

THE MEASUREMENT of small values of inductance has always been a problem, especially with regard to correlation. The nomenclature used to describe the inductance has varied, depending on the measurement method used. Such measurements are of increasing importance with the very small inductances used in uhf equipment.

During efforts to establish a standard line of small r-f choke



Testing small choke coils by using calibrated terminals on top of Q meter

Instruments

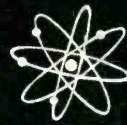

that complement the high quality
of fine electronic equipment

Available in all the types, sizes, and ranges for all
electronic and electrical built-in requirements . . .
including *approved* ruggedized panel instruments.
Complete literature on request . . . WESTON
Electrical Instrument Corporation, 614 Frelinghuysen
Avenue, Newark 5, New Jersey.

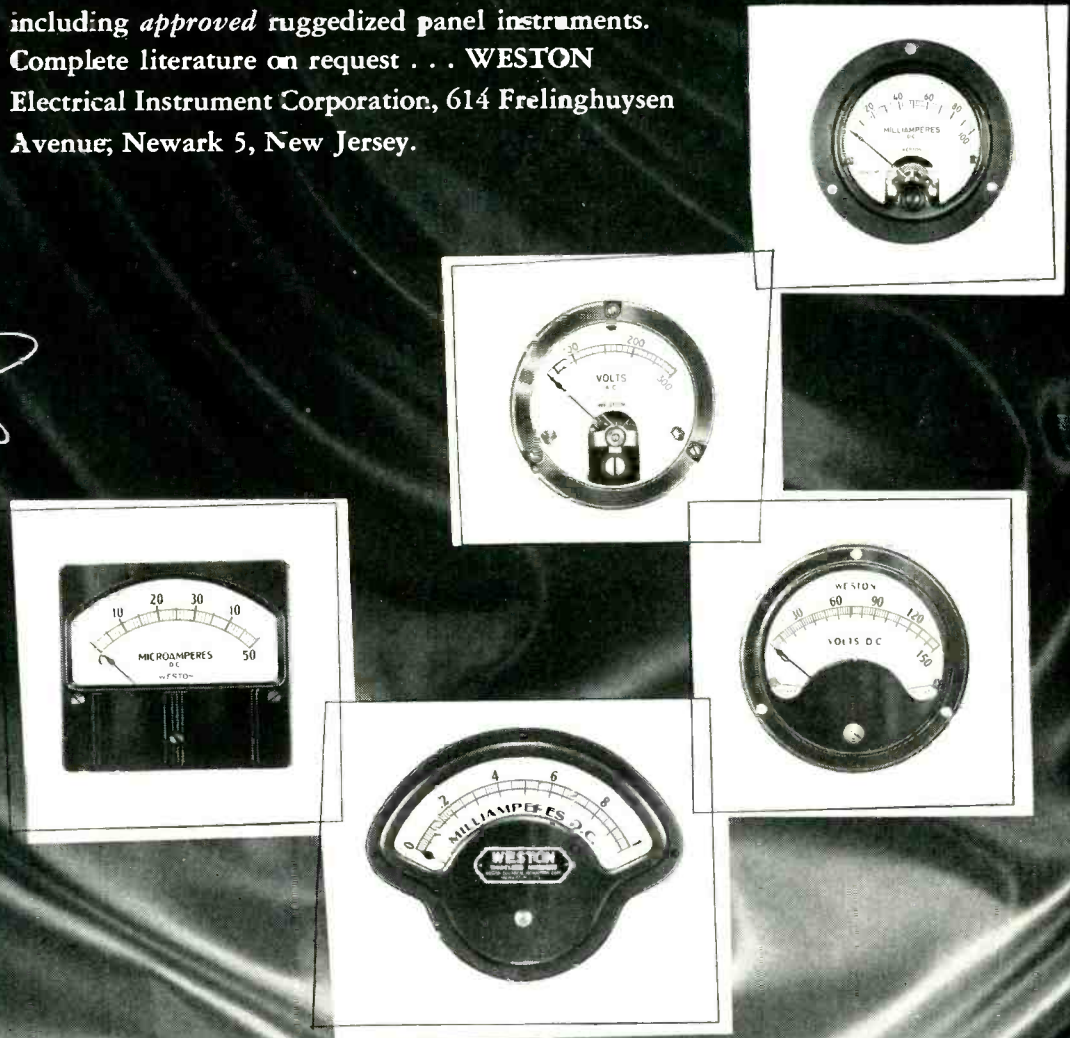
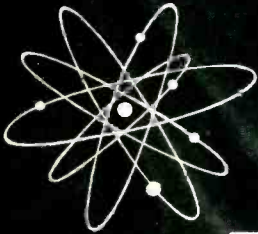

Weston

 PANEL INSTRUMENTS

the world's
most widely used
Electronic Supply
Guide

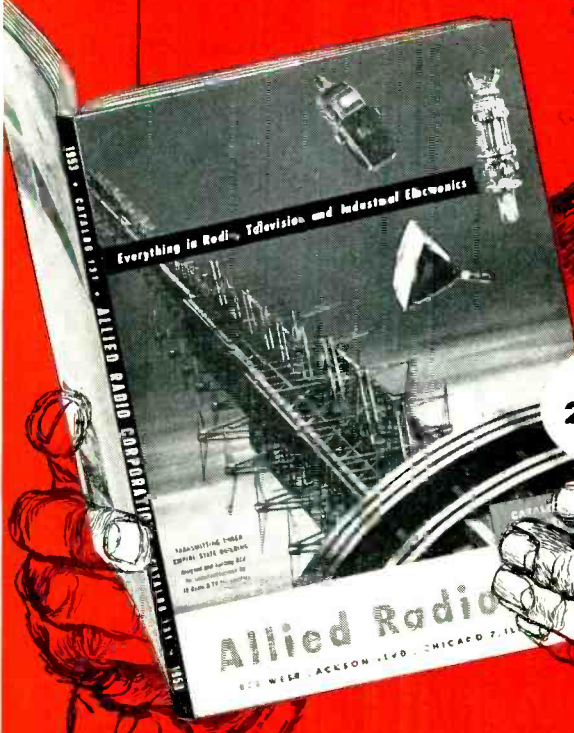

**ALLIED'S
236-PAGE 1953
CATALOG**

**THE WORLD'S LARGEST STOCKS OF ELECTRONIC SUPPLIES
FOR INDUSTRY AND BROADCAST STATIONS**

Simplify and speed the purchasing of all your electronic supplies and equipment. Send your orders to us at **ALLIED**—the reliable one-supply-source for all your electronic needs. Depend on us for the world's largest stocks of special-purpose electron tubes, test instruments, and equipment, electronic parts (transformers, capacitors, controls, etc.) and accessories—everything for industrial and communications application, for research, development, maintenance and production. We make immediate shipment from complete quality lines that are always in stock. Send today for your **FREE** copy of the 1953 **ALLIED** Catalog—the complete, up-to-date guide to the world's largest stocks of Electronic Supplies for Industrial and Broadcast use.

ALLIED RADIO
833 W. Jackson Blvd., Dept. 11-C-3
Chicago 7, Illinois

One complete
dependable source for
everything in
electronics



coils ranging from 0.15 to 120 microhenrys, it was realized that some simple, easily-reproduced inductance-measuring method should be used so that anyone with ordinary equipment could be assured of close correlation.

For values where the inductance is large, so that the instrument calibration is fine enough to be a very small part of the tolerance, the common 1,000-cycle inductance bridge (such as General Radio No. 667) may be conveniently used. These readings are easily reproduced and correlation is good. For coils of less than 10 microhenrys, however, the smallest inductance increment on such a bridge is too great a percentage of the total to be useful. It has been a common practice to use for such coils the Boonton Q meter and prepare the specification in terms of capacitance limits. Here it is difficult to name the coil inductance in coil terms; instead, each coil drawing specifies a different capacitance or frequency test.

The instrument chosen for production-line measurement of these small inductances is the Q meter because of its already widespread usage and flexibility. The Boonton 160A Q meter is now equipped with a capacitance dial calibrated in microhenrys, and by proper choice of frequency, this dial can be read directly; however, the choice of connection method will radically alter the reading so that some standard holder is required. When this is done the inductance of the holder must be considered, as well as the internal inductance of the meter, due to its connections to the terminals. The inductance *B-C* shown in Fig. 1 is the internal plug jig inductance.

By establishing a standardized

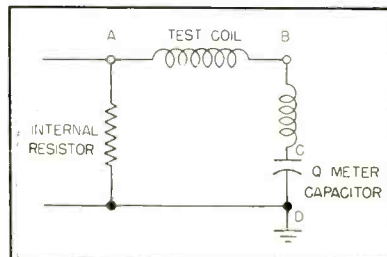

FIG. 1—Output circuit of Q meter

The advertisement features a central text area surrounded by numerous vacuum capacitors of various shapes and sizes, arranged in a grid-like pattern. The background is a light, textured grey. The Jennings Radio logo is prominently displayed at the top center.

Jennings
RADIO®

VACUUM ELECTRONIC COMPONENTS

VACUUM CAPACITORS

now
available
in such
varieties of types,
sizes, and electrical
characteristics that
you can design
your next circuit
around these units
with ease. Our
development
laboratory is
available to
design and
produce
units for
specialized
application.

Voltages: Up to 65 KV

Currents:
Up to 400 AMP

Capacities:
Up to 2,500 MMFD

Ratio of change:
Up to 180:1

SEE US AT THE MARCH I. R. E. ELECTRONICS SHOW, BOOTH 4-211

JENNINGS RADIO MANUFACTURING CO. · 970 McLAUGHLIN AVE.
P. O. BOX 1278 · SAN JOSE 8, CALIFORNIA

the pioneer is the leader

PANORAMIC

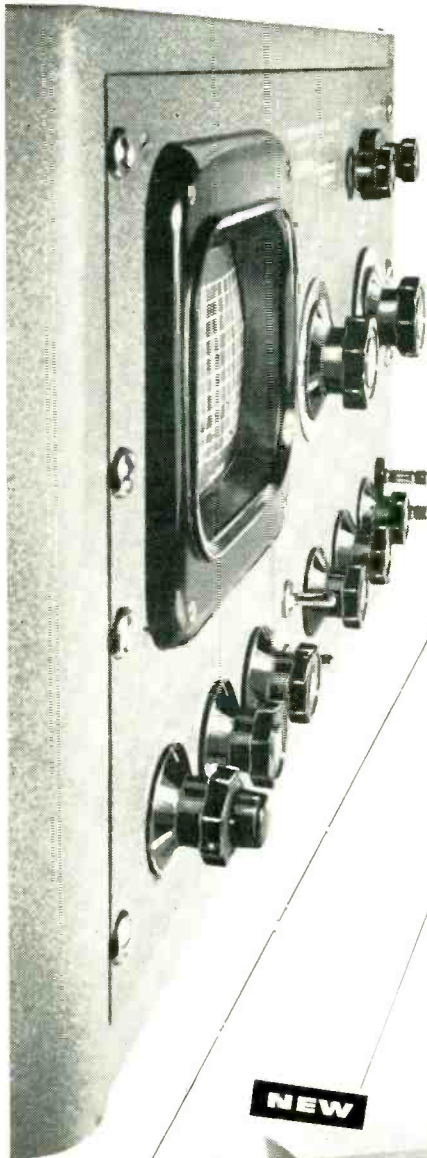

As pioneers and developers of the panoramic technique, the measure of our success is reflected in the fact that the electronic field refers to the transformation of spectrum content into visual spectrographic displays as the "Panoramic Method."

Panoramc leads the industry in producing instruments unexcelled for laboratory, research and production applications requiring high speed spectrum or waveform analysis. Whatever your problem, a Panoramc Analyzer solves it quickly, accurately. Specialized models covering audio to microwave frequencies simplify analysis of waveform distortions, sounds, vibrations, spurious oscillations or modulation, response characteristics of filters or transmission lines, characteristics of AM, FM or pulsed signals, or monitoring many frequency channels simultaneously.

NEW



ULTRASONIC RESPONSE INDICATOR—MODEL G-3

Used as an adjunct to the Model SB-7 Panoramic Ultrasonic Analyzer, the G-3 permits visual inspection of amplitude versus frequency characteristics of networks and devices between 2KC and 300 KC. Direct readings of frequency and amplitude. Indicates fundamental response only.

NEW



SIGNAL SWITCHER—SW-1

Designed to apply alternately test and standard signals to Panoramc Sonic Analyzers. Enables frequency comparisons to within a fraction of a cycle. Used with the G-2 Sonic Response Indicator, it facilitates rapid comparisons of the frequency responses of amplifiers, filters, transmission lines, etc.

NEW

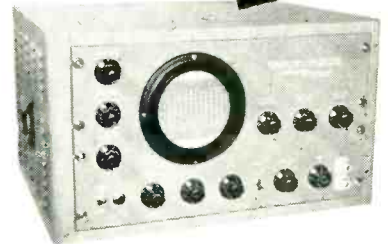

PANALYZOR—MODEL SB-12

Designed specifically for applications requiring extreme resolution or demanding measurement of levels of signals spaced very closely in frequency or widely divergent in amplitude.

- Maximum Sweepwidth—100KC
- Maximum Resolution—10 CPS
- Sweep Rates—30 cps, 5 ps, 1 cps and 1 scan in 10 seconds.

The new products described here, together with the complete line-up of standard Panoramc equipment will be demonstrated at the I.R.E. Show.

Booth #2-123

Models AP-1 & LP-1—Panoramc Sonic Analyzers, Model SB-7 Panoramic Ultrasonic Analyzer, Panalyzers—Models SB-3 & SB-8a, Panadaptors—Models SA-3 & SA-8a, Model G-2—Sonic Response Indicator.



Inquiries invited on special Panoramc Spectrum Analyzers.

10 South Second Avenue, Mount Vernon, N. Y. • Mount Vernon 4-3970

WRITE TODAY FOR COMPLETE SPECIFICATIONS AND PRICES

TAKE PERFECTION FOR GRANTED

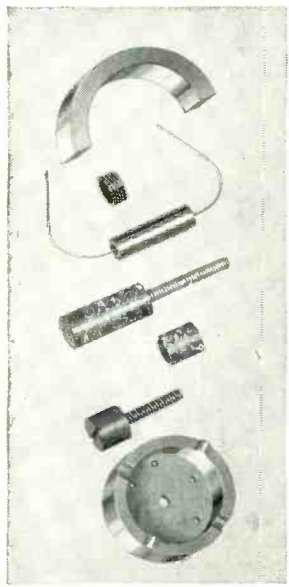
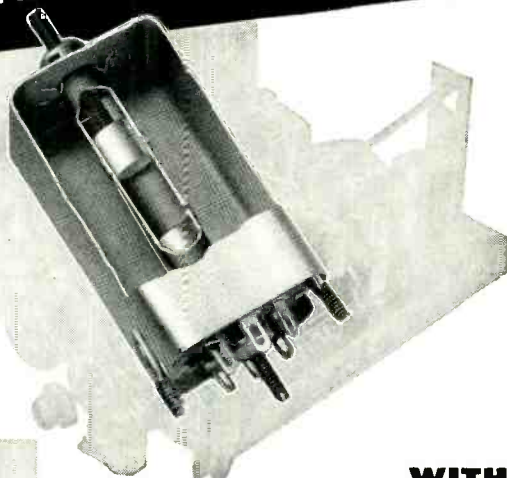

**WITH
MOLDITE
IRON CORES**

It's smart to use parts you can depend on completely . . . that are exactly right. Moldite Iron Cores are at the heart of the dependable electronic performance of product after product. They are made with absolute precision . . . by a company that specializes in making iron cores only . . . that has developed its own exclusive

formulas and production techniques for assuring uniformity, quality, dependability and economy.

- MAGNETIC IRON CORES • FILTER CORES • MOLDED COIL FORMS
 THREADED CORES • SLEEVE CORES • CUP CORES

NATIONAL



COMPANY

1410 Chestnut Ave., Hillside 5, N. J.

Samples promptly submitted upon request for design, pre-production, and test purposes
 SEND FOR CATALOG 110

- | | | | | |
|--|---|---|--|--|
| Robert T. Murray
614 Central Ave.
East Orange, N. J. | Jerry Golten Co.
2750 W. North Ave.
Chicago 2, Ill. | Martin P. Andrews
Mott Road
Fayetteville, N. Y. | Perlmuth-Colman & Assoc.
1335 South Flower
Los Angeles, Cal. | Jose Luis Pontet
Cardoba 1472
Buenos Aires |
|--|---|---|--|--|

pared to the tolerance of the unit under test, no consideration need be given. For a 0.10 microhenry coil, disregarding it can cause serious error.

This method is not as precise as might be desired for some laboratory work due to the tolerances on Q meter frequency and calibration and the distributed capacitance of the coil. It is possible to improve the precision by use of frequency standards and closer dial calibration. However, it does suffice for the majority of common ± 10 percent to ± 20 percent small coils, and makes possible the convenient specifications and actual naming of the inductance in microhenrys, instead of indirectly in terms of capacitance or frequency.

TV Alignment Techniques

A LONG SPRING suspended from the ceiling supports the isolation transformer above the test bench in the television receiver alignment section of Olympic's plant. Input to the transformer is by coaxial cable from a sweeping oscillator, and output goes to a short length of twin-lead having a clothespin-type connector that snaps over the lugs of the antenna terminals on the chassis. When not in use, the transformer moves up far enough to be out of the way when bringing

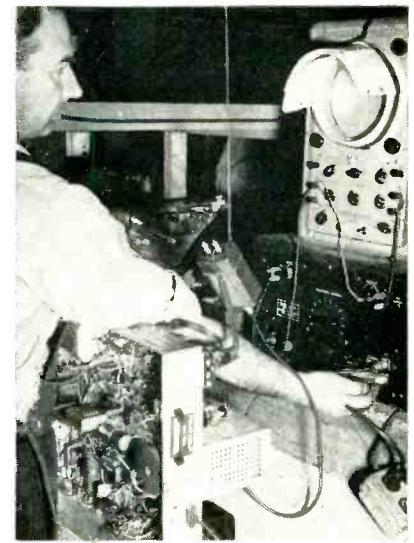

Operating tape-covered attenuator switches. Spring-supported isolation transformer, above forearm, is fed by output of sweeping oscillator

BRIGHT MINDS CONJURE UP ELECTRONIC MENTAL GIANTS

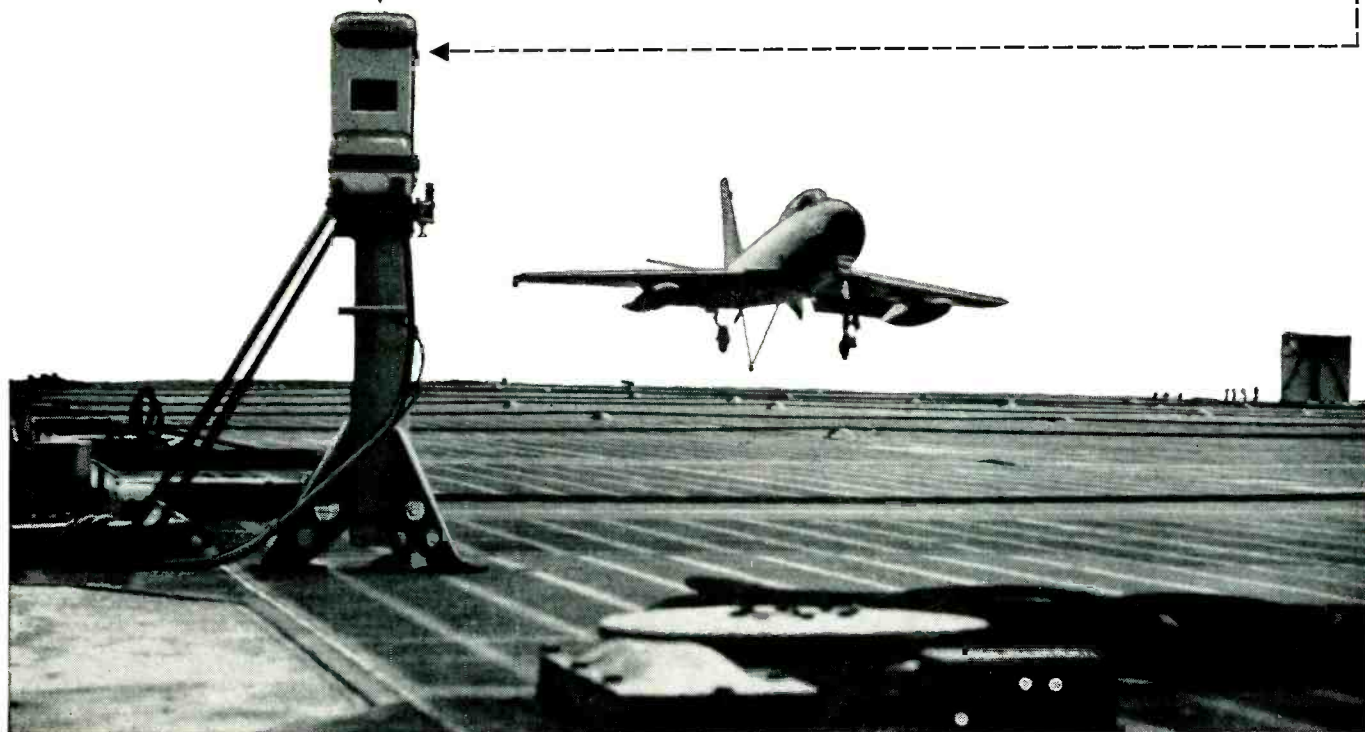

AT NORTH AMERICAN AVIATION

An airplane's rate of descent used to be painstakingly computed from photographs which took several days to evaluate. Then North American's electro-mechanical engineers developed TRODI (above) for the Navy for carrier suitability tests.

TRODI is an electro-optical Touchdown Rate of Descent Indicator that watches the airplane descend, measures its rate, and electronically readies its information so it's available the minute the pilot lands. TRODI's electronic brain saves untold time, men and money for the Navy.

TRODI is just one ingenious example of the challenging electronic and electro-mechanical work being pioneered at North American by some of the

nation's best scientific minds, using the most advanced facilities.

If you like theory, you may find an exciting and secure future at North American in the field of operations analysis, advanced dynamics, kinematics, noise, error or information theory, systems engineering, statistical quality control or servo analysis.

If research and development are your specialty, you'll find attractive opportunities in radar and communications systems, analogue and digital computers, automatic guidance systems or optics.

Write today, including a summary of your education and experience, to:

NORTH AMERICAN AVIATION, INC.

Engineering Personnel, Missile and Control Equipment Department



12214 Lakewood Boulevard, Dept. 93-E, Downey, California

NORTH AMERICAN HAS BUILT MORE AIRPLANES THAN ANY OTHER COMPANY IN THE WORLD

VISITING IRE ?

for something really new, see these...

- high-speed magnetic tape handler
- high-speed "teledeltos" digital recorder
- plug-in decades, shift registers, frequency dividers
- four all-new frequency-time counters
- multiple sequence pre-determined counters
- photo-electric detectors
- high resolution 8-mc chronograph

let's talk about your application!

Let Potter experts analyze and simplify your work in any phase of counting, timing, frequency measurement, data handling or control. In a very few minutes of your time, we can show you how a standard, low-cost, time-saving Potter Instrument can be applied in your work program. Why not consult us?

staying home?

Write for our catalog covering operating principles and typical applications. There is a Potter Instrument ideally suited to your needs. ADDRESS DEPT. 3-C



POTTER INSTRUMENT COMPANY, INC.

115 CUTTER MILL ROAD GREAT NECK, NEW YORK

a new chassis on the bench.

To speed up the setting of attenuator switches on the Kay Electric Co. Marka-Sweep instrument when adjusting sound r-f transformers, television tester Simon Cohen has wound adhesive tape around the group of five toggle switches. With this, he can move the entire bank of five switches in one movement yet still move individual switches at either end of the group as desired.

Checking Torque of Adjusting Screws

THE TORQUE in ounces needed to turn each adjusting screw of an i-f transformer in both directions is measured with a simple balance set-up in DuMont's incoming inspection department. The balance arm is a notched metal strip on which sliding weights can be hung. The arm is pivoted on ball bearings at its center and a screwdriver bit is clamped onto the front end of the shaft.

In use, a transformer is held up to the screwdriver bit so that an adjusting screw engages with the bit, and the transformer is turned. With one weight close to the pivot, the transformer is held so that the other arm is up on the air, and its weight is moved out until it is just far enough to turn the screw of the ferrite core. Next, this weight is moved in to the center and the other weight is moved out step by step to check the torque needed to loosen the screw in the other direction.

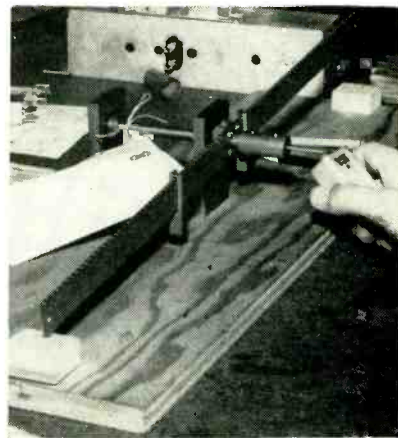

Bringing an i-f transformer up to the screwdriver bit on the shaft of the balance arm for checking turning torque

LOW POWER FACTOR

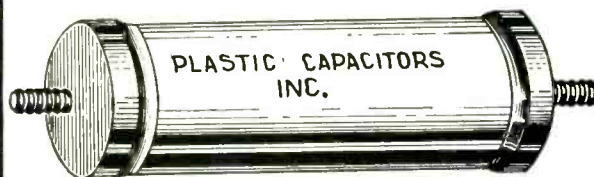
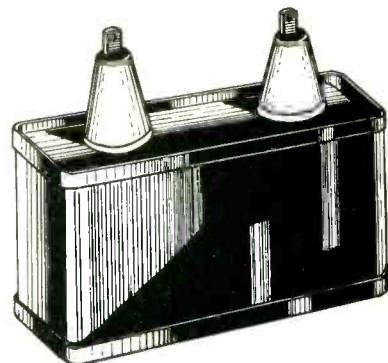
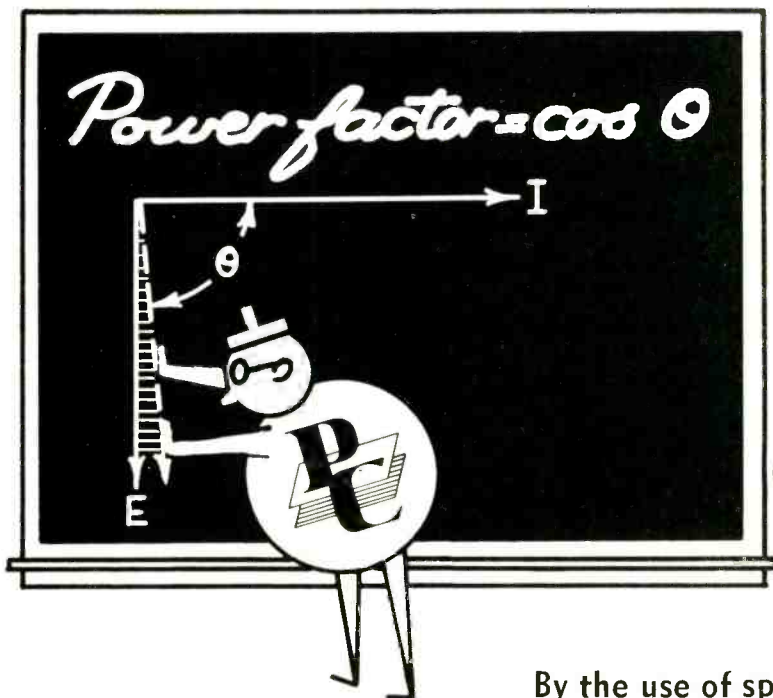

By the use of specially selected and processed plastic films for the dielectric and painstaking and meticulous craftsmanship in their fabrication, P-C Capacitors are available with extremely low power factors.

Capacitance stability and low dielectric absorption, coupled with high resistance and low temperature coefficient characteristics result in units of almost pure capacitance.

As a consequence, power factor is available as low as .01% to .02% in the audio range. Comparable Q values may be had up to 100 kc.

If your capacitor requirements call for low power factor, specify P-C Capacitors.

Your inquiries are invited.

**GET THIS
Free CATALOG**



This catalog of plastic film capacitors is yours FREE if requested on your company letterhead.

Plastic Capacitors, Inc.

PLASTIC FILM CAPACITORS • HIGH VOLTAGE POWER PACKS • PULSE FORMING NETWORKS
2511 WEST MOFFAT STREET • CHICAGO 47, ILLINOIS

NEW PRODUCTS

Edited by WILLIAM P. O'BRIEN

Control, Testing and Measuring Equipment Described and Illustrated . . . Recent Tubes and Components Are Covered . . .
Forty-Three Trade Bulletins Reviewed

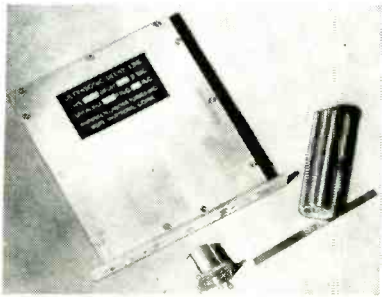

Ultrasonic Delay Lines

ANDERSEN LABORATORIES, INC., West Hartford, Conn., has developed a series of fused quartz ultrasonic delay lines for radar and electronic computer applications. These solid delay lines are available in bandwidths of 12 mc or greater and feature an extremely low ratio of spurious to desired signals. This can be held as low as -50 db for special requirements. Insertion losses are also kept to a minimum, 34 to 50 db being characteristic depending on the terminating impedance necessary.

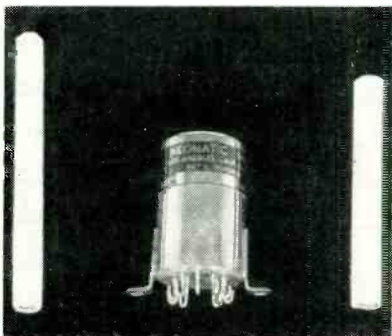

Subminiature Relay

NEOMATIC, INC., 9010 Bellanca Ave., Los Angeles 45, Calif., in announcing its new dpdt relay, calls attention to its small size by this comparison shot with both standard and king-sized cigarettes. It is obtainable in the range from 50 to 1,000 cycles, operating on an input

of 115 v. Two models are offered: Model 10220, with a contact rating of 1 ampere, noninductive; and model 10320, with a contact rating of 4 amperes, noninductive. All units are hermetically sealed with dry air or inert gas to withstand severe environmental conditions and insure long life. Optimum operation is in the temperature range from -55 C to ± 85 C. Weight is 1.51 oz; diameter, 1.0 in.; and length, 1.71 in. It connects with 9-hook or 9-pin header. The a-c relay is especially suited to aircraft applications but may be used for remote control mechanisms in almost all military or industrial applications.

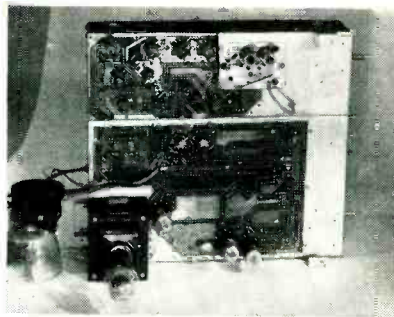

Printed Circuit

CIRCUITRON, INC., 400 Ninth St., Hoboken, N. J. The Circuitron is a new type of printed circuit using a radically different method of bonding the pattern to the insulating base. The conductive pattern can be run from one side of the base material to the other by plating through holes, maintaining circuit continuity without the need for eyelets or other hardware. This permits crossovers, greater design flexibility, and easy adaptation to single-dip soldering. Copper, silver and other metals in any specified thickness can be used for the con-

OTHER DEPARTMENTS

featured for this issue:

	Page
Electrons At Work	160
Production Techniques	274
Plants and People	428
New Books	472
Backtalk	492

ductive circuit. The pattern can be overplated with nickel, silver, rhodium or gold. The conductive pattern can be applied to such base materials as phenolics, melamines, silicones, polystyrene, polyesters and Teflon. Circuitrons can be custom-engineered and produced in quantity for a wide variety of electrical and electronic applications.

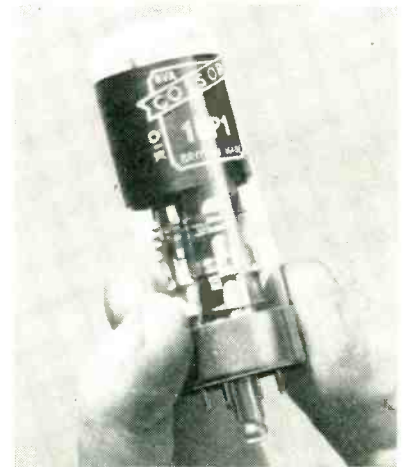

Miniature C-R Tube

BEAM INSTRUMENTS CORP., 350 Fifth Ave., New York, N. Y. The Cossor type 1CP1 is a miniature cathode-ray tube with a lock-in (B8G) base. The focusing of the beam is automatic and only one anode potential is required. For simple display purposes the grid bias is most easily developed by inserting a resistance of about 10,000 ohms in the cathode line of the tube; thus the excitation of the tube is exceedingly simple. Also, the

Make your UHF circuits as simple as VHF designs...

Use these two New Sylvania Tubes in tuners and converters

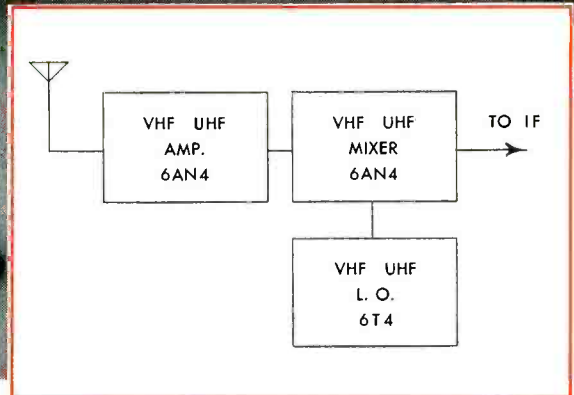

Equipment Manufacturers! Simplify design of combination VHF-UHF tuners, UHF converters for TV! Two new Sylvania-developed tubes permit adaptation of conventional amplifier-mixer-local oscillator circuit to the new frequency bands—completely eliminate complicated switching arrangements or stage duplication. Leading Tuner Manufacturers have adopted these types for current tuner production.

- Short Bulb T-5½ 7-pin miniature construction
- Requires no special socketry
- Designed for use at frequencies up to 1000 mc
- Double plate and grid leads
- Uniformity at high frequency means lower cost and better availability

THE SYLVANIA 6T4 is designed for use as a local oscillator at frequencies up to 1000 mc. Used as the companion tube to the 6AN4, it makes possible the design of extremely simple combination tuners and UHF converters.

THE SYLVANIA 6AN4 can be used both as an rf amplifier and as a mixer. Its performance in the VHF band is equal to or better than previously existing types of tubes, and in UHF tuners it gives comparable performance to VHF tuners.

The 6AN4 is designed for both high g_m and high μ . Under representative operating conditions as a Class A amplifier, the transconductance is 10,000 micromhos and the amplification factor is 70.

When used as a mixer, the 6AN4 offers the advantages of a conversion gain and of relatively low oscillator drive requirements.

Complete technical information on operating characteristics, including performance curves, is included in the manual, "Sylvania's UHF Story." A copy is yours for the asking. Write to: Sylvania Electric Products Inc., Dept. 3R-1003, 1740 Broadway, New York 19, N. Y.

Representative block diagram of combination VHF-UHF tuner using the new Sylvania 6AN4 as rf amplifier and mixer, and the 6T4 as local oscillator.

COMPARATIVE PERFORMANCE OF THE 6AN4 AT VHF AND UHF

CONDITIONS	VOLTAGE GAIN	NOISE FIGURE
Single tube in Channel 13 booster	VHF { 5	9.2 db
Two tubes in cascade in Channel 13 booster		
Single tube in open half-wave tuned amplifier at 450 mc.	UHF { 12 db	13 db
Single tube in open half-wave tuned amplifier at 900 mc.		

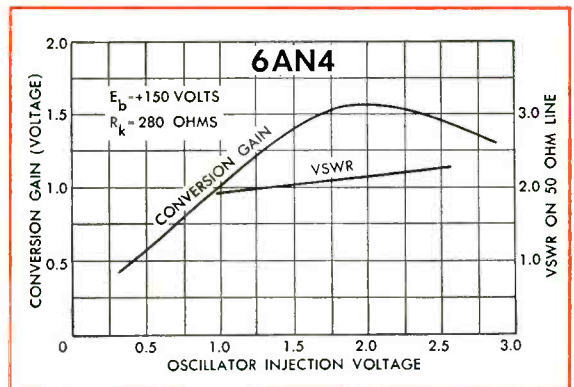

Curve shows representative relationships between conversion gain and input VSWR of the 6AN4 when used in mixer service, plotted against oscillator injection voltage.

SYLVANIA



heater cathode insulation is such that up to 250 v may be applied between them and this simplifies the derivation of the heater voltage. This tube is intended to be incorporated for monitoring purposes in a wide variety of electronic equipment to permit the observation of waveforms in various stages of complex circuits.

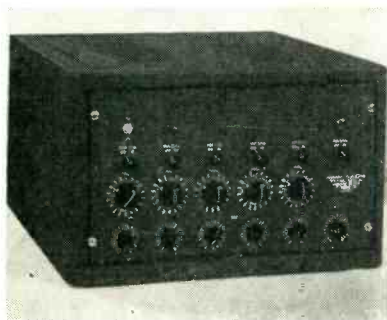

Harmonic Generator

COMPUTING DEVICES OF CANADA LTD., 338 Queen St., Ottawa, Canada. Type C020 harmonic generator is a new instrument designed to produce electronically a sine waveform with a frequency of 400 cps and the 2nd, 3rd, 4th, 5th and 7th harmonics of this frequency. The phase of each harmonic voltage is independently adjustable over a range of 360 deg with respect to the fundamental. This generator is designed as a piece of demonstration equipment to be used in conjunction with a cathode-ray oscilloscope for the production and analysis of complex waveforms.



Pulse Forming Network

PCA ELECTRONICS, INC., 6368 De-Longpre Ave., Hollywood 28, Calif. The PFN 7030 B pulse forming network, presently being used on

radar, missile and computer applications, measures only $\frac{1}{16}$ in. in diameter and $1\frac{1}{8}$ in. in length. Its small size plus two convenient $1\frac{1}{4}$ -in. No. 22 solid copper-tinned leads make mounting easier, especially when used in miniaturized circuits. It has an impedance of 1,050 ohms and forms a 0.15- μ sec pulse when used in a suitable circuit. They are also available with pulse widths from 0.02 to 20 μ sec. They will operate satisfactorily in ambient temperatures that vary from -65 to $+105$ C.



Full-Wave Rectifier Tube

NATIONAL ELECTRONICS, INC., Geneva, Ill., has announced a new high-current full-wave rectifier. This tube, designated as the NL-606, carries 6.4 amperes d-c and 25.6 amperes peak rating. It was designed especially for industrial power rectifier applications requiring higher voltages up to 900 v peak inverse or 250 v d-c. The NL-606 is gas and mercury filled for quick-starting, long-life, and high peak inverse within wide temperature limits. Other ratings are: filament voltage, 25 v; filament current, 17 amperes; and peak inverse voltage, 900 v.

General Purpose Speakers

JAMES B. LANSING SOUND, INC., Los Angeles, Calif., is now producing the D-130-15 in., D-131-12 in. and D-208-8 in. general purpose speakers. Power output for D-130 is 25 w; for D-131, 20 w; and for D-208-12 w. Impedance for the D-208 is 8 ohms; and for the D-130

and D-131, 16 ohms. Voice coil diameter is 2 in. for the D-208 and 4 in. for the D-130 and D-131. A new principle of magnetic structure design has been incorporated in the units. It utilizes a special pure iron high-intensity casting structure, producing a greater usable flux density.



Sensitivity Tester

SERVICE INSTRUMENTS Co., 422 South Dearborn St., Chicago 5, Ill. The SensiMeter is a tester that accurately measures the sensitivity of any tv receiver in microvolts. Its scale is divided into very sensitive receiver, medium sensitivity and insensitive receiver, to enable the serviceman to quickly determine the condition of the receiver. Checking receivers from antenna terminals to picture tube, it is an excellent method of determining the cause of bad pictures in fringe areas.

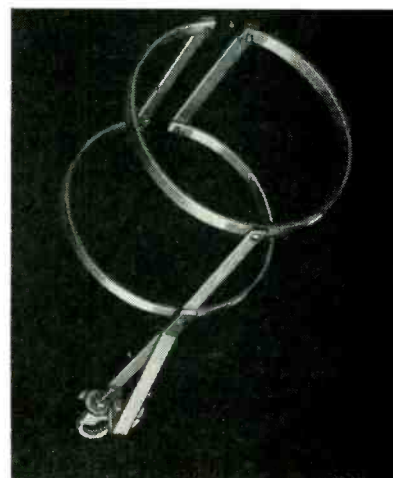

UHF Antenna

RYTEL ELECTRONICS MFG. Co., 9820 Irwin Ave., Inglewood, Calif., has

the **RIGHT COMBINATION** for
maximum performance at minimum cost



audiotape*

that meets the most exacting
professional requirements

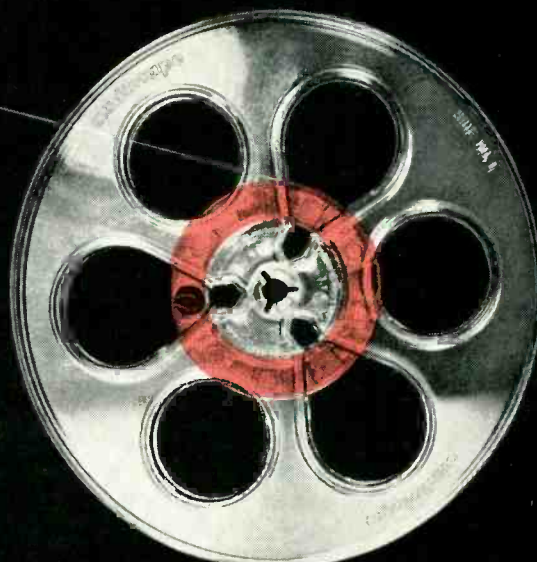

NEW 7" REEL

that eliminates the
"high-tension" zone

NO SPLICES. As always, plastic-base Audiotape in 1200 and 2500 ft reels is guaranteed *splice-free*.

NO FRICTION SQUEAL. Perfected anti-friction process eliminates annoying tape squeal—prevents "tackiness" even under extreme temperature and humidity conditions.

MINIMUM DISTORTION. Audiotape's oxide coating is especially formulated to give *maximum undistorted output*. Comparative tests show its marked superiority in this respect.

MAXIMUM UNIFORMITY. All 7" and 10" reels of plastic-base Audiotape are *guaranteed* to have an output uniformity within $\pm\frac{1}{4}$ db—and a reel-to-reel variation of less than $\pm\frac{1}{2}$ db. And there's an actual output curve in every 5-reel package to prove it!

PRECISION TIMING. Improved reel design with $2\frac{3}{4}$ " hub reduces timing errors by eliminating the tension and speed changes formerly encountered at the beginning and end of the winding cycle. Ratio of OD to hub diameter is the same as the standard NAB 2500 ft reel.

CONSTANT PITCH is another advantage of the new reel design resulting from the more uniform tape speed throughout the winding cycle.

SLOWER ROTATIONAL SPEED, due to larger hub diameter, minimizes vibration and avoids possible damage to tape on fast forward and rewind.

REDUCED HEAD WEAR can also be expected, because the maximum tape tension is materially decreased.

audiotape gives you all these advantages at no extra cost!

* Trade Mark

This new 1200 ft plastic reel with $2\frac{3}{4}$ " diameter hub is now being supplied on all orders for 7" reels unless otherwise specified... at no increase in price. Remember— with Audiotape, there's only *one* quality—the finest obtainable! Audiotape is available in all standard size reels from 150 to 5,000 feet.

AUDIO DEVICES, Inc.

444 Madison Ave., New York 22, N. Y.

Export Dept. 13 East 40th St., New York 16, N. Y., Cables "ARLAB"

audiodiscs audiotape audiofilm audiopoints



THE PULSE-MARKET PULSE

Pulses are here to stay. In a few short years the pulse-forming network has replaced the grid-leak, the artichoke has superseded the slowpoke choke. Waveforms are no longer sinusoidal, they're spinusoidal. (Ever been bit by radar? Very sharp pips in that there.)

The high-sounding term "Pulse Techniques" calls to mind a keen, up-to-the-minute, young engineer pawing at the threshold of tomorrow, but one of the oldest families in this business is the Pulse family. One of the early American graphic artists, a Mr. S. Finlay Breed Morse, amused himself by arranging a communication system based on a Pulse Code, the transmission of which was electrical and the reception magnetic. This was in the 1840's.

In communication, pulses are still very popular. An estimated 10^{63} of them are made and shipped annually. Many of them get worn quite round by distributed constants, some are split and distorted and others are lost altogether.

There is, of course, in any pulse communication system, an attempt to restore or reform tired pulses. Moderately bad ones can be squared up by passage through a relay. By twisting knobs, either on the relay or on its bias supply, it is even possible to restore original width to a tired pulse. The trouble is, relays having cured amorphia, often give pulses schizophrenia, palsy, and Heaven knows what else.



Considering how advanced the electronic side of the Pulse art is, and how good loud-speakers (and scopes) are, it's a wonder that the dirty telegraph relay hasn't been improved in 30 years. Of course, the English and the Germans

have some excellent models, but they probably only work on English and German pulses.

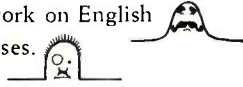

Aside from self-destruction, there are three basic weaknesses in the usual telegraph relays which have largely limited the transmission rate and usefulness. First, the transfer time is stolen from the pulse, for which the 5% or 10% usually allowed is a nuisance. Then there is bounce, which hurts the relay contacts and robs more pulse time. Finally, there is a mechanical oscillation of the armature-contact system after make. This has a very definite frequency which, in a common telegraph relay, is about 150 c.p.s. This persists so long that it introduces lead or lag at the leading edge of the following pulse, depending on the elapsed time between.

Obviously, in a long circuit, all the faults are cumulative if the relays all have similar characteristics. One very common American telegraph relay avoids reverberation at the expense of high frequency bounce and slow transfer, which minimizes the mischief, but it is an expensive monster. The foreign types, by intelligent design, have eliminated bounce and raised the reverberation frequency to about 1000 c.p.s., at the expense of contact capacity and life.

We have a prototype in development now which takes the reverberation frequency over 2000 c.p.s., doesn't bounce at all, and transfers .005" in .3 millisecond. This allows 75% efficiency at 400 c.p.s. pulse rate or 1000 words a minute. The contacts have limited life, but the ease of replacement and adjustment may well justify its use in the pulse-market.

†A basic feature of Sigma Type 7JOZ telegraph relay.

announced the Double-O uhf antenna. Circular construction means greater directivity along a horizontal plane, a 1-db gain over single dipole, a low pickup response in vertical directions and effective reduction of ghosts, because noise, multipath and other signals which arrive at an angle other than perpendicular to the plane of the circle cancel out at the terminals. With the two circle antennas fed 90 deg out of phase, an additional gain of 3.8 db for each circle of antenna is obtained. This, plus the 1-db gain over the single dipole for each circle, yields an overall gain in the forward direction of 5.8 db. Since the dielectric of the Double-O is air (no fragile or expensive insulators), and since the unit is supported at a current node (ground potential), there can be no mechanical or electrical breakdown.



Vectorlyzer

ADVANCE ELECTRONICS Co., P. O. Box 394, Passaic, N. J. Type 202 Vectorlyzer is based on a new fundamental circuit that permits unusual speed and accuracy for measuring vector relations of alternating voltages. It may be used to measure vector sum or difference of two voltages, phase angle between two voltages, imaginary and real components of an unknown voltage in terms of reference voltage. Frequency range is 8 cps to 2 mc through panel binding post, 20 kc to 500 mc through probe. Input impedance at the probe is 2.5 μ f shunted by 100,000 ohms; at the panel binding post, 14 μ f shunted by 1.0 megohm. Voltage range through post is 0.06, 0.6, 6 60, or 600 v full scale; through probe, 0.6, 6 or 60 v full scale. Accuracy of the instrument is ± 2 percent

SIGMA INSTRUMENTS, INC.

62 Pearl Street, So. Braintree, Boston 85, Mass.

Adv.

VARIAN X-BAND RADAR KLYSTRONS

Now in full production...

guaranteed specifications — quantity prices — assured delivery

V-260

Rugged local oscillator for mobile radar. Highly non-microphonic. Shaft tuner; no chatter or backlash; excellent for motor-tuned systems. Reflex, 8.5-10.0 kmc, replacing Varian V-50.

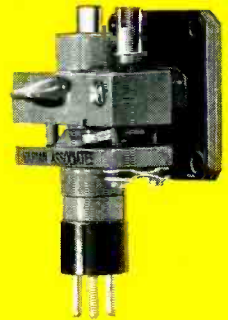

V-280

For radar, beacon or low-power transmitter operation under severe mechanical punishment. Lock-nut tuner holds the tube on frequency even under shocks of several hundred g. Reflex, 8.5-10.0 kmc, replacing Varian V-51.



V-270

V-290

For high altitude or high humidity applications. Silicone-rubber-potted base and reflector connections instead of conventional base and reflector cap. Electrically identical with V-260 and V-280.



X-13

Reflex tube for test and measurement work at x-band. Integral tuner covers the full frequency range, 8.2-12.4 kmc. Typical power output is 150 mw over the band, 500 mw at center frequency.

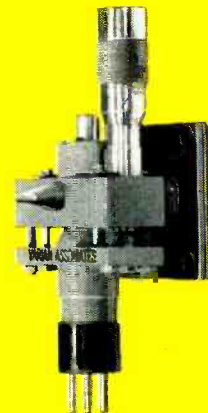

See them in Booth 1-617, New York IRE Show



VARIAN associates

990 VARIAN STREET • SAN CARLOS, CALIFORNIA

TRADE MARK

representatives in principal cities

Detailed data sheets available.
Write Varian Associates,
Code AAAX, 990 Varian Street,
San Carlos, California

maintenance and replacement are simplified with Fairchild

plug-in potentiometers

These plug-in type ganged potentiometers are another excellent example of Fairchild's service in meeting the special requirements of customers. The problem was to provide ganged precision potentiometers that would simplify maintenance of airborne fire control equipment through quick and easy replacement. A series of packaged plug-in units like that shown was the answer.

An entire gang can be replaced in a few minutes because only the end mounting plates are fastened down. There are no wires to disconnect or solder. Test points are provided on the top of each potentiometer so it can be checked quickly.

Maximum rigidity of the gang is assured by mounting the individual units on a single shaft. These plug-in potentiometers have the same mechanical and electrical tolerances and performance characteristics that have made the Model 746 unit the first choice for many critical applications.

Use the coupon below to get full information.



SEE THESE PLUG-IN UNITS AND OTHER INTERESTING DEVELOPMENTS IN PRECISION POTENTIOMETERS AT THE I. R. E. SHOW—BOOTH NOS. 2-405 AND 2-406

Potentiometer Division, Department 140-34A
Fairchild Camera and Instrument Corporation
Hicksville, Long Island, New York

Gentlemen:

Please send me complete information about Fairchild Precision Potentiometers and tell me how you might solve my potentiometer problems.

Name _____

Position _____

Company _____

Address _____

through panel binding post, and ± 1 db through probe.

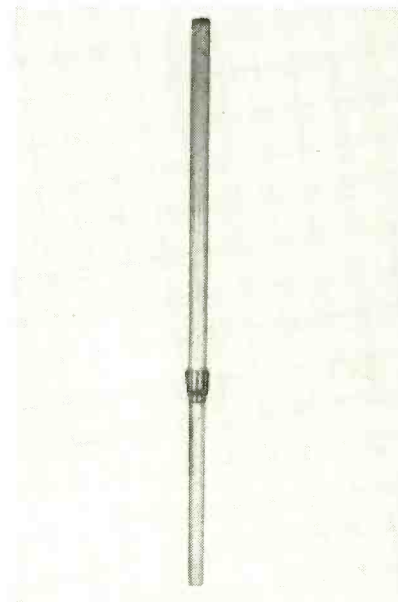

Base Station Antennas

MARK PRODUCTS Co., 3547 Montrose Ave., Chicago 18, Ill., has available a line of omnidirectional vertically polarized high-gain base station antennas for the communications services in the 150 and 450-mc regions. Based upon a new colinear stacking and feed design that permits high gain and excellent bandwidth performance at low cost, the units are available as standard production items for the 148 to 174-mc and 450 to 470-mc bands. Both three element and seven-element arrays are in production providing a 4 db and 7.2 db gain over a half-wavelength dipole. They are designed to withstand 100-mph wind velocity with $\frac{1}{2}$ -in. radial ice load.

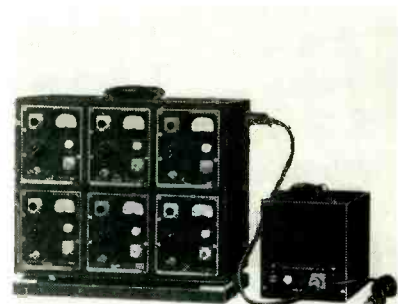

Amplifier Unit

YELLOW SPRINGS INSTRUMENT Co.,
INC., P. O. Box 106, Yellow Springs,

RADAR *Control*

test SET radar

S AND X BAND

MICROWAVE EQUIPMENT
FROM V. H. F. to S. H. F.



LABORATOIRES

OFFICE AND FACTORIES
6, RUE JULES-SIMON, BOULOGNE-SUR-SEINE
TÉL. : MOLITOR 37-00 FRANCE



R. DERVEAUX

LABORATORIES
64, RUE DU CHATEAU-BOULOGNE-SUR-SEINE
TÉL. : MOLITOR 13-91, 92 et 93 FRANCE

Ag. PUBLÉDITEC-DOMENACH

REEVES-HOFFMAN CRYSTAL UNITS

keep the chaos out of communications



Reeves-Hoffman Quartz Crystal Units bring unerring accuracy of frequency control to thousands of radio signals being generated in transmitters throughout the world.

The precision of frequency control inherent in every Reeves-Hoffman Crystal is a result of the extraordinary care taken in each stage of its manufacture.

REEVES
HOFFMAN Corporation
A subsidiary of Claude Neon, Incorporated
CHERRY AND NORTH STREETS — CARLISLE, PENNSYLVANIA

LICENSED UNDER PATENTS OF THE BELL SYSTEM

Ohio. Model 201-A six-channel amplifier unit is a portable, (69 lb complete with power supply), self-contained system used primarily for the accurate measurement of such physical phenomena as strain, pressure, acceleration, vibratory displacement and velocity. It consists of six individually excited, three-stage, single-channel amplifiers, with output metering and overload indicating circuits and with linear and integrated amplification employed to provide for the use of a wide variety of pickup devices; a separate electronically regulated power supply providing both a-c and d-c power to all channels; a shock mounted cabinet with power plugs for inserting the single channel amplifier units and the necessary power and test cable assemblies. Recording of the amplifier output is usually accomplished by a recording oscillograph, a tape recording device or similar recording instruments.



Infrared Meter

GENERAL ELECTRIC Co., Schenectady 5, N. Y., has developed a new infrared meter designed to measure radiant-energy intensities up to 10 watts psi. Designated as type DW-69, the meter is especially suited for determining in a matter of seconds the intensity of high range, radiant energy sources and for studies of infrared radiation effects concerning absorption and transmission properties of materials. The pocket-sized instrument's operation is simplified because no separate thermopile or other accessory equipment is needed. Accuracy is ± 5

Sensational Advancements In Science & Industry

Created the Need for

THE NEW

Stabelex "D" CAPACITORS

YOUR FREE
INDUSTRIAL CONDENSER CORPORATION
 Stabelex "D" Capacitor Catalog
 may prove to be the most important
 new single piece of literature for
 you this year!

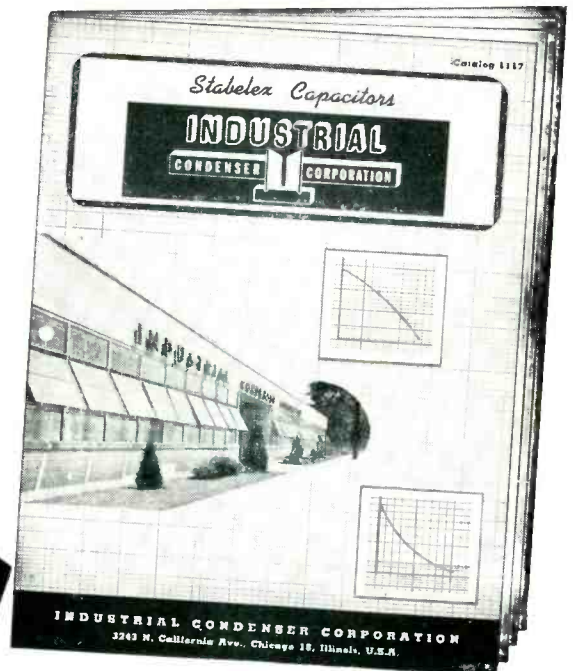

Curve #1110, shown at right, is of particular interest and illustrates the long self time constant of Stabelex "D". The time constant of the 10 MFD capacitor illustrated on this curve is 200 days, or 4800 hours. This curve represents measurements on capacitors allowed to stand at normal room conditions of temperature and humidity. This, therefore, represents the time constant of these capacitors under normal conditions of operation.

Performance curves illustrating various characteristics of the Stabelex "D" Capacitor will appear in this magazine each month.

OUTSTANDING FEATURES

INSULATION RESISTANCE AT 20° C. AFTER THREE MINUTES CHARGE—900,000 megohm microfarads

INSULATION RESISTANCE AT 75° C.—78,000 megohm microfarads

INSULATION RESISTANCE AT -75° C.—In excess of 5 million megohm microfarads

CHANGE IN CAPACITANCE FROM 25° C. TO -80° C. +0.76%

SELF TIME CONSTANT OF 10 MFD CAPACITOR—4800 hours

Q AT 50 KILOCYCLES—10,000

POWER FACTOR AT 1 KC—0.00025

SEND FOR CATALOG 1117 TODAY

After a long period of research, Industrial Condenser Corporation now offers to industry for the first time the first of their family of Stabelex capacitors, stabelex "D", which has been produced for special applications for some time.

Complete information performance curves, characteristics, and suggested applications of the various types now available will be found in this catalog.

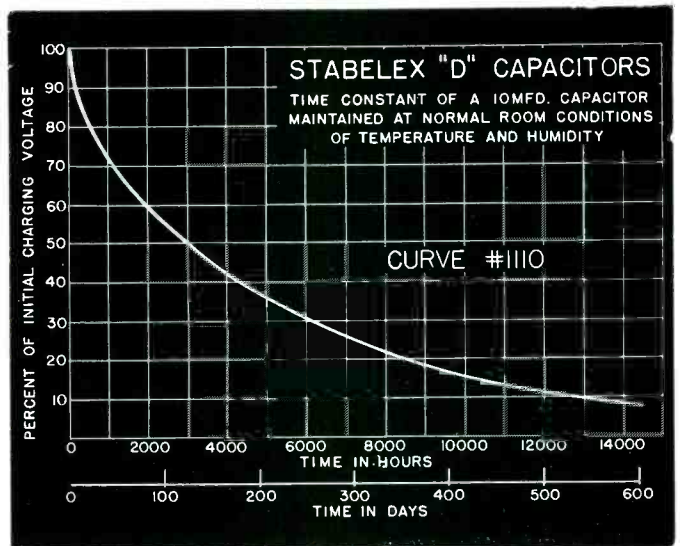

INDUSTRIAL CONDENSER CORPORATION

3244 N. California Avenue
 Chicago 18, Illinois, U.S.A.

Please send me my FREE copy of your new Catalog 1117 on Stabelex "D" Capacitors.

Name

Company Position

Street

City Zone State

Mfrs. of OIL, WAX, ELECTROLYTIC, PLASTIC CAPACITORS and RADIO INTERFERENCE FILTERS

NEW

miniature damped control motor type 17 ID....



...for servo and instrument applications

SERVOMECHANISMS, Inc. Type 17IDZ-8 is a balanced 2-phase, 26-volt, 5500-RPM, 400-cycle damped induction motor employing a drag cup and an axially adjustable magnet to achieve velocity damping. This design provides for variable and smooth linear velocity damping and lower operating temperature. The desired degree of viscous damping is achieved by operating setscrew adjustment.

* * *
The non-damped induction control motor 1712-8 of 8,000 RPM is also available.

FEATURES OF DAMPED CONSTRUCTION DESIGN INCLUDE

- Cogless Damping
- Zero Residual Noise Signal
- Constant Damping
- Lower Inertia
- Lower Cost

Write to Dept. CLO-3
for specific information
on motors.

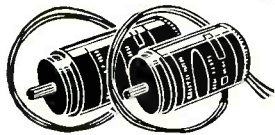

OTHER INSTRUMENT MOTORS

..... Hysteresis Synchronous design, Type 17HI-8 for 26 volts and Type 19H for 115 volts in speeds of 8,000, 12,000, and 24,000 RPM are available for various applications. Special windings and external shaft configuration can be provided on request.

SERVOMECHANISMS INC.

WESTBURY, L. I., N. Y.

EL SEGUNDO, CAL., NEW CASSEL, N. Y.

NEW PRODUCTS

(continued)

percent of full-scale value over a response range of 300 to 3,500 millimicrons (3,000 to 35,000 angstroms).

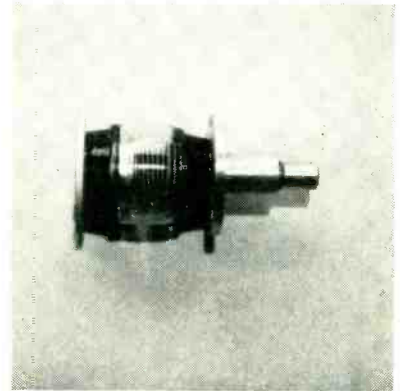

Miniature Vacuum Capacitors

JENNINGS RADIO MFG. Co., 970 McLaughlin Ave., San Jose 8, Calif. A full line of miniature vacuum capacitors is now available in both fixed and variable types. These new low-voltage units, rated at 3 kv and 5 kv, are characterized by small physical size, negligible power factor and extremely wide capacitance ranges. For example, one variable unit has a capacitance range of 5.5 μf to 1,000 μf . Another has a range of 4 μf to 250 μf and is only 4 in. long. The fixed JCSL series and the variable UCSL series are both available in capacitances ranging up to 2,000 μf .

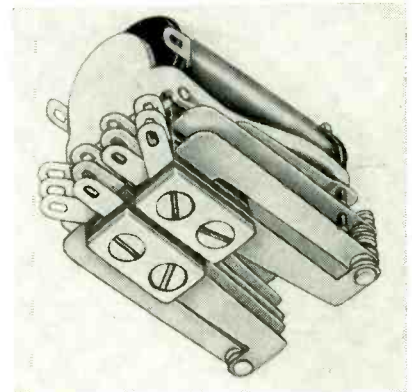

Telephone Type Relays

POTTER & BRUMFIELD, Princeton, Ind. Newly developed MJ series miniature telephone type relays, available open or hermetically sealed, have been announced. The

General Ceramics' *engineered* STEATITE INSULATORS

Specified with Confidence for—

RADIO
TELEVISION
UHF CIRCUITS
ELECTRONICS
AND ELECTRICAL
MANUFACTURING

**Pressed and
Extruded Shapes to
Close Tolerances**

Engineered Steatite by General Ceramics offers the designer and engineer both excellent electrical and mechanical advantages and the economies of standard catalog body types. Offers low loss factor, zero moisture absorption, high surface and volume resistivity, high tensile and great compressive strength. Steatite insulators can be produced to countless sizes and shapes for practically all requirements.

**Standard Shapes
AVAILABLE:**

- PILLAR INSULATORS
- LEAD-IN BUSHINGS
- ENTRANCE BUSHINGS
- COAXIAL CABLE INSULATORS
- LEAD-IN INSULATORS
- SPREADER INSULATORS
- STRAIN INSULATORS
- COIL FORMS
- SUPPORT BARS
- COUPLING INSULATORS

"STEATITE-BONDED-TO-METAL" COMBINATIONS

Steatite bonded to metal by the Solder-Seal method produces a permanent hermetic seal. Also recommended for re-inforcing steatite where exceptional mechanical strength is required.

FOR UHF CIRCUITS, SPECIAL G-C STEATITE

General Ceramics Special Steatite developed for UHF service. An engineered insulation with extremely low loss factor. Recommendations made on specific applications without obligation.

CUSTOM DESIGNS TO SPECIFICATION —

Special steatite insulators can be produced in any size or shape by pressing, extruding, casting or machining. Experienced engineers are available for consultation.

BOOTH #1-506
FIRST FLOOR
AT THE I.R.E. SHOW

*FULLY CONFORMS TO THE REQUIREMENTS OF GRADE 1-6A IN ACCORDANCE WITH JAN-1-10.



MAKERS OF STEATITE, FLUORATES, ZIRCON PORCELAIN, FERRIMICS, LIGHT DUTY REFRACTORIES, CHEMICAL STONWARE, IMPERVIOUS GRAPHITE AND FERRIMIC MAGNETIC CORES

General CERAMICS and STEATITE CORP.
Perth Amboy 4-5100

GENERAL OFFICES and PLANT: KEASBEY, NEW JERSEY

IF YOU HAVE A PROBLEM —

For complete information on General Ceramics Steatite Insulators, request the new illustrated catalog; for engineering assistance on specific problems, contact a General Ceramics Sales Engineer.

Mechanically Right...

VICKERS RECTIFIERS

Are Better For Your Product

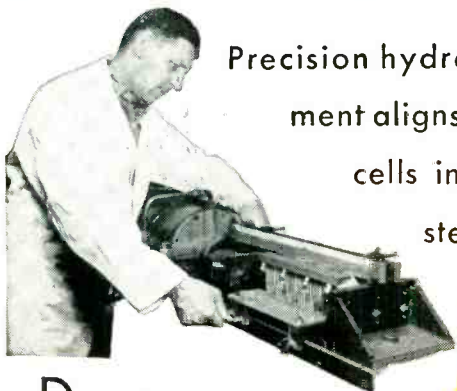
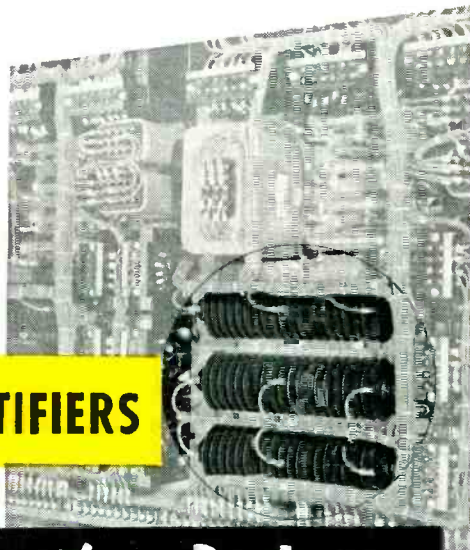

Precision hydraulic equipment aligns and compresses cells into "stacks". Special steel studs keep stacks tight and true.

Dimensions are exact, mountings accurately aligned, for easy assembly in your product. Terminals—for bolting or soldering—are precisely positioned for your connections. Tinned terminals speed soldering. Color code eliminates wiring errors. Protective finishes, plating of exposed metal parts, guard electrical quality, prolong service life. Shock and vibration tests—to military specifications—prove the mechanical durability of Vickers Selenium Rectifiers.

more reasons why VICKERS makes a better rectifier:

- 255 tests and inspections guard quality from start to finish
- Automatic electro forming "pre-stresses" cells
- Precision-matched cells prevent overloading—overheating

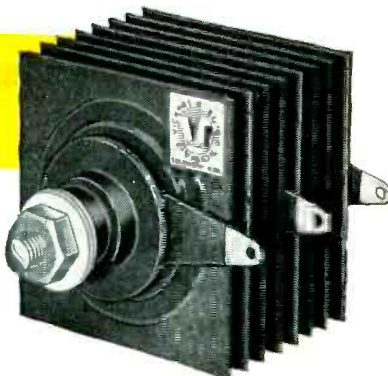

Write for Bulletin 3000. Vickers engineering service is available without obligation.

VICKERS ELECTRIC DIVISION

VICKERS Inc.

A UNIT OF THE SPERRY CORPORATION
1801 LOCUST STREET • SAINT LOUIS, MISSOURI

new construction features longer, more flexible contact arms resulting in a lower spring load rate. This combination permits wider contact gap, more overtravel, improvement in sensitivity, faster action and longer life. The MJ series is available with a maximum of 4 Form C contacts for either d-c or 60 cycle a-c operation. Coils are furnished up to a maximum resistance of 22,000 ohms. Insulation resistance is better than 1,000 megohms and breakdown is tested at 500 v rms. The open relay measures 1 in. wide, 1 $\frac{1}{2}$ in. long, by 1 $\frac{3}{8}$ in. high.

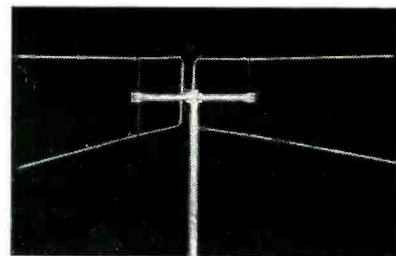

UHF-VHF Antenna

THE BRACH MFG. CORP., Division of General Bronze Corp., 200 Central Ave., Newark, N. J., announces the No. 481 Dual -V antenna designed for both uhf and vhf areas. The construction features perfect balance at the mast point for minimum strain and maximum life. Elements are made of high-strength aluminum with resilient plastic insulators to prevent breakage from wind gusts. The antenna has a gain of approximately 8 db at uhf and a directional pattern at uhf which is like that of a 6-element conical at vhf. On vhf the pattern is nondirectional and the efficiency averages about that of a dipole.

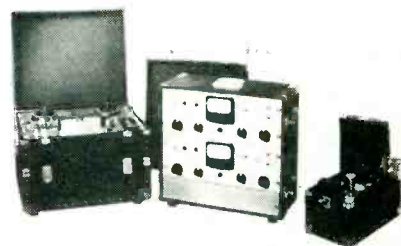

Stereophonic Recorder

AMPEX ELECTRIC CORP., 934 Charter St., Redwood City, Calif., has in-

If longer service life from vacuum tubes

is your problem,

remember... from

Peanuts to Power

...tubes perform better with **NICKEL**

From the tiny peanut tube in hearing aids to the tremendous power producer in transmitting equipment . . . in almost every tube . . . electronics manufacturers turn to Nickel to improve performance.

In cathodes, side rods, lead wires, grids, sleeves, connecting straps...in virtually every part...it's Nickel's special qualities that make that part do its special job...and do it better.

10 Reasons Why Nickel Improves Tube Life

- Excellent forming quality. Simplifies production of precision parts.
- Strong, spot-welded joints practically free of oxidation.
- Strength to maintain precision despite handling in mounting parts.
- Rustproof in handling and storage. Corrosion resisting to solvents in cleaning.
- Lower gas content. Faster evacuation because gas can be removed at higher temperatures.
- Greater strength at high evacuation temperatures without crystal change, means less change in dimensions and tube constants.
- Better electron emission from coated nickel cathodes.
- Better carbon coating adherence with less embrittlement of strip.
- Conducts heat better at elevated temperatures.
- Good damping characteristics minimizing microphonic effects.

All of which means an electronic tube made with Nickel Alloy components can perform better, whatever its application.

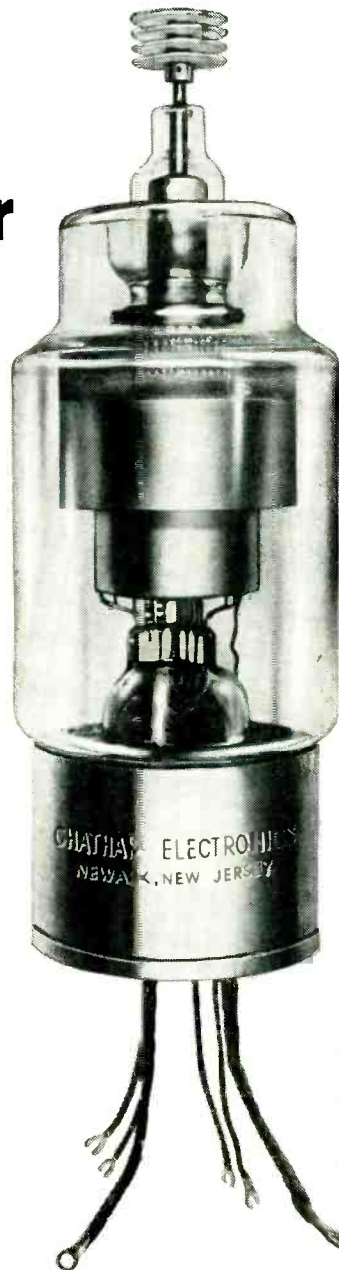

Low carbon Nickel was the choice for the spun anode sleeve and other critical parts in this 40 million watt power tube produced by the Chatham Electronics Corp., Newark 2, N. J.

Perhaps there's a Nickel or a Nickel Alloy that will help improve your product's performance. There's a concise booklet available—"Inco Nickel Alloys for Electronic Uses"—which may answer your questions. Send to Bruce Winter for your copy today. Also, if you have a special metal selection problem, just write giving full details.

The International Nickel Company, Inc., 67 Wall Street, New York 5, N. Y.



Inco Nickel Alloys

MONEL® • "R"® MONEL • "K"® MONEL • "KR"® MONEL
"S"® MONEL • NICKEL • LOW CARBON NICKEL • DURANICKEL®
INCONEL® • INCONEL "X"® • INCOLOY® • NIMONICS®

Foul Weather Friend!

No matter how marginal the weather, planes land safely on fields equipped with TVOR. This new let-down facility keeps your airport operating through rain, low ceilings and restrictions to visibility—extends its usefulness by 40%. TVOR provides all the security of VOR—at less than one-fourth the cost.

TVOR was developed to meet the needs of small and medium-sized airports. Its single installation provides a terminal omnidirectional radio range that can be installed in an inexpensive shelter directly on the airport.

Any plane with standard VOR instrumentation can make *positive approaches* to a TVOR equipped field. On course indication is steady. Over the station cone is definite. Fifty watts of antenna power provides ample coverage for omnirange navigation. TVOR is built by the Maryland Electronic Manufacturing Corporation, producers of similar installations for the CAA.

The cost of a complete TVOR installation is less than a quarter that of VOR. Yet the components are of the same high quality and the system is given the same rugged tests!

Corporation, municipal and private airfields can't afford to be without the safety and convenience of this all-weather let-down facility. Installations are ready for 90 day delivery. Write or call today for further information. Or flight test and inspect the equipment at the College Park Airfield.

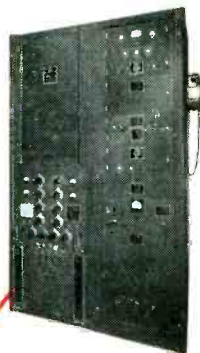
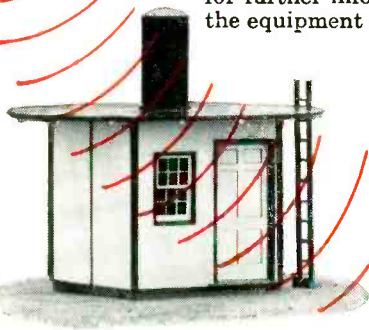

TVOR changes fair-weather to all weather airline service.



TVOR guides corporation aircraft safely to their home fields, in spite of low ceilings.



TVOR works with standard instrumentation. Private planes "home" on their own airfield.

roduced a stereophonic recorder having the same performance characteristics as the model 403 magnetic tape audio recorder. The new model, known as the 403-2, employs a dual track head assembly that records or plays back two separate channels simultaneously. Thus, material recorded by two properly placed microphones may be played back through two similarly spaced loudspeakers to give sound a directional effect. This third dimension of sound provides a realism comparable to the visual realism obtained from stereoscopic photography. The two-speed machine is supplied as a three-case portable or for rack mounting. Performance characteristics include 7½ and 15 in. per second tape speeds; solenoid control of all push-buttons, permitting full remote control; built-in preamplifiers for microphone and bridging low level lines; frequency response to 15,000 cycles at 7½-in. tape speed and signal-to-noise ratio over 55 db as defined by NARTB standards.



Beam Power Tube

RADIO CORP. OF AMERICA, Harrison, N. J. The 12V6-GT is a beam power tube of the heater-cathode type intended primarily for use in the output amplifier of automobile radio receivers operating from a 12-v storage battery. A single 12V6-GT operated with a plate and screen voltage of 250 v can deliver a maximum-signal power output of 4.5 w with a driving voltage of only about 12 v. These features together with the relatively low plate-current drain make the tube especially suit-

MARYLAND ELECTRONIC MANUFACTURING CORPORATION
COLLEGE PARK 24, MARYLAND

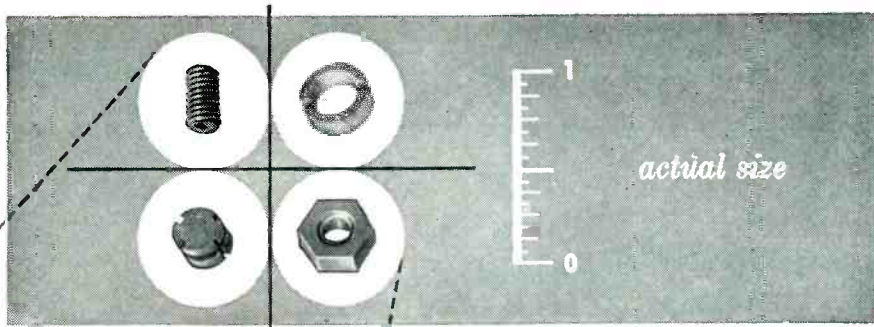

pyroferric

iron cores

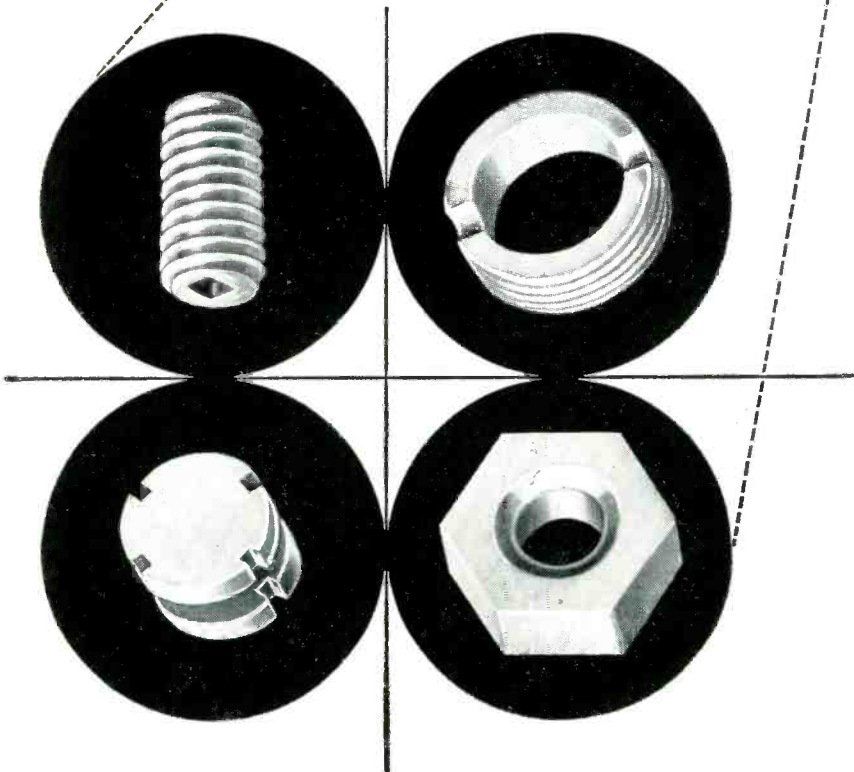

PYROFERRIC IRON CORES
 are scientifically manufactured,
 under strictest quality controls
 and rigid maintenance of close
 electrical and mechanical tolerances.

PYROFERRIC services
 are available for the engineering
 of your core production requirements . . .
 your letterhead request for Catalog 22B
 will bring you complete information
 including the manufacture of iron
 cores, their electrical properties,
 materials, design considerations,
 standardization data, uses
 and other helpful information.

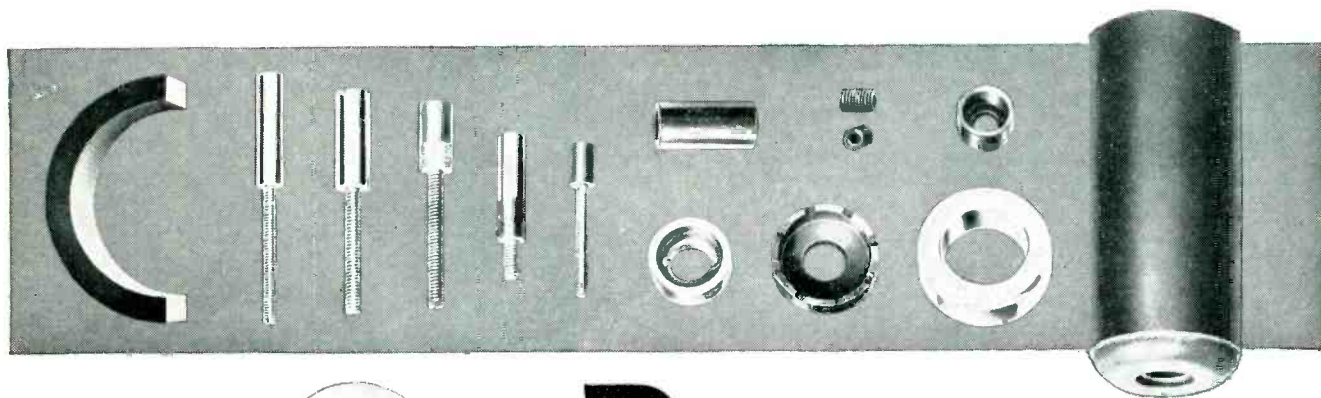

PYROFERRIC

PYROFERRIC BLDG.

BRONX BOULEVARD
 at 216th St., N.Y.C. 67

able for use in the output stage of automobile receivers.

Two-Way Radio Packset

INDUSTRIAL RADIO CORP., 428 N. Parkside Ave., Chicago 44, Ill., has introduced a portable two-way radio packset for industrial, police, fire, utility and conservation department applications. The Pak-Fone, consisting of a powerful 8-tube transmitter and a sensitive 15-tube receiver, is completely self powered. It conforms with FCC licensing regulations and is designed to provide dependable two-way radio-telephone communication between other portable stations, mobile or fixed stations. Optional power supplies permit the unit to be used also as a mobile station with a 6-v automobile battery as the power source or as a fixed station using 115 v a-c for power. The Pak-Fone is designed to operate in either the 25 to 50-mc or the 152 to 174-mc bands.



Miniature Thermostat

FENWAL INC., Ashland, Mass. A tiny thermoswitch, available in both rectangular and cylindrical models, has been designed for precise temperature control and overheat detection in instruments and precision mechanisms where minimum volume and weight are important. Depending on the thermal and electrical characteristics of the particular system, temperature control to within 1 deg F is readily attainable, since the inherent thermostat sensitivity is actually less than 1 deg. F. Either model may be set at any temperature in the range from 0 deg to 200 deg F by turning an adjusting screw. A high resistance to vibration permits the miniature units to maintain accurate control under vibration conditions of 5 g's

magnecord Voyager

the new portable

professional tape recorder



WITH A WORLD OF USES FOR
ELECTRONIC ENGINEERS



Designed with your needs in mind . . . a professional portable recorder and amplifier in a single case. Easier to handle, lightweight, ruggedly constructed to take the most difficult remotes, the Voyager insures perfect recording in field or engineering laboratory.

Professional Quality—Frequency response up to ± 2 db from 50 to 15,000 cycles per sec. at 15 in. per sec. tape speed. The amplifier has bridging input and one low impedance mike input with 600 ohm balanced output. Switch for 2-speed equalization (7 1/2" and 15") and headphone monitor jack on front.

For demonstration see your Classified Telephone Directory under "Recorder," or write Magnecord, Inc.



New! The first automatic continuous recorder . . . up to 4 channels on a standard 1/4 inch tape. For commercial and industrial monitoring of communications. Precision engineered and JAMized for CAA. Magnecorders also available for one and 2 channel monitoring.



The famous Magnecorders—
Standard of Broadcasters

Write for complete details

Magnecord INC.

Dept. E-3 • 225 W. Ohio Street • Chicago 10, Illinois

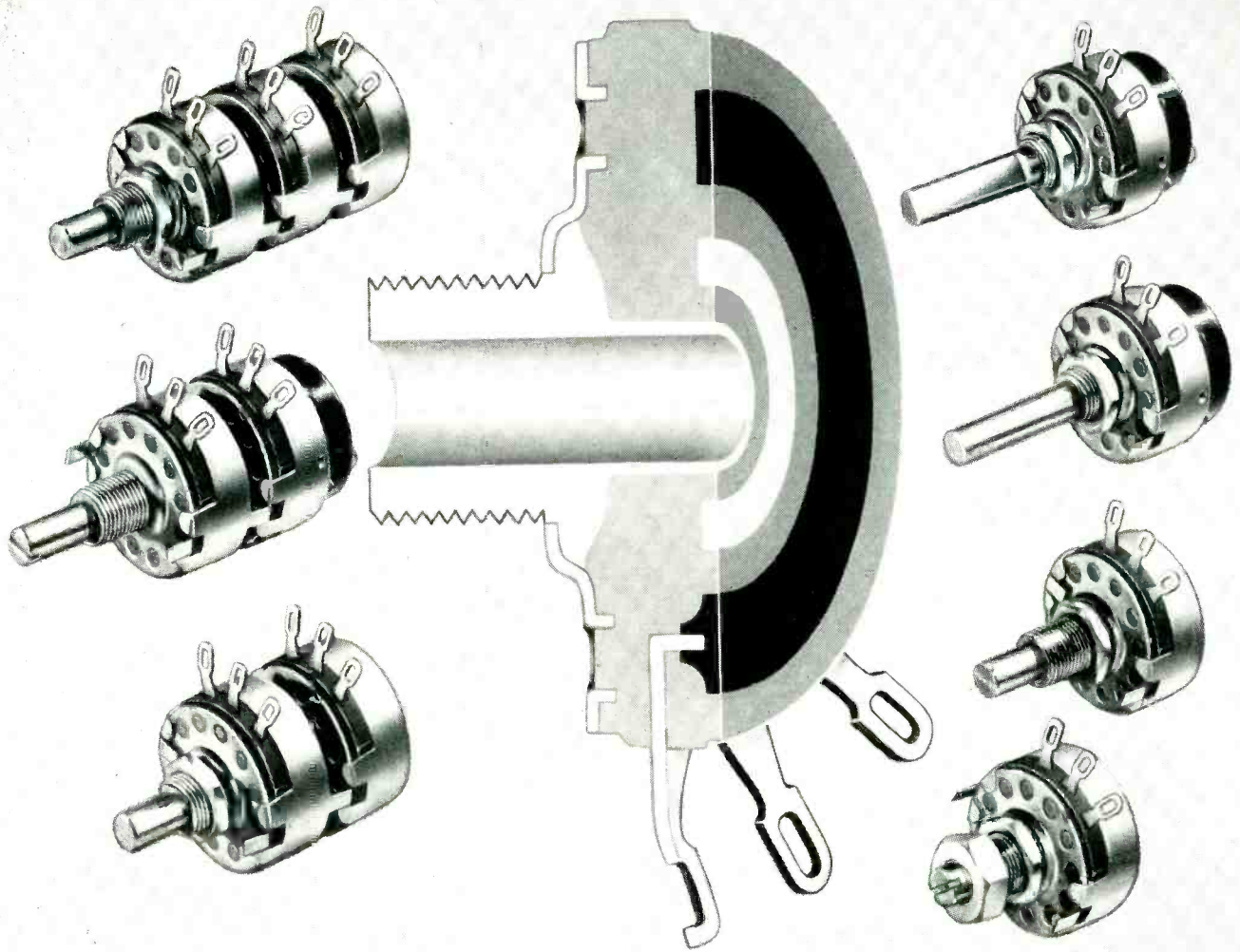

Quality **ADJUSTABLE RESISTORS** FOR CRITICAL ELECTRONIC REQUIREMENTS

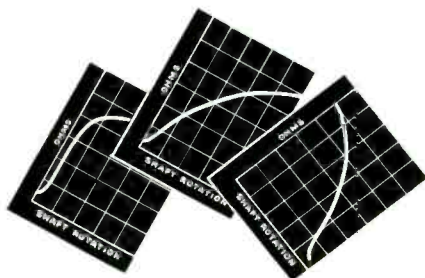

ANY RESISTANCE-ROTATION CURVE

Prior to molding, the composition of the resistor ring may be varied to produce any resistance-rotation curve. After molding, the resistance is permanently fixed. There are no soldered connections. Shaft, faceplate, and other ferrous parts are stainless steel.

If your electronic circuits require a noiseless, adjustable resistor with long life and permanent characteristics . . . if you need a rheostat or potentiometer which is unaffected by heat, cold, moisture, or hard use . . . the Allen-Bradley Type J Bradleyometer is the logical answer.

It is not a film or paint type resistor. The molded resistor does not become noisy with age. The carbon contact brush actually improves with use. Type J Bradleyometers are available in single, dual, and triple unit assemblies.

Allen-Bradley Co., 110 W. Greenfield Ave., Milwaukee 4, Wis.



ALLEN-BRADLEY

FIXED & ADJUSTABLE RADIO RESISTORS

Sold exclusively to manufacturers

QUALITY

of radio and electronic equipment

GEARED TO SERVE the electrical industry

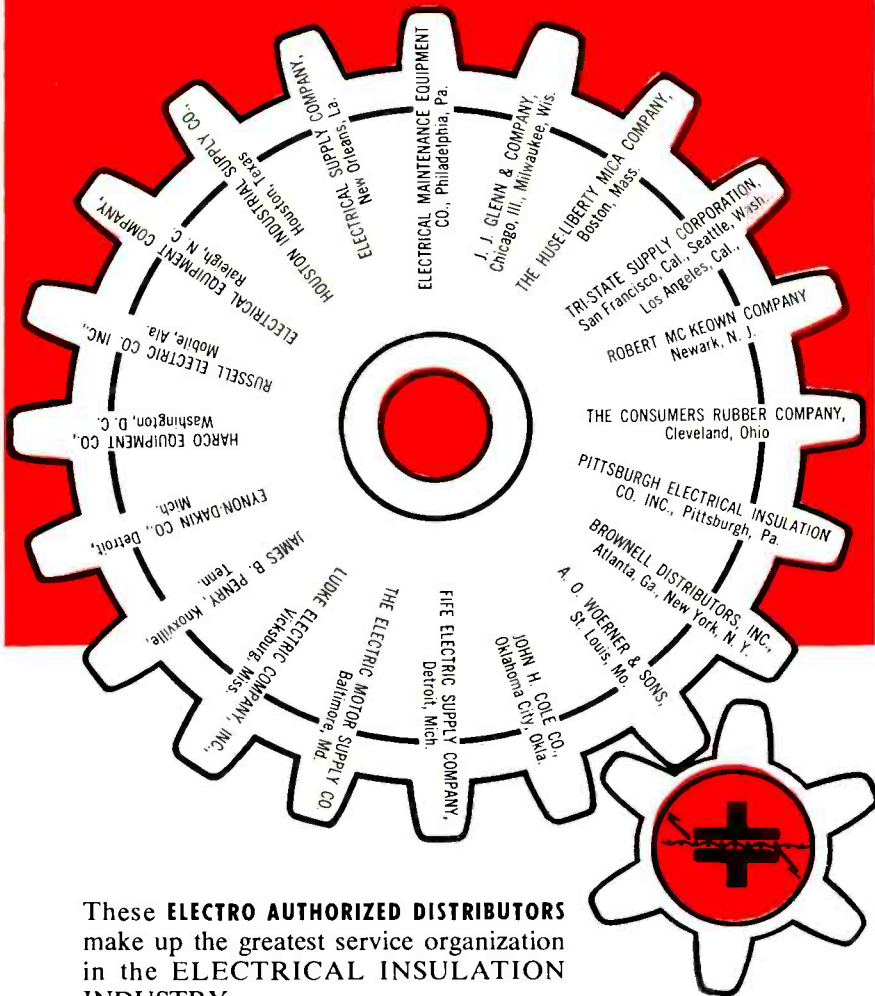

These **ELECTRO AUTHORIZED DISTRIBUTORS** make up the greatest service organization in the **ELECTRICAL INSULATION INDUSTRY.**

Today, design and maintenance engineers are confronted with the job of selecting trouble-free insulation materials. This task is made easier with **ELECTRO'S** dependable products plus engineering service and availability through **ELECTRO AUTHORIZED DISTRIBUTORS.**

Manufacturers of electrical equipment have two important rights: (1) To use the finest electrical insulation materials made, (2) To have the latest technical data concerning these products. **Electro-Technical** offers you both through their authorized distributors. Write for information and samples.

ELECTRO-TECHNICAL PRODUCTS

DIVISION OF SUN CHEMICAL CORPORATION

113 East Centre Street, Nutley 10, N. J.

NEW PRODUCTS

(continued)

at 50 to 500 cps. Both models are rated at 2.5 amperes at 115 v a-c or 2 amperes at 28 v d-c.

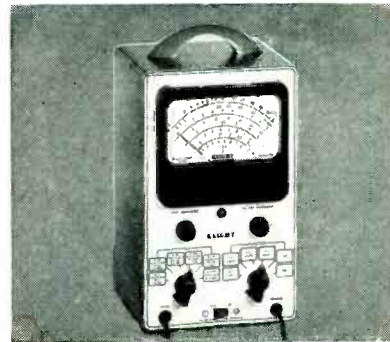

VTVM

ALLIED RADIO CORP., 833 W. Jackson Blvd., Chicago 7, Ill., announces a new, Knight vtvm kit. Designed for maximum versatility, the unit has 6 ranges for measuring a-c peak-to-peak volts. It also includes 6 ma ranges and 5 capacitance ranges—29 ranges in all. Frequency response is as high as 2.5 mc, adequate for servicing tv circuits as well as audio units. Complete instructions include schematic pictorial diagrams for easy assembly and wiring. The unit reads up to 1,000 v d-c and 2,800 v a-c; to 1,000 megohms and 5,000 μ f. Stability is assured by use of one zero setting for all d-c ranges. Special probes are available for extending the d-c range to 30,000 v and for extending the a-c range to read r-f to 200 mc.



Miniature Delay Line

ADVANCE ELECTRONICS Co., P. O. Box 394, Passaic, N. J. Type 507 was developed to meet the increas-

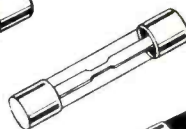

You'll Find the
Right Protection
Every Time When
You Look to

BUSS FOR FUSES

A COMPLETE LINE FOR TELEVISION • RADIO • RADAR •
INSTRUMENTS • CONTROLS • AVIONICS

For almost four decades, BUSS has specialized in the production of fuses that are unexcelled for dependability and quality. Today, this experience and forward-looking BUSS research combine to give you the most complete line of fuses for modern needs.

Your added assurance of BUSS dependability is the rigid testing every fuse must undergo. Sensitive electronic testing devices check BUSS fuses for proper construction, correct calibration and accurate physical dimensions.

Turn To BUSS Engineers With Your Fuse Problems.

They will be glad to assist you in selecting the fuse to do the job best . . . and if possible a fuse that will be available from local wholesaler's stocks.

If your protection problem is still in the engineering state, tell us current, voltage, load characteristics etc.

BUSSMANN Mfg. CO., *Division McGraw Electric Company*
University at Jefferson, St. Louis 7, Missouri

and A COMPLETE LINE OF FUSE CLIPS,
BLOCKS AND HOLDERS

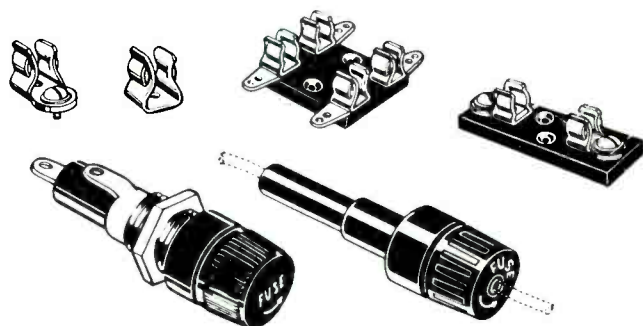

BUSSMANN Mfg. Co. (Division of McGraw Electric Co.)
University at Jefferson, St. Louis 7, Mo.

Please send me bulletin SFB containing facts on
BUSS small dimension fuses and fuse holders.

Name _____

Title _____

Company _____

Address _____

City & Zone _____ State _____ ELRC-353

ing need of miniature delay line capable of providing continuously variable time delay from zero to several hundreds of millimicroseconds. By means of a novel mathematical method the amount of equalization was made exactly equal to its correct optimum value. The miniature continuously variable delay line is essentially a condensed r-f cable with one conductor changed into a long thin coil and the other conductor spaced closely to the first, thus producing a large amount of time delay yet maintaining low attenuation at high frequencies. Time delay is continuously variable from 0 to 0.8 μ sec. Characteristic impedance is 390 ohms nominal. Attenuation in db per 100 millimicroseconds delay is essentially zero below 3 mc, 0.5 at 8 mc, 1 at 15 mc. Size of the unit is 1 in. deep, 4 in. long and 4 in. high.

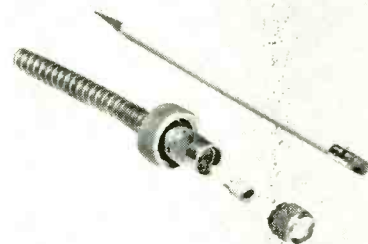

Flame Failure Safeguard

COMBUSTION CONTROL CORP., 720 Beacon St., Boston 15, Mass. The Firetron scanner type 48PT1 provides flame failure protection for gas, oil, pulverized coal or combination fuel burner installations. It is used in conjunction with control type 26SJ5 for the protection of manually ignited burners and with programming control type 26RJ8 for the protection of automatically fired installations. The eye of the scanner is the Firetron, a photoconductive cell highly responsive to infrared. With its associated electronic circuits it distinguishes between the infrared of a flame and that of other sources of infrared. The tiny cell, hardly bigger than a pencil eraser, is plugged into the scanner unit that consists of a mounting for the cell and a length of cable for electrical connections. The single scanner views both the pilot and main flames and replaces



Designed

TO TAKE

"PRODUCTION LINE PUNISHMENT"



WALL INDUSTRIAL

HEAT-CONTROLLED, THERMOSTATIC ACTION

SOLDERING IRONS



HEAT-CONTROL
Thermostatic
Action guaranteed for the life
of the iron, or
double your
money back!

The new, superior WALL INDUSTRIAL IRONS will outperform and outlast any soldering irons you've ever tried! Exclusive thermostatic action (without the use of fragile thermostats) controls heat so perfectly that fusing and tip-burning are held to a minimum. Iron stays at "on-the-button" production heat all day long, day after day. Wall Irons heat four times faster than ordinary irons. No radionic interference while iron is in use. And Wall is more economical to use than irons of like wattage because of heat output efficiency! From 20 watts to 1000 watts . . . thermostatic action up to 2600 watts. Send for catalog today.

See Your Distributor

OVER 20,000,000 SOLDERING PRODUCTS SINCE 1864



WALL MANUFACTURING CO.

GROVE CITY • PENNSYLVANIA

Armco Thin Electrical Steels in production NOW

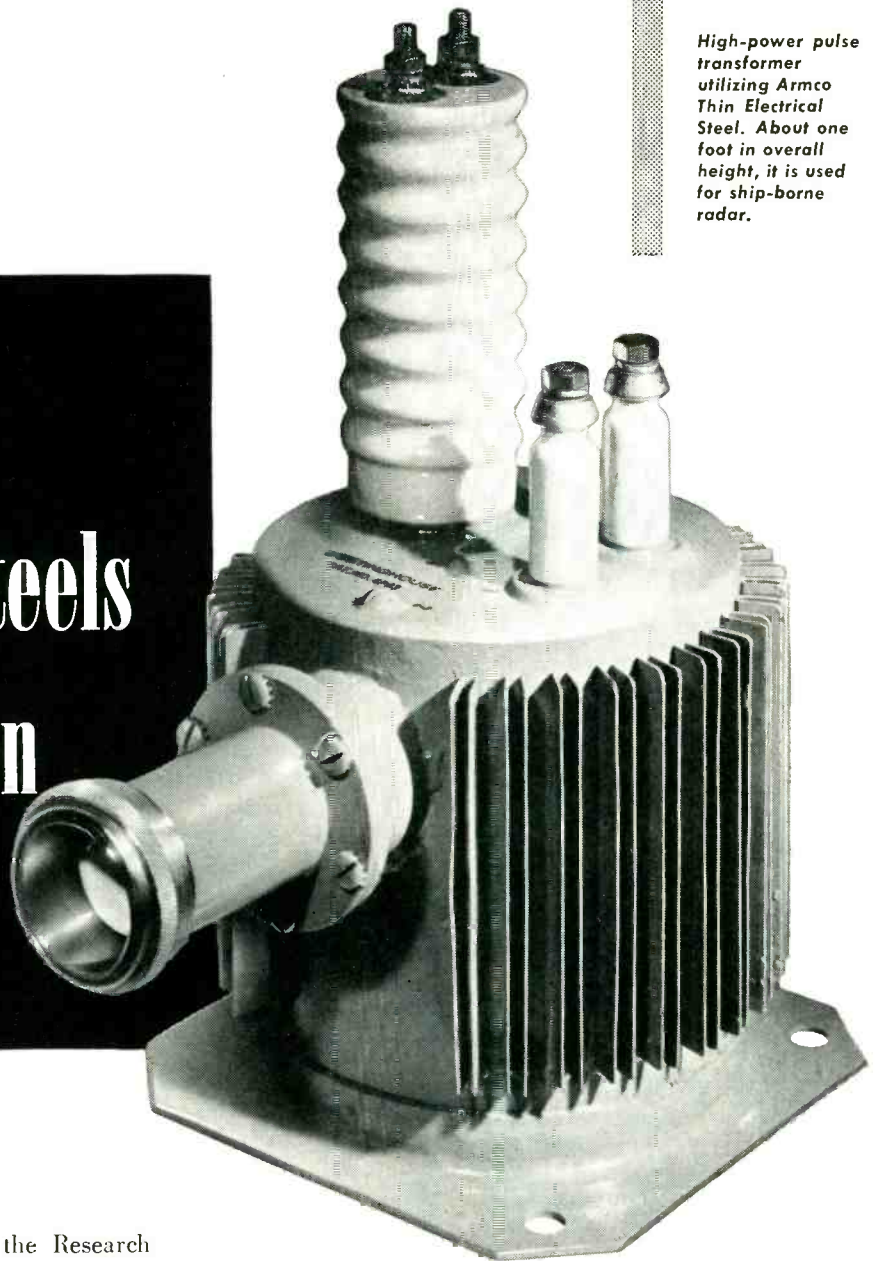

High-power pulse transformer utilizing Armco Thin Electrical Steel. About one foot in overall height, it is used for ship-borne radar.

THEY'RE ON THEIR OWN

Armco Thin Electrical Steels are out of the Research Laboratory. They are now being produced in a brand-new production department of their own. Like other Armco Special-Purpose Steels, they now need Research attention only to plan improvements.

THE NEW SET-UP

The making of these steels is much different from producing ordinary electrical steels. Personnel in the new department work on Thin Electrical Steels alone. They have specialized rolling, annealing, slitting and testing equipment, used exclusively for Thin Electrical Steels.

RELIABLE DELIVERY

You can specify these grades of thin magnetic materials with confidence because they are production items:

TRAN-COR T in 7 and 5 mil thicknesses with good permeability in all directions; *TRAN-COR T-O*, in 4, 2 and 1 mil thicknesses, an "oriented" grade with best permeability

exhibited in the rolling direction; and TRAN-COR T-O-S, in 4 mil thickness only, a super-oriented grade.

THE CATALOG TELLS THE STORY

If you are interested in the advantages of reduced core losses and smaller core dimensions at frequencies of 400 to 200,000 cycles, write for the 32-page booklet, "Armco Thin Electrical Steels." It has complete information and graphical data on the 6 Armco Thin Electrical Steels.

ARMCO STEEL CORPORATION

1683 Curtis St., Middletown, Ohio • Export:
The Armco International Corporation





*For
hard
service...
heavy
currents*

CAROL POWER SUPPLY AND CHARGING CABLE

Really rugged... but unusually easy to handle... Carol Charging Cable is designed to carry heavy currents for rectifiers, battery chargers, large motors and other equipment needing portable power cable.

Soft copper wires are rope lay stranded for extra flexibility. They are either tinned, or bare and served, then enclosed in high dielectric, long-wearing rubber compound. For most severe service, the jacket is made of Carol Neoprene... a specially compounded material which resists acids, alkalis, sunlight, corona, oil and grease; withstands extremes of weather and temperatures.

Carol Charging Cable is supplied in sizes from No. 4/0 to 10 AWG, with either rubber or neoprene jacket.

Write or call today for full information on our complete line of cable for electronic applications.

CAROL
CABLE DIVISION
of The
CRESCENT COMPANY
INC.

Pawtucket, Rhode Island

Want more information? Use post card on last page.

366

NEW PRODUCTS

(continued)

both flame rod and photocell flame detectors.

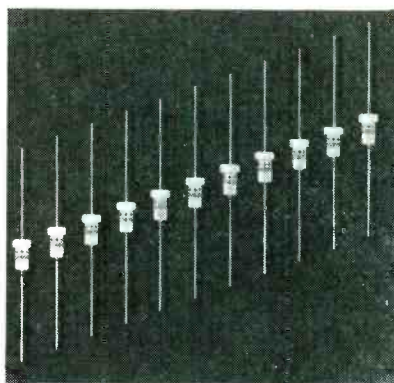

Tantalum Capacitors

FANSTEEL METALLURGICAL CORP., 2200 Sheridan Rd., North Chicago, Ill., has available a line of electrolytic capacitors that employ porous tantalum anodes. They range from 1.5 to 30 μ f with working voltages up to 125 v d-c. The normal temperature range at rated working voltage is from -55 to $+85$ C. Excluding connection leads, the capacitors occupy less than 1/10 of a cubic inch. They are intended for applications where unusually stable characteristics are required and space is at a premium.

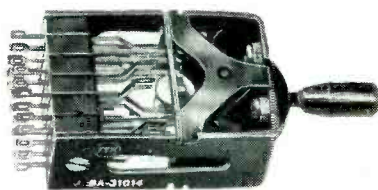

Switching Key

FEDERAL TELEPHONE AND RADIO CORP., Clifton, N. J., has announced a new miniature anticapacitance switching key that weighs only 2 $\frac{1}{2}$ oz and combines compactness with increased reliability and long life. Designed to meet military requirements, the new key is ideal for use in airborne and other types of equipment where compactness and light weight are prime factors. The unit consists of four sets of transfer contacts on each side. The key is nonlocking in both directions. It is mounted on an aluminum frame

Laboratory Standards

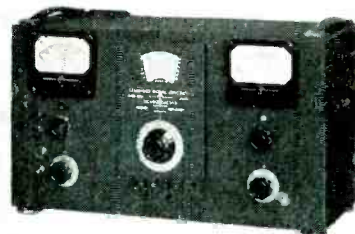

STANDARD SIGNAL GENERATOR

Frequency range: 75 kc. to 30 mc. Output 0.1 microvolt to 2.2 volts. MODEL 65B

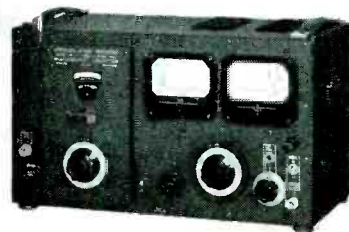

STANDARD SIGNAL GENERATOR

Frequency range: 2 mc. to 400 mc. Output 0.1 microvolt to 0.1 volt. MODEL 80



SQUARE WAVE GENERATOR

5 to 100,000 cycles. Recommended for AM, FM and television testing. MODEL 71



MODEL 59

MEGACYCLE METER

MANUFACTURERS OF
Standard Signal Generators
Pulse Generators
FM Signal Generators
Square Wave Generators
Vacuum Tube Voltmeters
UHF Radio Noise & Field
Strength Meters
Capacity Bridges
Megohm Meters
Phase Sequence Indicators
Television and FM Test
Equipment

A versatile grid-dip oscillator covering the frequency range of 2.2 mc. to 400 mc.

CIRCULARS
ON REQUEST

MEASUREMENTS CORPORATION
BOONTON  NEW JERSEY

Want more information? Use post card on last page.

March, 1953 — ELECTRONICS

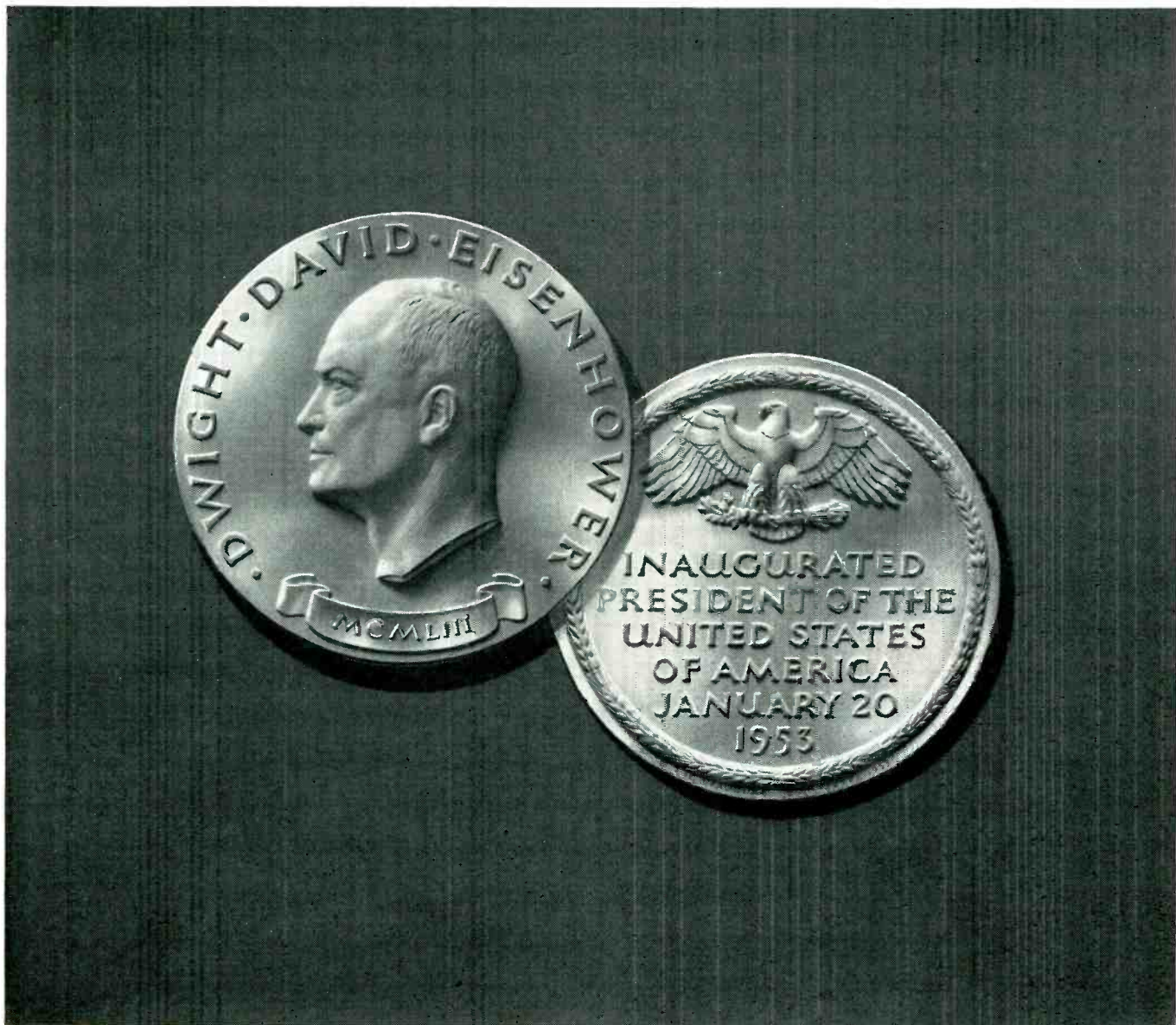

The Eisenhower Inaugural Medal *is made of Lasting Bronze*

WE ARE PROUD to announce that one of our customers is executing the official 1953 Presidential Inaugural Medal. The striking of over 10,000 replicas by the Medallic Art Company of New York City marks the return of this commission to private enterprise after many years of government manufacture. Walker Hancock, well-known American sculptor, prepared the original model from which the medal

for General Eisenhower and the replicas were reproduced.

This memorable medal may be obtained for \$3.00 from the Inaugural Committee, 1420 Pennsylvania Avenue N. W., Washington 25, D. C.

A special alloy of bronze, carefully prepared to exacting specifications, is being supplied for this medal from our mill here in Bristol.



The **BRISTOL BRASS CORPORATION**
makers of Brass since 1850 in Bristol, Conn.

Offices or warehouses in

Boston, Chicago, Cleveland, Dayton, Detroit, Los Angeles, Milwaukee, New York, Philadelphia, Pittsburgh, Providence, Rochester

TRIAD

Sub-Miniature Pulse Transformers

Designed for simplifying and miniaturizing short-pulse circuits, these new Triad sub-miniature transformers meet the continuing demand for higher performance in smaller packages. In many cases they meet existing circuit requirements—saving engineering time. In every case they save space and weight. Prices on types shown here on request. For special designs, submit outline of contemplated circuit.

type #20284

Two or three winding types. Size: .40" Dia. x .56" L.—Positive Hermetic Sealing—Ambients up to 135°C—Pulse widths 15 to .65 microseconds—Rise time .05 microseconds—Duty cycle .05 maximum.



actual size

type #20285

Two, three or four winding types. Size: .50" Dia. x .68" L.—Positive Hermetic Sealing—Ambients up to 135°C—Pulse widths .35 to 1.2 microseconds—Rise time .06 microseconds minimum—Duty cycle .05 maximum.



actual size

type #20086

For severe mechanical problems, this Hermetic Sealed, Miniature 3-winding pulse transformer is designed for under-chassis mounting, using a single 8/32 mounting stud and a Triad Multiple Terminal. Same electrically as type #20284.



actual size

Class H

For severe heat problems, these Sub-Miniature Pulse transformers are constructed entirely of inorganic material and impregnated with Silicone varnish for duties in ambients up to 200° Centigrade. Same electrically as type #20285.



For information on other Triad transformers, write for Catalog TR-52G

TRIAD
TRANSFORMER MFG CO
4055 Redwood Ave. • Venice, Calif.



with four screws and can be easily removed from the key frame for inspection and adjustment. Other features include a molded spring nest and a special restoring spring heat-treated for maximum life and endurance.

Insulation

IRVINGTON VARNISH AND INSULATOR Co., 6 Argyle Terrace, Irvington 11, N. J. Irv-O-Bestos, a new class B insulation consisting of Mylar polyester film bonded to Quinterra asbestos papers in duplex and triplex combinations, has been announced. This new type of insulation not only has high tensile and tear strength, but exceptional dielectric strength as well. For example, the 0.003-in. duplex construction has a dielectric strength of 1,900 vpm with 1/4-in. electrodes, and 1,500 vpm with 2-in. electrodes. Suggested applications for this high dielectric strength material might be as motor and dry-type transformer insulation, magnet wire insulation, coil and relay insulation, sheet insulation, or as primary cable insulation.

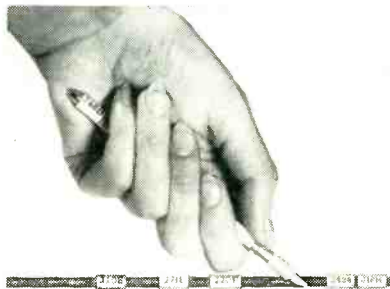

Split-Sleeve Tagging

DURAMARK, INC., 2 Secatoag Ave., Port Washington, N. Y., has available a line of split-sleeve laminated tags made of vinylite. Only a light pressure on the tag is required for application to wire, cable or tube. A unique method of packing the tags permits direct, quick loading of a number of tags on an applicator and a fast continuous tagging operation. Because of a protective laminated overlay the tags are impervious to abrasion, corrosion, erasure, water, oil, acids and gases. Application is simple. The marker

Are Your Laboratories Overloaded?



A PRACTICAL SOLUTION TO THE PROBLEM OF TECHNICAL MANPOWER SHORTAGE

Are you interested in the possibility of getting some of your testing analysis and trouble shooting work done without hiring additional technical help?

Our solution is very direct. No doubt many of your trained engineers and chemists are tied down by routine but essential testing and analytical tasks. You can release these men for more demanding, more responsible duties by entrusting our laboratories with your routine testing and analytical schedules.

Why is this possible? Because Testing is our Business. Your assignments to us will be handled by men who live and think testing. They will receive the care and attention that only a specialized laboratory can give. That means speed, accuracy, and real economy.

We would like to get together and discuss your manpower problems and possibly point the way to a solution.

UNITED STATES TESTING COMPANY, Inc.

ESTABLISHED 1880

1550 Park Avenue, Hoboken, N. J.
PHILADELPHIA • BOSTON • PROVIDENCE
CHICAGO • NEW YORK • LOS ANGELES
MEMPHIS • DENVER • DALLAS

Member of American Council of Commercial Laboratories

Want more information? Use post card on last page.

March, 1953 — ELECTRONICS

VOLTAGE REGULATED POWER SUPPLIES

For Industrial and Research Use

THE KEPCO MODEL 1520 FEATURES A REGULATED HIGH VOLTAGE POWER SUPPLY WITH EXCELLENT REGULATION, LOW RIPPLE CONTENT AND LOW OUTPUT IMPEDANCE.

SPECIFICATIONS

OUTPUT VOLTAGE DC: 0-1500 volts continuously variable.

OUTPUT CURRENT DC: 0-200 milliamperes continuous duty.

REGULATION: In the range 30-1500 volts the output voltage variation is less than 1/2% for both line fluctuation from 105-125 volts and load variation from minimum to maximum current.

RIPPLE VOLTAGE: Less than 20 millivolts.

FUSE PROTECTION: Input and output fuses on front panel. Time delay relay is included to protect rectifier tubes.

POWER REQUIREMENTS: 105-125 volts, 50-60 cycles.

MODEL 1520

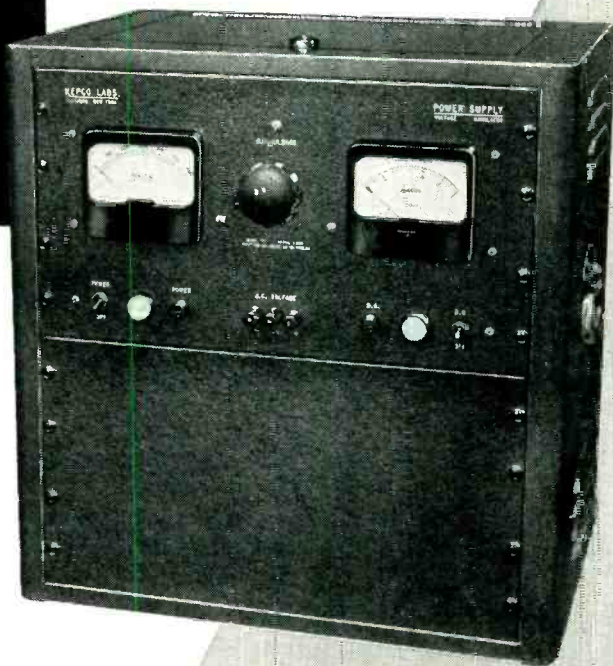

OUTPUT TERMINATIONS: DC terminals are clearly marked on the front panel. Either positive or negative terminal of the supply may be grounded. DC terminals are isolated from the chassis. A binding post mounted on the front panel is available for connecting to the chassis. All terminals are also brought out at the back of the chassis.

METERS: Voltmeter: 0-1500 volts, 4" rectangular. Milliammeter: 0-200 milliamperes, 4" rectangular.

PHYSICAL SPECIFICATIONS: Cabinet height 22 3/4", width 21 3/4", depth 15 1/4", color gray, panel engraved. Rack panel height is 21", width 19".

CONTROLS: Power on-off switch, HV on-off switch, HV control.

KEPCO

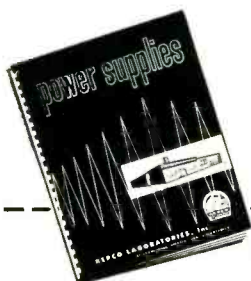

KEPCO LABORATORIES

131-38 SANFORD AVENUE • FLUSHING 55, NEW YORK



Complete catalogue available upon request . . . write dept. A

VISIT KEPKO BOOTH NOS. 4-406 and 4-408 AT THE I.R.E. SHOW

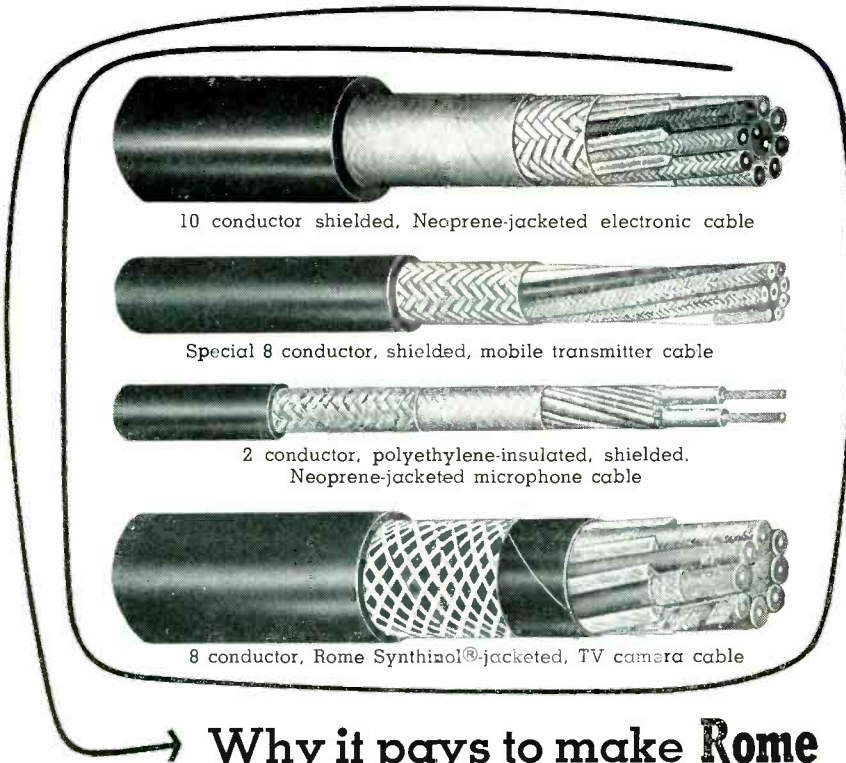

10 conductor shielded, Neoprene-jacketed electronic cable

Special 8 conductor, shielded, mobile transmitter cable

2 conductor, polyethylene-insulated, shielded.
Neoprene-jacketed microphone cable

8 conductor, Rome Synthinol®-jacketed, TV camera cable

Why it pays to make Rome your source of special electronic cables

When you have an electronic wiring problem it pays to go to a specialist, such as Rome Cable.

Wires and cables made by Rome, first, are designed by engineers with training and experience in electronic applications. Further, Rome Cable has the manufacturing knowledge and facilities to produce unusual constructions... with quality controlled step by step. By standardizing on Rome wires and cables you assure dependable performance for your product and add obvious quality... with a component *engineered to your requirement.*

Rome manufactures a wide range of hook-up wires, inter-communication cables, co-axial cables, electronic computer ca-

bles, R. F. transmission line, television camera cables as well as other special constructions.

Commercial type hook-up wires

Rome offers commercial type hook-up wires with three standard insulations.

Rome Hi-temp—a rubber insulation with exceptionally high resistance to heat and moisture. Underwriters' approved for 75° C.

Rome Synthinol—a polyvinyl chloride thermoplastic compound, highly resistant to acids, oils, alkalis, moisture and flame. Underwriters' approved for 80° C.

Rome Synthinol 901—offers all the advantages of Synthinol plus higher resistance to heat deformation, shrinkage and cracking, also improved solderability. Underwriters' approved for 105° C.

Military hook-up wires

Rome manufactures military type SRIR, SRHV and WL, complying with Army-Navy Joint Specification JAN-C-76, as well as shipboard types SRI and SRIB conforming to Specification MIL-C-915. Insulated with Rome Synthinol, these wires are made in a complete range of specification sizes.

----- **IT COSTS LESS TO BUY THE BEST** -----

ROME CABLE
CORPORATION

Dept. E-3 • Rome, N. Y.

Please send me information
on Electronic Wiring.

Name

Company

Address

City.....State.....

ROME CABLE CORPORATION
ROME, NEW YORK and TORRANCE, CALIFORNIA



is slipped over an applicator tool and slid into position. Once in position the tag grips tightly and remains permanently. Applicator tools are available for every size tag. A four-page descriptive bulletin is available.



Voltage-Regulated Power Supplies

KEPCO LABORATORIES, INC., 131-38 Sanford Ave., Flushing 55, N. Y. Model 700 power supply features one regulated d-c voltage supply with excellent regulation, low ripple content and low output impedance. The high voltage supply is continuously variable from 0 to 350 v and delivers from 0 to 750 ma. In the 30 to 350-v range the output voltage variation is less than 0.5 percent for both line fluctuations from 105 to 125 v and load variation from minimum to maximum current. The ripple voltage is less than 10 mv peak to peak. Cabinet height is 22 $\frac{1}{2}$ in., width 21 $\frac{1}{2}$ in. and depth 15 $\frac{1}{2}$ in.

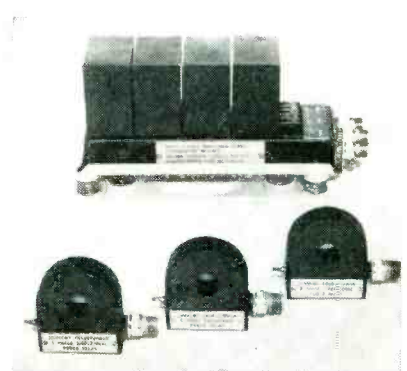

Power Relay

GENERAL AVIATION CORP., 540 E. 80th St., New York 21, N. Y., has

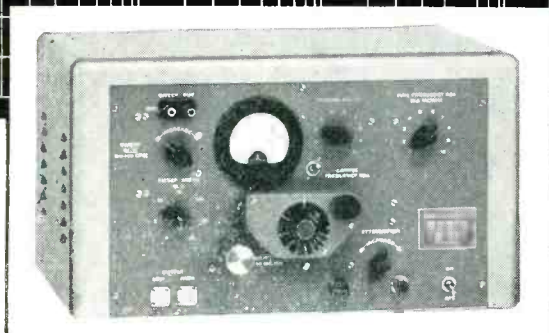
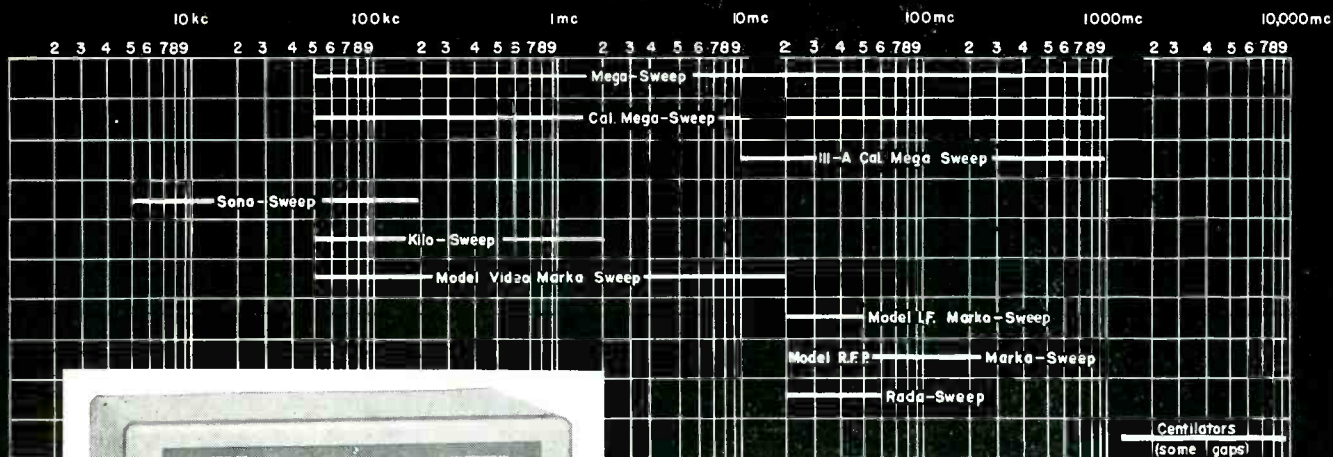

NEED SWEEPING OSCILLATORS

FOR RAPID and ACCURATE VISUAL MEASUREMENTS ?

	Frequency Range	Tuning	Maximum Sweep Width	Markers	Output (Open Circuit)	Price* f.o.b. factory
Mega-Sweep	50 kc - 1000 mc	Continuous	30 mc	None	0.1 volt	\$395.00
Calibrated Mega-Sweep	50 kc - 950 mc	Continuous	30 mc	None	0.1 volt	425.00
111-A Calibrated Mega-Sweep	10 mc - 950 mc 450 mc - 900 mc	Continuous	40 mc	None	0.3 volt, 70 ohms 0.6 volt, 300 ohms	575.00
Sona-Sweep	5 kc - 200 kc	Continuous	20 kc	Up to six crystal positions	1.0 volt	525.00
Kilo-Sweep	50 kc - 2 mc	Continuous	100 kc	Up to six crystal positions	1.0 volt	525.00
Model Video Marka-Sweep	50 kc - 20 mc	Three Ranges 50 kc - 5 mc 50 kc - 10 mc 50 kc - 20 mc	Complete Range	Up to six crystal positions	0.6 volt	495.00
Model IF Marka-Sweep	20 mc - 50 mc	Four Ranges	500 kc (Narrow) 15 mc (Wide)	Up to nine crystal positions	0.5 volt	295.00
Model RF-P Marka-Sweep	All 12 channels, VHF TV Range	Switchable	15 mc	Pix and Sound crystal positions	0.5 volt, 70 ohms 1.0 volt, 300 ohms	795.00
Rada-Sweep	30 & 60mc centers; Others, special	Switchable	3 mc (Narrow) 20 mc (Wide)	Up to nine crystal positions	0.5 volt	395.00
No. 1214 Centilator	1245 mc - 1460 mc	Continuous	5 mc	None	134 mw	595.00
No. 3439 Centilator	3400 mc - 3960 mc	Continuous	40 mc	None	106 mw	495.00
No. 4249 Centilator	4240 mc - 4910 mc	Continuous	35 mc	None	115 mw	450.00
No. 6274 Centilator	6250 mc - 7425 mc	Continuous	50 mc	None	110 mw	450.00
No. 8596 Centilator	8500 mc - 9660 mc	Continuous	60 mc	None	30 mw	395.00

*In some cases small extra charge for crystal substitutions or additions

SEE OUR NEW INSTRUMENTS

BOOTH 1-401
NY IRE SHOW



REQUEST NEW
1952-1953 CATALOG
FOR FULL DETAILS



KAY ELECTRIC COMPANY

14 Maple Avenue

Phone CALdwell 6-4000

Pine Brook, New Jersey

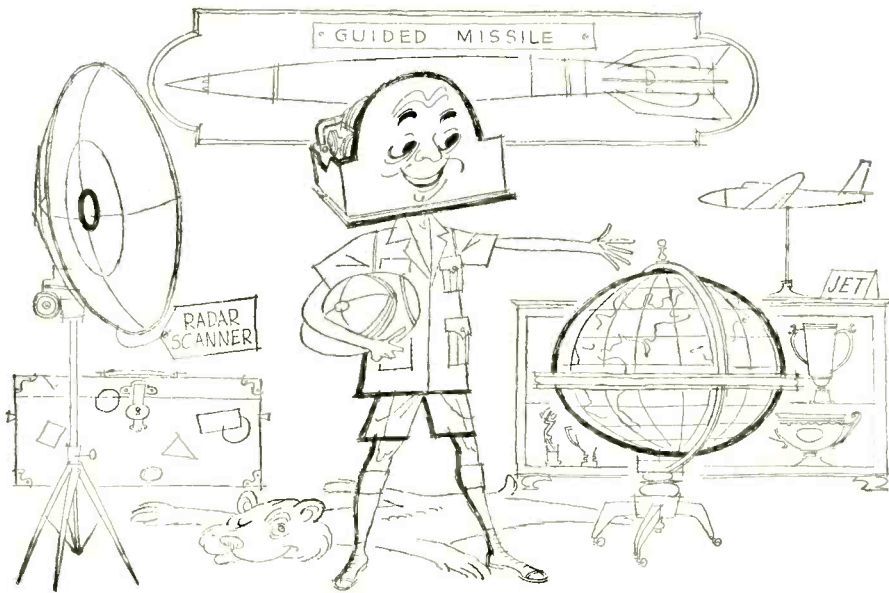

GYRO LOOKING FOR NEW WORLDS TO CONQUER

We're mighty happy with the performance of our Cageable Vertical Gyro as an autopilot component in fighters and guided missiles—and in radar stabilization systems.

But we feel that this gyro—which can be caged in under ten seconds, uncaged in only three seconds—has a lot of undeveloped possibilities.

Some of them we know. But you may have problems and applications of which we are not aware.

So if you get any ideas after you've looked over the specs below, drop us a line.

And remember, here at Honeywell we're specialists in gyros, have become one of the leaders in the field. Our gyro "family"—which includes other vertical, rate and the extremely sensitive Hermetic Integrating Gyros—is now available to manufacturers who require *precision* performance.

If you'd like to know more about any of the products in our gyro line, we'd be pleased to send details. The address is Honeywell Aero Division, Dept. 401 (E), Minneapolis 13, Minnesota.

Cageable Vertical Gyro JG 7044A Specifications

Power Requirements: Gyro motor: 115 volts, 400 cps $\pm 10\%$, single-phase. Erection motors: 30 volts, 400 cps, single-phase. Caging circuit: 28 volts dc.

Power Load: Gyro motor: 50 watts max. (starting); 20 watts max. (running).

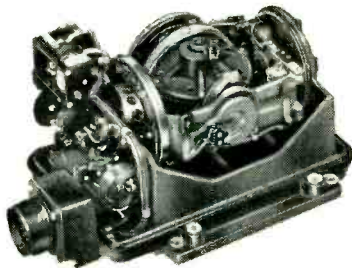

Erection motors: 5 watts (each). Caging operation: 12 watts (operating); 6 watts (standby).

Gyro Speed: 22,000 rpm. (minimum).
Angular Momentum: 4.75×10^6 gm-cm²/sec.

Roll Axis Freedom: 360°.

Pitch Axis Freedom: $\pm 85^\circ$.

Caging Time: 10 seconds. (max.).

Gyro Run-down Time: 8 min. (min.).

Erection Rate: 2° to 6° per minute (factory adjustment).

Drift Rate: 30° per hour (maximum).
Accuracy: 0.15° of true vertical in each axis.

Resolution: 1/13° each axis.

Environment: Designed to meet AAF Spec. 27500D.

Weight: 5 lbs.

developed an a-c current sensing and cutoff system to protect aircraft alternators hooked up in parallel from reverse current and overvoltage. It can also be used for d-c overvoltage protection. The equipment is a three-phase directional power relay. It provides a more precise trigger point action and is less sensitive than other d-c equipment. The unit weighs 3 lb and is 100-percent hermetically sealed. The set consists of four small boxes. Three of these are individual sensing units, one for each phase of current, in which are contained the trigger tubes and master relays. Current conditions in the main alternator circuits are telegraphed to these sensing units by three doughnut-shaped current transformers that impress on the sensing circuits a voltage proportioned to line current. A reverse power flow of 2,000 w or overvoltage in any phase will cause the master relay of the respective sensing unit to be triggered, which in turn operates a slave relay. The slave relay in turn shuts down the alternator.

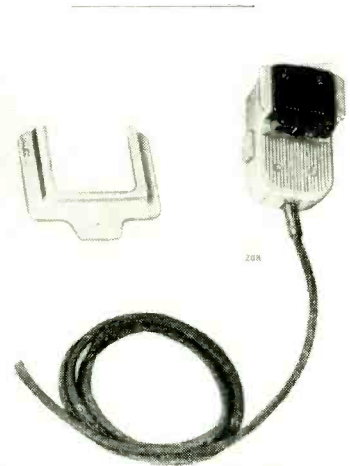

Carbon Microphone

ELECTRIC-VOICE, INC., Buchanan, Mich. A new model 208 hand-held differential type noise cancelling, high-output, single-button carbon microphone is now being produced. It is designed for convenient close-talking and maximum intelligibility in mobile communications and similar applications. Articulation is at least 97 percent under quiet conditions, 88 percent under 115 db of ambient noise. Frequency response to sounds of close origin is sub-

MINNEAPOLIS
Honeywell



Aeronautical Controls

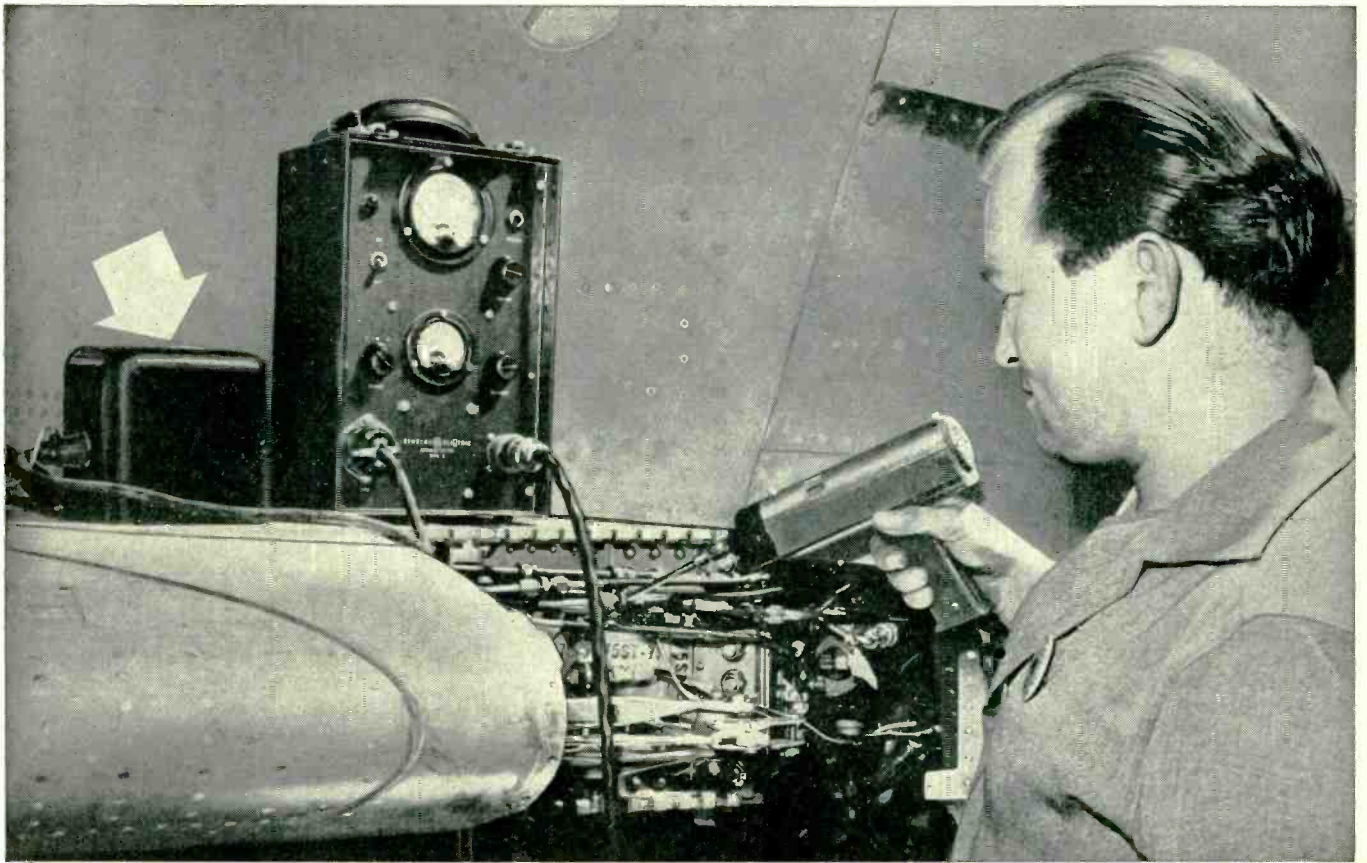

PRECISE INSTRUMENT DETECTS LEAKS AS SMALL AS 1/100 OUNCE A YEAR, USES G-E VOLTAGE STABILIZER.

For Precision Performance Use G-E Voltage Stabilizers

Accurate to within $\pm 1\%$ in standard models, G-E Automatic Voltage Stabilizers correct voltage fluctuations between 95 and 130, or 190 and 260 volts, delivering a stable 115 or 230 volts to your product.

AUTOMATIC OPERATION: Compact standard models are now made in sizes 15 to 5000 va. Special designs are available for specific applications, and others can be engineered for your purpose. Operation on all G-E Voltage Stabilizers is completely automatic. Whatever your varying voltage problem, G-E experience will provide the answer.

SIMPLE INSTALLATION: G-E Automatic Voltage Stabilizers have only two sets of terminals to connect—one for supply, one for load.

NO MAINTENANCE: Since there are no moving parts or electronic components, there is virtually no need for replacement parts, adjustments, or any other maintenance. General Electric Co., Schenectady 5, N. Y.

MORE HELPFUL INFORMATION

The "why" and "how" of stabilization, including specific details on operating characteristics, uses, and application information, is explained in a new bulletin number GEA-5754. To get your free copy of this practical, helpful manual on voltage stabilization, fill in and mail the coupon below.



General Electric Company
Section A411-108
Schenectady 5, New York

Please send me, without charge, Manual GEA-5754 on Automatic Voltage Stabilization.

For immediate project _____ For reference only _____

NAME _____ TITLE _____

COMPANY _____

ADDRESS _____ CITY _____ STATE _____

Product or type of product for which stabilizers are to be used,
if not confidential: _____

GENERAL  **ELECTRIC**

Your Helping Hand...

HUDSON

RADIO & TELEVISION CORP.



One Call for All!
**EVERYTHING IN
 ELECTRONIC EQUIPMENT
 FOR LABORATORY
 AND INDUSTRY**

If it's NEW... HUDSON has it FIRST! Leading Authorized Distributor of Electronic Equipment in the East... Your ONE Complete Dependable Source.

FREE!

New 1953 HUDSON CATALOG...

... your helping hand for Everything in Electronic Equipment. Over 196 pages of the latest in Radio, TV and Industrial Electronics. High Fidelity and PA Sound Equipment PLUS JAN type Electronic Components with latest JAN Cross-Reference Guide. Send for your copy... KEEP IT HANDY for ordering... It's Quick, Convenient... Time and Money Saving! ONE Order, ONE Dependable Source — ONE Call for ALL!

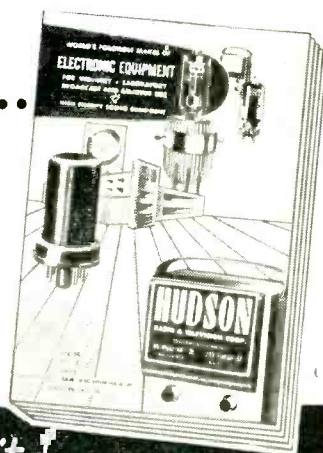

Send for FREE Catalog to Dept. M-3

You're Invited...

When you attend the IRE SHOW, you're invited to visit our uptown salesroom, adjoining Radio City... only 4 1/2 blocks from Grand Central Palace! Make yourself at home. See our Vast Facilities... Tremendous Stocks... Gigantic Salesrooms!... Meet the men who serve America's foremost users of electronic equipment. Open until 9 P.M. during show time, March 23-26.



HUDSON (Uptown)

HUDSON

RADIO & TELEVISION CORP.

48 WEST 48th ST. • 212 FULTON ST.
 New York 36, N. Y. New York 7, N. Y.

Circle 6-2060

NEW PRODUCTS

(continued)

stantially flat from 100 to 4,000 cps. Output is -50 db. Temperature range is from -40 to +185F.

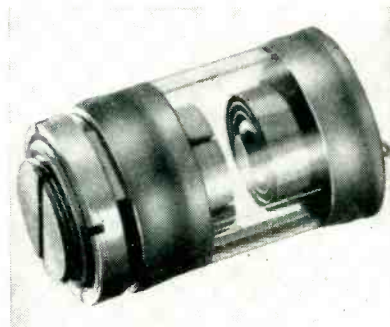

High-Ratio Capacitor

THE JOHANSON MFG. CORP., Boonton, N. J., has developed a new concentric high ratio capacitor with a maximum capacitance of 35 μf and a minimum of 1 μf . Because of the ratio of capacitance it has many applications in electronic equipment where capacitive adjustments need to be made over a wide range with great accuracy. It is being used in 10-channel transceivers with very good results. Because of its construction of silver-plated brass and Pyrex glass, it has excellent performance characteristics at the higher frequencies. It is a high Q capacitor at and above 200 mc.

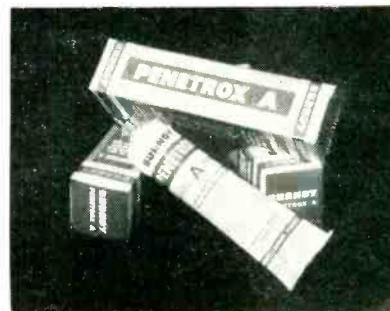

Connector Compound

BURNDY ENGINEERING CO. INC., Norwalk, Conn. For easy on-the-job application of Penetrox A, this oxide-penetrating, corrosion-inhibiting compound for all electrical connections involving aluminum now comes in a sturdy 5-oz tube. Each tube is individually packaged in a strong cardboard carton to prevent crushing or leakage, with full directions printed on both tube and carton. The protruding spout facilitates application of the compound neatly and quickly in all in-



Preview of a New Precision Analog Computer for Solving Problems in Dynamics . . .

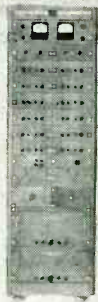

Amplifier Group Type
16-31B 24 contact-sta-
bilized d-c amplifiers.

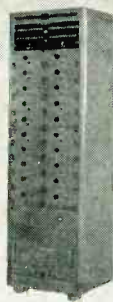

Multiplier Group Type
16-31A 20 multiplying
channels.

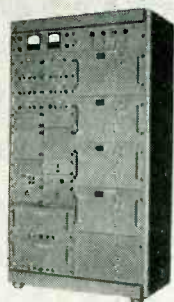

Resolver Group Type
16-31D 4 resolving
channels, 6 amplifier
channels.



Servo Group Type 16-
31G 2 resolving chan-
nels. 4 multiplying
channels.

True, you'll find many analog computer systems on the market. However, we have spent a great deal of time developing a system which we feel does a more effective, more efficient job with the highest degree of accuracy. Here are the reasons:

New 20-channel servo-mechanical multiplier in which several channels may be used as incremental function generators.

New centralized control from operating console for greater flexibility.

New automatic select and set keyboard-operated attenuator system for ease of operation.

New controlled environment to insure maximum accuracy at all times.

New grounded metal problem board eliminates errors due to leakages between terminals.

For more information on this system, write for our Components Book. Address inquiries to:

ELECTRONIC ASSOCIATES, INCORPORATED
COMMERCIAL SALES DEPARTMENT
100 LONG BRANCH AVENUE
LONG BRANCH, NEW JERSEY

See this new system at Booths 1-114, 1-115—I.R.E. Show, Grand Central Palace



NOW

**..Wire Lead Mic
with 500 times better
moisture resistance
than ever before!**

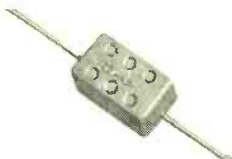
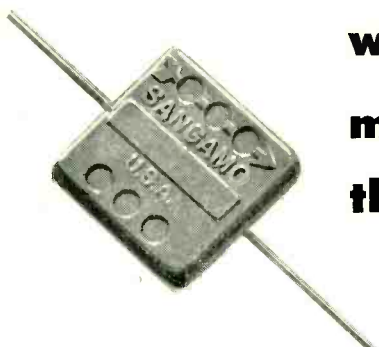

Sangamo HUMIDITITE* Mica Capacitors

When you use Sangamo HUMIDITITE molded Mica Capacitors, you gain all the advantages of an amazing moisture seal that offers previously unheard-of moisture resistance characteristics for compression molded plastic-encased mica capacitor components.

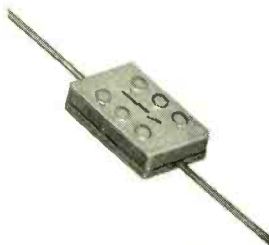

*what is HUMIDITITE?

Humiditite is a remarkable new plastic molding compound, developed by Sangamo, that gives Sangamo Mica Capacitors moisture resistance properties far superior to any others on the market.

HERE'S THE PROOF... The standard moisture resistance test described in MIL-C-5A (proposed) Specification requires mica capacitors to offer at least 100 megohms of insulation resistance after ten 24 hour cycles in a humidity chamber at 90% to 95% relative humidity. The best competitive micas barely meet this requirement... but Sangamo HUMIDITITE Mic, *under the same conditions*, all tested in excess of 50,000 megohms! Continued tests, over and above requirements, with the same HUMIDITITE Mic, proved them capable of withstanding from 21 to 52 cycles (from the smallest sizes to the largest) before failure.

Humiditite is just another example of the advanced engineering that enables Sangamo to meet the existing and future needs of the electronic industry. For additional information about HUMIDITITE, write for Engineering Bulletin No. TS-111.

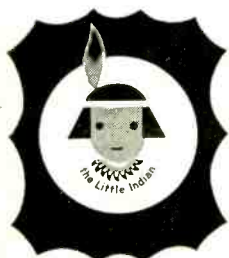
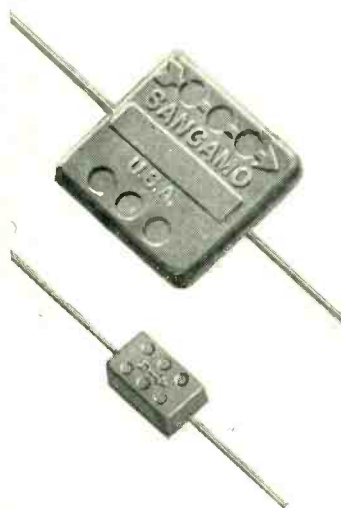

Those who know... choose Sangamo



**SANGAMO
ELECTRIC COMPANY
MARION, ILLINOIS**

SC53-5

NEW PRODUCTS

(continued)

stallations. The compound is also available in pint, quart and gallon cans.



Rapid Scanning System

TIGERMAN ENGINEERING Co., 4332 No. Western Ave., Chicago 18, Ill., has announced a new rapid scanning system known as the Telescan. This Metrotype system of numerical recording and telemetering makes printed records of process data directly from the primary information. Readings are presented in numerical form tabulated for convenient use and on a single page for easy handling and storage. It reads voltage, current, power, temperature, flow or anything else that can be translated to an electrical indication with a suitable transducer. Telescan also sets up an alarm for any abnormal condition.

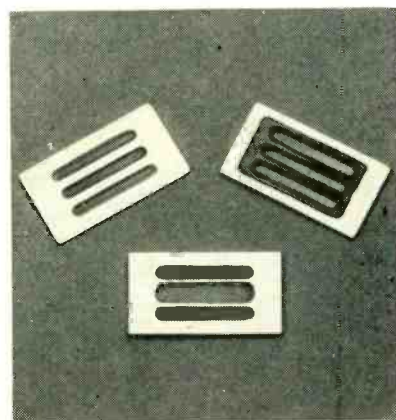

Wide-Band Microwave Window

MICROWAVE ASSOCIATES INC., 22 Cumington St., Boston 15, Mass. The glass-metal window illustrated

From miniature to giant.... insuline METAL GOODS for every requirement!



INSULINE manufactures one of the most diversified lines of metal goods . . . built-up in the past 32 years by supplying every type needed by manufacturers, servicemen, engineers and hams. Huge stocks are maintained from the smallest cabinet to massive transmitter racks . . . for immediate shipment.

If your requirements are special, INSULINE can produce anything in metal . . . steel, aluminum, brass, copper, etc. . . to your specifications. Our facilities are adequate to manufacture your complete job from beginning to end . . . in fast time. Send prints and specifications for estimate.

Guide to Illustrations

1. Chassis Base.
2. Utility Cabinet with built-in chassis.
3. Slip Cover Aluminum Box.
4. Multi-Use Cabinet.
5. Sloping Panel Cabinet.
6. "Watchmaster" Precision Timer (American Time).
7. Portable Amplifier Case.
8. Portable Transmitter Cabinet.
9. Transmitter Rack.

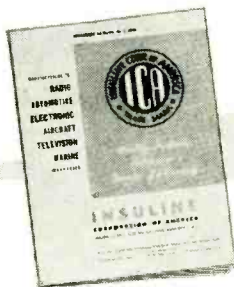
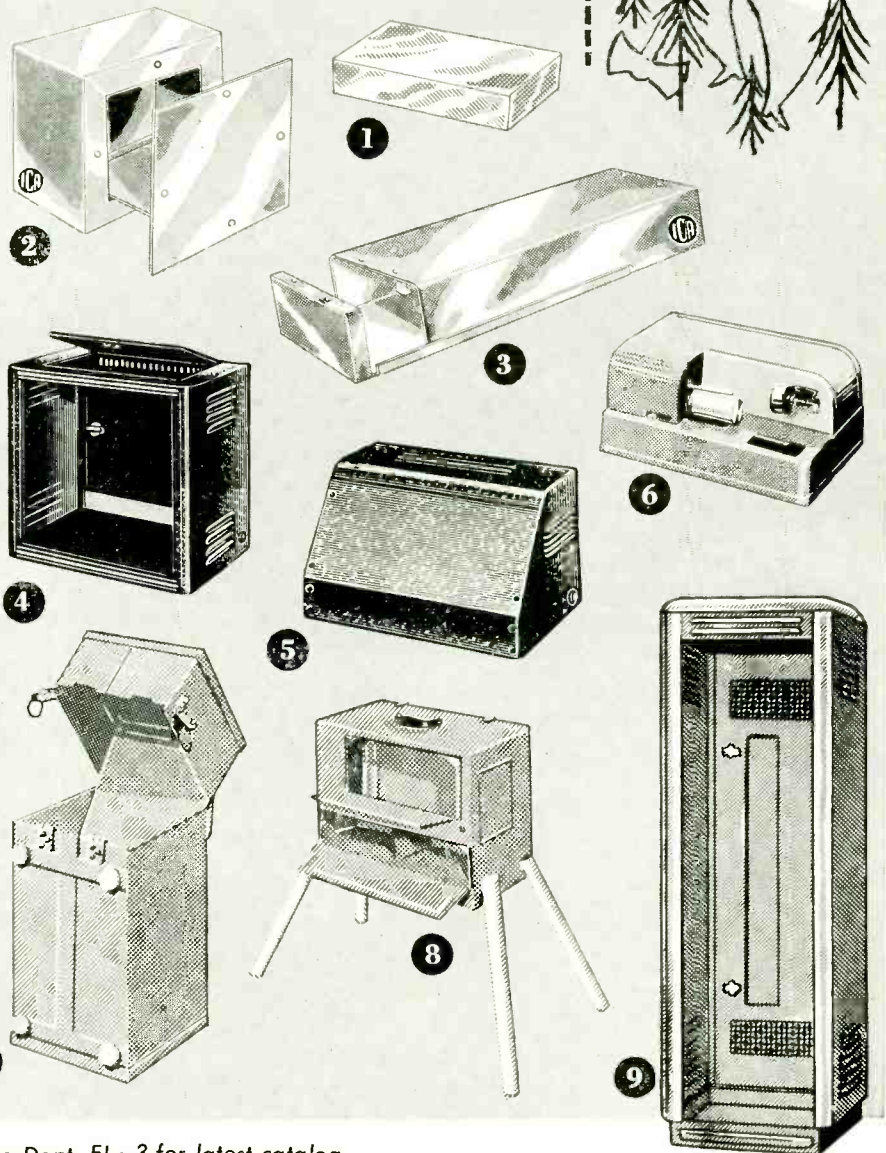

Write Dept. EL-3 for latest catalog.
Over 2000 items, including metal goods, tools, hardware, components, television and accessories.



insuline CORPORATION OF AMERICA

INSULINE BUILDING • 36-02 35th AVENUE • LONG ISLAND CITY, N. Y.
West Coast Branch and Warehouse: 1335 South Flower Street, Los Angeles, Calif.
Exclusive Canadian Sales Agents: CANADIAN MARCONI COMPANY, Toronto
Visit our Booth No. 2-202 at the I.R.E. Show



the **NEW** S-8 Oscillograph

Here, in a versatile instrument of advanced design, are all the things you need for complete oscillographic recording. The Hathaway Type S-8 Oscillograph, which has long been the standard of oscillographic recording, has been improved to meet the rapidly expanding demands of modern research. Whether your measurement problems are simple or complex, the **NEW** Type S-8 Oscillograph has the inherent capabilities necessary to measure vibration, pressure, acceleration, and strain with new ease and accuracy.

The newest features include:

QUICK-CHANGE TRANSMISSION fully enclosed with gears running in oil to provide instantaneous selection of 16 record speeds over the range of 120:1

CHART TRAVEL INDICATOR provides continuous indication of chart motion. Operator knows instantly by flashing lamp if anything should happen to interfere with chart motion

FULL-RESILIENT MOUNTING FOR MOTOR AND TRANSMISSION isolates all possible vibration and makes possible the use of modern super-sensitive galvanometers

NEW GALVANOMETER STAGE accommodates all Hathaway galvanometer for recording milliamperes, microamperes, or watts

NEW RECORD-LENGTH CONTROL AND NUMBERING SYSTEM designed for long, trouble-free service under all kinds of ambient conditions

All the other valuable features are retained, such as **PRECISION TUNING-FORK-CONTROLLED TIMING SYSTEM** produces either 1/10-second or 1/100-second time lines across sheet

WIDE RANGE OF GALVANOMETER TYPES AND CHARACTERISTICS provide for almost any recording requirements. Natural frequencies to 10,000 cps. Sensitivities to 50,000 mm per ma, single and polyphase watts

DAYLIGHT LOADING AND UNLOADING RECORDS TO 200 FT. IN LENGTH, width to 10 inches

SIMULTANEOUS VIEWING AND RECORDING

AUTOMATIC BRILLIANCY CONTROL

12 TO 92 ELEMENTS

Whatever your needs may be, investigate the **NEW** Type S-8 Oscillograph and its 170 types of galvanometers — the most versatile equipment in existence for general-purpose applications.

WRITE FOR BULLETIN 2B1-K FOR DETAILS

Hathaway 
INSTRUMENT COMPANY.
 1315 SO. CLARKSON STREET • DENVER 10, COLORADO

covers a bandwidth of 40 percent in the frequency range of 8,200 to 12,500 mc at a vswr less than 1.25. The vswr frequency characteristic behaves like a single resonant circuit with a minimum value of 1.03 in the neighborhood of 9,800 mc. The doubly loaded Q of the unit is approximately 0.25. The window blank consists of three parallel slots stamped in a thin blank of Kovar 0.600 in. × 1.100 in. o.d. to which is sealed a rectangular blank of low-loss glass. The windows are copper and silver plated and may be soft soldered into a UG-39/U flat flange. It is necessary to mill out the flange to accommodate the window dimension and to break the inside edges of the waveguide at the flange connection to avoid cracking the glass in the seal. The windows may be used in pressurizing applications and will withstand pressures up to 30 lb psi absolute.



Restorer

CHEMICAL ELECTRONICS CORP., Irvington, N. Y., has announced an improved combination solvent, lubricator, restorer and silencer for all electrical and electronic controls and contacts. The new solution has proved to be entirely safe even for critical uhf circuits. It does not affect inductance, capacitance or resistance, and is wholly nonreactive to heat, cold, oil or corrosives. It is a special hydrocarbon colloidal suspension of a highly refined vegetable gum. Its hypercapillary action forces it into the ordinarily inaccessible places where it cleans instantly and forms a durable non-

We grew to help you

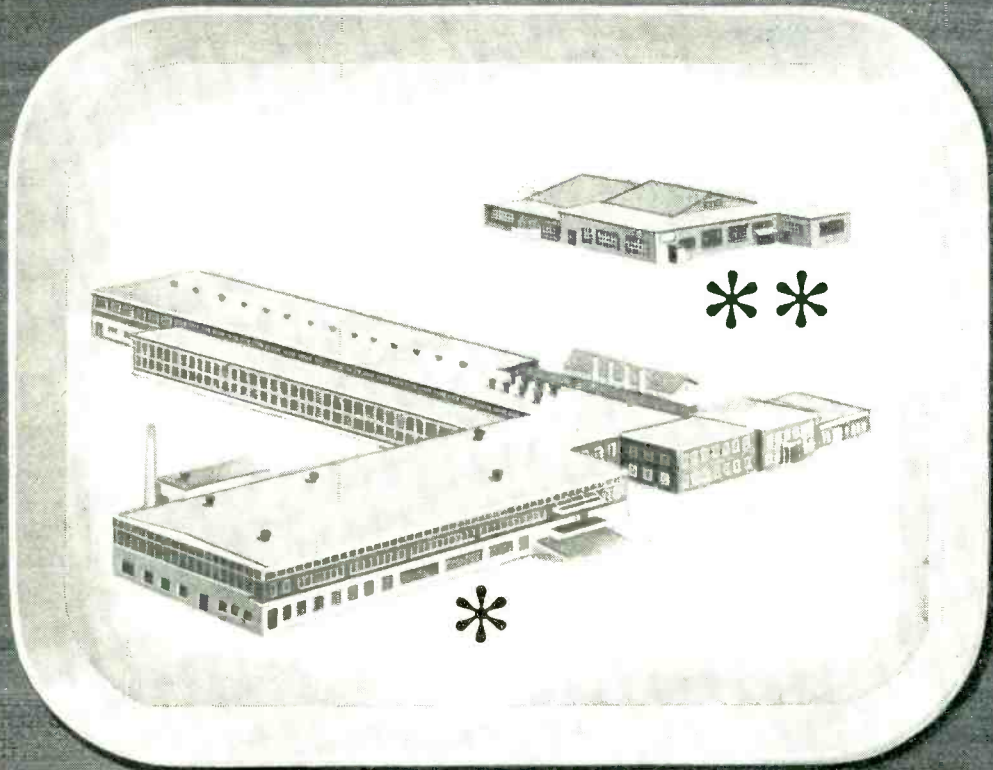

← **BIG, NEW 2-PLANT SIZE** →
50% more seamless nickel cathode capacity

Of this we are sure: you made us what we are today.

You demanded so many of our seamless nickel cathodes that we had to add capacity. We did.

We built another plant—this time at Wapakoneta, Ohio—increasing our seamless nickel cathode output by 50%.

Other familiar characteristics of Superior service remain—the desire to help you with your problems, the experience of skilled tube-fabricators, and quality-controlled manufacture.

Take advantage of Superior service and capacity now.

*Main Superior Tube plant at Norristown, Pa.

**NEW Superior Tube plant at Wapakoneta, Ohio

SEAMLESS NICKEL CATHODES				
Representative size and shape specifications in current production				
Type	Bead	O.D.	Wall Thickness	Length
ROUND	None	.015"	.002"	25.4 mm
ROUND	None	.121"	.0035"	8.0 mm
ROUND	Single	.045"	.002"	27 mm
ROUND	Double	.025"	.002"	28.5 mm
OVAL	Double	.025" x .048"	.003"	12 mm
OVAL	Single	.045" x .149"	.002"	31 mm
OVAL	Single	.025" x .048"	.003"	12 mm
ELLIPTICAL	Double	.025" x .048"	.003"	11 mm
RECTANGLE	Single	.030" x .0975"	.002"	11 mm
RECTANGLE	Double	.040" x .132"	.004"	33.4 mm

Many other types of nickel cathodes—made in Lockseam† from nickel strip, disc cathodes—and a wide variety of anodes, grid cups and other tubular fabricated parts are available from Superior. For information and Free Bulletin address Superior Tube Company, Electronics Division, 2500 Germantown Avenue, Norristown, Pa.

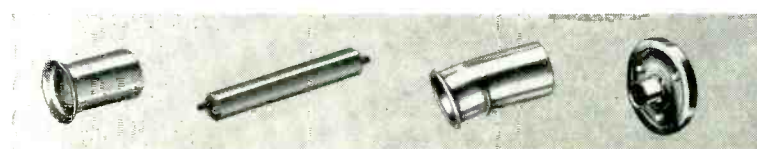

Seamless Nickel Cathode—Round, flanged one end. .115" O.D. x .105" I.D. .130" long.

Lockseam† Nickel Cathode Plate. .170" O.D. x .005" wall. 1" long.

Weld drawn† 305 Stainless Steel Anode Rolled and Bent 10°. .499" I.D. x .010" wall x 1.050" long.

Disc Cathode .121" O.D. .312" long.

Superior
 THE BIG NAME IN SMALL TUBING

All analyses .010" to 1/4" O.D.
 Certain analyses (.035" Max. wall) up to 1 1/4" O.D.

† Manufactured under U.S. Patents
 ‡ Trademark Reg. U.S. Pat. Off.

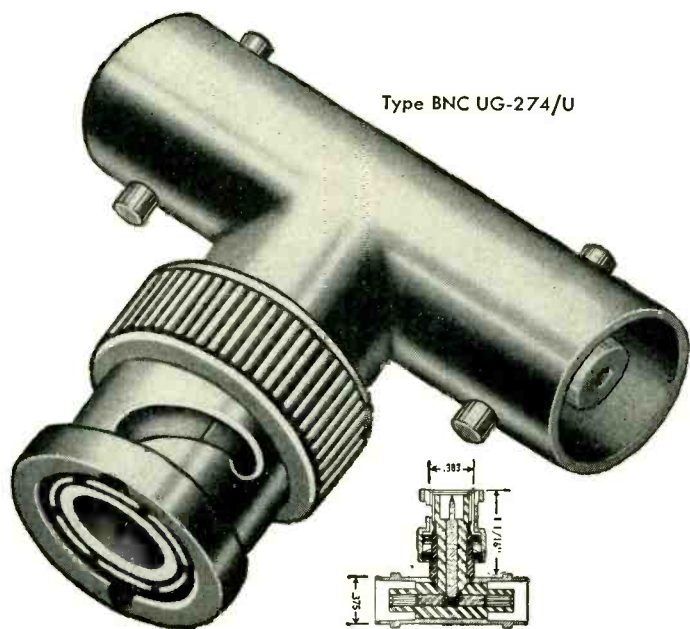

Type BNC UG-274/U

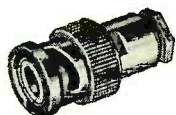

Type BNC UG-88/U



Type N UG-188/U



Type BNC UG-290/U

QUALITY • QUANTITY • QUICKLY

ALWAYS SPECIFY

DAGE

RADIO FREQUENCY CONNECTORS

To be sure your RF connectors are *right*, specify DAGE.

Dage RF connectors are expertly designed, carefully made. Each part and each completed connector is thoroughly checked, carefully shipped—further assurance that your order placed with Dage receives the atten-

tion it deserves. Dage offers versatility to your demands for superior RF connectors; any standard or special connector can be quickly produced at Dage.

When you write your next specification, remember Dage—makers of the finest Radio Frequency Connectors.



Complete design and manufacturing facilities enable skilled craftsmen to quickly produce all types of coaxial connectors. Write for Catalog No. 101

DAGE ELECTRIC COMPANY, INC., 67 NORTH SECOND STREET, BEECH GROVE, IND.

greasy, nonsticky hard-bonded lubricating surface.

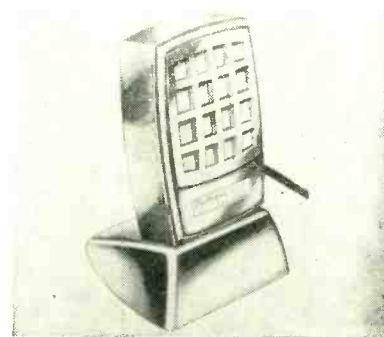

Ceramic Microphone

ELECTRO-VOICE, INC., Buchanan, Mich. The model 715 Century microphone has a moisture-proof ceramic generating element and unusually high output (-55 db). Dependable and long-lasting service in extremely hot, humid climates is assured. The microphone is essentially nondirectional, becoming directive at higher frequencies. It is a-c/d-c insulated, features high impedance, has a 5-ft cable, measures 3 in. \times 2 $\frac{3}{8}$ in. \times 1 in., and weighs 6 oz.

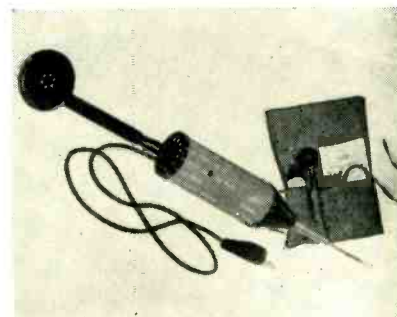

Circuit Analyzer

LEE ELECTRONIC LABS, INC., 233 Dudley St., Roxbury 19, Mass. Model E-C dynamic Serviset is a complete portable test lab in itself. It is designed for field or bench servicing of radio, tv, radar and communications equipment. Among its many uses are: r-f and a-f signal tracer, r-f and a-f signal injector, a-c and d-c voltage indicator, d-c polarity indicator, low ohms continuity and short indicator, high ohms continuity and leakage checker. Accessories, besides phone, extension cord, insulated extension tip, tv high-voltage adapter and test lead, include a complete instruction

EVENLY

Wind

SMALL TOROIDAL COILS AT HIGH SPEEDS WITH MINIMUM WIRE BREAKAGE

The MICAFIL Model RW-0 Toroidal Coil Winder automatically winds toroidal coils continuously around 360° and sector coils from 30° to 270°. To produce smooth, even layers of wire, the winder is adjusted easily to wind any wire size between 26 and 44 AWG and to obtain the proper pitch. Winding direction can be changed and feeds can be adjusted while machine is in operation.

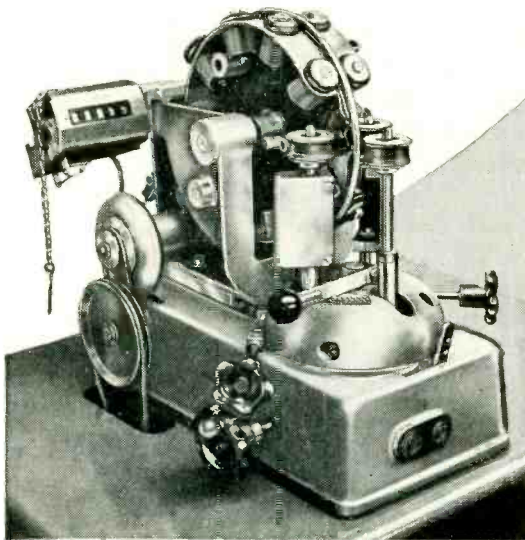

CAPACITY

Coil Sizes
 Minimum finished I.D. 1/4"
 Maximum finished O.D. 2"
 Minimum finished O.D. 1/2"
 Wire Sizes 26 to 44 AWG
 Winding Speed—
 according to wire size . . up to 1000 rpm
 Shuttle Capacity—
 according to wire size . . . 60 to 800 feet

MICAFIL Toroidal Coil Winders are made in three larger sizes for winding coils up to 8" O.D. and with 10 AWG Wire.

COSA CORPORATION

405 Lexington Ave., New York 17

IN DETROIT AREA contact DETROIT-COSA CORPORATION, 16923 James Couzens Highway, Detroit 35, Mich.
 IN CANADA contact COSA CORPORATION OF CANADA, LTD. • 40 Front Street, West, Toronto 1, Ontario

9/16" O.D. x 3/8" I.D.
 Wire—44 AWG
 Winding Speed—800 rpm

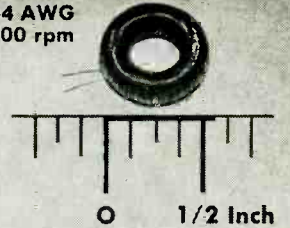

1-1/8" O.D. x 3/4" I.D.
 Wire—44 AWG
 Winding Speed—800 rpm

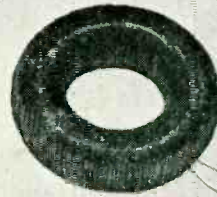

1-1/8" O.D. x 3/4" I.D.
 Wire—38 AWG
 Winding Speed—1000 rpm

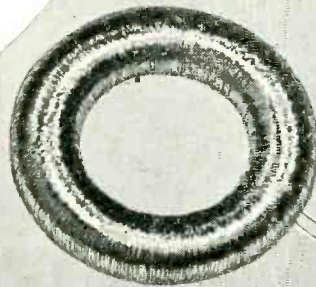

O.D. 1-5/8" x 7/8" I.D.
 Wire—38 AWG
 Winding Speed—1000 rpm

SPIRALING DEVICE—Device winds spirals for shuttle loads—in advance . . . Newly developed to permit continuous operation of Coil Winder . . . Winds to pre-determined lengths.

SHUTTLES—Made in four different ring diameters to accommodate range of spiraled wire sizes . . . Larger wire capacities . . . *More than one coil can be wound with single loading* . . . Changed within 30 seconds . . . Loaded in less than a minute.

ACCURATE TURNS COUNTER—Preset for required number of turns . . . Automatically stops winder when turn count is reached.



WHILE IN NEW YORK

See this RW-0 and other Micafil Coil Winders. COSA is in the CHRYSLER BLDG.—4 blocks from the IRE SHOW. Telephone: OREGON 9-3560.

Here's a laminate with
high insulation resistance



It's the New G-E 11541 TEXTOLITE* Industrial Laminate

It offers outstanding characteristics! G-E 11541 has high insulation resistance and retains maximum stability under humid conditions. *It can be readily hot punched and fabricated* without losing its basic properties, and will provide long service under difficult conditions.

It's brand new! This versatile G-E Textolite industrial laminate has just been placed on the market—after intensive development and testing by G-E engineers. Now you can develop even better performance characteristics in the equipment you manufacture—by using G-E 11541 Industrial Laminate.

It's amazingly versatile! G-E 11541 is a paper-base phenolic laminate available in a variety of sizes and thicknesses. It has excellent electrical properties, which make it suitable for a wide variety of applications.

For full details and samples, get in touch with your nearest fabricator or assembly manufacturer, today. Or write: General Electric, Section 327-1B, Chemical Division, Pittsfield, Massachusetts.

*Reg. U.S. Pat. Off.

You can put your confidence in—

GENERAL  ELECTRIC

manual showing application and latest tv trouble-shooting techniques.

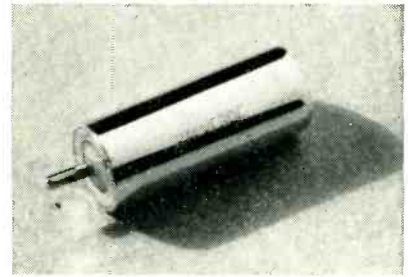

Miniature Thermostat

VALVERDE LABORATORIES, 252 Lafayette St., New York 12, N. Y. The VAL90 is a miniature hermetically sealed thermostat measuring $\frac{3}{8}$ in. in diameter and $\frac{1}{8}$ in. in length. One terminal is the pin of an eyelet thermetic header; the other, the cylindrical brass capsule. The bimetal is friction couple snap action, and both the temperature and differential are adjustable. The thermostat can be used without the capsule for on-the-job adjustment. It holds its setting permanently. At 85 C setting tolerance can be ± 2 C, differential, less than 3 C.

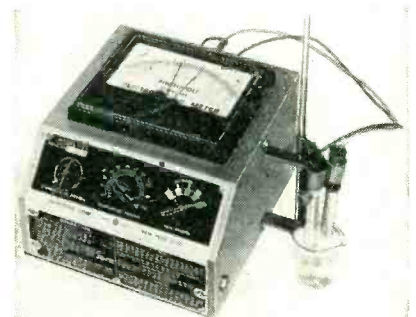

Portable pH Meter

PHOTOVOLT CORP., 95 Madison Ave., New York 16, N. Y. Model 125 portable pH meter is powered by only three ordinary radio batteries that give 2,000 hours of service. Reading accuracy is 0.03 pH. All electronic components are contained in a single plug-in unit that can be exchanged as easily as a tube of a radio set. The readings are taken on a single 0-14 scale without switching of ranges. While primarily intended for battery operation, a stabilized power supply unit can be furnished to operate the pH

Phaostron

SENSITIVE MINIATURE RELAYS

PERFECTLY COUNTER-BALANCED

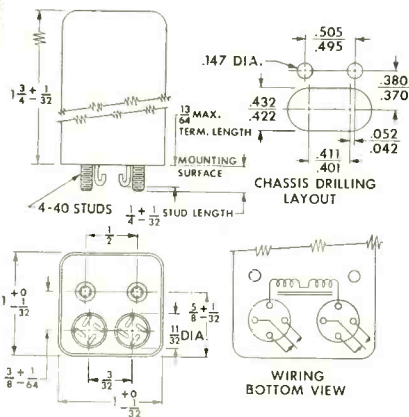

Contact arrangements up to and including DP DT 3 Amp at 28 volts D.C., or 100 Milliamperes at 150 volts D.C. resistive load.

Hermetically Sealed.

Required coil power as low as 20 milliwatts.

Coil resistance up to 15,000 ohms.

Weight, maximum 3.5 oz.

DUE TO ITS PERFECTLY COUNTER-BALANCED FEATURES THIS RELAY WILL WITHSTAND HIGH ACCELERATION, VIBRATION, SHOCK AND TUMBLING

Mass Production Requirements Invited

Detailed information on request.

ENVIRONMENT FREE ELECTRICAL EQUIPMENT by



PHAOSTRON COMPANY • 151 PASADENA AVE. • SOUTH PASADENA, CALIF.

GOAT Electronic Components

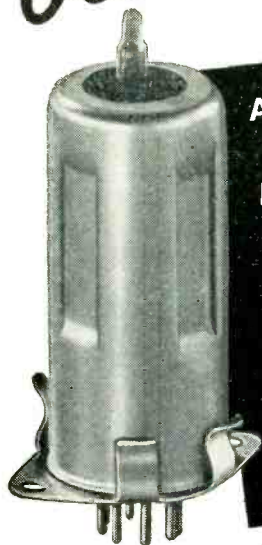

GOAT lanced tube shield G1702-2 and clip G1770

An example of GOAT engineering — THE TUBE SHIELD WITH BUILT-IN SPRING ACTION GRIP

Particularly suited for high vibration situations involving uhf tubes, the four spring-like lances of this shield expand with the tube without sacrificing full shielding efficiency.

This is only ONE of a wide variety of stock miniature and standard size GOAT shields.

A complete design service is available for those long-run, tough-spec custom jobs.

For a full description of tube shields, clips and other GOAT electronic components, send for GOAT catalog E52.

The Fred Goat Co., Inc.
308 DEAN ST. BROOKLYN 17, N. Y.

Pioneers in metal stamping
Serving the electronics industry since 1926



Established 1893

Specified for Precision Performance!

STANDARD PACKAGED PUSH-PULL MAGNETIC AMPLIFIERS

by

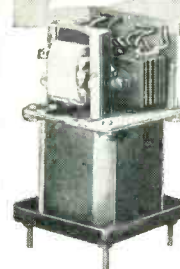

MAGNETIC AMPLIFIERS— These high gain, high performance Magnetic Amplifiers are especially suitable to drive two phase induction servo motors requiring from 0.1 watt to 20 watts per phase on either 400 cps or 60 cps powerlines. The output power is either in phase or 180 out of phase with the powerline depending on the D.C. input signal polarity.

SATURABLE TRANSFORMERS, REACTORS

Lower power gain, Magnetic Amplifiers designed to drive two phase induction motors. Output powers available are from 0.5 watt to 1000 watts, 400 or 60 cps. Catalog available.



DATA SHEETS AVAILABLE

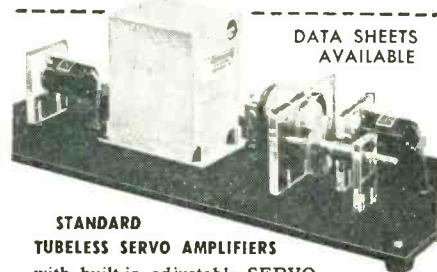

STANDARD TUBELESS SERVO AMPLIFIERS

with built-in adjustable SERVO LOOP STABILIZATION. Packaged, completely self-contained, magnetic servo amplifiers for position servo systems where either A.C. or D.C. error signals are available. Designed for instrument type and power type servo systems to work with synchro control transformers or potentiometers and two phase induction servo motors.

Facilities Know-How to Engineer Design and Manufacture MAGNETIC SERVO AMPLIFIERS, VARIABLE SPEED DRIVES, MAGNETIC VOLTAGE, CURRENT FREQUENCY REGULATORS

Where the standard units do not meet your requirements our engineering facilities are available to work with you an overall system design.

MAGNETIC AMPLIFIERS • INC

An Affiliate of General Ceramics & Steatite Corp.
632 TINTON AVE., NEW YORK 55, N. Y.
Telephone: CYPRESS 2-6610

On display at I.R.E. Show—Booth 4-206

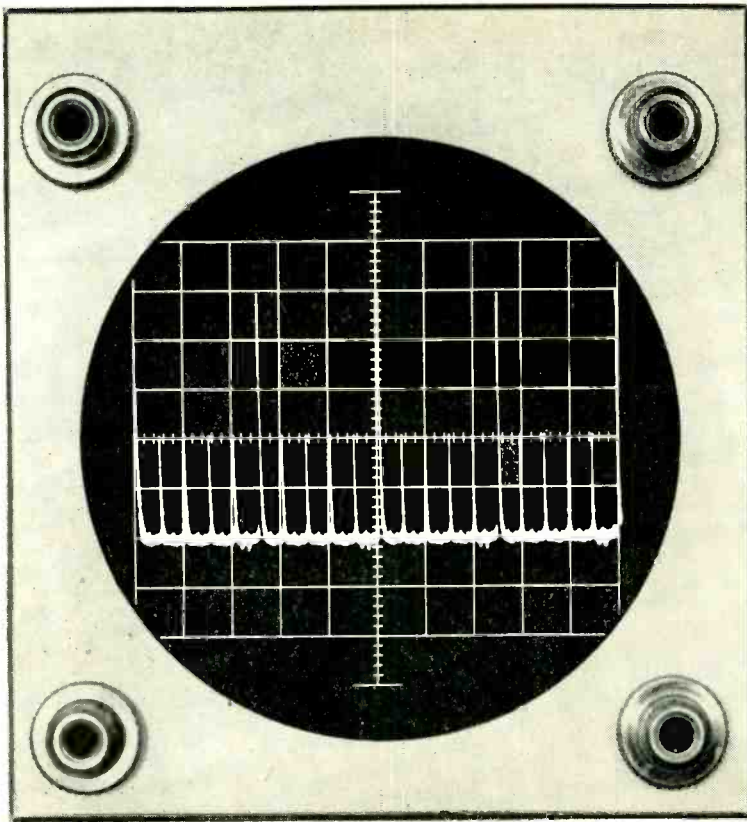

ACCURATELY CALIBRATED ...in both TIME and AMPLITUDE

With the TEKTRONIX Type 315-D you read time intervals and amplitudes directly from the screen. In the actual-size photograph above the time base setting is 20 μ sec/division, showing the time interval between the small pips to be 10 μ sec; between the large pips, 50 μ sec. Vertical sensitivity is set at 0.5 v/division, showing the amplitude of the small pips to be 1 volt, and the amplitude of the large pips to be 2.5 volts.

Twenty-four calibrated time bases: 0.1, 0.2, 0.5, 1, 2, 5, 10, 20, 50, 100, 200, 500 microseconds/division, 1, 2, 5, 10, 20, 50, 100, 200, 500 milliseconds/division, 1, 2, 5 seconds/division. Calibration accuracy 3% or better except at 0.1, 0.2, 0.5 μ sec/div and 1, 2, 5 sec/div where accuracy is within 5%. Uncalibrated time base continuously variable from approximately 0.1 μ sec/div to 10 sec/div.

Twelve calibrated vertical sensitivity positions: 0.01, 0.02, 0.05, 0.1, 0.2, 0.5, 1, 2, 5, 10, 20, 50 volts/division. When set on any one position by means of a front panel screwdriver control all other positions will fall within 3% of this accuracy. Choice of ac or dc coupling except in the 3 most sensitive positions. Sensitivity continuously variable but uncalibrated from approximately 0.01 v/div to 100 v/div.

OTHER CHARACTERISTICS OF THE TYPE 315-D

Vertical Bandwidth — dc to 5 mc

Risetime — 0.07 μ sec

Voltage Calibrator — square wave, approx. 1 kc

Attenuator Probe — 10x, small, insulated

3" CRT — high-definition, flat-faced

Graticule — edge lighted, $\frac{1}{4}$ " divisions

5x Magnifier — expands time base to right and left of center

Direct Coupled Unblinking

Trigger Amplitude Discriminator

Size — 12 $\frac{3}{8}$ " high, 8 $\frac{5}{8}$ " wide, 18 $\frac{1}{4}$ " deep

Weight — only 36 lbs.

Type 315-D — for use on 50-60 cycle line only — \$770

Type 315-D — for use on 50 to 800 cycle power line — \$785

PRICES F.O.B. PORTLAND, OREGON

Call or write your TEKTRONIX Field Engineer for a demonstration of the Type 315-D
See and try the Type 315-D and other TEKTRONIX instruments at the March I.R.E. show.



TEKTRONIX, Inc.

P. O. Box 831B, Portland 7, Oregon • Cable: TEKTRONIX

meter from the a-c power line without the use of batteries.

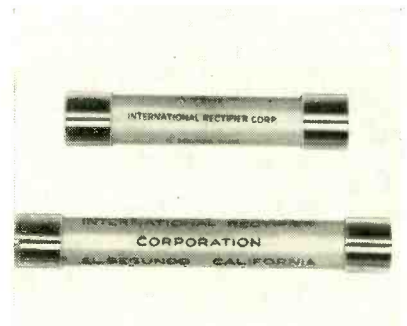

H-V Selenium Rectifiers

INTERNATIONAL RECTIFIER CORP., 1521 E. Grand Ave., El Segundo, Calif. Two high-voltage selenium rectifiers, types V-75HF and V-100HF, have been developed for use in tv equipment in which long life and reliability are of prime importance. The units are designed with ferrule terminals for insertion into standard 30-ampere fuse clips. Diameter of the rectifiers is $\frac{9}{16}$ in. Type V-75HF is 3 $\frac{1}{2}$ in. long; and the V-100HF, 4 $\frac{3}{8}$ in. long. Both are designed to deliver 5 ma into a capacitive load at a d-c output voltage of 1,500 and 2,000 v respectively.

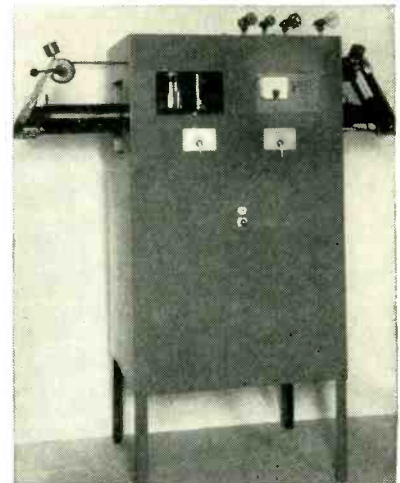

Controlled Atmosphere Furnace

STEWART ENGINEERING CO., Box 145, Soquel, Calif. The model 3 controlled atmosphere furnace was developed for hydrogen firing and brazing operations in the laboratory where its fast heating and fast cooling cycle are advantageous in sav-

NOW

a really high-powered

RADIO ENGINEERING LIBRARY

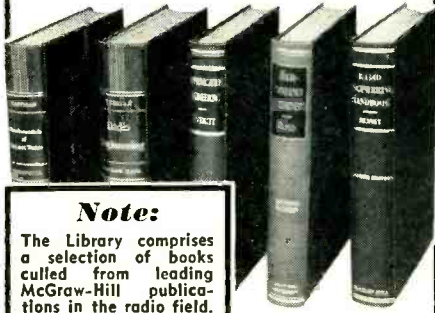

Note:

The Library comprises a selection of books culled from leading McGraw-Hill publications in the radio field.

- especially selected by radio specialists of McGraw-Hill publications
- to give most complete, dependable coverage of facts needed by all whose fields are grounded on radio fundamentals
- available at a special price and terms

These books cover circuit phenomena, tube theory, networks, measurements, and other subjects—give specialized treatments of all fields of practical design and applications. They are books of recognized position in the literature of the field—books you will refer to and be referred to often. If you are a practical designer, researcher, or engineer in any field based on radio, you need these books for the help they give in hundreds of problems throughout the whole field of radio engineering.

5 volumes, 4213 pages, 2949 illustrations

Eastman's **FUNDAMENTALS OF VACUUM TUBES**, 3rd edition

Terman's **RADIO ENGINEERING**, 3rd edition

Everitt's **COMMUNICATION ENGINEERING**, 2nd edition

Hund's **HIGH FREQUENCY MEASUREMENTS**, 2nd edition

Henney's **RADIO ENGINEERING HANDBOOK**, 4th edition

SPECIAL LOW PRICE • EASY TERMS

Special price under this offer less than cost of books bought separately. In addition, you have the privilege of paying in easy installments beginning with \$7.50 in 10 days after receipt of books, and \$6.00 monthly thereafter. Already these books are recognized as standard works that you are bound to require sooner or later. Take advantage of these convenient terms to add them to your library now.

FOR 10 DAYS' EXAMINATION SEND THIS

ON APPROVAL COUPON

McGraw-Hill Book Co., Inc., 330 W. 42nd St., N. Y. 36

Send me Radio Engineering Library for 10 days' examination on approval. In 10 days I will send \$7.50 plus few cents postage, and \$6.00 monthly till \$37.50 is paid, or return books postpaid. (We pay postage on orders accompanied by remittance of first installment.)

(PRINT)

Name

Address

City Zone State

Company

Position FL-3

This offer applies to U. S. only

ELECTRICAL and ELECTRONIC ENGINEERS

With Several Years' Experience
or Advanced Degrees for Permanent Positions with

Endicott, N. Y. **IBM** Poughkeepsie, N. Y.
TRADE MARK

Excellent Opportunities in the Fields of:
Audio Amplifier Design • Servo Amplifier Design • Servo and Computer Theory • Receiver-Transmitter Design • Small Transformer Design • Regulated Power Supply Design • Circuit Design • Test Equipment Design • Logical Design • Pulse Techniques • Programming • Electrostatic Storage • Magnetic Recording • Component Development • Environmental Testing • Production Engineering

Good salaries, unusual opportunities for professional development, exceptional employee benefits, excellent working and living conditions, moving expenses paid.

Write, giving full details, including experience and education to: Mr. W. M. Hoyt, Coordinator of Engineering Recruitment, International Business Machines, Dept. 686 (4), 590 Madison Avenue, New York 22, N. Y.

GET THE BENEFIT OF A SPECIALIST IN THE *ELECTRONICS* FIELD FOR PRECISION MOLDED PLASTIC PARTS

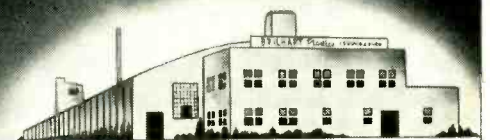
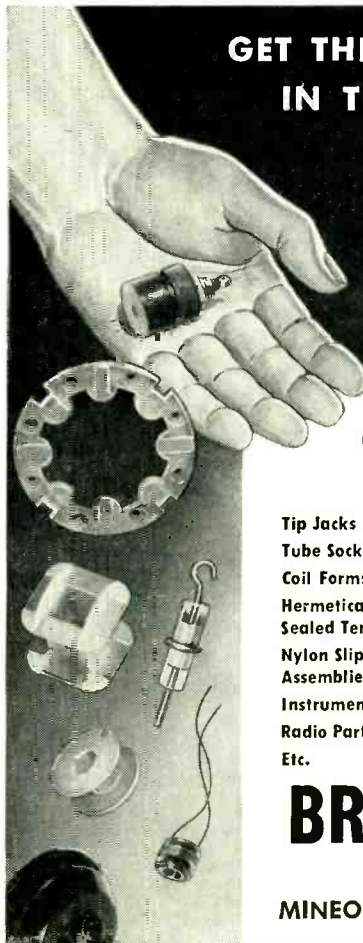

CUSTOM MOLDING FOR ALL INDUSTRIAL APPLICATIONS

- Tip Jacks
- Tube Sockets
- Coil Forms
- Hermetically-Sealed Terminals
- Nylon Slip-ring Assemblies
- Instrument Cases
- Radio Parts
- Etc.

Specializing in Injection Molding and Small Insert Work in Compression and Transfer Molding

A complete service to help you design and produce your plastics requirements in all materials including KEL-F, Nylon, etc. Over 30 Injection molding machines at your service.

BRILHART *Plastics* CORPORATION

MINEOLA, L. I., N. Y. Phone GArden City 7-0425-6-7

NOW 5 PLANTS

on industry's doorstep to expedite your needs for quality tubular and split rivets, rivet-setting machines and special cold-headed fasteners. Write for an important new brochure, "THE MILFORD METHOD", describing Milford's latest contribution to industrial progress... a complete service integrating fastener research, design and engineering with manufacturers' production.

THE NEW PACIFIC DIVISION

715 S. Palm Ave. Alhambra, Calif.



NEW ENG. DIVISION

855 Bridgeport Ave. Milford, Conn.



ILLINOIS DIVISION

806 Illinois Ave. Aurora, Ill.



OHIO DIVISION

1106 W. River St. Elyria, O.



PENN DIVISION

26 Platt St. Hatboro, Pa.



the **MILFORD** RIVET & MACHINE CO.

the name to rivet in your memory
for fasteners

ing time. An Inconel tube is used as the furnace muffle and is heated to a high temperature in a short period of time by passing current from a low-voltage high-current transformer directly through the muffle, which serves as the heating element. The heating time, unloaded, from room temperature to 1,000 C is about 5 minutes. A high volume, quiet operating blower is built into the unit, and allows cooling in about the same period of time. Temperature is regulated by a thermocouple and Simplytrol pyrometer. One of its many uses is for deoxidizing and cleaning certain metals such as nickel and Kovar for use in vacuum tubes. Most of the occluded or absorbed gases are replaced by hydrogen, which is easily removed during evacuation. When used with a dry nitrogen atmosphere it is useful for the annealing of glass joined to metal or annealing of complete vacuum tubes before evacuation.



General-Purpose Power Supplies

OPAD-GREEN Co., 71 Warren St., New York 7, N. Y., has available general-purpose power supplies that are designed to furnish an adjustable source of unfiltered d-c from single phase 50 or 60-cycle a-c power lines. A unique feature is their stepless control of the d-c output voltage that permits them to serve as power sources for a wide variety of electrical equipment and electrochemical processes. The secondary of a two-winding step-down transformer, whose primary is fed by a variable autotransformer, supplies power to a full-wave selenium rectifier. The step-down transformer is provided with taps to

PRECISION-FIXED WIREWOUND

resistors

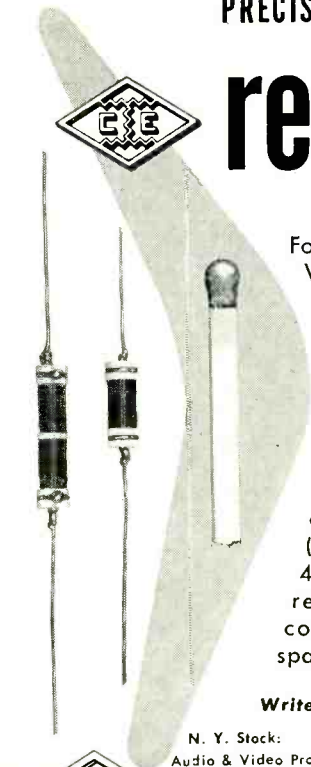

Forty-two types in all, from 1/4 Watt to 10 Watts. Three wire alloys. Accuracies to .025%. Resistance range from .1 Ohm to 15 megohms. All receive aging treatment for assured stability. A variety of impregnation treatments and installation mountings to meet your requirements. Shown actual size (left) are the new 412 HE and 413 HE types designed for direct replacement of carbon composition resistors where space is at a premium.

Write for Complete Catalog

N. Y. Stock:
Audio & Video Products Corp. • 730 Fifth Ave. Plaza 7-3091



CINEMA ENGINEERING COMPANY
1510 WEST VERDUGO AVENUE, BURBANK, CALIFORNIA

Export Agents: Frazar & Hansen, Ltd. • 301 Clay St • San Francisco, Calif., U.S.A.



A. E. C. GENERATOR

insulated
by **BIGGEST**
MYKROY Moldings
ever made



**NOW IT CAN
BE TOLD!**

The Atomic Energy Commission chose MYKROY above all other materials as insulator for its generator. The 4-ft. diameter of the rings was only one of many reasons.



**CHECK THESE
FEATURES**



- can be machined or molded to closest tolerances
- lightweight—with the mechanical strength of cast-iron
- high dielectric and flashover properties
- won't warp; keeps its shape
- low-loss factor at sub-zero or 1000° F.
- bonds with most metals

Surely, MYKROY, the perfect glass bonded mica, can solve your insulating problems. Supplied in sheets and rods . . . machined or molded to specifications. We'll be glad to quote on your requirements. Write today for MYKROY Brochure #203. Made exclusively by



101 CLIFTON BOULEVARD,
CLIFTON, NEW JERSEY
MYKROY, INC., WHEELING, ILL.

See us at Booth # 4-610
Radio Engineering Show

T TRANSFORMERS

built to **MIL-T-27** specifications



We have had considerable experience in designing and building transformers to MIL-T-27 specifications.

Our testing equipment includes facilities to test over a temperature range from minus 50°C to plus 85°C. In addition, Corona test equipment, hot, cold, salt water bath equipment, and vacuum equipment to conduct impregnation tests and assimilate high altitude conditions are available.

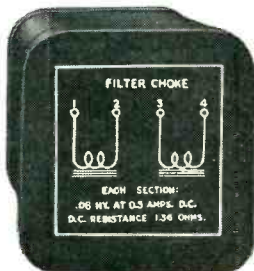
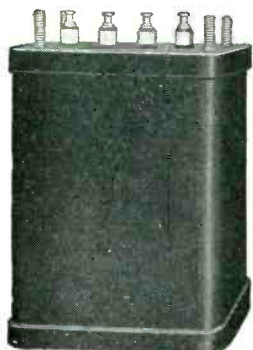

ACME ELECTRIC CORPORATION
313 WATER ST. CUBA, N. Y.

Acme  **Electric**

How HONEYWELL

Mercury Switches solved a sensitive pressure control problem

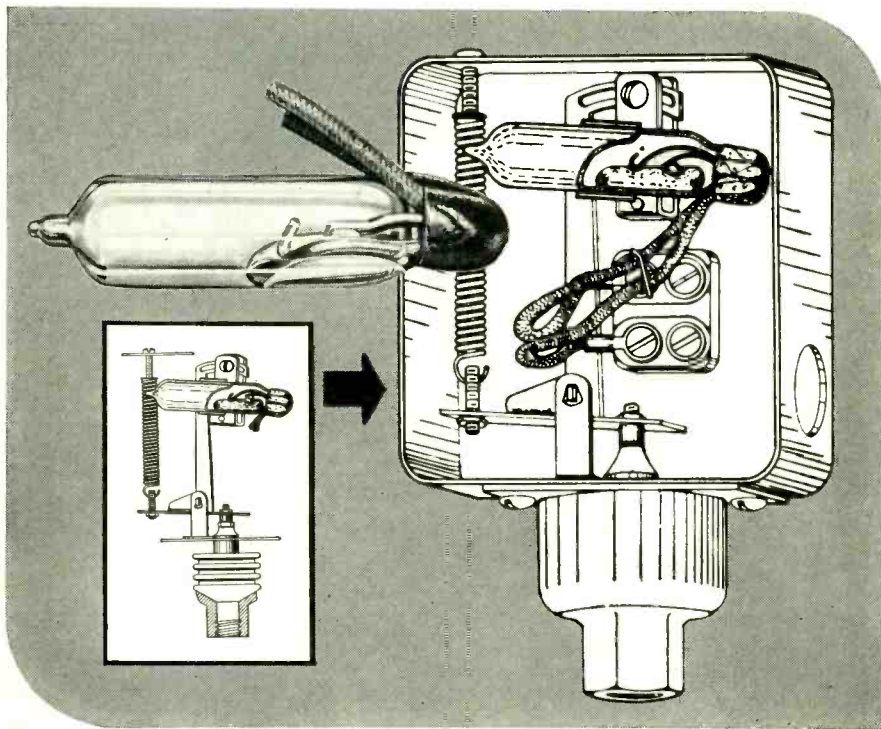

THESE illustrations show how a HONEYWELL Mercury Switch was used to provide direct control and high capacity for substantial electrical loads from a light energy pressure system without the use of intermediate relays.

By use of a bellows to establish a rocking motion to actuate a HONEYWELL Mercury Switch, the available motion was multiplied to move the switch through a greater angle than was available directly.

There are over 90 designs of HONEYWELL Mercury Switches from which to select the exact switch characteristics to meet your specific problems. You are invited to contact the nearest MICRO branch for help in selecting the exact switch to meet your needs.

MICRO A DIVISION OF
MAKERS OF PRECISION SWITCHES MINNEAPOLIS-HONEYWELL REGULATOR COMPANY
FREEPORT, ILLINOIS



NEW PRODUCTS

(continued)

compensate for line voltage variations and rectifier aging. Panel controls include a power switch, a-c line fuse, voltage control knob, two 3-in., 2-percent-accurate D'Arsonval meters and two binding posts for d-c load connections. A 6-ft line cord is furnished for a-c input.

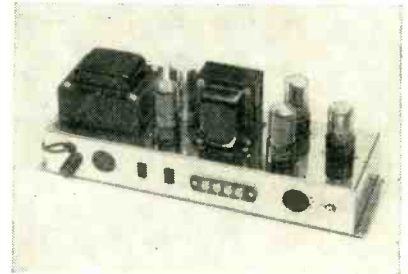

High-Fidelity Amplifier

PRECISION ELECTRONICS, 9101 King Ave., Franklin Park, Ill. Model 100BA is designed as a basic amplifier for the average high-fidelity home system. Features include full-range reproduction with low distortion. Power output is 10 w, 20 w peak. Distortion at 10 w is 1.0 percent harmonic, and 2.0 percent intermodulation. Frequency response at 3 w \pm 0.5 db is 20 to 50,000 cps. Frequency response at 10 w, \pm 1.0 db is 30 to 20,000 cps.



Magnetic Heads

THE BRUSH DEVELOPMENT Co., 3405 Perkins Ave., Cleveland 14, Ohio, announces two new magnetic heads. One is a record-reproduce head, BK-1090; the other, its erase head companion, is a BK-1110. The BK-1090 is intended for dual track recording and distinguishes itself by very high resolution and uniformity. The most outstanding feature

GALBRAITH OUTDOOR SPEAKERS

All bronze housings, complete with mounting brackets 15" horn diameter, double re-entrant type. Frequency response from 400 to over 6000 cycles. Thoroughly weatherproof. Powered with Alnico-V-Plus driver unit, U. S. Coast Guard approved made by specialists in the manufacture of Marine equipment and Controls, Emergency Loud-speaker Systems, Public Address Systems, Music Broadcast Systems and Docking and Navigating Systems.

**C. C. GALBRAITH & SON
ELECTRIC CORP.**

450 Ave. of the Americas
New York 11, N. Y.



Weatherproof, E-27, 544
Front and Back View, showing assembly details

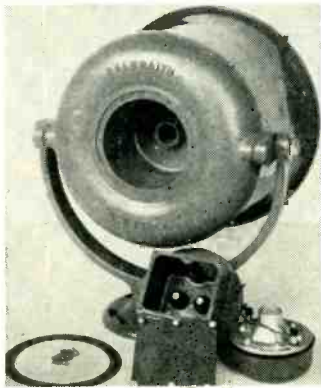

let WILLIAMS
help you apply
ferric oxides to
the manufacture
of your

ferrites

You'll be well repaid by getting the facts on a special group of Pure Ferric Oxides, developed by Williams especially for use in the manufacture of ferrites.

Williams Ferric Oxides analyze better than 99% Fe_2O_3 . They contain a minimum of impurities. They are available in a broad range of particle sizes and shapes. Among them, we're certain you'll find one that's "just right" for your requirements. The proper application of Ferric Oxides to the manufacture of Ferrites is our specialty.

Tell us your requirements... we'll gladly send samples for test. Chances are good that our Ferric Oxide "Know How" can save you considerable time and money. Address Dept. 25, C. K. Williams & Co., Easton, Pa.

WILLIAMS
COLORS & PIGMENTS

C. K. WILLIAMS & CO.
Easton, Pa. • East St. Louis, Ill.
Emeryville, Cal.

P. S. We also produce IRN Magnetic Iron powders for the Electronic Core Industry, the Magnetic Tape Recording Industry and others. Write for complete technical information.

Sterling Relays

JUST OFF THE PRESS!

This catalog of *Sterling RELAYS* will be of help to you in planning your requirements of fine relays



Send for Your
copy Today!

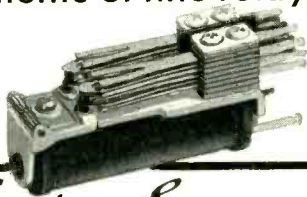

Sterling Engineering Company, Inc.
54 MILL STREET - LACONIA, N. H.

Subsidiary of **AMERICAN MACHINE & FOUNDRY CO.** New York

DANDUX

CANVAS
and leather
PRODUCTS



BG-44 Bag

DESIGNED TO SPECIFICATIONS

BG BAGS, CW BAGS, CLIP BAGS,
TOOL ROLLS, BAGS & CASES for
ordnance, radio, electronic and
radar equipment.

C. R. DANIELS, INC.
DANIELS, MD.

75 West St. New York 6, N. Y. 549 W. Randolph St. Chicago 6, Ill.

40 MC TO 225 MC TV AMPLIFIERS

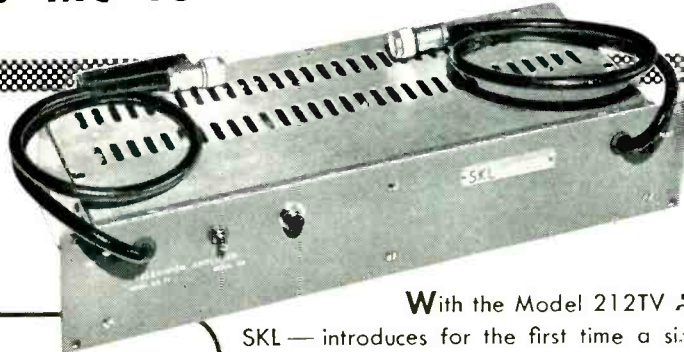

With the Model 212TV Amplifier — SKL — introduces for the first time a single broad band chain amplifier type booster capable of amplifying all 13 television channels simultaneously. Because of its stability and reliability — a tube failure means only a slight loss of gain, not amplifier failure — the Model 212TV Amplifier can be safely left unattended for long periods of time. Its low noise level, high output, and low impedance make the Model 212TV Chain Amplifier ideal for television distribution systems in hotels, apartment houses, sales rooms, television stations, cities and towns.

Write today for further information

- SPECIFICATIONS**
- BANDWIDTH
40 MC — 225 MC
 - IMPEDANCE
180, 52 and 72 ohm unbalanced, 300 ohm balanced
 - GAIN
21 db
 - OUTPUT VOLTAGE
6 volts peak maximum
 - RESPONSE
± 2 db over bandwidth
 - POWER SUPPLY
117V, 60 cps, 55 watts

SKL SPENCER-KENNEDY LABORATORIES, INC.
186 MASSACHUSETTS AVE., CAMBRIDGE 39, MASS.

for the **ELECTRONIC INDUSTRIES**

Quality

Ribbons STRIPS

**MOLYBDENUM
TUNGSTEN
TANTALUM
FORMED PIECES**

Your Special Metals Rolled to Thin Sizes & Close Tolerances

YOUR INQUIRIES WILL RECEIVE PROMPT ATTENTION

H. CROSS CO.
15 BEEKMAN ST., N. Y. 38, N. Y.
WCrth 2-2044 and COrtlandt 7-C470

High-quality, Low-cost TOROIDAL COILS

Universal-developed coil-winding machines produce a better toroidal coil, custom-built to your blueprint specifications, at considerably lower unit cost! Wound on any type cores (any I.D. to 3/8"), in any size wire, Universal toroidal coils are perfectly uniform and fully insulated. Send your blueprint specifications today, and let us quote the lower cost of better Universal toroidal coils on your next order.

Address:

Toroidal Coil Division
Universal Manufacturing Company, Inc.
404 Hillside Avenue Hillside, N. J.

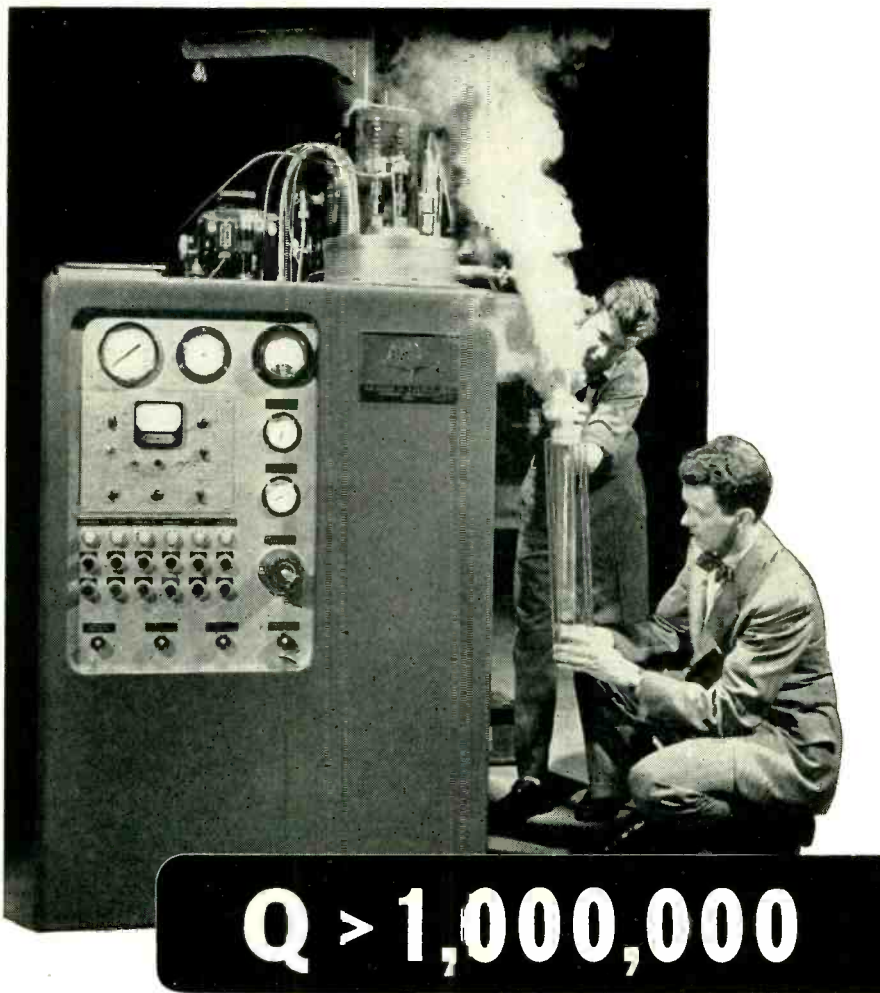

Q > 1,000,000

Resonant circuits with Q's in the range of millions are one of the many practical applications of low-temperature techniques and phenomena being studied by laboratories equipped with our Collins Helium Cryostat. With this reliable equipment for the production of liquid helium, phenomena known to occur in the neighborhood of Absolute Zero are now being exploited for useful purposes.

Various industrial low-temperature laboratories are studying the very low energy effects, masked by thermal noise at normal temperatures, for their application to communications and control processes. Other potential uses of low-temperature phenomena include the development of sensitive bolometers, perfect conductors, magnetic shields, and insulators which will hold a charge for unusually long periods.

Your industry, equipped for low-temperature research, can expand the growing list of practical uses for these low-temperature effects.

For further information on the Collins Helium Cryostat and other potential applications of low-temperature research write for Bulletin E11-3



ARTHUR D. LITTLE, Inc.
Mechanical Division

30 MEMORIAL DRIVE • CAMBRIDGE, MASS.

a new electronic level control for nonconductive materials ranging from condensed gases to semisolids. It has proved extremely valuable for precise level control, particularly in the high temperature and high pressure ranges where exacting level controls are desired. The Ktrol is a compact unit with plug-in, sealed housing containing all components. The plug-in unit can be replaced in a matter of seconds. Exchangeable sealed component units are available for insertion in control without disturbing or removing equipment from tank or vat. It is so designed that the electronic circuit will maintain level control from $\pm \frac{1}{16}$ in. and up. Custom-built noncorrosive probes are available for the material to be controlled and the kind and size of tank or container to be used. It is available in an oil-filled housing making it acceptable for explosion-proof installation.



Streamlined Chassis

ELECTRIC REGULATOR CORP., Norwalk, Conn., has designed a new, streamlined steel chassis for mounting the Regohm and associated resistor elements. The Regohm mentioned is an electric circuit controller that has found wide application in the precise control of voltage current, speed and servos. The chassis, built in accordance with military specifications, has overall dimensions of 5 in. x 6 in. x 3 1/4 in., and weighs about 2 lb complete with plug-in Regohm controller. Its sturdy construction, including built-in vibration mounts, permits efficient operation under

from
Accelerometers
to
Yokes

you'll find the
correct answer to
who makes
everything in the
entire field
of electronics
including... components
equipment
and
materials

in the...
electronics
BUYERS'
GUIDE

Get in the habit of looking it up in...

the **electronics**
BUYERS' GUIDE

"The Book that has all the answers"

A MCGRAW-HILL PUBLICATION
330 West 42nd Street
NEW YORK 36, N. Y.



GIANT in miniatures

The inevitable process of "separating the men from the boys" is still going on in the comparatively new electronics industry. Yet Volkert has already established itself as the leading independent supplier of stamped components for miniature tube sockets, and other precision stampings.

Volkert was the *first* to produce shield bases for sockets on a progressive die in a one-press setup. Through Volkert's creative die engineering, a cost-saving method was initiated to stamp the tiny contacts *two at a time*. And now Volkert turns out over

one hundred million contacts every year.

Add to these achievements Volkert's modern production facilities, its ability to work with all types of specialty metals, and its emphasis on precision *plus* automaticity—and you have the reasons why Volkert is your *best* source for *all* precision stampings at low cost.

Volkert's outstanding facilities for design engineering, tooling, production, assembly and inspection—all combined under a single roof—are described in a 16-page booklet, "3-Way Facilities for Precision Stampings." Write for your copy.

John Volkert Metal Stampings, Inc.
222-34 96th Avenue
Queens Village 8,
L. I., N. Y.



For design...tooling...production and
assembly of precision stampings

Volkert

SUB-MINIATURE WIDE-RANGE

INTERFERENCE FILTERS

for aircraft service

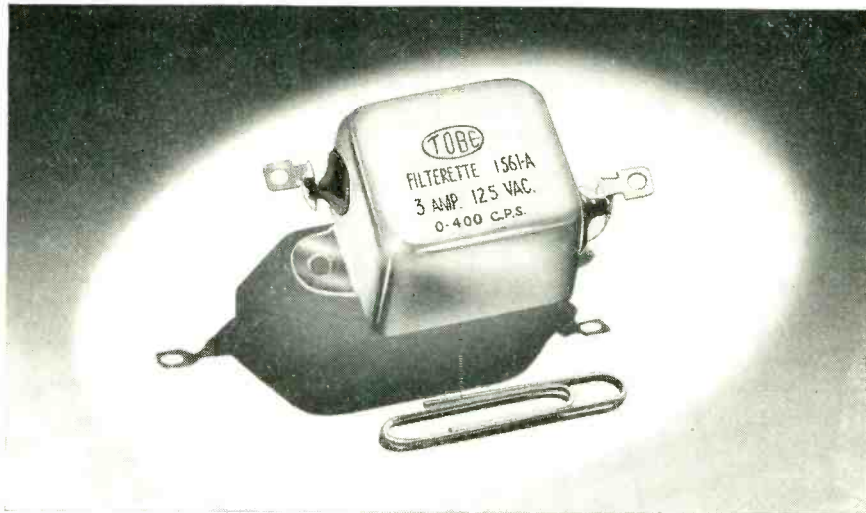

TOBE FILTERETTE No. 1561-A

Effective protection from radio interference throughout the 150 kilo-cycle to 400 megacycle range is afforded communications circuits, signal circuits, and low-current power circuits by the sub-miniature interference filter shown above.

FEATURES

- Small size . . . only 1-1/8 x 1 x 11/16 inch
- Light weight . . . only one ounce
- Handles 3 amperes at 125 volts, 0 - 400 c.p.s.
- Hermetically sealed in bathtub case, with glass-insulated solder-sealed terminals
- Better than 40 db attenuation throughout 0.150 - 400 mc. range

Other miniature and sub-miniature filters can be furnished to meet the performance requirements of your particular applications. Ask us for filter engineering assistance with any problem.

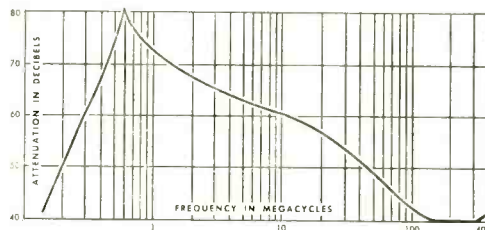

TOBE DEUTSCHMANN
CORPORATION
NORWOOD, MASSACHUSETTS

severe service conditions of temperature, shock and vibration.

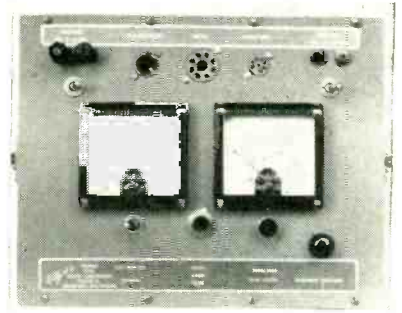

Regulator Tube & Selenium Rectifier Tester

LLOYD'S ENTERPRISES, Box 313, Alhambra, Calif., has available a regulator tube and selenium rectifier tester. It measures the voltage regulation under the minimum and maximum currents as shown in the manufacturers' data sheets, and permits the matching or selection into groups of tubes to be used in critical applications. The test for selenium rectifiers permits several tests to be made such as the forward current, back current or creepage if present. The tester could also be used as a variable voltage 50-ma power supply when not being used as a tester. A complete set of instructions is included with the tester.



Electrical Resolvers

FORD INSTRUMENT Co., Division of the Sperry Corp., 31-10 Thomson Ave., Long Island City 1, N. Y. An electrical resolver system, capable of operating with accuracy

over a wide environmental range, has been developed for use in computers and computing systems. The system is composed of a resolver, a high-gain amplifier and a summing network box. The network box suitably combines its inputs for introduction into the high-gain amplifier; the amplifier feeds the resolver, either the basic resolver or the vector solver type; and the outputs of the resolver are the desired functions. The system, designed originally for the armed services, operates accurately at temperatures from -60 to $+160$ F; moreover, it is standardized thereby allowing interchangeability without upsetting the system of which it is a part. Flexibility is provided through a choice of network boxes and amplifiers; in this way, many different type problems may be solved by minor equipment substitutions. Brochure R1-11-52-4M, now available, gives typical ratings and technical data.



Oscillograph Trace Reader

BENSON-LEHNER CORP., 2340 Sawtelle Blvd., Los Angeles 64, Calif. The Oscar Model C oscillograph trace reader is designed to expedite the analysis of continuous trace records, 35 mm to 12 in. in width, presented either on film or paper. In one operation it applies non-linear calibrations, scales, zero corrections, logs and squares, as well as interpolating time. It produces instantaneous records in the form of tabulations, plots, or punched cards as required. Accuracy of the amplitude measuring system is in the order of ± 0.1 percent of full scale movement. Only one person is required to operate the equipment and produces approximately 20 points of final data per minute

RESIN-IMPREGNATED RESIN-FILLED CAPACITORS

for 125°C service — without derating

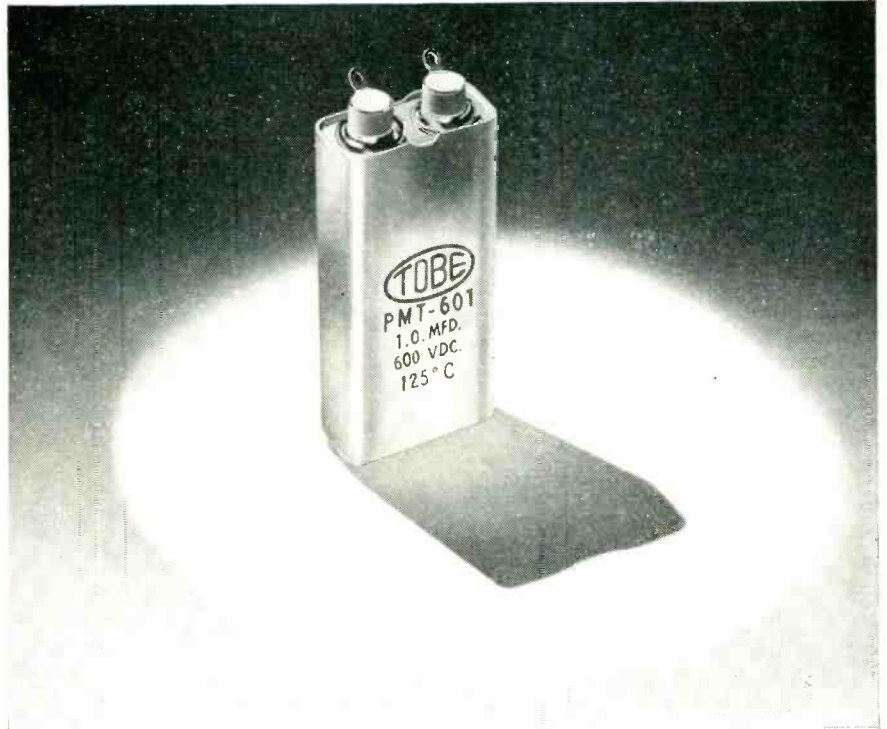

TOBE DURATOR CAPACITORS

Higher working temperatures at no increase in size are now possible, with Tobe Durators. Features of these capacitors are:

- 125°C ratings in same space as 85°C
- 150°C operation for 20 hours without derating
- Welded terminals with silicon insulators
- Hermetically sealed metal cases in bathtub, deep-drawn, and lock-squeeze-seam styles
- Capacitance drift below $7\frac{1}{2}\%$ from -65°C to $+125^{\circ}\text{C}$
- Power factor below 1.5% from -65°C to $+125^{\circ}\text{C}$
- Suitable as coupling capacitors at minimum voltage



Write for data sheet listing available ratings and sizes.

TOBE DEUTSCHMANN
CORPORATION
NORWOOD, MASSACHUSETTS

temperatures!

atmospheres!

pressures!

For ACCURACY

TEST WITH **Tenney**

... for Tenney Test Chambers are precision-engineered for maximum efficiency and can be designed to simulate the complete range of temperature, atmospheric or pressure conditions found anywhere on earth—or above it to altitudes of 120,000 ft. plus! They attain sub-zero temperatures quickly, maintain them efficiently and provide full instrumentation for accurate evaluation of complete test data.

TENNEYSPHERE ALTITUDE CHAMBERS

Designed to withstand atmospheric pressure and to simulate global conditions of pressures, temperatures and humidities. Altitudes from sea level to approx. 80,000 ft. Temperature range from plus 200°F to minus 100°F. Also simulates desired (20% to 95%) relative humidity.

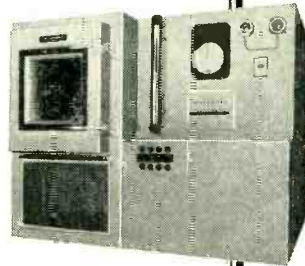

TENNEY SERVO UNIT

Portable air conditioning unit which may easily be attached to various types of laboratory enclosures—impact machines; tension machines; torsion testers; cold boxes and similar equipment. Through its use, articles undergoing testing, aging or weathering can be subjected to wide variations of humidity, heat and cold. Photo shows servo attached to companion chamber.

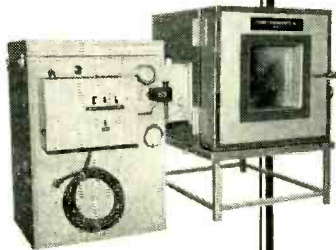

TENNEY TEMPERATURE AND HUMIDITY CHAMBER

Designed for positive control of temperature, humidity and air circulation. Permits the accurate checking of physical quality, fragility, tension and other factors. Also built to incorporate extreme low temperatures, to -100°F.

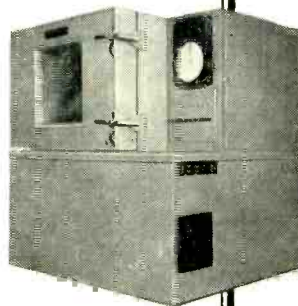

TENNEY SUB-ARCTIC INDUSTRIAL CABINETS

Designed for low-temperature testing of metals, radios, instruments, plastics, liquids, chemicals and pharmaceuticals. Temperature ranges of -40°F, -60°F, -95°F and -150°F are standard for each size.

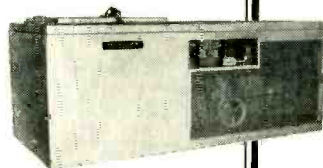

For further information on these and other Tenney test equipment, write to Tenney Engineering, Inc., Dept. A, 26 Avenue B, Newark 5, New Jersey.



Tenney

Engineers and Manufacturers of Automatic Environmental Test Equipment

8470

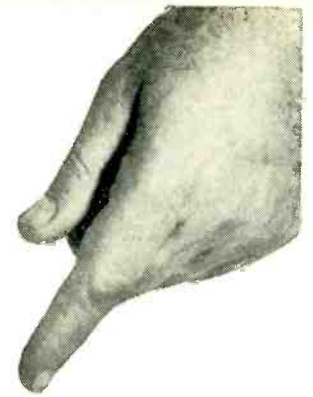

How to keep informed on the "with what" part of your business

AT YOUR FINGER TIPS, issue after issue, is one of your richest veins of job information—advertising. You might call it the "with what" type—which dovetails the "how" of the editorial pages. Easy to read, talking your language, geared specifically to the betterment of your business, this is the kind of practical data which may well help you do a job quicker, better—save your company money.

Each advertiser is obviously doing his level best to give you helpful information. By showing, through the advertising pages, how his product or service can benefit you and your company, he is taking his most efficient way toward a sale.

Add up all the advertisers and you've got a gold mine of current, on-the-job information. Yours for the reading are a wealth of data and facts on the very latest in products, services, tools... product developments, materials, processes, methods.

You, too, have a big stake in the advertising pages. Read them regularly, carefully to keep job-informed on the "with what" part of your business.

McGRAW-HILL PUBLICATIONS



with no additional equipment required.

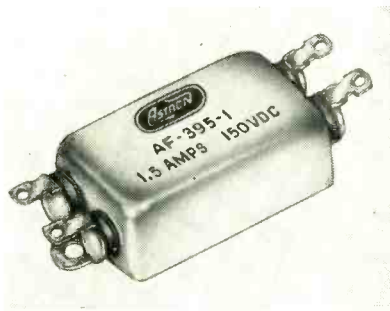

Subminiature Filters

ASTRON CORP., 255 Grant Ave., E. Newark, N. J., is currently effecting reductions of from 40 to 50 percent in the size of r-f interference filters through the use of metallized paper capacitor elements and inductances made with special windings on high permeability core materials. Standard or specially designed r-f interference filters are available in single or multiple-filter sections for suppressing conducted and radiated noise on one or more power lines and for noise attenuation from 14 kc to 1,000 mc. The units conform to all existing government specifications.

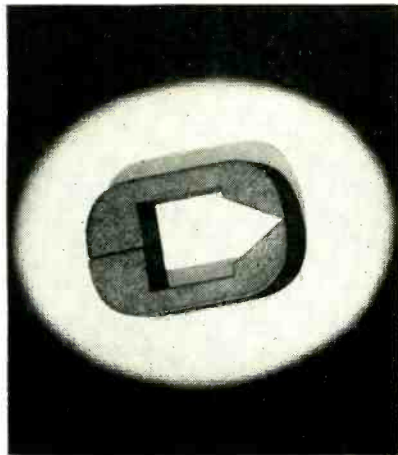

Ferrite Recording Heads

FERROXCUBE CORP. OF AMERICA, 35 Marshall St., North Adams, Mass. Increasing use of nonmetallic ferromagnetic cores for recording heads in various types of magnetic recorders has resulted from the introduction of a new material—type 1-90-1—developed especially for this purpose. The new material is very homogeneous and more nearly

REPUBLIC WATCHES THE LITTLE THINGS THAT MEAN BIGGER PRODUCTION FOR YOU

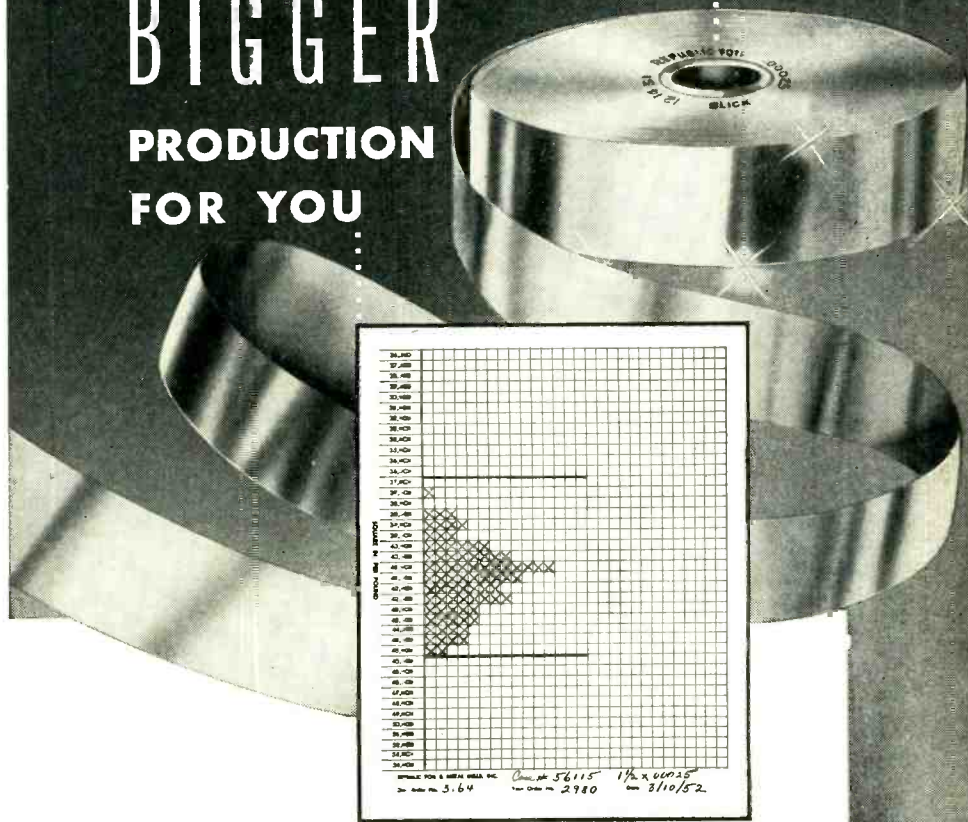

Take the matter of quickly identifying coils of Republic Aluminum Foil. Republic coils are clearly marked with the customer's code, the gage and the packaging date. Because the marking is on the edge of the coil, close to the core, a partially used coil is as quickly and readily identified as a new one.

As an added service, Republic is always glad to furnish their customers with an inspection chart covering each order. This chart tells at a glance the detailed yield factors of any given order. It is a pictorial representation of what can be anticipated in production.

But the most significant characteristic of Republic capacitor foil is its consistently good quality. Accurate gage, clean, straight edges and individual boxing mean more production, less down time, and fewer rejects.

Republic capacitor foil is available in widths of 1/4" and wider, and in gages from .00017" to .005".

REPUBLIC FOIL & METAL MILLS INCORPORATED

DANBURY

CONNECTICUT

Branch Sales Offices: 209 W. Jackson Blvd., Chicago 6, Ill.
666 Mission St., San Francisco 5, Calif.
1103 Murphy Ave., S. W., Atlanta, Ga.



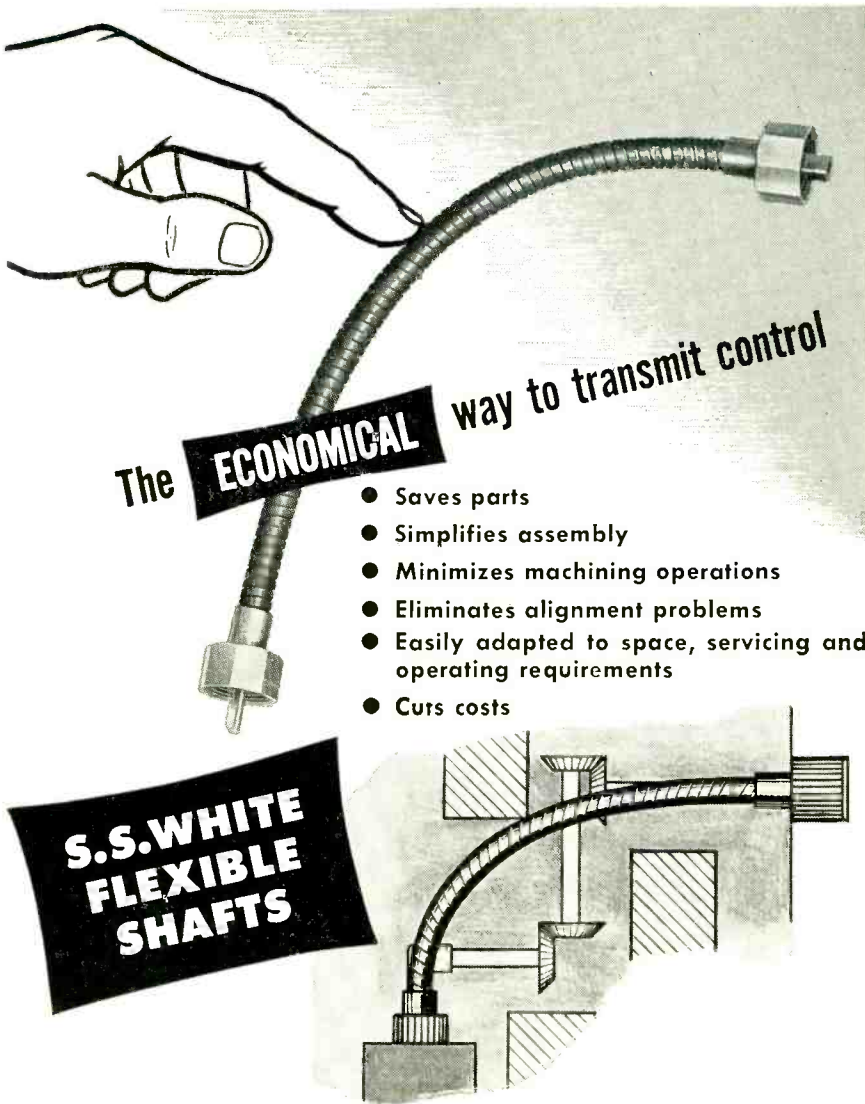

**S.S.WHITE
FLEXIBLE
SHAFTS**

- Saves parts
- Simplifies assembly
- Minimizes machining operations
- Eliminates alignment problems
- Easily adapted to space, servicing and operating requirements
- Cuts costs

It only takes a single S.S.White flexible shaft to provide an efficient, smooth operating control linkage between any two parts, regardless of curves, obstacles or distance. Compare this to the systems of belts and pulleys—universal joints—or solid shafts and bearings that might otherwise have to be used—systems that call for extra care in alignment, machining, and assembly time. The advantages are obvious and most important in electronic equipment design. With S.S.White flexible shafts you need fewer parts, can simplify assembly, and **improve product performance at far less cost.**

S.S.White remote control flexible shafts come in a large selection of sizes and characteristics to meet almost any control requirement. Let S.S.White engineers assist you in working out details. There's no obligation.

Write for the Flexible Shaft Handbook. This 256-page handbook has full details on flexible shaft selection and application. Copy sent free if requested on your business letterhead.



THE S.S.White INDUSTRIAL DIVISION
DENTAL MFG. CO.



Dept. E 10 East 40th St.,
NEW YORK 16, N. Y.

Western District Office • Times Building, Long Beach, California

free from voids and cracks than most commercially available ferrites. Technical information on the new material is available in bulletin FC-5103 upon letterhead request.

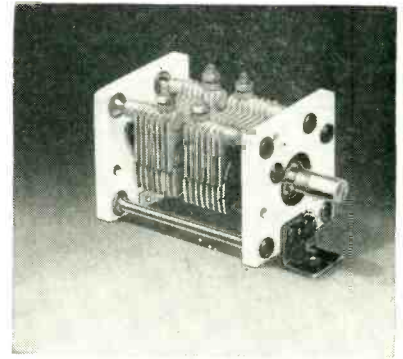

VHF/UHF Capacitor

HAMMARLUND MFG. CO., INC., 460 W. 34th St., New York 1, N. Y., has introduced a vhf-uhf variable capacitor specifically designed for use in tuned circuits that operate at frequencies from 50 mc to 500 mc. This 'VU' capacitor incorporates a unique design that places two capacitor sections in series and eliminates the need for contacts to the rotor. The rotor is completely isolated by the use of pyrex-glass ball bearings. As a result of this construction, contact and bearing noise is completely eliminated.



Casting Resins and Potting Compounds

CARL H. BIGGS CO., 11616 W. Pico Blvd., Los Angeles 24, Calif., has announced a new line of casting resins and potting compounds to meet today's needs of military and civilian users. When used for cast-

resin embedments of circuits and components, Helix potting compounds provide hermetic sealing protection against moisture, fungus and fumes, and offer rugged protection against shock and vibration with considerable elimination of mounting hardware and consequent reduction of labor time and costs since bare point-to-point wiring may be used. These resins have a shrinkage of less than 1 percent, with excellent adherence to metal leads and other elements. Corrosive effects are nil. Supplied in liquid form, Helix resins are poured cold and will cure at room temperature. They are 100 percent resin solids compounds that give a nonporous casting with a temperature range from -100 F to $+400$ F with very slight changes in their electrical or physical properties. Moisture absorption is less than 0.01 percent and excellent humidity chamber tests have been recorded.

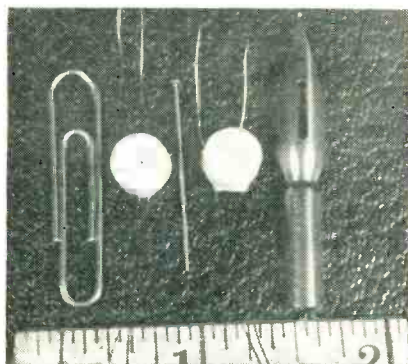

Subminiature Pulse Transformers

THE JACOBS INSTRUMENT CO., 4718 Bethesda Ave., Bethesda 14, Md., has developed a new line of potted pulse transformers. They are cylindrical in shape, the cylinder being $\frac{1}{8}$ in. in diameter and $\frac{1}{2}$ in. high. They weigh 1/100 oz each when potted in a thermoplastic capsule. A novel mounting means, comprising a pin passing axially through the transformer, is provided. This pin may be used to fasten the transformer to a mounting panel. A standard transformer with a 1 to 1 turns ratio is offered, and in addition transformers with special windings can be supplied on special order. These subminiature transformers should be very valuable in

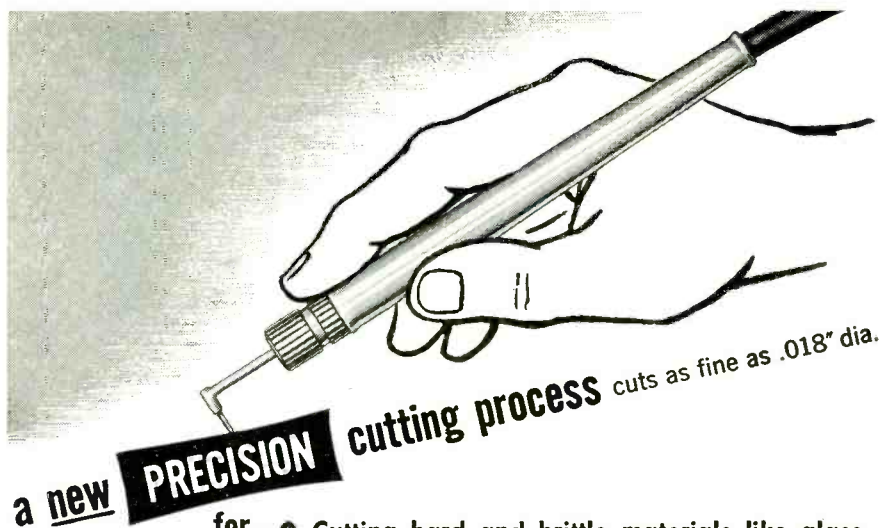

- for—
- Cutting hard and brittle materials like glass and germanium.
 - Controlled removal of surface coatings on printed circuits and deposited carbon resistors.
 - Drilling holes in thin sections.
 - Cutting small holes, cavities and slits.
 - Light etching and finishing operations.



The S.S. White "Airbrasive" Unit produces a cutting action by means of a high-velocity stream of abrasive particles which are directed at the work through an .018" diameter nozzle. The cutting action is cool and eliminates the vibration and pressure ordinarily associated with other cutting methods. Furthermore, the accuracy of the cut is not affected by surface irregularities of the work or by wear, as might be the case with a standard cutting tool. The Unit is ideal for laboratory work and can be readily adapted to any production set-up.

Write for Bulletin 5212. It gives full details about the S.S. White Industrial "Airbrasive" Unit, including specifications, prices and operating and performance data.



THE S.S. White INDUSTRIAL DIVISION
DENTAL MFG. CO.



Dept. E, 10 East 40th St.
 NEW YORK 16, N. Y.

Western District Office • Times Building, Long Beach, California

TUBE COST DATA
you've always wanted!

FREE!



Most comprehensive and accurate purchasing and cost-analysis tool in tube history! Product of over 2 years' research. Covers every tube type and crystal manufactured in U.S.—from tiniest crystal to largest transmitting tube—including...

Amperex • Bomac • Chatham • Cetron Du Mont • Eimac • Federal • General Electric Hytron • Industro • Lewis & Kaufman Machlett • National • National Union North American Philips • Philco • Raytheon RCA • Sperry • Sylvania • Taylor • Tung-Sol • United • Western Electric • Westinghouse

Tells list prices and your current costs for over 4,000 tube types! Kept up-to-date by State Labs' famous Weekly Market Guides mailed free to all owners of the Tube Buyers' Guide. In loose-leaf form, alphabetically and numerically indexed for quick, easy reference.

PRAISED BY INDUSTRY LEADERS

Says W. L. Urquhart, President, W. L. Urquhart, Inc. one of America's leading electronic tube exporters:

"Without doubt your new 1953 U.S. Electronic Tube Buyers' Guide contains the most extensive tube cost information ever to hit the tube markets of this country. It's invaluable to me—I wouldn't be without it for a day."



For YOUR copy-USE the COUPON!

Note: This Tube Buyers' Guide is necessarily restricted to Purchasing Agents, Manufacturers, Industrials, Government Agencies, Distributors, Exporters. Please fill out the coupon in full and attach to your letterhead.

STATE LABS, INC. Dept. E
37 East 28th St., New York 16, N. Y.
Send me your FREE 1953 U.S. Electronic Tube Buyers' Guide.

NAME _____
TITLE _____
COMPANY NAME _____
ADDRESS _____
CITY _____ STATE _____
NATURE OF COMPANY BUSINESS _____

State Labs, Inc., 37 E. 28 St., N.Y.C.
MUrray Hill 3-9802



Style 18 (Medium),
500 yd. spools,
black or natural.

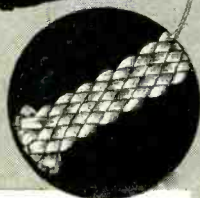

Write for **FREE**
samples and prices.

*Patent Pending.

for lacings that stay put!

GUDELACE

BRAIDED NYLON LACING TAPE*

A New and Revolutionary Type of Lacing

- Saves time, saves money, greatly reduces the number of rejects
- Won't "bite through" insulation
- Won't cut wiremen's fingers or cause dermatitis
- Ties easier, ties tighter and cuts down on slipping of knots

Let **GUDELACE** answer your lacing problems.

GUDEBROD BROS. SILK CO., INC.

Electronics Division, Dept A

Main Office: 12 South 12th Street, Philadelphia 7, Pa.

225 West 34th Street, New York 1, N.Y.

FOR
FASTER
PUMPING
WITH
SMALLER
PUMPS

**INTERNATIONAL
HIGH VACUUM
COMPOUND PUMPS**

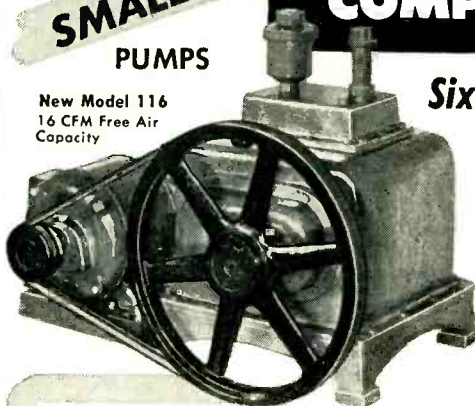

New Model 116
16 CFM Free Air
Capacity

Six Ways a Better Pump:

1. SIMPLIFIED CONSTRUCTION
2. ROTARY VANE
3. AUTOMATIC LUBRICATION
4. HIGH EFFICIENCY
5. QUICK RECOVERY
6. RUGGEDLY BUILT

Speed production and reduce maintenance with these ready-to-operate, high efficiency vacuum pumps!

International rotary vane pumps are extremely compact and operate unusually quiet. Simplified construction and automatic lubrication assure trouble-free operation, long life and low-cost upkeep. Pump mechanisms are totally oil submerged, preventing atmosphere to vacuum leakage.

CAPACITIES UP TO 30 C.F.M.
WRITE FOR LITERATURE TODAY

International Pump & Machine Works
PUMP DIVISION
11-13 GOVERNOR STREET
NEWARK 2, NEW JERSEY

SPECIALIST MANUFACTURERS OF INDUSTRIAL GLASS-WORKING MACHINERY AND HIGH VACUUM PUMPS FOR ELECTRONICS, NUCLEONICS AND RESEARCH FOR OVER A QUARTER CENTURY

accelerating the trend toward smaller size and increased reliability in modern electronic equipment.

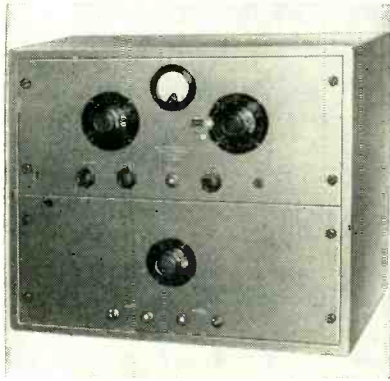

Master Oscillators

WUNDERLICH RADIO Co., 2 Fifth Ave., New York 11, N. Y., has announced a series of high stability master oscillators for use in the laboratory or as a frequency source for radio transmitters and receivers. There are three models covering the following ranges: 200 to 600 kc, 500 to 1,640 kc and 1 to 16 mc. A stability of 5 parts per million is attainable and a resettability of the same order is featured, thus making it unnecessary to reference the frequency against a master standard. Power output of 2 to 5 w across a 75-ohm load is provided, which permits full excitation of most radio transmitters. The oscillators are mounted on standard width relay rack panels and are supplied with a cabinet for table top mounting. Primary power source is 115 v, 50 to 60 cycles.

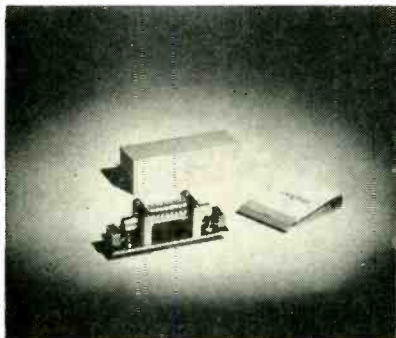

Mechanical Filter

COLLINS RADIO Co., Cedar Rapids, Iowa. The mechanical filter illustrated is a magnetostrictively

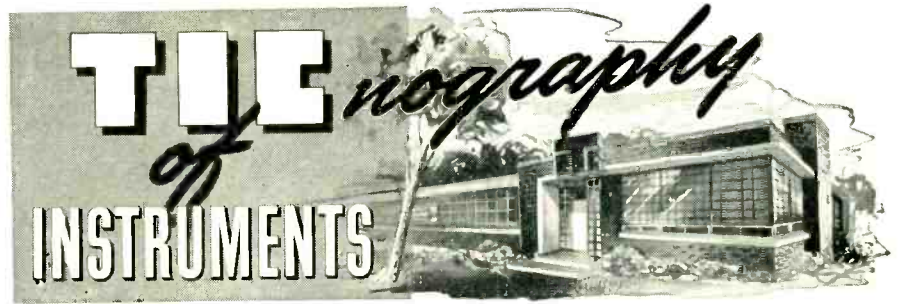

Measurement of
Impedance

Inductance

Capacitance

Resistance

Dissipation
Factor (D)

Storage
Coefficient (Q)

Plot Impedance
Functions

310A

Z-Angle Meter



The type 310A Z-Angle Meter measures impedance directly in polar coordinates as an impedance magnitude in ohms and phase angle in degrees: Z/θ . Impedance Range: .5 to 100,000 ohms, covered by a single dial and a four position range switch.

Accuracy: $\pm 1\%$

Frequency Range: 30 cycles to 20 kc. for impedances below 5000 ohms, measurements can be made up to 40 kc. For frequencies from 100 kc. to 2 mc., write for specifications for the type 311A-RF Z-Angle Meter.

Phase Angle Range: 0° to 90° Direct reading on panel meter. Meter is also Calibrated in D and Q.

Phase Angle Accuracy: Within 2° of meter indication.

Internal Oscillator: 60 cycles and 400 cycles. Terminals are provided for an external, variable frequency signal generator for measurements at other frequencies.

In the field, the laboratory, the production test floor or the class room, the extreme accuracy and the simplicity of operation has proved the type 310A Z-Angle Meter to be a superb and reliable instrument.

Write now for more detailed information.

ENGINEERING REPRESENTATIVES

Chicago, Ill. — UPtown 8-1141	Ann Arbor, Ont., Can. — Ann Arbor 400
Cleveland, Ohio — PRospect 1-6171	Hollywood, Cal. — HOLLYWOOD 9-6305
Waltham, Mass. — WAltham 5-6900	Dallas, Texas — DIXon 9918
Boonton, N. J. — Boonton 8-3097	Roseland, New Jersey — Caldwell 6-4545
Dayton, Ohio — MichigAn-8721	Wyncote, Pa. — Ogontz 8805
	Silver Spring, Md. — Sligo 7-550

TECHNOLOGY INSTRUMENT CORP.

533 Main Street · Acton, Massachusetts · Tel. ACTon 3-7711

Want more information? Use post card on last page.

If it's made of
SHEET METAL
Check with

**TRANSFORMER
METAL
PRODUCTS**

FAST, DEPENDABLE SERVICE
TO MEET HIGHEST STANDARDS

► **COMPLETE
SHEET METAL
FACILITIES**

- ★ DESIGN ★ DEVELOPMENT
- ★ PRODUCTION

Typical products we engineer and build to specifications include . . .

- TRANSFORMER CANS
- CHASSIS
- HOUSINGS
- CABINETS
- ELECTRONIC ENCLOSURES
- BRACKETS
- RACKS
- METAL SPECIALTIES

► Our work is of the kind you will be proud to use . . . Specialists in:

- METAL CUTTING
- FORMING
- BENDING
- PIERCING
- EMBOSSING
- DRAWING
- WELDING
 - Spot ★ Arc ★ Heliarc
- PAINTING & BAKING

Write or telephone us today . . . TMP engineers will be glad to supply quotations without obligation!

**TRANSFORMER METAL PRODUCTS
CORPORATION**
343 West 26th St., New York 1, N. Y.
Telephone: Wlconsin 7-6472

ACE COILS EVERYWHERE!

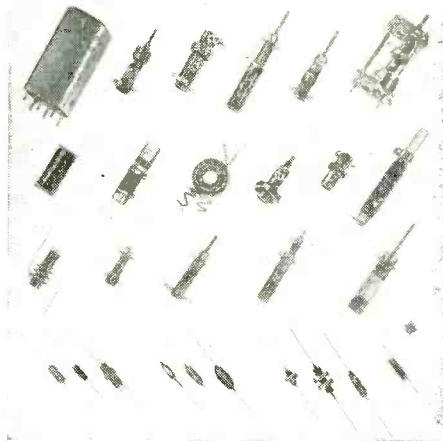

Yes, throughout the world, with our Armed Forces . . . From Coast to Coast, in Commercial Equipment . . . ACE Coils and Chokes are faithfully performing their designated functions. We stress "All Level Quality Control", "Advanced Engineering Techniques", and "Timely Deliveries".

ACE Coil & Electronics Co.
912 MIDDLESEX AVE • Met-6-3580 • METUCHEN, N. J.

on applications
where

TOP QUALITY CERAMICS

are essential
insist on

Isolantite

the first name in steatite



Leading electronic manufacturers depend on the original, pre-war quality of all ISOLANTITE products *because* it saves them time-money-production headaches.

It will pay you to secure quotations from Isolantite.

a few
"ISO"
PRODUCTS

- Bushings, Stand-off and Antenna Insulators,
- Beads, Washers,
- Supports, Coil Forms,

Standard and Special Designs of all types of Pressed, Extruded or Machined Steatite Components.

Isolantite MANUFACTURING CORP.
Stirling, N. J.

driven unit for intermediate frequency application and is composed of three sections: the input transducer, the resonant section and the output transducer. Input and output sections are identical and function to convert the electrical signal to a mechanical form and vice versa. In the resonant section, disks composed of special alloy metal have a very sharp resonance and excellent frequency stability. By means of magnetostrictive action, mechanical vibrations are converted into a varying magnetic field. A coil intercepts this field and supplies the output voltage. The entire unit is housed in a hermetically sealed case smaller in size than a normal intermediate transformer. The unusual selectivity of this filter and its miniature size make it readily applicable to both military and commercial transmitter and receiver designs.

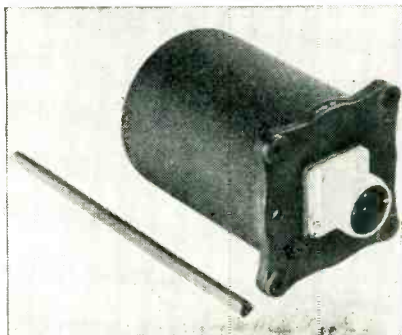

Oil-Filled Accelerometer Unit

G. M. GIANNINI & Co., INC., Pasadena 1, Calif., announces the 24133 accelerometer designed to fit in an oil-filled case. It utilizes a potentiometer resistance with a large output, requiring no amplifying unit in most cases. Instrument ranges may be obtained up to 30G while standard resistance ranges are 2,000 or 5,000 ohms. The potentiometer element safely carries current up to 15 ma. The unit has good resolution with 0.25 percent minimum offered on the standard instrument. The 24133 is a 1.0-percent instrument in performance. It is designed to operate in temperatures between -54 C and +71 C. Damping is 0.5 ± 0.075 of critical for a 7.5 G instrument as a typical case. It is designed for applications

TIC-TALKS FEATURE

PRECISION POTENTIOMETERS of optimum accuracy meeting your space requirements

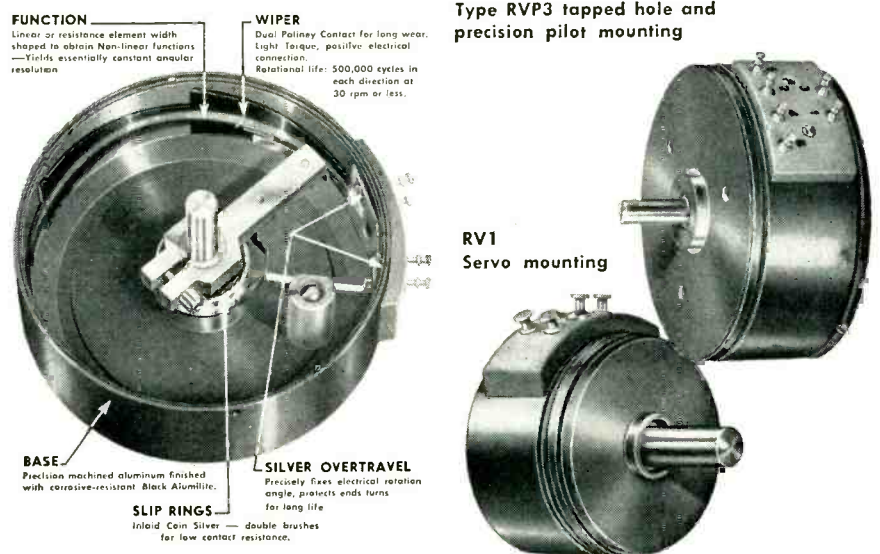

Technology Instrument Corporation potentiometers are designed for application in computing devices, instrumentation, electronic control and servo mechanisms — wherever extreme electrical and mechanical precision is an essential requirement.

As a result of years of custom manufacturing a complete line of standard sizes is available ranging from 7 inches in diameter to the sub-miniature $\frac{7}{8}$ " in diameter.

Custom design both mechanical and electrical is a featured TIC service. Precision non-linear pots may be designed to meet customer's requirements from either empirical data or implicit functions. Taps and special winding angles anywhere up to 360° continuous winding can be incorporated into both linear and non-linear precision potentiometers. Greatly expanded facilities plus mass production techniques meet customer volume needs yet maintain precision tolerances in both linear and non-linear potentiometers.

TYPE	DIAM.	RESISTANCE	ELECTRICAL ANGLE	LINEARITY	POWER RATING	MOUNTING	EXAMPLE OF NON-LINEAR FUNCTION AVAILABLE AS STANDARD
RVP-7	7"	1-500,000 Ω tol. to $\pm 1\%$	320° tol. to $\pm 5^\circ$	As low as $\pm .05\%$	6 watts at 25°C.	Servo	Type RVP7-S2 function: $\frac{E_{out}}{E_{in}} = \sin \Theta / 2 \pm 0.1\%$ peak amplitude
RVP-3	3"	Std. values to 200,000 Ω tol. to $\pm 1\%$	320° tol. to $\pm 5^\circ$	As low as $\pm .1\%$	6 watts at 25°C.	Servo-tapped hole and precision pilot or threaded bushing	Type RVP3-S4 function: 50 db logarithmic conformity; $\pm 2\%$ constant fractional accuracy
RV-3	3"	Std. values to 200,000 Ω tol. to $\pm 1\%$	315° tol. to $\pm 1^\circ$	As low as $\pm .25\%$	8 or 12 watts	3 tapped hole	Available for non-linear functions Note: Phenolic base precision potentiometer, stainless steel or bakelite shaft
RV2	2"	Std. values to 100,000 Ω tol. to $\pm 1\%$	320° tol. to $\pm 5^\circ$	As low as $\pm .2\%$	4 watts at 25°C.	Servo-tapped hole and precision pilot or threaded bushing	Type RV2-S112 function: $R = K\Theta^2$, conformity: $\pm .5\%$ over 64° to 320°
RV1-3/4	1-3/4"	Std. values to 100,000 Ω tol. to $\pm 1\%$	320° tol. to $\pm 1^\circ$	As low as $\pm .25\%$	3 watts at 25°C.	Servo-tapped hole and precision pilot or threaded bushing	Type RV1-S104 function: $\frac{E_{out}}{E_{in}} = \sin \Theta \pm 4\%$ peak amplitude per quadrant
RV1	1-1/8"	Std. values to 50,000 Ω tol. to $\pm 1\%$	320° tol. to $\pm 2^\circ$	As low as $\pm .5\%$	2 watts at 25°C.	Servo or threaded bushing	Type RV1-S7 function: $\frac{E_{out}}{E_{in}} = \sin \Theta / 1.78 \pm 4\%$ of peak amplitude
LINEAR TYPES ONLY:							
RV-3/4	3/4"	Std. values to 40,000 Ω tol. to $\pm 1\%$	320° tol. to $\pm 3^\circ$	As low as $\pm .5\%$	1 watt	Servo or threaded bushing	
RV1 Translatory	10,000 Ω 3 3/4" x 1 1/2"	$\pm 15\%$	Stroke* 2 1/2"	$\pm 1\%$ total resistance	1 watt	Provides output proportional to a linear displacement rather than a rotary motion of a shaft	

* Special resistance values and stroke lengths from .5 inches to 15 inches can be provided on a custom basis.

TECHNOLOGY INSTRUMENT CORP.

533 Main Street, Acton, Massachusetts, Phone Acton 3-7711

NOW ... smallest practical sizes

GARDE

MINIATURE
Insulated Standoff

Terminals

Molded Melamine Insulation
in accordance with latest revisions of
Mil-P-14 Specification

▼ **SUBMINIATURE**

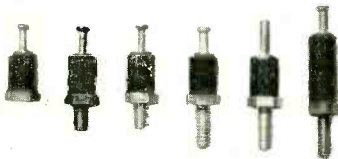

▼ **MINIATURE**

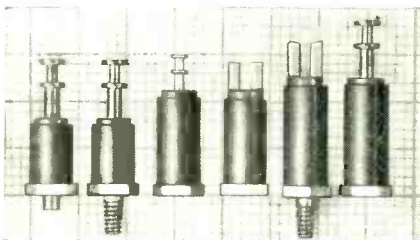

▼ **FEED-THRU** (HARDWARE INCLUDED)

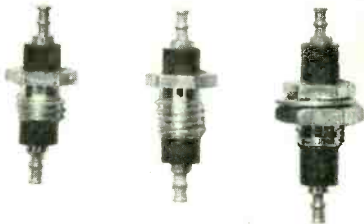

Terminal and Mounting Insert styles shown are available in all body sizes (3/8", 17/32", 19/32")

OTHER TYPES AVAILABLE

For specific details, write

GARDE
MANUFACTURING CO.

588 Eddy Street, Providence 3, R. I.

REPRESENTATIVES in Principal Cities

For **SPECIFIED PERFORMANCE**
Specify **JELLIFF RESISTANCE WIRE**

COMPLETE CONTROL OF MANUFACTURE . . .

A WIDE RANGE OF EXPERIENCE . . .

A WIDE RANGE OF ALLOYS . . .

make JELLIFF the ideal source of
Resistance Wire to assure your Product's

Performance According to Specs.

*Precision resistors—rheostats—
relays—thermocouples—ohmmeters
—bridges—high-temperature furnaces can all benefit from the
PLUS-PERFORMANCE of
JELLIFF RESISTANCE WIRE*



Detailed Enquiries Welcomed. Address Dept. 17.



HILLBURN

Specialists in the manufacture
of Components for Electronic,
Electrical, Communication and
Control Equipment.

For dependable uniform quality,
precision and economy, specify
HILLBURN:

COILS and TRANSFORMERS

including —

- R. F. Filters
- Precision Resistors
- Horiz. Output Transformers
- I.F. Coils and Transformers
- Linearity and Size Coils
- Peaking Coils and Plate Checks
- Loading Coils
- Bobbins
- Electronic Assemblies
- Solenoid, Universal, Random and Space Winding to Commercial and Military Specifications

HILLBURN ELECTRONIC PRODUCTS, 55 NASSAU AVE., BROOKLYN 22, N. Y.

in computing, telemetering and aircraft missile control.

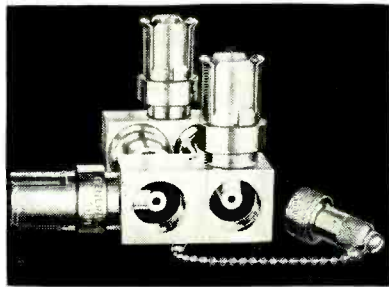

Balun

GENERAL RADIO Co., 275 Massachusetts Ave., Cambridge 39, Mass. Accurate measurements of balanced impedances in the frequency range from 50 to 1,000 mc can be made with the help of the type 874-UB balun. The balun, a tunable semiartificial half-wave line, acts as a transformer and makes it possible to connect a balance impedance to an unbalanced coaxial system such as is used on high-frequency measuring instruments. The balun has two important advantages over a conventional transformer—it can be tuned over a wide frequency range and has very low losses. The unbalanced end of the balun is a type 874 coax connector, and thus it can be used directly with any of the company's measuring equipment. New adaptors are available to connect to any of the other commonly used connector systems.

Literature

Electronic Level Control. Fielden Instrument Division, Robertshaw-Fulton Controls Co., 2920 North 4th St., Philadelphia 33, Pa. Brochure No. F-101 deals with the Tektor level control. This 8-page, 2-color publication describes the product, outlines applications, stresses its outstanding features (such as no moving parts or diaphragms to get out of order), and lists the various types of electrodes available. Ordering information is included.

Power Tetrode. Lewis and Kaufman, Ltd., 50 El Rancho Ave., Los Gatos, Calif. A new technical data



MISSION: To eliminate the needless waste of manpower, machines, and technical skill in the modification of servo components.

In applying servo systems to their operations, many engineers are restricted by "stock" components. They either sacrifice efficiency by building systems around the components available, or waste manpower, machines, and skill in modifying units to make them useable.

It is the mission of the Transicoil Corporation to provide precision components for each particular servo application . . . ready for immediate application . . . with all the accuracy and efficiency for which they are designed.

REFERENCE: Technical catalog "Precision Components" available upon request.



During the I.R.E. Show, see us at the Belmont Plaza Hotel, Suites 744, 745, 746.

TRANSICOIL

CORPORATION

107 GRAND STREET
NEW YORK 13, N.Y.

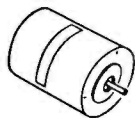

Miniature Control Motors

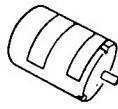

Motor and Gear Train Assemblies

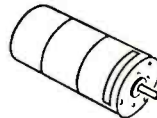

Motor, Generator, and Gear Train Combinations

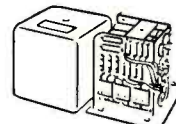

Servo Amplifiers

**ELECTRONIC GLASS WORKING EQUIPMENT for RADIO, TELEVISION TUBES,
INCANDESCENT LAMPS, GLASS LATHES for TELEVISION TUBES**

We make Transformers, Spot and Wire Butt Welders, Wire Cutting Machines and 500 other items, indispensable in your production. Eisler Engineers are constantly developing New Equipment. If you prefer your own designs, let us build them for you. Write to Charles Eisler who has served The Industry over 32 years.

Machines for small Radio Tubes of all kinds:

High Temperature Hydrogen Electric Furnaces

Hydrogen atmosphere heating chamber, hydrogen drying tower, water cooled unloading chamber, heat control with air cooled transformer with 11 position tap switch. Automatic temperature control (optional) standard furnaces from 1" bore 1800° C. to 8" bore 1100° C. Molybdenum wound heating units, loading and unloading chambers equipped with safety doors. Supplied with hydrogen flow gauges. Made to order in many sizes.

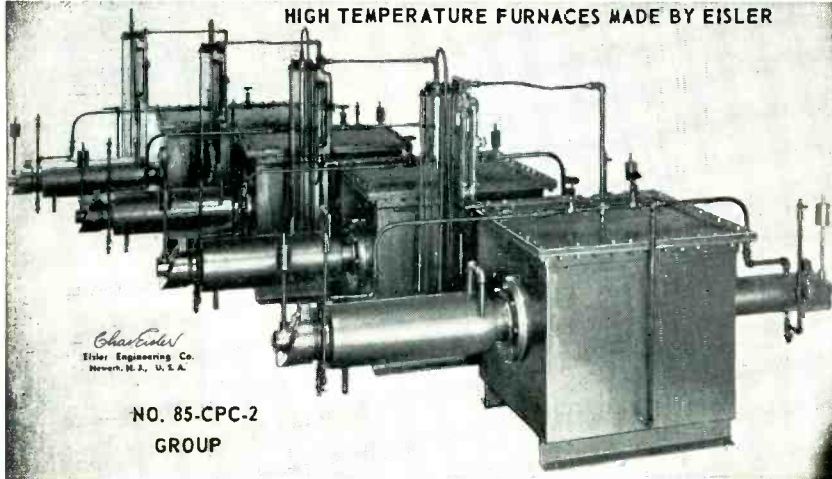

HIGH TEMPERATURE FURNACES MADE BY EISLER

Charles Eisler
Eisler Engineering Co.
Newark, N. J., U. S. A.

NO. 85-CPC-2
GROUP

EISLER ENGINEERING CO., Inc.

751 So. 13th St.
Newark 3, N. J.



Mobile Mountings

Mountings for Whip Antennas

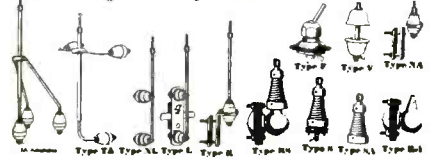

*To Meet Every Need
For Civil Defense,
Utility or Amateur Use*

Premax presents a wide variety of low-cost yet sturdy Mountings for mobile and marine use. There are types to meet practically every situation, including a new spring mount and spring adapter which will take every shock. Write for Bulletin and prices.

PREMAX PRODUCTS
DIVISION CHISHOLM-RYDER CO., INC.

5301 HIGHLAND AVE., NIAGARA FALLS, N. Y.

Thor

leading users of
STEATITE
insulators
SPECIFY
Thor

Thor steatite insulators are available as standard or custom-made items to Jan-I-10 or customers' specifications. Specialists in metalizing, and grinding to close tolerances.
Write Dept. R for Details and Catalogs.

Thor Ceramics, Inc.
225 Belleville Avenue, Bloomfield, New Jersey

VISIT BOOTH 3-409 IRE SHOW, GRAND CENTRAL PALACE

For
**HIGHEST ELECTRICAL
& MECHANICAL EFFICIENCY!**

New
JONES
SERIES 2400
PLUGS & SOCKETS

- Improved Socket Contacts—4 individual flexing surfaces. Positive contact over practically their entire length.
- Cadmium plated Plug and Socket, Contacts mounted in recessed pockets, greatly increasing leakage distance, INCREASING VOLTAGE RATING.
- Interchangeable with 400 Series.

P-2406-CCT

S-2406-S8

Send for complete Catalog No. 18. Plugs, Sockets, Terminal Strips.

HOWARD B. JONES DIVISION
CINCH MANUFACTURING CORPORATION
CHICAGO 24, ILLINOIS
SUBSIDIARY OF UNITED-CARE FASTENER CORP.

sheet on the Los Gatos brand 4D21 power tetrode illustrates the tube, gives dimensional data, general electrical characteristics and constant current curves for 350 screen volts. Maximum ratings and typical operation figures are provided for: Class-AB₁ audio-frequency power amplifier and modulator, class-AB₂ audio-frequency power amplifier and modulator, class-C r-f power amplifier and oscillator (unmodulated) and class-C r-f high level modulator-amplifier.

Test Chambers. Minneapolis-Honeywell Regulator Co., Wayne and Windrim Aves., Philadelphia 44, Pa. Instrumentation data sheet 11.0-7, "Test Chamber by Bowser," presents basic instrumentation data on all types of test chambers including those for relative humidity, low temperature, altitude, flight similitude and environmental tests. Also included in the literature are engineering data and general specifications for the company's standard reach-in and walk-in test chambers.

Infrared Photo Resistance. J. W. Bootz, 1009 Prinsengracht, Amsterdam, Holland, has available a leaflet illustrating and describing the Eletro-Cell, a lead-sulfide infrared photo resistance of great sensitivity. The unit discussed, featuring specially small construction, can be used for infrared measuring and directional apparatus as well as for many other scientific and technical purposes.

Teflon Products. Raybestos-Manhattan, Inc., Manheim, Pa., has issued a new, attractive 8-page bulletin featuring the company's Teflon products. Included in the line described are gaskets, rings in irregular shapes, sheets, tubes, rods, tape, braided and plastic packings, packings for stuffing boxes and valve stems, and Vee-Flex packing rings. The products covered are ideal for use against acids, solvents and alkalis, because no known industrial acids or caustic will attack Teflon.

Portable Power Megaphone. Austin-Lee Inc., 1624 Eye St., N.W., Washington 6, D. C., has avail-



they
can't
shake
loose...

if the clamp is made by **BIRTCHER**

There is a Birtcher Clamp... or one can be designed ... for every tube you use or intend to use.

Regardless of the type tube or plug-in component your operation requires... and regardless of the vibration and impact to which it will be subjected... a Birtcher Tube Clamp will hold it securely and rigidly in place.

Catalog and samples sent by return mail.

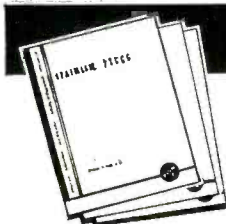

The BIRTCHER CORPORATION

4371 Valley Blvd.

Los Angeles 32, Calif.

Please send catalog and samples by return mail.

Company _____ E-3-3
 Attention of: _____
 Address _____
 City _____ State _____

METAL FABRICATION

To Your Specifications

Abalon's excellent engineering facilities and expert production supervision are at your service.

We have a large stock of dies on hand and complete up-to-date facilities for metal fabrication from any type metal with any type finish.

Estimates per your blueprints cheerfully given.

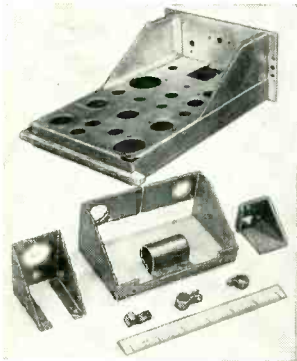

- PANELS
- CHASSIS
- ENCLOSURES
- INSTRUMENT PANELS
- HIGH VOLTAGE CAGES
- SPARE PARTS BOXES
- MULTI-RACK CABINETS
- RECEIVER and TRANSMITTER HOUSING
- FOLDAWAY and HINGED CHASSIS
- CHASSIS of ALL TYPES
- METAL ASSEMBLIES
- BRACKETS and SMALL STAMPINGS
- TRANSFORMER LAMINATIONS

Years of experience in metal fabrication



Abalon PRECISION MFG. CORP.

540 CASANOVA STREET NEW YORK 59, N. Y.
LUdlow 9-6330

from

Accelerometers

to

Yokes

you'll find the correct answer to who makes everything in the entire field of electronics including... components equipment and materials

in the...

electronics BUYERS' GUIDE

Get in the habit of looking it up in...

the electronics BUYERS' GUIDE

"The Book that has all the answers"

A MCGRAW-HILL PUBLICATION

330 West 42nd Street
NEW YORK 36, N. Y.

IMMEDIATE DELIVERY FROM STOCK!

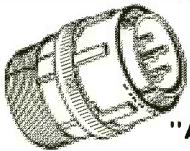

"AN" CONNECTORS



C O A X I A L C A B L E S



"UHF" CONNECTORS



"UG" CONNECTORS

C O A X I A L C A B L E S

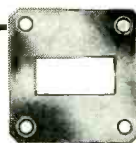

RADAR

SERVING THE ELECTRONIC AND NUCLEAR SCIENCES



Schweber ELECTRONICS

122 Herricks Road, Mineola, New York
Telephone: GArden City 7-6521

able a 4-page bulletin describing the Little Bull portable, self-contained power megaphone that operates on a magnetic amplifier without any electronic amplifier or vacuum tubes. The unit discussed features instant trigger action, has a range that is effective up to $\frac{1}{4}$ mile, and weighs 5 $\frac{1}{2}$ lb complete. Some of the many possible uses of the megaphone are listed.

Electronic Track Scales. Cox and Stevens Aircraft Corp., P.O. Box 30, Mineola, N. Y. Electronic track scales for motion and stationary weighing of freight cars are described and illustrated in this new catalog. Data are given on accuracies, installation, operation and maintenance.

Bobbin Winder & Dereeling Tension. Geo. Stevens Mfg. Co., Inc., Chicago, Ill. A new catalog sheet illustrates and describes the model 119-A bobbin winder and model T-102 dereeling tension for extremely fine wire. Among the features of model 119-A described are types of windings, coil sizes, wire sizes-tension equipment, economy box-type cam, gears, winding speeds, setup time, motor equipment, automatic stop, automatic counter, mounting and other features. Model T-102 tension's descriptive features include wire sizes handled, size of spools, description of operation and other features.

Mass Spectrometer. Consolidated Engineering Corp., 300 North Sierra Madre Villa, Pasadena 15, Calif. Bulletin CEC-1800 B discusses mass spectrometry and its uses for control analyses, complex mixture analyses, exploratory analyses, purity determinations and research investigations. It describes and illustrates the model 21-103A analytical mass spectrometer, an integrated assembly of precision units. Performance characteristics, specifications and information on accessories are included.

Miniature Metal-Cased Capacitors. Aerovox Corp., New Bedford, Mass., has published a bulletin announcing a wide choice of foil-paper capacitors housed in compact tubular metal cases with vitreous-



Simplifies Your Instrumentation

with this *New* Expandable Console Recorder



Start with a 2 Channel System

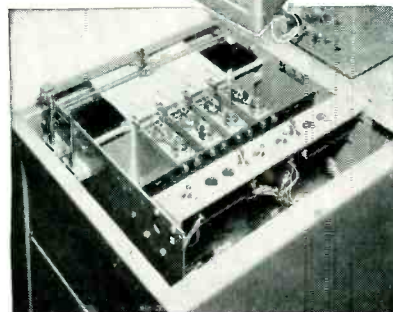
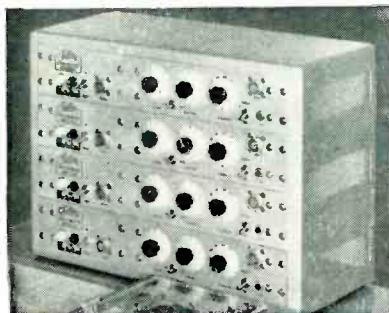

Add units, as you need them, to make a 4, 6 or 8 Channel System.

The Console gives you rack mounted dimensions with option of Direct Coupled, Condenser Coupled or Carrier Amplifiers; a wide variety of chart speeds and galvanometer types; full writing desk for review of intelligence; and an efficient, modern and beautifully designed instrument.



THE EDIN COMPANY
 207 Main St., Worcester 8, Mass., Dept. B
 Gentlemen:

Send complete information on the new Edin Console Recording Instruments Companion Amplifiers.

Name.....

No..... Street.....

City..... State.....

Position.....

THE



COMPANY

207 Main St. • Worcester, Mass.

Test Proven Hermetic Sealing

E3-LW TERMINAL
 "E-Series terminals are applicable on MIL requirements and will withstand thermal shock, vibrations, mechanical strains, and excessive pressures with no impairment of the seal or other functional characteristics. E-3LW terminals are now being used at 1000 psi static oil pressure and undergo 5000 psi tests."

1/4" SHAFT WATERSEAL BUSHING
 "Rotary Waterseal Panel Assemblies, with GRAF-SIL Packing Glands, have an excellent seven year customer history on gas filled pressurized components. They are available for 1/4" shafts and for potentiometers and switch bushings."

We welcome your inquires on any phase of design, development or production.

NEO-SIL CORPORATION
 26 CORNELISON AVE., JERSEY CITY 4, N. J.

Precision drilling made easy! Phillips & Hiss 204-C

6" Throat
 0-1/8" Capacity
 1" Quill Travel

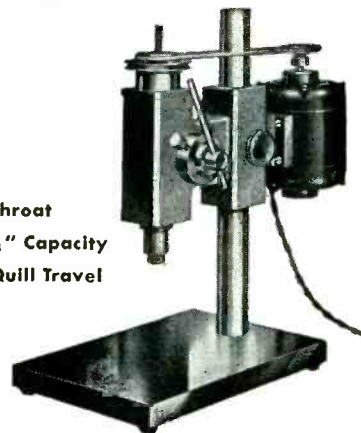

Sensitive "Feel"

Sensitive Speed Control:
 Foot-operated, leaves both hands free

High Precision: Selected Chuck and Bearings. Spindle true within .0002". Table square .0005" in 5" circle. Permanent accuracy, castings annealed and ground.



WRITE: Bulletin E2
 Phillips & Hiss Co., Inc.
 1155 N. McCadden Place
 Hollywood 38, California

There is an Original BEEDE ELECTRIC METER

... for every spot where dependable accurate indication is a must.

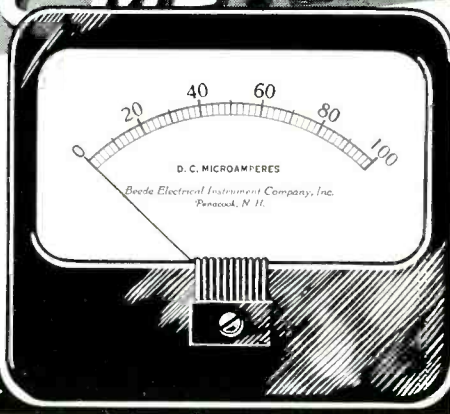

EASY TO READ →

CATALOG or INFORMATION on REQUEST

BEEDE ELECTRICAL INSTRUMENT CO., INC.
 PENACOOK, N. H.

— FOUNDED BY — WALTER E. BEEDE — 1880 — 1947 —

Runzel WIRE CORD and CABLE



"Products of Science"

The Runzel Laboratory insures that every inch of Runzel wire, cord and cable is thoroughly tested before shipping. Your wiring needs in hook-up, lead-in, shielded wire and cords, speaker cords and all types of insulated wire products, in almost endless variety of colors, sizes and specifications, are available from this centrally located plant.

WRITE FOR SAMPLES



RUNZEL CORD & WIRE CO.
 4723 Montrose Avenue
 Chicago 41, Illinois

ceramic terminal end seals to meet high-temperature and miniaturized space requirements of present-day electronic equipment. Depending on the impregnant used, the capacitors described operate in temperature ranges from -40 to $+85$ C, and from -55 to $+125$ C. The bulletin contains standard listings, specifications, drawings, how-to-order and other pertinent data. It includes several variations from the plain grounded-to-case design, such as an insulated-from-case unit, the plastic insulating sleeve, the threaded terminal and the tangential mounting bracket.

Motors and Timers. Amglo Corp., 2037 W. Division St., Chicago 22, Ill., has available a mailing piece on its reed-controlled d-c motors and timers that feature self-starting, constant speed and light weight. Included are technical specifications and two pages of performance curves.

Certified Alloys. Cannon-Muskegon Corp., 2875 Lincoln St., Muskegon, Mich. A brochure describing a new service whereby precision casting foundries can quickly and for the first time obtain stainless, super stainless and alloyed tool steels specifically developed for remelting purposes is now available. The publication illustrates a new model plant, designed and built specifically for producing master heats of alloys in shot and ingot form. Shown are laboratories, melting equipment of latest design and other equipment to produce and guarantee quality alloys.

Nut Clip Fastener. Prestole Corp., Toledo, Ohio. Catalog sheet 751-A contains complete engineering and application data on the company's new heavy duty nut clip fastener that features (1) assembly ease of a nut clip unit; (2) security and holding power of a multiple thread fastener; a spring steel lead tongue that provides (3) ease in clipping fastener onto panel edge and acts as (4) a lock washer when assembly is in a fixed position.

Cold Drawn Steel Tubing. Pacific Tube Co., 5710 Smithway St., Los Angeles 22, Calif. Steel tubing and

THE HIGH-PRECISION LINEAR POTENTIOMETER

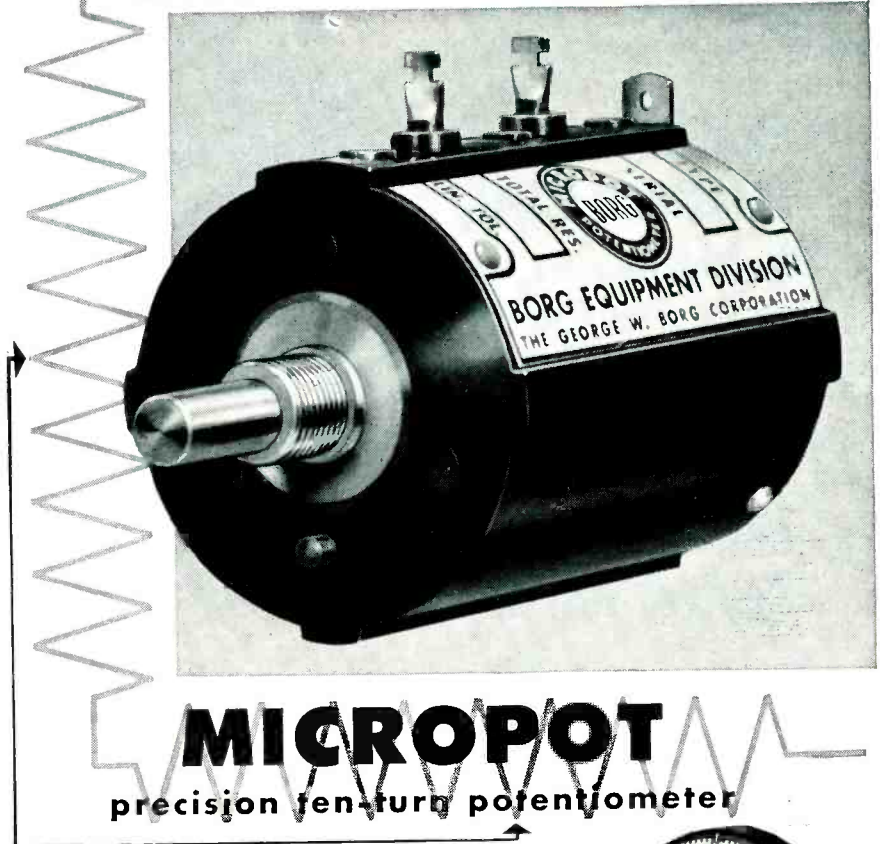

MICROPOT precision ten-turn potentiometer

BORG MICROPOT TEN-TURN POTENTIOMETER: Built to fit the specifications of control system engineers and designers . . . constructed with Micro accuracy for precise voltage adjustments . . . featuring an assembly scientifically designed, machined, assembled and automatically machine tested for linearity of $\pm 0.1\%$ and 0.05% , zero-based. MICROPOTS ARE AVAILABLE IN 1.15 to 3 OHM and 30 to 250,000 OHM RANGES FOR IMMEDIATE SHIPMENT.

BORG MICRODIAL: Two concentrically mounted dials: one for counting increments of each turn and the other for counting turns . . . delivered completely assembled with dials synchronized. Outstanding features include smooth, uniform action . . . no backlash between incremental dial and potentiometer contact . . . less wear, only one moving part aside from the two dials . . . contact position indicated to an indexed accuracy of 1 part in 1,000.

**SEE US AT BOOTH 2-517 AT
THE I.R.E. SHOW, NEW YORK**

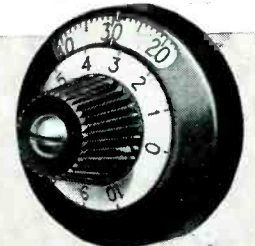

**BORG
MICRODIAL
746-A**

A precision ten-turn indicating dial assembly. Has screw locking device on operating knob.

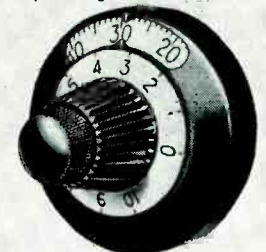

**BORG
MICRODIAL
746-B**

Same as 746-A but has knurled locking screw mounted externally to operating knob.



**BORG EQUIPMENT DIVISION
THE GEORGE W. BORG CORPORATION
Janesville • Wisconsin**

These new books

will be at your Radio Engineering Show. Be sure to see them.

Flux Linkages & Electromagnetic Induction

by L. V. Bewley. An outstanding contribution to basic electrical knowledge, this book presents the reasons for the difficulties commonly encountered in problems involving induced voltages and simple, straightforward methods of analyzing and solving these problems. \$3.50

Direct Current Machines for Control Systems

by A. Tustin. Explains in practical engineering terms the basic principles common to the various types of electronic control mechanisms, the comparative characteristics of the major types being manufactured today, and the salient features to consider in the selection and use of these mechanisms for a particular purpose. \$10.00

Hearing Aids

by Matthew Mandl. Here for the first time is a clear, simple explanation of the major types of modern hearing aids in terms of their efficiency for the user and their service problems. Written both as a guide to the hard-of-hearing in the selection and use of a hearing aid and as a basic manual for the serviceman, this book will be a valuable sales aid to manufacturers and dealers as well as an excellent training text for their service personnel. \$3.50

Qualitative Analysis and Analytical Chemical Separations

by P. W. West, M. M. Vick, and A. L. LeRosen (Febr. 24th)

The principles and laboratory techniques, including new, non-sulfide procedures.

Physical Chemistry 3rd Ed.

by F. H. MacDongall

New, up-to-date edition of a leading text, noted for its thorough, rigorous treatment of the subject. \$6.00

Analytic Mechanics

by V. M. Faires & S. D. Chambers

New 3rd edition of the authors' well known "Mechanics of Engineering." \$6.00

Calculus

by J. F. Randolph

\$5.00

Elementary Differential Equations

by E. D. Rainville

\$5.00

Laboratory Manual of Materials Testing

by R. T. Liddicoat & P. O. Potts

Full, up-to-date information on equipment and techniques. \$4.00

These and many other important new books will be at Brentano's book (\$01-2) at the IRE show. Look them over there, or write us for further information.

The Macmillan Company

60 FIFTH AVENUE, NEW YORK 11, N.Y.

A NEW SWITCHCRAFT "LITTEL-PLUG"

No. 480 "Littel-Plug" (JAN type PJ-068) features a unique assembly of metal parts, assembled into the mold as inserts; providing a finished plug with complete continuity of thermoplastic insulation. Design and material strictly in accordance with specification JAN-P-642.

See This **NEW** Switchcraft "Littel-Plug" and Many Other New Products at Booth No. 3-114, IRE Show - March 23-26

Write for catalog

SWITCHCRAFT
INC.

Canadian Representative: Atlas Radio Corp. Ltd., 560 King St., W., Toronto 2B, Canada. Phone: Waverly 4761.

1336 N. Halsted St. Chicago 22, Ill.

* The name "Switchcraft" is a registered trade mark and is the property of Switchcraft, Inc.

AVAILABLE AT ALL LEADING RADIO PARTS JOBBERS •

ELECTRONIC COMPONENTS

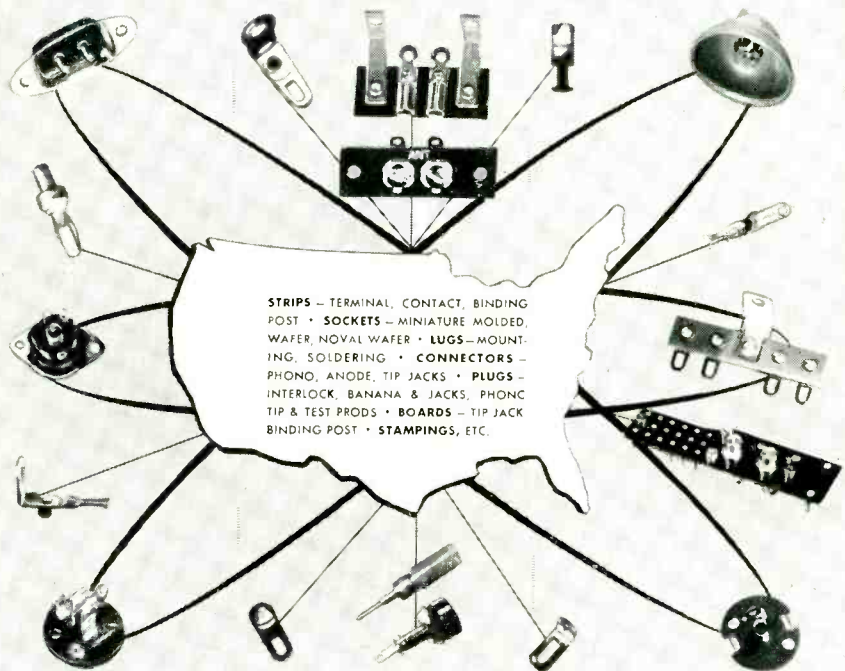

STRIPS - TERMINAL, CONTACT, BINDING POST • SOCKETS - MINIATURE MOLDED, WAFER, NOVAL WAFER • LUGS - MOUNTING, SOLDERING • CONNECTORS - PHONO, ANODE, TIP JACKS • PLUGS - INTERLOCK, BANANA & JACKS, PHONO TIP & TEST PRODS • BOARDS - TIP JACK BINDING POST • STAMPINGS, ETC.

Manufacturers of Electronic components of the highest quality . . . now serving some of the leading manufacturers in the country. For more complete information, send for our catalog.

NATIONAL TEL-TRONICS CORPORATION

35 ST. CASIMIR AVENUE, YONKERS, N. Y. TEL. YONKERS 8-6400

cold finished rods and bars are described in bulletin No. 10. The six-page folder gives standard manufacturing tolerances on outside diameter, inside diameter, wall thickness and commercial lengths for various sizes of tubing; also, size ranges for standard production of cold drawn carbon steel and alloy steel tubing, electric resistance welded steel tubing, stainless welded and drawn tubing, cold finished bars and precision shafting. A table lists average physical properties of various tubing analyses regularly produced. Included in the folder are illustrations of plant facilities, useful information for users of tubing and information on mill practices.

Insulation Handbook. Mycalex Corp. of America, Clifton Blvd., Clifton, N. J. A 24-page engineers' handbook and catalog contains important data on the ideal insulation for all frequencies. Included are the product's outstanding properties, a listing of the company's new developments, a table showing a comparison of glass-bonded mica with other insulating materials, and an illustrated description of different grades of Mycalex. The catalog also contains information on a line of switches, commutator plates and tube sockets.

High-Vacuum Apparatus. Central Scientific Co., 1700 Irving Park Road, Chicago 13, Ill. An interesting and informative 56-page booklet on high-vacuum apparatus, recently revised to include new type vacuum connectors and couplings, has just been published. It contains detailed information on planning the high-vacuum system together with many valuable tables and charts. Also included in bulletin 10E is a complete description of the various types of high-vacuum apparatus and accessories.

Power Measurement Transducers. Minneapolis-Honeywell Regulator Co., Wayne and Windrim Aves., Philadelphia 44, Pa. Bulletin 15-16 contains technical data on the application of power measurement transducers to process control. Application data on all subjects such as salt operation, pulverizing, clay

LOOK at any part UP CLOSE!

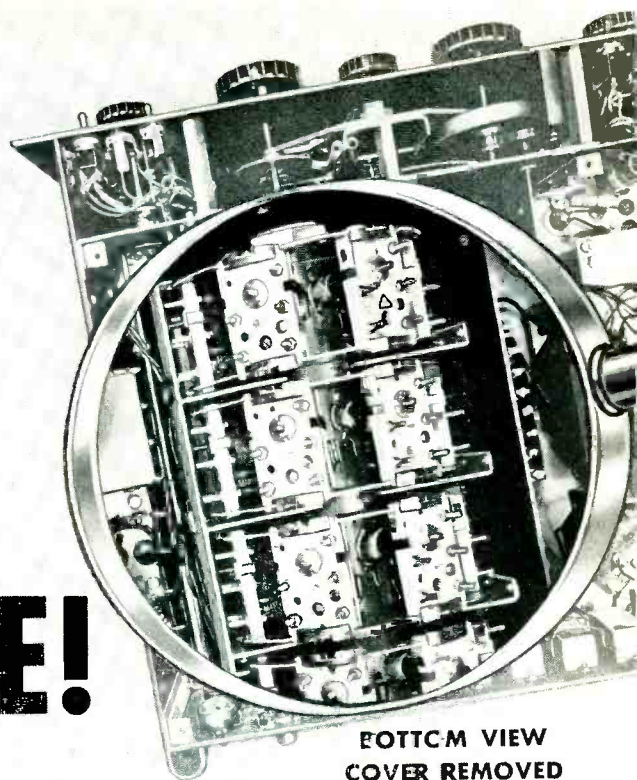

ROTARY TURRET VIEW
COVER REMOVED

THE SP-600-JX Communications Receiver USES ROTARY TURRET FOR MAXIMUM SENSITIVITY!

A rotary turret, uniquely incorporated into the "Super-Pro 600-JX," makes possible the placement of the coil assemblies of the two RF Amplifier stages, Mixer stage and First Heterodyne Oscillator stage directly adjacent to their respective sections of the four-gang tuning capacitor and the individual tubes.

Coil assemblies are mounted on the turret. Turning the band selector switch to any one of the six frequency bands places the required coils immediately in their correct positions. This arrangement increases receiver stability, provides uniform maximum performance from band to band, and simplifies servicing.

Every part of the "SP-600-JX" is designed to the highest standards of receiver design. The rotary turret is one example of the fine engineering in this magnificent 20-tube receiver.

The "SP-600-JX", the only professional communications receiver available that provides up to six crystal controlled frequencies, has a range of 540 kc. to 54 mc. It is now being used by the U. S. Army, Navy, and Air Force, other governmental agencies, airlines, the press, maritime, and commercial services, for both single channel and diversity reception. Write today for further details.



Visit our booth 4-214 at the I.R.E. Show



HAMMARLUND

42 YEARS EXPERIENCE COUNTS!

HAMMARLUND MANUFACTURING CO., INC.

460 WEST 34th STREET • NEW YORK 1, N. Y.

2 MUSTS

For Low-Cost Servicing of Mobile Radio Systems

Lampkin equipment gives you the lowest cost per channel, whether you supervise a large multiple-frequency system, or whether you service numerous smaller installation! Lampkin equipment measures center frequency and modulation deviation, to FCC specifications!

The Type 205 FM Modulation Meter For Multiple Mobile Frequencies.



The Type 205 FM Modulation Meter measures peak frequency swing due to voice modulation of FM transmitters, as required by the FCC. Indicates 0-25 KC. deviation. Instantly tunable to any frequency from 25 MC. to 200 MC. Simple to use. Direct reading. No charts. No tables. \$240.00.

For Any Number of Frequencies, AM or FM. The Type 105-B Micrometer Frequency Meter



The Type 105-B Micrometer Frequency Meter measures center frequency deviation on any number of transmitters, AM or FM, from 0.1 MC. to 175 MC. The accuracy, determined by over 500 field tests, is conservatively guaranteed better than 0.0025%, surpassing FCC requirements. Readily checked against WWV. \$22.00

Return coupon TODAY for complete literature.



LAMPKIN LABORATORIES, INC.
Instruments Div., Bradenton, Florida

Please send me complete technical literature and delivery information on the following Lampkin-designed instruments:

- Type 205 FM Modulation Meter
- Type 105-B Micrometer Frequency Meter

Name

Address

City Zone State

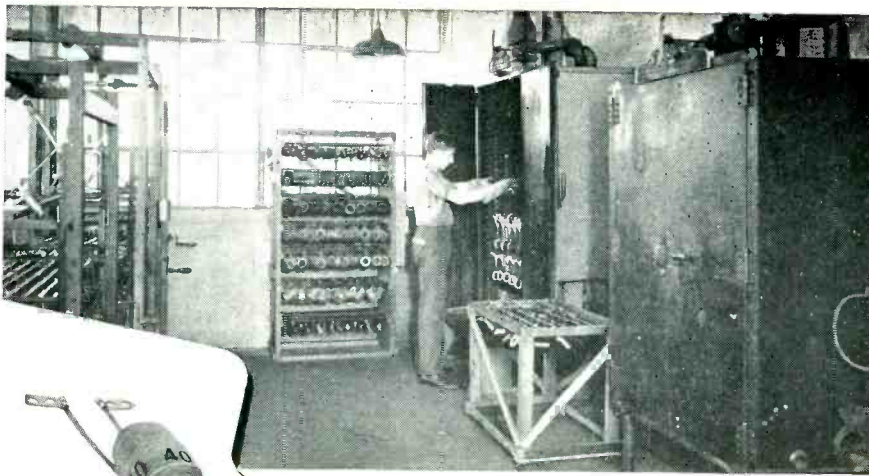

Here at Coto-Coil . . .

Finished coil impregnated with varnish coating

. . . the Impregnating Department applies the final protective coating to precision-made Coto Coils. Each coil is pre-heated, immersed in varnish and drained . . . sometimes 3 or 4 times. The varnish finish, baked in these modern ovens, not only provides a hard, durable outer surface but completely fills all voids within the coil, resulting in a solid, pocket-free mass. Such modern production facilities, plus 35 years of experience, combine to make Coto Coils the first choice for engineered coils. Coto-Coil Company, 65 Pavilion Avenue, Providence 5, R. I.

Coto PRECISION WOUND **Coils**



Announces

a NEW 90° YOKE for 27" TUBES



It's Engineered for TOP PERFORMANCE . . . in Production NOW!

This new DX 90° Deflection Yoke has everything a television receiver manufacturer wants . . . a sharp full-screen focus, a minimum of pincushioning, the ultimate in compactness and a price that's downright attractive. Because this yoke has been brilliantly designed for mass production on DX's specialized equipment, it warrants immediate consideration in your 27" receiver plans. Write us today.

DEFLECTION YOKES . . . TOROID COILS . . . CRYSTALS
I. F. TRANSFORMERS . . . R. F. COILS . . . DISCRIMINATORS
SPEAKERS . . . TV TUNERS . . . ION TRAPS . . . TRANSFORMERS

DX RADIO PRODUCTS CO.

GENERAL OFFICES: 2300 W. ARMITAGE AVE., CHICAGO 47, ILL.



mixing, sodium production and measurement and control of a-c power plus the measurement and control of d-c power are covered. Engineering descriptions of applications of thermal converters, solenoid-plunger ammeter, torque-meter, vacuum thermocouple, rectifying current system, precision shunt, saturable reactor and magnetic amplifier are given. Also included in the 12-page booklet are diagrams, tables of characteristics and mathematical formulas.

Radio Equipment. Marconi's Wireless Telegraph Co. Ltd., Chelmsford, Essex, England. The 1953 catalog of radio equipment is a 432-page hard-covered book giving an overall picture of the extensive range of the company's products. It is divided into seven sections: aeronautical, broadcasting, communications, maritime navigational aids, crystals and electronic tubes, and miscellaneous. The last-named section covers antenna equipment, sound reproduction equipment and test and measuring instruments. By the aid of a comprehensive index at the end, the reader may immediately turn to the pages covering those items in which he is particularly interested. Also, each of the seven sections mentioned has its own contents page that indicates the broad classification of equipments within that section.

Information on Magnets. Eriez Mfg. Co., 1945 Grove Drive, Erie, Pa. A new chart, "What Makes A Magnet?", describes the natural forces causing magnetism and how they are harnessed to create a useful tool for industry and the home. The chart, made up of diagrams and drawings with explanatory captions, describes the potential magnetic forces found in a ferromagnetic atom. How these natural forces are organized by the application of an external magnetic field is also shown.

Test Chambers. International Radiant Corp., 40 Matinecock Ave., Port Washington, N. Y., has issued a 4-page bulletin giving an illustrated technical description of the following testing equipment: A

little terminal . . .

BIG performance

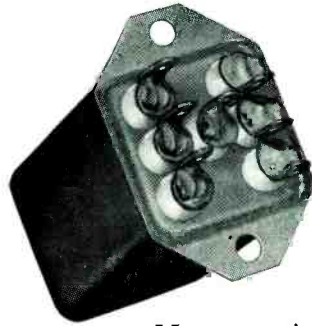

No extrusion needed for mounting this terminal!

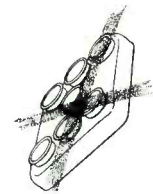

NOW, an entirely *New* miniature hermetic terminal — Lundey series 199, which offers: the superior properties of TEFLON and silicone rubber; effective spring loading.

This terminal is assembled with simple tooling in a drilled or punched hole. As an extra service, Lundey Associates will supply the terminals installed in your covers, if desired.



These important features will help solve YOUR terminal problems —

- Teflon external member
- silicone or neoprene core
- minimum mounting — 15/64" on centers
- voltage rating — 500V RMS operating
- current rating — 8 amps.
- three electrode styles:
 - eyelet with hollow conductor
 - single turret with solid conductor
 - double turret with solid conductor
- production-proved
- meets MIL-T-27 specifications



Send for your samples and Bulletin #E199

LUNDEY ASSOCIATES

694 MAIN STREET · WALTHAM 34, MASSACHUSETTS

MINIATURE SLIP RING ASSEMBLIES

Commutators and other Electro-Mechanical Components

PRECISION MADE TO YOUR OWN SPECIFICATIONS

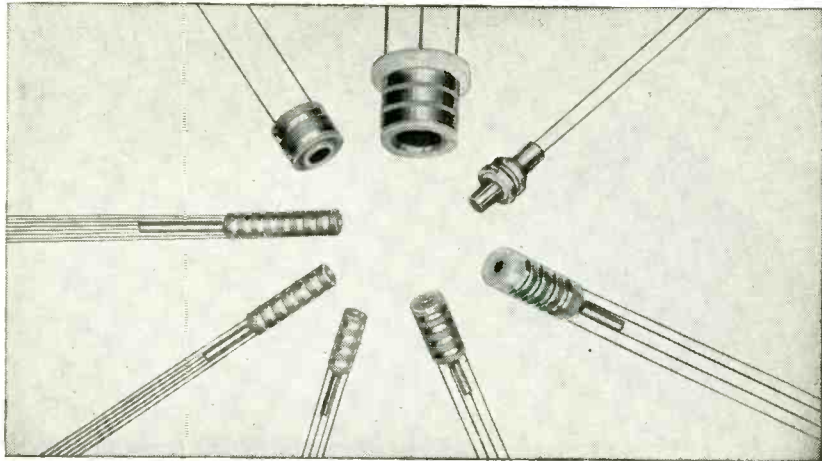

Our Swiss methods and techniques are geared to meet exacting requirements. We invite your inquiries.

COLLECTRON CORPORATION

216 EAST 45th STREET • NEW YORK 17, N. Y.

Murray Hill 2-8473

PRIMARY BATTERIES for your Specialized Needs

DRY TYPES

78 Standard Industrial, Laboratory and Government Types.



LAB-BILT BATTERIES

Our engineers will design and create to your requirements. Send us your specifications.

HI-DRIVE MINIATURE MOTOR

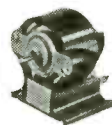

Precision-built, low-cost, battery-operated — available for delivery now.

RESERVE TYPES

Water activated "One Shot" Batteries.

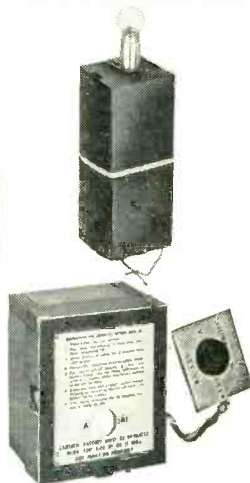

Send for FREE Catalogs

SPECIALTY BATTERY COMPANY

A Subsidiary of the **RAYOVAC** Ray-O-Vac Company

MADISON 10, WISCONSIN

WHEN you need a quick answer to

WHO MAKES IT...

Just look it up in
the **electronics
BUYERS'
GUIDE**

There are ...

23,367 ANSWERS

to

1,445 PROBLEMS

covering every ...

**COMPONENT
EQUIPMENT
and MATERIAL**

*used in every phase
of electronics*

GET IN THE HABIT OF
LOOKING IT UP IN
the

**electronics
BUYERS' GUIDE**

A MCGRAW-HILL PUBLICATION

330 West 42nd Street

NEW YORK 36, N. Y.

plastic Bell Jar portable altitude chamber, a shock testing bath, an explosion chamber, a walk-in room, low and high temperature chests, an altitude chamber and calibration equipment.

House Organ. John Volkert Metal Stampings, Inc., 222-34 96th Ave., Queens Village 8, L. I., N. Y. A new quarterly publication featuring precision metal stamping case histories was recently issued. The first issue of the highly-illustrated publication, called "The Volkert View," contains a story on how precision stampings shoot the picture onto the tv screen. Another highlight is a round-up story on the recent plant expansion program that has brought about a 20-percent increase in capacity for this leading supplier of precision stampings and assemblies. Those interested in having their names added to the mailing list should write to the company.

Recorders and Indicators. Minneapolis-Honeywell Regulator Co., Wayne and Windrim Aves., Philadelphia 44, Pa. Catalog 1520 covers a broad line of ElectroniK recorders and indicators. Illustrations, general specifications, various models and ordering information are given for strip chart recorders, circular chart recorders and precision indicators. Measuring circuits and scale ranges are included.

Geiger and Scintillation Probe Monitor. Measurement Engineering Ltd., Arnprior, Ontario, Canada. A single catalog sheet covers the model AEP 19035 Geiger and scintillation probe monitor, a portable mains operated instrument capable of measuring low values of alpha, beta and gamma radiation with a probe at distances up to 100 ft. Electrical and mechanical features, uses, circuit design and operation are given.

Plastic Insulated Wires. Sequoia Process Corp., 881 Douglas Ave., Redwood City, Calif., presents a compilation of technical information to aid users of plastic insulated wires in determining wire requirements. The purpose of the catalog is to provide data on the various

Attention!...
ELECTRONIC DEVELOPMENT
ENGINEERS...Reduce your problems
with the **NEW EUREKA "SNAPPER"**

THERMAL TIME DELAY RELAY

Visit our Booth
No. 1-605
I.R.E. SHOW

• **features... SNAP ACTION.**

Single Pole Double Throw. Light-weight. Low operating temperature. Operates in any position. High contact rating. Gas filled. Low heater current. Durability and long life.

VOLTAGE...

6.3, 26.5, 115 volts (A.C. or D.C.)
or as required.

AMBIENT TEMPERATURE RANGE...

- 60°C. to + 80°C.

ENVELOPE... Miniature (7 and 9 pin),
or octal (8 pin) metal.

TIME DELAY PERIODS... Preset
from 5 seconds up.

VACUUM... Evacuated, inert gas filled.

HEIGHT... 1³/₄" maximum seated.

EUREKA PRESENTS POSITIVE

SNAP ACTION

The **ELIMINATION OF CHATTERING** is accomplished with the incorporation of "**POSITIVE SNAP ACTION**" in the **EUREKA "SNAPPER"**... **LEADING ELECTRONIC MANUFACTURERS** have acknowledged the new **EUREKA "SNAPPER"** as a major advancement in this field, and have already accepted this relay as a standard component of their latest equipment.

Inquiries are invited... send for
our "**Bulletin Number Snapper**".

**EUREKA TELEVISION AND
TUBE CORPORATION**

Manufacturers of Cathode-Ray Tubes
and Electronic Products

69 FIFTH AVENUE, HAWTHORNE, N. J.
HAWTHORNE 7-5800



better all around...

Precision COIL BOBBINS

because PRECISION Coil Bobbins are quality controlled you can be sure they'll improve your coils all-around. Every PRECISION Coil Bobbin is precision-engineered to give you:

- Greater Insulation
- Better Heat Dissipation
- Higher Moisture Resistance
- 15 to 20 % Greater Strength
- Lighter Weight
- More Winding Space

All at lower unit cost!

PRECISION Coil Bobbins can be designed to your exact specifications... any size or shape in dielectric Kraft or Fish Paper, Cellulose Acetate or Combinations. Flanges are supplied plain or fitted with leads, slots, holes flat, recessed or embossed to fit any mounting.

Send specifications for free sample and ask for new Arbor list of over 1500 sizes.



PRECISION PAPER TUBE CO.

2041 W. Charleston St. Chicago 47, Ill.
Plant No. 2, 79 Chapel St., Hartford, Conn.
Also Mfrs. of PRECISION Paper Tubes

SHOCKPROOF VACUUM TUBE RETAINERS

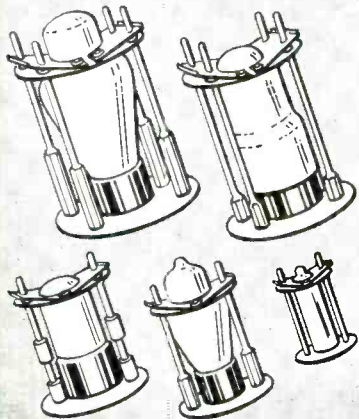
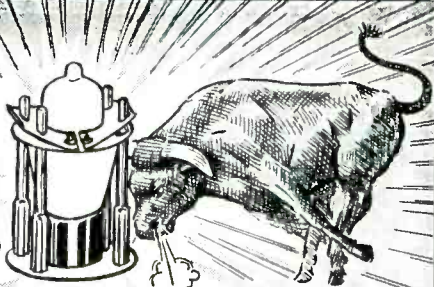

These retainers are used to secure Vacuum Tubes and to resist side motion of Vacuum Tubes used in radio equipment which is subject to shock and vibrations. These retainers meet the requirement of all JAN specifications. The insulated portion is made of a melamine base Fibre Glass Phenol which provides 300 volts insulation to ground and withstands a temperature of 350 F. The insulated plate can readily be fastened or released by hand.

Available for envelope types T7, T8, MT8, T9, T12, ST12, T12ZDL, ST14, S14, ST16, T5½, T6½, MT-IC, ST19, T14, ST128CT-9.

Manufacturers of
Electronic Components

JAMES IPPOLITO & CO., INC.
401 CONCORD AVENUE, BRONX 54, N. Y.

dependable instruments

Heiland
DENVER

oscillograph
recorders

FOR AIRCRAFT
LABORATORY AND INDUSTRIAL
APPLICATIONS

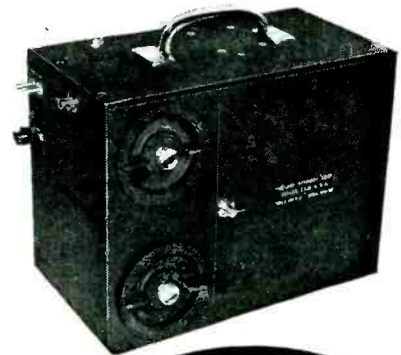

A-500
Compact... Lightweight
12 channels

The A-500 Portable Recorder is being widely used in many diversified fields as it is designed for applications where space is at a premium. Although extremely compact, 6¾" x 97/8" x 12¾", and lightweight, 33 lbs., the Heiland A-500 retains the versatility and embodies many of the features usually found only in much larger instruments. The features of the A-500 include four quick change paper speeds; precision time lines; trace identification; direct monitoring of galvanometer light spots. Paper width, 4"-100' long. Available for either 12 volt or 24 volt D.C. operation.

Write today for catalog of Heiland oscillograph recorders, galvanometers and associate equipment.



HEILAND RESEARCH CORP.
130 E. FIFTH AVE. • DENVER, COLORADO

characteristics of each component used in plastic insulated wire so that the best combination for each specific use can be determined. In addition, a brief listing is included of the properties of the more common wires manufactured.

Timing Relays. Allen-Bradley Co., Milwaukee, Wisc., is offering a 16-page bulletin featuring its complete line of timing relays. Fluid dashpot, pneumatic and electronic timers are fully described. It also contains complete operation and engineering data. Applications are clearly stated. Timers are shown in a wide variety of standard enclosures. A selector chart is provided along with suggestions in choosing a timing relay for a particular application.

Master TV Systems. Blonder-Tongue Laboratories, Inc., 526 North Ave., Westfield, N. J., has issued a new installation manual giving complete technical data on all types of master tv systems. It describes the characteristics and functions of each of the company's units and accessories. Picture diagrams offer convincing evidence of the great flexibility and ease of installation of low-cost master tv systems. There is complete information regarding the layout of a master system, including the type of transmission line to use, location and installation of the various units, and elimination of ghosts and other interference.

Products Catalog. JAN Hardware Mfg. Co., 25-30 163rd St., Flushing, N. Y. A new four-page catalog introduces the company's line of electronic hardware. Included are illustrations, description and use, chief features and specifications for an insulated coupling assembly, a panel bearing and shaft assembly, a shaft lock, an offset extension shaft coupler, a jack cover and a bushing extender.

Parabolic Reflectors. Workshop Associates Division, The Gabriel Co., Endicott St., Norwood, Mass., has prepared a catalog sheet listing over 100 different parabolic reflectors. Describing stock reflectors, the sheet covers a wide

Over 30 variations of this MICRO door interlock switch designed to meet specific needs!

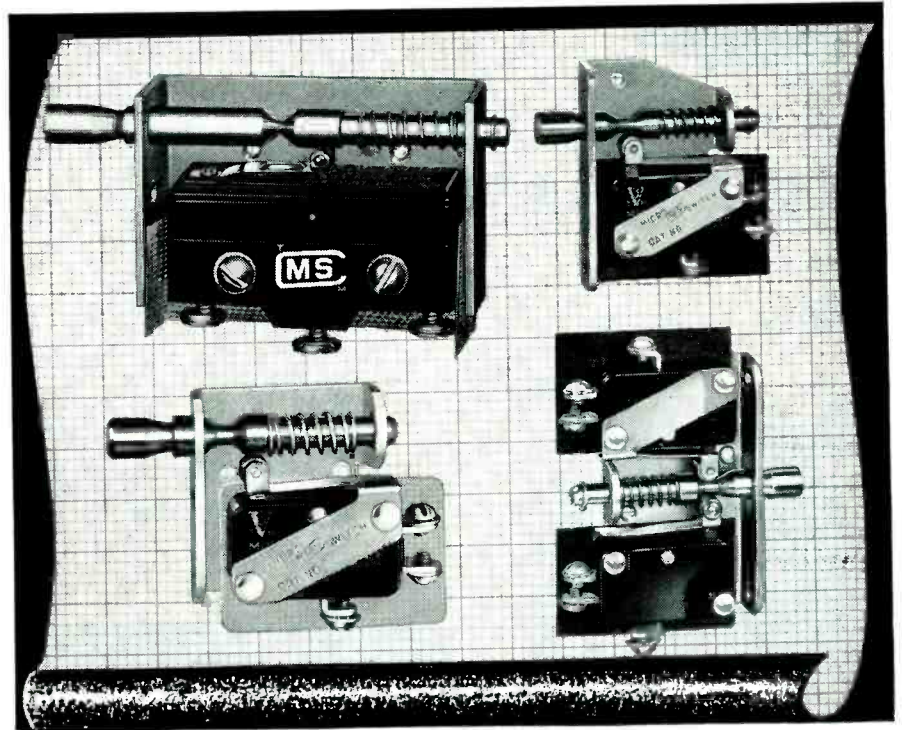

SINCE the first MICRO door interlock switch was designed several years ago to meet the specific requirements of one of the world's largest manufacturers of electronic equipment, MICRO engineers have developed over 30 variations to meet the exacting needs of other makers of electronic equipment.

Shown here are four typical variations of the MICRO door interlock switch developed for the automatic protection of personnel working with high voltage cabinets.

These switches will (1) automatically cut off current when cabinet door is opened; (2) permit a manual reclosing of the circuit when necessary while the door is open and (3) restore protection automatically when door is reclosed.

Other variations than those shown here include the use of a hermetically sealed switch as the switching element, double-pole, double-throw switches and others. MICRO engineers will be glad to give you complete information on these and other variations of MICRO door interlock switches. Call or write your nearest MICRO branch office.

MICRO A DIVISION OF
MAKERS OF PRECISION SWITCHES MINNEAPOLIS-HONEYWELL REGULATOR COMPANY
FREEPORT, ILLINOIS



ATR

AUTO RADIO VIBRATORS
have Ceramic Stack Spacers



A COMPLETE LINE OF VIBRATORS . . .

Designed for Use in Standard Vibrator-Operated Auto Radio Receivers. Built with Precision Construction, featuring Ceramic Stack Spacers for Longer Lasting Life. Backed by more than 20 years of experience in Vibrator Design, Development, and Manufacturing.

NEW MODELS
NEW DESIGNS
NEW LITERATURE

ATR

"A" Battery Eliminators, DC-AC Inverters, Auto Radio Vibrators

See your jobber or write factory

AMERICAN TELEVISION & RADIO CO.
Quality Products Since 1931
 SAINT PAUL 1, MINNESOTA—U. S. A.

Use Engraved Dials ?

READ HOW YOU CAN SIMPLIFY YOUR PROBLEMS AND SAVE ABOUT 40% IN COST

Save design, drafting time, and money by using Stock Dials. Dials calibrated, engraved and machined to close tolerances. 126 styles and sizes in metal and plastic.

Send for dial specification folder containing stock list. —Ask for Brochure A

ALSO DIALS AND PANELS MADE TO YOUR DRAWINGS.

EDGED LIGHTING PANELS A SPECIALTY

ACKERMAN ENGRAVERS
 75 Warren St., New York 7, N. Y.

MARK OF PRECISION

sub-miniature AND moisture-proof

IN-RES-CO S-15 & S-30 WIRE WOUND RESISTORS

THE ECONOMICAL SOLUTION where moisture proof resistive elements of comparatively small size are required for commercial applications. Type S-15 is 3/8" long by 1/4" diameter; type S-30 measures 3/4" by 1/4" diameter. Both types are moisture proof and capable of high performance over long periods of continuous service. IN-RES-CO Resistors for every ordnance or civilian requirement are available at a cost that solves circuit design problems both performance-wise and cost-wise. Check up now, on the complete line of IN-RES-CO quality wire wound resistors.

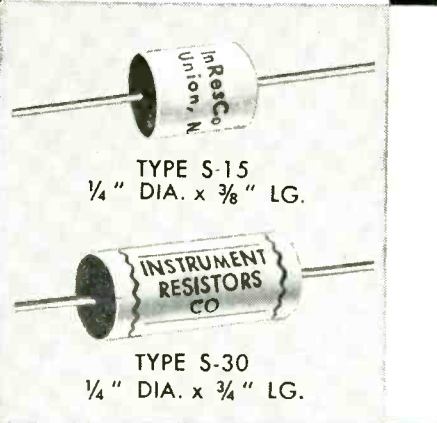

INSTRUMENT RESISTORS CO.

COMMERCE AVENUE UNION NEW JERSEY

FOR JAN SPECIFICATION RESISTORS — consult the new illustrated literature describing the complete in-res-co line. Write for your copy today!

APPLICATION-DESIGNED RESISTORS FOR ELECTRONICS AND INSTRUMENTATION

assortment of dishes available for experimental and design work. A major item is a 48-in. stamped reflector at very low cost. Complete mechanical dimensions and specifications are given for all models.

Pulse Generator. Rutherford Electronics Co., 3707 South Robertson Blvd., Culver City, Calif., has available a six-page, two-color brochure on the model B-2 pulse generator. The instrument described and fully illustrated is a general purpose unit having high repetition rates, fast rise times and narrow pulse widths. Chief features and complete technical specifications are included.

Soldering Information. Wasserein Mfg. Co., Inc., 126 W. Cass St., Joliet, Ill., has announced bulletin No. 105-D, entitled "The New Way to Solder." This illustrated brochure explains resistance soldering and outlines its many uses for production and maintenance in industry. The publication also contains concise operating instructions for using the Wassco Glo-Melt resistance soldering unit and its many labor-saving accessories.

Miniaturized Tubulars. Cornell-Dubilier Electric Corp., South Plainfield, N. J. Bulletin NB-147 deals with the Demicon miniaturized tubular metal-cased paper capacitors. All 12 types of the capacitor series described will comply with applicable parts of specifications JAN-C-25 and MIL-C25A. The bulletin includes illustrations, technical characteristics and dimensional diagrams.

Multichannel Sampling Switches. Applied Science Corp. of Princeton P. O. Box 44, Princeton, N. J. A recent four-page brochure gives a representative cross section of highspeed multichannel rotary sampling switches. Switch plates with as many as 240 contacts and switch assemblies with 1,500 contacts are covered. The switches described and illustrated are being used for industrial and airborne telemetering, drift compensation a d-c amplifiers displaying parameters such as input-output char-

Your "Regulated High Voltage"
Problems can be Economically
Solved . . . NOW!

ANTON

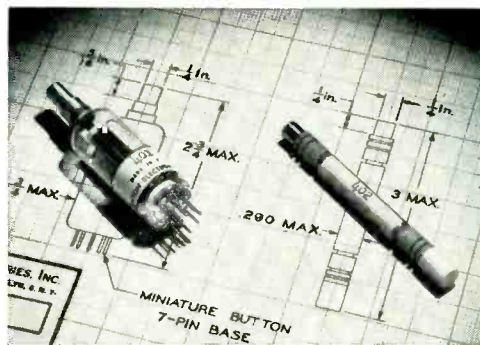

You will see Anton V-R Tubes in operation at Booth 4-108 . . . IRE Show

JAN APPROVED

AEL has produced and supplied over 100,000 JAN 5962/BS-101 Corona Discharge Voltage Regulator Tubes (equivalent to 401 shown here) to the U. S. Navy—Signal Corps and prime contractors like Admiral, Westinghouse, Kelly-Koett and Hoffman. Because of the experience gained by the mass manufacture of these tubes, AEL is able—now—to furnish Corona Discharge V-R Tubes, both fixed and variable, to suit a wide range of voltage and current applications.

Corona Discharge V-R Tubes New Freedom for Circuit Designers

SALIENT FEATURES

- Stabilized Voltages from 300 to 4000 Volts
- Currents up to 2 milliamperes
- Low Dynamic Resistance
- No hot cathodes
- Unlimited Life
- Weight—less than an ounce
- Size—smaller than a pen

TYPICAL APPLICATIONS

- Cathode Ray Oscilloscopes
- Airborne Radar Power Supplies
- TV receivers and monitors
- Voltage Reference Tubes
- Meter Safeguards
- X-ray Equipment
- Electron Microscopes

CATALOG—free upon request on your letter-head. Please send us the specifications of your individual requirements. Write care of Dept. E.



ANTON ELECTRONIC LABORATORIES, INC.

1226 Flushing Avenue, Brooklyn 37, N. Y.

ANNOUNCING!...

HARRISON

adds another famous line to its **TREMENDOUS STOCK** of Top Electronic Equipment

CHICAGO



TRANSFORMERS

Really rugged, dependable transformers, built to "take it" during critical continuous service operation. Meet every circuit requirement: Power, Bias, Audio, Filament, Filter, MIL-T-27, Stepdown and others. One-piece, drawn-steel seamless design provides excellent electrostatic and magnetic shielding, with complete protection against adverse atmospheric conditions.

3 "Sealed-in-Steel" Case Mountings Available

H-TYPE

Hermetic sealing meets all MIL-T-27 specs. Steel base cover is deep-seal soldered into case. Terminals hermetically sealed. Ceramic bushings. Stud-mounted unit.



S-TYPE

Steel base cover fitted with phenolic terminal board. Convenient numbered solder lug terminals. Flange-mounted.



C-TYPE

With 10" color-coded leads brought out through fibre board base cover. Lead ends are stripped and tinned for easy soldering. Flange-mounted.

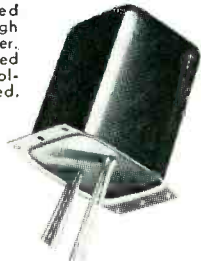

Free Catalog on Request



FREE!

To Purchasing Executives and Chief Engineers . . . Latest 1200-page encyclopedia of electronic parts and equipment. Write to Bert Schreiner on your company letterhead and mention your title.

Dependability — Since 1925!

● Phone BARclay 7-7777

HARRISON
RADIO CORP
225 GREENWICH STREET
NEW YORK 7, N.Y.

INSTRUMENT GRADE REGULATED SUPPLY

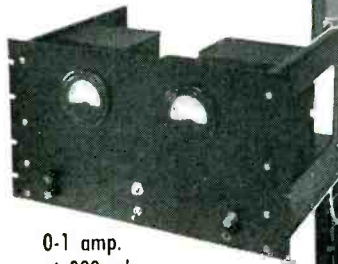

0-1 amp.
at 300 vdc.

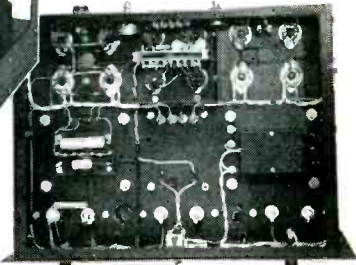
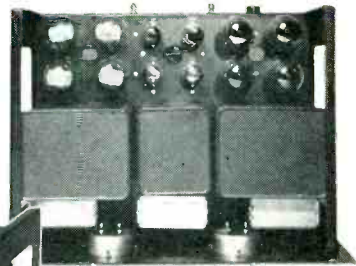

Design features of the new Eastgap Model Two Regulated Power Supply assure reliability. Ripple including noise and jitter less than 1/3 millivolt. Impedance — 1/20 ohm or less throughout load range. 15 microfarad oil condenser directly across output for impulse stability. Stabilized high-performance balanced-input amplifier. All transformers and inductors are hermetic and have grain oriented cores. Operates from 50-60 cycle, 115 volt line. Suitable either on bench or rack.

MODEL TWO FOB Factory \$868.

Eastgap Company

285C Columbus Ave., Boston 16, Mass.

New ALTITUDE SIMULATION CHAMBER



- Altitude Range to 120,000 feet.
- Temperature Range from 300°F. to -140°F.
- Micrometer Temperature Adjustments hold $\pm 2^\circ\text{F}$.
- Compact Design . . . Requires less Floor Space
- Humidity Cycle available

Providing extreme flexibility in temperature and vacuum ranges, M & M Altitude Simulation Chambers give you precise control and easier, simpler operation that will reduce test costs considerably. Custom-quality built in every detail, M & M Chambers are designed to meet Government altitude simulation test standards. Available with many optional features to speed testing, such as Program Heating, Cooling, and Humidity Cycles, Automatic Recorder for controlling and integrating temperature, humidity and altitude. Write for details on Altitude SIMULATION Chambers as well as M & M Cold Temperature Test equipment.

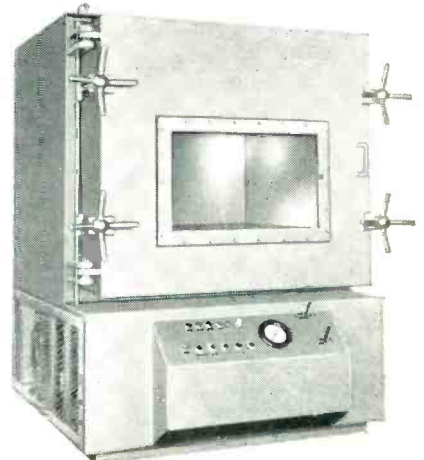

MURPHY & MILLER, Inc.

1322 South Michigan Avenue

Chicago 5, Illinois



acter of electrical components for multichannel voltage comparison, for sampling many thermocouples with a single alarm, for generating pulse trains and many other uses.

Klystron Power Supplies. Furst Electronics, 3322 W. Lawrence Ave., Chicago 25, Ill. A four-page folder presents the models 910 and 2310 electronically regulated klystron power supplies for precise microwave measurements. It gives illustrated descriptions of the units along with chief features and complete technical specifications. The units described feature high stability, good regulation and low ripple.

Direct-Writing Recording Systems. Sanborn Co., 38 Osborn St., Cambridge 39, Mass. A new 6-page bulletin explains the scope of application of the company's equipment for the recording of a wide variety of electrical and mechanical phenomena. The bulletin includes a chart of various phenomena that can be recorded with these direct-writing recorders together with transducer data and examples and comments. It also features complete performance data and specifications.

L-F Transformers and Reactors. Magg Transformer Co., 419 Bedford Ave., Brooklyn, N. Y. A recent company bulletin announces a new line of hermetically-sealed low-frequency transformers and reactors. The components described are characterized by their high performance, light weight, excellent shielding and close electrical tolerances.

Optical Gaging. Eastman Kodak Co., 343 State St., Rochester 4, N. Y. A new 12-page booklet describes advanced methods of optical gaging to cut inspection and tool-room costs. The booklet illustrates the uses of special fixtures and charts to inspect to close tolerances, large parts, complex shapes, and blind holes and recesses using contour projection. Profusely illustrated, it shows how optical gaging may be adapted to a wide variety of parts for faster, more economical checking. Specifica-

You can win \$100

Anton Electronic Laboratories' Radioactivity Industrial Applications Contest

4 Awards Totaling \$250.00

1st prize	\$100.00
2nd prize	75.00
3rd prize	50.00
4th prize	25.00

CONTEST RULES

- Each entry must state a specific and existing industrial problem.
- The solution of this problem must be arrived at by the use of a radioactive source and any instrument or circuit, which utilizes for detection a Geiger Counter Tube, an Integrator Tube or any similar device.
- Simple, clear, illustrative sketches plus adequate descriptions will be acceptable.
- It is not necessary for you to be an expert in the nuclear field. If through your knowledge of industrial problems you are able to describe a solution based on the use of a radioactive source and a detection device—you may submit your entry in a non-technical form. Your entry must include your name, home address and occupation.
- The judges' decision in all cases will be based on practicality of the suggested applications. In the event of a tie duplicate awards will be made.
- All entries must be postmarked no later than midnight June 15, 1953. Winners will be notified on or before July 15, 1953.
- No entry will be returned and all entries will become the property of the Anton Electronic Laboratories, Inc. Brooklyn, New York. The decision of the judges will be final. No employee, previous employee, of the Anton Electronic Laboratories, Inc. or relative of either shall be eligible to enter this contest.
- Judges will be named by Anton Electronic Laboratories, Inc.
- All entries must be addressed:

CONTEST

Anton Electronic Laboratories, Inc.
1226 Flushing Avenue
Brooklyn 37, New York

TYPICAL APPLICATIONS IN USE—NOW | • logging of oil-wells • flow detection
• thickness gauges

SEE A HALOGEN QUENCHED
ANTON GEIGER TUBE
IN ACTUAL OPERATION
AT THE IRE SHOW
BOOTH 4-108



ANTON ELECTRONIC LABORATORIES
INCORPORATED
1226-1238 FLUSHING AVENUE, BROOKLYN 6, NEW YORK
TELEPHONE 6-5715

March, 1953

ATT: CONTEST ENTRANTS

We believe the time is now at hand for American industry to benefit by the vast store of atomic information gained by research on government atomic projects.

As manufacturers of radioactivity detection tubes and instruments we have been closely allied with this government work for many years. Now — we feel our discoveries in the nuclear field should be exploited for the good of private enterprise.

That's why we at Anton Electronic Laboratories are sponsoring this Radioactivity Industrial Applications Contest. We know that the genius and practical know-how that exists in American industry will certainly come up with many devices based on the use of radio-active sources and detection circuitry.

Some of the ideas you offer may be involved projects. Some of them may be gadgets — but I'm certain that all of them will be ideas born of definite industrial needs. If you need additional information you may receive it personally at our I.R.E. Show Booth No. 4-108.

Good luck to you in our contest. We are looking forward to reading your entry.

Sincerely,
Nicholas Anton
ANTON ELECTRONIC LABORATORIES, INC.

ANTON ELECTRONIC LABORATORIES, INC.
1226 Flushing Avenue, Brooklyn 37, N. Y.

only **TURBO**

miniaturization wire
stands temperatures
from -55°C to
 $+105^{\circ}\text{C}$

AND MEETS OR
BEATS ALL OTHER
REQUIREMENTS OF
JAN-C-76 AND MIL-W-5086



- **PROVE TO YOURSELF** that wire does not need bulky insulation to stand extreme temperatures, or give you insulating values above 1000 megohms per 1000 ft.
- **SEND FOR A SAMPLE** of Turbo Miniaturization Wire. Test it on any electronic application where the continuous operating voltage does not exceed 600 volts R.M.S. See how its thin extruded vinyl primary insulation and thinner extruded nylon jacket resist boiling water, oils, fuels, hydraulic fluids, fungus, abrasion, etc.
- **TURBO MINIATURIZATION WIRE COMES IN AWG SIZES FROM 30 TO 12 GAUGE . . .** in standard or flexible wiring . . . in solid colors, or candy-striped colors with 1, 2 or 3 tracer combinations, to fit your circuit coding needs.
- **BULLETIN A-4662** gives you more information about TURBO insulation. Ask for it when requesting your samples of TURBO Miniaturization Wire. Write Dept. E-3.

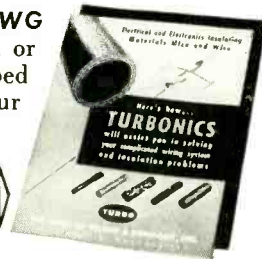

INSULATING MATERIAL

TURBO

THE BRAND ONLY BRAND MAKES

THE WILLIAM BRAND AND CO., INC.

North and Valley Streets, Willimantic, Connecticut — Phone 3-1661

tions and features of both models 2A and 3 contour projectors are described and illustrated.

Adjustable-Speed Drive. General Electric Co., Schenectady 5, N. Y. Thy-mo-trol (thyatron motor control) drive, what it consists of and how it operates are described in two new four-page bulletins. A simplified drive for $\frac{3}{4}$ to 3-hp applications is discussed in bulletin GEA-5829. Photos and diagrams are used to explain the system that is designed for use on testing equipment, conveyors and many other applications. A precision-controlled drive for $\frac{3}{4}$ to 10-hp applications is described in bulletin GEA-5827. The packaged adjustable-speed drive described is intended for application on machine tools, reeling and processing equipment, textile machines and other uses.

Fasteners. Simmons Fastener Corp., North Broadway, Albany 1, N. Y. Catalog 1252 covers a complete expanded line of fasteners that are suited for widely divergent applications. The 36-page, highly-illustrated booklet introduces the company's new Dual-Lock, a high-load, positive-locking structural fastener. The new catalog, which features an illustrated table of contents, contains dimensional drawings, engineering data, installation details and instructions for ordering. Numerous applications of each fastener type are pictured and described.

Motor Catalog. Gleason-Avery, Inc., 45 Aurelius Ave., Auburn, N. Y., has available a new catalog of products and services. The catalog includes specifications and illustrations of all the company's synchronous and nonsynchronous instrument motors, series 500 gear reduction motors and temperature controls, complete with rating charts and mounting dimensions. Also included to aid manufacturers is a list of possible applications of the motors.

Variable Resistors. Chicago Telephone Supply Corp., Elkhart, Ind. A complete civilian line and a com-

To:
THE PROJECT ENGINEER

Does your project require, or will future projects require?

PLASTIC LIGHTING PLATES

Mil-P-7788 (AN-P-89)

Have you ever designed one?

Are you familiar with the technical problems involved?

Do you realize that your complete equipment is judged by the operating layout and lighting of the control box?

Do you know that our approved laboratory and facilities can help you?

IRE BOOTH 708 FOURTH FLOOR

BODNAR INDUSTRIES, INC.

New Rochelle, N. Y.

THINKING OF STAINLESS...

THINK OF
ALLMETAL

FOR THE
FINEST IN

**STAINLESS
STEEL
FASTENERS**

FOR QUALITY
AND DELIVERY

Complete facilities under one roof assures controlled quality and immediate delivery. Standard and "AN" specs. Specials to order.



ALLMETAL, Specialists in Stainless, Produce Stainless Products Exclusively

Write for Catalog C



MANUFACTURERS SINCE 1929

ALLMETAL

SCREW PRODUCTS COMPANY, INC.

33 GREENE STREET NEW YORK 13, N. Y.



CAN SOLVE YOUR CAPACITOR PROBLEMS

TYPES IMMEDIATELY AVAILABLE

Property	Poly-styrene	Teflon	Synthetic D
Capacity	.001 up	.001 up	.01 up
Voltage	100 up	300 up	200 up
Power Factor	.01%	.01%	0.5%
I. R.	10 ⁶ meg/mf	10 ⁶ meg/mf	10 ⁶ meg/mf
Max. Op. Temp.	90°C	125°C	125°C
Soakage	.02%	.02%	1.0%
Temp. Coef.	-100 ppm/°C	-100 ppm/°C	+500 ppm/°C
Bulk at lowest voltage given	5 in ³ /mf	10 in ³ /mf	1.2 in ³ /mf

Unicon capacitors have found a wide acceptance among leading electronic laboratories and manufacturers specifying the most exacting requirements.

Representative users of standard and special Unicon capacitors are;

Mass. Institute of Tech.
General Electric Co.
Airborne Instrument Labs.
Los Alamos Scientific Labs.
Jet Propulsion Labs.
Freed Transformer Corp.
Boeing Airplane Co.
Northrop Aircraft, Inc.

Capacitors made to your specifications.

Write for catalog EE

united condenser corp.

UNICON

337 EAST 139th STREET NEW YORK 54, N. Y.

THE *Mayhill* **PLATING PROCESS**

GUARANTEES

**ACCURATE PLATING
IN
ELECTRONICS!**



Since 1946, M-W LABORATORIES has electroplated precious metal for suppliers to the U. S. Army, U. S. Navy, Atomic Energy Commission and to leading manufacturers in the electronics industry.

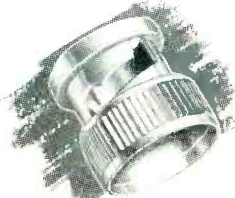

M-W LABORATORIES, featuring their Mayhill Plating Process, are equipped to plate these precious metals: gold, silver, rhodium, palladium, albaloy and indium.



Controlled thickness, smoothness, color, hardness and adhesion of plating is assured through constant testing by our own chemists and engineers, in our chemical and metallographic laboratory.



Contact us for a no-cost-to-you consultation on your plating problems.

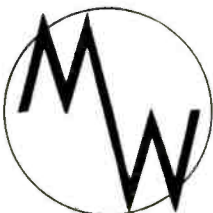

M-W Laboratories, Inc.

1824 N. Milwaukee Ave.

Chicago 47, Illinois

plete military line of variable resistors are pictured and described in data sheet No. 164. Attached switches for the civilian line are illustrated as well as a variety of concentric shaft tandem constructions with panel and rear sections operating separately from concentric shafts. Also shown is the new miniaturized type 70 civilian control designed for use in new radio and tv sets. Military resistors covered include JAN-R-19 and JAN-R-94 types and special composition controls specifically designed for military communications equipment subject to extreme temperature and humidity ranges.

Small Precision Metal Parts. The Torrington Co., 500 Field St., Torrington, Conn., has available a catalog listing the small precision metal parts now being made by the company. Some of the many parts described and illustrated are special pins and pivots; screw driver blades; all types of rotary swaged rods, wires and tubing in practically all kinds of metals; mandrels for grinding wheels, abrasive points and polishing wheels; perforating punches in straight carbon or alloy steels; and tapered or pointed wires and rods.

Hermetically-Sealed Resistors. Shallcross Mfg. Co., Collingdale, Pa. Bulletin L-27 with supplement 1 covers a complete line of precision wirewound resistors that meet every requirement of specification JAN-R-93, characteristic A. The resistors described are hermetically sealed in ceramic for extremely stable performance under wide temperature variations and high humidity—even total salt water immersion.

Radio Kits. Stockman Electronics Research Co., 543 Lexington St., Waltham, Mass., has a series of circuit diagrams, parts, kits and circuit display boards for school laboratories and lecture rooms. The items covered are vtvm's, signal generators, amplifiers and other test instruments, transceivers and new type radio receivers. A formula booklet reviewing circuit theory completes the series.

High Sensitivity . . . Logarithmic AC VOLT METER

50 MICRO VOLTS TO 500 VOLTS

MODEL 47 VOLT METER

SELF-CONTAINED
ALL AC OPERATED UNIT

An extremely sensitive amplifier type instrument that serves simultaneously as a voltmeter and high gain amplifier.

- Accuracy $\pm 2\%$ from 15 cycles to 30 kc.
- Input impedance 1 meg-ohm plus 15 uuf. shunt capacity.
- Amplifier Gain 23000

Also MODEL 45
WIDE BAND
VOLT METER
.0005 to 500 Volts!
5 Cycles 1600 kc

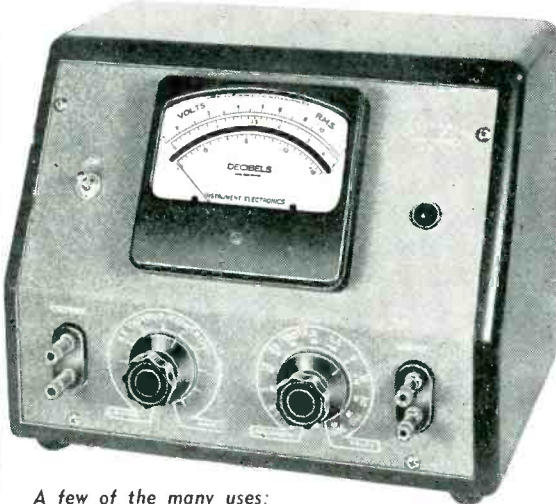

A few of the many uses:

- Output indicator for microphones of all types.
- Low level phonograph pickups.
- Acceleration and other vibrator measuring pickups.
- Sound level measurements.
- Gain and frequency measurements for all types of audio equipment.
- Densitometric measurements in photography and film production.
- Light flux measurements in conjunction with photo cells.

Write for Complete Information

Instrument Electronics Corp.

90 MAIN STREET
PORT WASHINGTON, N. Y.

The New 1953 EDITION of the WELCH CHART OF THE ATOMS

A comprehensive, 48-page, key booklet is furnished with each chart. It contains a brief discourse on the atom and the periodic law, a bibliography, a detailed explanation of the chart data, numerous tables and graphs, and a large black and white reproduction of the chart.

No. 4854, Chart of The Atoms, 1953 Edition. With formed-metal chart molding at top and bottom with eyelets for hanging; non-glare protective coating and key booklet. Each, \$7.50

No. 4854A, Chart of The Atoms, 1953 Edition. Mounted on a spring roller within a metal case, suitable for permanent wall mounting; non-glare protective coated, and with key booklet. Each, \$15.00

With 1952
International
Chemical
Society Atomic
Weights

Extensively Revised
to Include

- Comprehensive Tabulation of Isotopes
- The Latest Data on All 98 Elements
- The Most Recent Information About the Transuranic Elements Including Berkelium and Californium

Booth 2-137
I. R. E.
Convention
Grand Central
Palace
N. Y. City
Mar. 23-26

W. M. WELCH SCIENTIFIC COMPANY

DIVISION OF W. M. WELCH MANUFACTURING COMPANY
Established 1880

1515 SEDGWICK STREET, DEPT. H

CHICAGO 10, ILLINOIS, U.S.A.

OIL IMPREGNATED
CHICAGO APPROVED
VACUUM FILLED
CAPACITORS

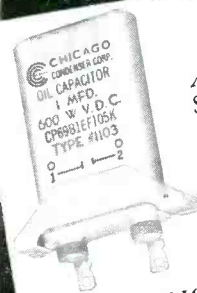

Approved
SILICONE
BUSHING
capacitor, oil
impregnated,
hermetically
sealed.

Featuring SILICONE BUSHINGS
for peak performance at high temperature operation.



SILICONE BUSHING
BATHTUB TYPE capacitor, oil impregnated, hermetically sealed, and tested at twice rated voltage to meet all specifications.



GLASS SEALED TUBULAR TYPE capacitor, oil impregnated, hermetically sealed to meet all specifications.

WRITE US FOR
FURTHER INFORMATION.

CHICAGO CONDENSER CORPORATION

3255 WEST ARMITAGE AVE.
CHICAGO 47, ILLINOIS

PLANTS AND PEOPLE

Edited by WILLIAM G. ARNOLD

Pye And General Precision Sign Research Agreement

AN AGREEMENT has been signed by Pye Limited of Cambridge, England, and General Precision Laboratory, Inc., New York, providing for an expanded program of joint research and development in the field of industrial and broadcast television cameras and studio equipment. The two companies have been associated for 3 years under an agreement which provided for the development of the items of studio equipment currently marketed by GPL.

Pye will manufacture cameras and associated studio items in England and General Precision will do the same in the U.S. for independent sale through their respective marketing organizations. The combined engineering knowledge of the two firms, reflecting world-wide operations, will be pooled.

In addition to the television broadcast cameras of the image orthicon and photocon types, a new miniature camera has been announced, chiefly for use in industrial and military applications. This is based on a new type of camera tube developed by Pye engineers, the details of which have not yet been announced.

The unit together with the Pye-GPL remote pan and tilt pedestal (ELECTRONICS, Sept. 1952, p. 22) will permit remote viewing with complete control of focus, iris, lens and turret.

The Pye-GPL agreement mainly covers television cameras but it is reported that the two firms are also working closely on theater television and are planning a similar co-operation in other industrial fields.

Raytheon To Build Picture Tube Plant

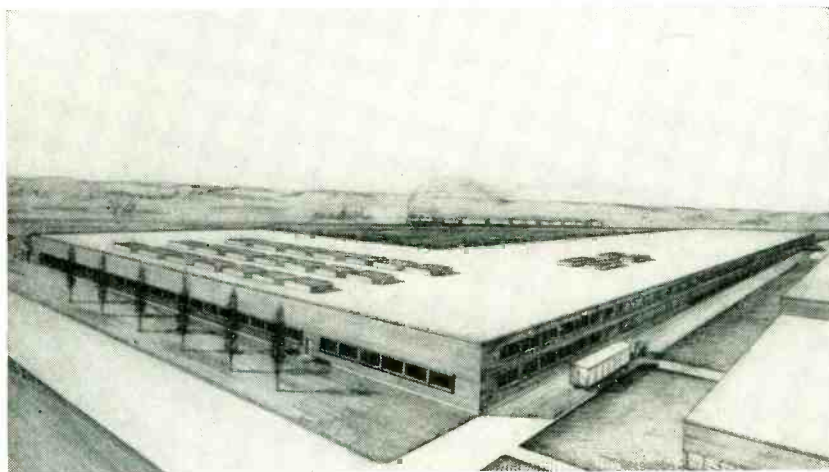

Plans for the erection of a new plant in Quincy, Mass., were recently announced by C. F. Adams, Jr., president of Raytheon Manufacturing Co. When completed, the plant, shown in the architect's sketch, will provide 100,000 sq ft of space which will be devoted exclusively to the manufacture and warehousing of television picture tubes, especially the new large sizes such as the 24-inch and 27-inch rectangular tubes. The plant is expected to be in operation next summer. It will employ 350 workers.

OTHER DEPARTMENTS featured for this issue:

	Page
Electrons At Work.....	160
Production Techniques... ..	274
New Products.....	344
New Books.....	472
Backtalk	492

IRE Appoints Officers And Directors For 1953

THE BOARD of directors of the Institute of Radio Engineers, at its annual meeting in New York City, appointed 6 officers and directors for the year 1953. Haraden Pratt, telecommunications advisor to former President Truman, was re-appointed secretary of the Institute, a post he has held since 1943.

W. R. G. Baker, vice-president of the General Electric Co., was appointed treasurer for the third successive year.

Alfred N. Goldsmith, consulting engineer, was appointed editor, an office he has held since the IRE was founded in 1912.

Appointed as directors for 1953 were Ralph D. Bennett, technical director of the U.S. Naval Ordnance Laboratory; William R. Hewlett, vice-president of Hewlett Packard Co. and Arthur V. Loughren, vice-president in charge of research at Hazeltine Electronics Corp.

General Instrument Elects Cohen President

MONTE COHEN, veteran of 37 years in the radio-electronics field, has been elected president of General Instruments Corp., it was announced by Abraham Blumenkrantz, chairman of the board and chief executive officer.

Mr. Cohen has been executive vice-president of the company since 1951, and president of the F. W. Sickles Division of General Instru-

horizons unlimited

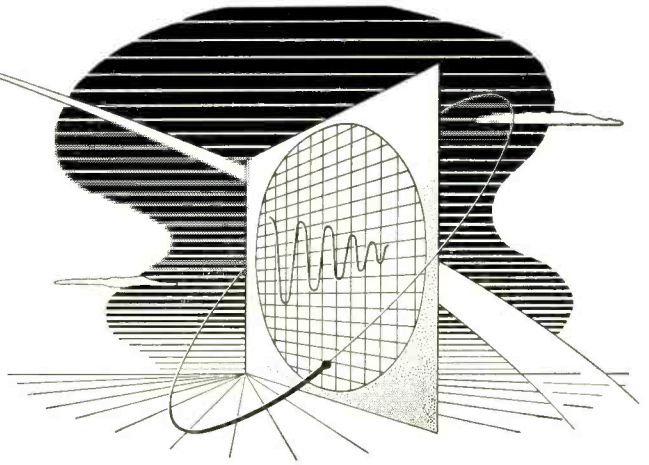

Inhibitions must be stifled if creative development is to have full freedom of expression. Only with a young, imaginative, "of course it can be done" attitude are the great advances of this modern era accomplished.

Ketay

has earned its place among the leaders in precision instrumentation on the record of its virile development and production staffs. Throughout its cumulative years of accomplishment, Ketay has confined its efforts to the development, engineering, and production of new types of electro-mechanical and electronic equipment.

Today, industrial and government orders almost fill the Ketay plants on both coasts. Currently in production is the miniaturized highly precise Ketay Resolver—a type which opens new horizons in automatic control operations. Ketay developments are geared to performance above and beyond present military standards—which, in turn, were set by earlier Ketay product capabilities.



SYNCHROS SERVOS
RESOLVERS MAGNETIC AMPLIFIERS
AUTOMATIC CONTROL SYSTEMS
ELECTRONIC EQUIPMENT

Tomorrow, and for many tomorrows to come, Ketay is dedicated to a relentless search for new ways to solve the electronic problems of American Industry.



MANUFACTURING CORP.
 New York, N.Y. Hawthorne, Cal.
 Executive offices: 555 Broadway, New York 12, N.Y.

DESIGN

DEVELOPMENT

MANUFACTURE of precision instruments

ment since that year. He started his career in radio in 1916 with the old Marconi Company. He has helped design and manufacture numerous electronic, radio and television components which are widely used today in military and civilian products.

Black Receives Research Corp. Annual Award



Harold S. Black

HAROLD S. BLACK, transmission engineer at the Bell Telephone Laboratories, received the Research Corporation Annual Award for Contribution to Science. This is the foundation's 17th annual award.

Mr. Black, who joined the laboratories in 1921, was chosen as the 1952 recipient of the award in recognition of his invention and development of the negative feedback principle and for his general record of contribution in the field of communications. The negative feedback amplifier has been widely utilized wherever freedom from distortion and a high degree of perfection is required.

A native of Leominster, Mass., Mr. Black received a B.S. degree in electrical engineering from Worcester Polytechnic Institute. In 1940 he was honored by the NAM as a modern pioneer, in recognition of distinguished achievement in the field of science and invention. He also holds the John Price Wetherill medal of the Franklin Institute for his technical contribution to the efficiency of modern long distance telephony.

New Officers Elected By WCEMA For 1953

NORMAN H. MOORE, chief engineer of Litton Industries, San Carlos, Calif., became the 1953 president of the West Coast Electronics Manufacturer's Association as a result of his election to the post of chairman of the San Francisco council. Moore, who served as vice-chairman of the Northern California group in 1952, has long been active in WCEMA activities, having served in various other capacities during the past years.

Vice-president of the association for the new year is Ed Grigsby, sales manager of the western division of Altec-Lansing Corp., Beverly Hills. Grigsby was elected chairman of the Southern California council for 1953, succeeding Leon B. Ungar.

Secretary is Don Larson, advertising director of Hoffman Radio Corp., Los Angeles. Treasurer for 1953, representing the Northern California council, is H. Myrl Stearns, vice-president and general manager of Varian Associates, San Carlos.

New WCEMA 1953 directors elected include: Hugh P. Moore, president of Acme Electronics, Inc.; Paul H. Tartak, president of Tartak-Stolle Electronics, Inc.; E. P. Gertsch, president of Gertsch Products, Inc.; Noel E. Porter, production manager for Hewlett-Packard Co.; William Hefin, Lenkurt Electric Co.; Winfield Wagener, Eitel-McCullough, Inc.; and M. J. Murdock, general manager of Tektronix, Inc. This brings the directors to 14 members, including the immediate past president, Leon B. Ungar, Los Angeles, who automatically joins the board. The organization sponsors the annual Western Electronic Show and Convention. This year it will be held in the San Francisco civic auditorium August 19-21.

Motorola Elects Officers

ELECTION of two new officers of Motorola, Inc. was announced by Paul V. Galvin, president. Walter Scott, formerly works manager, became vice-president in charge of

manufacturing, consumer product division. John Silver, general manager of the communications and electronics division, was named vice-president in charge of operations, communications and electronics division.

Mr. Scott has been with the electronics firm since 1946. For five years prior to that he was assistant to the production head of the J. I. Case Company.



John Silver

Mr. Silver came to Motorola in 1944 and was appointed general manager of the communications and electronics division in 1949. Prior affiliations included 12 years in engineering with Crosley Radio Corp., and several years as chief production engineer for Collins Radio.

Teal Joins Texas Firm As Research Head

GORDON K. TEAL, well-recognized for his work in the semiconductor field, has joined Texas Instruments Inc. of Dallas as assistant vice-president and director of the materials and components research department of the engineering division.

He has been prominently associated with several recent advances in electronics. He and his former associates at Bell Telephone Labs are credited with the introduction of single-crystal germanium and silicon into the transistor field. He is also co-developer of the n-p-n junction transistor and of the boron-carbon resistor. He had been with

AT YOUR SERVICE WITH OUR TWO FACTORIES TO HELP YOU WITH YOUR SHEET METAL FABRICATION REQUIREMENTS.

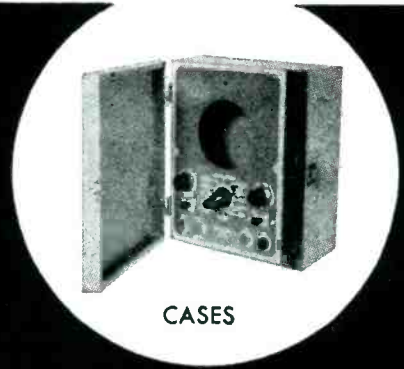

CASES

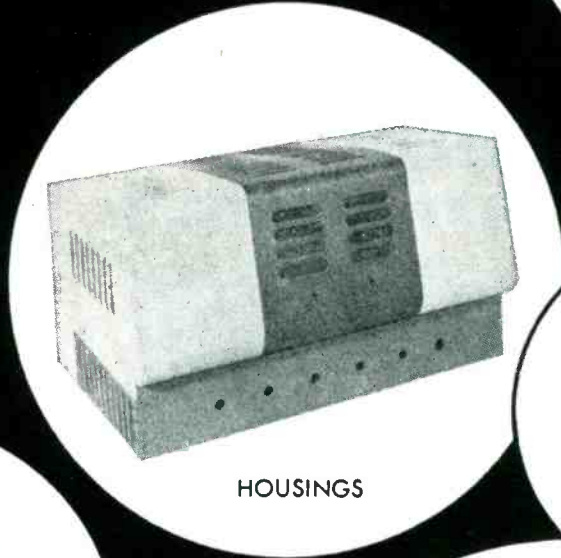

HOUSINGS

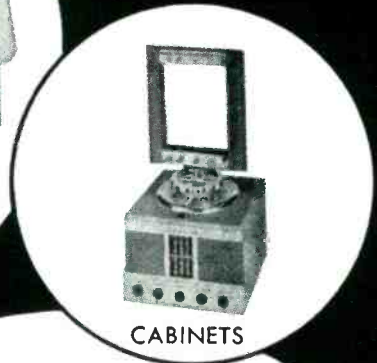

CABINETS

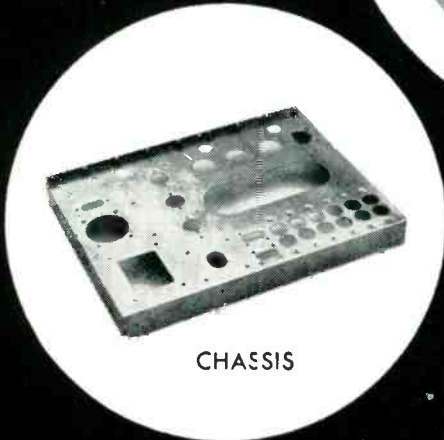

CHASSIS

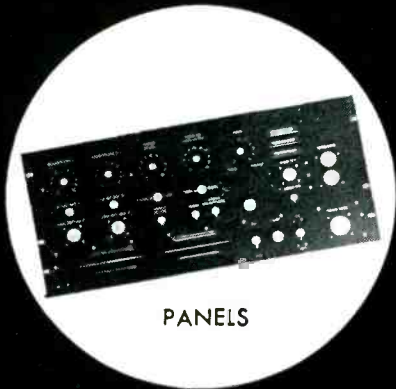

PANELS

**PRODUCING FOR
THE FINEST!**

- R. C. A.
- WESTERN ELECTRIC
- GENERAL ELECTRIC
- STROMBERG-CARLSON
- MOLDED INSULATION CO.
- ADMIRAL
- THOMAS EDISON INC.

Thousands of varied Production Dies and Tools available at no extra charge—to speed production and reduce your costs. We specialize in "Whistler Die Setups" for economic and speedy production.

Our modern Conveyorized Finishing Dept. includes—Pickling — Degreasing — Bonderizing and Baked Enamel Painting of all types; thus assuring you of a fine quality product.

We can assure you of excellent workmanship and prompt deliveries. Send us your blueprints and specifications. We shall quote you immediately.

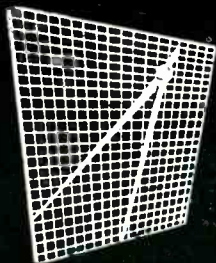

S. WALTER Co., Inc.
PRECISION SHEET METAL PRODUCTS

1400 ATLANTIC AVENUE

• BROOKLYN 16, N. Y.

HYacinth 3-9460

Now...

COUNTING PLUS CONTROL

AT RATES TO
40,000 CPS
WITH

Berkeley PRESET COUNTERS

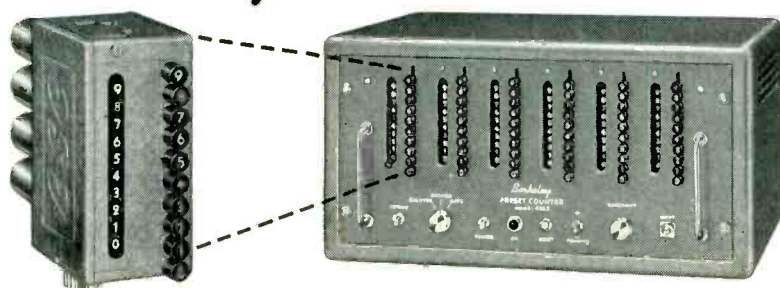

DESCRIPTION—The Berkeley Preset Counter is an electronic decade with provisions for producing an output signal or pulse at any desired preset count within the unit's capacity. Any physical, electrical, mechanical or optical events that can be converted into changing voltages can be counted, at rates from 1 to 40,000 counts per second. Total count is displayed in direct-reading digital form. Presetting is accomplished by depressing pushbuttons corresponding to the desired digit in each column. Model 730 Preset Decimal Counting Units are used. These are completely interchangeable plug-in units designed for simplicity of maintenance and replacement.

APPLICATIONS—Flexibility and simplicity of operation make the Berkeley Preset Counter suitable for both production line and laboratory use. It has practical applications wherever signalling or control, based on occurrence of a predetermined number of events or increments of time is desired. Output signals from the unit can be used to actuate virtually any type of process control device, or to provide aural or visual signals.

SPECIFICATIONS	Model				
	422	423	424	425	426
MAX. COUNT CAPACITY	100	1000	10,000	100,000	1,000,000
INPUT SENSITIVITY (MIN.)	± 1 v. to ground, peak; at least 2 μ sec. wide				
OUTPUT	Choice of pos. pulse and relay closure, or pos. pulse. SPST relay closure approx. 1/30 sec; pulse output is + 125 v. with 3 μ sec. rise time and 15 μ sec. duration.				
PANEL DIMENSIONS	15 3/8" x 8 3/4"		19" x 8 3/4"		
OVERALL DIMENSIONS	16 5/8" x 10 1/4" x 13"		20 3/4" x 10 1/2" x 15"		
POWER REQUIREMENTS	117 v. ± 10% @ 90w.		117 v. ± 10% @ 180 w.		
PRICE (F.O.B. FACTORY)	\$375	\$450	\$595	\$695	\$795

M 3

For complete information, please request Bulletin 103

Berkeley Scientific

division of BECKMAN INSTRUMENTS INC.
2200 WRIGHT AVENUE • RICHMOND, CALIFORNIA

"DIRECT READING DIGITAL PRESENTATION OF INFORMATION"



Gordon K. Teal

Bell Labs since 1930 and has been responsible for about 45 patents in his field.

Railroads Select New Communications Officers

C. O. ELLIS, general superintendent of communications of the Chicago, Rock Island and Pacific Railway, has been selected as chairman of the communications section of the Association of American Railroads for the two-year term ending December 31, 1954.

R. A. Hendrie, general superintendent of communications of the Missouri Pacific Railroad has been selected as vice-chairman of the section for the same term.

RCA Honors Engineers

AMONG the 20 employees of RCA Victor who received the company's top citation, the RCA Victor Award of Merit, were M. John Heffernan, field engineer, John D. Callaghan, senior engineer and Clarence A. Gunther, assistant chief engineer.

Mr. Heffernan was honored for unusual ingenuity and initiative which resulted in the development of an antenna-detector device that makes possible vastly improved air-weather station communications for the U. S. Air Force. It eliminates the need for long and expensive antenna arrays, and the necessity for heavy investment by the government in purchase of land, antenna towers and other associated equipment.

Mr. Callaghan received the award for his role in the development of

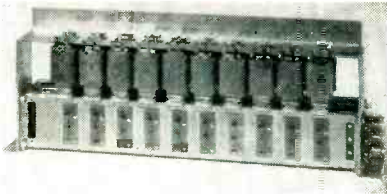

CROSSBAR SWITCHES

Major Characteristics
of 2 x 10 Switch

- Strap wiring eliminated
- Switches up to ten M. C.
- Low Crosstalk level
- 1/2 millisecond operating and release time
- Palladium twin contacts
- Low operating power
- Small size

For additional characteristics write for Specification Sheet.

For Applications in:
**TELEVISION, COMPUTERS,
RADIO, TELEGRAPHY,
TELEMETERING**

Also Available in 10 x 10 Design
Write us about your
switching problems

Cunningham
ESTABLISHED 1928

15 Canal Street

Rochester 8, N. Y.

Phone: Baker 7240

ZOPHAR

WAXES

COMPOUNDS

Zophar Waxes, resins and compounds to impregnate, dip, seal, embed, or pot electronic and electrical equipment or components of all types; radio, television, etc.

Cold flows from 100°F. to 285°F.

Special waxes non-cracking at -76°F.

Compounds meeting Government specifications plain or fungus resistant.

Let us help you with your engineering problems.



ZOPHAR MILLS, INC.
112-130 26th Street,
Brooklyn 32, N. Y.

**NO SHORT
CIRCUITS**
when you
use.

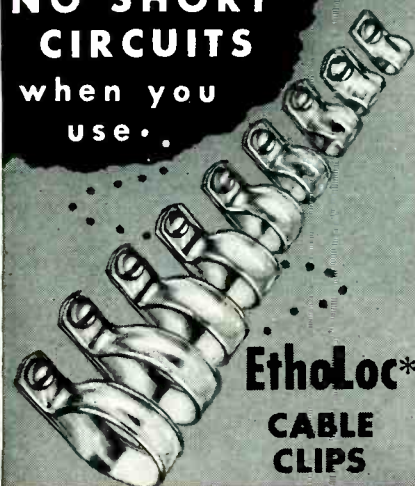

EthoLoc*
**CABLE
CLIPS**

*TRADE MARK PAT. PEND.

ALL SIZES
1/8" dia. to 1 1/4" dia.

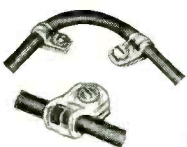

Made of
**TOUGH, DURABLE
ETHYL CELLULOSE PLASTIC**
—FLEXIBLE, EASY TO INSTALL

Write for Sample and Full
Information, including Strength
Tests and Prices

WECKERSSER CO.



5267 N. Avondale Ave. • Chicago 30, Ill.

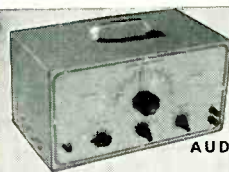

AUDIO GEN.
KIT
\$29⁵⁰

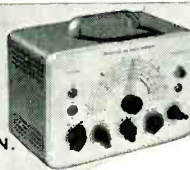

R. F. SIGNAL
GEN. KIT
\$19⁵⁰

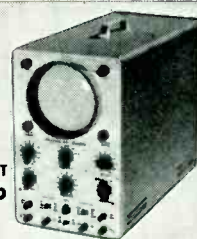

5"
SCOPE KIT
\$43⁵⁰



T.V. ALIGN.
GEN. KIT
\$39⁵⁰

BUILD
YOUR OWN
Heathkit
TEST EQUIPMENT

Heathkits are completely engineered instruments supplied unassembled. Every kit goes together smoothly and easily. All drilling, punching, and painting has already been done for you. All parts are furnished and are of highest quality.

Detailed construction manual shows clearly where each wire and part goes and tells exactly how to build the kit. Write for free catalog.



SIGNAL
TRACER KIT
\$22⁵⁰



VACUUM TUBE
VOLTMETER KIT
\$24⁵⁰



BATTERY
ELIMINATOR
KIT
\$24⁵⁰

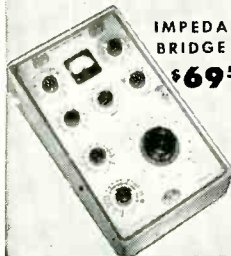

IMPEDANCE
BRIDGE KIT
\$69⁵⁰

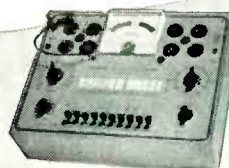

TUBE CHECKER
KIT
\$29⁵⁰

HEATH COMPANY
BENTON HARBOR 14,
MICHIGAN

EXPORT AGENT
ROCKE INTERNATIONAL CORP.
13 East 40th Street
NEW YORK CITY (16)



CONDENSER
CHECKER KIT
\$19⁵⁰

GRID DIP METER
KIT \$19⁵⁰

antennas, transmission lines and other equipment that helped make possible the introduction of uhf tv service to the public.

Mr. Gunther was cited for invaluable counsel on the selection of government projects best suited to the company's facilities and type of production. His analysis of electronic equipment while visiting Korea enabled him to make recommendations of the greatest importance to the armed forces.

Ford Instrument Promotes McKenney to Chief Engineer

HENRY F. MCKENNEY has been appointed chief engineer of the Ford Instrument Company, division of the Sperry Corp., Raymond F. Jahn, president of the company announced. He will be responsible to William H. Newell, vice-president for engineering.



Henry F. McKenney

Mr. McKenney, a graduate of the University of Cincinnati, came to Ford Instrument eleven years ago as a test engineer. He entered the design engineering department shortly thereafter, specialized in airborne equipment, and has been assistant chief engineer for the past two years.

He holds four patents with eight more pending on magnetic amplifiers, servo-mechanisms and electronic equipment.

Cotton Returns To Philco

RICHARD W. COTTON, on leave from Philco since June 16, has resigned as director of NPA Electronics Di-

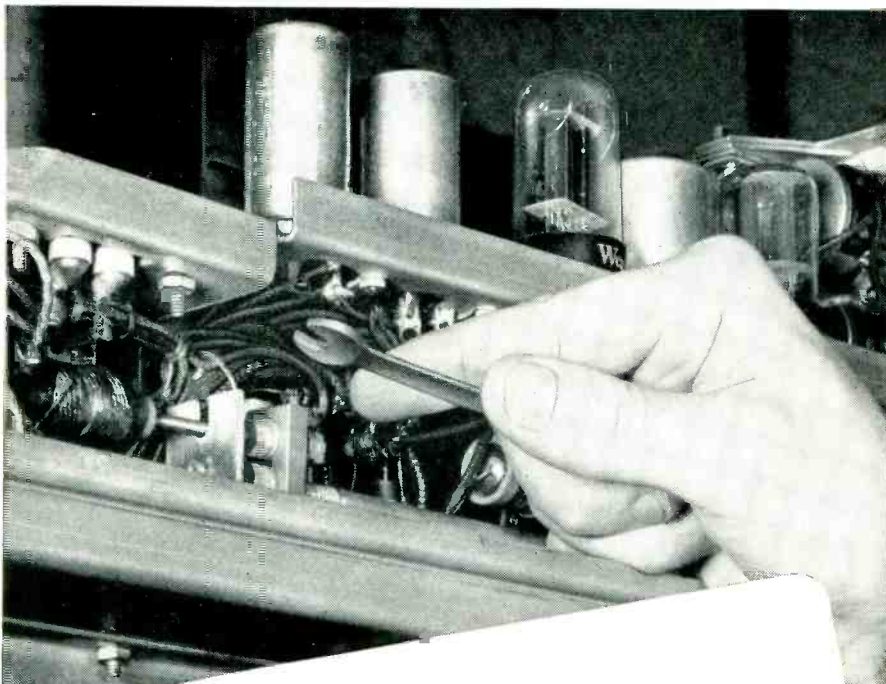

SOLVE CORROSION PROBLEMS WITH

FASTENINGS by HARPER

Fastenings represent a vital part of any electronic equipment. And yet, fastenings represent an extremely small part of the cost. That's why so many electronic manufacturers demand the best fastenings procurable—Harper.

Over 7,000 different Harper Fastenings are available from stock—bolts, nuts, screws, washers, lock washers, rivets—of brass, naval bronze, silicon bronze, Monel, stainless steel and aluminum.

Harper offers electronic manufacturers these advantages: One source of supply, one order to write, one account to keep, one bill to pay. There is a Harper distributor near you with stocks to fill your order. Harper engineers and metallurgists will gladly assist you in the solution of any fastening problem you may face.

THE H. M. HARPER COMPANY
8244 Lehigh Avenue, Morton Grove, Ill.

Mail the coupon below for complete catalog of Harper Everlasting Fastenings. There is a Harper distributor near you with stocks to fill your requirements.

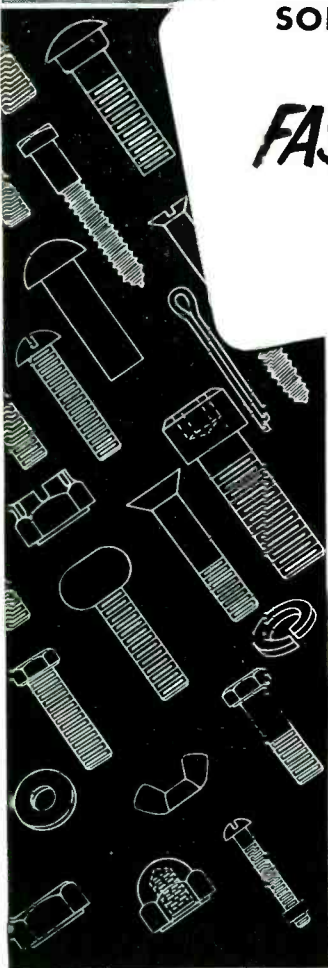

Specialists in all Non-Corrosive Metals

The H. M. Harper Company
8244 Lehigh Avenue
Morton Grove, Illinois
Please send the complete catalog of Harper Everlasting Fastenings.

Name.....
Position.....
Company.....
Address.....
City..... Zone..... State.....

Advertisers:

How about the NUCLEAR field?

There are a good many advertisers using **ELECTRONICS**, who should also be advertising in **NUCLEONICS**.

Particularly in instrumentation and laboratory equipment, there is a cross-over of use in the electronic and in the nuclear field.

But, there is very little cross-over in the subscriber lists of the two publications—a matter of a few percentage points.

It is quite possible that you are doing an effective presentation of your products and abilities in this excellent issue, but are missing such presentation before one of the fastest growing fields in the country's history—the field of atomic energy.

The sales representatives of **ELECTRONICS** are also the sales representatives of **NUCLEONICS**. They have much evidence pointing to the opportunities in this great **NEW** field. Ask them to show you what your potentials can be.

NUCLEONICS

ABC

ABP

A McGraw-Hill Publication
330 West 42nd St.
New York 36, N. Y.

IF THE WIRING FAILS

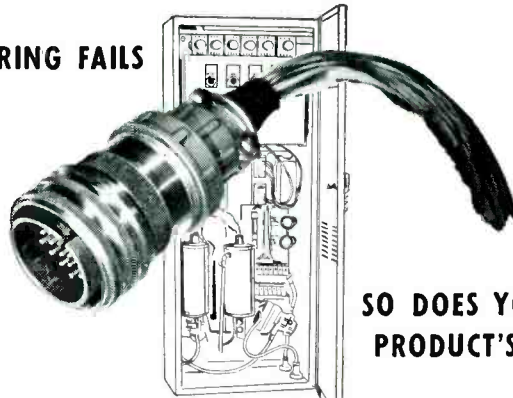

SO DOES YOUR
PRODUCT'S REPUTATION

FOR DEPENDABLE PRODUCT WIRING USE

UNILETRIC *WIRING SYSTEMS*

Year after year — for over ten years — UNILETRIC has produced millions of wiring systems, for more than 150 leading manufacturers of electric and electronic products. From controls to complex armed forces equipment, these wiring systems have consistently met the most exacting requirements and provided substantial savings to each customer.

To assure utmost dependability plus cost saving engineering assistance, low cost production and "on-schedule delivery" investigate UNILETRIC today.

UNILETRIC *WIRING SYSTEMS*

Manufactured by
UNITED MANUFACTURING & SERVICE COMPANY
409 SOUTH 6th STREET • MILWAUKEE 4, WISCONSIN

EXTEND THE RANGE OF STANDARD FREQUENCY COUNTERS WITH THE **DECAVIDERS**

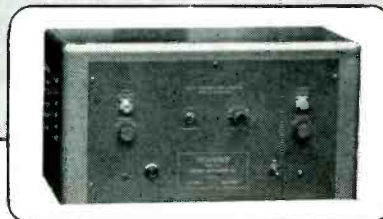

- NO LOSS OF ACCURACY
- LESS SIGNAL LEVEL REQUIRED

(Gains of up to 1000:1
with some models)

Read your
counter and
add speci-
fied fixed
frequency

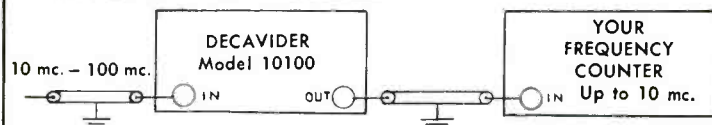

Frequency Counter Range	DECAVIDER Model No.	Extends Range to	Price f.o.b Caldwell, N. J.
Up to 10 mc	1020	10 mc.— 20 mc.	\$295.00
Up to 10 mc	10100	10 mc.—100 mc. (9 ranges)	495.00
Up to 1 mc	110	1 mc.— 10 mc. (9 ranges)	395.00
Up to 100 kc	10	100 kc. — 10 mc. (10 ranges)	545.00

NEW HIGH GAIN (50 DB) UNITS FOR LOW LEVEL (5 MILLIVOLT OR LESS) PRECISION FREQUENCY MEASUREMENTS

Decaider for use with any single 10 mc band in range from 20-250 mc — \$495.00. Decaider for use with any single 10 mc band above 250 mc— price upon request.

BOOTH NO. 4-905

DECADE INSTRUMENT CO. Box 153, Caldwell, N. J.
Phone CALdwell 6-4258

Holding 3×10^{11} ohms within 1%
depends on
**PRECISION AMBIENT
COMPENSATION**



The Beckman Model V Micro-Microammeter—for the precise measurement of extremely small electrical currents. Beckman Instruments, Inc., South Pasadena, California.

TO MEASURE ELECTRICAL CURRENTS as small as *three-tenths of a trillionth* ampere within 5%, the Beckman Model V Micro-Microammeter depends on precision ambient compensation by an EDISON sealed-in-glass thermostat.

IN OPERATION, the Micro-Microammeter conducts the current to be measured through a very high input resistance—from 3×10^7 to 10^{11} ohms. The voltage produced across this resistance charges a vibrating reed capacity modulator, oscillating at 120 cycles per second, which converts the voltage to an alternating signal. After passing through a four-stage amplifier, the signal is converted back to direct current for measurement.

WITHOUT THE PROTECTION of an EDISON thermostat to control the temperature of the input compartment, the precise, 1% reproducibility could be destroyed through variation of the temperature with input resistance or contact potential of the vibrating reed.

EDISON THERMOSTATS feature stability measured in years, control within $\pm 0.1^\circ$ F and capacity to 115 volts, 8 amperes d.c. or 1000 watts. EDISON temperature control engineers will be glad to work with you on the solution of your ambient protection problems. Just call or write to:

Thomas A Edison
INCORPORATED

Instrument Division • Dept. 54, West Orange, New Jersey

AT THE I.R.E. SHOW, Grand Central Palace, March 23-26, be sure to visit the Edison booth—No. 4-714.

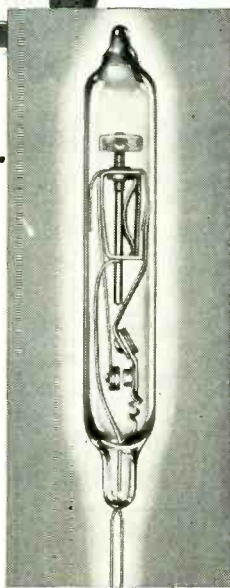

TIME has no apparent effect on Edison Sealed-In-Glass Thermostats.



**YOU CAN
ALWAYS RELY
ON EDISON**

vision to return to his position as assistant to the president of Philco, William Balderston. He has agreed to remain as head of the electronics board on a part time basis until the new director takes over. Deputy Director Donald S. Parris will become director of the Electronics Division.

Ryder Named President Of '53 NEC

J. D. RYDER, head of the electrical engineering department, University of Illinois, has been named president of the 1953 National Electronics Conference Inc. C. E. Barthel, Jr., Illinois Institute of Technology, was named chairman of the board.

The ninth annual conference will be held September 28, 29 and 30, 1953 at the Hotel Sherman in Chicago.

Other officers are: executive vice-president, R. M. Soria of American Phenolic Corp.; executive secretary, Karl Kramer of Jensen Radio Co.; secretary, J. M. Cage of Purdue University; treasurer, G. E. Foster of Metrotype Corp.

The conference is sponsored by the AIEE, IRE, Illinois Institute of Technology, Northwestern University and the University of Illinois, with participation by Purdue University and the University of Wisconsin.

Wright Advanced To V-P at Capehart-Farnsworth

THE PROMOTION of Anthony Wright to vice-president in charge of the commercial products division of the Capehart-Farnsworth Corp. was recently announced by Fred D. Wilson, president.

Mr. Wright, who joined Capehart early in 1950 as chief engineer, became vice-president in charge of engineering for the consumer products division in February of that year. A pioneer in the radio and television industry, Mr. Wright was chief engineer for the Magnavox Corp. immediately prior to joining Capehart. From 1929 to 1947 he was with the RCA Victor Division of RCA and was responsible for many of the advances in radio, phonograph, and television engineering at RCA. As chief engineer



- DESIGNED
- ENGINEERED
- MANUFACTURED for PRECISION PERFORMANCE

• Designed for use on AC lines where successful servicing of electronic or electrical equipment depends upon the regular servicing of such equipment based on actual operating (or idle) time. Unit has a range of 9999.9 hours and resets automatically at 10,000 hours. Can be supplied for either 120 or 240 volts. 60 cycle operation and has operating temperatures of -55 to $+55^{\circ}$ C.

Running Time Meter is available 3" square or 3 1/2" round Bakelite case or 3 1/2" round hermetically sealed case.

HERMETICALLY SEALED
RUNNING TIME METER



- 9999.9 hour range
- 10,000 hour automatic reset
- -55 to $+55^{\circ}$ C. operating temperature.

Write Dept. F-33 for further details



BURLINGTON INSTRUMENT COMPANY
DEPT. F-33 BURLINGTON, IOWA

STILL TOPS IN THE FIELD...



Whatever your requirements, you'll find a JOHNSON socket ideally suited for your purpose.

This socket will have high frequency insulation, low contact resistance and will hold the tube securely.

Design is such that mounting is simple. Insulation and

spacing are more than adequate for voltages involved. High frequency tube performance is not impaired by stray capacity.

Catalog 973 describes the most complete line of transmitting and industrial tube sockets on the market.

WRITE FOR CATALOG 973



E. F. JOHNSON COMPANY

CAPACITORS, INDUCTORS, SOCKETS, INSULATORS, PLUGS, JACKS, DIALS, AND PILOT LIGHTS

228 SECOND AVENUE SOUTHWEST

WASECA, MINNESOTA

Now . . . do away with wasteful "cut-and-try" methods

Read

VACUUM TUBE OSCILLATORS

By WILLIAM A. EDSON
*Director of Electrical Engineering
Georgia Institute of Technology*

HERE is the volume engineers and designers have been waiting for . . . the very first comprehensive work on oscillator design and operation.

It covers the many factors affecting the behavior of oscillators, shows you how to *predict* this behavior and how to design circuits to meet your specific needs.

You would have to scour through hundreds of books, journals and bulletins to get all this valuable information. Instead, Edson has done the research for you, giving you in one handy source all the facts you need on electronics, circuit theory and dynamics for the clearest possible picture of oscillator operation. Each chapter is self-sufficient, making the book a convenient handbook.

A pre-publication reviewer said:
". . . an important contribution to the field of vacuum tube circuits. It gives a very comprehensive presentation of the subject of practical oscillators. The material is largely descriptive but does contain some mathematical analysis where it can be handled without difficulty. The general level of the material is such that it could be easily handled by an average engineer in the field . . . Edson's book is very complete and has many of the characteristics of a handbook on oscillators."

1953 268 illus. 476 pages \$7.50

Write for a copy on 10-day approval

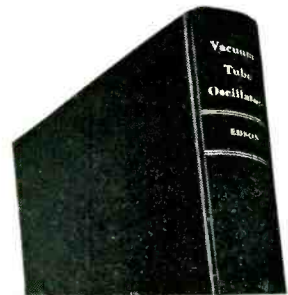

JOHN WILEY & SONS, INC.
440 Fourth Ave., New York 16, N. Y.

Transformer Engineering

- DESIGN AND DEVELOPMENT
- SAMPLES DELIVERED QUICKLY
- QUALITY FROM "KNOW HOW"

*Expanded facilities available
for immediate delivery
of your production requirements*

TRANSFORMERS ENGINEERED AND MANUFACTURED
BY **TRESCO**

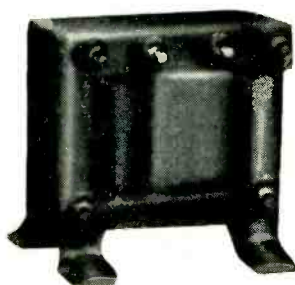

Coated to meet
MIL-T-27

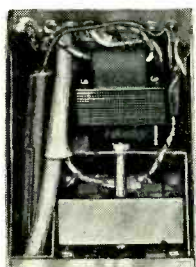

Specialized Trans-
former Assemblies
Potted and Cased

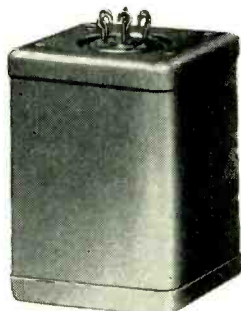

Hermetically
Sealed

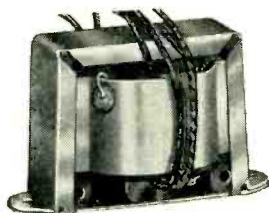

Open Frame

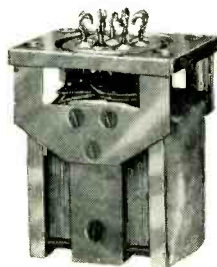

Magnetic Amplifiers

Send information on quotes or have us send a representative to call on you.



TRESCO

3826 Terrace St., Phila., Pa.
Phone IVyridge 3-1383

for the home instrument department, television section, he was responsible for the development of RCA's first postwar television receivers; he was also in charge of the development of airborne television equipment. While vice-president in charge of engineering at Capehart he has designed many highly successful television chassis, including the CX-37 now in production.

In addition to his work in radio and television engineering, Mr. Wright has spent much time in the radio retailing field. A native of England, he was educated at Oxford University.

PCA Moves Into New Plant

PCA ELECTRONICS, INC., manufacturers of miniature pulse transformers and delay lines used in computers, guided missiles and radar equipment, recently moved into a new building in Santa Monica, Calif.

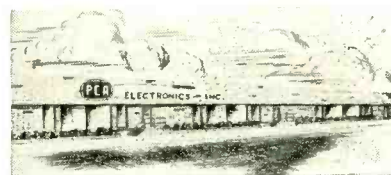

New PCA Plant

The new building has more than 5 times the floor area of the previous plant, increasing production facilities and providing room for the expanding research and development departments of the company.

Sylvania In Canada Elects New Officers

THE ELECTION of four new top-ranking officers of Sylvania Electric (Canada) Ltd., wholly owned manufacturing subsidiary of Sylvania Electric Products Inc., was announced by the Canadian corporation's board of directors.

Ralph E. Niedringhaus, a member of the Sylvania staff in the United States since 1938, becomes president of the Canadian subsidiary under the new organization. Other officers elected by the directors are: W. Benton Harrison, treasurer; William B. O'Keefe, vice-president in charge of manufactur-



NEW PRODUCT DEVELOPMENT SHOWS

LAVOIE HAS EYES ON FUTURE

NEW AUTOMATIC HYDRO-TUNER NEEDS NO PRE-SETTING

Here, at last, is an electronically controlled hydraulic power transmission system for tuning stages of electronic equipment that needs no mechanical pre-setting.

This system has many advantages:

It tunes on the signal rather than on a pre-set mechanical point. This eliminates the possibility of errors due to wear, chassis distortion, shock and temperature changes . . . Means less maintenance problems, longer life for equipment.

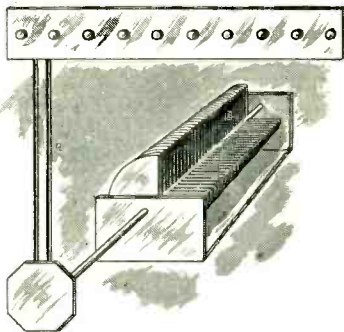

Dependable tuning of high Q circuits is made possible because of the extreme accuracy of the tuner.

Rigid locking of moving parts after tuning eliminates the chance of detuning due to shock, vibration, etc.

Greater flexibility—The basic system may be applied to many types of tuning or positioning problems, because of the simplicity of the operating principles.

We invite you to write for more information on the Hydro-Tuner and how it can be applied to your particular problems. Write Lavoie Laboratories, Morganville, N. J.

VHF OMNIRANGE NOW PACKAGED IN SINGLE UNIT

Now . . . A VHF Omnirange which is packaged in a single unit, eliminating the purchase of components section by section from different manufacturers.

VHF Omnirange has been accepted by international agreement as the most desirable, dependable, and economical system for short range navigation.

Instead of permitting only four courses as is the case with the conventional Aural "A-N" system, VHF Omnirange will:

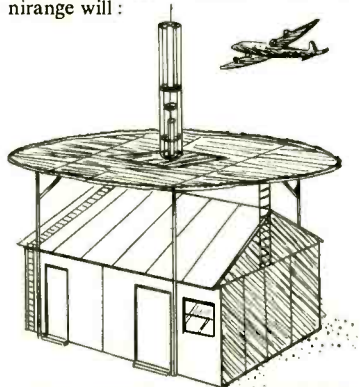

Make possible a theoretically infinite number of courses;

Allow for tangential approaches in addition to conventional head-on approaches;

Enable the pilot to determine his position quickly by "fixes" on two Omni stations;

Allow the pilot to maintain any angle of approach, either in azimuth or elevation, by pre-setting the aircraft receiver.

The transmitter has a nominal range of 100 miles at normal flying altitudes, and the system operates in the VHF range, on an assigned band of 112 to 118 Megacycles. For further information, contact Lavoie Laboratories, Morganville, N. J.

239-B OSCILLOSCOPE SHOWS ADVANCED DESIGN

For those who require a rugged, precision instrument for the study of pulse phenomena, here is a new, revised oscilloscope. Its new features make it one of the most outstanding instruments in its field. Look at these features:

1. New scale design allows insertion of special scales as aid in interpretation of curved patterns.
2. Frequency range from 5 to 15 Megacycles.
3. Improved rise time of .035 microseconds.

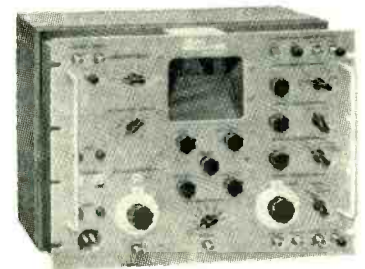

4. New Input impedance without probe—1 Megohm. With Probe—10 Megohms.

5. Continuous trigger rate permits selection of any rate from 10 cycles to 10 Kilocycles. For further information, write Lavoie Laboratories, Morganville, New Jersey.

Lavoie
Laboratories
Inc.

MORGANVILLE, NEW JERSEY

Visit us at Booths 1-126 and 1-127—Radio Engineering Show

ing; and Guy Therien, secretary.

Mr. Niedringhaus has been sales manager of Sylvania's lighting division in the Cleveland, Ohio district since 1947. Mr. Harrison also is treasurer of Sylvania Electric Products Inc. Mr. O'Keefe has been plant manager at Drummondville since 1949 and Mr. Therien joined the Canadian corporation in the same year as supervisor of plant accounting, becoming office manager in 1951.

The company is now building a large new plant in Drummondville, Canada to produce electronic devices for Canadian defense purposes.

Law Joins CBS-Hytron As Assistant to V-P

CHARLES F. STROMEYER, vice-president in charge of manufacturing and engineering of Hytron Radio & Electronics Co., announced the appointment of Dr. Russell R. Law as his assistant. He will advise Mr. Stromeier on special technological problems.

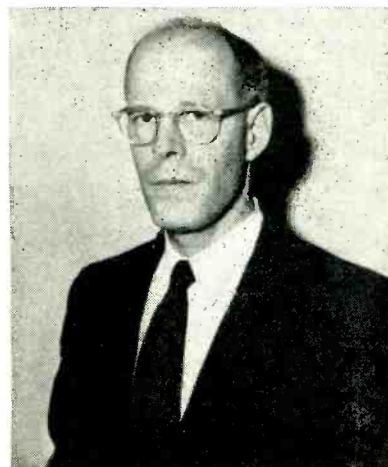

Russell R. Law

During the last eighteen years, Dr. Law has been with RCA in Harrison and Princeton. Among his contributions are improvements in electron optics, projection screens and tri-color picture tubes. More recently, he has devoted his efforts to color television and semiconductor.

Sarkes Tarzian Expands

THE RECTIFIER DIVISION of Sarkes Tarzian, Inc., is expanding its facilities by adding a two-story struc-



CONNECTOR news

MINIATURE, SUB-MINIATURE AND POWER PRECISION CONNECTORS

NEW SUB-MINIATURE 30% SMALLER Without Sacrificing Pin Diameter

Here's the way to solve your sub-miniature connector problems without getting the usual complaints from Production because of special sub-standard wiring requirements, misalignment due to bent or broken contacts, and damaged moldings.

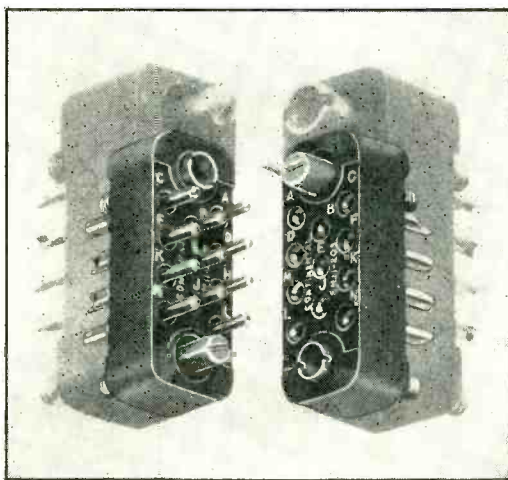

.040 DIAMETER CONTACT PINS

Although the unit itself is a full 30% smaller than our Series 20 miniature Connectors, the Continental Sub-Miniature Rectangular Series SM-20 Connectors feature the same husky .040 diameter contact pins — precision machined phosphor bronze and assembled in a unique floating arrangement to insure self-alignment of each individual contact for reduced engagement and disengagement force. POSITIVE POLARIZATION is achieved with the use of a reversed guide pin and guide socket.

NO SPECIAL WIRING NECESSARY

This new SM-20 Series, the only sub-miniaturized connector that will stand up under a continuous 5 amp. operation, requires no special wiring. Unlike other sub-miniatures, SM-20's use #20 AWG wire, thus avoiding the necessity for soldering sub-standard wires.

24 HOUR DELIVERY ON A VARIETY OF STOCK CONNECTORS

SM-20's presently can be supplied within 24 hours with either 11 or 20 contacts, and a choice of molding compounds... choice of mineral filled flame-resistant, high strength Melamine insulation, Plaskon glass reinforced alkyd type 440A, or Diallyl Phthalate type 1-501. All these stock SM-20 models have been designed to withstand the same adverse field conditions under which the popular miniature Continental Series 20 has been tested and approved by leading manufacturers.

CUSTOM MODELS AVAILABLE

Our engineering staff will be pleased to discuss your particular sub-miniature application problems. Sub-miniature connectors other than our stock designs delivered within 6 weeks. Please write for Bulletin S-M to DeJur Amsco Corporation, Dept. E-1, 45-01 No. Blvd., Long Island City 1, N. Y.

VISIT US AT BOOTH 4-125, I.R.E. SHOW



Continental Connectors

DeJUR AMSCO CORPORATION
LONG ISLAND CITY 1, NEW YORK

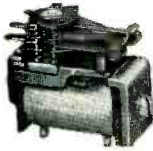

*a rugged little
space saver...*

MIDGET TELEPHONE TYPE RELAYS SERIES (80)—OPEN TYPE FOR SURFACE MOUNTING, OR IN HERMETICALLY SEALED CONTAINERS

This vibration and shock-proof Midget Type Relay is the answer to numerous applications where unailing operation is necessary. In fact, it is built to meet rigid Army and Navy specifications. This "rugged little space saver" is a compact, multiple contact relay which has been developed over years of specialized engineering in the field by Signal Engineering and Mfg. Co., manufacturers of a comprehensive line of relays and signals of various designs and sizes.

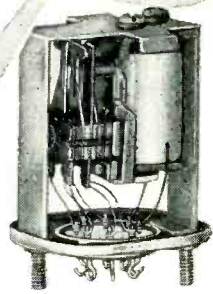

Write for Bulletin MTR-6

Engineering Representatives in Principal Cities.



ELECTRONICS SALES AND APPLICATION ENGINEERS

High-Frequency Heating, Microwave Communication, V.H.F. Communication, Power-Line Carrier and Military Communication and Radar Equipment

The expanding Electronics Division of Westinghouse has a number of desirable sales and application engineering positions open for men well qualified in one or more of the above fields. These openings require technical graduates with good personalities and business sense, men who like to meet people and work with them on a broad range of equipment application problems rather than specializing in a narrow field of design. Previous technical sales experience is desirable but not necessary.

Permanent positions are available at Headquarters (Baltimore) as well as in various sales offices throughout the country. The latter positions generally require training at Headquarters for a period depending on previous experience.

All these positions offer top pay, commensurate with ability and experience, with excellent opportunity for advancement on merit. They carry the usual generous employee benefits offered by Westinghouse—low-cost group life and hospitalization insurance, an excellent retirement plan, graduate study opportunities and paid vacations. Re-location allowances will be made by the Company.

Send resume of qualifications to:

Manager, Industrial Relations, Dept. CK
Westinghouse Electric Corporation
41 Hopkins Place
Baltimore 1, Md.

DeJUR

EXTERNAL PHASING C-200 Potentiometers



- MULTIPLE GANGING
- INDIVIDUAL EXTERNAL PHASING
- POSITIVE INTERLOCK
- PRECISION MACHINED ANODIZED ALUMINUM CASE
- ADJUSTABLE TAPS WITHIN $\pm 1/2^\circ$

Designers are invited to submit their applications to DeJur engineers for recommendations and suggestions.

- 2" Diameter
- 4 Watts Fully Enclosed
- 10 to 200,000 Ohms Accuracy up to 1%
- Linearity up to 0.3%
- Non Linear Windings
- 360° (Continuous) Mechanical Rotation
- 320° Electrical Rotation
- Taps as Required
- High Resolution 1,000,000 Cycles Operational Life
- Precious Metal Contacts
- Low Torque 1 oz. inch
- Centerless Ground Stainless Steel Shafts
- Ball Bearings to Special Order
- Single or Ganged Units
- Servo Type Mounting or Single Hole Threaded Bushing
- Numerous Shaft Designs

WRITE FOR BULLETIN E-3



DeJUR AMSCO CORPORATION

45-01 NORTHERN BOULEVARD, L. I. C. 1, N. Y.

KENYON

SPECIAL Transformers

Have Many Applications

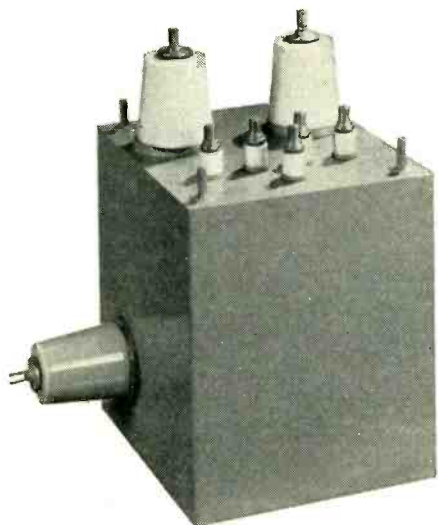

Kenyon oil-filled hermetically sealed transformers have particular application to pulse and high voltage plate transformers and to charging reactors.

They are specially valuable for reactors and plate transformers operating on 400 cycle or higher frequency primary supply voltage.

Because of their internal characteristics oil-filled transformers present different problems from conventional types. Cases must be correctly designed, terminals properly constructed and sealing methods highly efficient to eliminate oil leakage. Kenyon has successfully solved these problems.

The result is a unit with high quality insulation, small in size yet possessing excellent life and exceptional dependability.

Because of substantial savings in size and simplicity of insulation, use of Kenyon Oil-Filled Transformers frequently results in lower final cost.

Booth No. 1-615, I.R.E. Show



No matter what your transformer requirements may be contact Kenyon first. Our engineers will endeavor to show you how you can increase efficiency at low cost by choosing a transformer from the complete Kenyon line.

KENYON TRANSFORMER CO., Inc.

840 Barry Street, New York 59, N. Y.

ture to the present plant. It will contain approximately 20,000 sq ft of floor space. This additional space will be used to make more rectifiers for the radio and television industries and to take care of increased government requirements. When this building is completed the production output can be doubled.

Guided Missiles And Atomic Energy Appointments Made

WALTER G. WHITMAN, chairman of the Research and Development Board of the Department of Defense, announced two appointments on the RDB Committees on Guided Missiles and on Atomic Energy.

James C. Starks, who is on leave from the Sandia Corp., has been named executive director of the Atomic Energy Committee of RDB.

Allen E. Puckett, head of the aerodynamics section of the Hughes Aircraft Company, has been appointed to the Committee on Guided Missiles.

Beacon Plans To Open Plants In Australia

BEACON CORP. of Chicago is planning to open factories in Sydney and Adelaide, Australia, to manufacture television receivers and antennas. The firm is negotiating with the Australian Federal Government for permission to do so. If permission is granted, a subsidiary company with some Australian participation would be created. A standard tv receiver would cost \$225 and smaller ones about \$160 in the country.

At least 4 Australian manufacturers of wireless equipment have also advanced plans for the local production of tv sets and equipment.

Consolidated Engineering Names Nunan V-P

J. KNEELAND NUNAN has been elected vice-president in charge of sales of Consolidated Engineering Corp. and executive vice-president of CEC Instruments, Inc., a wholly-owned subsidiary. Phillip S. Fogg, president of Consolidated, made the announcement.

The Pasadena firm's recent purchase of the vacuum equipment department of Eastman Kodak Co.'s

ELECTRONICALLY REGULATED
**LABORATORY
POWER SUPPLIES**



BENCH MODEL 50

• STABLE
• DEPENDABLE
• MODERATELY PRICED

ALSO AVAILABLE
STANDARD
RACK
MOUNTING

MODEL 50-R
PANEL SIZE
10 1/2" x 19"
DEPTH 14 1/2"

- **INPUT:** 105-125 VAC, 50-60c
- **OUTPUT #1:** 0-500 VDC at 500 ma regulated
- **OUTPUT #2:** 0-50 VDC, 0-200 VDC Bias Output.
- **OUTPUT #3:** 6.3 VAC at 5A unregulated
- **OUTPUT #4:** 6.3 VAC at 5A unregulated
- **RIPPLE OUTPUT:** Less than 8 millivolts rms

For complete information write for Bulletin 50S



LAMBDA ELECTRONICS
CORPORATION
CORONA NEW YORK

ELECTRONICALLY REGULATED
**LABORATORY
POWER SUPPLIES**



GRAND CENTRAL PALACE
NEW YORK CITY

**BOOTH
3-501**

VISIT OUR DISPLAY
OF CURRENT AND
NEW MODELS



LAMBDA ELECTRONICS
CORPORATION
CORONA NEW YORK

ELECTRONICALLY REGULATED
**LABORATORY
POWER SUPPLIES**



**BENCH
MODEL 25**

• STABLE
• DEPENDABLE
• MODERATELY PRICED

WIDTH 14"
DEPTH 6"
HEIGHT 8"
WT: 17 LBS.

- **INPUT:** 105 to 125 VAC, 50-60 cy
- **OUTPUT #1:** 200 to 325 Volts DC at 100 ma regulated
- **OUTPUT #2:** 6.3 Volts AC CT at 3A unregulated
- **RIPPLE OUTPUT:** Less than 10 millivolts rms

For complete information write for Bulletin E-5S



LAMBDA ELECTRONICS
CORPORATION
CORONA NEW YORK

ELECTRONICALLY REGULATED
**LABORATORY
POWER SUPPLIES**



RACK MODEL 32

• STABLE
• DEPENDABLE
• MODERATELY PRICED

STANDARD
RACK
MOUNTING
PANEL SIZE
10 1/2" x 19"
DEPTH 9"
WEIGHT 38 LBS

- **INPUT:** 105 to 125 VAC, 50-60 cy
- **OUTPUT #1:** 200 to 325 VDC at 300 ma regulated
- **OUTPUT #2:** 6.3 Volts AC CT at 5A unregulated
- **OUTPUT #3:** 6.3 Volts AC CT at 5A unregulated
- **RIPPLE OUTPUT:** Less than 10 millivolts rms

For complete information write for Bulletin E-2S



LAMBDA ELECTRONICS
CORPORATION
CORONA NEW YORK

ELECTRONICALLY REGULATED
**LABORATORY
POWER SUPPLIES**



• STABLE
• DEPENDABLE
• MODERATELY PRICED

MODEL 28
STANDARD
RACK
MOUNTING
PANEL SIZE
5 1/2" x 19"
WEIGHT 16 LBS.

- **INPUT:** 105 to 125 VAC, 50-60 cy
- **OUTPUT #1:** 200 to 325 Volts DC at 100 ma regulated
- **OUTPUT #2:** 6.3 Volts AC CT at 3A unregulated
- **RIPPLE OUTPUT:** Less than 10 millivolts rms

For complete information write for Bulletin E-8S



LAMBDA ELECTRONICS
CORPORATION
CORONA NEW YORK

ELECTRONICALLY REGULATED
**LABORATORY
POWER SUPPLIES**



RACK MODEL 33

• STABLE
• DEPENDABLE
• MODERATELY PRICED

STANDARD
RACK
MOUNTING
PANEL SIZE
10 1/2" x 19"
DEPTH 9"
WEIGHT 38 LBS

- **INPUT:** 105 to 125 VAC, 50-60 cy
- **OUTPUT #1:** 100 to 200 VDC at 300 ma regulated
- **OUTPUT #2:** 6.3 Volts AC CT at 5A unregulated
- **OUTPUT #3:** 6.3 Volts AC CT at 5A unregulated
- **RIPPLE OUTPUT:** Less than 10 millivolts rms

For complete information write for Bulletin E-3S



LAMBDA ELECTRONICS
CORPORATION
CORONA NEW YORK

NO OTHER SOURCE CAN MATCH
RAYTHEON'S Complete Facilities
 for Designing and Producing

TOROIDS

Over 10 Years' Experience in Designing and
 Building Toroid-L Units

TOROID-L-COILS

Designed from the problem up, or wound to specified C, L and Q values. Precision wound on temperature stabilized, powdered permalloy cores, high permeability solid materials or stamped "O" cores. Able to wind #20 to #42 wires on "wedding ring" cores to small ultimate I.D. Facilities for all types of winding, including square coils wound from strip materials for improved geometry.

TRANSFORMERS

Multiple wound and tapped . . . cased or uncased . . . for all commercial and military applications.

FILTER NETWORKS

Complete networks for audio or ultra-sonic work.

LITZ-WOUND TOROIDS

One of the very few sources equipped for litzendraht coil windings.

LUMPED PARAMETER DELAY LINES

For time-measuring applications.

MAGNETIC AMPLIFIER COILS

For complete servomechanism and other magnetic amplifiers.



Excellence in Electronics

OTHER RAYTHEON
 PRODUCTS INCLUDE:

MARINERS PATHFINDER* radar; Submarine Signal FATHOMETERS*; Marine radio-telephones; WELDPower* welders; Voltage stabilizers (regulators); Transformers; Recti-Charger* battery chargers; RectiFilterR* battery eliminators; Sonic oscillators for laboratory research; Standard control knobs; Electronic calculators and computers; Television receivers; Radio, television, subminiature and special purpose tubes; MICRO-THERM* diathermy and other electronic equipment.
 *Reg. U. S. Pat. Off.

Raytheon welcomes inquiries from manufacturers and design engineers for specific information. Immediate attention given to all problems submitted. Complete facilities for engineering design and production of models as well as large volume production.

RAYTHEON
 MANUFACTURING COMPANY
 EQUIPMENT SALES DIVISION
 DEPT. 6270-A, WALTHAM 54, MASSACHUSETTS

DISTRICT OFFICES: BOSTON, NEW YORK, CLEVELAND, CHICAGO, NEW ORLEANS, LOS ANGELES (WILMINGTON), SAN FRANCISCO, SEATTLE
 INTERNATIONAL DIVISION: 19 RECTOR STREET, NEW YORK CITY

Distillation Products Industries is expected to boost its annual sales volume, currently running between \$8 million and \$8.5 million, to approximately \$15 million by the end of 1953. An immediate responsibility of Nunan's will be to coordinate and administer this sales expansion.

New Company To Make UHF Equipment

GRANCO PRODUCTS, INC., a new company in the electronics field, has been organized to design, manufacture and distribute uhf converters and uhf measuring instruments. Production will begin at a 10,000 sq ft plant in Long Island City, N. Y. The new company was formed to meet the increasing demand for uhf converters.

Henry Fogel, formerly manager



Henry Fogel

of commercial products division of the Radio Receptor Co., Inc., has been appointed president of the new firm. As manager at Radio Receptor he directed the development and production of uhf tuners and industrial tv devices.

RTMA Makes Staff Changes

Two promotions and a staff addition at RTMA headquarters were announced recently by executive vice-president James D. Secrest.

Peter H. Cousins, who has been information director of RTMA for several years, has been appointed special assistant to Mr. Secrest and staff assistant to the technical

Just a Few of The
Many Items We Carry

TUBES

1619.....	.35	717A.....	1.49
801A.....	.39	250TH.....	17.95
2J531.....	5.95	845.....	5.50
6X34/2C34.....	.45	WL460.....	13.95
837.....	1.39	803.....	3.75
1629.....	.39	3FP7.....	2.75
1625.....	.35	CK1005.....	1.95
615.....	4.95	724A.....	2.95
1203A.....	.49	724B.....	2.95
2J50.....	24.50	815.....	3.50

100TH... \$7.95

DC9 CRYSTALS
1000 Kc for BC 221 Frequency Meters. Brand New, Guaranteed **\$15.95**

Transmitting Crystals in CR1 Holders

4970 Kc	5660 Kc	69¢ Each
5080 Kc	7010 Kc	
5570 Kc	7440 Kc	
	7810 Kc	

Sockets for above Crystals... 19¢
Call or write us for your requirements.
Prompt delivery assured.

MICHAEL STAHL Inc.
215 Fulton St.
New York 7 New York
Tel. WOrth 4-2882

FOR MARKING...



**PLASTIC • METAL
GLASS • PAPER
RUBBER • CERAMIC
CARDBOARD**

in such products as Resistors, capacitors, valves, tubes, labels, sleeves, spark plugs, cartons, etc., etc.

THESE PRODUCTS AND MANY OTHERS OF ALMOST ANY MATERIAL AND SHAPE CAN BE IMPRINTED

ON THE

REJAFIX MARKING MACHINE

Why not send us samples of your products? They will be test-printed and returned to you for your examination!

- REJAFIX HAND-OPERATED MODELS FOR SMALL RUNS. FULLY AUTOMATIC MODELS FOR MASS PRODUCTION.

EST. 1922

POPPER & SONS INC. 300 FOURTH AVENUE
NEW YORK 10, N. Y.

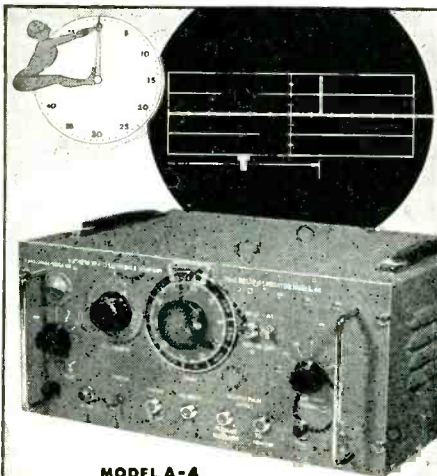

MODEL A-4 TIME DELAY GENERATOR

- A precision device for the generation of accurate and variable time intervals from .00001 to .10 seconds.
- Also available: Model A-2—.8 to 100,000 μs.

Write for complete data:
Our bulletins E-A-4 and E-A-2

Rutherford ELECTRONICS CO.

3707 S. ROBERTSON BLVD., CULVER CITY, CALIF.

quality
"precision" LEADS

of
TUNGSTEN
MOLYBDENUM
NICKEL
NICKEL-CLAD
COPPER
and ALLOYS

quality
hand-wound COILS

of Tungsten and Molybdenum

quality
MACHINED TUBE COMPONENTS
to customers' specifications

SEND US YOUR BLUEPRINTS or SPECIFICATIONS FOR QUOTATIONS!

ELECTRONIC PARTS MANUFACTURING CO., Inc.
508 25th St., Union City, N. J.

VISIT BOOTH 3-508 IRE SHOW, GRAND CENTRAL PALACE

Electronic Parts Manufacturing Co., Inc.
508 25th St., Union City, N. J.
Send me copy of your brochure.
Name.....
Address.....

Autosyn*

SYNCHROS

Precision-Built by

ECLIPSE-PIONEER

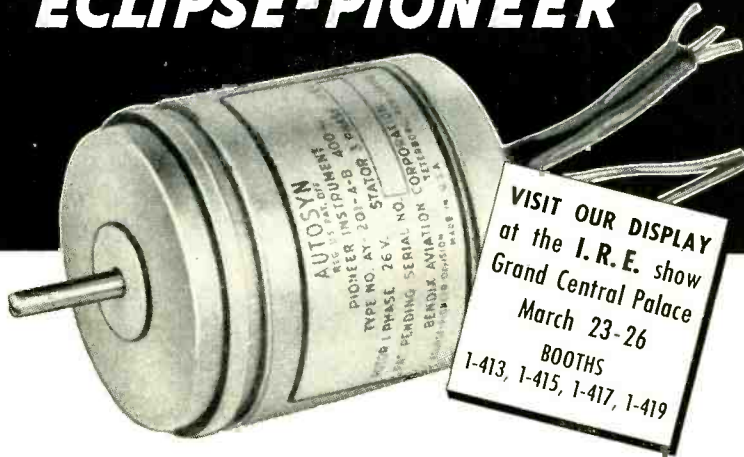

For more than 18 years, Eclipse-Pioneer has been a leader in the development and production of high precision synchros for use in automatic control circuits of aircraft, marine and other industrial applications. Today, thanks to this long experience and specialization, Eclipse-Pioneer has available a complete line of standard (1.431" dia. X 1.631" lg.) and Pygmy (0.937" dia. X 1.278" lg.) Autosyn synchros of unmatched precision. Furthermore, current production quantities and techniques have reduced cost to a new low. For either present or future requirements, it will pay you to investigate Eclipse-Pioneer high precision at the new low cost.

*REG. TRADE MARK BENDIX AVIATION CORPORATION

AVERAGE ELECTRICAL CHARACTERISTICS—AY-200 SERIES**

	Type Number	Input Voltage Nominal Excitation	Input Current Milliamperes	Input Power Watts	Input Impedance Ohms	Stator Output Voltages Line to Line	Rotor Resistance (DC) Ohms	Stator Resistance (DC) Ohms	Maximum Error Spread Minutes
Transmitters	AY201-1	26V, 400~, 1 ph.	225	1.25	25+j115	11.8	9.5	3.5	15
	AY201-4	26V, 400~, 1 ph.	100	0.45	45+j225	11.8	16.0	6.7	20
Receivers	AY201-2	26V, 400~, 1 ph.	100	0.45	45+j225	11.8	16.0	6.7	45
Control Trans- formers	AY201-3	From Trans. Autosyn	Dependent Upon Circuit Design				42.0	10.8	15
	AY201-5	From Trans. Autosyn	Dependent Upon Circuit Design				250.0	63.0	15
Resolvers	AY221-3	26V, 400~, 1 ph.	60	0.35	108+j425	11.8	53.0	12.5	20
	AY241-5	1V, 30~, 1 ph.	3.7	—	240+j130	0.34	239.0	180.0	40
Differentials	AY231-3	From Trans. Autosyn	Dependent Upon Circuit Design				14.0	10.8	20
**Also includes High Frequency Resolvers designed for use up to 100KC (AY251-24)									
AY-500 (PYGMY) SERIES									
Transmitters	AY503-4	26V, 400~, 1 ph.	235	2.2	45+j100	11.8	25.0	10.5	24
Receivers	AY503-2	26V, 400~, 1 ph.	235	2.2	45+j100	11.8	23.0	10.5	90
Control Trans- formers	AY503-3	From Trans. Autosyn	Dependent Upon Circuit Design				170.0	45.0	24
	AY503-5	From Trans. Autosyn	Dependent Upon Circuit Design				550.0	188.0	30
Resolvers	AY523-3	26V, 400~, 1 ph.	45	0.5	290+j490	11.8	210.0	42.0	30
	AY543-5	26V, 400~, 1 ph.	9	0.1	900+j2200	11.8	560.0	165.0	30
Differentials	AY533-3	From Trans. Autosyn	Dependent Upon Circuit Design				45.0	93.0	30

For detailed information, write to Dept. C.

ECLIPSE-PIONEER DIVISION of
TETERBORO, NEW JERSEY



Export Sales: Bendix International Division, 72 Fifth Avenue, New York 11, N. Y.

products division.

Tyler Nourse, who served as assistant information director under Mr. Cousins, has been promoted to the position of editorial director in charge of RTMA publications.

Herbert F. Hodge, Jr., formerly in government information service, has joined RTMA headquarters staff as an editorial assistant to Mr. Nourse.

The staff reorganization was effected following the resignation of R. M. Haarlander, who has served as staff assistant to the technical products division for the past five years. Mr. Haarlander resigned to take a position in private industry,

Carpenter Forms Summit Engineering Co.

DOUGLAS H. CARPENTER, president, announced the establishment of Summit Engineering Co., Hartford, Conn., for the manufacture of television antennas and electronic equipment.



Douglas H. Carpenter

Mr. Carpenter holds many basic patents in antenna design and electronics circuitry. His business experience includes 5 years as chief engineer of the McMurdo Silver Co. and several years in a similar capacity with the LaPointe-Plascomold Corp.

ERCO Apoints Greene V-P And General Manager

BOARD of directors of the Engineering and Research Corp. announced the appointment of William L. Greene as vice-president of engineering, and general manager.

As chief engineer, Mr. Greene assumed the leadership in organiz-

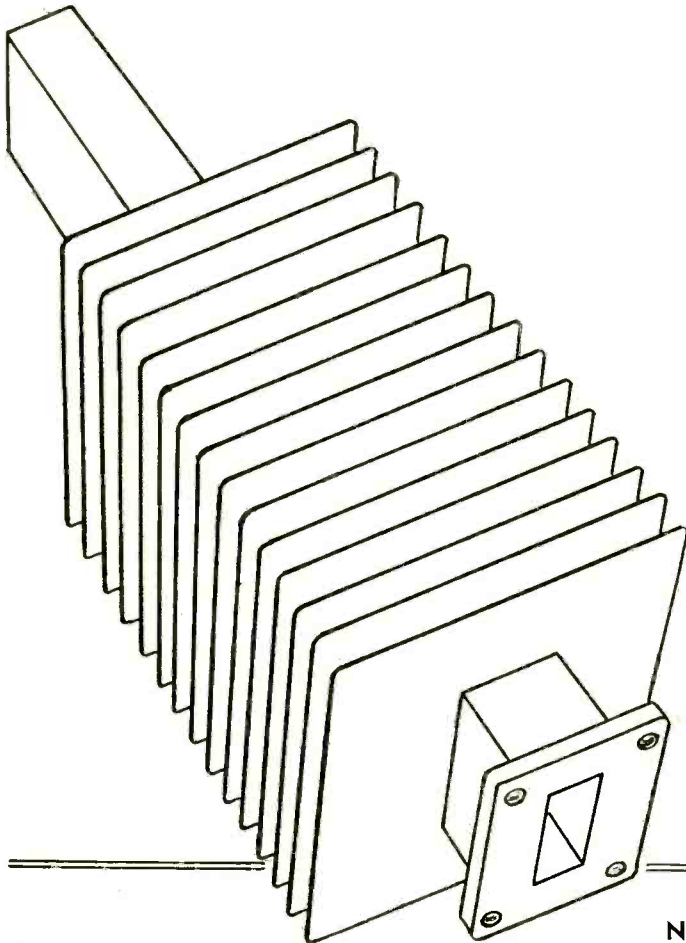

New Ceramic Lossy Material Stable Up to 2000°F Means Greater Efficiency in These Waveguide, High Power Terminations, and Attenuators

"Eilex", a new ceramic lossy material, is now available in waveguide, high power terminations and attenuators from Electro-Impulse Laboratory.

This new material is extremely durable, provides a strong adhesive bond to waveguide walls, withstands temperatures up to 2000°F, and handles the thermal shock efficiently.

Eilex is stable up to 2000°F (doesn't emit steam or water, characteristic of dummy loads using a Portland cement and graphite mixture for the lossy material.)

The waveguide loads use walls that are poor conductors, which means

a more efficient removal of the heat generated in the load, and less tendency toward pulsepower breakdown (arcing) as may occur in designs which use filling material in the waveguide.

New construction shortens path between inner surface of lossy guide to heat conducting material.

Hot spots have been eliminated.

Attenuators are accurately calibrated and may be used as a termination and power measuring device in conjunction with a thermister bridge.

For details, write Department "E".

Type	Freq Range KMC	Waveguide in inches	Nominal* Average Power Dissipation	Maximum V.W.S.R.	Size in inches	Weight	Flange
DUMMY LOADS							
HPTK100	18-26.50	1/2 x 1/4	60 W.	1.15	8 long	2 lbs.	UG425/U
DA22/U	8.2-12.4	1.2 x 1	175 W.	1.15	11 x 2.5 x 2.5	3 lbs.	UG39/U
HPTXS250	8.2-12.4	1/2 x 1	250 W.	1.15	11 x 3.5 x 3.5	3 1/4 lbs.	UG39/U
HPTXS150	8.2-12.4	1/2 x 1	150 W.	1.15	11 x 2.5 x 2.5	3 lbs.	UG39/U
HPTXS75	8.2-12.4	1/2 x 1	75 W.	1.15	11 long	2 1/2 lbs.	UG39/U
DA21/U	7-10	1 1/4 x 5/8	280 W.	1.15	11.5 x 3.5 x 3.5	6 lbs.	UG51/U
HPTXL250	7-10	1 1/4 x 5/8	250 W.	1.15	12 x 3.5 x 3.5	3 1/4 lbs.	UG51/U
HPTXL200	7-10	1 1/4 x 5/8	200 W.	1.15	11.25 x 2.75 x 2.75	2 lbs. 4 oz.	UG138/U
HPTXL100	7-10	1 1/4 x 5/8	100 W.	1.15	10 long	2 lbs.	UG51/U
HPTXL500	7-10	1 1/4 x 5/8	450 W.	1.15	11.25 x 4.5 x 4.5	5 1/4 lbs.	UG51/U
HPTX600	5.85-8.20	1 1/2 x 3/4	600 W.	1.15	14 long	8 lbs.	UG344/U
HPTX800	3.95-5.85	2.00 x 1.00	800 W.	1.15	14 long	12 lbs.	UG149A/U
TS 338	2.4-3.7	1.5 x 3	700 W.	1.1	24 x 5.4 x 5.4	13 lbs.	UG438/U
HPTS1500	2.60-3.95	3.00 x 1.50	1500 W.	1.15	25 long	13 lbs.	UG438/U
HPTLI500	1.70-2.60	4.46 x 2.31	1500 W.	1.15	15 long	20 lbs.	UG435/U
HPTL2000	1.12-1.70	6.66 x 3.41	2000 W.	1.15	32 long	24 lbs.	UG417/U
ATTENUATORS							
HPAXS	8.2-12.4	1.2 x 1.00	250 W.	1.15	Attenuation 2-60 decibels (fixed)		UG39/U
HPAXL	7.00-10	1 1/4 x 5/8	450 W.	1.15	Attenuation 2-60 decibels (fixed)		UG51/U

* Without the use of water or forced air cooling.

ELECTRO IMPULSE Laboratory

62 WHITE STREET • RED BANK, N.J.
RED BANK 6-0404

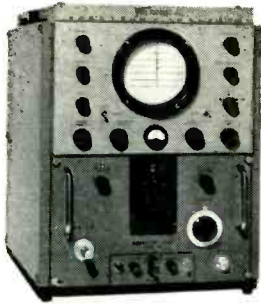

.....
VECTRON'S
NEW Microwave
SPECTRUM
ANALYZER

.....**The**.....
Operating
Frequencies
YOU Need

... provides a wide choice of operating frequencies in a single, compact unit.

... eliminates the unnecessary bulk and extra cost of equipment which covers large areas in bands you never use.

SPECIFIC BAND COVERAGE to fulfill your particular requirements is readily available with separate, interchangeable R. F. Heads.

INTERCHANGEABLE R. F. HEADS are easily installed and removed from the Vectron chassis. Separate heads are supplied in convenient, protective storage cases. S-band and X-band Heads from stock; others available for early delivery.

For Microwave Radar and Communications Equipment
 The Vectron SA20 Spectrum Analyzer presents visually the frequency distribution spectrum of the power output of pulsed or CW microwave oscillators and can be used as a sensitive RF detector for checks and measurements in the design, production and maintenance of microwave radar and communications equipment and components.

FEATURES

- Large, clear 5" oscilloscope pattern
- Standard bezel to accept camera, hood or filter
- Minimum number of controls . . . maximum operating convenience
- Double conversion assures I. F. alignment stability
- Built in regulated supply for Klystron oscillators
- Easy access for maintenance or adjustment

SPECIFICATIONS

- Overall Gain** — 130 decibels.
- Sensitivity** — Approx. —60dbm for 1 usec. pulse width.
- IF Bandwidth** — Choice of 50 kc, recommended for CW and 0.2 to 2 usec. pulse widths, or 20 kc. bandwidth to 5 usec.
- Sweep Frequency** — 10 to 30 cps standard — available to 2 cps and with long persistence tube.
- Power Requirements** — 105 to 125 volts, 60 cycles.



Vectron's development program includes additional R. F. Heads to cover microwave frequencies newly opened for military and civilian use. For information on these additional R. F. Heads and for complete engineering and operating data, send for Bulletin SA20. Write today and be sure to specify the operating frequencies you need.

VECTRON also offers custom design and production facilities for development and contract manufacture of servo-mechanisms, communication networks and filters, gyro-mechanisms, electronic systems, electro-mechanical equipment and instrumentation. Write us today and specify your requirements.

VECTRON, inc.



Electronic and Electro-Mechanical Equipment

404 MAIN STREET, WALTHAM 54, MASS.

ing and equipping the company for its entry into the electronic flight simulator field. Following the successful completion of the first Flightronic simulators, Mr. Greene was appointed vice-president of engineering. He began his career with ERCO more than fifteen years ago as an aeronautical engineer.

Norde Joins Hammarlund As Chief Receiver Engineer

LESLIE NORDE has joined the Hammarlund Manufacturing Co., Inc. as chief receiver engineer after nearly 5 years at the Northern Radio Corp. where he was senior project engineer, it has been announced by S. H. Van Wambeck, chief engineer of Hammarlund.



Leslie Nord

In his new position Norde is supervisor and technical consultant for the design of Hammarlund commercial and amateur radio receivers. At Northern Radio he supervised the designing of space diversity receivers and carrier shift radio teletype transmitting equipment.

Mallory Forms Electronic Equipment Department

TO MEET increasing demand for electronic products by both the consumer and the military, P. R. Mallory & Co. Inc., Indianapolis has created a new electronic equipment department to manufacture special assemblies, including complete electronic systems.

Named as manager of the new department is Joseph C. Rah, for-

S.S. White MOLDED RESISTORS

The All-Weather Resistors

Of particular interest to all who need resistors with inherent low noise level and good stability in all climates



TYPE 65X

Actual Size

STANDARD RANGE
1000 OHMS TO 9 MEGOHMS

Used extensively in commercial equipment including radio, telephone, telegraph, sound pictures, television, etc. Also in a variety of U. S. Navy equipment.

HIGH VALUE RANGE
10 to 10,000,000 MEGOHMS

This unusual range of high value resistors was developed to meet the needs of scientific and industrial control, measuring and laboratory equipment—and of high voltage applications.

SEND FOR BULLETIN 4906

It gives details of both the Standard and High Value resistors, including construction, characteristics, dimensions, etc. Copy with Price List mailed on request.



THE S.S. White INDUSTRIAL DIVISION
DENTAL MFG. CO. Dept. R, 10 East 40th St.



NEW YORK 16, N. Y.

Western District Office • Times Building, Long Beach, California

ELECTRIC INSTRUMENT & CONTROL HEADQUARTERS

YES, OFF-THE-SHELF SERVICE



Electro-Tech maintains one of the largest and most complete stocks in the country of electrical meters, instruments and industrial control equipment—representing over 250 top lines.

Yes, our warehouse is bulging with standard stocks of

- | | | |
|--------------------------|--------------|---------------------|
| Counters | Solenoids | Toggle Switches |
| Panel Meters | Tachometers | Shunts (Electrical) |
| Transformers | Thermometers | Meggers |
| Switchboard Meters | Thermostats | Solenoid Valves |
| Micro Switches | Rectifiers | Pyrometers |
| Photo Electric Equipment | Rheostats | Multimeters |
| Relays | Timers | Oscilloscopes |

and Laboratory Standard Instruments

In addition, we manufacture and stock **Special Test Equipment** • Electric Heating Units • Current Transformers • Pyrometers • Thermocouples • Rectifiers.

Our laboratory is available for repair work, rescaling, recalibration and special calibration of your electrical and industrial instruments. Often months are saved by rescaling and calibrating stock instruments to your specifications.

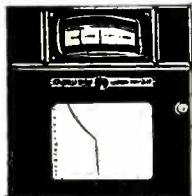

FOR SPEED
Wire — Code RDL
Teletype — NY 1-2906
Phone — BArlay 7-4209

CONSULT US ABOUT YOUR REQUIREMENTS

"The Industries Buying Guide" our GENERAL CATALOG E-15 FREE

ELECTRO-TECH EQUIPMENT CO.
55 LISPENARD ST., NEW YORK 13, N. Y.

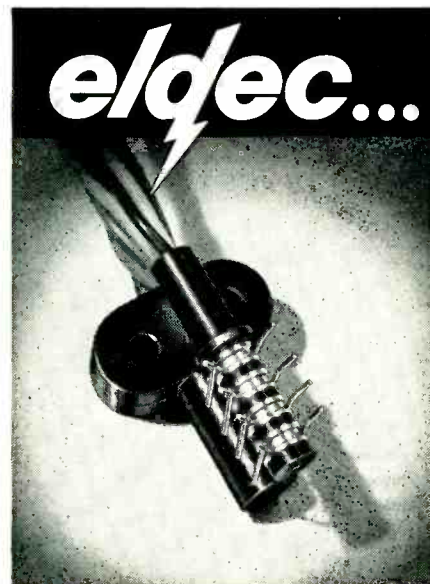

...the finest Slip Ring Assemblies made for Gyro Applications!

- Minimum 1250 V.A.C. hi-pot factory test
- Consistently lower cost
- Solid, turned rings of coined silver, platinum-silver or gold alloys
- Rings and leads spot-welded together to assure permanent connection
- Molded in one piece for maximum insulation, high dielectric strength
- Concentricity to .002" T.I.R.
- Rhodium or gold plating over solid silver for hardness, low noise level, low coefficient of friction
- Miniaturized to .023" (2 rings); .035" (3 rings); .060" (9 rings); etc.

Eldec's exclusive manufacturing process, using special thermo-plastic or thermo-setting materials, *guarantees* the outstanding features you demand. 1250 V.A.C. hi-pot test... low cost... no shorting or rejects because of residual plating solutions. To date, total rejects for all causes have been less than 1/2 of 1%! Compare Eldec units with any other type made. Feature by feature, Eldec sub-miniature Slip Rings are the best you can buy.

Brush Assemblies for Eldec Slip Rings are also available. (See picture at top.)



SYNCHRO, RESOLVER AND COMMUTATOR ASSEMBLIES

Eldec Units are available for synchros, resolvers, computers, guided missiles and other electronic applications.



WRITE TODAY... for complete data. Eldec specializes in miniaturization and insulation problems. We welcome your inquiries and will work with your engineers on the development of miniature units. Give detailed specifications.

ELECTRO DEVELOPMENT COMPANY

6006 West Washington Blvd. • Culver City, Calif.
NEW YORK • ROCHESTER • BRIDGEPORT • NEWTON
DETROIT • MILWAUKEE • CULVER CITY

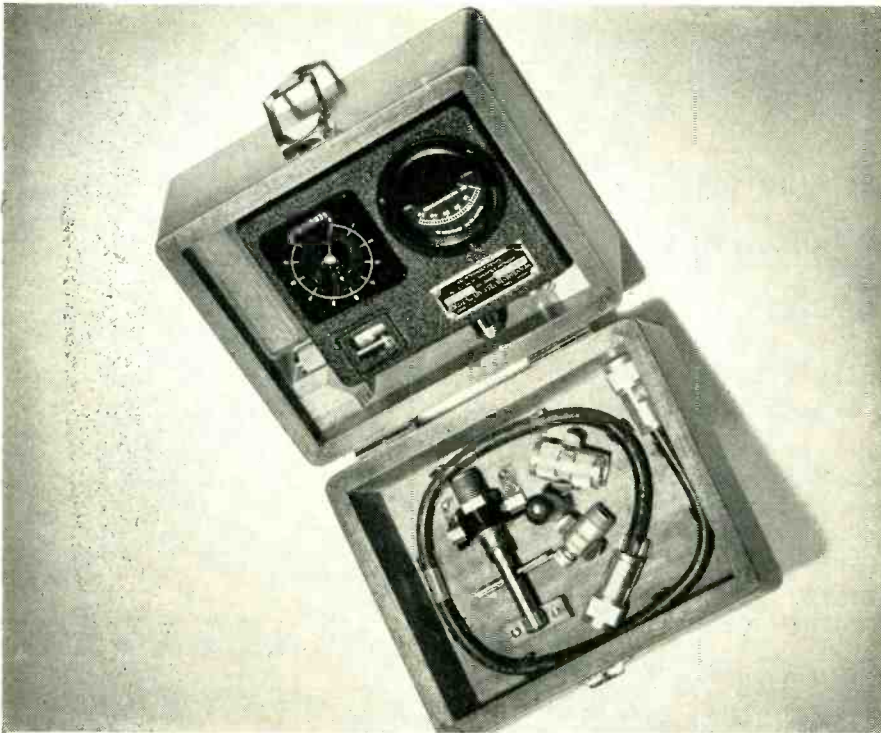

IF YOU USE MICROWAVES . . .
 This self-contained, compact, versatile
WAVEMETER TEST SET*
 can help you

Now, with one easy-to-carry instrument, you can determine the frequency of both pulsed and c-w microwave systems . . . you can make accurate measurements by both transmission and reaction methods. Because the new Wavemeter Test Set needs no external power source, it is ideal for field work—equally good for laboratory work! Its applicable range is from 2400 to 3400 megacycles. A low cost instrument—now in production, and used by U. S. Signal Corps as #TS-117/GP.

Write us today for bulletin giving complete technical data on the Wavemeter Test Set!

**Licensed under Sperry Patents.*

ELECTRONICS DIVISION

American Encaustic Tiling Co., Inc.
 904 Kenilworth Ave., Lansdale, Pa.

Gentlemen:

Please send your Technical Data Bulletin on the Wavemeter Test Set. No obligation, of course.

Name..... Title.....

Address.....

City..... Zone..... State.....

ELECTRONICS DIVISION
AMERICAN ENCAUSTIC TILING COMPANY
 904 Kenilworth Ave. Lansdale, Pa.

merly manager of the firm's switch division. Mr. Rah has been with the Mallory firm for 16 years, serving in engineering capacities throughout the company.

Dyson of Erie Resistor Honored By England

A. A. DYSON, managing director of Erie Resistor Ltd., has been included in Queen Elizabeth's New Years Honors List to receive the Order of British Empire, which is presented to civilians of the British Empire that have performed outstanding service to the Empire.

Mr. Dyson has been active during and since World War II on many British Government electronics planning and production boards.

Electronic Company Formed By Universal Match Corp.

A NEW electronic company, Unitronics, Inc., has been formed by Universal Match Corp. to replace Precision Engraving Company, also a subsidiary company.

Phillip Gilbert, director of graphic art research and development, and Theodore Hommel, chief electronic engineer, have been named vice-presidents of Unitronics. Mr. Hommel will be the company's general manager and Mr. Gilbert will be in charge of engineering and production.

The new company is manufacturing electronic light-integrating instruments and plans to introduce a new line of industrial electronic equipment later this year.

O'Neill Heads New Plant

WILLIAM O'NEILL JR. has been appointed plant manager of the new \$2 million battery factory of Sonotone Corp. at Cold Spring, N. Y.

Hickok Opens Plants

OFFICIAL opening of a new assembly plant of the Hickok Electric Instrument Co. in Cleveland recently took place. The \$200,000, one-floor modern factory houses assembly operations for electronic

LEAK-TIGHT

HERMETIC SEALING

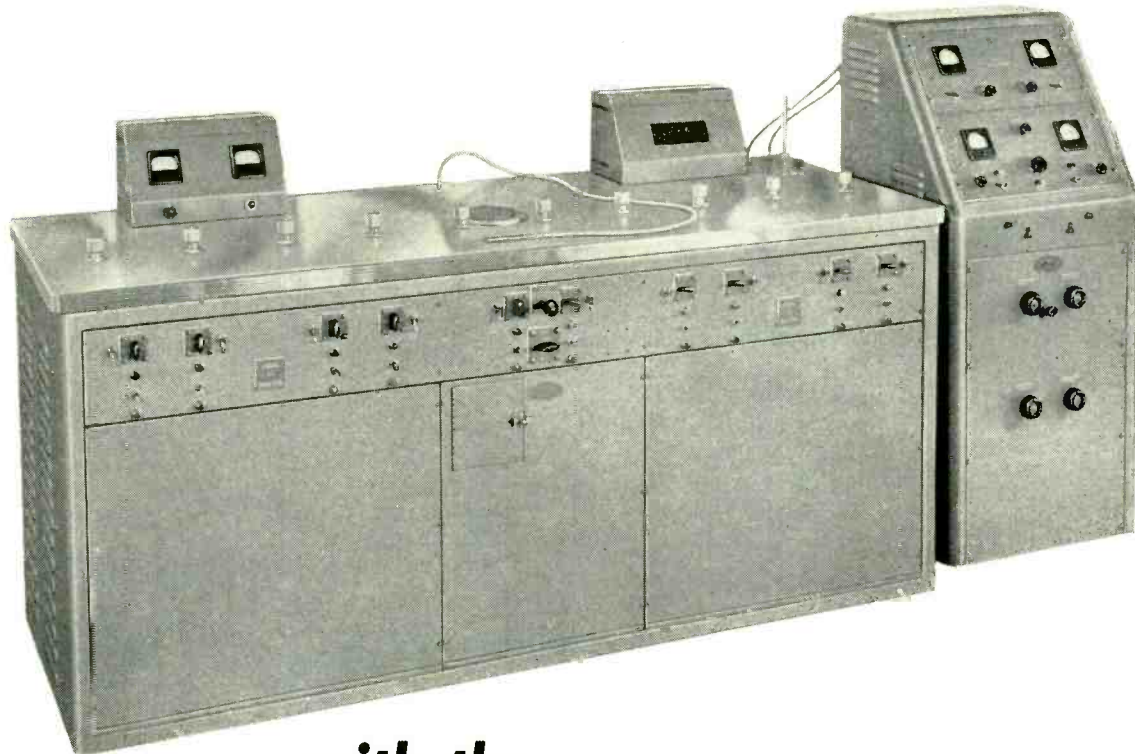

with the

VEECO ten-port manifold and leak detector

The equipment pictured above is a complete unit for evacuating, leak-testing, and back-filling hermetically sealed components such as relays, switches, amplifiers, electronic tubes, gyros and aircraft instruments.

The manifold simultaneously evacuates ten components; first with a rough pump, then a high vacuum diffusion pump. The vacuum process is monitored by self-contained gauges. If any leakage exists it is immediately located by the Veeco Leak Detector, proven to have the highest, constant sensitivity. After leak checking, components are filled with a suitable gas through separate filling lines.

Veeco Solenoid Vacuum Valves control pumping and filling operations. The valves are energized by switches on the front panel. The standard manifold has both local and master control, giving greatest flexibility. Each port can be operated by its own switch, or any number of ports can be controlled at one time with a master switch.

Both smaller and larger manifolds are available, built to your special requirements, if necessary.

Write for bulletin EM-3.



VACUUM-ELECTRONIC ENGINEERING CO.

86 Denton Avenue, New Hyde Park, Long Island, N. Y.

Now for the First Time . . .

Continuously Variable

Straight-sided Selectivity*

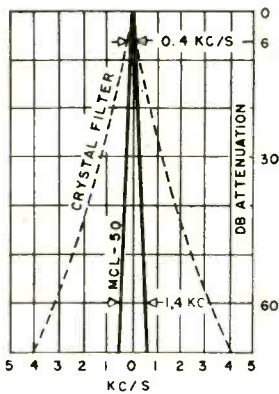

MINIMUM: The MCL-50 has 5 times more CW selectivity without "ringing" than 455 kc/s crystal-filter.

INFINITELY VARIABLE
0.4 kc/s to 6.0 kc/s

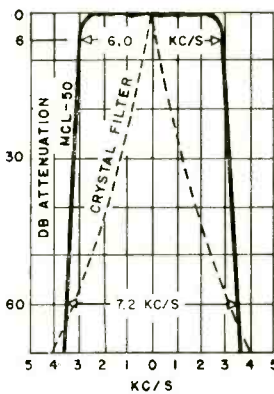

MAXIMUM: The MCL-50 has 15 times more useful speech bandwidth than 455 kc/s crystal-filter for same 60 db selectivity.

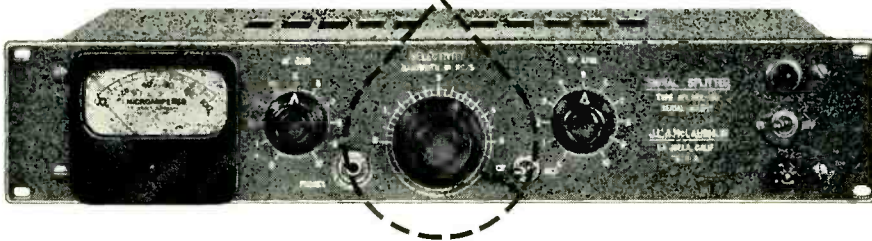

The McLAUGHLIN type MCL-50 SIGNAL-SPLITTER is the first and only selectivity converter deliberately designed to provide exact jam-free-bandwidths for every CW/SPEECH receiving conditions. It is compact, requiring only 3½ inches of rack-panel space . . . Simple connection to I-F in receiver . . . Has self-contained power supply and audio amplifier . . . Output is 18 dbm/600 ohms. Price \$1200

*Patents Pending

SIGNAL
SPLITTER

MCL-50

SOPHISTICATED SELECTIVITY . . .



Continuously Variable selectable-single-sideband models are available on order — with filter cutoffs at the 60 db points as low as 250 cps for any 3 db bandwidth from 0.1 kc/s to 6.0 kc/s in either selected sideband. Prices and literature available on request.

J. B. A. McLAUGHLIN • LA JOLLA, CALIFORNIA • U.S.A.

PLANTS AND PEOPLE

(continued)

test equipment. Designing, engineering and meter manufacturing continue in an older building.

Gray Research Names Smith

NEWLAND F. SMITH, formerly director of general engineering for the Mutual Broadcasting System and WOR, has been appointed assistant general manager for Gray Research and Development Co., Inc.

Harrison Named Wilcox V-P

ARTHUR E. HARRISON, formerly chief engineer of Air Associates electronics division, is now vice-president and chief engineer of Wilcox Electric Co., Kansas City, Mo.

Maxson Assigns Personnel

THE W. L. MAXSON CORP. announced several personnel assignments. S. Merrill Skeist has been elected vice-president and is now in charge of the Contracts Division.

Other appointments with the Contracts Division are: J. W. Bjorkman, executive assistant to the vice-president and manager of the planning department; J. L. Comer, staff assistant to the vice-president and manager of the administrative department; W. P. McNally, manager of the Air Force contracts department; J. J. Ryan, manager of the Navy contracts department; A. J. Colton, manager of the Army contracts department.

OTHER NEWS

Hazeltine Gets Navy's "Basic" Agreement

NAVY'S first basic contract agreement has been signed with Hazeltine Electronics Corp. This is an experiment that the Navy is trying out with a few large contractors to speed up the work with company negotiators and attorneys.

It is a master-type agreement in which the Navy and a contractor agree to general provisions to be included in all future contracts. It is not a contract but it allows all applicable general conditions in future contracts to be included

ANALYSIS OF ALTERNATING CURRENT CIRCUITS

Just Published

Here's a modern introduction to a-c circuits completely devoted to the steady state in lumped linear networks. Notations for potential differences follow newly recommended practices, and the two dimensional quantities used in network analysis likewise are in accord with the latest trends. The appendix gives you a comprehensive coverage of d-c circuits. By Wilbur R. LePage, Professor of Electrical Engineering, Syracuse University. 444 pp., 520 illus., \$6.50

ELECTRONIC MEASUREMENTS

Second Edition

Just Published

Covers measurement fundamentals in many fields beyond conventional radio, including television, radar, and other pulsed systems, microwave techniques, and techniques of value to engineers in other areas who use electronics in their instrumentation. Treats circuit constants and lumped circuits; wave-form, phase, and time interval measurements; receiver and antenna measurements; generators of special waveforms; attenuators and signal generators, etc. By F. E. Terman, Dean, School of Engineering, and J. M. Pettit, Associate Professor of Electrical Engineering, Stanford University. Second Edition, 683 pp., 450 illus., \$10.00

PRINCIPLES OF RADAR

Third Edition

Just Published

Deals with the fundamental concepts and techniques of pulse radar. Presents the engineering principles of the pulse circuits and the high-frequency devices common to nearly all radar systems. Describes the general features of radar systems and system components; discusses pulse circuits and their application to radar modulators, indicators, and receivers. Covers radio-frequency aspects of radar, including basic concepts pertaining to transmission lines, wave-guides, cavity resonators, and antennas, and the techniques of their use in radar systems. By the Massachusetts Institute of Technology Radar School Staff, Revised by J. F. Reintjes, MIT, and Godfrey T. Coate, formerly of MIT. Third Edition, 887 pp., 565 illus., \$7.75

HANDBOOK OF INDUSTRIAL ELECTRONIC CIRCUITS

A ready, practical source of information on the circuits you need for industrial electronic applications. Provides a clearly-drawn diagram for every one of 433 circuits . . . and includes concise descriptions of how the specific circuit works . . . its performance . . . its characteristics. Valuable cross-reference index. By John Markus and Vin Zeff, Editors, Electronics, 272 pp., 433 illus., \$7.50

SEE BOOKS TEN DAYS FREE!

McGraw-Hill Book Co., 330 West 42 St., N.Y.C. 36
Send me book(s) checked below for 10 days' examination on approval. In 10 days I will remit for book(s) I keep, plus a few cents for delivery, and return unwanted book(s) postpaid. (We pay for delivery if you remit with this coupon; same return privilege.)

- LePage—ANALYSIS OF A-C CIRCUITS, \$6.50
 Terman—ELECTRONIC MEASUREMENTS, 2nd Ed., \$10.00
 M.I.T.—PRINCIPLES OF RADAR, 3rd Ed., \$7.75
 Markus—HND BK. OF IND. ELECTRONIC CIRCUITS, \$7.50

Name
Address
City..... Zone..... State.....
Company
Position F.L.-3
This offer applies to U. S. only.



Hermetically Sealed

Precision Resistors

The New Series "H" Hycor Precision wire-wound resistors have been developed to meet the increasingly stringent requirements of the electronics industry.

The resistors are permanently sealed in a high stability plastic compound which virtually immunizes them against the effects of HIGH HUMIDITY, MECHANICAL SHOCK and AMBIENT TEMPERATURES UP TO 135° C. They will conform to JAN R-93 or MIL R93A specifications. Hycor Series "H" Precision wire-wound resistors have a temperature coefficient of 25 parts per million per degree C. and are available in resistances from 0.1 ohm to 6 megohms.

11423 VANOWEN ST., NORTH HOLLYWOOD, CALIFORNIA

HYCOR

Company, Inc.

SUnset 3-3860

Manufacturers of Precision Resistors, Toroid Inductors and Electric Wave Filters

REPRESENTATIVES:

Jack Beebe, 5707 W. Lake Street, Chicago, Illinois
George E. Harris & Co., Box 3005, Municipal Airport, Wichita, Kansas
Marvin E. Nulsen, 5376 E. Washington St., Indianapolis 19, Indiana
Burlingame Associates, 103 Lafayette Street, New York City

For further information contact your nearest Hycor representative or write for Bulletin H

Fine Wire
FOR
TRANSISTORS

In line with our specialization in wire for new applications, we produce wires of composition suitable for the manufacture of Transistors; including GALLIUM GOLD and ANTIMONY GOLD. These alloys have been made to fill a specific need arising from new developments in this field.

Other wires we make regularly for similar application are PHOSPHOR BRONZE, bare or electroplated, and PLATINUM Alloys produced to meet rigid specifications of tensile strength, size and straightness.

VISIT
BOOTH 2-214
Grand Central
Palace Mar. 23-26

Write for Latest List of Products

SINCE 1937

SIGMUND COHN CORP. 121 So. Columbus Avenue • Mount Vernon, N.Y.

Here's the COMPLETE answer to— PACKAGING INSTRUMENTS ASSEMBLIES COMPONENTS



The 12-Page CARGO PACKERS Brochure

on

CLIMATE-PROOF, SHOCK-PROOF *Individually-engineered* PACKAGING

Contains complete, authoritative information on specification packing for SIGNAL CORPS, AIR FORCE, NAVY and COMMERCIAL EQUIPMENT. The Cargo Packers service includes individual attention to every order. For complete data on the all-inclusive Cargo Packers service call or write for your copy. For recommendations on a specific packaging problem, contact one of our sales engineers. Advisory consultation is invited—no obligation.

- SPECIAL PACKAGING EQUIPMENT
- EXPERTS ON MILITARY REQUIREMENTS
- ECONOMICAL ASSEMBLY LINE METHODS
- INTERPRETATION OF SPECIFICATIONS
- FULL COMPLIANCE TO EVERY DETAIL

CARGO-PACKERS
INCORPORATED
73 RUTLEDGE STREET
BROOKLYN 11, NEW YORK



See our display at
BOOTH 4-802
on the Fourth Floor
I.R.E. SHOW!

merely by reference to the clauses contained in the basic agreement. The only matters left for negotiation will be quantities, prices, specifications and delivery dates.

The general conditions agreed upon fall into two categories. They are mandatory provisions required by the armed services procurement regulation executive orders and other applicable statutes which are used in specific procurements.

Since it will be necessary to send copies of each basic agreement to every Navy purchasing office, inspection office and other interested governmental agencies, it is not considered economical to sign basic agreements with companies making only a few contracts each year.

The Air Force has used basic agreements successfully under its centralized purchasing office at Wright-Patterson Air Force Base.

Tentative Program Set For '53 IRE National Convention

AN ESTIMATED 30,000 radio engineers and scientists will convene on March 23-26 at the Waldorf-Astoria Hotel and Grand Central Palace in New York City for the 1953 IRE National Convention. The program of 220 technical papers and 400 engineering exhibits will be key-noted by the theme "Radio-Electronics, A Preview of Progress." The 43-session technical program will be highlighted by an all-day seminar on "Acoustics for the Radio Engineer" and nine symposia organized by Professional Groups of IRE. The complete tentative program follows:

MONDAY, MARCH 23, 1953—2:30 P.M.

Session 1: Antennas I—General

The Measurement of Highly Directive Antenna Patterns and Over-All Sensitivity of a Receiving System by Solar and Cosmic Noise by Jules Aarons of Air Force Cambridge Research Center, Cambridge, Mass. Radiation Patterns for Aperture Antennas with Non-Linear Phase Distributions by Charles C. Allen of General Electric Co., Schenectady, N. Y. Factors Affecting Radiation Patterns of Corrugated Surface Antennas by M. Ehrlich and L. Newkirk of Hughes Aircraft Co., Culver City, Calif.

A Microwave Anechoic Chamber for Antenna Pattern Measurements by Alan H. Simmons of Naval Research Lab., Washington, D. C. Wide-Frequency-Range Tuned Circuits and Antennas by A. G. Kandoian and William Sichak of Federal Telecommunications Labs., Nutley, N. J.

Session 2: Television I

Theory of Synchronization Applied to NTSC Television by Donald Richman of Hazeltine Corp., Little Neck, N. Y. Color Synchronization in the NTSC Color



HIGHLY ADAPTABLE ELECTRONIC DIFFERENTIAL ANALYZING EQUIPMENT

REAC®

(REEVES ELECTRONIC ANALOG COMPUTER)

SIMULATOR • COMPUTER • TESTER



THE REAC FAMILY of electronic and electro-mechanical units continues to grow in number and capability. The Electronic Function Generator and the Electronic Multiplier were recently introduced for real time applications requiring high speed response, where mechanical methods with their inherent frequency limitations were unsatisfactory.

NOW A NEW SIX CHANNEL RECORDER is available featuring, convenient table top recording, interchangeable electric or ink styli and simplified paper loading. Low drift amplifiers, absence of paper weave, and good power regulation combine to make this unit highly accurate.

A ONE CABINET INSTALLATION will soon be in production. The Reeves Electronic Analog Computer C-202 Mod O will contain, in addition to the computing components, four servos and the required power supplies.

PRECISION RESOLVERS

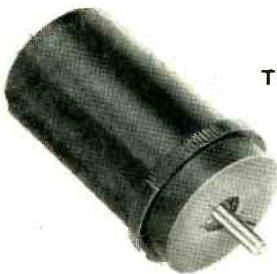

TYPES R-600, R-602

For 60, 400 or 1000 cycle operation; network or winding compensated for high precision trigonometric applications and winding compensated for additional sweep circuit usage. The winding compensated resolvers type R-602 are capable of operation within a frequency range of 10 to 40,000 cps.

TYPES R-150, R-151

A new miniature resolver in a Navord size 15 case featuring very high input impedance (17,500 ohms when tuned at 400 cps) and a large dynamic range of operation. The unit can withstand better than 50G shock or vibration and operates perfectly above altitudes of 50,000 feet. Type R-151 is winding compensated.



STANDARD AND MINIATURE BREADBOARD INSTRUMENTATION PARTS

STANDARD INSTRUMENTATION PARTS

Reeves Instrument Corporation manufactures a complete line of precision breadboard parts in standard sizes for economical construction of experimental servos and computers including precision gears, component hangers, slotted mounting plates, etc. A shaft diameter of 1/8" is used.

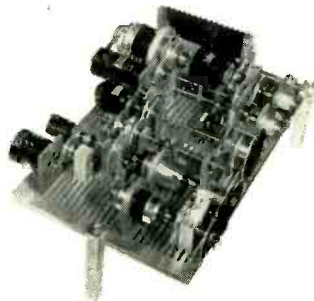

MINIATURE STANDARD INSTRUMENTATION PARTS

Facilities are completed for the manufacture of a new line of miniature standard breadboard instrumentation parts designed on the basis of a 1/8" shaft size, for applications where small size and light weight are important factors warranting the use of miniature parts.

The Reeves Instrument Corporation is now manufacturing miniature rate and integrating gyros, two inches in diameter, and weighing slightly more than one pound.

REEVES INSTRUMENT CORPORATION

215 E. 91st Street

Dept. E

New York, New York

Our answer to the High Cost of ANALOG COMPUTERS

The ANSER

Model 300A

ANalog Simulator and computER

Featuring

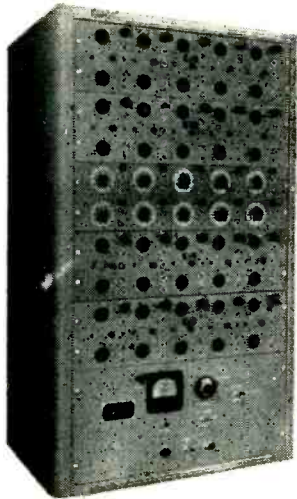

SIMPLICITY: Plug in pre-matched components, patch the "blocks" together, and compute.

FLEXIBILITY: Start small, expand as required. High speed—"one shot" or repetitive computations. Wide variety of plug-in networks (some include vacuum tubes), simple or complex, linear or non-linear.

ACCURACY:

High gain wide band amplifiers. Pre-matched components, $\pm 0.25\%$. Coefficients set by use of precision potentiometer and meter—no loading corrections.

and really **LOW COST**

BASIC COMPUTER . . . \$1,980

Average set of plug-in computing components is approximately . \$500

RECORD DATA AT ITS SOURCE

Portable MAGNETIC TAPE DATA RECORDER

Designed for Aircraft,
Mobile, and Other
Field Uses; 6, 12, or
24 v. DC Power Sup-
ply, Remote Control.



SMALL SIZE 11" x 11½" x 20½" **WEIGHT** only 55 lbs.

RECORDS UNDER SEVERE VIBRATION, ANY POSITION

Up to 13 data channels, plus timing signal.

Data channel frequency response—DC to 5 kc.

Linearity—2% (with suitable playback equipment).

Playback equipment available—single or multi-channel—for laboratory use, 60 cps power. Also special analysis equipment.

Write for detailed information

THE
DAVIES
LABORATORIES
INCORPORATED

4705 Queensbury Road

Riverdale 2, Maryland

Telephone: Appleton 7-1133

PLANTS AND PEOPLE

(continued)

Television Receiver by Means of the Crystal Filter by W. E. Good of General Electric Co., Syracuse, N. Y.
Automatic-Phase-Control Color Synchronization for NTSC Color Television by Donald Richman of Hazeltine Corp., Little Neck, N. Y.
Transient Response in a Color Carrier Channel With Vestigial Side Band Transmission by J. S. S. Kerr of General Electric Co., Syracuse, N. Y.
Transients in Color Television by P. W. Howells of General Electric Co., Syracuse, N. Y.

Session 3: Circuits I—Network Theory

A General RLC Synthesis Procedure by L. Weinberg of Hughes Aircraft Co., Culver City, Calif.

A General Theory of Wide-band Matching by H. J. Carlin and R. LaRosa of Polytechnic Institute of Brooklyn, Bklyn., N. Y.

Synthesis of Electric Filters With Arbitrary Phase Characteristics by B. J. Bennett of Stanford University, Stanford, Calif.

Wide-Band Filter Amplifiers at Ultra-High-Frequencies by J. M. Pettit and W. A. Christopherson and D. O. Pederson of Stanford Univ., Stanford, Calif.

Network Analysis With the Aid of Generating Polynomials by H. Kurss of Polytechnic Institute of Brooklyn, Bklyn., N. Y.

Two New Equations for the Design of Filters by M. Dishalf Federal Telecommunication Labs., Nutley, N. J.

Session 4: Electronic Computers I

Multichannel Analog Input-Output Conversion System for Digital Computer by P. A. Adamson and M. L. MacKnight of Hughes Aircraft Company, Culver City, Calif.

An Analog to Digital Converter With an Improved Linear Sweep Generator by D. W. Slaughter of California Institute of Technology, Pasadena, Calif.

Dynamic Binary Counter With Analog Read-Out by L. Packer of Columbia Univ., New York, N. Y.

Life and Reliability Experience With Transistors in a High Speed Digital Computer by J. J. Scanlon of Bell Telephone Labs., Whippany, N. J.

Engineering Experience in the Design and Operation of a Large Scale Electrostatic Memory by J. Logue, A. Brennemann and A. Koelsch of IBM Corp., Poughkeepsie, N. Y.

Session 5: Symposium: Instrumentation I—Automatic

A New Method for Measuring Noise Figure and Gain of a Radar Receiver by R. J. Parent and V. C. Rideout of Univ. of Wisconsin, Madison, Wis.

Automatic Instrumentation for Continuous Monitoring of Systems Performance by M. V. Ratynski, M. Kant and H. Webb of Rome Air Development Center, Rome, N. Y.

Automatic One-Shot Methods for Bandwidth Measurement by J. B. Woodford, Jr. and E. M. Williams of Carnegie Institute of Technology, Pittsburgh, Pa.

Microwave Power Meter with Automatic Zero Setting and Telemetering by L. A. Rosenthal and G. M. Badoyannis of Rutgers Univ., New Brunswick, N. J.

Monitoring of Errors in Synchro Servo Systems by G. Quazza of Polytechnic Institute of Brooklyn, Bklyn, N. Y.

Session 6: Radio Location, Navigation and Airborne Electronics

The Technique of Monopulse Radar by W. Hausz of General Electric Co., Syracuse, N. Y.

Reducing Sky Wave Errors in CW Tracking Systems by Marvin S. Friedland of Patrick Air Force Base, Fla. and Nathan Marchand of Electronics Lab. Greenwich, Conn.

An Application of Integrator Type Signal Enhancer to Direction Finding Equipments by C. A. Strom and J. A. Fantoni of Rome Air Development Center, Rome, N. Y.

A Theory of Target Glint or Angular Scintillation in Radar Tracking by Richard H. Delano of Hughes Aircraft Co., Culver City, Calif.

Automatic Dead Reckoning Navigation Computers for Aircraft by James L. Dennis of Wright Air Development Center, Dayton, Ohio.

TUESDAY, MARCH 24, 1953—10:00 A.M.

Session 7: Antennas II—Microwave

Arrays of Flush Mounted Travelling Wave

A NEW

quality standard

FOR

CAPACITORS

PULSE FORMING NETWORKS

SUPPRESSION FILTERS

BY

National

CAPACITOR COMPANY
585 WASHINGTON STREET
QUINCY 69, MASSACHUSETTS

NEY

PRECIOUS
METAL ALLOYS AND
COMPLETE ASSEMBLIES

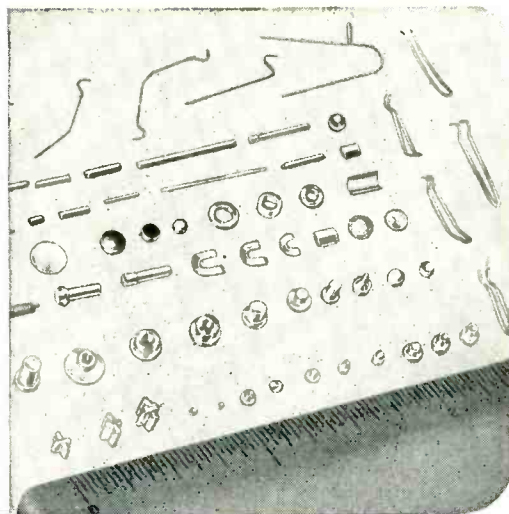

IMPROVE INSTRUMENT PERFORMANCE

Paliney*#7, Ney-Oro G, Ney-Oro #28, and Ney #90 Alloy are precious metal alloys developed in the laboratories of the J. M. Ney Company for the fabrication of contacts, brushes, wipers, slip rings, commutator segments, and similar components used in precision control and instrumentation. Each alloy has specific qualities which mean greater accuracy and prolonged instrument life, as well as resistance to most corrosive industrial atmospheres.

Parts fabricated from Ney's Precious Metal Alloys are now components of instruments used in navigation, recording, computing, and many other devices. Consult the Ney Engineering Department for assistance with your problems.

* Reg. Trade Mark J. M. Ney Co.

THE J. M. NEY COMPANY • 179 Elm Street, Hartford 1, Conn.
Specialists in Precious Metal Metallurgy Since 1812

3NY63

NEW ALCAR Model 101 Universal Coil Winder

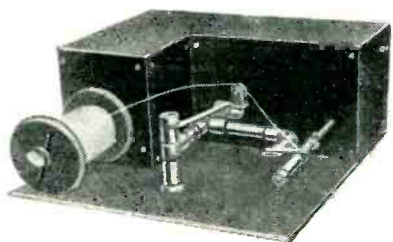

A completely self-contained, self-powered unit for winding pi or universal coils of variable width, to a diameter of 4 inches.

The Model 101 will provide the development or design engineer with a precision source of experimental coils, and is suitable for small production.

Unit is complete.
No Accessories Required.

ALCAR
INSTRUMENTS, INC.

2 Godwin Ave., Fairlawn, N. J.
Fairlawn 6-0007

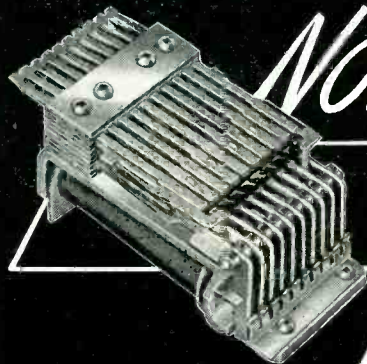

Now... for the first time
KELLOGG
magnetic
impulse counter

- The long life normal to relay equipment!
- Occupies the space of only two telephone relays!
- Operates over the same wide range of pulse ratio and frequency as a chain of well-designed counting relays!

It's simple! It saves space! It saves money!
... Actuated by electrical impulses, the Kellogg Magnetic Impulse Counter performs the counting and marking function of a chain of 10 to 20 relays or of a two-magnet ten-point stepping switch, in less space and with top reliability! It has a wide application in many fields—from industrial control to any system where trains of impulses, such as generated by a telephone dial are to be counted.

KELLOGG... **AN I&T ASSOCIATE** ... An Associate of International Telephone and Telegraph Corp.

KELLOGG SWITCHBOARD AND SUPPLY COMPANY

KELLOGG SWITCHBOARD AND SUPPLY COMPANY
77 West Monroe St., Chicago 3, Ill. Dept. 26-C

GET THE
FACTS—
MAIL
COUPON
TODAY!

Please send me complete information regarding the Kellogg Impulse Counter.

NAME _____
COMPANY _____
ADDRESS _____
CITY _____ STATE _____

AGE or PREHEAT up to 100 vacuum tubes for 50 hour reliability tests ...

You can quickly apply any nominal voltage and/or load to any tube element for practically all receiving and many transmitting types with the P.T.L. Aging Rack. Plate, filament, screen and grid voltages may be varied as desired.

Multiple banks of ten production-type sockets accommodate octal, small seven, noval nine or subminiature tubes. Each bank is individually controlled so that up to ten different tube types may be aged simultaneously.

Self contained filament and plate power is supplied together with adequate bias voltages. Overload protection is included in all circuits.

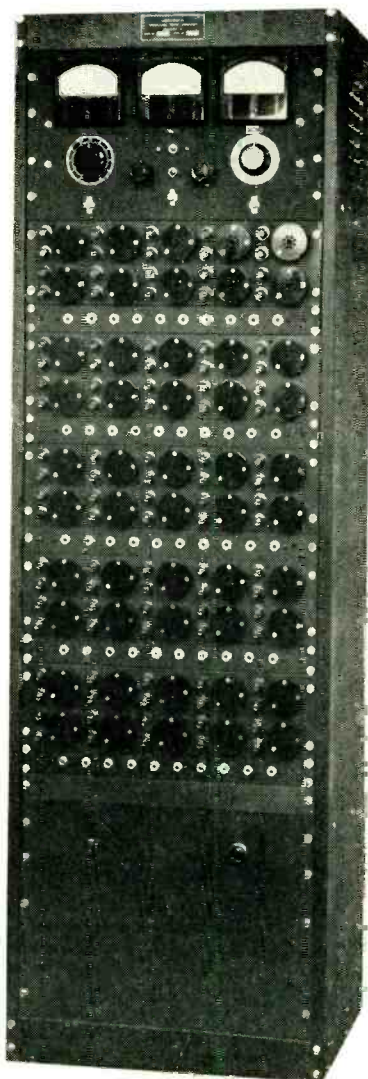

Fast, accurate, VISUAL indication of the null point for A-C bridges

With the P.T.L. Type 239 Bridge Null Indicator you can see by simultaneous and independent indications, the reactive and resistive unbalances of A-C bridges on a 3" cathode ray tube. After a simple initial set-up, no further manual operation is required.

The indicator amplifier has gain sufficient to give 1 inch deflection for 20 microvolts of input signal. At maximum sensitivity, the hum and noise level is less than 2 microvolts. Continuous tuning in 9 ranges adequately reduces harmonic errors from 20 cps to 20 Kc. A.V.C. is incorporated to reduce overload distortion and speed production testing. The equipment is very useful in a laboratory as well as being essential for fast production testing of audio coils, condensers, etc.

WRITE FOR DATA



PENNSYLVANIA TESTING LABORATORY

Specializing in Research, Design, Development and manufacture of Electronic Production Testing Facilities.

DOYLESTOWN, PENNA.

Arrays of Flush Mounted Travelling Wave Antennas by J. N. Hines, V. H. Rumsey and T. E. Tice of The Ohio State University, Columbus, Ohio.
Transient Build-Up of the Antenna Pattern in End-Fed Linear Arrays by Norman H. Enestein of Hughes Aircraft Company, Culver City, Calif.
A New Microwave Reflector by K. S. Kelleher of Naval Research Lab., Washington, D. C.
Crosstalk in Radio Relay Systems Caused by Foreground Reflections by H. W. Evans of Bell Telephone Labs., New York, N. Y.
Low Side Lobes in Pencil-Beam Antennas by E. M. T. Jones of Stanford Research Institute, Stanford, Calif.

Session 8: Television II

Probability Distribution Measurements of Television Signals by W. F. Schreiber, Cruft Lab. of Harvard University, Cambridge, Mass.

Colorimetric Properties of Gamma-Corrected Color Television Systems by D. C. Livingston of Sylvania Electric Products, Inc., Bayside, N. Y.

Phase Measurements at Subcarrier Frequency in Color Television by A. P. Stern of General Electric Company, Syracuse, N. Y.

A Precision Line Selector for Television Use by I. C. Abrahams and R. C. Thor of General Electric Company, Syracuse, N. Y.

A Monitoring System for NTSC Color Television Signals by C. E. Page of Hazeltine Corp., Little Neck, N. Y.

Session 9: Circuits II—Symposium: Panel Discussion on Wideband Amplifiers

Conventional Amplifiers by W. Bradley of Philco Corp., Philadelphia, Pa.

Feedback Amplifiers by H. N. Beveridge of Raytheon Mfg. Co., Newton, Mass.

Transistor Amplifiers by R. L. Wallace of Bell Telephone Labs.

Distributed Amplifiers by W. G. Tuller and E. H. Bradley of Melpar Electronics Alexandria, Va.

Traveling Wave Tube Amplifiers by L. Field of Stanford Univ., Stanford, Calif.

Session 10: Electronic Computers II

Analog Computing with Magnetic Amplifiers Using Multi-Phase A-C Voltages by J. E. Richardson of Hughes Aircraft Company, Culver City, Calif.

Some Recent Developments in Logical 'Or-and-Or' Pyramids for Digital Computers by C. Leondes of University of Pennsylvania, Philadelphia, Pa.

Magnetic Core Switches as Logical Elements in Computers by Eugene A. Sands of Magnetics Research Co., Chappaqua, N. Y.

Magnetic Shift Register Using One Core Per Bit by R. D. Kodis, S. Ruhman and W. D. Woo of Raytheon Mfg. Co., Waltham, Mass.

Simple Computer for Automatically Plotting Correlation Functions by A. H. Schooley of Naval Research Lab., Washington, D. C.

Session 11: Instrumentation II—Symposium: Transistor Measurements

Transistor Metrology by D. A. Alsberg of Bell Telephone Labs., Murray Hill, N. J.

Measurement of Transistor Parameters by CRO and Other Methods by W. E. Morrow, Jr., MIT of Cambridge, Mass.

Transistor Static Characteristics Obtained by Pulse Techniques by D. R. Fewer of Bell Telephone Labs., Murray Hill, N. J.

Bridges for Measuring Junction Transistor Admittance Parameters by L. J. Giacchetto of RCA Labs., Princeton, N. J.

A Transistor Alpha Sweeper by H. G. Follingstad of Bell Telephone Labs., Murray Hill, N. J.

Rapid Tracing of Transistor Characteristics by Oscillographic Methods by V. Mathis of General Electric Co., Syracuse, N. Y.

Session 12: Significant Trends in Airborne Equipment

Some Systems Considerations in Flight Control Servomechanism Design by Robert J. Bibbero and Roland Grandgent of Republic Aviation Corp., New York, N. Y.

Faired-In ADF Antennas by Louis E. Rarburn of Electronics Research Inc., Evansville, Ind.

Magnetic Amplifiers for Airborne Appli-

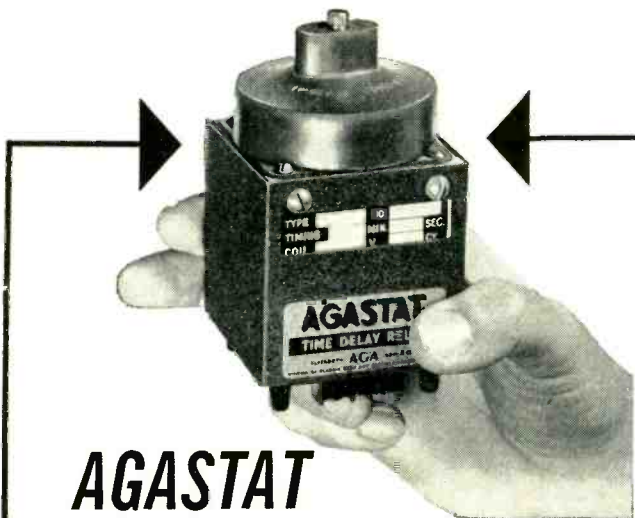

AGASTAT

**Compact ... Dust-Proof
TIME DELAY RELAYS**
solenoid actuated—pneumatically timed

Introduces time delays into a-c or d-c circuits. Easily adjusted to provide delays ranging from 0.1 second to five or more minutes.

The AGASTAT is small, light, and operates in any position. Dust-proof timing chamber assures long operating life with a minimum of maintenance.

Write for Bulletin.
Dept. A1-34,

AGA

Division of Elastic Stop Nut Corporation of America
1027 Newark Avenue, Elizabeth 3, New Jersey

A TRUE ELECTROSTATIC VOLTMETER

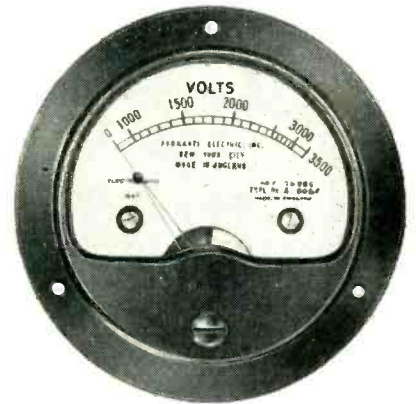

This instrument permits voltage readings on AC or DC circuits of very high resistance. The only current drawn is the very small leakage current and a very low capacitance current on AC circuits. Very useful for the many high voltage—low current circuits employed in nuclear research. Available with full scale voltages ranging between 300 and 3500 volts. Special laboratory instrument available with full scale reading of 150 volts. Full scale capacitance ranges from 8 mmfds for the 3500 volt model to 100 mmfds for the 150 volt instrument. Magnetic damping. 2½" dial. Write for complete specifications.

FERRANTI

FERRANTI ELECTRIC, INC.
30 Rockefeller Plaza • New York 20, N. Y.
FERRANTI, LTD., Hollinwood, England
FERRANTI ELECTRIC, LTD., Toronto, Canada

See Us at Booth 4-416 IRE Show

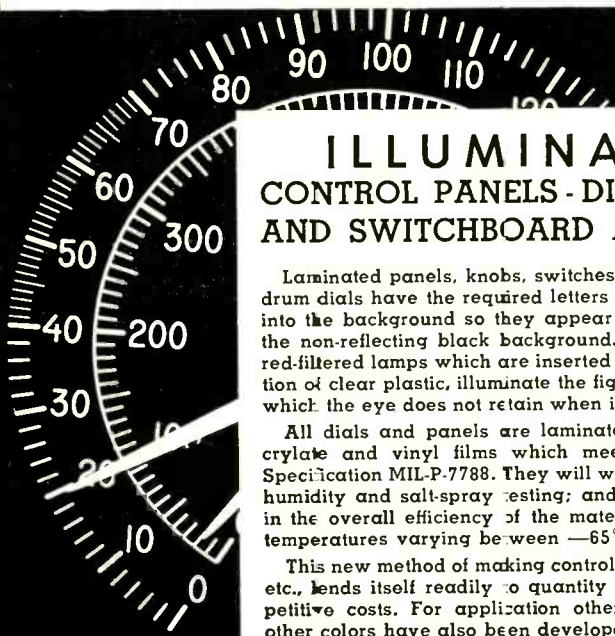

ILLUMINATED CONTROL PANELS - DIALS - KNOBS AND SWITCHBOARD ASSEMBLIES

Laminated panels, knobs, switches, flat dials and even drum dials have the required letters or figures processed into the background so they appear dead white against the non-reflecting black background. In the dark, small, red-filtered lamps which are inserted in the inside lamination of clear plastic, illuminate the figures with a red light which the eye does not retain when in motion.

All dials and panels are laminated of methyl methacrylate and vinyl films which meet the standards of Specification MIL-P-7788. They will withstand all standard humidity and salt-spray testing; and no change is noted in the overall efficiency of the materials when tested at temperatures varying between -65°C and +85°C.

This new method of making control panels, dials, knobs, etc., lends itself readily to quantity production and competitive costs. For application other than military use, other colors have also been developed.

A booklet with complete information is available.

Manufacturers of test equipment for organic coatings.



UNIVERSAL AVIATION EQUIPMENT, INC.
187 LAFAYETTE STREET, NEW YORK 13, N. Y.
Phone Worth 4-2670

To Wind Coils of "INVISIBLE WIRE"

(or other minute
precision operations)



At the Hathaway Instrument Company, tiny galvanometer coils are wound with wire so fine that it is almost invisible to the unaided eye. Ingenious tooling and use of an AO Stereoscopic Microscope assure fast, precise workmanship.

These unique AO Microscopes provide *two* complete optical systems (one for each eye) to enhance the perception of depth and to provide *three-dimensional* reality plus an exceptionally wide field of view. Unlike ordinary microscopes, objects and movements are *not* inverted. Instead they appear in their natural directions. Because AO Stereoscopic Microscopes are unequalled for fabrication, assembly, inspection of minute precision parts, they are widely used in electronics, metal working, food and many other industries.

Let AO Stereoscopic Microscopes help *you* achieve high precision at low cost. Mail coupon below.

You NEED



Stereoscopic Microscopes

American Optical

 INSTRUMENT DIVISION
BUFFALO 15, NEW YORK

American Optical Company
Dept. J 178
Instrument Division
Buffalo 15, New York

Gentlemen:

Please send me further information on AO Stereoscopic Microscopes.

Signed

Organization

Address

City..... Zone..... State.....

cations by J. K. McKendry of General Precision Labs., Pleasantville, N. Y. Aircraft Electrical Power by J. C. Diefenderfer and George W. Sherman of Wright Air Development Center, Dayton, Ohio.

The Effects of Electronic Equipment Standardization on Aircraft Performance by George C. Sumner of Consolidated Vultee Co., Fort Worth, Texas.

TUESDAY, MARCH 24, 1953—2:30 P.M.

Session 13: Antennas III—Propagation

Notes on Propagation by L. A. Byam, Jr. of The Western Union Telegraph Co., New York, N. Y.

Tropospheric Propagation in Horizontally Stratified Media over Rough Terrain by H. M. Swarm, R. N. Ghose, G. H. Keitel of University of Washington, Seattle, Wash.

Radio Wave Scattering in Tropospheric Propagation by J. W. Herbstreit, K. A. Norton, P. L. Rice and G. E. Schafer of National Bureau of Standards, Boulder, Col.

Extended-Range Radio Transmission by Oblique Reflection from Meteoric Ionization by O. G. Villard, Jr., A. M. Peterson, L. A. Manning and Von R. Eshleman of Electronics Research Lab., Stanford University, Stanford, Calif.

An Interpretation of Vertical Incidence Equivalent Height versus Time Recordings on 150 Kc/s by Rune Lindquist of Ionosphere Research Lab. The Pennsylvania State College, State College, Pa.

Session 14: Symposium: Diagnostic Programs and Marginal Checking for Large Scale Digital Computers.

(Program to be announced)

Session 15: Circuits III—Time Domain Networks—Delay Lines

Continuously Variable Delay Line by C. Berkley of Allen B. Du Mont Labs. Inc., Clifton, N. J.

General Transmission Theory of Distributed Helical Delay Lines with Bridging Capacitance by M. J. DiToro of Du Mont Labs. Inc., Passaic, N. J.

Distributed Constant Delay Lines with Characteristic Impedances Higher Than 5000 OHMS by W. S. Carley of U. S. Naval Ordnance Lab., Silver Spring, Md.

Helical Winding Exponential-Line Pulse Transformers for Millimicrosecond Service by J. Kukel and E. M. Williams of Carnegie Institute of Technology, Pittsburgh, Pa.

Time Domain Approximation by Use of Pade Approximants by R. D. Teasdale of RCA, Camden, N. J.

Frequency Transients in Idealized Linear Systems by B. Gold of Hughes Aircraft Co., Culver City, Calif.

Session 16: Electron Devices I—Transistors

The Negative Resistance Diode by I. A. Lesk and Vernon P. Mathis of General Electric Co., Syracuse, N. Y.

Reliability of Transistors by W. R. Sittner of Bell Telephone Labs., Allentown, Pa., and R. M. Ryder of Bell Telephone Labs., Murray Hill, N. J.

Characteristics of the M-1768 Transistor by L. B. Valdes of Bell Telephone Labs., Murray Hill, N. J.

Developmental High Frequency Alloy Transistors by C. W. Mueller and J. I. Pankove of RCA Labs. Div., Princeton, N. J.

Behavior of Germanium Junction Transistors at Elevated Temperatures and Power Transistors Design by L. D. Armstrong of RCA Labs Div., Princeton, N. J.

Session 17: Instrumentation III—Electronics

The Response of a Panoramic Receiver to CW and Pulse Signals by H. W. Batten, R. A. Jorgensen, A. B. Maone and W. W. Peterson of University of Michigan, Ann Arbor, Mich.

A VHF Impedance Meter by J. H. Mennie of Boonton Radio Corp., Boonton, N. J.

Simplified Measurement of Incremental Pulse Time Jitter by W. T. Pope of Griffiss Air Force Base, Rome, N. Y.

Wide-Band Wave Analyzer by O. Kummer of Bell Telephone Labs., Murray Hill, N. J.

Ultra-Low Frequency, Three-Phase Oscillator by G. Smiley of General Radio Co., Cambridge, Mass.

Session 18: Symposium: Trends in Mo-

Make a **GM** PORTABLE D'ARSONVAL

GALVANOMETER

*the Heart
of Your
Instrument*

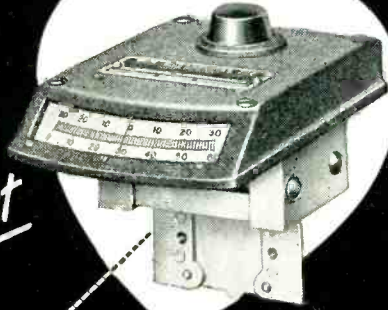

FOR MEASURING HEMOGLOBIN content of blood samples, the Fisher Scientific Co. of Pittsburgh uses a Model 100 G-M Galvanometer in its popular Electro-Hemometer (at left). Whatever your own particular instrument field, you can achieve this same self-contained portability, ruggedness and high sensitivity with G-M Galvanometers. Complete catalog on request.

GM LABORATORIES · INC.

In Canada: Cossor (Canada) Ltd., 301 Windsor St., Halifax, N. S.

4336 NORTH KNOX AVE., CHICAGO 41

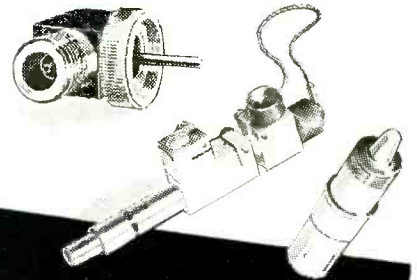

manufactured
to your design

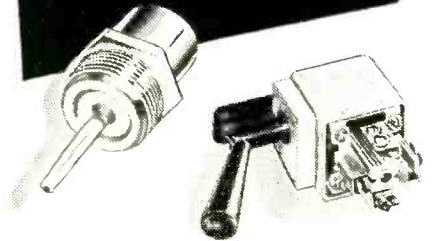

electronic
components...

accurate to the most
exacting tolerances

- Design & Engineering Assistance
- Machining
- Assembling
- Testing

Experienced in precision work with such alloys as beryllium copper, molybdenum, tantalum and Monel as well as Plexiglas and polystyrene. Approved for sub-contractor defense work and cleared to handle classified matter.

Send for illustrated
brochure on
complete facilities.



JOHN GOMBOS
CO., INC.
103-109 MONTGOMERY AVE.
IRVINGTON, N. J.



A NAME YOU CAN
RELY ON FOR

TRANSFORMERS MIL-T-27 & COMMERCIAL

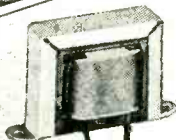

CHANNEL
MOUNT

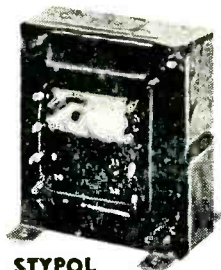

STYPOL
ENCAPSULATED

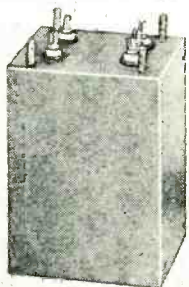

HERMETICALLY
SEALED

- Pulse
- Audio
- Power
- Filter Choke
- Filament
- RF Coils

Custom Built to
your Specifications

**WE SOLICIT ONLY
SAMPLES AND SHORT
RUN PRODUCTION**



297 North 7th St., Brooklyn 11, N. Y.

SHE'D BE SUNK WITH NO MOVING PARTS!



BUT THE C. G. S. **INCREDUCTOR*** LINE OF CONTROLLABLE INDUCTORS NEEDS NO MOVING PARTS

THIS FEATURE, COMBINED WITH RUGGED, SHOCK RESISTANT, COMPACT AND LIGHT WEIGHT CONSTRUCTION PROVIDES THE IDEAL UNIT FOR ADVANCED CIRCUITRY.

SOME OF THE OUTSTANDING AND VALUABLE FEATURES OF THE **INCREDUCTOR** UNITS ARE:

- WIDE RANGE • REMOTE CONTROL • FAST RESPONSE •
- HIGH SENSITIVITY • EXTREME FLEXIBILITY •

THE **INCREDUCTOR** UNIT IS A NATURAL FOR ADVANCED TECHNIQUE APPLICATIONS SUCH AS:

- High Speed Switching • F. M. Oscillators •
- Automatic Frequency Control Systems •
- Receiver Front Ends • Sweep Oscillators •
- Amplitude Controls • Variable Filters •

Write on your company letterhead for engineering data and technical bulletins covering standard types. We will be glad to give you our recommendations regarding your specific problems.



*Trade Mark

C. G. S. LABORATORIES, INC.

391 LUDLOW STREET, STAMFORD, CONN.



One-half size.

"Visit the dynamic display at our I.R.E. Show Exhibit—Booth 2-125"

PLANTS AND PEOPLE

(continued)

Mobile Communications

The Effects of Selectivity, Sensitivity and Linearity in Radio Circuits on Communications Reliability and Coverage by J. G. Schermerhorn of Rome Air Development Center, Rome, N. Y.

Single Sideband for Mobile Communications by A. Brown and R. H. Levine of Coles Signal Lab., Ft. Monmouth, N. J. Major Factors in Mobile Equipment Design with Emphasis on 460 MC Mobile Equipment Characteristics by John Byrne and A. A. Macdonald of Motorola, Inc., Chicago, Ill.

Field Experience with 450 MC Mobile Systems by P. H. Bellingham and J. Q. Montrese of Bell-Mont Communications Service Corp., Englewood, N. J.

TUESDAY, MARCH 24, 1953—8:30 P.M.

Session 19: (to be announced)

WEDNESDAY, MARCH 25, 1953—10:00 A.M.

Session 20: Electron Devices II—Electron Tubes

Gas Pressure Effects on Ionization Phenomena in High-Speed Hydrogen Thyratrons by William C. Dean of Odessa, Texas and G. W. Penney and J. B. Woodford, Jr. of Carnegie Institute of Technology, Pittsburgh, Pa.

Low Noise, Hot Cathode, Gas Tubes by E. O. Johnson, W. M. Webster and J. B. Zirker of RCA Labs. Div., Princeton, N. J. New Dispenser Type Thermionic Cathode by R. Levi.

Multi Output Beam Switching Tubes for Computers and General Purpose Use by Saul Kuchinsky of Burroughs Adding Machine Co., Philadelphia, Pa.

An Equivalence Principle in High Frequency Tubes by Robert Adler of Zenith Radio Corp., Chicago, Ill.

Session 21: Circuits IV—Active Networks—Transistors

Transient Analysis of Junction Transistor Amplifiers by J. J. Suran and W. F. Chow of General Electric Co., Syracuse, N. Y. The Grounded-Collector Transistor Amplifier at Carrier Frequencies by F. R. Stansel of Bell Telephone Labs., Murray Hill, N. J.

Symmetrical Properties of Transistors and Their Application by G. C. Sziklai, RCA Labs. Div. of Princeton, N. J.

A Study of Transistor Circuits for Television by G. C. Sziklai, R. D. Lohman and G. B. Herzog of RCA Labs. Div., Princeton, N. J.

Conductance Curve Design of Relaxation Circuits by K. A. Pullen of Ballistic Research Labs., Aberdeen Proving Ground, Md.

Transistor Relaxation Oscillators by S. I. Kramer of Fairchild Guided Missiles Div., Wyandanch, N. Y.

Session 22: Noise and Modulation

Noise Problems of Theoretical and Practical Interest by Bernard Gold of Hughes Aircraft Co., Culver City, Calif.

A Note on Receivers for Use in Studies of Signal Statistics by R. Deutsch and H. V. Hance of Hughes Aircraft Co., Culver City, Calif.

Amplitude Modulation by Plate Modulation of CW Magnetrons by J. S. Donal, Jr., and K. K. N. Chang of RCA Labs. Div., Princeton, N. J.

Comparison of Modulation Methods by R. M. Page of Naval Research Lab., Washington, D. C.

A Technique of Intermodulation Interference Determination by A. J. Beauchamp of Rome Air Development Center, Rome, N. Y.

Session 23: Symposium: Television Broadcasting

The Design of Speech Input Consoles for Television by Robert H. Tanner of Northern Electric Co. Ltd., Belleville, Canada. Building TV Broadcast Facilities for Growth, Flexibility and Economy by Allen R. Kramer and Edwin R. Kramer of Kramer, Winner and Kramer, New York, N. Y.

Fashions in TV Transmitting Antennas by Frank G. Kear of Kear and Kennedy, Washington, D. C., and John G. Preston of American Broadcasting Co., New York, N. Y.

High Gain Amplifiers for High Power Television Transmitters by John Ruston of DuMont Labs., Inc., Clifton, N. J.

Optimum Utilization of the Radio Frequency Channel for Color TV by Ray D.

the annual
electronics
BUYERS'
GUIDE

is the electronic engineer's

BREADBOARD
WHO'S WHO

for

quick, accurate
answers to any
questions about

COMPONENTS
EQUIPMENT
MATERIALS

used in electronics

*Get in the habit
of looking it up in...*

the **electronics**
BUYERS' GUIDE

"The Book that has all the answers"

A. MCGRAW-HILL PUBLICATION
330 West 42nd Street
NEW YORK 36, N. Y.

U. G. CONNECTORS

*Our Coaxial Cable
Connectors Meet All
Government Specifications*

★ ALL ORDERS DELIVERED PROMPTLY ★

*Manufacturers of
Highest Quality Connectors*

ALLIED INDUSTRIES, INC.

**1023 S. 21st STREET
LOUISVILLE 10, KY.**

Phone Arlington 4640

Why You Should Depend on
BENNETT For

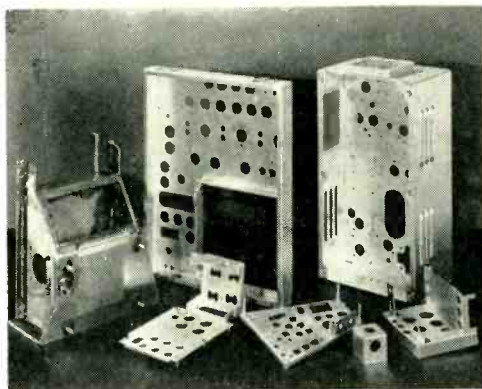

- ✓ CABINETS
- ✓ CHASSIS
- ✓ CUSTOM SHEET METAL PARTS

◀ Typical examples of the wide range of metal fabricated parts produced by Bennett.

MANY LEADING ELECTRONIC COMPANIES DO

Engineering, plant capacity, experienced "know how" and metal craftsmanship have made Bennett a prime source of supply for many leading electronic and electrical equipment manufacturers. Located in a suburb of Buffalo, the Bennett plant with complete facilities can deliver what you need when you want it. Send blueprints or sample parts today for prices and delivery.

THE BENNETT MANUFACTURING COMPANY

REPRESENTATIVES INQUIRIES
SOLICITED

ALDEN, NEW YORK

close temperature control is a snap with STEVENS

TYPE M BIMETAL DISC THERMOSTATS



Thermostats shown approximately full size. Other designs available.

APPLIANCES AND APPARATUS

ELECTRONIC DEVICES AND AVIONIC EQUIPMENT

INSTRUMENTS AND DEVICES

Stevens Type M* thermostats are engineered for compactness . . . lightness . . . close temperature control. Featuring quick make and break operation, fast snap of bimetal disc and series double-breaking contacts reduce arcing . . . assure positive On and Off.

Bimetal thermal element actuates a low-resistance bridging contact disc which carries current. Bimetal disc responds only to temperature of controlled device or air surrounding thermostat . . . prevents false cycling or life-shortening "jitters."

For operation in any ambient from -75°F to nearly 600°F, Stevens Type M thermostats are available with virtually any terminal or mounting arrangement in standard or hermetically sealed types.

Get faster response . . . closer temperature control. Specify Stevens Type M thermostats for your product—for better performance, longer life.

A-4719

*Patented

STEVENS manufacturing company, inc.

MANSFIELD, OHIO

Kell and A. C. Schroeder of RCA Labs., Princeton, N. J.

Session 24: Quality Control Methods Applied to Electron Tube and Electronic Equipment Design

Use of Statistical Tolerances to Obtain Wider Limits on Tube Component Dimensions by E. V. Space of RCA, Harrison, N. J.

Tolerance Considerations in Electronic Product Design by Raymond C. Miles of Airborne Instruments Lab., Mineola, N. Y. Distribution Patterns for the Attributes of Electronic Circuitry by R. F. Rollman and E. D. Karmiol of DuMont Labs., East Paterson, N. J.

The Application of Statistics to Field Surveillance of Product Performance by R. Herd of Aeronautical Radio, Inc., Washington, D. C.

Reliability of Electron Tubes in Military Applications by E. F. Jahr of Aeronautical Radio, Inc., Washington, D. C.

Dynamic Environment Testing by D. T. Geiser of Boeing Airplane Co., Wichita, Kansas.

Session 25: Seminar: Acoustics for the Radio Engineer—I

Fundamental Theory by Leo L. Beranek of MIT, Cambridge, Mass.

Microphones by Harry F. Olson, RCA of Princeton, N. J.

Loudspeakers by Hugh S. Knowles of Industrial Research Products, Inc., Franklin Park, Ill.

WEDNESDAY, MARCH 25, 1953—2:30 P.M.

Session 26: Electron Devices III—Microwave Tubes

High Power Traveling Wave Tube Amplifiers by M. Ettenberg of Sperry Gyroscope Co., Great Neck, N. Y.

Operation of the Traveling-Wave Tube in the Dispersive Region by L. A. Roberts and S. F. Kiesel of Electronics Research Lab., Stanford Univ., Stanford, Calif.

A Traveling-Wave Electron Buncher by R. B. Neal of Stanford Univ., Stanford, Calif.

Some Properties of Periodically Loaded Structures Suitable for Pulsed Traveling Wave Tube Operation by Marvin Chodorow and Ervin J. Nalos of Microwave Lab., Stanford Univ., Stanford, Calif.

Experiments on Millimeter Wave and Light Generation by H. Motz, W. Thon and R. N. Whitehurst of Stanford Univ., Stanford, Calif.

Session 27: Information Theory I—Recent Advances

Recent Advances in Information Theory by Louis DeRosa of Federal Telecommunication Labs., Inc., Nutley, N. J.

Radar Problems and Information Theory by Harry Davis of Airmaterial Command, Redbank, N. J.

Analysis of Multiplexing and Signal Detection by Function Theory by Nathan Marchand of Marchand Electronic Labs., Greenwich, Conn.

Optimum Nonlinear Filters for the Extraction and Detection of Signals by L. A. Zadeh of Columbia University, New York, N. Y.

Detection of Information by Moments by J. J. Slade, Jr., S. F. Fich, D. A. Molony of Rutgers University, New Brunswick, N. J.

Session 28: Communications Systems

Automatic-Tuning Communications Transmitter by M. C. Dettman of Federal Telecommunication Labs., Nutley, N. J.

Doubling of Channel Capacity of Single Sideband Systems by Clifford D. May of the Office of Chief Signal Officer, Washington, D. C.

Performance of Space and Frequency Diversity Receiving Systems by R. E. Lacy of Fort Monmouth, N. J., M. Acker of Fort Monmouth, N. J., and J. L. Glaser of Bell Telephone Labs., New York, N. Y.

Effect of Hits in Telephotography by P. Mertz and K. W. Pfeiffer of Bell Telephone Labs., New York, N. Y.

Reliability of Military Electronic Equipment and Our Ability to Maintain it for War by A. S. Brown of Stanford Research Institute, Stanford, California.

Session 29: Symposium: Television Broadcasting and UHF

A Flexible TV Studio Intercommunication System by R. D. Chipp and R. F. Bigwood

"INDUSTRIAL"

for
**ELECTRONIC
COMPONENTS**

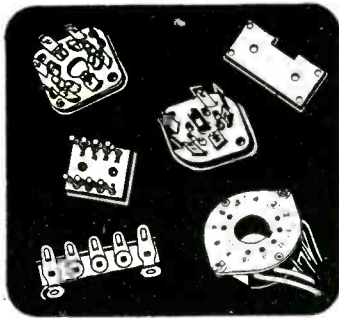

Precision engineered electronic components and connecting devices for all your needs.

- LAMINATED TUBE SOCKETS
- TERMINAL STRIPS
- WIRED ASSEMBLIES
- BAKELITE STAMPINGS
- TERMINAL BOARD ASSEMBLIES

Our extensive design and production facilities are available for developing your special requirements and applications. Representatives in principal cities throughout U. S. A. Call or write for samples and information. ORegon 7-1881.



INDUSTRIAL HARDWARE Mfg. Co., Inc.
109 PRINCE STREET • NEW YORK 12, N. Y.

ELECTRON TUBE TECHNICIANS

We now have several openings for technicians to work in the fabrication and processing of advanced type electron tube research models.

To qualify for one of these openings you should be experienced in experimental work for research and development in vacuum tubes, which includes the fields of mechanics, electronics, chemistry and high-vacuum techniques.

ADDRESS RESUME OF TRAINING
AND EXPERIENCE TO

HUGHES
RESEARCH AND
DEVELOPMENT LABORATORIES

*Technical
Personnel
Department*

CULVER CITY,
LOS ANGELES COUNTY,
CALIFORNIA

**See us at
BOOTH 212
Radio Engineering Show
MARCH 23-26
Grand Central Palace
New York City**

Microwave Assemblies, Radar Components, and Precision Instruments . . . manufactured to your Blueprints and Specifications.

N. R. K. MFG. & ENGINEERING CO.
4601 WEST ADDISON STREET • CHICAGO 41, ILLINOIS

**MAGNET, RESISTANCE
and ALLOY WIRE**

- Small space factor
- Unaffected by chemicals or corrosive atmosphere
- Capable of withstanding 250° centigrade
- High dielectric
- Excellent flexibility and abrasion resistance
- Sizes: 10 through 50 A.W.G.

Send for **NEW Warren Wire Specification 1001**

WARREN WIRE CO.
POWNAH VERMONT

Producers of Nylon, Plain Enamel and Served Magnet Wire, Tinned and Bare Copper Wire.

*Du Pont trademark for Polytetrafluoroethylene Enamel

AFSCO AMPLIMETER

MODEL
M-10

A PRECISION
ELECTRONIC WIDE BAND
VTVM and WIDE BAND
AMPLIFIER

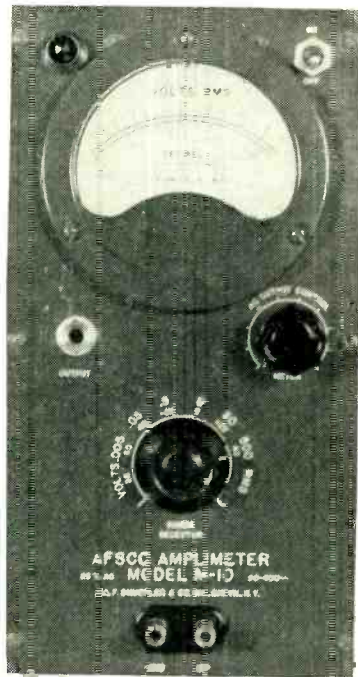

ACCURATE—SENSITIVE—STABLE—RUGGED

MEETS MIL REQUIREMENTS ON TEMPERATURE, HUMIDITY and STABILITY. Used by the Military Services.

SPECIFICATIONS

METER RANGES: Accurate readings from 500 microvolts to 500 volts rms in six overlapping decade ranges (or -65 to +57 VU).

INSTRUMENT ACCURACY: $\pm 2\%$ at any scale point from 15 cycles to 250,000 cycles per second.

INPUT IMPEDANCE: 2 megohms in shunt with 15 micro-microfarads.

DECIBEL METER SCALE RANGE: -5 to +17 db.

DECIBEL CONVERSION BASIS: .001 watt reference level in 600 ohm line.

STABILITY: $\pm 1\%$ over line variation from 105 to 125 volts AC.

UNDISTORTED AMPLIFIER OUTPUT: Up to 8 volts AC supplied from an internal impedance not greater than 2000 ohms.

AMPLIFIER GAIN: 1600

AMPLIFIER NOISE: Less than 50 MV with input terminals shorted.

RESPONSE OF INTERNAL AMPLIFIER: 15 to 250,000 cps $\pm 2\%$.

POWER REQUIREMENTS: 105-130 volts AC, 50-400 cps, 31 watts.

DIMENSIONS: 5 $\frac{7}{8}$ " x 5 $\frac{3}{4}$ " x 11-5/16".

SHIPPING WEIGHT: Approximately 13 lbs.

PRICE: \$200.00 F. O. B. Plant, Brooklyn, New York.

FOR FURTHER INFORMATION WRITE

A. F. SMUCKLER & CO., INC.

Electronic and Communication Engineers and Manufacturers

202-208 TILLARY ST., BROOKLYN 1, NEW YORK

PLANTS AND PEOPLE

(continued)

of DuMont Television Network, New York, N. Y.

CBS Television's Hollywood TV City: Video, Audio and Intercommunication Facilities by Richard O'Brien, Robert Monroe and Price Fish of Columbia Broadcasting System, New York, N. Y.

An Experimental Study of Wave Propagation at 850-MC by Jess Epstein and Donald W. Peterson of RCA Labs., Princeton, N. J.

A Typical UHF Installation by W. H. Sayer, Jr. of DuMont Labs., Passaic, N. J. High Power UHF Klystron Application by A. E. Rankin of General Electric Co., Schenectady, N. Y.

High Power UHF Klystron Amplifier Design by N. P. Hiestand of Varian Associates, San Carlos, Calif.

High Power UHF Television Broadcasting Systems by H. M. Crosby of General Electric Co., Syracuse, N. Y.

Session 30: Microwaves I—Symposium: Manufacture of Microwave Equipment

How to Design Microwave Components for Ease of Assembly by F. Neukirch of N. R. K. Manufacturing & Engineering Co., Chicago, Ill.

The Design of Microwave Components for Production by Henry J. Riblet of Microwave Development Labs., Waltham, Mass. Fabrication of Microwave Components Employing the Dip Brazing Process by William J. Rudolph of The Glenn L. Martin Co., Baltimore, Maryland.

Electroforming with Copper, Nickel and Other Metals by C. L. Duncan of Chamblee, Ga.

Manufacturing Microstrip Printed Circuit Components by H. F. Engelman (probable speaker) of Federal Telecommunication Labs., Nutley, N. J.

Session 31: Seminar: Acoustics for the Radio Engineer—II

Phonograph Reproducers by Benjamin B. Bauer of Shure Brothers, Inc., Chicago, Ill.

Tape Recording by Marvin Camras of Armour Research Foundation, Chicago, Ill.

Studio Acoustics by Hale J. Sabine of Celotex Co., Chicago, Ill.

THURSDAY, MARCH 26, 1953—10:00 A.M.

Session 32: Symposium: Nucleonics

Servomechanism for Remote Manipulation by Raymond C. Geertz of Argonne National Lab., Chicago, Ill.

The Applications of Secondary Emission Multiplier to Nuclear Particle Measurements by George Morton of RCA Labs., Div., Princeton, N. J.

Electronic Circuitry for Nuclear Reactors (speaker to be announced)

Billion-electron-volt Accelerators by Kenneth Green of Brookhaven National Lab., Upton, L. I., N. Y.

Instrumentation Developments in Fast Neutron Dosimetry by G. S. Hurst and R. H. Ritchie of Oak Ridge National Lab., Oak Ridge, Tenn.

Session 33: Information Theory II—Theoretical

Error Probabilities of Binary Data Transmission Systems in the Presence of Random Noise by S. H. Reiger of Air Force Cambridge Research Center, Cambridge, Mass.

Statistical Properties of the Output of Certain Frequency Sensitive Devices by G. R. Arthur of Sperry Gyroscope Co., Great Neck, N. Y.

Cross-Correlation Applied to Automatic Frequency Control by M. J. Stateman of Sylvania Electric Products, Inc., Bay-side, N. Y.

Approximate Probability Density Function of First Level Crossing for Linearly Increasing Signal Plus Noise by G. Preston and R. Gardner of Philco Corp., Philadelphia, Pa.

A Design Criteria for the Optimum Demodulation of Generalized Modulated Signals by F. W. Lehan of California Institute of Technology, Pasadena, Calif.

Session 34: Medical Electronics

Electric Photograph by K. S. Lion, MIT, Cambridge, Mass.

Concerning the Use of High Energy Particles and Quanta in the Determination of the Structure of Living Organisms by R. J. Moon of University of Chicago, Chicago, Ill.

Possible Medical and Industrial Application of Linear Electron Accelerators by

one week
delivery

LAMINATED PHENOLIC



- LABEL PLATES
- DISCS
- PANELS
- STRIPS

Fabricated to specifications
Ask for price list.

HERMES Plastics, Inc.
13-19 University Pl. • N. Y. 3, N. Y.

VARIABLE DC POWER SUPPLY REGULATION 1/10 OF 1 PERCENT

FEATURING

- Precise Regulation
- Low Ripple
- Low Output Impedance
- Bias Supply
- Fil. Supply
- Small Size

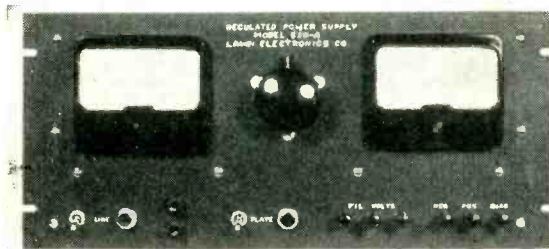

This unit is designed for general laboratory use where good regulation, low ripple, and low output impedance along with wide voltage range and heavy load current are required. It incorporates a bias and filament supply so that this single source may supply all the power required for most design or test set ups.

MODEL 630-A SPECIFICATIONS

Output Voltage: Continuously variable 0 to 600 pos. or neg. volts.	Hum Voltage: Less than 1 MV ripple.
Output Current: 0 to 300 MA at any voltage setting.	Output Impedance: Less than 5 ohms from 20 to 20,000 CPS.
Regulation: Output voltage varies less than 0.1% for any condition of line or load.	Plus: 0 to -250 Bias volts stabilized to less than 0.1 volts. 6.3 volts 6 ampere fil. supply center tapped ungrounded.

For Information on this unit or regulated supplies to your specifications write or call —

LAWN ELECTRONICS COMPANY
E. FREEHOLD ROAD
FREEHOLD 8-0175
FREEHOLD, N. J.

Now
PL-4D21

**POWER
TETRODE**



125 WATT PLATE DISSIPATION.
FULL RATINGS TO 120 Mc.
HIGH OVERLOAD CAPABILITIES.
AVAILABLE IMMEDIATELY.

For data, Write:



PENTA LABORATORIES INC.
216 North Milpas Street
SANTA BARBARA, CALIFORNIA

MICROWAVE RESISTORS TELEWAVE TYPE R

**SMALLEST
RESISTOR
AVAILABLE**

(Ideal for Miniaturization)



TYPICAL APPLICATIONS

- Power measurement at any frequency
- Matched terminations for waveguides or coaxial lines
- Resistive power pickup loops
- RF pads or attenuators
- Dummy loads
- Temperature measurements
- Impedance matching

SPECIFICATIONS

Resistance: 50 ohms standard, other values on request.
Tolerance: 5% or 10%
Wattage: 1/4 watt continuous duty at 25°C
Size: 1/16 inch diam. x 3/16 inch long
Terminals: Tinned sections 1/16 inch long
Film Length: Type R-063 — 1/16 inch
Type R-093 — 3/32 inch
Temperature Coefficient:
approx. 0.0019 ohms/ohm/°C.
Power Sensitivity: Approx. 10 ohms/watt

TYPE R RESISTORS employ noble metal film deposits on specially selected heat resistant glass.

FILM THICKNESS offers negligible skin effect, at microwave frequencies.

POWER CAPACITY of 1/4 watt provides high power handling ability.

PHYSICAL STRUCTURE is ideally suited to impedance matching in standard coaxial line and waveguides.

FINISH. Coated with a special silicone varnish to protect the film.

TELEWAVE LABORATORIES, INC.
100 Metropolitan Ave. • Brooklyn 11, New York

AVAILABLE
FOR
IMMEDIATE
DELIVERY

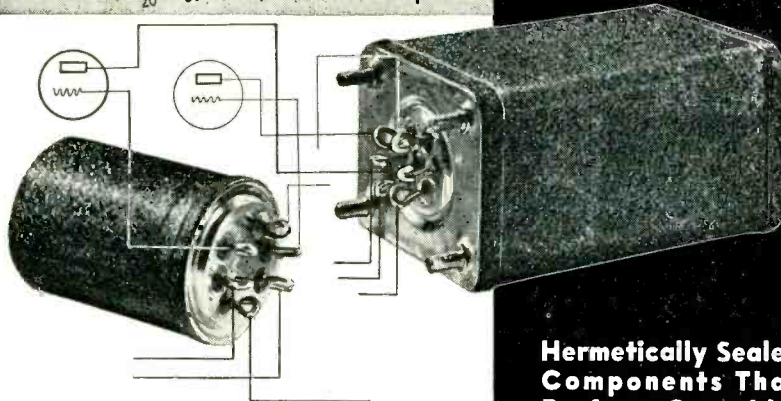
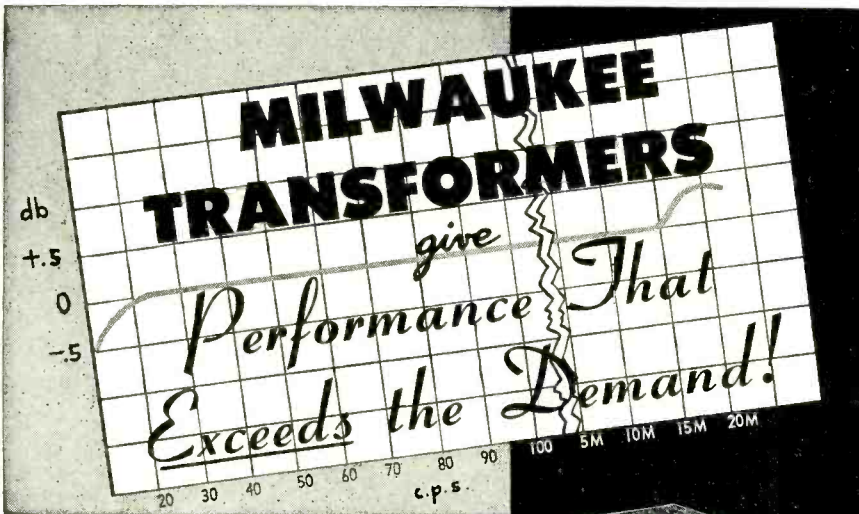

More and more exacting engineers and designers are getting firsthand, *proof* of the rigid, round-the-clock performance standards built into every Milwaukee Transformer Co. product.

Stringent quality control methods combined with modern production facilities and skilled engineering are reasons why you can expect and get "Performance that *Exceeds* the Demand."

Custom-engineered components for MIL-T-27 government, and commercial requirements. Quotations submitted upon request.

SPECIALTY ENGINEERING . . . DESIGN, DEVELOPMENT AND PRODUCTION



Write for your **Free** Copy of Brochure MTR-1

Hermetically Sealed Components That Perform Superbly. Lastingly In Airborne, Ground Applications.

AUDIO, POWER, PULSE TRANSFORMERS — REACTORS, FILTER NETWORKS

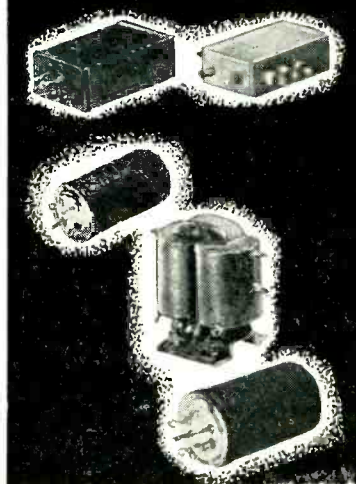

MILWAUKEE TRANSFORMER CO.

5231 NORTH HOPKINS STREET
MILWAUKEE 9, WISCONSIN



W. C. Barber of Stanford University, Stanford, California.
Capacity and Conductivity of Body Tissues at Ultra High Frequencies by Herman P. Schwan and Kam Li of University of Pennsylvania, Philadelphia, Pa.
The Problem of Application of Electronics to Medicine by Robert S. Schwab of Mass. General Hospital, Boston, Mass.
Progress Report in Electronic Mapping of the Electrical Activity of the Heart by Stanford Goldman, W. D. Spence, Mary Rizika and Silvan Lidovitch of Syracuse Univ., East Syracuse, N. Y.

Session 35: Broadcast and Television Receivers—I

Gain Stable Mixers and Amplifiers with Current Feedback by Gail E. Boggs of National Bureau of Standards, Washington, D. C.

Video Amplifiers with Instantaneous Automatic Gain Control by William E. Ayer of Stanford University, Stanford, Calif.
An Automatic Level-Setting Sync and AGC System by E. O. Keizer of RCA Labs, Princeton, N. J. and M. G. Kroger of Motorola, Inc., Chicago, Ill.
Packaged Adjacent Channel Attenuation for Television Receivers by John P. Van Duyn of DuMont Labs, Inc., Clifton, N. J.
Methods of Matrixing in an NTSC Color Television Receiver by Will M. Quinn of General Electric Co., Syracuse, N. Y.

Session 36: Microwaves II—Discontinuities and Transitions

R-F Measurements on Metallic Delay Media by Seymour B. Cohn of Sperry Gyroscope Co., Great Neck, N. Y.
Impedance Measurement in a Circular Waveguide with TE_{01} Excitation by Leonard S. Sheingold of Sylvania Electric Products Inc., Boston, Mass.

Experimental Determination of the Properties of Microstrip Components by M. Arditi of Federal Telecommunication Labs, Inc., Nutley, N. J.

A Wideband Transition Between Waveguide and Coaxial Line by Ned A. Spencer and Harold A. Wheeler of Wheeler Labs., Great Neck, N. Y.

A Contribution to the Ridge Guide Problem by Bela A. Lengyel of Hughes Aircraft Co., Culver City, Calif.

Session 37: Radio Telemetry

Telemetry Requirements for Upper Air Rocket Research Experiments by Marcus O'Day of Air Force Cambridge Research Center, Cambridge, Mass.

Telemetry—Broad Band on Short Order by Thomas F. Jones, Jr., of General Electronic Labs., Inc., Boston, Mass.
Flutter Compensation for FM/FM Telemetry Recorder by John T. Mullin of Bing Crosby Enterprises, Inc., Los Angeles, Calif.

A Magnetic Tape Recording System for Precision Data by Louis L. Fisher of Ampex Electric Corp., Redwood City, Calif.

An Improved FM/FM Decommulator Ground Station by Foster N. Reynolds of The Ralph M. Parsons Co., Pasadena, Calif.

Some Industrial Applications of Telemetry by F. N. Stephens of Midwest Research Institute, Kansas City, Mo. and Lee Bergren of Great Lakes Pipe Line Co., Kansas City, Mo.

THURSDAY, MARCH 26, 1953—2:30 P.M.

Session 38: Audio

Sound Reinforcement System, General Assembly, United Nations by Leo L. Beranek of MIT, Cambridge, Mass. and C. W. Goyder of United Nations, Telecommunications Div., New York, N. Y.
A Variable Time Delay by Kenneth Goff of Acoustics Lab., MIT, Cambridge, Mass.
A Flux Sensitive Head for Magnetic Recording Play Back by David E. Wiegand of Armour Research Foundation, Chicago, Ill.

Uniaxial Microphone by Harry F. Olson, John Preston and John C. Bleazey of RCA Labs., Princeton, New Jersey.
Sound Pressure Measurement Between 50 and 220 BD by J. K. Hilliard of Altec Lansing Corp., Beverly Hills, Calif.

Session 39: Engineering Management

Report of Year's Activities by the Chairman of the Professional Group on Engineering Management by Ralph I. Cole

WESGO

ALUMINA CERAMIC INSULATORS

Our Engineering Department will gladly answer all inquiries relative to your particular problems.

- High purity . . . free of all impurities such as Iron, Titania, Alkali group elements.
- Made to various formulations with Alumina content from 94% to a pure sintered Alumina with 99.85% minimum Al₂O₃.
- Available in porosities ranging from 20% to an impervious, vacuum tight body.
- Formed to dimensional tolerances of plus or minus 1/2%, minimum of plus or minus .001".
- Completely homogeneous structure.

WESTERN GOLD & PLATINUM WORKS

Ceramic Division

589 BRYANT ST., SAN FRANCISCO, CALIF.

production speeds with **BUTTON STEM MACHINE** for sub-miniature tubes

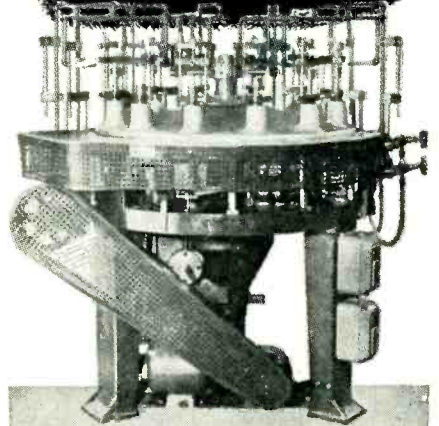

Leading manufacturers of sub-miniature tubes were frantically re-vamping their old machines to avoid production tie-ups in making glass buttons with lead wires. These machines did not meet the exacting requirements of sub-miniature tube production.

Shown above is Kahle's new model 427 Button Stem Machine designed for T2, T3 and T2 x 3 sub-miniature button stems. This is a 12 head machine, with upper and lower moulds on every lead; dual-motor drive — indexing and head are driven by separate motors — indexing by barrel cam and rollers (hardened and ground) totally enclosed, in oil. This machine can be made available for any stems, — with any number of heads, — with automatic feeds.

But this is the solution to only one of many problems which Kahle engineers have been asked to solve over the past 40 years. If you have any difficulty which can be overcome with custom-designed machinery, write today and learn—without obligation—how Kahle's experience can benefit you.

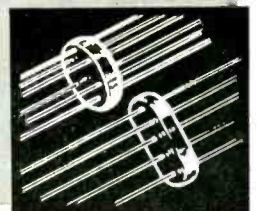

HIGH TENSION DC SUPPLIES

- FINE REGULATION
- LOW RIPPLE • SAFETY

ALL NEUTRONIC Power Supplies are housed in standard 19 inch rack panel cabinets



MODEL No.	VOLTAGE RANGE	CURRENT RANGE	REGULATION
21M	1-15 KV	6 ma. @ 10 KV	
21MR	1-15 KV	6 ma. @ 10 KV	.5%
22C	3-26 KV	2 ma. @ 18 KV	
22CR	3-26 KV	2 ma. @ 18 KV	.5%
22M	3-26 KV	3 ma. @ 20 KV	
22MR	3-26 KV	3 ma. @ 20 KV	.5%
23C	5-40 KV	1.3 ma. @ 25 KV	
23CR	5-40 KV	1.3 ma. @ 25 KV	.5%
23M	5-45 KV	1.5 ma. @ 30 KV	
23MR	5-45 KV	1.5 ma. @ 30 KV	.5%
24C	5-50 KV	1 ma. @ 35 KV	
24CR	5-50 KV	1 ma. @ 35 KV	.5%
24M	5-55 KV	2 ma. @ 30 KV	
24MR	5-55 KV	2 ma. @ 30 KV	.5%
33S	1-30 KV	4.5 ma. Entire Range	
33HRR	1-30 KV Reversible	5 ma. Entire Range	0.1%

NEUTRONIC ASSOCIATES CONTROL DEVICES

8356 VIETOR AVE., ELMHURST, L. I., N. Y.

The Green Engraver



ENGRAVES ✓ ROUTS ✓ PROFILES ✓ and MODELS

Used and endorsed by tool and die, electronic, machine, plastics, radio, electrical and instrument manufacturers. A real money saver.

Specify the Green Engraver for precision engraving on metal, plastics, wood, glass, hard rubber etc. . . engraves panels, name plates, scales, dials, molds, lenses, instruments, instruction plates, directional signs . . . by simple tracing from master. Routing, profiling and three dimensional modeling indicate its versatility.

Electric etching attachment available.

Special attachments and engineering service available for production work.

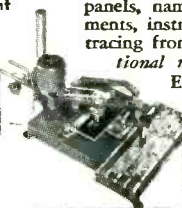

FREE: Brochure—yours upon request.

Green Instrument Co.
INCORPORATED

363 PUTNAM AVENUE - CAMBRIDGE - MASS.

Kahle

ENGINEERING COMPANY

1310 SEVENTH STREET
NORTH BERGEN N. J.

ELECTRICAL INSULATION THAT WILL TAKE 2000° F. FOR BRIEF PERIODS!

Aircraft fire detection apparatus needs that. Here is the Mycalex glass-bonded mica part that has it.

Mycalex 410 molded with steel ring inserts for thermo-coupling device produced by Thomas A. Edison, Inc.



● For permanent endurance Mycalex can take 650°F. continuously without heat distortion or any other injury.

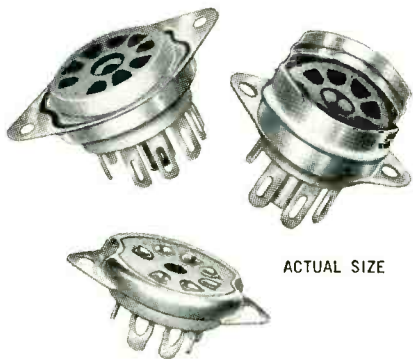

ACTUAL SIZE

Mycalex is superior for high voltage, high frequency components that must operate in small spaces.

For example, tube sockets like these — now used in over 60% of all television receiver tuners. — Manufactured and sold by Mycalex Tube Socket Corporation, Clifton, N. J.

If your insulation must take heat or get rid of heat, investigate Mycalex!

WRITE FOR ENGINEERING DATA BOOK



MYCALEX CORPORATION of AMERICA

Owners of "MYCALEX" Patents and Trade-Marks
Executive Offices: 30 Rockefeller Plaza, New York 20, N.Y.

GENERAL OFFICES AND PLANT
114 CLIFTON BOULEVARD, CLIFTON, N. J.

WANTED—

Television Antennas—VHF and/or UHF—or
Related Electronic Products for Manufacture
and Distribution by a Large, Nationally Known
Electronics Manufacturer with Complete Na-
tional Distribution Facilities.

ATTRACTIVE ROYALTY CAN BE ARRANGED
WHAT HAVE YOU TO OFFER? WRITE AT ONCE

ADDRESS: BOX 1247—MAGNOLIA PARK STATION
BURBANK, CALIFORNIA

"PERFECT..."



That's What Production Engineers Say
about **DANO COILS**

And, it's no accident, of course. The Dano rigid policy of attentive testing and inspecting every coil in all vital stages of production guarantee perfect performance.

Send us samples or specifications with quantity requirements for our recommendation. No obligation!

- Form Wound
 - Paper Section
 - Acetate Bobbin
 - Molded Coils
 - Bakelite Bobbin
 - Cotton Interweave
 - Coils for High Temperature Application.
- Also, Transformers
Made To Order



THE DANO ELECTRIC CO.
MAIN ST., WINSTED, CONN.



High Current Regulated Power Supplies

New
Series!

Standard Sizes, 350 Series
0-350 V @ 750. ma.
0-350 V @ 1. Amp.
0-350 V @ 2. Amp.
0-350 V @ 3. Amp.

Featuring: Very low output impedance at high power levels;
1/2% regulation; 5 MV ripple.
Continuous duty components; short delivery.

Other units available: any voltage and capacity, regulated or un-regulated, fixed or adjustable output voltage. We invite inquiries.

PESCHEL ELECTRONICS, INC.

13 GARDEN STREET, NEW ROCHELLE, N. Y. • NEW ROCHELLE 6-3342

ELECTRICAL INSULATION THAT CAN BE MADE TO THE SAME TOLERANCES AS STEEL

YES, we do mean any tolerances that can be produced in steel.

For example:

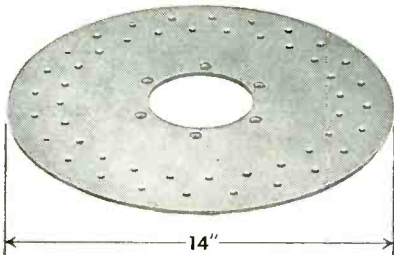

Two of these 14" Mycalex 400 discs revolve with only .004" clearance. Dimensionally stable, too. Mycalex stays accurate.

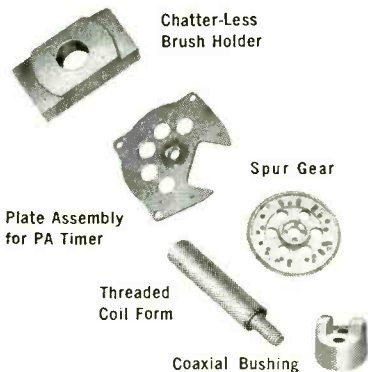

Mycalex glass-bonded mica is found in **HIGH PRECISION** electrical components.

WRITE FOR ENGINEERING DATA BOOK



MYCALEX CORPORATION of AMERICA

Owners of "MYCALEX" Patents and Trade-Marks
Executive Offices: 30 Rockefeller Plaza, New York 20, N.Y.

GENERAL OFFICES AND PLANT

114 CLIFTON BOULEVARD, CLIFTON, N. J.
Want more information? Use post card on last page.
ELECTRONICS — March, 1953

PLANTS AND PEOPLE

(continued)

of Rome Air Development Center, Rome, N. Y.
General Problems of Engineering Management Facing the Electronics Industry by Haraden Pratt, Telecommunications Advisor to the President, Washington, D. C.
Research and Development Problems of Engineering Management in the Electronics Industry by M. J. Kelly of Bell Telephone Labs., Inc., New York, N. Y.
Production Aspects of Engineering Management in the Electronics Industry by W. A. McDonald of Hazeltine Electronics Corp., Little Neck, N. Y.
What the Military Services Expect from Engineering Management of the Electronics Industry by Donald L. Putt of Air Research and Development Command, Baltimore, Md.

Session 40: Information Theory III—Coding

A Necessary and Sufficient Condition for Unique Decomposition of Coded Messages by A. A. Sardinas and G. W. Patterson of Burroughs Adding Machine Co., Philadelphia, Pa.
A Systematic Survey of Coders and Decoders by B. Lippel of Fort Monmouth, N. J.
Method for Time or Frequency Compression—Expansion of Speech by G. Fairbanks, W. L. Everitt and R. Po. Jaeger of University of Illinois, Urbana, Ill.
A New Coding System for Pulse Code Modulation by A. G. Fitzpatrick of Burroughs Adding Machine Co., Philadelphia, Pa.
Coincidence Detectors for Binary Pulses by Clarence Gates of California Institute of Technology, Pasadena, California.

Session 41: Broadcast and Television Receivers—II

Factors Affecting the Design of VHF-UHF Tuners by E. H. Boden of Sylvania Electric Products Inc., Emporium, Pa.
Theory of A.F.C. Synchronization by Wolf J. Gruen of General Electric Co., Syracuse, N. Y.
Standardization of Printed Circuit Materials for Mechanized Radio Assembly by W. Hannahs, J. Caffiaux and N. Stein of Sylvania Electric Products, Bayside, L. I., N. Y.
A Color TV Receiver for the NTSC System by Kenneth E. Farr of Westinghouse Electric Corporation, Metuchen, N. J.
A Simple Pickup Camera Attachment for Television Receivers by V. K. Zworykin, L. E. Flory and W. S. Pike of RCA Labs. Div., Princeton, N. J.

Session 42: Microwaves III—Ferrites and Detectors

Space Charge Detector for Microwaves by A. B. Bronwell, John May, Charles Nitz, T. C. Wang, and Hilliard Wachowski of American Society for Engineering Education, Evanston, Ill.
Low Level Synchronous Mixing by M. E. Brodwin, C. M. Johnson of The Johns Hopkins University, Baltimore, Md. and W. M. Waters of Bendix Radio, Towson, Md.
Guided Wave Propagation Through Ferrites and Electron Gases in Magnetic Fields by L. Goldstein, M. Gilden, and J. Etter of University of Illinois, Urbana, Ill.
Cavities with Complex Media by A. D. Berk and Benjamin Lax of MIT, Cambridge, Mass.
Resonance in Cavities with Complex Media by Benjamin Lax and A. D. Berk of MIT, Cambridge, Mass.

Session 43: Remote Control Systems

The Organization of a Digital Real Time Simulator by H. J. Gray, Jr. of University of Pennsylvania, Philadelphia, Pa.
Control System Engineering Applied to Suspension Systems by C. J. Martin, R. Jeska and E. B. Therkelsen of University of Michigan, Ypsilanti, Mich.
Experimental Evaluation of Control Systems by Random-Signal Measurements by William W. Seifert of MIT, Cambridge, Mass.
Extension of Conventional Techniques to the Design of Sampled-Data Systems by W. K. Linvill and R. W. Sittler of MIT, Cambridge, Mass.
Generalized Servomechanism Evaluation by W. P. Caywood and William Kaufman of Carnegie Institute of Technology, Pittsburgh, Pa.
Method for Reducing the Forced Dynamic Error of Closed-Loop Systems by L. H. King of MIT, Cambridge, Mass.

IS THERE ANYTHING WRONG WITH MYCALEX?

YES

It's inelastic

- But inserts won't shake loose.

It has high density

- But permits reduction of overall size and weight.

It has no color appeal

- But has certain surface finish interest.

MYCALEX GLASS-BONDED MICA
IS THE ONLY
CERAMOPLASTIC

The only material combining most of the best properties of ceramics and plastics, plus some of its own.

GET THE FULL, FRANK STORY



WRITE FOR ENGINEERING DATA BOOK



MYCALEX CORPORATION of AMERICA

Owners of "MYCALEX" Patents and Trade-Marks
Executive Offices: 30 Rockefeller Plaza, New York 20, N.Y.

GENERAL OFFICES AND PLANT

114 CLIFTON BOULEVARD, CLIFTON, N. J.
Want more information? Use post card on last page.

- FOR . . .
- PULSE INVERSION
 - D-C ISOLATION
 - IMPEDANCE MATCHING
 - MAGNETIC CORE CIRCUITS
 - BLOCKING OSCILLATOR TRANSFORMER

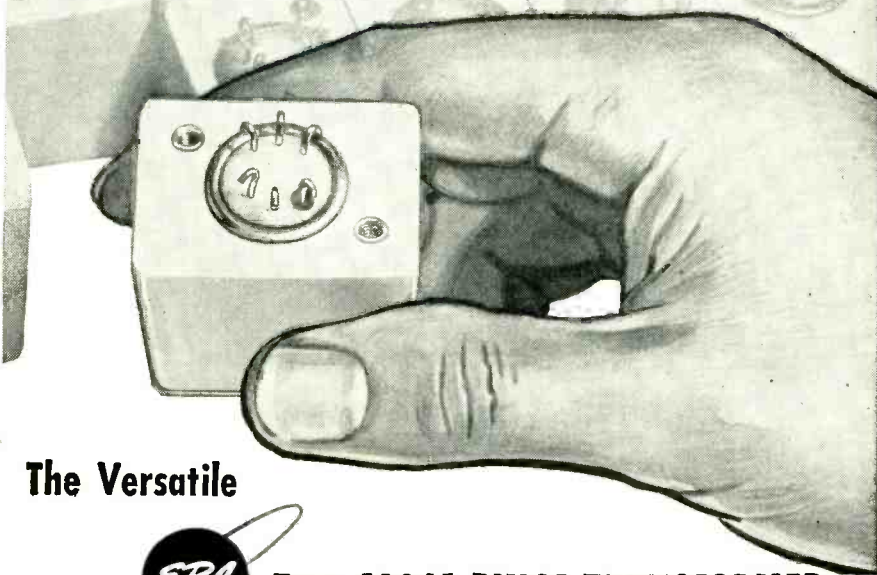

The Versatile



Type 130A1 PULSE TRANSFORMER for Low-Power applications

SUPERIOR ELECTRICAL CHARACTERISTICS—The ERA 130A1 pulse transformer provides appropriate impedance levels for operation in low-power circuits. Short rise time and small droop minimize critical circuit design problems.

VERSATILITY—ERA three-winding pulse transformers can be used in several different ways. For example, the Type 130A1 can be used as low-impedance 1:1, high impedance 1:1, conventional 2:1, 2:1 with two outputs or as 3:1.

CONVENIENT MOUNTING—Through-panel mounting utilizes same mounting hole pattern as a conventional nine-pin miniature tube socket. This compact transformer design permits mounting on a tube strip in approximately the same space required for a standard miniature tube.

INSULATING CASE—The plastic case permits mounting the transformer in close proximity to other components and terminals without danger of short-circuits caused by metal-cased or uncased transformers.

Immediate delivery on
sample quantities

WRITE FOR
DESCRIPTIVE BULLETIN

Engineering Research Associates
Division of *Remington Rand*
INC

1902 West Minnehaha Avenue, Dept. E-9, St. Paul W4, Minnesota

DIGITAL COMPUTERS . . . DATA-HANDLING SYSTEMS . . . MAGNETIC STORAGE SYSTEMS . . .
INSTRUMENTS . . . ANALOG MAGNETIC RECORDING SYSTEMS . . . COMPUTING SERVICE

NEW BOOKS

Electrical Fundamentals of Communication

By A. E. ALBERT. 2nd Edition, McGraw-Hill Book Co., Inc., New York, 1952, 531 pages, \$7.00.

PROFESSOR Albert's first edition of "Electrical Fundamentals of Communication" appeared in 1942 as a text designed for the individual interested in familiarizing himself with simplified laws of electrical communication. The book was designed for the student with only a limited background in physics and mathematics. The main topics discussed were d-c and a-c circuit constants, networks and measurements of electrical quantities, electron tubes and circuits, transmission of electromagnetic waves and electro-acoustics.

The second edition is a replica of the first with minor changes in symbolisms and terminology. The format of the original edition has been retained. Each chapter terminates with a summary, review questions on the theory, and problems requiring numerical computations which involve a knowledge of simple algebra and trigonometry. These features are well integrated.

Inductors, capacitors, filters, rectifiers and oscillators are prematurely introduced for the sole purpose of acclimating the reader to a new language. Later on, attempts are made to clarify these terms with descriptions and illustrations which are adequate.

The quantitative aspects relate to the application of Kirchhoff's laws to simple circuits. The concept of a-c impedance is delved into as a complex quantity and effective measurable quantities, such as current, voltage and power, are defined. Examples illustrate the importance of phase angles and their influence on instantaneous variations of current and voltage in circuits containing combinations of resistance, inductance and capacitance. The importance of matching networks is considered for the realization of maximum power transfer from a source to a terminating load.

Electromagnetic waves are discussed very qualitatively. Attempts are made to describe the sig-

KULKA TERMINAL BLOCKS for Electronic Equipment

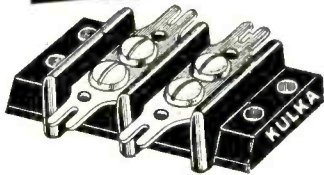

- ✓ Eliminate Splicing
- ✓ Stop leaks and Shorts
- ✓ Increase Insulation
- ✓ Make Better Connections
- ✓ Reduce Assembly Work
- ✓ Quality Blocks at Low Cost
- ✓ Assured Supply Source

MADE IN VARIOUS STYLES AND SIZES UP TO 26 TERMINALS. WRITE FOR ILLUSTRATED BULLETIN.

KULKA

ELECTRIC MFG. CO. INC.
MOUNT VERNON, N. Y.



PRECISION GEARS AND GEAR TRAINS

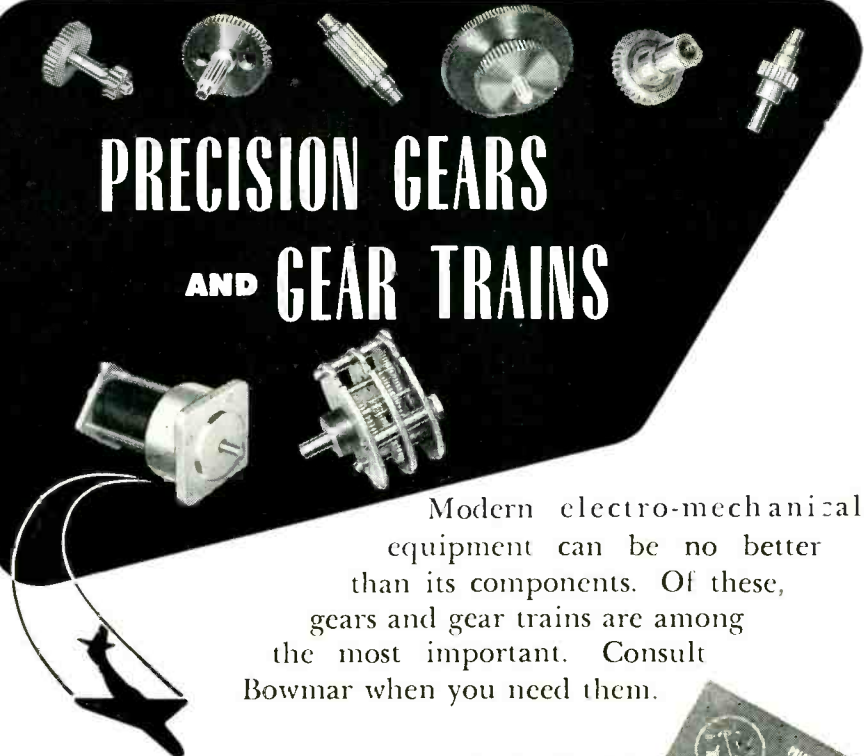

Modern electro-mechanical equipment can be no better than its components. Of these, gears and gear trains are among the most important. Consult Bowmar when you need them.

SEND FOR DESCRIPTIVE LITERATURE, DEPT. E-3

BOWMAR INSTRUMENT CORP.

SMITH MUNICIPAL AIRPORT
FORT WAYNE, IND. • A-2455



BE SAFE WITH

Q-max

A-27

LOW-LOSS LACQUER & CEMENT

- Q-Max is widely accepted as the standard for R-F circuit components because it is chemically engineered for this sole purpose.
- Q-Max provides a clear, practically loss-free covering, penetrates deeply, seals out moisture, imparts rigidity and promotes electrical stability.
- Q-Max is easy to apply, dries quickly and adheres to practically all materials. It is useful over a wide temperature range and serves as a mild flux on tinned surfaces.
- Q-Max is an ideal impregnant for "high" Q coils. Coil "Q" remains nearly constant from wet application to dry finish. In 1, 5 and 55 gallon containers.

Communication
Products Company, Inc.

MARLBORO, NEW JERSEY
(MONMOUTH COUNTY)
Telephone: Freehold 8-1880



COILS to exact specification for every requirement

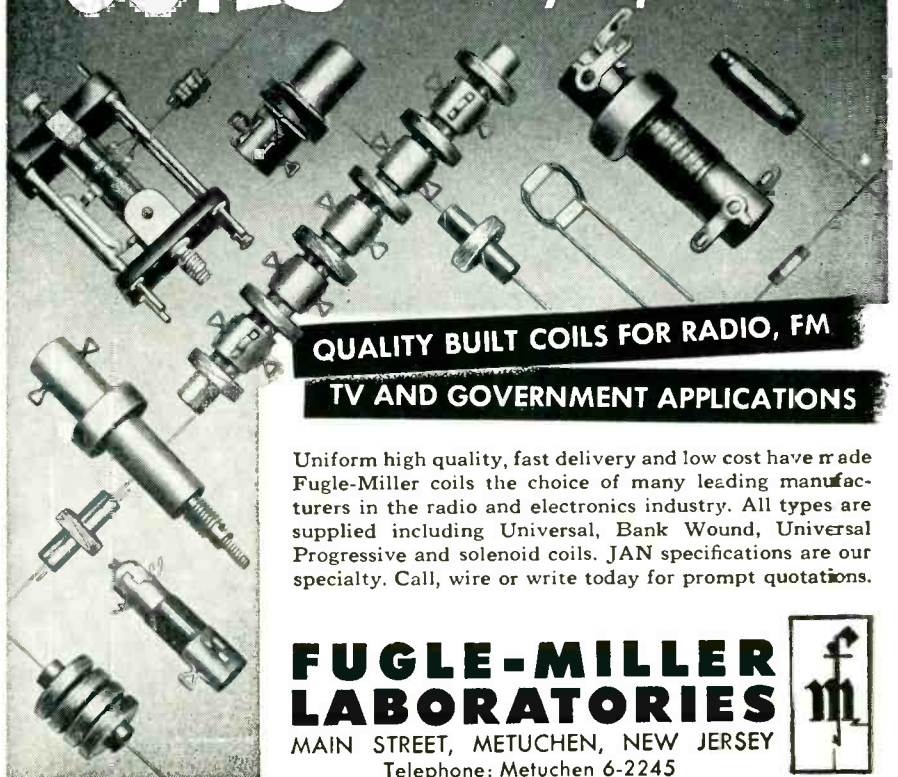

QUALITY BUILT COILS FOR RADIO, FM
TV AND GOVERNMENT APPLICATIONS

Uniform high quality, fast delivery and low cost have made Fugle-Miller coils the choice of many leading manufacturers in the radio and electronics industry. All types are supplied including Universal, Bank Wound, Universal Progressive and solenoid coils. JAN specifications are our specialty. Call, wire or write today for prompt quotations.

FUGLE-MILLER LABORATORIES

MAIN STREET, METUCHEN, NEW JERSEY
Telephone: Metuchen 6-2245



TEST CHAMBERS

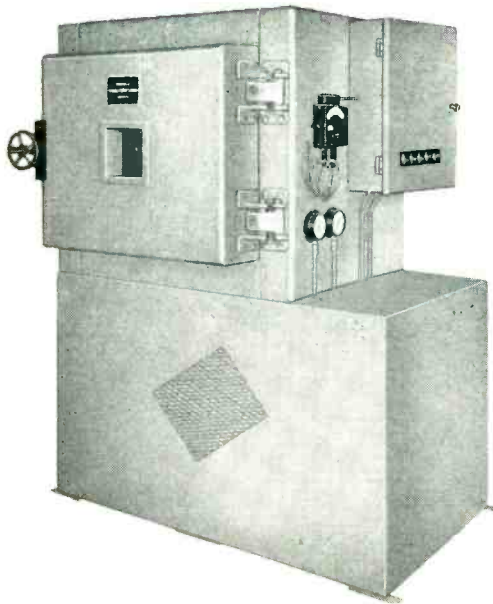

HIGH & LOW
TEMPERATURES

CONTROLLED
HUMIDITY

- -150°F. to $+200^{\circ}\text{F.}$
- 20% to 95% R.H.
- 1 cu. ft. to 75 cu. ft. cabinets

Walk-in Rooms
Temperature Baths

Electronic or pneumatic
recording or indicating
control systems

CUSTOM CHAMBERS
built to specifications.

Years of Satisfactory Service

56 Washington Avenue
Carlstadt, New Jersey



YOUR PRODUCTION RESERVE!

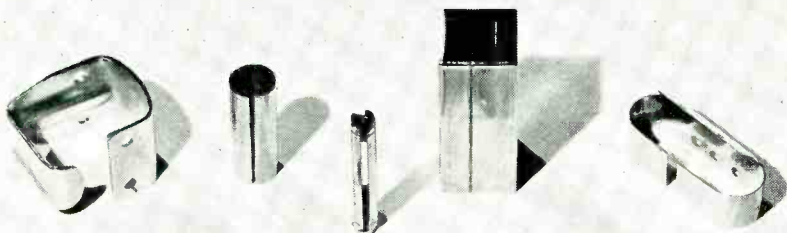

THOMAS



is standing by to quickly tool up
for your metal parts requirements.
Specializing in large volume
production of quality parts at
competitive prices. Facilities for
all secondary operations, auto-
matic assemblies and finishing.
4-slide equipment available for
multi-forming operations.

WILLIAM THOMAS & SONS
91 Pearl St., Brooklyn 1, N. Y., TRiangle 5-5626

FOUR GENERATIONS OF EXPERIENCE...

the annual
electronics
BUYERS'
GUIDE

is the electronic engineer's

BREADBOARD WHO'S WHO

for

quick, accurate
answers to any
questions about

COMPONENTS
EQUIPMENT
MATERIALS

used in electronics

*Get in the habit
of looking it up in...*

the **electronics**
BUYERS' GUIDE

"The Book that has all the answers"

A MCGRAW-HILL PUBLICATION

330 West 42nd Street

NEW YORK 36, N. Y.

EFFICIENT, LOW-COST SPROCKET-DRIVE employs BEAD CHAIN

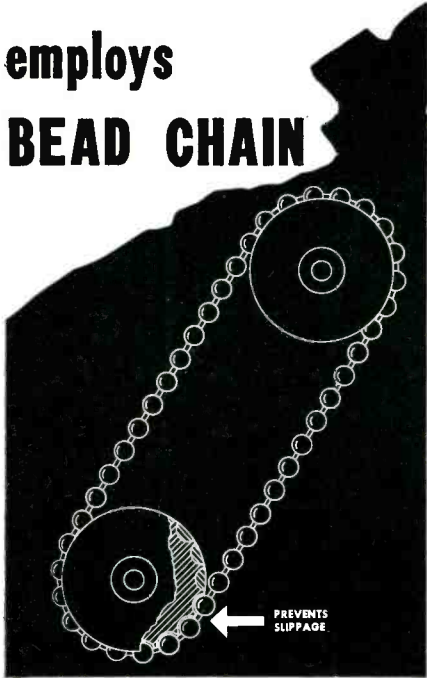

Because of its unique characteristics, Bead Chain is frequently employed by alert designers to make a simple, low-cost and highly efficient sprocket drive. Ideal for many products, it has been proved on business machines, television tuners, venetian blinds, etc. Slippage is absolutely prevented as each bead fits into an individual pocket.

Just check the qualities you want in a drive chain against the qualities offered by Bead Chain: It will not kink, bind, jam or shrink. It is completely flexible, strong, light, rustproof and long-wearing. Because every bead acts as a universal joint, changes in direction of pull are easily made.

SOLVES MANY DESIGN PROBLEMS

BEAD CHAIN—the chain you think of first as an electric light pull is truly "the Kinkless Chain of a Thousand Uses"—serving many industries and solving a wide variety of design problems. It may pay you well to check your product for opportunities to reduce costs and add sales appeal with this unique chain.

Bead Chain is available in many metals and finishes, and in five sizes, from:



The BEAD CHAIN[®] Mfg. Co.

88 Mountain Grove St., Bridgeport 5, Conn.
Manufacturers of: **BEAD CHAIN**—the kinkless chain of a thousand uses, for fishing tackle, novelty, plumbing, electrical, jewelry and industrial products; **MULTI-SWAGE**—the most economical method of producing small tubular metal parts for electronic and mechanical applications. Want more information? Use post card on last page.

ELECTRONICS — March, 1953

NEW BOOKS

(continued)

nificance of propagation along transmission lines and in the atmosphere. The phenomena of reflected waves as a function of terminating impedances are mentioned.

The book is elementary in its approach. The fullest intent is to present a panoramic view of the field aimed toward initiating the beginner into its folds. It creates an atmosphere which may either satisfy the reader or stimulate him toward higher plateaus of learning.

There are sixteen chapters in all. The material is well selected. The author has avoided the matter of how these fundamentals are applied in practice. The text is quite suitable for self-study. However, it is not intended to be a royal guide to learning since its scope is rather limited.—ANTHONY B. GIORDANO, *Polytechnic Institute of Brooklyn.*

Strain Gauges: Theory and Application

PUBLISHED BY N. V. PHILIPS, *Eindhoven, Holland*, 95 pages, \$2.75, 1952.

PART of Philips Technical Library, this small book presents a great deal of information on strain gauges that is not usually found in books on industrial electronics and measurements.

The material has been divided into six sections written separately by five scientists of the Netherlands Industrial Organization for Applied Scientific Research, Section for Research of Stress and Vibration, Delft, and Philips Industries, Eindhoven, Holland.

A particularly interesting section is the one on how to make and apply strain gauges. Complete step-by-step instructions are included along with excellent photographs illustrating each step. This section might be useful to engineers faced with a problem that could not, for some reason, be solved by use of commercially available gauges.

A separate chapter is devoted entirely to the theoretical aspects of stresses. The usual bridge circuits are described with various schemes of compensating for errors. One chapter tells how resistance strain gauges may be used in instruments with suitable coupling devices to

Important
SAVINGS
to **VOLUME** users
of small parts

..like these

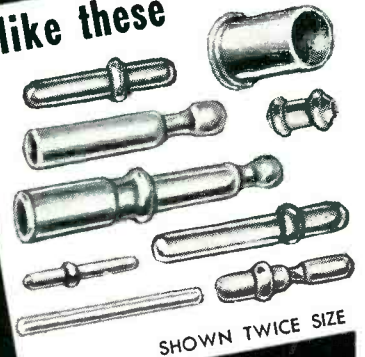

SHOWN TWICE SIZE

thanks to
MULTI-SWAGE

If you need small tubular metal parts like these in large **VOLUME**, Bead Chain's **MULTI-SWAGE** Process can mean important savings to you.

Much Cheaper Than Solid Pins

Many prominent users of solid pins for electronic and mechanical purposes have cut costs by switching to Multi-Swaged *tubular* pins . . . without sacrificing strength or accuracy.

Typical Applications—

As terminals, contacts, bearing pins, stop pins, male-female connections, etc., in a wide variety of products such as Business Machines, Ventilator Louvres, Toys, Radio and Television Apparatus, Terminal-boards, Electric Shavers, Phonograph Pickups, etc.

Send part (up to 1/4" dia. and to 1 1/2" length) and your specs for a quotation or write for **DATA BULLETIN**.



THE **BEAD CHAIN[®]** MFG. CO.

£ Mountain Grove St., Bridgeport 5, Conn.

Manufacturers of **BEAD CHAIN**—the kinkless chain of a thousand uses, for pull and retaining chains and other industrial uses; plumbing, electrical, jewelry, fishing tackle and novelty products.

Want more information? Use post card on last page.

NEW CIRCUITRON

Printed Circuits

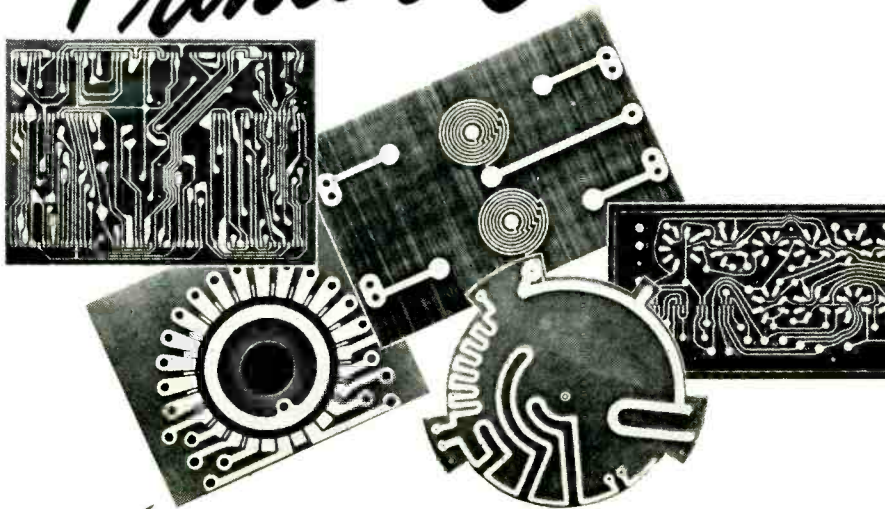

✓ Carry pattern through holes

✓ Further reduce assembly costs

CIRCUITS THRU HOLES... patterns can be run from one side of the insulating base to the other through holes—eliminating eyelets and solving knotty design problems.

PERMANENT BOND... strong, uniform adhesion... high resistance to dip-soldering heat.

QUICK CIRCUIT CHANGES... flexible Circuitron process easily accommodates design alterations.

BASE MATERIALS... patterns can be supplied on such bases as phenolics, melamines, silicones, polyethylene, polystyrene and polyesters.

METALS AVAILABLE... copper, silver and other metals can be used for conductive pattern. Available overcoatings include nickel and rhodium for high wear resistance... or solder to reduce oxidation and facilitate dip-soldering.

FLUSH SURFACE... conductive pattern can be made flush to insulating base... an important advantage for switch applications.

ENGINEERING SERVICE... our engineering staff is skilled in adapting many types of electronic equipment to printed circuits. We will be glad to assist in redesign of equipment to use the Circuitron.

*Quotations or samples gladly furnished.
Write for new folder with further details.*

CIRCUITRON, INC.

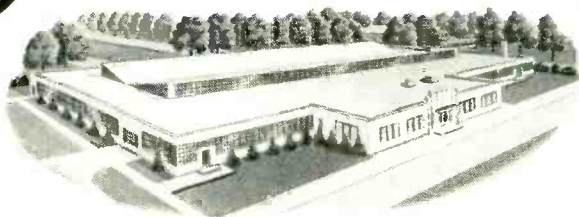

400 NINTH ST., HOBOKEN, N. J. • PHONE: HOBOKEN 4-0200

NEW BOOKS

(continued)

permit measurement of such phenomena as weight, pressure, thickness, vibration, rate of flow and so on.

One shortcoming of the book is its lack of good circuit information between the actual gauge circuit to the recording pen or oscilloscope. Only circuits of commercial Philips instruments are given, and these are without component parts values.

The book should provide an excellent background for any engineer who is confronted with a strain gauge problem.—J. F.

Storage Tubes

BY M. KNOLL AND B. KAZAN, *Princeton University and RCA Laboratories, John Wiley and Sons, Inc., New York, N. Y., 1952, 143 pages, \$3.00.*

THIS is the first book published on storage tubes. It is essentially descriptive and is designed to explain the fundamental operation of the many different types of electronic storage tubes and to provide this information in an easily accessible manner. The book should be useful to physicists, electronic engineers, and teachers interested in the general subject of storage and television-camera tubes.

In addition to describing the many tubes under development in this country, the book acquaints us with past developments in Germany through the wide experience of Professor Knoll who was a leader in this field in Germany and is continuing his work at RCA Laboratories and Princeton University.

A substantial portion of the text was initially prepared for the U. S. Army Signal Corps in the form of a report, and Parts I, II, III, and VIII of the book have appeared in a paper by the authors in *RCA Review*, Vol. XII, p. 702, December, 1951.

Part I of the book begins with a description of the equilibrium potentials acquired by an insulating surface under electron bombardment and the action of light. Part II defines terms used in connection with storage tubes. Part III of the book gives a descriptive outline of the different methods of writing and reading. This outline serves as

CUSTOM DESIGNED PROTECTION
for SUB-MINIATURE TUBES . . .

THE NEW STAVER SUB-MINI-SHIELD

Here is a combination Shield, Clip and Mount to meet your T3 Sub-Miniature Tube holding and shielding requirements.

Wrap-around shield (A) assures close tube to shield contact for maximum heat dissipation. Firm clamping action of phosphor bronze shield mount (B) secures tubes under the most severe conditions of vibration and shock. Easy-to-get-at rivet holes in base of mount facilitate easy riveting of mount to chassis.

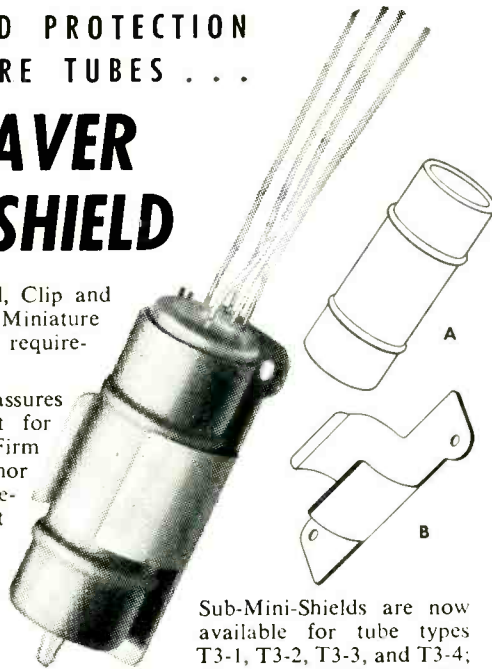

Sub-Mini-Shields are now available for tube types T3-1, T3-2, T3-3, and T3-4; Diameter .366" to .400".



Manufacturers of the famous:
MINI-SHIELDS & MINI-SPRINGS
Bay Shore, Long Island, N. Y.
Bay Shore 7-3620

Our Engineering Department welcomes your special Subminiature Shielding problems!

DIGITAL COMPUTER ENGINEERS

ELECTRICAL ENGINEERS and PHYSICISTS

needed for circuit design and development. Engineers and Physicists with 1 to 4 years experience in pulse circuits, pulse handling techniques, and systems development. Openings also for recent graduates.

- Replies strictly confidential
- Interviews arranged at our expense

Engineering Research Associates

Division of *Remington Rand*

Leaders in the Development of Digital Computers

1902 W. Minnehaha, St. Paul 4, Minn. ● "You Will Enjoy Living in Minnesota"



**WE CARRY
IN STOCK**



**ALNICO
PERMANENT MAGNETS**

**CAST
AND SINTERED
CARBOLOY
PERMANENT
MAGNETS**

EXPERIMENTAL OR PRODUCTION
QUANTITIES

Catalog upon request

PERMAG
services include:

- ENGINEERING
- PRECISION CUTTING
- PRECISION GRINDING
- MAGNETIZING

PERMAG CORP. 214 TAAFFE PLACE, BROOKLYN 5, N. Y.

RADIO-ELECTRONICS
A Preview of Progress

I. R. E. CONVENTION

RADIO ENGINEERING SHOW

**405
EXHIBITS**

WALDORF-ASTORIA HOTEL
GRAND CENTRAL PALACE
NEW YORK CITY

MARCH 23-26 1953

**Come again—
Electronic Men**

Welcome to the Radio Engineering Show —

**March 23-26, 1953
at New York City**

19 IRE Professional Groups have prepared skillfully organized symposia and technical sessions on all phases of radio, TV, and electronics. These papers will keep you up-to-the-minute on the developments which are to come in the next few years—for the IRE Convention Theme is:

**Radio-Electronics
"A Preview of Progress"**

The colorful Annual Meeting on Monday at 10 (opening morning) will feature the "Founders' Award". Social Events include the "Get Together Cocktail Party" Monday, and the Annual Banquet Wednesday, all at the Waldorf Astoria Hotel.

405 Exhibitors are using 58,680 square feet—the entire four floors of Grand Central Palace, to give you a "Preview of Progress" in the apparatus, components and instruments of Radio-Electronics. Registration: IRE Members \$1.00, Non-Members \$3.00. Register at Grand Central Palace, 47th & Lexington Avenue, or The Waldorf Astoria Hotel, 49th & Lexington Avenue, New York City.

**THE INSTITUTE OF
RADIO ENGINEERS**

GRC CUTS COST AND TIME!

NEW BOOKS

(continued)



TINY INJECTION MOULDED PRECISION PLASTIC PARTS

Completely automatic... parts delivered trimmed, ready for use, in one operation, with Gries' speedy, specialized production facilities.
NYLON A SPECIALTY

INDIVIDUAL PARTS
No limit on smallness. Intricacy and precision — our unique features.

INDIVIDUAL INSERTS
Automatic insert feed permits wide variety of product possibilities.

CONTINUOUS INSERTS
Small members accurately spaced on tape, cord, wire, chain, etc.



Maximum Size:
.025 oz.—1 1/4" long
NO MINIMUM!

LOW MOLD COSTS

Write Today for Demonstration Samples

GRIES REPRODUCER CORP.

100 Willow Ave., New York 54 • Phone: MO 5-7400

INSULATION FORMVAR • FORMEX • ENAMEL

STRIPPED CLEAN IN SECONDS

with **X-VAR**

IN



1. DIP WIRE in X-VAR for 3 seconds.

OUT



2. WITHDRAW and watch coating disintegrate.

WIPE



3. WIPE CLEAN. Operation completed in seconds.

X-VAR is non-corrosive, non-creeping — leaves wire ready for soldering. Now in use by leading manufacturers of electrical products. Write for **FREE SAMPLE** for testing.

FIDELITY CHEMICAL PRODUCTS CORP.

472 Frelinghuysen Avenue, Newark 5, New Jersey

a complete account of the fundamental processes of writing and reading involved in present-day storage tubes. Parts IV through VII are concise descriptions of the different types of storage and television-camera tubes. The tubes are classified first as to application and then as to reading and writing processes. Part IV is assigned to signal converter tubes having electrical input and output. Part V is a description of direct-viewing storage tubes which have electrical input but visual output. An account of digital computer storage tubes is given in Part VI. An up-to-date description of modern television-camera tubes is included in Part VII.

Part VIII consists of a fairly complete bibliography with a short abstract of many of the papers. To the tube engineer this bibliography by itself is worth the price of the book.

It is the opinion of the reviewer that the diagrams and notation in Part I are unnecessarily complicated. For this reason it is suggested that the reader introduce himself to the book by first referring to the descriptions of the tubes that interest him before attempting to absorb the contents of Part I.

The book leaves one with a strong desire for more quantitative data such as performance comparisons, measurements of redistribution effects, and construction techniques. It is hoped that the authors will supply this information in later editions as progress is made in the storage tube field.—S. T. SMITH, *Hughes Aircraft Company*

Airborne Radio Equipment Symposium

International Air Transport Association, International Aviation Building, Montreal 3, Canada; 252 pages plus appendices, \$3.00, 1952.

THIS is an edited version of the verbatim transcript of part of the Fifth IATA International Conference held in Copenhagen in May 1952 and attended by experts of 23 member airlines and some 45 manufacturers of aircraft radio equipment, government agencies and research laboratories. Among the appendices are papers on aircraft



Radio Telemetering Data Handling Vehicle Instrumentation High Speed Sampling

Research, Development, Design, and Production Services
Involving Specialized Application of the
Principles of Electronics, Mechanics, and Optics



Your Inquiries Are Invited — Wire, Write or Phone

APPLIED SCIENCE CORPORATION OF PRINCETON
P. O. Box 44, Princeton, New Jersey • Plainsboro 3-4141
See Us at the Radio Engineering Show—Booth No. 4-806

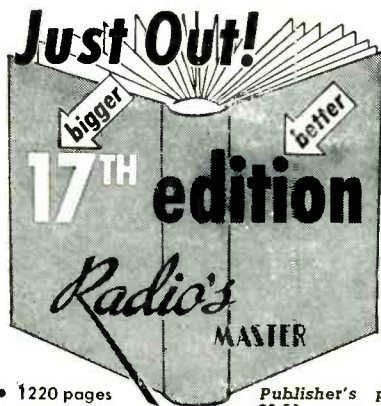

- 1220 pages
- 80,000 items
- 8,000 illustrations
- 8" x 11" — 5 lbs.

Publisher's price
\$6.50—your price
through your regular parts distributor \$1.95

The right part when you need it for production or laboratory requirements

This permanent, hard cover Official Buying Guide of the electronic-TV parts and equipment industry with its comprehensive detailed index, eliminates the need for maintaining files of small catalogs and manufacturers' literature. RADIO'S MASTER catalogs 90% of TV and electronic equipment. Not merely part number listings—complete descriptions, specifications and illustrations written and compiled by each manufacturer. Enables you to make comparisons or substitutions right now!



UNITED CATALOG PUBLISHERS, INC.
110 Lafayette St., New York 13

PRECISION RESISTOR COMPANY

Specialists in the design and manufacture of quality wire wound resistors for a quarter of a century have again doubled their facilities to meet the growing demand for QUICK DELIVERY along with COMPETITIVE PRICES. TINY SUB-MINIATURES and (JAN) GOVERNMENT TYPES are included in their wide range of resistor applications.

PRECISION RESISTOR CO., INC.

332 BADGER AVE.

TELEPHONE BIGELOW 3-3809

NEWARK 8, N. J.

On Display At The I. R. E. Show The Model 1440 OMNIPHASE GENERATOR



This unique instrument was developed primarily to make it possible to use two or three CML high power single phase variable frequency generators in combination as a source of variable frequency 2 or 3 phase power. In its own right, the Model 1440 has many uses in the development laboratory.

It covers a range of 17 cycles to 18,000 cycles in 5 ranges. Three output voltages are developed throughout the frequency range (10 volts across 5,000 ohms). The phase of all three voltages is continuously adjustable through 360 degrees by means of panel controls. This makes it possible to set up any desired relationship between the three phases.

See our printed circuit packages delay lines and other new items. If you can't be with us at the IRE show, write for our catalog.

COMMUNICATION MEASUREMENTS LABORATORY, INC.

350 Leland Ave. Plainfield, N. J.

Tel. PL 4-5502

Rx for HARMONIC TROUBLES

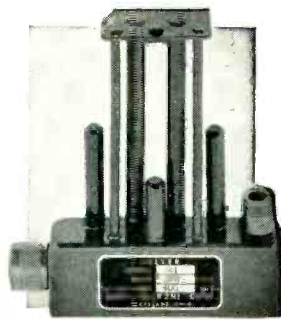
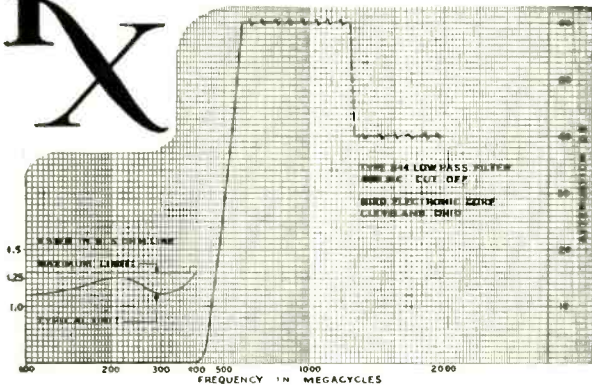

**Model 844
Low Pass Filter**

• Suppression of low-order harmonics in transmitters operating below 400 mc is the prime function of Model 844 Low Pass Filter. 40 db or more attenuation of 2nd to 5th harmonics of transmitters operating between 225-400 mc is afforded. Insertion loss and VSWR are very low thruout the pass band. Teflon insulation and rugged construction thruout assures reliability.

FREQUENCY RANGE — pass band 0-400 mc. Stop band 500-2000 mc.

POWER RANGE — 150 watts maximum.

IMPEDANCE — 50 ohms. VSWR better than 1.35 thru pass band.

CONNECTORS — Type N. One male and one female. Filter is reversible with equal results.

ATTENUATION — pass band -3db or less below 400 mc. Stop band -40db or more 500 to 2000 mc.

PHYSICAL DIMENSIONS — 5 1/8" H x 5" W x 1". Weight — 12 oz.



**BIRD
ELECTRONIC CORP.**
 1800 EAST 38TH ST., CLEVELAND 14, OHIO
TERMALINE Coaxial Line Instruments

**NEELY
ENTERPRISES**
 Hollywood • San Francisco
 Albuquerque
**EARL LIPSCOMB
ASSOCIATES**
 Dallas • Houston

antenna problems, radar systems, instrument presentation and suppressed carrier single-sideband transmission.

It is a remarkable document since it gives the day by day discussion by men of all degrees of knowledge and interest in the very important problem of communication between aircraft and ground; it shows how far from ideal presentday apparatus is; how very difficult it is to get agreement among those involved; and how the problem will not ease but will get worse as the number of planes in the air and their speed increase. Not the least interesting aspect revealed by a reading of this report is the tremendous contrast between the old and the new concepts and instrumentation employed today—the necessity of using the old carbon microphone side by side with the elegant methods of getting a plane out of the air safely to ground (ILS, GCA.)

The extraordinary complexity of the communication-navigation-control problem of the modern airways system is made very clear in this report; and the reader must inevitably come to the conclusion that a new approach to the overall problem is necessary. Those now in the thick of the situation seem to be too close to it, have too much knowledge of the past, and of the prejudices and biases so inextricably interwoven with the realization that something must be done.

For when you get all through, the airplane, unlike any other vehicle, cannot stop and wait until the weather clears or until it gets definite instructions what to do. It must keep moving—and fast.—K.H.

Physical Foundations of Radiology

By GLASSER, QUIMBY, TAYLOR, AND WEATHERWAX. *Paul B. Hoeber, Inc., Second Edition, 1952, 581 pages, \$6.50.*

HERE is the long awaited, revised, and expanded second edition of a basic and yet practical book on radiation physics, written primarily for the radiologist and the medical student by a team of authors outstanding for their teaching and re-

GLUTTONS for PUNISHMENT



**CUSTOM
CORD SETS**

RUBBER .. PLASTIC ..
NEOPRENE ...

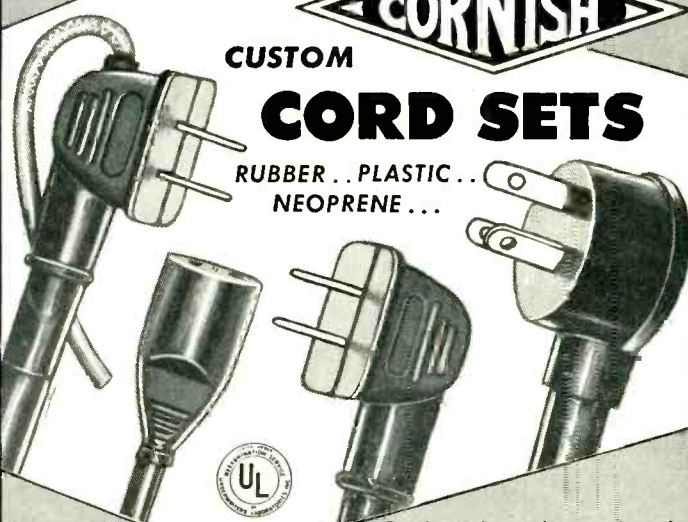

Also
"NOFLAME-COR"
 The Television Hookup Wire

Designed, engineered and produced for YOUR products! For a delicate "walkie-talkie" or a huge arc welding unit . . . put your wire problems up to CORNISH experts!

MADE BY ENGINEERS FOR ENGINEERS

CORNISH WIRE CO., INC.
 50 Church St. New York 7, N. Y.

free! NEW AGF BURNER CATALOG

The first complete catalog of never before available technical data.

Gives hole sizes, flame patterns, gas consumption on various gases and complete information with illustrations of —



- BURNERS
- BLOW PIPES
- GLASS FIRES
- MIXERS
- INSERTS
- BALL JOINTS
- MANIFOLDS
- CROSSFIRES
- MACHLET TIPS
- GOVERNORS
- TUNNELS
- OXYGEN —
- GAS BURNERS

Write for your copy today on your company letterhead.



AMERICAN GAS FURNACE CO.

130 SPRING ST., ELIZABETH 4, N. J.

PRODUCTIMETER "SPECIALS"

for Radar and Electronic Applications

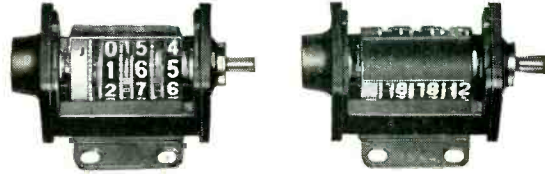

Companion shutter counters used as dual direction indicators. One counter add, while the other subtracts. Shutter blanks out counter which is on negative side of 000.



"Y" 2-figure Rotary Counter used in navigating instruments.



High-speed, non-reset "Y" type counter for building into radar instruments.



Special Model "Y" with window at rear designed for use in radar equipment.

These are a few of the "specials" developed by Durant for Radar and Electronic applications. When one of the many standard Productimeters is not the exact answer to a problem, Durant engineers modify, combine, or develop entirely new counters to meet the particular requirements of the job.



DURANT MFG. COMPANY
1912 N. Buffum St. 112 Orange St.
Milwaukee 1, Wis. Providence 3, R. I.
Representatives in Principal Cities

PRODUCTIMETERS
SINCE 1879 *Count Everything*



TRANSFORMERS

" Fill Your Need to a "

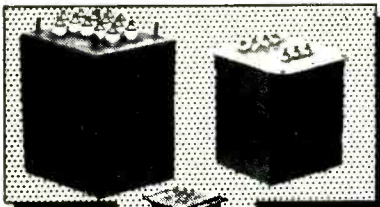

For INDUSTRIAL and ELECTRONIC EQUIPMENT

SAMPLE SHORT and LONG RUNS

Let us quote on your Specifications, no obligation

Delivery as Promised!

DESIGNED TO COMMERCIAL AND MILITARY SPECIFICATIONS (MIL-T-27 and AN-E-19)

EPCO Products Inc.

2500 Atlantic Ave.
Brooklyn 7, New York

These days are busy ones for the electronics industry... days when you will especially appreciate the time-saving, time-tested services of

"THE REPRESENTATIVES" of Electronic Products

Manufacturers, Inc. Here is an organization whose membership numbers the most highly qualified men in the field. It is fully equipped to assist you and your employees in understanding the accepted electronics industry trade practices, and to promote better relations in the industry through ethical sales representation either locally, regionally or nationally.

Since 1935, the REPM has served electronic products manufacturers ably and efficiently.

National Headquarters Office
"THE REPRESENTATIVES"
of Electronic Products Manufacturers, Inc.
600 S. Michigan Avenue, Chicago 5, Illinois
Harrison 7-2402

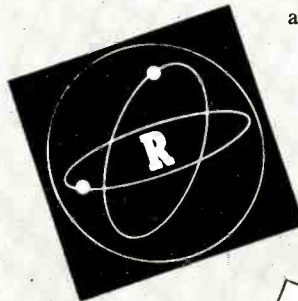

Burton browne advertising

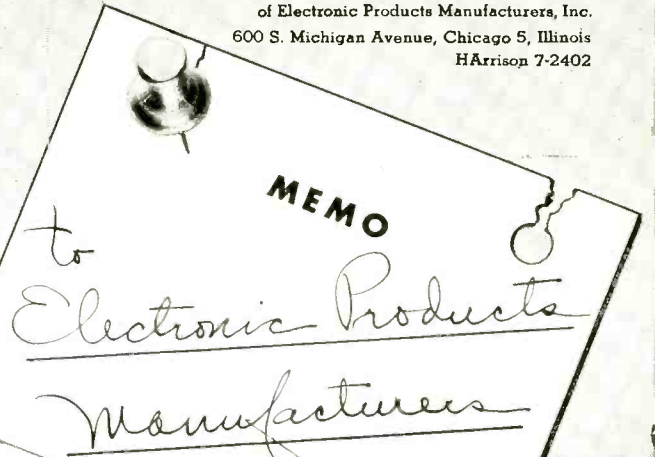

MU METAL SHIELDS

FOR MILITARY AND COMMERCIAL APPLICATIONS

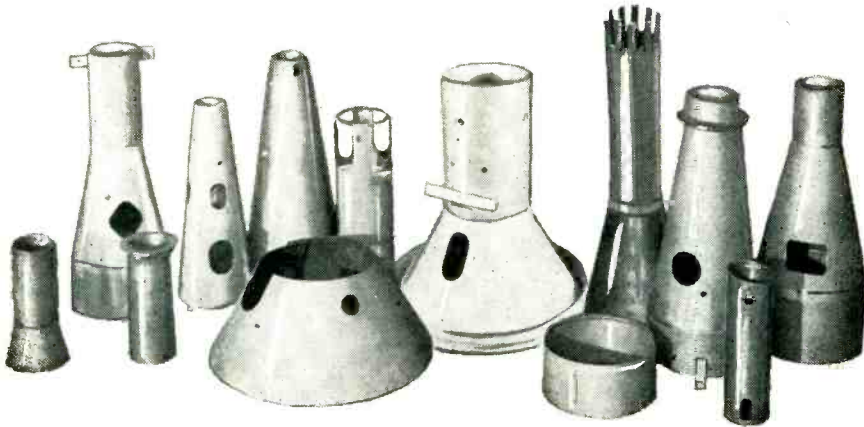

Specializing in precision sheet metal fabrication, Multi-Metal produces components to exacting specifications.

Our engineering staff can help solve design and production problems. Your inquiries will receive prompt attention.

VISIT US AT BOOTHS 4-314, 316 AT THE I.R.E. CONVENTION

Multi-Metal Co. 1350 Garrison Ave.
New York 59, N. Y.

BIRNBACH Electronic COMPONENTS

Cut production costs — speed operations, by specifying BIRNBACH — your reliable Source of Supply for all requirements in Radio, Television, and Electronic Components, Accessories, Wire and Cables.

COMPLETE WAREHOUSE STOCKS

FOR PROMPT DELIVERY

- Govt. Spec. Hookup Wire
JAN-C-76 SRIR-SRHV
Plastic
WL-Extruded Nylon
Jacket
Aircraft Wire—Nylon
Jacket
105° C. UL Approved
JAN-C-76 WL-Glass
Braid
- Multiconductor Rubber
Covered Cables,
shielded, unshielded
- Tinned and Bare Wire
- Magnet Wire
- Heavy Formvar Wire
- Vinyl Extruded and
Radio Grade Tubing
- Shielded Wires
- Insulated Hardware
- Plugs, Jacks,
Sockets
- Test Leads, Switches
- Insulators, Steatite
and Ceramic
- Terminal Strips

Quality Products
for the Electronics Industries since 1923



BIRNBACH RADIO CO. INC.
145 HUDSON STREET
NEW YORK 13, N. Y.

WRITE FOR
CATALOG 53-E

NEW BOOKS

(continued)

search in medical physics. That the first edition—whose title and quartet of authors is a trade expression in the radiological field—has gone through eight printings since its appearance in 1944 is owing as much to the simplicity and clarity of the presentation as to the thoughtful inclusion of a broad background of material ranging from basic concepts of matter and radiation and their interaction to a wealth of practical data for diagnostic and therapeutic use.

A primary purpose of the little volume—5 x 8 inches—is to give the interested physician an authoritative though simplified understanding of the basic principles involved in the production, measurement, and use of all forms of ionizing radiation. In this objective it succeeds remarkably well, though the medical reader still will often need the help of his physicist associate to clarify the more difficult pages and fill in the occasionally scanty detail. The book fits in admirably as a text in radiation physics for residents in radiology and is an interesting guide even for the beginner in physics who plans to specialize in the medical field. It is well illustrated, some 70 illustrations having been added and many others made more descriptive. An adequate bibliography is found at the end of each chapter. The number of equations has been kept close to the minimum and illustrative computations are included with commendable frequency justified by years of working with the medical student.

Two new chapters on radioactive isotopes covering measurements and dosage considerations have been added as well as one on high energy accelerators and supervoltage generators. Of particular value is the improved and expanded presentation of radium dosage information, including new Quimby dosage tables for linear radium sources and a generous supply of Patterson and Parker charts for the quick determination of surface and volume dose in radium therapy. This presentation will now serve not only to teach the method of quantitative radium therapy, but is sufficient to meet the ordinary needs

THIS IS IT.... Measures or Generates ANY Frequency

From 20 — 640 M. C.*
WITHIN 10 PARTS PER MILLION



Direct Reading VHF Frequency Meter Model FM-3

Accuracy: $\pm 0.001\%$
Stability: $\pm 0.001\%$
Resetability: $\pm 0.0005\%$

*Under certain conditions can be used below 20 mc and above 640 mc.

GERTSCH PRODUCTS
INC.

11846 Mississippi Avenue
P.O. Box 13856
Los Angeles 25, California
In Canada, Atlas Radio Corp. Ltd., Toronto.

ALUMINUM FABRICATION

FOR MILITARY AND COMMERCIAL APPLICATIONS

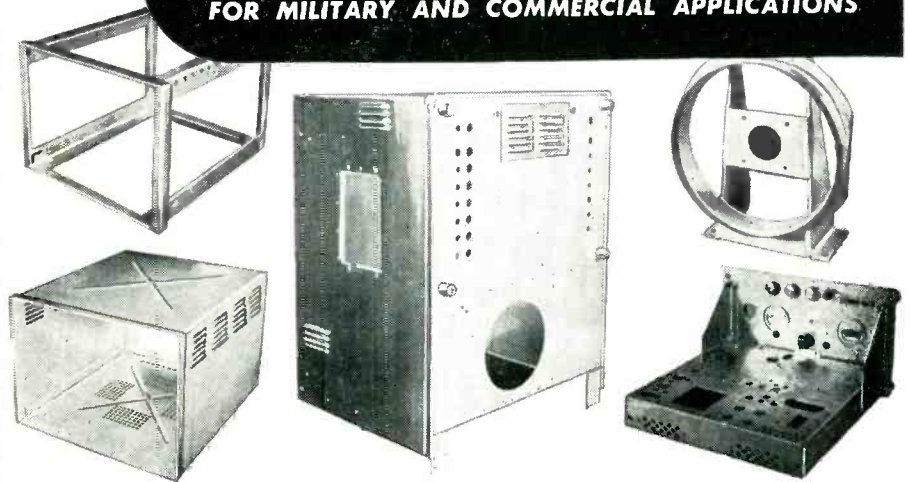

Complete Aluminum fabrication facilities include Heliarc welding and Sciaky spotwelding equipment.

Multi-Metal specializes in precision sheet metal fabrication to rigid specifications, in all metals including: Aluminum, Carbon Steel, Copper, MuMetal, Stainless Steel, etc.

Our engineering design staff is at the service of our customers.
VISIT US AT BOOTHS 4-314, 316 AT THE I.R.E. CONVENTION

Multi-Metal Co. 1350 Garrison Ave.
New York 59, N. Y.

Roanwell



Style
No. 2906

CLOTHES CLIP

Sturdily constructed for maximum life. Finished in semi-gloss black enamel. Ribbed, firm-gripping clamping pads made of hard neoprene. Mounting plate enables clip to be attached to hard surface, such as a switch case. Hard drawn steel spring wire insures optimum spring action.

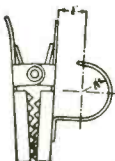

WITH MOUNTING HOOK FOR USE ON CORDSETS . . . This model utilizes a steel mounting hook which can be hooked directly on a cordset molded for this purpose.

DATA SHEETS
ON REQUEST.

ROANWELL CORPORATION
27 SIXTH AVENUE, BROOKLYN 17, NEW YORK



ROTARY ELECTRICAL EQUIPMENT

... designed to meet your specifications

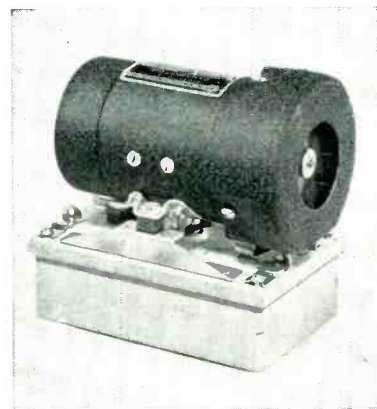

Booster Dynamotor Unit
Model D Y X—2712

Built to rigid military specifications. Operates at input of 14 volts, 5.5 amps, continuous duty. Externally fan cooled, complete with radio noise filter. For aircraft use.

The precision engineered booster dynamotor unit shown above is typical of the many special solutions provided by EEPCO engineers for tough military and industrial applications. Thoroughly field tested and proved, this motor performs satisfactorily under the most extreme conditions of service.

Whether your power problem relates to a highly developed radar unit or an industrial control device, EEPCO'S research and development engineering facilities are available to you. Because of our specialized experience in the design and manufacture of precision rotary electrical equipment, we can often save you both time and money in finding the most practical answer for you.

Moreover, once the design is established, you can count on EEPCO'S manufacturing skill to produce the equipment you need with unsurpassed, unvarying quality. Whatever your power problem—simple or complex—EEPCO engineers will welcome the opportunity to work with you.

ELECTRO ENGINEERING PRODUCTS CO.
609 WEST LAKE STREET, CHICAGO 10, ILLINOIS

• P-M DC MOTORS & GENERATORS • CAPACITOR TYPE MOTORS • UNIVERSAL MOTORS
• DC MOTORS & GENERATORS • SHADDED POLE MOTORS (2 & 4 Pole) • P-M AC GENERATORS

LICK SOLDERING FATIGUE!



—with the new **HEXACON**
FEATHERWEIGHT
MODEL 30H

So light its weight is hardly noticeable, but more powerful than its wattage rating indicates. Hatchet design makes it more comfortable and practical to use than a soldering pencil. No transformer required.

WEIGHT— $5\frac{1}{2}$ OUNCES (LESS CORD);
WATTS—40 OR 60; TIP DIA.—BOTH
 $\frac{1}{8}$ " AND $\frac{1}{4}$ " TIPS FURNISHED WITH
EACH IRON; PRICE— **\$5.75**

Write today for catalog describing
the complete line of screw tip, plug
tip and hatchet irons.

**HEXACON
ELECTRIC CO.**

130 WEST CLAY AVE.,
ROSELLE PARK, N. J.

HEXACON

of the practicing therapist. There likewise has been a real improvement in the chapter on X-ray dosage calculations; the depth dose tables in the appendix cover X-ray qualities from half-value-layer (HVL) of 1mm Al to 8mm Cu. It is some slight regret that this range did not reach the quality produced by 2.0 mev X-ray sources, not only because such accelerators are coming into general use, but also because 2.0 mev X-rays are close in their physical and biological properties to the gamma rays from Radium and Cobalt 60.

Perhaps the most comprehensive revision has been done on the chapter on Protection in Radiology, which was rewritten to include the latest international agreements on protection. This chapter contains much practical data for the attainment of adequate personnel protection in the diagnostic research and therapeutic use of X-rays, radium, and isotopes.

While "Physical Foundations of Radiology" will not serve every need of the radiologist, it is bound to be one of his most useful references.—JOHN G. TRUMP, *High-voltage Research Laboratory, MIT*

Statistical Quality Control

By EUGENE L. GRANT. *2nd Edition, McGraw-Hill Book Co., Inc., New York, 1952, 557 pages, \$6.50.*

THIS excellent volume is valuable to a far wider audience than the title indicates. Any engineer who has responsibility for development, design or production of any piece of equipment in which quality is of importance, (this covers 99.9 percent of everything manufactured) can benefit from a host of extremely important suggestions given throughout the book.

Professor Grant recognizes the human factors involved in quality control programs of all types. Though most of the book is devoted to the techniques and theory of statistical quality control, he does not hesitate to interject discussions relevant to the practical side of implementing the techniques, which, by the way, are not necessarily restricted to large-quantity productions, as the author points out in



Nothelfer

SPECIALISTS IN TRANSFORMERS

NOTHELFER

WINDING LABORATORIES

9 ALBERMARLE AVE.

TRENTON 3, N. J.



Just right for your job!

high-precision thermistors by **BENDIX-FRIEZ**

As temperature measuring elements and liquid level sensors, these temperature responsive resistors are the best you can buy. In standard or special types, their high-precision manufacture makes them precisely right for your job when it comes to resistance values, size, temperature coefficient, mountings and quality. Ask us about applications.

STANDARD TYPES FOR IMMEDIATE DELIVERY

Size (inches)	@ +30°C.	@ 0°C.	@ -30°C.
.140 x .75	45.0 ohms	86 ohms	194 ohms
.040 x 1.5	12,250 ohms	26,200 ohms	65,340 ohms
.018 x 1.5	35,000 ohms	82,290 ohms	229,600 ohms

Write for details.

FRIEZ INSTRUMENT DIVISION of . . .

1454 Taylor Avenue, BALTIMORE 4, MARYLAND

Export Sales: Bendix International Division
72 Fifth Avenue, New York 11, N. Y.

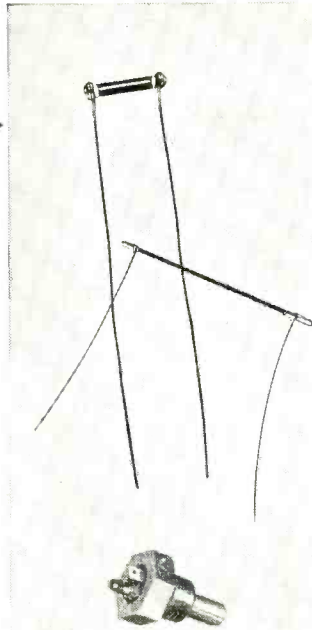

Used in this typical application for sensing the temperature of hydraulic oil.



PIX WIRE FORMING SPECIALISTS

Precision Parts to meet your Production and Engineering needs From .002" dia. to .125" dia. Rad tube parts—Stampings—Drawing Modern facilities, high-production equipment.

Metal Crystal Holder Parts
Send sketch or print for quotation.

PIX MANUFACTURING CO., Inc
24-B Bedford St., Newark 3, N. J

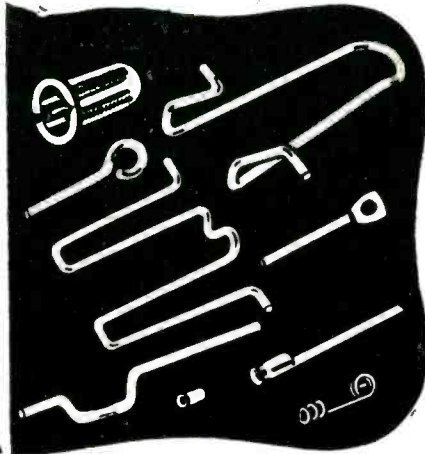

MICROWAVE NOISE GENERATOR

Model 1000



WAVEGUIDES AND FREQUENCIES PRICE

RG 48/U	2,600 to 3,950 megacycles	\$385.
RG 49/U	3,950 to 5,850 megacycles	285.
RG 50/U	5,850 to 8,200 megacycles	285.
RG 51/U	7,050 to 10,000 megacycles	285.
RG 52/U	8,200 to 12,400 megacycles	285.

Including Power Supplies

SPECIFICATIONS:

Random Noise Output: -15.8 db all guides ± 0.25 db above thermal noise. Power Input: 30 Watts at 115 Volts, 50-60 cycle. Output Couplings-Standard JAN.

COLOR TV

TELECHROME
INCORPORATED

THROUGH ADVANCED RESEARCH & DEVELOPMENT

88 MEPRICK ROAD, AMITYVILLE, N. Y.

TELEPHONE: AMITYVILLE 4-4446

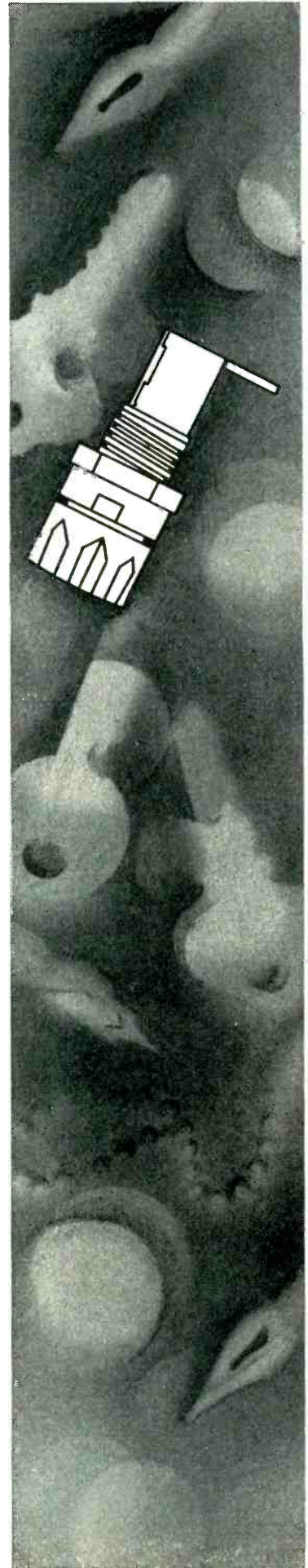

LITTELFUSE MINIATURE FUSE EXTRACTOR POST FOR 3AG FUSES LITTELFUSE, INC., 1865 MINER STREET, DES PLAINES, ILLINOIS BURTON BROWNE ADVERTISING

drawn cases

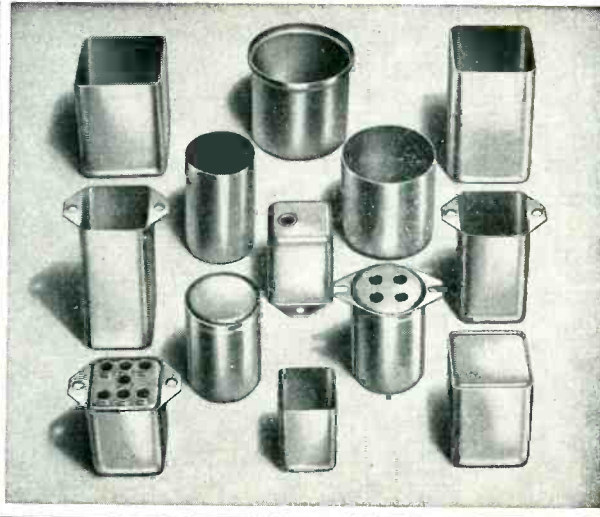

hot tin dipped . . . fabricated terminal and vent holes . . . smooth, one-piece construction using cold rolled steel . . . draw depths up to 2½" . . . inside fit covers for easy hermetic sealing in all sizes . . . available as stock sizes and as special fabrications.

OLYMPIC METAL PRODUCTS COMPANY, INC.
P. O. BOX 71A PHILLIPSBURG, N. J.

NOISE and FIELD INTENSITY METER Model NF-105 (Commercial Equivalent of AN/URM-7)



ENGINEERING DATA

- Frequency range 20 MC to 400 MC by means of two quick-change tuning heads. (Tuning head to 1000 MC under development.) At least one RF amplifier with tuned input is employed for each tuning range.
- Built-in impulse noise calibrator flat to 1000 MC (Output externally available).
- 4½" logarithmic indicating meter reads carrier or true peak.
- Aural slideback operation.
- Input VSWR better than 1.2 to 1.
- Built-in regulated "A" and "B" supply.
- Complete line of accessories available.

Visit our Booth Number 2-147 at the IRE Show.

EMPIRE DEVICES, INC.  38-25 BELL BOULEVARD, BAYSIDE 61, N. Y.

MANUFACTURERS OF
FIELD INTENSITY METERS • DISTORTION ANALYZERS • IMPULSE GENERATORS • COAXIAL ATTENUATORS • CRYSTAL MIXERS

the first chapter.

The aim of quality control according to the author, is "better quality at lower cost." To this end the Shewhart control chart has been developed, and has proved itself of enormous value in effecting cost savings in all types of industrial applications. The book is essentially an elaboration of the problems and methods involved in the application of the Shewhart chart.

In the book are discussed the fallacies of such methods as 100-percent inspection where the fatigue factor of the inspector is not taken into account, or sampling procedures not based on the theory of probability. Thus, as a vivid example, Professor Grant shows that a sampling procedure calling for the inspection of five articles out of a lot of 50, with acceptance of the entire lot if no defectives are found and rejection of the entire lot if one or more defectives are found—a common-sense method—turns out to be not particularly sensible because, if on the average 4 percent are defective, a negligible improvement in quality is effected. If 4 percent were defective originally, 3.5 percent would still be defective after inspection. Yet, 18.5 percent of the submitted product is rejected to improve the outgoing quality from 4 percent defective to 3.6 percent defective.

The reviewer has been striving for years to train all engineering and test personnel to date and time all data, no matter how unimportant the data may seem. The reviewer is therefore particularly pleased to see on page 65 a special paragraph devoted to "importance of preserving the order of measurement." These and many other important hints in the book on how to take and record data for proper control of quality make the volume unusually valuable.

The most important changes from the first edition of this book are:

(1) The chapters dealing with acceptance sampling of attributes has been considerably expanded and rewritten. An objective of the rewriting was to improve the presentation of fundamental princi-

STAR PERFORMANCE

with
STAR AIDS ★ ★ ★

Precision Production Tools

★ Star's precision-fabricated 7- and 9-pin socket wiring plugs and pin straighteners — used and specified by leading miniature tube and electronic equipment manufacturers — conform to U.S. Navy and Air Force specifications.



7-Pin and 9-Pin

STAR MINIATURE WIRING PLUGS

★ For accurate alignment of miniature socket contacts during wiring . . . for preventing contact-clogging by solder, lacquer, etc. Precision cast in one piece of non-corrosive ZAMAK-5 zinc alloy with stainless steel pins.

STAR MINIATURE PIN STRAIGHTENERS

★ Accurately spaced and counterbored to guide pins into proper alignment without any strain on the glass button. Cast of non-corrosive zinc alloy, ZAMAK-5, with an insert of stainless steel.



7-Pin and 9-Pin

To Insure Positive Contacts — STANDARDIZE ON STAR

WRITE FOR DATA

STAR EXPANSION PRODUCTS COMPANY

(INCORPORATED)

147 CEDAR STREET, NEW YORK 6, N. Y.

Offices in Principal Cities

HERMETIC SEALS

- Vacuum Tight—Glass to Metal
- Standard Types from Stock
- Special Designs to Fit Your Product
- Write or Call for Full Information

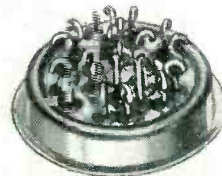

MINIATURE 20
TIN HEADER

Representatives:

PAUL D. AARON
J. R. GASTON CO.

120 Liberty St., New York 8, N. Y.
213 Locust St., Harrisburg, Pa.
or 618 N. Calvert St., Baltimore, Md.

SCIENTIFIC ELECTRONIC LABS, INC.

866 Bergen St.

Bigelow 8-6553

Newark 8, N. J.

SCOPE DOLLY

Model 1

Convenient Height and Viewing Angle
Adjustable to Hold Portable Scopes
Ball Bearing Swivel Rubber Tired Casters
Lightweight Aluminum Construction
Recommended by Laboratories Wherever Used

\$35.00 FOB LOUISVILLE, KY.

Formerly manufactured by UNIQUE DEVICES

Now manufactured and sold by

TECHNICAL SERVICE CORPORATION

3116 Michigan Drive

Louisville 5, Kentucky

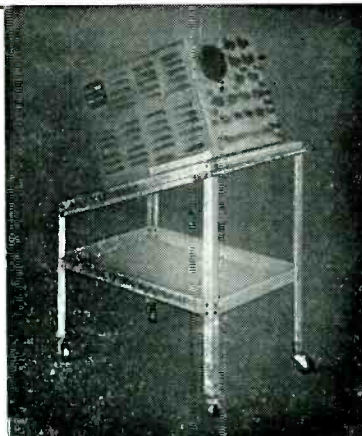

(T)
POT
(R)

POTENTIOMETERS

precision

IN MINIATURE SIZE

Electro-Mec Laboratory specializes in potentiometers of extreme accuracy, low torque*, and small size, engineered for each individual application. Close coordination between engineering and manufacturing provides laboratory quality and performance in production quantities, one or a thousand.

The "know-how" and facilities are also available for the solution of non-standard potentiometer design problems. For more information please write or telephone the Engineering Department. HANover 2-3155

* Torque in the range of .003 to .100 oz. in., Resolution to 1300 turns of wire per inch, Linearity to .1%.



Type 1395

"G" stability and Minimum Torque. High resolution and Linearity. Resistances 20 to 200,000 ohms.



Type 1396

Servo Mounting. Ultra-low torque. Maximum accuracy in Minimum size.



Type 1418

Computer accuracy and Highest Resolution Low torque of .025 oz. in.

**ELECTRO-MEC
LABORATORY**

19 MURRAY STREET
NEW YORK 7, N. Y.

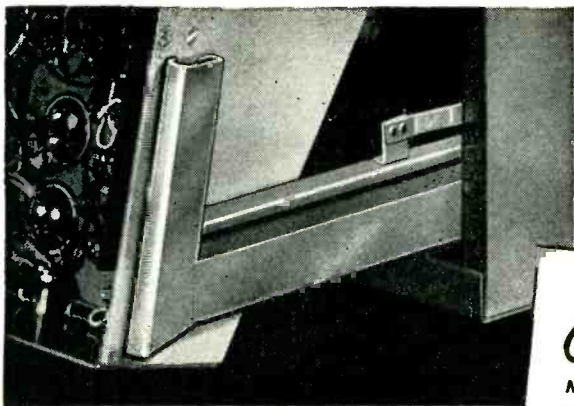

Try Remler for
Service-Tested
"Hard-to-Get"
Components

*Custom
Components*

Metal-plastic components
designed and manufactured
to order. Write for quota-
tions specifying electrical
and mechanical character-
istics. Describe application.
No obligation.

FOR EFFICIENT MAINTENANCE

SPECIFY REMLER TILT-UP

EQUIPMENT SLIDES

Remler slide rails for rack or cabinet mounting permit complete withdrawal or inspection of top and bottom of apparatus chassis. Positive . . . self-locking. Full roller type . . . handles equipment up to 50 lbs. Stainless steel for

military applications; cadmium plated cold rolled steel or bonderized cold rolled steel. Nickel plated brass rollers; roller studs in stainless or copper flashed cold rolled steel.

Remler Company Ltd. 2101 Bryant St. San Francisco 10, Calif.

Remler

Since 1918 PIONEERS IN ELECTRONICS AND PLASTICS

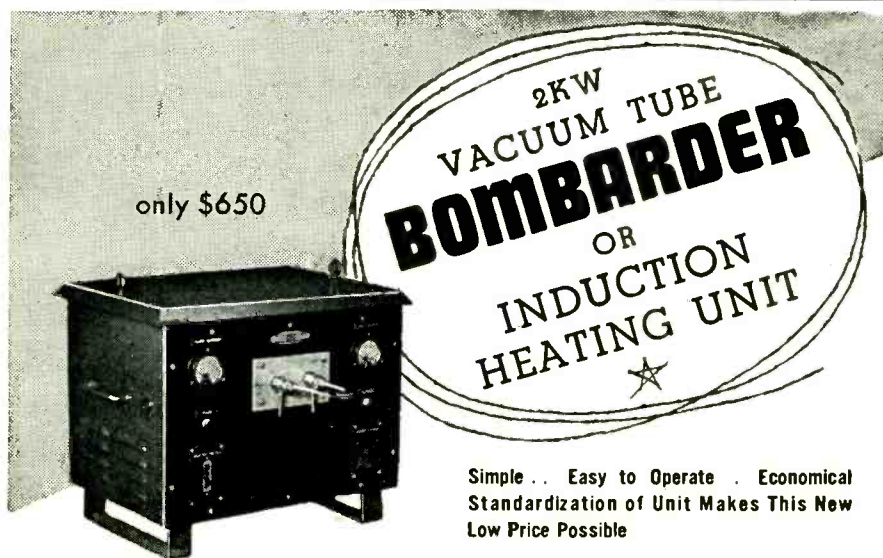

only \$650

2KW
VACUUM TUBE
BOMBARDER
OR
INDUCTION
HEATING UNIT
★

Simple . . . Easy to Operate . . . Economical
Standardization of Unit Makes This New
Low Price Possible

Never before a value like this new 2-KW bench model "Bombarder" or high frequency induction heater . . . for saving time and money in surface hardening, brazing, soldering, annealing and many other heat treating operations.

This compact induction heater saves space, performs with high efficiency Operates from 220-volt line. Complete with foot switch

and one heating coil made to customer's requirements. Send samples of work wanted. Specify time cycle required for your particular job. We will quote on proper size unit for your requirements. Immediate delivery.

Scientific Electric Electronic Heaters are made in the following ranges of power: 1-2-3½-5-7½-10-12½-15-18-25-40-60-80-100-250KW.

Scientific Electric

DIVISION OF "S" CORRUGATED QUENCHED GAP CO.
107-119 MONROE STREET GARFIELD, NEW JERSEY

ples, so that newcomers to the field of quality control would appreciate the theory behind the systems.

(2) The chapter dealing with acceptance sampling by variables has been entirely rewritten.

(3) A treatment of the economic aspects of quality control decisions has been considerably expanded. (This is an extremely important aspect of all quality control, since management will often feel that quality control methods are unnecessary expenses. It is up to the engineer to prove that quality control techniques will result in lower costs, and better products in the end.)

(4) A large number of additional problems have been included, with a greater percentage of the problems having answers.

(5) Additional sampling tables have been included.

Since the basic contents of the second edition are similar in many respects to the first edition, it is not necessary to list a chapter-by-chapter breakdown here.

This reviewer wishes to emphasize again the excellent attitude of Professor Grant towards the human problem of quality control. Part 5 of the book, entitled "Making Statistical Quality Control Work," is a section that should be read by all people associated with production, whether they are engineers, technicians, or part of management. The fact that all industrial processes are subject to statistical variations and chance occurrences in the final product should be drummed home, as other wise vast amounts of money and time can be wasted.—VICTOR WOUK, *Beta Electric Corp., New York.*

High Speed Photography

BY GEORGE A. JONES. *John Wiley & Sons Inc., New York*, 1952, 112 pages, \$6.50.

USEFUL to anyone interested in the history, equipment, techniques and applications of this fascinating avenue in photography. The eleven chapters plus appendices giving data on cameras, tubes, processing formulas, etc, cover the whole subject. Plentifully illustrated.

The history of the numerous

Advertisers:

How about the NUCLEAR field?

There are a good many advertisers using ELECTRONICS who should also be advertising in NUCLEONICS.

Particularly in instrumentation and laboratory equipment, there is a cross-over of use in the electronic and in the nuclear field.

But, there is very little cross-over in the subscriber lists of the two publications—a matter of a few percentage points.

It is quite possible that you are doing an effective presentation of your products and abilities in this excellent issue, but are missing such presentation before one of the fastest growing fields in the country's history—the field of atomic energy.

The sales representatives of ELECTRONICS are also the sales representatives of NUCLEONICS. They have much evidence pointing to the opportunities in this great NEW field. Ask them to show you what your potentials can be.

NUCLEONICS

ABC

ABP

A McGraw-Hill Publication
330 West 42nd St.
New York 36, N. Y.

☆ SEE ☆
the NEW DEVELOPMENTS

in ☆
coil winding
equipment ☆

AT THE ☆
1953 IRE SHOW
MARCH 23 - 26
BOOTH 3 - 521

Coil Winding Equipment Co.

109 AUDREY AVE., OYSTER BAY, NEW YORK



HEAT RESISTANT WIRES FOR EVERY APPLICATION . . .

HOT WIRE

Do you have an electrical wiring problem involving high temperatures? We build just the wire for such jobs. Write us about your problem and let our engineers make a recommendation.

HEATING UNITS
HEATING ELEMENT
RESISTANCE
LINE CORD
THERMOCOUPLE WIRE
ASBESTOS LEAD
& FIXTURE WIRE
INSULATED
RESISTANCE WIRE
FIBERGLAS
INSULATED WIRE
WIRE TO ANY
SPECIFICATIONS

Send your electronic control, communications or appliance wiring specifications for a recommended solution by our engineers.

FOR A TRIAL ORDER OR A CARLOAD consult



THE LEWIS ENGINEERING CO.

Wire Division
NAUGATUCK CONNECTICUT

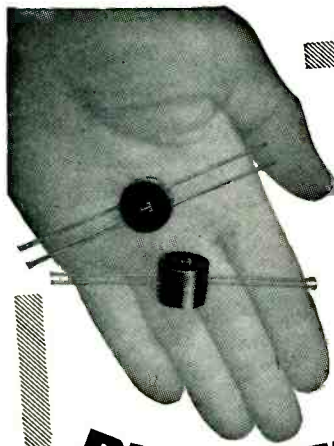

LOOK WHAT'S NEW!

MADE TO YOUR
SPECIFICATIONS
TECHNITROL Type TE
PULSE TRANSFORMERS

SEALED IN CASTING RESIN

Currently available in one physical size— $3/4$ " diam. x $9/16$ " deep, with 2" leads of No. 20 wire—made to your order within the following range of specifications.

Pulse Width: 0.1 to 2.0 microseconds
Maximum Pulse Repetition Rate: 2.0 mc.
Operating Range: -55° to $+105^{\circ}$ C.

One or two secondaries may be provided, either inverting or non-inverting.

NOW YOU CAN SIMPLIFY
AND MINIATURIZE YOUR
SHORT-PULSE CIRCUITS

WRITE US YOUR SPECIAL REQUIREMENTS
including a brief outline of the contemplated circuit, or ask for our blank specification sheets.

LOOK AT THESE PRICES!

1 to 3	\$7.50 each
4 to 10	6.35 each
11 to 100	5.85 each

Write us for quotations for quantities over 100

TECHNITROL
ENGINEERING COMPANY

2751 North 4th Street, Philadelphia 33, Pa.

See us at the IRE Show—Booth 4-107

SPECIALTY MASS PRODUCTION PRECISION FABRICATION OF SHEET METAL PRODUCTS TO YOUR OWN OR GOVERNMENT SPECIFICATIONS

COMPLETE facilities under one roof for quality mass production—including Helicarc welding, baking and finishing. Whistler and Wiedermann equipment for short runs. Tool and die engineering and designing. Completely conveyerized finishing facilities.

Large assortment of stock and special dies for the radio, television and electronic field. Production and engineering under the direction of a competent executive who has had over 38 years experience in sheet metal fabrication backed up by a substantial organization and personnel with Know-How.

Chassis
Enclosures
Metal Cabinets
Consoles

Instrument Housings
Panels—Boxes
Sample Models
Water Tight Boxes

Spare Part Boxes to MIL-B-233A Joint Army-Navy Specifications

Expert Design Consultation on your sheet metal requirements

QUOTATIONS CHEERFULLY GIVEN UPON REQUEST

ART-LLOYD METAL PRODUCTS CORP.
2973 Cropsy Avenue
Brooklyn 14, N. Y.
Telephone: CO ney Island 6-5100

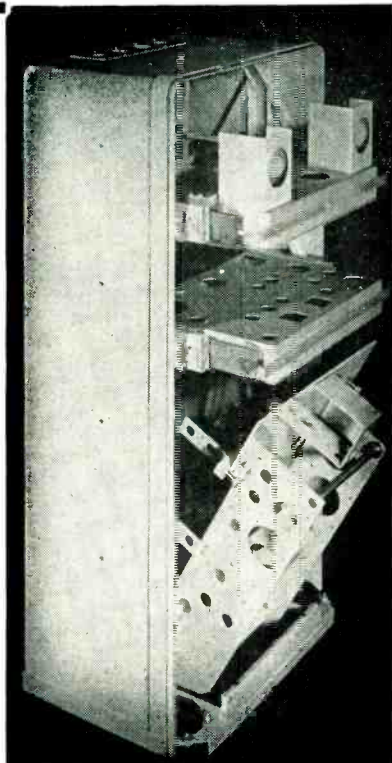

methods of making photographs or records in microseconds is very interesting in showing the difficulties encountered and the methods of solving them. Although written in England there are few language differences and they are easily understood here. The bibliographies are extensive and up to date.

Subjects covered are spark photography, high-intensity illumination methods, exposure determination, camera design, use of image dissectors, rotating mirror and multiple-lens cameras, etc. The two final chapters deal entirely with the scientific and industrial applications of the numerous methods of making high-speed still and moving-picture photographs.—K.H.

THUMBNAIL REVIEWS

ASTM STANDARDS ON METALLIC ELECTRICAL CONDUCTORS. American Society for Testing Materials, 1916 Race St., Philadelphia 1952, 262 pages, \$3.00. New and revised standards, test methods, etc., on copper, aluminum, steel and non-ferrous bars, rods, conductors etc.

LES FILTRES ELECTRIQUES. By Pierre David. Gauthier-Villars, 55 quai des Grands-Augustins, Paris, VI, France. 192 pages, 1952, large format, 1952, 2,500 francs, \$7.46. Third edition, completely revised. Covers simple and multielement filters of all types.

DESIGN FOR A BRAIN. By W. Ross Ashby, Director of Research, Barnwood House, Gloucester (England), John Wiley & Sons Inc., 1952, 260 pages, \$6.00. A serious attempt determine the nervous system's unique ability to produce adaptive behavior—to determine what sort of mechanism it must be to behave so differently from any existing man-made machine.

DIRECT CURRENT MACHINES FOR CONTROL SYSTEMS. By A. Tustin, Professor of Electrical Engineering, University of Birmingham, England. Macmillan, 1952, 306 pages, \$10.00. Explains common principles on which modern control machines such as the amplidyne, rototrol, torque motors, etc, depend. For engineers, designers and users of control apparatus.

THEORY OF ELECTRIC POLARIZATION. By C. J. F. Bottcher, Professor of Physical Chemistry, University of Leyden. Elsevier Press, Inc., 300 Park Ave., New York, 492 pages, 1952, \$10.00. Theoretical, requiring adequate background in electrostatics and vector calculus.

Simpler... faster
**LOGARITHMIC
CONVERSION**



with a
Kay-Lab
LOGATEN
(Improved Models)

KAY-LAB Logatens are non-linear attenuating networks whose output is the logarithm of the input voltage. New models afford larger dynamic range, higher accuracy, and greater stability. These units are suitable for dynamic compression plotting logarithmic decay curves and many other applications. High accuracy units are also available for incorporation in logarithmic computer systems.

WRITE FOR
BULLETIN 'R'

Visit KAY LAB's
booth at the
I. R. E. Show

Kay-Lab

PRECISION
ELECTRONIC
INSTRUMENTS

KALBELL LABORATORIES, INC.
1090 MORENA BLVD. P. O. BOX 1578
SAN DIEGO 10, CALIFORNIA

SQUARE PULSE GENERATORS

for the
**MILLIMICROSECOND to
MICROSECOND RANGE**

MODEL 100

SQUARE PULSE GENERATOR

Price: \$395. FOB New York

FOR RACK MOUNTING

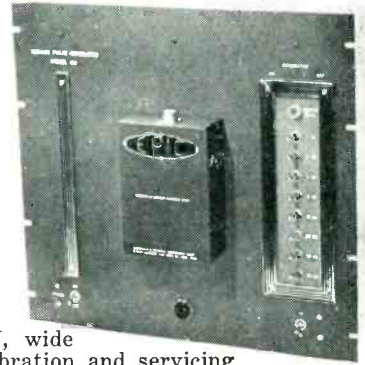

For nuclear pulse work, radar, TV, wide band amplifiers and in the design, calibration and servicing of fast electronic systems:

FOR THE FIRST TIME—A square pulse generator with a rise time of one millimicrosecond (10^{-9} seconds) and a pulse width which can be varied from 2 millimicroseconds to several microseconds is commercially available. Both positive and negative pulses of a 100 volts maximum amplitude into low impedance cable, such as 50 ohms, are generated, the pulse amplitude can be varied from 100 volts to .006 volts in 1 decibel steps by means of selector switches on the front panel. One, two, or more pulse outputs, each, of which, can be individually attenuated and delayed are available in various models.

FOR FURTHER DETAILS, write for Bulletin "P-4", or contact our engineering division.

Electrical and Physical Instrument Corporation

Sales and Business Office
25 West 43rd Street
New York 36, New York
Telephone: Longacre 4-8510

Engineering Division
42-19 27th Street,
Long Island City 1, New York
Telephone: Stillwell 4-6389

DOUBLE BARREL ADVERTISING

Advertising men agree—to do a complete advertising job you need the double effect of both Display Advertising and Direct Mail.

Display Advertising keeps your name before the public and builds prestige.

Direct Mail supplements your Display Advertising. It pin-points your message right to the executive you want to reach—the person who buys or influences the purchases.

In view of present day difficulties in maintaining your own mailing lists, our efficient personalized service is particularly important in securing the comprehensive market coverage you need and want.

Ask for more detailed information today. You'll be surprised at the low overall cost and the tested effectiveness of these hand-picked selections.

for Results



Mc Graw-Hill
DIRECT MAIL LIST SERVICE

McGraw-Hill Publishing Co., Inc.
330 West 42nd St., New York 36, N. Y.

TEFLON now
in 14 COLORS*

Featuring

- EXTRA FLEXIBILITY
- FREE STRIPPING
- HIGH DIELECTRIC
- RATING - 90 TO + 250°C

*Black, brown, red, orange, yellow, green, blue, violet (purple), grey (slate), white, tan, pink (flesh), light green, light blue.

At the IRE Show—Booth 4-124!

TENSOLITE INSULATED WIRE CO., INC., TARRYTOWN, N. Y.

Tensolon
**HI-TEMP
HOOK-UP WIRE**

Built to meet rigid government requirements, Tensolon Hook-up Wires are available in sizes from AWG30 through 20 with stranded silver-plated copper conductors and the patented Tensulated Teflon® covering which eliminates pin holes and other irregularities.

TEFLON KIT FOR LABORATORY REQUIREMENTS —

Twelve 100 ft. rolls of AWG 22, in assorted colors in convenient compact container

\$124.00



TOPS! AEROCOM'S DUAL AUTOMATIC PACKAGE-TYPE RADIO BEACON!

This aerophare, for unattended service, consists of two 100 watt (or 50 watt) transmitters with keyer, automatic transfer and antenna tuner.

Frequency range 200 — 415 kcs., crystal controlled (self-excited oscillator coils available). High-level plate modulation of final amplifier is used, giving 40% tone modulation in 100 watt transmitter and 60% in 50 watt model. Microphone P-T switch interrupts tone, permitting voice operation.

This unit can be operated in air temperature range — 35°C to + 45°C using 3B25 rectifiers; humidity up to 95%

The "stand-by" transmitter is selected when main transmitter suffers loss (or low level) of carrier power or modulation. Audible indication in monitoring receiver tells which transmitter is in operation.

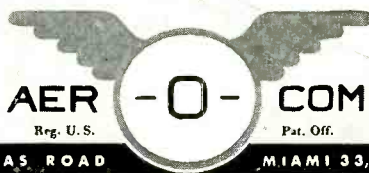
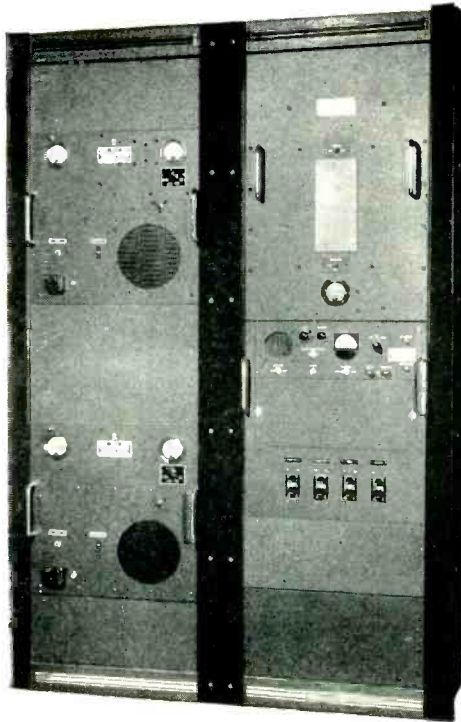

3090 DOUGLAS ROAD

MIAMI 33, FLA.

UNIFORMITY • DEPENDABILITY • SERVICE • ECONOMY in SPECIAL FASTENERS

Get all 4 with WESTFIELD METAL PRODUCTS

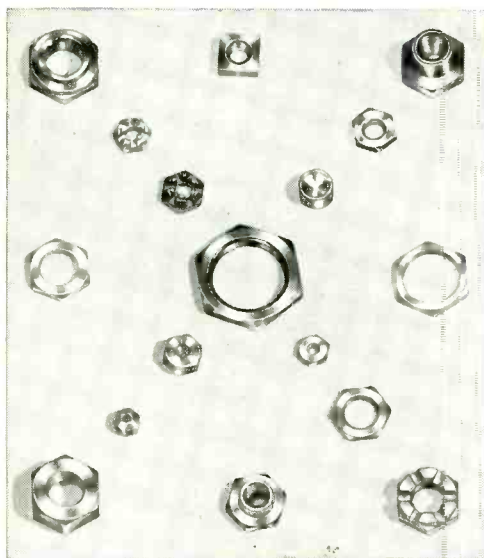

- ★ MATERIALS—Steel, brass, stainless steel, bronze and aluminum.
- ★ CAPACITY—From 3/16" hexagon to and including 1-1/16" hexagon across flats, from 1/16" thick to and including 3/4" thick.
- ★ THREAD SIZES—From #2 up to and including 7/8" diameters, any pitches desired.

SEMI-FINISHED MILLED-
FROM-THE-BAR STANDARD
AND SPECIAL NUTS
HEXAGON OR SPECIAL
SQUARE NUTS
SCREW MACHINE
PRODUCTS
PLATING AND HEAT
TREATING

Write to Dept. A for NEW
ILLUSTRATIVE
FOLDER

WESTFIELD METAL PRODUCTS CO., INC.
WESTFIELD, MASS.

BACKTALK

Community TV

DEAR SIRs:

I HAVE READ with interest your article in the December 1952 issue of *ELECTRONICS* entitled, "Community Antennas Bring TV to Fringe Areas" by John M. Carroll (p 106). While your article deals principally with community antenna and distribution systems I would like some additional information.

Geographically we are some 175 airline miles from the nearest tv station in Denver, Colorado. That rules out any use of a community antenna system. I have thought of possible use of a microwave relay system to bring the signal from a receiver located some 60 miles closer to the Denver tv stations. Then a distribution system would be used around our community to furnish service.

Are there any instances of this method at the present time? Is microwave equipment for this purpose available? Does the FCC approve microwave links for this purpose?

I would certainly appreciate an answer to these questions and any suggestions you might have. Kindly let me hear from you at your earliest convenience.

WILLIAM G. WALTER
Radio Station KOLT
Scottsbluff, Nebraska

(Editor's Note: J. E. Belknap & Assoc. of Poplar Bluff, Mo. considered building a microwave relay to deliver signals from KSD-TV, St. Louis and WMCT, Memphis to proposed community antenna systems in their area. Their proposal met opposition from several quarters and no permit has been granted in their case.)

W2TY de W9KQX

Amateur Radio Station W2TY
c/o Wm. W. MacDonald
Editor, *ELECTRONICS*
330 West 42nd Street
New York 36, N. Y.

DEAR MR. MACDONALD:

THIS LETTER is written by a ham reader of *ELECTRONICS* to a ham who happens to be Editor of the same magazine. *ELECTRONICS* is one of the four radio magazines I read regularly, and it occupies

Experienced Electronics
Production Test Equipment
ENGINEERS
Needed

to
apply
techniques

to
GUIDED MISSILES



Inquire:
MGR., ENGR. PERSONNEL



P. O. BOX 1, BUFFALO, N. Y.

SEALING
DIPPING
POTTING
IMPREGNATING



INSULATING
FUNGUSPROOFING
MOISTUREPROOFING
HEAT CONDUCTING

WAXES BIWAX COMPOUNDS

Developed and produced for manufacturers of electronic components and other electrical units.

Specifications and samples available on request.

Information relative to your problem or application will enable us to make suggestions and recommendations.

BIWAX CORPORATION

3445 HOWARD STREET
SKOKIE, ILLINOIS

TYPE
"M"

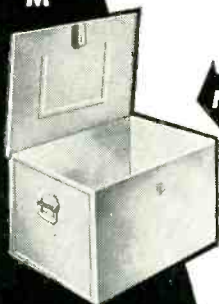

19 STOCK SIZES AT
PUBLISHED PRICES!

NOW available to you . . . without
costly sub-contracting problems
MIL-B-233A SPARE-PARTS BOXES...

FOR THE PROTECTION OF ON-BOARD REPAIR PARTS
Stock standard TYPE M
STEEL SPARE OR REPAIR
PARTS BOXES, made in
strict accordance with
Military Specifications.
To better service your
need for Specification
Spare-Parts Boxes we
have put them on a mass
production line.

Write for Size and Price Chart

DOLIN METAL PRODUCTS INC.
319 LEXINGTON AVE., BROOKLYN 16, N. Y.

DC - AC CHOPPERS

A model for every use.

10 — 500 cycles

Single pole

60 cycles

Single pole and double pole

Make-before-break contacts

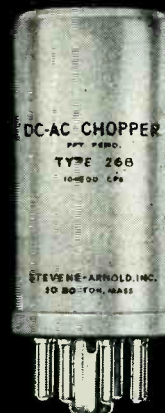

These Choppers convert low level DC into pulsating DC or AC so that servo-mechanism error voltages and the output of thermocouples and strain gauges, may be amplified by means of an AC rather than a DC amplifier.

They are hermetically sealed, precision vibrators having special features which contribute to long life and low noise level.



WRITE FOR THESE

CATALOGS . . .

#28MA

10-500 cycle

#246C

=0 cycles

STEVENS ARNOLD INCORPORATED

22 ELKINS STREET
SOUTH BOSTON 27, MASS.

SA-5

NEW!

FUNGUS-PROOF NYLON LACING CORD and FLAT BRAIDED TAPE

Meets Army, Navy and Civilian "specs"

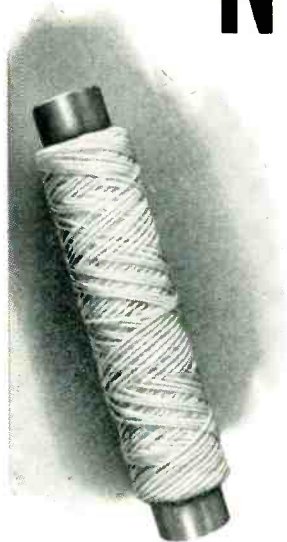

This sensational new development has proved to be a boon to electronic equipment. The special synthetic resin coating on Heminway & Bartlett's Nylon Lacing Cord and Flat Braided Tape resists the growth of mold and micro-organisms — factors most often responsible for the deterioration of linen and cotton lacing cords and tapes. They have high abrasion resistance and low moisture absorption. The finish has the desirable malleability of wax and is non-toxic to humans.

We'll be glad to send you full information and samples. Why not write us today.

VISIT OUR BOOTH
No. 3-513
AT THE I. R. E. SHOW

The Heminway & Bartlett Mfg. Co., 500 Fifth Avenue, New York 36, Sales Offices: Chicago, Boston, St. Louis, Philadelphia, Cincinnati, San Francisco, Charlotte, N.C., Gloversville, N. Y.

SECON

**DEVELOPMENT and PRODUCTION
METALLURGISTS**

Fine wire and ribbon in base, rare, and precious metals, and alloys for new and highly engineered applications. In small units and sizes, and to close tolerances.

Further details on request.

SECON

SECON METALS CORPORATION
228 East 45th Street, N. Y. 17, N. Y., MU 7-1594

its own unique position in the group. I have several comments from the ham point of view which may be of interest both to you as W2TY and as Editor.

With the introduction of printed circuits in domestic radio gear, it would seem that now is the time for manufacturers to start using "good engineering practice" in their designs.

My worst cases of broadcast interference from a 2-meter transmitter with an input of 40 watts arose from two combination receivers made by responsible manufacturers who *should* know better. In these receivers the designer took "calculated risks" in the design of the first audio stage. Use of high-gain triodes with 6 or 10-megohm grid resistors, with absolutely no shielding and no r-f filtering in order to save a few cents in manufacturing cost cannot be termed "good engineering."

Another gripe is the way in which advertising copy is presented by various manufacturers. For instance, some manufacturers use the space they buy to transmit some real information. This class includes the makers of test apparatus, antennas and specialties. As a rule, they are relatively small in unit production and dollar volume. These firms do not hesitate to give "catalog" information. Their ads are interesting, even though they may not be of immediate interest.

In contrast, take plugs for the 6AF4, 6AJ4, 6AM4 series of tubes. About all they say is, "They're the latest, the best." The copy must have been written by an ex-ad writer for a fur coat concern or perfume manufacturer. The art work did not even sneak in a base diagram. The pay-off is that the same type of copy was used in the ham magazines. The 6BK7 is one of the really good vhf tubes, yet its introduction was made in the same vague manner.

This business is, of course, not under the magazine's control, but I think you will agree that some of the advertisers do not use their space effectively. In the case of tubes, I would like to see the data presented as a tear sheet so that complete information would lead, rather than lag, the availability of

Transitron

electronic corporation
announces
its

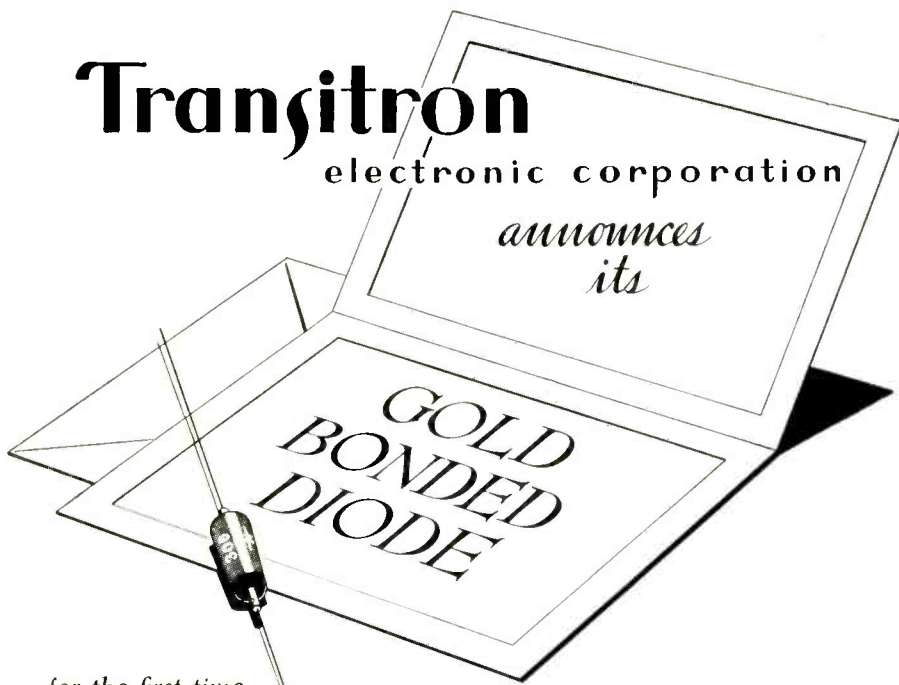

for the first time —

MEGOHMS AT 100 VOLTS INVERSE!

Plus — superior forward conductance.

These NEW diodes and standard grades are now available in production quantities.

Write to

TRANSITRON ELECTRONIC CORPORATION
403 Main Street, Melrose, Mass.



WRIGHT-HEPP Associates, Inc.

*a new source of
supply for electronics
sheet metal specialties*

TRANSFORMER CASES

MIL-T-27 AND NON-STANDARD

TERMINAL ASSEMBLIES

FABRICATED COVERS . . . BRACKETS

CENTRIFUGAL HOT TINNING

IN OUR OWN PLANT

SPECIAL SERVICE on SAMPLES

WRITE, WIRE OR PHONE YOUR SPECIFICATIONS

138 WEST STREET

SOUTH HACKENSACK, N. J.

PRECISION

IS THE WATCHWORD
TODAY IN ELECTRONICS

... as technological
advancements call for
circuits of increasing accuracy
and dependability!

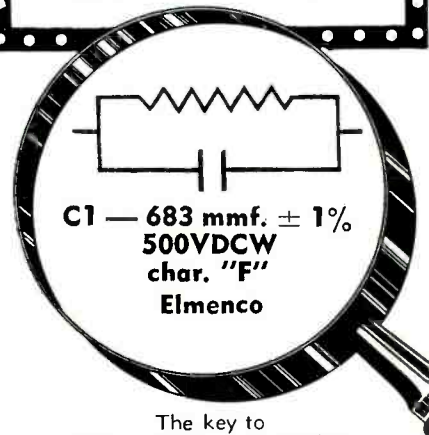

The key to high precision and stability lies in proper selection of mica capacitors, made possible through our ability to provide ANY CAPACITY at ANY TOLERANCE with the highest characteristics within the ranges specified for molded mica capacitors.

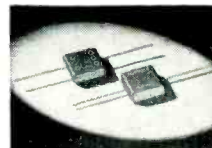

SINGLE UP TO
15000 MMF



DUAL UP TO
30000 MMF



TRIPLE UP TO 45000 MMF

Any Capacity
Any Tolerance (to $\pm 0.5\%$)
JAN Characteristic "F" or Better
for Most Capacity Values.

All capacitors are ELMENCO and are manufactured in accordance with JAN-C-5 specifications. Known the world over for their reliability under all operating conditions, ELMENCO CAPACITORS are chosen by manufacturers requiring the highest quality components for their products.

Write for our free descriptive catalog and for information regarding your special product requirements.

**ARCO
ELECTRONICS INC.**
103 LAFAYETTE ST., N. Y. 13, N. Y.

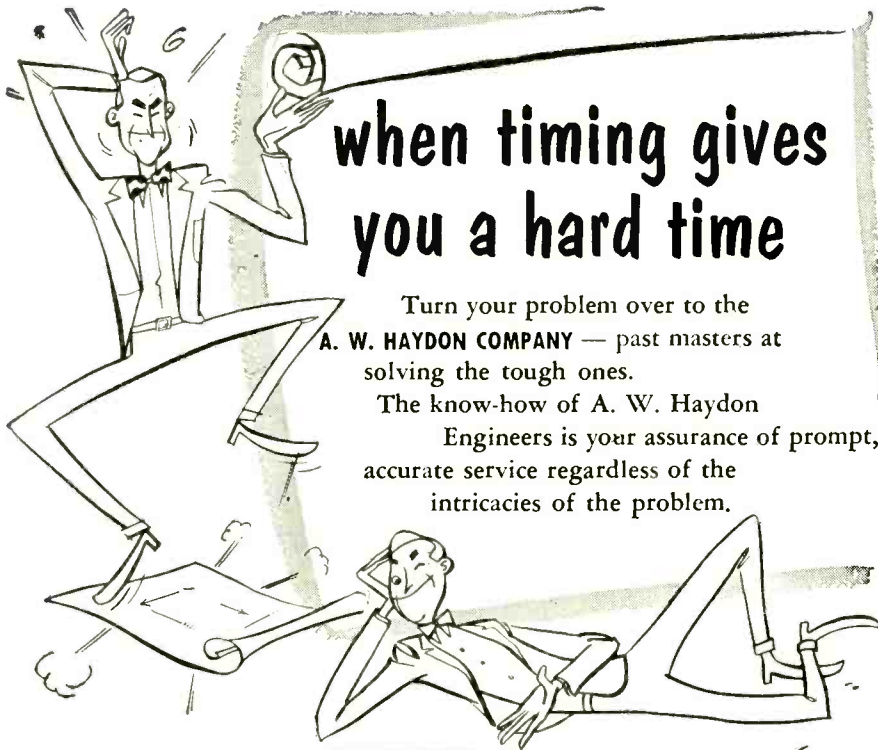

when timing gives you a hard time

Turn your problem over to the **A. W. HAYDON COMPANY** — past masters at solving the tough ones.

The know-how of A. W. Haydon Engineers is your assurance of prompt, accurate service regardless of the intricacies of the problem.

Send for catalog.

Would you like to work with us? We need qualified engineers *now*. Excellent opportunities for men who are looking to the future.



The **A.W. HAYDON**
COMPANY
235 NORTH ELM STREET
WATERBURY 20, CONNECTICUT
Design and Manufacture of Electrical Timing Devices

Introducing A NEW

PHALO CATALOG For Users of Insulated Wire, Cable and Cord Set Assemblies

Phalo wires, cables and cord set assemblies for radio, television, electronics, communication and industrial applications — illustrated and described for easy reference in — **THE NEW 46-PAGE**

PHALO CATALOG

Use This
CATALOG COUPON
To Order Your Copy.

PHALO PLASTICS CORP.
Corner of Commercial St., Worcester, Mass
Gentlemen:

We wish a copy of your 46-page catalog.

Company Name.....

Address.....

My Name..... Title.....

We are interested in insulated wire for.....

(List Use)

in cable for.....

(List Use)

in cord set assemblies for.....

(List Use)

PHALO
PLASTICS
CORPORATION
WORCESTER, MASSACHUSETTS

PHALO

Insulated wire
and cable
cord set assemblies



a tube, or any other component.

You would be very much gratified at the reception by the ham readers of **ELECTRONICS** of articles that cover items of direct interest. Examples are Villard's selective amplifier; Morgan's horn antenna; articles on vhf; the development work by Hollis on the citizen's band equipment. This sort of material is really appreciated. Incidentally, I would make a small bet that amateurs constitute your largest single field of readers, because so many of the specialists in other phases of electronics are at the same time hams.

Thanks to you and your staff for putting out a swell magazine, serving many fields in **ELECTRONICS**.

F. D. WHITE, W9KQX
Springfield, Ill.

W9KQX de W2TY

DEAR MR. WHITE:

IT IS nice to hear from you on two counts, first because we like very much the things you say about **ELECTRONICS** and, secondly, because it is always good fun to correspond with another amateur.

We certainly agree with you that it is a tough job to get receiver designers to pay any attention to anything except cost. As an editor, and also an amateur, I certainly intend to keep trying.

We have been plugging for more informative advertising for some time in our promotion piece, *Electronic Markets*, which goes to most advertising managers and agencies. I think this has borne some fruit.

Your last point, about amateurs reading **ELECTRONICS**, is very gratifying indeed. We realize that many of our readers are in the industry but take a busman's holiday via amateur radio. We don't often address them directly, but we certainly do like to publish things that interest them indirectly.

W. W. MACDONALD, W2TY
Editor

Mobile Radio Sales

DEAR SIRS:

I TOO have been interested in your discussions of the mobile radio service question as discussed in

PRECISION in MINIATURE!

520-A
Voltmeter

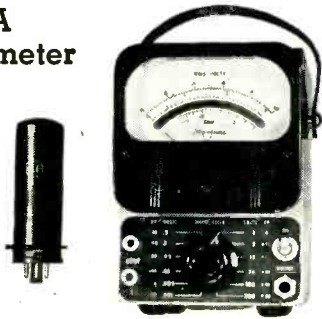

- 1 Millivolt Full Scale to 300 Volts
- 10 Cycles to 2 Megacycles
- Only 6" high

\$180

ALSO — MATCHING 510-B OSCILLATOR

- 18 Cycles to 1.2 Megacycles
- Distortion Less Than 0.2%
- Constant Output ± 0.5 db

\$150

Literature on Request

Waveforms, inc.

333 SIXTH AVE.
NEW YORK, N. Y.



there's more to a
MEYERCORD
Nameplate **DECAL**
than meets the eye...

What the eye does NOT see is the miracle of graphic arts engineering that is a part of every Meyercord Decal Nameplate. As the illustration-diagram indicates, the Meyercord Decal starts with a specially engineered adhesive and stacks color upon color, topping it all with a tough protective coating.

The Meyercord Decal Nameplate you apply to your product is the result of vast experience and never-ending engineering improvement. Just "any" decal won't do the job. Today's multiplicity of commercial surfaces and finishes demand exhaustive pre-testing to make very sure your Meyercord Decal Nameplate lasts the full life of the product.

Meyercord Decals cut production costs when used as nameplates, trademarks, instructions, markers, wiring diagrams, safety warnings and other important applications. Write for full information on our complete technical and designing services. No obligation, of course.

Write for the big Meyercord "Mark-It" Decal Nameplate Manual...FREE

Specify Meyercord Decals to

Shows hundreds of uses for durable, washable decal nameplates. The "Mark It" manual is FREE... request it on your business letterhead, please.



THE MEYERCORD CO.
World's Largest Decalomania Manufacturers

DEPT. C-303, 5323 WEST LAKE STREET
CHICAGO 45, ILLINOIS

Western IS READY
TO SERVE YOU



Radio and electronics manufacturers in the West know from experience that Western Coil Co. is completely reliable, its products completely dependable. Western has the facilities to serve you—in design, development and manufacturing. We invite your inquiries relative to your needs and problems.

Western
COIL PRODUCTS CO.
2993 Middlefield Rd.
Palo Alto, Calif.



DC to AC Converters



Dynamotors



Genemotors



Recorder Converters



Inductor Alternators



Magmotors

DEPENDABLE... COMPACT... EFFICIENT

Carter Rotary Power

Carter DC to AC Converters, Dynamotors, Genemotors, Magmotors, and Inductor Alternators (inverters) are made in a wide variety of types and capacities adaptable to communications, laboratory, and industrial applications, of many kinds. Widely used in aircraft, marine, and mobile radio, geophysical instruments, laboratory work, ignition, timing and many other uses.

Carter Motor Co.
2646 N. Maplewood Ave., Chicago 47
Sales Offices in Principal Cities

MAIL COUPON FOR CATALOGS

Please send catalogs containing complete information on Carter Rotary Power Supplies.

Name _____

Address _____

City _____ State _____

*Trade Mark Registered



FOR
FREQUENCY
Stability
IN
Mobile
EQUIPMENT . . .

make sure your crystals are made by Standard Piezo.

For years, our Crystals have been standard as original equipment with leading manufacturers and for replacement purposes by large operators of mobile equipment.

Precise, accurate, Standard Piezo Crystals are available for ALL types of mobile communication equipment.

Request catalog E for complete details.

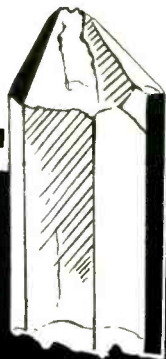

Standard Piezo
COMPANY
CARLISLE, PENNSYLVANIA

your various articles and *Backtalk* letters in *ELECTRONICS*. We have service contracts with several of the largest suppliers of this type of equipment but feel that one aspect of the problem has not been touched upon.

To the best of my knowledge not one of the five leading manufacturers will set up a service shop so that it can solicit and profit directly from the sale of equipment. Some have a minute percent available for "sales assistance" but by no means enough to actually go out and sell equipment.

In contrast I wonder how many television sales and service establishments would continue operation if they were confined entirely to service, especially in areas where the volume of business cannot support a one man full time service set up.

Seventy-five percent of our gross business is in the marine field where we cater to yachts and commercial vessels of all sizes. Were it not for the substantial discount available through marine suppliers, we would certainly look to other sources for an income.

The mobile manufacturers reason that they have their own salesmen but a recent potential order made known to four or five manufacturers brought forth not one reply.

I feel sure that until this outdated system of merchandising is changed, there will be little to attract competent technicians to this field.

You have my full permission to publish this letter completely or in part in the hopes that it might help to change the situation.

EDWARD P. YORK
Stonington, Connecticut

SEE
OUR
DISPLAY
AT
YOUR
LOCAL
Distributor

SEND FOR
COMPLETE
CATALOG

VISIT OUR
BOOTH

No. 4-509

I. R. E. SHOW

Grand Central
Palace, N. Y. C.

Mar. 23-24

25-26

Canadian CRT's

DEAR SIRS:
IN YOUR January 1953 issue on page 18, under the heading of "Television Sales Boom in Canada", you make the surprising statement that "cathode ray tubes . . . are not yet made in appreciable quantities in Canada". I feel that your reporter

another **PREMIER**
Precision-built **METAL HOUSING**

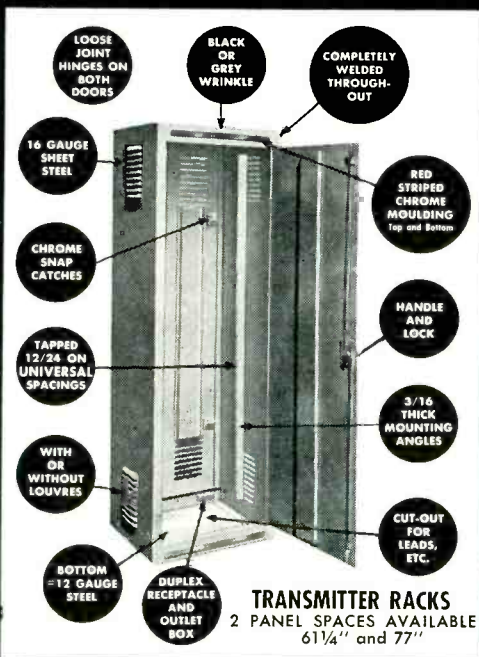

TRANSMITTER RACKS
2 PANEL SPACES AVAILABLE
61 1/4" and 77"

PREMIER METAL PRODUCTS COMPANY • 3160 WEBSTER AVE., BRONX 67, N.Y.

PERMATAG PLASTIC WIRE MARKERS— SNAP ON and GRIP TIGHTLY

PERMATAG wire and cable markers consist of a split sleeve which can be applied to a wire or cable by opening the split with the fingers or an applicator tool. After the marker has been applied to the wire or cable, it snaps on and grips tightly. For severe working conditions, the split sleeve can be welded into a solid sleeve by application of our special sealing liquid.

Made of Vinylite plastic with a clear overlay to protect the lettering. They are resistant to abrasion, water, oil, gasoline and alcohol and most acids, and are vermin proof and fungus proof as well. They are made in sizes from .040" diameter up to 3" diameter. We specialize in markers for very small wires from .040" O.D. to .080" O.D. Flat markers and apparatus name plates are available in any size, shape or thickness, punched with any number of holes of any shape. A special high speed printing process is used to make "non repetitive" markers and name plates at very low cost. Markers are also available in color.

ACTIONCRAFT PRODUCTS

8 SAGAMORE HILL DRIVE PORT WASHINGTON, N. Y.

Tel. Port Washington 7-1077

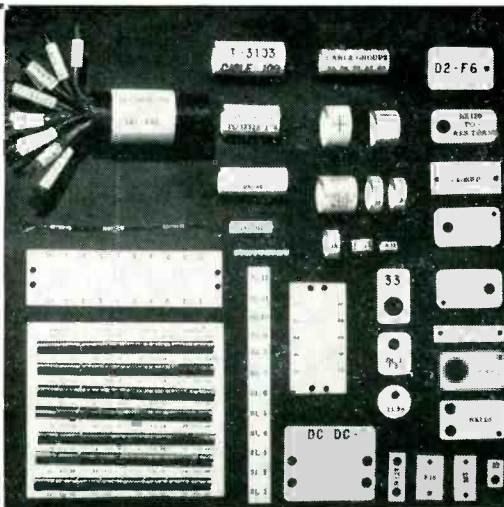

New 800-2600 mcs Frequency Meters Lightweight-Portable Units.. For Field and Laboratory Use!



Models:

FS-C-17-A 800-1200 MCS
FS-C-172-A 1200-1600 MCS
FS-C-173-A 1600-2250 MCS
FS-C-174-A 1700-2600 MCS

The input circuit is a type N connector (UG-58/U) . . . The output is monitored by a 1N21B crystal and microammeter circuit with adjustable sensitivity control for varying input power levels. The output of the crystal may be obtained from pin jacks provided on the panel of the instrument. A switch is provided to change the output from the microammeter to the pin jacks.

YOUR PRODUCTS HERMETICALLY SEALED

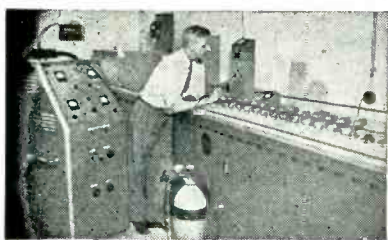

- Meet Military Specifications
- Provide permanent protection from dust and corrosive atmospheres
- Insure reliability
- Forever free from humidity effects
- Unexcelled high altitude operation

Our engineers will design suitable enclosures for your electronic parts. We assemble and seal your units in dry air or inert gas. All assemblies are evacuated and 100% leak tested by the Veeco Mass Spectrometer. Write for complete information.

GENERAL HERMETIC SEALING CORPORATION

99 E. Hawthorne Ave.
Valley Stream, L. I., N. Y.
Tilden 4-6300

WASHERS—ALL KINDS

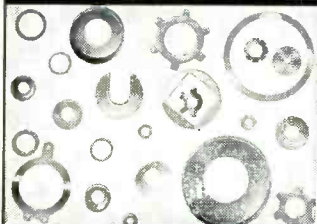

WASHER SPECIALISTS for nearly half-a-century. Dies in stock will produce most sizes. Big runs made with automatic presses. An economical, accurate, and highly reliable source for washers, also all kinds of metal stampings. HAVE WHITEHEAD'S CATALOG ON FILE; write for it.

BEVELED CUP
D-HOLE RETAINER
LOCK
SPACERS
SPRING TENSION
SQUARE HOLE
STAR LOCK
THRUST
TONGUE



WHITEHEAD STAMPING COMPANY

1691 W. LAFAYETTE • DETROIT 16, MICH.

SPECIFICATIONS

- 1 **ACCURACY**
Better than .05% from 20°F to 120°F
- 2 **SENSITIVITY**
Usable indication with 1 milliwatt input
Adjustable for higher levels
- 3 **INDICATOR** 50 Microammeter
- 4 **INPUT**
50 Ohm Type N Connector
- 5 **EXTERNAL DC OUTPUT**
Pin Jacks
- 6 **EXCURSION OF MICROMETER**
One-half inch
- 7 **MICROMETER SCALE**
at 1000 Mc — 1 Division equals 290 KC
at 1400 Mc — 1 Division equals 350 KC
at 2000 Mc — 1 Division equals 450 KC
at 2600 Mc — 1 Division equals 555 KC
- 8 **EXTERNAL SIZE** 6½ x 9¾ x 7"
- 9 **WEIGHT** Four pounds

CAVITY UNITS AVAILABLE

Units consist of cavity body, micrometer control, crystal, suitable connectors and calibration chart. Write for specifications and prices.



frequency standards

P. O. Box 504,
Asbury Park, New Jersey



Choose The Right Size Screwdriver And Save The Point!

WHICH Would YOU Pick ?

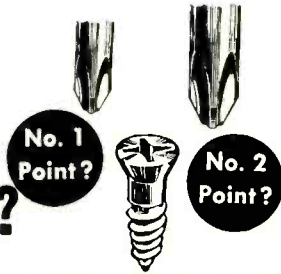

The Phillips screw and the two XCELITE Phillips points are shown actual size. You can use the #1 point—but it will fit somewhat loosely, and damage results to both screw and point. The #2 point does fit snugly, even though it appears too large. So, to make your points last longer, always try a size larger screwdriver than you think would fit.

And to get the best buy in precision-made screwdrivers with genuine Phillips points, always ask for XCELITE, the quality tools craftsmen use in earning their living.



NO EXCUSE for using "almost" the right screwdriver for the job! XCELITE makes the size, length and type you want—ask your dealer!

XCELITE, INCORPORATED

(Formerly Park Metalware Co., Inc.)

Dept. C Orchard Park, N. Y.



Precision Potentiometers

Designed by CORNELL for application wherever extreme precision is essential requirement.

Linear and NON-linear pots are designed to meet customer's requirements. Taps and special winding angles anywhere up to 360° continuous winding can be incorporated into both linear and non-linear units.

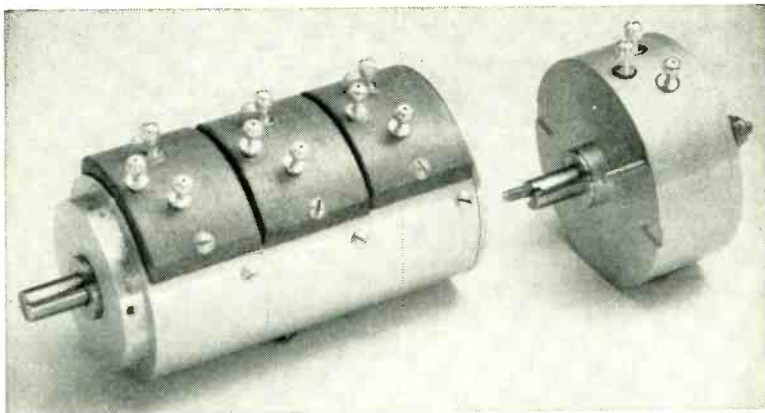

Type DS-6: 1 5/8" in diameter, RAS-4: 1 1/2" in diameter. Other Types available.

Request additional information please.

CORNELL ELECTRONICS CORP.

40-33 MAIN AVENUE

DOUGLASTON, N. Y.

slipped a cog on this one, as we have been manufacturing this type of tube in Canada since 1941.

One is led to believe that there is, and will be, a substantial shortage of cathode-ray tubes in the United States, very likely throughout 1953. The situation is also tight in Canada, but I know of no set manufacturer in Canada who has been forced to cut back his production for lack of tubes, and can assure you that this information would get to my desk rather quickly.

In 1942, when cathode-ray tubes were in short supply in the United States, we shipped substantial quantities to you. In 1948 and 1949, when you were again short, we shipped substantial quantities to you.

Last year, and currently, we have been buying some cathode-ray tubes in the United States to supplement our production. This would not have been necessary had the member companies of R.T.M.A. made more realistic estimates. (Sound familiar?).

I can assure you that the number of tubes imported is not too great in relation to the number made. We expanded last August, again in November, and will again in May. Further, we have very substantial and approved plans which we are confident will insure a complete supply of "Made in Canada" tubes for the trade.

Yours for more and better electronics!

W. E. DAVISON
President.
The Radio Valve Company
Toronto, Canada

Feedback

DEAR SIRS:

IN STUDYING the interesting article, "Effective Cathode Impedance," by W. Chater and N. Golden, on page 184 of the Dec. 1952 issue of ELECTRONICS, I think it will be found that to calculate $R_{eq} = \frac{R_k R_m}{R_k + R_m}$

and apply it as such to the feedback network will lead to extremely large errors in the feedback ratio calculations.

If the feedback voltage were the only voltage applied to this network

Insulation Tester



- Variable D.C. voltage to 16,000 v.
- Current readings 0 to 50 microamperes and 0 to 200 microamperes over full range of output voltage.
- Cut-out relays disconnect high voltage at flash-over and gaseous tube meter protection.
- External high voltage disconnect terminals.
- Housed in 8 1/2 x 13 x 9 1/2 inch hardwood veneer case with leather carrying handle.

A practical hi-pot and insulation testing device that will allow insulat on testing at hi-voltage. Instrument weights 24 pounds and is readily portable. Jack-bar at side of case for output circuit also designed for electrode chamber for dielectric or moisture absorption tests.

Manufactured by

TINKER & RASOR

P. O. Box 281 San Gabriel, California

*Priced
Right!*

WIRE FORMS

& Metal Stampings

High-speed, quality production with custom-made precision. Wire formed to any shape for every need.

**IMMEDIATE CAPACITY FOR
DEFENSE SUB-CONTRACTS**

STRAIGHTENING & CUTTING
Perfect straight lengths to 12 ft.
.0015 to .125 diameter

WIRE FORMS

.0015 to .125 diameter

SMALL METAL STAMPINGS

.0025 to .035 thickness

.062 to 3 inches wide

Specializing in Production of Parts for
Electronic, Cathode Ray Tubes & Transistors

Write for illustrated folder.

Send Blueprints or Samples
for Estimate.

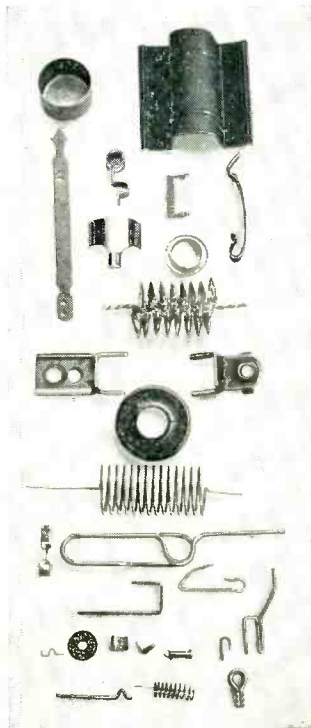

ART WIRE and STAMPING

COMPANY

1 BOYDEN PLACE
NEWARK 2, N. J.

Linde
Trade-Mark

M. S. C.

(Mass Spectrometer Checked)

RARE GASES

HELIUM · NEON

ARGON · KRYPTON · XENON

LINDE Rare Gases are mass spectrom-
eter checked to assure you gases of
known purity and uniformly high
quality. Available in commercial-size
cylinders and glass bulbs.

LINDE, the world's largest producer of
gases derived from the atmosphere,
can meet your individual needs of pur-
ity...volume...mixture...containers...

LINDE AIR PRODUCTS COMPANY
A DIVISION OF UNION CARBIDE
AND CARBON CORPORATION

30 East 42nd Street  New York 17, N. Y.

In Canada:
Dominion Oxygen Company, Limited, Toronto

The term "Linde" is a registered trade-mark
of Union Carbide and Carbon Corporation.

**For HEAVY DUTY
HIGH VOLTAGE**



PRODUCTS ARE BETTER*

**YES . . . WE BUILD BETTER EQUIPMENT
BASED ON MANY YEARS OF EXPERIENCE**

*While this word has been overworked in many instances,
we will be pleased to demonstrate the extras built into our
transformers to make them better.

← NEW UNITIZED RECTIFIERS

For high voltage D.C. sources . . . lower ini-
tial cost . . . minimum upkeep . . . convenient
— ready to connect to A.C. line and D.C.
load . . . compact — requires minimum floor
space.



34 KW 17,000 V.D.C.

AIR . . . OIL . . . ASKAREL

Plate Transformers · Filament Transformers · Filter Reactors · Modulation
Transformers · Distribution Transformers · Pulse Transformers · Testing
Transformers · Precipitation Transformers · General Purpose Transform-
ers · Hi-Voltage Transformers.

WRITE FOR DETAILED INFORMATION

Askarel
Immersed
Filter Reactor
50,000 Volt Test



MEETS STANDARDS
OF AIEE-NEMA

A NAME SYNONYMOUS WITH EXPERIENCE

MAGNATRON INCORPORATED

TRANSFORMERS AND ELECTRICAL EQUIPMENT
WALTER GARLICK, JR., PRESIDENT

246 SCHUYLER AVE., KEARNY, NEW JERSEY



STABLE DC FOR ADVANCED EQUIPMENT



Voltage precise enough for reference purposes—at an impedance of less than .01 ohm! The Type 200 will give you one ampere at zero to 15 volts, with output variations less than one millivolt, under most conditions. Ripple is extremely low, and a stabilizing chopper eliminates drift. Designed for use with strain gages, galvanometers, recorders, in analog computers, data-handling equipment, wind-tunnel installations, and similar critical applications.

OWEN LABORATORIES

412 WOODWARD BLVD.
PASADENA 10, CALIF.

the above would be true as presented in the original article. However, in addition there is a voltage generated on the cathode of the tube by the grid swing of that particular tube which is in phase with the feedback voltage.

If the feedback is around 20 db letting $R_{c_1} = R_k$ will lead to errors of only a few percent and as the feedback is increased this error gets smaller. A small amplifier using 2 sections of a 12AX7 twin triode in cascade will demonstrate this fact very nicely. In this particular case the cathode resistors were 1,000 ohms and the feedback resistance a 100,000-ohm resistor. The measured gain was 100!

DONALD W. NELSON
Seattle, Washington

More on Nim

DEAR SIR: THIS LETTER refers to an article appearing in the November 1952 issue of ELECTRONICS, "Digital Computer Plays Nim" by Herbert Koppel.

I have been interested in machines of this type for several years and know something of their history. The first Nim machine was invented jointly by E. U. Condon, G. L. Tawney and W. A. Derr and is described by U. S. Patent No. 2,215,544. Condon's machine was built by Westinghouse and displayed at the New York World's Fair. Redheffer describes a machine that directs the correct play of Nim in the *American Math. Monthly*, 55, p. 343. In 1949, at Washington University, I built a relay operated Nim machine to be displayed at an "Engineer's Day" exhibition.

The omission of any reference to Condon's or Redheffer's work was undoubtedly an unintentional oversight on the part of Mr. Koppel.

As to the method of winning at Nim, Mr. Koppel does not discuss the exceptional case where it is the machine's turn to play and the field appears

XX
X
X

or in a similar configuration. Here,

7 OUT OF 10 MAJOR POLICE DEPARTMENTS USE

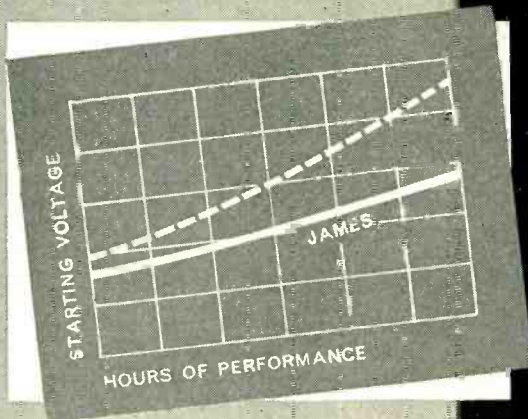

low voltage starting insures long life

JAMES "Red Ball" design means full, instant, low voltage starting . . . your insurance of longer vibrator life and superior performance even under maximum battery drain conditions.

** Write for detailed story.*

JAMES*



See your Distributor or write directly for FREE booklet on "Improving Vibrator Life Through Good Maintenance."

JAMES VIBRAPOW COMPANY
4038 N. Rockwell St. - Chicago 18, Ill.

EUROPEAN
RADIO TUBES

Obtainable from Stock

INTERNATIONAL ELECTRONICS CORPORATION
137, Hudson Street, N.Y. 13, N.Y.

Sole distributors in the U.S.A. for:
Mullard Overseas Ltd
MEV 13

Over 85% of the torque wrenches used in industry are

STURTEVANT
TORQUE WRENCHES
Read by Sight, Sound or Feel.

- Permanently Accurate
- Practically Indestructible
- Faster—Easier to use
- Automatic Release
- All Capacities

in inch ounces . . . inch pounds . . . foot pounds (All Sizes from 0-6000 ft. lbs.)

STURTEVANT TORQUE MANUAL

Every manufacturer, design and production man should have this valuable data. Sent upon request.

PA STURTEVANT & CO
ADDISON [QUALITY] ILLINOIS

Save time... **ENGRAVE** your own **NAME PLATES**
DIALS • PANELS

TRACER GUIDED FOR UNSKILLED LABOR

Engravo-graph

Send for Catalog IM29

The fastest, easiest method for engraving individual nameplates, dials and panels.

- Automatic depth regulator
- Engraves 15 sizes from One Master alphabet
- Equipped with self-centering device

NEW HERMES, Inc. 13-19 University Place, N.Y. 3, N.Y.
In Canada: 359 St. James St., Montreal • Sales representatives in principal cities
World's Largest Manufacturer of Portable Engraving Machines

For all owners of pantograph and routing machines . . .

NEW HERMES CUTTER GRINDER

The only belt-driven grinder at low cost.

- Smooth, vibration-free operation.
- Ball bearing grinding spindle.
- Tool head indexed for single lip and 2, 3, 4-sided cutters.

* Write for folder CG 29

NEW HERMES, Inc. 13-19 University Place, N.Y. 3, N.Y.

Specify **GM SERVO MOTORS** PRECISION ENGINEERED

RELIABLE PERFORMANCE • RUGGED CONSTRUCTION

In the operation of • GUNFIRE CONTROLS • ROCKET CONTROLS
GUIDED MISSILES • AIRCRAFT CONTROLS • INDUSTRIAL CONTROLS

G-M Servo Motors can be supplied to meet rigid military specifications with regard to humidity, temperature range, vibration and altitude. Available in 2, 4 or 8 pole construction and for frequencies from 50 to 400 cycles.

Write today for complete information.

3/4 ACTUAL SIZE

Another product of **GM LABORATORIES INC.** 4336 NORTH KNOX AVENUE CHICAGO 41, ILLINOIS

SPECIFY QUALITY-BUILT

Magnetic Amplifiers

Powered by Quality-Controlled



SELENIUM RECTIFIERS

Presently used in a wide range of successful applications for industry and the Armed Forces, such as:

- Voltage Control
- Temperature Control
- Current Control
- Photoelectric Control
- Speed Control
- Counting
- Position Control
- Automatic Regulation

Federal Selenium Rectifiers, in partnership with the right magnetic components, provide Magnetic Amplifiers outstanding for:

Stability • Accuracy • Long Life
High Gain • Fast Response • Low-cost Operation

Submit your magnetic amplifier requirements to Federal — write to Dept. E-913

In addition to magnetic amplifiers and complete magnetic amplifier systems, Federal also manufactures—

Toroidal Windings, Selenium Rectifiers, DC Power Supplies, Battery Chargers, Voltage Regulators, Speed Regulators and a complete line of Coaxial Cables and TV Lead-ins

Federal Telephone and Radio Corporation



SELENIUM-INTELIN DIVISION

100 Kingsland Road

Clifton, N. J.

Boost performance, lower cost with Beryllium Copper micro processed Electronic Components

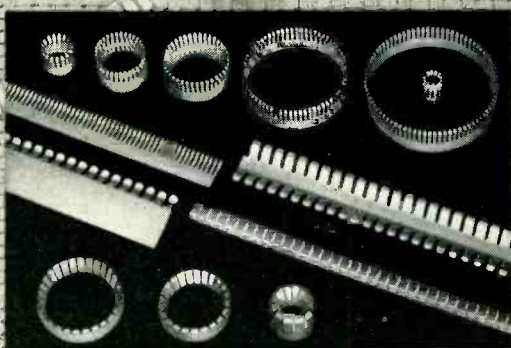

I-S Beryllium copper finger contact strips and contact rings combine higher elastic performance, accuracy of contour and choice of three finishes. Precision methods extended into mass production, eliminate hand adjustment at assembly — reducing final costs.

For full information on I-S Micro-processed Springs, write today for your free copy of Catalog 7, for Electronic Components, ask for Catalog No. 7-A.

To assist in developing the most effective and economical design, our experienced engineering staff is at your disposal.

INSTRUMENT SPECIALTIES CO., INC.
258-A Bergen Blvd., Little Falls, N. J.
Tel. Little Falls 4-0280

the machine's winning play is to leave an odd number of markers in a given column.

Another way of finding the correct play is to employ a radix four notation. First, we must introduce the concept of the "balanced set". A balanced set is defined as the set of numbers 1, 2, 3 or as an even number of like integers. The application of this method is best illustrated by an example. Let us say the markers on the field are

XXXX	Row I
XXXXXX	II
XXXXXXXX	III
XXXXXXXXX	IV

We can then make a table

	I	II	III	IV
4 ⁰	0	2	3	0
4 ¹	1	1	1	2

showing the number of markers in each row in base 4 notation. Note that neither the 4⁰ or the 4¹ columns constitute balanced sets. In order to win, one must leave the field such that a balanced set exists in each column. A winning move would be removing 3 markers from Column IV leaving the field

	I	II	III	IV
4 ⁰	0	2	3	1
4 ¹	1	1	1	1

in which case both columns are balanced. I do not recall who first described this method.

Your readers may be interested in the generalized game of Nim described by E. H. Moore in 1910. In this game the play is not limited to one row at a time, but to an arbitrary number of rows agreed upon by the players at the outset. The general game is won by

1. Writing the number of markers in each row in binary notation.
2. Adding these columns *decimally*.
3. Examine each integer of the sum.

A winning position is obtained by adjusting the markers such that each integer of the sum is congruent to zero modulo $K + 1$, where K is the limit to the number of rows one may operate on in a given move.

HOWARD L. FUNK
Poughkeepsie, New York

CONTACTS

FOR THE FIELD OF ELECTRONICS

ELECTRICAL COILS

Bobbin, spool, form, layer, interleaved, interwoven types. Made of any material, any finish, for any application.

Send blue-prints and specifications for prompt quotation.



THE FIVE STAR COMPANY

West Main Street
Plantsville, Conn.

WALKIE-RECORDALL 8 1/2" miniature BATTERY RECORDER-PLAYBACK

Continuous, permanent, indexed recording, up to 4 hrs., only 3c hr. Instantaneous, permanent playback. Picks up sound up to 60 ft. Records conferences, lectures, dictation, 2-way phone & sales talks; while walking, riding or flying. Records in closed briefcase with "hidden mike"! Write for Detailed Literature.

MILES REPRODUCER CO., INC.

812 BROADWAY Dept E-2 NEW YORK 3, N. Y.

For certification of Induction and Dielectric Heating Equipment

In accordance with F.C.C. rulings

NEW ROCHELLE TOOL CORP.

320 Main St. New Rochelle, New York
Phone NE 2-5555

'Mobile Unit' Quotations on request

Compare With Compasses at \$5.00 or More
LARGE CENTER WHEEL \$3.95
BOW COMPASS No. 804

"ALVIN" PRECISION MADE CIRCLES

1/8" TO 8 1/2", USED ALSO AS DIVIDERS.

EXTRA PARTS INCLUDED.

10 Day Money Back Guarantee

Send Check or Money Order and

Save C.O.D. Charges

TED ENTLICH 50-16 31 AVE.

WOODSIDE 77, NEW YORK

COMING

- in June, the Annual BUYERS' GUIDE Issue of ELECTRONICS.

- It is the only one of its kind
- —the one in which design engineers and purchasing agents will find a complete, accurate and up-to-date list of the manufacturers of all types of electronic and allied products . . . components and complete equipment.

- Make sure that your advertising appears in it—for complete information contact your District Representative or write

CONTACTS

ELECTRONICS

330 W 42nd St., NY 36, NY

WAVEGUIDE WAVEGUIDE Assemblies WAVEGUIDE Components

- Low Cost • Quantity Production • Light-weight "One-piece constructions"
- Dimensions to $\pm .0005$ • Internal finishes, 10 micro-inch • Excellent V.S.W.R
- Copper, Nickel, Silver • • • Some items shipped from stock.

Others, produced to your specifications, on short notice
Write now for additional information.

ALLIED RESEARCH & ENGINEERING INC.

1041 NORTH LAS PALMAS • HOLLYWOOD 38, CALIFORNIA



EISLER MANUFACTURES COMPLETE EQUIPMENT

WELDERS FOR SPOT & WIRE BUTT
RADIO, TV TUBE EQUIPMENT & REPAIR UNITS
INCANDESCENT, FLUORESCENT MFG EQUIPMENT
NEON SIGN MAKERS EQUIPMENT, GLASS LATHES
ELECTRONIC EQUIPMENT, VACUUM PUMPS, Etc.
Wet Glass SLICING & CUTTING MACHINES for Lab Use
TRANSFORMERS, SPECIAL & STANDARD TYPES

EISLER ENGINEERING CO., INC.
751 So. 13th St. Newark, N. J.



Have you problems in -

Metal to Glass Seals?

NAME IT . . . WE'LL MAKE IT!

TERMINALS

HEADERS

END SEALS . . . SPECIAL ITEMS

QUALITY PRODUCTS CO.

387 Charles St., Providence, R. I.

ELECTRO PLATING

SPECIALISTS IN
Silver, Cadmium & Zinc
Barrel Plating

Iridite and Cronak
Processes

To Government Specifications
Government Certified

EVEREADY PLATING CO.

1790 FIRST AV. N.Y.C.
EM 9-1222

SUBCONTRACTING

MILITARY and COMMERCIAL.

Power supplies, controls, test equipment,
sub-assemblies, cable and harness work.

PESCHEL ELECTRONICS, INC.

13 GARDEN ST. NEW ROCHELLE, N. Y.
New Rochelle 6-3342

Shorted Turn Indicator

for unmounted coils
MODEL 101C BULLETIN 42
HUNTINGTON BEACH, CALIF.

K&ARTRON

USE DECALS

for
NAME PLATES
INSTRUCTION PLATES
SERIAL NUMBERS, TRADEMARKS
etc.

Cheaper—Easier to apply
Durable—Multi-Colored
Made to your specifications
Send sketch or sample for
prompt quotation

Dept. E **NORSID**
MFG. CO., INC.

21 ATHONTON STREET, YONKERS 1, N. Y.



FLUXES

SOLDERING
BRAZING & WELDING

L. B. ALLEN CO. INC.

Chicago 31, Ill.

6751 BRYN MAWR AVE.

SUB-CONTRACTING MILITARY and COMMERCIAL

receivers—test equipment
transmitters—controls
sub-assemblies

TELETRONICS LABORATORY, INC.
Westbury, L. I., N. Y. Westbury 7-1028

We invite inquiries on



WRITE FOR CATALOG

REX RHEOSTAT CO.

BALDWIN, L. I., N. Y.

PROFESSIONAL SERVICES

ANNIS ELECTRIC RESEARCH LABORATORY, INC.

CONSULTING — RESEARCH — DEVELOPMENT
AND DESIGN OF RADIO AND ELECTRONIC
EQUIPMENT.
SPECIALIST
Military Radio Direction Finding
Equipment and Directional Antennas.
P. O. Box 581 1401½ S. Nell St.
Champaign, Ill. Tel. 6-1780

CROSBY LABORATORIES, INC.

Murray G. Crosby & Staff
Radio - Electronic
Research Development & Manufacturing
Communications, FM & TV
Robbins Lane, Hicksville, N. Y.
Hicksville 3-3191

EDGERTON, GERMESHAUSEN & GRIER, INC.

Consulting Engineers
Research, Development and Manufacture
of Electronic and Stroboscopic Equipment
Specialists in High-Speed Photography
160 Brookline Avenue, Boston 15, Mass.

Eldico of New York, Inc.

Pioneers of Television Interference Elimination from
Transmitters, Induction Heaters, Diathermy and
etc.
Donald J. S. Merten & Engineering Staff
44-31 Douglaston Pkwy Douglaston, N. Y.
Bayside 9-8686

ERCO RADIO LABORATORIES, INC.

Radio Communications Equipment
Engineering - Design - Development - Production
Pioneers in Frequency Shift Telegraph
Garden City • Long Island • New York

HARRIS GALLAY

Consultant
MICROWAVE AND
PULSE TECHNIQUES
Plymouth 9-4237 60 Perry St., Belleville 9, N. J.

GENERAL LABORATORY ASSOCIATES, INC.

Specialists in Glass to Metal Sealing
Manufacturing and development facilities now
available covering special vacuum and gas tube
Development and Fabrication. We invite your
inquiries.
Norwich, N. Y. Telephone Norwich 4-3264

HANSON-GORRILL-BRIAN INC.

Products & Mfg. Development
ELECTRICAL - ELECTRONIC
HYDRAULIC - MECHANICAL
One Continental Hill Glen Cove, N. Y.
Glen Cove 4-1922

HIGHLAND ENGINEERING CO.

William R. Spittal & Staff
DESIGN, DEVELOPMENT AND MANUFACTURE
OF TRANSFORMERS, CHOKES, ETC.
FOR THE
ELECTRONIC, INDUSTRIAL & ALLIED FIELDS
Main & Urban, Westbury, L. I., N. Y.
WE-7-2933

R. W. HODGSON

RESEARCH & DEVELOPMENT ENGINEERS
SPECIALIZING IN ELECTRONICS, NUCLE-
ONICS, INSTRUMENTATION, SERVOMECHA-
NISMS & CYBERNETICS
Office—6600 Lexington Ave., Hollywood 38, Calif.
All Mail to Box 874, Sherman Oaks, Calif.
Gladstone 9680

R. W. HODGSON

PATENT AGENT SPECIALIZING
IN ELECTRONICS
Registered to Practice Before the U. S. &
Foreign Patent Offices
Office—6600 Lexington Ave., Hollywood 38, Calif.
All Mail to Box 874, Sherman Oaks, Calif.
Gladstone 9680

ALBERT PREISMAN

Consulting Engineer
Television, Pulse Techniques, Video
Amplifiers, Phasing Networks,
Industrial Appliances
Affiliated with
MANAGEMENT-TRAINING ASSOCIATES
3308-14th St., N. W. Washington 10, D. C.

HOGAN LABORATORIES, INC.

John V. L. Hogan, Pres.
Applied Research, Development, Engineering
Est. 1929. Electronics, Optics, Mechanisms, Fac-
simile Communication, Digital Computers (Circle).
Electro-sensitive recording media, Instrumentation.
155 Perry Street, New York 14. CHelsea 2-7855

JOSEPH RACKER COMPANY

Radar Consultants & Editors
Technical Manuals
Research and Development
140 Nassau Street, New York 38, N. Y.
Worth 4-1463

THE KULJIAN CORPORATION

Consultants • Engineers • Constructors
Electronic Control
Specialists
Utility • Industrial • Chemical
1200 N. Broad St., Phila. 21, Pa.

W. C. ROBINETTE CO.

MOTRON DEADBEAT HIGH GAIN SERVOS
Speed control of any Prime Mover ¼% to .001%
average. Electric Transmissions ½ to 50 HP plus
controls—Zero droop—No load to full load.
802 Fair Oaks Ave. South Pasadena, Calif.
Py 11594

MEASUREMENTS CORPORATION

Research & Manufacturing Engineers
Harry W. Houck Jerry B. Minter
John M. van Beuren
Specialists in the Design and
Development of Electronic Test Instruments
Boonton, N. J.

SKINNER, HARLAN AND IRELAND, INC.

Consulting Engineers
Specializing in Magnetic Materials and
Their Application
Office and Laboratory Indianapolis 7, Indiana

Eugene Mittelmann, E.E., Ph.D.

Consulting Engineer & Physicist
High Frequency Heating—Industrial Electronics
Applied Physics and Mathematics
549 W. Washington Blvd. Chicago 6, Ill.
State 2-8021

THE TECHNICAL MATERIEL CORPORATION

Communications Consultants
Systems Engineering
General Offices and Laboratory
121 Spencer Place, Mamaroneck, N. Y.

NIAGARA ELECTRON LABORATORIES

CONSULTATION - DESIGN - CONSTRUCTION
MFG. THE THERMOCAT RELAY
Specializing in solution of problems of electronic
and electro-physical instrumentation for the re-
search of analytical laboratory. Industrial plant
problems also invited.
Andover, New York Cable Address: NIATRONLAB

TELECHROME, INC.

Electronic Design Specialist
COLOR TELEVISION EQUIPMENT
Flying Spot Scanners, Color Synthesizers, Keyers,
Monitors, Oscilloscopes and Related Apparatus
J. R. Popkin-Clurman, Pres. & Ch. Engr.
88 Merrick Rd. Amityville, L. I., N. Y.

MAURICE I. PARISIER & CO.

Communications Experts
International Engineering Consulting
RADIO BROADCASTING & COMMUNICATIONS
Planning & Installation Supervision
Communication Equipment for Armed Forces
1475 Broadway New York 36, N. Y. LOngaere 4-5434
Offices: Paris-Buenos Aires-Sao Paulo-Bombay

WHEELER LABORATORIES, INC.

Radio and Electronics
Consulting—Research—Development
R-F Circuits—Lines—Antennas
Microwave Components—Test Equipment
Harold A. Wheeler and Engineering Staff
Great Neck, N. Y. Great Neck 2-7886

PHYSICS RESEARCH LABORATORIES, INC.

Applied Mechanics, Thermodynamics, Heat Trans-
fer, Optics, Magnetic and Electrical Devices, Elec-
tronics, Nuclear Physics.
507 Hempstead Turnpike,
West Hempstead, L. I., N. Y.

WIHTOL LABORATORIES

Consulting - Research - Development
Electron tubes-Vacuum and gas tube
manufacturing techniques-Glass
techniques-Special purpose tubes
2333 Grey Evanston, Ill. Un. 4-7896

PICKARD AND BURNS, INC.

Consulting Electronic Engineers
Analysis and Evaluation
of Radio Systems
Research, Development and Design
of Special Electronic Equipment
240 Highland Ave., Needham 94, Mass.

YARDNEY LABORATORIES, INC.

Research - Design - Development
Electro-Chemical Generators of Energy
105 Chambers Street WORTH 2-3634, 35, 36
New York 7, N. Y.

SEARCHLIGHT SECTION

(Classified Advertising)

EMPLOYMENT: "OPPORTUNITIES" EQUIPMENT
BUSINESS: USED OR RESALE

EXEC. DEV. ENGINEER \$12,000—NO FEE

Supervise a development section for the country's most progressive manufacturer of electrical and electronic equipment.

Contact Ray Edwards

O'SHEA EMPLOYMENT SYSTEM
"America's Largest"

64 E. Jackson, Chicago, Ill. Tel-WAbash 2-1884

REPLIES (Box No.): Address to office nearest you
NEW YORK: 330 W. 42nd St. (36)
CHICAGO: 520 N. Michigan Ave. (11)
SAN FRANCISCO: 68 Post St. (4)

POSITIONS VACANT

ASSISTANT CHIEF Engineer: Ohio company manufacturing electronic equipment has opening for electronic engineer approximately 27-31 years of age in capacity of administrative assistant to the Chief Engineer. Duties will include engineering office work, supervision of laboratory projects and occasional traveling. Must have at least 5 years professional experience in circuit design and project supervision. Starting salary \$7000 per year. Allowance for moving expense. Replies held in confidence. Submit resume to P-6785, Electronics.

ELECTRONICS ENGINEER GS-7, \$4205 per annum—Duties: As an engineer in the Installations Section, Instrument Branch, Power Plant Division, cooperates in the design of new instrumentation and modification of existing testing facilities. Performs experiments on instruments and allied equipment to ascertain characteristics of same. Supervise and participate in the calibration and test operation of all instrumentation on an assigned project. Applicants should complete Standard Form #57, available at any post office. Forward applications to, or secure further information from Industrial Relations Officer, Industrial Relations Department, U. S. Naval Air Rocket Test Station, Lake Denmark, Dover, New Jersey.

SELLING OPPORTUNITY OFFERED

WANTED DISTRIBUTORS low cost laboratory precision electronic coil winder entirely self contained. SW-6720, Electronics.

POSITIONS WANTED

EXPORT MANAGER, Electronic background twenty continuous experience desires develop or manage manufacturers export department. PW-6827, Electronics.

YOUNG EUROPEAN Engineer, wide background of communications engineering, commercial and military, speaks English fluently, many years overseas, at present in Canada, wishes to join progressive U. S. firm, where his often very unusual ideas are recognized. PW-6885, Electronics.

SELLING OPPORTUNITIES WANTED

CANADIAN ENGINEERING Representative available. Electrical engineering graduate from leading university. Varied industrial experience. Considerable travel experience. RA-6872, Electronics.

GOVERNMENT-INDUSTRIAL Business. Manufacturers Representative selling USAF, Signal Corps, Navy and Industry (Phila, Washington, N. Y.) seeks additional lines and plants. RA-6821, Electronics.

RECTIFIER ENGINEER

will set up production line on any selenium or oxide cell and show you how to get started on a profitable basis.

PW-6680, Electronics,
68 Post St., San Francisco 4, Calif.

P4 SYNCHROSCOPES

Completely Reconditioned

CLEGG LABORATORIES, INC.

142 S. Livingston Ave. Livingston, N. J.

TWO INSTRUMENT MINDED RESEARCH SCIENTISTS

Expansion of our long range program for instrument development provides permanent, challenging opportunity for two additions to our staff:

Ph.D. in E.E.,

Electronics Background

Ph.D. in PHYSICS,

Background in temperature radiation and/or spectroscopy.

While experience is highly desirable, it is by no means necessary. Far more important is interest in a career devoted to the origination of instruments which shall render new or improved services to science & industry. Inventive ability and ingenuity should be well defined.

Please address preliminary correspondence to our Personnel Manager.

LEEDS & NORTHRUP CO.

4901 Stenton Ave. Philadelphia, 44, Pa.

ELECTRONIC ENGINEERS

We are looking for electronic engineers, with experience in the development of electronic digital computers, to work in the development of business machines. Plenty of opportunities for advancement.

Write, giving full details, including education and experience.

THE NATIONAL CASH REGISTER CO.

South Main and "K" Streets
Dayton 9, Ohio

BUILD IN WORLD ELECTRONICS CENTER

Metropolitan Oakland Area (MOA) home of the University of California and close to Stanford University, offers unmatched research or consultation facilities and personnel source for manufacturers, fabricators and marketers in electronics field. Besides its ideal location in shadow of two world-renowned research centers, MOA provides many additional, exclusive profit advantages to industry: proximity to users in great electronics center; geographic hub of multi-billion dollar West market; sizeable savings in shipping time and cost; major terminus for rail, truck, air, sea carriers; all-season production; temperate climate; acres of level plant sites; phenomenal, continuing G-R-O-W-T-H. For a free FACTBOOK and/or answers to specific questions, write:

Alameda County

New Industries Committee

Suite 601, 427 - 13th St. Oakland, Calif.

CANADIAN MANUFACTURING FACILITIES

Light Engineering and Electronics Plant in Canada with excellent facilities is prepared to manufacture for U. S. Firms desiring to enter Canadian market but unable to export owing to Customs or other obstacles.

CW-6550, Electronics
330 W. 42 St., New York 36, N. Y.

Massachusetts Institute Of Technology's

Digital Computer Laboratory of the
Department of Electrical Engineering

HAS

STAFF OPENINGS

for research and development engineers and scientists for work on the development of high-speed electronic digital equipment. The program ranges from logical planning up through component and circuit research, construction, installation, and testing, to computer operation, and also work on necessary associated terminal equipment. The construction phase involves problems of designing, packaging, production planning, scheduling, material procurement, and liaison. Experienced electronic engineers and a few mechanical designers are especially needed.

There are also staff openings for experienced people and recent graduates for work on use of high-speed digital computers to control requirements of the whole system, reduction of these requirements to a simple pattern or sequence of control instructions, and translation of the pattern into computer code. Position requires appreciation of physical systems, ingenuity, and imagination. Prior experience with digital computers is unnecessary, and training in computer principles will be provided.

Persons transferring from other fields to acquire experience in digital computers for engineering and military uses are encouraged to apply and may come on leave of absence from their permanent organizations. Position carries opportunity for academic study. Salary appropriate to candidate's experience and training.

Massachusetts Institute of Technology
Digital Computer Laboratory
211 Massachusetts Ave.
Cambridge 39, Mass.

ELECTRONIC ENGINEERS

FOR DESIGN & DEVELOPMENT WORK IN
RADAR

COMPUTERS

DIGITAL TECHNIQUES

with a young progressive company,
send resumé of experience and
education, with salary requirements,
to



Electronic Engineering Company

of California

140 SOUTH ALVARADO STREET LOS ANGELES 4, CALIFORNIA
DUNKIRK 2-7353

YOUNG ENGINEERS WANTED

Recent graduates from engineering colleges in Aeronautical, Mechanical, or Electrical Engineering. After a training course at our factory we will locate men in Dallas, Texas, and Los Angeles, California. Prefer men 25 to 30 years of age.

If you are interested in making connections with a company which is geared to war or peace conditions and which has plans for a long-range program independent of Government defense appropriations, we can offer qualified men an excellent future.

P-6742, Electronics
330 W. 42 St., New York 36, N. Y.

**MAKE THIS YOUR HOME
FOR IMPORTANT WORK
UNDER IDEAL CONDITIONS**



- TV RECEIVER DESIGN ENGINEERS
- ELECTRONICS ENGINEERS
- FIELD ENGINEERS
- TEST & INSPECTION ENGINEERS
- LAB. TECHNICIANS

NEEDED TO WORK ON: Radar, G.C.A., Mobile Radio, Auto Radio, Airborne Communication & Navigation Equipment, Television, Antennas, Microwave Equipment, Servo Mechanisms, Guided Missiles and Test Equipment Design.

YOU BENEFIT AT BENDIX RADIO: from high wages, a modern, air-conditioned plant, paid vacations and holidays, group insurance and a good chance for advancement.

Housing immediately available in the beautiful suburban and country areas that surround the Bendix Radio plant.

Write, Wire or phone
MR. E. O. COLE, DEPT. J.

Bendix Radio

DIVISION OF BENDIX AVIATION CORPORATION

BALTIMORE-4, MD. Phone: TOWSON 2200

*Makers of the World's Finest
Electronic Equipment*

**ELECTRONICS ENGINEERS
WANTED
SOUTHERN CALIFORNIA**

Attractive opportunities offered to Engineers experienced in and qualified to design aircraft flush antennas and radomes.

Complete modern facilities for laboratory testing and evaluation available.

Salary dependent upon experience and ability.

Contact Mr. J. C. Buckwalter,
Chief Engineer



DOUGLAS AIRCRAFT COMPANY, Inc.
LONG BEACH, CALIFORNIA



Opportunities for

ENGINEERS

DESIGNERS

SR. TECHNICIANS

in radio and electronic

system development

KOLLSMAN INSTRUMENT CORP.

80-08 45th Avenue, Elmhurst, Long Island, New York

**ENGINEERS
AND
PHYSICISTS
BS-MS-Ph.D:**

Responsible positions in mechanical, electrical or electronic engineering, physics or engineering physics for advanced development and design of special equipment and instruments. Prefer men with minimum of two years' experience in experimental research design and development of equipment, instruments, intricate mechanisms, electronic apparatus, optical equipment, servomechanisms, control devices and allied subjects. Positions are of immediate and permanent importance to our operations. Southwestern location in medium sized community. Excellent employee benefits. Reply by letter giving age, experience and other qualifications. All applications carefully considered and kept strictly confidential.

Ind. Rel. Manager
Research & Development Dept.

**PHILLIPS
PETROLEUM COMPANY**
Bartlesville • Oklahoma

Men of Vision

**SCIENTISTS
ENGINEERS
DESIGNERS**

apply **CREATIVE** engineering to research, development,
and design ... the **KEY** to **SOLID SUCCESS** at

GOODYEAR AIRCRAFT

If you are seeking a position where ingenuity, personal initiative, and ability count most, investigate the various opportunities offered by Goodyear Aircraft. We have openings for able, experienced personnel in the following fields:

- | | | |
|-----------------------|---------------------------|--------------------------|
| ✓ Electrical Systems | ✓ Aerodynamics | ✓ Tool Design |
| ✓ Circuit Analysis | ✓ Physics | ✓ Tool Planning |
| ✓ Analog Computers | ✓ Flight Test | ✓ Tool Processing |
| ✓ Servomechanisms | ✓ Stress Analysis | ✓ Industrial Engineering |
| ✓ Test Equipment | ✓ Dynamics | ✓ Estimation |
| ✓ Applied Mathematics | ✓ Microwave | ✓ Time Study |
| ✓ Electronics | ✓ Structures | ✓ Plant Engineering |
| | ✓ Designing in All Fields | |

Openings also exist for welding, civil, and mechanical engineers with experience in metals fabrication. Needed too are personnel with ability and experience in technical editing, copywriting, illustration, and photography.

Positions are available at several levels; inquiries are also invited from recent graduates. Liberal salaries are based on education, ability, and experience. Paid vacations and holidays, sick leave insurance, and retirement plans are added benefits.

Goodyear Aircraft is centrally located in the Great Lakes region ... in the heart of northeastern Ohio. Akron, a community of 350,000, is a clean and friendly home town to thousands of Goodyear employees and their families who enjoy metropolitan living and fine cultural and educational advantages. Excellent parks, golf courses, and inland lakes give active, year-round enjoyment. The Aircraft division is a full-fledged member of the Goodyear family ... a name famous the world over.

If YOU are interested in a secure future, write and give full details to
Mr. C. G. Jones, Salary Personnel Department

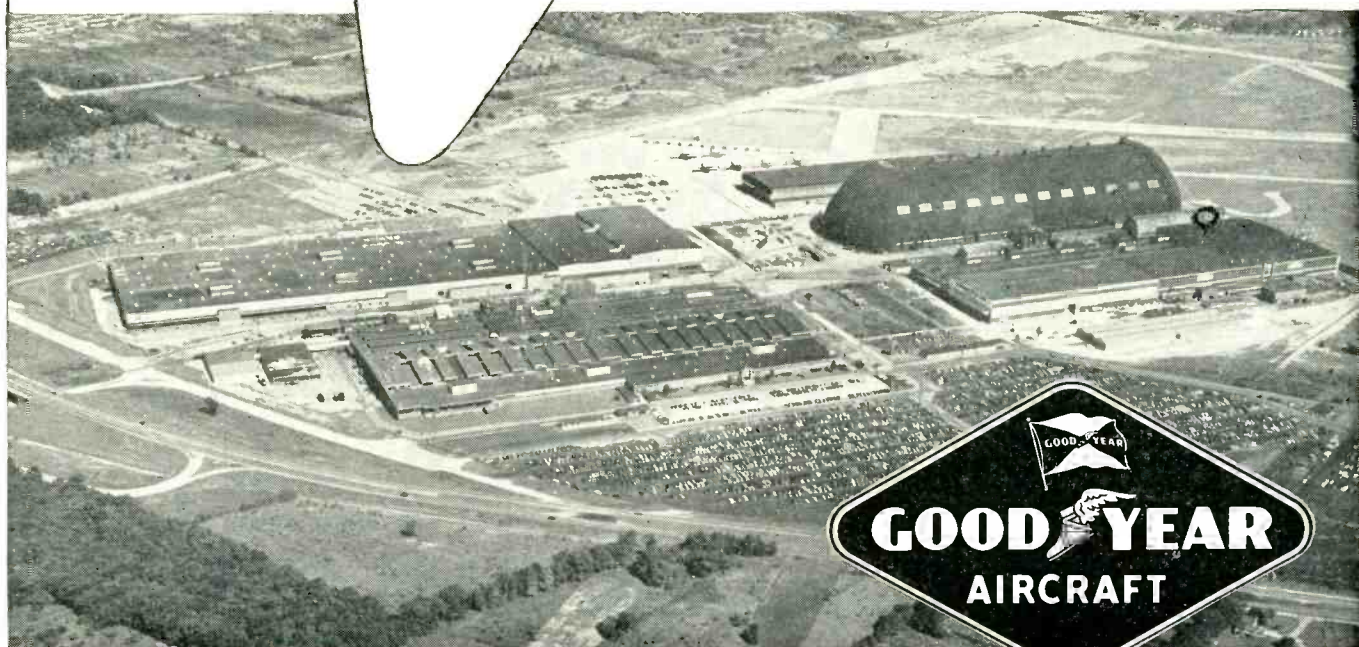

GOODYEAR AIRCRAFT CORPORATION • 1210 Massillon Road, Akron 15, Ohio

We desire personnel of the highest caliber—experienced in the field of airborne automatic electro-mechanical control equipment.

ENGINEERS

MECHANICAL DESIGN
ELECTRONIC
SERVO

DESIGNERS-LAYOUT MEN

ELECTRONIC
MECHANICAL

This work deals with the manufacture and development of highly complex equipment of the most advanced type in a new and expanding division of an established firm with 20 years of successful experience in the precision instrument field.

We cite a few of the good reasons why you might like to join our organization . . .

SALARY increases are based on merit and initiative—two weeks VACATION, HOSPITALIZATION BENEFITS, GM's own INSURANCE PLAN—POSITIONS ARE PERMANENT due to long range manufacturing and developing programs—EXPENSES incident to interviews and moving all absorbed by company—HOUSING and LIVING CONDITIONS among the best and finest of any along Lake Michigan.

• We have a Junior Engineering Training Program of one year for inexperienced engineering graduates. Opportunity to become acquainted with all phases of industry.

• For the convenience and direct use of engineers in our Engineering Department, we have our own model shop where highest skilled mechanics are employed.

• Educational opportunities for advanced degrees available at U. of W., Marquette. Technical engineering offered at Milwaukee Vocational School.

. . . all inquiries answered—write or apply . . .

★ AC SPARK PLUG DIVISION

GENERAL MOTORS CORPORATION

1925 E. KENILWORTH PL.

MILWAUKEE 2, WIS.

Armour Research Foundation of Illinois Institute of Technology

Has openings for outstanding engineers and scientists in the fields of:

Analog Computer Research
Digital Computer Research
Electronic Instrumentation
Magnetic Circuit Design
Radar and Radio Communication
Servomechanisms

Foundation projects are sponsored by industry and government; they are diversified and challenging and require the services of top level engineers and scientists.

Excellent working conditions and stimulating associates; opportunity for graduate study with special tuition privileges; salaries corresponding to level of candidates. Please write giving full details of background to:

ASSISTANT DIRECTOR FOR PERSONNEL

35 West 33rd Street

Chicago 16, Illinois

STAFF ENGINEERS

Design and Development

Leading Chicago Electronics firm is seeking the services of qualified men to fill several staff openings in its Electronic Design and Development Division. Persons selected will be given intermediate and advanced level assignments in our Television, Radio and Government Equipment Laboratories.

Experience in monochrome receivers, deflection and high voltage circuits, radiation interference, NTSC color receivers, color generating equipment or UHF systems essential.

These are permanent positions and offer excellent opportunities for advancement. Company has well planned, long range program of design and development.

Please write Mr. Walter Wecker, Personnel Division, giving related experience and educational qualifications.—Or telephone SPaulding 2-0100.

Interviews arranged at your convenience.

Admiral Corporation

3800 W. Cortland St.

Chicago 47, Illinois

ELECTRONIC ENGINEER WANTED!

An established business organization engaged in development and manufacture of products for VHF and UHF Television Application, requires an individual qualified to work independently, to organize, and to supervise development projects.

This position is to be permanent and will offer the opportunity for unlimited advancement to a successful career. Offers stimulating and congenial surroundings in a newly acquired plant.

Attractive Salary

Write stating qualifications

Blonder-Tongue

LABORATORIES

526-536 North Avenue
Westfield, New Jersey

A QUESTION FOR ALL ENGINEERS:

*Where will you be
10 years from now?*

A:



Will *your* achievements be recognized? Will *you* be associated with distinguished scientists and engineers? Will *your* work provide a challenge for *your* talent and ability? Will *your* position and income be founded upon *your* real merit?

At RCA, you'll find plenty of "future insurance" . . . and right now is the time to investigate RCA opportunities. Because RCA is now looking for experienced **ELECTRONIC, COMPUTER, ELECTRICAL, MECHANICAL, and COMMUNICATIONS ENGINEERS . . . PHYSICISTS . . . METALLURGISTS . . . PHYSICAL CHEMISTS . . . CERAMISTS . . . GLASS TECHNOLOGISTS**. Whichever your specialty, there's a chance of a lifetime for a

career with RCA—world leader in electronic development, first in radio, first in recorded music, first in television. RCA growth has remained steady through war and depression . . . you'll find positions open today in many commercial projects, as well as military lines.

**WHY RCA IS A GOOD PLACE
FOR YOU TO WORK**

Facilities for creative engineering are top-notch. Working conditions and associates stimulate you. Periodic merit reviews help you advance in grade and income. Your family can enjoy pleasant country or suburban living. RCA encourages growth of your professional status and recognition. Company-paid benefits—including life, accident and hospitalization insurance—increase your feeling of security. You look forward to retirement through a progressive program. RCA has a modern tuition refund plan for advanced study at recognized universities.

Personal interviews arranged in your city.

Please send a complete resume of your education and experience to:

MR. ROBERT E. McQUISTON, Manager, Specialized Employment Division
Dept. 200-C Radio Corporation of America, 30 Rockefeller Plaza, New York 20, N.Y.

Positions Open In

**RESEARCH—DEVELOPMENT—
DESIGN—APPLICATION**

in any of the following fields:

RADAR—Circuitry—Antenna Design—Servo Systems—Information Display Systems—Gear Trains—Stable Elements—Intricate Mechanisms

COMPUTERS—Digital and Analog—Systems Planning—Storage Technique—Circuitry—Servo Mechanisms—Assembly Design—High Speed Intricate Mechanisms

COMMUNICATIONS—Microwave—Aviation—Mobile—Specialized Military Systems

MISSILE GUIDANCE—Systems Planning and Design—Radar and Fire Control—Servo Mechanisms—Vibration and Shock Problems

NAVIGATIONAL AIDS—Loran—Shoran—Altimeters—Airborne Radar

TELEVISION DEVELOPMENT—Receivers—Transmitters and Studio Equipment

COMPONENT PARTS—Transformer—Coil—Relay—Capacitor—Switch—Motor—Resistor

ELECTRONIC TUBE DEVELOPMENT—Receiving—Transmitting—Cathode-Ray—Phototubes and Magnetrons

ELECTRONIC EQUIPMENT FIELD ENGINEERS—Specialists for domestic and overseas assignment on military electronic communications and detection gear.



RADIO CORPORATION of AMERICA

Engineers... Scientists...

Mechanical Engineers — Electrical Engineers
 Servo Engineers - Aerodynamicists - Physicists

Do You Know the MELPAR Story?

For complete information about the opportunities available
 for qualified engineers and scientists write to

PERSONNEL DIRECTOR
melpar, inc.

The Research Laboratory of Westinghouse
 Air Brake Co. and its subsidiaries
 452 Swann Avenue, Alexandria, Virginia
 or 10 Potter St., Cambridge, Mass.



STAVID ENGINEERING, INC.

has openings for
**GRADUATE
 ELECTRONIC and
 MECHANICAL
 ENGINEERS**

Experience in Design and Development of Radar
 and Sonar necessary.

Broad knowledge of Search and Fire Control
 Systems; Servo Mechanisms, Special Weapons,
 Microwave, Antennas and Antenna Mounts, etc.
 Mechanical Engineer should also have experi-
 ence in packaging of Electronic Equipment to
 Gov't specifications including design of com-
 plex cabinets, shock mounts and sway brace
 structures.

FIELD ENGINEERS

Qualified to instruct in the operation and su-
 pervise installation, maintenance and repair of
 Radar, Sonar and allied electronic equipments
 in the Field.

A chance to grow with a young and progressive
 company; salary and advancement commensu-
 rate with ability; liberal vacation, sick leave,
 9 paid holidays, group life, sickness and acci-
 dent insurance plans, and a worthwhile pension
 system.

Personnel Office, 200 W. Seventh St.
 Plainfield, N. J. - Tel. PL. 6-4806

ELECTRONICS ENGINEERS

Project • Design • Group • Field • Junior • Senior

AIRCRAFT ARMAMENTS' development engineering program in
 the fields of radar, fire control and associated equipment has pro-
 vided more openings for men at all levels of experience.

If you are considering a change and are looking for a young,
 growing company with a continuing program of development
 work, we would appreciate receiving your resume and would
 welcome the opportunity of providing you with information about
 our company.

D. J. WISHART
 Director of Personnel



ENGINEERS ELECTRONICS TOP JOBS

We are a large established Company.
 Company which is spearheading a dy-
 namic expansion program in the Electronic
 Tube field. Top quality men are needed
 to augment our present staff.

Development—Creative mechanical engi-
 neering talent required to visualize tomor-
 row's products today, in product develop-
 ment, procedure, equipment. Should
 possess manufacturing, research or engi-
 neering background in this field. This
 opening presents a challenge to a quali-
 fied man whose abilities and knowledge
 presently are restricted.

Application—An inventive, ingenious en-
 gineer with a background in electronic
 circuits. One whose abilities (EE preferred)
 can meet the constant challenges of tube
 application. Personality and persuasive-
 ness are desirable attributes.

Tube Production—A-1 man required for
 tailor-made position for experienced re-
 ceiving tube plant manufacturing execu-
 tive. Our expansion program is sole reason
 for considering applicant from another
 company.

All replies are strictly confidential. Our
 management is aware of these openings.
 Please submit resume.

P-6684, Electronics
 330 W. 42nd St., New York 36, N. Y.

WANTED: DIRECTOR OF ENGINEERING

An outstanding opportunity for an electronics engineer of executive caliber to head up
 the development program for a nationally known manufacturer in the electronics field.
 A smaller firm with two well-equipped plants and excellent laboratory facilities, par-
 ticularly in the audio and electro-acoustic fields, 70% of the company's business is
 civilian.

Starting salary \$12,000, with opportunity for increased earnings through bonus and
 advancement. Stock participation open. Appointee will be a member of small top man-
 agement group.

QUALIFICATIONS: Must be a graduate engineer or physicist, preferably in communi-
 cations field. Age: 30 to 50. At least 8 years of engineering experience with some super-
 visory activity. American citizenship and clearance for secret. Originality and creative
 thinking essential plus ability to plan, organize, direct, and coordinate the efforts of
 various project groups.

CONFIDENTIAL PERSONAL INTERVIEW may be arranged during IRE meeting in
 March in N.Y.C. Address reply stating personal qualifications, including: education, em-
 ployment, and earnings record, patents and inventions, publications, interests, family
 status.

All replies treated in strict confidence. Our own staff knows of this advertisement.
 P-6894, Electronics, 520 N. Michigan Ave., Chicago 11, Ill.

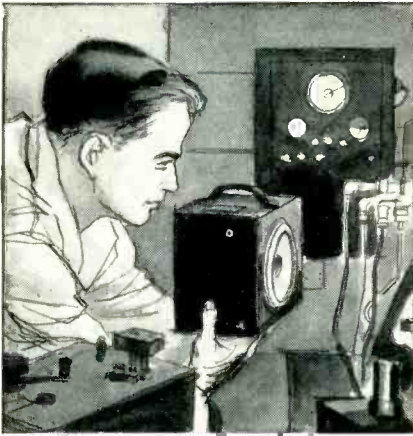

Design,
development engineers...

*Like to further
your career?*

IF YOU'VE HAD some experience in design or development engineering, and would really like to develop and further your career, you owe it to yourself to look into the promising opportunities available at Honeywell.

There's a real opportunity for you to go places in the Honeywell organization in six areas where we now have openings:

- Servomechanisms • Vacuum tubes
- Gyros • Electromechanics
- Relays • Aircraft Control Systems

Duties of the jobs. Take on complex design work requiring analysis and decision to bring into design form the requirements for a new or modified instrument, device or control system.

Requirements. B.S. or M.S. in Electrical, Mechanical or Aeronautical Engineering.

Atmosphere. A company that understands engineering—where one out of every ten employees is actively engaged in engineering or research.

Openings. In Minneapolis, Philadelphia and Freeport, Illinois.

For details write H. D. Elverum, Personnel Dept. EL-3-41, Honeywell, Minneapolis 8, Minn. Ask for our book, "Emphasis on Research."

MINNEAPOLIS
Honeywell



First in Controls



SPECIAL OPPORTUNITIES FOR SENIOR ENGINEERS

Convair in beautiful, sunshiny San Diego invites you to join an "engineers" engineering department. Interesting, challenging, essential long-range projects in commercial aircraft, military aircraft, missiles, engineering research and electronics development. Positions open in these specialized fields:

Electrical Design
Mechanical Design
Structural Design
Structures
Weights

Servo-mechanisms
Aerodynamics
Thermodynamics
Operation Analysis
System Analysis

Generous travel allowances to those accepted. For free brochure, write Mr. H. T. Brooks, Engineering Dept. 900

CONVAIR

IN BEAUTIFUL
SAN DIEGO

3302 PACIFIC HIWAY
SAN DIEGO 12, CALIFORNIA

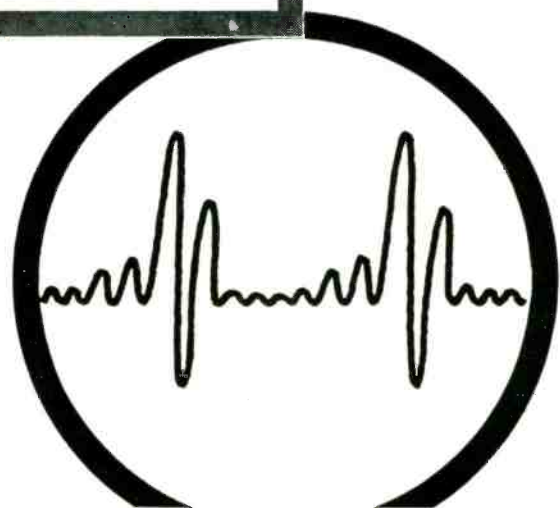

ELECTRONIC ENGINEERS & PHYSICISTS

OUR STEADILY EXPANDING LABORATORY OPERATIONS
ASSURE PERMANENT POSITIONS AND UNEXCELLED
OPPORTUNITY FOR PROFESSIONAL GROWTH IN

RESEARCH & DEVELOPMENT

GUIDED MISSILES

TELEVISION

ELECTRONIC NAVIGATION

SOLID STATE PHYSICS

VACUUM TUBES

RADAR

ADDRESS

INQUIRIES TO **CAPEHART FARNSWORTH CORP.**
FORT WAYNE, IND.

THE EMPLOYMENT DEPT.

THE JOHNS HOPKINS UNIVERSITY

RESEARCH ENGINEERS—PHYSICISTS

This University Laboratory offers a variety of challenging problems at both senior and junior levels. A position here means:

- Faculty rank and privileges for Senior Staff
- Favorable arrangements for advanced study in the Hopkins Graduate Schools
- One month paid vacation
- An air-conditioned laboratory near the University Campus

The Radiation Laboratory of the Johns Hopkins University has positions in the fields of:

- Electronics Circuits and Pulse Techniques
- Microwaves and VHF

Address inquiries to:

RADIATION LABORATORY

1315 St. Paul Street
Baltimore 2, Maryland

WANTED

SALES MANAGER

Leading manufacturer of ceramic capacitors needs an aggressive top-flight sales manager. Our product is used by all of the larger electronic equipment manufacturers and is well established. This man must have excellent contacts in this field and must be able to obtain full co-operation from our sales representatives. This position will pay upwards of \$25,000 per year, but the man we want will be accustomed to a high income. If you think you can meet our requirements we would like to hear from you giving full details. Your reply will be confidential.

SW-6824, Electronics
520 N. Michigan Ave., Chicago 11, Ill.

ELECTRONIC ENGINEERS

ALL GRADES

Small electronic research and development laboratory, located 8 miles outside of Washington, D. C., has several openings for junior and senior electronic engineers. Degree essential. Varied projects, including considerable Defense work. Liberal salaries dependent upon experience. Excellent personnel policies.

THE DAVIES LABORATORIES

Incorporated
4705 Queensbury Road, Riverdale, Maryland

SENIOR • JUNIOR

ENGINEERS



TECHNICIANS



TECHNICAL WRITERS

FOR PERMANENT POSITIONS

With a well established progressive organization engaged exclusively in the design and manufacture of specialized electronic equipment; both for defense and for an expanding commercial line. Projects are varied and include radar systems, computers, antenna systems, microwave equipments, airway navigation aids, transmitters and receivers.

Write full resume of education and employment record.

Located in suburban Washington, D. C.

MARYLAND ELECTRONIC MANUFACTURING CORPORATION

5009 Calvert Road
College Park 26, Md.

ELECTRICAL and ELECTRONIC ENGINEERS

Excellent opportunities
in the field of

AUDIO AMPLIFIER DESIGN
SERVO AMPLIFIER DESIGN
COMPONENT DEVELOPMENT
EQUIPMENT DESIGN

Senior and
Junior Engineers

Write, giving full details to:

Personnel Director, Dept. A,
**GIBBS MANUFACTURING AND
RESEARCH CORPORATION**
Janesville, Wisconsin

TRANSFORMER ENGINEER

We can offer outstanding opportunity to a man with two or more years experience in transformer design and development. Position requires initiative and ingenuity. Excellent future.

B.S. in E.E. or equivalent required.

Free life-accident and health insurance. Paid holidays and vacation.

Replies kept confidential. Contact F. J. Kennedy—

PERMOFLUX CORPORATION

4900 W. Grand Ave. Chicago 39, Illinois

A NEW Bendix Division!
A NEW Electronic Product!
NEW JOB OPPORTUNITIES

In our modern plant at York, Pennsylvania, this new division of Bendix Aviation Corporation is producing a new electronic product. This division has a big future; and this is your opportunity to get in on the ground floor, with excellent possibilities for rapid advancement. We need the following:

- **ELECTRONICS ENG.**
- **MECHANICAL ENG.**

Also We have many openings for men qualified by education or experience in all phases of electronics.

YOU BENEFIT

With the Bendix York Division, you will benefit from high wages, paid vacations and holidays and ideal living conditions in a beautiful suburban area.

Write, Wire or Phone,
 Department Y-1



AVIATION CORPORATION
YORK DIVISION

Phone: York 5521

York, Penna.

ENGINEERS
SYSTEMS
RADAR
SERVO
COMPUTER

You gain MORE with W. L. MAXSON. Top salaries . . . greater opportunities . . . more responsibilities. Advance with W. L. Maxson.

BACKGROUND: Practical and research experience in advanced Electronic Circuits and Systems Engineering DESIGN & ANALYSIS, related to: Instrumentation, Fire Control, Communications, Navigation, or Optical Fields. Ability in management and supervision desirable.

If your skills are now being fully utilized in a vital defense industry please do not apply.

Kindly send resume and salary requirements to



The W. L. MAXSON Corp.
 460 W. 34th St., NEW YORK 1, N.Y.

ENGINEERS

FOR ATOMIC WEAPONS INSTALLATION

Mechanical Engineers, Electronics and Electrical Engineers, Physicists, Aerodynamicists, and Mathematicians. A variety of positions in research and development open for men with Bachelors or advanced degrees with or without applicable experience.

These are permanent positions with Sandia Corporation, a subsidiary of the Western Electric Company, which operates the Laboratory under contract with the Atomic Energy Commission. The Laboratory offers excellent working conditions and liberal employee benefits, including paid vacations, sickness benefits, group life insurance and a contributory retirement plan.

LOCATE IN THE

Healthful Southwest

Albuquerque, center of a metropolitan area of 150,000, is located in the Rio Grande Valley, one mile above sea level. Albuquerque lies at the foot of the Sandia Mountains which rise to 11,000 feet. Cosmopolitan shopping centers, scenic beauty, historic interest, year 'round sports, and sunny, mild, dry climate make Albuquerque an ideal home. New residents experience little difficulty in obtaining adequate housing in the Albuquerque area.

THIS IS NOT A
 CIVIL SERVICE APPOINTMENT

Make Application to the
 PROFESSIONAL EMPLOYMENT DIVISION

SANDIA

Corporation

SANDIA BASE
ALBUQUERQUE, N. M.

BLOCKED?

ARE YOU WORKING IN THE FIELD OF YOUR CHOICE?
 ARE YOU INCREASING YOUR PROFESSIONAL VALUE?
 ARE YOUR ENGINEERING TALENTS FULLY UTILIZED?

The scope of electronic research and development at Cornell Aeronautical Laboratory allows qualified applicants a wide choice of opportunities. Alert administration and colleagues insure maximum professional growth and utilization.

CORNELL AERONAUTICAL LABORATORY, INC.
 B U F F A L O N E W Y O R K

UNUSUAL OPPORTUNITIES IN COLOR TELEVISION

Expansion of activity in Color Picture Tube Development has created requirements for research, production, and engineering personnel having a background in one or more of the following fields:

- Production Supervision— ALL PHASES
- Material Control
- Screen Application SILK SCREENING & CONVENTIONAL SETTLING
- Chemistry
- Gun Design and Mounting
- Tube Finishing
- Metallurgy
- Electronics
- Glass and Glass-To-Metal Sealing LARGE & SMALL
- Equipment Design

REPLIES HELD CONFIDENTIAL—SEND REPLIES TO:

**CHROMATIC TELEVISION LABORATORIES
 INC.**

WEST COAST DEVELOPMENT LABORATORY
 703 - 37th AVE. OAKLAND 1, CALIFORNIA

SALES ENGINEER

- ELECTRONIC COUNTERS
- AUTOMATIC CLERICAL SYSTEM
- DATA HANDLING EQUIPMENT
- DIGITAL COMPUTERS
- PRECISION TIMING INSTRUMENTS
- AUTOMATIC MACHINE CONTROL
- FLYING TYPEWRITER

Excellent opportunity for a man with electronic background, mechanical aptitude, and IMAGINATION.

Well-established and expanding company.

Please send resume of education and experience to Sales Manager.

**POTTER
 INSTRUMENT COMPANY**

115 Cutter Mill Road,
 Great Neck, N. Y.

MICROWAVE ENGINEER

1-10 cm. Antenna Design

AND

COMPUTER ENGINEER

Circuits and Systems

Unusual problems on both commercial and defense equipment. Need originality, solid theoretical background and five or more years of design experience.

Excellent opportunity for full development of the professional engineer. An unusual laboratory location in a rapidly growing, well established firm encouraging a broad contribution and giving wide responsibilities.

**VICTOR
 Adding Machine Co.**

3900 N. Rockwell Chicago 18

RCA VICTOR COMPANY, LTD.

(Canadian Affiliate of
RADIO CORP. OF AMERICA)

has vacancies in its expanding research
and engineering staff for:

**ELECTRONICS ENGINEERS
MECHANICAL ENGINEERS
PHYSICISTS**

in such fields as:

**MILITARY RADIO AND RADAR
MICROWAVE COMMUNICATIONS
ANTENNA DESIGN
TELEVISION
TV AND RADIO COMPONENTS**

If you are interested in the career opportunities of Canada's expanding economy, coupled with the advantages of associating with a leading member of a growing industry, you should investigate.

Write or apply

RCA VICTOR COMPANY, LTD.
1001 Lenoir Street,
MONTREAL 30, QUE., CAN.

ENGINEERS PHYSICISTS TAKE INVENTORY OF YOUR FUTURE WHAT MAKES A GOOD JOB?

Check off the items in the following list that you look for in a good job.

- 1—Professional Recognition
- 2—Interesting work
- 3—Equitable salary
- 4—Recognition of Ability
- 5—Security
- 6—Good future prospects
- 7—Reward for ideas
- 8—Good working conditions
- 9—Liberal benefit program
- 10—Family protection
- 11—Paid vacations and holidays

If you look for all of the above items and more, in a good job, it will be to your advantage to investigate the opportunities in Electronic Circuit Design and specialized vacuum tube research and development at

NATIONAL UNION RADIO CORP.
ELECTRONIC RESEARCH DIVISION
P. O. Box 352 Orange, New Jersey

ENGINEERS

OPPORTUNITIES

WITH

SYLVANIA

**Where Product Development
Is The Key To Continuing Growth**

Product development has always played a major role in Sylvania's operations and is largely responsible for the company's growth to 40 plants throughout the nation. Similarly, Sylvania's Electronics Division is continuing its expansion program to accommodate increased development engineering and manufacturing activities.

To engineers this means increasing opportunity with this 51 year old leader in the important field of electronics. At the Electronics plants in Woburn, Newton and Ipswich, Massachusetts you will enjoy the unique advantages of small plant operations in suburban areas minutes from the cultural and social activities of Boston. And — with Sylvania's assistance, you may continue your graduate studies at near-by world-famous universities.

Positions available for engineers with the following backgrounds:

MICROWAVE — with graduate work or experience in microwave theory. Positions will involve applications, measurements, or design of electronic test equipment for semi-conductor devices.

MECHANICAL — with experience in the following fields: 1. Design of small parts, tools, and jigs and fixtures. 2. Design of automatic production equipment.

SOLID STATE PHYSICISTS — Ph.D. or equivalent in experience in physics with a specialty in solid states work preferred. Will study electrical and optical behavior of semi-conducting materials.

METALLURGISTS — advanced degree or experience required. Will work on metallurgical preparations of semi-conducting devices.

ELECTRONIC — with graduate work or experience in product or circuit design and development.

Send complete resume to:

Mr. Robert L. Koller

SYLVANIA ELECTRIC

Electronics Division
WOBURN, MASS.

CAREER OPPORTUNITIES

ENGINEERS and PHYSICISTS

Desiring the challenge of interesting, diversified, important projects —
 Wishing to work with congenial associates and modern equipment and facilities —
 Seeking permanence of affiliation with a leading company and steady advancement —
 Will find these in a career here at **GENERAL MOTORS**.

Positions now are open in **ADVANCED DEVELOPMENT** and **PRODUCT DESIGN**,
INDUSTRIAL ENGINEERING, **TEST** and **TEST EQUIPMENT DEVELOPMENT**.

- COMMERCIAL AUTOMOBILE RADIO
- MILITARY RADIO, RADAR AND ELECTRONIC EQUIPMENT
- ELECTRONIC COMPONENTS
- TRANSISTORS AND TRANSISTOR AND VACUUM TUBE APPLICATIONS
- INTRICATE MECHANISMS such as tuners, telemetering, mechanical linkage, controls, etc.
- ACOUSTICS—loud speakers, etc.

Inquiries invited from recent and prospective graduates as well as experienced men with bachelors or advanced degrees in physics, electrical or mechanical engineering, chemistry, metallurgy.

Salary increases based on merit and initiative.
 Vacations with pay, complete insurance and retirement programs.
 Location is in a low living cost center.
 Relocation expenses paid for those hired.

All inquiries held in confidence and answered—WRITE or APPLY to

DELCO RADIO DIVISION
GENERAL MOTORS CORPORATION
 Kokomo, Indiana

DEPARTMENT HEAD

MISSILE ELECTRONICS

Prominent well-established aircraft and missile manufacturer offers an outstanding opportunity to a person qualified to head an expanding electronics organization. Salary commensurate with responsibility. Must have at least ten years experience in airborne electronics, five of which should be in missile or radar design and development. Advanced degree preferred. Position reports to chief engineer. Send detailed resume of background. Recent photograph optional.

P-6690, Electronics
 520 N. Michigan Ave., Chicago 11, Ill.

ELECTRONIC ENGINEERS



Wide range of experience including design of wide band receivers, radar display systems, analogue computers, servo systems & CR oscillographs . . . thorough knowledge of RF circuits, wave shaping, pulse forming, triggers & gates (microwave techniques unnecessary)

A FEW KEY POSITIONS . . .

Opening of our own manufacturing facilities creates permanent positions in research and development of vital, long-range products.

CONSIDER THESE ADVANTAGES . . .

- . . . Gracious country living, free from big-city pressures, provides a relaxing atmosphere in which you can do your best work . . . yet within easy reach of the cultural advantages of New York City.
- . . . Association with an established yet growing organization with few competitors in the field, where your merit and ability are given full consideration.
- . . . Unusual company-paid benefits . . . 40-hour week with considerable premium overtime . . . moving expenses paid.

TAKE ADVANTAGE OF THIS OPPORTUNITY NOW!

Address all inquiries to J. H. McCann

SPERRY PRODUCTS INC.

DANBURY
 CONNECTICUT

WILCOX ELECTRIC COMPANY, INC.

of
 KANSAS CITY, MISSOURI
 requires

ENGINEERS!

- with Experience in
- HF and VHF systems
 - Aeronautical Equipment
 - Application of Advanced Circuit Technique
 - Ability to combine associated engineering skills in electronic systems
- also needed

PROJECT ENGINEERS (2)

who can accept responsibility for successful completion of a system design
 These positions are available in a company which supplies equipment to the major airways of the world.

Write stating Education & Professional history to:
 A. E. HARRISON, Director of Engineering

WILCOX
ELECTRIC COMPANY, INC.
 1400 Chestnut Street
 Kansas City 27, Missouri

The New
 Scientific Research Laboratory
 of the Ford Motor Company

has openings for

ELECTRONIC ENGINEERS ELECTRICAL ENGINEERS PHYSICISTS

to research, design and develop electronic controls, instrumentation, and devices on a permanent, non-military program.

Positions available at various levels of engineering achievement.

FORD MOTOR COMPANY
Engineering Personnel
 Oakwood Boulevard
 West Dearborn, Michigan

ELECTRONIC ENGINEERS

Mechanical Designers for Research and Engineering

To work in the design and development of new electronic equipment. Excellent working and living conditions, good salaries and exceptional employee benefits. Write, giving full details including education and experience. Personal interviews will be arranged.

THE NATIONAL CASH REGISTER COMPANY
 Main & K Sts., Dayton 9, Ohio

ENGINEERS

interested in

COLOR TELEVISION!

Sylvania is leading the field in its development of an all-electronic compatible color television receiver. Your imagination and engineering talent can be used in furthering this development. Here is your chance to get real professional recognition.

Sylvania, a sound, well established firm, is still expanding, still reaching out for new ideas. If you are interested in challenging assignments and definite opportunity for personal growth.

Investigate NOW!

All replies will be held in strict confidence. Send your personal resume' to

JOHN WELD
Supervisor of Employment
Department B

Sylvania Electric Products, Inc.

Radio & Television Division
254 Rano Street

Buffalo 7, New York

Engineers

Research & Development
Electronic Organs

Well rated company also has government prime contracts.
Reasonable rental housing available.
Write giving full details—education and experience.

CENTRAL COMMERCIAL INDUSTRIES
1215 W. Washington Blvd.
Chicago 7, Ill.

STANDARDS ENGINEER

Massachusetts Institute of Technology's Digital Computer Laboratory has a staff position open for an electrical engineer with 2 to 5 years experience in standards engineering. Work involves study, testing and specification of electronic components for use in high-speed digital computing equipment. Salary commensurate with candidate's experience and training. For further information write:
DIGITAL COMPUTER LABORATORY, M.I.T.
211 Mass. Avenue, Cambridge 39, Mass.

QUARTZ CRYSTALS ENGINEERS

World's largest producer of crystals needs additional projects engineers. Applicants should have a working knowledge of crystal manufacturing. Send complete resume—age, education, experience, salary expected.

Midland Manufacturing Company
3155 Fiberglas Road, Kansas City 15, Kansas

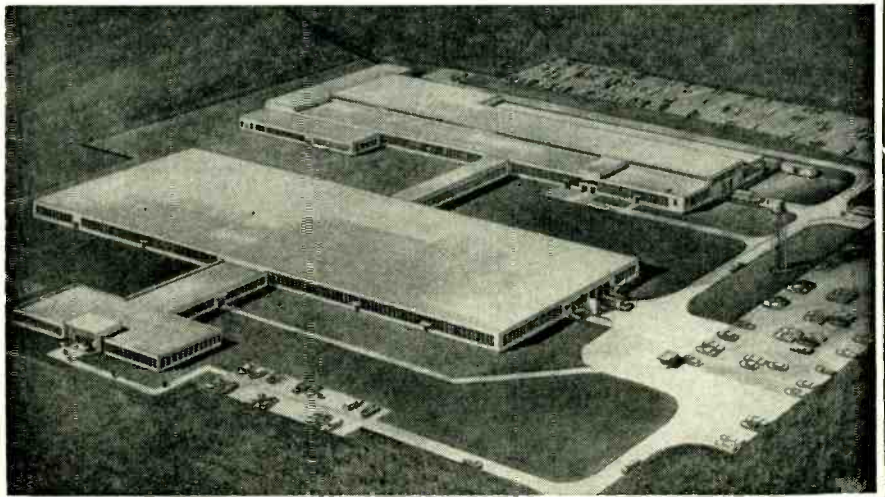

● ELECTRONIC SYSTEMS ENGINEERS

Experienced in:

Development and Design of Electronic Systems including experience in

SERVO DRIVES
RADAR MICRO WAVE TECHNIQUES
PRECISION TIME MEASUREMENTS
COMPUTERS
GYROS
SYNCHROS
UHF CIRCUITRY

● MECHANICAL ENGINEERS

Experienced in:

Design and Development of Mechanical Systems including experience in

MACHINE DESIGN
STRESS ANALYSIS
MECHANISMS
CAM DESIGN
GEAR AND GEAR TRAINS

Daystrom offers unparalleled opportunities for rapid advancement, a post defense future, ideal working and living conditions in one of the world's most modern plants, located in the heart of the winter and summer resort area of Northeastern Pennsylvania—in the Scranton-Wilkes-Barre area.

Write or Phone—**INDUSTRIAL RELATIONS DEPARTMENT**

DAYSTROM

Instrument Division

OF DAYSTROM,
Incorporated
ARCHBALD, PA.
Phone JERMYN 1100

AFFILIATE COMPANIES:

*American Type Founders—Daystrom Electric Corp.
Daystrom Furniture Division*

PULSE TRANSFORMERS

Table listing Utah Pulse Transformers with specifications like KV, PPS, and prices.

COAXIAL CONNECTORS



Table listing various coaxial connector models and their prices.

FULL LINE OF JAN APPROVED COAXIAL CONNECTORS

IN STOCK

UHF—N—PULSE—BN—BNC

Table listing coaxial connector models (e.g., UG-7/AP, UG-12/U) and their prices.

QUOTATIONS UPON REQUEST ON ANY CONNECTORS NOT LISTED HERE

Table listing connector models (e.g., M-358, M-359A) and their prices.

COAXIAL CABLE

Table listing coaxial cable models (e.g., RG-5/U, RG-6/U) and their prices per foot.

ADD 25% TO PRICES SHOWN FOR QUANTITIES UNDER 500 FT.

ANTENNAS

Table listing antenna models (e.g., AT-4/ARN-1, AT-38/ARN-PT) and their prices.

OIL FILLED CONDENSERS

Table listing oil-filled condenser models (e.g., MFD 2 400, MFD 5-5 400) and their prices.

FILAMENT TRANSFORMERS

Table listing filament transformer models (e.g., MFR 5V, UTC 5V) and their prices.

FILAMENT TRANSFORMERS INPUT—115 V., 50/60 CYCLES

Table listing filament transformer models (e.g., GE 5V, UTC 5V) and their prices.

INPUT—208/230 V., 50/60 CYCLES

Table listing filament transformer models (e.g., GE 2.5V, GE 5V) and their prices.

OILMITES

Table listing Oilmites models (e.g., MFD .02 600, .05 600) and their prices.

TEST EQUIPMENT

Table listing test equipment models (e.g., Gen. Radio 475B, Gen. Radio 69A) and their prices.

2 φ LOW INERTIA SERVO MOTORS

Table listing servo motor models (e.g., Dichi FPE-25-11, KOLLSMAN-45) and their prices.

RELAYS

Table listing relay models (e.g., Sigma type 4AH, Stevens Arnold type 171) and their prices.

TYPE "J" POTENTIOMETERS

Table listing potentiometer models (e.g., Resis. 60 9/16", 100 5/8") and their prices.

DUAL "J" POTS.—\$2.95 ea.

Table listing dual potentiometer models and their prices.

TRIPLE "JJJ" POTS.—\$3.95 ea.

Table listing triple potentiometer models and their prices.

SOUND POWERED TELEPHONES

Table listing telephone models (e.g., U. S. NAVY TYPE M, E. GL832BA) and their prices.

SPARE PARTS FOR ARMY AND NAVY RADIO, RADAR & SONAR EQUIPMENT

Table listing spare part models (e.g., AN/APS-2, AN/APN-4) and their prices.

QUOTATIONS UPON REQUEST

CABLE ADDRESS - "ELECTRONIC PHILADELPHIA"

ELECTRONIC RESEARCH LABORATORIES

715-19 ARCH ST. PHILA. 6, PA.

Telephones - MARKET 7-6771-2-3

!!! NEW LOW PRICES !!! TUBE SPECIALS

GUARANTEED
BRAND
NEW

STANDARD
BRANDS
ONLY

Receiving Tubes	6AH6	1.29	6SO7	.65	14E6	.99	1B27	14.95	4AP10	4.40	WE-101F	3.62	HY615	.49	886	2.60	
	6AJ5	1.84	6SR7GT	.65	14E7	1.09	1B29	2.75	4B22	2.75	WE-102F	2.85	KU-623	39.50	902P1	9.95	
O0A	\$1.50	6AK5	1.85	6SS7	.63	14F7	.89	1B32	3.75	EL5B	8.95	FG-104	5.75	KU-628	22.50	905	3.50
O1A	.67	WE-6AK5	1.85	6ST7	.99	14H7	.89	1B35	11.00	4B24	5.75	5561	24.60	KU-634	39.50	918	1.65
O2A	.59	6AK5W	2.95	6T7	1.05	14J7	.89	1B36	12.50	4B25	5.75	FG-105	19.50	WL-652/		919	1.95
O3A	.63	6AK6	.99	6T7G	1.09	14N7	.89	1B38	32.50	EL-6CFT	8.95	WE-113A	1.32	5551	62.50	927	1.35
1A3	.71	6AL5	.59	6T8	.98	14R7	.89	1B40	4.95	6C37	27.00	HY-114B	.75	WL-654/		927	1.85
1A5GT	.72	6AL5W	2.65	6U5	.98	14S7	.89	1B41	47.50	4E27	21.50	WE-117A	.95	659	82.00	931A	5.00
1A6	.72	6A05	.72	6U7G	.65	14V7	.89	1B42	9.80	4J36	150.00	F-123A	7.75	WL-670A	8.70	954	.39
1A7GT	.79	6A06	.79	6V6	1.49	14X7	.89	1B54	32.50	4J38	120.00	WE-124A	3.80	WL-672	22.00	955	.55
1B3GT	.99	6AR5	.79	6V6G	.89	19	.89	1H20	.88	4J52	275.00	F-127A	22.50	WL-681/		956	.49
1B4	.79	6AS5	.99	6V6GT	.67	19T8	.99	1P21	35.00	5AP1	5.95	VT-127A	3.60	5550	39.50	957	.49
1G5C	.74	6AS6	2.25	6W4GT	.64	22	1.16	1P23	1.22	5AP4	4.75	AB-150	12.50	700A	24.50	958A	.69
1C5GT	.85	6AS7G	4.25	6W6GT	.88	24A	.89	1P24	1.27	EL-C5B	5.95	FG-166	48.50	700B	24.50	959	2.25
1C6	.69	6AT6	.63	6X4	.59	25A6	1.16	1S21	9.50	5BP1	5.50	FG-172	29.50	700C	24.50	991	.45
1C7G	.69	6AUSGT	1.21	6X5GT	.59	25L6GT	.69	1Z2	3.75	5BP4	5.50	FG-178	14.50	700D	24.50	1003	.90
1D5GP	.69	6AU6	.65	6Y6G	.89	25Z5	.79	2A4G	1.22	5C22	47.75	FG-190	12.15	701A	6.95	CK-1005	.69
1D7G	.69	6AV6	.55	6Z55G	.89	26	.79	2AP1	8.95	5CP1	4.50	HF-200	16.50	702A	24.50	1006	3.30
1D8GT	.71	6B4G	1.25	7A4	.76	27	.79	2AP5	8.95	5CP7	9.80	9L200B	65.00	702B	4.25	E-1148	.35
1E5GP	.69	6B5	1.20	7A5	.79	28D7	1.95	2B4	2.10	5D21	19.50	203A	7.40	703A	5.95	1201	.79
1F4	.69	6B7	.95	7A6	.75	30	.79	2B22	2.20	5FP7	1.95	203B	6.33	704A	.95	1203	.45
1F5G	.69	6B8	.75	7A7	.76	30 Spec.	.45	2C21	.65	5HP1	5.50	204A	47.50	705A	2.25	1291	.57
1F6	.71	6B8G	.75	7A8	.78	31	.59	2C22	.45	5HP4	5.75	CE-206	3.15	706AY	45.00	1294	.69
1G4GT	.69	6BA6	.65	7AD7	1.44	32	.69	2C26	.39	5J29	18.50	211	26.50	706BY	45.00	1602	2.25
1G5C	.69	6BA7	1.20	7AH7	1.08	32L7GT	1.08	2C26A	4.95	5J2E	26.50	WE-211D	12.50	706CY	45.00	1613	.89
1G6GT	.69	6BA8	.63	7B7	.69	33	.69	2C41	4.95	5J2F	26.50	WE-211E	12.50	706GY	45.00	1614	2.00
1H4C	.69	6BC7	1.10	7B5	.79	34	.69	2C44	.49	5JPA	26.50	212E	42.50	707B	7.95	1616	1.07
1H5GT	.89	6BDSGT	1.60	7B6	.79	35/51	.59	2C39	22.00	5LP1	21.75	WE-215A	.24	707A	14.90	1619	.39
1H6G	.75	6BD6	.65	7B7	.79	35A5	.72	2C4D	12.00	5LP5	19.75	217C	8.95	708A	4.75	1620	6.25
1H6GT	.79	6BE6	.85	7B8	.78	35H8	.72	2C42	23.75	5MP1	10.50	221A	1.95	709A	3.85	1622	2.25
1J5G	.74	6BE5	1.10	7C4	.45	35L6GT	.69	2C43	17.75	6B	8.85	5C27	4.60	710A	1.70	1624	1.90
1J6G	.69	6B86	1.59	7F3	.79	35V4	.69	2C44	1.20	C6A	6.75	5C27	4.60	713A	1.45	1625	.39
1L4	.69	6BG6G	1.89	7C7	.79	35Y4	.72	2C46	21.50	6AN5	3.30	WE-231D	2.25	714AY	10.75	1626	.30
1L4A	.87	6BH6	.95	7E5	.79	35Z4GT	.69	2C51	5.75	6AR6	3.25	232CCH	240.00	715A	6.25	1629	.30
1L4B	.99	6BJ6	.95	7E6	.58	35Z5GT	.55	2D21	1.55	6C21	27.50	RX-233A	4.95	715B	8.25	1632	2.25
1L4C	1.01	6BK7	1.60	7E7	.83	36	.64	2E22	1.85	6C24	52.50	555	94.50	715C	19.50	16331	1.38
1L5	.81	6BL7GT	1.45	7F7	.99	37	.69	2E24	4.10	C6J	9.95	WE-244A	5.20	717A	1.47	1632	.75
1L6	.69	6BN6	1.59	7F8	1.35	38	.78	2E26	2.85	6J4	6.85	WE-245A	2.35	718AY	45.00	1636	3.10
1L5D	.93	6BO6GT	1.26	7G7	.79	39/44	.59	2J21	.71	7-7-11	1.19	WE-249B	3.50	718BY	45.00	1638	.70
1LE3	.93	6C4	.55	7H7	.79	41	.79	2J21A	8.95	7BP1	8.65	WE-249C	3.50	720DY	95.00	1642	.65
1LH4	.82	6C5	.70	7J7	1.10	42	.79	2J26	24.75	7BP7	6.50	730TH	22.50	721A	2.50	1649	.70
1LH5	.74	6CB6	.79	7K7	1.10	43	.79	2J26	24.75	7BP7	6.50	250T	22.50	722A	2.25	1645	1.95
1NSGT	.83	6C6	.73	7L7	.97	45	.79	2K31	27.00	7BP14	14.95	WE-252A	5.65	723A	9.95	1655	1.90
1N6	.75	6C6G	.86	7M7	.79	46	.79	2J32	36.50	7CP1	14.95	WE-254A	5.90	723A/B	18.50	1665	1.80
1PSGT	.69	6CD6G	2.21	7O7	.79	47	.99	2J33	39.50	9GP7	11.75	WE-257A	3.77	724A	3.22	1904	14.80
1Q5GT	.99	6D6	.88	7R7	.94	47	.99	2J34	27.00	9LP7	4.50	FG-271/		724B	3.22	1909	1.70
1R4	.69	6DG8	.83	7S7	1.11	50	1.09	2J34	27.00	10BP4	17.95	5551	62.50	725A	8.25	2050	1.70
1R5	.79	6E5	1.10	7V7	1.11	50A5	.89	2J37	13.70	10BP4	22.50	WE-274A	5.50	726A	14.50	2051	1.10
1S4	.69	6F5GT	.83	7W7	1.11	50B5	.69	2E28	36.50	10T1	8.8	WE-274A	2.85	726B	45.00	5611	115.00
1S5	.69	6F6	.99	7Y4	.73	50C5	.69	2J39	36.50	10T1	8.8	WE-275A	6.95	726C	65.00	5651	2.75
1T4	.71	6FG6	.87	7Z4	.79	50L6GT	.63	2J40	34.50	10Y	.39	WE-283A	4.25	730A	25.00	5654	2.90
1T5GT	.71	6F7	1.05	10	.39	50Y6GT	.92	2J48	49.50	12DP7	14.50	WE-285A	5.57	731A	2.45	5691	8.55
1U4	.73	6FG8	.91	12A	.65	53	.95	2J49	65.00	12GP7	18.50	WE-286A	7.90	WL-787	9.40	5692	8.55
1U5	.77	6GG6G	.99	12A6	.64	55	.92	2J50	39.50	12HP7	14.75	WE-294A	5.75	788Y	8.00	5693	6.95
1V	.65	6H6	.66	12A6GT	.64	55B	.64	2E29	45.25	15E	1.95	304TH	8.75	800	1.75	UX-6653	.65
1X2	.93	6H6GT	.63	12A8GT	.77	57	.69	2J61	165.00	15R	.65	304TL	8.75	801A	4.75	1933	.45
2A3	1.28	6J5	.64	12AH7GT	1.32	58	.69	2K23	37.50	FG-17/	4.95	307A	4.25	803	4.95	8011	.87
2A5	.79	6J5G	.55	12AL5	.79	59	.59	2K25	28.50	5557	4.95	WE-309A	6.45	805	24.50	8012	2.60
2A7	.79	6J5GT	.95	12AT6	.55	70L7GT	1.29	2K26	105.00	RFL-21	1.95	WE-310A	6.25	806	24.50	8013	2.75
2B7	.79	6J6	.95	12AT7	.79	71	.79	2K27	29.50	24C	1.85	WE-313C	4.15	807	1.65	8013A	4.90
2E5	.99	6K6	.86	12A7	.71	75	.85	2K29	27.50	HK-24	4.95	316A	.89	808	2.65	8016	1.05
2X2	.50	6J7GT	.99	12AU6	.86	76	.69	2K33	265.00	RK-25	3.82	327A	4.25	809	2.95	8020	1.25
2X2A	1.85	6J8C	.99	12AV6	.54	77	.69	2K33A	280.00	FG32/	6.75	WE-331A	9.75	810	10.95	8025	6.95
3A4	.65	6K5GT	.99	12AV7	.99	78	.79	2K39	135.00	5558	17.50	WE-345A	185.00	811	3.60	9001	1.50
3A5	.95	6K6GT	.65	12AV8	1.20	79	.89	2K45	129.50	FG33	17.50	WE-350A	6.95	813	10.50	9002	.95
3BGT	1.50	6K7	.79	12AW6	.80	80	.59	2K55	135.00	RK34	4.9	350B	4.95	815	2.95	9003	1.50
3B7	.53	6K7G	.86	12B7	.99	81	1.41	3AP1	8.95	35T	4.95	WE-356B	5.45	816	1.45	9004	.45
3C6	1.15	6L5C	1.06	12BA6	.69	82	1.19	3AP4	10.25	35T ION gauge.	5.95	361A	4.75	826	1.25	9006	.35
3D6	.57																



Micro-Wave Lavoie Freq. Meter 375 to 725 MCS

Model TS-127/U is a compact, self-contained, battery powered, precision (± 1 Mc) frequency meter which provides quick, accurate readings. Requires a standard 1.5V "A" and 45V "B" battery. Has 0.5 MIN. time switch. Contains sturdily constructed HI-"Q" resonator with average "Q" of 3000 working directly into detector tube. Uses 957, 1S6 and 3-4 Tubes. Complete, new with inst. book, probe and spare kit of tubes. Less batteries.

Full data on request \$79.50



HIGH VOLTAGE OIL CAPACITORS

.001 MFD 50,000V DC	\$37.50
.01 MFD 5,000V DC	\$2.95
.02 MFD 8,000V DC	\$9.50
.025 MFD 50,400V DC	\$45.00
.025, .025 MFD 50,000V DC	\$59.50
1 MFD 500V DC	\$.95
1 MFD 3,000V DC	\$2.95
.135 MFD 7,500V DC	\$6.95
15 MFD 12,000V DC	\$7.50
2 MFD 50,000V DC	\$67.50
.25 MFD 15,000V DC	\$19.50
.25 MFD 20,000V DC	\$26.50
.25 MFD 50,000V DC	\$72.50
1 MFD 7,500V DC	\$12.50
1 MFD 15,000V DC	\$49.95
2 MFD 6,000V DC	\$14.50

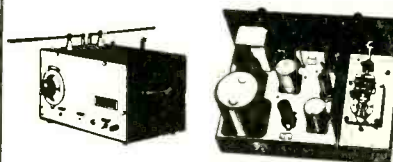

RADIO MODULATOR

Type RC-423-B, or treeter, is a miniature keying unit, modulator and transmitter combined. A dipole mounted atop the treeter case radiates a signal pulse at 205 megacycles modulated by pulses occurring at 4,098 CPS. Uses 2-6J7, 1-6F6, 1-955, 1-5W4 tubes. Operates from 115V, 60 cy. source. Brand new including tubes and instruction book...\$29.50

MOTOR GENERATORS

2.5 KVA Diehl Elec. Co. 120DC to 120AC, 60 cy., 1 Ph., Complete with Magnetic Controller, 2 Field Rheos and full set spare parts including spare armatures for generator and motor. New. \$295.00
2 KVA O'Keefe and Merritt, 115DC to 120AC, 50 cy., 1 Ph. Export Crated. New. \$195.00
MOTOR GENERATOR, TYPE CGU-2
Unit of U. S. Navy TCK-7 Transmitter
Motor: 2 H.P., 230 V.D.C., 10 amps.
Generator: 1800V, D.C., 0.4 A, 500V, D.C., 0.35A, 115 V.D.C., 1.5A, 12 V. D.C., 2A, 3480 R.P.M. Self excited. Brand new including spare armature. \$365.00

INVERTERS

Onan M-G-.215H. Navy type PU/13. Input 115/230, 60 cy., 1 Ph. Output: 115, 480 cy., 1 Ph., 1.2KW and 26V DC at 4 amps. New. \$295.00
Leland Elec. Co. PE206A. Input: 28DC at 38 Amps. Output: 80V, 800 cy., 1 Ph., 480VA. New. \$22.50
G.E. J8169172. Input: 28DC. Output: 115, 400 cy., 1 Ph., 1.5KVA. New. \$32.50
G.E. 5AS1345511A. Model 218J. Input: 28DC. Output: 115, 400 cy., 1 Ph., 1.5KVA. Regulated. New. \$39.50
Heizer-Cabot M.G. 164. Input: 440, 3 Ph., 60 cy. Output: 20V, 146 cy., 3 Ph., 0.140KVA. New. \$7.50
Elec. 74DC to 110AC, 60 cy., 1 Ph. at 2.4 Amps. New. \$39.50

DYNAMOTORS

Navy type CAJ0-211444. Input: 105 to 130DC. Output: either 26DC at 20 amps or 13DC at 40 amps. Radio filtered and complete with line switch. New. \$89.50
Type PE94CM. For SCR-522. Brand new in overseas cases \$19.50

AMPLIDYNES

G.E. 5AM211J7. Input: 27VDC. Output: 60VDC. 150 Watts, 4600 RPM. Type MG-27-B. New \$34.50
Edison 5AM31N18A. Input: 27VDC, 44 Amps. 8300R.P.M. Output: 60VDC at 8.8 Amps. \$530 Watts. New. \$22.50

SMALL D.C. MOTORS

G.E. 5BA50LJ2A. Armature 27VDC at 8.3 Amps. Field 60VDC at 2.3A RPM 4000. H.P. 0.5. New. \$27.50
Oster E-7-5. 27.5DC. 1/20HP, 3600RPM. Shunt Wound. New. \$9.50
Dunmore Co. type ELB6. 24VDC. 40-1 gear ratio. For type B-4 Intervalometer. New. \$8.50
G.E. Model 5BBY47AB12 250VDC Perm. Mag. 1/4 H.P., 1725 RPM. \$23.50

BLOWERS

Westinghouse. Type FL. 115V, 400 cy., 6.700 RPM. Airflow 17C.F.M. New. \$9.50
E.A.D. Type J50-CW-80 cycle-NEW. \$15.50

SYNCHROS

Ford Inst. Co. Synchro Differential Generator. Mod. 3 Type 5SDG. 90/90V, 400 cy., Ord. Dr. 173020. New. \$22.50
Armor. Synchro Differential Generator. Type 6DG. New. \$60.00
Hohart Mfg. Co. Synchro Differential Synchro Type XIX 115V. 60 cy. New. \$9.50

RELAYS

Struthers-Dunn 1BXX129, 110 A.C. \$2.60
Advance type 455C, SPDT, 115 A.C. \$1.95
Leach type 1154A, SPDT, 115 A.C. \$2.35
Leach type 1054, BSN 20-28V D.C. \$2.35
Clare Plug-in base No. 30FMX, 115 A.C. \$2.45
G.E. Plug-in base Sensitive K27J853. \$3.25
Western Electric D-163781, Plug-in. \$4.95
Guardian Time Delay type B-9-SPDT. \$2.95

SWEEP GENERATOR CAPACITOR

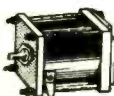

High speed ball bearings. Split stator silver plated coaxial type 5/16 mmfd. Brand new
Price \$2.25

RADAR EQUIPMENT

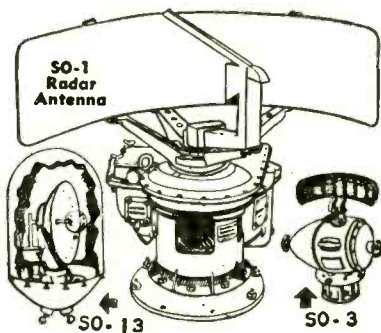

RADAR ANTENNAS

Type SO-1 (10CM) assembly with reflector, wave-guide nozzle, drive motor. New. \$279.50
Type SO-3 (3 CM.) Surface Search type with reflector, drive motor, etc., but less plumbing. New in original cases. \$189.50
Type SO-13. (10CM.) Assembly with 24" dish, dipole, drive motor, gearing. New. \$149.50
Also in stock - spare reflectors, nozzles, probes, right angle bends for SO-1 antennas.

MODEL AN/APA-10 PANORAMIC ADAPTER

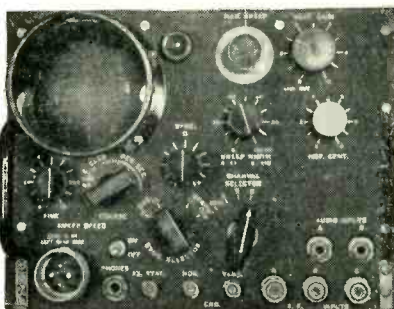

Provides 4 Types of Presentation:
(1) Panoramic (2) Aural
(3) Oscillographic (4) Oscilloscopic

Designed for use with receiving equipment AN/AIR-7, AN/AIR-5, AN/APA-4, SCR-587 or any receiver with I.F. of 455 kc, 5.2mc or 30mc. With 21 tubes including 37 scope tube. Converted for operation on 115 V. 60 cycle source.
Price \$245.00
Gov't Cost \$1800.00.
AN/APA-10 80 Page Tech Manual. \$2.75

TERMS: Rated Concerns Net 30, FOB Bronxville, New York. All Merchandise Guaranteed
Prices Subject to Change

400 CYCLE TRANSFORMERS

AUTO, 400 cy. G.E. Cat. No. 80G184.
KVA .9455-520P Volts 460/345/200/115.
New. \$4.50
FILAMENT-400/2000 CPS. Input-0/75/80/85/105/115/125V. Output-5V3A/5V3A/5V6A/6.3V 0.5A. No. 7249010-New. \$4.95
PLATE WECO KS 9560 800 cy. Pri: 115V. Sec: 1350-0-1350 at .057A (2700 V. Total). Elecstat shlded. Wt. 2.3 lbs. New. \$2.95
Plate. Thordarson #T46889. 1650 VA. Pri: 105-120V. 500 cy. 1 PH. Sec: 5600V. Center tapped. 1.5kV. insulation. Brand new. \$29.50
PLATE & FIL. WECO KS9555. 400 cy. Pri: 115V. Sec: #1: 830-830. Sec: #2: Three 6.3V windings. \$3.95
FILAMENT. 400/2400 cps. WECO KS9553. Pri: 115V. Sec: 8.2V, 1.25A/6.35V, 1.5A Elecstat shlded. Wt. 0.5 lbs. New. \$2.95
PLATE & FIL. 400/2600 cy. Pri: 0/80/115V. Sec: #1=1200VDC at 1.5MA. Sec. #2=400 VDC at 130MA. Fil. Secs: 6.4V4.3A/6.35V0.8A (Ins. 1500V)/5V2A/5V2A. \$4.95
RETARD. 400 cy. WECO KS9598. 4 Henry 100 MA \$1.75

PULSE TRANSFORMERS

PULSE WECO KS-9563 Supplies voltage peaks of 3500 from 807 tube. Tested at 2000 Pulses/sec and 5000 peak. Wdg. 1-2=18 ohms. Wdg. 1-3=72 ohms. L of Wdg. 1-3=0.82H at 100 cps. \$3.95
PULSE. WECO KS-161310. 50 KC to 4MC. 1 1/2" Dia. x 1 1/2" high. 120 to 2350 ohms. New. \$3.95
High Reactance Trans. G.E. type Y-3502A. -60 cy. Voltage 11200-135. Inductance ILV. Winding 135 Henries. Output: Peak Voltage 22.8KV. Cat. 8318065G1. New. \$39.50

HIGH POT TRANSFORMERS

High Voltage Trans. Westinghouse Pri: 115. 60 cy. Sec: 15,000 C.T., 60 MA. Good for III-Pot test set up. C. T. ungrounded. \$39.50

TEST EQUIPMENT

TS-127/U Lavoie Freq. Meter-375 to 725 MC. New, with instruction book. \$79.50
TS-47/APR Test Oscillator. Range on fundamentals 40 to 500 MC. Part of APR test set-up. New with instruction book. \$275.00
TS-487/U Peak to Peak V.T.V.M. New with instruction book. \$50.50
R111A/APR-5A Receiver. Range from 1000 to 6000 MC. with instruction book. \$575.00
APR-1 Receiver with TN-18 tuning unit 300 to 1000 MC. with instruction book. \$450.00
APR-1 Receiver with TN-17 tuning unit and instruction book. \$450.00
TU-58 tuning unit (110-370MC). \$65.00

HIGH QUALITY CRYSTAL UNITS

Western Electric-type CR-1A/AR in holders. 3/8" pin spacing. Ideal for net frequency operation. Available in quantities. 5910-6350-6370-6470-6510-6610-6670-6690-7270-7350-7380 - 7390 - 7480 - 7580-9720. All fundamentals in KC. Gano multipliers to higher frequencies. \$1.25 each

RAYTHEON VOLTAGE REGULATORS

Adj. input taps 95-130V. 60 cy. 1 Ph. Output: 115V. 60 Watts. 1/2 of 1% Reg. Wt. 20 lbs. 6 1/2" H x 8 3/4" L x 4 3/4" W. Overload protected. Sturdily constructed. Tropicalized.



PRICE-NEW \$16.75

ELECTRONICRAFT INC.

27 MILBURN ST. BRONXVILLE 8, N. Y.
PHONE: BRONXVILLE 2-0044

AMPLIFIERS

GE Servo type 2CV1C1 400 cycle
Constant Output Line RC-730C
Synchro Amplifiers for Radar
Intercommunication type BC-805

ANTENNAS

MR-162 Coast Guard 23 1/2 ft. whips
AS-33 APT-2, AT-38A/APT, AS-62/APS-13
AS-125/APR for APR-5A
TDY RADAR JAMMER HORNS
PARABOLOIDS, MAGNESIUM DISHES 17 1/2" dia.
SCR-623-A (part of RC-153-B Antenna)
CU 64/APT Antenna matching unit 50 ohm unbal.
to 100 bal.

POTENTIOMETERS

W. E. KS-15138 Linear Sawtooth
W. E. KS-8732 for SCR1517 Radar
W. E. KS-8801 Motor Driven

**LINEAR SAWTOOTH
POTENTIOMETER**



W. E. No. KS 15138

The d-c potentiometer consists of a closed type die-cast aluminum alloy frame consisting of a continuous resistance winding to which electric power is supplied through two fixed taps 180 degrees apart. Two rotating brushes (180 degrees apart and bearing on the resistance winding) and two take-off brushes are provided for the output voltage. Varying the position of the brushes varies the output voltage in accordance with a linear sawtooth wave. The potentiometer is excited with 24-volt direct current, is arranged for panel or bracket mounting, is approximately 3-11/16 inches in diameter, 3 inches deep, 4 1/2 inches long, and has an approximate weight of one pound. External connections are made through a standard AN type connector.

Brand New \$5.75

REPAIR PARTS FOR

BC-348 RECEIVERS (H, K, L, R, Only)

Also RC 224 Models F, K, Coils for ant., r.f. det., osc., I.F., c.w. osc., xtal filters, 4 gang cond., front panels, dial assemblies, vol. conts., etc. Write for complete list and free diagram.



AUTO TRANSFORMER

G.E. 400 cy. Cat. No. 80G184
K.V.A. .945S—.520P Volts 460/
345/230/115 New \$4.50

**G. E.
400 CYCLE
SERVO
AMPLIFIERS**

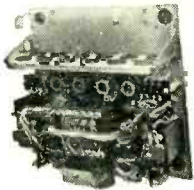

Type 2CV1C1

Brand New \$29.50
Metal Dust Cover Included

RADAR SETS

MODEL SQ. Portable radar set, 10CM. Operates on 90-130 volt, 60 cy., 1 Ph. "A", "B", and "PPI" presentation. Complete with tech manual and full set of operating spare parts.

MODEL SG-1. Consists of complete equipment including Radar Transmitter-Receiver CRP-43AAK-3, Range and Train Indicator CRP-55ABC-3, Control Amplifier CRP-50AAT-1, Motor Dynamo-Amplifier (Amplidyne) CG-21AAY and Antenna Assembly CRP-66ABJ-1.

MODEL ASG-1 Radar unit consisting of transmitter and converter assembly CPR-43ABC, Antenna Assembly CRP-ACZ, Mounting Base CPR-10ABE, etc.

Spare Parts available for Model SQ and SG-1 Radar.

PARABOLOIDS

17 1/2" diameter, spun magnesium dishes, 4 inches deep. Reinforced perimeter. Two sets of mounting brackets on rear. Opening at apex for waveguide dipole assembly 1 1/2 x 1 3/8".

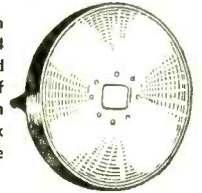

BRAND NEW PER PAIR \$12.50

SCR-522 EQUIPMENT

Complete BC-624C receivers and BC-625AM Transmitters including mounting racks, plugs, connectors, P.E. 94CM dynamotor. Brand new equipment with instruction manuals.

CRYSTAL DIODE

Sylvania 1N21B. Individually boxed and packed in leaded foil.



\$3.00

Westinghouse "Variac type" Controllers; 600 watts; 110/220 (designed as an adjustable speed controller but can be used for any application requiring a variable transformer. Brand new and an exceptional buy at \$12.00

MISC. RADAR EQUIPMENT

Modulator Units for SO-11 (CUZ-50AGD)

Pulse Timer units for SD-5

Transmitter-Receiver units SQ-13

Spare Parts for SG-1

Spare Parts for SQ

Marker Oscillator Crystals in holders 98.35KC

Bearing Control Units CRP-23AEK

Synchro Amplifiers—Bendix

90° Waveguide Bends 10CM Bronze

Signal Monitors CRP-60AAN

Repeater Amplifiers CBM-50AFO

Oscillator Tube Cavities for SO-1, 13 etc., RF303.

10CM Horns, 1 1/2" x 3" waveguide, standard contact, flange input, circularly polarized horn output

Duplex Tees ==Z3005-17

APS-10 Modulator

Auxiliary Rectifier CABM-20237 (SO-2 Radar)

SO-1 (66AGE) Antenna R.F. Nozzle Assemblies (RF502)

SO-1 (66AGE) Antenna Reflector Assemblies (RF503)

SO-1 (6AGE) Antenna Waveguide Resonance Chamber Assemblies (RF515)

SO-1 RF Coupling Waveguide to Transmitter (Z304)

SO-1 RF System and duplexing cavity (RF301 with V309)

**G. E. BATTERY CHARGER
Charges 54 cell battery
at from 1 to 10 ampere rate**

Input 115V., 60 cy. 1 Phase.

The model 6RC89F16 Copper Oxide battery charger consists of a transformer, a secondary reactor, a copper oxide rectifying element, a ventilating fan, control circuits and auxiliary equipment necessary for proper operations. Transformer tapped for various supply voltage. Eight secondary taps for adjusting changing rate. Built into metal cabinet. Metered.

Complete with spare fan and fuses. New in original packing cases. Shipping weight approx. 305 lbs.

Price \$255.00

**SOUND POWERED
CHEST SETS**



U. S. Instrument Co. No. A-260 Combination headset and chest microphone. Brand new, including 20 ft. of rubber covered cable. \$17.50 each

MISCELLANEOUS

- Cathode Ray Shields for 3" tube \$3.75
- 10 CM Waveguide 90° elbow \$20.00
- Adel Clamps assorted types—write for samples
- Shock Mounts Lord #20 \$.40
- Shock Mounts U. S. Rubber #5150C \$.30
- Commando Pole Jacks (Cook Elec. Co.) \$1.00
- Switchboard Lamp Receptacles & Jewels \$.40
- Fire Detector Wlicolator
- No. A-4242 Ord. No. B 257738 \$1.00
- Dial Drive Assembly for Bendix, MN-28-Y \$4.50
- Instruction Manual for SCR 193A, B, C, D, E \$2.00
- Solenoid Cannon 24 V. D.C.—New \$1.45
- Attenuators Tech-Lab 500/500 type 700 \$4.75
- Volume control Dual for BC-433G \$2.85
- Switch 600 V., 60A. Bendix CB19078 \$9.50
- Switch Arkless 9 sec. Rotary \$4.50
- Switch Arkless 16 sec. Rotary \$7.50
- Switch Panels SA-2/FRG \$12.50
- Switch Micro R-RL2T \$.65
- Switch Navy Rotary #647491 \$17.50
- Contact CRP-23AGO for SG-1 radar \$24.75
- Band-Switch assembly for AR-88 receiver \$9.50
- RT-7-AN/APN-1 Receivers
- BC-423B Modulators
- BC-1366M Jack Boxes—Large quantity

**MICRO-SWITCH
S.P.ST NORMALLY CLOSED**



BRAND NEW \$.85 EACH

TERMS: Rated Concerns Net 30, FOB Bronxville, New York. All Merchandise Guaranteed. Prices Subject to Change

**24V DC SOLENOID
2 LB. PULL—3/4" STROKE**



BRAND NEW \$1.45 Each

**ELECTRONICRAFT
INC.**

27 MILBURN ST. BRONXVILLE 8, N. Y.
PHONE: BRONXVILLE 2-0044

A LEADING SUPPLIER OF ELECTRONIC & AIRCRAFT EQUIPMENT

IMMEDIATE
DELIVERY -- FULLY
GUARANTEEDA. C.
SYNCHRONOUS
MOTORS

110 Vt. 60 Cycle

HAYDON TYPE 1600, 1/240 RPM
 HAYDON TYPE 1600, 1/60 RPM
 HAYDON TYPE 1600, 4/5 RPM
 HAYDON TYPE 1600, 1 RPM
 HAYDON TYPE 1600, 1 1/5 RPM
 TELECHRON TYPE B3, 2 RPM
 TELECHRON TYPE BC, 60 RPM
 HOLTZER CABOT, TYPE RBC 2505, 2 RPM,
 60 oz. 1 in. torque.

SERVO MOTORS

PIONEER TYPE CK1, 2 ϕ 400 CYCLE
 PIONEER TYPE 10047-2-A, 2 ϕ , 400 CYCLE,
 with 40:1 reduction gear.

D. C. MOTORS

BODINE NFHG-12, 27 VTS., governor con-
 trolled, constant speed 3600 RPM, 1/30
 H.P.
 DELCO TYP 5068750, 27 VTS., 160 RPM,
 built in brake.
 DUMORE, TYPE E1Y2PB, 24 VTS., 5 AMP.,
 .05 H.P., 200 RPM.
 GENERAL ELECTRIC, TYPE 5BA10AJ18D,
 27 VTS., 110 RPM, 1 oz. 1 ft. torque.
 GENERAL ELECTRIC, TYPE 5BA10AJ37C,
 27 VTS., 250 RPM, 8 oz., 1 in. torque.
 BARBER COLMAN ACTUATOR TYPE AYLC
 5091, 27 VTS., .7 amp., 1 RPM, 500 in.
 lbs. torque.
 WHITE ROGER ACTUATOR TYPE 6905, 12
 VT., 1.3 amp., 1 1/2 RPM, 75 in. lbs.
 torque.

AMPLIDYNE AND MOTOR

AMPLIDYNE, GEN. ELEC. 5AM31NJ18A In-
 put 27 vts., at 44 amp. output 60 vts. at
 8.8 amp., 530 watts.
 MOTOR, GEN. ELEC. 5BA50LJ22, armature
 60 vts. at 8.3 amp., field 27 vts. at 2.9
 amp. 1/2 H.P., 4000 RPM.

PIONEER AUTOSYNS
400 CYCLE

TYPE AY1, AY5, AY14G, AY14D, AY20,
 AY27D, AY38D, AY54D.
 PIONEER AUTOSYN POSITION.
 INDICATORS & TRANSMITTERS.
 TYPE 5907-17, single, Ind. dial graduated
 0 to 360°, 26 vts., 400 cycle.
 TYPE 6007-39, dual Ind., dial graduated
 0 to 360°, 26 vts., 400 cycle.
 TYPE 4550-2-A, Transmitter, 2:1 gear ratio
 26 vts., 400 cycle.

INVERTERS

WINCHARGER CORP. PU 16/AP, MG750,
 input 24 vts. 60 amps. outputs 115 vts.,
 400 cycle, 6.5 amp., 1 phase.
 HOLTZER CABOT, TYPE 149F, input 24 vts.
 at 36 amps., output 26 vts. at 250 V.A.
 and 115 vts. at 500 V.A., both 400 cycle,
 1 phase.
 PIONEER TYPE 12117, input 12 vts., output
 26 vts. at 6 V.A., 400 cycle.
 PIONEER TYPE 12117, input 24 vts., output
 26 vts. at 6 V.A., 400 cycle.
 WINCHARGER CORP., PU/7, MG2500 in-
 put 24 vts. at 160 amp., output 115 vts.
 at 21.6 amp., 400 cycle, 1 phase.
 GENERAL ELECTRIC, TYPE 5D21NJ3A, in-
 put 24 vts. at 35 amps., output 115 vts.
 at 485 V.A., 400 cycle, 1 phase.
 LELAND, PE 218, input 24 vts. at 90 amps.
 output 115 vts. at 1.5 K.V.A., 400 cycle,
 1 phase.
 LELAND, TYPE D.A. input 28 vts., at 12
 amp. output 115 vts. at 115 V.A., 400
 cycle, 3 phase.

ENGINE HOUR METER

JOHN W. HOBBS, MODEL MI-277 records
 time up to 1000 hours, and repeats,
 operates from 20 to 30 volts.

VOLTAGE REGULATOR

LELAND ELEC. CO. TYPE B, CARBON PILE.
 Input 21 to 30 volts D.C. regulated out-
 put 18.25 vts. at 5 amp.
 WESTERN ELEC. TYPE BC937B, input 110
 to 120 volts 400 cycle. Output variation
 0 to 7.2 ohms at 5 to 2.75 amps.
 WESTERN ELEC. TRANSTAT, input 115 vts.,
 400 cycle output adjustable from 92 to
 115 vts., rating .5 K.V.A.
 AMERICAN TRANS. CO., Transtat input
 115 vts., 400 cycle output 75 to 120 vts.
 or 0 to 45 volts, rating .72 K.V.A.

SYNCHROS

1 F SPECIAL REPEATER 115 vt. 400 cycle.
 2J1F1 GENERATOR, 115 vt. 400 cycle.
 2J1F3 GENERATOR, 115 vt. 400 cycle.
 2J1G1 CONTROL TRANSFORMER 57.5 vt.
 400 cycle.
 2J1H1 DIFFERENTIAL GEN. 57.5/57.5 vt.
 400 cycle.
 5G GENERATOR, 115 vt. 60 cycle.
 5DG DIFFERENTIAL GEN. 90/90 vts. 60
 cycle.
 5HCT CONTROL TRAN. 90/55 vts. 60 cycle.
 5CT CONTROL TRAN. 90/55 vts. 60 cycle.
 5SDG DIFFERENTIAL GEN. 90/90 vts. 400
 cycle.

ALL PRICES
 F. O. B.
 GREAT NECK
 N. Y.

TACHOMETER GENERATOR
& INDICATOR

GENERAL ELECTRIC, GEN. TYPE AN5531-1,
 Pad mounting 3 phase variable frequency
 output.
 GENERAL ELECTRIC, GEN. TYPE AN5531-2,
 Screw mounting 3 phase variable fre-
 quency output.
 GENERAL ELECTRIC, IND. 8DJ13AAA,
 works in conjunction with above genera-
 tors, range 0 to 3500 RPM.

D. C. ALNICO FIELD MOTOR

DIEHL TYPE FD6-23, 27 vts. 10,000 RPM.

GENERAL ELECTRIC
D. C. SELSYNS

8TJ9-PAB TRANSMITTER 24 VTS.
 8TJ11- INDICATOR, dial 0 to 360°, 24
 vts.

RECTIFIER POWER SUPPLY

HAMMETT ELECTRIC MFG. CO. MODEL
 SPS-130. Input voltage 208 or 230 volts,
 60 cycle, 3 phase, 21 amps. Output 28
 volts at 130 amps. continuous duty, 8
 point tap switch, voltmeter ammeter,
 thermo reset all on front panel.

MISCELLANEOUS

PIONEER MAGNETIC AMPLIFIER ASSEM-
 BLY Saturable reactor type, designed to
 supply variable voltage to a servo motor
 such as CK1, CK2, CK5 or 10047.
 SPERRY A5 CONTROL UNIT, part No.
 644836.
 SPERRY A5 AZIMUTH FOLLOW-UP AM-
 PLIFIER, part No. 656030.
 SPERRY A5 DIRECTIONAL GYRO, part No.
 656029, 115 vt. 400 cycle, 3 phase.
 SPERRY A5 PILOT DIRECTION INDICATOR,
 part No. 645262 contains AY 20.
 ALLEN CALCULATOR, TYPE C1, TURN &
 BANK IND., part No. 21500, 28 vts. D. C.
 TYPE C1, AUTO-PILOT FORMATION STICK,
 part No. G1080A3.
 PIONEER GYRO FLUX GATE AMPLIFIER,
 type 12076-1-A, 115 vt. 400 cycle.

INSTRUMENT
ASSOCIATES

Write for Catalog NE100

363 GREAT NECK ROAD, GREAT NECK, N. Y.
Telephone Great Neck 4-1147

U. S. Export License-2140

Western Union address:
WUX Great Neck, N. Y.

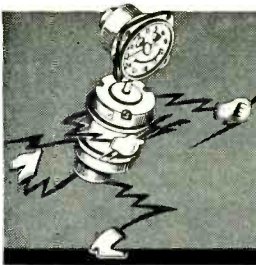

Available for IMMEDIATE DELIVERY!

SYNCHROS • DC MOTORS • AC MOTORS • INVERTERS
SERVO MOTORS • ACTUATORS • GEAR MOTORS • GENERATORS

GUARANTEED TO MEET ORIGINAL MANUFACTURERS' SPECIFICATIONS



C-1 AUTOPILOT INVERTER — Eicor and Westinghouse. 24-28 volts d-c input, 45 va output @ 19 volts a-c, 105 cycles and 1.0 power factor. Filter in base. 7½" x 5¾" x 5¾". Wt. 9 lb. #SA-177 \$24.50



SERVO OUTPUT TRANSFORMER — Sperry #661824. Hermetically sealed saturable reactor type. 1" x 1¼" x 3¼" high. Wt. 9 oz. #SA-266 \$6.75



AIRESEARCH LINEAR ACTUATORS — 4 types available; AR-42, AR-46, AR-4017, and AR-63. 115 volts, 400 cycle single phase. Compression and tension 25-50 lb. static 200 lbs. Approx. 4" travel. Wt. 1.5 lb. #SA-326 \$19.50



15F NAVY SYNCHRO — 115 volts 400 cycles. May be used on 26 volts 60 cycle for industrial purposes. 3.625" x 2.25" diam. Large quantity available. Other Navy synchros in stock. Wt. 1.5 lb. #SA-29 \$54.50



GEARHEAD SHUNT MOTOR — John Oster Type B-9-1, 27.5 volts d-c @ 7 amp. Motor speed 5600 rpm. Gearhead has dual output shafts upon which cams actuate roller lever arms. Reduction ratios 930: 1 and 230: 1. 7½" x 2¾" diam. Wt. 2 lb. #SA-335 \$9.75
SA-46 also available with 12 volt motor.



ROTARY OIL COOLER FLAP ACTUATOR — Lear Model 156-W24 volts d-c @ 9.0 amp. Motor speed 10,000 rpm. Intermittent duty. Potentiometer follow-up and adjustable limit switches. 7½" x 3½" x 5½". Wt. 4 lb. #SA-343 \$19.50

- **RADIO CONTROLLED SERVO UNIT** — Used in Glide Bomb, complete from receiver to actuators which move control surfaces. Contains the following major components: 1. Receiving set #AN/CRW-3 (BC-455) with DM-32A Dynamotor. Frequency range 6.0 to 9.1 mc. 2. Multichannel servo amplifier (Amplifier Selector AM-41/CRW-3) 3. Barber Colman 14 volt d-c rotary actuator. 4. White Rogers rotary actuator. 5. 24-volt d-c Gyro. 6. Heating unit. #SA-387A \$175.
SA-387B As above but with BC-454 receiver. Frequency range 3 to 6 mc.
- **C-1 (M-7) SERVO MOTOR UNIT** — Manuf. Norden. Small size unit containing a 1/50 hp. 24 volt d-c motor which runs constantly @ 3000 rpm. Electric clutches and brakes engage motor to differential gear which turns a 1.15625" diam. cable drum @ 44 rpm. and @ 13.3" lb. torque. This type of arrangement permits almost instant start, stop, and reverse of output drum. Wt. 8 lb. #SA-372 \$29.50



HIGH PRECISION AUTOSYN — Pioneer Type AY-201-3-B transmitter or control transformer for controlled servo circuits. Same as AY-200-3 and AY-202-3 except for shaft detail. 26 volts 400 cycle single phase. Max. error 15 min. Eclipse-Pioneer specification sheet available on request. Wt. 5 oz. max. #SA-365 \$27.50

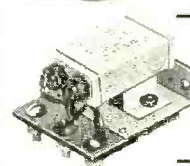

PHASE CHANGING TRANSFORMER — GE #70G23. 115 volt single phase 400 cycle input, providing 3 phase 115 volt 400 cycle output @ .048 kva and .33 power factor. Size 2¼" x 2¾" x 2". Wt. ½ lb. #SA-364 \$3.75

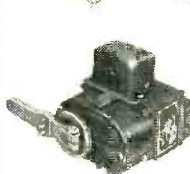

DC ROTARY ACTUATOR — White Rogers #6912X-4 Type 3. 24-volts d-c @ .4 amp. 50 in. lb. torque @ 1.5 rpm. 5½" x 4" x 4½". Wt. 3 lb. #SA-385 \$12.50



DC ROTARY ACTUATOR — White Rogers #6913-3 Type 3. 24 volts d-c @ .65 amp. 150 in. lb. torque @ 2.5 rpm. 6½" x 4" x 4½". Wt. 4 lb. #SA-391 \$19.50



ELECTRIC TURN AND BANK — Army Type C-1. 24 volt d-c instrument size gyro in standard case 3¼" diam. x 6¾" long. May be modified for signal take-offs. Wt. 1 lb. #SA-382 \$24.50

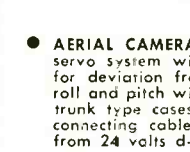

GEARHEAD DC SERIES REVERSIBLE MOTOR — John Oster Type A-16B-26R. 26 volts d-c. Output shaft limited to two revolutions in either direction by cam operated G-E Switchettes. Pinion and worm gear used in gearhead. 4½" long x 1¾" high x 3" wide. Shaft extends from top of gearhead 7/16" and is ¼" diam. Wt. 1 lb. #SA-328 \$9.50

- **AERIAL CAMERA MOUNT** — Minneapolis-Honeywell #A-15B. 3-channel servo system with variable reluctance pendulous error sensing devices for deviation from vertical. Completely stabilized camera platform for roll and pitch with remote control of azimuth rotation. Packed in durable trunk type cases for semi-portable use. Supplied with all tubes, interconnecting cables, amplifier, power supply, and inverter for operation from 24 volts d-c. Only one available. Wt. 109 lb. #SA-9 \$475.
- **CONVERSION TRANSMITTER** — Eclipse-Pioneer #PEX-29752. Consists of 2 major assemblies. One unit contains a complete magnetic amplifier assembly and 115 volt 400 cycle inverter. Other unit consists of 1F synchro, servo motor with integral rate generator, dial, plus gears and other components. Complete schematic available. #SA-40E \$195.
- **MAGNETIC AMPLIFIER ASSEMBLY** — Removed from above Conversion Transmitter. Contains 12SN7 electron tube, magnetic amplifier, plus other transformers and components in shock-mounted case. #SA-407 \$39.50

WRITE FOR LISTING

Prices F.O.B. Hawthorne

Telephone: HAWthorne 7-3100

1086 GOFFLE ROAD
HAWTHORNE, NEW JERSEY

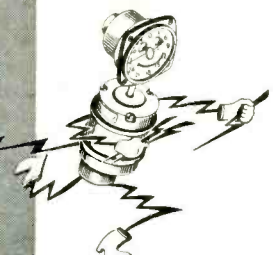

Buy TOP Radio-Electronic Values!

RECTIFIER POWER UNIT

PP35/ART. Sig. Corps No. 3H 4698-35 Input 115 Volts 400-2500 Cycles Note: P/O AN/ART5 to AN/ART11 complete with 2-836 H.V. Rectifiers.

Stock No. 6248A Price Each **\$7.50**

HEAVY DUTY SWITCH



H&H 4 P. D. D. T. Toggle Switch, 5 AMP. @ 250 Volt. 10 Amp. @ 125 Volt. Single 3/4" hole mount. Ball Handle

Stock No. 6203A Price Each **\$1.95**

PULSE TRANSFORMER

For Navy I F F Responder. Jeff. Elec. No. 300362-1. Farnsworth No. 467-001-228. Navy No. N17-T 80105-2758. Available in large quantity.

Prices on request. PRICES BASED ON QUANTITY

D.C. GENERATORS

High voltage continuous duty fully enclosed D.C. Generator. Delivers 440 volts at 200 M.A. Motor driven by 3450 RPM motor (not furnished). Made to Navy Specs. for Collins Radio by Fractional Motors Co. Navy No. 211220-C, Collins No. 231-0002-00. Brand New.

Stock No. 6147A Price Each **\$15.00**

SIGNAL CORPS & NAVY TRANSFORMERS

Over 200,000 transformers, chokes etc. For Signal Corps and Navy Equipment. Send us your requirements, or ask for our catalog listing by Signal Corps Numbers, DON'T DELAY!

G. E. HEAVY DUTY SWITCH

Type SB-1. No. 6075 732-G1. 8 pole double throw. 1/4" contacts. 10 AMP. 115 V 2 1/2" x 3" x 9" long. 3 hole panel mount. Moulded bakelite frame with heavy barriers between terminals.

Stock No. 6250A Price Each **\$9.95**

ONAN GAS-DRIVEN GENERATOR

14 V-2500 WATT D.C. \$225.00
GAS DRIVEN LIGHT PLANT
125V 3 Phase 3KVA 50-60 Cycle
\$395.00

SWITCHBOARD BD74

JAN TUBES

OB3/VR90.....	5.85	832A.....	8.50
OC3/VR105.....	.85	836.....	3.00
3E29.....	12.95	GL8002R.....	95.00
6C21.....	12.95	9003.....	1.00
204A.....	75.00	3BP1.....	5.95
368AS.....	7.00	5FP4.....	3.95
371B.....	.75	12GP7.....	14.95

BASIC UNIT FOR RECEIVING SET

AN/CRW-2. Sig Corps No. 2Z-1508-2. Complete with 6 tubes and 28 volt dynamotor.

Stock No. 6249A Price Each **\$10.00**

RADAR OSCILLATOR APR-5

Sig. Cr. Stk. No. 2C 2784. Used for tuning 1000-3100 Mc.

AN-109A ANTENNA

5' Whip with base in quantity. Per 100: \$95.00; \$1.25 EACH

POWER TRANSFORMER

Horizontal Double Half Shell Type. Pri.: 117 Volt—60 Cycle. Sec.: 265-0-265 V.A.C. & 40 Ma. Sec.: 6.3 V.A.C. @ 1.65 Amps. Mtg. Centers 2 1/2" x 2". H.V. Center Tap is grounded to core.

Stock No. 6183 Price Each **\$1.25**

HIGH FIDELITY TRANSFORMER

P. P. 10,000 ohm to 250 ohm Line. Frequency Response 30 to 20,000 C.P.S. plus or minus 1 DB. Grey Rectangular Case 3" x 2 1/2" x 3 3/8" high. Bottom Solder Lug Terminals, 4 Std Mtg. Bolts

Stock No. 5792A Price Each **\$3.50**

HIGH CURRENT FILAMENT TRANSFORMER

Primary 115 VAC 60 Cycle. Secondary 1.25 VAC at 100 Amp.

Stock No. 5783A Price Each **\$5.00**

.01 MFD.—600 VOLT MICA CONDENSERS

Large quantities available in both CM-35 and CM-40 case sizes.

TOLERANCE	PRICE PER 1000
5%	\$150.00
10%	125.00
20%	100.00

SENSITIVE RELAYS



MIDGET TYPE RELAYS

Automatic Electric Type R-45, 6500 ohm Coils. Normally open contacts except as noted.

Stock No.	Contacts	M. A.	Price Each
102152 j	S.P.S.T.	2.0	\$1.25
102249	2.P.S.T.*	4.5	1.50
102264	3.P.S.T.	6.0	2.00

* 1 Norm. open-1 Norm. closed.

Same type and style as above, but has 24 V.A.C. coil. Intermittent duty. Will operate on 6 V.D.C. Continuous duty. Contacts: S.P.S.T.-N.O. and S.P.D.T.

Stock No. 102248A Price Each **\$1.25**

RELAYS

LEACH TYPE 1204. D.P.S.T.

1/4" Diam. Normally open contacts. Bakelite base. 24 V.D.C., 265 ohm Coil.

Stock No. 6169A Price Each **\$1.95**

ALLIED CONTROL TYPE BOX 60

D.P.D.T. 1/4" Diam. Contacts. One Pole makes before break. 9.6 V.D.C., 40 ohm Coil.

Stock No. 6170A Price Each **\$1.25**

STRUTHERS-DUNN. TYPE 61AXX100. S.P.S.T. Normally open contacts rated at 20 amps @ 24 V.D.C. 80 ohm, 24 V.D.C. Coil.

Stock No. 6171A Price Each **75¢**

TRANSMITTING MICAS

Stock No.	Cap.	Test Volts	Type No.	Price Each
5493A*	.01	1000	144S	.35¢
5494A	.02	1000	144T	.40¢
5495A	.006	1200	A2	.40¢
5496A	.0001	1500	BE 15	.20¢
5498A	.004	2500	A	.30¢
5499A	.001	5000	F	.60¢
5600A	.0036	5000	A2	\$1.00
5601A	.15	1000V	XS	1.90
5602A	.00007	2500V	3	.90¢
5603A	.00005	3000V	15L	1.00
5604A	.0001	5000V	F2L	1.00
5605A	.0008	5000V	F2L	1.00
5606A	.000025	10,000	PL-34L	1.95
5607A**	.00015	10,000	PL-315	7.95

**Applied with Meter Bracket

**D.C. Working Voltage

OTHER TYPES AND SIZES AVAILABLE

THORDARSON AUDIO PASS FILTERS

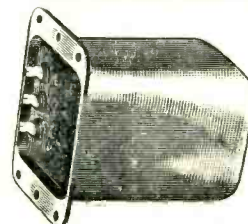

Band pass 800 to 1200 cycles Input 10000 ohms — Output 25000 Ohms Level 10DB

Stock No. T48500 Price to: \$5.50 ea.

6.3 VOLT FILAMENT TRANSFORMERS

Primary 115 Volt 60 Cycle 1600 Insulation Three 6.4 Volt Secondaries

6.3 Volts @ 4.9 Amps.
6.3 Volts @ 4.5 Amps.
6.3 Volts @ 1.1 Amps.

Horizontal Half Shell Mounting. 2 1/4" x 2 13/16" Mounting Centers. 2 13/16" x 3 3/8" Core Size. 1/2" above Chassis. Solder Lug Terminals—All Terminals Marked.

Stock No. 5254A



Price Each **\$2.65**

TERMS:

Open Accounts to rated or Acceptable reference accounts. Others Pre-payment of 25% deposit with order, balance C.O.D. Price F.O.B. Chicago and subject to change without notice. Merchandise subject to prior sale.

ORDER TODAY!!

Radio Surplus Corp.

732 South Sherman Street
Chicago 5, Illinois
Phone: HARRISON 7-5923

ALNICO FIELD MOTORS



(Approx. size overall)
3 3/4" x 1 1/4" diameter)
Delco-Type #506930: 27.5
volts; DC; 145RPM . . . \$19.95 ea.

DELCO TYPE #5069600: 27.5 volts DC; 250 RPM . . . \$19.95
PM Motor, Delco Type #5069370: 27.5 volt; DC Alnico Field; 10,000 r.p.m.; dimensions 1" x 1" x 2" long; shaft extension 1/2", diameter 0.125" . . . \$12.50
PM Motor, Diehl Mfg. SS FD6-21: 27.5 volt; DC Alnico Field; 10,000 r.p.m.; dimensions 1" x 1" x 2" long; shaft extension 1/2", diameter 0.125" . . . \$12.50

AC CONTROL MOTOR

Diehl Mfg. Co., FPE-25-7, 20 Volts, 2 ph 1600 RPM, .85 amps . . . \$15.00
A. C. SYNCHRONOUS MOTOR Type RBC 2505: Volts 115; Cycles 60; RPM 60; Mfg. HOLTZER CABOT ELBCT. Approx. size: 2 3/4" x 2 3/4" x 2 3/4" . . . \$15.00 ea.

400 CYCLE MOTORS

PIONEER: TYPE CK5 2 Phase; 400 cycles \$35.00 ea.
EASTERN AIR DEVICES TYPE J49A: 115 V; 0.1A; 7000 r.p.m. Single phase 400 cycle . . . \$17.50 ea.
AIRESEARCH: 115V; 40 CPS; Single phase 6500 RPM; 1.4 amp; Torque 4.6 in. oz.; HP .03 . . . \$10.00 ea.
EASTERN AIR DEVICES TYPE JM6B: 200 VAC; 1 amp; 3 phase; 400 cycles, 6000 RPM . . . \$12.50 ea.
EASTERN AIR DEVICES, TYPE J31B: 115 V, 400-1200 Cycle. Single Phase . . . \$12.50 ea.

AIRESEARCH: AC Induction, 200 V; 3 Phase, 400 Cycle, 2 H.P.; 11,000 RPM; 8 amps . . . \$79.50 ea.
AIRESEARCH: AC Induction, 200 V; 3 Phase, 400 Cycle, 12 H.P., 6500 RPM; 1.5 amps . . . \$25.00
Electric Motor: PNT-1400-A1-1A Serial No. 207, 208 V., 400 cycles, 3 phase Kearfoot Co., Inc. . . \$17.50 ea.
SERVO MOTOR 10047-2-A; 2 Phase; 400 Cycle; with 40-1 Reduction Gear . . . \$17.50 ea.



TELECHRON SYNCHRONOUS TIMING MOTORS: 110 VAC; 6 cycle; 2 RPM and 4 RPM; approx. 2 1/4" square overall . . . \$2.95 ea.
In lots of 10 or more . . . \$2.50 ea.

SMALL DC MOTORS

DELCO #5068750: constant speed; 27 VDC; 160 RPM; built-in reduction gears and governor . . . \$17.50 ea.
J. OSTER: series, reversible motor; 1/50th H.P.; 10,000 RPM; 2 1/2 VDC; 2 amps; RPM; #806069; approx. size 1 1/2" x 3 1/2" . . . \$7.50 ea.
(Approx. size . . . 4" long x 1 1/4" dia.)
General Electric Type 5BA10AJ57: 27 volts DC; .5 amps. 8 oz. inches torque; 250 RPM. shunt wound; 4 leads; reversible. \$15.00 ea.
General Electric, Mod. 5BA10FJ33: 12 oz. inches torque, 12 V DC, 56 RPM, 1.02 amp. \$15.00 ea.
General Electric-Type 5BA10AJ52C: 27 volts DC; .5 amps. 8 oz. inches torque; 145 RPM; shunt wound; 4 leads; reversible \$15.00 ea.
GENERAL ELECTRIC DC MOTOR Mod. 5BA10AJ64: 160 r.p.m.; 65 amp; 12 oz.-in. torque; 27V DC . . . \$19.95 ea.

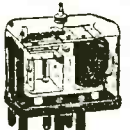

WESTINGHOUSE OVER-CURRENT RELAY: Type MN, adjustable from .04-16 amp (1210991). External reset push button. Enclosed in glass case. . . hand calibrated. NEW LOW PRICE. \$14.95

BLOWER



Eastern Air Devices, Type J31B: 115 volt; 400-1200 cycle; single phase; variable frequency; continuous duty; L & R #2 flow; approx. 22 cu. ft./min. . . \$15.00

BLOWER ASSEMBLY

115 Volt, 400 Cycle, Westinghouse Type FL 17CFM, complete with capacitor. New . . . \$12.50 ea.



SENSITIVE ALTIMETERS

Pioneer Sensitive altimeters, 0-35,000 ft. range . . . calibrated in 100's of feet. Barometric setting adjustment. No hook-up required. . . \$12.95 ea.

INVERTERS

10563 LELAND ELECTRIC

Output: 115 VAC; 400 cycle; 3-phase; 115 VA; 75 PF. Input: 28.5 VDC; 12 amp. . . \$80.00 ea.

PE 218 LELAND ELECTRIC

Output: 115 VAC; Single Phase; PF 90; 380/500 cycle 1500 VA. Input: 25-28 VDC; 92 amps; 8000 RPM; Exc. Volts 27.5. BRAND NEW . . . \$39.95 ea.

MG 153 HOLTZER-CABOT

Input: 24 V. DC, 52 amps; Output: 115 volts—400 cycles, 3-phase, 760 VA. and 26 Volt—400 cycle, 250 VA. Voltage and frequency regulated . . . \$95.00 ea.

PIONEER 12130-3-B

Output: 125.5 VAC; 1.15 amps, 400 cycle single phase, 141 VA. Input: 20-30 VDC, 18-12 amps. Voltage and frequency regulated . . . \$89.50 ea.

12116-2-A PIONEER

Output: 115 VAC; 400 cyc; single phase; 45 amp. Input: 24 VDC 5 amp. . . \$90.00 ea.

10285 LELAND ELECTRIC

Output: 115 Volts AC, 750 V.A., 3 phase, 400 cycle, .90 PF, and 26 volts, 50 amps, single phase, 400 cycle, .40 PF. Input: 27.5 VDC, 60 amps. cont. duty, 6000 RPM. Voltage and Frequency regulated. . . \$195.00

10486 LELAND ELECTRIC

Output: 115 VAC; 400 Cycle; 3-phase; 175 VA; .80 PF. Input: 27.5 DC; 12.5 amp; Cont. Duty . . . \$90.00 ea.

TRANSFORMERS

SOLA

One KVA, 210-270 Volts,

240 Sec., 3-Phase

#30663 . . . \$175.00

FILAMENT, Gen. Elec. #7455321: Primary 110/125 Volts. Secondary 11 Volts, 65 Amps, 975 KVA. Shipping wt. approx. 60 pounds. \$24.95
FILAMENT, AMERTRAN #29048: Primary 115 Volts, 50/60 cycle. Secondary 5 volts, 190 amp. Shipping weight approx. 75 lbs. \$36.50
VARIABLE, AMERTRAN #29144: 250 VA, 103-126 commutator range, fixed windings, 115 volts, max. 2.17 amps. . . \$19.95

PLASTIC ADHESIVE TAPE

Industrial—High Voltage Type
Bauer & Black No. 822 Polyken Industrial Adhesive Tape. Measures 3/4" wide—7 yards per roll. Rated 10,000 volts. Packed 8 rolls to the can . . . \$3.50/can
Ten cans or more . . . \$3.00/can

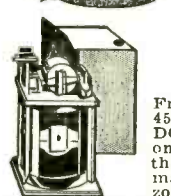

SCHWEIN REMOTE CONTROL DUAL GYRO

Free and rate gyro type 45600. Contains two 28 volt DC constant speed gyros . . . one operates horizontally, the other vertically. Vertical master gyro influences horizontal gyro position, which in turn will actuate a series of limiting switches controlling any number of electrical devices. Both gyros turn in excess of the 30,000 rpm. Size 8" x 4 1/4" x 4 1/4". Comes with metal cover. . . \$22.50 ea.

Immediate Delivery
ALL EQUIPMENT FULLY GUARANTEED
All prices net FOB Pasadena, Calif.

PIONEER GYRO FLUX GATE AMPLIFIER
Type 12076-1-A, complete with tubes . . . \$27.50 ea.



TACHOMETER INDICATOR SINGLE

Sensitive Type, Kollsman Mark V; Range 0-3500 RPM in 3 1/2 revolutions of the indicating pointer \$9.95 ea.

Tachometer Indicator and Generator (above) Both \$33.50
TACHOMETER GENERATOR (MARK V) . . . \$25.50 ea.



G. E. GENERATORS

General Electric Type 6ASB-31J33; 400 cycles out at 115 volts; 7.2 amps; 8,000 rpm.; size 6" long x 6" dia. . . \$99.50 ea.

SINE-COSINE GENERATORS

(Resolvers)

Diehl Type FJE43-9 (Single Phase Rotor). Two stator windings 90° apart, provides two outputs equal to the sine and cosine of the angular rotor displacement. Input voltage 115 volts, 400 cycle. . . \$30.00 ea.
Diehl Type FPE-43-1 same as FJE-43-9 except it supplies maximum stator voltage of 220 volts with 115 volts applied to rotor . . . \$25.00 ea.
Arma Resolver Type 218014; equal in size to size 5 synchro; 65-60 cycle; single phase primary, 2 phase secondary . . . \$79.50

GENERATORS

Eclipse-Pioneer; 716-3A (Navy Model NEA-3A) OUTPUT: 115 VAC; 10.4 amps; 800 cycle; single phase; 28.6 VDC; 60 amps @ 2400 rpm; spline drive; self exciting; wt. 60 lbs.
BRAND NEW in original box. . . \$39.95 ea.

SYNCHRONOUS SELSYNS

110 volt, 60 cycle, brass cased, approx. 4" dia. x 4" long; Mfg. by Diehl and Bendix. Quantities Available.
REPEATERS . . . \$20.00 ea.
TRANSMITTERS . . . \$20.00 ea.



SYNCHROS

IF Special Repeater (115V-400 Cycle) . . . \$15.00 ea.
2J1F 3 Generator (115-400 cyc.) . . . \$10.00 ea.
5CT Control Transformer; 90-50 Volt; 60 Cyc. . . . \$50.00 ea.
5F Motor (115/90 volt—60 cyc.) . . . \$60.00 ea.
5G Generator (115/90 volt—60 cyc.) . . . \$50.00 ea.
5/DG Differential Generator (90/90 volts—400 cyc.) . . . \$30.00 ea.
TRANSMITTER, BENDIX C-78248; 115 Volt, 60 Cycle. . . . \$25.00 ea.
Differential—C-78249; 115 Volt; 60 Cycle . . . \$5.00
REPEATER, BENDIX C-78410; 115 Volt, 60 Cycle . . . \$37.50 ea.
REPEATER, AC synchronous 115 V., 60 cycle, C-78863 . . . \$15.00 ea.
7G Synchro Generator (115/90 volt; 60 cycle) . . . \$75.00
GG Synchro Generator (115/90 volt; 60 cycle) . . . \$60.00
6DG Synchro Differential Generator (90/90 volt; 60 cycle) . . . \$60.00
2JF51 Synchro Control Transformer; 105-55 Volts; 60 Cycle. . . . \$50.00
2JD5J2 Selsyn Motor; 115-90 Volts; 60 Cycle . . . \$50.00
5JD5HA1 Selsyn Generator; 115-105 Volts; 60 cycle . . . \$50.00
2J1F1 GENERATOR; 115—57.5 Volt; 400 cycle . . . \$12.50 ea.
2J1H1 DIFFERENTIAL GENERATOR; 57.5—57.5 Volt; 400 cycle. . . . \$12.50 ea.
2J1G1 CONTROL TRANSFORMER; 57.5—57.5 Volt; 400 cycle. . . . \$7.50 ea.

PIONEER AUTOSYNS

AY-1 . . . 26 Volt—400 Cycle . . . \$6.95
AY-5 . . . 26 Volt—400 Cycle . . . \$7.95
AY27D . . . \$25.50
AY6—26 Volt—400 cyc . . . \$1.95 ea.
AY30—26 Volt—400 cyc . . . \$25.00 ea.
AY14D . . . \$14.00
AY34 . . . \$20.00
AY20—26 Volt—400 cyc . . . \$12.50 ea.

PIONEER TORQUE UNITS

TYPE 12604-3-A: Contain CK5 Motor coupled to output shaft through 125:1 gear reduction train. Output shaft coupled to autosyn, follow-up (AY43). Ratio of output shaft to follow-up Autosyn is 15:1. \$70.00 ea.
TYPE 12602-1-A: Same as 12606-1-A except it has a 30:1 ratio between output shaft and follow-up Autosyn. . . \$70.00 ea.
TYPE 12602-1-A: Same as 12606-1A except it has base mounting type cover for motor and gear train. . . \$70.00 ea.

MICROPOSITIONER

Barber Colman AYLZ 2133-1 Polarized D.C. Relay; Double Coil Differential sensitive, Alnico P. M. Polarized field. 24V contacts; 5 amps; 28 V. Used for remote positioning, synchronizing, control, etc. . . \$12.50 ea.

C and H Sales Company

BOX 354-X EAST PASADENA STATION • PASADENA 8, CALIFORNIA

Reliance Specials

GEAR ASSORTMENT
100 small assorted gears. Most are stainless or brass. Experimenters' dream! Only \$6.50



HAYDON TIMING MOTOR
1 R.P.M., 115 V., 60 Cycle..... \$1.95

TIMING MOTOR
8 RPM 115V 60 cyc
E. Ingraham Co.



\$1.79

400 CYCLE INVERTERS
Leland Electric Co.

#10800 In: 20-28 V.D.C., 92 A. 8000 R.P.M. Out: 115V. 400 Cyc. 1 phase, 1500 V.A. 90 PF..... \$24.95

3 AG FUSES

Amp.	Per 100	Amp.	Per 100	Amp.	Per 100
1/8	\$4.00	3/4	\$4.00	8	\$3.00
3/8	4.00	4	3.00	10	3.00
1/2	4.00	5	3.00	15	3.00

3 AG FUSE HOLDERS (Finger) 25¢

BALL BEARINGS

Mfg. No.	ID	OD	Thick	Price
MRC5028-1	5 1/2	6 1/2	1 9/16	\$3.75
MRC7026-1	5 5/8	6 5/8	1 1/4	3.50
MRC106M2	1 17/64	2 7/16	25/64	1.75
MRC106M1	1 13/64	2 7/16	25/64	1.60
Federal LS11	1 1/8	2 1/2	5/8	1.75
Norma S11R	1 1/8	2 1/8	5/8	1.70
Federal AS41	1 1/16	1 1/2	9/32	1.50
Schatz	5/8	1 3/4	1 1/8	1.00
Norma 203S	3/8	1 9/16	7/16	.90
ND5202-CI3M	1/2	1 3/8	1 3/8	1.00
ND 3200	25/64	15/32	11/32	.60
ND R6	3/8	7/8	7/32	.40
MRC39R1	11/32	1 1/32	5/16	.45
MRC38R3	S/16	55/64	13/32	.45

NEEDLE BEARINGS

TORRINGTON B108 1/2" wide 3/8" 13/8"..... 30¢

Brand New Meters—Guaranteed

0-10 ma. D.C. 3 1/2". \$3.95 0-80 Amp. D.C. 2 1/4". \$2.50
0-1 Ma D.C. 3 1/2" Delur. (Scale Reads 0-4 KV)..... \$5.75

SELENIUM RECTIFIERS

Full Wave 200 MA 115V..... \$1.79
Half Wave 100 MA 115V..... .91

SOUND POWER HANDSET BRAND NEW

Includes 5 ft. cord.—Uses no batteries or external power source..... \$18.50 pr

Sound Powered Chest Set RCA—With 24 Ft. Cord



Per Pair
USED \$17.60
NEW \$26.40

POSTAGE STAMP MICAS

mmf	mmf	mmf	mmf	mmf	mmf	mmf	mfd	mfd
10	40	70	125	240	400	680	.0016	.004
20	47	75	135	250	430	800	.002	.0044
22	50	80	150	270	470	820	.0027	.005
23	51	82	160	300	500	910	.0033	.006
24	56	90	175	330	510	.001	.0038	.0065
25	60	100	180	360	580	.0012	.0048	.007
33	62	110	200	370	600	.0013	.0052	.0082
39	62	120	220	390	650	.0015	.0058	.01

Price Schedule

10 mmf to 820 mfd..... 5¢
.001 mfd to .0016..... 2¢
.002 mfd to .0082 mfd..... 15¢
.01 mfd..... 28¢

SILVER MICAS

mmf	mmf	mmf	mmf	mmf	mmf	mmf	mfd	mfd
10	50	100	170	360	510	.001	.0024	.0047
18	51	110	180	370	525	.0011	.0025	.005
22	56	115	208	390	500	.0013	.0027	.0051
23	60	120	225	400	570	.0015	.0028	.0056
24	62	125	240	410	680	.0016	.003	.006
25	66	130	250	430	700	.0018	.0033	.0068
27	68	135	255	470	800	.0022	.0039	.0082
30	75	150	280	485	900	.0023	.004	
40	82	155	270	500				

Price Schedule

10 mmf to 700 mfd..... 10¢
.0011 mfd to .002 mfd..... 20¢
.0022 mfd to .0082 mfd..... 50¢

PULSE TRANSFORMERS

UTAH—9262 9278 9289 9318 9340 9350
WESTERN ELECTRIC—D166173 D161310
KS8696, KS9800, KS9862, KS13161
GENERAL ELECTRIC—80-G-5
JEFFERSON ELECTRIC—C-12A-1318
DINTON COIL—TR1048 TR1049
also 352-7250-2A; 352-7251-2A; T-1229621-60

COAXIAL CABLE CONNECTORS



14¢	\$1.20	30¢	70¢	40¢	12¢
UG175/U	83-1F	83-1AP	83-LJ	SO-239	HOOD
83-1AC	\$0.42	PL-274	\$1.10	UG-87/U	\$1.50
83-1AP	.30	PL-275	1.90	UG-88/U	.90
83-1BC	.35	SO-239	.40	UG-89/U	1.10
83-1F	1.10	UG-13/U	1.70	UG-102/U	.80
83-1H	.12	UG-18B/U	1.10	UG-103/U	.68
83-1HP	.22	UG-20B/U	1.65	UG-104/U	1.40
83-1J	.70	UG-21/U	.95	UG-105/U	1.50
83-1RTY	.65	UG-21B/U	1.00	UG-106/U	1.2
83-1SP	.45	UG-21C/U	.95	UG-107B/U	5.70
83-1SPN	.53	UG-21D/U	1.45	UG-107/U	5.70
83-1T	1.30	UG-22/U	1.35	UG-146/U	2.00
83-2AP	1.95	UG-22A/U	1.60	UG-175/U	.14
83-2T	2.10	UG-22B/U	1.20	UG-176/U	.14
83-2Tc	1.65	UG-23/U	1.20	UG-185/U	.99
83-22AP	1.25	UG-23B/U	1.50	UG-196/U	1.65
83-22F	1.90	UG-23C/U	1.10	UG-203/U	.65
83-22J	1.50	UG-24/U	1.30	UG-224/U	1.15
83-22R	.68	UG-27/U	1.25	UG-255/U	1.98
83-22SP	.80	UG-27A/U	2.25	UG-260/U	.85
83-22T	1.65	UG-27B/U	2.95	UG-261/U	1.10
83-168	.14	UG-28A/U	2.95	UG-262/U	1.10
83-165	.14	UG-28B/U	1.65	UG-262/U	1.10
CW-128A/U	.45	UG-30/U	2.30	UG-273/U	1.45
M-358	1.30	UG-57B/U	1.70	UG-274/U	2.30
M-359	.30	UG-58/U	.70	UG-291/U	.95
M-359A	.65	UG-58A/U	.90	UG-306/U	2.65
PL-258	.75	UG-59A/U	1.90	UG-414/U	1.95
PL-259	.45	UG-83/U	1.75	UG-499/U	1.25
PL-259A	.53	UG-85/U	1.70	UG-625/U	1.00

NEW COAXIAL CABLES

Price per 1000 ft.	Price per 1000 ft.
RG 5/U*..... \$140.00	RG 22/U*..... \$135.00
RG 6/U..... 180.00	RG 22A/U..... 285.00
RG 7/U*..... 80.00	RG 24/U..... 675.00
RG 8/U*..... 80.00	RG 26/U..... 475.00
RG 9/U*..... 250.00	RG 29/U..... 50.00
RG 9A/U..... 275.00	RG 34/U..... 300.00
RG 10/U..... 240.00	RG 35/U..... 900.00
RG 11/U..... 150.00	RG 41/U*..... 295.00
RG 11A/U*..... 100.00	RG 51A/U..... 97.00
RG 12/U..... 240.00	RG 55/U*..... 110.00
RG 13/U..... 216.00	RG 57/U..... 325.00
RG 17/U..... 650.00	RG 58/U*..... 60.00
RG 18/U..... 900.00	RG 58A/U*..... 65.00
RG 19/U..... 1250.00	RG 59/U*..... 55.00
RG 20/U..... 1450.00	RG 62/U*..... 70.00
RG 21/U..... 220.00	RG 77/U*..... 100.00

* Add 25% for orders less than 500 feet.
* No minimum order—others 250' minimum.

UNIVERSAL JOINT ALUMINUM
1/4" hole x 1/2" O.D.
1 1/8" long **85¢**

TYPE "J" POTENTIOMETERS

100 S.S.*	1,500 1/4S.S.	15K 1/4	200K S.S.*
150 S.S.*	2,000 1/4	25K S.S.	250K 5/8
300 S.S.*	2,500 S.S.	70K S.S.	250K S.S.*
400 S.S.	3,000 3/8	80K S.S.	500K S.S.
500 S.S.	4,000 3/8	100K 7/16	1Meg S.S.
1,000 3/8	5,000 3/4	100K S.S.*	
1,000 S.S.	10K 5/8	200K 5/8	

*Split Locking Bushing **\$1.25 EACH**

TYPE "J" POTENTIOMETERS

Ohms	Shaft	Ohms	Shaft	Ohms	Shaft
1000	S.S.	30K-10K	3/8"	1 Meg.	1/2"
10K	5/16"	3K-90K	1/4"	1 Meg.	S.S.
15K	S.S.			1 Meg.	S.S.

SD—Screw Driver *Split Locking Bushing with Switch

PRICE—\$2.00 EACH

JONES BARRIER STRIPS

2-140Y	\$0.17	3-141W	\$0.27	9-141Y	\$0.71
3-140 1/2 W	.21	4-141	.24	3-142	.24
6-140	.28	5-141	.29	2-150	.43
10-140W	.59	5-141 1/2 W	.41	3-150	.60
10-140 1/2 W	.59	7-141 3/4 W	.56		
3-141 3/4 W	.27	8-141 3/4 W	.64		

TIME DELAY RELAY

Raytheon CPX 24166
1 Min. Delay, 115 V., 60 Cycle
2 1/2 second recycling time spring return • Microswitch contact, 10A • Holds ON as long as power is applied • Fully Cased • **ONLY \$6.50**

RADIO FREQUENCY GENERATOR

RCA 1KW 400 KC: Input: 220 V 60 cycle Needs minor repairs to power circulating system. Otherwise in good condition **\$295.00**

PRECISION RESISTORS—1/4 WATT—30¢

2	6.68	11.74	14.98	79.81	147.5	414.3
2.5	8.33	12.32	15.8	105.8	147.8	705
2.8	10.48	13.02	16.37	123.8	220.4	2,193
3.5	11	13.52	20	125	301.8	3,500
6	11.25	13.89	62.54	142	366.8	59,148

PRECISION RESISTORS—1/2 WATT—35¢

25	11.1	86.6	298.3	4,000	14,825	33,300
334	13.07	75	400	4,255	15,000	35,888
444	13.15	87	723.1	4,300	15,750	36,000
502	13.3	97.8	855	4,451	15,755	37,000
557	15	97.85	970	5,900	15,810	45,000
627	25	125	1,000	6,500	16,000	47,000
76	30	178	1,500	6,650	16,700	50,000
1	35	180	1,800	6,670	17,000	56,000
1.01	46	200	2,250	7,000	20,000	60,000
1.53	50	210	2,280	7,300	20,150	59,905
2.04	52	213	2,500	7,500	25,000	68,000
4.35	54	235	2,850	8,000	30,000	79,012
5.26	55.1	260	3,427	8,500	32,700	100,000
5.85	65	270	3,700	8,800	32,888	150,000
10.48	65	273.1	3,995	10,000	33,000	180,000

PRECISION RESISTORS—1 WATT—45¢

.1	2.6	32	89.8	2,000	8,000	50,000
.11	2.66	35.7	125	2,200	8,250	52,525
.2	3.39	38	250	2,950	9,000	55,000
.31	5.21	45.1	270	2,550	9,700	56,000
.861	12	45.5	420	3,300	10,000	65,000
1.01	15	54.25	425	5,000	12,000	68,000
1.166	17.9	56.7	800	5,221	15,000	75,000
2.55						

NEW YORK'S RADIO TUBE EXCHANGE

TYPE	PRICE	TYPE	PRICE	TYPE	PRICE	TYPE	PRICE	TYPE	PRICE	TYPE	PRICE	TYPE	PRICE
OA2	51.40	2J21A	17.95	4E27	17.50	RK73	1.95	450TH	45.00	806	27.50	955	.55
OA3	1.10	2J22	17.95	4J25	199.00	100TH	9.95	450TL	45.00	807	1.69	956	.69
OB2	1.35	2J26	27.75	4J26	199.00	FG95	24.95	464A	9.95	808	3.50	957	.29
OC3	1.25	2J27	29.95	4J27	199.00	FG105	19.00	471A	2.75	810	11.00	958A	.69
OD3	1.25	2J31	29.95	4J31	199.00	203A	8.95	527	15.00	811A	3.95	991	.65
CB1	3.95	2J32	69.95	4J32	199.00	211	.95	WL530	3.50	813	9.95	FL148	.35
1B21A	2.75	2J36	105.00	4J33	199.00	217C	18.00	WL531	22.50	814	3.95	1280	1.25
1B22	3.95	2J38	17.95	4J37	199.00	242C	10.00	WL533	17.50	815	3.50	1611	1.95
1B23	9.95	2J39	12.50	4J38	89.00	244A	12.95	700/D	25.00	816	1.45	1613	1.38
1B24	17.95	2J40	35.00	4J39	199.00	249C	4.95	701A	7.50	829	12.95	1616	2.95
1B26	2.95	2J42	200.00	4J41	199.00	250TH	22.50	703A	6.95	829A	13.95	1619	.89
1B27	13.50	2J49	109.00	C5B	3.95	250TL	19.95	705A	3.95	829B	15.95	1622	2.75
1B32	4.10	2J50	195.00	5BP1	6.95	274A	3.00	707A	17.95	830B	2.50	1624	2.00
1B38	33.00	2J61	45.00	5BP4	6.95	204B	3.00	707B	832	832	7.95	1625	.45
1B42	19.95	2J62	45.00	5CP1	6.95	304TH	10.00	714Y	17.95	832A	9.95	1851	1.85
1B51	9.95	2K25	29.50	5D21	21.00	304TL	10.00	715A	7.95	833A	49.95	2050	1.75
1B56	49.95	2K28	37.50	5JP1	27.50	307A	4.95	715B	12.00	834	7.95	2051	1.80
1B60	69.95	2K29	37.50	5JP2	19.50	310A	5.95	715C	25.00	836	4.95	8012	4.25
1N21	1.35	2K41	150.00	5JP4	27.50	311A	6.95	717A	1.95	837	2.95	8013	2.95
1N21A	1.75	2K45	149.50	WE6AK5	2.50	312A	3.95	718A/EY	48.50	838	6.95	8013A	5.95
1N21B	4.25	2V3G	2.10	C6A	12.50	323A	15.00	719A	29.50	845	5.95	8019	1.75
1N22	1.75	3BP1	7.95	C61	10.95	327A	3.95	721A	3.95	849	52.50	8020	3.50
1N23	2.00	3B24	5.50	7BP7	7.95	328A	6.95	722A	3.95	851	80.50	8025	6.95
1N23A	2.75	3B24W	7.50	7DP4	10.00	350A	6.95	723A/B	24.95	860	4.95	PD8365	89.00
1N23B	4.25	EL3C	5.95	12AP4	55.00	350B	5.95	724A	4.95	861	29.50	9001	1.75
1N34A	.96	3C22	120.00	15E	1.95	357A	20.00	724B	6.95	866A	1.79	9002	.95
1N43	2.50	3C24	1.95	15K	.95	368AS	6.95	725A	9.95	869B	57.50	9003	1.75
2B2	1.95	3C31	3.95	NE16	.66	371B	2.95	726A	24.00	869HX	35.00	9004	1.75
2B26	3.75	3DP1A	10.95	FG17	6.95	385A	4.95	726B	56.00	872A	3.95	9005	1.90
2C34	.35	3DP182	12.00	KY21A	8.75	388A	2.95	726C	69.00	878	1.95	9006	.35
2C40	10.00	3E29	15.50	FG33	12.95	394A	7.95	728AY	27.00	884	1.95		
2C43	20.00	3GP1	5.50	35T	4.95	MX408U	.75	730A	24.00	885	1.75		
2C44	.90	4A21	2.75	45 Special	.35	117A	17.95	801A	1.00	889H	199.50		
2E21	1.75	4B26	6.95	RK39	2.95	434A	19.95	802	4.25	911	75.00		
2E22	2.75	4C27	25.00	HF50	1.75	446A	1.95	803	7.95	931A	5.00		
2E30	2.75	4C28	35.00	VT52	.25	446B	3.95	805	5.95	954	3.50		

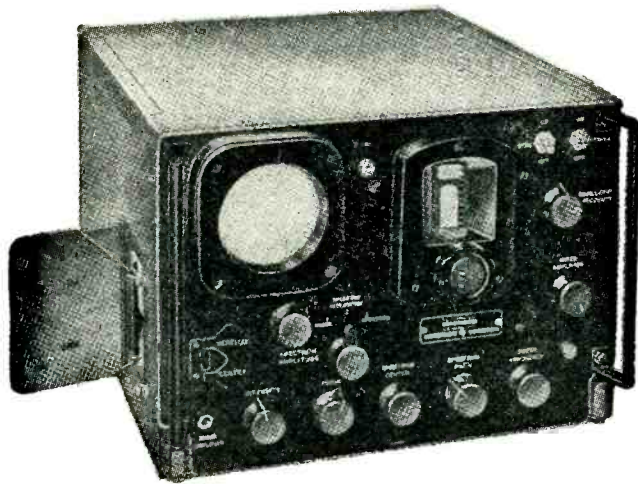

MICROWAVE TEST EQUIPMENT TS148/UP SPECTRUM ANALYZER

Field type X Band Spectrum Analyzer, Band 8430-9580 Megacycles.

Will check Frequency and Operation of various X Band equipment such as Radar Magnetrons, Klystrons, TR Boxes. It will also measure pulse width, c-w spectrum width and Q or resonant cavities. Will also check frequency of signal generators in the X band. Can also be used as frequency modulated Signal Generator etc. Available new complete with all accessories, in carrying case.

Also available of new production TS239A Synchroscope.

Other test equipment, used checked out, surplus.

TSK1/SE K Band Spectrum Analyzer
TS3A/AP Frequency and power meter S Band
RF4A/AP Phantom Target S Band
TS10/APN Altimeter Test Set
TS12/AP VSWR Test Set for X Band
TS13/AP X Band Signal Generator
TS14/AP Signal Generator
TS15/AP Flux Meter
TS16/AP Altimeter Test Set
TS19/APQ 5 Calibrator
TS33/AP X Band Power and Frequency Meter
TS/34AP Western El Synchroscope
TS34A/AP Western El. Synchroscope

T35/AP X Band Signal Generator
TS36/AP X Band Power Meter
TS47/APR 40-400 MC Signal Generator
TS69/AP Frequency Meter 400-1000 MC
TS100 Scope
TS102A/AP Range Calibrator
TS108 Power Load
TS110/AP S Band Echo Box
TS125/AP X Band Power Meter
TS126/AP Synchroscope
TS147 X Band Signal Generator
TS251 Range Calibrator APN9
TS270 S Band Echo Box

TS174/AP Signal Generator
TS175 Signal Generator
TS226 Power Meter
TS239A Synchroscope

SURPLUS EQUIPMENT

APA10 Oscilloscope and panoramic receiver
APA38 Panoramic Receiver
APS 3 and APS 4 Radar
APR5A Microwave Receiver
APT2 Radar Jamming Transmitter
APT5 Radar Jamming Transmitter

MINIMUM ORDER
25 Dollars

YOU CAN REACH US ON TWX NY1-3235

Cables:
TELSERSUP

SPECIAL

Wide Band S Band Signal Generator
2700/3400MC using 2K41 or PD 8365
Klystron, Internal Cavity Attenuator,
Precision individually calibrated
Frequency measuring Cavity. CW or Pulse
Modulated, externally or internally.

Large quantities of quartz crystals mounted and
unmounted.

Crystal Holders: FT243, FT171B others.

Quartz Crystal Comparators.

North American Philips Fluoroscopes Type 80.

Large quantity of Polystyrene beaded coaxial
Cable.



LIBERTY ELECTRONICS, INC.

135 LIBERTY STREET NEW YORK 6, N. Y.
PHONE WORTH 4-8262

Headquarters for MICROWAVE TEST EQUIPMENT

— the widest assortment, the strongest depth and the most immediate availability of any source on test equipment.

Of special interest to American industry is the wide attention given inquiries for test equipment now no longer available. Our greatly expanded facilities, our library of original tech manuals and engineering notes, and our experienced personnel provide the medium for rapid delivery of recreated pieces of test equipment. S-Band, X-Band, and K-Band equipments are offered in packaged forms to interested laboratories. Some 20 pieces of equipment are now being manufactured in their entirety in our shops; the balance of material listed below is generally refurbished and recertified equipment, absolutely checked-out and sold with a money back guarantee.

TS-3A/AP	TS-51/APG-4	TS-147/UP	TS-268B/U	AN/APA-A	I-186	BC-959-TU
TS-8A/U	TS-56/AP	TS-148/UP*	TS-279	AN/APA-10	I-198A	BC-1050
TS-10A/APN-1	TS-62/AP	TS-155*	TS-293	AN/APR-4	I-208/A	BC-1203
TS-11/AP	TS-65A/FM2-1	TS-159/TPX	TS-294/U	I-56	I-212	BC-1236/A
TS-12*	TS-69A	TS-170/APN-5	TS-303	I-86A	I-222/A	BC-1277
TS-13	TS-90	TS-173/UR	TS-323	I-95/A	I-224A	BC-1287/A
TS-14	TS-92	TS-174/U _j	TS-359/AU	I-97A	I-225	SCR-522
TS-15B/AP	TS-96/TPS-1	TS-175/U	TS-377/U	I-100	I-245	AS-23/AP
TS-16/APN	TS-98/AP	TS-182/UP	TS-418	I-117	IE-17	AS-48/AP
TS-18	TS-100/AP	TS-184/AP	TS-419	I-106A	IE-21/A	AT-39/AP
TS-23*	TS-101	TS-197/CPM-4	TS-420B/U	I-122	IE-36	AT-68/UP
TS-24	TS-102	TS-203/AP	TS-421/U	I-223A	IF-12/C	ME-6/U _j
TS-26A/TSM-1	TS-108	TS-204/AP	TS-460/AU	I-130A	IS-185	OS-1/U _j
TS-27/TSM	TS-110	TS-205/AP	TS-465/U	I-135E	BC-221*	TSS-45E
TS-32A/TRC-1	TS-111/CP	TS-210/MPM	TS-480/U	I-139A	BC-376	TSS-45E
TS-33/AP	TS-117/GP	TS-220/TSM	TS-487	I-140A	BC-438	TVN-R5E
TS-34/AP	TS-118/AP	TS-233/TPN	TS-505/U	I-145	BC-638	
TS-36/AP	TS-125/AP*	TS-251/UP	TS-589/U	I-147	BC-906/D	
TS-39A/TSM-1	TS-127/U	TS-250/APN	TS-615/U	I-168	BC-918B	
TS-45/APN-3	TS-131/AP1	TS-257/AWR	TS-617/U	I-177	BC-923A	
TS-47/APR	TS-144/TRC-6	TS-266A/AP	AN-5841	I-178	BC-949/A	

*Of new manufacture.

BEFORE SELLING YOUR IDLE TEST EQUIPMENT...

... please get our offer

WESTON LABORATORIES INCORPORATED

WESTON 93, MASS.

Cable: WESLAB Tel: Boston: WE 5-4500

SEE OUR PREVIOUS ELECTRONICS ADS FOR LISTINGS OR WRITE FOR CIRCULARS

TELEPHONE TYPE RELAYS

These relays have been standardized so that coils and frames of most manufacturers can be interchanged without affecting adjustments. A wide variety of applicable combinations are thus possible from a comparatively small number of relays.

Listed below are frames and coils from our stock. They may be purchased separately. However, a complete relay consists of coil and frame. In ordering complete relays specify which coil with which frame, i.e.: F101 with K117.

Representative completed relays are also listed with voltage and current ratings. Values are indicative of sensitivity that may be expected from similar combinations.

107 COOK, 3-6VDC, 6 make, 1 break (5As, 1C), 12 ohm. Part of BC654, #R407.....	3.95
CLARE, 6500 ohm, 8maDC, 3 makes (3As) #276.....	4.25
5035A7 AUTOMATIC, 1300 ohm, 8maDC, SPST n.o. (1A), #103.....	1.75
CLARE K101, 6500 ohm, SPDT, 2 ma DC, Fast Action #175.....	4.25

A18258 BENDIX (Cook 102) 8-12 VDC, Copper Slug, Slow Release, SPDT, 200 ohm, Part of SCR 522, #R365.....	2.49
R5229A1 AUTOMATIC 6VDC, 3PST n.o. (3As), 75 ohms, Slow Release, #412.....	2.50
R5021A1 AUTOMATIC 1300 ohm, 20maDC, SPST n.c. (1B), #R413.....	2.95

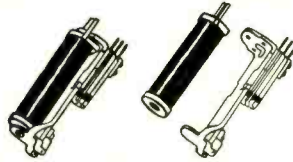

FRAMES

(For Cost of Relay Add Price of Frame to Price of Coil)



Stock No.	Contacts	Price each	Stock No.	Contacts	Price each
F101	1A	1.25	F111	1B, 2A	1.75
F102	2A	1.50	F114	1B, 3A	2.00
F103	3A	1.75	F108	1B, 1A, 1C	2.00
F104	4A	2.00	F107	2B, 1A	1.75
F105	5A	2.25	F112	2B, 2A, 2C	3.00
F106	1A, 1B	1.50	F118	2B, 5A, 1C	3.25
F107	1A, 2B	1.75	F113	5B, 2A	2.75
F108	1A, 1B, 1C	2.00	F121	5B, 1C	2.75
F109	1A, 1C	1.75	F122	1C	1.50
F110	1A, 2C	2.25	F123	2C	2.00
F111	2A, 1B	1.75	F109	1C, 1A	1.75
F112	2A, 2B, 2C	3.00	F116	1C, 4A	2.50
F113	2A, 5B	2.75	F117	1C, 5A	2.75
F114	3A, 1B	2.00	F121	1C, 5B	2.75
F115	3A, 2C	2.75	F110	2C, 1A	2.25
F116	4A, 1C	2.50	F115	2C, 3A	2.75
F117	5A, 1C	2.75	F108	1C, 1A, 1B	2.00
F118	5A, 2B, 1C	3.25	F118	1C, 5A, 2B	3.25
F120	1B	1.25	F112	2C, 2A, 2B	3.00
F106	1B, 1A	1.50			

FRAMES WITH MICROSWITCH

F125	1A, 1C (Microsw.)	1.75
F126	1A, 1A (Microsw.)	1.75

A = Normally Open; B = Normally Closed; C = Double Throw.

COILS

(For Cost of Relay Add Price of Coil to Price of Frame)



Stock No.	Ohms	Price each	Stock No.	Ohms	Price each
K101	0.75	1.25	K106	1100/500 Dual	2.00
K102	12	1.25	K111	1300	1.75
K103	250	1.25	K112	2000	2.25
K104	450	1.50	K113	3000	2.50
K105	500	1.50	K115	4600	2.75
K106	500/1100 Dual	2.00	K116	6500	2.75
K107	750	1.50	K130	11,300	3.00
K108	900	1.75	K118	40,000	3.25
K109	1000	1.75			

A-C COILS

Stock No.	Voltage	Price each
K119	6V AC	1.75
K121	110V AC	2.50

SLOW ACTION COILS

Stock No.	Ohms	Slow Action	Price each
K122	33	Make	1.50
K123	75	Release	1.50
K124	200	Release	1.50
K125	300	Make	1.75
K126	2000	Make	2.00
K127	2500	Release	2.00

FERRULE AND OTHER WIRE WOUND RESISTORS AT A FRACTION OF MANUFACTURERS' ORIGINAL COST!



IMMEDIATE DELIVERY

From Our Wide Assortment from 0.2 to 15 Megohms.

ENAMEL • GLASS FIXED • ADJUSTABLE

New and in Perfect Condition. Nearly all made to JAN Specifications.

Send us your requirements. We have 250,000 wire wound resistors in a large variety of sizes in stock.

SELENIUM RECTIFIERS Full-Wave Bridge Types

CURRENT (Continuous)	18/14 Volts	36/28 Volts	54/42 Volts	130/100 Volts
1 Amp.	\$1.25	\$2.20	\$3.60	\$8.95
2 Amps.	2.20	5.60	6.50	10.50
2 1/2 Amps.	3.75	6.75	8.75	13.00
4 Amps.	4.95	7.95	12.95	27.00
5 Amps.	5.50	9.00	14.00	36.00
6 Amps.	6.75	12.00	20.00	45.00
10 Amps.	8.50	16.00	25.50	52.50
12 Amps.	13.25	24.00	36.00	90.00
20 Amps.	16.00	31.00	39.50	98.00
24 Amps.	18.50	36.00
30 Amps.	25.50	45.00

ULTRA SENSITIVE RELAYS

KURMAN BK35 — Nominal Operating Characteristics, 11,000 Ohms, 0.4 Ma. 4V DC SPDT. Adjustable contacts and armature. #R277, 10 for \$55.00, 100 for \$475.00.



5.95 each



SIGMA 5RJ; 5000 ohms Hermetically sealed SPDT; 1.5 ma. DC, #R281

6.95 each

KOVAR GLASS TO METAL SEALS HIGH-VOLTAGE FEED THRU

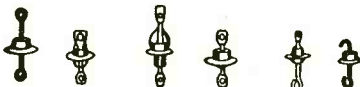

Many types and sizes. Send us your blueprint or sample for our quote. Our prices are a fraction of original factory cost.

SAMPLE KIT 96 Seals (8 ea. 12 types) 5.00 postpaid in USA

LAB KIT 300 Seals (20 types) 15.00 postpaid in USA

H-F TIE POST

Low-loss Melamine Insulation, pictured actual size (4-40 Thread).....7.50/C \$67.50/M



RELAYS

RELAYS

RELAYS

324 CANAL ST. (Near B'way) N. Y. — WA 5-9642
Universal general corp.

TERMS:—All Prices F.O.B. Our Plant. Rated Firms Net 10 Days. All others Remittance with Order. Orders Under \$10 Remittance With Order, Plus Approximate Shipping Charges (overage will be returned.)

A.C. SOLENOIDS



GUARDIAN No. 1: 24 VAC, 6 ohms 1/2 to 1/2" stroke, 6 oz.-in. #R 804 1.95

GUARDIAN No. 4: 115 VAC, 133 ohms 1/2 to 1 1/4" stroke, 14 oz.-in. #R 805 3.95

GUARDIAN No. 4: 115 VAC, Intermittent Duty, 49 ohms 1/2" to 1 1/4" Stroke, 2 lb.-in. 3.95

ALLEN BRADLEY BULLETIN 860, 110 VAC, 1/2 to 1" stroke, 2 lb.-in pull; #R942 3.50

WARD LEONARD N83 CONTACTOR; 110 VAC, Heavy Duty. 8 lb-in stroke; #R233 10.95

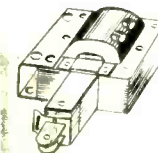

UNIVERSAL 110V AC, 6-lb. pull, 2x2x2 1/4", 1" thrust. #R176\$2.75

UNIVERSAL Type 1109, 110V AC, Intermittent duty, 12-lb. pull, 2 1/2x2 1/2x3", 1 1/2" thrust. #R177\$7.95

D. W. DAVIS MINIATURE 110V AC, Intermittent duty, 1 1/2x1 1/2x1 1/2", 1/2" stroke, 12 oz-in pull, #R178.....\$1.95

D. W. DAVIS MINIATURE 24V AC, 1 1/2x1 1/2x1 1/2", 1/2" stroke, 12 oz-in pull, #R179 \$1.79

LEACH 980, 110V AC Intermittent duty, 1 1/2x3 1/2x2 1/4" Hinged type, #R180....\$2.25

AMPERITE THERMOSTATIC DELAY RELAY



Amperite Thermostatic Delay Relays are actuated by a heater and can therefore be used on AC, DC, or pulsating current. Being hermetically sealed, Amperite Relays are not affected by altitude, moisture, or other atmospheric conditions. At the present time only SPST is available — normally open or normally closed.

LIST 4.00 each Available in voltage ratings of 2.5, 5, 6.3, 12, 26 and 115 volts.

NET 2.40 each Delays in seconds are available as follows: 2, 3, 5, 10, 15, 20, 30, 45, 60, 75, 90 and 120 seconds.

Most types from stock. When ordering specify: Voltage—Delay in Seconds—Open or Closed.

COMMUNICATIONS EQUIPMENT CO.

SHOCK MOUNT RACKS

FT-156	FT-265A	MT-62/ARC-5
FT-162	FT-338	MT-167-U
	FT-449	
FT-185	FT-487	MT-170A
FT-225	MT-5/ARR-2	MT-171A

SILVER MICA BUTTON COND.

MMF	MMF	PRICE
40	180	\$7.00/100
50	185	
175	500	15.00/100
	2000 MMF	

CERAMIC TYPE CAPACITORS

MMF	MMF	MMF	PRICE
14	50	125	\$5.00/100
15	51	180	
20	60	200	
27	62	240	
30	65	345	
47	82		

COAX CABLE

RG8/U
RG9/U
RG34/U
RG37/U
RG57/U

932 PHOTO TUBE

Gas Phototube having SI Response, particularly sensitive to Red and Near Infrared Radiation. Can be used with incandescent light source. Send for data. Price **75¢**



MICA CAPACITORS

CM-45—2500 V. TEST

MFD.	Price	MFD.	Price	MFD.	Price
.01	\$0.85	.0024	.60	.0075	.80
.015	.85	.0025	.60	.0076	.80
.02	.85	.0027	.60	.008	.80
.04	.85	.003	.60	.0085	.80
.081	.60	.004	.60	.009	.60
.0815	.60	.005	.60	.0095	.60
.082	.60	.0056	.60	.01015	.60
.0822	.60	.006	.60		
.0823	.60	.0063	.60		

CM-55—2500 V. TEST

MFD.	Price	MFD.	Price	MFD.	Price
.00001	\$0.29	.001	.35	.0075	1.79
.000025	.29	.0015	.35	.0076	1.79
.00003	.29	.0016	.35	.008	1.79
.00008	.29	.0017	.35	.01	1.10
.000075	.29	.002	.50	.015	1.10
.0001	.29	.0023	.50	.02	1.10
.00015	.29	.003	.50	.025	1.10
.00025	.29	.004	.79	.027	1.10
.0003	.29	.005	1.79	.03	1.10
.0004	.29	.006	1.79		
.0008	.35	.0063	1.79		
.00075	.35	.0069	1.79		
.0008	.35	.007	1.79		

UNIVERSAL SUPPLY KIT

Delivers 230V @ 40MA DC. From 110/220VAC 60 CY. Kit Consists of 1-PWR Transformer, 1-5 HY @ 40MA Choke, 2-B MFD @ 450V Filter Cond. **\$3.95**

INTERPHONE TRANSFORMER SET

Rig your own interphone. Kit consists of 1-Input Transformer (Matches 4 or 6 OHM SPKR to Grid) and 1-Output Transformer (Matches 50L6, 35L6, 25L6, etc., to 4 or 6 OHM Speaker Set) **\$1.00**

12-14V SUPPLY KIT

Delivers 12-14VDC at 3.5A from 115V, 60 cy. Kit contains 1-Transformer Rated 18.5V, 4A, 1-Selenium Rectifier, F. W. Bridge. **\$6.95**

24 VOLT TRANSFORMERS

For operating surplus gear, toy trains, gadgets, etc. Operates from 115V, 60 cy. sealed and cased. **A Great Buy at Only \$1.49**

RECTIFIER TRANSFORMERS

Pri: 115V, 60 Cy. Sec: 28V/3.1A, 26V/8.4A 7.3V/14A	\$12.95
Pri: 210/215/220/225/230/235/240V, 60 Cy., 1 Phase Sec: 11/10/7.5/5VGT @ 35A	\$19.50
Pri: 115V 60 Cy. Sec: 8.1V @ 1.5A	\$1.39
Pri: 115V 60 Cy. Sec: 18.5V @ 5A	\$4.25

FLEXIBLE COUPLING SHAFTS

MC 215
(ALL LENGTHS IN INCHES)
34 163 260
135 186

MC 124

(ALL LENGTHS SHOWN IN INCHES)

23	61	120	175
29	65	140	205
39	103	161	241
52	114	166	348

PRICE: MC 124 or MC 215

2¢ PER IN.

SELENIUM RECTIFIERS—Full-Wave Bridge Types

Current (Continuous)	18/14 Volts	36/28 Volts	54/42 Volts	130/100 Volts
1 Amp.	\$1.25	\$2.10	\$3.60	\$7.50
2 Amps.	2.20	3.60	6.50	10.50
2 1/2 Amps.				13.00
4 Amps.	3.75		8.75	
5 Amps.	4.95	7.95	12.95	27.00
6 Amps.	5.50	9.00	14.00	33.00
10 Amps.	6.75	12.00	20.00	40.00
12 Amps.	8.50	16.00	25.50	50.00
20 Amps.	13.25	24.00	36.00	90.00
24 Amps.	16.00	31.00	39.50	98.00
30 Amps.	18.50	36.00		
36 Amps.	25.50	45.00		

POWER TRANSFORMERS

Comb. Transformers—115V/50-60 cps Input		Price
CT-15A 2-600VCT/2A, 5V/6A	6.3V/1.8A	\$5.95
CT-16A 4200V .002A/12KV Test, 5VCT/3A/12KV Test, 6.3V/0.6A/5400V Test.	5 MA, 26V @ 4.5A	12.95
CT-341 1050 10 MA, 6.25V @ 3A	5 MA, 26V @ 4.5A	16.95
CR 825 360VCT .340A	6.3VCT/3.6	3.95
CT-626 1500V .160A	2.5/12, 30/100	9.95
CT-071 110V .200A	33/200, 5V/10, 2.5/10	4.95
CT-367 580VCT .050A	5VCT/3A	2.25
CT-39A 2x110VCT .010A	6.3/1A, 2.5VCT/7A	3.25
CT-403 350VCT .026A	5V/3A	2.75
CT-931 585VCT .086A	5V/3A, 6.3V/6A	4.25
CT-456 390VCT 30 MA	6.3V/1.3A, 5V/3A	3.45
CT-160 800VCT 100 MA	6.3V/1.2A, 5V/3A	4.95
CT-931 585VCT 86 MA	5V/3A, 6.3V/6A	4.99
CT-442 525VCT 75 MA	5V/2A, 10VCT/2A, 50V/200 MA	3.85
CT-720 550-0-550V/250 MA, 6.3V/1.8A		8.95
CT-43A 600-0-600V/.08A, 2.5VCT/6A, 6.3VCT/1A		6.49
CTT-501 650VCT/200 MA, 6.3V/8A, 6.3V/5A		6.49
CT-444 230-0-230V/.085A, 5V/3A, 6V/2.5A		3.49

Filament Transformers—115V50-60 cps Input		Price
ITEM	Rating	Each
FT-38A	6.3V/2.5A, 2.5V/7A, 2.5V/7A, 7500 VDC Test.	\$3.45
FT-674	8.1V/1.5A	1.10
FT-157	4V/36A, 2.5V/1.75A	2.95
FT-101	6V/25A	.79
FT-824	5.25V/21A, 2x7.75V/6.5A	14.95
FT-92A	2x26V/2.5A, 16V/1A, 7.2V/7A, 6.4V/10A, 6.4V/2A	8.95
FT-468	6.3VCT/1A, 5VCT/3A, 5VCT/3A	5.49
FT-55-2	7.2V/21.5A, 6.5V/6.85A, 5V/6A, 5V/3A	8.95
FT-986	18V @ 4.5A or 12V @ 4.5A	3.75
FT-38A	6.3/2.5A, 2x2.5V/7A	4.19
FT-A27	2.5V/2.5A, 7V/7A, TAP 2.5V/2.5A, 16KV Test.	18.95
FT-608	6.3V/3A/750V Test	1.79
FT-873	4.5V/5A, 7V/7A	2.19
FT-899	2x5V A 5A, 29KV Test.	24.50

Plate Trans.—115V, 60 cps		Price
ITEM	Rating	Each
PT-699	300/150V/.05A, 300/150V/.05A	\$2.79
PT-302	120-0-120V/350 MA	4.69
PT-108B	17,600V/14A MA	120.00
PT-671	62V/3.5A	7.95

Special Fil. Transformers—60 cps		Price	
Item	Pri. Volts	Secondaries	
STF-370	220/440	3x2.5V/5A, 3KV Test, 2.5V/15A	\$6.95
STF-11A	220V	2x40V/.05A, 2x5V/6A	4.49
STF-608	220V	24V/0.6A, 5V/3A, 6.3V/1A, 6.3V/1A	3.45
STF-968	230V	2.5V/6.5A	3.50
STF-631	230V	2x5V/27A, 2x5V/9A	17.59

Special Plate Transformers—60 cps		Price	
Item	Pri. Volts	Secondaries	
STP-613	230V	230/.05A, 230V/.05A	\$1.79
STP-409	220/440V	136VCT/3.5A	5.69
STP-815	240/440, 3ph	1310V/.67A, 6KV Test.	27.50
STP-129	230V	3850V/3.12KVA	42.59
STP-823	137V	222VCT/0.1A	2.35
STP-08B	50V	2x750V/0.01A	1.79
STP-622	210/220/230	5000V/1A	59.75
STP-945	210/220/230	550-0-550V/3A	5.95

Special Comb. Transformers—60 cps		Price	
Item	Pri. Volts	Secondaries	
STC-16A	220V	260V/.03A, 300V/1A, 6.3V/4.2A	\$4.69
STC-609	220V	220V/3A	6.95

CIRCUIT BREAKERS

AM 1614—80: 28VDC 80 AMP	\$1.59
AM 1614—100: 28VDC 100 AMP	\$1.69
KJ—600V, 115 AMPS, UP TO 100% OVERLOAD RATING. TRIP ADJ. 10 MIN.—INST.	\$21.95

DYNAMOTORS

Type	Input Volts	Input Amps	Output Volts	Output Amps	Radio Set
PE86	1.25	250	1.5	50	RC 36
DM416	14	6.2	330	.170	RU 19
DM33A	13/26	7	540	.250	BC 456
PE101C		12.6	400	.135	SCR 515
		6.3	800	.020	
Bd AR 93	28	3.25	375	.150	
23350	27	1.75	285	.075	
ZA0515	12/24	4/2	500	.050	APN-1
B-19 pack	12	9.4	275	.110	MARK 11
			150	.100	
D-104	12		225	.100	
			440	.200	
DA-3A	28	10	300	.060	SCR 522
			150	.010	
			14.5	.5	
5053	28	1.4	250	.050	APN-1
PE73CM	28	19	1000	.350	BC 376
CW21AAX	13	12.6	400	.030	
		6.3	800	.020	
			9	1.12	
PE94	28	10	350	.101	SCR 522
			150	.01	
			14.5	.5	

INVERTERS

PE-218-H: Input 25 28 VDC, 92 amp. Output: 115 v. 350 500 cy 1500 volt-amperes. New \$44.50
PE-206: Input 28 Vdc, 38 amps. Output: 80 v 800-cy. 500 volt-amps. Dim: 13"x5"x3 1/4". New \$22.50
LELAND No. 10536: IN: 28 VDC, 12A. OUT: 115V, 115VA, 400 CY 3 PHASE. EXC. COND. \$70.00

This Month's Special

PHASE-SHIFTING HELMHOLTZ COILS 0-360 DEGREES	\$3.95
BLEEDER RESISTOR, TYPE-HA, 3000 OHM—25W 7500 OHM—5W, 23 OHM—1W, 23 OHM—1W WITH MTG. BRACK.	.69¢
SA4A/APA-1 Motor Driven Coaxial Ant. Switch DPDT, Continuous Operation from 24VDC. Completely Enclosed.	\$24.50
MP-22 MAST Base Mobile Antenna Mount SA1A/APN-1 Altitude Limit Switch for APN-1 Altimeter	4.59
ALTITUDE INDICATOR for APN-1	7.95
C-387-D Final P.A. Coll for BC610 2-3.5 MC. Variable Link.	12.50
RA-74 Power Supply for Super Pro J-17/ARC-5 Junction Box for ARC-5. J-22/ARC-5 Junction Box	4.89
SUPERSONIC CRYSTALS, Rochelle salt.	69.50
MOTOR, 24vdc, 3 HP 3800 rpm, New	75.00
TV LEAD-IN WIRE, 300 ohms, HI-6	
Lo-Loss 10 Ohms	\$17.50/M FT Roll
BC 306 ANTENNA TUNING UNIT, NEW	6.95
R9/APN-4, New, With Tubes	75.00
ID6/APN-4, New, With Tubes and Crystal	75.00
A-62 Phantom Antenna	8.50
Z Meter Choke, 100 MA, 20-144	1.00
Supersonic Crystal Head, M-1, 22-27KC HI-2	27.45

FILTER CHOKES

Stock	Description	Price
CH-366	20H/3A	\$6.95
CH-322	35H/350 MA	
	10 Ohms	
CH-141	Dual 7H/75 MA, 11H/60 MA, 5KV DC Test.	2.75
CH-119	8.5H/12 MA	4.69
CH-69-1	Dual: 120H/17 MA	2.79
CH-8-35	2 / .5H/380 MA/25 Ohms 1.79	2.35

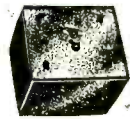

Stock	Description	Price
CH-776	1.28H/130 MA/75 ohms	\$2.25
CH-344	1.5H/145MA/1200V Test	2.35
CH-43A	10H/1515MA—850 ohms DCR	1.75
CH-366	20H/300MA	6.95
CH-999	15H/15MA—400 ohms DCR	1.95
CH-511	6H/80MA—310 ohms DCR	2.45
CH3-501	2 x .5H/40	

COMMUNICATIONS EQUIPMENT CO.

PULSE EQUIPMENT



H/I-Volt Pulse Bulkhead, Feed-thru. Fits UG-38 Connector—as shown \$15.00
APQ-13 PULSE MODULATOR. Pulse Width .5 to 1.1 Micro Sec. Rep. rate 624 to 1348 Pps Pk Pwr out 35 KW Energy 0.018 Joules. \$49.00
TPS-3 PULSE MODULATOR. Pk power 50 amp. 24 KW (1200 KW pk); pulse rate 200 PPS. 1.5 microsec. pulse line impedance 50 ohms. Circuit series charging version of DC Resonance type. Uses two 705-A's as rectifiers. 115 v. 400 cycle input. New with all tubes \$49.50

PULSE TRANSFORMERS

G.E. # K2731 Repetition Rate: 635 PPS. Pri. Imp: 50 Ohms. Sec. Imp: 450 Ohms. Pulse Width: 1 Microsec. Pri. Input: 9.5 KV P.K. Sec. Output: 28KV P.K. Peak Output: 800 KW Biflar 2.75 Amp. \$65.00
 U-10198 Pri: 4-5KV, 97A P.K. Sec: 18KV, 26A, PTR-350-500 Cy. Duration 1.3 usec. \$42.50
 D-166173: Video. Ratio = 50:900 Ohms 10KC-2MC \$39.50
 G.E.K.-2745 \$39.50
 G.E.K.-2744-A. 11.5 KV High voltage. 3.2 KV Low voltage @ 200 KW oper. (270 KW max.) 1 microsec. or 1 microsec. @ 600 PPS. \$39.50
 W.E. D169271 Hi Volt input pulse Transformer. \$27.50
 G.E. K2450A. Will receive 13KV, 4 micro-second pulse on pri. secondary delivers 14KV. Peak power out 100 KW G. E. \$34.50
 G. E. K2748A. Pulse Input line to magnetron. \$36.00
 Ray UX 7886—Pulse Output Pri. 5v. sec. 41v. \$7.50
 Ray UX 8442—Pulse Inversion—40v + 40v. \$7.50
 RAY UX7361 \$5.00
 PHILCO 352-7250, 352-7251, 352-7287
 UTAH 9332, 9278, 9341.
 RAYTHEON: UX8693, UX5986 \$5 ea.
 W.E.: D-166310, D-16638, KS 9800, KS9948.

DELAY LINES

D-168184: 0.5 microsec. up to 2000 PPS 1800 ohm term \$4.00
 D-170499: 25/50/75 microsec. 8 KV 50 ohms imp. \$16.50
 D-165997: 1 1/4 microsec. \$7.50
 RCA 255686-502, 2.2μ sec. 1400 ohms. \$2.00

PULSE NETWORKS

G.E. #6E3-5-2000-50P2T. 6KV "E" circuit, 3 sections, 5 microsecond, 2000 PPS 50 ohms impedance. \$6.50
 15A-1-400-50: 15 KV, "A" CKT. 1 microsec. 400 PPS. 50 ohms imp. \$37.50
 G.E. #3E (3-84-810) (8-2-24-405) 5014T. 3KV "E" CKT Dual Unit; Unit 1, 3 sections, 0.84 microsec. 310 PPS. 50 ohms imp; Unit 2, 8 sections, 2.24 microsec. 405 PPS. 50 ohms imp. \$6.30
 7-5E3-1-200-67P. 7.5 KV. "E" Circuit, 1 microsec. 200 PPS. 67 ohms impedance 3 sections. \$7.50
 7-5E3-3-200-67T. 7.5 KV. "E" Circuit, 3 microsec. 200 PPS. 6 ohms imp. 3 sections. \$12.50
 #754: 10KV, 2.2usec., 375 PPS. 50 ohms imp. \$27.50
 #754: 10KV, 0.85usec., 750 PPS. 50 ohms imp. \$27.50
 KS8865 Charging Choke: 115-150HI @ .02A, 32-40TI @ .08A, 30.700V Corona. 21KV Test. \$37.50
 G.E. 25E5-1-350-50 P2T. "E" CKT. 1 Microsec. Pulse @ 350 PPS. 50 ohms impedance. \$69.50

TEST EQUIPMENT

- Signal Gen. RCA 710A, 370-550 MC. \$350.00
- Signal Gen. 20A Microvolt. \$175.00
- TS 10A Altimeter Test Set. \$32.50
- TS 16/AP Altimeter Test Set
- TS 36 Power Meter, 3 CM.
- TS 47/APR Test Osc. 50-3000 MC. \$325.00
- TS 56/AP Slotted Line, 500 MC. \$325.00
- TS 127/UP Wavemeter, 300-700 MC. \$72.50
- TS 69/AP Wavemeter, 340-1000 MC. \$72.50
- TS 70/AP Pwr. Meter, 200-800 MC
- TS 110/AP Echo Box, 2400-2700 MC

THERMISTORS VARIATORS

D167018. \$1.50	D171812. \$1.50
D167332. 1.50	D172155. 1.50
D167613. 1.50	D167176. 1.50
D166228. 1.50	D168687. 1.50
D164699. 2.50	D167208E. D171858. 1.50
D163903. 1.95	308A, 27-B. 1.50
D166792. 2.15	D168403. 2.15

MICROWAVE COMPONENTS

S BAND—3" x 11 1/2" W.G. 10 CM.

DIRECTIONAL COUPLER. Broadband. 20 db. Coupling. Type "N" Tapped. Complete with all Hardware. Navy # CABY-47AAN-2. \$37.50
WAVEMETER 2700-3400 MC. Reaction Type with counter Dial—Mfg. W.E. \$92.50
REACTION WAVEMETER, Mfg. G.E. 3000-3700 MC. Mfg. Head. \$125.00
LHT LIGHTHOUSE ASSEMBLY. Part of RT39 APG 5 & APG 15. Receiver and Trans. Cavities w/assoc. Tr. Cavity and Type N CPLG. To Recv. Uses 2C40, 2C43, 1B27. Tunable A1X 2400-2700 MCS. Silver Plated. \$49.50
BEACON LIGHTHOUSE cavity 10 cm. Mfg. Bevacor. \$47.50
MAGNETRON TO WAVEGUIDE Coupler with 721A Duplexer Cavity, gold plated. \$45.00
RT-39/APG-5 10 cm. lighthouse RF head c/o Xnutr. Recv. TR cavity, compl. recv. & 30 MC IF strip using 6AK5 (2040, 2C43 1B27 lineup) w/Tubes. \$12.50
721A TR BOX complete with tube and tuning plug. \$12.50
McNALLY KLYSTRON CAVITIES for 707R or 2K38. \$4.00
F 29/SPR-2 FILTERS, type "N" input and output III-Pass Over 1000 MC. \$12.50
WAVEGUIDE TO 7/8" RIGID COAX "DOORKNOB" adapter choke flange. \$32.50
AS14A/AP-10 CM Pick up Dipole with "N" Cables. \$4.50
OA J ECHO BOX, 10 CM TUNABLE. \$22.50
HOMEDELL-TO-TYPE "N" Male Adapters. \$2.75
I. F. AMP STRIP, 30 MC 120 db. gain. 2 MC Bandwidth. uses 6ACT9s—with video detector. Less tubes. \$24.50
POLYROID ANTENNA, AS31/APN-7 in Lucite Ball. Type "N" feed. \$22.50
ANTENNA, AT49A/APR: Broadband Conical. 300 MC Type "N" Feed. \$12.50
"E" or "H" PLANE BENDS, 90 Deg. less flanges. \$7.50
COAXIAL FILTER, F3/APR-2. LO-PASS, BELLOW 400 MC. \$32.50

7/8" RIGID COAX—3/8" I. C.

ROTARY JOINT, Stub-supported, UG 46/UG 45 fittings. \$27.50
10 CM STABILIZER Cavity, tunable, standard UG46/UG 45 fittings. \$30.00
RG 44/U RIGID COAX, stub support, 5 ft. sections, with UG46/UG45 connectors. \$12.50
RT. ANGLES for above. \$4.50
RIGHT ANGLE BEND, with flexible coax output pick-up loop. \$8.00
SHORT RIGHT ANGLE BEND, with pressurizing nipple. \$3.00
RIGID COAX to flex coax connector. \$3.50
RT. ANGLE BEND 15" L. OA. \$3.50
FLEXIBLE SECTION, 15 L. Male to female. \$1.25
7/8" RIGID COAX. BULKHEAD FEED-THRU. \$14.00

X BAND—1" x 1/2" W.G. 3 CM.

CROSS-GUIDE COUPLER. Main Section 7" long with 90 deg. bend (E-Plane). 2 1/2" radius. Broadbanded coupling figure is 20 db. Individually calibrated. \$22.50
1" x 1/2" waveguide in 5' lengths. 100 30 flange to UG40 cover. \$7.50
Rotating joints supplied either with or without deck mounting. With UG40 flanges. each \$17.50
Bulkhead Feed-thru Assembly (As Shown) \$15.00
Pressure Gauge Section 15 lb. gauge and brass nipple. \$15.00
Pressure Gauge, 15 lbs. \$2.50
Waveguide Section 12" long choke to cover 45 deg. twist & 2 1/2" radius, 90 deg. bend. \$4.50
Twist 90 deg. 5" choke to cover w/pres nipple. \$6.50
Waveguide Section 2 1/2 ft. long silver plated with choke flange. \$5.75
Rotary joint choke to choke with deck mounting. \$12.50
3 cm. miter elbow "E" plane. \$12.00
UG 39 Flanges. \$.85
90 degree elbows, "E" or "H" plane 2 1/2" radius. \$12.50
45 degree twist \$8.00
APS-4 Under Belly Assembly, less tubes. \$375.00

MICROWAVE RECEIVER, 3 CM.

SENSITIVITY: 10-13 MICROWATT COMPLETE WITH L.O. AND AFC MIXER AND WAVEGUIDE INPUT CIRCUITS. 6 I.F. STAGES GIVE APPROXIMATELY 120 DB GAIN AT A BANDWIDTH OF 1.7 MC. VIDEO BANDWIDTH: 2 MC. USES LATEST TYPE AFC CIRCUIT. COMPLETE WITH ALL TUBES, INCLUDING 723A/B LOCAL OSCILLATOR \$175.00

K BAND—1/2" x 1/4" W.G. 1.25CM.

APS-3 Rotating joint. \$49.50
Right Angle Bend E or H Plane, specify combination of couplings desired. \$12.00
45° Bend E or H Plane, choke to cover. \$12.00
Mitered Elbow, choke to cover. \$4.00
TR-ATR-Section, choke to cover. \$3.00
Flexible Section 1" choke to choke. \$5.00
"S" Curve Choke to cover. \$1.50
Adapter, round to square cover. \$5.00
Feedback to Parabola Horn with pressurized window. \$27.50
90° Twist \$10.00

MAGNETRONS

Tube	Tube	Tube
2J27	2J49	7Z08Y
2J31	2J61	7Z5-A
2J21	700	730-A
2J22	706	OK 62
2J26	2J62	OK 61
2J32	3J31	OK 60
2J37	5J30	2J56
2J38	718DY	2J32
2J39		

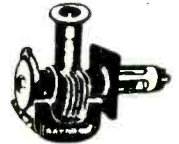

400 CYCLE TRANSFORMERS

(All Primaries 115V, 400 Cycles)

Stock	Ratings	Price
352-7039	640VCT @ 380MA, 6.3V/.9A, 6.3V/.6A, 5V/.6A	\$5.49
702724	9800/8600 @ 32MA	8.95
12013	4540V/250MA	17.50
K59584	5000V/290 MA, 5V/10A	22.50
52J652	13,500V/3.5MA	14.65
K59507	73VCT/177A, 1710VCT/.177A	6.79
352-7273	700VCT/350MA, 6.3V/0.9A, 6.3V 2.5A 6.3V/.06A, 5V/CA	6.95
352-7070	2X2.5V/2.5A (2KV TEST) 6.3V/2.25A, 1200/1000/75 OV @ .005A	7.45
352-7196	1140V/1.25MA, 2.5V/1.75A, 2.5V/1.75A	3.95
352-7176	320VCT/50MA, 4.5V/3A, 6.3VCT/20A, 2X6.3VCT/6A	4.75
RA6400-1	2.5V/1.75A, 6.3V/2A—5KV Test	2.39
901692	13V 9A	2.49
901698-501	2.7V @ 4.25A	3.45
901698-501	900V/75MA, 100V/.04A	4.29
UX8855C	900VCT/.067A, 5V/3A	3.79
RA6405-1	800VCT/65MA, 5VCT/3A	3.69
T-48852	700VCT/80MA, 5V/3A, 6V/1.75A	4.25
352-7098	2500V/6MA, 300 VCT, 135MA	5.95
KS 9336	1100V/50MA TAPPED 6.25V 2.5V/5A	3.95
M-7474319	6.3V/2.7A, 6.3V/.66A, 6.3VCT/21A	4.25
KS 8984	27V/4.3A, 6.3/2.9A, 1.25V/.02A	2.95
52C080	525VCT/50MA, 6.3VCT/2A, 5VCT/2A	3.75
32332	400VCT/35MA, 6.4V/2.5A, 6.4V/.15A	3.75
68C631	115V-0-1150V	2.85
80G198	6VCT/.0006 KVA	1.75
302433A	6.3V/9.1A, 6.3VCT/6.5A, 2.5V/3.5A, 2.5V/3.5A	4.85
KS 9445	592VCT/118MA, 6.3V/8.1A, 5V/2A	5.39
KS 9685	6.4/7.5A, 6.4V/3.8A, 6.4V/2.5A	4.79
	ALL CT	
70C30G1	600VCT/35MA	2.65
M-7474318	2100V/.027A	4.95
95-G-45	2000V/.025A, 465V/.6A, 44V/10A, 6.3V/23.5A, 6.3V/1.8A, 5V/9A, 2X2.5V/1.75	17.95
TRANSTAT INI:	115V, 400 CY.	12.95
	OUT: 75 120V, 6.0 Amps.	
M-7467886	2X140V/.014A, 120V/.012A, 1200VRMS Test. P/O MX-8/APG-2	4.95
352-7102	6.3V/2.5A	1.45
M-7472426	1450V/1 MA. 2.5V/1.75A, 6.4V/3.9A, 5V/2A, 6.5V/.3A P/O 1D-39/APG-13	4.95

MICROWAVE ANTENNA EQUIPMENT



AT49A/APR—Broadband Conical. 300-3300 MC. Type N Feed. (AS SHOWN) \$12.50
AS-31/APN-7: 10 cm Polyrind in Lucite Ball. Type "N" Fitting Coax Feed. \$22.50
Relay System Parabolic reflectors approx. range 2400 to 6000 Mc. Dimensions 4 1/2" x 3". New. \$100.00
Dipole for above. \$12.00
TDY "JAM" Radar rotating antenna, 10 cm. 30 deg. beam. 115 V AC drive. New. \$150.00
Parabolic Peel. Radiation pattern approx. 25 deg. in horizontal 33 deg. in vertical planes. \$35.00
Cone Antenna, AS 125 APR. 1000-3200 mc. Stub supported with type "N" connector. \$14.50
AS14A/AP, 10 CM pick up dipole assy, complete w/length of coax and "N" connectors. \$33.50
AS46A/APG-4 Yagi Antenna, 5 element arr. \$22.50
30" Parabolic Reflector Spun Aluminum dish. \$4.85

RADAR ANTENNAS

AS-12/APG-3	AS-125/APR
AS-17/APG-2	AS-217/APG-15
AS-13/APG-2	AT49/APR
AS69/APT	AS-14/AP

30' SIGNAL CORPS RADIO MASTS

Complete set for erection of a full flat top antenna. Of rugged plywood construction telescoping into 3 ten-foot sections for easy storage and transportation. A perfect set-up for setting out. Supplied complete: 2 complete masts, hardware, shipping crate. Shipping wt. approx. 300 lbs. Sig. Corps No. 2A289-223-A. New \$19.50 per set

MAIL ORDERS PROMPTLY FILLED. ALL PRICES F.O.B. NEW YORK CITY. SEND M.O. OR CHECK ONLY SHIPPING SENT C.O.D. RATED CONCERNS SEND P. O. ALL MDSE SUBJECT TO PRIOR SALE, AND PRICES SUBJECT TO CHANGE WITHOUT NOTICE. PARCELS IN EXCESS OF 20 POUNDS WILL BE SHIPPED VIA CHEAPEST TRUCK OR RAIL

131 Liberty St., New York 7, N. Y. Dept E-3 Chas. Reson Phone: Dlgby 9-4124

Wilgreen Industries

99 MURRAY ST., NEW YORK 7, N. Y.
 WOrth 4-2490-1-2

48 Hour Delivery on AN PROMPT Service on UG

We carry a complete and diversified stock of "AN" connectors at all times and are in a position to make deliveries within 48 hours, thereby eliminating all unnecessary stoppages due to the lack of "AN" connectors.

Many manufacturers have come to depend upon our prompt deliveries of AN & UG connectors from stock, without delay.

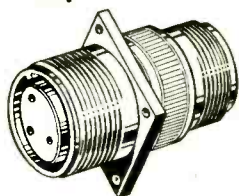

AN 3100 A/B

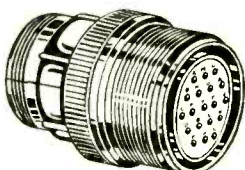

AN 3101 A/B

"UG" CONNECTORS "UG"

TYPE	TYPE	TYPE	TYPE	TYPE
UG 9/U	UG 46/U	UG 115/U	UG 234/U	UG 348/U
UG 10/U	UG 49/U	UG 119 U/P	UG 235/U	UG 349/U
UG 11/U	UG 50/U	CW 123 A/U	UG 236/U	UG 352/U
UG 12/U	UG 57/U	UG 131/U	UG 237/U	M 584
UG 13/U	UG 57 B/U	UG 146/U	SO 239	MT 359A
UG 14/U	UG 58/U	UG 148 A/U	UG 241/U	MT 412
UG 15/U	UG 58 A/U	UG 149 A/U	UG 242/U	UG 414/U
UG 16/U	UG 59/U	UG 154/U	UG 243/U	UG 419/U
UG 17/U	UG 59 A/U	CW 155/U	UG 244/U	UG 421/U
UG 18/U	UG 60/U	UG 155/U	UG 245/U	UG 422/U
UG 18 A/U	UG 60 A/U	UG 156/U	UG 246/U	UG 423/U
UG 18 B/U	UG 61/U	UG 157/U	UG 249/U	UG 478/U
UG 19/U	UG 61 A/U	UG 158/U	UG 250/U	UG 479/U
UG 19 A/U	UG 63/U	CW 159/U	UG 251/U	UG 482/U
UG 19 B/U	UG 65/U	UG 159 A/U	UG 252/U	UG 484/U
UG 20/U	UG 66/U	UG 160 A/U	UG 253/U	UG 486/U
UG 20 A/U	UG 67/U	UG 160 B/U	UG 254 A/U	UG 487/U
UG 20 B/U	UG 68/U	UG 166/U	UG 255/U	UG 491/U
UG 21/U	UG 82 A/U	UG 167/U	UG 256/U	UG 492/U
UG 21 A/U	UG 85/U	UG 167 A/U	UG 257/U	UG 493/U
UG 21 B/U	UG 90/U	UG 173/U	PL 258	UG 494/U
UG 21 C/U	UG 91/U	UG 174/U	PL 259	UG 495/U
UG 21 D/U	UG 91 A/U	UG 175/U	PL 259 A	UG 496/U
UG 22/U	UG 92/U	UG 176/U	UG 259/U	UG 499/U
UG 22 A/U	UG 92 A/U	UG 180 A/U	UG 260/U	UG 503/U
UG 22 B/U	UG 93/U	UG 181 A/U	UG 261/U	UG 504
UG 22 C/U	UG 93 A/U	UG 182 A/U	UG 260 A/U	UG 505/U
UG 23/U	UG 94/U	UG 185/U	UG 262/U	UG 506/U
UG 23 A/U	UG 94 A/U	UG 188/U	UG 266/U	UG 507/U
UG 23 B/U	UG 95/U	MX 195/U	UG 269/U	UG 526/U
UG 23 C/U	UG 95 A/U	UG 197/U	UG 270/U	UG 530/U
UG 27 A/U	UG 96/U	UG 201/U	UG 271/U	UG 531/U
UG 27 B/U	UG 96 A/U	UG 202/U	UG 272/U	UG 532/U
UG 28/U	UG 97/U	UG 203/U	UG 273/U	UG 533/U
UG 28 A/U	UG 97 A/U	UG 204 A/U	UG 274/U	UG 535/U
UG 28 B/U	UG 98/U	UG 206/U	PL 274	UG 536/U
UG 29/U	UG 98 A/U	UG 207/U	UG 275/U	UG 541/U
UG 29 A/U	UG 100/U	UG 207 A/U	UG 276/U	MX 544
UG 29 B/U	UG 100 A/U	UG 212 A/U	UG 278/U	UG 547/U
UG 30/U	UG 101/U	UG 213 A/U	UG 286/U	MX 564/U
UG 32/U	UG 101 A/U	UG 215/U	UG 287/U	UG 568/U
UG 33/U	UG 102/U	UG 216/U	UG 290/U	UG 571/U
UG 34/U	UG 106/U	UG 217/U	UG 291/U	UG 572/U
UG 35 A/U	UG 107 A/U	UG 218/U	UG 294/U	UG 573/U
UG 36/U	UG 107 B/U	UG 219/U	UG 295/U	UG 574/U
UG 37/U	UG 108/U	UG 220/U	UG 306/U	UG 575/U
UG 37 A/U	UG 108 A/U	UG 222/U	UG 309/U	UG 627/U
UG 38 A/U	UG 109/U	UG 223/U	UG 333/U	UG 628/U
UG 39/U	UG 109 A/U	UG 224/U	UG 334/U	UG 634/U
UG 40/U	UG 110/U	UG 224/U	UG 335/U	MX 913/U
UG 45/U	UG 114/U	UG 233/U	UG 347/U	

"AN" CONNECTORS "AN"

851P	165-6P	18-18P	20-15P	22-12P
851S	165-6S	18-18S	20-15S	22-12S
105-2P	16-7P	18-19P	20-16P	22-13P
105-2S	16-7S	18-19S	20-16S	22-13S
105L-3P	165-8P	18-20P	20-17P	22-14P
105L-3S	165-8S	18-20S	20-17S	22-14S
105L-4P	16-9P	18-21P	20-18P	22-15P
105L-4S	16-9S	18-21S	20-18S	22-15S
105L-656P	16-10P	18-22P	20-19P	22-16P
105L-656S	16-10S	18-22S	20-19S	22-16S
125-1P	16-11P	18-23P	20-20P	22-17P
125-1S	16-11S	18-23S	20-20S	22-17S
125-2P	16-12P	18-24P	20-21P	22-18P
125-2S	16-12S	18-24S	20-21S	22-18S
125-3P	16-13P	18-25P	20-22P	22-19P
125-3S	16-13S	18-25S	20-22S	22-19S
125-4P	165-14P	18-26P	20-23P	22-20P
125-4S	165-14S	18-26S	20-23S	22-20S
12-5P	16-15P	18-27P	20-24P	22-21P
12-5S	16-15S	18-27S	20-24S	22-21S
125-6P	16-16P	18-28P	20-25P	22-22P
125-6S	16-16S	18-28S	20-25S	22-22S
145-1P	165-17P	18-29P	20-26P	22-23P
145-1S	165-17S	18-29S	20-26S	22-23S
145-2P	18-1P	18-30P	20-27P	22-24P
145-2S	18-1S	18-30S	20-27S	22-24S
14-3P	18-2P	18-31P	20-28P	22-25P
14-3S	18-2S	18-31S	20-28S	22-25S
145-4P	18-3P	18-404P	20-29P	22-27P
145-4S	18-3S	18-404S	20-29S	22-27S
145-5P	18-4P	20-1P	20-30P	22-28P
145-5S	18-4S	20-1S	20-30S	22-28S
145-6P	18-5P	20-2P	20-31P	22-29P
145-6S	18-5S	20-2S	20-31S	22-29S
145-7P	18-6P	20-3P	20-32P	22-30P
145-7S	18-6S	20-3S	20-32S	22-30S
145-9P	18-7P	20-4P	20-33P	22-31P
145-9S	18-7S	20-4S	20-33S	22-31S
145-10P	18-8P	20-5P	22-1P	22-32P
145-10S	18-8S	20-5S	22-1S	22-32S
145-11P	18-9P	20-6P	22-2P	22-33P
145-11S	18-9S	20-6S	22-2S	22-33S
145-12P	18-10P	20-7P	22-3P	22-34P
145-12S	18-10S	20-7S	22-3S	22-34S
145-13P	18-11P	20-8P	22-4P	22-35P
145-13S	18-11S	20-8S	22-4S	22-35S
145-14P	18-12P	20-9P	22-5P	22-36P
145-14S	18-12S	20-9S	22-5S	22-36S
165-1P	18-13P	20-10P	22-6P	22-37P
165-1S	18-13S	20-10S	22-6S	22-37S
16-2P	18-14P	20-11P	22-8P	22-404P
16-2S	18-14S	20-11S	22-8S	22-404S
165-3P	18-15P	20-12P	22-9P	24-1P
165-3S	18-15S	20-12S	22-9S	24-1S
165-4P	18-16P	20-13P	22-10P	24-2P
165-4S	18-16S	20-13S	22-10S	24-2S
165-5P	18-17P	20-14P	22-11P	24-3P
165-5S	18-17S	20-14S	22-11S	24-3S

"AN" CONNECTORS "AN"

24-4P	28-2P	28-840P	36-2P	40-5P
24-4S	28-2S	28-840S	36-2S	40-5S
24-5P	28-3P	28-852P	36-3P	40-6P
24-5S	28-3S	28-852S	36-3S	40-6S
24-6P	28-4P	28-880P	36-4P	40-7P
24-6S	28-4S	28-880S	36-4S	40-7S
24-7P	28-5P		36-5P	40-8P
24-7S	28-5S		36-5S	40-8S
24-9P	28-6P	32-1P	36-6P	40-9P
24-9S	28-6S	32-1S	36-6S	40-9S
24-10P	28-7P	32-2P	36-7P	40-10P
24-10S	28-7S	32-2S	36-7S	40-10S
24-11P	28-8P	32-3P	36-8P	40-11P
24-11S	28-8S	32-3S	36-8S	40-11S
24-12P	28-9P	32-4P	36-9P	40-12P
24-12S	28-9S	32-4S	36-9S	40-12S
24-125	28-9S	32-5P	36-10P	40-13P
24-14P	28-10P	32-5S	36-10S	40-13S
24-14S	28-10S	32-6P	36-11P	40-14P
24-15P	28-11P	32-6S	36-11S	40-14S
24-15S	28-11S	32-7P	36-12P	44-1P
24-16P	28-12P	32-7S	36-12S	44-1S
24-16S	28-12S	32-8P	36-13P	44-2P
24-17P	28-13P	32-8S	36-13S	44-2S
24-17S	28-13S	32-9P	36-14P	44-3P
24-18P	28-14P	32-9S	36-14S	44-3S
24-18S	28-14S	32-10P	36-15P	44-4P
24-19P	28-15P	32-10S	36-15S	44-4S
24-19S	28-15S	32-12P	36-16P	44-5P
24-20P	28-16P	32-12S	36-16S	44-5S
24-20S	28-16S	32-13P	36-17P	44-6P
24-21P	28-17P	32-13S	36-17S	44-6S
24-21S	28-17S	32-14P	36-18P	48-1P
24-22P	28-18P	32-14S	36-18S	48-1S
24-22S	28-18S	32-15P	36-19P	48-2P
24-23P	28-19P	32-15S	36-19S	48-2S
24-23S	28-19S	32-16P	36-20P	48-3P
24-24P	28-20P	32-16S	36-20S	48-3S
24-24S	28-20S	32-17P	36-21P	48-4P
24-25P	28-21P	32-17S	36-21S	48-4S
24-25S	28-21S	32-18P	36-22P	48-5P
24-26P	28-22P	32-18S	36-22S	48-5S
24-26S	28-22S	32-19P	36-23P	48-6P
24-27P	28-23P	32-19S	36-23S	48-6S
24-27S	28-23S	32-20P	36-24P	3057-3
24-28P	28-24P	32-20S	36-24S	3057-4
24-28S	28-24S	32-21P	36-25P	3057-5
24-29P	28-25P	32-21S	36-25S	3057-6
24-29S	28-25S	32-22P	36-26P	3057-7
24-30P	28-26P	32-22S	36-26S	3057-8
24-30S	28-26S	32-23P	36-27P	3057-9
24-31P	28-27P	32-23S	36-27S	3057-10
24-31S	28-27S	32-24P	36-28P	3057-11
24-32P	28-28P	32-24S	36-28S	3057-12
24-32S	28-28S	32-25P	36-29P	3057-12-6
24-33P	28-29P	32-25S	36-29S	3057-16
24-33S	28-29S	32-26P	36-30P	3057-20
24-34P	28-30P	32-26S	36-30S	3057-24
24-34S	28-30S	32-27P	36-31P	40-2P
24-35P	28-31P	32-27S	36-31S	40-2S
24-35S	28-31S	32-28P	36-32P	3057-28
24-36P	28-32P	32-28S	36-32S	3057-32
24-36S	28-32S	32-29P	36-33P	3057-40
24-37P	28-33P	32-29S	36-33S	
24-37S	28-33S	32-30P	36-34P	
24-38P	28-34P	32-30S	36-34S	
24-38S	28-34S	32-31P	36-35P	
24-39P	28-35P	32-31S	36-35S	
24-39S	28-35S	32-32P	36-36P	
24-40P	28-36P	32-32S	36-36S	
24-40S	28-36S	32-33P	36-37P	
24-41P	28-37P	32-33S	36-37S	
24-41S	28-37S	32-34P	36-38P	
24-42P	28-38P	32-34S	36-38S	
24-42S	28-38S	32-35P	36-39P	
24-43P	28-39P	32-35S	36-39S	
24-43S	28-39S	32-36P	36-40P	
24-44P	28-40P	32-36S	36-40S	
24-44S	28-40S	32-37P	36-41P	
24-45P	28-41P	32-37S	36-41S	
24-45S	28-41S	32-38P	36-42P	
24-46P	28-42P	32-38S	36-42S	
24-46S	28-42S	32-39P	36-43P	
24-47P	28-43P	32-39S	36-43S	
24-47S	28-43S	32-40P	36-44P	
24-48P	28-44P	32-40S	36-44S	
24-48S	28-44S	32-41P	36-45P	
24-49P	28-45P	32-41S	36-45S	
24-49S	28-45S	32-42P	36-46P	
24-50P				

Checked-Tested and APPROVED

It has to be right! . . . when it's from Semler. Semler is one of the leading suppliers of precision test equipment to the aircraft industry. Semler is a recognized and approved source of supply for many foreign and U.S. Government agencies.

... WHEN IT'S FROM

Recording Theodolite PHB-33 (Spotting Set PH-32)

ORIGINAL APPLICATION

To analyze effectiveness of anti-aircraft fire by accurate "three dimensional" determination of shell burst position with respect to the target.

PRESENT APPLICATIONS

1. To determine accurate "landing and take-off" measurements in aircraft flight test work. By placing these units at points from 1,000 to 3,000 feet normal to the center line of a runway, this "photographic recording theodolite" provides an accurate film record of azimuth and elevation of the position of the airplane on both take-off and landing. Since the distance of the theodolite from the runway is a known factor, all other distances can then be computed by the method of triangulation.

2. The "recording theodolite" also provides a rapid method for measuring acceleration and deceleration of airplanes in acceleration and stop tests.

3. For tracking of missiles at relatively low altitudes up to 8,000 feet. By modification to a 20" lens, the "recording theodolite" may be used for tracking missiles or target planes from 20,000 feet to 25,000 feet.

4. If modified to a 20" lens, the theodolite may be used for photographing airplane spin tests at these same high altitudes.

DESCRIPTION

Each theodolite is a complete unit consisting of a built-in motion picture camera, camera magazine, sighting telescope, lamps, controls, gearing and associated mechanisms necessary for operation. Junction boxes, cords, timing interval devices, time interval multiplier, and time interval signal units are supplied with each theodolite.

Further technical information is available upon request.

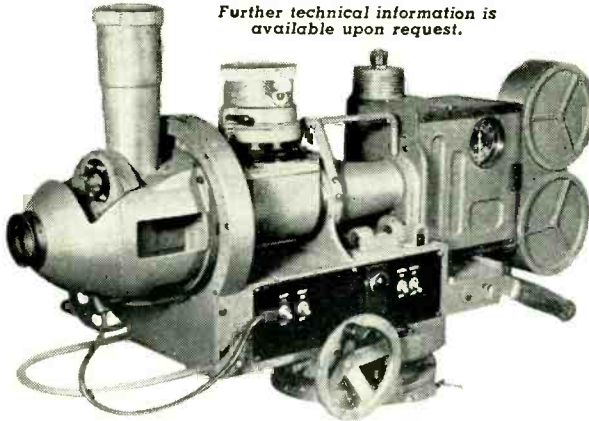

Aircraft and Instrument Inverters

800-1 Inverter Input: 24V DC—75 Amp. Output: 115 V AC 800 Cycle—10.5 Amp.— Single Phase	\$27.50
12126-2A Instrument Inverter—Pioneer Input: 27.5V DC—1.25 Amp. Output: 26V 400 cycle—10V Amp.— Three Phase	\$35.00
12117-2A Instrument Inverter—Pioneer Input: 24V DC—1 Amp. Output: 26 V 400 cycle—6 V. Amp.— Single Phase	\$27.50
12116-2A Instrument Inverter—Pioneer Input: 24V DC—5 Amp. Output: 115 V—400 cycle—45 Watt— Single Phase	\$90.00
12119-1-B Instrument Inverter—Pioneer Input: 12V DC—2 Amp. Output: 26V 400 cycle—6 V. Amp.— Single Phase	\$27.50
12117-5A Instrument Inverter—Pioneer Input: 12V DC—2 Amp. Output: 26V—400 cycle—6 V Amp.— Single Phase	\$27.50

Eastman High Speed Cameras

Now being used for oscillograph recording, ballistic studies, slow-down and stop-motion studies: This remarkable instrument pre-selects determined speeds of from 1,000 to 3,000 frames per second on 16mm. film. Standard equipment includes 63mm. F2.0 Ektar lens. Auxiliary lenses and equipment are available.

Authorized dealers for Eastman, Bell & Howell, Graflex, Zeiss and leading photographic manufacturers.

Graflex "ID" Cameras

Now almost universally used for plant identification and security procedures, the versatile Graflex "ID" units provide photos suitable for pre-printed pass cards, metal badges with photo inserts, and plastic photo laminates. This Graflex Camera is equipped with an 84mm F 4.5 lens, automatic release and film advance, removable magazines with a capacity of 100 feet of 35mm film, and takes 750 pictures per roll. Auxiliary identification stands, lights, enlargers and developing equipment are available.

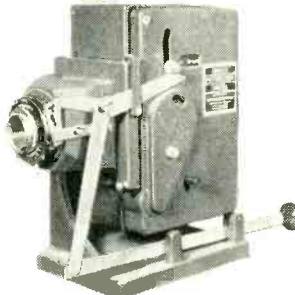

PHONE COLLECT if you have any of the following: TS3, TS12, TS13, TS33, TS35, TS45, TS62, TS117, TS120, TS146, TS147, TS148, TS155, TS174, TS175, TS239, TS251, TS268, TS375; I-100, I-182, I-201; TSX45E; AN/ARC3; I-152C; APN9; BC788C. Semler pags TOP BUCK for all electronic equipment.

CABLE ADDRESS:
Sembro
Los Angeles

Semler

ASSOCIATED INDUSTRIES, INC.

PHOTOGRAPHIC

5730 Wilshire Blvd.
Los Angeles 36,
California

ELECTRONIC

6855 Tujunga Ave.
North Hollywood,
California

AIRCRAFT

118-18 Ventura Blvd.
North Hollywood,
California

PRECISION TEST EQUIPMENT

In Stock Now

TS3/AP	TS51/APG4
TS10B/APN	TS56A/AP
TS12/AP	TS59/APN1
TS13/AP	TS61/AP
TS15/AP	TS62
TS16/APN	TS67/ARN5
TS19/APQ5	TS69
TS21/CRN5	TS78/U
TS23/APN	TS80/U
TS24/ARR2	TS89/AP
TS26/TSM	TS100/AP
TS27/TSM	TS101/AP
TS32/TRC1	TS102
TS33/AP	TS110/AP
TS34A/AP	TS111/CP
TS35/AP	TS117
TS36/AP	TS118/AP
TS45/APM3	TS125

Semler Photographic Division;
**COMPLETE LINE OF AERIAL
CAMERAS, LABORATORY, &
SPECIALIZED PHOTOGRAPHIC
RECORDING EQUIPMENT.** Semler
Aircraft Division; **COMPLETE
LINE OF AIRCRAFT INSTRUMENTS
& ACCESSORIES.**

TS125/AP	TS184A/AP
TS126/AP	TS204/AP
TS131/AP	TS226/AP
TS148/UP	TS239/UP
TS155	TS251
TS170/ARN5	TS268/U
TS174/U	TS323
TS175/U	TS428

IE19	I-122	I-222
IE21	I-130	I-223
IE36	I-139A	IS-185
IE45	I-145	BC-221
IE46	I-148	BC-376
IE57	I-155	BC-906
I-56	I-173	BC1066
I-72	I-176	BC1201
I-95	I-177	BC1203
I-96	I-196A	BC1277
I-100	I-198	BC1287
I-115	I-208	BE-67
		OAP-1

AN/APR-1 AN/APR-4
Boonton "Q" Meter 120

Dumont 224 — Dumont 241
Oscilloscopes

Ferris 18B Microvolter

Hewlett-Packard 200D

Audio Oscillator

General Radio 804C

Semler

ASSOCIATED INDUSTRIES, Inc.

6855 Tujunga Ave., North Hollywood, Calif.
Phone: STANley 7-5458

— THE BEST IN ELECTRONIC SURPLUS —

BC-221 FREQUENCY METER

Precise Signal Generator and Heterodyne Meter, with crystal calibrator for check points every 1,000 KC. Range .125 to 20.0 MC. Complete with tubes, crystal. Excellent Condition units, BUT NON-MATCHING Calibration Books. Follow the Instruction Manual for "Adjustments," and you can make the instrument and calibration book jibe. We could do it and charge you \$95.00 per unit, but we think you would prefer to do it yourself and save \$30.00.

BC-221 Freq. Meter, \$65.00
as Described. EACH.....

MISCELLANEOUS SPECIALS

GE Voltage Regulator & Power Supply, Cat. #36VD14B5, output 750 V at 10 mA.
Kato Rotary Converter, 32 V DC to 110 V, 60 cycles AC, 250 Watts.
SCR-283 Nmttg-Regv Eqpts. Complete.
IN-127 Insulators.
YJ-1 & YJ-2 1FF Equipments.
HS-23 & HS-33 Headsets.
Relay Box BC-616.
GE Low Pressure Switch, Cat. #2027D100J1.
GE Overload Relay CR-5882-C1G.
EE-8 Telephone Gen. Crank Handles.
MAB Walkie-Talkie Spares.
DM-28 Dynamotors.
DM-32 Dynamotors.
DY-2A/ARR-2 Dynamotors.
JACK BOX BC-629.
Microphone Switch SA-26/U.
Tuning Units, TU-56 & 57.
GE Ionization Gage Power Supply, Cat. #36VD1281.
Remote Control Units RM-14.
Phantom Antenna A-62.
GE Capacitor Transformer, Cat. #69G210, 60 cycles 132/200 volts, 140/10 Watts.
GE Voltage Regulator Stabilizer, Cat. #67G92.
PE-91 Dynamotors.
Cable Coaxial Coupler JR45 (14 inches).
Tuning Units, TU-5 to TU-9.
AT-49/APR-4 Antennas.
Magnetron Magnets for 2J29.
Mounting Plates FT-498, FT-154-H (BC-348), FT-349.
Shock Mounts MT-38/APA-1.
BC-601 & 684 Transmitters.
PE-218E Inverters.
FE-1A Aircraft and Engine Testers.
Antenna Mast Sections, AN-49 to 54.
I-292A Signal Generator.
BC-1236A Signal Generator (15 to 40 MC & 90 to 250 MC).
Frequency Meter CRV-60028, 236 to 256 MC.
TS-143 CPM-1 Synchroscope.
RC-163 Radio Beacon Equipment.
RM-55 Remote Antenna Drive.
LR-1A Loran Equipment.
TP-51 & 55 Cable Vulcanizing Equipment.
SB-14GY Console Switchboard.
NW-23/GTA Power Supply for above.
BC-221 Receivers.
Janette Rotary Converters, 12 V DC to 110 AC, 225 Watts.

Immediate Delivery from Stock

Cable: Telemarine, N. Y.
Tel. ESplanade 2-4300

INFRA-RED IMAGE "SNOOPERSCOPE" TUBE

Extra-Special!!

We've sold thousands of them to Labs, experimenters, Industrials, studios, etc. By using Infra-Red rays, this tube enables you to see in the dark. No scanning, no amplifiers, just a high-voltage power supply is all you need with this tube. Shows image in greenish-white on 1 1/2" screen. For night photography, signalling, snooper or sniper scopes, underwater detectors, etc. British mfr. **SOLD IN LOTS OF 6 ONLY!** Literature and diagrams furnished with each sale.

6 for \$15.00

FRONT-END LENS, for Infra-Red Tube. Bausch & Lomb... Ea. \$10.00
Plain, Mounted Type..... Ea. 7.00

CONDENSER MICROPHONE With 2-Stage Pre-Amp.

Real, Precision quality construction, double Helmholtz Resonator type, with combination microphone and amplifier built in cylindrical brass case 16 x 6 ins. Uses types 30 and 32 tubes in amplifier. Employs acoustical low-pass filter plugs (removable) for 5-25 cycle response; removing plugs (threaded) and venting cylinder case will result in high-quality, wide-range studio-type microphone. As is, excellent for vibration testing, percussion noises, shock sounds, oil exploration work. Original use — Sound (Artillery) Ranging Eqpt. NEW UNITS. **EACH..... \$34.95**

INDUSTRIAL CAPACITORS

Standard Brand Type 18F75
Synco—Capacitor

50-50-50 mfd., oil filled, Delta connected, 90 V. AC, 60 cps. All NEW, packaged capacitors. For power-factor correction on 115 V. 3 phase AC, etc. Large quantity available. **EACH..... \$6.95**

ATTENTION, Please!

IRE Show visitors, Purchasing Personnel, etc., we invite you to visit our Retail Dept. and Bargain Counters, at this address. We have a terrific quantity of transformers (all types), capacitors of all types, relays, receivers, transmitters, electronic devices that will intrigue you, etc.—all at sensationally low prices. We're in the heart of Coney Island, so visit the Beach, the Amusement area, and our Retail Display. No Parking Problem here!

All Prices F.O.B. N.Y.C.

PARTIAL LISTING OF OUTSTANDING SURPLUS COMMUNICATIONS EQPT.

MARINE

TCS X'mtr-Receiver for Ship or Shore.
TAJ 500 Watts Output, 175-550 KC. New Equipment, with Spares, Motor Generator (AC and DC available) Starter, Tubes, Complete.
TBK HF 500W. Transmitter with MG, Starter, and Spares.
GO-9 100/125 W. IF/HF Ship or Aircraft Transmitter, A1 or A2 Emission. All New with Spares.
150-AY Mackay IF Ship X'mttrs.
8707 RMCA Ship Radio Compass.

MISCELLANEOUS

DZ-2 Direction Finders.
GI-7 Aircraft Transmitters.
ZIR-11AS Eqpt.
SCR-283 RCVG and X'mtting Eqpt. Complete.
RT-3/ARN-1 Altimeter.
RADIOSONDES AN/AMQ-1A to D. New.
250 & 500 WATT SOUND SYSTEMS for Airports, Shipyards, Amusement Parks, Civilian Defense, Etc. Write for Prices and Literature.

SCR-610 Crystals, in sets (120 channels) or individually. TESTED. Write for PRICES.

EXTRA!

PE-104 POWER SUPPLIES for Receiver of SCR-284, NEW, with Spare Vibrator, Export-Packed. Large Quantity Available. **WRITE FOR PRICES.**

GROUND & AIR COMMUNICATIONS

TDQ VHF 100-156 MC 50W. AM X'mtr for 110 V. 50/60 C. AC.
BC-797 VHF 110-126 MC, 50W. AM Output for 110 V. 50/60 C. AC.
SCR-284 Ground Portable AM, Trans-Reer Eqpt. for Field Communications.
SCR-522 VHF, 4-Channel, 100-156 MC Trans-Reer Eqpt. for Plane or Ground Communications.
SCR-511, Walky-Talky, 3-6 MC, Crystal Controlled Trans-Reer. with Plug-In Units for Freq. Changing.
LINK-1498, VHF Trans-Regv Eqpt, 70-100 MC, 50 Watts output FM. Available in 14 VDC & 110 V AC operation.
AN/TRC-1, VHF Trans-Regv Eqpt, 70-100 MC, 50 Watts output FM. For 110 V AC operation.
96-200A, 2 KW Wilcox X'mtr, 125-525 KC, 3 Cabinets: RF Unit, Modulator, Rectifier; A1, A2 and A3 Emission.
10 KW GE FM RF AMPLIFIERS, Type BF-3-A, 88-108 MC, Complete with RF Power Supply (separate unit). New Eqpt. For increasing power FM and Television stations. Write for descriptive sheets and prices.

All Material Offered Subject to Prior Sale

3040 W. 21st St.,
B'klyn 24, N. Y.

TELEMARINE COMMUNICATIONS CO.

JAN TUBES

0A2	.90	3B24	4.75
0B2	1.00	3B24W	7.50
0C3	1.00	3B27	3.75
0D3	1.25	3B28	5.75
1A4	1.25	3BP1	4.75
1E1	.50	3CP1	1.75
1B22	2.00	3CP1/S1	1.50
1B24	9.50	3D23	4.50
1B26	2.00	3DP1	3.75
1B37	15.00	3E29	14.50
1P23	2.75	3EP1	4.50
1Z2	3.75	3Q4	.75
2C22	.25	3S4	.75
2C26	.25	4B24	5.75
2C26A	.40	4C25	25.00
2C44	.60	5D21	15.00
2C40	12.50	5J29	11.50
2C51 (W.E.)	5.75	6-4	.50
2D21	1.35	6-4B	.75
2E25	5.00	6A35	1.35
2J21A	6.50	6AK5	.65
2J22	15.00	6AK5WE	1.50
2J31	22.50	6AK5W	2.00
2J32	25.00	6AL5	.60
2J34	25.00	6AQ5	.50
2J40	35.00	6AR6	2.75
2J61	35.00	6AMP-Tungar	4.00
2J61A	45.00	6C4	.50
2K22	45.00	6H6	.75
2K23	35.00	6HG6	.75
2K28	27.50	6J5	.50
2B4	2.25	6J6W	3.50
3B4	2.25		
3B7	4.50		

6L6G	1.50	252A	7.50	807	1.25
6SC7	.85	253C	15.00	826	.75
6SF5	.75	286A	7.50	827R	125.00
6SG7W	3.75	304TH	6.75	829B	12.00
6SJ7	.75	304TL	7.50	835	37.50
65J7Y	.85	307A	4.50	837	1.25
65L7	.75	310A	5.75	843	.35
65N7	.75	313C	2.75	861	20.00
6V6GT	.75	316A	1.25	866A	1.25
6V8GT	.85	327A	4.25	866JR	1.10
6X5GT	.75	371A	7.5	872AS	3.00
7A7	1.75	388A	1.25	874	.90
7C24	95.00	394A	3.75	930	1.50
10Y	.35	412A WE.	1.25	945	7.50
12AU7	1.00	417A	15.00	954	.25
12J5GT	.60	446B	3.50	955	.35
6X5GT	.60	450TL	35.00	1616	.85
12SG7Y	2.85	471A	2.25	1625	.35
12SK7	.75	700-A/B/C	25.00	1626	.35
12SL7	.75	702A	3.00	1630	.85
12SN7	.75	704A	7.5	1632	.70
12SR7	.75	707A	7.50	1633	.70
24C	2.25	708A	4.50	1644	.75
26A7GT	5.00	715-A	4.50	2024	.75
28D7	1.50	717A	1.25	2050	1.25
101L WE.	1.00	718CY	35.00	2051	1.00
201-C	75.00	724A	3.75	5552/FG235A	
283Z	4.50	728A-Y-GY	35.00	116-C	75.00
227A	4.50	801A	.35	5643	2.00
247A	8.50	802	3.75	5654	2.00

5670	5.50	GL691	1.75
5686	3.75	HY31Z	2.50
5687	5.25	HY148B	.50
5702	3.00	HY615	.25
5703	1.50	KC4	47.50
5726	2.10	KC4-3	35.00
5744	3.00	KY21A	8.75
5763	1.50	LVR	3.50
5787	4.50	QK1117	50.00
5829	2.25	QK117A	65.00
6035	50.00	RK34	.75
7050	Write	RK47	4.50
8005	6.75	RK60	1.75
8013	2.50	RK72	1.00
8033A	5.75	RK73	1.25
8020	.90	RX212	15.00
9006	1.25	SD828A	7.50
AB150	12.50	VS1	12.50
CE2	1.50	VT3	50.00
CE2A	3.50	VU508	1.50
CE2B	3.50	WL481	1.00
CE2C	2.50	WL532A	3.00
CE2T	1.50	WL670A	7.50
CE2S	1.25	ZB120	12.50
CE2SC/927	2.50	45X674	10.00
ELC1A	8.50	5AP	3.75
ELC1B	3.25	5BP4	3.75
ELC5B	2.50	5HP1	4.75
ELC6A	3.50	5SP7	Write
ELC6J	7.50	7BP7	7.50
ELC6C	14.50	7HP4	7.50
ELC6D	17.50	9LP7	4.50
FG97	22.50		
FG105	17.50		

ROSE PRODUCTS COMPANY

NEW YORK 7, N. Y.

REctor 2-8078-9

102 WARREN STREET

CONDENSERS

MICRO & TOG. SWS. - RELAYS - "J" POTS

OIL CONDENSER SPECIALS

10 mfd.—1500 V....	\$6.25
8 mfd.—600 V.....	\$1.49
2" dia. x 4 1/2" H. Bkt.	
2 mfd.—600 V.....	\$0.85
3 S.T. Bath tub. Lots of 100 10% disc.	
Same Type with 2 terms.....	\$0.70
.25 mfd.—600 V.....	\$5.53
Standard Brand OM-625	
4 mfd.—1000 V.....	\$1.75

10 mfd.—600 V.....\$0.98
 Three term, bot. mfg. channel type.
 Dims. 3 3/4" x 2 1/2" x 2". Two 5 mfd. sections
 rated 400 V at 72 deg "C". 1800
 V test. Meets commercial specs. for 800
 V operation up to 40 dees "C". Ideal
 for filter or power factor application.
 Repeat sales prove this rugged high
 quality condenser to be of outstanding
 value. Carton of 24, weight
 42 lbs. Large qua. available **\$0.89**

4 mfd. 600 V.....	\$1.15
Standard Brand TRS-604	
7 mfd.—1000 V.....	\$2.49
4-3/16" H x 3 3/4" W x 1 1/4" D	
.25 mfd.—20 KV.....	\$19.95
.1 mfd.—7500 V.....	\$1.75
Standard Brand	

DIESEL GEN.

25 KW 3 phase 60 cy. Hill
 diesel, G.E. gen. Complete with
 control panel & starting batter-
 ies. Ready for immediate opera-
 tion. Guaranteed. P.U.R.

— TRANSTAT —

115V, 1 phase, 100 amps., Kva.
 11.5, Range 0-115 V. Amertran
 #29145. Specially priced.

CHANNEL CONDS.

Mfd	Vwdc	Price	Mfd	Vwdc	Price
.025	600	\$5.19			
.05	1000*	.22			
2x.05	500	.28	5	400*	.21
	600	.30			
	800	.32			
	1000	.35			
2x.1	400	.34	2x.5	600	.49
2x.1	600	.40	2x.5-1	600	.59
2x.1	800	.42			
2x.1	1000	.44			
2x.1	400V	.48			
2x.25	600V	.48			

25 W. POWER RHEOS.

Ohms	Shaft	Price	Ohms	Shaft	Price
1.3-1.3	1/8S	\$9.28	200	1/2	.69
16	1/2	.69	225	1/8L	.69
20	1/2	.69	250	1/4S	.69
25	1/2	.69	300	1/2	.69
37.5	1/2	.69	350	1/2	.69
50	1/8S	.69	37.5	1/2	.69
60-50	1/2	1.25	500	1/4S	.69
75	1/2	.69	2500	1/2	1.20
100	1/2	.69	5000	1/2 & 1/8S	1.20
125	1/2	.69			
150	1/2	.69			
175	1/2	.69			
186	1/2	.69			

100 ohm Lots of 100
 @ \$5.40

METAL TUBULAR OIL CONDS.

Mfd	Vwdc	Price	Mfd	Vwdc	Price
.0025	400	\$4.10	.05	1000V	.19
.005	600	5.14			
.01	800	5.14			
.01	1000	5.14			
.01	1500	5.14			
.01	2000	5.14			
.01	2500	5.14			
.01	3000	5.14			
.01	4000	5.14			
.01	5000	5.14			
.01	6000	5.14			
.01	7000	5.14			
.01	8000	5.14			
.01	9000	5.14			
.01	10000	5.14			

Quas. of 100, 10% disc.

BATHTUB CONDS.

Mfd	Volts	Price	Mfd	Volts	Price
.01-01	600	\$5.25			
.02-02	600	.25	25-25	600	.49
.04-04	600	.25	1000		.48
.08-05	600	.25	3	400	.35
.08-08	600	.25	5	600	.47
	600	.25	5	1000	.52
	600	.25	5	600	.59
	600	.25	1	200	.25
	600	.25	1	300	.30
	600	.25	1	400	.45
	600	.25	1	600	.59
	600	.25	1	800	.60
	600	.25	1	1000	.91
	600	.25	1	100	.40
	600	.25	1	1000	.21

Sp. Bathtub Kit
 15 @ \$1.00

Mfd	Volts	Price	Mfd	Volts	Price
.005-005	20KV	82.00			
.01	10KV	4.75			
.01	10KV	4.75			
.012	25KV	22.50			
.02	20KV	17.90			
.025-.025	50KV	55.00			
.03	12KV	15.95			
.05	5KV	2.98			
.08	12.5KV	15.95			
.1	1500V	.59			
.1-1	2000V	.49			
.1	2500V	1.39			
.1	3000V	1.89			
.1	7500V	1.75			
.1	7500V	3.50			
.1	10KV	9.50			
.1	10KV	12.95			
.1	12KV	14.95			
.1	15KV	16.95			
.1-1	7500V	17.95			
.15-1.5	8000V	1.95			
.2	10KV	10.95			
.2	15KV	17.95			
.25	2000V	1.35			
.25	3000V	2.05			
.25	4000V	1.75			
.25	18KV	15.95			
.25	20KV	19.95			
.25	50KV	85.00			
.25	2000V	1.45			
.4	10KV	14.95			
.5	1500V	1.20			
.5	2000V	1.85			
.5	2500V	2.20			
.5	3000V	2.50			
.5	4000V	3.15			
.5-1	2000V	.90			
.5-5	600V	.69			
.5	25KV	55.50			
1	400V	.45			
1	500V	.55			
1	1000V	.69			
1	1500V	1.35			
1	2000V	1.95			
1	2500V	2.50			
1	3000V	3.00			
1	5000V	5.25			
1	6000V	5.98			
1	7000V	12.00			
1	10KV	14.95			
1	15KV	P.U.R.			

TRANS. MICA CONDS.

Mfd	Vwdc	Price	Mfd	Vwdc	Price
.000024	2500	.19	.0025	1200	.42
.00003	2000	.15	.003	6000	5.35
.000047	2500	.21	.0035	2500	.55
.00005	2500	.29	.004	2500	.65
.00008	1200	.12	.0043	2500	.79
.00009	3000	.75	.0045	600	.24
.0001	600	.22	.005	1200	.43
.0001	1200	.32	.006	4000	2.25
.0001	3000	.85	.006	1200	.45
.0001	5000	1.95	.01	600	.40
.00015	5000	1.95	.01	1200	.65
.0002	15KV	Quote	.01	15KV	Quoted
.00025	1200	.35			
.00025	5000	2.05			
.00027	2500	.35	.015	2500	.95
.001	600	.23	.0125	6000	Quote
.001	1200	.32			
.001	2500	.48	.02	600	.27
.001	4500	1.45			
.001	8000	3.95	.02	600	.39
.0015	5000	2.25	.02	1200	.85
.002	1200	.40	.02	2000	1.25
.002	2500	.50	.03	600	.48
.0024	5000	2.35	.033	600	.59

MICA CONDENSERS

5, 6, 8, 10, 15, 25, 30, 34, 39, 50, 70, 75, 100, 140, 150, 185, 200, 230, 240, 250, 300, 350, 390, 400, 470, 530, 510, 600, 650, 700, 750, 1000, 1200, 1250, 1400, 1500, 2000, 2200, 2400, 3000, 3300, 3700, 3900, 4000, 4700, 5000, 5100, 6000, 6200, 6500, 7900, 7950, 7960, 8000, 9100 & 10,000 Mmfd.

PRICE SCHEDULE

5 to 750 mmd.	4c
1000 to 1500 mmd.	6c
2000 to 5100 mmd.	10c
9100 to 10000 mmd.	26c

Special Mica Kit—100 @ \$3.50

SILVER MICA CONDENSERS

7, 24, 25, 33, 50, 60, 75, 95, 100, 120, 150, 170, 200, 270, 300, 330, 390, 400, 450, 500, 750, 800, 1000, 1400, 1450, 1700, & 2500 mmd.
 7 to 95 mmd. 8c
 1000 to 1700 mmd. 14c
 100 to 800 mmd. 9c
 2500 mmd. 16c

Special S. Mica Kit—100 @ \$6.50

CERAMICON CONDS.

10, 56 & 100 mmd @ .05
 1000 to 5000 mmd @ .06
 .01 400 V

WANTED

Condensers of all types in
 any quantity. Also other
 standard components. Top
 prices.

AIRCRAFT TOG. SWS.

Aircraft type—20A @ 24VDC-10A @ 125VAC-C-II
 CH# Govt. Spec. Circuit
 8201K4 B-5A SPST On-Off
 8211K5 H-6B SPST On-Mom. On
 8208K4 H-7A SPST On-Off-Mom. On
 8210K5 B-1B SPST On-Off-Mom. On
 8200K8 AN3022-1B SPDT On-Off-On
 Push Mounted-Luminous Tip-Bat. Handle—
 Price—\$.22 ea.; \$20/100; \$170/1000.
 To get 1000 qua. disc. you may combine types.

OTHER AIRCRAFT TYPES

CH#	Circuit	Cur.	@ 125vac	Price
8871K-1	SPST	15A	Push but.	
			Type A2—On-Nom.—Off \$5.59 P.T.	
8305K-514	SP-4Pos.	35A	@ 24VDC On-Off-Mom.	
8905K-526	SPST	5A	B-6A-1 1/2" Bat. .32 L.T.	
8905K-722	3PST	10A	Off-Mom. On .79 L.T.	
8911K-524	DPST	15A	Push But.-Off-Mom. On .59 P.T.	
8302K-7	SPST	10A	2 Gang B-6A .32 L.T.	

10% Dis. in quas. of 100 or more per Type.

TOGGLE SWITCHES

CH#	Circuit	Price	AH & H	Circuit	Price
8800K4	SPDT	\$6.00	6A, 125V	DPST	\$4.20
8824K4	DPDT	.75	6A, 125V	DPDT	.50

RELAYS & CONTRACTORS

Type	Volt	Ohms	Current	Action	Price
1027-	12	Leach	67	8 DPDT	1.25
1277-REW	24	Leach	160	4 Cont. DPDT	1.50
1220-DE	24	Leach	95	20 SPST	1.25
1222-BF	24	Leach	160	10 SPST	1.25
1227-B2A	24	Leach	140	25 SPST	1.25
1254M	24	Leach	160	10 SPST	1.25
7055	12	Leach	100	50 SPST N.O.	3.50
2791-B100-C3	24	GE	150	DPDT	.95
2791-B100-G3	24	GE	150</		

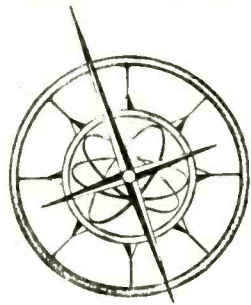

COMPASS

COMMUNICATIONS COMPANY

393 GREENWICH STREET
NEW YORK 13, N. Y.

CABLE ADDRESS: COMPRADIO, N. Y.
ALL PHONES: BEEKMAN 3-6509

WE MAINTAIN
OUR OWN FULLY
EQUIPPED TESTING
LABORATORY TO
TEST AND GUARANTEE
ANYTHING WE SELL

TCS—Collins mfd. Navy radiotelephones for shipboard and mobile use, complete with all accessories for operation from 12, 24, 110, 230 volts d.c. and 110 or 220 volts a.c.

TDE—Navy or commercial marine transmitters, complete 110 & 220 volts d.c. and a.c.

TBK—Navy high frequency transmitter, 2-20 mcs; 500 watts output. Supplied complete with m/g and starter for d.c. or a.c. operation.

TBM—same transmitter but with speech input equipment to give 350 watts phone.

TBL—Navy all-wave transmitter; 350 watts output; CW and phone. Supplied complete with m/g and starter for d.c. or a.c. operation.

TAJ—Navy intermediate freq. transmitter, 175-550 kcs; 500 watts output. Supplied complete with m/g and starter for a.c. or d.c. operation.

SCR-284—the famous mobile and ground station for field use.

SCR-528 SCR-628 SCR-828

MAG—10 cm. portable link radar transmitter receivers, 6-volt operation.

TBN—200-3,000 kcs, complete with 220/440 volt, 3 ph. 50-60c. power supply—conservatively rated at 1 kw. output.

SCR-510 and 610 in quantity.

RADAR BEACONS

AN/CPN-6	3 cm.
AN/CPN-8	10 cm.
YJ and YG	for shipboard use
AN/CPN-6	3 cm.
AN/CPN-8	10 cm.

AND TUBES— SPECIAL PURPOSE and TRANSMITTING TYPES

THIS IS A SAMPLE LISTING • WRITE FOR OTHER ITEMS & UNLISTED PRICES

Tube#	Selling Price	Tube#	Selling Price	Tube#	Selling Price	Tube#	Selling Price	Tube#	Selling Price
O1A	write	2J33	100.00	4C27	25.00	304TH	9.75	813	9.00
OC3	\$1.60	2J34	write	4C28	35.00	304TL	9.75	829A	12.00
OD3	1.50	2J36	100.00	4C35	27.50	307A	5.00	832A	10.00
C1A	6.00	2J38	49.50	4D32	write	339A	35.00	833A	42.50
C1B	7.00	2J39	49.50	4E27	17.50	371B	2.50	836	4.75
C6A	write	2J42	100.00	4J25	175.00	388A	2.75	837	2.75
C6F	12.50	2J49	100.00	4J26	175.00	446A	2.00	843	write
C6J	write	2J50	75.00	4J28	175.00	446B	3.75	849	50.00
1B22	3.95	2J61	75.00	4J29	175.00	450TH	45.00	851	45.00
1B23	10.00	2J62	75.00	4J30	write	450TL	45.00	860	5.00
1B24	write	2K22	write	4J31	175.00	464A	9.50	861	write
1B44	write	2K25	35.00	4J33	190.00	705A	3.25	865	.40
2B22	4.95	2K26	150.00	4J52	350.00	706AGY	45.00	872A	3.85
2B26	3.75	2K29	35.00	5C22	write	707B	12.50	874	1.50
2C40	18.00	2K36	write	5J23	write	714AY	17.50	889R	195.00
2C43	25.00	2K41	150.00	5J26	350.00	715B	17.50	891R	250.00
2D21	1.70	2K45	100.00	5J29	write	720	write	892	150.00
2E22	3.75	2K54	150.00	6C21	29.50	721A	3.75	892R	250.00
2J21	17.50	2K55	100.00	10Y	1.25	723A/B	25.00	2X2 879	1.75
2J22	17.50	3B24	5.40	100TH	9.00	724B	6.50	K1069P7	write
2J26	27.50	3B27	10.00	204A	60.00	725A	write	1614	write
2J27	27.50	3B28	9.00	211	1.00	730A	45.00	1616	2.75
2J31	27.50	3C31	5.75	250TH	30.00	803	7.00	1619	.75
2J32	65.00	3E29	15.00	250TL	30.00	807	1.65	1624	2.00

All tubes guaranteed. All prices are F.O.B. our warehouse, and are subject to change without notice.

Also:
IGNITRONS
PLIOTRONS
PHANOTRONS

FLASH! MANY PRICES REDUCED—Too late to note in this issue, write for New Prices.

K-RK-ARC-UG-PL-AN

CONNECTORS

In Stock for Immediate Delivery

Connector Corporation

OF AMERICA

137 Hamilton St., New Haven 11, Conn. Phone: Spruce 7-2513

New York Phone: Lexington 2-6254

HIGH FREQUENCY EQUIPMENT

GE-Leland MG set. 5 HP, 220V, 3 ph. 60 cy. motor & 24/32V DC, 78 amp. generator, on common shaft, direct-driving Leland 3KVA, self-excited, 3450 RPM, 400-cy., 3-ph., 120/208V, 4-wire alternator. Alternator has excellent wave form. 400-cy. alternator is electrically independent of low voltage generator.....\$995.00

Voltage regulator for above to regulate plus or minus 2 volts\$125.00

Newton Bros. MG set. 2 1/2 KW, 1-ph. 400-cy. 2400 RPM alternator, belt-driven by 220V, 3-ph., 60 cy., 5HP motor.....\$500.00

Holtzer-Cabot MG set. 800VA, 3 ph., 400-cy. 115V. Self-excited. Belt-driven by 2 HP motor, 220V, 3-ph., 60-cy. With variable speed sheave & voltage regulator\$425.00

Ballantine MG set. NEW. 1KVA, 1-ph., 400-cy. alternator, 115V, self-excited; belt-driven by NEW 2HP motor, 220V, 3-ph., 60-cy. With voltage regulator & variable speed sheave.....\$300.00

Onan Electric Plant. BRAND NEW. Gasoline-driven. AC output 120V, 10 amps, 1200W. 300 cy. DC output 28V, 18 amps, 500W.....\$250.00

EDWARD WOLF COMPANY
P. O. Box 82 Mattapan 26, Mass.
Bluehills 8-1254

FOLLOW ARROW

FOR
MILITARY ELECTRONICS

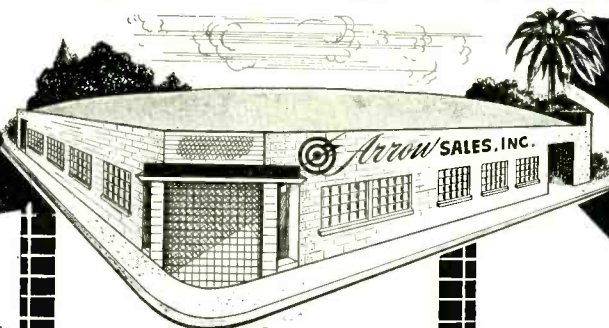

ATR-13 TRANSCEIVER

Dynamotor powered, either 14 or 28 V. Shook mounted, remotely controlled, transceiver. Tunable receiver, range 108-160 M.C., 4-channel crystal controlled VTF transmitter, built-in provisions for omni. Weight, complete with plugs, less cable, 19 Lbs. Less \$245.00 crystal, new

Radar

AN/APS-3 Complete	APT-1	RC-1841FF
APR-4 New Complete	APT-2	RC-214
APR-5 Complete	APT-3	RC-224
APS-4 New, Complete	APT-4	RC-266
APS-6 New, Complete	Mark 16	RT34/APS13
	MD4/APS2	T-85/APT-5
	MDS/APS3	
	MD22/UPN2	
	MD38/APQ13	

PORTABLE RADAR

Model SQ. 12 cm. Used on small ships. Has PPI indicator. Max. range 20 miles, 1 Kw. output. Operates from 110 VAC, 60 cps. P.U.R.

AN/ART-13 PARTS

Part #	Transmitter	Item
564916	T-47A/ART-13	Barometric Switch
565927	4-Pile Ceramic	Variable Cap.
K7890443	6-Pile Ceramic	Variable Cap.
564605	4 Centralap-Type	#43-003 Cap Assembly
Antenna Loading	CU-25	

GAS ENGINE POWER SUPPLY

1½ Kw. 110 V. 60 cps. Complete gas engine power supply. New, with spare parts. P.U.R.

GOVERNMENT, AIRLINES & INDUSTRIALS!

Send for FREE Catalogue No. 112 for complete list of Military, Industrial and Aviation Electronics. WE HAVE THE LARGEST INVENTORY OF SUCH EQUIPMENT IN THE UNITED STATES.

Test Equipment Complete Line

CuMont 224-A Oscilloscope	TS159
1-77 Hickok Tube Checker	TS-159/TPX
1-208 FM Signal Generator	TS170/ARN
RPC Model 644 Multimeter	TS-173/UR
Hewlett Packard 200-C	TS-174/UR
I-198	TS27/TSM
BC-638	TS-33
BC-1255	TS34/AP
IE-36	TS-35/AP
I-95	TS36/AP
I-96-A	TS-45A/APM-3
I-122	TS-59/APN
I-130A	TS61/AP
I-139	TS62/AP
I-145	TS89
I-212	TS92
I-222	TS100/AP
TS-3A/AP	TS-102
TS10A/APN	TS111/CP
TS12/AP	TS-118/AP
TS16/APN	TS126
TS19/APQ	TS127/U
TS-23/APN	TS131
TS24A/ARR-2	TS-148/UP
	TS251
	TS311A/UP
	TS323/UP
	1-146
	TS-268/U
	Boonton Mod.
	78B Sig. Gen.
	Boonton Type
	102F Sig. Gen.
	LAD Sig. Gen.
	LAE-2
	LAVOIEFREQ.
	Meter: 300
	600 Mc.

SUPREME TEST EQUIPMENT

Model 600 Tube and Set Tester.....\$89.50
Model 616 Tube and Battery Tester.... 69.50

FLUX METER

For measuring flux density between magnet poles. Has two meters in series with a potentiometer and battery for power supply. Range: 500-4000 Gauss in 3 scales. Requires 1 battery which mounts in case. NEW.....\$37.50

MISCELLANEOUS

MINE DETECTOR: SCR-425 for prospecting, mining, etc. NEW.....\$59.50
LP-21 LOOPS: Mod. LM, AM, A, Excel. cond.

TRANSCEIVER—MODEL 52

5W. 2-way, 2-channel radio transmitter-receiver unit. Complete with tubes, battery charger, microphone. Less crystal and antenna. Operates from 6 V. battery. New.....\$89.95

Headsets & Handsets

HS-23	HS-38	TS-13-C
HS-30	TS-10-GJ	HS-18
HS-33	T-26	EE-8

TRANSTAT

11-5 KVA50/60 cycles. Commutator range 0-115 V. Max. 100 amp. Good cond...\$125.00

Specials

RECEIVERS—TRANSMITTERS

ARC-1	PE-125AX	RTA/1B1
ARC-3	R-9/APN-4	SCR-522
R-4/ARR-2	BC-733-D	TA2J-24
ID-6/APN-4	R-57/ARN	R-89/ARN
MP-10G	BC-788-A-AM-C	R-1/ARR-1

RA-52 RECTIFIER

Transtat controlled to produce high voltage DC from 110 VAC 60 cycle source. Up to 11,500 VDC @ 50 W. Metered high voltage (0.15-15 KV) and current (10-20 MA). NEW....\$74.50

EQUIPMENT WANTED!

To meet government and industrial orders we urgently need all types of new and used Test Equipment, Radar, Receivers, and Transmitters. WE PAY HIGHEST PRICES. Tell us what you have.

Arrow SALES INC.

Mailing Address: P. O. BOX 3878-E, N. HOLLYWOOD, CALIF.
Office-Warehouse: 7460 VARNA AVE., N. HOLLYWOOD, CALIF.
POplar 5-1810 * Stanley 7-6005 * Cable Address: ARROWSALES

For Sale **SURPLUS NEW** For Sale

METERS, INSTRUMENTS AND ACCESSORIES

For Commercial, Signal Corps, Navy and Aircraft Applications

Panel, Switchboard and Lab. Types
Voltmeters, Ammeters, Milliammeters, Microammeters, R.F. Ammeters, Multipliers, Current Transformers, Shunts, Thermocouples, etc.

MANUFACTURED By WESTON, WESTINGHOUSE,

GENERAL ELECTRIC, etc.

All items are surplus, new in original packaging!

All items are fully guaranteed! We specialize in meters and instruments—Let us know your requirements!

OVER 75,000 METERS IN STOCK—FOR IMMEDIATE SHIPMENT

MARITIME SWITCHBOARD

Instruments & Accessories
336 Canal Street New York 13, N. Y.
Worth 4-8216 (7,8)

PULSE TRANSFORMER

Tube base plug in type

Here are precision made, high quality compact pulse transformers wound on hypersil cores. They are built in octal bakelite tube bases and can be adapted to many uses. They are completely impregnated and sealed.

SUGGESTED USES

- *—Blocking Oscillator, Multivibrator and Scope Circuits.
- *—Wherever Accurate Timing and Triggering are necessary.
- *—Unexcelled in circuit applications for generating low power and low voltage pulses.
- *—Can be used in circuits utilizing repetition rates from 0 to well over 1 MC and pulse widths ranging from .05 Microsecond up.

Price \$4.50 each Immediate Delivery

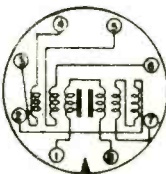

TYPE UX 7350
Each Coil—50-T#36E
Max. DC Res. Ohms
1 & 8= 4.02Ω
2 & 7=4.542Ω
3 & 4=2.357Ω
5 & 6=2.185Ω

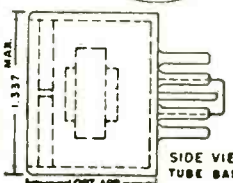
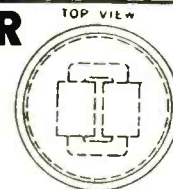

HATRY and YOUNG

THE Elect IN ELECTRONICS

811 Boyston St., Boston 16, Mass. CO 7-4700

TEST EQUIPMENT

S BAND ANTENNA—Coax feed from type RG 44/U line, Disc reflector and fixed choke, for use with parabolic reflector. Completely weatherproofed, for use on pressurized system. Made of silver plated brass with all R.f. surfaces polished. New **PRICE \$20.00**

S BAND ROTATING JOINT—Low speed rotating joint for use with type RG 44/U coaxial line. Tapped for pressure valve. **PRICE \$20.00**

HIGH POWER WAVEGUIDE TERMINATION—Manufacturer overproduced on Government contract. X Band, 7 to 10 kmc, type UG 138/U flat flange, VSWR less than 1.15 dissipation 150 watts in still air. **PRICE \$50.00**

X BAND FREQUENCY POWER METER—Built to Navy specifications, measures frequency from 8.5 to 9.6 kmc, accurate to ± 4 mc; Power from .1 mw to 1w average, external attenuator may extend this to 1 kw. Power measuring accuracy ± 1 db. Video outlet for connection to scope. Sealed against moisture. This instrument is battery powered, portable, and completely self contained. **PRICE \$475.00**

X BAND THERMISTOR Mount 8500 to 9600 MC. VSWR less than 1.4, RG-51 guide **\$70.00**

X BAND VARIABLE ATTENUATOR Guillotine type, 0 to 30DB Attenuation. Dial direct reading within 1DB—**\$80.00**

VSWR AMPLIFIER tunable high gain linear amplifier, for measurement of standing wave ratios in conjunction with slotted lines. Crystal or Bolometer input—**\$300.00**

DELAY LINE, Z-1000 $\pm 10\%$ band pass 0-2 MC., delay time 4 micro-seconds, type YE-4 B.

TUNING UNITS FOR APR-4 RECEIVER

These tuning units are incomplete, new, in operating condition but lack the front panel, tuning motor and tuning shaft and side panels. **\$100.00**
 TN 18 300-1000 MC TN 19 1000-2200 MC TN 51 2200-4000 MC

BUTTERFLY TUNERS

- 110-330 megacycles oscillator butterfly **\$25.00**
- 80-300 megacycles mixer butterfly with socket for 955 (used as diode mixer) **\$25.00**
- 400-800 megacycles oscillator butterfly with 703 tube mounted on it **\$20.00**
- X Band Spectrum Analyzer 8500-9600 MC. Calibrated frequency meter, tuned mixer, 4 i.f. stages, 3 Video stages over-all gain 125 db, reg. Power Supply.
- S Band Spectrum Analyzer 2700-3900 megacycles—Similar to above.

HIGH POWER DUMMY LOADS

- DC-2000 MC. 100 watts dissipation, VSWR less than 1.1, no cooling necessary.
- X Band, $1\frac{1}{4}$ " x $\frac{3}{4}$ " guide, choke or plain flange, dissipates 350 watts average power continuously in still air, VSWR less than 1.15 between 7 and 10 KFC, weight 5 $\frac{1}{4}$ pounds.
- X Band, $\frac{1}{2}$ " x 1" guide, choke, flange, dissipates 250 Watts average power continuously in still air, VSWR less than 1.15 between 8.2 x 12.4 KMC, weight 3 $\frac{1}{4}$ pounds.
- X Band, $1\frac{1}{4}$ " x $\frac{3}{4}$ " guide, plain flange, dissipates 200 watts average power continuously in still air, VSWR less than 1.15 between 7-10 KMC, weight 3 $\frac{1}{4}$ pounds.
- X Band, $1\frac{1}{4}$ " x $\frac{3}{4}$ " guide, plain flange, dissipates 150 watts average power continuously in still air, weight 2 pounds 4 ounces.
- S Band $1\frac{1}{2}$ " x 3" guide, dissipates 1000 watts average power in still air, VSWR less than 1.15 between 2.5 to 3.7 KMC, choke flange, weight 13 pounds.

S Band Mixer, tunable by means of slider; type N connector for the R.F. and local oscillator input, U.H.F. connector for the I.F. output, variable oscillator injection **\$30.00**

33 MC I.F. STRIP, VIDEO, and AUDIO AMPLIFIER and 110 Volt 60-2600 cps POWER SUPPLY. Bandwidth 10 mc new, part of SPR-2 Receiver. AMPLIFIER STRIP AM-SSA/SPR-2 contains I.F. amplifier, detector, video amplifier, pulse stretcher and audio amplifier and Rectifier Power Unit PP-155A/SPR-2 bandwidth 10 mc, center frequency 30 mc, sensitivity 50 microvolts for 10 milliwatts output. Power supply 80/115 V ac 50-2600 cps 1.3 amps. Send for schematic **\$65.00 less tubes**

S Band Signal Generator Cavity With Cut-Off Attenuator, 2300-2950 mc., 2C40 tube, with modulator chassis. **\$30.00**

High Pass Filter F-29/SPR-2, cuts off at 1000 mc and below; used for receivers above 1000 mc **\$12.00**

TS-89 Voltage Divider for measuring high video pulses, ratios 1:10 and 1:100 transmission flat within 2 db 150 c.p.s. to 5 mc., with cable for attaching to syndroscope. **\$30.00**

Variable Waveguide Below Cut-Off Attenuator, with crystal holder and IN27 end calibration 30-100 db. **\$25.00**

S Band Standard Frequency Cavity, adjustable, with crystal holder and IN27 crystal **\$50.00**

S Band Test Load TPS-55P/BT, 50 ohms **\$12.00**

NIBUR SALES CORP

62-A WHITE ST.

RED BANK, N. J.

148 CHAMBERS ST., NEW YORK **BUY AND OR SELL** RECTOR 2-1591

We do both!—Electronic Equipment and Parts of every description. No lot too large. TOP PRICES. Ask us to help you. RAPID ACTION ALWAYS.

ELECTRONIC SURPLUS BROKERS

RADIO Surplus Buys

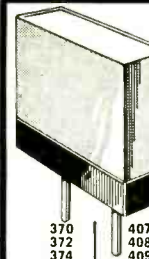

CRYSTALS

... in FT 241-A Holders— $1\frac{1}{2}$ " Pin SPC. Marked 54th OR 72nd Harmonic MC Freq. Listed below by fundamental frequency with fractions omitted.

500 KC Crystals **ea. \$1.95**
 1000 KC Crystals **ea. \$3.95**
 200 KC Crystals

370	407	444	476	509
372	408	445	477	511
374	409	446	479	512
375	411	447	480	513
376	412	448	481	514
377	413	450	483	515
379	414	451	484	516
380	415	452	485	518
381	416	453	486	519
383	418	454	487	520
384	419	455	488	522
385	420	456	490	523
386	422	457	491	525
387	423	458	492	526
388	424	459	493	527
390	425	461	495	529
391	426	462	495	530
392	427	463	496	531
393	429	464	497	533
394	430	465	498	534
395	431	466	501	535
396	433	468	502	537
397	434	469	503	538
398	435	470	504	540
400	436	472	505	
401	437	473	506	
402	438	474	507	
403	440	475	508	
404	441			
405	442			
406	443			

\$100 EACH

10 for \$8.00, Postpaid

FOLLOWING CRYSTALS AVAILABLE IN FT 243 HOLDERS $1\frac{1}{2}$ " PIN SPACING

3590	5035	7350
4165	5127.5	7450
4280	5285	7550
4335	5587	7675
4350	5660	
4370	5730	
4440	6073.3	
4445	6075	
4450	6140	
4540	6150	
4580	6350	
4620	6525	
4635	6700	
4710	6875	
4880	6975	
4980	7075	
4995	7150	

\$100 EACH

11 for \$10.00, Postpaid

PLEASE ENCLOSE FULL AMOUNT WITH ORDER
 QUANTITIES AVAILABLE
 WRITE FOR YOUR REQUIREMENTS

C & H SALES CO.

BOX 356-FE EAST PASADENA STA. • PASADENA 8, CALIF.

S BAND

converter—RF end & 2 stage 15 mc. I.F. Navy type CG-46ABW cavity autodyne mixer using 446B lighthouse tube designed to cover 2850 to 3150 megacycles (approx. 9.5 to 11 Cm). Tuning by self contained 115v 60 cy. reversible 1 rpm Bodine motor with limit switches. Comes set up to cover range once in 5 1/2 minutes. Complete with tubes & motor less power supply, in case 11" x 6 1/2" x 7 1/4". Brand New **\$124.50**
 Cavities & other parts of the CG-46ABW & CG-55ACQ units of Mark II Radar available.

30-40Mc Link xmtr 25UFM of SCR-298. **\$59.50**

GUARANTEED SURPLUS—FAST SERVICE

- TIME DELAY RELAY 115v 60cy adjustable 6 sec. to 2 minutes Craner TD2-1208 **\$12.95**
- RELAY 3PDT 24 vdc 250 ohm Clare Type K **\$2.95**
- RELAY 4 PDT 12 vdc 70 ohm Mini tel type **\$1.95**
- SELSYN—1F Special 115/90 v 400 cy. **\$11.95**
- FIL XFMR 6.3 @ 1.3A (other sizes avail.) **\$.99**
- CHOKE 2H 70ma .69c; 2H 70ma 110 ohm. **\$.49**
- BLOWER MOTOR 400-1800cy 115v EAD J31C **\$9.95**
- BIRCHER CLAMPS 926A, 926B, 926C **\$2.25**
- VARIABLE 3-15 mmf Hammar. Hb $1\frac{1}{2}$ " shft. **\$.69**
- ISOLATION XFORMER 35 watts prim 115v sec. 115 or 135v & 6.3 tap $2\frac{1}{4}$ " x $2\frac{1}{2}$ " x 3" **\$2.45**
- SUBMINIATURE tube socket 5 pin. 100 for **\$10.00**
- POWER XFMR 760VCT @ 179ma5 @ 5.6.3 @ 4. **\$4.25**
- SILVER TRMR ERIE T2SA, 1.5-7, 7-45. **\$.36**
- AN-3106-10S-2S, PL-68, 83-1H, JK-33a, JK-34a
- CONDENSERS: BATHUB, MICA, AIR, OIL, HV.
- CER. J POTS, RELAYS, MIKES, 3AG&MDL TUBES, SWITCHES, SPARES for: BC-1296A, NK11 Radar, AN/TPN-2 2% .002 Silver Mica CM30. Ask for flyer.

EMPIRE ELECTRONICS COMPANY

409 Avenue L Brooklyn 30, N. Y.
 CLoverdale 2-2411 BRYant 9-1220

10 Seconds to 24 Minutes Timer

A hand wound electric TIMING SWITCH Pointer moves back to ZERO and shuts off RADIO-TV-Electric Mixer-Photographic Devices-Time Delay etc. Furnished with Calibration Chart and Pointer \$1.25 Knob. Biggest bargain we ever had.

HAYDON SYNCHRONOUS TIMING MOTOR



110 v. 60 cycle 30 RPM....	\$2.60
110 v. 60 cycle 1/10 RPM....	\$2.35
110 v. 60 cycle 1 RPM.....	\$2.85
110 v. 60 cycle 2 RPM.....	\$2.00
220 v. 60 cycle 2 RPM.....	\$1.65

ISOLATION TRANSFORMER

Step-Up or Step-Down 1 1/2 lbs.....	230 volts to 115 volts 115 volts to 230 volts 115 volts to 57 volts	\$2.85
--	---	--------



MARKTIME 5 HOUR SWITCH

A 10 amp. timing device. Pointer moves back to zero after time elapses. Ideal for shutting off radios and TV sets when you go to bed. Limited supply at this special PRICE..... \$4.90

Also available in 15 min., 30 min., 1 hr. at \$5.90



REDMOND Powerful 5" Blower or Ventilator 115 volts AC 60 cycles 18 watts. For Kitchen - Laboratory. Heat or Cold or Chemicals...\$7.50

Genuine TELECHRON Motors

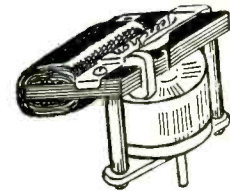

2 RPM.....	\$2.90
3 RPM.....	3.90
3.6 RPM....	3.15
1 RPM.....	3.95
60 RPM.....	4.30
One of each	\$15.00



Mossman Lever Switch \$2.50

10 Amp. Heavy Duty Silver Contacts. Contacts can easily be re-stocked and changed to suit your needs. Now momentary OFF CENTER but can be changed by user to stay either side. Brand New.

Assorted Micro Switches, Acro Switches, MU-Switches..... \$1.00

DID YOU EVER WISH FOR A 3-LEVER SWITCH?

A FOOT SWITCH MADE OF NEW SURPLUS MATERIAL

\$4.95 KIT \$5.75 COMPLETE

USING A 15 AMP. MKM 63 SWITCH

Westinghouse Elapsed Time Meters..... \$15.50

ALL PRICES F.O.B. N. Y.

EST. 1923

BLAN

EST. 1923

64 Dey St.

New York 7, N. Y.

CARRIER EQUIPMENT

Western Electric CF-1A 4-channel carrier telephone terminals.
EE-101-A 2-channel 1000/20 cycle carrier ringers.
CFD-B 4-channel carrier pilot regulated telephone terminals complete with four channels 1000/20 cycle ringing.
CFD-B 4-channel pilot regulated telephone repeaters.
C-42-A V. F. telegraph in from 2- to 12-channel terminals.
FMC 1 or 2 channels carrier telephone terminals, automatic regulation, duplex signaling each channel. Carrier frequencies above 35 KC. Ideal for adding channels above type "C".
Complete engineering and installation services offered.

RAILWAY COMMUNICATIONS, INC.

Raytown, Missouri
Telephone: FLEMing 2121

DIRECTRON SELENIUM RECTIFIERS

Buy Direct From M'facturer

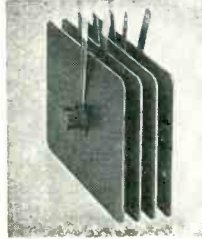

Full-Wave Bridge Types

Current (Continuous)	18/14 Volts	36/28 Volts	54/42 Volts	130/100 Volts
1 Amp.	\$1.35	\$2.15	\$3.70	\$7.50
2 Amps.	2.20	3.60	5.40	10.50
4 Amps.	4.25	7.95	12.95	25.25
6 Amps.	4.75	9.00	13.50	33.00
10 Amps.	6.75	12.75	20.00	40.00
12 Amps.	8.50	16.25	25.50	45.00
20 Amps.	13.25	25.50	39.00	79.50
24 Amps.	16.25	32.50	45.00	90.00
30 Amps.	20.00	38.50
36 Amps.	25.00	48.50

New Selenium Rectifier Transformers

PRI: 115 V., 60 cycles in } 4 Amps..... \$ 8.75
SEC: 0, 12, 18, 24, and 36 } 12 Amps..... 16.75
volts } 24 Amps..... 35.75
Continuous Ratings } 60 Amps..... 59.75

New Selenium Rectifier Chokes

4 Amps.—.07 Hy.—6 ohm..... \$7.95
12 Amps.—.01 Hy.—1 ohm..... \$14.95
24 Amps.—.004 Hy.—.025 ohm..... \$29.95

We can manufacture other Selenium Rectifiers, Selenium Rectifier Supplies, XFMRs., & Chokes.

TRANSFORMER SPECIALS

• 115V. PRI—5V. @ 190 Amp. SEC..... \$49.95

• Sole Heavy-Duty Plate Transformer.

PRI: 200, 220, 240 volts—60 cy.
SEC: 700-0-700 • conservative 200 MA. 5" x 6" x 6 1/2" NEW—Wt. 10 lbs. Special @ \$17.50

• THORNDARSON Boxed Filament XFMR. (T-50F61)
115V.—2.5V. @ 3.5 A..... \$2.00

PARTIAL LISTING OF TUBES AND DIODES IN STOCK

0A2.....	.90	6C4.....	.45	50L6GT.....	.55
0A4G.....	1.00	6CB6.....	.55	FG-105.....	17.00
0B2.....	1.10	6CD6-G.....	1.60	117Z6.....	1.00
0D3/VR150.....	.88	6F6 Metal.....	.69	F-123A.....	6.50
1A7GT.....	.89	6F8-G.....	.35	211(GE).....	.75
1A7F.....	.90	6G6-G.....	.35	250-TH.....	17.00
1B3/8016.....	.80	6J5GT.....	.45	274-A.....	2.95
1B23.....	8.00	6L6-G.....	.62	275-A(WE).....	3.00
1B27.....	12.50	6J7.....	.70	304-TH.....	7.00
1L4.....	.60	6K4(Syl).....	3.50	304-TL.....	8.75
1LA6.....	.90	6K6GT.....	.59	310-A(WE).....	5.95
1N21B.....	2.50	6K7 Metal.....	.70	311-A(WE).....	6.50
1N21C.....	17.50	6L5-G.....	.49	328-A(WE).....	5.00
1N23A.....	2.25	6L6-G.....	1.19	337-A(WE).....	3.00
1N23B.....	3.49	6L6-GA.....	1.20	319-A(WE).....	1.35
1N34A.....	.75	6L6-Metal.....	1.95	350-B(WF).....	3.95
1N41/400B.....	1.21	6L7.....	.80	359-A(WE).....	4.00
1N45/400C.....	1.39	6N7-Metal.....	.80	371-B.....	4.00
1N48(GE).....	1.50	6O7GT.....	.52	407-A(WE).....	5.00
1N54(Syl).....	.77	6S7 Metal.....	.98	374-A(WE).....	3.50
1X2A.....	.90	6SD7.....	.79	387-A(WE).....	2.50
2C40.....	9.95	6SG7.....	.72	400-A(WF).....	2.50
2C43(GE).....	13.95	6SJ7.....	.59	403-B(WF).....	7.50
2C52.....	5.50	6SR7GT(Syl).....	.52	407-A(WE).....	5.00
2E21.....	1.25	6U6GT.....	.60	408-A(WR).....	2.75
2E24.....	2.50	6SN7GT.....	.70	421-A(WE).....	3.50
2E30.....	1.95	6V6GT.....	.55	GL-559.....	1.00
2I22.....	6.50	6W4GT.....	.55	717-A.....	.88
2I32.....	29.95	6W6GT.....	.85	725-A.....	5.50
2I34.....	23.25	6Y6-G.....	.38	805.....	1.59
2I39.....	40.00	6X5GT.....	.35	807.....	1.59
2I48.....	24.25	7A7.....	.69	811-A.....	3.50
2K25.....	29.50	7A8.....	.69	812-A.....	2.70
3A4.....	.59	7C5.....	.69	812-A.....	3.50
3AP1.....	9.00	7C6.....	.69	816-A.....	1.10
3I32B.....	7.00	7C30.....	85.00	828-A.....	8.50
3I329.....	9.95	7F7.....	.69	837.....	1.45
3BP1.....	5.75	7H7.....	.72	860.....	3.95
3BP11.....	9.50	12A6.....	.50	861.....	15.00
3C23(GE).....	9.50	12A7.....	.75	866A.....	1.55
3C27.....	7.50	12A7U.....	.62	(Hytron).....	3.95
3C33.....	9.00	12A7V.....	.49	873-A.....	2.25
3D6/1299.....	.50	12AX7.....	.79	959.....	2.75
3E29.....	9.95	12BA6.....	.57	1613.....	.75
3Q5GT/G.....	.99	12BD6.....	2.10	1616.....	.70
354.....	.80	12BF6.....	.57	1622(6L6M).....	1.95
4C35.....	22.50	12BH7.....	1.15	1625(RCA).....	.35
4E27.....	13.00	12SA7.....	.75	1651.....	.70
4-125A.....	22.00	12SF5.....	.70	1632.....	.70
4-250A.....	32.00	12SG7.....	.80	2050(RCA).....	1.35
5D21(WE).....	16.75	12SH7.....	.63	2051.....	1.10
5R4GY.....	1.25	12SH7.....	.69	5514(Hytron).....	4.50
5U4G.....	.55	12SK7.....	.70	5529(CGL).....	3.00
5V4G.....	.95	12SN7GT.....	.65	5608-A.....	3.95
6A7.....	.98	12SN7GT.....	.70	5646(Syl).....	3.95
6AC7.....	.77	12SQ7GT.....	.63	5654.....	1.75
6AG7.....	1.25	12SH7.....	.69	CK-5702.....	3.23
6AT6.....	1.90	14F7.....	.80	CK-5744.....	2.25
6A16.....	1.30	19P-1A.....	44.00	CK-5886.....	3.00
6AK5.....	.70	(GE).....	.44	5800(Vict.).....	6.50
6AK5-W.....	.90	25AV5.....	1.25	5803(Vict.).....	2.75
6AL5.....	.50	25B06GT.....	1.00	5814.....	2.95
6AN5.....	2.25	25L6GT.....	.85	5910.....	.75
6AT6.....	.60	25Z6.....	.67	5995.....	3.50
6A16.....	.69	35B5.....	.40	8020.....	.98
6AV6.....	.49	35C5.....	.40	9001.....	1.35
6BE6.....	.55	35L6.....	.69	9002.....	.95
6BG6-G.....	1.35	35-T(EIM).....	3.00	9003.....	1.50
6BH6.....	.60	35Z5GT.....	.49	9004.....	.35
6BQ6GT.....	1.20	42.....	.65	9006.....	.35
6BZ7.....	1.35	50C5.....	.50	AN9003.....	17.75

WRITE ON TYPES NOT LISTED

Terms: FOB-NYC—25% Deposit with order—or send full remittance to save COD charges—Rated Firms (D.B.) Net 10 days—All merchandise guaranteed. Phone: REctor 2-2562

Western Electric Push-To-Talk Handsets (Type F₃)

BRAND NEW WITH SWITCH AND COILED CORDS... \$9.75
IN CASE LOT OF
20 PIECES... \$9.50

RADIO TELEPHONE SETS

Western Electric 4 Channel Ship-to-Shore Sets. Brand new. Made for U. S. C. G. deluxe compact, includes transmitter, receiver and built-in power supply for 12-volt D. C. operation. Original cost \$550. Our price..... \$149.50

SELENIUM POWER SUPPLY

0 to 12VDC/2 Amp. Variable DC supply, uncase and completely built-inpt. 115v/60 cy. Usable LAB supply. filament D.C. plating, battery charging, model railroad, includes voltage or speed control and center off reversing sw. Ideal for two "110" locomotives..... \$10.95
2 for \$20.00

FILTER CAPACITORS

Capacity	W. Voltage	Ea.
500 MFD.	50 V.	.98
500 MFD.	200 V.	2.50
1000 MFD.	12 V.	.50
3000 MFD.	20 V.	2.25
5000 MFD.	50 V.	3.75

• W.E. HERM. SLD. PWR XFMR PRI—115V.—60 cy. SEC—930V. CT @ 520 ma and 5.2V. @ 4 amps. Brand New—III-Voltage Insulation \$9.95
• Choice to match above XFMR. New. Mfd by Western Electric..... \$4.95

QUANTITY USERS OF GENERAL ELECTRIC JOBBERS' 2C43 (COLORED) BOXED, CURRENT PRODUCTION IN PLIOFILM PACKAGE.
QUANTITY PRICE..... \$12.95

7C30 12 KW. POWER TRIODE WITH 16 VOLT FILAMENT XFMR. (TAPPED AT 11V.). 220 V. PRIMARY—COMBINATION—ALL NEW.
\$105.00

JOBBERS... LARGE QUANTITIES OF W.E. COMPONENTS, XFMRs, CAPACITORS, ETC. WRITE.

CBS—Hytron Cathode-Ray Picture Tubes

First Quality in factory-sealed cartons. Full Year Warranty Card on each tube. Remember... no seconds, no re-builds... Prices include Fed. Tax. C.R. Tubes via Express Collect.

7JP4.....	18.75	16KP4.....	28.75	17HP4.....	25.50
10BP4A.....	21.00	16RP4.....	30.00	20CP4A.....	38.50
12LP4A.....	21.50	16TP4.....	30.00	21EP4A.....	38.50
14CP4.....	24.00	17BP4A.....	24.75	21FP4A.....	38.00
16AP4.....	31.00	17CP4.....	25.25		

• AR-11—Complete Station for 20, 40, or 80 meter Superhet Rcvr—50 Watts CW w/built in 115V. A. C. Pwr Supply. New—in compact suitcase (orig. cost over \$500) An excellent buy for only..... \$99.50

Trinim. Model 100 "Featherweight" Headsets & Band. New, in orig. mfr.'s carton..... \$4.95

• Biley-Type SMC100—Crystal Standards New—100 KC and 1,000 KC BAR..... \$8.50

• LM FREQUENCY METER—INT. MODULATION—Orig. Book. Excellent condition..... \$115.00

Top Dollar Paid for SURPLUS TUBES & EQUIPMENT — Send List With Details

BARRY ELECTRONICS CORP.

136 LIBERTY STREET • NEW YORK 6, N. Y.

WIRE-CABLE TUBES PARTS

CORDAGE

CO-122 3 conductor each #22 AWG neoprene jacket 550' lengths
 CO-127 single #14 AWG braided and tinned copper braid shield

MULTI-CONDUCTOR

2 conductor AWG 12 7 conductor AWG 16
 7 conductor AWG 14 19 conductor AWG 16
 14 conductor AWG 16 6 conductor AWG 20
 11 conductor shielded 10 conductor AWG 16 AWG 20 22 conductor AWG 16
 2 conductor AWG 18
 2 conductor shielded AWG 10

AMOUR

DRIA-23 DHFA-100 FRIA-4

SINGLE CONDUCTOR AWG 10

shielded cable with terminal lug each end 100' and 150' lengths

WIRE

AWG 18 copperweld
 AWG 29 tinned copper
 Resistance wire AWG 32
 AWG 22 with nylon core plastic insulation

LINEAR WIRE WOUND POTENTIOMETERS

10 Ohm	25 Watt	\$.90	15000 Ohm	25 Watt	\$ 1.70
15	25	.95	20000	25	2.00
20	25	.95	6	50	1.60
25	25	.95	150w/switch	50	2.15
50	25	.95	200 w/switch	50	2.15
100	25	.95	10000	50	2.95
200	25	1.20	15	75	2.95
350	25	1.20	.5 Meg 1" Shaft	AB "J"	1.45
500	25	1.20	200,000 1/8 SD	AB "J"	1.40
1000	25	1.30	200 1/8 SD	AB "J"	1.40

SPECIALS

80-86 Crystal in Holder \$2.50
 Balloon with Hydrogen Generator \$2.50
 300 Feet Aerial Wire \$2.00

SWITCHES—BATHTUB—OIL FILLED—MICA CONDENSERS—POTENTIOMETERS. SEND FOR CATALOG

MICROWAVE TEST EQUIPMENT

10 CM echo box CABV 14ABA-1 of OBU-3, frequency range 2890 MC — 3170 MCS. Direct reading micrometer head. Ring prediction scale plus 9% to minus 9% Type "N" input. Resonance indicator meter. With accessories, spares and 10 CM directional coupler. Brand New.

TUBES

2C34	5.45	801A	.25	9006	.30
2X2/879	.55	803	3.60	CSB	8.00
3B24	4.95	826	.65	CK 70	4.15
3C24	1.60	864	.25	E1148	.30
7C4/1203A	.70	931A	4.45	MY 615	.20
10Y	.35	955	.30	RK 73	.45
15R	.65	957	.35	SBP4	4.25
30 Spec	.40	CK 1005	.45	SFP7	1.75
39/44	.25	CK 1007	.90	1J6 G	.70
45 Spec	.35	1626	.35	1B3 GT	.80
WE 203A	6.75	1629	.25	3A4	.60
316A	.60	2051	1.10	5U4G	.57
WL 531	4.95	7193	.50	6K6GT	.60
713A	.90	8011	1.50	371B	.75

HI VOLTAGE FILTER CHOKES

.4 HY 4.5 Amp DC 3 ohms 1230 RMS to ground. New.
 1 HY 3.2 Amp DC 3.5 ohm GE69G459. New.
 1.7-3 HY 2 AMP DC 34,000 VDC GEY346A. New.

NAVY ENTERING TYPE INSULATOR

Porcelain flanged bowl with brass rod, fittings and aluminum shield. Dimensions 4 7/8" high, 6-5/16" OD at base. Brand new \$4.50.

10 CM ROTATING ANTENNA

24" Parabola in turret 360° span at 12 RPM DC, motor control and reversing switch New.

TIME DELAY SWITCHES

1 Minute 115 VAC 60 cycle Enc. in Water-proof Metal Case. New \$5.25
 3 Micro Switches Contact at 40-41-42 Second Time Delay 110 VAC Motor New \$4.50
 Thermo Switch 50° to 300° F 115 VAC @ 6A 230 VAC @ 5A
 Breaks Contact with increase in Temperature. New \$1.35

CONTACTORS

DPST 115 VAC 60 cycle 15 Amp De-Ion Line Starter Westinghouse \$6.95
 DPST 115 VAC "AB" #700 \$5.95

RELAYS

12 VDC DPST Allied Control Box 32... \$1.25
 24 VDC DPDT Allied Control BID36... \$1.45
 24 VDC 3PDT 8 Amp... \$1.50
 110 VAC DPST 1 Amp Contacts Struthers Dunn CKA 1970... \$3.65
 115 VAC DPST Struthers Dunn CXA 2997... \$3.65
 220 VDC DPDT Struthers Dunn CK 2122... \$4.50
 230 V 50 cycle DPDT G.E. 12HGA11A2... \$4.00

OIL FILLED CONDENSERS

FD	VDC	Each	Ten	MFD	VDC	Each	Ten
1	600	.85	.80	.5	2000	2.00	1.90
2	600	.95	.95	.25	3000	2.85	2.80
4	600	1.40	1.40	.5	3000	2.95	2.90
5	600	1.65	1.60	.2	5000	4.50	4.25
1-8	600	2.50	2.35	.1	7500	3.95	3.95

METERS

Portable 0-25 Amps AC Weston #433 Brand New \$37.50
 Switch Board Panel 0-100 Amps DC Weston #269 with 100 Amp Shunt Brand New \$24.95

EQUIPMENT

Walkie-Talkies 2.3-4.6 MC
 MN-26Y Bendix Compass Receiver
 BC-733 Glide Path Receiver
 DAB 3—Direction Finder
 RDF Receiver Equipment 200-500 KC Fixed Tuned

COMET ELECTRONIC SALES CO.

22 Washington St.

Tel. BEacon 2-7863

Brighton 35, Mass.

TERMS: Minimum order \$5.00 — Mail orders promptly filled—All prices F.O.B. Boston, Mass. Send M.O. or check. Shipping charges sent C.O.D. 25% deposit required with all C.O.D. orders.

IF RESISTORS.....

where unit measurement is Ω

..... CALL LEGRI S COMPANY

since 1945 Resistors is our business

ANY RESISTORS

Fixed or variable
 Carbon or wirewound
 1/8 Watt up to 300 Watt
 Precision of 1/4 of 1% or 20%
 Any makes—any types—any values
 One piece or one million

ANY CONTROLS

Potentiometers, Rheostats, Attenuators
 For development research or production

News is added:

Guaranteed aged resistors. Ask for Particulars by G. Grinn

LEGRI S COMPANY

158 West 99 Street

Phone: UNiversity 5-4110

New York 25, N. Y.

Mr. Purchasing Engineer—

"COMPONENTS" invites you to dial BEekman 3-8717, and check our wide variety of electronic parts we can deliver at once from stock.

7 FLOORS OF MERCHANDISE

✓ JAN-Spec. and other specials, plus standard components of industrial, television and radio apparatus. Some end equipment, too, including telephone switchboards, transmitters, portable filter centers, power supplies and dynamotors, etc. Compare our prices on these items:

1.154 PE-94 DYNAMOTOR POWER SUPPLIES. In: 28 V. D-C; out: 300 V. at 260 ma., 14.5 V. at 4.9 A., and 150 V. at 10 ma., D-C P/O SCR-522 \$5.00 ea.

8,000 TYPE 120KT RESISTORS, 120 watts, 10,000 ohms. Individual overseas wrapped. \$.69 ea.

31 RM-23 CONTROL UNITS. Part of RC-76 equipment. Signal Corps Stock #2C679-23. \$24.00 ea.

26 RM-25 CONTROL UNITS. Part of SCR-561, 572 and -642 eqpt. Sig. C. 2C679-25. \$4.00 ea.

8,000 NF-1 NOISE FILTERS. Mfr. P. R. Mallory. Rating up to 100 amperes; oil condensers. F.O.B. warehouse. Subject to prior sale. Minimum order \$50.00.

FACTORY EXCESS—STANDARD BRANDS
✓ T-V focus and deflection coils, tubes, wire, phono, turntables and motors, transformers, sockets, etc., available in production quantities.

FUSES—Littelfuse and Busman. \$15.00M/100

CERAMICONS—Nearly all values, in hollow, solid and disc types \$20.00M/100

ELECTROLYTICS—Metal can and paper tubulars. Tens of thousands. Standard brands. Priced low.

MICA AND PAPER BYPASS CONDENSERS. Most capacities.

VARIABLE CONDENSERS—TRF and Superhet. TRIMMERS and PADDERS—"Mica compression" and "air variable" types. Large quantities.

RESISTORS— $\frac{1}{2}$ and $\frac{1}{3}$ -W., uninsulated carbon. Most values SPECIAL, \$5.00M. Min. sale, 1,000.

• "CSC" 5-watt Audio Amplifiers, available in current production, meet general-purpose needs.
• "CSC" low-voltage and heavy-current, Selenium-rectifier Power Supplies are an economical source of current for testing and servicing 12- and 24 V. D-C equipment (Aircraft transmitters, etc.).

Catalog sheets upon request on your letterhead.
WE MANUFACTURE TO YOUR SAMPLE AND SPECIFICATIONS

COMPONENTS SUPPLY CO.

161 E Washington St., N. Y. 6, N. Y.

TELEPHONE EQUIPMENT & PARTS

New TS9 handsets W/Flip switch in handle \$7.00 Each.

Reconditioned Like New TS9 handsets. \$4.95 Each.

New Receiver and Transmitter elements for TS9 handset, etc. \$1.00 Each

C-161 repeat coils \$3.50 Each.

Reconditioned EE8 telephones in stained leather bags \$20.00 Each.

TS 10 sound power handset with rubber cord \$10.00 Each.

New R.C.A. Transmitter & receiver elements sound power \$2.50 Each.

Operator head & chest sets HS 19 for BD72 switchboards, etc. \$5.50 Each.

New CC 333 rubber cords. \$0.35 Each.

Upright desk telephones for extensions, intercoms, etc. \$2.95 Each.

New W.E. FI and HAI receiver & transmitter elements \$1.50 Each.

New W.E. FIW handsets W/rubber cord & PL47 plug \$7.00 Each.

Repeat coils 94E \$4.00 Each.

New Tape recorder BC 1016 \$150.00 Each.

New ATR Inverter 110 V.D.C. input output 110V. A.C. 60 Cycles \$50.00 Each.

W.E. Rectox Rectifiers 25-40 cycles KS 5300-L3 \$20.00 Each.

G. E. Tungar Battery Chargers Cat #221514 \$30.00 Each.

W.E. Rectifier KS 5536-01—Input 105-125V. A.C. Output 120V. D.C. \$50.00 Each.

BD 71 switchboard magneto 6 lines. \$25.00 Each.

Dials . . . A.E. W.E. Federal. \$3.50 Each.

Jack Box JB 84 \$5.00 Each.

Line Men safety belts. \$2.00 Each.

EE2C line units magneto, less cord. \$1.00 Each.

Jacks JK 47 \$0.25 Each.

Switch SW 150 \$0.50 Each.

New TS13 handsets with CD494 cord & PL68 & PL55 Plugs \$10.50 Each.

Telephone Ringer Box w/induction coil, capacitor and bell.

Terms: Check with order F.O.B. Brooklyn 5, N. Y.

EASTERN TELEPHONE COMPANY
323 VANDERBILT AVENUE
BROOKLYN 5, N. Y. MA 2 - 3753

DC SMALL MOTORS

24 VDC REVERSIBLE

MOTOR—3.7 RPM, 40 lb. Torque. Motor Size: 5- $\frac{1}{2}$ " x 4- $\frac{1}{2}$ " x 3- $\frac{1}{2}$ ". Shaft Size: 21/32" x 5/16". Also operates 24 VAC. Philco No. 441-1008 \$5.95



27.5 VDC—6000 RPM, 1.5 oz. In. Shaft Size: 1- $\frac{1}{2}$ " x $\frac{3}{4}$ ". Motor Size: 2- $\frac{1}{2}$ " x 1- $\frac{1}{2}$ ". No. 5069-267 \$6.95

27 VDC—1/10 HP—3500 RPM. Shaft Size: $\frac{5}{8}$ " x $\frac{1}{4}$ ". Motor Size: 4" x 3- $\frac{1}{2}$ ". Air Assoc. No. EE-763 \$6.95

80 VDC—1/50 HP—3000 RPM. Shaft Size: $\frac{3}{8}$ " x $\frac{1}{4}$ ". Motor Size: 5" x 3". G. E. No. 5 BN38HA10. \$6.95

28.5 VDC—1/35 HP—2200 RPM. Shaft Size: 1- $\frac{1}{2}$ " x $\frac{3}{4}$ ". Motor Size: 4- $\frac{1}{2}$ " x 3- $\frac{1}{2}$ ". Electrolux No. 16876 \$5.95

ANTENNA EQUIPMENT

MAST BASES—INSULATED:



MP-132 BASE—(As illustrated at left) 1" heavy coil spring, 2" insulator. Overall length: 11- $\frac{1}{2}$ ". Weight: 2- $\frac{3}{4}$ lbs. Price \$3.95

MP-S-33 BASE—Insulated type with heavy coil spring and 5" dia. insulator. Requires 2" hole for mounting. Weight: 9 lbs. \$5.95

MAST SECTIONS FOR ABOVE BASES

Tubular steel, copper coated, painted, in 3 ft. sections, screw-in type. MS-53 can be used to make any length with MS-52-51-50-49 for taper. Any section 50c Each

Larger Diameter Sections: MS-55-54. \$1.25 Each

AN-104B Antenna—100-156 MC.—Copper \$5.95

AN-104B Antenna—100-156 MC.—Steel 3.95

AN-104A Antenna—100-156 MC.—Copper 3.00

AN-104A Antenna—100-156 MC.—Steel 2.00

AN-117 Whip Steel—6 Ft. length 1.50

AN-109A Whip Steel—5 Ft. w/ base 1.50

AS-27/ANR-5 Ram's Horn, 10 MC.—USED 5.95

AT-37/APT Stud—113-115 Mc. 6.95

AT-42/APT-3 or APT-1 Stub—113-150 MC. 6.95

AS-97/ARQ-3 Spike with coaxial lead in base. 4.95

AS-61/ANR-5 Half-Wave Dipole—335 MC. 3.95

AT-2/APN-2 4.95

AIRCRAFT CONTROL CABLE—3/32"—7 x 7 Strand, Weatherproofed, Galvanized, Preformed. 920 lb. test. Ideal for Television Guying and many other uses. Prices: 4- $\frac{1}{2}$ c per Ft.—1000 Ft. or more at 4c per Ft.

BLOWERS:

115 Volt 60 cycle BLOWER (pictured), approx. 100 CFM. Dis. 2- $\frac{1}{2}$ " intake; 2" outlet. Quiet running. Motor size: 2- $\frac{1}{2}$ " x 3- $\frac{1}{4}$ ". NEW — NOT GOV'T surplus. Order No. 1C939 \$8.95



DUAL BLOWER—Same as RN-520 above, except has blower assembly in each side of motor. Order No. 1C880 \$13.95

COMPACT TYPE—108 CFM, motor built inside squirrel cage, 4- $\frac{1}{2}$ " Intake; 3- $\frac{3}{4}$ " x 3" Dis. Complete size: 4- $\frac{1}{2}$ " W x 9- $\frac{3}{8}$ " H x 8- $\frac{1}{8}$ " D. Order No. 2C067 \$14.50

FLANGE TYPE—140 CFM, 3- $\frac{1}{2}$ " Intake; 2- $\frac{1}{2}$ " Dis. Complete size: 8- $\frac{1}{2}$ " W x 7- $\frac{1}{4}$ " H x 6- $\frac{3}{4}$ " D. Order No. 1C807 \$13.95

FLANGE TWIN—275 CFM, 4- $\frac{1}{2}$ " Intake; 3- $\frac{1}{4}$ " x 3" Dis. Complete size: 11- $\frac{3}{4}$ " W x 9- $\frac{3}{8}$ " H x 8-1/16" D. No. 2C069 \$21.95

AERIAL WIRE—Phosphorus Bronze #16 Stranded. 200 lb. test. Weatherproof. 150 ft. on Reel. RL-3 with Clips \$1.50

TELEPHONE WIRE—3 Cond. copper & steel, 525 ft. \$4.75

ADDRESS DEPT E • All Prices Are F.O.B., Lima, Ohio • 25% Deposit on C.O. Orders

FAIR RADIO SALES • 132 SOUTH MAIN ST. LIMA, OHIO

AIRCRAFT ELECTRONICS

ARC—1's, ART—13's, RTA 1B's, BC348's AND COMPONENT PARTS FOR ABOVE

WRITE OR CALL FOR BULLETIN

MERRICK ELECTRONICS

166-08 DOUGLAS AVE.

JAMAICA, N. Y.

RE 9-5960

RADIO FREQUENCY AMPLIFIERS:

RADIO FREQUENCY AMPLIFIER AM-14/APT 100 W. Used to increase output Transmitting Equipment AN/APT-1. Input 80 or 115 V. AC 400 to 2600 Cycle 600 W. \$59.50

RADIO FREQUENCY AMPLIFIER AM-18/APT 140 to 210 MC.; Power Output 110 W. @ .5 Amps. Used to amplify output Radar Trans. T-28/APT-1; Power Input 80 or 115 V. AC 400 to 2600 cycle 600 W. \$59.50

RADIO FREQUENCY AMPLIFIER AM-33/ART Freq. Range 35 to 105 MC. Band width 3.5 \pm 0.5 MC. Used to increase power output AN/ARQ-8 to 150 Watts. Input 80 or 115 V. AC 400 to 2600 Cycle 600 W. \$59.50



SELSYN

2J1G1 CONTROL TRANSFORMER WITH CAPS. 57.5 VOLT; 400 CYCLE. NEW; \$5.95 EACH.

SELENIUM RECTIFIER UNITS

HEAVY DUTY—30 VOLT DC OUTPUT:

115/200 V. Three Phase 400 Cycle Input:
TYPE 143 w/Transformer & VR 100 Amp. \$69.50
TYPE 3FS15 w/Trans., VR, & Blower—200 Amp. \$39.50
TYPE-52A-11 Rectifier Only, Cased, 200 Amp. \$39.50
TYPE A-1 Rectifier Only, Cased, 300 Amp. \$49.50

BATTERY CHARGING RESISTOR PANEL

115 VDC—6.67 ohms 30 Amps. Max. Switching High-Low & Off. Charging rate: 6.2 Volt Cells; High 30 A.; Low 15 A.—12.2 Volt Cells; 25.8 High; Low 12.7—15.2 Volt Cells; High 23.7; Low 11.6. Complete with Cable. Panel size: 21" x 22" x 10". Mfg. by Ward Leonard—NEW. Price: \$29.95

TRANSFORMERS—100V. 60 Cycle Pri.

5 VOLT CT-25A—10,000 V. Ins. OPEN FRAME—6" x 5" x 4- $\frac{1}{2}$ " \$7.95
Sec. Two 12 V. 4 A. Wind-ings—gives 12 V. 8 A. or 24 V. 4 A. \$5.95
Sec. 24 Volt $\frac{1}{2}$ amp \$1.50
Sec. 24 Volt 1 Amp \$1.95
Sec. 24 Volt 6 Amp. \$5.95
Sec. 6-24 or 30 Volts 8 Amp. \$5.95



MOTOR—GENERATOR:

Navy type CCL-211014, 115 VDC— $\frac{3}{4}$ HP—1750 RPM. Generator 27 VDC, 9.3 Amp. Direct Drive Price: \$89.50

DYNAMOTORS:

DYNAMOTOR and BLOWER: 9 Volts DC input; output 450 Volts 60 MA. 4500 RPM. At 6 Volts DC input; output 260 Volts 65 MA. 3000 RPM. \$4.95

Input	Output	Stock No.	Price
14 V. DC	600 V. 300 MA.	BD-36	\$9.95
12 V. DC	220 V. 70 MA.	DM-24	6.95
12 V. DC	220 V. 100 MA.	DM-18	4.95
12 or 24 V. DC	440 V. 200 MA. & 220 V. 100 MA.	D-104	14.95
14 V. DC	375 V. 150 MA.	DM-375	8.95
14 V. DC	330 V. 135 MA.	DM-330	7.95
14 V. DC	500 V. 500 MA.	PE-59	14.95
12 or 24 V. DC	275 V. 110 MA.	USA/0516	3.95
12 or 24 V. DC	500 V. 50 MA.	USA/0515	3.95

ALSO—PE-73; PE-86; DM-53; DM-33; 5055; DM-416; PE-101, etc.

24 HOUR DELIVERY FROM STOCK!

RELAYS

Our stock of more than a million relays — in over a thousand different types — is the world's largest. Don't delay your production for want of large or small quantities of relays of any type.

Telephone, wire or write for quotations.

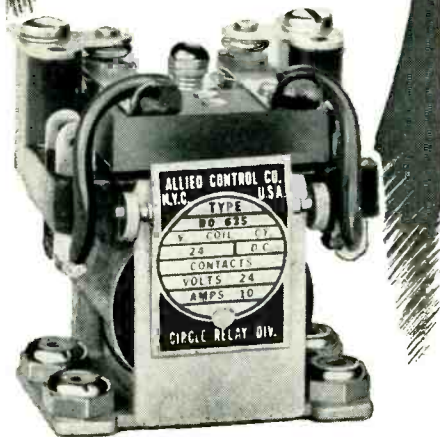

NEW AND MORE COMPREHENSIVE

1953 RELAY SALES CATALOG

NOW READY

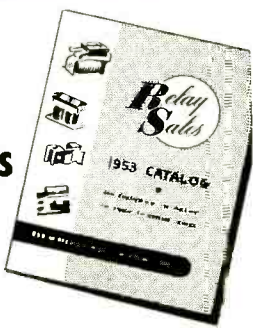

Be sure to send for your copy

Telephone
SEeley 8-4146

Relay Sales

833 W. CHICAGO AVE.
DEPT. 4, CHICAGO 22, ILL.

We have one of the largest stocks of special purpose tubes in the United States for immediate shipment. We sell tubes only and consequently each order receives individual attention from tube specialists. We sell only new tubes, standard brands, either JAN or commercial specifications depending on stocks on hand.

OA2	.98	3E29	14.95	331A	6.95	841	.59
OB3/VR75	1.04	3PP7	1.95	350B	3.95	843	.39
OB3/VR90	1.25	3Q4	.59	353A	4.25	846	75.00
OC3/VR105	1.05	4AP10	3.95	357A	14.95	860	4.50
OD3/VR150	.99	4B28	2.95	3711	1.95	861	32.50
1B22	.85	4J42/700A	24.50	388A	1.49	864	.75
1L26	2.25	5AP1	3.49	394A	4.75	865	1.25
1B27	2.25	5C30/C5B	3.75	WL417A	14.95	866A	1.49
1B29	13.95	5FP7	1.95	450TH	44.00	872A	3.95
1B36	2.45	5B	3.75	530	16.95	874	1.19
1B56	6.95	5R4GY	1.49	531	16.75	876	.95
EL1C	34.50	6A	5.75	533	16.95	879	.49
1D8GT	2.49	6AK5	.79	559	1.00	931A	4.95
1L4	.89	6B8	.85	HY615	.39	954	.35
IN21R	.59	6K7G	.49	700A	22.50	955	.55
IN23A	2.75	7B5	14.95	701A	4.50	956	.69
IN23B	2.50	7C4	.59	702A	2.49	957	.35
IN34A	3.50	7E5/1201	.59	703A	4.75	958A	.45
IN34A	1.19	10Y	.75	704A	.89	E1148	.95
IN38A	1.19	12A6	.59	705A	1.49	EP50	1.09
IN54A	1.19	24G	1.39	706AY-DY	39.50	CK1005	.75
IN58A	1.19	30Spec	.69	706EY-GY	39.50	1291	.59
IR4/1294	.89	RK34	.59	707A	7.49	1294	.89
IT4	.69	45 Spec	.35	708A	3.75	1299	.39
2C21/1642	.59	FG81A	3.49	710/8011	.89	1608	3.95
2C22/7193	.30	RK72	1.25	713A	.95	1616	1.95
2C26	.19	RK73	1.25	714AY	9.95	1619	.75
2C26A	.45	RK75	5.75	715A	16.25	1625	.40
2C34, RK34	.59	RE15	16.95	715B	14.95	1626	.40
2C40	8.95	VT90	.89	715C	22.50	1629	.39
2C43	14.95	VT98	16.95	717A	1.25	1636	2.95
2C44	1.15	100TH	7.75	721A	2.95	1642	.59
2J21	16.95	HY114B	.95	722A	2.95	2051	1.09
2J26	16.95	VT127	1.75	724B	4.95	7193	.49
2J26	24.95	VT127A	2.95	725A	8.95	8011	.89
2J27	24.95	F128A	89.50	800	1.75	8012	3.95
2J39	29.95	205B	1.49	801A	.75	8013A	3.95
2J40	29.95	211	1.75	803	4.95	8020	2.95
2J61	39.95	217C	6.95	805	3.90	8021	2.95
2J62	39.95	250TH	18.75	807	1.65	9001	1.50
2K25	27.50	250TL	16.95	808	2.50	9002	.95
2V3G	.89	285A	8.95	811	2.90	9003	1.75
2X2	.55	286A	5.75	812	2.70	9004	.95
3B7/1291	.59	304TH	6.50	815	3.25	9005	1.90
3B22	2.49	304TL	13.95	830B	3.45	9006	.33
3C24/24G	1.39	307A	5.75	832A	9.50	6 Amp Tungar	
3C28	4.95	316A	1.25	836	4.95	Bulbs	2.95
3CP1/S1	1.49	328A	6.95	837	1.95		
3D6/1299	.39	329A	7.95				

MARITIME INTERNATIONAL COMPANY

11 STATE STREET NEW YORK 4, N. Y.
Phone: Dlgby 4-3192 Cable Address: FOXCROFT

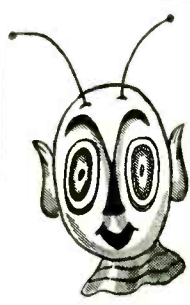

WANTED!

THE GREEN-EYED, SLAB-JAWED, BALD-HEADED, BOGGLE-FACED, "SHORT US' ELECTROCUSS" AND OTHER TIME-WASTING BUGS! HUNT 'EM DOWN WITH THESE BARGAIN-PRICED DEPENDABLE TEST INSTRUMENTS:

- 106-M IH. Indicator
- 616A UHF. Signal Generator
- 300A Harmonic Wave Analyzer (Hewlett-Packard)
- B-41451 Shield SC # P/OTS-34/AP5
- 1-82-F Indicator. P/O SCR-269F
- EE-65-F Test Set
- 188X Signal Generator (Hickok)
- A-27 Antenna Phantom P/O SCR-508
- BC-1016 Recorder
- BC-1255-A Delco Het. Monitor
- BC-906-D Frequency Meter
- CW-60-ABM Wavemeter
- CZH-50152 Audio Amplifier
- EE-65-E Test Set
- EE-85 Time Interval Apparatus
- EE-99-T3 Telephone Repeater Equipment
- Type 1 Officers' Intercept Kit
- Type 7 Oscilloscope
- TVFM Electronic Sweep Generator
- TS-16/APN Test Set
- TG-10-B Automatic Keyer
- Video Sweep Oscillator
- US-253 G.E. Square Wave Generator
- 155 R.C.A. Scopes
- 620A G.R. Test Set
- 720A G.R. Het. Freq. Meter
- BC-221-J Frequency Meter (Mercury)
- E-400 Sweep Signal Generator (Precision)
- 1-56-E Test Set, Weston Model 714 Type 4
- 1-95-A Field Strength Meter
- 1-102-A Indicator
- 1-135-E Galvin Test Set
- 1-198-A Signal Generator
- 1-222A Signal Generator
- ID-6A/APN-4 Oscilloscope Indicator
- ME-21A Maintenance Equipment
- OAN (Fada) Test Oscillator
- PRC Analyzer Test Set Recorder, by Leeds & Northrup
- S-6 Browning Lab. Freq. Meter
- SR-90A Het. Freq. Meter
- TS-59/APN-1 Test Set
- TS-323UR Freq. Meter
- TG-10 Keyer
- VM-27 Vac. Tube Voltmeter, (Barber)
- 19X Hickok Microvolt Generator
- 546B G.R. Microvolter
- 715 RCA Scope Console
- 726A G.R. Vac. Tube Voltmeter
- BC-221J Freq. Meter (Howard)

Details and Prices on Request.

Bigelow 2-6666

Telegraph WUX, Newark, N. J.

Always Right With Earl White

RADCOM Engineering Co.

8 LIVINGSTON ST. NEWARK 3, N. J.

WAREHOUSE CLEARANCE TUBE SALE

NEW, STANDARD MANUFACTURERS, IMMEDIATE DELIVERY

OB3/VR90	\$.99	6AC7	.95	721A	2.45	EL302.5/3B21	2.95
OC3/VR105	.99	6AG7	1.15	723AB	22.50	FG27A	6.50
OD3/VR150	.85	6AJ5	1.50	724A	2.95	FG90	4.95
1A3	.78	6AJ6	1.50	724B	3.95	GL316A	2.50
1A5GT	.62	6B6G	.75	725A	8.50	GL434A	22.50
1B22	2.50	6C6	.74	726A	14.95	GL446A	2.50
1B24	9.95	6C8G	.74	801	.85	GL605	49.95
1B27	17.50	6H6	.59	803	3.95	ML-531	14.50
1B32/532A	2.95	6K7	.63	804	10.50	QK59	65.00
1N21	1.00	6C67	.97	805	3.95	QK60	65.00
1N22	1.19	6SH7GT	.79	807	1.65	QK61	65.00
1N23	1.19	6SH7	.79	810	10.95	QK72	65.00
1N27	1.65	7C4/1203A	.75	811	2.85	RK25	3.69
1P23	2.75	7E5/1201	.89	813	8.95	RK72/CRP72	1.95
1R4	.59	7E6	.55	814	2.79	RX233A/2C33	2.75
1T4	.59	10Y	1.30	815	3.40	VR90	.99
2A3	.95	12A6	.85	816	1.45	VR105	.99
2AP1	7.50	12C8	.89	826	1.39	VR150	.85
2B22	2.95	12J5GT	.52	830B	2.95	VT127A	2.10
2C33/RX233	2.75	12S7	.69	832	7.95	WL417A	22.50
2C40	17.50	12SJ7GT	.55	832A	9.50	WL653B	75.00
2E22	2.75	14H7	.79	838	3.50	ZP653	65.00
2J21	7.95	14J7	.79	866A	1.10		
2J21A	8.50	15R	.75	872A	3.65		
2J22	9.50	23D4	.65	884	1.50		
2J27	14.95	30	.48	902P1	5.50		
2J34	29.95	45	.35	954	.45		
2I50	69.50	53A	2.50	957	.45		
2J55	84.50	71A	.69	1616	1.95		
2X2	.89	100TH	10.50	1619	.75		
2X2A	1.65	112A	.49	1624	1.45		
3A4	.85	211	1.25	1625	1.65		
3B7/1291	.62	227A	4.50	1629	1.25		
3B24	4.95	274B	2.95	1655/65C7	.97		
3C23	9.95	304TH	13.95	1846	95.00		
3C24/24G	1.95	304TL	19.50	2051	.95		
3DP1	3.50	350A	6.25	8005	5.85		
3D6/1299	.62	359A	1.85	8020	2.50		
3EP1	4.50	371B	2.95	9001	1.35		
3FP7	3.50	388A	2.95	9002	1.00		
3GP1	3.95	394A	4.25	9003	1.49		
3JP12	10.50	450TH	44.50	9004	1.00		
4B22/EL5B	6.50	450TL	44.50	9006	.75		
4B25/EL6CF	6.50	464A	8.95	CE22	1.00		
4J36	145.00	531	14.50	CK501X	1.00		
4J37	145.00	532A/1B32	2.95	CK1089	1.00		
5BP1	4.69	705A	2.95	EL5B/4B22	6.50		
5D21	19.95	706AB	19.50	ELC5B	6.50		
5FP7	1.65	706AY-GY	27.50	ELC6A	6.50		
5JP2	19.50	707A	9.95	ELC6F	6.50		

NEW! FOR REMOTE CONTROL!
ROTARY, SOLENOID-OPERATED
6V DC MULTI-CIRCUIT
WAFER SWITCH!

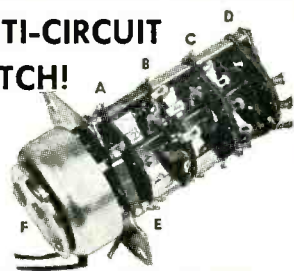

REG. \$7.25

\$3.95

THE SWITCH OF 1000 USES!

Wonder solenoid that obsoletes manual switching. Remote selection of crystals, band changing, audio circuits, antenna switching etc. Solenoid (F) produces a rotary motion (from 6V DC source), transmitting this motion to rotor shaft of 4 gang wafer switch by novel ratchet mechanism, advancing switch. Cam-operated interrupter switch (E) attached to wafer (A) opens when solenoid nears end of stroke, de-energizing solenoid. By combining E and A, either stepping or rotary selective action is achieved. Requires 6V DC @ 10A for .03 seconds. Control wafers: Decks A, B and C are 1 pole 6 pos. Deck D is DPST. Resistance 1/2 ohm DC. 25 degree rotary stroke; 8 lbs./in. torque. Size: 4 1/2 x 2 1/2 x 2 1/2". Shipping weight 1 lb. Pictorial schematic circuits included.

ORDER NO. RE-4519 \$3.95

SALE!
 1 mfd
 @ 15,000
 OIL
 CONDENSER
\$38.75

Order No. RE-370

RADIO SHACK

CORPORATION

167 Washington St., Boston 8, Mass.

WRITE TODAY FOR
 FREE 8-PAGE FLYER.
 HUGE LISTING OF
 OFF-PRICE VALUES!

SOLA
CONSTANT VOLTAGE
TRANSFORMERS

Input: 95-125
 250 VA
 500 VA

Out: 115
 \$30
 50

PLATE TRANSFORMERS

Galvin FMT-50	\$10
690 V 280 MA	
Collins 32RA	15
675 V 350 MA	
Federal BC-365	40
1500 V 950 MA	
Hallicrafters BC-610	50
2500 V 500 MA	
RCA MI-7186	85
2900 V 1.3 A	
Press Wireless 981	150
3400 V 1.7 A	
Wilcox 96-C	300
4000 V 3.0 A	

TUBES

Eimac 304TL
 RCA 833A
 Federal F-128A
 Federal F-207
 Amperex 232CH

\$5	24,000 ohms imp.	\$3
30	6' cord & PL-55	
50	Type P-20	
100	8000 ohms imp.	1.50
150	Type HS-18	

MODULATION
TRANSFORMERS

Collins BC-401
 425 watt
 Collins BC-642
 2000 watt
 Wilcox 96-C
 2000 watt

		OIL CAPACITORS	
	MFD	WVDC	
\$35	8	600	\$1.50
	8	1000	2.50
	1	2000	1.50
	2	2500	2.50
100	2	3000	3.50
	2	4000	\$5
	1	5000	4
	1	6000	6
	3	8000	35
\$10	5	10,000	50
	1	15,000	30
10	.25	20,000	15
	1	25,000	50

FILAMENT
TRANSFORMERS

Amertran 29106
 5 V 10 A (35 KV)
 Kenyon S14940
 5 V 115 A

western engineers

elk grove, california

GEORGE WHITING, SOLE OWNER

GEAR HEAD MOTORS



GENERAL ELECTRIC—DC motor #5BA50LJ22. 1/2 H.P. 4000 RPM. 60v-8.3a armature and 27v-2.9a field, reversible and has magnetic Brake. Gear Box #T8254252G1, with two 380 RPM take-offs. Throw-out type clutch actuated by lever on front top. Size 6x8x12". Wt. 14 lbs. Acquisition cost \$194.00. Our Price NEW. \$12.95

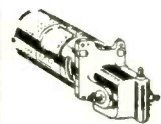

EMERSON ELECTRIC—DC motor type D14FZ-454-0417. 1 H. P. 5800 RPM, 27v-40a armature and 27v-2.5a field, reversible. Throw-out type clutch on gear box controls two 480 RPM take-offs. Ball bearings. Size 6 1/2 x 4 1/2 x 11". Wt. 15 1/2 lbs. Price NEW \$12.95

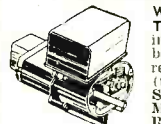

WHITE-ROGER SERVO MOTORS—24 VDC. Torque 150 in.-lbs. Reversible. Control box on top has limit switches, relays, and selenium rectifiers (to block AC out of motor). Size 5x5x4". Can be supplied in Models 6904-5 RPM or 6904-3 1/2 RPM. Price each NEW. \$8.50

DC MOTORS

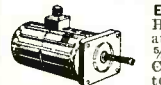

ELCOR—Part No. 82706. 1/2 H.P. 4500 RPM. 60v-8.3a armature, 24v-2.3a field, reversible. 5/8" spline shaft 9/16" long. Comes with 3" long-spline adapter. Size 6x4 1/2 x 7 1/2". Wt. 9 lbs. Price NEW \$7.45

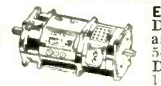

EMERSON ELECTRIC—Type D41P0447-0417. Can be used as motor or generator. 1 H.P. 5400 RPM. 12 volts 100 amps. Double-end shaft. 5/8" dia. by 1 3/16" length on each end. 4 1/2 x 1 1/2 x 9". Wt. 17 lbs. Price NEW. \$8.50



SYNCHRO - DIFFERENTIAL—Bendix #C78249. 115V 60 cycle. Used as a dampener between two C78248 Synchros. Easily converted to 3600 RPM motor (instructions included). Size 3-3/8 x 5-3/8". Price Brand New in original containers. \$8.50

SLIP RING ASSEMBLY

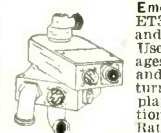

Emerson Electric Part ET35300 (shown with and without housing). Used to transfer voltages between stationary and moving parts as in currents or revolving displays. Full 360° rotation up to 15 RPM. Rating 12 conductors—ten 100 amp and two 100 amp at 28 VDC. Adaptable to higher voltages. Also has swivel plumbing designed to transfer oxygen at 15 P.S.I. Size 9x8x10". Wt. 10 lbs. Price complete NEW. \$8.50

HEAVY DUTY TRANSFORMERS

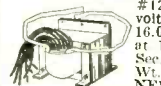

#1221—1.8 KVA. Input 120 volts 60 cycle. Output: 12.0, 14.5, 16.0, 17.0, 17.2, 17.8, 18.0 volts at 100 amps. Pri. leads 28" long. Sec. leads 17" long. Size 7x7x7". Wt. 26 1/2 lbs. Price Brand NEW \$23.50

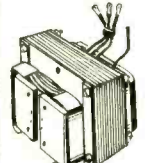

GENERAL ELECTRIC—#79G907. 2 KVA Intermittent duty. Input: 100/110/120 volts 60 cycle. Output 0.8 (eight-tenths) volt at 2,500 amps. (Can be used for quick-heat applications, spot welders, testing, etc. Size 5 1/2 x 6 1/2 x 5". Wt. 27 lbs. Price NEW \$12.50

WHOLESALE ONLY

AMPLIDYNES—General Electric #5AM31NJ9A. Input 27 VDC-44 amps. Output 60 VDC-8.8 amps. 530 Watts. Quantity 200 Brand NEW at \$475.00 per 100.

VOLTAGE REGULATORS—Leece-Nelville Co. #S-20686. 12 VDC. Precision adjustment vibrator type. Brand NEW in original cartons. Quantity 450 at \$65.00 per 100.

RADIO NOISE FILTERS—General Electric. Cat. 1C-206. 100 amps. 50 VDC. Contain two 5 mu-fd 50 VDC oil capacitors and choke coil. Quantity 2000 Brand NEW original boxes at \$500.00 per 1000.

PROMPT DELIVERIES ON ALL ORDERS. ALL MERCHANDISE FULLY GUARANTEED. Terms: Prices FOB St. Louis. Cash or 25% with orders. Balance COD. Rated Concerns (D&B) Net 10 days cash. Prices subject to change without notice.

McNEAL ELECTRIC & EQUIPMENT CO.
4736 Olive St. St. Louis 8, Mo.



CHECK AND COMPARE OUR COMPLETE STOCKS

The following is just a partial list of the current electronic and aircraft equipment now in our warehouse. Write for complete information. Prompt replies to all inquiries.

RC-103 & AN/ARN-5 ILS

New in original cartons. Complete. Consists of all accessories, plus AS-27A, R89B/ARN-5 and BC-733D. Modified to flag alarm.

- BC-611 & BC-721 HANDIE TALKIES, Plus SPARE PARTS, Quantity available.
- IE-17 TEST SET
- AN/ARN-7 COMPLETE
- SCR-269 COMPLETE
- TBS 4 & 5, NEW, COMPLETE
- AN/ARC-1 VHF EQUIPMENT
- BC-348 RECEIVERS
- BC-342 RECEIVERS

AN/ART-13 EQUIPMENT

- ATC XMTR T-47A/ART-13 XMTR
- T-47/ART-13 XMTR CU-24 ANT. LOAD
- CU-25 ANT. LOAD DY-11 & 12 Dynam't'r
- MT-283 MOUNT 0-16 LFO
- MT-284 MOUNT ATC DYNAM'T'R
- SA-22 ANT. LOAD C-87 CONTROL BOX

AN/APG-13A RADAR

Absolutely complete, brand new

- AN/APN-2 MG-153
 - SCR-729 New APS-2, 3, & 15
 - TA2J-24 Components
 - RTA-1B AN/ARC-5 VHF
 - BC-1016 SCR-274 & ARC-5
 - APA-6 INDICATOR Command Equip'm't
 - APA-11 INDICATOR R-4/ARR-2 Receivers
 - APA-17 RADAR BC-640 VHF XMTR
 - HS-33 HEAD SETS, SCR-510
 - NEW SCR-522
 - MG-149F & H MG-153
- SPARE PARTS**
- SCR-720 SCR-522
 - SO-7 AN/ART-13
 - AN/ARN-7 AN/ARC-1
 - SCR-269 BC-611

SCR-718 A, AM, B & C

Altimeter equipment—complete

To insure the finest of service and quality of merchandise, we have just recently put into operation our own reconditioning and function-testing plant, complete with all facilities.

WANTED

ART-13 BC-788
I-52 BC-348 Q & R
TOP DOLLAR PAID

EXPORT INQUIRIES INVITED

We carry an unusually large stock of Airline Equipment, Test Equipment, Radar Sets, etc. Write for our low prices and complete information. We furnish immediate answers to all inquiries. Write today!



V & H ELECTRONIC INDUSTRIES INC.
2033 West Venice Blvd.—Dept. E-21
Los Angeles 6, California
Phone: REpublic 3-1127

Excellent "RW" Values!

WRITE FOR PRICES

- APR4 with tuning units
- APS4 components
- BC1306
- PE237
- BC433G
- TS51
- MG153
- TN16, TN17, TN18, TN19
- BC1033
- APS13
- ARN7
- SCR269F&G
- SCR619
- BOONTON SIG. GEN. I, 26 B
- TS 100/AP
- AS38
- BC639 with RA52 Rectifier
- TS184/APS13
- BC611
- SCR714 (BC1137)
- Dynamotor DM28 (large quantity available)
- SCR619
- LP21LM
- TS61
- TS92
- BC1277
- BC1287
- APR-4
- MN26C

Write for our new 1953 catalog!

TS159/TPX COMBINATION SIGNAL GENERATOR AND FREQUENCY METER

Freq. range: 150-200 MC., crystal calibrated. Has separate 30MC signal output, crystal cal: 3-stage, AF amplifier. Power measurements by built-in VTVM circuit 0-1 MA. meter as 2-range voltmeter. Built-in 400 cps. voltage regulated power supply. New \$69.95

WOBLULATOR

BUILD TV-FM-AM SWEEP GENERATOR
You can build "Versatile Sweep Frequency Generator" with APN-1 magnetic units... \$5.95

RM 29 with the TS-13 handset \$14.95 ea. 2 for \$27.50
RL-42 Reversible Motor with antenna reel and clutch, used... \$2.95

TS10 TEST UNIT

Complete with attenuator, indicators and 350 ft. of coaxial cable. Originally cost \$300.00... new condition... ONLY \$14.95
Plugs... large quantity available... write for prices!

- 166 171 MC277
- 167 172 ART13-U6U
- 169 170 UHU
- U10U

WANTED!

All TS, APR, APS, ARC, ARN, ART, SCR, R89 and BC equipment... write today!
Quote lowest prices in your first letter

Shipments FOB warehouse. 20% Deposit on orders. Minimum order \$5.00. Illinois residents, add regular sales tax to remittance.

Prices subject to change without notice.

R W ELECTRONICS

Dept. EL, 1712-14 S. Michigan Ave.
Chicago 16, Ill.
PHONE: HArrison 7-9374

SAVE ON TUBES BRAND NEW TUBES GUARANTEED TUBES

OA2..... 51.00	2J61..... 39.50	4J29..... 149.50	6AS6..... 2.30	217C..... 4.95	615..... Write	726C..... 52.50	931A..... 5.95
OA3/VR75.. 1.10	2J62..... 39.50	4J30..... 199.50	6BM6..... Write	221A..... 1.95	632..... 19.95	730A..... 25.00	954..... .33
OB2..... 1.40	2K22..... 39.50	4J31..... 99.50	6C21..... 24.50	RX233A..... 3.50	WUG676..... 39.50	801A..... 3.95	955..... .45
OB3/VR90.. 1.09	2K23..... 39.50	4J41..... 99.50	6D4..... 2.50	FG-235A..... Write	WLS77..... 39.50	802..... 3.95	956..... .45
OC3/VR105. 1.00	2K25..... 28.50	4J52..... 200.80	6F4..... 4.50	250R..... 8.95	700A/B/C/D..... 16.50	803..... 3.75	957..... .45
OD3/VR150. .90	2K26..... 79.50	4X150A..... 25.80	6J4..... 6.95	250TH..... 18.00	701A..... 4.50	804..... 10.95	958A..... .69
1B22..... 2.25	2K28..... 32.00	4X500A..... 85.00	6K4..... 3.50	250TL..... 9.95	702A..... 2.75	805..... 3.25	959..... 2.95
1B23..... 8.95	2K29..... 23.95	C5B..... 7.50	6SN7WGT.. 2.50	FG-253A..... Write	703A..... 4.50	807..... 1.59	977CX..... Write
1B24..... 9.50	2K45..... 110.00					807W..... 9.95	979..... Write
1B25..... 2.95	2K46..... 360.00					808..... 2.95	980D..... Write
1B27..... 14.50	2K48..... Write					809..... 2.95	991..... .39
1B32..... 3.10	2K54..... Write					810..... 9.95	1005..... .69
1B42..... 17.50	2K55..... Write					811..... 2.90	1006..... 4.50
1N21B..... 2.75	2K56..... 115.00					812..... 2.75	1007..... .89
1N21C..... 14.95	3AP1..... 8.95	5AP1..... 4.50	6SU7GT..... Write	FG-258A..... Write	704A..... Write	813..... 11.95	K1069P7.. Write
1N22..... 1.25	3B23..... 4.95	5BP1..... 4.50	7C23..... 69.50	274B..... 3.25	705A..... 1.75	814..... 2.95	1613..... .90
1N23..... 1.25	3B24..... 4.95	5BP4..... 4.50	9LP7..... 4.95	304TH..... 8.95	706AY..... 39.50	815..... 2.90	1616..... .90
1N23A..... 2.25	3B24W..... 7.50	5CP1..... 4.50	12AY7..... 2.00	304TL..... 7.95	706BY..... 39.50	826..... 1.95	1619..... .39
1N23B..... 3.50	3B26..... 3.50	5C22..... 42.50	12DP7..... 16.95	307A/RK75.. 4.25	706CY..... 29.50	828..... 9.95	1624..... 1.45
1N26..... 7.50	3B28..... 6.50	5D21..... 18.55	12HP7..... 13.50	310A..... 5.95	706FY..... 45.00	829..... 9.95	1625..... .39
1N34A..... .79	3BP1..... 1.95	5FP7..... 1.55	15E..... 1.25	310B..... 12.95	707A..... 7.95	830B..... 2.75	1629..... .39
1N38..... 1.50	3C22..... 75.00	5FP14..... 16.50	15R..... .69	316A..... 1.25	707B..... 14.95	832A..... 9.95	1631..... 1.50
1N40..... 1.50	3C23..... 9.95	5GP1..... 4.50	FG-17/5557.. 3.95	327A..... 4.50	708A..... 3.95	833A..... 34.95	1642..... .69
1N47..... 4.50	3C24/24G... 1.50	5HP1..... 6.55	RX-21..... 5.95	331A..... 10.95	713A..... .95	836..... 3.45	1644..... .89
1N55..... 2.75	3C27..... 3.75	5HP4..... 4.55	FG-27A..... 4.05	345A..... 8.50			2051..... 1.40
1N56..... .89			28D7..... 1.75	350A..... 5.95			5514..... 3.40
1N58A..... 1.25			FG-32..... 12.95	350B..... 3.95			5516..... 5.50
1N60..... .60			45 Spec..... .32	355A..... Write			5523..... Write
1N63/K63.. 2.39			RK47..... 4.95	371B..... .75			5586..... 175.00
1N64..... .30			FG-57..... 13.95	374B..... 3.95			5611..... 115.00
1N69..... .89			RK60/1641.. 1.95	388A..... 1.49			5635..... 8.95
1Z2..... 2.95			HY69..... 4.50	393A..... 8.95			5646..... 8.95
VS-2..... 9.50			CRP-72..... 1.20	394A..... 3.95			5651..... 2.75
2C21/1642. 27.50			RKR72..... 1.20	417A..... 8.50			5654..... 2.00
2C39..... 27.50			75T..... 6.95	423A..... 4.50			5670..... 4.30
2C40..... 9.95			75TL..... 8.95	434A..... 17.50			5672..... 1.50
2C43..... 15.00			83V..... 1.10	455A..... 4.19			5676..... 3.35
2C44..... 1.19			VT98..... 19.95	446B..... 3.50	714AY..... 5.50	837..... 1.45	5687..... 4.25
2C51..... 6.95	3C31..... 3.15	5JP1..... 22.50	98R..... 5.95	450TH..... 42.50	715A..... 6.25	838..... 3.98	5694..... 2.60
2C52..... 4.95	3C33..... 9.95	5JP2..... 19.95	100TH..... 9.50	450TL..... 44.50	715B..... 8.95	845..... 8.50	5702..... 3.25
2D21..... 1.80	3C45..... 14.95	5JP4..... 22.50	FG-104..... 29.95	451..... 3.95	715C..... 19.75	851..... 55.00	5703..... 1.95
2D21W..... 2.49	3DP1..... 3.95	5JP5..... 22.50	FG-105..... 19.00	464A..... 10.95	717A..... .98	852..... 19.95	5704..... 4.50
2E24..... 4.65	3DP162..... Write	5J23..... 59.50	VU-111..... .95	465..... 13.05	720AY..... 24.50	861..... 3.9	5707..... 6.00
2E25A..... 4.50	3E29..... 13.95	5J29..... 39.50	HF120..... 9.95	471..... 2.25	721A..... 2.95	865..... .98	5844..... 4.50
2J21A..... 6.95	3FP7..... 1.95	5J30..... 1.55	VF-123A..... 7.75	527..... 11.50	721B..... 2.95	865..... .98	5844..... 4.50
2J22..... 6.95	4J21..... 129.50	5R4GY..... 1.50	VT-127A..... 3.75	530..... 16.95	721E..... 1.50	866A..... 1.50	5915..... 1.00
2J26..... 14.95	3HP7..... 3.95	5T4..... 12.50	FG-172..... 29.50	531..... 5.75	722A..... 1.95	866JR..... 1.25	6026..... 2.25
2J27..... 14.95	4-125A..... 25.00	6A15..... 1.95	HF200..... 14.50	532..... 2.98	723A/B..... 18.95	872A..... 3.25	6026..... 2.25
2J31..... 27.50	4B24..... 6.95	6AJS..... 1.95	20A..... 98.00	570..... 1.19	724B..... 2.75	874..... 1.10	8005..... 6.95
2J32..... 29.50	4C28..... 35.00	6AKSWE..... 1.95	201C..... 98.00	575..... 13.95	725A..... 7.50	876..... .59	8012..... 1.95
2J33..... 27.50	4C35..... 27.25	6ALSW..... 1.75	204A..... 49.50	609..... Write	726A..... 12.50	881..... 1.50	8020..... 1.25
2J34..... 27.50	4J21..... 129.50	6AN5..... 3.65	211/VT4C... .75	KU610..... 22.00	726B..... 52.50	884..... 1.40	8025..... 4.95
2J36..... 108.00	4J22..... 129.50	6AR6..... 2.25				889R..... 139.50	9001..... 1.25
2J37..... 12.50	4J23..... 129.50					905..... 3.25	9002..... .98
2J48..... 27.50	4J26..... 129.50					923..... 1.25	9003..... 1.50
2J55..... 85.00	4J27..... 129.50					927..... 1.25	9004..... .69
2J56..... 149.00	4J28..... 129.50						

YOUR SURPLUS WANTED
We Pay Highest Prices!

SPECIAL! Vacuum Capacitors



12 mm. 20,000 v..... \$7.50
12 mm. 32,000 v..... \$10.00
50 mm. 32,000 v..... \$12.50
100 mm. 20,000 v..... \$14.50

5 FIGURE VEEDER ROOT COUNTERS only **95¢**
MODEL S-1
Size 3/4" wide x 1-5/16" long. Dove-tail mounting—removable lever.

All Prices F.O.B. Los Angeles, subject to change without notice. Minimum order \$3.00.

Thousands of other types in stock. Send us your requirements.

jsh ELECTRONICS SALES CO.
Dept E22 • 7552 Melrose Ave.
Los Angeles 46, California

PRECISION RESISTORS

Wire wound, standard brands. Price is made sufficiently low as to warrant combining in series or parallel to obtain desired ohmage if not listed below:

OHMS	TYPE	TOLERANCE	UNIT PRICE	100 LOT PRICE
25	WW4	5%	.10	\$8.50
29	WW4	3%	.12	10.50
2.56	WW3	1/10%	.15	12.50
3.94	WW4	3%	.12	10.50
4.3	WW4	1%	.15	12.50
4.35	WW3	1%	.15	12.50
4.4	WW3	1%	.15	12.50
5.1	WW4	3%	.15	12.50
6	WW4	3%	.12	10.50
12	WW4	1/10%	.15	12.50
13.333	WW4	1%	.15	12.50
13.52	WW4	1/4%	.15	12.50
14	WW4	1%	.15	12.50
20	WW4	1%	.15	12.50
22	WW4	1/10%	.15	12.50
23.29	WW4	1%	.15	12.50
30	WW3	5%	.10	8.50
30	WW3	5%	.10	8.50
35	WW3	5%	.10	8.50
40	WW3	5%	.10	8.50
50	WW3	5%	.10	8.50
70	WW3	5%	.10	8.50
130	WW3	1%	.15	12.50
235	WW3	1%	.15	12.50
750	WW3	1%	.18	15.00
2200	WW3	1%	.18	15.00
2230	WW3	1%	.18	15.00
2500	WW3	1%	.18	15.00
4000	WW3	2%	.25	20.50
4300	WW3	1%	.18	15.00
5000	WW3	1%	.18	15.00
7500	WW3	1%	.18	15.00
8000	WW1	1%	.18	15.00
12K	WW3	1%	.18	15.00
15K	WW3	1%	.18	15.00
17K	WW3	1%	.20	16.50
17.3K	WW5	1/10%	.20	16.50
20K	WW3	1%	.25	20.50
33K	WW3	2%	.20	16.50
25K	WW4	2%	.25	20.50
26.5K	WW3	1%	.25	20.50
46.4K	WW3	1%	.25	20.50
50K	WW3	1%	.30	24.50
54.5K	WW3	1%	.30	24.50
80K	WW4	1%	.30	24.50
84K	WW4	2%	.35	28.50
92K	WW3	1%	.20	16.50
100K	WW5	1%	.45	37.50
220K	WW5	2%	.30	24.50
500K	WW5	1%	.55	45.00
700K	WW5	1%	.55	45.00

QUARTZ CRYSTALS

Made to a tolerance of .03% and produced by Crystal Research Labs., Billey, etc. Available in the following frequencies:

TYPE FT 243—PRICE \$1.15 ea
Frequency in K.C.

2300	5775	6400	6815	7775	8300
3105	6025	6425	6830	7800	8325
3825	6050	6450	6850	7825	8350
4600	6075	6475	6978.75	7850	8375
4300	6125	6525	7458.75	7875	8385
4375	6150	6550	7625	7900	8400
5300	6175	6575	7650	7925	8450
5500	6200	6625	7675	7950	8500
5633.333	6225	6650	7700	7975	8525
5635.555	6250	6675	7725	8000	8580.75
5700	6275	6700	7728.75	8025	8921.25
5722.2	6325	6725	7750	8050	9135
5725	6350	6750	7751.25	8225	9075
5750	6375	6775	7773.75	8275	10075
					16585.555

BB1102—TYPE FT 241—PRICE 79¢ ea
Frequency in K.C.

5020	5840	6300	6600	7780	8328
5030	5860	6325	6625	7790	8332
5040	5870	6330	6630	7800	8341
5050	5890	6340	6650	7830	8344
5080	5910	6350	6655	7850	8351
5090	5930	6370	6661	7870	8405
5100	5950	6400	6670	7875	8412
5120	5960	6401	6690	7880	8460
5170	5970	6403	6730	7900	8463
5180	6010	6410	6750	7910	8465
5200	6050	6418	6770	7925	8467
5210	6080	6420	6870	7930	8470
5220	6090	6421	6890	7940	8490
5230	6130	6425	6910	7950	8500
5250	6150	6430	6940	7975	8506
5270	6159	6431	7140	7990	8512
5280	6175	6450	7270	8232	8524
5290	6181	6470	7560	8238	8546
5295	6195	6475	7600	8249	8547
5300	6200	6480	7625	8240	8560
5310	6203	6490	7650	8241	8561
5330	6210	6500	7675	8245	8567
5340	6215	6525	7700	8248	8630
5404.166	6220	6530	7725	8247	8640
5740	6225	6535	7740	8298	8643
5757	6250	6547	7750	8300	8645
5780	6270	6550	7760	830	

STOCK DELIVERY

NEW SURPLUS

Dynamotor—Wineco #602—Type #5230F—SS #124—Signal Corp. #3H-1534-1. Input 26 volts at 27 amperes. Output 1100 volts D.C. at 400 amperes. 3600 rpm. Continuous duty. Used with BC-375. Physical size 11" long x 5 1/4" in diameter. Stock #A-125 Price \$6.95 each.

Drafting Machine—Manufactured by Star Watch Case Co. as Vector Plotting Machine Type AN-5748. Special scales give course, ground speed, and drift; when set for heading, airspeed and direction of wind, wind velocity. Movable 18" arms. New—Perfect. Ideal drafting machine for table use with T square or triangle. Stock #A-249. Special \$22.50 each.

Dynamotor—Gen-E-Motor #SP125—Model EN-2—Complete filter for each voltage. Input 12 volts at 2.2 amperes. Output 150 volts at 040 amperes and 3.0 volts at 4 amperes. 10 foot heavy duty cable with battery clips. Spare parts box contains 2 plug-in electrolytics, 3 metal tubular condensers, 3 filter chokes, 1 D.P.D.T. toggle switch, and 6 each 2 watt resistors. Stock #A-111. Price \$17.50 each.

Dynamotor—Pacific Division of Bendix Aviation Corp. #4120-147—Signal Corp. #3HK-1515. Input 24 volts at 5.7 amperes. Output 425 volts D.C. at 200 amperes. Continuous duty at 4800 rpm. Physical size 7 1/2" long x 4" in diameter. Stock #A-68. Price \$5.95 each.

Dynamotor—Input 12 volts at 4 amperes. Output 12 volts at 3 amperes and 275 volts at 110 amperes. Permanent magnet field. 3500 rpm. Continuous duty. Physical size 7 1/2" long x 4" wide and 3" high. Stock #A-266. Price \$6.50 each.

Dynamotor—Input 12 volts at 2 amperes. Output 500 volts at 060 amperes. Permanent magnet field. 3800 rpm. Continuous duty. Physical size 7 1/2" long x 4" wide x 3" high. Stock #A-267. Price \$6.50 each.

Dynamotor—Wineco Type 41S6—Input 13 volts D.C. at 13 amperes. Output 250 volts D.C. at 060 amperes and 300 volts D.C. at 225 amperes. Physical size 8 1/2" x 4 1/2" diameter. Stock #A-7. Price \$6.50 each.

Dynamotor—General Electric #5DY82AB52—Type D-101—Input 27 volts at 1.5 amperes. Output 220 volts D.C. at .080 amperes. Physical size 4 1/2" long x 2 3/4" diameter. Stock #A-60. Price \$5.95 each.

Attitude Gyro Indicator—Pioneer-Bendix (Post-war Part #14601-1A-A1. FSSC #88-1-1350. 26 volts, 3 phase, 400 cycles. These gyros are new, but were dismantled by Navy technicians for special modifications which were never performed. Guaranteed complete and ready for reassembly. Stock #A-120. Price \$34.50 each.

Sweep Generator Capacitor—Magnavox Part #XC-260048-G1. Rotating split stator capacitor. Cylindrical silver plated rotor concentric to silver plated stator on inside of bakelite housing. Housing diam. 1 1/4". Square end bells 1 1/2" square. Shaft extension 1/2" x 0.1875 diameter. High speed ball bearings. Capacity 5 to 10 mmf. Ideal for motor driven high frequency sweep generator. Stock #A-95. Price \$2.25 each.

Polarity Sensitive Relay—Large D'Arsonval movement in a hermetic sealed can. 17 ohm coil. S.P.D.T. Sensitivity of .020 amperes in each polarity. The moving contact moves to either one side or the other depending upon the applied polarity. Can size 3 1/4" long x 2 3/4" diameter. Ideal for servo work. Stock #A-278. Price \$4.95 each.

Microwave Antenna—AS-217A APG-15B. 12 centimeter dipole and 13 inch parabola housed in 16 inch weatherproof radome with 24 volts D.C. constant speed motor. Parabola rotates in elliptical pattern for conic scan. Export packed—shipping wt. 70 pounds. Stock #A-55. Price \$49.50 each.

Write for catalogue or call

ARMory 4-8989

Electro Devices
INCORPORATED
4 Godwin Ave. Paterson, N. J.

RADAR equipment

DESIGN, DEVELOPMENT, PRODUCTION

AIRBORNE-SHIPBORNE and LAND BASED SYSTEMS

FULLY EQUIPPED TEST FACILITIES AVAILABLE IN ALL UHF - VHF - SHF ranges

Some TS equipment available for sale from our stock. Your inquiries are invited on any phase of our activities.

LERU LABORATORIES, INC.
BLACK OAK RIDGE ROAD
WAYNE, New Jersey
Mailing Add RD4, Patterson, N. J.
Tel. Terhune 5-2765-6

COMPETITORS*

TEAM UP TO BRING YOU ONE GREAT ELECTRONICS FIRM GEARED TO SERVE YOU WITH

HARD-TO-FIND PARTS & EQUIP.

Just a partial list of our present stock:

- BC-348 • BC-342 • ART-13
- ARC-3 • APN-9 • LM
- BC-221 • BC-611
- VARIOUS TEST EQUIPMENT

NEW EXPORT DIVISION FOR ALL FOREIGN ORDERS

Prompt attention to all inquiries—all languages!

Attn: Schools, Labs, Hams!
WE PAY MORE
FOR RADIO PARTS & EQUIPMENT
Cash in on your surplus equipment—or we'll trade for something you really need. Write today!

HARJO SALES CO

* Formerly CANDEE-AIRCO combined with Alvarado Sales Co.

4109 BURBANK BLVD.
P. O. Box 1187
Magnolia Park Station
BURBANK, CALIFORNIA
Charleston 0-1486 • Rockwell 9-1070

TBW-RBM EQUIP.

Semi-portable transmitting-receiving Station. 200 Kc to 20 Mc. 100 watts power output. The equipment consists of the following:

- 2—Transmitters 1—gas eng. generator
 - 2—Receivers 2—50' ant. masts & acc.
 - 1—Frequency meter 2—storage batteries
 - 1—Rect. modulator 1—dynamotor supply
 - 1—Rect. power unit 1—control unit
- Details & price on request

Wheatstone Bridge Model 5430-A \$95.00
1-138-A "S" band 10 cm \$150.00
AN/TPN-2 Beacon * P.O.R.
APS-3 Radar * P.O.R.
L&N Hoops Conductivity Bridge 350.00
LM Freq. meters, unfinished, less tubes, crystal, Var. Cond. and dust cover 19.50

TRANSFORMERS (115V. PRI.) & CHOKES

Tapped-8, 9, 10, 11, 12V. 8 Amps. cased. \$ 4.50
15 KV. 100 Va.—\$19.00, 12 KV. 25 Va. 12.00
1470 V. CT. 1.2 Amp. cased. 37.50
6 Henry 500 Ma. cased. 7.25
3 Hy. 750 Ma. 15 ohms. cased Hypercil. 9.50
.02 Henry 18 Amp. cased. 19.00

Type GF transmitter 14.95
Type RU Receiver 9.95
Type B. C. 430 Transmitter 9.95
Type B. C. 429 Receiver 7.95
5000 MFD-50V. electrolytic cond. 2.95
Battery cable, 11 ft. Lg. with lugs 3.50
Co-ax. 2 wire RG 22/U 95 ohm. per ft.09
Twin line, 72 ohm 1 KW. 7/21 wire ft.06
Tubing—Surprenant red plastic for #20 wire. 1500 ft. spool 4.95

* Prices on request.

FOB Hempstead — 25% with COD orders

ALGERADIO ELECTRONICS CO.
385 JACKSON STREET
HEMPSTEAD, N. Y.

REMOVAL SALE!

PRIOR TO OUR MOVING TO NEW QUARTERS WE ARE OFFERING OUR COMPLETE

OIL CAPACITOR INVENTORY

at
65% TO 80%

off
LIST PRICES

(Limited Time Only)

- BATHTUB TYPES •
(CP-53 CP-54 CP-55)
- CHANNEL TYPES •
(CP-61 CP-63 CP-65 CP-67 CP-69)
- RECTANGULARS •
(CP-70)
- TUBULAR TYPES •
(CP-25 to CP-29 CP-40 CP-41)

NOTE:

At time of going to press ample stocks on hand but at these low prices we suggest your early inquiries.

FOR SALE! ENTIRE LOT ONLY!

8280—Pieces of W.E.—FT. 241-A Crystal Holders with Crystals. Assorted Sizes—All New. (Complete List on Request) **25¢ ea.**

MANY OTHER GOOD BUYS.
(Send for Bulletin.)

A. MOGULL CO.

50 West Broadway N. Y. 7, N. Y.
Phone: Worth 4-0865



ELECTRONIC EXPEDITERS

SUPPLYING

THE NEEDS OF INDUSTRY —
GOVERNMENT — FOREIGN
PURCHASING COMMISSIONS

WITH

COMMUNICATIONS
EQUIPMENT, RECEIVING
AND TRANSMITTING
TUBES, ELECTRIC WIRE
AND CABLE
AIRCRAFT ELECTRONICS—
INSTRUMENTS—
HYDRAULICS

PROMPT ATTENTION
GIVEN TO ALL INQUIRIES

Rated—Dun & Bradstreet

Electronic Expeditors

Dept. WW, 225 N. Wabash Avenue
Chicago 1, Illinois • ANdover 3-0841
Cable Address: "ELEXPEDITE" • TWXCG1510

SPECIAL

WHILE THEY LAST
JAN

2J39 RAYTHEON \$8.95
AR300A \$3.95

ALL BRAND NEW
IN ORIGINAL CARTONS

AVAILABLE IN QUANTITY—WIRE OR
WRITE FOR LOWEST QUANTITY PRICES

M & B SALES CO CORtlandt 7-7242
137 Hudson Street New York 13, NY

FOR SALE

Tantalum Wire: .002"—.01"—.015"—.03"—.05"—
.06" Ribbon .003"x125"
Tungsten Ribbon: .0015x.03"—.0015x.062"—.003x
.05"—.003x.03"—.005x.03"
Moly Ribbon: .005x.075" Tungsten mesh, KOVAR
wire .030"—.020"—.015"—.010"
Kovar tubing: 1/4"—1/8" O.D. 50% of manufacturers
price.

F. ALEXANDER 115 W. 23d St., N. Y. C.

WHOLESALE ONLY

ELECTRONIC COMPONENTS
AIRCRAFT EQUIPMENT
HYDRAULICS

RADIO & ELECTRONIC SURPLUS
13933-9 BRUSH STREET
Detroit 3, Mich. TO 9-3403

FOR SALE EQUIPMENT

1—SCR 522 (BC 624A-BC 625A). New in original crate with following accessories: Antenna AN 188, 3 control boxes BC 1312-13-14, 1 cord Cd 133 RG 8U, coax. cable w/ all plugs \$125.00
2—(same as above without accessories —slightly scratched cabinet, \$65.00 each
Signal generator 1-138-A \$165.00

HAYDON SYNCHRO MOTORS 110 VAC
3.6 watt—1/2 RPM \$2.75
2.2 watt—1/120 RPM 2.45
3.6 watt—.5 to 5 min #5901—adj. reset timer \$7.50
Cramer T.D. relay 115v., 60 cy. (3 or 4 min) \$5.25

AMPLIFIERS

G.E. Servo type 2CV1C1 400 cy no tubes \$14.95
Bendix CM—50131 for Synchro radar equipment—in original crate \$26.25

METER

Westinghouse Voltmeter, NA-35, style BX-48450-1, 0-150 V.A.C., 3" round . \$7.95

LEONARD GREENE

381 Tremont St. Boston, Mass.
HAcock 6-4794

T-47A/ART-13 Aircraft Transmitters
DY-12 Dynamotors, BC-639 Receivers
SCR-694-C Portable Trans. & Recvrs.
BC-610-E Transmitters. (SCR-499)

ARROW APPLIANCE COMPANY
Box 19, Boston, 1, Mass
TEL: RICHMOND 2-0916

HIGH VOLTAGE POWER SUPPLY

Many models available in ranges from 2500 to 25,000 volts D.C., with or without built-in meters.

Send for free catalogue Dept. E-3

PRECISE MEASUREMENTS CO.
942 KINGS HIGHWAY, BROOKLYN 23, N. Y.
Phone ES 5-9435

\$2.95 EACH OR 2 FOR \$5.00!



Upright Telephone complete with cord in Tested and Guaranteed condition. For inter-communication or extension. Complete list of telephone parts, inter-communication sets, switchboards, handsets, magneto and dial telephones, etc. Write for list. F.O.B. Simpson, Pa. C.O.D. Shipments accepted.

TELEPHONE ENGINEERING CO.
5 Regal Bldg., Simpson, Pa.

FOR SALE: RA-38 Rectifier

Mfd. by American Transformer Co. Input supply from 115 V. 60 cy, sgle ph. Max. filtered output is 15,000 V d.c. at 0.5 amperes. Transtat regulator permits continuous variation of the d.c. output voltage from zero to max. 25 hrs on running time meter. Entire assembly is mounted on casters. Priced far below replacement cost at \$350.00 F.O.B. Oakland, Calif. Write to:

CHROMATIC TELEVISION LABORATORIES, INC.
703 - 37th Avenue, Oakland 1, California

New "SEARCHLIGHT" Advertisements

received by March 2nd will appear in the April issue subject to limitations of space available.

Classified Advertising Division
ELECTRONICS

330 West 42nd St. New York 36, N. Y.

TUBES

All receiving and special purpose types. Real values that will save you 10 to 70%. Call or write today for special price list. State type & quantity for additional discount.

METROPOLITAN SUPPLY CORP
1133 Broadway, New York 10, N. Y. - CH 3-1105

SPECIAL PURPOSE TUBES

1Q26-G.E. @ \$68.95
2E24-JAN. @ 3.99
5C22-SYL. new 48.95

1P21-RCA 30.95
864-JAN. .29
CK-5702-RAYT 2.99

All Tubes listed below are fully guaranteed and in stock for immediate shipment.

Type	Price	Type	Price	Type	Price	Type	Price	Type	Price	Type	Price	Type	Price
OA2 Jan	50.90	1N31	3.00	2J32	38.50	3B24W	7.90	5C22	48.95	FG104	28.90	CK546DX	2.29
OA3 VR-75	.99	1N32	24.00	2J34	34.50	3B25	3.99	5D21	22.50	FG105	18.95	CK547DX	2.25
OB2 Jan	1.30	1N34	.65	2J56	145.00	3B28	6.95	5R4Y RCA	1.49	FG172	32.00	575A	14.90
OC3 VR-90	.98	1N35	1.59	2K22	50.00	3C22	94.50	5T4	2.25	250-R	9.45	702A	3.00
OD3 VR-150	.85	1N38-A	.74	2K23	45.00	3C23	10.50	6C1	8.50	300-B	12.50	703A	5.90
1B21/471-A	2.49	1N40	7.50	2K25	32.50			6AH6	1.19	307-A	3.95	705-A/8021	2.25
1B22	3.75	1N41	9.50	2K25/723A/B				6AK5	1.25	350-B	4.75	707-B	14.25
1B24	11.95	1N42	18.00	Sld. ctns.	24.95			6AK5W	3.00	355-A	13.95	715-B	8.50
1B27	12.90	1N45/400C	1.25	2K26	159.00			6AN5	3.95	393-A	11.50	715-C	21.95
1B36	9.90	1N46	.59	2K28	31.95			6AR6	3.25	394-A	4.75	719-A	26.95
1B38	28.50	1P21	39.95	2K29	28.90			6AS6	3.25	434-A	18.00	721A	2.25
1B41	48.90	1Q26 G.E.	79.50	2K33	290.00			6AS7G	4.50	CK501DX	.75	723A/B	18.75
1B42	14.95	1R4/1294	.79	2K34 Sperry	225.00			6C21	24.50	CK509AX	1.75	724A	3.50
1B60	69.50	2C39	23.95	2K35 Sperry	390.00			6J4	6.00	CK522AX	1.25	724B	3.50
1D21/631P1	5.00	2C39A	30.00	2K39 Sperry	135.00	3C33	14.50	6J4	6.85	CK526AX	1.45	726B	49.50
1N21	1.20	2C40 Jan	34.95	2K41	149.50	3C45	17.95	6K4	4.90	CK528AX	1.62	726C	59.25
1N21A	1.70	2C42	25.95	2K42 Sperry	142.50	3E29	14.50	6L6	2.19	CK531DX	1.95	804	12.95
1N21B	2.95	2C43	17.95	2K43 Sperry	139.50	3K22 Sperry	325.00	6L6G	1.25	CK532DX	1.95	807	1.60
1N21C	18.90	2C51	6.15	2K44 Sperry	139.50	3K23 Sperry	375.00	6L6 GAY	2.25	CK533AX	1.25	814	3.50
1N23	1.30	2D21 RCA	1.35	2K45 Sperry	145.00	4-125-A	24.95	6SN7 WGT	2.70	CK536AX	1.10	815	2.90
1N23A	2.40	2E24 Jan	3.99	2K46 Sperry	349.50	4C28	24.00	6SU7GT	2.50	CK537AX	3.25	829B	12.95
1N23B	3.45	2E25 HV65	4.95	2K47 Sperry	475.50	4C33	60.00	12K8Y	.85	CK538DX	1.25	832A	9.50
1N25	5.15	2E26	3.00	2K48	125.00	4C36	26.50	12SJ7-M-Jan	.62	CK542X	1.15	835A	35.95
1N26 (W. E.)	8.50	2E30	1.99	2K50	700.00	4J52	14.90	FG-17	3.70	CK543DX	1.20	845	5.75
1N27	2.50	2E43	1.35	3B24	5.20			FG-32-5558	12.95	CK544DX	1.15	861-Jan	22.75

Highest Cash Prices Paid for Your Special Purpose Tubes! Any Quantity 1 to 1,000.

Above Listing is only partial. TERMS: NET 15 days to rated firms.

ALL TUBES ARE NEW, MOST WITH JAN MARKINGS AND IN ORIGINAL CARTONS. Write or Phone if your requirements are not listed. *All Prices subject to change without notice.*

MICROWAVE EQUIPMENT SUPPLY CO.

425 Riverside Drive - Dept. 6B-3
N. Y. C. 25
MOnument 2-1480

State Labs Inc.

Nation's Largest Wholesale Supplier
Specializing ONLY in Buying and Selling

ELECTRONIC TUBES AND CRYSTALS

OVER 4000 TYPES AVAILABLE
TOP STANDARD BRANDS
IMMEDIATE QUOTATIONS

WRITE FOR FREE WEEKLY MARKET GUIDE

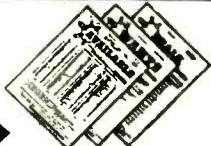

State Labs Inc.

37 EAST 28 STREET, NEW YORK 16, N. Y.
PHONE: MURRAY HILL 3-9802
WIRE: STATE LABS, WUX, N. Y.
TELETYPE: N. Y. 1-1807 CABLE: STATELABS

GLASS TUBING

PYREX - NONEX - URANIUM BULBS & CYLINDERS
WRITE FOR FREE MONTHLY LIST
HOUE SUPPLY COMPANY
PHONE KEYPORT 7-1286
M. R. #1 Box 86X Keyport, N. J.

Portable Instruments

Molded Bakelite case 7" x 4 1/2" x 3"
D.C. MICROAMMETERS
5, .10, .50 microamperes
THERMOCOUPLE MILLIAMMETERS
1, 5, .5, .10 milliamperes
THERMOCOUPLE VOLTMETERS
5 to 500 volts
Available in multiple range combinations

Precision Electrical Instrument Co.
146 Grand Street New York 13, N. Y.

FOR SALE! 39 UNITS BC957A RADAR INDICATOR UNUSED

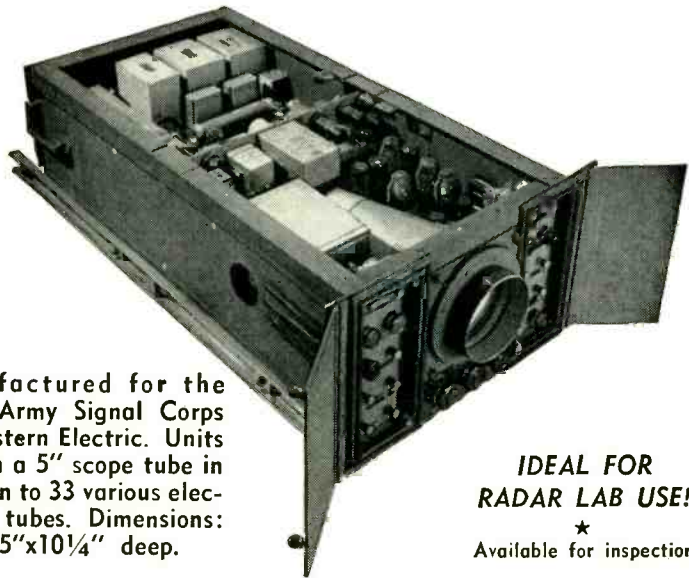

Manufactured for the U. S. Army Signal Corps by Western Electric. Units contain a 5" scope tube in addition to 33 various electronics tubes. Dimensions: 17 1/4 x 35" x 10 1/4" deep.

IDEAL FOR RADAR LAB USE!
★
Available for inspection

WRITE—WIRE—PHONE

COMMERCIAL SURPLUS SALES CO.

4101 Curtis Avenue, Baltimore 26, Maryland
Telephone Curtis 3300

FOR THE BEST BUYS IN ELECTRONIC MATERIALS TOPS IN QUALITY AT DOWN TO EARTH PRICES

SENSITIVE RELAYS

SIGMA 5AH 3000 ohm/2ma, plugin.....\$4.95
SIGMA 5AH 10000 ohm/1ma, plugin..... 6.95
SIGMA 5HJ 5000 ohm/1.5 ma sealed..... 6.95
SIGMA 5R 130 ohm 2-24 VDC..... 1.95
SIGMA 41F 10000 ohm .04 watt AC/DC..... 1.75
KURMAN BK-35 10000 ohm/.5 ma..... 4.95
G.E. MINIATURE, 10000 ohm 1.5 ma SPNO. 1.65
COMPACT ELTRON VIBRATOR PACK, 0V in. 90V
30 ma output, will operate on 4 D cells. 2 1/2"
2 1/2" DX3 1/2" excell. portable supply..... 3.95
AFSCO AMPLIFIER EQUALIZER, input .2V/600Z
output .5V/600Z. Total distortion 0.9%/1000 cy.
hi & lo freq switch varies from -15Db to 15Db
19.95

SPECIAL SYNCRO CAPACITORS

3 x .6 mf/90 VAC, MARK 12 MOD 2 TYPE 1C \$2.75
3 x 3 mf 90 VAC, MARK 14 MOD 2 TYPE 4C 3.75
3 x 10 mf/90 VAC, MARK 1 MOD 2 Type 8C 3.95
3 x 50 mf/90 VAC, MARK 4 MOD 2 TYPE 15C 5.95
10 mf/600 VDC/220 VAC round case..... 1.95
20 mf/285 VAC rect. metal case..... 2.95
50 mf/600 VDC rect. metal case..... 6.95

NOISE SUPPRESSOR CAPACITOR

CA-442 - CA-445 - C-275 - CA-481 - CA-209
MUMETAL - TRANSFORMER LAMINATIONS - 4750
F-11 - F-12, L-11, EE-24-25, EE-26-27 - SPARE
PARTS FOR ARMY & NAVY RADIO, RADAR, SPARE
EQUIPMENT - INQUIRIES INVITED
JAN-C-25 CAPACITORS STOCKED

For Fast Intelligent Friendly Service

"CALL ON ESSCO"

ELECTRONIC SPECIALTY SUPPLY CO.
58 Walker St. WA 5-8187 NYC 13 N.Y.

!! WANTED !!

IN ORDER TO SUPPLY GOVERNMENT AND INDUSTRIAL REQUIREMENTS, WE ARE PAYING TOP DOLLAR FOR ALL TYPES OF RADIO AND ELECTRONIC SURPLUS. WE SPECIALIZE IN TEST EQUIPMENT AND COMPLETE RADIOS, SUCH AS:

APA, APN, APQ, APR, APS, APT, ARB, ARC, ARN, ART, ATC, BC, DY, I, IE, LM, MG, PE, PU, SCR, TCS, TN, TS, and many others.

WE ESPECIALLY NEED: APA10, APN9, APR4, APS4, ARC1, ARC3, ART13, ATC, BC221, BC342, BC348, BC611, BC721, DY12, DY17, I100, LM10 to LM18, MG149F, MG149H, PU14, R5/ARN7, R5A/ARN7, SCR718C, TCS, TN16, TN17, TN18, TN19, TN54, TS3, TS13/AP, TS33, TS35, TS45, TS75, TS76, TS102, TS147/UP, TS148/UP, TS173, TS174, TS175, TS250, TS251, TS323, (ICT, 1F, 1G, 5CT, 5DG, 5F, 5G, 6DG, 6G 115V. 60 c.p.s. Selsyns), and all types of Hewlett Packard, General Radio Co., Measurements Corp., Boonton Radio, Ferris, Leeds & Northrup, and other test equipment.

Please state accurate description, condition, and your lowest price. Explain modifications, if any. We pay freight charges. PURCHASING AGENTS, ENGINEERS, EXPORTERS, INDUSTRIAL BUYERS, DEALERS, AND INDIVIDUALS, Please send us your requirements.

WRITE FOR OUR LATEST SURPLUS CATALOG

PHOTOCON SALES

417 N. Foothill Blvd. SYcamore 2-4131
Pasadena 8, California RYan 1-6751

IN STOCK FOR IMMEDIATE DELIVERY JAN-C-25 CAPACITORS

CP53—CP54—CP55
CP61—CP63—CP65
CP67—CP69

Every "E" Characteristic Item Listed In Jan-C-25
Also Every "F" Characteristic Where The Size Is Smaller Than "E"

ALSO
CP70 CAPACITORS
"E" Characteristic
600 and 1000 Volts
"B" and "E" Terminals

O'DEL ELECTRONICS CORPORATION

293 WEST BROADWAY
NEW YORK 13, N. Y.

WORTH 4-2176 WORTH 4-2177

Atte. Manf., Dealers, Exporters Dynamotors Offered Spring Sale

Orders accepted from 1- to 1,000

New low prices on all numbers. Special prices for quantity buyers. Over 50,000 in stock. All new guaranteed, checked out.

DM-21	DY-10	SS2669
DM-28	DY-22	PE-73
DM-25	DY-2ARRY	PE-86
DM-32	DY-16	PE-94
DM-33	DA-1F	PE-98
DM-37	BD69	PE-101
DM-40	BD-77	PE-103
DM-53	BDAR93	DM-36
DM-45	D-401	D-101
ZA	0516-5	DA-3A
ZA	0516-6	SP-175
		ML-3412

Quantities available in the above numbers. Other numbers and types available. Your inquiries appreciated, samples at request. Prices on request.

Need T-17 Mikes 1 to 1000 any model

VETS, DIST. CO.
3613 N. WESTERN PKY.
LOUISVILLE 12, KY. CY. 8904

AN Connectors, complete stocks on hand. Blue phthalate, melamine or bakelite with cadmium plated or sand blast shells. Write for four page reduced price list.

Up to 80% discount!

Coaxial Connectors, 23,064 pieces in stock in 167 different types.

Write for latest price list.

HAROLD H. POWELL & CO.
2104 Market Street Philadelphia 3, Pa.

WE BUY...

all kinds of

DOGS

SURPLUS MATERIAL
Aircraft & Electronics

- Amplidynes
- Dynamotors
- Motor Generators
- Switches
- Wire

or What Have You?

ATLAS EQUIP. CO.

229 Southwest Blvd.
KANSAS CITY, MO.

!!! WANTED !!!

Special RADAR Purpose TUBES

ATTENTION MANUFACTURERS, LAB'S. SCHOOL'S, HAM'S!!: We will pay you immediate and highest cash prices for special purpose tubes and X'TAL Diodes in any quantity.

HERE IS A PARTIAL LIST OF WHAT WE ARE LOOKING FOR:
"1B" series, including 1B35 & 1B63(A), 1N25 & 1N32, 1S21. ALL KLYSTRONS, INCLUDING: 2K33, 3S, 41 & 47, also 723A/B, 726-B & C, & 3K30, 3C22, 4C35, 393-A, & MANY OTHER THYRATRONS & IGNITRONS. 6A57-G, 6F4, 6J4, 804 & 5691-2 & 3. ALSO MANY MAGNETRONS.

For a prompt quotation write to:

MICROWAVE

425 Riverside Drive, New York City 25, N. Y.
Dept. 6B-4

Or for immediate action Phone Monument 2-1480 and ask for Miss Rainbow

WANTED

Radio transmitters, receivers, test equipment, tubes, parts, technical manuals, particularly: APR-4, 5, APN-9, APR-13, DY-12, DY-17, BC-348, BC-312, BC-342, BC-221, LM, SCR-694, BC-1306, PE-237, GN-58, BC-610-E, panoramic adaptors. Will trade.

ALLTRONICS

Box 252 Boston 1, Mass.

WE BUY

All kinds of surplus electronic equipment and components.

ELECTRONICRAFT, Inc.

27 Milburn St. Bronxville 8, N.Y.
Bronxville 2-0044

WE BUY AND SELL GOVERNMENT SURPLUS

electronic components, units, wire, etc.

Your Inquiries Invited

LAPIROW BROS.

1649 Hoffner St. Cincinnati 23, Ohio
K1rby 1285

WANTED

Western Electric gray-finished
EQUIPMENT CABINETS

For 19" panels. Heights of 2' 6", 3' 6", 7' 0" and 7' 6".

W-5956, Electronics

330 W. 42 St., New York 36, N. Y.

Will buy "ALL"

ART - 13 / type T-47A, BC-348 modified, \$55.00.
\$200.00. APN-9, \$200.00.
ART - 13 / type T-47, ARC-3 complete, \$750.00.
\$150.00. R77 Receivers, \$400.00.
ARC-1, \$600.00.
BC-348 unmodified, BC312, \$65.00.
\$75.00. BC342, \$60.00.

Ship via Express C.O.D., subject to inspection to:

H. FINNEGAN
49 Washington Ave. Little Ferry, N. J.

WANTED

BD110 Telephone Switchboards, BD100 Telegraph Switchboards, BD90 Power Boards, EE101 V-F Ringers, BE72 Cabinets, FM19 Frames, RA43, REC30, KS5988, RA87, RA37, RA91 Rectifiers, BD101 Test Boards, SB6 Switchboards, Type CFIA, CF3A, CF2B Carrier Equipments. Any condition and quantity.

W-6205, Electronics
330 W. 42 St., New York 36, N. Y.

WANTED

Federal type

101B Voice-frequency Ringers
Signal Corps type TA-3/FT.

W-4814, Electronics

330 W. 42 St., New York 36, N. Y.

WANTED

- AN/TRC-1 Equipments.
- T14 Transmitters.
- R19 Receivers.
- TS32 Test Oscillators.

Any condition or quantity

W-3858, Electronics
330 W. 42nd St. New York 36, N. Y.

Standard Brands **Electronics, INCORPORATED** All Items Fully Guaranteed

TREMENDOUS STOCK OF ELECTRONIC COMPONENTS—WRITE FOR OUR CURRENT CATALOG

Your Inquiries Answered Promptly

PULSE NETWORKS:

SPRAGUE: 15—E3—1/2—400—50P
 6—A5—1/2—2000—50M 15—E3—4—800—50P
 6—E3—25—2000—50P 15—E4—1—400—50P
 9—E3—25—2000—50P 15—E3—5—2000—50P
 9—E3—5—2000—50P 15—A—1—800—50
 10—E3—2—1000—50P
 10—E5—1—400—50P 25—E5—4—120—50P

PULSE TRANSFORMERS

UTAH: 9340 X 124 T3
 9280 X 143 T3
 9318 X 124 T2
 X 146 T1

RAYTHEON:

UX 7307 UX 13086
 UX 7350 UX 8092

WESTINGHOUSE:

132 AW 145 EW
 1P2 132 BW 145 EWP
 1P8 132 DW 166 AW
 1P26 133 AW 176 AW
 1P29 134 EW 301445-1

GENERAL ELECTRIC:

68G813 80G53 K 2478
 68G894 80G59 K 2721-A
 68G909 80G625 K 2728
 68G979 K 2449
 80G15 K 2460

SPECIAL

MOTOR STARTING CONDENSERS

110 Volts 60 Cycles

POPULAR BRANDS	
3276	145-175 mfd 51.02
95758	161-180 mfd 1.12
3282	182-198 mfd 1.14
3288	200-240 mfd 1.17
3298	200-240 mfd 1.22
3251	218-262 mfd 1.64
3915	234-286 mfd 1.64
3825	243-270 mfd 1.64
3275	243-282 mfd 1.68
3276	243-282 mfd 1.83
3275	400-480 mfd 2.38
3224	485-580 mfd 2.38

SYNCHROS

1CT
 5CT
 5F1
 5DG
 5D
 5F
 5G
 5LA1
 5SF

6DG
 6G
 7G
 7DG
 2J1E2
 2J1E1
 2J1H1
 2J1G1
 2J1M1

9J5H1
 C 78249
 C 81369
 C 56701
 C 69405-2
 C 78248
 KS 5950 L2

K-BAND CAVITY—TFK—75W

Complete with panel mounting
 Directly calibrated 23400-24500
 MCS. Geared Tuning . . . \$47.50 ea.

40 KILOWATT TRANSFORMER AND CHOKE KIT FOR THE PRESS—WIRE-LESS PW-40. NEW

VACUUM CONDENSERS

MFD	Voltage	Price Each
50	5K	5.50
100	7500	14.50
12	20K	7.50
50	20K	12.50
50	20K	11.50

TUBES

Klystrons—Magnatrons—Special Purpose—Receiving.

CONDENSERS

CP70 Style—Micas (all kinds)—Vacuum—Ceramic—Bathtub—Electrolytic.

TRANSFORMERS

We offer a tremendous stock of surplus transformers made for military equipment.

RELAYS • SWITCHES • JACKS • PLUGS • CONNECTORS • MOTORS • GENERATORS • DYNAMOTORS • COAX • CONNECTORS • RESISTORS • POTS • METERS • XTAL DIODES.

For more complete listing of tubes and condensers see our ad in January ELECTRONICS, pages 414-415.

We are 5 hours away from New York City. If you're at the IRE show why not visit or phone us. Our stock is worth seeing!

Write - Phone - Telegraph **Electronics, INCORPORATED**

92 Broad Street, Babson Park 57, Mass., Wellesley 5-5210-1

HIGH FREQUENCY

50 K.V.A. 400 MG SETS

We have been fortunate in acquiring a quantity of KATO 400 Cycle Alternators that we have made up into motor generator sets and are thus enabled to offer these at a very attractive price. These sets consist of a 75 H.P. Motor operative at 220/440 Volts, 3 Phase, 60 Cycles, 1750 R.P.M. which are coupled directly to a self-excited alternator with output of 50 KVA, 120/208 Volts, 400 CPS, 3 Phase. These motor-generator sets are BRAND NEW and complete with compensator for motor starting and field rheostat for voltage output control. Voltage regulator can be supplied at \$100.00 additional to price as quoted. We will be pleased to supply complete specifications relative to frequency and voltage variation and harmonic content. **SPECIALLY PRICED! \$5525.00**

KATO 25 KVA MG SETS. Motor: 40 HP, 220/440 Volts, 3 Ph., 60 Cycles, 1750 RPM, direct-connected to alternator having output of 115 Volts, 1 ph. 400 cycles, 25 KVA. Voltage Regulation can be supplied at \$100 additional to price as quoted. Brand new. Price \$4995.00

BOGUE THREE PHASE MG SETS. Consists of Motor 10 H.P. operative at 220/440-3-60 Self-exc. alternator with output of 120/208 V, 3 ph. 400 cyc. 5 KVA. Brand New. PRICE, \$1850.00 With Voltage Regulator. PRICE, \$1950.00

AMERICAN 400 CYCLE SETS. A precision built motor generator set ideal for laboratory test work. Consists of 10 H.P. motor directly connected to alternator with output of 5 KVA, 120/208 Volts, three phase, 400 cycles. With electronic exciter-voltage regulator. Freq. variation $\pm 5\%$; Voltage variation $\pm 1\%$; Total harmonic cont. 1.2%. PRICE \$1850.00

LOUIS ALLIS FREQUENCY CHANGER SETS. Pri. 25 H.P., 220/440-3-60; Sec. 15/10.8 K.W. 3500/2200 RPM/306/220 Volts 35/35 Amps. 2 ph. 500/360 C.P.S. Brand new. PRICE. \$1250.00 We can supply these units for 400 cycle output and with transformers to supply 3 phase, wye output. Write for further information.

BTH 400 CYCLE M-G SETS. Consists of an alternator of 6 KVA with output of 115 volts, 1 ph. 400 CPS. V belted drive to 10 HP. motor operative at 220/440-3-60. Excitation provided by dry disk rectifier. Complete with field rheostat. **SPECIAL PRICE \$1200.00**

KATO MG SET. Motor: 12.5 HP, 220/440-3-60. Output: 7.5 KVA, 250 Volts, 1 ph. 350 cyc. with direct conn. exciter. Brand New. PRICE. \$1395.00

BOGUE 7.5 KVA MOTOR GENERATOR SET. Motor: 10 HP., 220/440-3-60 direct connected to self-exc. alternator with output of 7.5 KVA, 120/208 Volts, 3 ph. 400 cycles. Wye connected. Harmonic content 1.2%. PRICE. \$2250.00 With GE Voltage regulator. \$2250.00

LELANO MG SET. Consists of 5 HP Motor operative at 220-3-60 direct connected to self exc. alternator with output of 3 KVA, 120/208 V, 3 ph. 400 cyc. PRICE \$960.00

GREAT LAKES 400 CYCLE UNIT. Output of 2 KVA, 120 V, single ph. 420 Cyc. with motor operative at 220/440-3-60. Compact two bearing unit. Rebuilt. PRICE. \$320.00

400 CYCLE COMBINATION 1 AND 3 PHASE MOTOR GENERATOR. Consists of 20 HP Synchronous 220/440V. Motor V belted to two self excited alternators. Generator I: Bourne 5 KVA 120/208 Volts, 3 Phase, 400 CPS with voltage regulator. Generator II: Onan 4 KVA, 115 Volts, single ph. 400 CPS with voltage regulator. Motor and both alternators and two voltage regulators are mounted on welded channel iron base complete with motor starting compensator. **SPECIAL PRICE \$3175.00**

CARSON MG SET. Motor: 220/440 Volts, 3 Ph., 60 cycles, 7.5 HP, 1750. Generator: Model CPM-28-2, 120 Volts, 1 Ph., 400 cycles, 41.6 A., 8 PF, 4 KW. Direct-Connected, Permanent-Magnet. PRICE \$699.50

LOUIS-ALLIS 3 UNIT MG SET. Consists of 5 HP motor operative at 220/440-3-60 directly coupled to alternator with output of 115 volts, 1 ph. 400 cyc. and with exciter unit all mounted on steel base. 1.8 K.V.A. PRICE. \$565.00

SPECIAL MG SET. Motor: 2.5 HP, 220/440-3-60. Self-exc. Alternator with output of 1.25 KVA, 115 V, single ph. 400 cyc. PRICE. \$325.00

BRITISH MADE 400 CYCLE SETS. Consists of 10 H.P. Motor, operative at 220-3-60 V-belted to Alternator with output of 6 KVA, 115 V, 1 ph. 400 cyc. Complete with GE voltage regulator. Brand new. PRICE \$1250.00

GENERAL ELECTRIC HIGH FREQUENCY MG. Consists of motor and dual output generator mounted on steel base. Motor operates at 220/440-3-60 direct connected to alternator with output of 115 Volts, 1 Ph. 1050 Cycles, 1 KVA and 115 Volts, DC., 2 KW. With field rheostat. PRICE. \$525.00

NORMAND ELEC. CO. (BRITISH MFG.) MG UNIT. Motor: 220 VDC, 8.8 amp, 2 HP, 4200 RPM, directly connected to H. F. alternator with output of cyc. 1200 watts. Exc. 24 VDC PRICE \$149.00

LOUIS ALLIS MOTOR GENERATOR. Consists of 2 HP Motor 220/440 Volts, 3 Ph., 60 Cycles, 3450 RPM direct connected to self-excited alternator, type POGIT, 115 Volts, 1 Ph., 400 cycles. Nema Frame, 3 bearing. NEW PRICE. \$475.00

VARIABLE FREQUENCY POWER SUPPLY.

Driven by 5 HP, 220/440 Volt, 3 Ph., 60 Cy US Synchronous Vari-drive motor. Special attachment permits remote pushbutton control of speed from 1430 to 10,000 RPM. Direct-Connected Alternator is made by Onan and is rated at 1.5 KVA, 115 Volts, single phase, .8 PF. The Frequency may be varied from 400 cycles to 2400 cycles. The generator is designated by Model #MG207E, and the excitation is provided by a separate motor generator furnished with the below price. **NEW \$2450.00**

US-ONAN VARIABLE FREQUENCY SUPPLY.

Motor: 10 HP, 208/416 Volts, 3 ph., 60 Cycles. Output speed is manually variably between 1600 and 8000 RPM. Direct connected alternator made by ONAN is rated at 5 KVA, 110 Volts, 45.5 Amps, 1 PF. Frequency Range is between 800 and 2400 cycles. Excitation is provided by Tunker rectifier mounted on same base. Price complete with rheostat panel and magnetic motor line starter. \$3990.00

GM-GE 400 CYCLE SUPPLY. Motor: Delco, 5 HP, 220/440 Volts, 3 ph., 60 Cy, 1750 rpm, V-belted to alternator, GE, Model 5A-26A3, 220 Volts, 15.9 Amps, 3.5 kva, 2.8 kw, 1 ph., 1600 RPM. Direct-connected exciter. Voltage regulated. NEW PRICE \$960.00

GE 120 CYCLE MOTOR-GENERATOR. Motor: 75 HP, 220/440 Volts, 3 ph., 60 cy, 1750 RPM, direct-connected to alternator, 50 KW, 225 Volts, 3 ph., 120 cycles, 128 amps. Type ATD, Direct-Connected exciter. PRICE \$2995.00

CANADIAN HIGH FREQUENCY UNIT. Operates with input of 110 VDC will deliver 200 watts, with adjustable frequencies up to 10,000 cycles. Controlled by knob at one end of machine. PRICE \$85.00

CONTINENTAL OC/AC SET. Motor: 1.5 HP, 230 VDC, 3440 RPM. Output: 120 VAC, 6.6 amps., 8 KW, 800 cyc., 1 ph., also output of 14 VDC, 4 amps., Model CG21637. Compact 2-bear. units. Completely rebuilt. PRICE. \$114.50 Also available for operation at 115 VDC at the same price. Same set operative at 440 V, 3 ph. 60 cyc. PRICE. \$119.75 Same set operative at 110/220 V, 1 ph. 60 cyc. \$155.00

ONAN 800 CYCLE MG UNIT. Employing 5 H.P. Motor operative at 220/440 Volts, 3 ph. 60 Cycles, 1750 RPM. Self-exc. generator with output of 1.5 KVA, 115 Volts, single ph. 800 CPS, and secondary output of 500 Watts 28.5 VDC 17.5 amperes. PRICE \$375.00

BENDIX POWER MG SET. Consists of G.E. 2 HP Rep-Ind Motor, 115 volts, single phase, 60 cyc. directly connected to Bendix alternator with output of 120 volts, 700 cyc., 600 watts and DC output of 14.5 volts, DC, 22 amp. Brand new. PRICE \$225.00

BURKE ALTERNATOR. 62.5 KVA, 220 Volts, 3 Ph. 180 Cycles, 1800 RPM, separately exc. at 125 VDC. 80% P.F. Type ACR-7. Complete with auxiliary exciter MG set and field rheostat. Ball bearings. Will deliver 400 cycles at 4000 RPM. Rebuilt. PRICE \$1375.00

IDEAL FREQUENCY CHANGER SET. Motor operative at 220-3-60 with direct connected induction type alternator with output of 12.5 KVA, 220 V, 3 ph. 180 Cyc. PRICE \$445.00

GENERAL ELECTRIC 400 CYCLE UNITS. Operate at 26 VDC 100 Amp. Output: 115 VAC 1 ph. 400 CPS, 1500 V.A. With filter system built-in. PRICE \$39.50

WINCHARGER PU-7/AP. Input 26 VDC, 160 Amps, Output: 115 VAC, single ph. 2500 V.A. 400 C.P.S. Frequency and voltage regulation built-in. PRICE \$97.00

WINCHARGER PU-16/AP INVERTER. Type MG750, Input: 28 volts, 60 amp. Output: 115 volts, 6.5, amp., 400 cyc., 1 ph. Brand new. PRICE \$69.50

PE 109 INVERTERS. Input 13.5VDC 29A; Output 115V 400 cyc. 1.58A 8000 RPM. \$59.95

HOLTZER-CABOT MG218. Compact 2 bearing units for low current 400 cycle output. Operative at 115 VDC, 2.3 amp. Output: 110 Volts, 1.0 amp, 1 ph. 400 CPS. Brand new. PRICE. \$79.50

INDEX SEARCHLIGHT

March, 1953

This index is published as a convenience to the readers. Care is taken to make it accurate but ELECTRONICS assumes no responsibility for errors or omissions.

EMPLOYMENT
 Positions Vacant 507-519
 Selling Opportunities Offered 507
 Positions Wanted 507
 Selling Opportunities Wanted 507
 Employment Services 507
SPECIAL SERVICES
 Contract Work 507
 Rebuilding 507
BUSINESS OPPORTUNITIES
 Offered 507
EQUIPMENT
 (Used or Surplus New)
 For Sale 520-558
WANTED
 Equipment 552

ADVERTISERS INDEX

Admiral Corporation 510
 Aircraft Armaments Inc. 512
 Algradio Electronics Co. 548
 Alexander, F. 550
 Allied Electronics Sales 556
 Alltronics 552
 Armour Research Foundation of Institute of Technology 510
 Arrow Appliance Co. 550
 Arrow Sales Inc. 539
 Atlas Equipment Co. 552
 Barry Electronics Corp. 541
 Bendix Aviation Corp., York Div. 515
 Bendix Radio Div. of Bendix Avia. Corp. 508
 Blan 541
 Blonder-Tongue Laboratories Inc. 510
 Brooks Inc., B. D. 556
 C & H Sales Co. 527, 540
 Capehart Farnsworth Corp. 514
 Central Commercial Industries 519
 Chase Electronics Supply Co. 549
 Chromatic Television Laboratories Inc. 516, 550
 Clegg Laboratories Inc. 507
 Comet Electronic Sales Co. 542
 Commercial Surplus Sales Co. 551
 Communications Devices Co. 556
 Communications Equipment Co. 532, 533
 Compass Communications Co. 538
 Components Supply Co. 543
 Connector Corp. of America 538
 Conair 513
 Cornell-Aeronautical Laboratory Inc. 516
 Davis Laboratories, The 514
 Daystrom Inst. Co. 519
 Douglas Aircraft Co., Inc. 508
 Eastern Telephone Co. 543
 Edlie Electronics Inc. 547
 Electro Devices Inc. 548
 Electro Sales Co., Inc. 555
 Electronic Engineering Co. of California 507
 Electronic Expeditors 550
 Electronic Specialty Supply Co. 551
 Electronic Surplus Brokers 540
 Electronicraft Inc. 522, 523, 552
 Electronics Inc. 553
 Empire Electronics Co. 540
 Engineering Associates 537
 Fair Radio Sales 543
 Finnegan, H. 552
 Ford Motor Co. 518
 Freeland Products Co. 556
 General Motors Corp., AC Spark Plug Div. 510
 General Motors Corp., Delco Radio Div. 518
 Gibbs Manufacturing & Research Corp. 514
 Goodyear Aircraft Corp. 509
 Greene, Leonard 550
 Harjo Sales Co. 548
 Hatry & Young 539
 Horlick Co., William I. 554
 Houde Supply Co. 551
 Instrument Associates 524
 (Continued on opposite page)

WILLIAM I HORLICK COMPANY

Est. in 1922

266 SUMMER ST.

BOSTON 10 MASS.

IF IT'S FROM ONE FREQUENCY TO ANOTHER; FROM DC TO AC OR AC TO DC, IF IT'S FROM ONE VOLTAGE TO ANOTHER, THEN CALL ON US.

TO THE ADVERTISERS

March, 1953

SEARCHLIGHT SECTION

(Classified Advertising)

H. E. Hilty, Mgr.

Johns Hopkins University, The	514
J.S.H. Sales Co.	547
Kollman Instrument Corp.	508
Lapirow Bros.	552
Lelectronic Research Laboratories	520, 521
Leeds & Northrup Co.	507
Legri S. Company	542
Leru Laboratories Inc.	548
Liberty Electronics Inc.	529
Maritime International Co.	544
Maritime Switchboard Co.	539
Maryland Electronic Manufacturing Co.	514
Massachusetts Institute of Technology	507, 519
Maxson Corp., W. L.	515
McNeal Electric & Equipment Co.	546
Melpar, Inc.	512
Merrick Electronics	543
Metropolitan Oakland Area	510
Metropolitan Supply Co.	550
Microwave Equipment Supply Co.	551
Midland Manufacturing Co.	519
Minneapolis Honeywell Regulator	513
Mogull Co., Inc., Alexander	550
Moumouth Radio Laboratories	537
M & B Sales Co.	550
National Cash Register Co.	507, 518
National Union Radio Corp.	517
Nibur Sales Corp.	540
O'Del Electronics Corp.	552
O'Shea Employment System	507
Peak Electronics Co.	549
Permoflux Corporation	514
Phillips Petroleum Co.	508
Photocon Sales	552
Potter Instrument Co.	516
Powell, Harold H.	552
Precision Electrical Instrument Corp.	551
Precise Measurement Co.	550
Radcom Engineering Co.	544
Radio Corp. of America	511
Radio Corp. of America Co., Ltd.	517
Radio Development & Sales Co.	537
Radio & Electronics Surplus	550
Radio Ham Shack Inc.	550
Radio Shack Corp.	545
Radio Surplus Corp.	526
Railway Communications Inc.	541
Resisco Corp.	549
Relay Sales	544
Reliance Merchandising Co.	528
Rose Products Co.	536
R W Electronics	546
Sandia Corp.	515
Semler Associated Industries Inc.	535
Servo Tek Products Co., Inc.	525
Sperry Products Inc.	518
State Labs Inc.	551
Stavid Engineering Inc.	512
Sylvania Electric, Electronics Div.	517
Sylvania Electric Products Inc.	519
"TAB"	557, 558
Telemarine Communications Co.	536
Telephone Engineering Co.	550
Universal General Corp.	531
Vets Distributing Co., The	552
V & H Electronics Industries Inc.	546
Victor Adding Machine Co.	516
Wells Sales Inc.	549
Western Engineering	545
Weston Laboratories Inc.	530
Wilcox Electric Co.	518
Wilgreen Industries	534
Wolf Company, Edward	538

ELECTRO—FOR ELECTRONIC SURPLUS

PULSE NETWORKS AND TRANSFORMERS

Sprague #7.5-E4-16-60-67-P.	7.5KV	\$7.95
Sprague #7.5-E-3-200-67-P.	7.5KV	\$6.75
Sprague #7.5-E-1-1000-50-P.	8KV	\$22.50
Sprague #10-E3-3-2000-50-P.		\$29.95
Sprague #15-A-1-400-50-P.		\$37.50
Sprague #15-E4-0.91-400-50-P.		\$19.95
Fast #15-E-1-33-700-50PZT.		\$29.50
W. E. #D-163330 Network Assy.		\$22.50
Raytheon Pulse Trans. Type WX-5137.	4KV	\$9.75
1 Mu. Sec. Sec: 16KV 15A		
Raytheon Pulse Inversion Trans. Type UX-8442		\$6.75
40V +40V		

MOTORS AND GENERATORS

Elec Spec Type 1A1, Spec 32159D.	24 VDC. 15A.	
1/4HP. 3800RPM		\$22.50
Pump Eng Type 1454ME.	24VDC 95A. 4000RPM	\$19.95
2.25HP		\$37.50
Holtzer Cabot Type RBD220.	24VDC. 8A. 1/5HP	\$19.95
6000RPM		\$19.95
G. E. Mod #5BC21M16A.	24VDC. 60A. 3800RPM.	\$32.50
1/4HP		\$32.50
Oster Type D-4-2.	24VDC. 116HP. 1800RPM.	\$4.95
Eicor ML2310-52.	24VDC. 0.32A. 1800RPM.	\$4.95
Oster Type ES-2.1.	motor for 7G selyslen.	\$7.95
Emerson Style 523.	115VDC. 1.2A. 5000RPM.	\$5.95
Westinghouse Style 171391.	27VDC. 1/4HP. 6.5A.	\$14.95
3800RPM		\$14.95
Holtzer Cabot Type 2505.	115VAC. 80 cv 3Ph.	\$9.95
9W. 1725RPM (LN)		\$9.95
Oster Motor, GVDC.	1.8A. 5000RPM.	\$8.95
W. #K5602101	24-28VDC. 0.6A. 5000RPM.	\$14.95
1/100HP		\$4.50
Alliance Type 2207.	27.5VDC. 7500RPM. 1/100HP	\$4.95
Oster Type C-2P-1L.	27.5VDC. 7000RPM. 1/100HP	\$8.95
Lear Type C004.	24VDC. 1.5A. SW. 7500RPM.	\$6.95
EAD Type J31.	115VAC. 400cy. 1/50HP.	\$9.95
Lear Type 133A.	24VDC. 5.5A. 72W. 9000RPM.	\$15.75
Barber Coleman #BYLC2190.	24VDC. 1A. Torque	\$14.95
100 lbs. 60 strokes. 177 sec.		\$14.95
W.E. Mod. #28944.	3 type SD. 45/52V. 3.5A. 1725	\$15.25
RPM		\$15.25
W.E. Mod #24517.	230/200V 60cy or 45/52VDC	\$17.50
1/8HP. 1725RPM		\$17.50
G.E. Mod #5A10A140.	24VDC. 10 oz/in torque	\$15.95
140RPM		\$15.95
Emerson Style 161-0212.	24VDC. 160 oz/in torque	\$17.50
100RPM		\$17.50
Westinghouse Type GN-WL33 Alternator.	12VDC @	\$32.50
0.6A and 1.5VAC @ 375-870 cycles.		\$32.50
G.E. Generators Type BY. Model 5BY9EB.	140VDC.	\$8.95
0.025A 1800RPM. Perm Mag Wound.		\$8.95
Delco Motor, A-7150.	27VDC. 1.2A.	\$12.95
G.E. #21161 Control Trans.		\$9.95
G.E. #211H1 Selyslen Generator.		\$12.95
G.E. #211D1 Selyslen Generator.		\$12.95
G.E. #211F3 Selyslen Generator.		\$12.95
Bendix Mk1 Mod. 3 Step by Step Motor.		\$14.95
Pioneer Magnesium PR-51505-1-2320-1A.		\$9.95
Pioneer Autodyn AY-20.		\$14.95
Pioneer Autodyn AY-14C.		\$14.95
Holtzer Cabot Pm Mtr #B-RB0808.	24VDC.	\$14.95
Pioneer Autodyn AY-20.		\$14.95
Pioneer Autodyn AY-59D1.		\$12.95
G. E. Selyslen 21D55B1.	60 cy	\$19.95
Diehl Control Mtr. FPE-25-11.		\$32.50
Rogers Switching Motor, Type 25. Ref #110FB/81.		\$8.95
24VDC		\$8.95
American Blower W/G.E. mtr. 230VAC 50/60cy		\$42.50
1/3HP		\$42.50
EAD Blower & Mtr. 115VAC 400cy 110CFM.		\$14.95
Redmond Blower & Mtr. 115VAC. 60cy 85CFM.		\$14.95
Redmond Blower & Mtr. 24VDC. 1.35A 4750RPM		\$12.50
Dual Output 100CFM (LN)		\$12.50
Stingwood Blower & Mtr. 115VAC. 400cy.		\$8.95
400cy. 8700RPM. 50CFM.		\$8.95
F. A. Smith Motor 69C Blower & Mtr. 115VAC.		\$12.95
400cy. 50CFM.		\$12.95
Oster Blower & Mtr. Type C-2P-1L. 28 VDC. 1/100		\$12.50
HP 0.8A		\$12.50
Delco Motor, A-7155.	27VDC @ 2.4A	\$12.95
3600RPM		\$12.95
Elec Ind Mtr. Type 203.	115VAC. 60cy 1ph. 0.45A	\$17.50
1800RPM		\$17.50
Ohio Elec Type CP35220.	115VAC. 60cy 1ph. 3400	\$15.95
RPM. 1/40HP		\$15.95
Diehl Mtr. C78291 & Delco C78889.	115VAC.	\$12.95
50/60cy. 3ph. 1/40HP (LN)		\$12.95
Delco Model A7501B Mtr. 24VDC. 1/4HP 11A. 6000		\$17.50
RPM		\$17.50
Eicor. ML4620-43. 24VDC. 17A. 1/3HP 3000 RPM		\$22.50
W. E. Sine Wave Motor Generator. KS-5913102.		\$19.95
Mtr. 115V 60cy 1 HP. 50hp 1725 RPM; Genera-		\$17.95
tor 16V 2ph 1725 RPM		\$17.95
Pioneer Gen-E-Motor. Input 18VDC; Output 450		\$4.95
VDC @ 150MA		\$4.95
D. C. Generator #2CBF-21263A. Input 12.6V 0.88		\$14.95
A. Output 500VDC @ 0.085A. Power drive speed		\$14.95
2 1/2 Hand Drive 500RPM		\$14.95
PE-103A Dynamotors; Input 6-12VDC @ 21/11A.		\$39.95
Output 500V @ 0.15A. filtered w/cables.		\$39.95
PU-16/AP Inverters. Input 28VDC 60A; Output		\$89.50
115V 400cy 6.5A 8000 RPM 750VA		\$89.50
PU-7/AP Inverters. Input 28VDC 160A; Output		\$89.50
115V 21.6A 400cy 8000 RPM 2500VA		\$89.50
PE218 Inverters. Input 28VDC 00A; Output 115V		\$59.95
400cy 1.53A 8000 RPM		\$59.95
PE109 Inverters. Input 13.5VDC 29A; Output 115V		\$59.95
400cy 1.53A 8000 RPM		\$59.95
MC149F Inverters. Input 28VDC; Output 500VA @		\$115
115V 400cy 1ph & 250VA @ 26V 400cy 1ph.		\$115
G.E. Amplidyne 5 AM 31N39A.		\$29.95
G.E. Amplidyne 5 AM 31N18A.		\$19.95
West type FK. 1 1/2HP. 230VDC. Armature. 115VDC		\$17.50
fields 1725 RPM.		\$17.50
GE Gear Mtr Model 58C44A1643. Gear Red		\$29.95
2:1 20X18 250V. Armature/115V. Fields 115VDC		\$29.95
Gear Speed 95.5 Gear Ratio 9 to 1.		\$29.95
GE Gear Mtr Model 58C44A1643. Gear Red		\$39.95
2:1 20X18 250V. Armature/115V. Fields 115VDC		\$39.95
Gear Ratio 11.7 to 1.		\$39.95
GE Model 58C44A1635 3/4HP Shunt Wound. 250V		\$29.95
Armature 30V. Field 6000RPM		\$29.95
Jay Elec Frame 145. 1/4HP 230V Armature 30V		\$23.75
Fields. Shunt. 3450RPM.		\$23.75

HEAVY DUTY COPPER OXIDE RECTIFIERS

Hammett Model 1 SPS-130. Input AC: 208/230V 60 cy 3ph. 21A. Output DC: 28 volts @ 130A. Cont. Duty. Output voltage variable by means of power tap switch. Complete with indicating meters on front panel. Self Cooled. Schematic available. Brand New. Export Packed. \$297.50

HIGH VOLTAGE CAPACITORS

Cat. #	Mfd.	WVDC	Price
18F269	60	3KV	\$65.00
OLKAP30	120	2KV	\$7.50
22F84	7	4KV	14.95
PFD40244C	7	4KV	42.50
14F1	7	5KV	42.50
19F210	0.1	6KV	37.50
A7648	2K.25	6KV	27.50
TK5020	2K.25	6KV	27.50
1227132	2K.25	7.5KV	27.50
7520	2K.25	7.5KV	27.50
14F338	4.5	7.5KV	29.95
CC1218	240.5	7.5KV	79.50
10020	1.0	10KV	32.50
Inerteen	1.0	10KV	37.50
26F68	0.1	12.5KV	19.95
TPS19065	1.0	15KV	19.50
15020	1.0	15KV	19.50
14F17	1.5	15KV	49.95
14F18	1.5	15KV	62.50
26020	1.0	20KV	27.50
37485	0.25	20KV	27.50
26F68	0.5	20KV	27.50
14F139	0.1	22KV	15.50
20005	0.5	20KV	45.00
14F135	0.1	22KV	15.50
Inerteen	0.5	25KV	57.50
24020	1.0	25KV	99.50
14F88	0.75	25KV	72.50
Inerteen	1.0	25KV	99.50
14F88	1.0	25KV	99.50
Inerteen	1.25	32.5KV	67.50
14F88	0.25/0.25	50KV	55.50
14F127	0.25	50KV	49.50
14F37	0.25	50KV	72.50

RELAYS

Auto Elec. R45H.	6500 Ohm. 2MA. SPST. NO.	\$1.45
Auto Elec. R45.	6500 Ohm. 2MA. SPST. NC. & SPST-NC	\$1.45
Guardian G39327.	6VAC. SPDT & SPST-NO Simul	\$1.45
Struthers-Dunn ABD78.	6VAC. DPST. 30A.	\$1.95
Edison Thermal 184805.	6V AC-DC. SPST-NC.	\$1.95
Allied FX-31A.	6VDC. SPDT. 2A.	\$2.25
Allied PK-86.	6VDC. DPDT.	\$2.95
RM #5984712.	6VDC. SPST-NO. 5A.	\$1.95
RM #5608-10.	6VDC. SPST. double break.	\$1.45
Allied B09D29.	6VDC. SPDT. 15A.	\$1.95
G.E. CR2791-G10F2.	6VDC. SPST-NO. 200MA.	\$1.95
Struthers-Dunn 8XAX100.	18VAC. SPDT. 8A.	\$2.25
Auto Elec. R45P.	24VAC. SPST-NC & SPST-NO	\$1.95
Auto Elec. R-30.	20-30VDC. 3PST-NO & DPDT.	\$2.95
Clare #35EC.	12-24VDC. DPST-NO & SPST-NC	\$1.75
G.E. CR2791-B108C20.	12-24VDC. DPDT.	10A.
G.M. #13020.	18-24VDC DPST-NO & SPST-NC.	\$1.75
Leach 1054ARW.	22-30VDC. DPDT & SPST-NO	\$2.25
15A		\$2.25
Henry #1010 Min.	24VDC. SPST-NC.	\$1.35
Allied B01D35.	24VDC. SPST-NO. double break	\$2.95
15A		\$2.35
Allied E5691526.	Min. 24VDC. DPDT. 3A.	\$1.35
Allied 452-1272.	24VDC. SPDT. 2A.	\$1.65
G.E. CR2791-G10F2.	24VDC. DPDT. 5A.	\$1.95
G.E. E5836.	24VDC. DPST. 6A. Miniature.	\$1.95
G.M. #13013.	24VDC. SPDT. double break.	\$1.95
G.E. CR2791-D101F3.	24VDC. DPDT. 10A.	\$2.25
Allied B014D35.	24VDC. SPST-NC. double break.	\$2.95
15A		\$2.95
G.E. E5837.	24VDC. SPST-NO. double break. 2A	\$1.95
Sperry E120248.	24VDC. DPST-NO. 2A.	\$1.95
Leach 1222ED.	24VDC. SPDT. 8A.	\$1.95
G.E. CR2791-B100F3.	24VDC. DPDT. 15A.	\$2.25
G.E. E55251.	24VDC. SPST-NO. 6A. Min.	\$1.75
Leach 1074.	24VDC. DPST-NO. 15A. Ceramic.	\$3.25
Allied B015D35.	24VDC. SPDT. double break.	\$2.95
Allied B06D35.	24VDC. DPDT. 10A.	\$2.25
Allied B18D33.	24VDC. DPDT. 15A.	\$5.25
Allen Bradley X95545.	Type B6B. 24VDC. SPST-NO double break. 200A	\$2.95
Allen Bradley X99309.	Type B6B. 24VDC. SPST-NO double break. 200A	\$3.95
Allied B0X48.	24VDC. SPST. double break.	\$2.95

RADAR — COMMUNICATIONS — TEST EQUIPMENT

AN/ARC-1—Transceiver 100-156 mcs	
APA-11—Pulse Analyzer	
APN-1—Airborne Radio Altimeter	
ARC-4—VHF Transceiver 140-150 MC	
ARN-5—Glide Path Receiver	\$69.50
ARN-7—Airborne Direction Finder	
ARR-2—Homing & Receiving Equipment	
BC-223—30-Watt Transmitter 2-5.2 MC	
BC-342—Receiver—1.5 to 18 MC 110v AC	
BC-348—Receiver—1.5 to 18 MC 28v DC	
BC-375E—Radio Transmitter	
BC-039—VHF Receiver 100-156 MC	\$400.00
BC-640—VHF Transmitter 100-156 MC	\$950.00
BC-1206—Beacon Receiver 200-400 KC	
RC-103—Airborne Localizer Receiver	
SCR-269—Radio Compass	\$129.50
SCR-274N—Command Equipment	
SCR-284—Field Radio Station	\$365.00
SCR-291—Semi-Portable Direction Finder	
SCR-300—Field Transmitter and Receiver	
SCR-522—VHF Transmitter and Receiver	\$129.50
SCR-536—Handi-Talkie PAIR: \$185.00	
SCR-555—Semi-Portable Direction Finder	
SCR-694—Portable Field Transceiver	
SCR-718A-AM-G—High Altitude Altimeter	
T-50—Radio Telegraph Transmitter	
TS-3/AP—S-Band Power Frequency Meter	
TS-10/AP—APN-1 Test Set	\$25.00
TS-12/AP—X-Band V.S.W.R. Test Set	
TS-13/AP—X-Band Signal Generator	
TS-14/AP—S-Band Signal Generator	\$400.00
TS-15/AP—Field Meter	
TS-16/AP—APN-1 Test Set	\$29.95
TS-18/AP—Capacity Divider	
TS-23/APN—SCR-718 Test Set	
TS-33/AP—X-Band Frequency Meter	
TS-34/AP—Synoscope complete with acces	\$290.00
TS-35/AP—X-Band Test Set	
TS-36/AP—X-Band Power Meter	\$140.00
TS-45/APM-3—X-Band Signal Generator	
TS-59/APN—APN-1 Test Set	
TS-61/AP—S-Band Echo Box	\$140.00
TS-62/AP—S-Band Echo Box	
TS-69/AP—300-1000 MC Frequency Meter	\$69.50
TS-89/AP—Pulse Voltage Divider	
TS-98/AP—Pulse Voltage Divider	
TS-102/AP—Range Calibrator	
TS-111/AP—S-Band Wavemeter	
TS-118/AP—Power Meter	
TS-125/AP—S-Band Power Meter	
TS-155/UP—S-Band Signal Generator	
TS-170/ARN-5—I.L.S. Test Set	
TS-184/AP—Test Set	
TS-226/AP—300-1000 MC Power Meter	
TS-268/UP—Crystal Test Set	
TS-278/AP—AT-13 Test Set	
IE-19—SCR-522 Test Set	\$290.00
IE-36—SCR-522 Test Set	
BC-221—Frequency Meter	\$125.00
BC-1277—S-Band Signal Generator	\$275.00
TBN/3EV—Thermistor Bridge	
CP-60/ABM—S-Band Frequency Meter	\$97.50
FLUX METER—10-4000 Gauss	\$32.50
APA-10—Panoramic Adaptor	\$225.00
APA-17—Automatic Direction Finder 250-1000 MC	
APQ-5—Low Altitude Tracking & Bombing Equip.	
APR-1—Radar Search Receiver 40-3400 MC	
APR-2—Radar Search Receiver 85-1000 MC	

APR-4—Radar Search Receiver 38-4000 MC	
APR-5—Radar Search Receiver 1000-3100 MC	
APR-6—Radar Search Receiver 3000-6000 MC	
APS-2—S-Band Search Radar	
APS-3—X-Band Search Radar	
APS-4—X-Band Search & Homing Radar	
APS-6—X-Band Search & Gun Laying Radar	
APS-15A—X-Band Blind Bombing Radar	
APT-4—Radar Jamming Xmitter 165-780 MC	
APT-5—Radar Jamming Xmitter 350-1400 MC	\$189.50
SO-13—S-Band Marine Radar, Lightweight	
SO-10 CM Portable Radar \$850.00	
TPS-1—Portable Search Radar	
TPS-3—I-Band Search Radar	
UPN-1 & 2—S-Band Portable Beacon Battery or 110v AC	
RA-34—Power Supply for RC-375E	\$225.00
RA-62—Power Supply for SCR-522	
BC-1016—Ink Tape Recorder	
PE-103—Dynamotor Power Supply	\$24.50
GN-58—Hand Cranked Generator W/Legs & Seat	
SCR-578—Gibson Girl (Emergency Xmitter)	
GR-3—Victory Girl Dual Freq. Emergency Xmitter	
Sound Powered Chest & Headsets MI-2454-B: Type O. Mfg. RCA.	
AS-32/APX-1—Antenna	\$2.75
AN/CRC-7—V.I.F. Handi-Talkies 112MC Xtal Controlled PAIR: \$200.00	
MM/26-Y—Compass Receiver	
BC-733D—Receiver with Tubes	\$18.95
C-3—Navy Sniperscope in Carrying Case	\$400.00
BC-1284—Lighthouse Tube Preamplifier	
BC-996—Interphone Amplifier	\$6.75
RL-42—Motor Antenna Reel	\$6.25
30 MC—F. Strips Using 6AK5	
RD-7/APA-29—Recorder for APR	
AS-27/ARN-5—Antenna	\$3.50
ARA—Receiver—500-1500 KC	\$16.50
1D/80/APA-17—Indicator	
R-28/ARC-5—Receiver—100-156 MC	\$24.50
RM-29—Remote Control	
BC-454—Receiver—6-9 MC	\$16.50
BC-454—Receiver—3-6 MC	\$16.50
BC-800—Transmitter/Receiver	
BC-950—Transmitter—100-156 MC	\$34.50
FL-300—FM Exciter (Mfg. Tempo)	\$19.50
FL-8—Filter	
FL-5—Filter, Less Cables	
3C-18-D GSAF—Gun Camera Computers with All Accessories; in Carrying Case	\$14.50
AT-2A/APN-2—Antenna	\$3.75

PANEL METERS

2" SQUARE WESTON—SANGAMO	
0-20 Volts D.C.	\$2.95
0-5 Ma	\$2.95
0-40 Volts D.C.	2.95
0-500 Microamp.	4.95
0.5 Amp. R.F.	2.95
0-100 Ma (0-300 scale)	2.95

XMITTING TUBES

0A3/VRT5	\$1.04	15R	\$0.69	866A	\$1.38
0B3/R90	1.19	28D7	1.95	866JR	1.29
0C3/VR105	1.19	30 Spec	4.55	869B	65.00
0D3/VR150	.95	35T	3.22	874	3.50
1B23	9.75	45 Spec	3.22	874	1.19
1B24	9.75	100TH	7.95	878	1.59
1B27	1.45	211	1.95	922	1.39
1B29	2.45	250TH	19.95	902A	9.95
1N21B	3.25	250TL	17.95	918	1.40
1N23	1.25	252T	1.25	922	1.25
1N23A	2.19	274B	2.95	923	.95
1N23B	3.69	304TH	8.95	927	1.05
1N24	1.25	304T	1.25	930	1.25
1N34A	.97	307A/RK75	3.95	931A	4.45
2AP1	10.95	316A	6.95	954	.25
2C24	7.50	328	7.95	955	1.29
2C43	14.95	350A	6.45	956	.35
2C44	1.19	350B	3.95	957	.39
2C45	7.25	368AS	7.50	958	1.29
2C51	6.25	371A	95	959	2.35
2D21	1.35	371B	.69	991/NE16	3.95
2E22	1.75	393A	1.25	992	4.45
2E24	4.65	394A	3.95	1613	.79
2E26	3.15	417A	8.75	1616	.69
2K25/723AB	17.50	424A	2.50	1619	1.49
2K28	32.50	446B	1.15	1622	2.45
2K33A	310.00	446E	7.75	1624	1.45
3B24	5.95	575A	1.15	1625	1.45
3B24W	5.25	701A	5.75	1626	.25
3B24W	7.95	703A	5.25	1629	.25
3B26	2.59	705A	5.95	1630	.75
3BP1	5.95	707A	13.95	1632	.72
3C22	115.00	714AY	7.95	1638	.45
3E27/24G	1.75	715A	1.75	1851	1.49
3C45	15.95	715B	8.75	2051	1.18
3CP1	1.95	715C	19.95	5670	6.95
3DP1S1	1.95	717A	6.95	8005	5.95
3DP1A	4.45	721A	2.45	8011	.90
3DP1A	6.95	723A	9.50	8012	2.65
3DP1-52A	8.95	723AB	19.95	8013	2.59
3D21A	3.25	724A	3.25	8020	.98
3E29	13.95	725A	6.75	9001	1.50
3FP7	1.65	726A	18.95	9002	.98
3GP1	4.39	70A	29.90	9003	1.65
4-125A	27.50	803	1.75	9004	.75
4-125B	37.50	802	3.95	9005	7.95
4AP10	4.45	803	3.25	9006	.27
4C35	27.50	804	11.75	C1JA	9.95
4E27	14.95	805	3.75	C6A	7.95
SAP1	3.45	806	24.95	C16	6.39
SAP4	3.45	807	1.59	CA1005	.48
SBP1	4.45	808	2.59	F1A	7.75
SBP4	4.45	810	9.50	F127A	27.50
SCP1	4.59	811	2.95	F128A	89.50
SD1	1.75	812	2.95	F131A	8.85
SD21	19.95	813	11.75	F227A	4.95
SGP1	1.85	814	7.75	F332	6.95
SGP1	4.85	815	2.95	F337	14.95
SJP1	22.45	816	1.05	F381A	3.49
SJP2	22.50	826	2.95	G105	17.95
SJ2	22.50	828	9.95	F317	31.50
SNP1	5.50	829	10.95	G434A	29.95
GANS	3.30	828B	12.95	502A	1.75
AS6	2.50	830	2.75	HF100	8.95
CA57	4.45	832	6.75	HF300	22.45
6C21	21.00	832A	3.49	HF114B	.69
6J4	7.75	836A	1.45	ML101	55.00
7BP7	6.55	837	6.25	RF60/1641	2.25
7DP4	14.50	838	27.50	RF65	26.50
8LP7	8.95	845W	3.95	RF72	.48
10BP4	17.45	849C	27.50	RF65	26.50
10Y	.39	851	3.95	RF72	.48
12DP7	14.75	861	22.50	V127A	2.45
15E	1.35	865	.98	WL616	34.50

RECEIVING TUBES

0A2	\$0.95	6AK5	\$0.88	65T7	\$0.98
0A4G	1.05	6AK6	1.09	65U7GY	2.75
0D1	.85	6AV6	.85	6V7	.98
0Z4	.59	6AQ5	.57	6V8	1.55
1A3	.70	6AQ6	.85	6VGT	.65
1AT7	.70	6AQ7	.85	6VGT	.65
1B3-8016	1.25	6AT5	.65	6X4	.65
1CGT	.75	6AU6	1.19	6X5GT	.65
1DG7	.75	6AV7	.85	6Y7	.65
1GGT	.65	6AV8	.55	6Y7G	.75
1L4	.67	6B4G	1.25	7A6	.75
1L5	.75	6B6	.85	7C7	.75
1L6	.95	6B8G	.75	7C7	.75
1L8	.98	6BA6	.65	7C7	.75
1L85	.75	6B8G	.75	7C7	.75
1L86	.91	6BE8	.65	7N7	.59
1L85	.75	6BF6	.75	7N7	.59
1N5T	1.65	6C4	1.85	7Y6	.88
1PGT	.69	6BM6	.95	12A7	.75
1R4	.69	6BJ6	.95	12AT7GT	1.19
1R5	.65	6CQ6	.55	12AT7	1.10
1S4	.69	6C4	.55	12AT7	1.10
155	.65	6C5	.55	12AU6	.75
1T4	.65	6C6	.55	12AV6	.75
1U4	.67	6C8G	.85	12BA6	.69
1V4	.65	6D6	.72	12C8	.69
1X2	.95	6D8	.85	12H6	.69
2A3	1.10	6E5	.79	12K8	.72
2X2	.50	6F6	.85	12SA7GT	.88
2X2A	.50	6F6	.85	12SA7GT	.88
3A2	.65	6H6	.65	12S7GT	.85
3A4	.85	6H6GT	.65	12S7GT	.85
3B7/1291	.43	6J5GT	.55	12S7GT	.85
3D6/1299	.43	6J5GT	.55	12S7GT	.85
3Q4	.63	6J6	.95	12S7GT	.85
3Q5GT	.79	6J8	.95	12S7GT	.85
3S4	.74	6J7C	.69	12S7GT	.85
3V4	.74	6K6GT	.65	148R7	.72
5R4GY	1.65	6K7	.79	148R7	.72
5T4	1.32	6K8GT	1.15	25L6	.90
5U4G	.69	6L6	.85	25L6	.90
5V4G	.85	6L6	1.50	25Z6GT	.68
5W4	.79	6L6GA	1.50	41	.69
5Y3GT	.45	6L7	.85	45	.75
5Y4GT	.67	6N7GT	.85	45	.75
5Z3	.85	6R7	.79	50A5	.89
5Z4G	.95	6SA7GT	.65	50B5	.75
6A5	.85	6OC5	.85	50C5	.67
6A6	.82	6SF7	.75	50L6GT	.65
6A7	.85	6SM7	.65	50V6	.72
6AGT	.85	6SM7	.65	50V6	.72
GAB7	.85	6S7J	.75	53	.68
GACSGT	1.05	6S7GT	.75	53	.68
GAC7	.85	6SLT	.75	53	.68
6A65	.75	6SN7GT	.75	80	.65
6AG7	1.29	6SR7GT	.68	83V	.92
6AJ5	1.95	6SS7	.80	84/6Z4	.75

WANTED! WANTED!

Needed for Government Defense Projects—all types of military electronic gear with the prefix TS, BC, SCR, APIT, APS, etc. Highest prices paid or will exchange for your needs. No offer too small or too large.

Prices subject to change without notice. F.O.B. NYC, minimum order \$10.00, 20% deposit required. All merchandise guaranteed. Open account to rated firms. Telephone DIgby 9-0347.

RADIO HAM SHACK Inc.
189 GREENWICH STREET • NEW YORK, N. Y.

SEARCH RECEIVER — ARD-2

Frequency range 80 to 3000 Mcs.

Measures RF signals from 80 to 3000 Mcs and pulse rates from 50 to 8000 cycles. The ARD-2 can be used as a Direction Finder to locate signals, or as a frequency meter, by VISUAL and AURAL indicators, provided. Originally designed and used by USN aircraft. Ideally suited for military, laboratory and general purpose use.

Equipment consists of the following: Antenna Detector-CMD-66AP11—Has variable length antennas, diode detector and silver plated tuning stub with calibrated scale. AMPLIFIER CMD-50ADC—has three stage pulse amplifier, a trigger circuit, a pulse rate counter circuit and audio amplifier, visual signal indicator, rectifier power supply which is operative on 115 Volts AC 60 to 2400 cycles current, regulated.

Test OSCILLATOR-CMD-60ABC—Has cavity frequency of 400 cycles with selection of four pulse repetition rates.

ALL CABLES AND FITTINGS, ACCESSORIES AND SHOCK MOUNTED RACK for immediate installation, plus two Technical Manuals.

SPARE PARTS—Steel chest includes spares for components and two extra sets spare tubes. Guaranteed NEW

All the above in original export packed cases. Wt.: 113-lbs.

Price each . . . \$275.00

Other selected equipment for Radio Communications in our stocks TWX—N. Y. 1-223

COMMUNICATION DEVICES CO.

2331 Twelfth Ave. NYC 27, N. Y.
Cable: Communidev Tel: Ad 4-6174

SHARPENING STONE INDISPENSABLE for Lab or Workshop. Finest Silicon Carbide No. 124 Carborundum Co. Unsurpassed for Precision Grinding of Crystals ONLY. \$2.00 W/1/2. 45c; 3 for \$5.00

TEST EQUIPMENT MODEL 206P real mutual conductance tube tester. Checks all latest tubes, industrial, radio and TV types. Tests all elements for gas, shorts, opens and leakage. Meter has 150 microhms and English scales, relect and good-roll chart. Gtd includes factory warranty and new test information as available.

SPECIAL Post Paid \$80.00 MODEL 102 Pocket multimeter features: AC & DC 10 rns to 3000V, AC current 3 rns to 600 MA, DC current 4 rns to 1.2 amp, ohms 2 rns to 1 megohm. Compact accurate & durable construction. Std. Mfg. "TAB" GTD display Model.

866A KIT AND XFORMER 2 Tubes, Sekts, xfmr 15v 400yc 100A/Wineoil. SPECIAL \$5.49

DIODE PROBE TUBE Unexcelled for X-ray VHF testing. Ultra-sensitive subminiature envelope. VR92. 25c; 5 for \$1.

Table with columns: Mfd, Each, Mfd, Each, Mfd, Each. Rows include 150wvdc, 250wvdc, 300wvdc, 400wvdc, 500wvdc, 600wvdc, 700wvdc, 800wvdc, 900wvdc, 1000wvdc, 1200wvdc, 1500wvdc, 2000wvdc, 2500wvdc, 3000wvdc, 4000wvdc, 5000wvdc, 6000wvdc, 7000wvdc, 8000wvdc, 9000wvdc, 10000wvdc.

METER SPECIALS O-20MDC Airtight Type "AN" with Illustration. \$1.95; 3 for \$5.25

SELSYNS 2JH1 GE Selyns with Illustration. 2JF3 GE Brand New 115V/400 cyc. 2 for \$6.98

DYNAMOTORS INPT 50VDC, Output 200V/100ma, or 12V/4V Output 600V/50ma P. Mount. As Illustrated. 6.95

TELEVISION ANTENNAS Conical antenna, sturdy prefab const. Versatile 72, 150 or 300 ohm match. 8 elements & 100 ft of all copper twinax, cross bar and hardware. \$5.58

FUSES & HOLDER 3AG: 1/8, 1/4, 1/2, 3/4 Amp. Sec. 100 for 3.98

44C: 3.5, 10, 15, 20 Amp. Sec. 100 for 5.98

TAB PARTS CABINET 50 Draw Box, Steel 14 1/2" H/18" W/9" L/16" D. 100 Draw as above. 136 lbs. \$65.00

SPEED DRILLS 29 PIECE SET Chrome Vanadium Speed Steel. machinists or tool makers drills, or for all purpose use. Standard full length 1/16" to 1/2" by 64th in. With case Buot drill index. Delivered Prepaid. \$3.98

AUDIO AMPLIFIERS READY TO GO Model 305MP 5 Watt Ampl. Features Mike & Phono Inputs, W/Bar. Gain Control, Latest Component Tone Control Design, W/Tubes. \$14.98

PLIERS KIT Pliers 6" Long Nose & Side Cutters. \$5.89

SOLDERING GUNS 115 VAC "WELLER" 100 Watt & Lite. \$8.69

SOLDERING IRONS 115V-AC & DC 3/8" Jalous Make—Fully Guaranteed

MICA CAPACITORS Brand NEW Made to Rigid Gov't Specs.

Fig. C. 001 mfd. 10c; .006 mfd. 23c; .01 mfd. 35c

Mfd. 600 WV Each Mfd. 600 WV Each

Mfd. Fig. D. Screw Term. & Mts. Each

Mfd. Fig. E. Upright Xmts Micas Each

Mfd. 1500 VDC Each Mfd. 3000 VDC Each

TUBE CLAMPS 926B-5, 926B-10, 926B, 926-1 930-10

TEST CORDS 15 Feet Extension Cord W/ Duty, Rubber Covered. \$1.10

KITS AND COMPONENTS ELECTROLYTICS Condns. Asst. 25 for \$4.98

ALIGNMENT TOOL (Top) Ideal NO-LOSS Alignment

STORAGE BATTERIES 36 Volt WILLARD Mini-BRAND NEW 5 oz

CIRCULAR SLIDE RULE Equiv to 12" Only 2 1/4" Radius. LAMINATED—Prints Blue on White

Infrared Snopescope Image-Converter Tube InSensitivity simplified design 2" dia. Willemite screen—Resolution up to 350 line/in. Complete data & tube, ea. \$4.98

ONE YEAR GTD PICTURE TUBES 10B14A \$13.98

FILAMENT TRANS. 2.5V/2A @ 79c; 2 for \$1.49. \$6.49

TRANSFORMERS All 115 V 60 Cyc Input TV & CR Vwr Xmr 10 to 20" Tubes. Hi VOLTS to 20 KV

FILTER CHOKES Dual 30 Hy/60ma Ckt. \$9.20

400 CYCLE XFMRs WE K59608 123vvt/350Ma, 114vvt/70Ma

ALIGNMENT TOOL (Bottom) RELAY Spring Adjuster & Switch

KITS AND COMPONENTS OPTIC ELECTRONICS Asst. 25 for \$4.98

STORAGE BATTERIES 36 Volt WILLARD Mini-BRAND NEW 5 oz

PRECISION RESISTORS Over 2 1/2 Million In Stock

Table with columns: No, Mfrs Choice, We Ship Types In Stock. Rows include 0.11W, 0.25W, 0.5W, 1W, 2W, 5W, 10W, 20W, 50W, 100W, 200W, 500W, 1000W, 2000W, 5000W, 10000W, 20000W, 50000W, 100000W, 200000W, 500000W, 1000000W.

TRANSFORMERS All 115 V 60 Cyc Input TV & CR Vwr Xmr 10 to 20" Tubes. Hi VOLTS to 20 KV

FILTER CHOKES Dual 30 Hy/60ma Ckt. \$9.20

400 CYCLE XFMRs WE K59608 123vvt/350Ma, 114vvt/70Ma

ALIGNMENT TOOL (Top) Ideal NO-LOSS Alignment

STORAGE BATTERIES 36 Volt WILLARD Mini-BRAND NEW 5 oz

Vacuum Precision HiVOLT Resistors Megohms — 12, 26, 61, 75, 83, 99, 111, 52, 93, 75

VARISTOR & AUDIO COMPONENTS WE D-97966, Mrgd to Rigid Western Electric Spec.

ALIGNMENT TOOL (Bottom) RELAY Spring Adjuster & Switch

KITS AND COMPONENTS OPTIC ELECTRONICS Asst. 25 for \$4.98

STORAGE BATTERIES 36 Volt WILLARD Mini-BRAND NEW 5 oz

Vacuum Precision HiVOLT Resistors Megohms — 12, 26, 61, 75, 83, 99, 111, 52, 93, 75

VARISTOR & AUDIO COMPONENTS WE D-97966, Mrgd to Rigid Western Electric Spec.

THAT'S "TAB" THAT'S A BUY Dept. 3E 111 Liberty Street New York 6, N. Y., U. S. A.

SEMI-CONDUCTOR RECTIFIERS

We specialize in Rectifiers and Power supplies to your specifications. Immediate delivery.

Current	18/14	26/18	36/28	54/40	130/100
Cont. Volts	52.5	52.5	52.5	52.5	57.50
1 Amp	2.0	3.50	5.40	10.50	20.00
4 Amp	4.25	7.95	12.95	25.25	50.00
10 Amp	4.75	9.25	14.25	28.50	55.00
12 Amp	8.50	16.25	25.00	45.00	90.00
16 Amp	11.25	21.50	32.50	55.00	110.00
24 Amp	16.25	32.50	45.00	80.00	160.00
30 Amp	20.00	38.50	55.00	90.00	180.00

Full Wave Rect. & Trans. 115V/60cy inputs
up to 14VDC at 12 amps..... \$18.98
up to 28VDC at 12 amps..... 35.98
up to 28VDC at 48 amps..... 117.00
up to *20VDC at 8 amps..... 12.98

RECTIFIER XFMRs

18.8-19.2-20.4-21.4 Volts/12 Amp.	\$10.98
31-32-34-36 Volts/12 Amp 2 Kwins.	13.98
18-12-9-CT-9-12-18V/4 Amp.	8.75
18-12-9-CT-9-12-18V/12 Amp.	16.75
30CT-24V-18V/24-18V/12 Amp.	37.75
18V/2A..... \$1.98; 28-24-20 Volts/4A..... 4.69	

RECTIFIER CHOKES

4 Amp	.07 Ohm	1 Ohm	5.75
12 Amp	.01 Ohm	1 Ohm	14.95
24 Amp	.004 Ohm	.025 Ohm	29.95

"HO" RAIL PACK

0 to 12VDC/2 AMP
Variable DC supply unit in case and completely built-in. 115V/60 cy. Usable in all supply filament D.C. plating, battery charging, model railroad, includes voltage or speed control and center of all reversing. Deal for two.

"TAB" THAT'S A BUY

RADIO AMATEURS
1953 HANDBOOK
30th Edition "TAB" Special \$2.69

TAB "SUN-FLASH" LAMPS

No.	Replaces	W./Sec.	Max. Each
USV	GE FT105	100	55.98
U10	GE FT114	100	55.98
No. 1	AMGLO 5804X	100	10.98
238T	GE FT 210	200	9.98
238T	GE FT 403	200	9.98
V.A	SYLV. 4390	200	9.98
23MT	FT 214	250	9.98
238T	FT 110	200	9.98
353GTQ	FT 503	5000	49.98
VX4	X400	200	10.98
DX2	SIQIQA100	150	9.00

HIV PHOTOFLASH KIT

Includes: 1/4" X 1/8" Lamp Rated 200 Watt Seconds, Flash Lamp Holder & 8" Reflector & Cable, 115V/60Cy Int. Power Transformer, 60 Watt, Sec. Multi Section Capacitor Bank. All Resistors, Capacitors, Rads. Horn & Socks. \$14.95

PHOTOFLASH CAPACITORS

100MFD 500VDC	\$2.69
200MFD 450VDC	2.89
300MFD 450VDC	3.19
15MFD/330VAC/1500VDC	3.98
25MFD/330VAC/1500VDC	6.49
16MFD/300VAC/3000VDC	6.95
16MFD/560VAC/3000VDC	7.95
32MFD/1.2KVDC/23W. Sec.	7.49
27MFD/1.2KVDC/24W. 54W. Sec.	8.95
25MFD/330VAC/1.5KVDC Int. 29W.	6.98

CONTACTOR

G. E. CR281C22AQ Heavy Duty Electric Starter, Transmitter or Motor Starter Switch, For Single or 3 Phase Appl. Rated 1 Phase 3HP/110V, 7 1/2 HP/230V, 10 HP/600V. Rated or 3 Phase 7 1/2 HP/110V, 15 HP/230V, 25 HP/600V. Control Inpt. 220V/1PH/60-220V. 25 HP/600V. Control Inpt. 50 Amp. Contacts release 50 Amp. Open. GE List \$113. SPECIAL: \$119; 2 for \$36

PULSE TRANSFORMERS

7.5 K Pulse, Pri 4KV, 60-1000 ohm impad Permalloy Core, W.Eco D-103247..... \$12.00
Pulse Xfmr 1000 Pulse/Sec. 5 Watt, TR-1005..... \$7.98
PULSE SHAPING Xfmr Raytheon U12819..... \$5.00
UTAH 3340 1/2 O.P. 5A/APS15..... \$5.00

STEP UP TRANSFORMER

Primary 7.5KV, W/110V Int. Two Secondaries 110V/220V at 7.5 Amp Each, or One 440V at 7.5A. Same but 220V Pri. Will Deliver 2X440 W/1.5A Each, or 80V at 7.5A.

MICROWAVE

Klystron Mtg Assy (723AB) & Coupling to 2 Type N Co-Ax Fittings..... \$9.98
1 Microsecond Delay Line..... \$2.95; 2 for \$5.00
Microwave Light House Assy - P/O RT30 APG5 & 15, one Amp. Tr. Cavities, 1000 W. Watt Meter Low Power, Used with Holometer Bridge..... \$20.00; 2 for \$36.00

Measures Low Level Microwave Power, Balanced Bridge Direct Reading, Self-Calibrating Range, 10 Milliwatts to 100 Milliwatts. \$119.00
Band Adaptor UG39 to UG40 Choke Plate Flange Sperry Lab Gen. \$1.69; 2 for \$6.00

VARIAC

200CU/O-130V/1KW/7.5A Reconditioned, Tested & Gd. \$14.98
"GR" 100R/O-230V/2KVA..... \$30.00
"GR" 50B/O-270V/7KW..... \$110.00
Brushes 200CU & 116/116V 49c; 5 for \$2.

RHEOSTATS

2 ohm 50W Model J..... \$2.25; 5 for \$10.00
15 ohm 25W w/knob..... 1.98; 3 for 5.00
20 ohm 50W Model J..... 2.25; 6 for 12.00
60 ohm 50W w/knob..... 2.49; 3 for 7.00
100 ohm 50W Model K..... 2.25; 3 for 6.00
250 ohm 25W..... 1.39; 4 for 5.00
300, 600, 3000 ohm Slotted shaft..... 79c; 3 for 2.00

RELAY SPECIAL

SPST Mini Size 115VAC 3A CTS..... \$1.99; 3 for \$5.75
SPDT Mini Size 115VAC 3A CTS..... \$1.39; 3 for \$3.75
SPDT 24VDC/5A CTS..... \$1.99; 3 for \$5.97
ALLIED..... 98c; 6 for \$5.90
SPNO 115VAC/15A CTS..... \$1.99; 3 for \$5.97
DPDT & SPNO 12VDC/10A Contacts..... SPECIAL \$2.98
DPDT Clear SK5010 Octal 115V-18V/25A Contacts, Nitrogen Sld..... \$1.49; 4 for \$5.97
DPNC & SPNO Clear Telephone Type 115VAC Octal Base..... \$4.25

TABOGRAM

WRITE FOR IT
WE STOCK LARGE VARIETY OF COMPONENTS TELL US YOUR NEEDS
SELL US YOUR TUBES & EQUIPMENT.

0A2	50.95	2E31	1.49	6A3	.90
0A2G	1.05	2E32	1.49	6A4G	2.07
0B2	1.37	2E36	1.54	6A5	.85
0B3/VR90	1.15	2E43	1.49	6A8GT	.90
0D3/VR105	1.00	2G21	1.49	6A8A	.90
0Y4	2.25	2Y4	8.90	6A6/SNS	1.13
0Z4	6.00	2J21A	8.90	6AB7/1853	.98
C1A/ELC1A	9.75	2J22	8.90	6AC5GT	1.00
D1A	12.49	2J30	6.00	6A0	1.39
1A3	1.10	2J31A	79.95	6AD7G	1.29
1A4GT	.79	2J33	27.00	6AC7	1.39
1A6	1.49	2J34	27.00	6AH5G	1.49
1A7GT	1.49	2J36	108.00	6A5G	1.40
1A8	1.49	2J37	12.70	6A5J	1.40
1A8A	1.00	2J38	11.75	6A8	1.05
1B4P	.89	2J48	43.00	6A95WS	1.54
1B5/255	.99	2J50	21.25	6A96	2.90
1B7G18	.99	2J52	249.50	6A95WS	2.90
1B71A	2.85	2J53	249.50	6A95WS	2.90
1B72	1.82	2J54	149.00	6A96	2.90
1B74	9.45	2J62	49.95	6A96GT	1.29
1B75	1.24	2K22	49.95	6A96	2.98
1B76	12.75	2K22	49.95	6A96	2.98
1B77/532A	3.90	2K23	29.00	6A55	2.78
1B78	16.98	2K24	31.59	6A56WS	3.20
1B79	29.95	2K28	32.00	6A57G	4.65
1B80	1.49	2K29	32.00	6A57G	4.65
1B81	49.95	2K34	498.00	6A58GT	1.59
1B82	18.00	2K35	398.00	6A59	1.59
1B83	18.00	2K36	398.00	6A59GT	1.59
1B84	49.95	2K41	498.00	6A59	1.59
1B85	38.50	2K42	145.00	6A56	1.89
1B86	17.00	2K43	145.00	6A56GT	1.89
1B87	60.00	2K44	108.00	6A58GT	1.23
1B88	75.00	2K45	108.00	6A58GT	1.23
1B89	2.70	2M50	498.00	6B8C	.95
1C5GT	.89	2V3G	.98	6B7	1.27
1C7	.89	2V3GT	.98	6B7GT	1.27
1D5GP	.89	2X2A	1.53	6B8A7	1.63
1D6G	.89	2X2B	1.53	6B8A7GT	1.63
1D8GT	.89	2X3	.81	6B8C7	1.23
1D9GT	.89	2X4	.81	6B8C7GT	1.23
1E7G	.99	3B8T	1.59	6B8D5GT	1.63
1F4	.99	3B8T/1291	.69	6B8F5	.98
1F5G	.99	3B8T/1291	.69	6B8F5GT	.98
1F6	.89	3B23/RK22	4.45	6B8F7	2.55
1F7G	.89	3B24	5.40	6B8GG	1.39
1G4GT	.89	3B25	4.50	6B8G	1.39
1G5G	.89	3B26	7.70	6B8H6	.63
1G6GT	.89	3B28	3.70	6B8J6	.63
1H4G	.89	3B29	7.00	6B8K7	2.15
1H5GT	.89	3B31	9.90	6B8L7GT	1.45
1H6GT	.89	3B31/C1B	1.45	6B8M7	1.45
1H7G	.89	3B32	1.45	6B8N7	1.45
1H8GT	.89	3B34/HK24	5.49	6B8QGT	1.65
1L4	.69	3C45	15.48	6B8Q	1.65
1L5G	.69	3C46	15.48	6B8QGT	1.65
1L6GT	.69	3C47	15.48	6B8QGT	1.65
1L7	.69	3C48	15.48	6B8QGT	1.65
1L8	.69	3C49	15.48	6B8QGT	1.65
1L9	.69	3C50	15.48	6B8QGT	1.65
1M4	1.19	3D21A	4.98	6L6/GC	1.69
1M6	.99	3D22	13.50	6C6	1.26
1M7	.99	3D23	13.50	6C6GT	1.26
1M8	.99	3D24	13.50	6C6	1.26
1M9	.99	3D25	13.50	6C6	1.26
1N1	1.39	3J31	30.00	6C8	1.26
1N2	1.39	3J32	27.00	6C8GT	1.26
1N3	.99	3K23	405.00	6C21	29.45
1N4	.99	3K30	300.00	6C21GT	29.45
1N5	.99	3K31	300.00	6C21GT	29.45
1N6	.99	3K32	300.00	6C21GT	29.45
1N7	.99	3K33	300.00	6C21GT	29.45
1N8	.99	3K34	300.00	6C21GT	29.45
1N9	.99	3K35	300.00	6C21GT	29.45
1O1GT	.99	3V30GT	1.29	6D4	2.70
1O2	.99	3V31	1.29	6D4GT	2.70
1O3	.99	3V32	1.29	6D4GT	2.70
1O4	.99	3V33	1.29	6D4GT	2.70
1O5	.99	3V34	1.29	6D4GT	2.70
1O6	.99	3V35	1.29	6D4GT	2.70
1O7	.99	3V36	1.29	6D4GT	2.70
1O8	.99	3V37	1.29	6D4GT	2.70
1O9	.99	3V38	1.29	6D4GT	2.70
1P1	.99	3V39	1.29	6D4GT	2.70
1P2	.99	3V40	1.29	6D4GT	2.70
1P3	.99	3V41	1.29	6D4GT	2.70
1P4	.99	3V42	1.29	6D4GT	2.70
1P5	.99	3V43	1.29	6D4GT	2.70
1P6	.99	3V44	1.29	6D4GT	2.70
1P7	.99	3V45	1.29	6D4GT	2.70
1P8	.99	3V46	1.29	6D4GT	2.70
1P9	.99	3V47	1.29	6D4GT	2.70
1Q1	.99	3V48	1.29	6D4GT	2.70
1Q2	.99	3V49	1.29	6D4GT	2.70
1Q3	.99	3V50	1.29	6D4GT	2.70
1Q4	.99	3V51	1.29	6D4GT	2.70
1Q5	.99	3V52	1.29	6D4GT	2.70
1Q6	.99	3V53	1.29	6D4GT	2.70
1Q7	.99	3V54	1.29	6D4GT	2.70
1Q8	.99	3V55	1.29	6D4GT	2.70
1Q9	.99	3V56	1.29	6D4GT	2.70
1R1	.99	3V57	1.29	6D4GT	2.70
1R2	.99	3V58	1.29	6D4GT	2.70
1R3	.99	3V59	1.29	6D4GT	2.70
1R4	.99	3V60	1.29	6D4GT	2.70
1R5	.99	3V61	1.29	6D4GT	2.70
1R6	.99	3V62	1.29	6D4GT	2.70
1R7	.99	3V63	1.29	6D4GT	2.70
1R8	.99	3V64	1.29	6D4GT	2.70
1R9	.99	3V65	1.29	6D4GT	2.70
1S1	.99	3V66	1.29	6D4GT	2.70
1S2	.99	3V67	1.29	6D4GT	2.70
1S3	.99	3V68	1.29	6D4GT	2.70
1S4	.99	3V69	1.29	6D4GT	2.70
1S5	.99	3V70	1.29	6D4GT	2.70
1S6	.99	3V71	1.29	6D4GT	2.70
1S7	.99	3V72	1.29	6D4GT	2.70
1S8	.99	3V73	1.29	6D4GT	

INDEX TO ADVERTISERS

Abalon Precision Mfg. Corp.	408
Ace Coil & Electronics Co.	402
Ace Engineering & Machine Co., Inc.	326
Acheson Colloids Co.	43
Ackerman Engravers	420
Acme Electric Corporation	387
Actioncraft Products	499
Advance Electric & Relay Co.	334
Advance Electronics Co.	563
Aeronautical Communications Equip- ment, Inc.	492
Aerovox Corporation	325
A'GA Div. of Elastic Stop Nut Cor- poration of America	459
Air Associates, Inc.	173
Air Marine Motors, Inc.	70
Aircraft Transformer Corp.	231
Airpax Products Company	198, 199
Alcar Instruments, Inc.	457
Alden Products Company	56, 57
Allen-Bradley Co.	361
Allen Co., Inc., L. B.	505
Allied Control Company, Inc.	192, 193
Allied Industries, Inc.	463
Allied Radio Corp.	336
Allied Research & Engineering, Inc.	505
Allmetal Screw Products Co., Inc.	425
Alpha Metals, Inc.	50
American Encaustic Tiling Co.	450
American Gas Furnace Co.	181
American Lava Corporation	331
American Optical Company	460
American Phenolic Corporation	166, 167
American Television & Radio Co.	420
American Time Products, Inc.	196
Amperite Co., Inc.	244
Ampex Electric Corp.	62, 233
Anaconda Wire & Cable Company	217
Andrew Corporation	242
Antara Chemicals, Div. of General Dye- stuff Corp.	52, 53
Anton Electronic Laboratories, Inc.	421, 423
Applied Science Corp. of Princeton	479
Arco Electronics, Inc.	495
Armco Steel Corporation	365
Arnold Engineering Co.	269
Art-Lloyd Metal Products Corp.	490
Art Wire & Stamping Co.	501
Astron Corporation	311
Audio Devices, Inc.	347

Ballantine Laboratories, Inc.	27
Barker & Williamson, Inc.	316
Barry Corp., The	15
Bart Laboratories Co., Inc.	240
Bead Chain Mfg. Co.	475
Beaver Gear Works Inc.	270
Beede Electrical Instrument Co., Inc.	410
Bell Aircraft Corp.	493
Bell Telephone Laboratories	319
Bendix Aviation Corporation Eclipse-Pioneer Div.	416
Friez Instrument Div.	485
Pacific Div.	214, 215
Red Bank Div.	313
Bennett Manufacturing Company	463
Bentley, Harris Manufacturing Co.	279
Berkeley Scientific, Division of Beckman Instruments, Inc.	432
Beryllium Corporation	309
Bird Electronic Corp.	480
Birnbach Radio Co., Inc.	482
Birtcher Corporation	407
Blwax Corporation	493
Bliley Electric Company	76
Bodnar Industries, Inc.	425
Boonton Radio Corp.	161
Borg Corporation, George W.	411
Bomac Laboratories, Inc.	74
Bowmar Instrument Corp.	473
Boyle Metalcraft Corp.	194
Brand & Co., Inc., William	424
Brew & Co., Inc., Richard D.	214
Bridgeport Brass Company	172
Brilhart Plastics Corp.	385

Bristol Brass Corporation	367
Bristol Engineering Corp.	390
Brush Electronics Company	328
Burlington Instrument Company	437
Burnell & Company	81
Bussmann Mfg. Co.	363

C. G. S. Laboratories, Inc.	462
Cambridge Thermionic Corp.	293
Cannon Electric Company	230
Cargo Packers, Inc.	454
Cartier Motor Co.	497
Centralab, A Div. of Globe-Union, Inc.	11, 13
Century Geophysical Corporation	312
Chase Brass & Copper Co.	189
Chatham Electronics Corp.	84, 85
Chester Cable Corp.	245
Chicago Condenser Corp.	427
Chicago Telephone Supply Corp.	72, 73
Chicago Transformer, Div. of Essex Wire Corp.	318
Cinch Manufacturing Corp.	157
Cinema Engineering Company	387
Cireuitron, Inc.	476
Clarostat Mfg. Co., Inc.	303
Cleveland Container Co.	23
Cohn Mfg. Co., Inc., Sigmund	453
Coil Winding Equipment Co.	489
Collectron Corporation	416
Communication Accessories Co.	92
Communication Measurements Labora- tory, Inc.	479
Communication Products Company, Inc.	473
Condenser Products Company, Div. of New Haven Clock & Watch Co.	277
Consolidated Vacuum Corp.	259
Constantin & Co., L. L.	255
Continental Connectors, DeJur Amseco Corp.	440
Continental-Diamond Fibre Company	253
Cornell-Dubilier Electric Corp.	175
Cornell Electronics Corp.	500
Cornish Wire Co., Inc.	480
Cosa Corporation	381
Coto-Coil Company	414
Crescent Company, Inc.	366
Crosby Laboratories, Inc.	216
Cross Co., H.	391
Crucible Steel Company of America	249
Cubic Corporation	248
Cunningham, Son & Co., Inc., James	433

Dage Electric Co., Inc.	380
Dale Products, Inc.	178
Dano Electric Co.	470
Daniels Inc., C. R.	391
Daven Co., The	Third Cover
Davies Laboratories, Inc.	456
Decade Instrument Co.	435
DeJur Amseco Corp.	440, 441
Dialight Corporation	186
Doelcam Corporation	251
Dolin Metal Products, Inc.	493
Dow Corning Corporation	178, 329
Driver Co., Wilbur B.	64
Driver-Harris Company	183
Dumont Laboratories, Inc., Allen B.	42, 87
duPont deNemours & Co. (Inc.), E. L.	201
Durant Mfg. Company	481
DX Radio Products Co.	414

Eastern Air Devices, Inc.	332
Eastgap Company	422
Eastman Kodak Company, Industrial Optical Sales Div.	223
Edin Company, The	409
Edison Incorporated, Thomas A.	436
Edo Corporation	165
Eisler Engineering Co., Inc.	406, 505
Eitel-McCullough, Inc.	75

SILVER GRAPHALLOY

BRUSHES



AND

CONTACTS

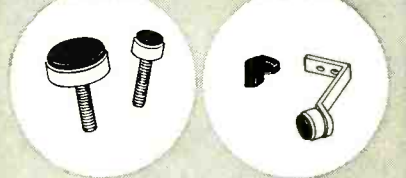

... for applications re-
quiring low electrical
noise, low and constant
contact drop, high cur-
rent density and mini-
mum wear.



EXTENSIVELY USED IN

SELSYNS
ROTATING THERMOCOUPLE and
STRAIN-GAGE CIRCUITS
ROTATING JOINTS
GUN-FIRE CONTROLS
DYNAMOTORS etc.

Wide range of grades available for standard and special applications.

Brush holders and coinsilver slip rings available for use with Silver Graphalloy Brushes.

OTHER GRAPHALLOY PRODUCTS:

Oil-free self-lubricating
Bushings and Bearings, Oil-
free Piston Rings, Seal Rings,
Thrust and Friction Washers,
Pump Vanes.



Write us for Data Sheets and further information.

GRAPHITE METALLIZING CORPORATION

1055 NEPPERHAN AVENUE • YONKERS, NEW YORK

- Please send data on Graphalloy BRUSHES and CONTACTS.
 Send data on BUSHINGS.

NAME _____
COMPANY _____
STREET _____
CITY _____ ZONE _____ STATE _____

Want more information? Use post card on last page.



FOR RAPID SERVO ANALYSIS

ONLY THE SERVOSCOPE

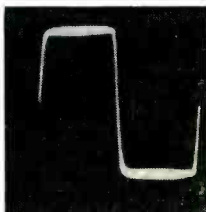
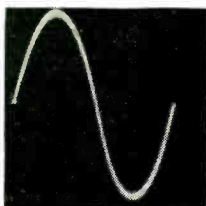
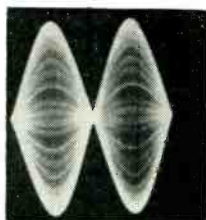

Output wave forms of Servoscope displayed against internal linear sweep generator frequency $\frac{1}{2}$ cycle.

- * is applicable to both AC carrier and DC servo systems.
- * has a built-in low frequency sine wave generator for obtaining frequency response of DC servo systems
- * has a built-in electronic sweep with no sweep potentiometer to wear out and require replacement.
- * has a dynamic frequency control range of 200 to 1.

MORE and MORE aircraft companies, universities, process control manufacturers, government laboratories and others are adding the Servoscope to their list of required laboratory equipment. If you are designing, developing or producing servomechanisms or process controls, the Servoscope will save many hours of design and engineering time.

The Servoscope is available in two standard models — 1100A (.1 to 20 cps.), 1100B (.15 to 30 cps.) Custom modifications quoted on request.

For bulletin giving complete specifications: write Dept. E-3



SERVO CORPORATION OF AMERICA

2020 Jericho Turnpike, New Hyde Park, N. Y.
Fieldstone 7-2810

Electrical & Physical Instrument Corp.	491
Electrical Industries Division Amperex	
Electronic Corp.	283
Electro Development Company	449
Electro Engineering Products Co.	483
Electro Impulse Laboratory	447
Electro-Mec Laboratory	487
Electro Motive Mfg. Co., Inc.	63
Electro Tec Corporation	197
Electro-Tech Equipment Co.	449
Electro-Technical Products, Div. Of Sun	
Chemical Corp.	362
Electronic Associates, Inc.	375
Electronic Mechanics, Inc.	387
Electronic Parts Manufacturing Co., Inc.	445
Electronic Transformer Company	298
Electronic Tube Corporation	238
Empire Devices, Inc.	486
Engineering Research Associates Inc.	472, 477
Entlich, Ted.	505
Epeo Products, Inc.	481
Erie Resistor Corporation	93
Etched Products Corp.	338
Eureka Television & Tube Corp.	417
Eveready Plating Co.	505

Fairchild Camera & Instrument Corp.	350
Fansteel Metallurgical Corp.	306
Federal Telephone & Radio Corporation	241, 504
Federated Metals Div. American Smelting & Refining Co.	202, 203
Ferranti Electric, Inc.	459
Fidelity Chemical Products Corp.	478
Five Star Company	505
Fortiphone Limited	34, 35
Freed Transformer Co., Inc.	287
Frequency Standards	499
Fugle-Miller Laboratories	473
Fusite Corporation	226

GM Laboratories, Inc.	461, 503
G-V Controls, Inc.	294
Galbraith & Son Electric Corp., C. C.	389
Gamewell Company	330
Garde Manufacturing Co.	404
Gavco Corp.	86
General Ceramic & Steatite Corp.	355
General Electric Company	
Apparatus Dept.	80, 90, 91, 177, 373
Chemical Div.	382
Electronic Dept.	235
Tube Dept.	38, 39
General Hermetic Sealing Corp.	499
General Precision Laboratory, Inc.	69
General Radio Company	17
General Transformer Co.	296
Gertsch Products, Inc.	483
Goat Co., Inc., Fred.	383
Gombos Co., Inc., John.	461
Graphite Metallizing Corp.	559
Green Instrument Co., Inc.	469
Gries Reproducer Corp.	478
Gudebrod Bros. Silk Co., Inc.	400
Guthman & Co., Inc., Edwin I.	188

Hammarlund Manufacturing Co., Inc.	413
Harper Company, H. M.	434
Harrison Radio Corp.	422
Hart Manufacturing Co.	190
Hathaway Instrument Co.	378
Haydon Co., A. W.	496
Haydon Manufacturing Co., Inc.	206
Haydu Brothers	237
Heath Company	433
Heiland Research Corporation	418
Heldor Manufacturing Corp.	77
Helipot Corporation, The	168, 169
Heminway & Bartlett Mfg. Co.	494
Hermes Plastics, Inc.	467
Hermetic Seal Products Co.	59
Hetherington, Inc.	182
Hewlett-Packard Company	82, 83
Hexacon Electric Co.	484
Hickok Electrical Instrument Co.	295

Hillbarn Electronic Products.....	404
Hinde & Dauch.....	250
Hopkins Engineering Co.....	214
Howard Industries, Inc.....	234
Hudson Radio & Television Corp.....	374
Hudson Tool & Die Company, Inc.....	307
Hudson Wire Co.....	225
Hughes Research & Development Laboratories.....	194, 195, 465
Hughey & Phillips.....	288
Hycor Company, Inc.....	453
Hytron Radio & Electronics Co.....	263

Induction Motors Corp.....	284
Industrial Condenser Corp.....	353
Industrial Hardware Mfg. Co., Inc.....	465
Insl-X Company, Inc.....	280
Institute of Radio Engineers.....	477
Instrument Corp. of America.....	229
Instrument Electronics Corp.....	427
Instrument Resistors Co.....	420
Instrument Specialties, Inc.....	504
Insuline Corp. of America.....	377
International Business Machines.....	385
International Instruments, Inc.....	312
International Nickel Company, Inc.....	357
International Pump & Machine Works.....	400
International Radiant Corp.....	562
International Rectifier Corp.....	243
Ippolito & Co., Inc., James.....	418
Irrington Varnish & Insulator Co.....	61
Isolantite Manufacturing Corp.....	402
I-T-E Resistor Division of the I-T-E Circuit Breaker Co.....	46

James Vibrapowr Company.....	502
Jelliff Manufacturing Corp., C. O.....	404
Jennings Radio Mfg. Co.....	337
Johns-Manville.....	184, 185
Johnson Company, E. F.....	437
Jones Div., Howard B. Cinch Mfg. Co.....	406
Joy Manufacturing Company.....	88

Kable Engineering Company.....	469
Kalbfell Laboratories, Inc.....	491
Karp Metal Products Co., Inc.....	71
Kartron.....	505
Kay Electric Company.....	371
Kellogg Company, M. W.....	164A, 164B
Kellogg Switchboard & Supply Co.....	457
Kenyon Transfer Co., Inc.....	442
Kepec Laboratories, Inc.....	369
Kester Solder Company.....	275
Ketay Manufacturing Corp.....	429
Keuffel & Esser Co.....	40, 41
Keystone Products Company.....	204
Kings Electronics Co., Inc.....	273
Kinney Manufacturing Co.....	239
Kirk & Blum Mfg. Co.....	252
Kulights Company, James.....	54
Kollsman Instrument Corporation.....	246
Krohn-Hite Instrument Company.....	89
Kulka Electric Mfg. Co., Inc.....	473

Laboratories R. Derveaux.....	351
Laboratory for Electronics, Inc.....	207
Lambda Electronics Corporation.....	443
Lampkin Laboratories, Inc.....	414
Lapp Insulator Company, Inc.....	58
Lavoie Laboratories, Inc.....	439
Lawn Electronics Company.....	467
Lenkurt Electric Sales Co.....	258
Lewis Engineering Co.....	489
Lewis Spring & Mfg. Co.....	228

Answer to VHF, UHF and Microwave Requirements

TEFLON* INSULATED CHEMELEC COMPONENTS



7-PIN MINIATURE TUBE SOCKETS



9-PIN MINIATURE TUBE SOCKETS

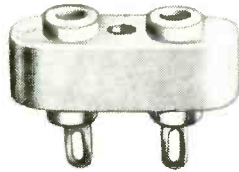

CRYSTAL SOCKETS

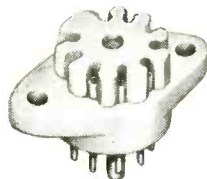

9-PIN CONNECTORS



STAND-OFF INSULATORS

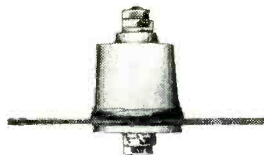

FEED-THROUGH INSULATORS AND TERMINALS

- **LOW LOSS FACTOR** — Less than 0.0005.
- **STABLE DIELECTRIC CONSTANT**—2.0 (60 cycles to 30,000 megacycles).
- **HIGH SURFACE RESISTIVITY**— 3.5×10^{13} ohms. Won't carbonize under arcing or DC plate.
- **WIDE SERVICE TEMPERATURE RANGE** — 110° F to $+500^{\circ}$ F.
- **ZERO WATER ABSORPTION**—ASTM Test.
- **DURABLE** — withstands thermal and mechanical shock and vibration in assembly and service.
- **CHEMICALLY STABLE**—Inert, non-gassing, immune to corrosive atmospheres, fungi, oils, solvents.

Write for Catalogs: Miniature Tube Sockets, No. SO-428; 9-pin Connectors, No. CN409-M; Crystal Sockets, No. CS-441; Stand-off Insulators, No. TE-401; Feed-Through Insulators and Terminals, No. CF-400.

UNITED STATES GASKET COMPANY

FLUOROCARBON PRODUCTS DIVISION
CAMDEN 1 NEW JERSEY



Representatives in Principal Cities Throughout the World

*du Pont's trademark for its tetrafluoroethylene resin.

TERMINAL REGENERATIVE ELECTRONIC REPEATER

*Electronically Reduces
Bias Distortion to a
Minimum Percentage*

Model TT-63 illustrated.

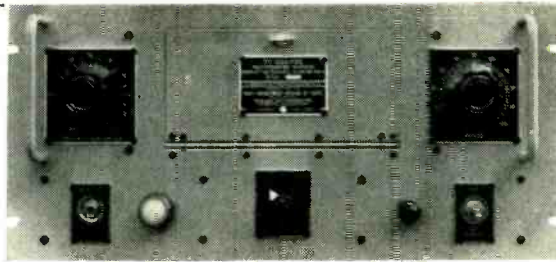

Designed to accept 60, 75 or 100 wpm Teleprinter signals with up to 45% mark or space bias and produce a corresponding signal with less than 5% distortion.

INPUT KEYING:

- A. Tone—500 to 8000 cps level +10 to -20 dbm.
- B. Neutral D.C. Input, 20 ma to 60 ma, 600 ohms.
- C. Polar D.C. Input, 30 ma, 1200 ohms. Polar input circuits will not provide distortion if the polar input signals have sloping rise and decayed times.

OUTPUT:

Neutral output relay contacts, optional output can be set to follow steady input state, (Normal) or can be made to return always to mark on steady state inputs (Mark hold).

POWER:

Built in power supply, operates from 115 or 230 volt source, 50-60 cycles, 85 watts.

DIMENSIONS:

Rack mounting panel 8 3/4 x 19 inches. Chassis extends 10 1/2 inches behind panel. Weight—26 lbs. Equipment is manufactured to conform with JAN Spec.

Other STELMA Products:

- Direct Reading Percentage, Bias Measuring Distortion Meter (60-75-100 wpm).
- Duplex Receiving Keyer. Double the number of teleprinter messages on any circuit by Time Division.
- Frequency shift package unit PKC.R-3/RT combines diversity input, receiver, converter—directly drives teleprinter.

We Are Communication Systems Specialists.

STELMA, INCORPORATED

Manufacturers of Electronic and Communications Equipment

389 Ludlow Street • Telephone 4-7561-2 • Stamford, Connecticut

7 DAYS PROGRAMMING OF . . .

TEMPERATURE • HUMIDITY • ALTITUDE

—100°F to +230°F 20% to 95% R.H. 100,000 Ft.
COMPLETELY SELF CONTAINED IN ONE PORTABLE UNIT

This machine was built for the U. S. Navy at Johnsville, Penna., to control and record a 7 day program of varying temperature, humidity and altitude conditions to very close tolerances. The first day's program involves temperature of -85°F., with altitude of 65,000 Ft., return to sea level with temperature of +221°F., and humidity of 95%, reduce temperature to +77°F., rise to +122°F., and reduce to +77°F. Then hold +77°F., and produce condensation in the chamber once each hour for the remainder of the 24 hour period. The following six days are occupied with variations of the first day cycle, all automatically controlled. Many variations of programming are possible and it is also possible to operate with conventional non-program control.

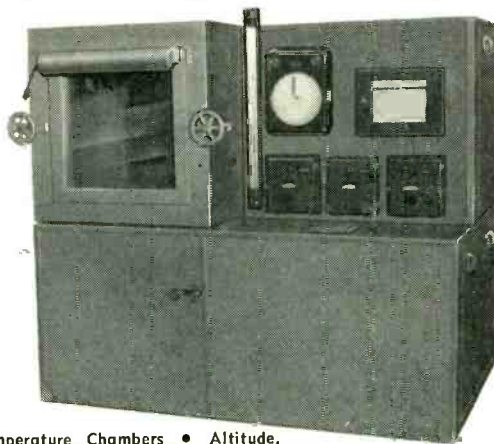

Manufacturers of:
Low and High Temperature Chambers • Altitude,
Humidity, Explosion and Walk-in Chambers with Vi-
bration test facilities

INTERNATIONAL RADIANT CORP.

40 MATINECOCK AVE. • PORT WASHINGTON, N. Y.

Linde Air Products Co., A Div. of Union Carbide & Carbon Corp.	501
Lion Fasteners, Inc.	308
Littelfuse, Inc.	485
Little, Inc., Arthur D.	392
Lundey Associates	415

MB Manufacturing Co., Inc.	327
Macmillan Company, The	412
Magnatran Incorporated	501
Magnecord Inc.	360
Magnetic Amplifiers, Inc.	383
Mallory & Co., Inc., P. R.	96, 159
Marconi Instrument, Ltd.	290
Marion Electrical Instrument Co.	2
Maryland Electronic Mfg. Corp.	358
McGraw-Hill Book Co.	240, 299, 385, 453
McLaughlin, J. L. A.	452
Measurements Corporation	366
Mepeco, Inc.	30, 31
Metal Textile Corp.	310
Metals & Controls Corp., General Plate Div.	66
Meyercord Co.	497
Mica Insulator Company	261
Micro, A Division of Minneapolis-Honeywell Regulator Co.	388, 419
Midland Manufacturing Co., Inc.	208
Miles Reproducer Co.	505
Milford Rivet & Machine Co.	386
Millen Mfg. Co., Inc., James	315
Mito Radio & Electronics Corp.	218
Milwaukee Transformer Co.	468
Miniature Precision Bearings Inc.	163
Minneapolis-Honeywell Regulator Co., Industrial Div.	267, 372
Aero Div.	47, 220, 221
Minnesota Mining & Mfg. Co.	257
Mitchell-Rand Insulation Co., Inc.	171
Moloney Electric Company	200
Motorola Communications & Electronics, Inc.	3
Muirhead & Co., Ltd.	503
Mullard Overseas, Ltd.	482, 483
Multi-Metal Co.	422
Murphy & Miller, Inc.	426
M-W Laboratories, Inc.	470, 471
Nycalex Corporation of America	465

N. R. K. Mfg. & Engineering Co.	457
National Capacitor Company	210
National Company, Inc.	340
National Moldite Co.	232
National Plastic Products Co.	412
National Tel-Tronics Corp.	187
National Vulcanized Fibre Co.	410
Neo-Sil Corp.	469
Neutronic Associates	324
New Hampshire Ball Bearings, Inc.	503
New Hermes, Inc.	224
New London Instrument Co.	505
New Rochelle Tool Corp.	272
New York Transformer Co., Inc.	457
Ney Company, J. M.	320
Norden Laboratories Corporation	505
Norsid Mfg. Co., Inc.	341
North American Aviation, Inc.	60
Northern Radio Company	484
Notthelfer Winding Laboratories	32A, 32B

Ohmite Mfg. Co.	486
Olympic Metal Products Co., Inc.	323
Opad-Green Company	502
Owen Laboratories	

Panoramic Radio Products, Inc.	339
Paramount Paper Tube Co.	312
Pennsylvania Testing Laboratory	458
Penta Laboratories, Inc.	467
Pernag Corp.	477
Peschel Electronics, Inc.	470, 505
Phalo Plastics Corporation	496
Phaotron Company	383
Phelps Dodge Copper Products Corp., Inca Manufacturing Division	28, 29
Phillips & Hiss Co., Inc.	410
Photocircuits Corporation	297
Pickard & Burns, Inc.	236
Pix Manufacturing Co., Inc.	485
Plastic Capacitors, Inc.	343
Polarad Electronics Corporation	44, 45
Polymer Corporation of Pennsylvania	286
Polytechnic Research & Development Company, Inc.	179
Popper & Sons, Inc.	445
Potter Instrument Company, Inc.	342
Power Equipment Company	300
Precision Apparatus Co., Inc.	564
Precision Paper Tube Co.	418
Precision Resistor Co.	479
Premax Products	406
Premier Metal Products Co.	498
Progressive Manufacturing Co.	262
Pyramid Electric Company	211
Pyroferrie Co., Inc.	359

Quality Products Co. 505

Radio Corporation of America	Back Cover
Radio Materials Corporation	265
Radio Receptor Company, Inc.	78
Railway Express Agency, Air Express Div.	68
Rauland Corporation	227
Raytheon Manufacturing Company	51
R-B-M Division, Essex Wire Corp.	33, 444
Reeves Hoffman Corporation	170
Reeves Instrument Corp.	352
Remler Company, Ltd.	455
Representatives of Electronic Products Manufacturers, Inc., The	488
Republic Foil & Metal Mills, Inc.	481
Resistance Products Co.	397
Resistoflex Corporation	25
Rex Rheostat Co.	292
Reynolds Metals Company	505
Rhode Island Insulated Wire Co., Inc.	191
Roanwell Corporation	21
Rome Cable Corporation	483
Runzel Cord & Wire Co.	370
Rutherford Electronics Co.	410
	445

Sanborn Company	305
Sangamo Electric Company	376
Schmidt, Inc., Geo. T.	304
Schweber Electronics	408
Scientific Electric Div. of "S" Corrugated Quenched Gap Co.	488
Scientific Electronic Laboratories, Inc.	487
Scintilla Magneto Div., Bendix Aviation Corporation	289
Secon Metals Corporation	494
Servo Corporation of America	560
Servomechanisms, Inc.	354
Shalleross Manufacturing Co.	48, 49
Shieldings, Inc.	268
Sigma Instrument Inc.	348
Signal Engineering & Mfg. Co.	441
Smuckler & Co., Inc., A. F.	466
Sorensen & Company, Inc.	19
Specialty Battery Company	416
Spencer-Kennedy Laboratories, Inc.	391



Sun Radio

ANNOUNCES

Grand Opening New York's Largest Electronic Center

650 Sixth Avenue, Cor. 20th St.

- ★ Central location for all Metropolitan New York, New Jersey and Connecticut
- ★ Over 20,000 sq. ft. of street level space to serve you more efficiently
- ★ Larger and more complete stocks of JAN and industrial components, plus latest testing equipment
- ★ Greatly enlarged switchboard to speed your calls
- ★ Increased competent personnel to serve you
- ★ Complete expediting staff to locate all hard-to-get items
- ★ Three spanking new audio studios
- ★ Over 150 ft. of service counters

Write for **FREE Parts Catalogue**

Sun Radio & ELECTRONICS CO., INC.

650 Sixth Ave. at corner of 20th St., New York, N. Y. **OREgon 5-8600**
Open Daily & Saturday 8:30-6:00

NEW VECTORLYZER TYPE 202

8 cps to 500 mc. 0.06 VOLT FULL-SCALE SENSITIVITY

Use It To Measure:

- (1) Vector sum or difference of two voltages.
- (2) Phase angle between two voltages.
- (3) Imaginary and real components of an unknown voltage in terms of a reference voltage.
- (4) Voltage across two points which are both above a.c. ground potential.
- (5) Magnitude and phase angle of an unknown impedance.



Type 202—\$445.00

SPECIFICATIONS

FREQUENCY RANGE:
8 cps to 2 mc through panel binding posts, 20 kc to 500 mc through probe.

INPUT IMPEDANCES:
Probe—2.5 uuf shunted by 100,000 ohms, coaxial arrangements for matching low impedance cables are available and will be furnished when specified.

Binding Posts—16 uuf shunted by one megohm.

VOLTAGE RANGE:
Binding Posts—0.06, 0.6, 6, 60, and 600 volts full scale.
Probe—0.6, 6, and 60 volts full scale.

PHASE ANGLE RANGE:
0-180, and 180-360 degrees, ranges with better angular sensitivity can be obtained through panel adjustment.

ACCURACY:
±2% through panel binding posts, ±1 db through probe for phase angle measurements.

POWER SUPPLY:
115 volts rms ±15%, 50-60 cycles, 80 watts.

CONTINUOUSLY VARIABLE DELAY LINES

MINIATURE TYPE 506
TIME DELAY: Continuously variable from 0 to 0.25 μ s.
IMPEDANCE: 190 ohms
PRICE: \$59.00

TYPE 302
TIME DELAY: Continuously variable from 0 to 0.6 μ s.
IMPEDANCE: 960 ohms
PRICE: \$88.00

WRITE FOR DATA!



ADVANCE ELECTRONICS CO.,
P. O. Box No. 394, Passaic, N. J.



—PRECISION—
SERIES ES-500A
High Sensitivity—Wide Range
5" OSCILLOSCOPE
 with **PUSH-PULL**
VERTICAL and HORIZONTAL
AMPLIFIERS
 20 mv. per inch "V" Sensitivity
 150 mv. per inch "H" Sensitivity

IMPORTANT FEATURES

- ★ High Sensitivity, Extended Range, Push-Pull, Voltage Regulated Vertical Amplifier — 10 cycles to 1 MC response. Input 2 meg. 22 mmfd.
- ★ Frequency Compensated "V" Input Step Attenuator.
- ★ Vertical Phase-Reversing Switch.
- ★ Extended Range, High Sensitivity, Push-Pull Horizontal Amplifier — 10 cycles to 1 MC response at full gain. Input 1/2 meg. and 20 mmfd.
- ★ Linear Multi-Vibrator Sweep Circuit — 10 cycles to 30 KC plus line and external sweep.
- ★ 4-Way Synchron. Selection — Internal Positive, Internal Negative, External and Line.
- ★ "Z" Axis Modulation terminal for blanking, etc.
- ★ Internal, Phasable, 60 cycle Beam Blanking.
- ★ Sweep Phasing Control. Wide-angle bridge circuit.
- ★ Direct H and V Plate Connections; all 4 plates.
- ★ Audio Monitoring Phone Jacks.
- ★ High Intensity CR Patterns through use of adequate high voltage power supply with 2X2 rectifier.
- ★ Tube Complement and Circuit — 6C4 "V" cathode follower, 6CB6 "V" amplifier, 6C4 "V" phase inverter. Push-Pull 6AU6's "V" CR driver, 7N7 "H" amplifier and phase inverter. Push-Pull 6AU6's "H" CR driver, 7N7 sweep oscillator, 5Y3 and 2X2 rectifiers. VR-150 voltage regulator. 5CP1/A CR Tube.
- ★ 7 Four-Way Lab. Type Input Terminals — Take banana plugs, phone tips, bare wire or spade lugs.
- ★ Light Shield and Mask removable and rotatable.
- ★ Extra Heavy-Duty Construction and components to assure "Precision" performance.
- ★ Heavy Gauge, Anodized, No-Glare, Aluminum Panel.
- ★ Fully Licensed under W.E. Co. patents.
- ★ In tourered, black ripple, heavy gauge steel case. Size 8 3/4" x 14 1/2" x 18". Complete with light shield, calibrating mask and instruction manual. **NET PRICE \$169.50**

See this "PRECISION" 5" Oscilloscope on display and available at leading radio equipment distributors.

Precision Apparatus Co., Inc.
 92-27 HORACE HARDING BLVD.
 ELMHURST 10, N. Y.

Export: 458 B'way, N.Y.C., U.S.A. Cables: MORHANEX
 In Canada: Atlas Radio Corp. Ltd., Toronto, Ontario

Want more information? Use post card on last page.

Sperry Gyroscope Co.....	281	Vectron, Inc.....	448
Sprague Electric Company.....	291	Veeder-Root, Inc.....	219
St. Regis Paper Company.....	271	Vickers Electric Division.....	356
Stackpole Carbon Co.....	333	Victoreen Instrument Co.....	314
Stahl, Inc., Michael.....	445	Victory Engineering Corp.....	278
Standard Cabinet Company.....	474	Volkert Metal Stampings, Inc., John.....	393
Standard Piezo Co.....	498		
Standard Transformer Corp.....	264		
Star Expansion Products Co.....	487		
State Labs, Inc.....	400		
Staver Company, Inc.....	477		
Stelma, Inc.....	562		
Sterling Engineering Company, Inc.....	389		
Sterling Transformer Corp.....	461		
Stevens-Arnold Incorporated.....	493		
Stevens Manufacturing Co., Inc.....	464		
Stoddart Aircraft Radio Co.....	256		
Stone Paper Tube Company, Inc.....	55		
Struthers-Dunn, Inc.....	254		
Sturtevant Co., P. A.....	503		
Sun Radio & Electronics Co., Inc.....	563		
Superior Electric Co.....	65		
Superior Tube Co.....	379		
Suprenant Mfg. Co.....	212		
Switchcraft, Inc.....	412		
Sylvania Electric Products, Inc.....	7, 345		

Tech Laboratories, Inc.....	322		
Technical Service Corporation.....	487		
Technitrol Engineering Company.....	490		
Technology Instrument Corp.....	401, 493		
Tektronix, Inc.....	384		
Tel-Instrument Co., Inc.....	222		
Telechrome Incorporated.....	485		
Telechron Dept. General Electric Co.....	213		
Teletronics Laboratory, Inc.....	270, 505		
Telewave Laboratories, Inc.....	467		
Tenney Engineering, Incorporated.....	396		
Tensolite Insulated Wire Co.....	491		
Terpening Company, L. H.....	260		
Texas Instruments, Inc.....	205		
Thomas & Sons, William.....	474		
Thor Ceramics, Inc.....	206		
Tinker & Razor.....	501		
Tinnerman Products, Inc.....	509		
Titoflex, Inc.....	79		
Tobe Deutschmann Corporation.....	394, 395		
Trad Television Corp.....	282		
Transformer Metal Products Corp.....	402		
Transformers, Inc.....	67		
Transcoil Corporation.....	405		
Transitron Electronic Corp.....	495		
Transradio, Ltd.....	299		
Tresco.....	438		
Triad Transformer Mfg. Co.....	368		
Triplett Electrical Instrument Co.....	181		
Tung-Sol Electric, Inc.....	247		

Ucinite Co., The.....	180		
Union Carbide & Carbon Corp., Linde Air Products Div.....	501		
United Catalog Publishers Inc.....	479		
United Condenser Corp.....	425		
United Manufacturing & Service Company.....	435		
United States Gasket Company.....	561		
United States Plywood Corp.....	32		
United States Testing Company, Inc.....	368		
United Transformer Co.....	Second Cover		
Universal Aviation Equipment, Inc.....	459		
Universal Manufacturing Company, Inc.....	391		
Universal Winding Company.....	317		

Vacuum-Electronic Engineering Co.....	451		
Vartlex Sales Co., Inc.....	176		
Varian Associates.....	349		

Waldes Kohinoor, Inc.....	301		
Wall Manufacturing Co.....	364		
Walter Co., Inc., S.....	431		
Ward Leonard Electric Co.....	36, 37		
Warren Wire Company.....	465		
Waterman Products Co., Inc.....	94, 95		
Waveforms, Inc.....	497		
Weckesser Company.....	433		
Welch Scientific Company, W. M.....	427		
Western Coil Products Co.....	497		
Western Gold & Platinum Works.....	469		
Westfield Metal Products Co., Inc.....	492		
Westinghouse Electric Corp.....	285, 321, 441		
Weston Electrical Instrument Corp.....	335		
Wheeler Insulated Wire Co., Inc.....	266		
White Dental Mfg. Co., S. S.....	398, 399, 449		
Whitehead Stamping Company.....	499		
Wiley & Sons, Inc., John.....	437		
Williams & Co., C. K.....	389		
Winchester Electronics, Inc.....	174		
Workshop Associates Div., Gabriel Company.....	302		
Wright-Hepp Associates, Inc.....	495		

Xcelite, Incorporated.....	500		
Zophar Mills, Inc.....	433		

PROFESSIONAL SERVICES..... 506

SEARCHLIGHT SECTION

(Classified Advertising)

H. E. HILTY, Mgr.

SEARCHLIGHT ADVERTISERS INDEX

554, 555

This index is published as a convenience to the readers. Every care is taken to make it accurate, but ELECTRONICS assumes no responsibility for errors or omissions.

IN Attenuators

WHY DOES
ONE NAME...

DAVEN

STAND OUT?

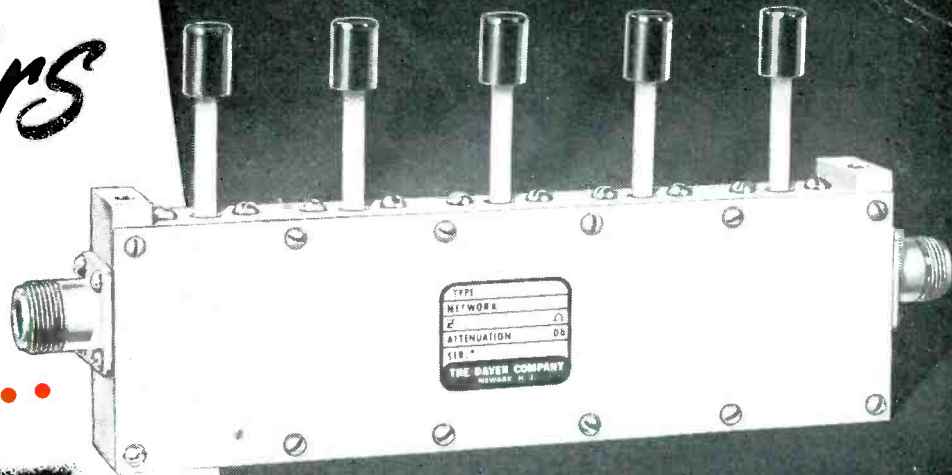

Series 550-RF Attenuator

In addition to Daven being the leader in audio attenuators, they have achieved equal prominence in the production of RF units. A partial listing of some types is given below.

DAVEN Radio Frequency Attenuators, by combining proper units in series, are available with losses up to 120 DB in two DB Steps or 100 DB in one DB Steps. They have a zero insertion loss and a frequency range from DC to 225 MC.

Standard impedances are 50 and 73 ohms, with special impedances available on request. Resistor accuracy is within $\pm 2\%$ at DC. An unbalanced circuit is used which provides constant input and output impedance. The units are supplied with either UG-58/U* or UG-185/U** receptacles.

TYPE	LOSS	TOTAL DB	STANDARD IMPEDANCES
RFA* & RFB 540**	1, 2, 3, 4 DB	10	50/50 Ω and 73/73 Ω
RFA & RFB 541	10, 20, 20, 20 DB	70	50/50 Ω and 73/73 Ω
RFA & RFB 542	2, 4, 6, 8 DB	20	50/50 Ω and 73/73 Ω
RFA & RFB 543	20, 20, 20, 20 DB	80	50/50 Ω and 73/73 Ω
RFA & RFB 550	1, 2, 3, 4, 10 DB	20	50/50 Ω and 73/73 Ω
RFA & RFB 551	10, 10, 20, 20, 20 DB	80	50/50 Ω and 73/73 Ω
RFA & RFB 552	2, 4, 6, 8, 20 DB	40	50/50 Ω and 73/73 Ω

GREATLY EXPANDED PRODUCTION FACILITIES ENABLE DAVEN TO MAKE DELIVERY FROM STOCK ON A LARGE NUMBER OF STANDARD ATTENUATOR TYPES.

These units are now being used in equipment manufactured for the Army, Navy and Air Force.

Write for Catalog Data.

THE **DAVEN** CO.

191 CENTRAL AVENUE
NEWARK 4, NEW JERSEY

Because **DAVEN** makes the most complete, the most accurate line of **ATTENUATORS** in the world!



*Series 640-RF
Attenuation Network*



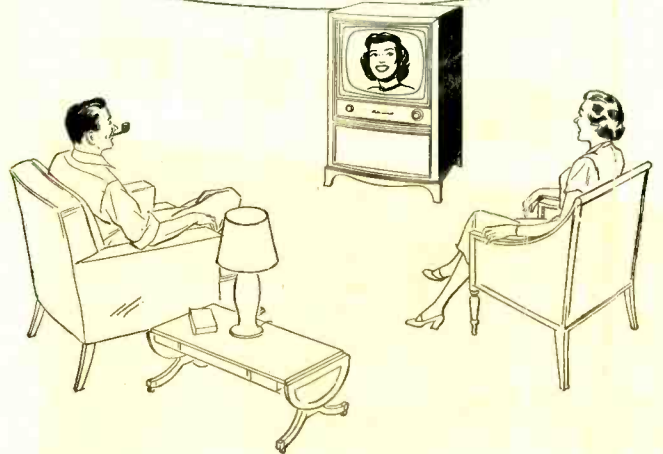
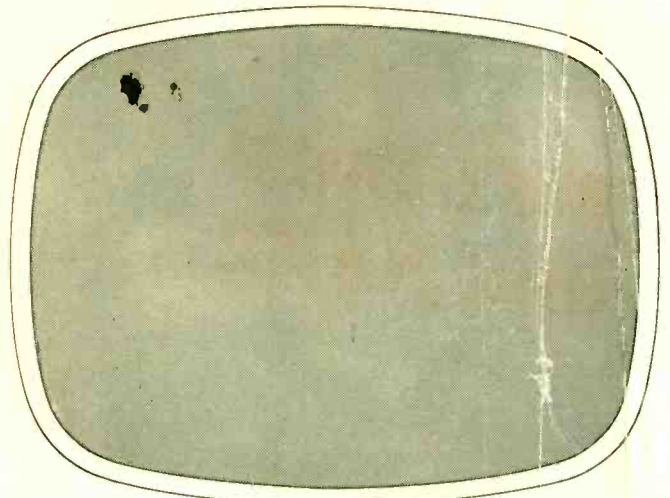
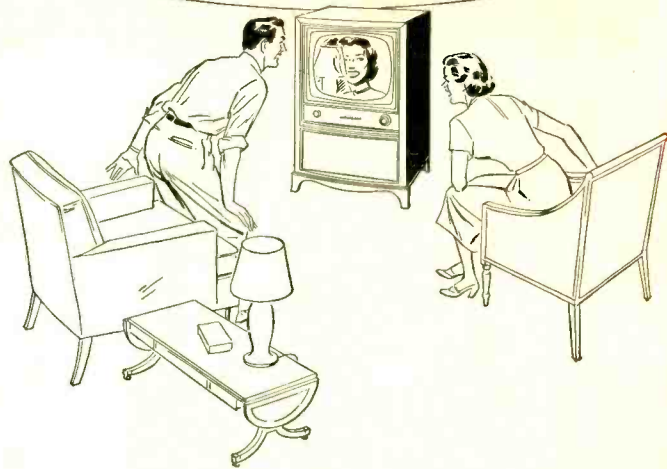
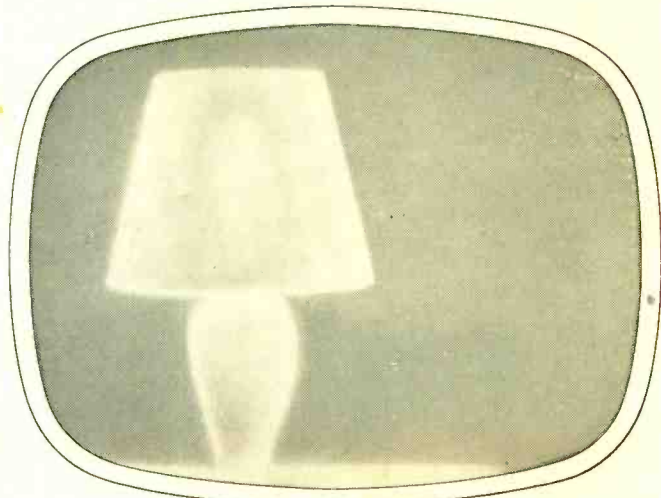

Why is one *Reflection-Free?*

THE picture tube faceplate on the right is free from annoying room reflections because its outer surface is lightly frosted. In this way, RCA metal-shell picture tubes give you an important sales feature—reflection-free faceplates.

Remember: RCA metal-shell picture tubes with their frosted faceplates not only suppress bothersome room reflections but preserve sharp, graphic picture quality over their entire faceplate area.

Why not make RCA frosted

faceplate picture tubes an important feature of your 1953 TV set design. Take advantage of the extra consumer appeal . . . give your merchandising program new sales power.

For technical data or design help, write RCA, Commercial Engineering, Section 42CR. Or simply call your nearest RCA Field Office:

(EAST) Humboldt 5-3900, 415 S. 5th St.,
Harrison, N. J.

(MIDWEST) Whitehall 4-2900, 589 E. Illinois St.,
Chicago, Ill.

(WEST) Madison 9-3671, 420 S. San Pedro St.,
Los Angeles, Cal.



RCA Metal-Shell Kinescopes

RCA-21AP4
(magnetic-
focus type)

RCA-21MP4
(electrostatic-
focus type)

All RCA metal-shell kinescopes feature faceplates which suppress annoying room reflections.



RADIO CORPORATION of AMERICA
ELECTRON TUBES
HARRISON, N. J.