

JUNE · 1949

electronics

A MCGRAW-HILL PUBLICATION

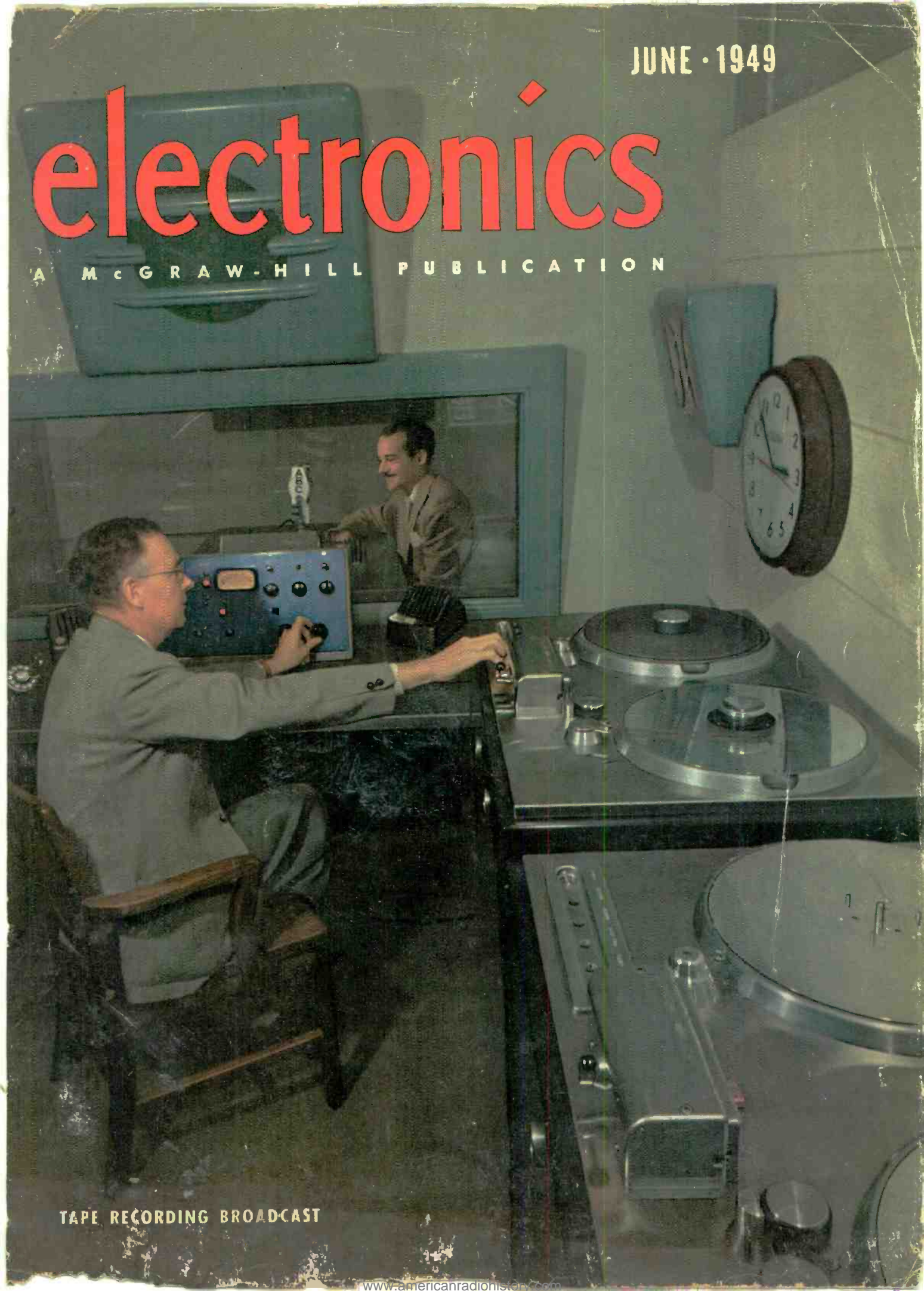

TAPE RECORDING BROADCAST



for High Q Inductors...

For Maximum Stability Permalloy Dust Toroids

The UTC type HQ permalloy dust toroids are ideal for all audio, carrier and supersonic applications. HQA coils have Q over 100 at 5,000 cycles . . . HQB coils Q over 200 at 4,000 cycles . . . HQC coils Q over 200 at 30KC . . . HQD coils Q over 200 at 60 KC. The toroid dust core provides very low hum pickup . . . excellent stability with voltage change . . . negligible inductance change with temperature, etc. Precision adjusted to 1% tolerance.

Inductance Value	Type No.	Net Price	Inductance Value	Type No.	Net Price
5 mhy.	HQA-1	\$7.00	70 mhy.	HQB-3	\$16.00
12.5 mhy.	HQA-2	7.00	120 mhy.	HQB-4	17.00
20 mhy.	HQA-3	7.50	.5 hy.	HQB-5	17.00
30 mhy.	HQA-4	7.50	1 hy.	HQB-6	18.00
50 mhy.	HQA-5	8.00	2 hy.	HQB-7	19.00
80 mhy.	HQA-6	8.00	3.5 hy.	HQB-8	20.00
125 mhy.	HQA-7	9.00	7.5 hy.	HQB-9	21.00
200 mhy.	HQA-8	9.00	12 hy.	HQB-10	22.00
300 mhy.	HQA-9	10.00	18 hy.	HQB-11	23.00
.5 hy.	HQA-10	10.00	25 hy.	HQB-12	24.00
.75 hy.	HQA-11	10.00	1 mhy.	HQC-1	13.00
1.25 hy.	HQA-12	11.00	2.5 mhy.	HQC-2	13.00
2 hy.	HQA-13	11.00	5 mhy.	HQC-3	13.00
3 hy.	HQA-14	13.00	10 mhy.	HQC-4	13.00
5 hy.	HQA-15	14.00	20 mhy.	HQC-5	13.00
7.5 hy.	HQA-16	15.00	.4 mhy.	HQD-1	15.00
10 hy.	HQA-17	16.00	1 mhy.	HQD-2	15.00
15 hy.	HQA-18	17.00	2.5 mhy.	HQD-3	15.00
10 mhy.	HQB-1	16.00	5 mhy.	HQD-4	15.00
30 mhy.	HQB-2	16.00	15 mhy.	HQD-5	15.00



HQA, C, D
1 1/8" Dia. x 1 1/8" High.



HQB
2 5/8" L. x 1 5/8" W. x 2 1/2" H.



UNCASED TOROIDS
(Deduct \$1.50 for unccsd units)

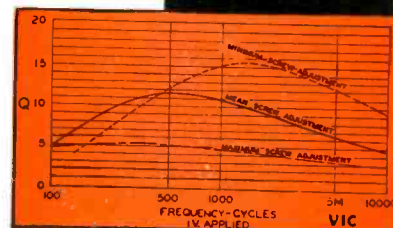
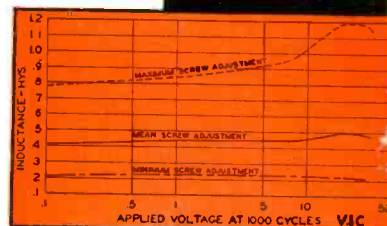
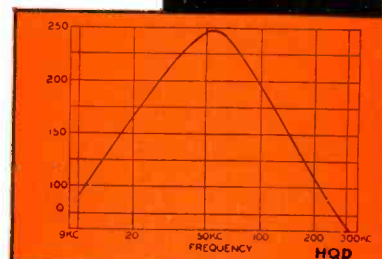
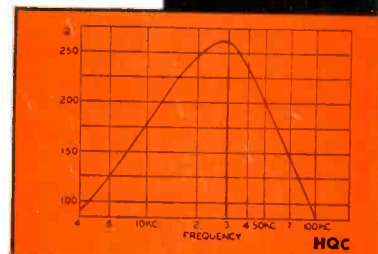
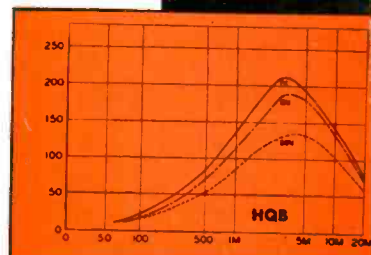
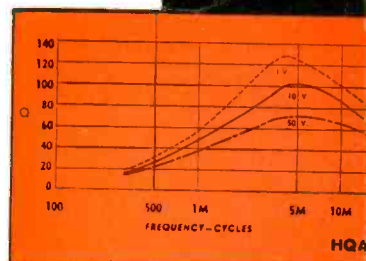

Sub-Ouncer Permalloy Dust Toroids...

Weight 1/2 ounce uncased. HQE coils have characteristics similar to HQA, C, and D coils with little reduction in Q considering minute size.

For Maximum Flexibility... The VIC Variable Inductor

The set screw on VIC units permits positive adjustment of inductance to plus 90% minus 50% from rated value. Revolutionary approach for tuned audio circuits. Q and L vs. screw adjustment for a typical coil are illustrated.

Type	Mean Hys.	List Price	Type	Mean Hys.	List Price
VIC-1	.0085	\$11.00	VIC-12	1.3	\$14.00
VIC-2	.013	11.00	VIC-13	2.2	14.00
VIC-3	.021	11.00	VIC-14	3.4	14.00
VIC-4	.034	11.00	VIC-15	5.4	16.50
VIC-5	.053	11.00	VIC-16	8.5	16.50
VIC-6	.084	11.00	VIC-17	13	16.50
VIC-7	.13	14.00	VIC-18	21	16.50
VIC-8	.21	14.00	VIC-19	33	16.50
VIC-9	.34	14.00	VIC-20	52	16.50
VIC-10	.54	14.00	VIC-21	83	17.50
VIC-11	.85	14.00	VIC-22	130	18.50

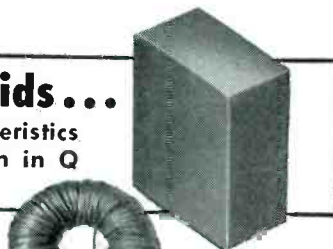

1 3/8" L. x 1 1/4" W. x 1 1/2" H.

United Transformer Co.

150 VARICK STREET • NEW YORK 13, N.Y.
EXPORT DIVISION: 13 EAST 40th STREET, NEW YORK 16, N.Y. CABLES: "ARLAB"

Write for catalog PS-409

electronics

A McGRAW - HILL
PUBLICATION



JUNE • 1949

TAPE RECORDING BROADCAST		Cover
Engineer Ed Starr of KECA, Hollywood, starts up Ampex equipment following an announcement (see p 118)		
BASIC RESEARCH PROJECTS UNDER ONR CONTRACTS, by Karl R. Spangenberg and Walter E. Greene		66
Details of current ONR programs of fundamental electronic research at 19 universities		
MINIMIZING TELEVISION INTERFERENCE by P. S. Rand		70
Suggestions for improving reception with existing receivers and design data for future sets based on experimental results		
AUDIO SMOKE ALARM, by Earle L. Kent		77
Produces signal when permissible smoke density is exceeded		
CITIZENS RADIO REPORT		78
Most of the people on the air use modified surplus BC645 transponders		
LETTER READING MACHINE, by V. K. Zworykin, L. E. Flory and W. S. Pike		80
Experimental device for the blind can be modified to interpret symbols representing phonetics, codes, or business statistics		
PICKUP PLACEMENT, by B. B. Bauer		87
Formulas for designing and positioning phonograph equipment		
TESTING TRANSISTORS, by K. Lehovec		88
Simple two-pentode test circuit gives all required a-c and d-c currents and voltages quickly and conveniently		
ADJACENT-CHANNEL OPERATION OF MOBILE EQUIPMENT, by D. E. Noble		90
New techniques reduce interchannel interference to a practical minimum		
LOW-FREQUENCY DISCRIMINATOR, by Harry M. Crain		96
Resistance-capacitance circuit replaces inductance discriminator at low frequencies		
CATHODE-COMPENSATED VIDEO AMPLIFICATION—Part 1, by A. B. Bereskin		98
New television circuit technique gives simplicity, lower cost, greater frequency range and other advantages		
SPARK-PLUG TESTER, by Craig Walsh and A. L. Livera		104
Triggered thyratron circuit provides high-voltage power supply		
VECTOR VOLTAGE INDICATOR, by Peter G. Sulzer		107
A complex quantity is presented on the screen of a cathode-ray tube		
STANDARD FOR WAVEGUIDES, by W. H. Fenn		110
Dimensions, tolerance and frequency range established by RMA		
ATTENUATION IN WAVEGUIDES, by Henry Lisman		112
Chart of power-handling capabilities and attenuation in the TE ₁₀ mode		
CATHODE-FOLLOWER BANDWIDTH, by Melvin B. Kline		114
Nomograph relates output resistance and capacitance with frequency at which bandwidth is 3 db down		
BUSINESS BRIEFS	60	
CROSSTALK	65	
TUBES AT WORK	116	
ELECTRON ART	120	
NEW PRODUCTS	124	
NEWS OF THE INDUSTRY	128	
		NEW BOOKS
		BACKTALK
		INDEX TO ADVERTISERS

DONALD G. FINK, *Editor*; W. W. MacDONALD, *Managing Editor*; John Markus, Vin Zeluff, A. A. McKenzie, *Associate Editors*; William P. O'Brien, James D. Fahnestock, *Assistant Editors*; Hal Adams Bureson, Ann Mastropolo, Sophie D. Feeny, *Editorial Assistants*; Gladys T. Montgomery, *Washington Editor*; Harry Phillips, *Art Director*; Eleanor Luke, *Art Assistant*; R. S. Quint, *Directory Manager*; Russell F. Anderson, *Editor, World News*; Dexter Keezer, *Director Economics Department*

KEITH HENNEY, *Consulting Editor*

H. W. MATEER, *Publisher*; WALLACE B. BLOOD, *Manager*; D. H. Miller, H. R. Denmead, Jr., *New York*; Wm. S. Hodgkinson, *New England*; Warren W. Shew, *Philadelphia*; C. D. Wardner, *Chicago*; J. L. Phillips, *Cleveland*; J. W. Otterson, *San Francisco*; Carl W. Dysinger, *Los Angeles*; Ralph C. Maultsby, *Atlanta*; Bernard H. Butler, *London, England*; J. E. Blackburn, Jr., *Director of Circulation*

Contents Copyright 1949, by McGraw-Hill Publishing Company, Inc. All Rights Reserved. McGRAW-HILL PUBLISHING COMPANY, INCORPORATED, JAMES H. McGRAW (1860-1948), Founder • PUBLICATION OFFICE 99-129 North Broadway, Albany 1, N. Y., U. S. A. EDITORIAL AND EXECUTIVE OFFICES, 330 West 42nd St., New York 18, N. Y., U. S. A.—Member A. B. P. Member A. B. C.

James H. McGraw, Jr., President; Curtis W. McGraw, Vice-President and Treasurer; Eugene Duffield, Executive Assistant for Publications; Nelson Bond, Director of Advertising; James A. Gerardi, Secretary; and J. E. Blackburn, Jr., Director of Circulation.
ELECTRONICS, June 1949, Vol. 22; No. 6. Published monthly, with an additional issue in June, price 75c a copy for U. S. and possessions, and Canada; \$1.50 for Latin America; \$2.00 for all other foreign countries. Directory issue \$2.00. Allow at least ten days for change of address. All communications about subscriptions should be addressed to the Director of Circulation. Subscription rates—United States and possessions, \$6.00 a year, \$9.00 two years, \$12.00 for three years. Canada (Canadian funds accepted), \$7.00 a year, \$11.00 for two years, \$14.00 for three years. Latin American countries \$15.00 for one year, \$25.00 for two years, \$30.00 for three years. All other countries \$20.00 for one year, \$30.00 for two years, \$40.00 for three years. Please indicate position and company connections on all subscription orders. Entered as Second Class matter August 29, 1936, at Post Office, Albany, New York, under the Act of March 3, 1879. BRANCH OFFICES: 520 North Michigan Avenue, Chicago 1, Ill.; 68 Post Street, San Francisco 4; Aldwych House, Aldwych, London, W. C. 2; Washington, D. C. 4; Philadelphia 3; Cleveland 15; Detroit 26; St. Louis 8; Boston 6; Atlanta 3, Ga.; 621 So. Hope St., Los Angeles 14; 738-9 Oliver Building, Pittsburgh 22. ELECTRONICS is indexed regularly in The Engineering Index.

MARION

helps TECHNOLOGY INSTRUMENT



measure Phase Difference

Type 320-A (electronic) Phase Meter by Technology Instrument Corporation is the first commercially available instrument for the direct measurement of Phase Angle as an independent quantity at audio and supersonic frequencies. Important fields of application are: Audio Facilities, Supersonics, Servomechanisms, Geophysics, Acoustics, Aerial Navigation, Electric Power Transformation and Signaling.

To make this instrument practical, T. I. C. had to have a special meter with special characteristics which would integrate extreme low frequency pulses and eliminate needle flutter. Other requirements included critical accuracy, an exceptionally long scale, readability, reliability, freedom from bearing failure, protection from heavy overloads and long life. By working in closest cooperation with Marion engineers and using all of Marion's extensive meter making experience and facilities a satisfactory type was finally developed.

When you need special- or general-purpose instruments for electrical or electronic measuring get in touch with us. Here at Marion we have solved many a complicated meter problem. We would appreciate the chance to help solve yours.

the
name
MARION
means the
most in
meters



MARION ELECTRICAL INSTRUMENT COMPANY

MANCHESTER, NEW HAMPSHIRE

Export Division, 458 Broadway, New York 13, U. S. A., Cables MORHANEX

IN CANADA: THE ASTRAL ELECTRIC COMPANY, SCARBORO BLUFFS, ONTARIO

LOW CURRENT PAYS OFF...

with the **GENERAL ELECTRIC PM-EM* FOCUS COIL!**

PERFORMANCE-ENGINEERED at Electronics Park, the General Electric Focus Coil is now being used by many leading television manufacturers. The reason for this widespread adoption of the G-E Focus Coil by design engineers is best explained by the following equation:

$$\begin{aligned} \text{PEM} &= I^2R = .109^2 \times 247 = 2.93 \text{ watts} \\ \text{PEM-PM} &= I^2R = .029^2 \times 960 = 0.81 \text{ watts} \\ \text{Power Saving} &= 2.12 \text{ watts} \end{aligned}$$

In addition to its low current requirements (which permit the use of lower-priced power supplies) the G-E focus coil is small, compact and light in weight. These features provide additional space which TV set designers can use to advantage.

For complete information on the G-E Focus Coil and other television components, write: General Electric Company, Electronics Park, Syracuse, New York.

*Permanent Magnet—Electro-Magnet.

You can put your confidence in—

GENERAL  ELECTRIC



Two BIG reasons why you'll want...

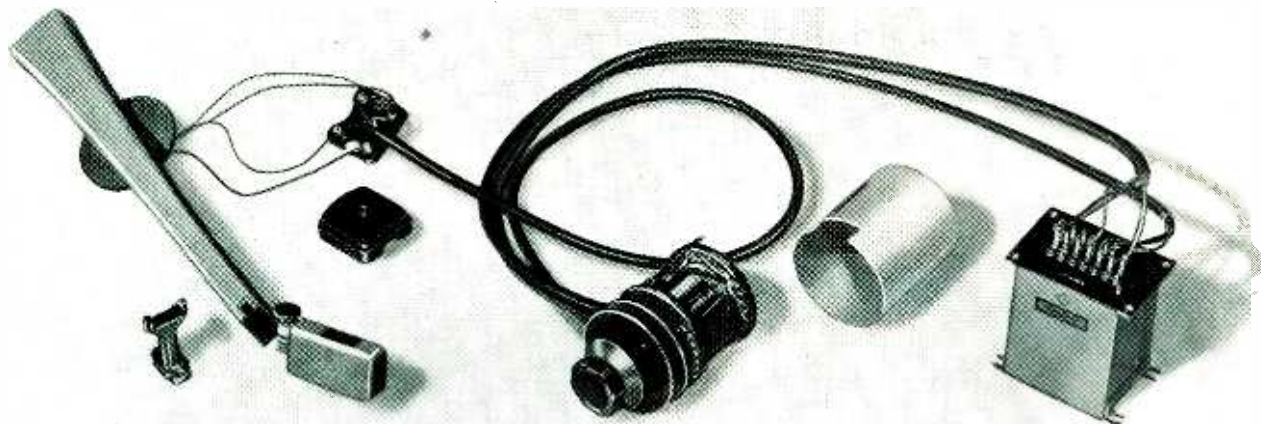

...the 109 Type Reproducer Group!

1. Low intermodulation distortion

Naturally, the Western Electric 109 Type Reproducer Group gives you extremely low harmonic distortion. But here's a still more important point—its advanced design practically eliminates *intermodulation* distortion.

Intermodulation distortion is one of the important factors that cause the "fuzziness" so often heard in the reproduction of the higher frequencies. Tests *prove* that the moving coil principle of reproduction, used in the 9 Type Reproducer, introduces far less intermodulation distortion than other currently used methods. That's *one* reason why the 109 gives exceptionally "clean" reproduction!

2. Wide, uniform frequency response

The combination of the 9 Type Reproducer and the equalizer used in the 109 Group is carefully designed for uniform frequency response—and this 7-position equalizer permits correction for any of the more commonly used recording characteristics. With the 109 Group, you can match within close tolerances all vertical and most lateral transcriptions and 90% of phonograph records.

The 109 Type Reproducer Group is available from stock—place your order with your local Graybar Representative, or write Graybar Electric Company, 420 Lexington Avenue, New York 17, N. Y.

— QUALITY COUNTS —

Immediate replacements on 9 Type Reproducers

If your 9 Type Reproducer needs repairs, send it to your Graybar District Warehouse — you can get a *factory-rebuilt* replacement immediately from stock.



Western Electric

DISTRIBUTORS: IN THE U. S. A. —
Graybar Electric Co. IN CANADA
—Northern Electric Co., Ltd.

ACCURATE TEST VOLTAGES

1/2 cps to 50 kc



Person-to-Person Help With Your Measuring Problems

Almost anywhere in America, *-hp-* field representatives can give you personal help with your measuring problems. They have complete data on *-hp-* instruments, their performance, servicing and adaptability. Call the nearest *-hp-* field representative whenever, wherever you need help with a measuring problem.

BOSTON, MASSACHUSETTS

Burlingame Associates
270 Commonwealth Ave.
KENmore 6-8100

CHICAGO 6, ILLINOIS

Alfred Crossley & Associates
549 W. Randolph Ave.
State 7444

CLEVELAND 12, OHIO

M. P. Odell
1748 Northfield Avenue
Potomac 6960

DALLAS 5, TEXAS

Earl W. Lipscomb
4433 Stanford Street
Logan 6-5097

DENVER 10, COLORADO

Ronald G. Bowen
1896 So. Humboldt Street
Spruce 9368

DETROIT 6, MICHIGAN

S. Sterling Company
13331 Linwood Avenue
TOWnsend 8-3130

FORT MYERS, FLORIDA

Arthur Lynch and Associates
P. O. Box 466
Fort Myers 1269M

HIGH POINT, NORTH CAROLINA

Bivins & Caldwell
Room 807, Security Bank Building
Phone 3672

LOS ANGELES 46, CALIFORNIA

Norman B. Neely Enterprises
7422 Melrose Avenue
Whitney 1147

NEW YORK 7, NEW YORK

Burlingame Associates
11 Park Place
Digby 9-1240

SAN FRANCISCO 3, CALIFORNIA

Norman B. Neely Enterprises
954 Howard Street
Douglas 2-2609

TORONTO 1, CANADA

Atlas Radio Corporation, Ltd.
560 King Street West
Waverley 4761

WASHINGTON 9, D. C.

Burlingame Associates
2017 S. Street N. W.
Decatur 8000

-hp- 202B LOW-FREQUENCY OSCILLATOR

New, wider frequency range, improved circuits, higher stability—those are but a few of the time-saving new features of this improved *-hp-* Model 202B Low-Frequency Oscillator.

This *-hp-* instrument now covers the low-frequency, audio and supersonic spectra from 1/2 cps to 50 kc. Throughout this range it provides excellent wave form, high stability and an unusual degree of accuracy.

Like other *-hp-* instruments, this resistance-tuned oscillator features amazing simplicity and speed of operation. Frequency is set and read directly. Frequency range is selected from 5 ranges by a front-panel control. No zero-set is required during operation. Construction is simple yet rugged; the instrument is designed for long years of

trouble-free operation in field or laboratory.

The *-hp-* 202B Oscillator is particularly designed for the following tests: Vibration or stability characteristics, electrical simulation of mechanical phenomena, performance checks on electro-cardiograph or encephalograph equipment, testing geophysical prospecting equipment, checking seismograph response. Its versatility makes it adaptable for almost any operation where an accurate low or audio frequency source is required.

HEWLETT-PACKARD CO.

1875-A Page Mill Road, Palo Alto, California

Export: FRAZAR & HANSEN

301 Clay Street, San Francisco, California, U.S.A.
Offices: New York, N. Y.; Los Angeles, Calif.

SPECIFICATIONS

Frequency Range: 1/2 cps to 50 kc, 5 ranges.

RANGE	FREQUENCY
X1	1/2 to 5 cps
X10	5 to 50 cps
X100	50 to 500 cps
X1K	500 to 5,000 cps
X10K	5,000 to 50,000 cps

Calibration Accuracy: ±2%.

Frequency Stability: Better than ±5% under normal conditions including warm-up drift. Less than ±1% for power voltage changes of ±10%.

Output Voltage: 10 v into 1,000 ohm resistive load over entire range.

Internal Impedance: Approx. 25 ohms at 10 cps.

Frequency Response: ±1 db, 10 to 50,000 cps; ±2 db, 1 to 50,000 cps.

Distortion: Less than 1% total distortion, 1 cps to 50 kc.

Hum Voltage: Less than 0.1% of rated output voltage.

Data subject to change without notice

hp laboratory instruments
FOR SPEED AND ACCURACY

Key to a Crystal Gateway

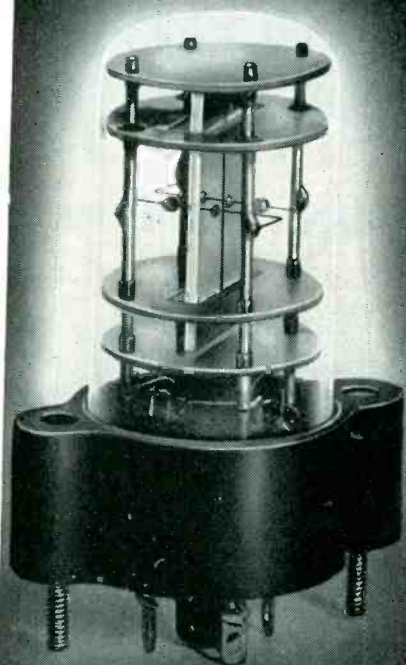
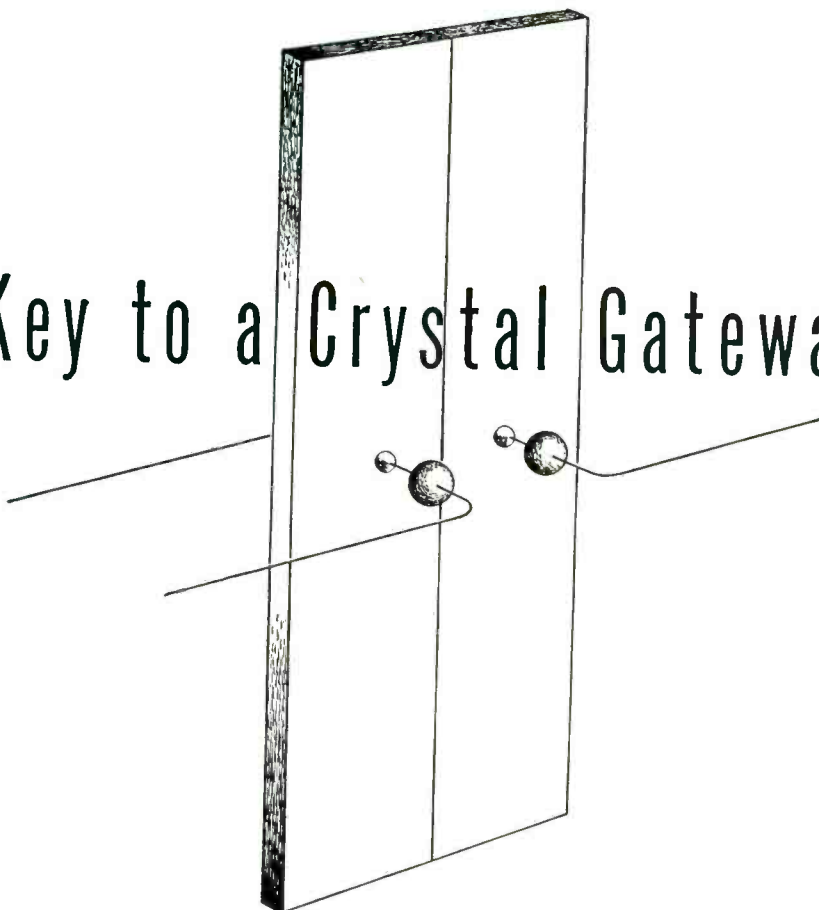

Above is a coaxial-circuit crystal in its glass enclosure. At right the crystal is shown, 3½ times actual size, with connecting wires soldered in position. Weights on wires reflect energy back into crystal, so cut losses.

How would you solder a wire to a crystal? This must be done for most of those wafer-thin plates of quartz used in electrical circuits. They play a big part in the myriad-channel telephone system that utilizes coaxial cables.

This is how Bell Laboratories scientists solved the problem: A spot of paste containing silver is deposited on the crystal and bonded to it by oven heat. The crystal is then vapor-plated with a thin layer of silver. Then a fine wire is soldered to the spot by a concentrated blast of hot air. The result

is a rugged electrical connection to the surface of the crystal which does not interfere with its vibrations.

Sealed in glass tubes, the crystals are precise and reliable performers in the telephone system. Each is a crystal gate to a voiceway, separating *your* conversation from the hundreds of others which may be using a pair of coaxial conductors, at the same time.

This spot of paste, this tiny wire, this puff of air are among the tremendous trifles which concern Bell Telephone Laboratories in finding new ways to improve your telephone service.

BELL TELEPHONE LABORATORIES

EXPLORING AND INVENTING, DEVISING AND PERFECTING, FOR CONTINUED IMPROVEMENTS AND ECONOMIES IN TELEPHONE SERVICE



ONCE AGAIN, MYCALEX 410 GETS THE CALL . . .

Leading Automobile firm specifies MYCALEX 410 molded insulation for new dashboard lightswitch . . .

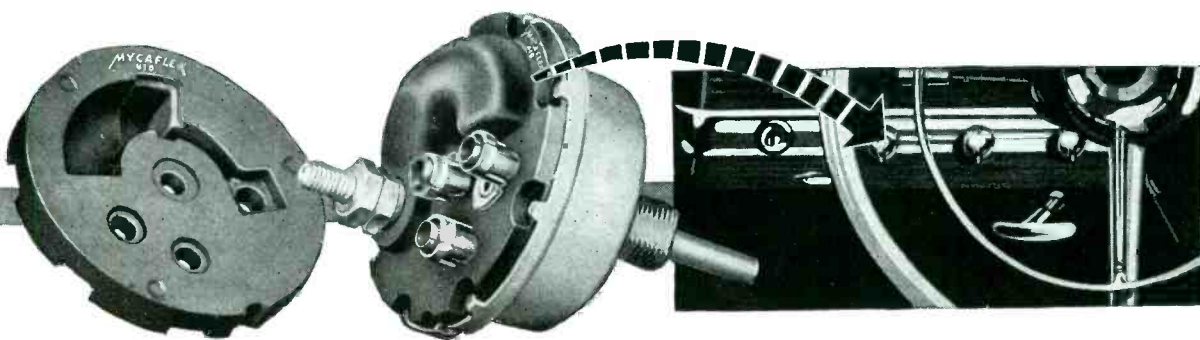

Sorry, we can't mention names, but this is the insulator body for a new type of dash-board light-switch being manufactured of MYCALEX 410 molded insulation for one of the leading lines of cars* . . . *names on request.

It's no great secret that automotive firms buy wisely and well . . . and it's justly proud we are that after making exhaustive tests and comparisons, this large maker of cars specified MYCALEX 410 molded insulation as ideal for the new type dash-board light-switch being introduced in their 1949 line.

Again, it was proved that on long run, round the clock production, MYCALEX 410 insulation parts, molded with or without metal inserts, are low-cost and competitive with less-effective molded insulation materials.

Again, MYCALEX 410 molded insulation demonstrated its absolute dimensional and electrical stability; low dielectric loss; high dielectric strength; high arc resistance; stability over wide

humidity and temperature changes; resistance to high temperatures, moisture and oils; and great mechanical precision and strength. Inserts of common or precious metals may be injected in the MYCALEX 410 molding process.

Yes, MYCALEX 410 molded insulation meets the most exacting requirements of high frequency applications.

REMEMBER . . .

MYCALEX 410 MOLDED INSULATION IS THE EXCLUSIVE FORMULATION OF MYCALEX CORPORATION OF AMERICA.

We stock these
MYCALEX 410
Tiny Tie-In Terminals
for . . .
Sub-miniature
Transmitting Equipment

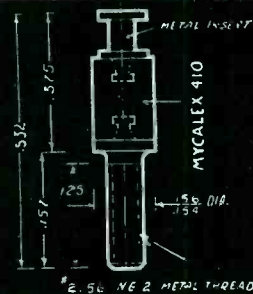

MYCALEX CORP. OF AMERICA

"Owners of 'MYCALEX' Patents"

Plant and General Offices, CLIFTON, N. J.

Executive Offices, 30 ROCKEFELLER PLAZA, NEW YORK 20, N. Y.

Heat dissipation can be

for resistors



Heat dissipation can be mighty tough . . . but not for IRC resistors. They are universally engineered for the lowest possible operating temperatures and maximum power dissipation within the smallest size units consistent with good engineering practice.

Long experience with the widest line of resistor types in the industry has provided IRC with a wealth of "know-how" on resistor heat dissipation. In Power Wire Wound Resistors for example, the complete range of tubular and flat types manufactured by IRC utilizes a special cement coating to attain rapid heat dissipation. This dark rough surface does double duty by effectively guarding the windings against harmful atmospheric moisture and corrosion. Use the handy coupon to get complete data on proven advantages of IRC Power Wire Wounds.

There are 52 specific types of IRC Power Wire Wound Resistors.

IRC Flat Wire Wound Resistors offer a higher space-power ratio.

Adjustable types feature the exclusive IRC non-corrosive contact band.

Power ratings from 2 to 225 watts. Variety of 8 terminal types.

Windings are of highest grade alloy wire on tough ceramic forms.

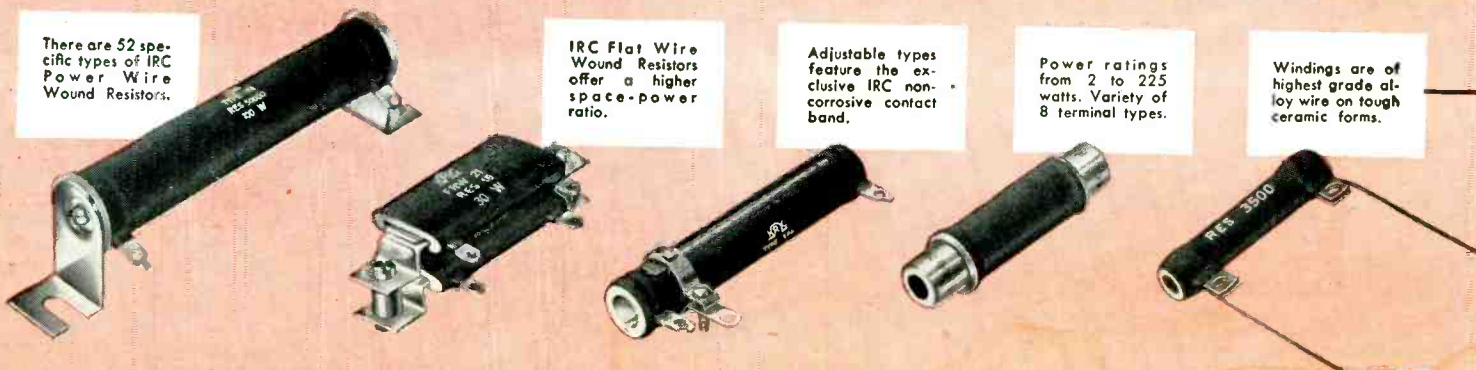

tough

too!

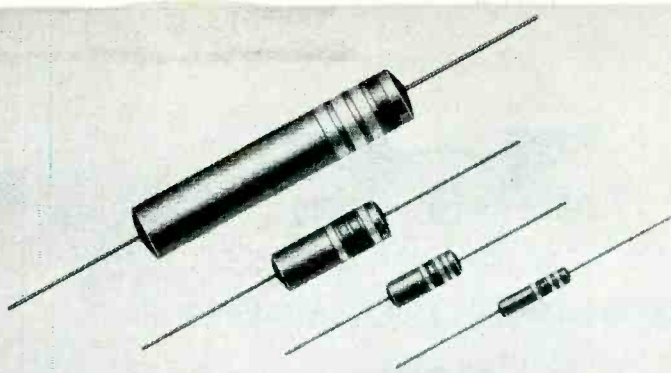

New, ADVANCED BT Resistors obsolete present performance standards for fixed composition resistors. Extremely low operating temperature and excellent power dissipation in compact, light weight, fully insulated units at $\frac{1}{3}$, $\frac{1}{2}$, 1 and 2 watts. These ADVANCED resistors meet JAN-R-11 specifications. All the facts are included in 12-page technical data Bulletin B-1.

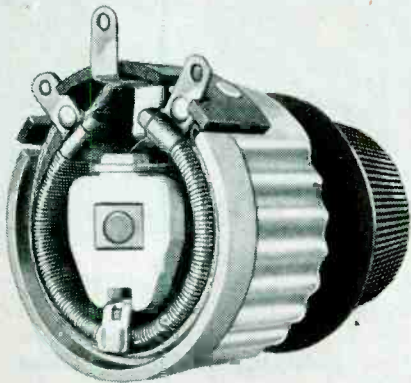

Heat dissipation properties of aluminum are used to full advantage in housing and winding core of IRC Power Rheostats, 25 and 50 watts. Type PR Rheostats operate at full rating at about half temperature rise of equivalent units. Can be operated at full power in as low as 25% of rotation without appreciable difference in temperature rise. Direct contact between rheostat and mounting panel allows rapid conduction to panel of a portion of heat dissipated. Send for Bulletin E-2.

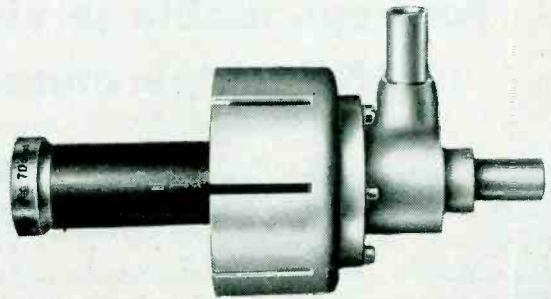

Water-cooled LP Resistors utilize high velocity water stream flowing in spiral path against thin resistance film. High power dissipation is made possible by centrifugal force holding water in thermal contact with resistance surface. Resistance film less than 0.001" thick with active length much less than $\frac{1}{4}$ wave length at FM and television frequencies, gives excellent frequency characteristics. Resistance values 35 to 1500 ohms; 15% tolerance standard; power dissipation up to 5 K.W. ac. Bulletin F-2 gives all the facts.



If you have the heat put to you for speedy service on small order resistor requirements for experimental work, pilot runs, etc., you'll appreciate the advantages of IRC's Industrial Service Plan. This enables you to get 'round-the-corner service from the local stocks of your IRC Distributor. He's a good man to know . . . we'll gladly send you his name and address.



INTERNATIONAL RESISTANCE COMPANY

401 N. Broad Street, Philadelphia 8, Pa.

In Canada: International Resistance Co., Ltd., Toronto, Licensee

Wherever the Circuit Says

Power Resistors • Voltage Dividers
Insulated Composition Resistors • Low
Wattage Wire Wounds • Controls
Deposited Carbon Precistors • Precisions
HF and High Voltage Resistors
Voltmeter Multipliers • Rheostats

INTERNATIONAL RESISTANCE COMPANY
403 N. BROAD ST., PHILA. 8, PA.

Send me additional data on items checked below:

- Power Wire Wounds (tubular) Flat Power Wire Wounds
 Advanced BT Resistors Power Rheostats Water-Cooled Resistors
 Name and address of our local IRC Distributor

NAME

TITLE

COMPANY

ADDRESS



ALL-WEATHER TRANSMITTERS

USE

ADLAKE RELAYS

For dependable service
at ANY temperature!

The Adlake Mercury plunger Type Relay, with its $+200^{\circ}$ -38.8° temperature range, is naturally suited to power control and time delay in Aerocom's new VH-200 all-weather radiotelephone transmitter. Aerocom demands dependability, and dependability in relays means Adlake.

The mercury-to-mercury contacts in Adlake Relays completely eliminate failures caused by low contact pressure, contact burning, pitting, and sticking—and the inherent high surface tension of mercury gives an ideal snap action to the contacts.

In addition, Adlake Relays bring these advantages to any relay job:

- Hermetically sealed contact mechanism, impervious to dust, dirt, and moisture.
- Silent and chatterless operation, producing high-fidelity modulation with a low noise level.
- Adlake armor design, which protects relays against outside vibration or impact.

Whatever your relay needs, there's an Adlake Relay to do the job. You'll want to see our free illustrated folder for full details. Write for it today: The Adams & Westlake Company, 1107 N. Michigan, Elkhart, Indiana.

THE Adams & Westlake COMPANY

Established 1857 • ELKHART, INDIANA • New York • Chicago



Manufacturers of Adlake Hermetically Sealed Mercury Relays for Timing, Load and Control Circuits

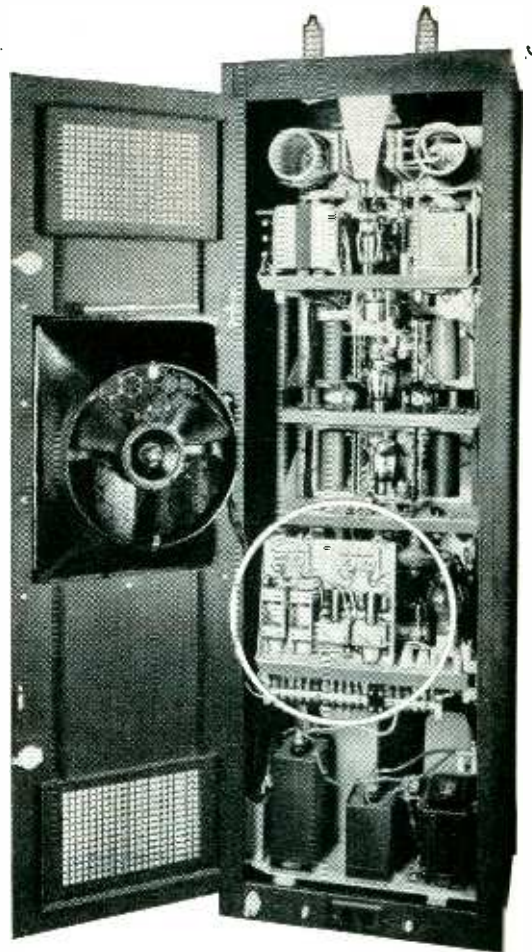

ABOVE—Rear view of Aerocom's Model 12GLX-2A, showing installation of Adlake Relays. Relays are (from left to right) Model 1200-87-5, Model 1200-87-3, Model 1040-87-1BP, and Model 1040-85-3.

BELOW—The new Aerocom VH-200, all-weather transmitter.



HARDEST WORKERS ON YOUR COMMUNICATIONS TEAM



G-E BEAM POWER TRANSMITTING TUBES



GL-2E26

—always ready for dependable service—
minutes or hours of it!



GL-807

—need low drive, so ask less of your power supply

—replacements are convenient to obtain...you can secure new tubes fast from your local G-E tube distributor!

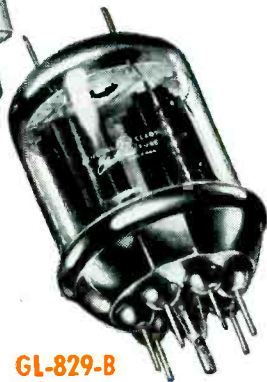

GL-829-B



GL-813

DESIGNERS of equipment give first place to General Electric beam power *economy* tubes. Their low drive requirements — a characteristic of this type — pay off in less space needed for the driving stages of a transmitter. That's Saving No. 1! And drain on the battery or other source of power supply is reduced . . . Saving No. 2.

If you operate police, taxicab, or ambulance radio equipment — if you maintain an airport, ship-to-shore, or other communications system — the benefits of a more compact transmitter and lower power consumption are matched by G-E tube dependability. These beam power types are amply proved in tough service!

A complete line of General Electric tubes is available, spanning the range of outputs and frequencies in communications work. Designers and builders of equipment, through their nearby G-E electronics office, may call on experienced G-E tube engineers to help select the right types for new circuits.

Transmitter owners will find that same-day, often same-hour service is given by their local G-E distributor on tube replacements. From coast to coast, stocks are in readiness for *your* emergency call! Get to know your G-E tube distributor; he's equipped to serve you fast . . . and well! *General Electric Company, Electronics Department, Schenectady 5, New York.*



Photo by courtesy N. Y. State Police

Ratings (ICAS) for typical operation, Class C plate-modulated					
Type	Plate voltage	Plate current	Driving power (approx)	Power output (approx)	Freq. at max ratings
GL-2E26	500 v	54 ma	0.15 w	18 w	125 mc
GL-807	600 v	100 ma	0.4 w	42.5 w	60 mc
GL-829-B	600 v	150 ma	0.9 w	70 w	200 mc
GL-813	2,000 v	200 ma	4.3 w	300 w	30 mc

GENERAL  ELECTRIC

180-H4

FIRST AND GREATEST NAME IN ELECTRONICS

AIR makes the BIG DIFFERENCE



in *Federal's* **INTELIN K-109** Crimped Type Coaxial Cable

Offering a Unique
Combination of Low
Capacitance and
Effective Shielding for

- PERMANENT AUTOMOTIVE LEAD-INS
- INTERSTAGE HF COUPLINGS
- HF TEST EQUIPMENT CONNECTIONS

AIR is the secret of this greatly improved, noise-free, ready-made automobile lead-in.

Federal's new production technique of crimping makes important use of the very low dielectric constant of air to obtain the low capacitance of Intelin K-109. The diagram shows the zig-zag crimp of the conductor—self-supported in air by equally spaced contacts with the polyethylene tube.

This ingenious device of introducing air in the cable dielectric makes it possible to shield Intelin K-109 and still maintain low loss and low capacitance. Thus, K-109 provides good impedance match—between antenna and receiver. This unique combination increases

gain in the antenna coil for better reception . . . with improved signal-to-noise ratio.

Crimping, moreover, gives K-109 the mechanical flexibility of a buggy whip. Spring action of the crimp soaks up vibration—so the conductor won't break away from terminals.

The same electrical and mechanical characteristics can be used to advantage wherever there may be HF requirements of low loss and low capacitance *plus* effective shielding. Already Intelin K-109 is finding applications in HF test equipment . . . interstage HF couplings . . . other vital connections in electronic equipment. For information and prices, write to Department D-813.



Federal Telephone and Radio Corporation

SELENIUM and INTELIN DIVISION, 900 Passaic Ave., East Newark, New Jersey

In Canada: Federal Electric Manufacturing Company, Ltd., Montreal, P. Q.
Export Distributors: International Standard Electric Corp. 67 Broad St., N. Y.

KEEPING FEDERAL YEARS AHEAD... is IT&T's world-wide research and engineering organization, of which the Federal Telecommunication Laboratories, Nutley, N. J., is a unit.

SMALLER, LIGHTER, LESS EXPENSIVE HIGH VOLTAGE D-C CAPACITORS

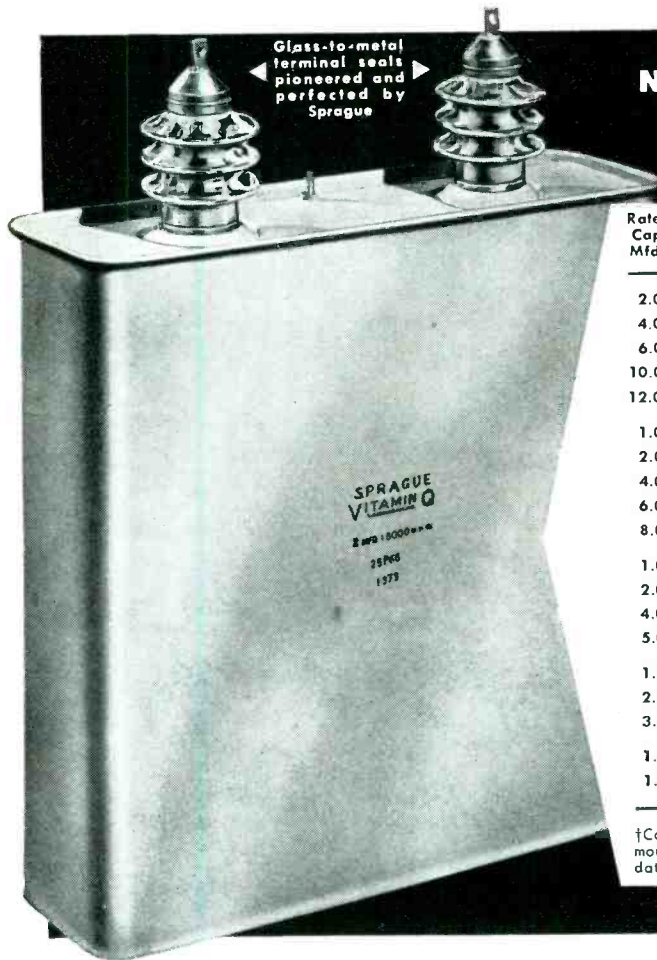

NOTE THE SIZES AND RATINGS!

Standard Vitamin Q Capacitors. Many special sizes and ratings also available.

Rated Cap. Mfds.	D-C† Rated Voltage	Width	Depth	DIMENSIONS		Cat. No.
				Can Height	Terminal Height	
2.0	8000	8½	4½	6	2¼	25P51
4.0	8000	8½	4½	9¼	2¼	25P52
6.0	8000	8½	4½	13	2¼	25P53
10.0	8000	13½	4¼	13½	2¼	25P54
12.0	8000	13½	5¼	12¼	2¼	25P55
1.0	10000	8½	4½	5½	3⅛	25P56
2.0	10000	8½	4½	8½	3⅛	25P57
4.0	10000	13½	4¼	9¼	3⅛	25P58
6.0	10000	13½	4¼	13½	3⅛	25P59
8.0	10000	13½	5¼	12¾	3⅛	25P60
1.0	12500	8½	4½	7½	3⅛	25P61
2.0	12500	8½	4½	12¼	3⅛	25P62
4.0	12500	13½	5¼	11½	3⅛	25P63
5.0	12500	13½	5¼	13¾	3⅛	25P64
1.0	16000	8½	4½	10½	4⅛	25P65
2.0	16000	13½	4¼	12¼	4⅛	25P66
3.0	16000	13½	5¼	13¾	4⅛	25P67
1.0	20000	13½	4¼	11	4⅛	25P68
1.5	20000	13½	5¼	12¼	4⅛	25P69

†Capacitors with voltage ratings above 10 KV are recommended for upright mounting only. For mounting in other positions, please supply complete application data for recommendation by Sprague engineers.

USE an ordinary capacitor rated for 40°C. operation on a high-voltage d-c filtering circuit and chances are the higher temperatures encountered will necessitate a serious de-rating. In other words, you will have to buy a larger, heavier and costlier capacitor than you actually need.

Standard Sprague high-voltage capacitors impregnated with Vitamin Q, however, are rated conservatively for operation at 85°C. They require no de-rating up to this temperature. Special units can be supplied for continuous use up to 105°C.

These capacitors are consistently superior in their ability to maintain a high degree of capacitance-temperature stability. Power factor is outstandingly low over a wide temperature range; d-c insulation resistance is notably high; and a-c ripple voltage at audio frequencies falls well within permissible limits. Equally important, Vitamin Q impregnated capacitors have a high safety factor at all temperatures, thus assuring long life.

Write for Sprague Engineering Bulletin 203.

SPRAGUE VITAMIN Q* CAPACITORS

*Reg. U.S. Pat. Off.

SPRAGUE ELECTRIC COMPANY • NORTH ADAMS, MASS.

Centralab reports to

JUNE, 1949

How Motorola uses Centralab's P.E.C. to help build more and finer TV receivers than ever before!

Arrow points to Centralab's Couplate which Motorola engineers are using to save space and cut assembling time of their new TV models.

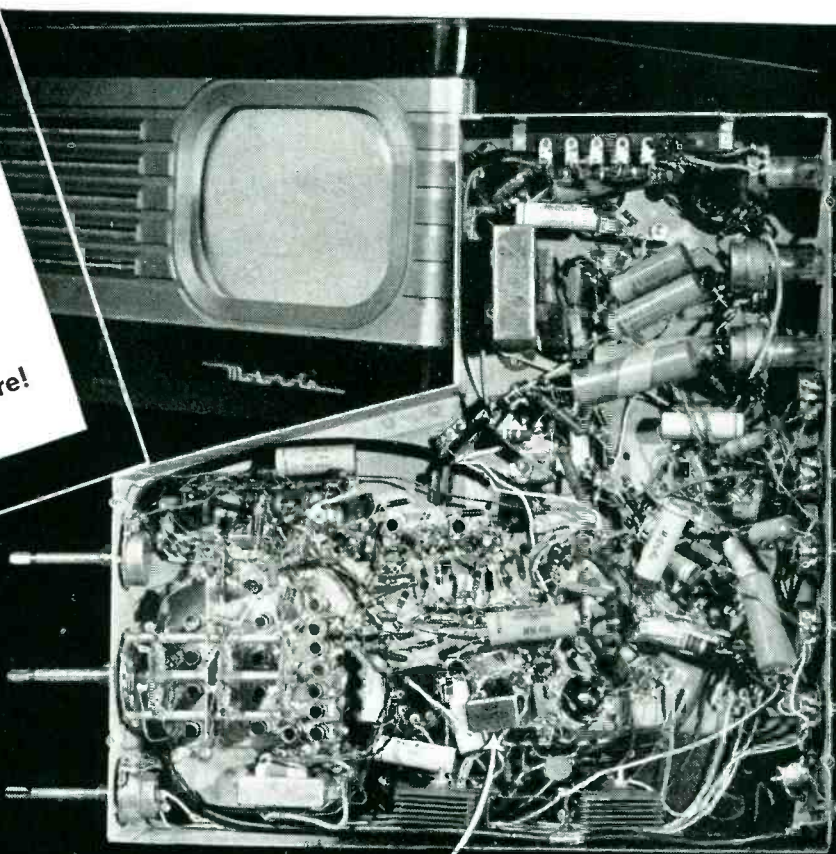

...basis courtesy of Motorola Corp.

1 Speeded production and finer products go hand in hand where CRL's amazing *Printed Electronic Circuit* is concerned. Take the case of Motorola's new TV sets. Engineers at Motorola find that CRL's *Couplate* — a printed interstage coupling plate — saves

production time by cutting in half the number of soldered connections... speeds assembly by simplifying wiring operations. They also find it helps produce finer receivers by eliminating loose or broken connections—from plate load resistor to coupling capacitor.

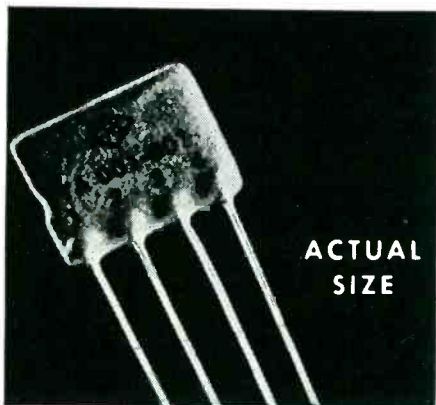

ACTUAL SIZE

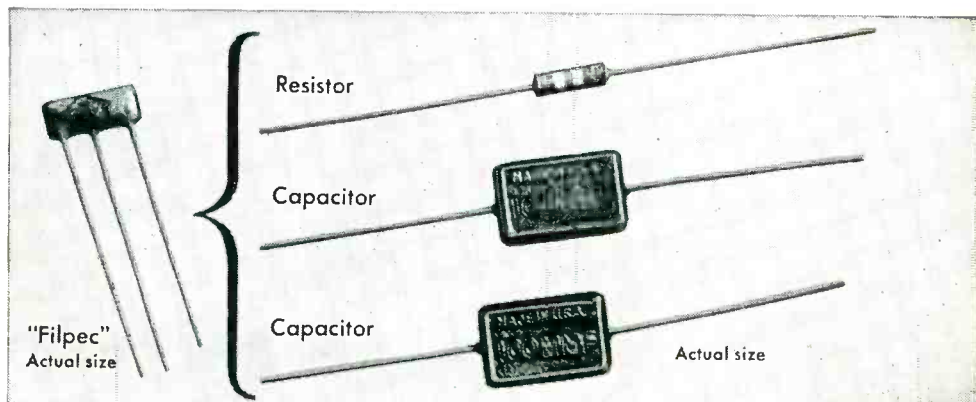

2 CRL's *Couplate* consists of a plate lead resistor, grid resistor, plate by pass capacitor and coupling capacitor. Write for Bulletin 42-6.

3 Centralab's *Filpec* is designed for use as a balanced diode load filter, combines up to three major components into one tiny unit, lighter and smaller than one ordinary capacitor. Capacitor values from 50 to 200 mmf. Resistor values from 5 ohms to 5 megohms. For complete information, write for Bulletin 42-9.

Electronic Industry

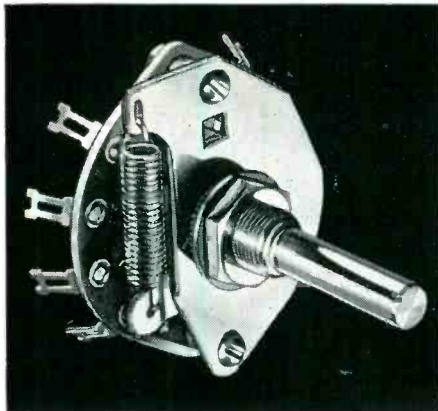

4 Great step forward in switching is CRL's New *Rotary Coil and Cam Index Switch*. Its coil spring gives you smoother action, longer life.

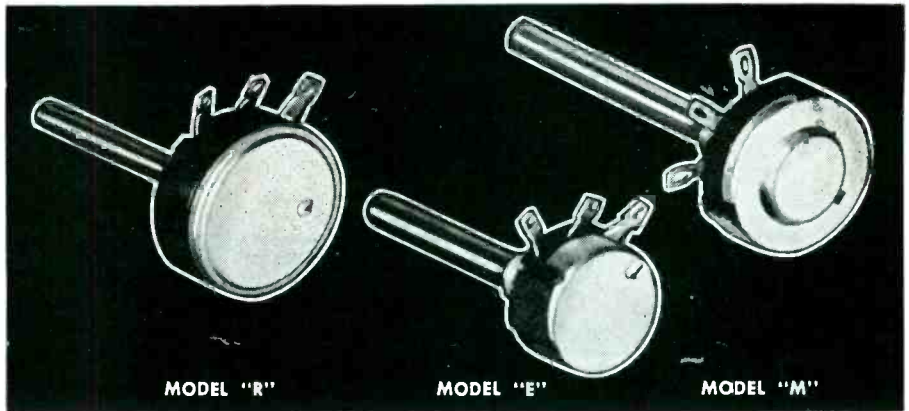

5 Let Centralab's complete *Radiobm* line take care of your special needs. Wide range of variations: *Model "R"* — wire wound, 3 watts; or composition type, 1 watt. *Model "E"* — composition type, 1/4 watt. Direct contact, 6 resistance tapers. *Model "M"* — composition type, 1/2 watt. Write for Bulletin 697.

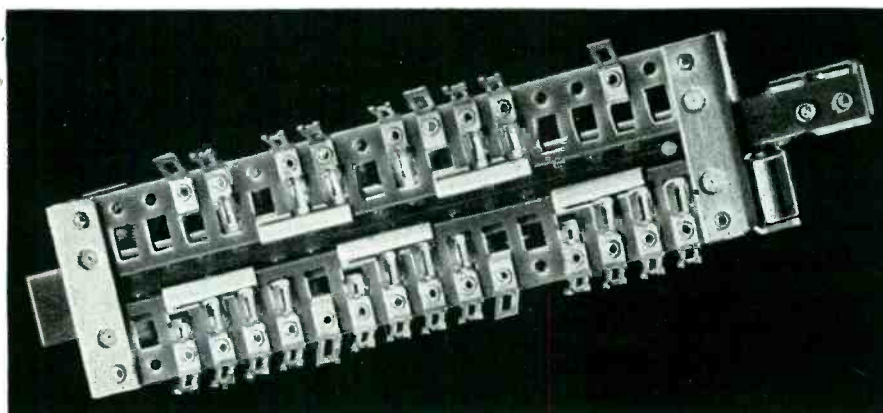

6 Centralab's development of a revolutionary, new *Slide Switch* promises improved AM and FM performance! Flat, horizontal design saves valuable space, allows short leads, convenient location to coils, reduced lead inductances for increased efficiency in low and high frequencies. Rugged, efficient. Write for Bulletin 953.

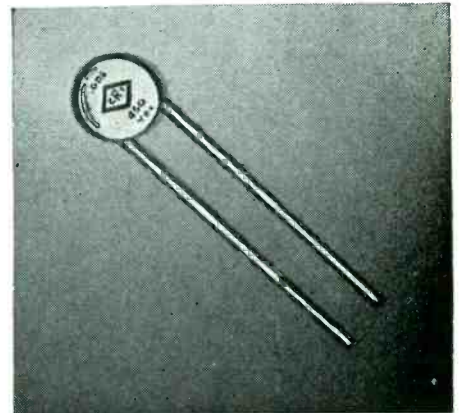

7 For by-pass or coupling applications, check CRL's original line of ceramic disc and tubular *Hi-Kaps*. For full facts, order Bulletins 42-3 and 42-4.

LOOK TO CENTRALAB IN 1949! *First in component research that means lower costs for the electronic industry. If you're planning new equipment, let Centralab's sales and engineering service work with you. Get in touch with Centralab!*

Centralab

DIVISION OF GLOBE-UNION INC., MILWAUKEE, WIS.



A
125,000 SQ. MILE
BLANKET!

The most powerful FM installation in the world recently completed on Red Mountain near Birmingham, Alabama for Station WBRC-FM brings static-free entertainment to residents in a transmission radius of 200 miles.

Important to this installation is the 450 ft. Blaw-Knox type N-28 heavy-duty tower supporting the 8-section Pylon FM antenna. Sturdy, safe and backed by the many years of Blaw-Knox design and engineering in the radio field, it will enable this great new FM Voice of the South to utilize the full capacity of its modern facilities.

BLAW-KNOX DIVISION of Blaw-Knox Company
2077 Farmers Bank Building, Pittsburgh 22, Pa.

BLAW KNOX



BLAW-KNOX
ANTENNA TOWERS

OHMITE HIGH-CURRENT TAP SWITCHES

preferred
OVER EVERY OTHER MAKE

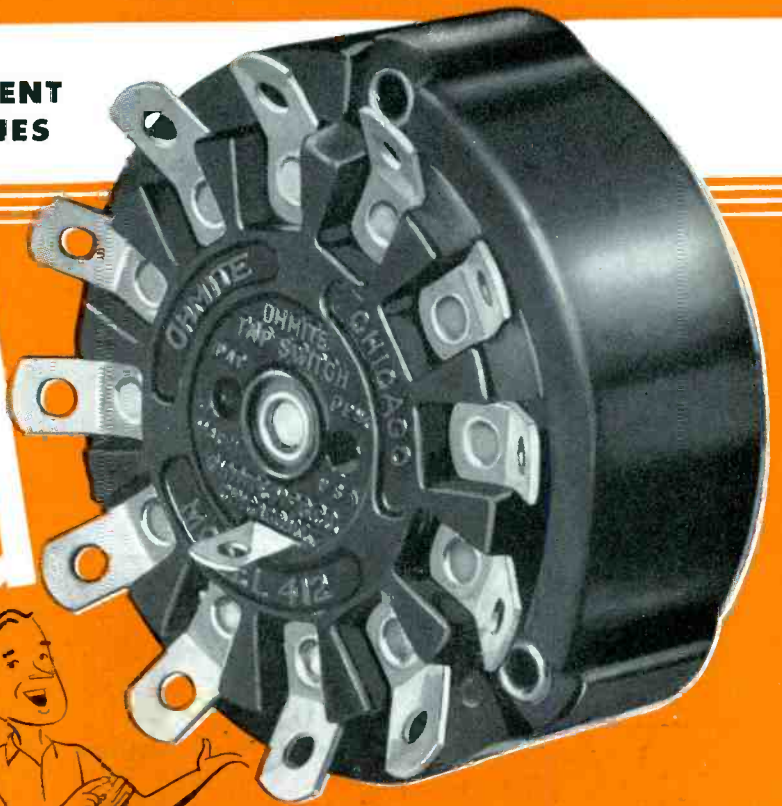

- **COMPACT**
- **CONVENIENT**
- **DEPENDABLE**

Where high-current, non-shorting tap switches are required, scores of equipment manufacturers prefer Ohmite over all others . . .

Because Ohmite tap switches combine high-current capacity and a large number of taps with unusual compactness . . .

Because their sturdy one-piece ceramic bodies provide permanent *non-arcing* insulation . . .

Because their heavy silver-to-silver contacts have a self-cleaning action . . . and provide continuous, dependable contact with low resistance . . .

Because their cam-and-roller mechanism has a positive "slow-break, quick-make" action—particularly suited for alternating current.

That's why more Ohmite high-current tap switches are purchased than all other makes combined . . . and why it will pay you to standardize on Ohmite in your product.

In addition to the types and sizes illustrated, Ohmite tap switches are supplied in open, all-ceramic, shorting and non-shorting types. All

AMPS.	MODEL No.	MAX. V. (A-C)	No. TAPS
10	111	150	2 to 11
15	212	150	2 to 12
25	312	300*	2 to 12
50	412	300*	2 to 12
100	608	300	2 to 8

*150 volts between taps

Ohmite tap switches can be mounted in tandem for multiple-pole operation.

Write on company letterhead for Ohmite Catalog and Engineering Manual No. 40.

OHMITE MANUFACTURING CO., 4818 W. Flournoy St., Chicago 44, Ill.

FIVE SIZES

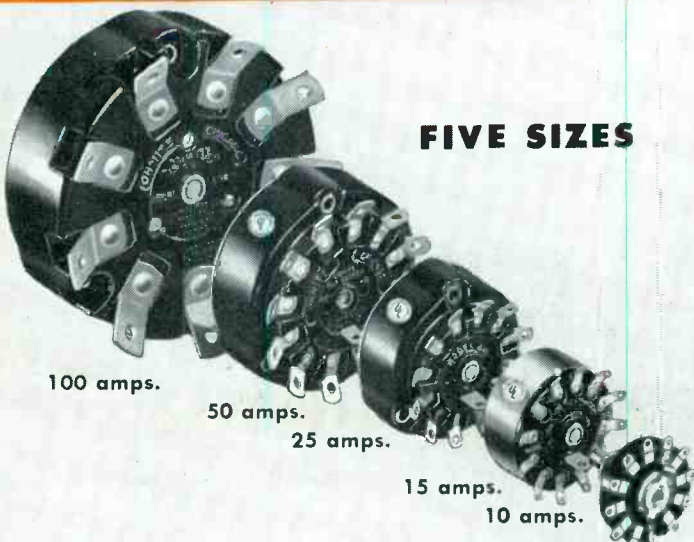

100 amps.

50 amps.

25 amps.

15 amps.

10 amps.

Be Right with...

OHMITE

RHEOSTATS • RESISTORS

TAP SWITCHES

Industry's first choice

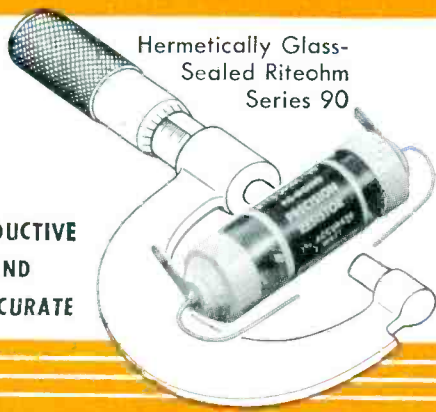

Hermetically Glass-Sealed Riteohm Series 90

NON-INDUCTIVE
PIE WOUND
±1% ACCURATE

For Accuracy... **OHMITE** RITEOHM PRECISION RESISTORS

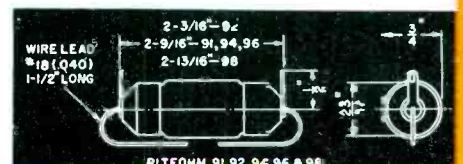
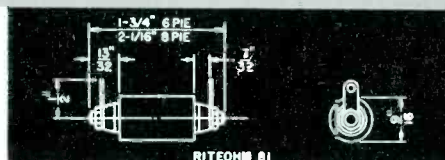
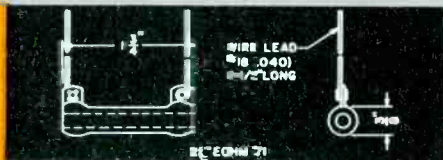
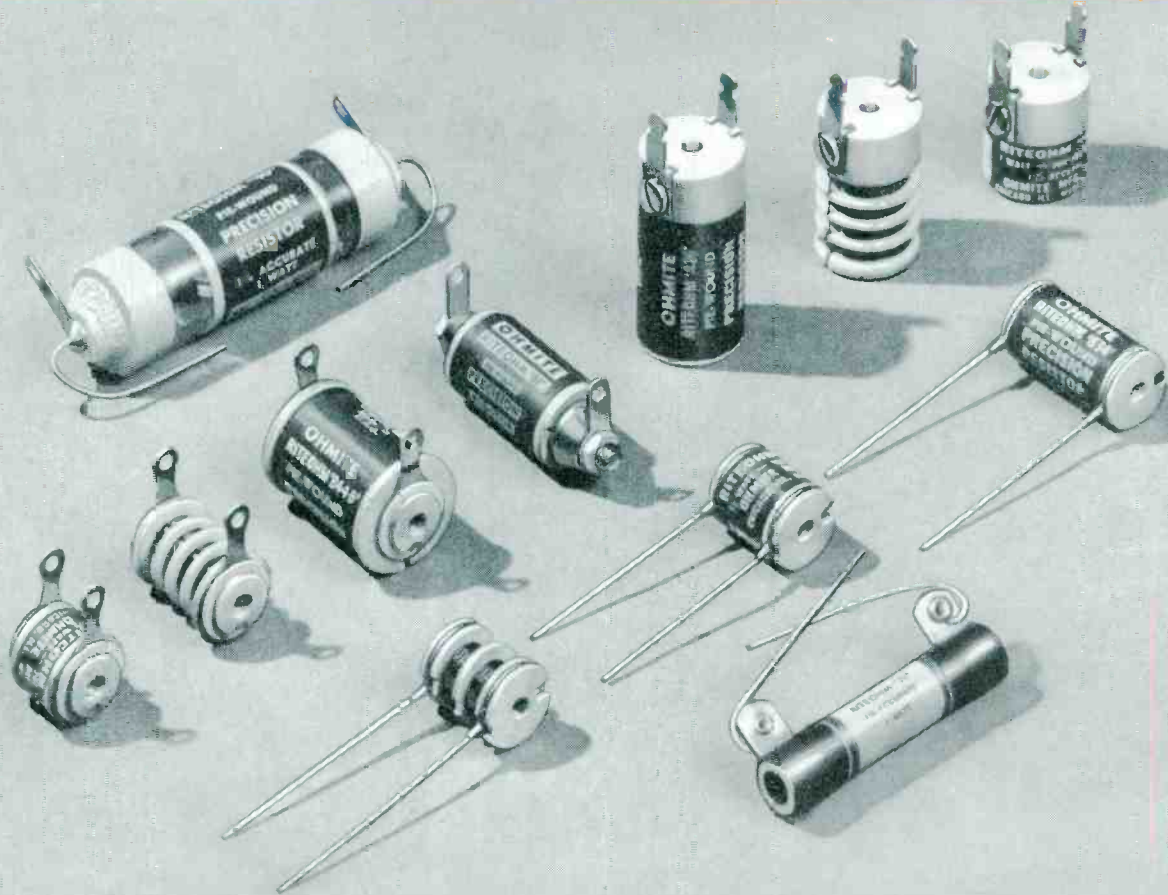

However critical the application, Ohmite Riteohm Precision Resistors assure reliability and consistent accuracy. They are ideal for use in voltmeter multipliers, laboratory equipment, test sets, and in elec-

tronic devices requiring extremely accurate resistance components. Available from stock in 1/2-watt and 1-watt units in a wide range of values and types... or made to order... as listed in Bulletin 126.

Write for Ohmite Precision
Resistor Bulletin No. 126

OHMITE MFG. CO.
4818 Flournoy St., Chicago 44

Be Right with...

OHMITE
RHEOSTATS • RESISTORS • TAP SWITCHES

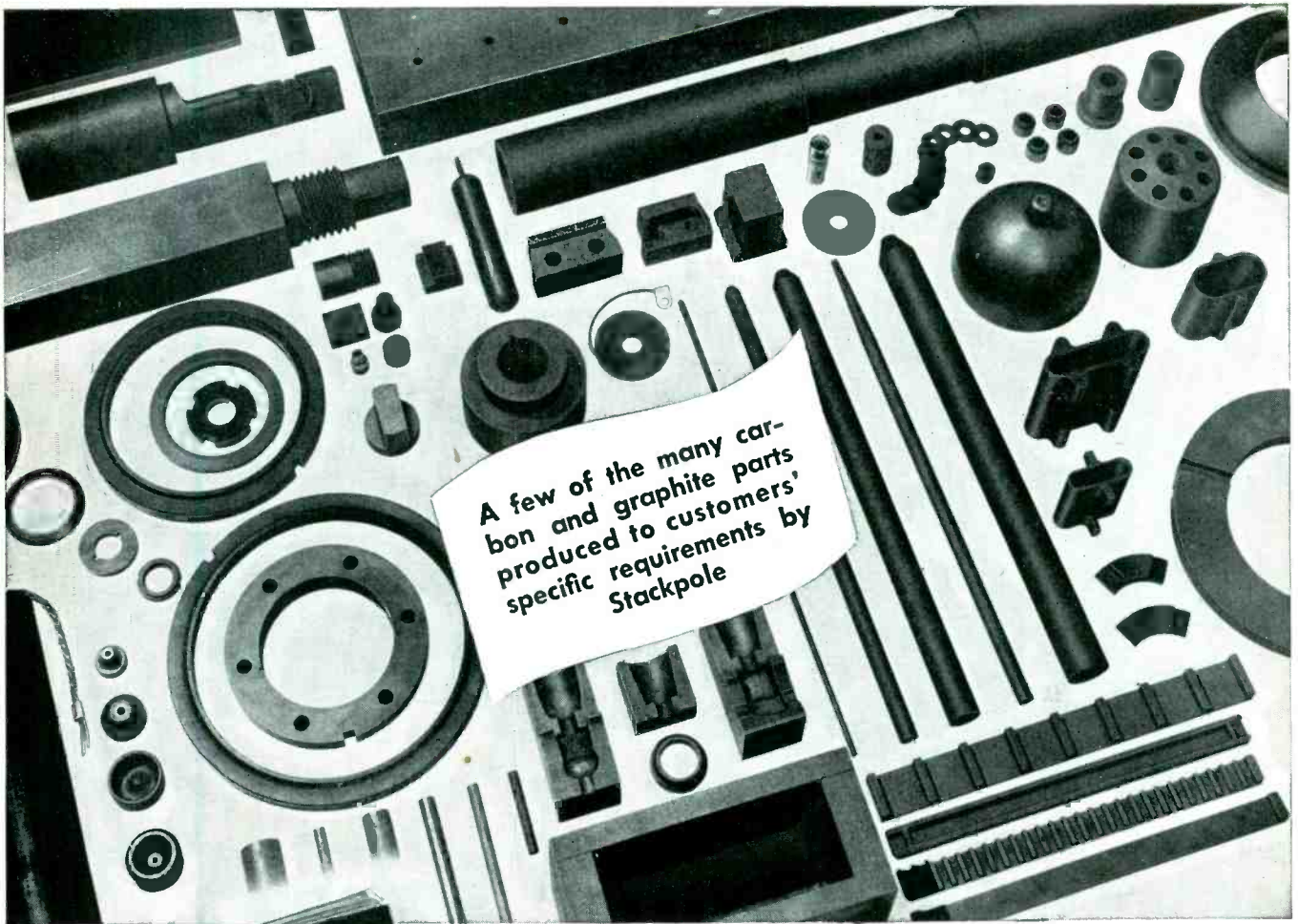

A few of the many carbon and graphite parts produced to customers' specific requirements by Stackpole

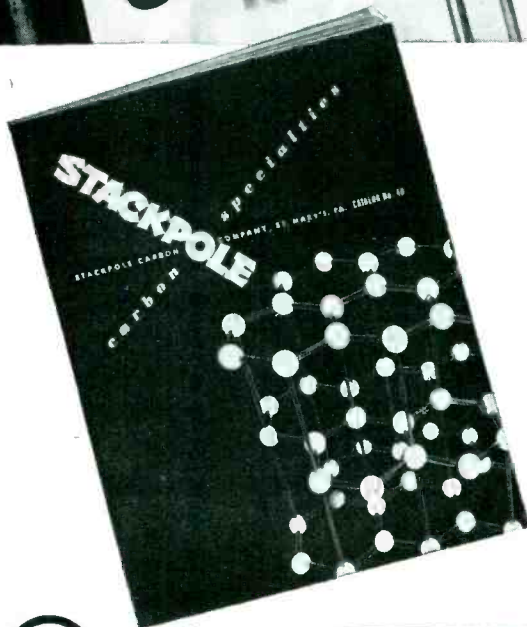

STACKPOLE

CARBON and GRAPHITE SPECIALTIES

Carbon and Graphite have been termed "the most flexible of Mother Nature's materials". . . and for more than two decades, Stackpole has been proving the accuracy of this statement as applied to engineering problems involving friction, temperature, arcing, corrosion, shaft sealing and other related factors. Stackpole will be glad to work with you and your organization on any specific problem which carbon, graphite or powdered metal specialties might help solve.

STACKPOLE CARBON COMPANY • ST. MARYS, PA.

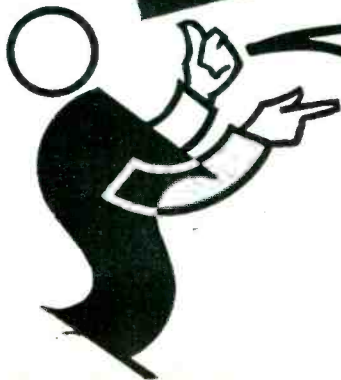

**WRITE
FOR THIS BIG
CARBON-
GRAPHITE
BOOK**

Far more than being a mere catalog, the Stackpole CARBON SPECIALTIES BOOK contains a wealth of detailed information that should prove invaluable in helping you evaluate the unique possibilities of carbon, graphite, and powdered metal materials in solving a wide range of engineering and production problems. Write for your copy today using your company letterhead. Ask for Booklet No. 40.

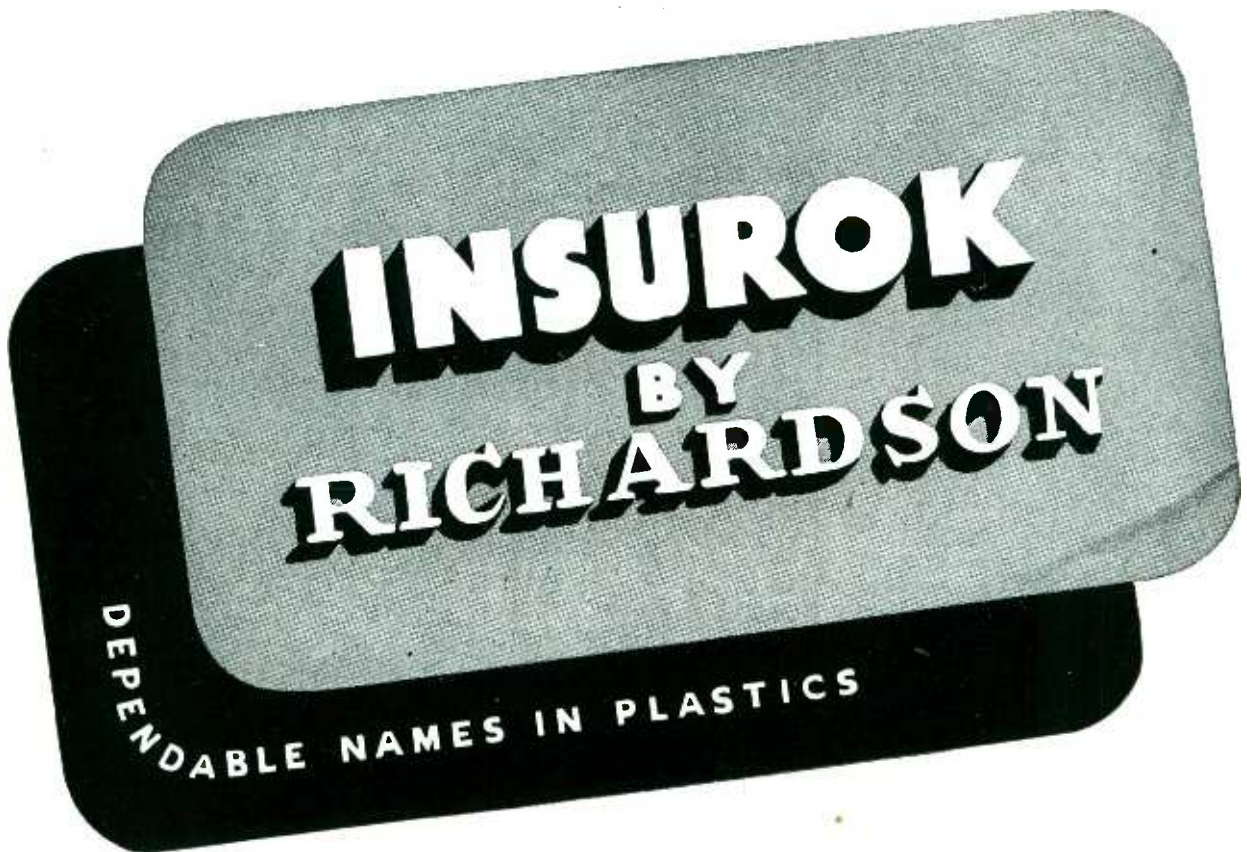

WORTHWHILE EXTRAS

We've learned over the years that "extra" precautions pay big dividends for our customers in the planning and production of parts from Laminated and Molded INSUROK. For example:

Richardson suggestions have led many customers to alter their original designs and/or materials specifications and thus obtain plastic parts better suited to the job at hand, at lower costs.

And Richardson production experience has, in many cases, pointed the way to substantial savings and advantages for customers.

These and other Richardson "extras" are not

specified on customers' purchase orders, but you get all of them . . . every time. Why? Simply because we've found that these extras make friends for us, and hold friends over the years.

If you now use, or contemplate using plastics, we sincerely believe you want and need considerate and experienced handling of your requirements. And we invite you to look, with confidence, to The Richardson Company for your needs in plastics.

Why not send us specifications today? Learn without obligation how Richardson would handle your next need for plastics.

*INSUROK is a registered
trade-mark of
The Richardson Company*

The **RICHARDSON COMPANY**

GENERAL OFFICES: LOCKLAND, OHIO

FOUNDED IN 1858

Sales Headquarters: MELROSE PARK, ILLINOIS

CLEVELAND • DETROIT • INDIANAPOLIS • MILWAUKEE • NEW BRUNSWICK, (N. J.) • NEW YORK • PHILADELPHIA • ROCHESTER • ST. LOUIS

Check YOUR NETWORK PROBLEM WITH LOGIC

In any technical business the specialist has a unique value in his specific field. It is logical that a manufacturer of a specialty product should be of greater value in his particular field.

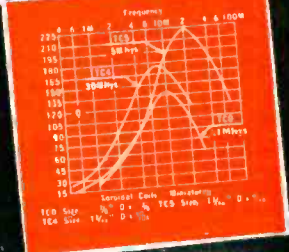
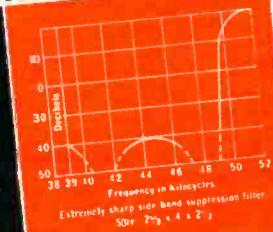
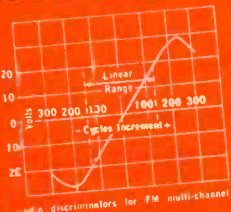
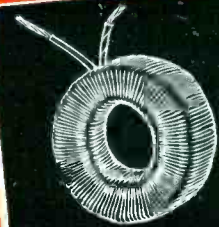
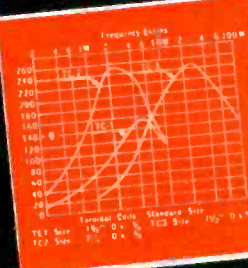
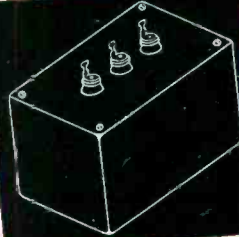
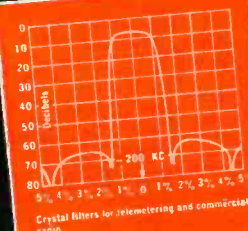
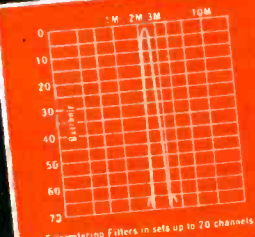
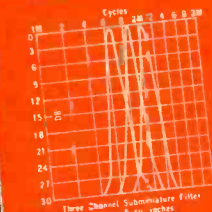
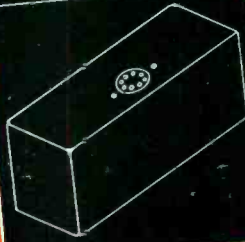
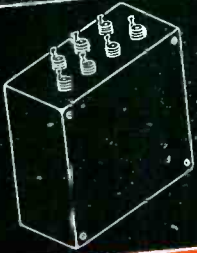

As one of the largest producers of toroidal coils and filters Burnell & Co's facilities and production experience have been of immeasurable technical and economical value to our customers. Many engineers have benefited by our prompt technical service. Why not bring your network problem to us for the most practical and economical solution?

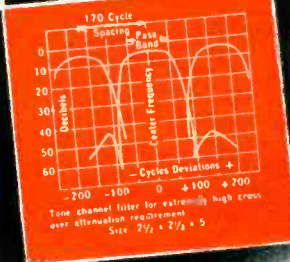
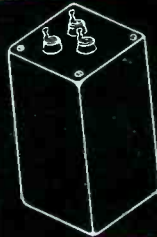

EXCLUSIVE MANUFACTURERS OF COMMUNICATIONS NETWORK COMPONENTS

WRITE FOR TECHNICAL INFORMATION
ALL INQUIRIES WILL BE PROMPTLY HANDLED

Burnell & Company
YONKERS 2, NEW YORK
CABLE ADDRESS "BURNELL"



▲ One of the Magnetrons made by Raytheon Manufacturing Co., Waltham, Mass. Most of the parts shown in the foreground are OFHC Copper.

Raytheon uses OFHC COPPER exclusively



Raytheon magnetron used in the "Microtherm," the microwave diathermy equipment.



Raytheon magnetron used in the "Rad-range" for swift cooking by microwaves.



One of the Raytheon magnetrons used in airborne radar apparatus.

● So important is OFHC in the manufacture of vacuum tubes that Raytheon will have no other copper in its plant. Thus there is no danger of getting it mixed up accidentally with other types. This copper (Oxygen-Free, High Conductivity) carries a premium, but it is well worth it, since some of the completed tubes cost between \$2,000 and \$3,000 each, and the wrong metal could ruin one quickly. OFHC copper has a number of important qualities that are essential in vacuum tubes. Its freedom from oxygen protects the vacuum. Its conductivity of electricity and heat play a part in tube efficiency. It seals to glass perfectly, and can be machined and rolled down to the .0025" edge that is necessary for that purpose. Copper segments which make up the cavity of the magnetron are brazed together in a hydrogen atmosphere, in

which oxygen would be detrimental... For its own part, Revere takes the greatest care to segregate OFHC copper in processing. Each lot and shipment is kept separate, and personally conducted through the mill. When you order OFHC from Revere you can be sure of getting it... The Revere Technical advisory service collaborates frequently with Raytheon, and will gladly work with you.

REVERE

COPPER AND BRASS INCORPORATED
Founded by Paul Revere in 1801
230 Park Avenue, New York 17, N. Y.

Mills: Baltimore, Md.; Chicago, Ill.;
Detroit, Mich.; Los Angeles and Riverside, Calif.;
New Bedford, Mass.; Rome, N. Y.
Sales Offices in Principal Cities,
Distributors Everywhere.

PROGRESS REPORT ON P. E. C.*

How Admiral is using CRL's new
"P. E. C." *Vertical Integrator Network* to
help build more and finer
television sets

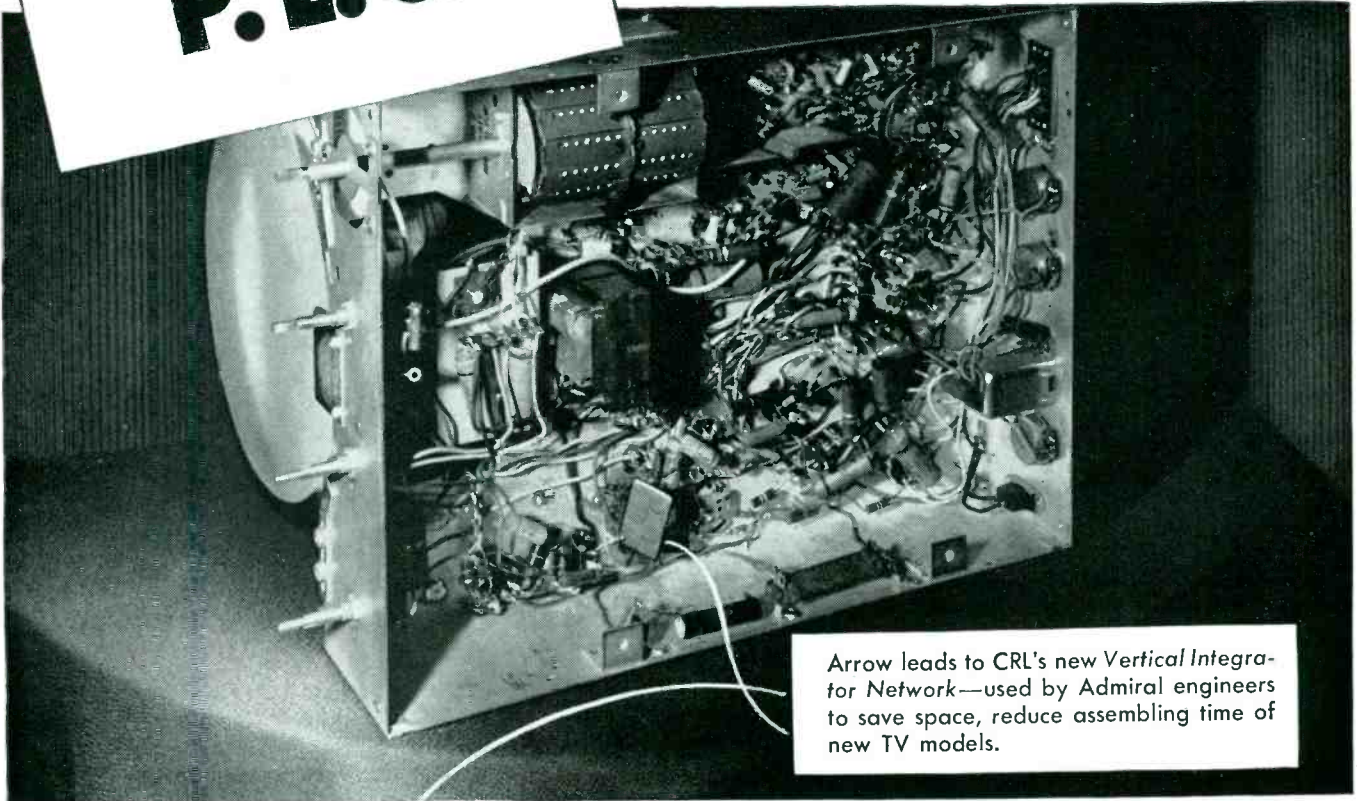

Arrow leads to CRL's new *Vertical Integrator Network*—used by Admiral engineers to save space, reduce assembling time of new TV models.

Chassis courtesy of Admiral Corp.

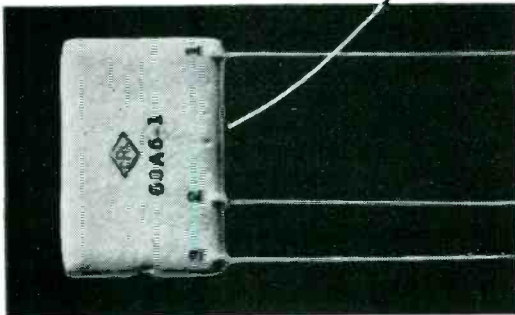

This is the new CRL *Vertical Integrator Network* used by Admiral, variations of which are available on special order. Circuit diagram of "network" used in new Admiral TV sets is shown below.

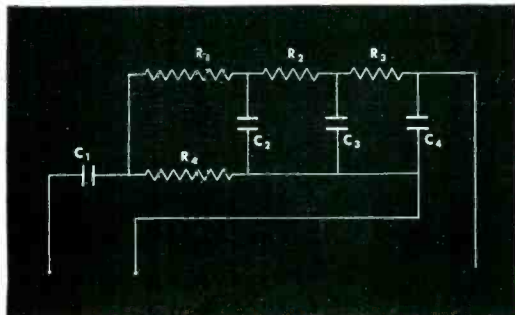

***Centralab's "Printed Electronic Circuit"**
— Industry's newest method for improving
design and manufacturing efficiency!

WHEREVER Centralab's revolutionary Printed Electronic Circuits are used, you are sure to find speeded production . . . quality products. Just look at Admiral Corporation's fine new television receivers. A series of Admiral's video sets makes use of CRL's *Vertical Integrator Network*—a tiny, compact plate containing both capacitors and resistors. It saves production time . . . reduces sixteen soldered connections to three. Simplifies wiring operations for faster assembly. What's more, the *Network* helps produce better TV receivers . . . practically eliminates loose or broken connections.

Integral Ceramic Construction: Each *Printed Electronic Circuit* is an integral assembly of *Hi-Kap* capacitors and resistors closely bonded to a steatite ceramic plate and mutually connected by means of metallic silver paths "printed" on the base plate.

For complete information about the *Network* as well as other CRL Printed Electronic Circuits, see your nearest Centralab representative, or write direct.

LOOK TO **Centralab** IN 1949!

Division of GLOBE-UNION INC., Milwaukee

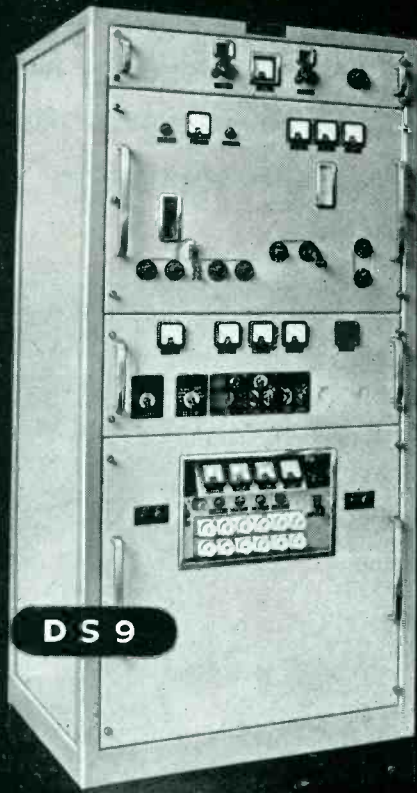

DS9

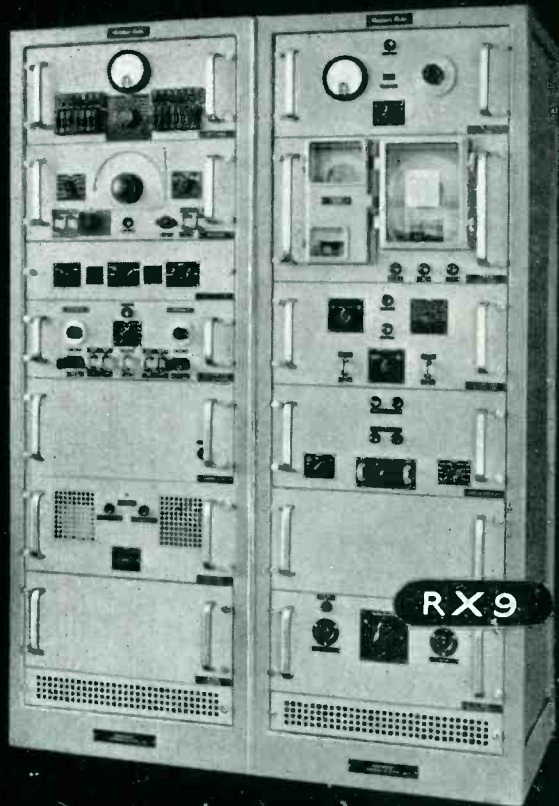

RX9

LOW POWER SINGLE SIDEBAND RADIO SYSTEM

The *Standard* DS9 Transmitter and RX9 Receiver at last make it possible to plan the *shorter* H.F. radio links to give the higher reliability, better quality and increased number of channels which characterize the Single Sideband System.

Type DS9 Single Sideband Radio Transmitter
Frequency Range 4—22 Mc/s. Power Output 300 watts. Two independent sidebands with reduced carrier. Total sideband width adequate for 3 telephone channels, many teleprinter channels or various combinations of telephone and teleprinter. Sideband generating equipment built into transmitter. Compact design and rugged construction with maximum accessibility from the front only.

Type RX9 Single Sideband Radio Receiver
Frequency range 4—25 Mc/s. Independent sideband single sideband and double sideband reception. Crystal selectivity combined with sideband acceptance matching DS9 transmitter. Precision automatic frequency control. Full front accessibility using withdrawable and tilting units for maximum ease of servicing.

DESIGNED and BUILT by

Standard

Standard Telephones and Cables Limited

RADIO DIVISION

An I. T. & T. associate

OAKLEIGH ROAD · NEW SOUTHGATE · LONDON N11 · ENGLAND

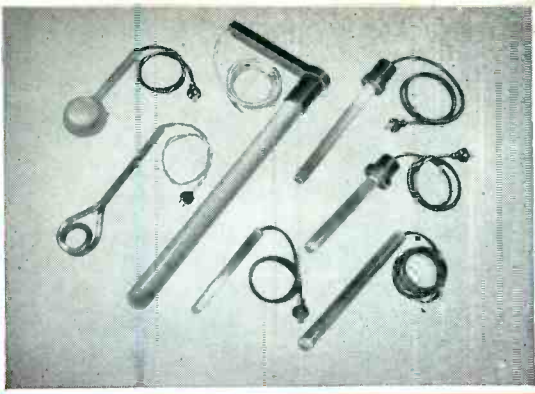

Amersil heaters are available in a variety of shapes and sizes for industrial and laboratory use.

NEW

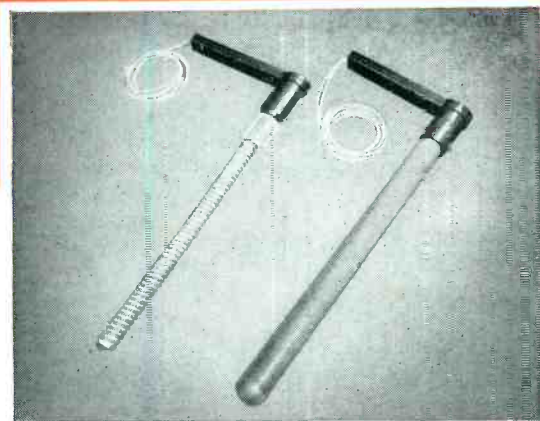

Amersil heater—fused quartz shell, and element wound with high heat and corrosion-resistant Nichrome V.

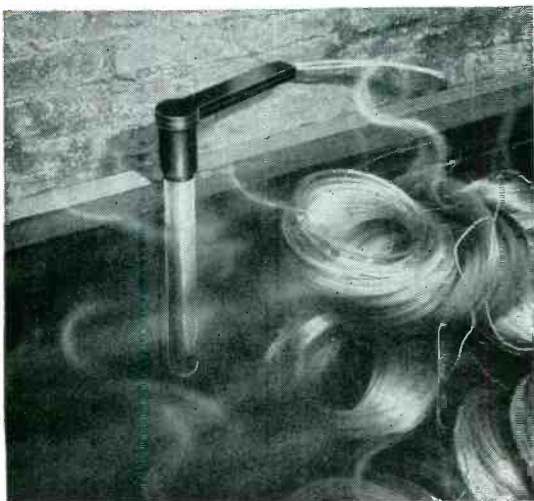

Amersil corrosion-proof immersion heater, heating acid solution in a pickling tank.

SUPERIOR IMMERSION HEATER for corrosive chemicals employs fused quartz and

NICHROME* V

Here is a new and superior unit for heating corrosive chemicals, manufactured by Amersil Company, Inc., Hillside, N. J.

A Nichrome V wire wound heating element is inserted into a shell of opaque fused quartz, which, in turn, is fitted with an acid-proof head or flange for operation in open or pressure sealed tanks.

The fused quartz shell is completely inert to corrosive chemicals, has a high rate of heat transfer, is a good electrical insulator, and is immune to thermal shock.

Since quartz filters out a very small percentage of infra-red heat waves, and the heat source is immersed, almost 100% efficiency is obtained. Moreover, the unusually compact design of the installation offers the added advantage of cutting heater obstruction within the tank to a negligible minimum—permitting freer flow of liquids.

Once the unit is assembled, it is good for a lifetime—because the shell is quartz and the heating element is *high heat and corrosion-resistant* Nichrome V.

This combination of features, makes the Amersil heater superior for service in chemical plant operations involving innumerable corrosive chemical heating problems.

If you have a product whose successful operation depends upon application of an alloy resistant to electrical heat and corrosion, send your specifications to us. In addition to world-famous Nichrome, there are more than 80 other Driver-Harris alloys specifically designed to fill the varied requirements of the electrical and electronic industries.

*Nichrome is manufactured only by

Driver-Harris Company

HARRISON, NEW JERSEY

BRANCHES: Chicago, Detroit, Cleveland, Los Angeles, San Francisco, Seattle

Manufactured and sold in Canada by

The B. GREENING WIRE COMPANY, LTD., Hamilton, Ontario, Canada



*T.M. Reg. U. S. Pat. Off.

BEAT the HEAT

Specify



"NOFLAME-COR"

the TELEVISION hookup wire

APPROVED BY UNDERWRITERS LABORATORIES AT

90° CENTIGRADE _____ **600** VOLTS

Preferred by leading producers of television, F-M, quality radio and all exacting electronic equipment. All sizes, solid and stranded; over 200 color combinations.

Production Engineers: Avoid high percentage of line rejects by specifying "NOFLAME-COR" (not an extruded plastic). Insulation does not "blob" under heat of soldering iron.

- ✓ Flame Resistant
 - ✓ High Dielectric
 - ✓ High Insulation Resistance
 - ✓ Facilitates Positive Soldering
 - ✓ Heat Resistant
 - ✓ Easy Stripping
- ✓ Also unaffected by the heat of impregnation—
therefore, ideal for coil and transformer leads

RUBBER _____ 75°

PLASTIC _____ 80°

"NOFLAME-COR" _____ 90°

"made by engineers for engineers"

CORNISH WIRE COMPANY, Inc.

605 North Michigan Avenue,
Chicago 11

15 Park Row, New York 7, N. Y.

1237 Public Ledger Bldg.,
Philadelphia 6

MANUFACTURERS OF QUALITY WIRES AND CABLES FOR THE ELECTRICAL AND ELECTRONIC INDUSTRIES



COMPONENTS

Specified by

The Leaders in Radio-TV & Communications

Emerson

FADA

Bendix Radio

Motorola



Admiral

RCA VICTOR

Packard-Bell

Magnavox

Farnsworth

CROSLEY

Andrea

Tele-tone

DUMONT

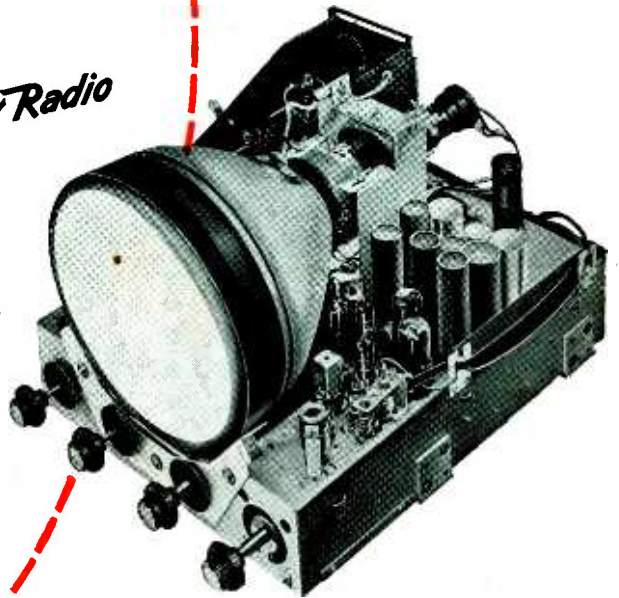

Chassis of the popular EMERSON Model 611 Television set. **HI-Q** components contribute their part to dependable operation.

—and many others too numerous to list in this limited space.

Hi-Q COMPONENTS
BETTER 4 WAYS

PRECISION Tested step by step from raw material to finished product. Accuracy guaranteed to your specified tolerance.

UNIFORMITY Constancy of quality is maintained over entire production through continuous manufacturing controls.

DEPENDABILITY Interpret this factor in terms of your customers' satisfaction . . . Year after year of trouble-free performance. Our Hi-Q makes your product better.

MINIATURIZATION The smallest **BIG VALUE** components in the business make possible space saving factors which reduce your production costs . . . increase your profits.

Look at the leaders in Radio, Television and Communications, and you'll find *they* look to **HI-Q** for quality components.

HI-Q engineers have worked closely with many of these companies in the development of electronic components demanded by the ever changing circuits of modern electronics.

These same engineers with their wide experience are available to your company for confidential consultation. Write—wire—or phone. Three (3) plants exclusively devoted to the manufacture of ceramic capacitors, resistors and choke coils assure prompt delivery of your orders.



Electrical Reactance Corp.

FRANKLINVILLE, N. Y.

Plants: FRANKLINVILLE, N. Y. — JESSUP, PA. — MYRTLE BEACH, S. C.
Sales Offices: NEW YORK, PHILADELPHIA, DETROIT, CHICAGO, LOS ANGELES



the first line of STANDARD electronic AC voltage regulators and nobatrons

GENERAL SPECIFICATIONS

- Harmonic distortion : max. 5% basic or 2% "S" models
- Input voltage range: either 95-125 or 190-250 volts
- Output: adjustable between either 110-120 or 220-240 volts
- Input frequency range: 50-60 cycles
- Power factor range: down to 0.7 P. F.

All AC Regulators and Nobatrons may be used at no load.

Special Models designed to meet your unusual applications.

Write for the new Sorensen catalogue. It contains complete specifications on standard Voltage Regulators and Nobatrons.

Special Transformers, D. C. Power Supplies, Saturable Core Reactors and Meter Calibrators made to order; please request information.

SORENSEN & Company, Inc.

Stamford, Connecticut

Represented in all principal cities.

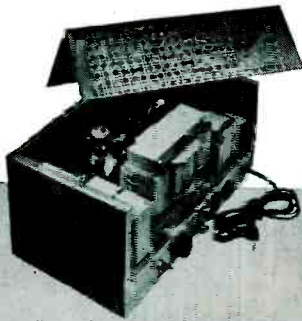

General Application

Model	Load Range Volt-Amperes	*Regulation Accuracy
150	25-150	0.5%
250	25-250	0.2%
500	50-500	0.5%
1000	100-1000	0.2%
2000	200-2000	0.2%

*Models available with increased regulation accuracy.

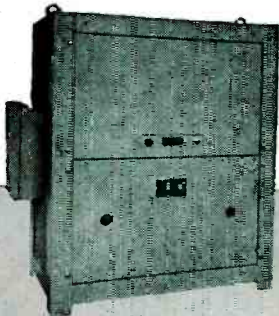

Extra Heavy Loads

Model	Load Range Volt-Amperes	*Regulation Accuracy
3,000	300-3000	0.2%
5,000	500-5000	0.5%
10,000	1000-10,000	0.5%
15,000	1500-15,000	0.5%

*Models available with increased regulation accuracy.

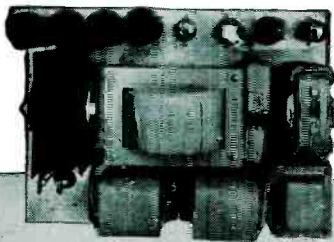

The NOBATRON Line

Output Voltage DC	Load Range Amps.
6	5-15-40-100
12	5-15-50
28	10-30
48	15
125	5-10

Regulation Accuracy—25% from 1/4 to full load.



400 Cycle Line

Inverter and Generator Regulators for Aircraft

Single Phase and Three Phase

Model	Load Range Volt-Amperes.	Reg. Accuracy
D 100	10-100	0.5%
D 500	50-500	0.5%
D 1200	120-1200	0.5%
D 2000	200-2000	0.5%



3-Phase Regulation

Star-connected three-phase systems can be handled effectively. Other three-phase systems must be reviewed by our Engineering Dept. VA Capacities up to 45 KVA.

Federated ROSIN CORE SOLDER

Look for the orange package . . . the universally popular solder for use in electrical applications where bonding must be secure and free from corrosion.

The flux is in the solder . . . all you need is heat! Federated Rosin Core Solder is available in 1, 5, and 20-pound sizes.



Federated makes every commercial solder . . .

Asarco Body Filler Metal, acid-core, solid wire, spray-gun, and bar . . . purity and composition guaranteed by the world's leading supplier of solder.

Federated METALS

Division of AMERICAN SMELTING AND REFINING COMPANY
120 Broadway, New York 5, N. Y.

OFFICES IN PRINCIPAL CITIES ACROSS THE NATION



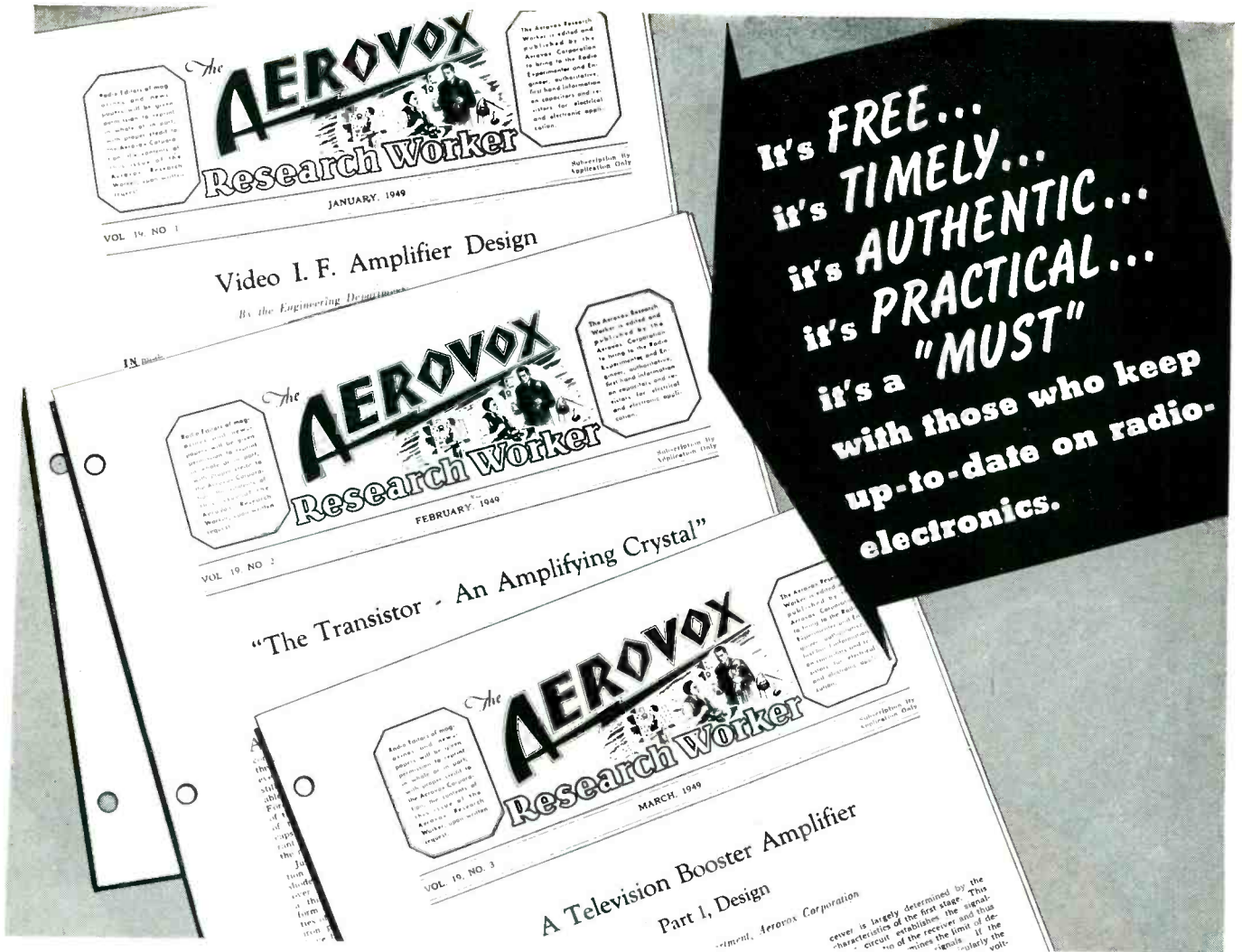

● The Aerovox Research Worker is edited for a specific reader audience—the engineers and designers of radio-electronic equipment. Every page, every word, is directed to the prime interest of this audience. The editorial program is patterned to serve the reader in all phases of the radio-electronic field.

Each monthly issue unfolds a new and useful phase of this round-the-calendar publication which aims to keep you informed on all that is new and significant. The editorial content anticipates the needs and interests of its readers. And it is always authentic.

Timely and practical articles on these subjects are written by men of the Aerovox engi-

neering departments who are authorities in their specialized field. Featured, too, are many helpful suggestions on processes and construction. Every article speaks the language of the reader—is written up to the level of his technical knowledge and training but down to earth in the bedrock fundamentals of the subject discussed.

The Aerovox Research Worker is distributed gratis to all interested parties. To get your FREE subscription, simply write us on your business letterhead.



FOR RADIO-ELECTRONIC AND INDUSTRIAL APPLICATIONS

AEROVOX CORPORATION, NEW BEDFORD, MASS., U.S.A.

SALES OFFICES IN ALL PRINCIPAL CITIES • Export: 13 E. 40th St., NEW YORK 16, N. Y.

Cable: 'ARLAB' • In Canada: AEROVOX CANADA LTD., HAMILTON, ONT.

Single TRUARC ring holds 3 valve rods, saves \$12 production, 10 hours maintenance

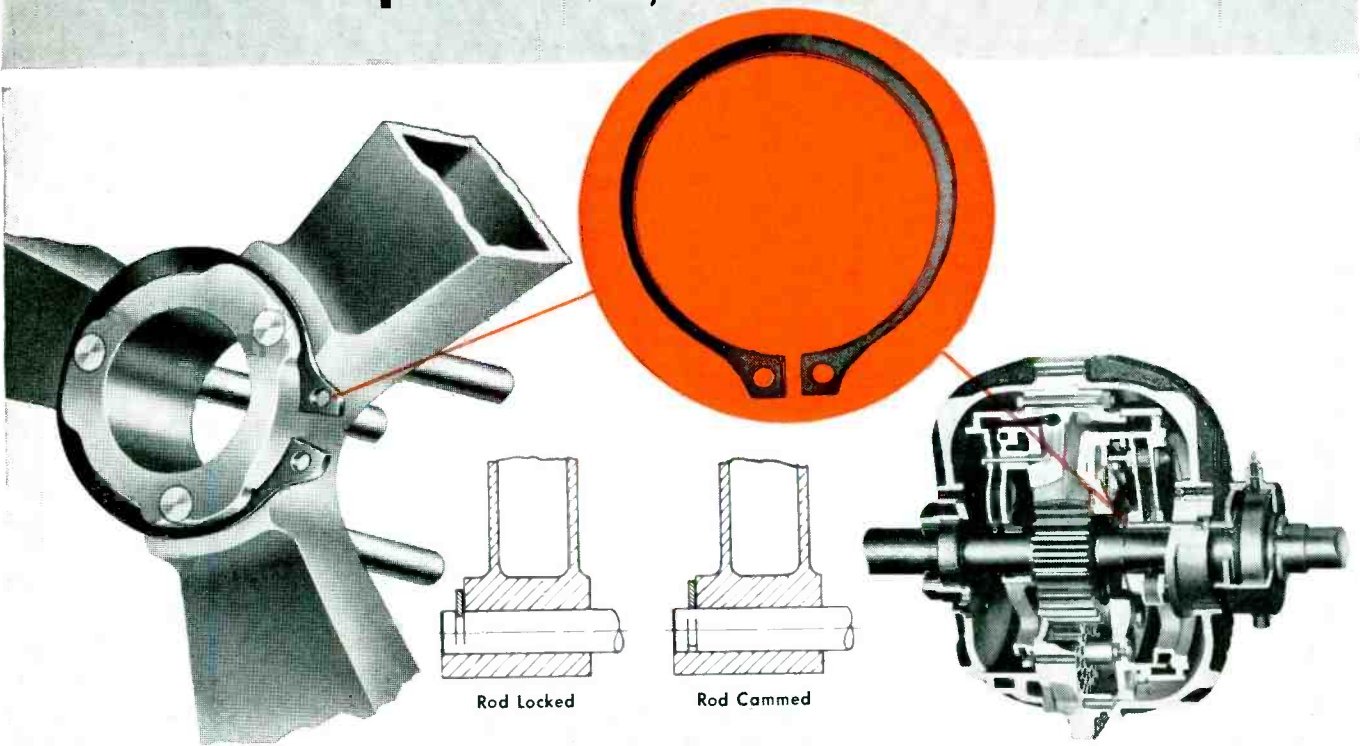

Unique feature of Thomas Varidraulic Drive design is this valve rod assembly, which permits removal and replacement of rods without disassembly of entire unit. One Truarc ring holds three rods, by engaging grooved recesses provided on one side only of each rod. When rotated

180°, rods act like cams . . . spread the ring . . . permit their easy removal. Ends of replacement rods are tapered for easy re-assembly. This design saves an average of 10 man hours of disassembly and assembly time, and eliminates the costly delay of returning the unit to the factory for repair.

Use of 8 Waldes Truarc Retaining Rings in the Varidraulic Drive results in an estimated production saving of \$12.00 per unit, reports Thomas Hydraulic Speed Controls, Inc., of Wichita, Kansas.

Savings in production materials and time, plus simplification of repair procedure with Waldes Truarc Retaining Rings tell only part of the story for Thomas Hydraulic. In their own words: "Considerably less skill is required in numerous machining operations and at assembly of the drive than would have been required if the design did not use Truarc rings.

"Our use of Truarc rings has contributed substan-

tially to a more economical design that permits sound sales pricing. Easier maintenance also provides an additional sales point."

Truarc can cut costs and improve your product, too. Wherever you use machined collars, nuts, bolts, snap rings, cotter pins—there's a Truarc ring that does a better job of holding parts together. Waldes Truarc Retaining Rings are precision-engineered, easy to assemble and dis-assemble. Only Truarc stays circular always, to give you a never-failing grip. Send us your drawings. Waldes Truarc engineers will be glad to show you how Truarc can help you.

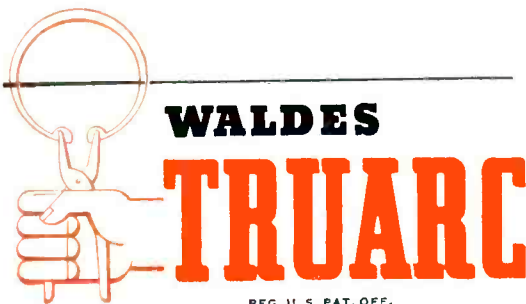

REG. U. S. PAT. OFF.

RETAINING RINGS

WALDES KOHINOOR, INC., LONG ISLAND CITY 1, NEW YORK

WALDES TRUARC RETAINING RINGS ARE PROTECTED BY U. S. PATS. 2,302,948; 2,026,454; 2,416,852 AND OTHER PATS. PEND

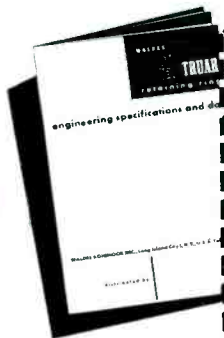

Waldes Kohinoor, Inc., 47-16 Austel Place
Long Island City 1, N. Y.

E-6

Please send 28-page Data Book on Waldes Truarc Retaining Rings.

Name _____

Title _____

Company _____

Business Address _____

City _____ Zone _____ State _____ ★



ELECTRONIC RESEARCH, ENGINEERING AND

REGULATED POWER SUPPLY



TYPE YPD-2

TYPE YPD-2—This G-E Regulated Power Supply is a superior quality, medium power, electronically regulated unit designed for use in laboratories, broadcast stations, and wherever a closely regulated d-c voltage of low ripple content is required.

SPECIFICATIONS:

DC Voltage Output 250-450 volts
DC Current Output 0-300 milliamperes

OTHER UNITS AVAILABLE

- YPD-4: 160-1500 volts.
Current: 0-125 milliamperes.
- PS-4: Dual power supply, each unit supplying 250-400 volts.
Current: 0-400 milliamperes max.
- 4ST1A1: 180-300 volts.
Current: 0-60 milliamperes.

INDUSTRIAL TEST EQUIPMENT



INDUSTRIAL OSCILLOSCOPE TYPE YNA-4—For applications where test equipment is essential for installation and maintenance purposes. Insulated case, sturdy construction, versatile circuits with D-C amplifiers, and good magnetic shielding recommend this oscilloscope for use in industrial and educational laboratories and for production testing.

INDUSTRIAL TUBE ANALYZER TYPE YTW-3—This portable equipment is designed so that non-technical personnel can quickly and efficiently determine the performance of mercury vapor and gas rectifier tubes by measuring the arc drop voltage under load. The periodic testing of rectifier tubes can help prevent equipment failure and loss of operating time.

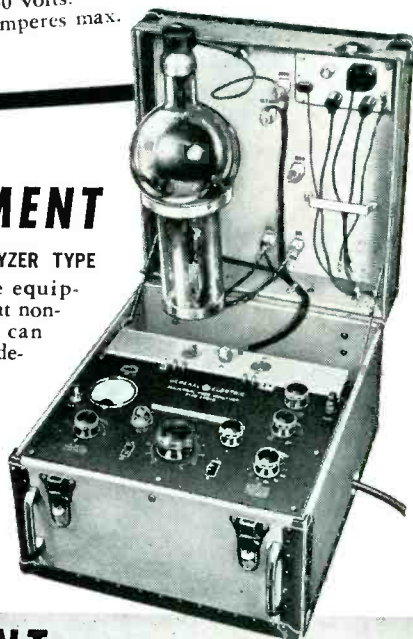

NUCLEONICS EQUIPMENT



BINARY SCALER TYPE 4SN1A1

Provides scale of two in self-contained unit that cuts installation and maintenance to a minimum. Permits flexible installations for industrial counting, interval timing, repeat cycling, photographic printing. Adequate speed for all ordinary nucleonics and computer applications.



DECADE SCALING UNIT TYPE YYZ-1

For high-speed counting

- Continuous counting rate up to 5 million counts per second.
- Direct reading with decimal indication.
- Two scales of ten for separate or cascade operation.

POCKET CHAMBER ELECTROMETER TYPE 4SN3A1

An extremely high-quality, self-balancing electrostatic potentiometer. A standard 3-inch meter provides direct measurement in two ranges—50 and 250 mr for rapid, accurate reading of "pencil" type pocket ionization chambers.



MAINTENANCE EQUIPMENT

BROADCAST, COMMUNICATION AND GENERAL PURPOSE TEST EQUIPMENTS

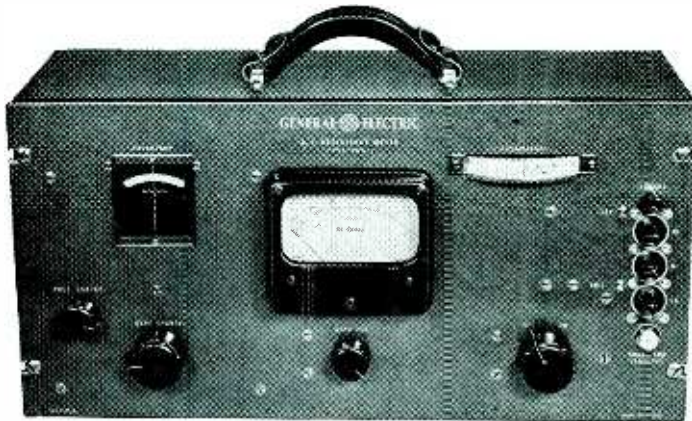

**RADIO FREQUENCY RESISTANCE METER
TYPE YKS-1**

A direct-reading precision instrument, designed to permit rapid, accurate measurement of the radio frequency resistance of radio components and circuits. Operating over the exceptionally wide range of 50 kc to 80 mc, and from 0 to 200 ohms, it is adaptable for measurement of such constants as RF resistance of ordinary coils, capacitors, transmission lines and antennas, or even complex combinations of such devices. F, C and R are read directly. Reactance and Q determined from simple monograph.

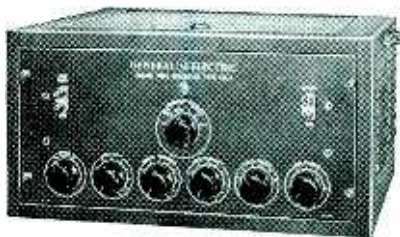

SQUARE WAVE GENERATOR TYPE YGL-1

- Wide frequency range: 5 to 125,000 cycles.
- Output voltage 0-75 volts.
- Low output impedance.
- Rise time .3 microsecond.



CAPACITOMETER TYPE YCL-1

General Electric radio frequency capacitometer is a convenient, self-contained unit for rapid and extremely accurate measurement of inductance and capacitance.



DISTORTION AND NOISE ANALYZER TYPE YDA-1

A precision instrument designed especially for broadcast and laboratory use. Whenever information is required on distortion, audio noise, or hum, the YDA-1 will provide accurate measurement down to extremely low levels.

OSCILLOSCOPE TYPE ST-2A

A new, general purpose oscilloscope. Wide frequency response—from DC to 500 kc, and with gradually reducing response to higher frequencies. High sensitivity. Sturdy construction. Voltage calibrator, Z-axis input, and DC input coupling to both amplifiers.

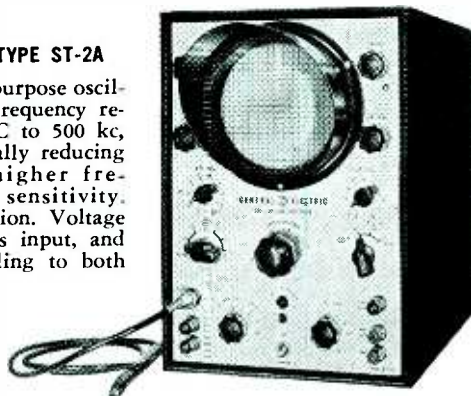

Send for this

FREE CATALOG!

Complete specifications, descriptions, charts and photographs of G-E electronic test equipment, quartz and germanium crystals. Write: *General Electric Company, Specialty Division, Electronics Park, Syracuse, New York.*

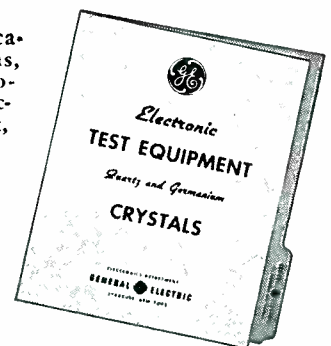

You can put your confidence in—

GENERAL  ELECTRIC

Power Loss = $55.5 \epsilon^1 \tan \delta \times f \times V^2 \times 10^{-6}$ Watts

**ZIRCON
PORCELAIN**

Because they influence efficient and effective operation, low loss characteristics of Zircon Porcelain are most desirable in the manufacture of high frequency equipment.

Meeting the requirements of the power loss formula, Zircon Porcelain retains its low loss characteristics over a wide range of temperatures and frequencies. This factor is clearly demonstrated in the charts shown.

For applications in the field of radio, radar and other equipment of this nature, it will pay to get more detailed information. Write direct or discuss the use of Zircon Porcelain with one of our qualified field staff.

CHART 1

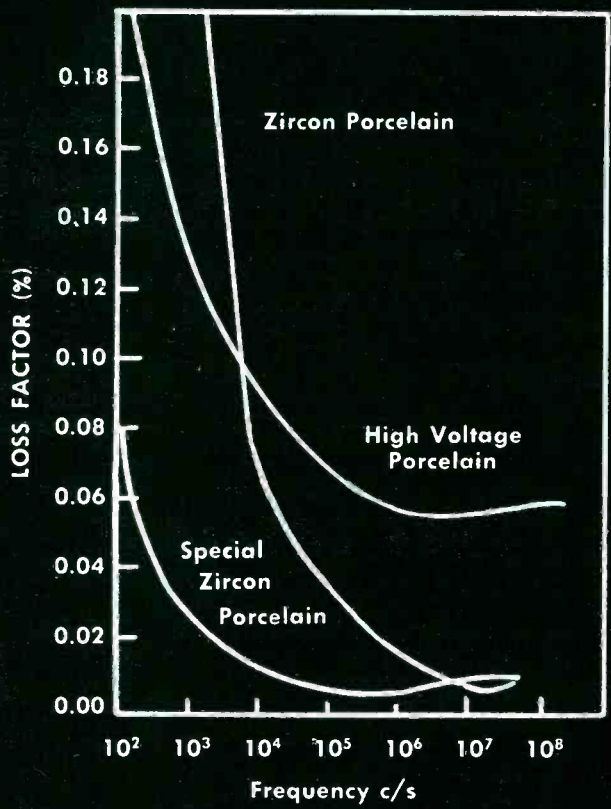
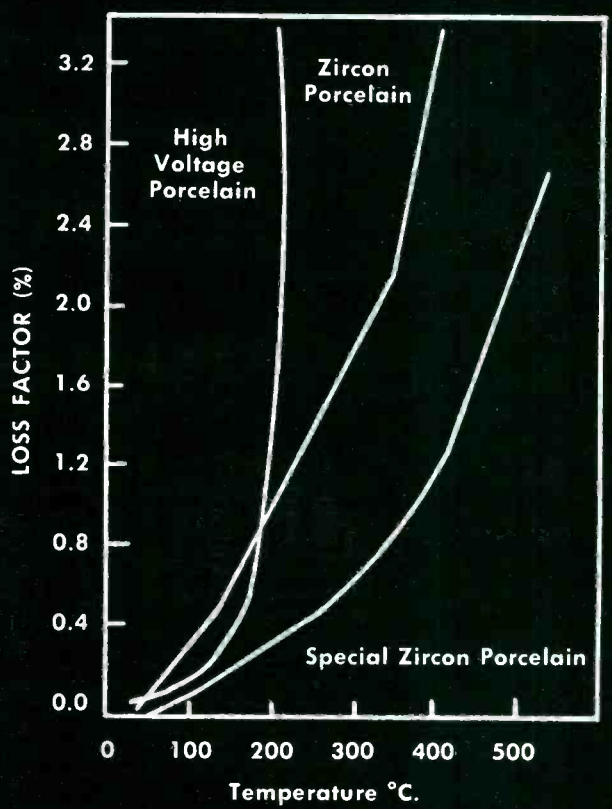

CHART 2



**TITANIUM ALLOY MFG. DIVISION
NATIONAL LEAD COMPANY**

Executive and Sales Offices: 111 BROADWAY, NEW YORK, N. Y. • General Offices and Works: NIAGARA FALLS, N. Y.

"Give us the tools . . ."

The 81st Congress Can Halt the Administration's *SOCIALIST PROGRAM*

In his speech at Massachusetts Institute of Technology, Winston Churchill said that America's possession of the atomic bomb is all that has kept Soviet Russia from overrunning Europe and bombing London.

Our State Department knows that there has been another deterrent to aggressive warfare by Russia and a deciding one. That deterrent is the superior industrial strength of the United States. But once Russia approaches our industrial strength, then watch out! For Stalin or no Stalin, there will be trouble. Therefore, the simple table below is worth every American's careful reading. It shows in percentages what Russia did with her national income in 1948 and what we did with ours:

	USSR	USA
Civilian use	60%	79%
New capital equipment and public works	21%	12%
Foreign aid		2%
Defense	13%	5%
Building of inventories and war stock-piling	6%	2%

These figures for Russia come from *The* (London) *Economist*, Britain's influential economic journal.

These figures are estimates based on information from behind the Iron Curtain, and so cannot be checked directly. But they fit with what is known of Russian development.

The table shows that Russia is straining every resource to build up its industrial strength. When Russia's effort is measured in *dollars*, and compared to ours, the figures show:

Where we spent \$20 to \$21 billion for new industrial plants and equipment last year, the Russians spent \$12 to \$14 billion.

But while we used about \$9 billion of this to *replace* old equipment, the Russians spent no more than \$2 billion for replacing old equipment. The Russians had much less worn-out and obsolete equipment to replace. They could concentrate their efforts on expanding their industries and buying new equipment.

So—we used only \$11 to \$12 billion to *expand* our industries.

And the Russians used almost as much to expand theirs—\$10 to \$12 billion.

Russia is gaining industrial strength as fast as we are—and may soon be gaining faster. The more she gains and the faster she gains on us, the greater is the danger of war.

continued on next page

American industry is pushing modernization and expansion hard. It is doing an heroic job. McGraw-Hill's recent survey* shows that *industry* already has in hand plans to build plants and buy equipment in the next five years adding up to \$55 billion. Industry plans that investment—*and much more—if it can get the money.*

On those plans of *industry* depend our national security.

If these plans of ours are cut back, the Russians will be years closer to their goal of industrial equality—the strength that they need to wage aggressive war successfully.

But more and more our industry's plans are being menaced by socialist policies in Washington. The President continues to urge a further increase in the tax on corporate profits, even though federal taxes alone now take 38 cents of every dollar of profit. He wants \$3 billion more in taxes on corporate profits now, plus added personal taxes.

Last year corporations spent almost two-thirds of their profits—about \$13 billion—for new plant and equipment. This year corporation profits will be lower than last year's \$21 billion, perhaps by 20 per cent. Subtract a fifth or more from last year's profits. Then adopt the President's proposal and take \$3 billion more in corporate taxes and you raise havoc with planned expenditures for new plant and equipment.

Approval by Congress of the President's tax program would cut industry's program of plant and equipment development by a third or more. That means a major blow to our prosperity as well as our national security. For as capital investment goes, so goes general prosperity.

Further serious damage would be done by Congressional approval of the President's industry-control bill. The so-called Stability Act of

* A complete report on our national survey may be obtained by writing McGraw-Hill Publishing Co., 330 West 42nd St., New York 18, N. Y. This is one of a special series of editorials on industry's needs for new plants and equipment.

1949 (the Spence Bill) would severely check industrial progress. That bill would put the federal government in the business of providing the added industrial capacity which the tax program would prevent private industry from doing for itself. It would be hard to conceive a better and surer way to dry up private investment in new plant and equipment. For every dollar of government investment will scare away many times more dollars of private investment. People will not want to risk their money in businesses competing with the U. S. Treasury. At the same time it will attack private investment in another way. It means that government would spend your income for you instead of allowing you to spend or invest for yourself. That is the high and quick road to socialism.

American industry needs right now great courage and incentives if it is to carry out its tremendous building program. It needs also a release from the program of a socialist administration in Washington with its systematic discouragement of enterprise and risk taking.

Above all, industry needs assurance by the actions of the 81st Congress itself that there is a future in this country for a system of dynamic capitalism, functioning in a free society. By acting now to strengthen the American people's faith in their industrial system, by providing needed incentives for management and investors, by protecting industry's capacity to buy new equipment, the 81st Congress can sustain American industrial progress and keep us united and strong.

But if we kill freedom of industrial planning and action by unneeded taxes and government controls we put ourselves—and our friends all over the world—in dire peril.

Nothing would please the Communists more.

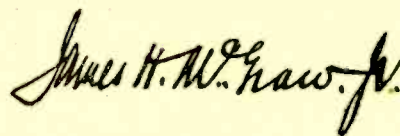

President, McGraw-Hill Publishing Company, Inc.

**Simple Jobs...
Intricate Jobs...**

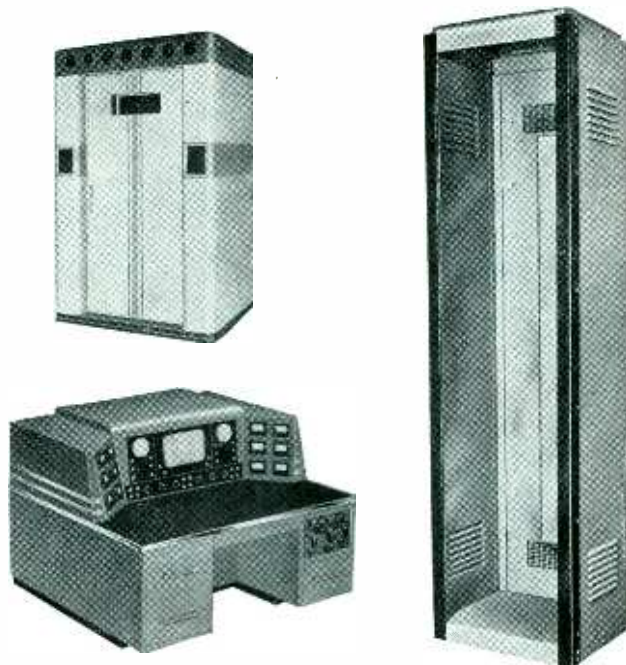
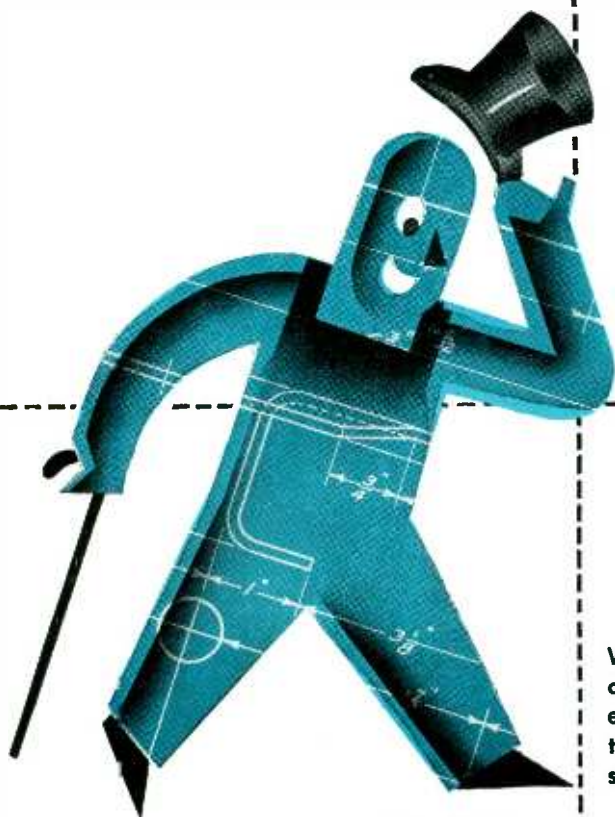

**We Give Them All
"High Hat" Quality**

Whether you come to us for simple stamped-out chassis, ordinary metal boxes or the most intricate electronic apparatus housing, your job will receive the same Karp quality treatment, plus every possible economy.

The same long-experienced principals of our staff will give you intimate, personalized service, from planning and design to delivery. Your work will be done by highly skilled specialists, in a plant which is without an equal in its field for up-to-date machinery and modern facilities. Welding, when needed, will be done under precise timing controls . . . painting and finishing with the most modern equipment and conditions.

In most cases, our vast variety of dies will save you the cost of special dies and jigs. We will give your work accuracy and uniformity that will make your final assembly easy, time-saving and hence economical.

Try us for the plain or the precise . . . the everyday or the elaborate and de luxe . . . in modest or substantial quantity. Whatever your needs in sheet metal fabrication, it pays to get our estimate.

WRITE FOR NEW CATALOG



KARP METAL PRODUCTS CO., INC.

215 - 63rd STREET, BROOKLYN 20, NEW YORK

Custom Craftsmen in Sheet Metal

NEW C-D Silicone Dilecto

withstands an inferno of



**heat
and
electricity**

to improve product performance for you!

There are three new grades of C-D Dilecto* that can withstand temperatures as high as 250°C. They are chemically inert, silicone-glass laminated plastics that offer exceptionally high heat resistance and good arc resistance, extra strength, and positive moisture resistance! At Continental-Diamond we've literally lived and worked with Silicone Dilecto—perfecting it to a point where we believe it can be highly useful in helping to solve your production problems — and improve product performance.

And this remarkable plastic is but one of many in the C-D family. They provide practical combinations of mechanical, electrical, and chemical properties— structural strength, light weight, positive moisture, heat and corrosion resistance. In hundreds of plants, C-D Plastics—Fibre, Vulcoid, Dilecto, Celoron, and Micabond— offer proof that it pays to see C-D first in your search for the right plastic for the job. For interesting, useful information on Silicone Dilecto, and other C-D high strength plastics, call or write your nearest C-D office, soon.

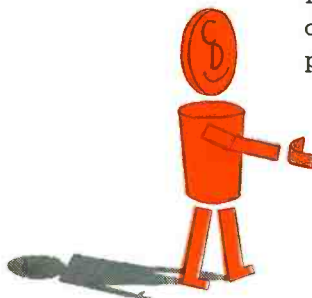

your partner in producing better products

*Dilecto GB-112-S
Dilecto GB-128-S
Dilecto GB-261-S

DE-2-49

BRANCH OFFICES: NEW YORK 17 • CLEVELAND 14 • CHICAGO 11 • SPARTANBURG, S. C. • SALES OFFICES IN PRINCIPAL CITIES
WEST COAST REPRESENTATIVE: MARWOOD LTD., SAN FRANCISCO 3 • IN CANADA: DIAMOND STATE FIBRE CO. OF CANADA, LTD., TORONTO 8

Continental - Diamond FIBRE COMPANY

Established 1895... Manufacturers of Laminated Plastics since 1911—NEWARK 16 • DELAWARE

To Top-Flight Development, Design and Instrumentation Engineers:

The accompanying table gives the characteristics of Arma Electrical Resolvers. The accuracy of these components is indicated by the tolerances in transformation ratio (S/P), phase shift, and angular accuracy.

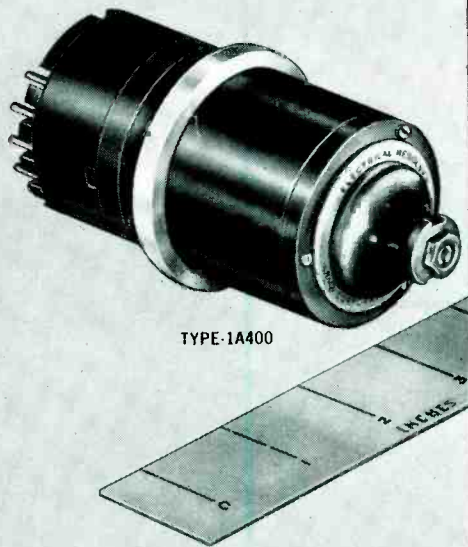

TYPE	FREQ.	IN-PUTS	OUT-PUTS	INPUT VOLTAGE	RATIO (S/P)	PHASE SHIFT	REQUIRED AUXILIARY UNITS
E	60	1	2	8	0.9750 ±.0010	6°20' ±5'	Compensator
H	60	2	2	8			Two Compensators
J	60	1	2		0.989 ±.015	4°35' ±60'	None
K	60	2	2				None
1A400		1	2	0.5-16			
1E400	400 ±10%	2	2	0.5-16	1.0000 ±.0006	0°0'±3'	Booster Amplifier
1C400		1	1	0.5-16			
1C400		2	1	0.5-16			
P	400	2	2	0.5-16	0.98±.02	75'±20'	None

Maximum Angular Inaccuracy Is $0.1\% \times (S/P) \times \text{Input Voltage}$
Operating Temperature Range for All Resolvers = 0° to 55° C

*One Booster Amplifier may be used for two (2) Resolvers of this type.

New Approaches to New Horizons Are Opened by These Resolvers*

They offer an accurate and dependable means of solving problems involving the trigonometric functions . . . for applications in electromechanical computing and control equipment . . . until recently highly restricted.

Arma Resolvers Are Computing Components

The Arma Electrical Resolver is an electromagnetic unit designed to deliver two alternating voltages proportional respectively to $e_1 \sin A$ plus $e_2 \cos A$ and $e_1 \cos A$ minus $e_2 \sin A$, where e_1 and e_2 are the voltages applied to the two primaries and A is the angle through which the rotor has been turned from the position defined as electrical zero.

They Solve Problems Involving Triangles, Coordinates, Vectors

Problems such as the rotation of coordinates, solution of triangles for angles or sides, addition of angles, transfer between rectangular and polar coordinates, and the resolution, composition or addition of vectors are readily solved using Arma Electrical Resolvers. Angular inaccuracy defined in terms of difference

between actual and theoretical output voltages for any rotor position is always less than 0.1% of $(S/P) \times \text{input voltage}$.

The Results are Fast and Accurate

Arma Electrical Resolvers may be regarded as high-precision signal transformers with continuously variable ratio. In common with other electromagnetic devices there are changes in the inherent transformation ratio and phase shift caused by changes in frequency, temperature or primary voltage. Arma resolver design recognizes these factors and gives results of extreme accuracy.

Advantages of Arma Resolvers Over Wire-Wound (Potentiometer Type) Units

1. Stepless operation — outputs are smooth accurate sine or cosine functions uninterrupted by "wire stepping."
2. Unlimited rotation with no circuit interruptions.
3. No wear; indefinite life with no change in accuracy.

Use These Other Arma Components, Too

Here are possible applications of other

Arma components released for private industry which invite interest: Tachometer-type Induction Generators for high performance servo systems; two-phase Induction Motors for servo mechanisms and control devices; Synchro Units (better than Navy "Specs") for remote control and indicating purposes; high-precision Mechanical Differentials for computer applications.

How Ideas Become Realities

For over 30 years Arma Corporation has been quietly taking on (under wraps) one complex development and design problem after another for the U. S. military establishments—problems concerned with instrumentation. In the initial stage these problems may be little more than a gleam in someone's eye, a vague hope, a "dream"! That's where Arma starts.

When Arma finishes, the problem is not only solved but the actual equipment to do the job, built—whether it be a complicated gun director, a gyro compass or a complex remote control system. Arma follows through to practical realities.

You are invited to request whatever information you may need to explore the possibilities of making use of any Arma product which has been released from security restrictions.

ARMA CORPORATION
254 361st STREET, BROOKLYN 32, N. Y.
SUBSIDIARY OF AMERICAN BOSCH CORPORATION

ARMA
PRODUCTS
RELEASED
FOR
PRIVATE
INDUSTRY

ARMA ELECTRICAL RESOLVERS • ARMA SYNCHROS • ARMA INDUCTION MOTORS • ARMA INDUCTION GENERATORS • ARMA MECHANICAL DIFFERENTIALS • ARMA ALTERNATING VOLTAGE COMPARATOR • COMPUTING MECHANISMS • INDUSTRIAL CONTROLS • STABILIZATION DEVICES • NAVIGATIONAL EQUIPMENT • LIMITRON AUTOMATIC INSPECTION SYSTEM

* Licensed for use under Arma patents Nos. 2,465,624 and 2,467,646. License information available.

QUALITY **ARMA** PRECISION
INSTRUMENT

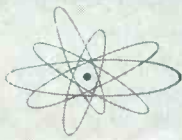

Designers

take your choice...
**FIXED
 PAPER-DIELECTRIC
 CAPACITORS**

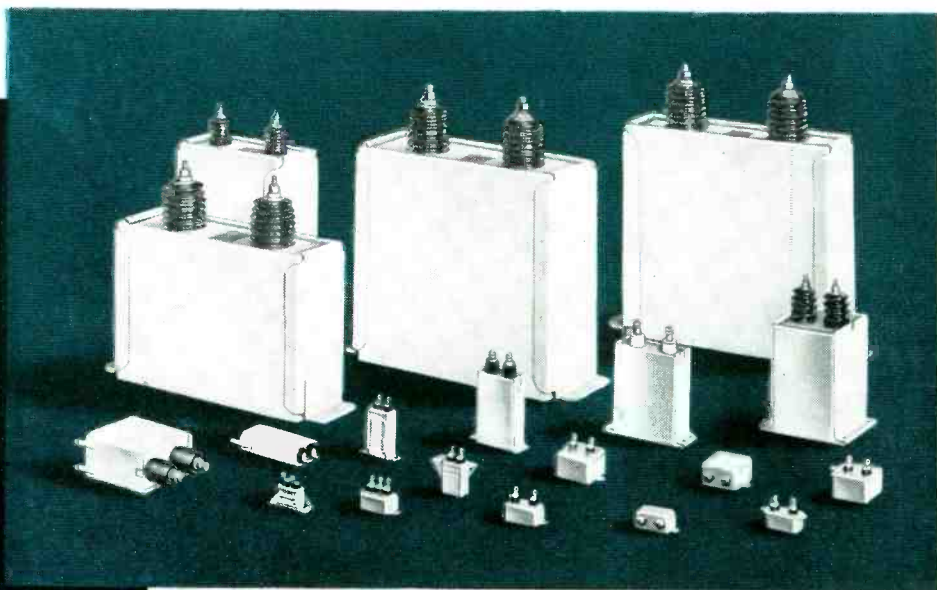

Readily available for DC electronic applications, these capacitors are manufactured in accordance with joint Army-Navy specifications JAN-C-25. Case styles include types CP 53, CP 54, CP 55, CP 61, CP 63, CP 65, CP 67, CP 69 and CP 70. Capacitance ratings are from .01 Muf to 15 Muf, and voltage ratings are listed from 100 to 12,500 volts.

These capacitors are constructed with thin Kraft paper, oil or Pyranol* impregnated, which provides stable characteristics and high dielectric strength. Plates are aluminum foil, manufactured according to detailed specifications. Special bushing construction provides for short internal leads, preventing possible grounds and short circuits. The cases have a permanent hermetic seal to provide longer life. A variety of mounting arrangements are available for various installation requirements. Write for detailed description and operating data: Bulletin GEA-4357A.

*Pyranol is General Electric's non-inflammable liquid dielectric for capacitors.

**SAVE SPACE
 CUT COSTS**

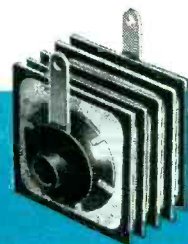

Less than one inch long, and only one inch square, this postage-stamp-size selenium rectifier offers radio builders substantial savings in production costs. Only two soldering operations and a minimum of hardware are necessary for installation in places where a rectifier tube and socket won't fit. They're built to safely withstand the inverse peak voltages obtained when rectifying (half-wave) 110-125 volts, rms, and feeding a capacitor as required in various radio circuits. Tests prove that selenium rectifiers will outlast the conventional type of rectifier tubes, at the same time costing less. Send for bulletin GEA-5238.

GENERAL  **ELECTRIC**

Digest

TIMELY HIGHLIGHTS ON G-E COMPONENTS



HOLDS OUTPUT VOLTAGE CONSTANT

This 500-va voltage stabilizer is suitable for a wide variety of electronic applications where constant voltage is demanded. Voltage variations from 95 to 130 volts are absorbed almost instantaneously and output voltage maintained at 115 volts (plus or minus 1 percent). There are no moving parts, no adjustments to make. This unit will operate continuously at no load or short circuit without damage to itself. It will limit the short circuit current to approximately twice stabilizer's normal full load current rating. Other sizes available range from 15 to 5000 va. For details, check bulletin GEA-3634B.



WANT TO TIME TUBE LIFE?

Suitable for installation in radio transmitters, these G-E time meters provide accurate record of tube operating time.

They record in hours, tenths of hours, or minutes. Ratings range from 11 to 460 volts. Installation on a panel or switchboard is simplified by quick-wiring leads. Timer harmonizes with other panel instruments in appearance and size. Dependability is assured by Telechron* motor drive. Also available for portable use or conduit and junction box mounting. Check bulletin GEC-472.

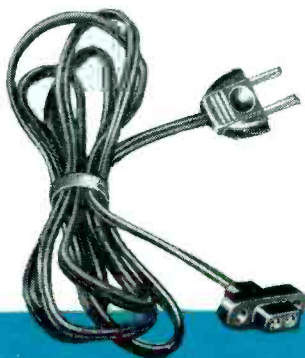

FOR YOUR TELEVISION SETS

General Electric's television cord set comes in 6-foot lengths, made of 2/18 Pot-64 brown Flamenol* rip-cord. Set has brown plastic plug and new brown Flamenol connector molded on opposite end. Rip-cord has smooth finish, resists oil, water, acids, alkalis, or sunlight deterioration. Rating is 7 amps., no. 18 wire. Set is designed for assembly on

*Trademark Reg. U. S. Pat. Off.

television receiver rear panel, automatically disconnects when panel is removed. Write for further information.

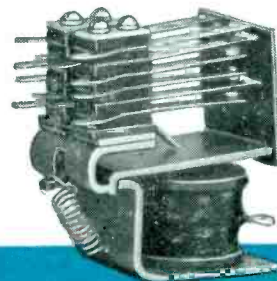

DEPENDABLE CONTROL FOR AUTOMATIC DEVICES

G.E.'s multi-contact relays are inexpensive units built specifically for appliances and vending machines. Construction features assure quiet, reliable operation, and compactness makes them adaptable to a variety of devices such as coin changers, phonographs, and television receivers. Single-circuit contacts or combinations of contacts for multi-circuit application are attached to the same sturdy frame and coil assembly, affording a multiplicity of relay forms. Ratings are 5 amperes at 115 volts or 24 volts, a-c or d-c. Get details from Bulletin GEC-306.

General Electric Company, Section G667-1
Apparatus Department, Schenectady, N. Y.

Please send me the following bulletins:

- GEA-3634B Voltage Stabilizers
- GEA-4357A D-C Capacitors
- GEA-5238 Selenium Rectifiers
- GEC-306 Multi-contact Relays
- GEC-472 Tube Timers

NAME

COMPANY

ADDRESS

CITY STATE

POPULATION - 0

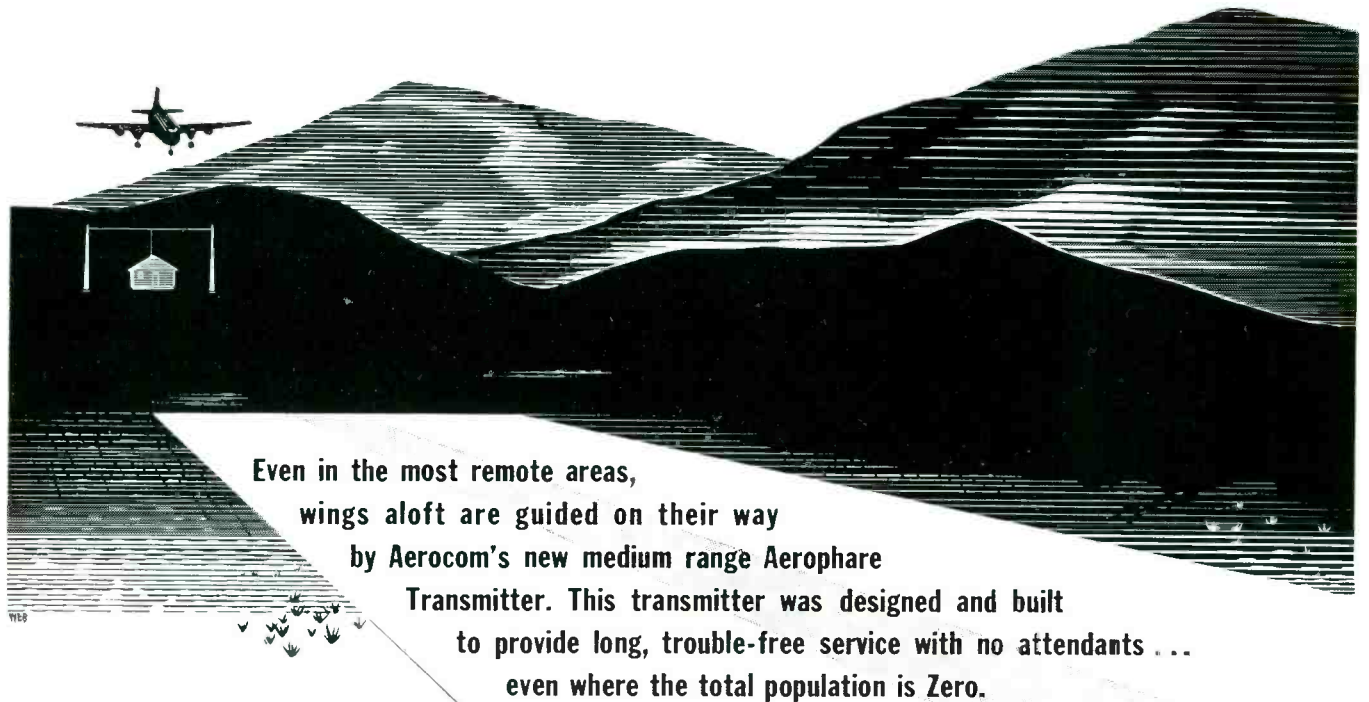

Even in the most remote areas,
wings aloft are guided on their way
by Aerocom's new medium range Aerophare
Transmitter. This transmitter was designed and built
to provide long, trouble-free service with no attendants ...
even where the total population is Zero.

AEROPHARE

The 100 Watt Aerophare illustrated consists of the following units--AK-3 automatic keyer; Model 100XL transmitter, (100 Watt carrier power, minimum of 30%-high level tone modulation for identification but with no provision for voice modulation); and antenna matching unit.

The smaller unit is similar, except transmitter is of 50 Watts carrier power with 90% high level tone modulation for identification, or, 90% high level voice modulation. Microphone P-T-Switch, when depressed interrupts tone, permitting voice operation. This feature makes this unit ideal for airport operation where both aerophare and traffic control are needed.

Both units are completely "tropicalized" to allow operation under unusual climatic conditions. Each unit is ruggedly constructed and conservatively rated, providing low operating and maintenance costs. Engineering data on both units upon request.

CONSULTANTS, DESIGNERS AND MANUFACTURERS OF STANDARD OR SPECIAL ELECTRONIC, METEOROLOGICAL AND COMMUNICATIONS EQUIPMENT.

AER - O - COM
Reg. U. S. Pat. Off.

AERONAUTICAL COMMUNICATIONS EQUIPMENT, INC.
3090 Douglas Road, Miami 33, Florida

DEALERS: Equipetro Ltda., Caixa Postal 1925, Rio de Janeiro, Brasil ★ Henry Newman Jr., Apartado Aereo 138, Barranquilla, Colombia ★ Radelec, Reconquista 46, Buenos Aires, Argentina

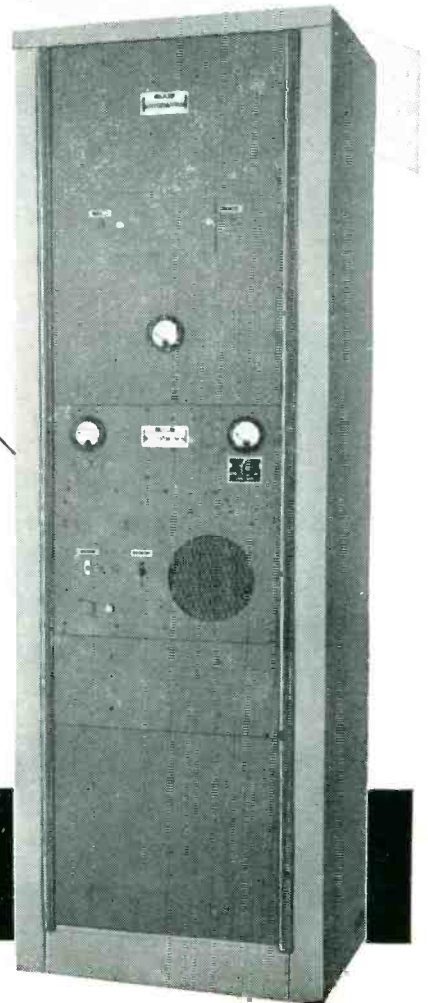

FOR

Whatever You Make That's

Electrical

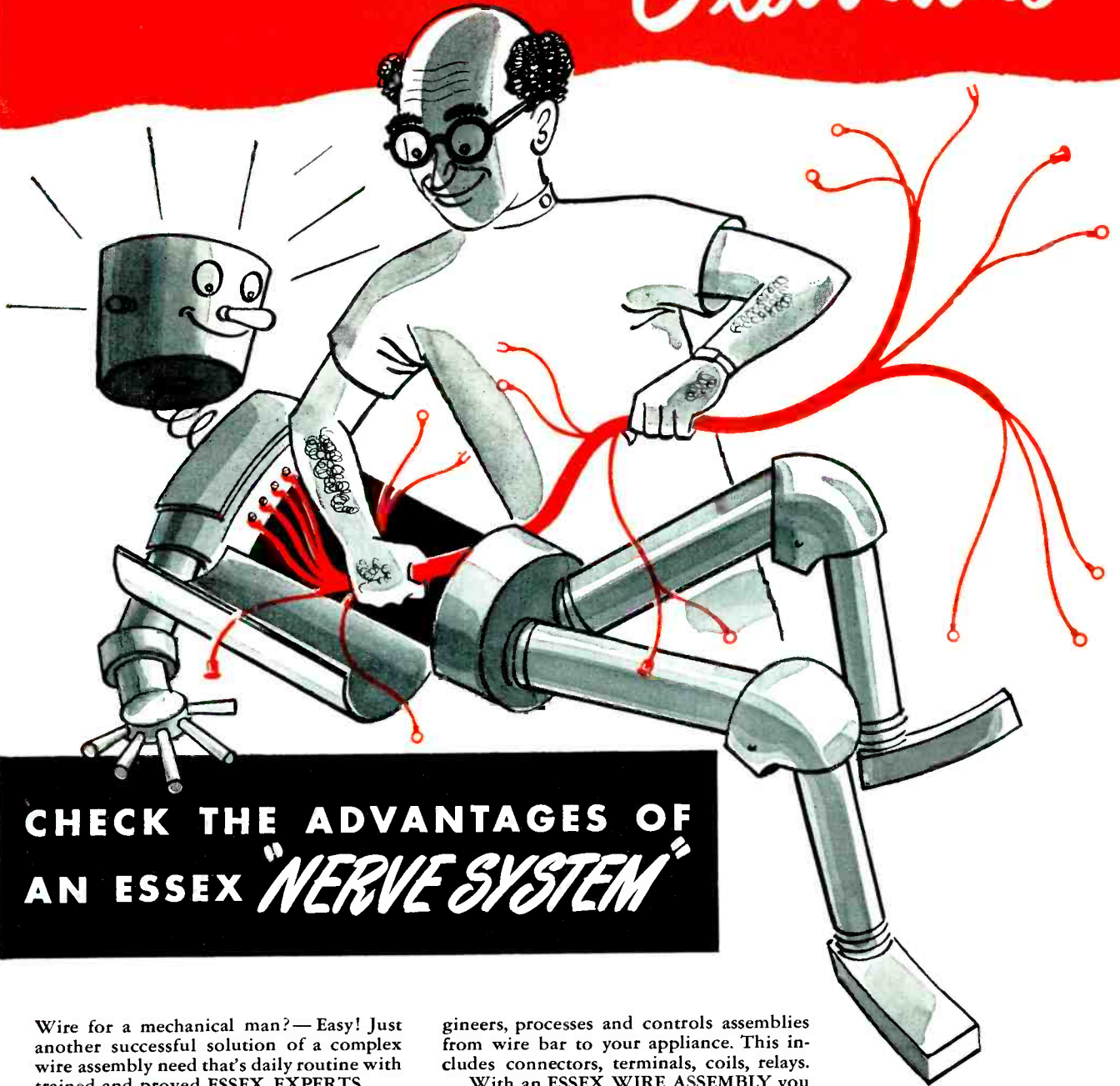

CHECK THE ADVANTAGES OF AN ESSEX "NERVE SYSTEM"

Wire for a mechanical man?— Easy! Just another successful solution of a complex wire assembly need that's daily routine with trained and proved ESSEX EXPERTS.

Drop a coin in a slot—out comes anything from a sandwich to a can of fishing worms. Is it any wonder people say these machines are almost human? There's a reason! ESSEX WIRE ASSEMBLIES operate such products dependably and accurately.

Thanks to experienced specialists and a network of twenty factories, ESSEX en-

gineers, processes and controls assemblies from wire bar to your appliance. This includes connectors, terminals, coils, relays.

With an ESSEX WIRE ASSEMBLY you can stop your electrical worries and actually enjoy greater economy, proved dependability and precise uniformity. Essex engineers diagnose your problems and custom-build assemblies for your products. Essex will prove its points by furnishing you with a sample assembly built to your specifications. Get the facts today.

BUILT TO PERFECTION

WIRE ASSEMBLY AND



PROVED BY INDUSTRY

CORD SET DIVISION

Consult an Essex representative, or send your specifications to the Service Engineering Department, Wire Assembly and Cord Set Division.

ESSEX WIRE CORPORATION MONTICELLO, INDIANA

 **a power house
nothing in the field
can touch**

the CORNELL-DUBILIER

BLACK CUB

BAKELITE MOULDED PAPER TUBULAR

A midget-sized gargantua . . . a powerhouse of a capacitor that's armored to take all the stress and strain, vibration, humidity and extremes of temperature that comes its way. If the paper tubulars you're now using lack any of these 8 strong points, you're being short-changed. Switch to C-D BLACK CUBS as other leading manufacturers have done!



- 1. "LEADWELD" CONNECTIONS!** Sturdy welded joints between wire leads and foil of capacitor section. Permanent connections! No intermit-tents! No open circuit defects!
- 2. BAKELITE CASE!** Capacitor element molded in high quality Bakelite provides maximum protection under most severe service conditions.
- 3. "POLYKANE" IMPREGNATION!** Polymerized resin impregnant provides excellent electrical properties and cannot leak through case at any temperature.
- 4. HIGH TEMPERATURE OPERATION!** Excellent electrical properties maintained after long service at temperatures up to 100° C.
- 5. EXCELLENT MOISTURE SEAL!** Will withstand long storage and service under extremes of humidity with minimum effect on electrical performance or appearance of tubular.
- 6. STURDY CONSTRUCTION!** Withstands extremes of handling, soldering temperature, vibration and shock without damage to case material, moisture seal, circuit connections or electrical performance.
- 7. HIGH INSULATION RESISTANCE!** Resistance exceeds 10,000 megohms per unit at 25° C.
- 8. ALUMINUM FOIL ELECTRODES!** Provides best electrical properties and maximum service life at high temperature.

C-D CAPACITORS — BEST BY FIELD TEST

Write, wire or phone for samples and further information on the type MBT Black Cub Tubulars. Catalog on request. Cornell-Dubilier Electric Corporation, Dept. K69, South Plainfield, N. J. Other plants in New Bedford, Brookline and Worcester, Mass.; Providence, R. I.; Indianapolis, Ind.; and subsidiary, The Radiart Corporation, Cleveland, Ohio.

CORNELL-DUBILIER
Consistently Dependable
capacitors • vibrators
antennas • converters



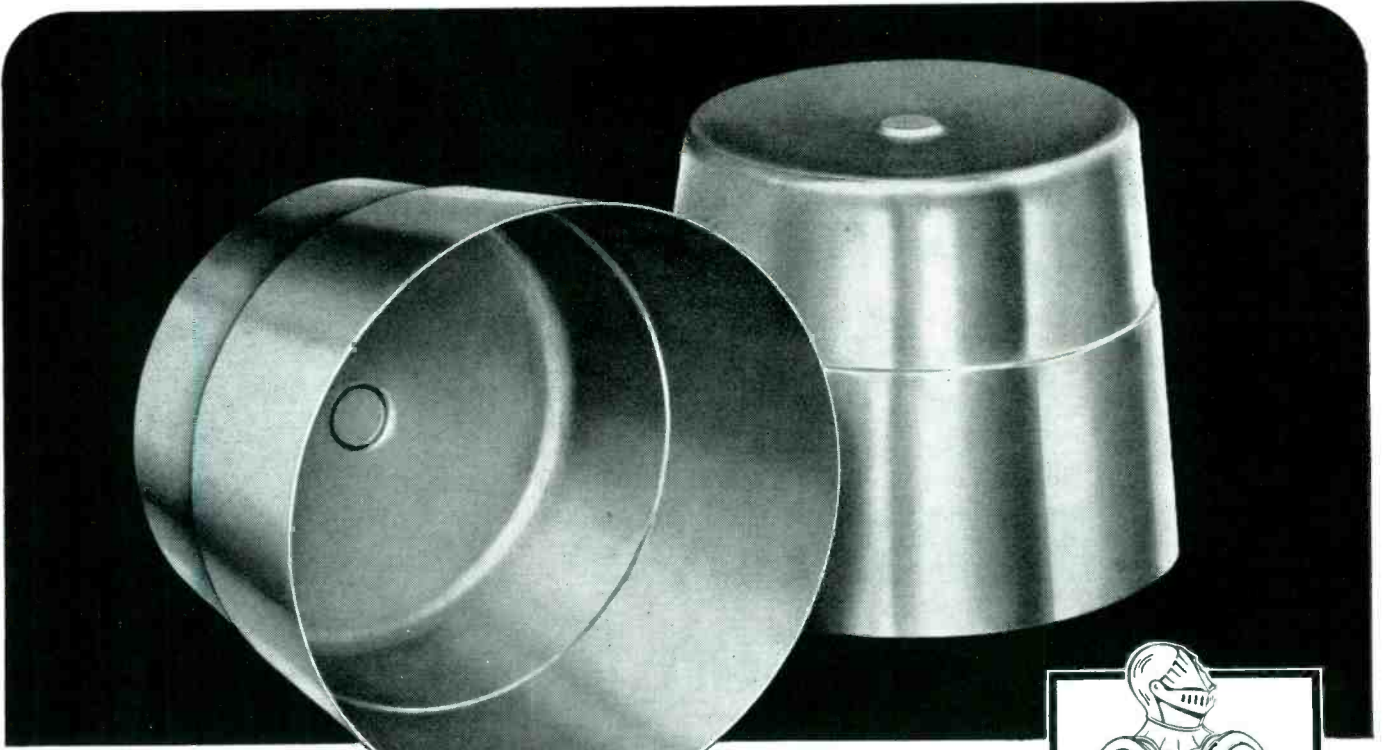

Ingenuity...



This appears to be a simple stamping. However, the combination of the tapered shape and the light gauge material makes it difficult to draw without wrinkles. Once introduced, it is almost impossible to eliminate a wrinkle.

Carefully planned tooling — the correct number of preliminary operations, plus an ingenious reverse draw — solved this difficult stamping problem.

Result... uniform parts with a minimum of die marks, permitting economical preparation of the surface for high lustre plating and polishing.

Representatives in

- ALEXANDRIA, VA.
- BUFFALO
- CANTON, OHIO
- CHICAGO
- DENVER
- DETROIT
- FORT WORTH
- INDIANAPOLIS
- LOS ANGELES
- NEW YORK
- PHILADELPHIA
- SYRACUSE
- TORONTO, CANADA

**ALLOY STEELS AND OTHER
METALS COLD FASHIONED
SINCE 1883**

PRECISION METAL STAMPINGS FOR EVERY TYPE OF INDUSTRY



WORCESTER PRESSED STEEL CO.

306 BARBER AVENUE
WORCESTER 6, MASS.

DIP TANK STABILITY

HIGH TEMPERATURE LIFE

MOISTURE RESISTANCE

FLEXIBILITY

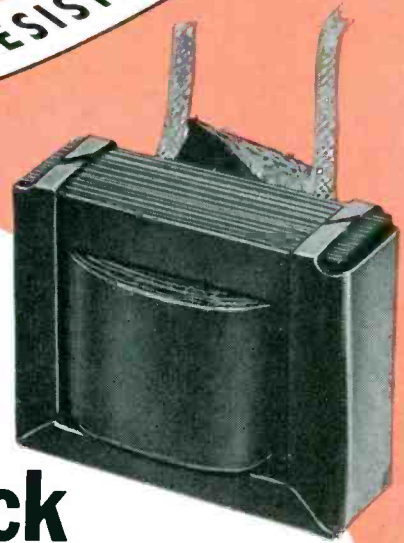

IRVINGTON'S #100 clear #500 black INSULATING VARNISH

(Internal Drying)

Here are high dielectric strength varnishes that are "tops" in insulation protection for high heat applications requiring high temperature flexible life. These varnishes remain tough, flexible and stable under the most rugged operating conditions. They penetrate deeply, dry from the inside, bind coil windings into a unit acting mass, preventing movement of wires. They resist damaging heat, moisture, oil, acids, alkalies . . . and will not attack enamel coating on magnet wire.



Use #100 where a clear varnish film is required for instrument coils, field coils, transformers and similar wound structures . . . leads remain flexible and are easily identified where color coded.

Use #500 where an exterior black coating, plus all of the excellent properties of Irvington #100 are needed . . . fine for infra-red baking. This varnish is suited to motor coils, wound stators and field coils.

Both #100 and #500 can lower manufacturing cost, and improve product quality. Try them. Samples, with complete technical data, sent upon request.

"Look to Irvington for Continued Leadership in Insulation"



IRVINGTON

Varnish & Insulator Company

Irvington 11, New Jersey

Authorized distributors in Atlanta; Baltimore; Berkeley; Bluefield, W. Va.; Boston; Charlotte; Chicago; Cleveland; Dallas; Denver; Detroit; Los Angeles; Milwaukee; Minneapolis; New Hartford, N.Y.; New Orleans; Philadelphia; Pittsburgh; Portland, Ore.; St. Louis; Seattle; Hamilton, Ont., Canada.

Now! A Top Quality Tape Recorder at a Reasonable Price

New PRESTO Magnetic Tape Recorder

AT LAST, a magnetic tape recorder that fully measures up to the most exacting requirements of broadcast network operations, independent stations and transcription producers, yet priced to have wide appeal.

Compare these specifications:

- Frequency response: 30 to 15,000 cps \pm 1 db.
- Signal to noise ratio: Over 60 db below max. signal.
- Fast speed, 240 ft. per second forward and rewind, instantly reversible.
- Recording speeds 7½" or 15" per second (15" or 30" per second provided on request). Speed selection by special 2-speed motor.
- Reels direct mounted on motor shafts. Uses any type and size of reel up to 14".
- Erasing, recording and playback heads all mounted in separate housing — entire unit connected by plug-in for immediate replacement.
- Full-size illuminated scale V. U. meter on top panel.

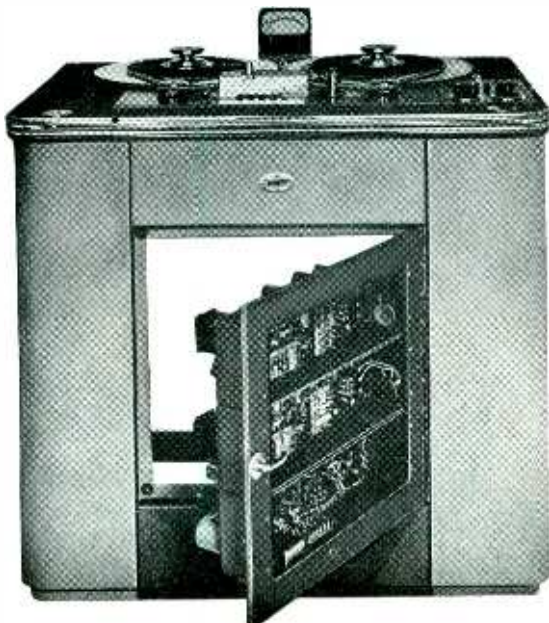
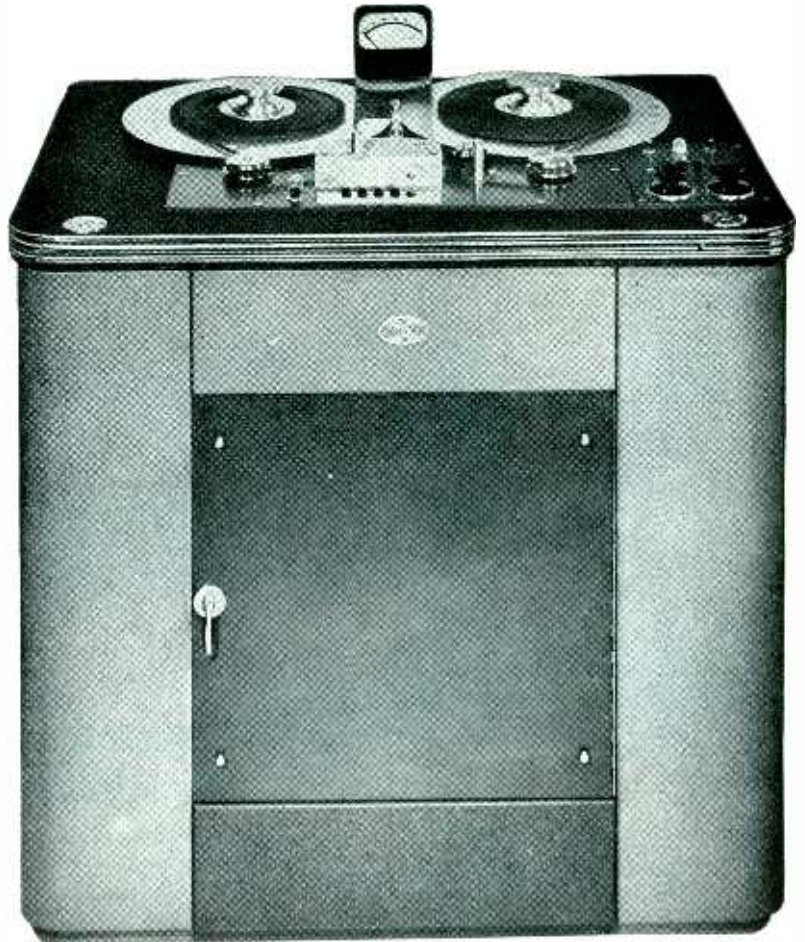

Now! Greater Accessibility

Illustration shows how everything mechanical and electrical can be serviced from the front and top. Amplifiers and power supply are in swinging door behind removable panels. Mechanical units are mounted on top panel, hinged at rear so it can be opened upwards.



PRESTO
RECORDING CORPORATION
Paramus, New Jersey

Mailing Address:
P. O. Box 500, Hackensack, N. J.

In Canada:
WALTER P. DOWNS, Ltd., Dominion Square Building, Montreal

WORLD'S LARGEST MANUFACTURER OF INSTANTANEOUS SOUND RECORDING EQUIPMENT AND DISCS

NEW Miniature Telephone Type Relay

NEW LK RELAY

MOUNTING: End mounting for back of panel or under-chassis wiring. Interchangeable with standard "Strowger" type mounting.

COIL POWER: From 40 milliwatts to 7 watts D.C.

CONTACTS: Standard 2 amperes, special up to 5 amperes. 2 amperes up to 6 P.D.T. 5 ampere contacts (low voltage) up to 4 P.D.T. Special 20 ampere power contacts S.P.S.T., normally open, paralleled.

DIMENSIONS:

1⁵/₈" HIGH, 2⁷/₃₂" LONG,
1³/₃₂" WIDE

*These are the dimensions
for the 6 pole relay.*

*Will meet Army and Navy
aircraft specifications
as a component unit.*

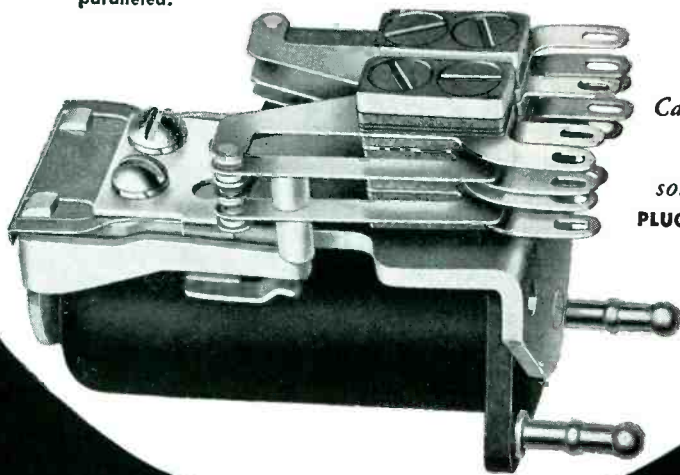

*Can be furnished
hermetically
sealed with
solder terminals.*
**PLUG-IN MOUNTING-
SPECIAL.**

SK RELAY

MOUNTING: Front of panel mounting and wiring.

COIL POWER: From 100 milliwatts to 4.5 watts D.C.

CONTACTS: Same as "LK".

DIMENSIONS: 1¹/₂" HIGH, 1⁹/₁₆" LONG, 3¹/₃₂" WIDE.

*These are the dimensions
for the 4 pole relay.*

*Will meet Army and Navy
aircraft specifications
as a component unit.*

**CAN ALSO BE FURNISHED
HERMETICALLY SEALED
WITH SOLDER TERMINALS.
PLUG-IN—SPECIAL.**

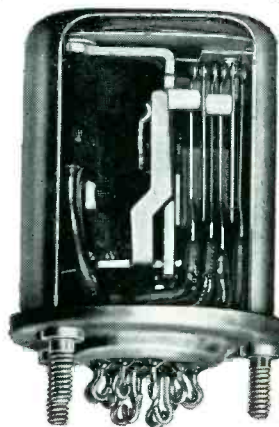

SK, HERMETICALLY SEALED

AL-132



ALLIED CONTROL CO. INC. 2 EAST END AVE., NEW YORK 21, N. Y.

YOU CAN BE **SURE**.. IF IT'S
Westinghouse

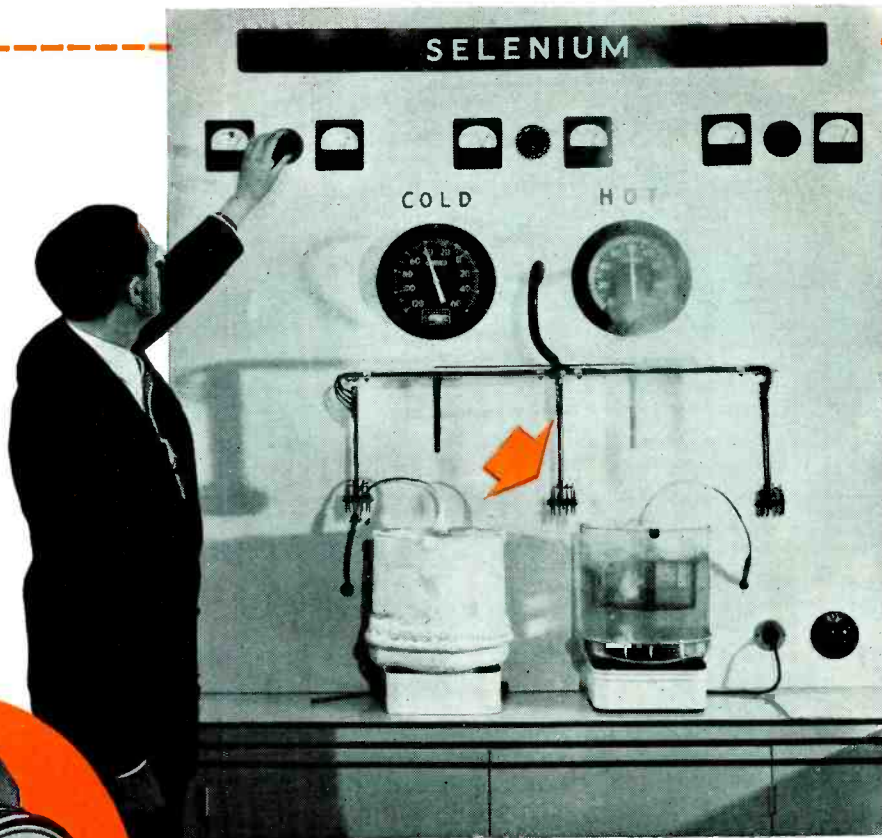

New Selenium Licks **HIGH TEMPERATURE** **...HIGH VOLTAGE**

Here's good news. Westinghouse offers you these important plus features in selenium rectifiers.

Visitors at the IRE Exposition, held recently in New York City, saw this demonstrated by a unique hot-cold shock cycle test. Every 5 minutes during the 4 days, shock changes in temperature from 40° C below zero to boiling water were applied to a Rectox 24-Volt DC/33 RMS Plate Rectifier. Variation in output was extremely small. Extensive laboratory tests at stack temperatures up to 125° C further prove ability to meet unusual requirements.

Since each plate will stand more voltage, fewer plates are needed . . . smaller stacks may be used.

The exclusive Westinghouse process of manufacture also assures lowest rate of

forward aging and constant, uniform cell performance.

TRY A SAMPLE.

Test it under your own conditions. Call your local Westinghouse office for details. Westinghouse Electric Corporation, P. O. Box 868, Pittsburgh 30, Penna. J-21532

Westinghouse

Rectox

SELENIUM RECTIFIERS



The NEW "dag" CRT Wall Coating ...

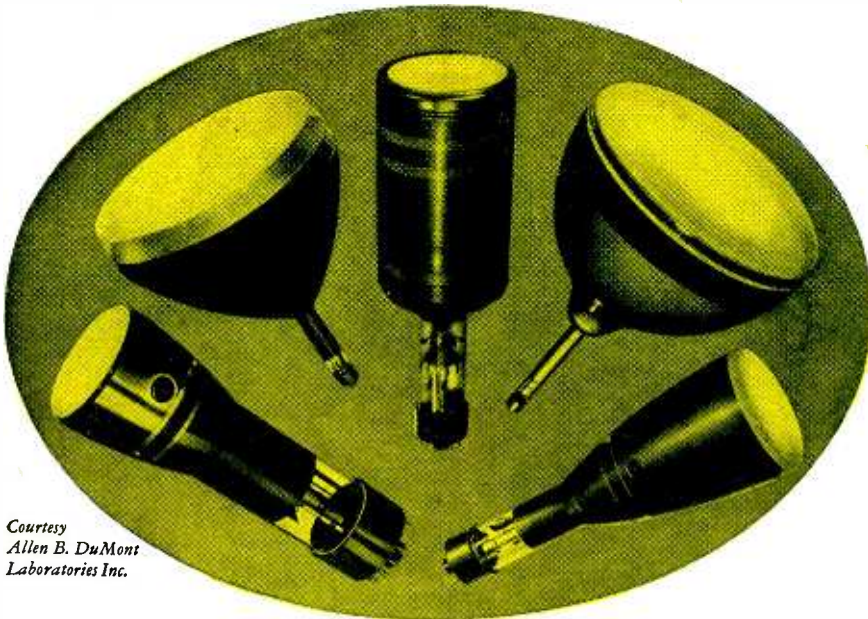

Courtesy
Allen B. DuMont
Laboratories Inc.

for all
CRT
glass
envelopes

Here's an entirely new CRT Wall Coating, developed by Acheson Colloids specifically and solely for use on CRT glass envelopes.

"dag" CRT Wall Coating is very easily applied ... adheres tenaciously to all types of glass ... does not yield objectionable by-products on heating.

Prominent cathode-ray tube manufacturers have already found this opaque, electrically conductive "dag" CRT Wall Coating eminently satisfactory, especially in tubes intended for television reception.

Let Acheson Colloids help you with your CRT wall coating problem. Mail the coupon today for information on this or other electronic applications of "dag" colloidal graphite dispersions.

Give me information on "dag" colloidal graphite dispersions for:

- Wall coating of CRT's
- Electrostatic shielding
- Corona prevention
- Dry-film lubrication
- Copper oxide rectifier disc coating
- Electrical resistances
- Filament cement

F-5

40th Anniversary Year

Acheson Colloids Corporation

Port Huron



Michigan

How to deal effectively with VIBRATION:

Locate it-

...with an MB PICKUP

Any trace of vibration comes to light when you attach this sensitive electrical pickup to your product. A rugged, precision-built product, it will withstand rough treatment.

When bolted to equipment under test, this velocity-type pickup faithfully converts vibratory motion to an electrical output. Signal can be visualized with an oscilloscope. Major industries today find it indispensable for accurate analyses. Write for bulletin 124.



Reproduce it-

...with an MB EXCITER

You can't beat this electro-dynamic exciter for shaking "bugs" out of products. With its frequency and force adjustments, you can "scan" a product for vibratory response—or fatigue-test it.

Take one case where a manufacturer of turbines was beset by blade failures. With an MB Exciter, he was able to resonate blades to destruction quickly—while studying their motions with stroboscopic light. In this way, he got to the cause of the trouble *visually!* More data in our bulletin 210B.



Isolate it-

...with ISOMODE* MOUNTS

Because Isomode mounts have equal spring rates in all directions, they're efficient at all angles — and they isolate all modes of motion!

That's why, by adopting Isomode units, one company was able to simplify suspension brackets and save on manufacturing costs in *addition to* improving vibration control! Another has been better able to cushion heavy duty engines—*without* re-designing the mounting system! Ask for bulletin 202 and Design Chart.

*Trade Mark Reg. U.S. Pat. Off.



You can see why more and more engineers contact MB when they run into trouble with vibration. We'll be happy to cooperate with you on *your* problems. For more information and for bulletins on the above MB products, write to Dept. E5.

THE
MB MANUFACTURING COMPANY, INC.
1060 State Street
New Haven 11, Conn.
VIBRATION ISOLATOR UNITS - VIBRATION TEST EQUIPMENT



2 GREAT NEW TUBES FOR

WITH television racing ahead to new records in popularity—to ever higher figures in dollar volume—choice of picture tubes takes priority with designers and builders of receivers. The picture tube is the heart of the TV set. Cost, picture size, brightness—these must be carefully weighed in the light of the particular market at which a new receiver is aimed.

Good news to designers is G.E.'s introduction of the two tubes shown here. One—the 8½-inch type (8AP4)—dovetails with requirements of the low-priced receiver market where costs must be scrutinized down to the last penny. The 12½-inch aluminized tube (12KP4) matches the needs of that field of sale—also large—where picture size and quality come first.

Both tubes are G-E-designed to embody tomorrow's advanced engineering concepts. Both tubes are G-E-built to highest precision standards of quality!

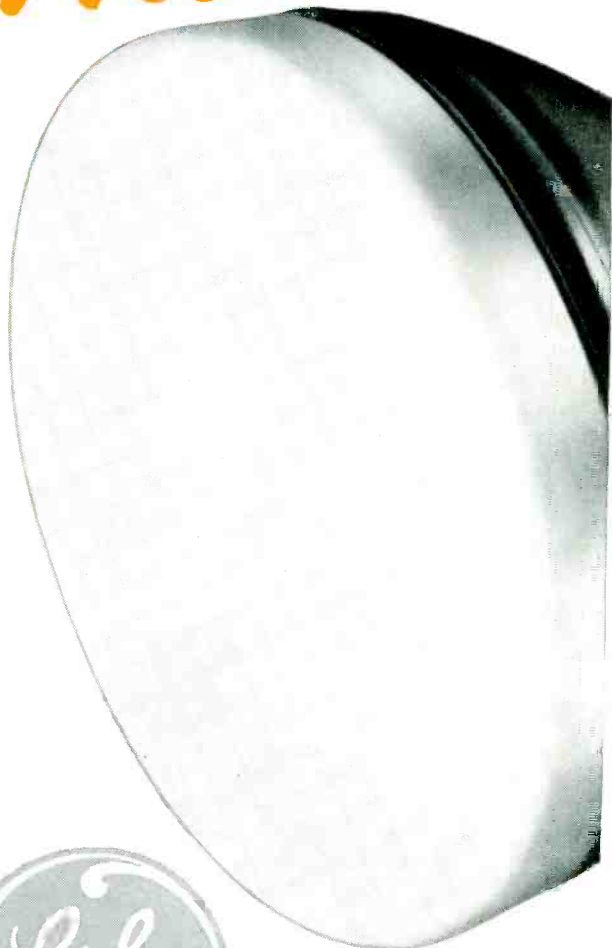

CHARACTERISTICS

	8AP4	12KP4
Max bulb diameter	8 11/16 inches	12 9/16 inches
Min useful screen diameter	7 3/4 inches	11 inches
Heater voltage	6.3 v	6.3 v
Heater current	0.6 amp	0.6 amp
Focusing method	magnetic	magnetic
Deflecting method	magnetic	magnetic
Deflecting angle (approx)	54 degrees	54 degrees
Screen fluorescent color	white	white
Over-all length	14 1/2 inches (max)	18 inches (max)
Bulb contact	metal-cone lip	J1-21
Base	B7-51	B7-51

MAX RATINGS, DESIGN-CENTER VALUES

	8AP4	12KP4
Anode voltage	10,000 v	12,000 v
Grid No. 2, voltage	none	410 v
Grid No. 1, voltage	-125 v	-125 v

TYPICAL OPERATING CONDITIONS

	8AP4	12KP4
Anode voltage	9,000 v	11,000 v
Grid No. 2, voltage	none	250 v
Grid No. 1, voltage for cut-off	-45 v	-45 v
Focusing coil current, d-c (approx)	120 ma	135 ma

NOTE: on Type 8AP4, the electron gun is designed for use with an external ion-trap magnet.

MASS TELEVISION MARKETS



TYPE 12KP4—A 12½-inch cathode-ray tube, all-glass construction. Aluminized screen. Offers *the brightest picture*—93 percent brighter (average) than a standard tube at 11,000 volts! Offers *a big picture*—95 square inches when the entire tube face is scanned; 75 sq. in. when standard raster of 3-by-4 aspect is employed. These areas are nearly half again as large as with the popular 10-inch type. . . . Here's the tube for TV-set manufacturers who put quality first, who wish to build consumer acceptance based on superior performance, on a larger, brighter, sharper picture. . . . *Here's the tube that's setting the pace in 1949 television!*

TYPE 8AP4—An 8½-inch cathode-ray tube with metal-cone envelope. Has plenty of picture area—47 square inches when the entire tube face is scanned; 36¾ sq. in. when standard raster of 3-by-4 aspect is used. . . . *Half the weight* of an all-glass tube, so ideal for small TV receivers that are lifted and moved about. . . . *Shortness of tube* (14½ inches) saves valuable space for the cabinet designer . . . *Requires a simpler, less costly circuit*, because the 8AP4's triode construction does away with need for a Grid-No.-2 voltage supply. . . . *Low in price*, up-to-the-minute in design—a combination that's putting this tube in first place with builders of small TV sets.

Size responsibility; wide facilities for research, for manufacture—these identify a top source of supply for any manufactured article. Your source for picture tubes need be no exception. General Electric is actively engaged in every phase of television—has pioneered many important TV developments—brings to each tube type the knowledge gained from designing and building numerous other products in this field in which G-E leadership is acknowledged.

G-E tube engineers are ready at all times to consult with you on technical problems relating to the application

of picture tubes to the receiver you may be designing. Your phone-call, wire, or letter will bring immediate, helpful response. General Electric's distributor-dealer facilities for replacing picture tubes in owners' sets are nationwide; your sales outlets and customers can count on tube service that is fast and reliable. Specify G-E picture tubes for value, quality, owner satisfaction! Buy the best for this best new market—television—that is generously rewarding the set builders who serve it well! *Electronics Department, General Electric Company, Schenectady 5, New York.*

You can put your confidence in—

GENERAL  ELECTRIC

101-M1

PICK A NUMBER
 ANY FREQUENCY FROM 10 TO 1,000

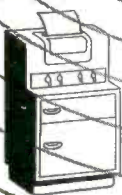
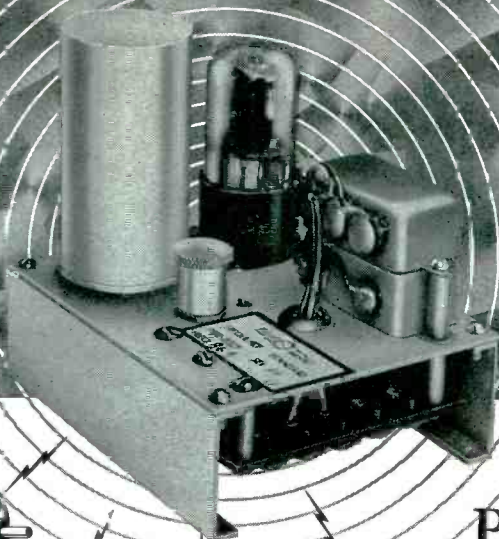

Pictured here is a tuning-fork frequency standard with accuracy guaranteed to one part per million per degree Centigrade. The fork is temperature-compensated and hermetically sealed against variations of barometric pressure. This standard, when combined with basic equipment, facilitates accurate speed and time control by mechanical, electrical, acoustical or optical means.

The unit is available separately or in conjunction with complete timing instruments. Our engineers are ready to cooperate on any problem.

MOTORS • FACSIMILE • AIRCRAFT • LABORATORIES

American Time Products, Inc.

580 Fifth Avenue

New York 19, N. Y.

OPERATING UNDER PATENTS OF THE WESTERN ELECTRIC COMPANY

Norelco PROTELGRAM

LIFE-SIZE
MORE
LIFE-LIKE
Television!

... from this 2½" tube

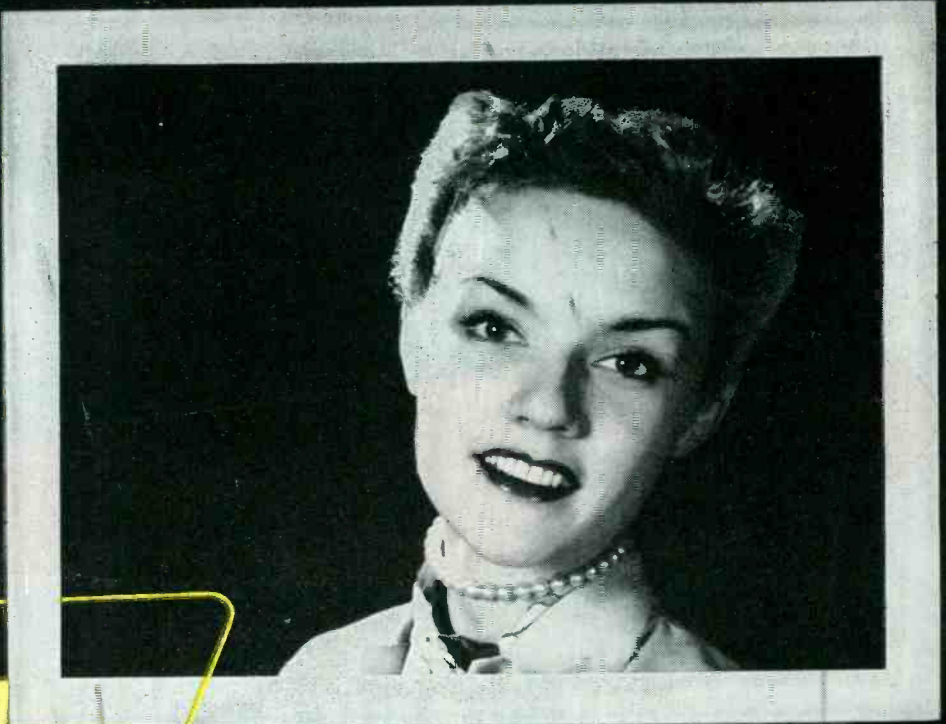

Chosen by these famous makers of quality projection TV receivers

**ANSLEY • EMERSON
FADA • FISHER
PILOT • SCOTT
STEWART WARNER
INTERNATIONAL
TELEVISION
BRUNSWICK**

and others soon to be announced

PROTELGRAM is the result of nearly fifteen years of research by the world's greatest electronics laboratories. This scientifically designed, optically correct projection system makes possible, for the first time, a life-size distortion-free picture of nearly 200 square inches (20" diagonal)... a more life-like picture without glare or eyestrain. And from a tiny long-life, low-cost picture tube!

PROTELGRAM is the answer to the public demand for a bigger, clearer picture that is easier on the eyes. It produces a better than 16" x 12" non-reflecting picture that fills a flat screen *all the way to the corners*, and permits wide angle visibility, fatigueless viewing from 5 feet or 50! Small size and light weight make possible compact consumer units. Write to Dept. PA-6, North American Philips Company, Incorporated, 100 East 42nd Street, New York 17, New York.



PROTELGRAM

for
life-size,
more
life-like
television



An Exclusive Development of

NORTH AMERICAN PHILIPS

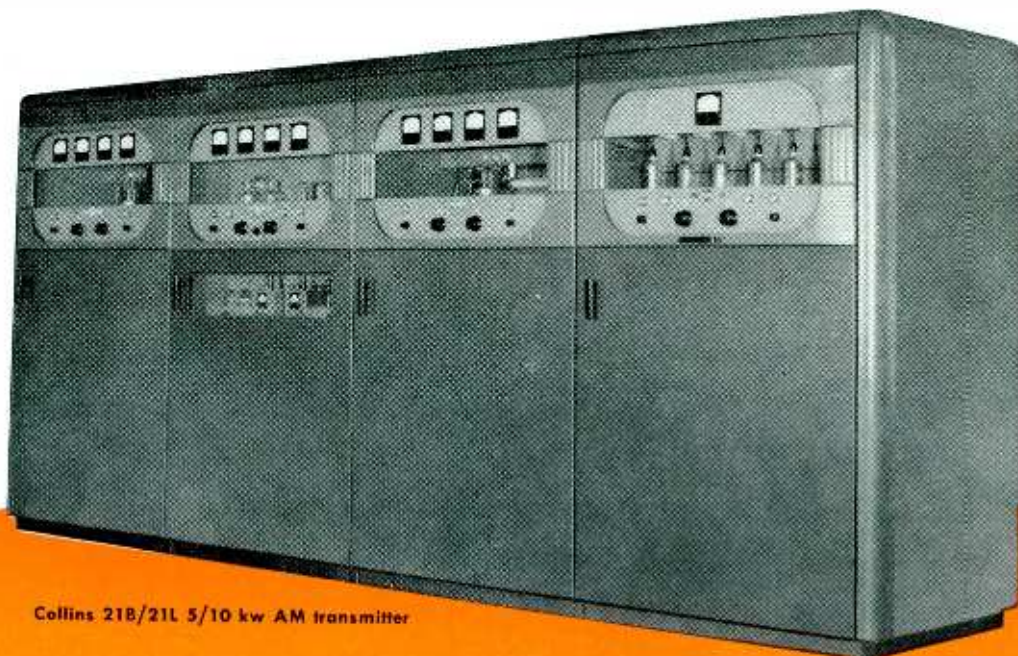

Collins 21B/21L 5/10 kw AM transmitter

This ultra modern transmitter is engineered to save you money

... and we are not referring to initial investment, though both the Collins 21B (5 kw) and 21L (10 kw) AM transmitters are very competitively priced in their respective power classes.

We are speaking of maintenance cost, month after month, year after year. That is where the saving mounts up.

The 5 kw 21B is designed and constructed as a conservatively rated 10 kw transmitter, minus the additional 892R power tube and associated parts needed to convert for 10 kw operation. The factor of safety is so great that the possibility of failure in any circuit approaches the vanishing point.

In addition, a newly designed, highly efficient differ-

ential relay, working in conjunction with the transmitter's recycling system, acts as a positive protective device in the final amplifier circuit.

This one device can save you many hundreds of dollars in the cost of tube and component replacements, and outage credits to sponsors.

When you convert to the 21L for 10 kw operation, you lose none of your original investment. No major component replacements are necessary. And you lose no air time.

These are examples of many advantages gained by choosing the Collins 21B/21L. For more complete information, write us for a fully illustrated bulletin describing this equipment.

FOR BROADCAST QUALITY AND ECONOMY, IT'S...

COLLINS RADIO COMPANY, Cedar Rapids, Iowa

11 West 42nd Street, New York 18, N. Y.

458 South Spring Street, Los Angeles 13, California



Eleven

NEW MODELS

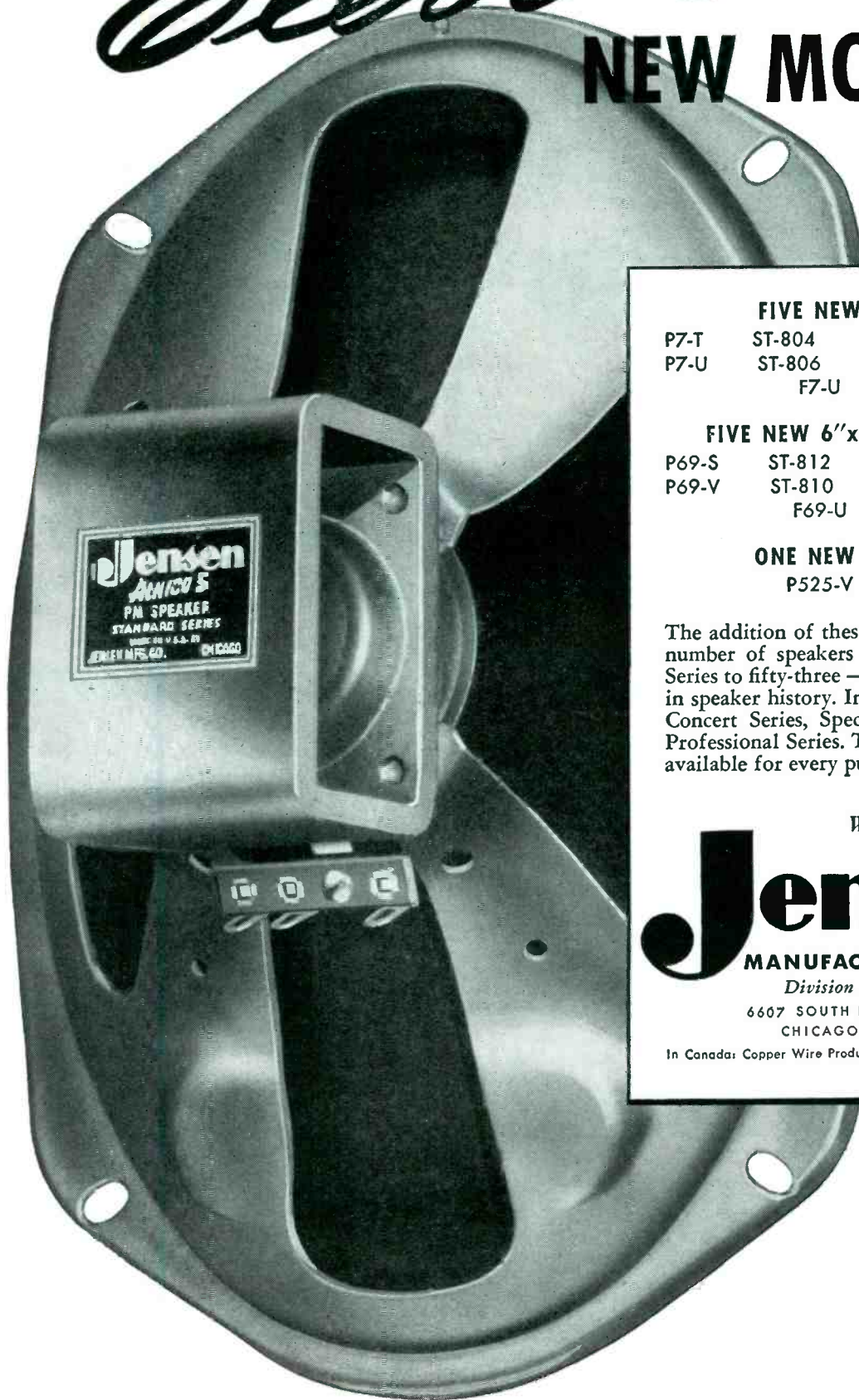

FIVE NEW 7" MODELS

P7-T	ST-804	P7-T	ST-807
P7-U	ST-806	F7-T	ST-809
	F7-U	ST-808	

FIVE NEW 6"x9" OVAL MODELS

P69-S	ST-812	P69-T	ST-811
P69-V	ST-810	F69-T	ST-814
	F69-U	ST-813	

ONE NEW 5 1/4" MODEL

P25-V ST-803

The addition of these new models brings the number of speakers in the Jensen Standard Series to fifty-three — the most complete array in speaker history. In addition are the Jensen Concert Series, Special Series, Coaxial, and Professional Series. There is a genuine Jensen available for every purpose.

Write for Catalog 1010-F

Jensen

MANUFACTURING COMPANY

Division of the Muter Company

6607 SOUTH LARAMIE AVENUE
CHICAGO 38, ILLINOIS

In Canada: Copper Wire Products, Ltd., 351 Corlaw Ave., Toronto

With more and still more telecasters it's Du Mont
TV camera equipment because of outstanding

DEPENDABILITY

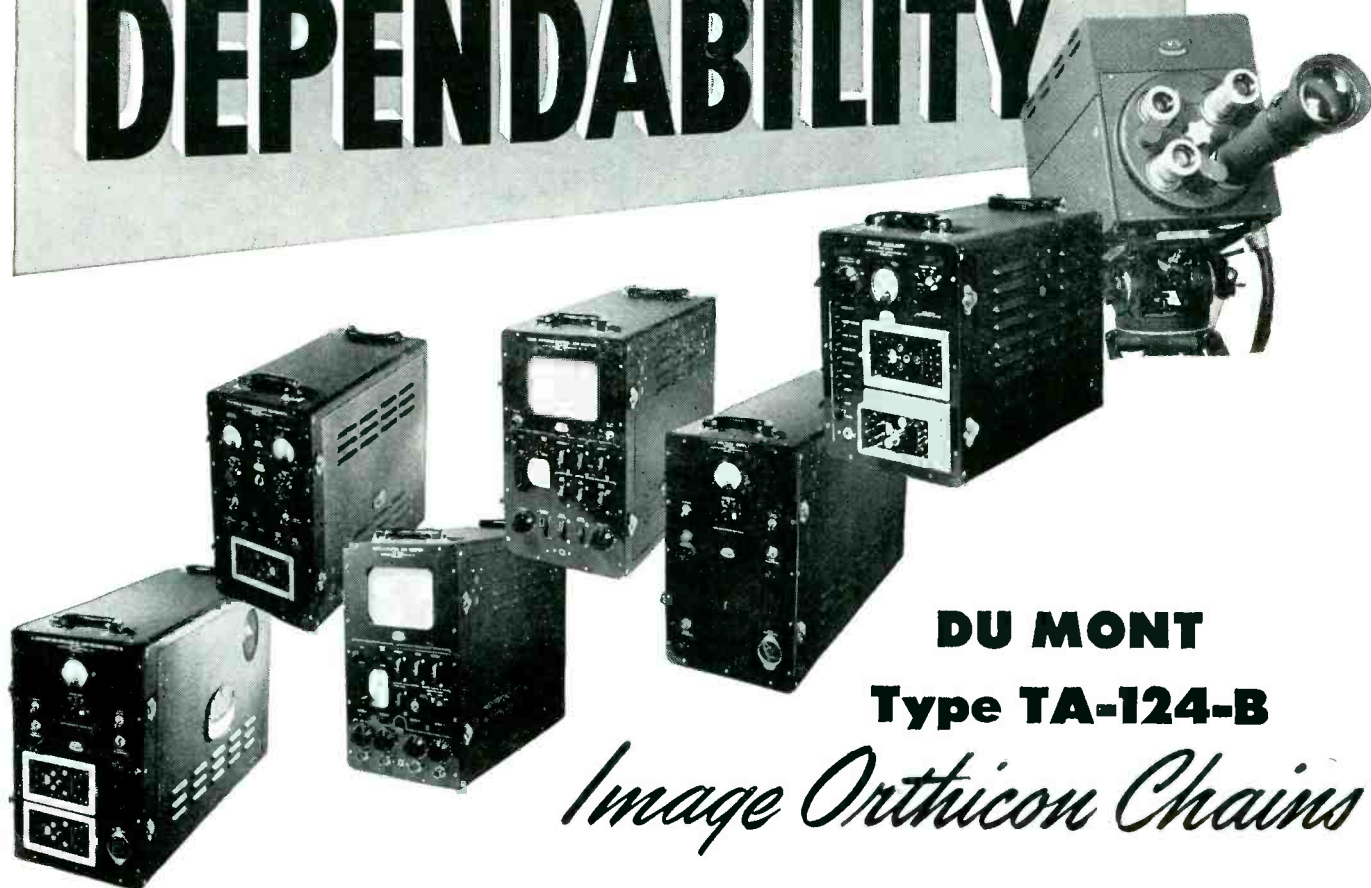

DU MONT Type TA-124-B

Image Orthicon Chains

Many TV stations either on the air or under construction, are Du Mont-equipped throughout. That means the Du Mont Type TA-124-B Image Orthicon Chain for studio and remote pickups, alike.

But of even greater significance is the growing use of Du Mont cameras and auxiliary equipment by TV stations originally using other makes of equipment; by intra-store television demonstrations; by wired television installations; by movie producers experimenting with television production possibilities; by TV training schools; by government

agencies both here and abroad.

The Du Mont advantages are many: Split-second action through quick set-

up; finger-tip controls; superlative image pickup with precise electronic viewfinder checkup; accessibility for time-saving inspection and immediate maintenance; handy matched units, jiffy-connected, for all required power, synchronizing, amplifying and monitoring functions, plus the latest camera effects.

But the outstanding characteristic of this popular Du Mont Type TA-124-B Image Orthicon Chain is **DEPENDABILITY**. That, in the final analysis, is the all-important consideration. For "The show must go on," regardless.

$$SD+QW = \frac{D}{FWFT}$$

(Simple Translation)

SUPERIOR DESIGN plus
QUALITY WORKMANSHIP equals
DU MONT

First With the Finest in Television

Consult us on your TV plans and requirements. Literature on request.

©ALLEN B. DU MONT LABORATORIES, INC.

DU MONT

First with the Finest in Television

ALLEN B. DU MONT LABORATORIES, INC. • TELEVISION EQUIPMENT DIVISION, 42 HARDING AVE., CLIFTON, N. J. • DU MONT NETWORK AND STATION WABD, 515 MADISON AVE., NEW YORK 22, N. Y. • DU MONT'S JOHN WANAMAKER TELEVISION STUDIOS, WANAMAKER PLACE, NEW YORK 3, N. Y. • STATION WTTG, WASHINGTON, D. C. • HOME OFFICES AND PLANTS, PASSAIC, N. J.

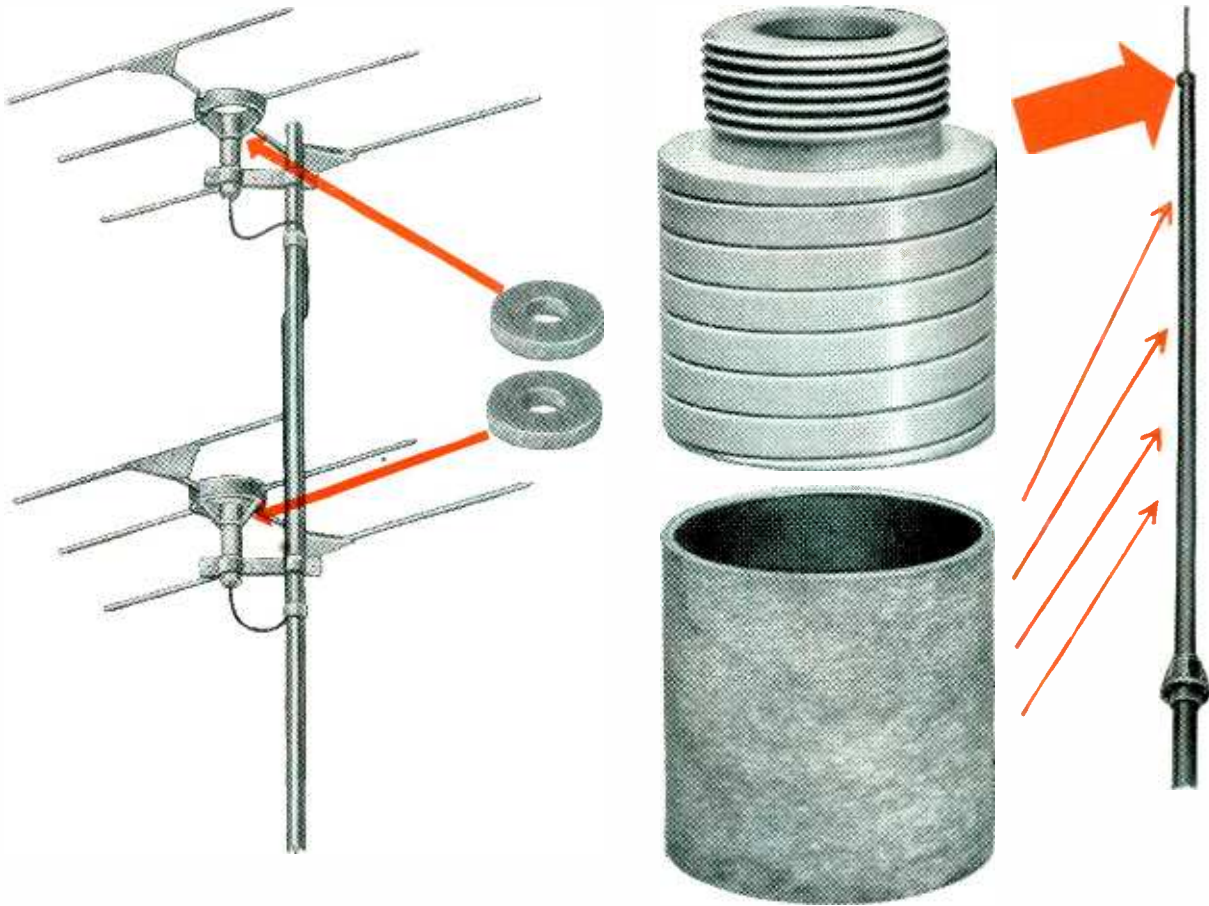

Lamicoid

Workshop Associates, Inc., specialists in high frequency antennas, use Lamicoid sheet, tubing and rod for many parts in television, FM radio and high-gain beacon antennas.

meets highest standards in custom-built TV and FM antennas

Workshop antennas are custom-built for exceptional performance. For dependability in parts serving structural and insulating functions, Workshop Associates rely on LAMICOID.

A thermosetting laminated plastic, LAMICOID combines tough-as-metal strength with lighter-than-wood weight. It has high dielectric strength, low power factor and good moisture and corrosion resistance. Made in sheet, rod and tube form, it can be readily fabricated by sawing, shearing, punching and machining into thousands of accurate shapes.

LAMICOID is made to the highest standards of quality, based on our 56 years of experience in making fine electrical insulating materials. Contact our nearest sales office or fabricator for further information.



MICA *Insulator* **COMPANY**

Schenectady 1, New York

Offices in Principal Cities

MITCHELL-RAND



the one dependable source
of supply for everything in
electrical insulation

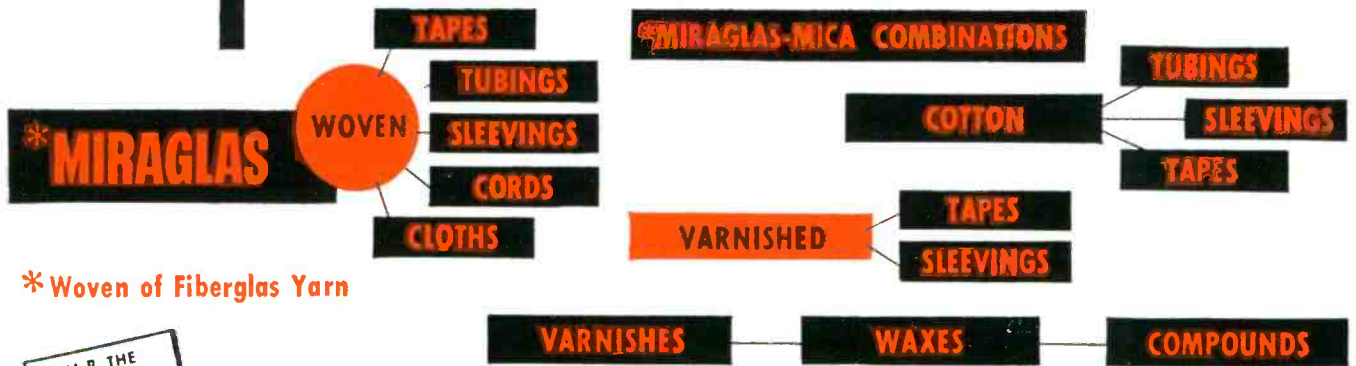

* Woven of Fiberglas Yarn

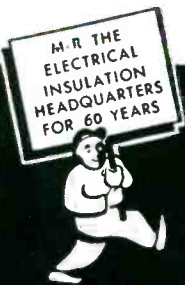

MITCHELL-RAND INSULATION CO. Inc.

51 MURRAY STREET • Cortlandt 7-9264 • NEW YORK 7, N. Y.

A PARTIAL LIST OF M-R PRODUCTS: FIBERGLAS VARNISHED TUBING, TAPE AND CLOTH • INSULATING PAPERS AND TWINES • CABLE FILLING AND POTHEAD COMPOUNDS • FRICTION TAPE AND SPLICE • TRANSFORMER COMPOUNDS • FIBERGLAS SATURATED SLEEVING • ASBESTOS SLEEVING AND TAPE • VARNISHED CAMBRIC CLOTH AND TAPE • MICA PLATE, TAPE, PAPER, CLOTH, TUBING • FIBERGLAS BRAIDED SLEEVING • COTTON TAPES, WEBBINGS AND SLEEVINGS • IMPREGNATED VARNISH TUBING • INSULATED VARNISHES OF ALL TYPES • EXTRUDED PLASTIC TUBING

Follow the Leaders to

Eimac
TUBES

The Power for R-F

Skill

HELPS BUILD BETTER VACUUM TUBES

Skill in the form of old-fashioned individual dexterity, teamed with modern manufacturing techniques, plays a very important part in the manufacture of better vacuum tubes . . . Eimac tubes.

Craftsmanship of Eimac employees is the result of years of training at one specific art . . . vacuum tube assembly . . . and the degree of proficiency they have attained is manifest in the quality of the product they produce.

Illustrated is the screen-grid assembly operation of the Eimac 4X150A tetrode. Precise geometric alignment of these parts provides the excellent electron beam action in the 4X150A. This operation is but one of over a hundred similar operations in the construction of this tube requiring the painstaking abilities of the Eimac craftsman.

ABOUT THE 4X150A

This extremely compact external anode type tetrode is capable of relatively high-output power at low plate voltage. It is intended for use as an r-f amplifier or oscillator. The 4X150A is used extensively as a wide-band amplifier for video and in single or multi-tube high-power ultra-high-frequency equipment. Good operational characteristics are maintained up to 950-Mc.

ELECTRICAL CHARACTERISTICS

Cathode: Coated Unipotential	6.0	volts
Heater Voltage	2.6	amperes
Heater Current	5.0	
Screen-Grid Amplification Factor (Average)	0.02	uuf.
Direct Interelectrode Capacitances (Average)	16.1	uuf.
Grid-Plate (without shielding)	4.7	uuf.
Input		
Output		
Transconductance ($i_b = 250$ ma., $e_b = 500$ v., $E_{c2} = 250$ v.)	12,000	umhos.

CLASS-C TELEGRAPHY OR FM TELEPHONY

Maximum Ratings; (Frequencies up to 500 Mc.)	1250	Max. Volts
D-C Plate Voltage	300	Max. Volts
D-C Screen Voltage	250	Max. Volts
D-C Grid Voltage	150	Max. Ma.
D-C Plate Current	15	Max. Watts
Plate Dissipation	2	Max. Watts
Screen Dissipation		
Grid Dissipation		

Complete data available on request.

EITEL-McCULLOUGH, INC.

728 San Mateo Ave., San Bruno, California

Export Agents: Frazar & Hansen, 301 Clay St., San Francisco, California

INDIANA PERMANENT MAGNETS MAY BE YOUR ANSWER, TOO

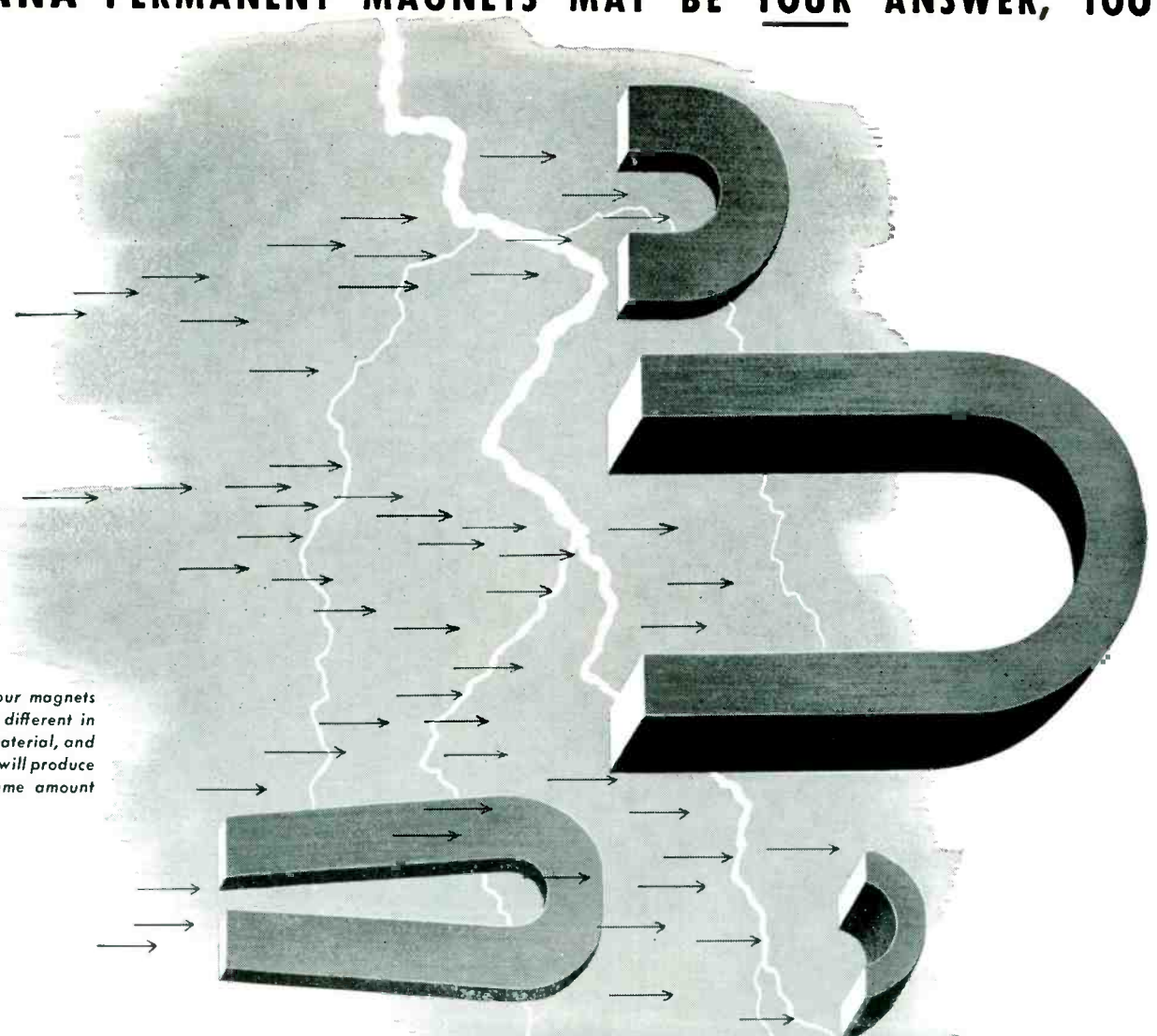

Each of the four magnets shown here is different in size, weight, material, and price; yet each will produce exactly the same amount of energy.

"PACKAGED ENERGY" SAVES SPACE, CUTS COSTS

INDIANA permanent magnets fit your need like a doctor's prescription—the right material, the right design, the right magnets to do your job best.

When you buy *Indiana* permanent magnets, you buy *product improvement* . . . new and higher efficiency . . . new versatility . . . new economy. Today, *Indiana* magnets are performing operations that were impractical only a few years ago—actually replacing many mechanical and electrical devices—and with less weight, less bulk, *lower cost*.

For example, certain radar magnets of Alnico originally weighed 14 pounds. Through *redesign* by *Indiana*, their size was reduced materially and their weight cut to 3½ pounds. Both were of identical material; both produced the same energy. The substantial savings in weight and cost were accomplished wholly by a change in design. Consultation with our engineers may result in similar savings for you.



NEW! BOOKLET NO. 4-E6— TELLS ALL ABOUT PERMANENT MAGNETS. A NOTE ON YOUR COMPANY LETTER-HEAD WILL BRING YOU A FREE COPY.

Indiana is the only manufacturer of all types of commercially used permanent magnet alloys. Continuous research and production control assure top quality and uniformity of all your *Indiana* permanent magnets, regardless of size or quantity. Call on our Special Design Service in solving your problems.



THE INDIANA STEEL PRODUCTS COMPANY

PRODUCERS OF "PACKAGED ENERGY"

SPECIALISTS IN PERMANENT MAGNETS SINCE 1908

6 NORTH MICHIGAN AVENUE • CHICAGO 2, ILL.

PLANTS: VALPARAISO, INDIANA; CHAUNCEY, N. Y.

ALL BUSTED UP?

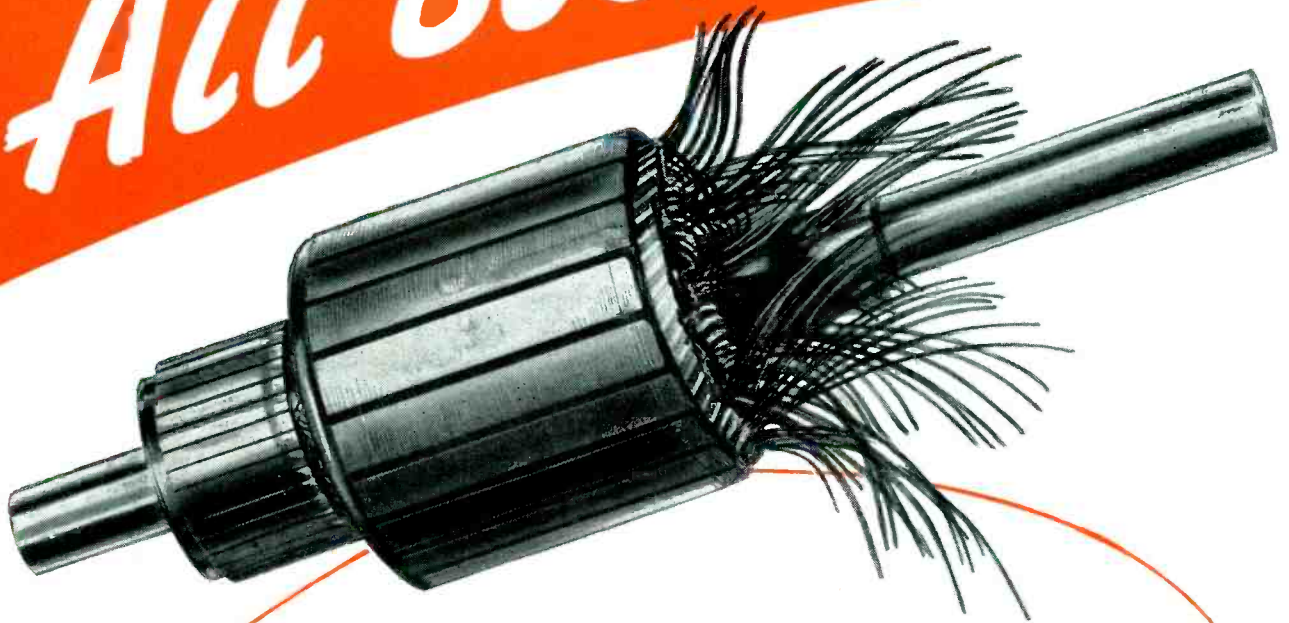

USE SCHENECTADY VARNISH

#150 *New*

for insulation at High Speeds



We are keeping pace with modern electrical design which stresses high operating speeds, high temperatures and smaller units. No. 150 answers this problem by offering an easy to apply varnish which has top insulating qualities. The mechanical strength of 150 varnish actually increases at elevated operating temperatures.

FOR COMPLETE SPECIFICATIONS OR TECHNICAL FIELD SERVICE... WRITE



SCHENECTADY VARNISH CO., INC.

200 CONGRESS ST., SCHENECTADY, NEW YORK

SCHENECTADY

RESEARCH KEEPS SCHENECTADY... "FIRST IN VARNISHES"

BUSINESS BRIEFS

By W. W. MacDONALD

Early In The Morning on the day FCC announced that licenses to operate citizens band transmitters would be issued generally beginning June 1 (see p 128) the CIO's Political Action Committee tipped off its local leaders that sets might be used by pickets and by block workers getting out the vote. This is, indeed, action.

TV-Tube Implosions have so far been few and far between and we know of no specific instance in which anyone has been injured. Nor is there any reason why anyone should be if the tubes are left alone by laymen and handled with reasonable care by technicians.

Manufacturers interested in preserving the safety record are planning a cooperative campaign telling technicians how to handle picture tubes in the plant, in the service shop and, where necessary, in the home. Suggestions will probably include cradling tubes to distribute their weight more or less evenly rather than carrying them by the neck, wearing masks or goggles and protective aprons when working around them with tools and driving a spike through tubes in cartons rather than striking the cartons a blow with a blunt instrument for disposal.

Solderless Connectors are commonly used in electrical equipment, in many instances speeding up production and, in most, simplifying installation and maintenance. They are being used in more and more industrial electronic devices and acceptance is slowly growing even among designers of sensitive instruments and communications apparatus.

Manufacturers of solderless wiring connectors, however, say there is one barrier they cannot seem to hurdle, and that is the application of their products in low-level high-gain circuits. Is this an unjustified taboo, a hangover from the days when everything associated with tubes had to be soldered? Or is too much noise produced by

fluctuation of contact resistance? Who has figures that tell how much noise is tolerable? How, indeed, should requirements be determined by test?

While soldering may be the easiest way to make most connections in low-level high-gain circuits we suspect that many could satisfactorily be made by means of solderless wiring devices and that there are production, installation and maintenance advantages. We also suspect that if noise standards were set up manufacturers could in most instances easily meet them.

A Reader working for one of the major airlines tells us he has developed an electronic converter, having no moving parts, that should be useful as an alternating-current power source for such things as aircraft, mobile and portable radios, and also possibly in connection with Geiger counters and hearing aids.

We'll be glad to forward letters from any interested manufacturers.

Two-Year Program to reduce size and weight of electronic equipment in military aircraft has produced savings up to 50 percent. The importance of the program becomes apparent when it is realized that in one large bomber over 4,000 pounds of such equipment, of 17 different types, has heretofore been carried.

Crystal Business, good during the war and, by comparison, bad immediately after, is reported to be picking up. Just how much of the pickup is due to increased government business and how much to reduced competition is hard to say.

Membership Drive currently under way by the Society of Motion Picture Engineers, having 3,000 technicians including theatre projectionists on its roster, makes television-station engineers welcome. Similarly, we are told that SMPE will extend its bids for financial support beyond the movie

Choose
PYRAMID
ELECTROLYTICS
for
Top performance
at 85°c



Pyramid Type 85TM Capacitors are now in volume production for leading TV-receiver manufacturers throughout the U.S.A. and Canada.

PYRAMID
CAPACITORS

PYRAMID ELECTRIC COMPANY

155 Oxford Street
Paterson, N. J., U.S.A.

TELEGRAMS: WUX Paterson, N. J.
CABLE ADDRESS: Pyramidusa



Let's Put the Chill on a Hot Subject . . .

As you read this message engineers the country over are hard at work planning, experimenting on fused hermetic sealing for their company's electrical product.

When the subject of a so-called glass terminal comes up (and it's bound to) they're apt to talk in terms of thermal shock. That's where Fusite Hermetic Terminals come in.

Take the interfusion of steel and inorganic glass that is a Fusite terminal. Apply the sizzling heat of a soldering or welding operation. And if you want to be ornery, shove it right out on the shipping dock on a zero day.

What happens?

Absolutely nothing. Your seal remains as tight as your production skill made it. All Terminals remain as smooth, as rugged, and uniform as only Fusite makes them.

Would you like to know more, or see samples? Write to Dept. E.

TERMINAL ILLUSTRATED 908HTO—For plug-in to standard "Octal" sockets. Available with two to eight hollow tube electrodes.



THE FUSITE CORPORATION

CARTHAGE AT HANNAFORD, NORWOOD, CINCINNATI 12, OHIO

FULL STRENGTH SOCKET WON'T STRIP OR WEAR

NEVER OUT-OF-ROUND. LEAKPROOF METAL-TO-METAL SEAL

NEW

ALLEN TRU-ROUND DRYSEAL PIPE PLUGS

100% Pressur-Formd

This newest Allen \odot Head product, made of Allenoy steel, meets all the demands of a dryseal plug in applications involving extreme pressure, such as in refrigeration and hydraulic equipment. For use with dryseal taps. No sealing compound required.

It stands up under repeated wrenching as no plug has before. Its Pressur-Formd socket, unweakened by drilling and broaching, is so strong the key will shear before the socket strips.

Pressur-Formd threading insures metal-to-metal contact all the way by producing burnished threads. This method prevents distortion and nicked, imperfect threads which gouge softer metals and impair the seal.

Accurate fit is assured by 360°

roundness, and by a perfect taper, at both the pitch and crest diameters. Here's positive protection against the high cost of leaky or faulty pipe plugs. Get "Tru-Round" Dryseal Pipe Plugs by ordering genuine Allens in the distinctive black and silver box.

Now available in sizes from $\frac{1}{16}$ " to $\frac{1}{4}$ ". No increase in price. Write us for samples and engineering data.



FOR NORMAL APPLICATIONS
Our "Tru-Round" standard pipe plug, also Pressur-Formd, is leakproof, and a sealing compound is not ordinarily needed for pressure-tight joints. Precise roundness and smoother threads make for better seal. Threaded strictly in accordance with Army-Navy Aeronautical Specification AN-P-363. Fully guaranteed.



ALLEN 
MANUFACTURING COMPANY
Hartford 2, Connecticut, U. S. A.
NEW YORK, CLEVELAND, DETROIT, CHICAGO, LOS ANGELES

ALLEN FOR 40 YEARS THE BUY-WORD FOR SOCKET SCREWS.

studios to television networks and makers of video gear. At the annual convention in New York in April the Society pulled the stops out and devoted the preponderance of its time to television.

TV Receiver Shipments by RMA-member companies in 1948 totaled 946,206, broken down as follows:

Alabama	23
Arkansas	61
California	81,536
Colorado	37
Connecticut	13,769
Delaware	2,557
District of Columbia	25,556
Florida	846
Georgia	4,831
Illinois	59,897
Indiana	4,414
Iowa	48
Kansas	9
Kentucky	3,119
Louisiana	3,983
Maine	14
Maryland	24,537
Massachusetts	33,276
Michigan	21,449
Minnesota	5,836
Mississippi	30
Missouri	12,337
Nebraska	31
New Hampshire	355
New Jersey	83,313
New Mexico	225
New York	232,684
North Carolina	1
North Dakota	231
Ohio	33,958
Oklahoma	28
Oregon	134
Pennsylvania	90,298
Rhode Island	4,378
Tennessee	3,146
Texas	8,706
Utah	1,001
Vermont	3
Virginia	2,921
Washington	4,569
West Virginia	167
Wisconsin	10,720
Areas Not Determined	26,991

Shipments, it should be noted, always trail behind production reports (some of the shipments listed above represent 1947 production). RMA-member companies produced 866,832 television receivers in 1948, and it is estimated that the whole industry made 975,000.

Sales Researcher Frank Mansfield of Sylvania, having so far interviewed 1,686 non-television owners in eight areas within video range, says at least 1,580,000 are wide open for sets in 1949 and that the industry ought to be able to sell as many as 2,710,000 if everything goes well.

Reading The Want Ads, we are always intrigued by the appearance of offers of jobs and offers of personal services almost on the same page. Like ships that pass forlorn, in the night. At the moment many of the jobs offered engineers seem to be in the field of airborne electronics, while many

of the job seekers seem to be from the radio-receiver field. This, perhaps, indicates not a recession but a migration.

Money Intake by the Radio Corporation of America and its domestic subsidiaries totaled \$357,617,231 in 1948 as against \$314,023,572 in 1947, broken down as follows:

	1948	1947
RCA (inc. Victor, Labs., RCA Int.)	75.7%	74.3%
NBC	19.8	20.9
RCA Comm. and Radio-marine	5.9	6.1
Less inter-company transactions	1.4	1.3

Money outgo, including cash carried to surplus to balance the books against the intake totals shown, broke down this way:

	1948	1947
Materials, talent, rent, adv., etc.	50.8%	53.2%
Salaries	34.5	34.4
Depreciation and amortization	1.8	1.5
Interest	.2	.2
Taxes	6.0	4.8
Dividends	2.8	2.3
Carried to surplus	3.9	3.6

Corporation profit after taxes was 6.7 percent in 1948, 6 percent in 1947.

Philco's 1948 Business broke down as follows: 46 percent television, radios and phonographs; 40 percent refrigerators, freezers and air-conditioners; 9 percent vacuum tubes, parts, dry batteries and accessories; 5 percent government and industrial business.

C-R Tube Sales to the television-receiver market increased 361 percent in units and 312 percent in dollars in 1948 as against 1947, according to RMA. During the year 1,265,472 tubes, valued at \$31,985,461, were sold. Of these, 1,179,444 went to set makers as original equipment, 84,230 were for renewal, 1,380 were bought by the government and 418 were exported.

Tele Drive-In Theatres are getting a big play on the West Coast.

Saddest Sight of the month, witnessed by one of our associates in a retail store, was a demonstration of a new radio set of a certain make during which the contraption poured out glowing commercials concerning a television receiver made by the same company.

Provocative CHARACTERISTICS

and
Precise PERFORMANCE

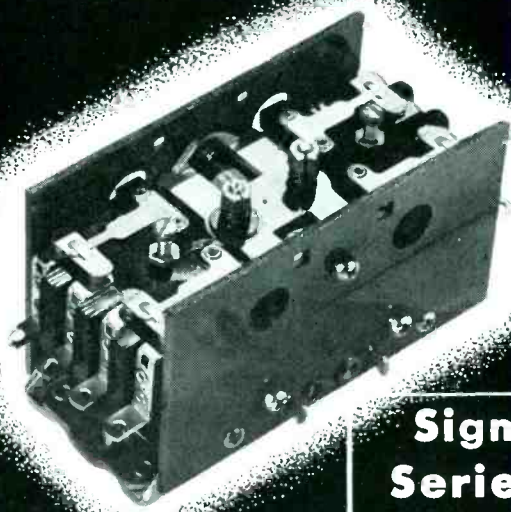

Hermetic Seal
Construction Also
Available

**Sigma
Series 6
RELAYS**

RUGGED POLARIZED RELAYS — 3 BASIC TYPES

"NULL SEEKING" ... "NORMAL" ... "LATCHING" ...

FORM "X" — Three-Position "Null Seeking" sensitive relay. Armature normally maintains central balanced position with all contacts open. No motion occurs until a predetermined amount of current is applied to coil. Armature then snaps right or left (depending on polarity of coil current) to close correct contacts. Snaps to return position at a lower value of coil current.

APPLICATIONS — For servo or control circuits where a variable must be restored to normal from either of two directions in which it may stray; and where automatic correction must consider direction, sense or polarity of the error. Examples: automatic steering, direction finding, guidance, process or machine control.

FORM "Y" — Two-Position, "Normal" Spring-Return Sensitive Relay. Effectively, this is a plate circuit relay and multicircuit contactor in one unit. It behaves like conventional sensitive relay but responds only to current of proper polarity.

APPLICATIONS — Wherever a sensitive relay with up to 4PDT substantially rated contacts is needed.

FORM "Z" — Two-Position, Latching relay. In this form armature motion and forces have characteristics like a strong spring toggle mechanism. However, these are magnetic and not mechanical. They derive from a powerful permanent magnet field which precludes wear, resists shock, vibration, etc.

APPLICATIONS — For overcurrent, reverse current or over voltage protective circuits, memory circuits, and the like — in place of mechanical latch relays. Extreme reliability with exceptionally long life.

CIRCUIT DESIGN SERVICE — To help you select the right Sigma relay for your particular guiding, control or "measuring" function — we offer complete cooperation. Write us today.



Sigma Instruments, Inc.
Sensitive RELAYS

62 CEYLON ST., BOSTON 21, MASS.



Ask
for Sigma
Bulletin 15.

Two Single or Double Section Switches...



RSA-50



RSA-60

... of Space Saving Design and Mallory Precision Quality

Where space is a factor—dependability essential—the Mallory RSA-50 and RSA-60 switches fill the bill!

These circuit selector switches, with section and terminal design identical to that of the famous Mallory RS-50 and RS-60 switches, are designed for band and tone control switching in radio receivers and other electronic applications where medium and low torque indexing action is desired.

The index assembly is of durable design and constructed with a minimum of parts—affording dependable service life with low torque and positive indexing action.

Note these many features, inherent in all the Mallory RS series, which contribute to their dependability and quality:

- Insulation of high-grade, low-loss laminated phenolic.
- Terminals and contacts of special Mallory spring alloy, heavily silver-plated to insure long life at low contact resistance.
- Terminals held securely by exclusive Mallory two-point fastening—heavy staples prevent loosening or twisting.
- Double wiping action on contacts with an inherent flexing feature—insures good electrical contact with the rotor shoes throughout rotation.
- Six rotor supports on the stator—insure accurate alignment.
- Brass rotor shoes, heavily silver-plated—insure low contact resistance.
- All shoes held flat and securely to phenolic rotor by rivets—prevents stubbing—insures smooth rotation—*minimum of noise in critical circuits.*

The RSA-50 and RSA-60 are both available in one or two section construction. The RSA-50 accommodates up to twelve terminals on either side of the section and provides from 2 to 6 positions. The RSA-60 accommodates up to ten terminals on either side of the section and provides from 2 to 5 positions. The RSA-60 has the narrow section design—ideal for under chassis mounting, where space saving is paramount.

ENGINEERING DATA SHEET

Send for the Mallory Engineering Data Sheet on the RSA-50 and RSA-60. It contains complete specifications for available circuit combinations with respective terminal locations, dimensional drawings—everything the engineer needs to adapt the RSA-50 or RSA-60 switch to a particular circuit.

SPECIFICATION SHEETS

Specification sheets for the RSA-50 and RSA-60 switches have also been prepared. These sheets are printed on thin paper to permit blueprinting. The sectional drawings indicate standard and optional dimensions—make it easy for you to order production samples built to your requirements.

Precision Electronic Parts—Switches, Controls, Resistors

P. R. MALLORY & CO., Inc.
MALLORY

P. R. MALLORY & CO., Inc., INDIANAPOLIS 6, INDIANA

SERVING INDUSTRY WITH

Capacitors Rectifiers
Contacts Switches
Controls Vibrators
Power Supplies
Resistance Welding Materials



CROSS TALK

► **SHADOW . . .** Electronic computers are often too fast for their own good, so much so that one of the principal problems now facing designers is a means of getting numerical information out of the computer as fast as it is computed. Magnetic tape is a great advance, over manual methods, but still limited in speed. Now comes word of the Charactron, a cathode-ray shadowgraph device, which passes a defocused beam through metal plates in which have been cut, stencil-fashion, the outlines of numbers. The beam, passing through the stencil outline, forms the corresponding number on the phosphor of the tube. By a selective deflection system similar in form to a honeycomb, it is possible to form multi-digit numbers, at selected positions on the tube face, at the rate of 20,000 characters per second, or about as fast as any computer can spew them out. A high-speed movie camera can photograph the output for storage and later study. The tube, developed by J. T. McNaney at Consolidated Vultee Aircraft Corporation, is also suitable for displaying other forms of printed information at high speed.

► **SALARIES . . .** We are surprised to note that recent electrical engineering graduates (the majority of whom are electronics or communications majors) are not the best paid of the current crop of technical newcomers. So, at least, is the report of a survey conducted by New York University among its recent engineering graduates.

In 1947 the "electricals" headed the list with an average starting salary of \$238 per month, followed by civil, chemical, mechanical and aeronautical graduates in that order. But in 1948, the highest pay went to the new crop of chemical engineers, followed by the mechanicals, civils, electricals and aeronauticals in that order. The salaries of all were higher in 1948 by from 5 to 16 per cent; the average starting salary of the electrical graduates went up 5.5 percent from \$238 to \$251. This is a rather small sample (177 men replied to the survey question-

naire), and perhaps not indicative of any general trend. But it bears watching.

The professors have been predicting overpopulation among electronics engineers ever since the end of the war. If the supply of new men in electronics is catching up with the demand (and we still doubt it) the time is ripe for a reassessment, by educators and employers, of the real needs of our field. Our firm belief is that a great many more engineers can be employed, particularly in the development of new techniques, than are envisaged in the current plans for expansion of our industry. Let's not discourage the new talent.

► **FREE TIME . . .** The common complaint that a television set in the house takes over too much precious leisure time has moved Paul Raibourn, vice-president of Paramount Pictures, to consider in a recent speech how a man spends his time. Of the 168 hours in a week, about 98 go to such essential needs as sleeping, eating, dressing, bathing, shaving and going to and from work. Time was, 100 years ago, when the remaining 70 hours were wholly occupied in work. Now, with the 40-hour work week, we have about 30 hours for leisure.

Surveys indicate that 7 to 8 hours per week go to radio listening, at a cost of \$42 a year, 1½ hours a week for the movies at \$35 per year, 1½ hours with newspapers at \$40, magazines ¾ hour at \$20, auto 3 to 6 hours at \$400 yearly, and 15 hours of spectator and participant sports and games, hobbies and the like. So along comes television. It costs about \$100 a year, all things considered, and the time it takes—well, you name it!

We might suspect Mr. Raibourn of whistling in the dark, were it not for his years of active support of television, when he remarked that a decrease in the work week from 40 to, say, 30 or 35 hours, might allow television to take its place without affecting other leisure-time-consuming industries. From where we sit, even that's not enough extra time.

Basic Research Projects

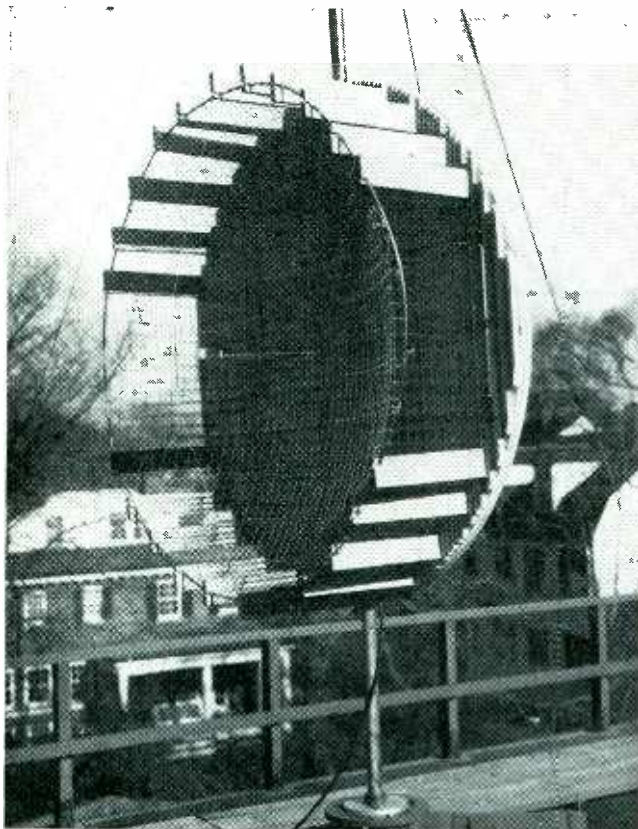

Parabolic reflector being used for tropospheric reflector studies at Cruft Laboratory



Jet aircraft model used at Cruft in connection with aircraft antenna research project

THROUGH the Office of Naval Research (ONR), the Department of the Navy is sponsoring basic research under an Act of Congress dated August 1, 1946. The objective of ONR is to plan, promote and coordinate Naval research. It is concerned mainly with basic research, while the Bureaus of the Navy are concerned with development and research directly associated with development.

ONR conducts a large amount of applied and basic research at the Naval Research Laboratory and other Naval laboratories. However, several divisions, including the Physical Sciences Division, are charged with basic and fundamental research for which it is expedient to utilize the facilities of universities and the talents of their civilian scientific personnel.

Placing work with universities achieves a number of objectives. These include the expansion of re-

search facilities of smaller institutions and distribution of activity over a wide area. In addition, the program establishes a reservoir of scientists who have become familiar with important problems while working on ONR-sponsored research. The program also trains many graduate students, thus increasing the nation's scientific manpower resources. Past deficiencies here were forcefully revealed in the Steelman Report to President Truman on the nation's scientific activity.

Work sponsored by the Electronics Branch of the Physical Sciences Division of ONR is not contained only in large university projects. A particular effort is made to sponsor smaller programs, with the result that much effective work is done which could never have been initiated without external support.

The field of electronics has been divided into seven subfields or cate-

gories for ONR-sponsored research. These are Propagation, Radiation and Matter, Electron Ballistics, Physics of Components, Circuitry, Systems and Instrumentation.

All of the present projects under active sponsorship have been coordinated with the other services and are considered to be important from a scientific as well as a purely Naval viewpoint. Some projects, however, are more interesting than others from the standpoint of immediate application and specific results obtained. In the field of purely basic research this probably is more the exception than the rule. However, this article is primarily concerned with such projects and gives some indication of the practical benefits accruing.

Cruft Laboratory at Harvard

In the fields of electromagnetic radiation, propagation and microwave circuits, Harvard University's

Under ONR Contracts

Survey of extent to which Office of Naval Research is sponsoring fundamental research in small as well as large universities, and details of several current projects that promise early practical applications

By **KARL R. SPANGENBERG**
*Head, Electronics Branch
Physical Sciences Division, ONR
(On leave from Stanford University)*

and

WALTER E. GREENE
*Lieutenant Commander
Electronics Branch, ONR
U. S. Navy Department*

Cruft Laboratory is doing some interesting work.

A rather large group there is involved in the recording and analyzing of sky-wave radio signals received over long distances. The objective of this group is to be able to predict the characteristics of radio transmission from point to point from a correlation of vertical and oblique ionospheric measurements. Signals of various frequencies received over long paths at Cambridge, Massachusetts, from Glenville, S. C., Las Cruces, N. M. and Lindau, Germany are being automatically recorded. On the Cambridge-Glenville circuit, it so happens that Sterling, Virginia, near Washington, is halfway between the ends of the circuit and directly under the point of grazing incidence of the skywave. It thus becomes possible to continuously examine at vertical incidence the point of reflection of a sky-wave from the ionosphere and correlate this vertical incidence data with signal strength and other factors at the receiving and transmitting sites.

Another group at Cruft is studying the stabilization of microwave oscillators. The ultimate goal of this group is setting up a new type of frequency standard, independent of most of the normal causes for inaccuracies in present standards. Such an accurate oscillator circuit could be used to operate an extremely precise chronometer. Present efforts are directed to the stabilization of such oscillators by an am-

monia absorption line.¹ Circuits developed so far are delicate, complex and rather sluggish in their reaction time to a correcting impulse. As a consequence, there still remains a fertile field for investigation of this problem. Variation of the ammonia absorption spectrum with changes in temperature and pressure is being investigated also.

Important work of a highly practical nature is also going forward at Cruft in the field of aircraft antenna measurements. This group is investigating new methods for the study of various antenna systems on full-scale aircraft structures. Measurements over a wide fre-

quency range have been made on a number of antennas, including the inverted-L, inclined wires and other configurations. Better radiation patterns will be developed as a result of such work as this.

Massachusetts Institute of Technology

In any discussion of basic research the question often arises as to just how basic can research be. The definition of basic research depends upon one's point of view. However, work in progress at the Laboratory for Insulation Research at Massachusetts Institute of Technology is probably as basic as any under the cognizance of the Elec-

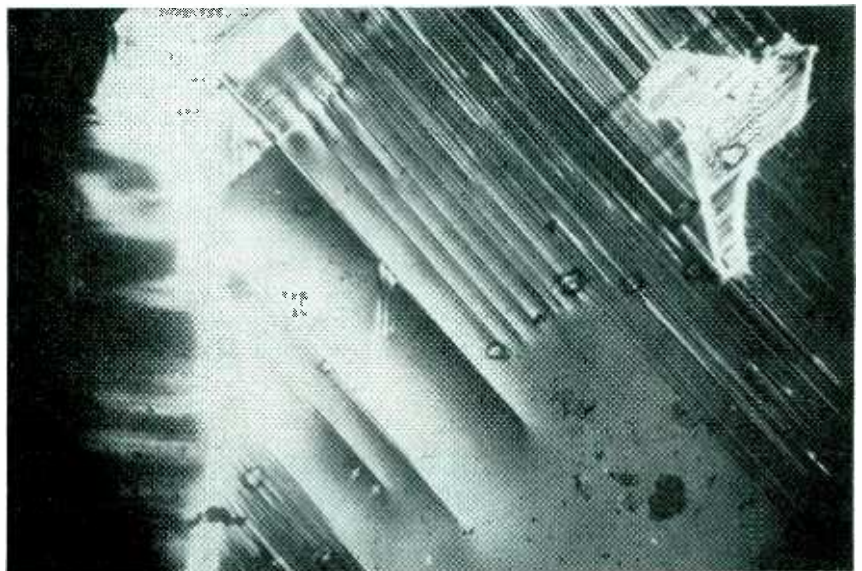

Optical demonstration of lattice strains near wedge-shaped domains in barium titanate. Fine laminar wedges move back and forth in a varying electric field to produce initial susceptibility. Research on nonlinear ferroelectrics such as this has been assigned to the Laboratory for Insulation Research at MIT

tronics Branch of ONR today.

Some of the most interesting work done at the Laboratory for Insulation Research has been in the field of high-dielectric ceramics such as barium titanate and mixtures of barium and strontium titanates. These ceramics are nonlinear ferroelectric dielectrics similar in many respects to Rochelle salt. Investigating emphasis has been on properties pertinent to the design of nonlinear capacitors.

There is considerable indication of hysteresis in measurements on barium titanate, showing that it is truly ferroelectric over certain temperature ranges. The ferroelectric properties of these materials can be exploited in nonlinear circuits such as harmonic generators, modulators and possibly dielectric amplifiers.

Under certain conditions barium titanate can also be piezoelectric. Many practical uses can be found for this, such as microphone elements, phono pickups^{2,3} and pressure gages. Pickups and microphones using the ceramic as the generating element are already on the market.

The advantage of the ceramic type of generating element over the conventional element is that the ceramic is much more stable over wide ranges of heat, moisture and dryness. Ceramic units can be designed to have a very good frequency response characteristic and are comparatively rugged.

Stanford University

Among the projects at the Electronics Research Laboratory of Stanford University may be mentioned the traveling-wave tube and radar reflections from ionized meteor trails.

In traveling-wave tube work, attempts are being made to extend

the use and understanding of this mechanism of continuous interaction between a traveling electromagnetic wave and an electron beam.⁴ The outstanding features of this novel tube are its great bandwidth and high gain at microwave frequencies. Voltage gain—bandwidth products are approximately 1,000 times those of conventional low-frequency tubes and nearly 2,000 times those of klystrons. Some typical performance figures are: Amplification 23 db; bandwidth 1,000 mc; operating frequency 4,000 mc; operating voltage 1,600 volts; beam current 10 ma; power output 2 to 3 watts.

At the present stage of development the traveling-wave type of tube has a rather objectionable noise figure, and much effort is being put on the noise reduction problem. This type of tube will be of use in such applications as broadband receivers for television services, broadband ultrahigh-frequency i-f amplifiers, broadly tunable uhf receivers with simple wide-range tuning mechanisms, local oscillators for uhf receiver, radar services and many others.

Other successful traveling-wave tubes have been produced which operate in other portions of the spectrum, such as at 3 cm.

In the meteor ionization research at Stanford it is desired to learn about the electrical and physical properties of the ionosphere through the study of radio reflections from meteor ionization trails. The use of these reflections as a means of studying meteors themselves will also be investigated. Both pulse and Doppler (continuous wave) measuring techniques are being used.

It has been shown that as meteors pass through the outer envelope of air surrounding the earth, they

leave behind a trail of ionized air. Even a minute particle may produce an ionized envelope one hundred kilometers long or more. This ionization can be great enough to readily reflect radio waves. Monitoring of short-wave radio stations is perhaps the simplest way to detect meteors by radio, although it is not completely satisfactory. The received signal strength must be of a certain value, the distance from the station to the receiver must be proper and the frequency must be coordinated with the above parameters. The research group is using laboratory transmitting, receiving and recording apparatus, and it is expected that much useful data on the earth's outer atmosphere will be obtained from this project.

University of Illinois

The Department of Electrical Engineering of the University of Illinois has a project on Direction of Arrival of Radio Waves. Work is currently going forward on Antenna Arrays for Direction Finding, System Analysis, Data Presentation and Amplifier Development.

A rigorous mathematical analysis has shown that super-gain antenna arrays are not practical due to a very large decrease in radiation resistance and bandwidth and a consequent increase in ohmic losses and difficulty of tuning.

The Data Presentation group is concerned with the construction of an eight-gun cathode-ray oscillograph for use in simultaneous presentation of bearing information from eight or fewer sources.

The System Analysis group is presently working on characteristics of existing direction-finding systems. Construction work on the Antenna Simulator has proceeded sufficiently far to allow preliminary examination of several radio d-f

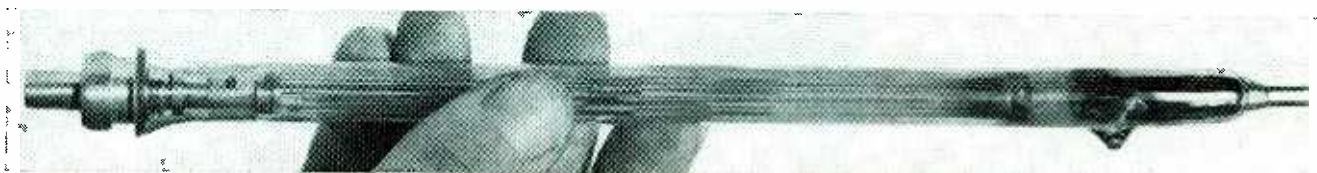

Three-centimeter wavelength traveling-wave tube being used at Stanford University in research aimed at reducing the noise figure of this broadband amplifying device

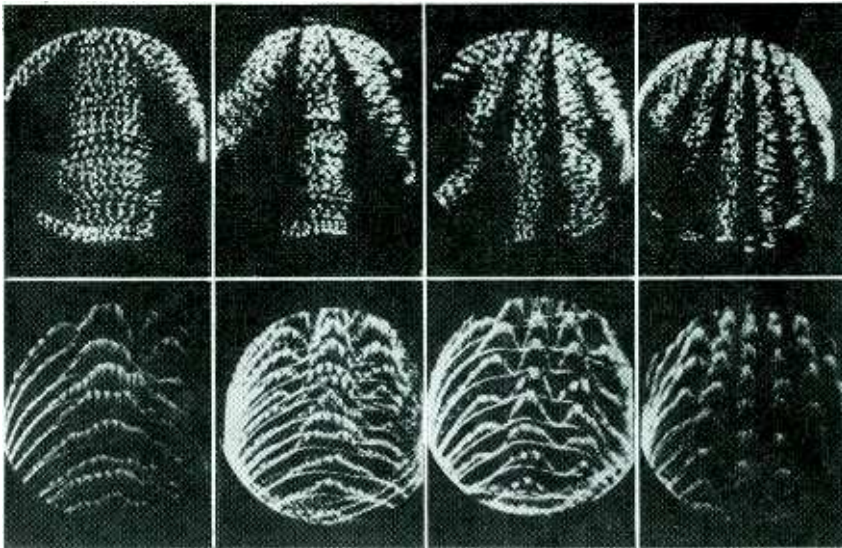

Oscilloscope patterns of wave interference in an electromagnetic field. Wavelength of both sources is 10 cm. Vertical columns from left to right are for distances of 1, 2, 3 and 5 wavelengths respectively between the interfering sources. University of Illinois photo

systems by this means. It is expected that much useful information will be forthcoming from this d-f work. The results should be of value to commercial organizations as well as the Armed Services.

Brooklyn Polytechnic Institute

The Brooklyn Polytechnic Institute has a program of investigation in the general field of nonlinear electrodynamics. One of their projects concerns an analysis of transient response of various circuits to f-m signals. The effect of the frequency swing-bandwidth ratio on the transient signal has been analyzed theoretically. It has been shown that the frequency swing should not exceed one-half the bandwidth for low distortion in conventional circuits.

Since in any f-m system the frequency discriminator is of great importance, considerable effort has been spent on analyzing various circuits. It was demonstrated that the balanced type of detector was most beneficial in reducing harmonic distortion.

Some effort is also being put on the mathematical analysis of iron-cored circuits, with emphasis on magnetic amplifiers. Analyses are being made to determine the effect of system parameters on the time constant and to investigate means whereby the overall speed of re-

sponse of magnetic amplifier circuits may be increased without undesirable effects on other characteristics.

It is expected that the newer highly permeable core materials now becoming available will have a more profound effect on the overall characteristics of future magnetic amplifier control systems than any radically different circuit arrangements which may be developed.

Other Projects

The particular projects mentioned here are by no means the

only projects of their kind under ONR sponsorship, nor do they represent the only productive work. For example, in the field of high-powered microwave generators, the 10-megawatt magnetron being developed by the MIT Research Laboratory for Electronics is one of several tubes under development. In other categories of research, much fine productive work is being done by many smaller institutions, but space limitations do not permit mention here.

More specific information on these and other interesting projects will be published by the research workers themselves in various scientific periodicals, since none of the work sponsored by the ONR Electronics Branch is of a classified nature. The scientists are encouraged to disseminate widely the results of their investigations. The thought behind this is that fundamental truths should be free to everyone in order to increase the efficiency of the transition from original basic considerations to practical, concrete applications.

REFERENCES

- (1) Stable Time and Frequency Standard, *ELECTRONICS*, p 82, April 1949.
- (2) L. Grant Hector and H. W. Koren, Ceramic Phonograph Pickup, *ELECTRONICS*, p 94, Dec. 1948.
- (3) G. N. Howatt, J. W. Crownover and A. Drametz, New Synthetic Piezoelectric Material, *ELECTRONICS*, p 97, Dec. 1948.
- (4) Wideband Microwave Amplifier Tube, *ELECTRONICS*, p 90, Nov. 1946.
- (5) Chas. R. Burrows, Radio Astronomy, *ELECTRONICS*, p 75, Feb. 1949.

UNIVERSITIES WITH ONR ELECTRONIC CONTRACTS

- CARNEGIE INSTITUTE OF TECHNOLOGY—Investigation of Magnetic Amplifiers
 CORNELL UNIVERSITY—Microwave Astronomy⁵
 DARTMOUTH COLLEGE—Electromagnetic Wave Polarization
 HARVARD UNIVERSITY—Measurement of Recombination Coefficient; Propagation and Circuit Studies (Cruft Laboratory)
 LINFIELD COLLEGE—The Field Emission of Electrons from Metals
 MASSACHUSETTS INSTITUTE OF TECHNOLOGY—Research in Physics of Components
 POLYTECHNIC INSTITUTE OF BROOKLYN—Nonlinear Electrodynamics
 PRINCETON UNIVERSITY—Dielectric Properties and the Structure of Matter
 STANFORD UNIVERSITY (Electronics Research Laboratory)—Special Microwave Tubes and Circuits
 UNIVERSITY OF ILLINOIS—Investigation of Radio Direction-Finding Systems; Research on the General Problem of Broadband Amplification in the Microwave Frequency Range
 UNIVERSITY OF MISSOURI—Solid-State and Surface Physics Research on Semiconductors and Insulators
 UNIVERSITY OF TEXAS—Tropospheric Propagation at Ultra High Frequencies
 WASHINGTON STATE COLLEGE—Facsimile Recording Paper
 YALE UNIVERSITY—Characteristics of Split-Anode Magnetrons and Reflex Klystrons; High-Frequency Discharge Through Gases and Self-Sustaining Arcs; Microwave Propagation in Material Media

Minimizing Television Interference

Techniques for making possible the reception of programs in regions far removed from the normal service areas of transmitting stations by improving the effective sensitivity and selectivity of receivers. Types of interference are explained and suggestions made for decreasing their effect on reception

By P. S. RAND

Laboratory of Advanced Research
Remington Rand Inc.
South Norwalk, Conn.

TELEVISION is growing up at a phenomenal rate and has already begun to experience growing pains. One of these is interference to the picture, commonly designated by the abbreviation tvi.

There is hardly a receiver sold that does not at some time receive tvi of some sort on some channel. Radio listeners long ago became accustomed to hearing static, whistles and other forms of interference on their broadcast receivers. It is unfortunate for television that the eyes are much more sensitive to interference.

The television industry is snowballing, doubling and redoubling production figures, turning out hundreds of thousands of receivers. New television transmitting stations are springing up all over the country and people in these new areas are clamoring for receivers. Each one expects to get bright, clear, movie-like pictures, despite the fact that the nearest television station is in some cases as much as 130 miles away.

Receiver Sensitivity

The receiver purchased may be designed to work satisfactorily in a primary coverage area of 5,000 microvolts signal strength, or in a rural area of 500 or more microvolts. Receivers are often installed in industrial areas where the signal strength may be as low as nine microvolts. Customers in such areas get plenty of snow or tube noise in pictures and undoubtedly will have the picture blanked out at times by various types of man-made interference.

Because of its relatively wide bandwidth, television is especially subject to interference. In a superheterodyne it is the function of the i-f amplifier to provide adequate rejection of undesired signals near the pass band, while the front end provides rejection of signals far removed from the pass band and especially signals at the intermediate frequency and image frequency.

Superheterodynes are inherently subject to interference from a multitude of signal frequencies and television superhets are no excep-

Receiver Design

There are many causes of television interference that lie outside the realm of receiver design, particularly if reception in weak-signal areas is involved.

Where venetian-blind effect is removed by synchronization of carriers (*Electronics*, Feb. 1949) there will still be many viewers who see two pictures at the same time. Diathermy, spark-plug and home-appliance interference may be very troublesome. The author has, however, proved to his own satisfaction that the present-day production receiver can be modified so as to remove a very large part of even the uncontrollable interference.

If television is to become a truly national service, the receiver manufacturer must continue to improve his product, not only for the urban viewer, but also for the millions in the uttermost fringe areas who are anxious to get almost any sort of reception so long as it moves and talks.

—The Editors

tion to the rule; in fact, because they must operate in the vhf region, they are more than usually susceptible to several types. Interference resulting from spurious responses most troublesome in television reception and the fault of receiver design includes:

- (1) Direct i-f feedthrough.
- (2) Image interference, arising from a combination of local oscillator frequency plus i-f.
- (3) Signal image interference, resulting from local oscillator frequency plus signal frequency.
- (4) Interference occurring at twice the oscillator frequency plus or minus the i-f.
- (5) Direct reception of the oscillator signal from a nearby television receiver.

The practical remedies for these faults as they apply to the various interference manifestations will be discussed below.

Receiver Radiation

It is necessary to have a high frequency oscillator in a superheterodyne type of circuit. However, it is not necessary to couple it to the antenna. Figure 1 shows the circuit of a front end used by several manufacturers during the past few years. Radio-frequency energy is coupled from the oscillator coil to the mixer grid coil, where it is detected with the television signal to form the i-f signal. Being only slightly higher in frequency than the desired signal, it is also fed into the r-f stage plate circuit where it easily finds its way through the partly neutralized push-pull triodes and thence to the antenna circuit.

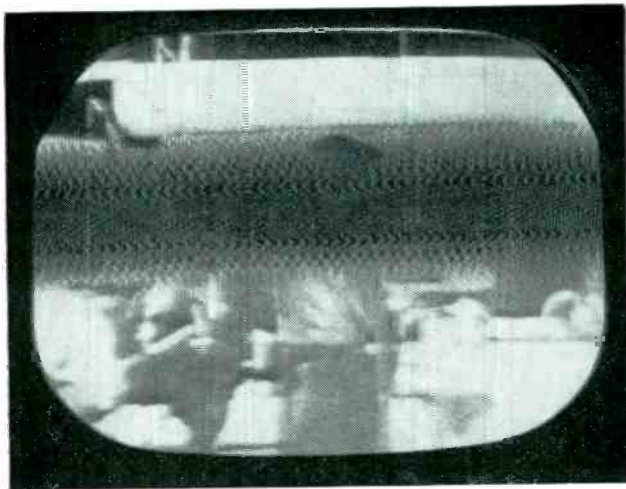

Mild diathermy interference. Single bar (60 cps) drifting slowly up and down

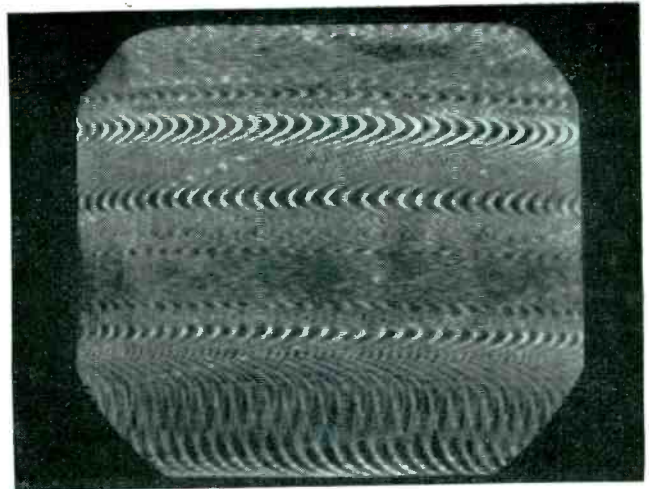

Severe diathermy type of interference at 120 cycles. Bars drift slowly up and down

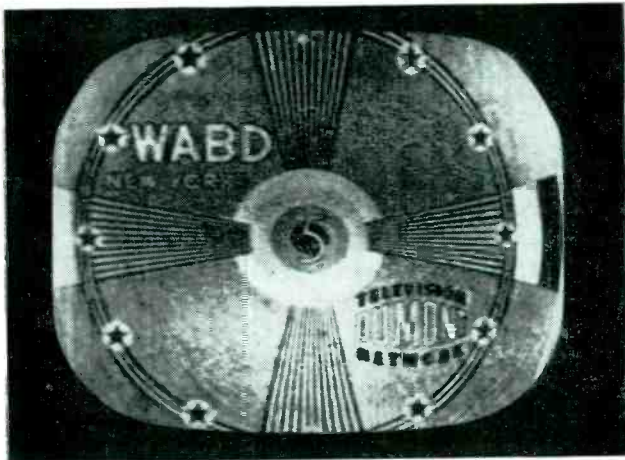

Sandpaper effect of mild electrical appliance noise

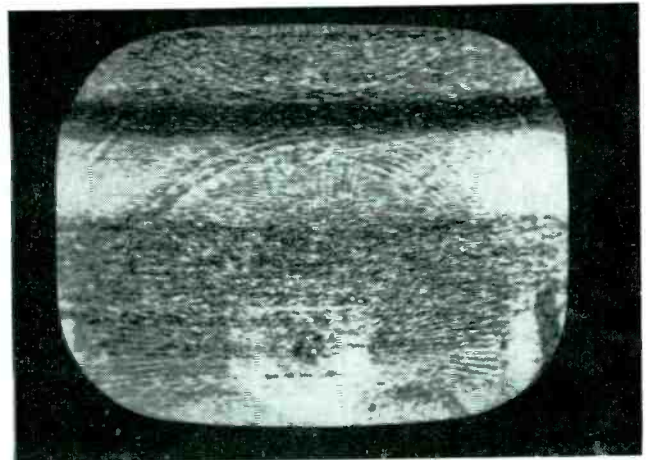

Strong electrical appliance noise causing loss of sync

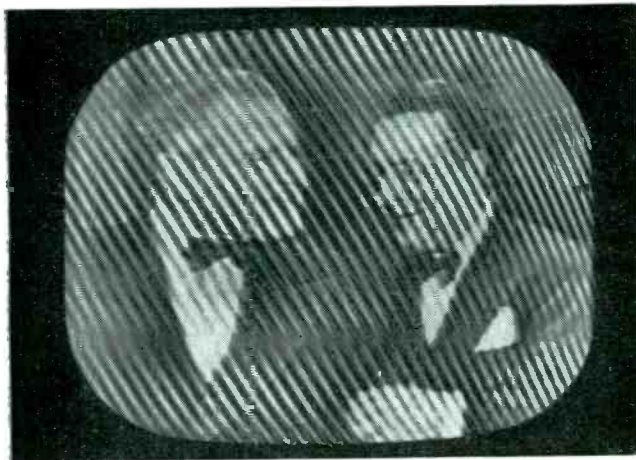

Medium-strength interference caused by neighboring receiver

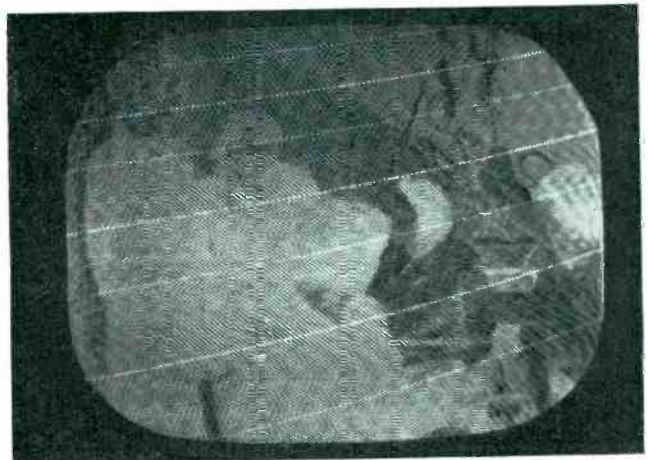

Very strong receiver radiation has turned picture to a negative

There being nothing to stop it here, it goes merrily on its way to be radiated from the antenna and eventually winds up in a nearby receiver tuned to a higher channel. Unless there is effective shielding, along with bypassing and filtering of power leads, it may also find its way to the receiver by direct radia-

tion without a regular antenna. One obvious solution to this problem is the use of a well-screened tube in the r-f amplifier, together with proper shielding, so that no energy from the oscillator coil can get into the r-f amplifier grid circuit. Since the oscillator frequency is some 20-odd mega-

cycles higher in frequency than the desired television signal it is also helpful to have the r-f grid circuit tuned and switched for each channel instead of employing a wide-band device such as L_c . The above effect can be easily demonstrated by placing a booster amplifier using a screen-grid tube ahead of the

offending receiver. However, it is hard for a man to convince his neighbors that they should spend \$20 or \$30 for something the manufacturer should have engineered into the receiver in the first place. Even if they could be convinced, it is first necessary to locate the offending receivers.

Much of this type of interference will be eliminated if and when a new intermediate frequency in the vicinity of 40 mc is adopted. However, it will still be necessary to stop most of this radiation in order not to jam services 40 mc higher than the television channels.

Diathermy

The complete elimination of radiated signals from diathermy, induction heating and similar types of equipment is very difficult. Many industrial units actually generate more r-f than a high-power broadcast station and interference elimination requires careful double shielding of the entire work space, together with thorough filtering of all conductors entering the shielded area.

The FCC has laid down rules covering the situation and manufacturers of this type of equipment are working on models that will cause less interference. However, assume that all harmonics and other spurious radiations have been eliminated and the only radiated signal is a reasonably stable one that lands in the band of frequencies at 27 mc set aside for the purpose. If this radio signal is strong enough it will still cause serious tvi to nearby sets utilizing the circuit shown in Fig. 1. The 27-mc signal will be picked up by the feeder acting as a long wire antenna and will pass through the r-f amplifier and mixer as though they were in parallel instead of pushpull. This equivalent circuit is shown in Fig. 2. No one would consider tying a long wire antenna

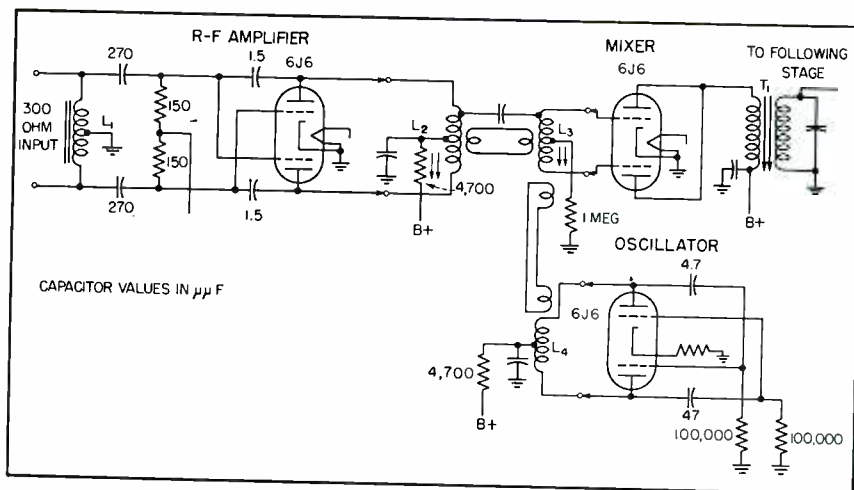

FIG. 1—Schematic of typical television receiver front end

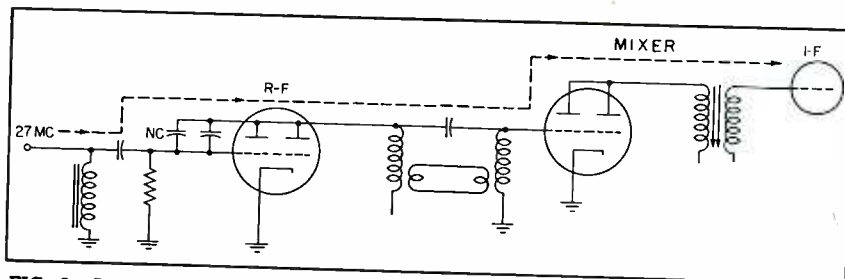

FIG. 2—Simplified circuit to show how diathermy signal passes circuit of Fig. 1 to show up as i-f interference

to the i-f amplifier through a small capacitor, the actual effect obtained here.

A tuned-grid, tuned-plate, push-pull 6J6 r-f amplifier, properly neutralized, is about the most effective thing to provide for these frequencies as far as sensitivity is concerned. However, a high-pass filter must be used ahead of it, with a Faraday screen and link coupling to the receiver. It is better in a production receiver to take advantage of the internal shielding offered by a screen-grid tube.

Spark-Plug Interference

Spark-plug impulses are of a wide-band nature and although they may peak in the vicinity of 50 to 60 mc they are strong all the way from 28 to 100 mc. The exact frequency on which they are most bothersome depends to a large extent on the length of the wiring of the particular car or truck. This type of interference should be suppressed at the source. However, there are plenty of other types of interference of a similar nature so that it is desirable to do as much as possible at the receiver. Fortunately, something can be done.

It is well known that the signal-to-noise ratio is a function of bandwidth; therefore it would be desirable to utilize as narrow a bandwidth as possible in the tuned grid of the first r-f stage. The best possible horizontal sync circuit should be used so that the receiver will not respond to random noise pulses and lose sync, as evidenced by horizontal tearing of the picture.

Nearby Radio Stations

Radio transmitters operating in the vicinity of a television receiver may or may not cause interference, depending largely on whether or not they are emitting harmonics that fall into television channels. Their fundamental may be overloading the receiver front end or feeding through it to the picture or sound i-f amplifiers. Harmonics and other such spurious emissions must be eliminated at their source. Methods for doing this have been shown by the author in *QST* for May and December 1948, February and May 1949, and *CQ* for May 1949. However, overloading or i-f pickup in the receiver must be cured at the receiver. This condition can largely be taken care of in the design of

Table I

Front End	Image Rejection	I-F Rejection
One tuned circuit	24 db	27 db
Two tuned circuits	58 db	41 db
Three tuned circuits	73 db	55 db

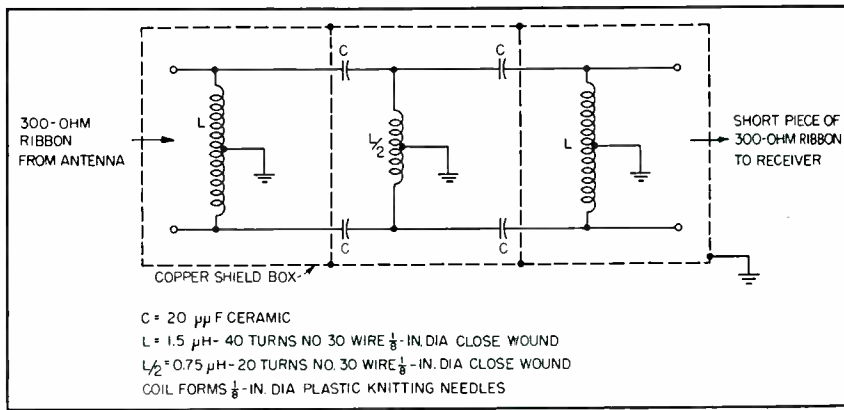

FIG. 3—Typical high-pass filter to attenuate interference below television frequencies

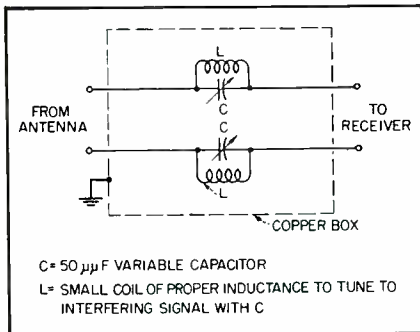

FIG. 4—Parallel-tuned wave traps to attenuate a specific frequency

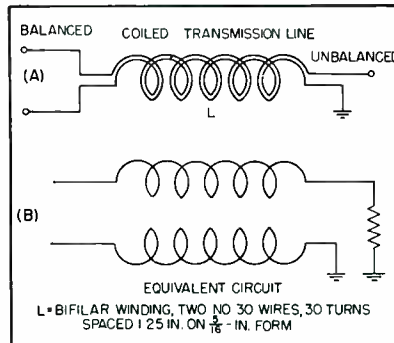

FIG. 5—Circuit for feeding grid from 300-ohm balanced line

the set but in the receiver of Fig. 1 external means must be employed.

The ideal arrangement would be to design a television receiver with a pass band of 5 mc for each channel and an infinite rejection of all other frequencies. Since this is not possible the next best is a design incorporating: (1) a network that will pass a balanced signal coming down the 300-ohm ribbon but will reject an unbalanced signal (prevent the ribbon from acting like a long-wire antenna); (2) a high pass filter that cuts off everything below 40 mc or so and yet passes all television channels; (3) two stages of tuned-grid tuned-plate r-f amplification ahead of the mixer; (4) good shielding and isolation of each of the tuned circuits; and (5) an oscillator well-shielded and filtered so that it cannot radiate an interfering signal to other receivers.

A receiver incorporating the above principles, connected to an indoor antenna, consistently receives channel 13, 60 miles away, in South Norwalk, Connecticut, with picture quality and signal strength approximately equal to WCBS-TV on channel 2, despite the fact that there is a

750-watt transmitter only two inches away from the receiver cabinet.

Figure 3 shows a high-pass filter that has been used successfully by the author to attenuate interfering signals on frequencies lower than the television channels. If it is desired to attenuate a specific frequency it may be accomplished through the use of parallel-tuned wave traps as shown in Fig. 4.

A device for matching a 300-ohm balanced feed line to a single-ended r-f grid is shown in Fig. 5. At (A) it is shown as a coiled transmission line while in (B) it is shown as it appears in the circuit. The coiled transmission line provides rejection to unbalanced energy by virtue of the inductive reactance of the coil, while balanced energy is not similarly attenuated.

Image Interference

Image interference is due to lack of sufficient selectivity in the r-f stage of the television set and its inability to reject a strong signal located some 40 to 50 mc higher in frequency than the desired channel. The improvement to be expected with more than one tuned r-f

stage is indicated in Table I. Use of a higher intermediate frequency, or more selectivity in the front end, are needed. It is the writer's opinion that both changes are desirable. The use of two r-f stages will not only give better reception of pictures in the fringe areas but will also keep down oscillator radiation.

In addition, there will be a better signal-to-noise ratio and better adjacent-channel selectivity, as well as reduced image interference.

Such a design will also eliminate another type of interference, caused by oscillator voltage in the r-f grid on a low-channel signal mixing with a television signal on a high channel and producing a spurious response which then interferes on the low channel. The use of a higher intermediate frequency not only reduces interference due to receiver oscillator radiation and interference due to images but also reduces the possibility of direct i-f pickup from radio services operating in the 21 to 27 mc range.

Figure 6 shows the schematic of an r-f amplifier that has been used by the writer with considerable success. It is surprising how much off-frequency and direct feed-through interference is eliminated in this manner. It is not unusual to receive a good picture from Philadelphia on channel 3 while both New York stations are operating on channels 2 and 4.

Electrical Appliances

Interference from household appliances is usually best attacked at the source; however, this is not always possible due to the difficulty in locating it and persuading the owner to spend some money for filters.

There are two possibilities at the receiver that often help. The first is an adequate r-f filter in the a-c line and the second is a bottom pan on the receiver chassis. Most receivers at least bypass the a-c line where it enters the chassis. However, in several cases an r-f filter has helped tremendously where the interference had been entering the set via the power cord. A schematic of the filter is shown in Fig. 7. Proper shielding of all exposed coils and wiring, plus a pan on the bottom of the chassis is definitely indi-

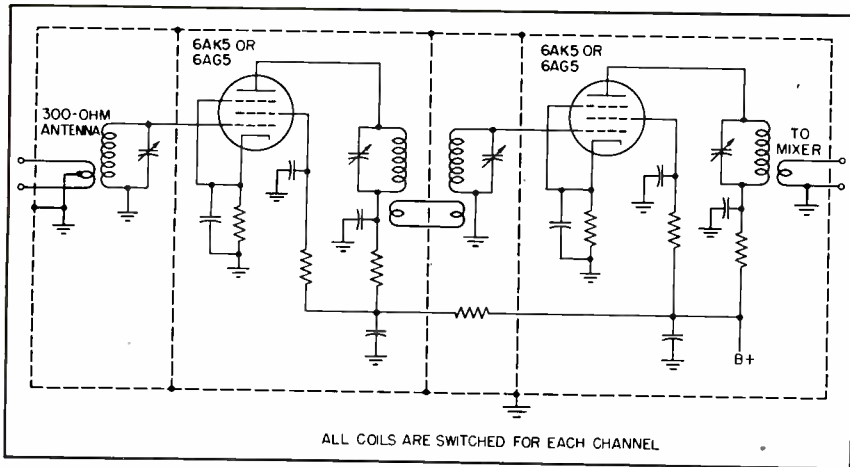

FIG. 6—Simplified circuit of an r-f amplifier used to improve reception. Construction of such a device requires careful placement of parts

cated as a precaution against direct pickup of interfering signals by the circuit wiring.

The Newer Receivers

In looking over the 1949 crop of television receivers, it is interesting to note that some of them are obsolete from an interference standpoint even before they are sold. Most of the 1948 and earlier sets also fall into this class. It is encouraging to find, however, that some of the manufacturers are taking a realistic view of the problem and are endeavoring to correct the situation. Many are changing from push-pull triodes to single-ended pentodes in the head end while others are using two stages of r-f, high-pass filters, and better sync circuits. There is even more talk of using higher intermediate frequencies.

Figure 8 shows a simplified circuit diagram of the front end of RCA 8-TS-241 production receiver.

The antenna terminals are arranged so that either a balanced 300-ohm ribbon or a 75-ohm unbal-

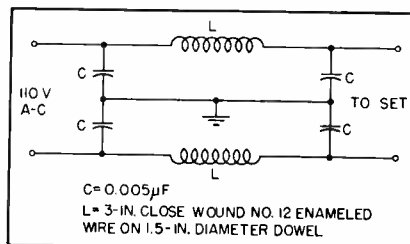

FIG. 7—Power-line filter for appliance interference

anced coax may be used as a feeder. This is accomplished through the use of a so-called "elevator" circuit consisting of two coiled 150-ohm transmission lines, previously shown in Fig. 5, wound on separate coil forms. These are connected respectively in series or parallel for 300 or 75 ohms. The balancing circuit is followed by an *m*-derived high-pass filter designed to attenuate at the input all interfering signals lower in frequency than channel 2, with maximum attenuation at the intermediate frequency. This includes diathermy at 27 mc and other radio signals that might overload the r-f stage and cause cross modulation.

Figure 9 shows the grid circuit of the r-f stage. It is drawn at A as a pi-network, while in B it is redrawn but still the same circuit. Figure 9C shows it with a tap on the coil instead of the capacitor; at D and E it is still essentially the same thing but in a more familiar form. The value of C_1 is 18 μf , C_2 is the input capacitance of the 6AG5 tube and L_1 is composed of many small inductances mounted between the contacts of the channel switch *S*. This circuit not only provides selectivity but also a step-up of voltage to the r-f grid.

Band-Pass Filter

Between the r-f plate and the mixer grid (Fig. 8) there is a band-pass coupled circuit with extremely low capacitance coupling. Extraordinary precautions were taken in the design to eliminate stray coupling and to provide the maximum rejection to spurious signals. The mutual inductance between the two circuits comprising the band-pass filter consists of a small inductance and capacitance in series. The series resonance of this combination is higher than the highest frequency for each group of channels and results in a very low coefficient of coupling in the vicinity of the oscillator and image frequencies. This is an important factor in obtaining the high image attenuation and the low oscillator radiation found in the design. The adjustment of the series capacitor of the mutual circuit allows for the adjustment of bandwidth for each of the two bands of television frequencies. Oscillator injection voltage is introduced to the mixer grid via link coupling from the push-pull 6J6 coil.

Another interesting innovation

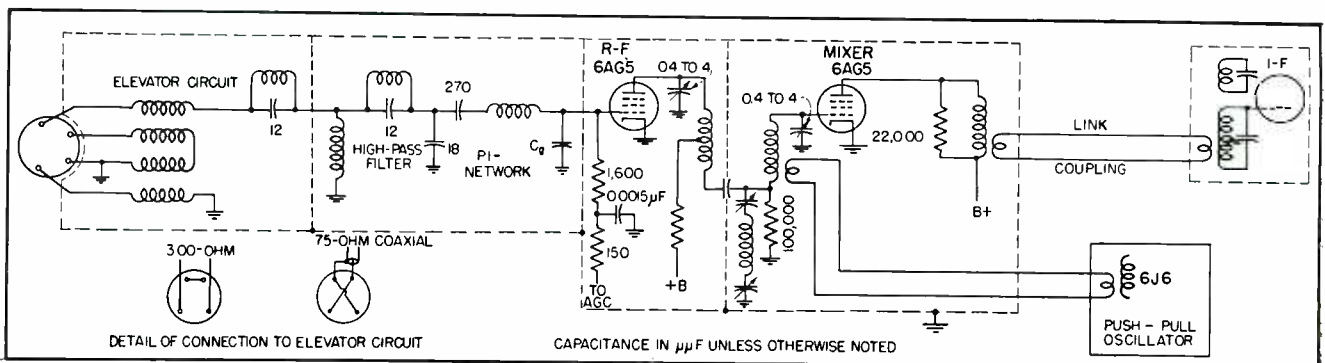
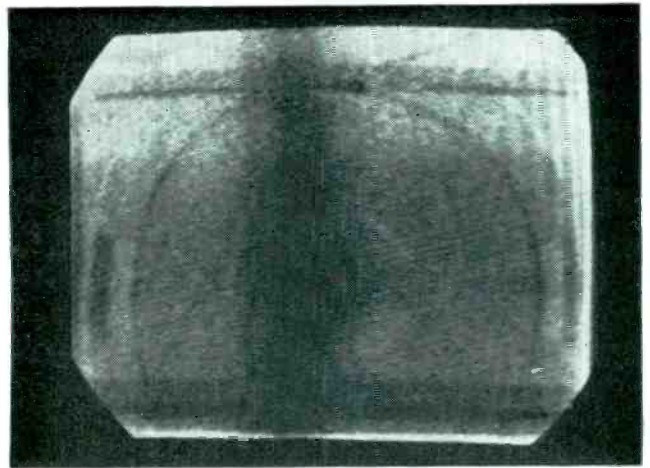

FIG. 8—Simplified circuit of the RCA 8-TS-241 receiver front end



Venetian-blind effect on station 40 miles away by Baltimore station 220 miles away. The horizontal bars represent a visible beat between carriers



Simultaneous reception from Boston and New York at Middletown, Conn. Carriers are synchronized. New York pattern is seen with Boston moving across it



Spark-plug interference. Black streaks are spark impulses and white are torn portions of horizontal scanning line

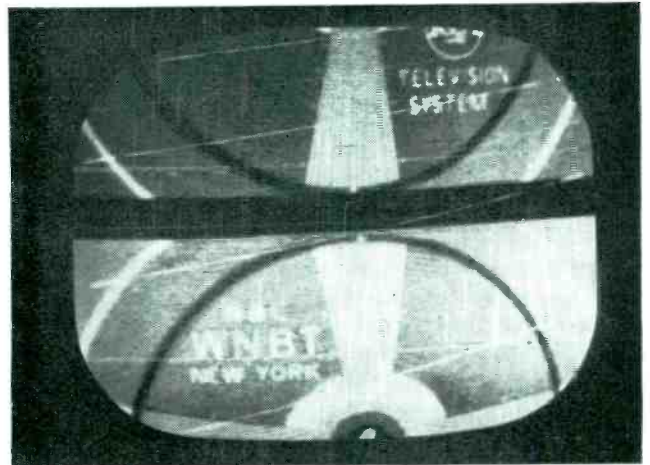

Spark-plug interference causing loss of synchronization. Horizontal white lines are torn scanning lines

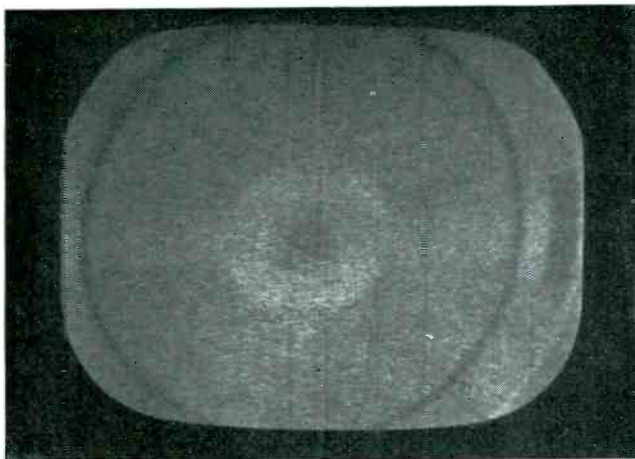

Reception of New York channel 13 at South Norwalk, Conn. after best possible commercial installation using standard antenna



Improvement in channel 13 reception after adding two-stage booster and erecting a good high-band antenna

and certainly one that helps reject interference is the link coupling between the mixer plate coil and the first i-f grid coil. This connection allows proper placement of components on the chassis in relation to the

tuner (which usually occupies a separate chassis) without a long, hot interconnecting lead. Each tuned circuit in the i-f amplifier has coupled to it a suitable absorption trap tuned to remove a possible

interfering signal. Even the triode video amplifier, an interesting circuit in itself, has an absorption trap tuned to 4.5 mc. This circuit is employed to remove the beat note that is caused by interaction between

the picture carrier and the sound carrier.

The horizontal oscillator and discharge circuits utilize a double triode, 6SN7GT, as shown in Fig. 10. The tube is connected as a blocking oscillator with a stabilizing tuned circuit in the plate supply. Plus B is derived from boosted B of the horizontal drive control, C_{153B} provides means for varying the sawtooth amplitude which in turn effects horizontal linearity, width, and second anode voltage.

Sync Waveforms

Synchronization is accomplished as follows: A complex wave consisting of sync pulses, a parabola, and a partially integrated kickback pulse, is supplied to the grid of the first half of the 6SN7GT. The tube is biased from the oscillator grid to such value that plate current flows only during positive peak values of the complex wave. The cathode voltage of this tube is essentially a d-c voltage obtained from the pulses of current by filter action of the filter capacitors. Since a portion of this voltage is applied to the oscillator grid through R_{176} , its magnitude affects the frequency

of the oscillator. The effect of the voltage is such that the oscillator will lock in synchronism automatically.

The plate current pulse of the 6SN7GT has a width equal to the width of the portion of the sync signal which appears on top of the parabola signal. As the phase between the oscillator and the sync

signal tends to change, the width of the portion of the sync on top of the parabola also changes. This changes the width of the current pulses in the tube and the average cathode voltage. The cathode voltage then acts on the oscillator in such direction as to restore the correct phase.

A kickback pulse from the plate of the damper tube through the 560,000-ohm resistor and 5- μ f capacitor to the grid of the 6SN7 is particularly effective on weak signals. If the sync pulse becomes weak, the pip fed back keeps the horizontal oscillator in step.

Field tests on this type of horizontal oscillator have shown excellent immunity to noise and other types of interference.

Acknowledgment

The writer wishes to thank RCA Victor Division, RCA Service Co, General Electric, and Hallicrafters, each of which supplied a television receiver for i-f interference tests conducted by the writer for FCC, RMA and ARRL. A complete report of these tests was mailed to RMA members Nov. 19, 1948 and was summarized in *QST* for December 1948.

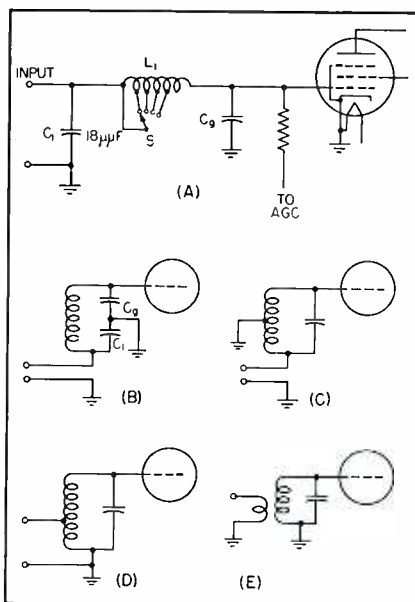

FIG. 9—Various conformations yielding essentially the same type of grid circuit used in the r-f stage

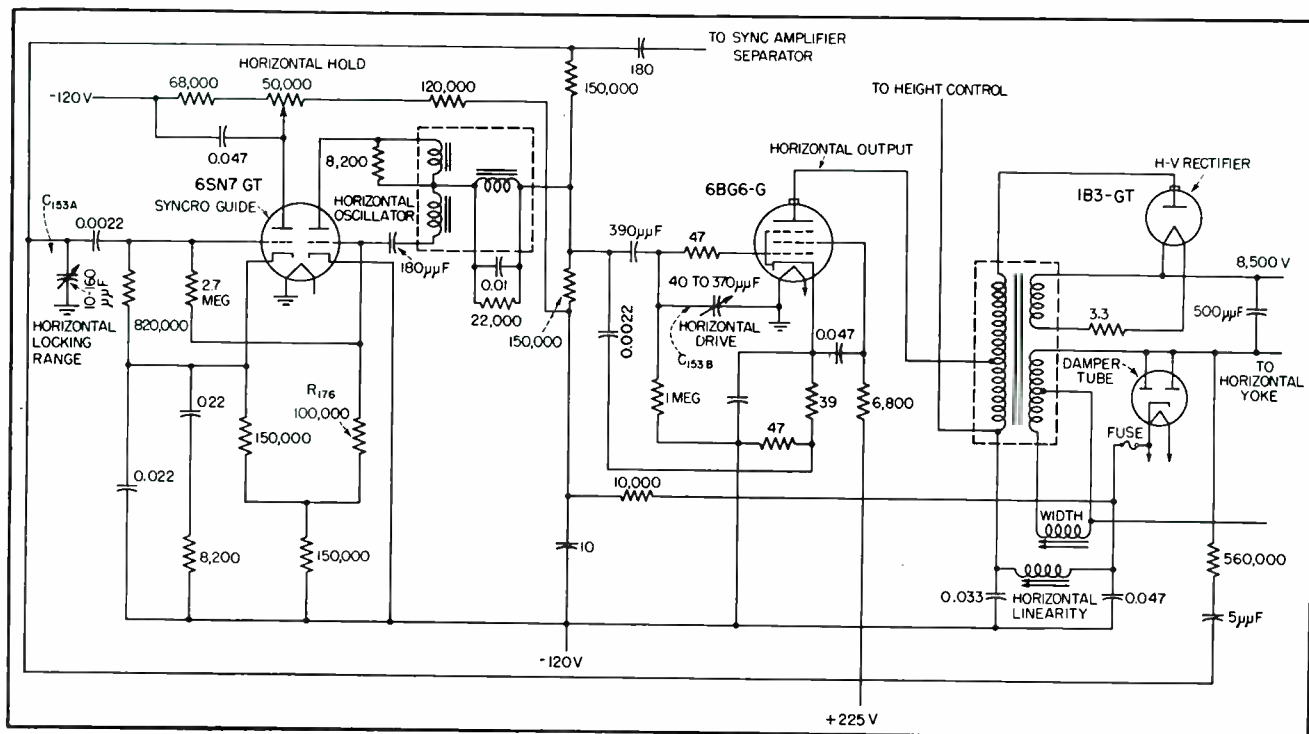

FIG. 10—The more important circuit elements used in a successful horizontal-synchronization circuit of a production receiver

Citizens Radio Report

Activity on 465 mc has so far been surprisingly limited, considering possible public uses for short-range uhf equipment. Interest is increasing, however, and this summer will see many more transmitters on the air

ACTIVITY on the citizens radio band has so far been surprisingly limited, considering the many possible uses for short-range uhf equipment. Interest is increasing, however, and this summer should see many more transmitters on the air. (see p 128)

So far as ELECTRONICS has been able to determine in Washington, experimental licenses covering 41 stations are in force. These stations are scattered over 20 states. The status of 25 additional licenses, some of which are overdue for renewal, is in doubt. Between 200 and 300 new applications are reported to be in FCC files.

Licenses appear to be about evenly divided among hobbyists desiring a personal communications system, experimenters interested in studying such things as radio-wave propagation at these frequencies and people with modest commercial objectives. Most of the gear in use is designed to meet Class-B requirements and much of it consists of modified surplus BC645 transponder units. Many of the licensees also hold amateur radio tickets.

Wide Range of Interests

John Mulligan of Elmira, N. Y., credited with the first citizens-band construction permit, issued February 14, 1947, services 157-mc commercial equipment for a living. His first 465-mc gear consisted of a pair of battery-operated transceivers using one half of a 6J6 as a modulated oscillator or super-regenerative detector, the other half of the tube as a speech stage or first audio and a 3Q5 as modulator or second audio. The circuit was a conventional ultra-audion, and the two units jockeyed each other all over the band due to frequency shift when switching from transmit

to receive. Distances up to four miles were nevertheless covered around town through trees and wood-frame buildings, using vertical antennas mounted on top of the transceiver cases.

Power was stepped up in two a-c-operated transceivers using a pair of HY615's as the oscillator-detector. Little improvement in coverage resulted, so a pair of surplus BC645 transponder units were modified and tried. Range fell off to $\frac{3}{4}$ -mile, despite better transmitter output, due to the relative insensitivity of the receiver. Use of a super-regen receiver permitted reception of signals radiated from a 40-foot high fixed-station antenna in a car 16 miles away. Johnnie thinks the ultimate answer involves crystal-controlled f-m transmitters and receivers but is concerned about the cost.

Bill Lurie, who lives in Bronxville, N. Y., and works for an industrial and transmitting-tube manufacturer in Connecticut, has already described his transceivers in these columns. He is at present working on a 30-watt rig that starts with a surplus ARC-5 unit modified to turn out a 155-mc signal, uses an outboard 829B amplifier and triples in a 2C39 final. A simple and inexpensive wavemeter for the citizens band is also under construction and will, in response to a number of requests, soon be described.

Guy Cornish runs a sound service company out in Cincinnati. Back

in 1939 he started announcing races and other public events over his receiver-equipped truck via radio on 310 mc to avoid the use of a microphone cable in congested areas. When that frequency was assigned to other services he shifted to 465 mc at the suggestion of the FCC. His transmitter uses a 955 oscillator and a 7C7 modulator.

Dick Benoit of Brooklyn, N. Y. is an engineer employed by the Watson Labs., Signal Corps, Red Bank, N. J. He applied for a citizens-band license in order to conduct uhf radio-wave studies of a classified nature in collaboration with associates *Cole, Kunze, Marks* and *Strom* of Long Branch, Allenhurst, Millburn and Belmar, N. J. He says the receiver of the BC645 unit drifts too much, and he is building a double superhet. The transmitter, not yet constructed, will use standard circuits designed for the 144-mc amateur band and converted to 155 mc. A multiplier driving a pair of 2C4's in the final will complete the transmitter. Directional antennas will be part of the setup.

Charles Moore works as a machinist in Trenton, but the minute his official day is over he boils into the job of selling more people the idea of applying for a citizens-band license, hoping some day to make this a business. Five converts are already working up to $4\frac{1}{2}$ miles around town, using modified BC645 transponders and four-element beams.

"*Skippy*" *Settle* runs a radio shop in Dallas and is the moving spirit in what he hopes will be an extensive public network of stations for the construction of which he can charge \$35 plus parts cost. Skippy has already installed five converted BC-645 units in the downtown area of

ELECTRONICS Articles

Transmitter	Nov. 1947
Receiver	Mar. 1948
Antennas	May 1948
Transceivers	Aug. 1948
Power Amplifier	Dec. 1948

the city, getting solid 10-block coverage and satisfactory communication up to 30 blocks under favorable conditions. Reception at 8½ miles has been reported in open country. Some 27 prospective customers have filed application for construction permits. Many of them expect to use their sets around Lake Dallas this summer.

Harold McKay, a San Francisco consultant, is working in the band to acquire first-hand knowledge of technical requirements and propagation characteristics. Equipment includes two BC645 transponders, APR-4 tuning units operated into ARR-5 receivers and an experimental super-regen transceiver using two 955 acorns. A TS69A/AP meter is used for frequency measurement. The city's stucco-front houses having wire-mesh backing seem to pass some energy at 465 mc and also to reflect some. Thus it has been possible to work up to two miles at street level through buildings without difficulty and, in some instances, much more where long streets act like waveguides. As other experimenters have reported, trees attenuate signals quickly and earth masses stop them completely, but reflection from objects on top of the earth masses frequently fills in holes.

O. C. Vidden of Fertile, Minn., is an experimenter interested in the design of antennas. Using converted BC645 equipment he has, so far, had best results with parabolic types but finds them too bulky for strictly portable applications and is trying to develop something more effective for this purpose than the conventional dipole.

Common Stumbling Block

Major stumbling block in the path of most people interested in utilizing the citizens radio band during its experimental stage is the difficulty of finding others who are located within receiving range and qualified to conduct tests.

ELECTRONICS will be glad to serve as a clearing house for information such as new call assignments, operating schedules and technical ideas that improve equipment performance until activity at 465 mc progresses beyond the limit of its facilities.—W. MACD.

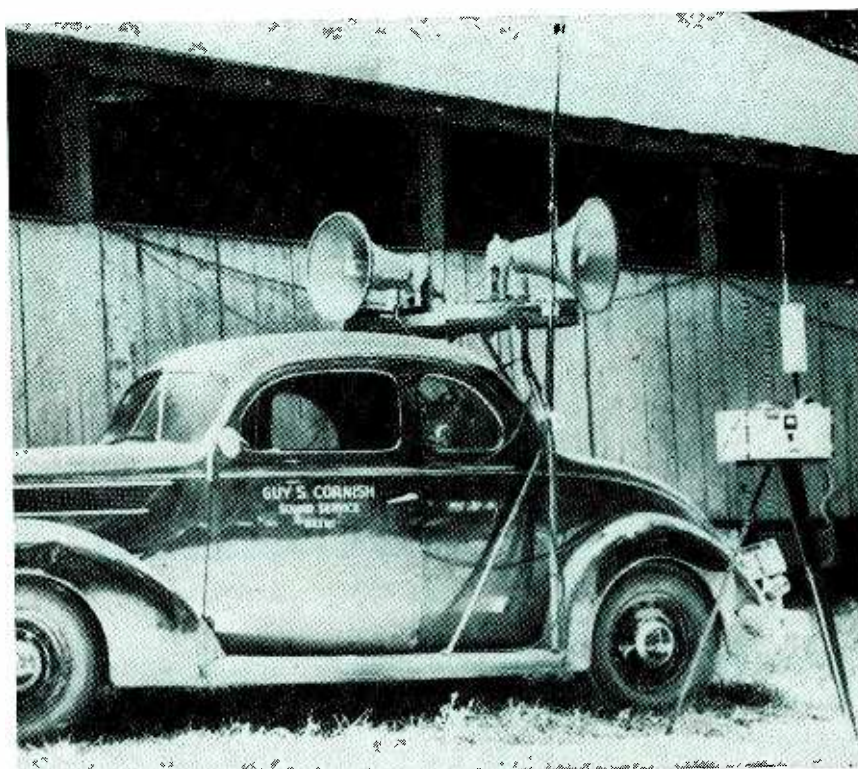

Guy Cornish of Cincinnati reports races and other public events over the tripod-mounted transmitter at the right, to a receiver-equipped sound truck that relays his voice to the crowd

EXPERIMENTAL LICENSES

CALIFORNIA.....	Fair Oaks	T. C. Mitchell	W6XST
	San Francisco	H. B. McKay	W6XRQ
FLORIDA.....	St. Petersburg	R. E. MacDonald	W4XJI
GEORGIA.....	Columbus	H. C. Lummus	W4XER
	Columbus	W. R. Burrus	W4XWH
ILLINOIS.....	Western Springs	R. V. Dondanville	W9XAM
	Westmont	H. L. Garton	W9XEV
INDIANA.....	Indianapolis	H. C. Porter	W9XME
KANSAS.....	Oskaloosa	L. Meyerson	WφXME
MARYLAND.....	Brandywine	L. M. Conner	W3XGW
MINNESOTA.....	Fertile	O. C. Vidden	WφXRE
NEBRASKA.....	Scottsbluff	H. H. Poppert	WφXQI
NEW JERSEY.....	Long Branch	R. I. Cole	K2XEC
	Millburn	R. L. Marks	K2XEF
	Trenton	C. S. Moore	K2XAR
	West Allenhurst	A. A. Kunze	K2XDS
	West Belmar	C. A. Strom	K2XEV
NEW YORK.....	Bronxville	W. B. Lurie	W2XRW
	Brooklyn	R. C. Benoit	K2XEZ
	Comstock	O. E. Frisbee	W2XUC
	East Aurora	T. F. Huff	K2XEH
	Elmira	J. M. Mulligan	W2XQD
	Ithaca	Rural Radio	W2XBU
	New York	ELECTRONICS	W2XSN
	New York	F. Heubner	W2XRV
	Orchard Park	F. H. Unger	K2XEG
	Scotia	R. J. Henry	W2XJC
OHIO.....	Cincinnati	G. S. Cornish	W8XWI
	Dayton	A. L. Brandenburg	W8XPW
	Dayton	J. O. Stofer	W8XVW
	Dayton	F. X. Thilken	W8XTD
	Sand Springs	W. S. Martin	W5XAJ
OKLAHOMA.....	Woonsocket	P. J. Donneau	W1XRH
RHODE ISLAND.....	Dallas	F. J. Ruetz, Jr.	W5XCV
TEXAS.....	Dallas	N. C. Settle	K5XGF
	Salt Lake City	H. M. Goates	W7XVF
UTAH.....	Richmond	J. E. Payne, Jr.	W4XLP
VIRGINIA.....	Seattle	F. G. Hiscox	W7XQM
WASHINGTON.....	Seattle	T. R. Waters, Jr.	W7XQV
	Harman	S. J. Bucher	W8XJA
WEST VIRGINIA.....	Thorpe	W. Hryniewicki	K9XAP

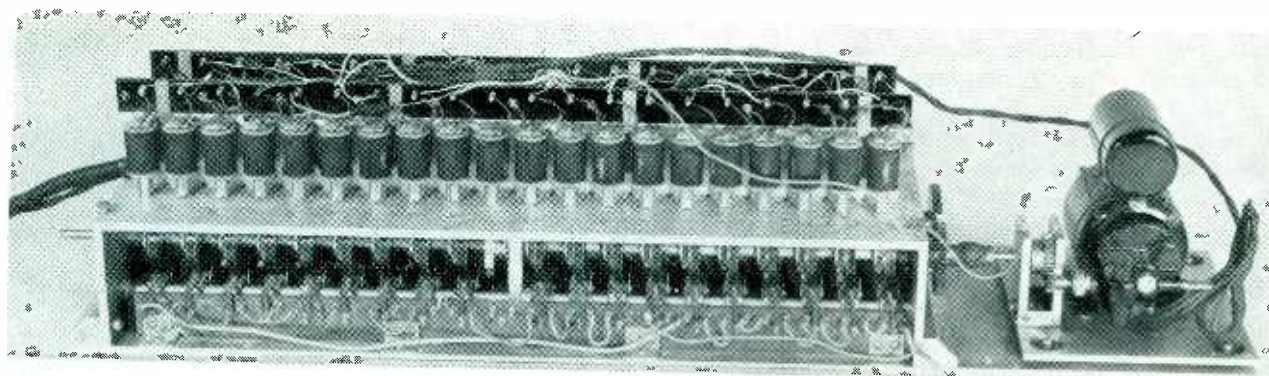

Letter-pronouncing section of the reader. The solenoids operate the magnetic tape recorders when tripped by the proper signals

Letter Reading Machine

Print scanned by a flying spot reflects varying amounts of light to a multiplier phototube. Binary counters operate appropriate trigger circuits and magnetic recordings pronounce the letters. Designed as an aid for the blind, the equipment could be modified for use in connection with printing and communication systems

THERE has recently been renewed interest in devices to replace the lost senses of those handicapped by blindness and deafness.

Loss of sight is probably the greatest obstacle to a normal existence. One device described in these pages¹ was designed to enable a blind person to read ordinary printed material. It translated the letters into coded tones that could be understood after sufficient training. In trying to minimize this training, one approach is to make the machine recognize the letters and actually pronounce them aloud to the user.

This paper describes an experimental form of such an instrument.

Operating Principles

In order to recognize letters, the scanner of the device divides the line of type into a number of horizontal bands, as shown in Fig. 1 each of which it explores with a spot of light. The light reflected from each band is converted to an electrical signal by a phototube.

Counting circuits interconnected with the scanner count the number

of times each light spot encounters part of a letter as it traverses its zone of the line of type recording the total number of black areas per letter per zone. From this information other circuits in the device recognize the letter or letters scanned and cause magnetic recordings of the correct letter sounds to be played back to the user.

Figure 2 is a block diagram of the apparatus. To avoid the bulk of eight light sources and phototubes, a combination of flying spot and time-division techniques is used. The internal arrangement of the scanner is given in Fig. 3. The small cathode-ray tube illustrated is the light source. It is provided, by the scanning generator, with a staircase deflection voltage having eight steps. The repetition rate is about 500 cycles per second. The beam is blanked except for a time interval of about 100 μ sec during the horizontal part of each step. The visible result is a pattern of eight light spots in a line across the face of the tube. This pattern is projected onto the material to be read by a simple optical system.

The eight spots bear the relation to the type indicated in Fig. 1. An advantage of this scheme is the ease with which the spot spacing may be varied to accommodate different type sizes.

Photoelectric Scanner

A type-931 multiplier phototube picks up light reflected from the paper. As the scanner is moved across the line of type, a series of interruptions in the amount of reflected light will be produced by the letters. If a particular scanning spot falls on blank paper, considerable light from it will reach the phototube, producing electrical pulses in its output. This will be referred to as the white signal condition, abbreviated WS. Conversely, if a particular scanning spot falls on a part of a letter less reflected light reaches the phototube. This will be referred to as the black signal condition, abbreviated BS.

The phototube output will contain information from each of the eight positions of the crt spot, and since the latter moves stepwise and in sequential fashion from each posi-

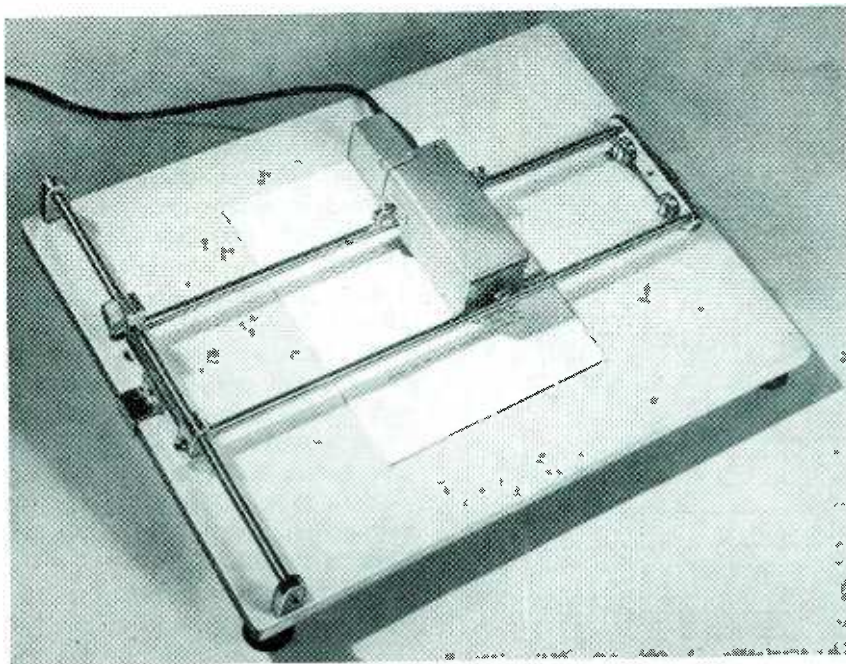

Scanning device used with the reader. It contains the phototube and scanner tube

By V. K. ZWORYKIN, L. E. FLORY, and W. S. PIKE

RCA Laboratories Division
Princeton, N. J.

tion to the next, a time-gating scheme may be used to separate out from the phototube output the signals corresponding to each spot position on the paper and thus to each horizontal band of the printed material. After separation the output from any one of the eight channels so formed may be thought of as a 500-cycle carrier which is present for WS, but which is suppressed or considerably attenuated under BS conditions in that channel.

Referring to Fig. 2, the channel separator time-gates the composite phototube output, routing the output of the various zones to individual demodulators and counters. Two-stage binary counters are used in channels 1 through 6 and single-stage circuits in channels 7 and 8. It must be remembered that the counters count the interruptions in the 500-cycle pulse trains of the several channels, not the individual pulses.

With eight scanning spots a unique interruption pattern exists for most letters of the alphabet. Referring to Fig. 1, the letter "b" interrupts channels 1 through 3

once, channels 4 and 5 twice, channel 6 once, and channels 7 and 8 not at all. Similar patterns exist for the other letters of the alphabet, and there are a few ambiguities. In many type faces "b" and "d" are mirror images of each other, thus providing identical count patterns. In the sample of Fig. 1 "c" and "z" produce identical count patterns. In general, the sequence of interruption will be different, however, and this property makes resolution of such ambiguities possible. Two sequence circuits for this purpose are indicated in Fig. 2.

The outputs of the channel counters and sequence circuits are applied to a function matrix similar to those used in electronic computers.² This circuit is a network consisting of a plurality of input circuits so interconnected with a

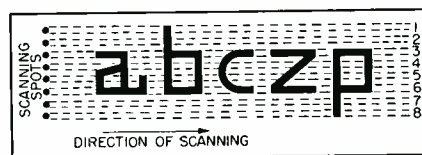

FIG. 1—Eight scanning spots are used in the letter reader

plurality of output circuits that when the inputs are activated by a certain combination of potentials one and only one of the associated output circuits is energized. Conversely, no other combination of input circuit potentials will energize that particular output circuit. In the reading machine about thirty input circuits are required and a separate output circuit is provided for each letter of the alphabet, plus a few spares for short words and figures.

The output circuits of the master selector matrix are connected via thyratrons to a multichannel magnetic reproducer in which all the letter sounds have previously been recorded. Thus, when a letter is scanned one of the magnetic-tape recordings will be played back to the user through a conventional audio amplifier and loudspeaker. A view of the magnetic tape mechanism is illustrated. The letters are recorded on strips of magnetic tape fastened to small aluminum disks. On demand from the master selector matrix, a simple solenoid and pin arrangement releases the proper disk. Half of the solenoids may be seen along the top of the photograph. The associated disks are directly beneath them.

Also shown in Fig. 2 is a reset circuit which performs two additional functions. The more obvious purpose of the circuit is to reset the counters to a standard position after each complete operating cycle. Less obvious is the secondary function of holding the entire master selector matrix inoperative except for a short time at the end of each letter just before the counters are reset. This is necessary because certain letters of the alphabet when partially scanned will feed into the master selector matrix complete information for some other letter. Thus, "m" when scanned to a point just to the right of the middle vertical bar will feed information for "n" into the master selector matrix. By holding the output thyratrons of the master selector matrix cut-off until the final transition from BS to WS in all zones at the end of the letter, such false reading is prevented.

The scanning generator provides synchronizing signals for the entire

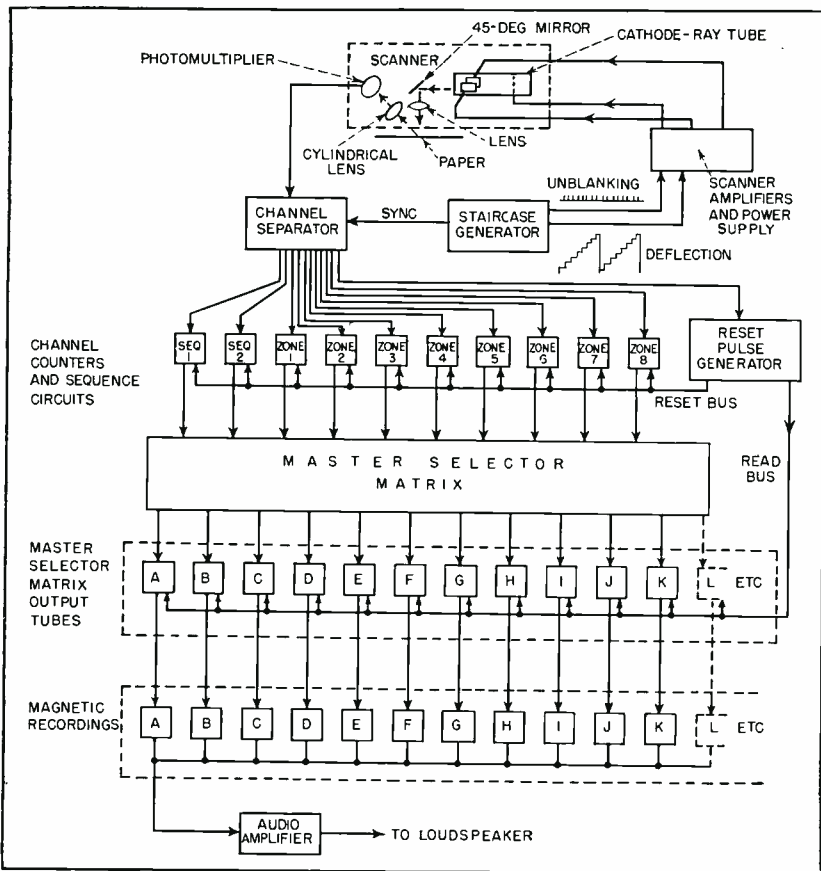

FIG. 2—Block diagram of the scanner, channel separator, master matrix and magnetic recorders that announce the letters

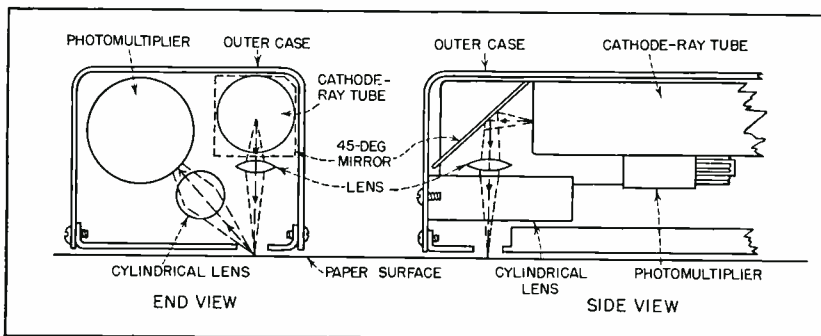

FIG. 3—Plan views of the scanner, showing placement of parts

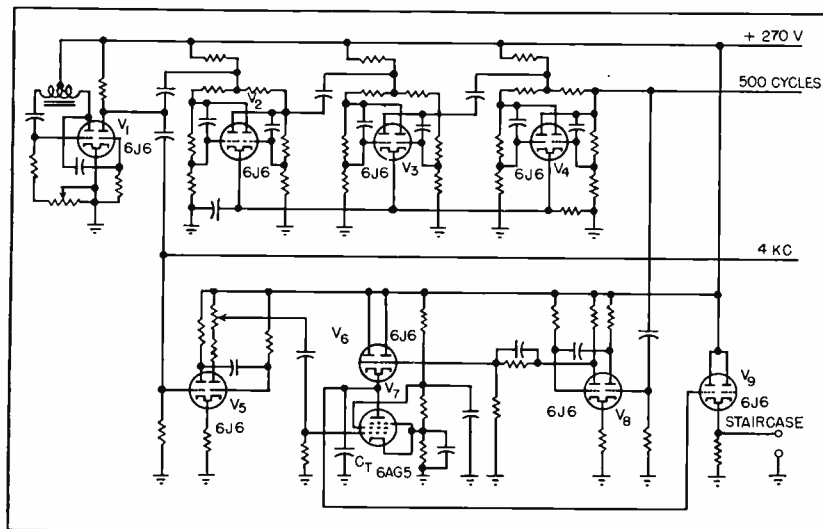

FIG. 4—The scanning generator that provides two tones and a staircase signal

instrument. The circuit is shown in Fig. 4. Oscillator V_1 and counter chain V_2, V_3, V_4 provide two pulse sources of 4,000 and 500 cycles per second which are locked together. An eight-step staircase wave is derived from these two pulse trains by partially charging capacitor C_1 , at each 4-kc pulse and completely discharging it at every 500-cycle pulse. Pentode V_7 , driven from pulse-shaping multivibrator V_6 , charges the capacitor. Tubes V_8 and V_9 discharge the capacitor after every seventh charging pulse. The waveforms involved are shown in Fig. 7A through 7G. The staircase voltage is used to deflect the crt beam in the scanner.

The writers are indebted to J. M. Morgan of this laboratory for this circuit. Its advantages are the equality of the staircase steps, owing to the constant-current characteristic of V_7 , and the ease with which the time interval corresponding to each step may be selected by auxiliary circuits.

Channel Separator

The composite signal from the scanner phototube consists of a series of pulses which occur during the horizontal portion of each step of the staircase wave. For WS conditions in all channels there is one pulse per step. The presence of a letter under the scanning head may cut off the pulses corresponding to one, several, or all steps. The channel separator time-gates these pulses, sending them to the proper demodulator and counter for the zone to which they correspond.

The circuit is shown in Fig. 5. Unblanking pulses are generated by multivibrator V_{20} , driven from the trailing edge of the delay multivibrator V_{21} , which is in turn driven from the 4-kc oscillator bus. The unblanking pulse is applied through cathode follower V_{10} to the grid of the crt. The action of the two multivibrators roughly centers the pulse in the time interval corresponding to each step. The phototube output resulting from the light pulses is amplified and limited by V_{17} and V_{18} . Figure 7 shows the waveform on the plate of V_{17} for conditions of all white (H) and one channel black (I).

The phototube pulses are supplied

to all eight channels of the separator circuit and in each channel a properly timed pedestal is placed under the desired pulses so that amplitude selection may be applied to them. The pedestal pulses are produced by a resistance matrix (the channel pulse selector matrix, Fig. 5) driven by the counter chain in the scanning generator.

Channel Circuit

A simplified circuit of one complete channel is shown in Fig. 6. Tubes V_{10} , V_{11} , V_{12} and V_{13} are common to all channels. The matrix resistors for this particular channel, RM_1 , RM_2 , RM_3 and RM_p are seen to resemble a resistance mixer such as is sometimes used in audio work. The waveform at C is the

sum of the waveforms at A and B , and the output tube is arranged to conduct only on the topmost portion of this waveform. The resultant output is shown at D . To select a pulse corresponding to some other channel, waveform A is altered by changing the connections of one or more of the matrix resistors RM_{1-3} from the X_{1-3} counter output to the Y_{1-3} output.

As the scanning head of the instrument traverses a line of type BS conditions will occur, causing gaps in the train of pulses at the plates of V_{13} , V_{14} , V_{16} , V_{18} , and so on. The number of gaps per channel per letter must be counted, hence, the envelopes of the modulated pulse trains must be recovered. The low carrier frequency makes a demodu-

lation by ordinary means impossible. A switched demodulator has been developed for this purpose. Switching pulses slightly narrower than the channel pulses and occurring at the same time are required by each of the eight demodulators. Tubes V_{23} and V_{22} provide these, with the assistance of a second resistance-mixer arrangement, the switch-pulse selector matrix. The switch-pulse selector matrix is identical to the channel-pulse selector matrix except that its input corresponding to the phototube signal is taken directly from V_{21} . No separate output tubes are provided for this selector matrix. Their place is taken by the gate tubes in the individual channel demodulators shortly to be explained. The output wave-

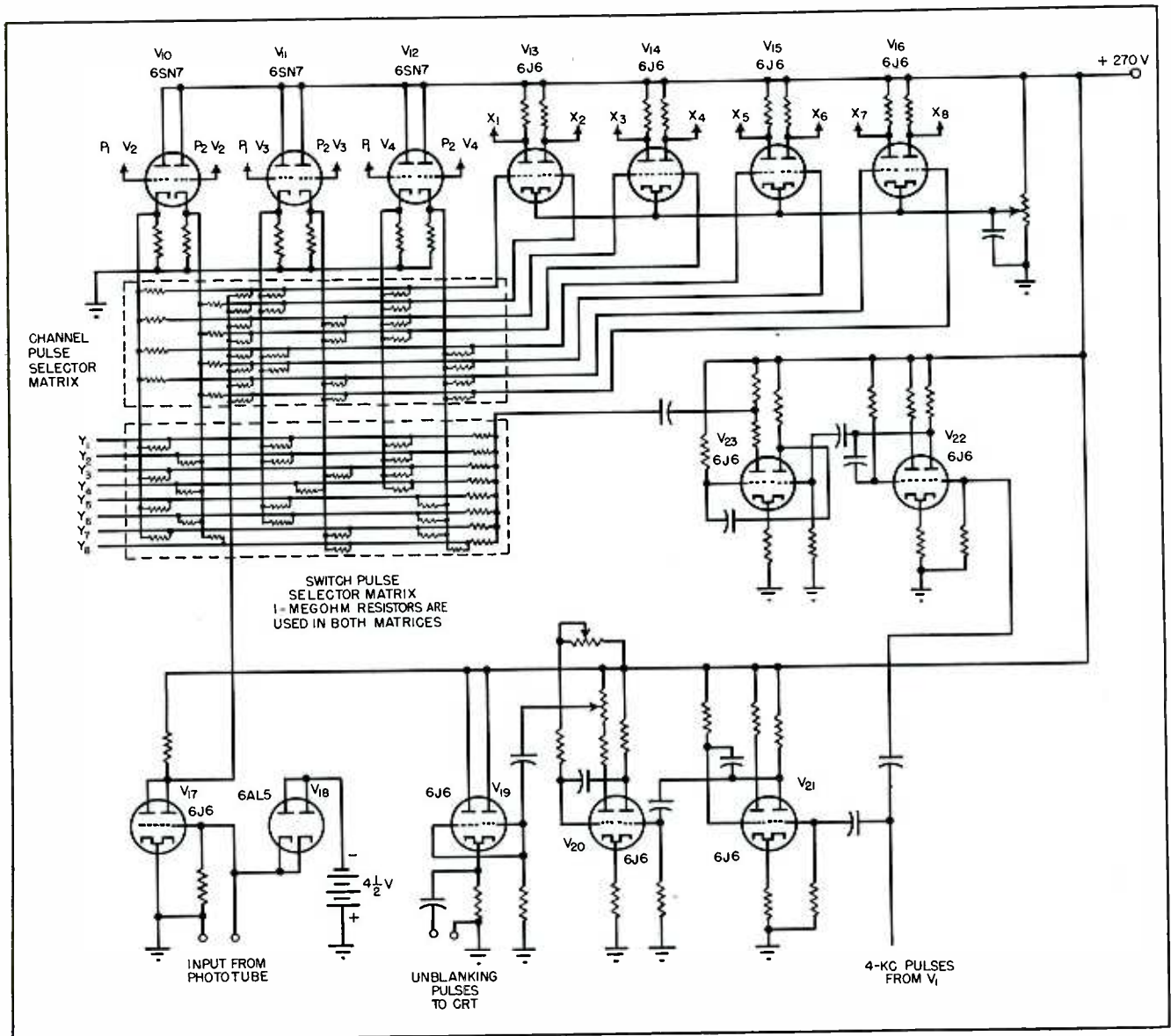

FIG. 5—Channel separator circuit, showing the channel-pulse selector and switch-pulse selector matrices

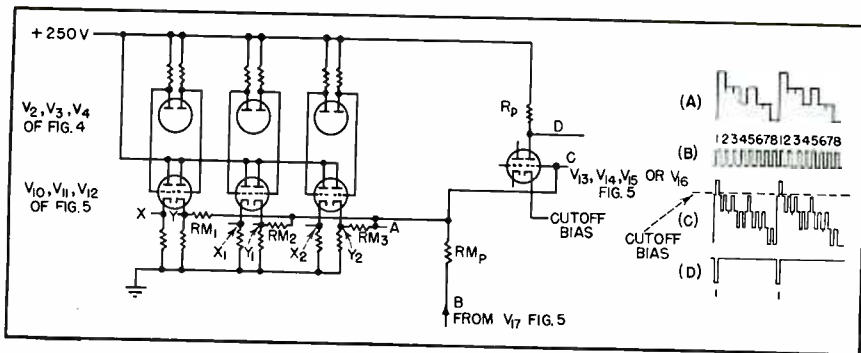

FIG. 6—Simplified diagram to show operation of the channel separator

forms at Y_1 through Y_8 are the switch pulse waveforms and are similar to Fig. 7J except that the topmost portion of each is narrower, occurs approximately in the center of the time interval occupied by the corresponding channel pulse, and that no change occurs when BS conditions occur in any or all zones. Figure 7P and Q indicate this relationship.

The Demodulators

One complete demodulator is shown in Fig. 8. There are eight such units, one per channel. The 6AS6 tube is normally cut off owing to its cathode connection. Neglecting the action of the channel pulses, it will conduct only on the positive spike of the switch-pulse waveform applied to the first grid.

Negative channel pulses are applied to grid three. When WS conditions are present they prevent the switch pulses from causing plate-current flow in the gate tube. Under BS conditions, the channel pulses cease, allowing the switch pulses to be amplified and inverted in the gate tube. The channel pulses are also applied through a diode to one grid of the 6SN7 flip-flop. If the channel pulses are present, the right-hand half of the 6SN7 will not conduct and the neon indicator will be dark, indicating that WS conditions prevail in that channel. The gated switch pulses from the 6AS6 are similarly applied to the other grid of the flip-flop and their presence during BS conditions will reverse the position of the flip-flop, lighting the neon indicator.

The output of the demodulator flip-flop can now be used to operate a counter to count interruptions in the channel pulse trains, or may be used to operate one of the sequence

circuits, or both. The absence of even a single channel pulse will be registered in the associated counter by means of this circuit although at most reading speeds the interruptions of the various channel pulse trains are considerably longer.

Channel Counters

The circuit of a typical channel counter is given in Fig. 9. It is a two-stage binary counter with direct-coupled cathode follower output.

Six two-stage units and two single-stage units are used in the reading machine, the single-stage units being obtained by reconnecting a standard two-stage counter, one of which is illustrated. Both manual and automatic resets are provided, the latter via diodes (not shown) from the automatic reset bus bar which is energized at the appropriate time by the reset circuit.

Sequence Circuits

A circuit used for resolving the ambiguity between letters producing identical counting patterns but different count sequences is shown in Fig. 10. It is sensitive to the order in which interruptions occur in any selected pair of zones and consists of a dual clipper, a flip-flop and a dual cathode follower.

One grid of the flip-flop is connected via the clipper to the demodulator output of one of the selected zones and the other grid is similarly connected to the other selected channel. After a random series of interruptions in both channels the triode section of the flip-flop connected to the channel in which the last inter-

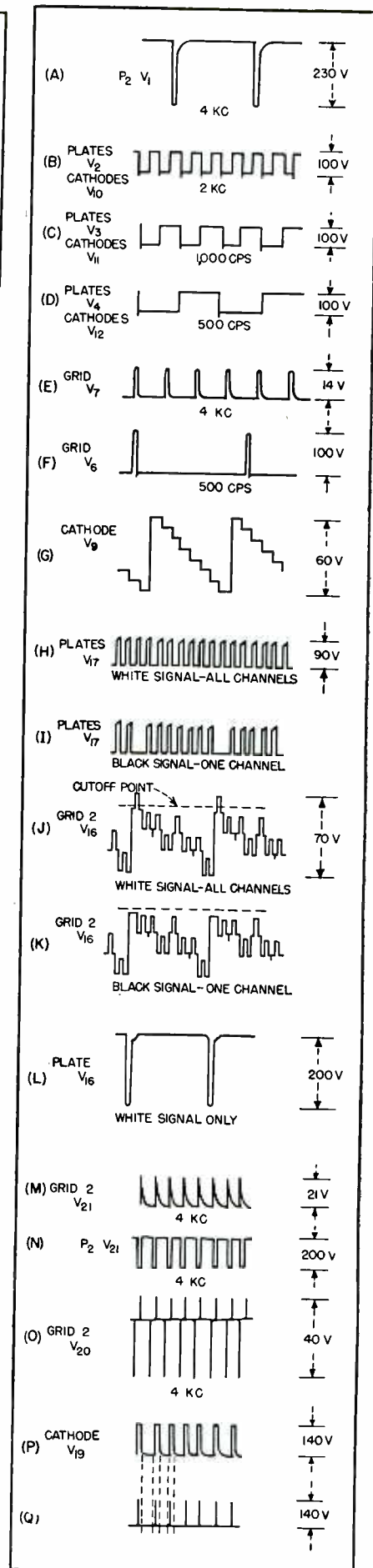

FIG. 7—Waveforms encountered in the reader circuits

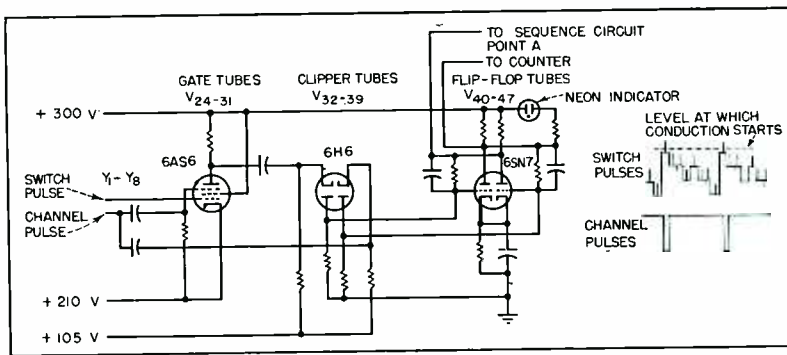

FIG. 8—Demodulator circuit, showing interaction of switch and channel pulses

ruption occurred will remain cutoff, thus providing the required information.

Master Selector Matrix

The foregoing circuitry provides a total of sixteen pairs of input bus bars feeding information into the master selector matrix. The latter is merely a much enlarged version of the channel pulse and switch-pulse selector matrices using a total of 960 resistors. It has an output thyatron for each letter of the alphabet.

The matrix connections, shown in Fig. 11, are such that when a given letter is scanned and its counting pattern is stored up in the counters, the first grid of the output tube for that letter is brought up to ground potential. At any other time it will be from 20 to 150 volts below ground, depending on the immediate past history of the counters. The output tubes are double-grid thyratrons and the second grids are all returned to the read bus bar which is normally biased negative but which is pulsed positive at the end of each letter, thus causing the output tube for that letter to fire, the negative first-grid potential holding off all other output tubes. Each thyatron has one of the release solenoids of the magnetic tape mechanism in its plate circuit.

The thyratrons are extinguished by an auxiliary circuit which opens a relay in the plate supply to them a short time after any one of them conducts.

Reset Pulse Generator

It is required that the reset circuit recognize the termination of each letter when WS occurs in all channels. Upon recognizing such,

it must produce a positive read pulse to be applied to the read bus of the master selector matrix, followed a few microseconds later by a reset pulse which is applied to the automatic reset bus to reset the counters. A diode matrix³ connected to the demodulators determines the all-white condition and conventional flip-flop circuits generate the required pulses.

For demonstration purposes the machine may be made to read a few simple words. The latter are recorded on disks in the magnetic reproducer like letters. A time-constant circuit is added to the reset circuit to slow up its operation. The result is that if the scanner is moved slowly over several letters normal operation ensues and the letters are pronounced. If the scanner is moved rapidly, the reset circuit cannot operate in the short space between letters but will trip on the wider space between words. If the total number of counts recorded is correct for the word scanned and corresponds with one of the words provided, the word will be pronounced. This feature has the practical limitation that one disk and one tube may be required per word. In some commercial applications, however, the principle might prove useful if certain groups of characters had to be recognized.

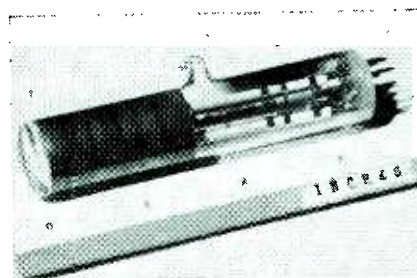

Cathode-ray-tube light source

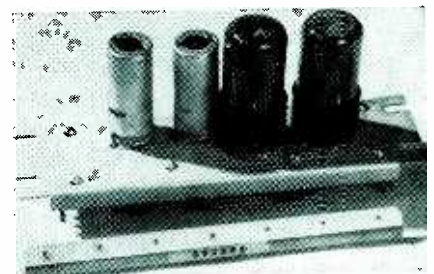

A representative binary counter

Perhaps the most serious limitation of this instrument is the accuracy with which the scanner may have to be aligned with the type. If the scanner spot pattern is displaced vertically from the position indicated in Fig. 1, incorrect counting patterns are likely to ensue. Hence, some form of mechanical guide for the scanner would be useful. One way of ameliorating this situation might be to use a much larger number of scanning spots and arrange the master selector matrix to trip whenever a certain percentage of channels contained the correct information. While this does not seem difficult in principle, it would increase the complexity of the system. On the other hand, it would make reading of slightly imperfect type more reliable.

Speed Limitations

The operating speed of the instrument is limited only by the speed with which the letters can be intelligibly recorded on the disks and later understood by the user, which seems to be of the order of 60 words per minute. The limit set by the counters and other elements is much higher in the present model, 200 words per minute, and could doubtless be increased if necessary. The letters sound rather unnatural at speeds above about 40 words per minute, and for purposes of public demonstration a speed of around 20 words per minute has been used. There is considerable room here for experiment into the optimum sound for each letter.

Other Applications

When work on this device was started, one of the design requirements was that it should work on ordinary type. This requirement has been met in the experimental model, but several interesting pos-

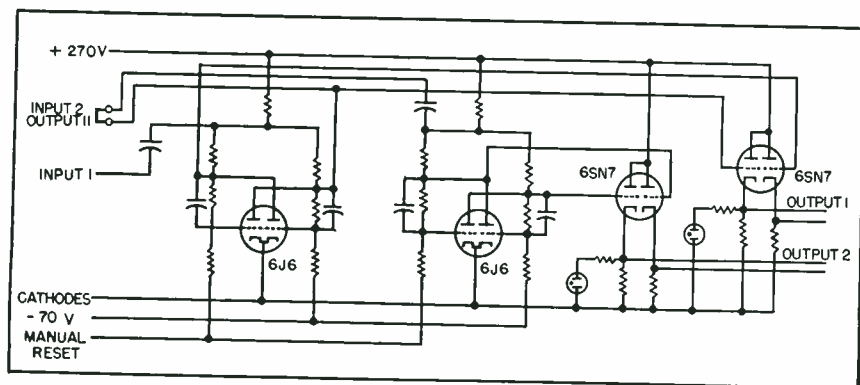

FIG. 9—Counter unit employing two-stage binary with cathode-follower

sibilities present themselves if the original design requirement is removed. For example, all the words of the English language are compounded of about thirty phonetic sounds. If, instead of recording letter sounds in the disks of the reading machine, these sounds were to be recorded and appropriate printed symbols for them devised, high-speed machine reading would become much more practical and the machine could actually read words.

Since the instrument is basically a device for recognizing printed patterns at a high rate of speed, its possibilities are not limited to those of a reading device. Coded information might be printed in a pattern much more distinctive than ordinary letters and in addition might be arranged on tape or cards which would make the alignment requirements much more easily met.

Applications visualized include such things as keying of transmitters directly from printed matter or coded information, transfer of information from printed cards to a computing device, operation of an automatic type-setting machine from printed copy, coding or decoding of material to be used in automatic machines or as a comparison device for checking such information against the original. Many of these operations are now performed by mechanical devices, but an electronic recognition system would in many cases remove the restriction in speed now imposed by mechanical systems.

A great portion of this work was done under Veterans Administration Contract Vam 21223, Subcontract 13, under the sponsorship of the Committee on Sensory Devices of the National Research Council.

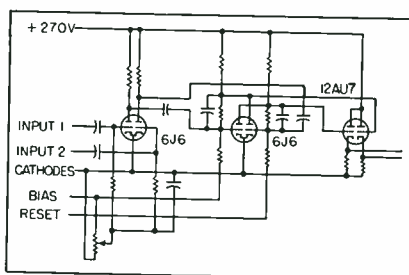

FIG. 10—Sequence circuit that removes ambiguity of identical-count letters

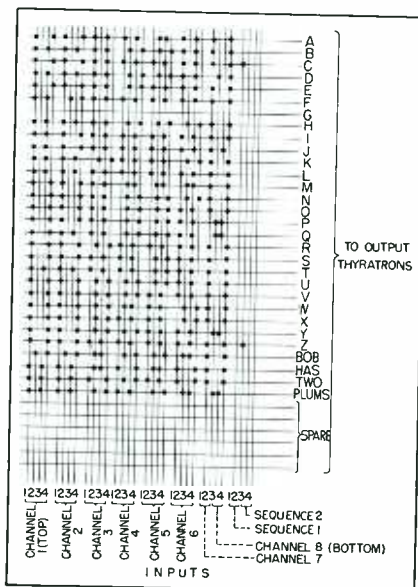

FIG. 11—Master selector matrix. The dots indicate connection through 5-megohm resistors. The crossed lines indicate no connection. Sequence-circuit 1 is connected between channels 5 and 6. Its No. 1 output bus is at 0 after scanning the letter C (lower case) and at -150 after scanning the letter Z. Reverse is true of bus 2

The writers wish to express their appreciation for the cooperation of this committee and in particular the former chairman Dr. George W. Corner. In addition, thanks are due to D. W. Epstein, F. H. Nicoll, and P. Herkart of RCA Laboratories, for the design and construction of

Table I—Master Matrix
(Channels 1-6)

Count	Bus 1	Bus 2	Bus 3	Bus 4
0 or 4 (Normal Pos.)	0	-150	-150	0
1	0	-150	0	-150
2	-150	0	-150	0
3	-150	0	0	-150

The input bus bars of the master selector matrix of channels 1-6 are connected to their respective counters so that their potentials are as shown in the table above.

Channels 7 and 8 are actuated only by letters such as Y, J, G, P, Q, which extend below the line of type, hence only half of a standard counter unit is used on each by breaking the link between the terminal marked input 2 and output 11 in Fig. 9.

The input bus bars of the master selector matrix of channels 7 and 8 are connected to their respective half counters so that their potentials are as shown in Table II, below.

Table II—Matrix
(Channels 7 and 8)

Channel 7		
Count	Bus 1	Bus 2
0—Normal Position	0	-150
1	-150	0
2	0	-150
3	-150	0
Channel 8		
Count	Bus 3	Bus 4
0—Normal Position	-150	0
1	0	-150
2	-150	0
3	0	-150

the cathode-ray tube used here.

REFERENCES

- (1) V. K. Zworykin and L. E. Flory, Reading Aid for the Blind, *ELECTRONICS*, August, 1946.
- (2) J. A. Rajchman, U. S. Patent 2,428,811.
- (3) C. F. West and J. E. DeTurk, A Digital Computer for Scientific Applications, *Proc. IRE*, 36, No. 12, p 1452, Dec. 1948.

PICKUP PLACEMENT

Equations for determining best mounting position for tone arm for use with records having groove radii other than those for which arm is intended

By **B. B. BAUER**

Vice President and Chief Engineer
Shure Brothers, Incorporated
Chicago, Illinois

PHONOGRAPH EQUIPMENT designers are confronted with three distinct problems pertaining to the geometry of phonograph arms.

The first of these is the design of arms to provide the least tracking error distortion on records of given dimensions with an arm of given length, or given distance between mounting centers.

The second problem deals with the design of arms where, as an additional restriction, the arm must overhang or underhang the center of the record by a specified amount, as in record changers, in order to assist the functioning of the tripping mechanism. In this instance, with a stated amount of overhang (or underhang) and a given arm length, or mounting-centers distance, it is desired to determine the offset angle of the pickup head to produce the least possible tracking-error distortion.

The third problem is that of finding the best position for mounting an existing arm with respect to records of groove radii other than those for which it was originally designed. A solution to this third problem is especially timely, as equipment originally designed for 78-rpm records has been modified and adapted for use with the slow-playing records recently announced by Columbia and RCA.

The equations listed below were derived to supplement those given in the article, Tracking Angle in Phonograph Pickups (ELECTRONICS, March, 1945) for the solution of these problems. The geometry of a pickup arm with respect to the record radius and mounting centers is shown in the accompanying figure. All linear dimensions are given in inches, and angles are measured in radians.

If an existing arm having length l and offset angle β is to be placed with respect to a record of groove radii r_1 and r_2 to produce the least distortion possible, the corresponding overhang D (or underhang $-D$) may be determined by finding β_0 and β_i and then using Eq. 3 if $\beta \leq \beta_i$, Eq. 4 if $\beta_i < \beta < \beta_0$ and Eq. 5 if $\beta \geq \beta_0$.

$$\beta_0 = \frac{r_1 \left(1 + \frac{r_1}{r_2}\right)}{l \left[\frac{1}{4} \left(1 + \frac{r_1}{r_2}\right)^2 + \frac{r_1}{r_2}\right]} \quad (1)$$

$$\beta_i = \frac{1}{l \left[\left(\frac{1}{r_1} + \frac{1}{r_2}\right) - \frac{r_1}{2} \left(\frac{1}{r_1^2} + \frac{1}{r_2^2}\right)\right]} \quad (2)$$

$$D = \frac{\beta \left(\frac{1}{r_1} + \frac{1}{r_2}\right) - \frac{1}{l}}{\left(\frac{1}{r_1^2} + \frac{1}{r_2^2}\right)} \quad (3)$$

$$D = \frac{r_2}{2} \left(\frac{r_2}{l} - \beta\right) \left[\left(1 + \frac{\beta^2}{\left(\frac{r_2}{l} - \beta\right)^2}\right)^{1/2} - 1\right] \quad (4)$$

$$D = \frac{r_1}{2} \left(\beta - \frac{r_1}{l}\right) \left[\left(1 + \frac{\beta^2}{\left(\beta - \frac{r_1}{l}\right)^2}\right)^{1/2} + 1\right] \quad (5)$$

If a new arm of length l is designed to provide the least distortion possible with a given overhang D (or underhang $-D$), the corresponding offset angle β may be determined by finding D_0 and D_i and

then using Eq. 8 if $D \leq D_i$, Eq. 9 if $D_i < D < D_0$, and Eq. 10 if $D \geq D_0$.

$$D_0 = \frac{r_1^2}{l \left[\frac{1}{4} \left(1 + \frac{r_1}{r_2}\right)^2 + \frac{r_1}{r_2}\right]} \quad (6)$$

$$D_i = \frac{r_1}{l \left[2 \left(\frac{1}{r_1} + \frac{1}{r_2}\right) - r_1 \left(\frac{1}{r_1^2} + \frac{1}{r_2^2}\right)\right]} \quad (7)$$

$$\beta = \frac{D \left(\frac{1}{r_1^2} + \frac{1}{r_2^2}\right) + \frac{1}{l}}{\left(\frac{1}{r_1} + \frac{1}{r_2}\right)} \quad (8)$$

$$\beta = 2 \left(\frac{2D^2}{r_2^2} + \frac{D}{l}\right)^{1/2} - \frac{2D}{r_2} \quad (9)$$

$$\beta = 2 \left(\frac{2D^2}{r_1^2} + \frac{D}{l}\right)^{1/2} - \frac{2D}{r_1} \quad (10)$$

If distance d is given instead of length l , find $l = d + D$, and proceed as before.

If a new arm is designed to have a length l and to provide minimum tracking-error distortion over a range of groove radii from r_1 to r_2 , optimum offset angle and overhang may be found by using Eq. 1 and Eq. 6.

When d is given instead of l , the overhang D_0 may be found from the following equation: $D_0 =$

$$\left[\frac{d^2}{4} + \frac{r_1^2}{\left[\frac{1}{4} \left(1 + \frac{r_1}{r_2}\right)^2 + \frac{r_1}{r_2}\right]}\right]^{1/2} - \frac{d}{2}$$

Find β_0 from Eq. 1 remembering that $l = d + D_0$.

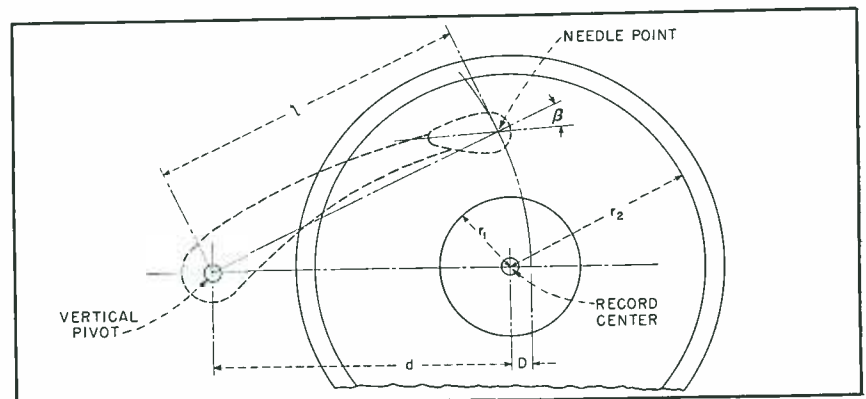
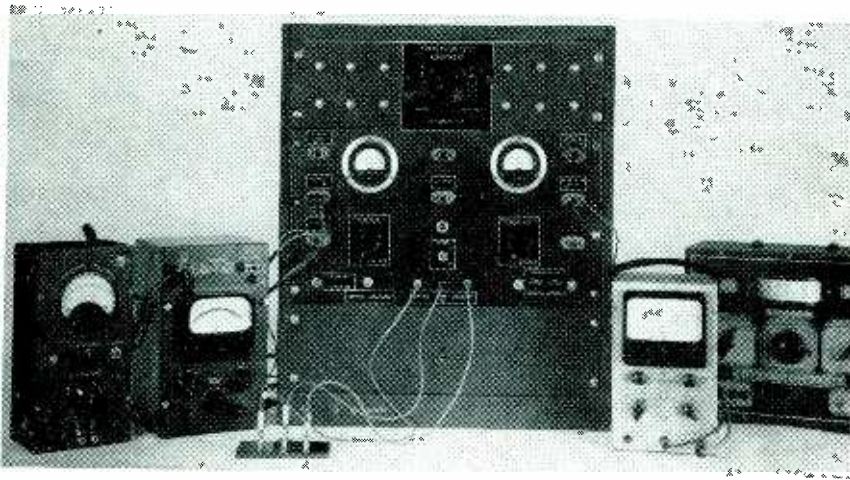

Diagram of typical phonograph layout

Testing Transistors

Simple test circuit using two pentodes gives direct currents and voltages at operating point, corresponding a-c values for zero and infinite collector load-resistance, and current and voltage amplification values. Resistance coefficients are then easily calculated



Complete equipment for testing transistors. Left to right: Electronic a-c voltmeter; vtvm for d-c emitter voltage; test unit, with transistor on three-terminal panel in foreground; vtvm for d-c collector voltage; audio signal generator. Jacks on test unit permit quick connection of additional precision meters and experimental connections to pentode grids

SINCE the transistor is now commercially available from different manufacturers, a simple method for testing which still yields rather extensive information becomes of wider interest.

If all a-c components are sufficiently small, a linear relation holds between the alternating current i_e through the emitter and the alternating current i_c through the collector on one hand, and the a-c voltage emitter-base v_e and the a-c voltage collector-base v_c on the other hand:

$$\begin{aligned}v_e &= R_{11} i_e + R_{12} i_c \\v_c &= R_{21} i_e + R_{22} i_c\end{aligned}\quad (1)$$

The four coefficients, R_{11} , R_{12} , R_{21} and R_{22} , may be used to describe the operation of the transistor at a particular operation point, given for instance by the direct currents.¹ The coefficients are practically independent of frequency up to several hundred thousand cycles.

In Table I some of the most important circuit qualities of the transistor are expressed in terms of these coefficients. A convenient method of measuring the coefficients is described. It is hoped that it may contribute to the establishment of a standardized method for test and characterization of transistors.

Test Circuit

The characteristic feature of the test circuit is the use of a pentode in the emitter circuit and a pentode in the collector circuit, both operating in the saturation range. Thus the direct current through emitter and collector can be adjusted independently of the emitter impedance or the collector impedance of the transistor by a proper bias voltage at the grid of the pentodes. By modulation of the grid voltage of

the pentode in the emitter circuit, an alternating current $i_e = 100$ microamperes rms at 5,000 cps is produced. This current is usually found to be sufficiently small so that distortion of the sine wave by the transistor may be neglected.

If the d-c bias at the grid of the pentode in the emitter circuit is changed, a small adjustment of the a-c grid voltage may be needed to keep the a-c emitter current constant. That can be avoided by using two pentodes in parallel in the emitter circuit, one as adjustable d-c current generator and the other as fixed a-c current generator.

For the calculation of the coefficients it is sufficient to measure v_e and i_e at zero collector load-resistance, and v_e and v_c at infinite collector load-resistance. The dpdt switch S_2 in position A shunts the pentode in the collector circuit by a capacitance of $1 \mu\text{f}$ and enables the a-c collector current to be measured at practically zero a-c load resistance (the collector impedance is of the order of 20,000 ohms).

With switch S_2 in position B, the pentode in the collector circuit is shunted by the capacitance in series with a 5-megohm resistance. This avoids sudden charge currents of the capacitance after changes in the switch position and provides a practically infinite a-c load resistance in the collector circuit.

Equipment Used

The test setup includes an electronic a-c voltmeter to measure the a-c components, a vacuum-tube voltmeter for the d-c emitter voltage, a vacuum-tube voltmeter for the d-c collector voltage and an audio signal generator which is connected internally to the grid of the pentode in the emitter circuit. The transistor is placed in a holder constructed to ground automatically the emitter and the collector input if the transistor is taken out.

The a-c components are measured on the same a-c voltmeter by throwing the appropriate switches. All

By K. LEHOVEC

Signal Corps Engineering Laboratories
Fort Monmouth, New Jersey

a-c components are measured on the same range (10 to 100 millivolts) of the electronic a-c voltmeter by means of proper voltage dividers included in the test circuit.

Presentation of Results

It is convenient to arrange the measured values in the form shown in Table II. The first or left-hand group contains the direct currents and voltages, which describe the operation point. The second group contains in the upper line the alternating currents and voltages at zero collector load-resistance and in the lower line the corresponding values for infinite collector load-resistance. The third group gives the current amplification at zero collector load resistance and the voltage amplification at infinite collector load resistance. The fourth group contains the four coefficients, which are calculated from the a-c components in the second group according to

$$\begin{aligned} |R_{11}| &= (v_e/i_e)_\infty \\ |R_{12}| &= [(v_e)_\infty - (v_e)_0]/(i_c)_0 \\ |R_{21}| &= (v_c/i_c)_\infty \\ |R_{22}| &= (v_c)_\infty/(i_c)_0 \end{aligned} \quad (2)$$

The above equations follow immediately from Eq. 1 if first $(i_c)_\infty$ and then $(v_c)_0$ are set equal to zero.

In Table III, numerical values obtained on a commercial Bell Telephone Laboratories germanium transistor are given in the arrangement of Table II.

For a quick test, one is often more interested in the maximum current amplification and the maximum voltage amplification than in the resistance coefficients. It is then an advantage of the circuit that the maximum current amplification is obtained without further calculation from the a-c collector current at zero collector load-resistance.

REFERENCE

(1) W. Bardeen and W. Brattain of Bell Telephone Laboratories used this representation of transistors in a lecture given in October 1948 in Princeton, N. J. for the local AIEE section.

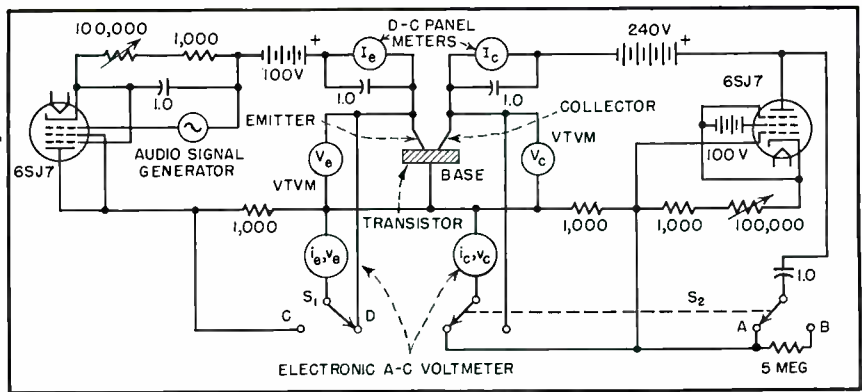

Test circuit for transistors. Batteries are used throughout, with on-off switch in heater circuit. Collector and emitter leads are automatically shorted to base when transistor is removed

Table I—Important Circuit Qualities of Transistors

- (1) Short-circuit stability $\delta = \frac{R_{12} R_{21}}{R_{11} R_{22}} < 1$
- (2) Input impedance $R_{11} - \frac{R_{12} R_{21}}{R_{22} + R_L}$
(collector load-resistance is R_L)
- (3) Output impedance $R_{22} - \frac{R_{12} R_{21}}{R_{11} + R_o}$
(external resistance in emitter circuit is R_o)
- (4) Power amplification $\frac{R_{21}^2}{R_{11} R_{22}} \frac{R_L}{(R_L + R_{22})} \frac{1}{(1 - \delta + R_L/R_{22})}$
(output power/input power)
- (5) Maximum current amplification $\frac{R_{21}}{R_{22}}$
(zero load)
- (6) Maximum voltage amplification $\frac{R_{21}}{R_{11}}$
(infinite load)

The following values refer specifically to $\delta < 1$ and a load resistance matched for maximum available power amplification:

- (7) Load resistance matched for maximum power amplification $R_{22} \sqrt{1 - \delta}$
- (8) Input impedance at maximum power amplification $R_{11} \sqrt{1 - \delta}$
- (9) Maximum power amplification $\frac{R_{21}^2}{R_{11} R_{22}} \frac{1}{(1 + \sqrt{1 - \delta})^2}$
- (10) Insertion gain at maximum power amplification $\frac{R_{21}^2}{4R_{11}^2} \frac{1}{(1 + \sqrt{1 - \delta})^2}$
- (11) Insertion gain (at maximum power amplification)/maximum power amplification $\frac{R_{22}}{4R_{11}}$
- (12) Current amplification at maximum power gain $\frac{R_{21}}{R_{22}} \frac{1}{1 + \sqrt{1 - \delta}}$
- (13) Voltage amplification at maximum power gain $\frac{R_{21}}{R_{11}} \frac{1}{1 + \sqrt{1 - \delta}}$

Table II—Arrangement of Measured Values

I_e	I_c	i_e	$(v_e)_0$	$(i_c)_0$	0	$(i_c/i_e)_0$	$ R_{11} $	$ R_{12} $
V_e	V_c	i_e	$(v_e)_\infty$	0	$(v_c)_\infty$	$(v_c/v_e)_\infty$	$ R_{21} $	$ R_{22} $

Table III—Test Values for Commercial Germanium Transistor

0.5 ma	2.0 ma	100 μ a	18mv	132 μ a	0	1.32	420 ohms	182 ohms
0.13 v	22.5 v	100 μ a	42mv	0	3.1v	74	31,000 ohms	23,500 ohms

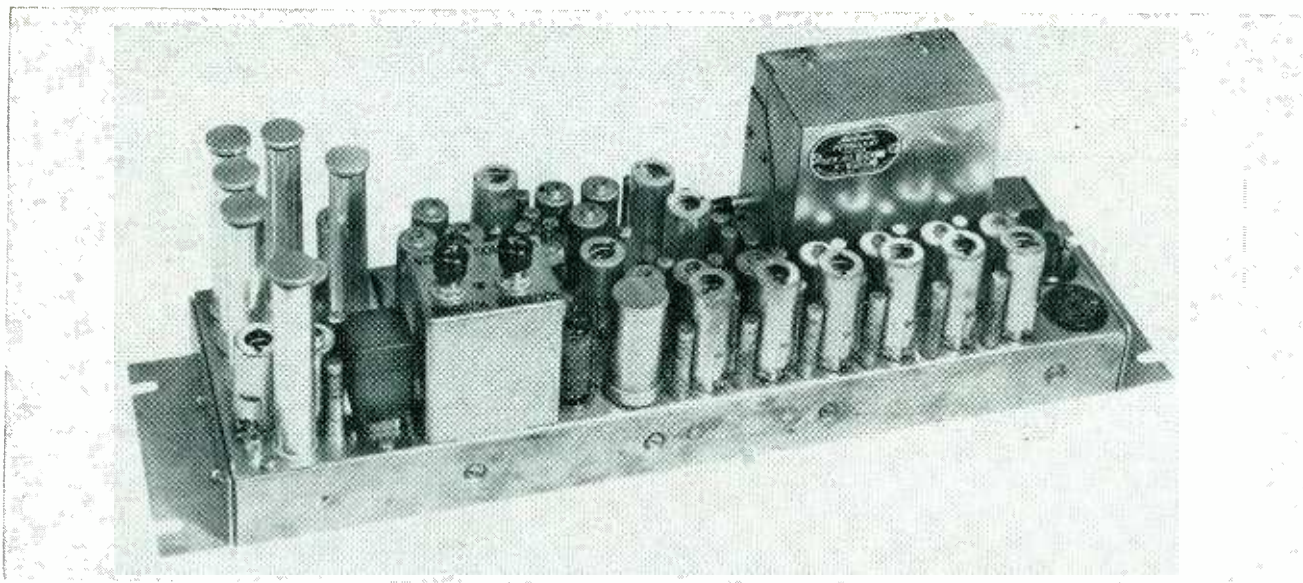

Receiver unit designed for adjacent-channel operation. Midget cavities and special oscillator are at the left, i-f wave filters in can at right rear

Adjacent-Channel Operation of Mobile Equipment

AS THIS IS WRITTEN the Federal Communications Commission is reaching a decision removing mobile radio services from the experimental category and assigning permanent channels. It is contemplating standardization of rules and regulations to provide for full growth of these services while at the same time insuring efficient utilization of channels to be assigned.

The move is indeed timely, since the need and demand for mobile-service channels is increasing at a very rapid rate, particularly in metropolitan areas. Here, especially, any waste of spectrum space cannot be tolerated, perhaps not even for guard bands that characterize the broadcasting industry, and it is this that prompts the writer to suggest that adjacent-channel operation of mobile-service stations in the same area may be a necessity.

The problem of adjacent-channel operation in the same area is not a simple one to solve, but there is reason to believe that with reasonable boundaries for the allocation limits a solution can usually be found.

The Basic Problem

It is generally understood that i-f selectivity, usually the controlling selectivity in receiver design, is not the dominant and deciding factor in design for adjacent-channel operation. If it were possible to provide real r-f selectivity in the receiver, adjacent-channel operation would be limited only by the perfection of this parameter. However, until engineers can provide r-f selectivity of 100 db down, ± 30 kc at 160 megacycles, it is vain to attack the problem from this angle. Even the massive stabilized cavities that are practicable for base-station installation will not provide at-

tenuation of more than 20 or 30 db at 200 kc off resonance, and are of little value where the adjacent and alternate-channel stations are removed from the desired frequency by 60 and 120 kc, respectively.

Proper system design, together with controlled geographical assignment of channels, can do much to keep the boundaries of the problem within reasonable limits, so that straightforward engineering principles can be applied within the known art to make utilization of adjacent channels feasible. However, without some control of the system design, the problems of intermodulation or crosstalk may loom so large that no practicable equipment design can be found. The control of crosstalk in a 10-pair telephone cable for instance may be impracticable, unless some limits are placed upon the signal levels carried by the individual pairs and upon the gain of amplifiers asso-

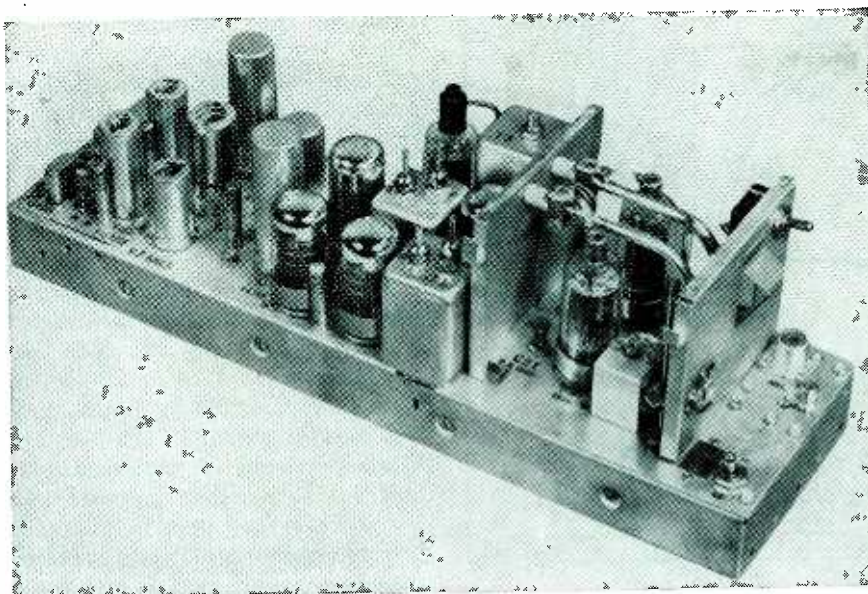

Thirty-watt transmitter chassis. Instantaneous-deviation-control tubes are in second row from left

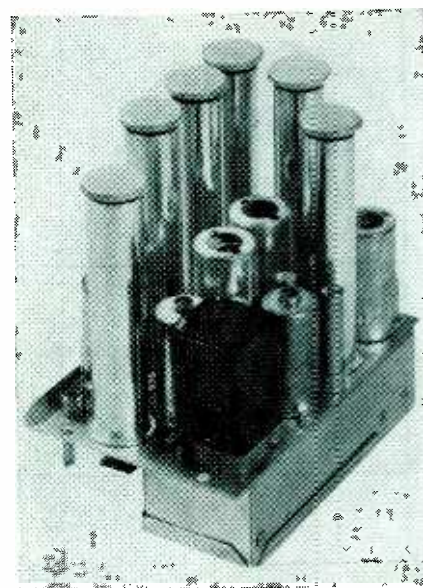

Closeup of receiver r-f deck. Crystal oven is in foreground

Increasing vhf activity requires more economical use of a limited radio spectrum. New equipment techniques and proper geographical separation of fixed transmitters reduce interchannel interference to a practical minimum. Guard bands may not be necessary

By DANIEL E. NOBLE

Director of Research
Vice President in Charge
Communications and Electronics Div.
Motorola, Inc., Chicago, Ill.

ciated with the individual pairs.

Almost any desired degree of i-f selectivity can be attained, spurious radiation can be controlled, and spurious responses in the receiver attenuated to a point where they may be forgotten. Transmitter deviation can be satisfactorily limited to prevent excursion into adjacent and alternate channels. With all these elements under control, there remains still a dominant difficulty to be surmounted. If a difficulty could be termed a masterpiece, this one should bear that designation. Months of work will yield an improvement of 20 db and elaborate equipment may add another 2 db, but 100-db improvement seems as remote as the twinkling stars. The name of this masterpiece of contrariness is intermodulation (meaning r-f intermodulation) and this one factor places greater limits upon successful adjacent-channel operation in the same area than all

other technical factors combined.

Intermodulation may be of two types: (1) that produced within a transmitter group and (2) that produced in the front end of a receiver. Of the two types, the receiver intermodulation is far more important and considerably more difficult to control.

R-F Stage Intermodulation

Briefly, receiver intermodulation is the combining of two strong, un-

desired signals so that the beats resulting from nonlinear circuit characteristics produce modulation products directly on the frequency of the desired station. For example, consider transmitters A, B and C, spaced 60 kc apart. Considering station A the desired channel, when a mobile receiver is operated close to stations B and C strong signals in the front end of the receiver operate the mixer in its nonlinear region, resulting in beats between B and C. The second harmonic of station B generated within the receiver will beat with the fundamental of station C to produce a carrier or product exactly on the frequency of station A.

NEW RULES

FCC announced new rules for the General Mobile Services May 3, effective July 1.

Details appear on page 128

A	B	C
f	$f + \Delta f$	$f + 2\Delta f$

$$2B = 2f + 2\Delta f$$

$$C = f + 2\Delta f$$

$$A = f \text{ (difference)}$$

Unless the desired signal A is

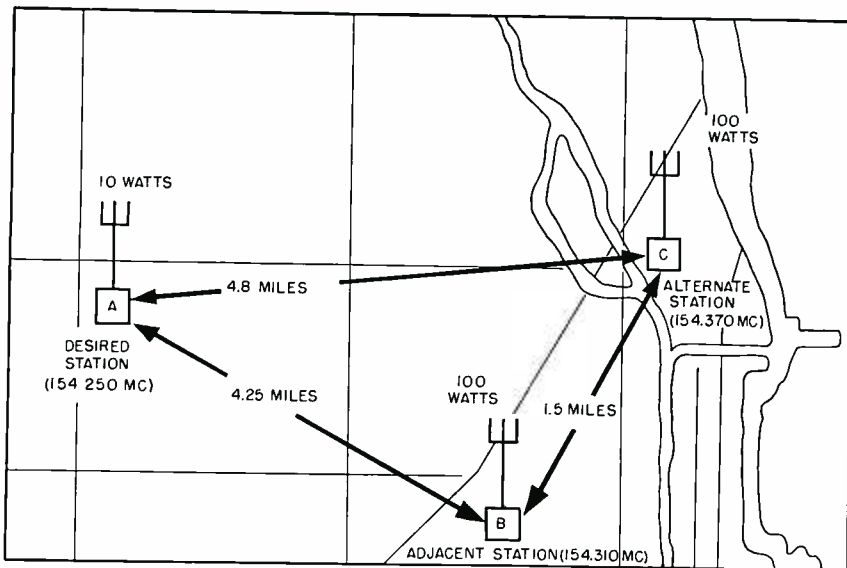

FIG. 1—Geographical layout of stations used in actual test

strong enough to wipe out this undesired product of intermodulation, the receiver will not respond to the desired station A, and modulation from both B and C will be heard. This is one combination which produces an interfering carrier, but there are many other combinations which will produce results equally disastrous.

There are two obvious solutions to the problem. Intermodulation could not take place in the r-f stage, the mixer, or any succeeding stages of the receiver, if stations B and C were not allowed to pass through the front-end selective circuits. Similarly, if all circuits (r-f, mixer, i-f, and other amplifiers) are designed so that they operate over a purely linear characteristic, no mixing or intermodulation can take place and the undesired signals will be rejected by the i-f selectivity. Both solutions are theoretically possible, but they are both practically impossible to achieve unless well-defined limits are placed upon the levels of the signals involved.

A mobile unit operating in the vicinity of a 100-watt transmitter, radiating from a 100-ft antenna, may receive more than a volt on the grid of the first r-f tube. If stations B and C are close together geographically and each supplies a full volt on the grid of the first r-f amplifier, while the desired station A supplies a mere microvolt, a solution to the problem becomes impossible. Some r-f selectivity can be

provided to offer slight attenuation to the station 120 kc removed from the frequency of station A and receiver design can improve the linearity of all amplifier and mixer stages to reduce the susceptibility to strong intermodulation signals. However, even the combination of maximum practicable r-f selectivity and the best possible design for linearity of amplifiers will not be sufficient to control the conditions outlined above.

Grouping of Stations

Several years ago, the writer proposed that one possible solution might be the locating of all three stations, or a group of stations, at one geographical position, so that the mobile unit would receive a strong desired signal, and on this basis it was argued that the products of intermodulation produced by B and C would always be weaker than the direct desired signal transmitted by A, so that the desired station signal would wipe out the undesired intermodulation products of B and C.

This solution has merit only where there are no other licensees in the area except those occupying the single block of channels. Severe interference would result in the channels above and below the concentrated block of stations and there would be danger of severe transmitter intermodulation, as well as a high level of receiver intermodulation on those channels. In

addition, the standing-wave patterns produced by the various grouped radiators could not be matched exactly in space, with the result that a difference of received signal level of as much as 10-to-1 might exist between desired and undesired signals at particular locations.

The control of intermodulation even within a block of centralized stations is difficult, and both age and the use of a 10 or 20-db pad have been resorted to for holding the level of signal in the receiver below the point of nonlinear mixing. To the receiver engineer who has worked for years to raise the level of receiver sensitivity to better than a microvolt, the use of a 20-db pad to knock down signal levels is equivalent to repairing a watch with a sledge hammer.

The joint operation of stations at one location, then, is an impracticable, unsatisfactory solution, which does not lend itself to reasonable procedures for the administration of all channel assignments. Successful operation for all licensees can be achieved only when geographical separation controls relative signal levels within the tolerable limits dictated by receiver-design practicability.

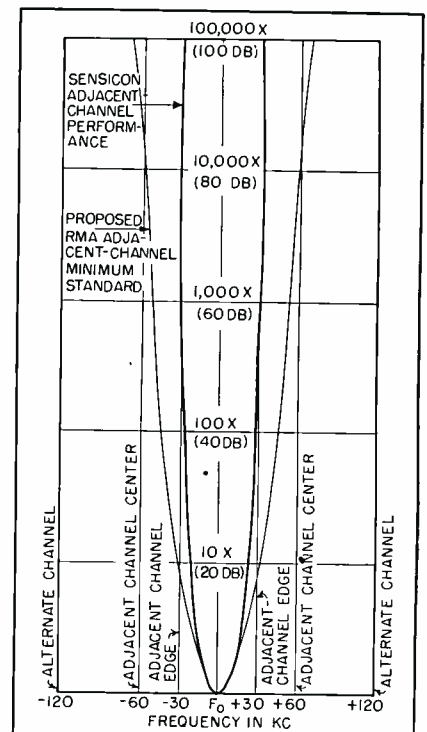

FIG. 2—Sensicon receiver selectivity curve

Consider again a group of stations A, B and C, (Fig. 1) operating on channels separated by 60 kc. We have already considered the case where A, B and C were operated at a single location, and the case where B and C were at one location and A at a distant location. Now consider the third possibility with A, B and C separated.

With Stations Separated

To make an actual test reasonably difficult, we separated B and C by approximately 1.5 miles, while A (the desired station) was placed 4.25 miles from B, the adjacent-channel station, and about 4.8 miles from C. The receiver was mounted in a mobile unit and required to communicate with station A while cruising in the immediate vicinity of B, and in the area between B and C.

With both B and C at one location, the receiver cruising in the vicinity of these stations would receive two strong signals, and the products of modulation would be large. But, for the case described above, with all three stations separated, the mobile unit cruising in the vicinity of station B receives one strong signal from B and a comparatively weak signal from C,

with the result that the level of the intermodulation product is greatly reduced. A comparatively weak signal from station A will dominate the intermodulation product and wipe out the interference.

Figure 1 shows the geographical layout of the three stations. The frequencies and relative powers are marked. In a test car with the receiver tuned to station A, no interference was found except in a few spots in the immediate vicinity of station B, even when all three stations operated simultaneously. Cruising in the B area located certain signal-shaded points where the received signal from the undesired station B, less than a quarter of a block away, was abnormally strong while the shielding produced an abnormally weak signal from desired station A. By driving the car very slowly, it was possible to find interference areas, but the interference patterns were limited to a matter of yards. The squelch control could be set at a level sensitive enough for the response of the desired station, but insensitive enough to prevent opening by the operation of stations B and C, either simultaneously or independently.

It should be noted at this point that when tests are carried on in

close proximity to interfering stations the problems of receiver desensitizing and intermodulation join. There is a question, perhaps somewhat academic, as to whether interference is caused by desensitizing or by intermodulation.

Needed Receiver Characteristics

The special receiver used in the test provided an i-f selectivity of more than 100-db attenuation at ± 30 kc of the desired frequency as shown in Fig. 2. In other words, 100-db attenuation was provided between the channels or at the common boundary between channel A and channel B.

The receiver design principle brought the elements of r-f selectivity and intermodulation control to a maximum degree of effectiveness. Emphasis should, however, be given to the fact that the extraordinary degree of i-f selectivity in the test receiver was not the dominating factor that made adjacent-channel operation in the same area possible. The same degree of i-f selectivity in a receiver of conventional design, with conventional r-f and mixer circuits, did not provide satisfactory adjacent-channel operation under the conditions described. There is, nevertheless, the obvious limiting factor that the i-f selectivity must be sufficient to prevent the adjacent-channel signal from passing through the receiver at a level great enough to dominate the desired signal at the limiter.

Modern production receivers of a type in wide use provided excellent reception under the conditions outlined, except for the radius of approximately one-half mile around the adjacent channel station, while both B and C were on the air. Under all tests, the tendency towards interference with the older type receivers was lessened when only one of the opposing stations was on the air. One receiver of excellent selectivity characteristics, but without the new control of intermodulation, was tested. Interference reception over the entire mile-and-a-half separation path between stations B and C was received.

All of the observations pointed with emphasis to the fact that, by geographically separating the stations operating on the successively

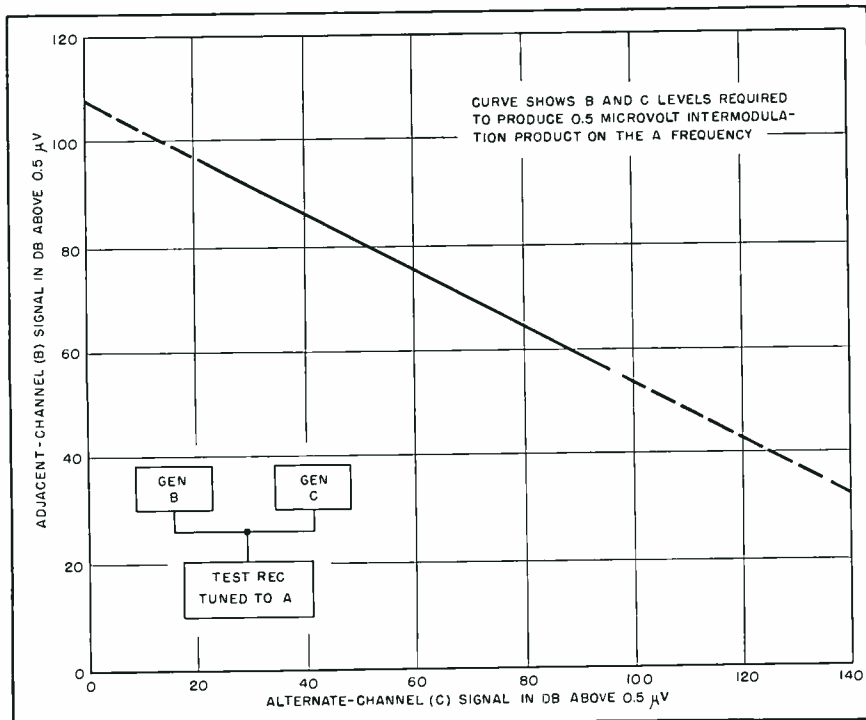

FIG. 3—R-f intermodulation characteristics of the receiver for various levels of adjacent and alternate-channel signals

adjacent channels the extreme limits of intermodulation production in the receiver could be brought under control to a point where the effects of special receiver design became significant.

Laboratory Tests

Intermodulation characteristics obtained by connecting two signal generators to supply signals to the test receiver simultaneously are shown in Fig. 3. Generator B supplied the signal 60 kc removed from the desired signal and generator C supplied a carrier 120 kc removed. By increasing the level of the two signals, the intermodulation product on the desired frequency equivalent to A produced 20 db quieting in the receiver.

Figure 4 clearly illustrates the need for base-station separation. The curve was taken with the generators B and C connected as in Fig. 3, but with the difference that the adjacent-channel signal B was held constant at 97 db above one-half microvolt, or with a constant input of more than 28,000 microvolts.

With the B signal (60 kc removed) fixed, the amplitude of the alternate-channel signal C was varied, while the amplitude of the intermodulation product appearing on the desired frequency A was recorded. Extrapolation of the curve of Fig. 4 will show that, for

B and C both at 97 db above the reference level, an intermodulation interference product on channel A will be produced with an amplitude of approximately 2,800 microvolts.

This fact is so important in system design that it deserves restatement: With two base stations at the same location, each one supplying a signal to our receiver at 97 db above the reference level or more than 28,000 microvolts, the interfering product of modulation will have an amplitude of 2,800 microvolts and the desired station will need to supply a signal of not less than 5,600 microvolts to gain control. Because of the standing waves in space, even 5,600 microvolts from the desired station would not be ample to maintain control.

With the desired station located at the same point as stations B and C, we may assume a 28,000-microvolt signal on the desired channel, but again, because of the standing waves in space (which may be as great as 10-to-1) we may expect the desired signal to drop as low as 2,800 microvolts, while the interfering product remains at 2,800 microvolts. Because the intermodulation products are relatively high in amplitude for strong adjacent and alternate-channel signals, the installation of a group of successively adjacent channel stations at one location does not provide practicable operational limits within which it is

possible to design satisfactory receiving equipment for systems that are not at the group location.

Further Tests

By separating stations B and C geographically, so that at the mobile pickup point close to station B where a 28,000 microvolt signal is received the signal from station C may, for example, be limited to 500 microvolts, the product of intermodulation will be approximately 50 microvolts instead of 2,800 microvolts as indicated above. The threshold requirement of the desired station would then be 100 microvolts and, even on a 10-to-1 basis, only a 500-microvolt signal would be needed to dominate.

Further geographical separation of the two stations B and C may be employed to limit the input to the receiver from signal C when 28,000 microvolts is applied by station B. It can be shown from Fig. 4 that with 2.5 microvolts input from station C, no intermodulation products would be produced on the desired channel in the critical area near B.

The calculation of relative signal levels required for the control of intermodulation presents the problem in a more severe light than actually exists in practice. Because of the vertical directivity of the antenna pattern of the base station, the signal level close to the base of the antenna supporting structure is lower than the signal amplitude a few blocks away. Shielding effects introduced by buildings and other structures also alter the field pattern from all stations and, fortunately, the magnitude of interference produced by a group of separated stations in an urban area is less by practical test than that calculated on the basis of idealized radiation conditions. This statement is substantiated by the test conditions shown in Fig. 1, where stations B and C each radiating more than 100 watts produced an almost negligible pattern of interference with the mobile unit operating close to B, although station A radiated no more than 10 watts. The mobile unit received no interference as soon as it was moved away from an area of approximately a quarter of a block to one block from B, where reflections provided a strong

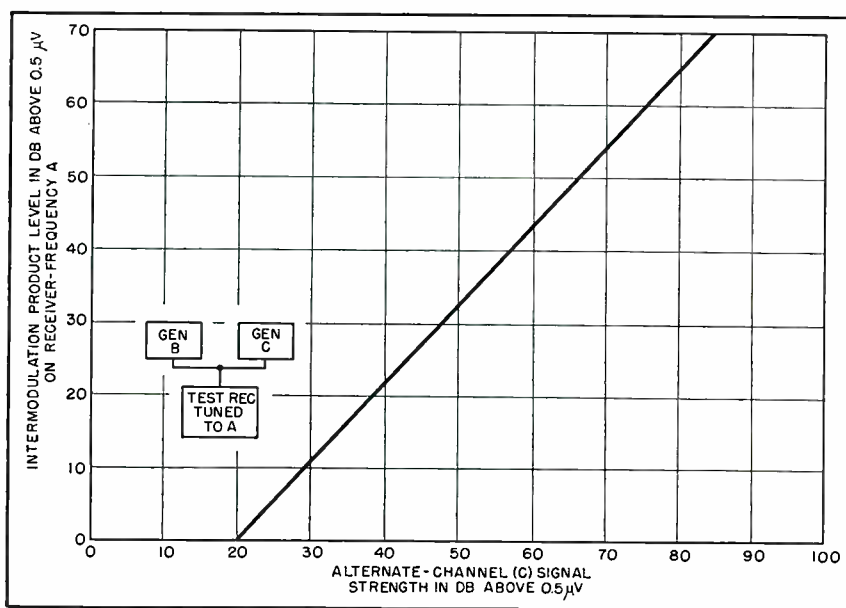

FIG. 4—R-f intermodulation characteristics of the receiver with adjacent-channel signal constant at 97 db above 0.5 μv

signal from B and a weak signal from A.

Data plotted in Fig. 4 further explains the significance of the Sensicon receiver intermodulation characteristic, and that characteristic may be stated in simple terms. For a strong adjacent-channel signal of 97 db above 0.5 microvolt, the level of the interfering product of intermodulation will always be approximately 20 db less than the amplitude of the alternate channel signal. If the desired signal and the alternate-channel signal are of equal amplitude, the desired signal (neglecting standing waves) will always have an advantage over the undesired product of modulation, under these conditions, of at least 10-to-1.

To understand the significance of this relationship, emphasis must be given to the fact that this condition of 20-db improvement for protection occurs only in areas where the mobile receiver is operating geographically close to the adjacent channel station B, but for all other areas where the mobile unit is some distance from station B (the adjacent-channel station) the protection will be substantially greater than 20 db. In other words, the curve of Fig. 4 shows the most severe conditions, applying only to areas close to the adjacent-channel station.

Receiver Design

To a controlling degree, the selectivity of the receiver illustrated in these pages is determined by the characteristics of the wave filter. Permeability-tuned components and compensating capacitors are permanently sealed and fixed electrically and mechanically by casting the entire filter structure in polyester styrene. This construction not only frees the filter from possible variation owing to moisture and vibration, but also prevents the loss of selectivity characteristics as a result of attempted tuning without necessary instrumentation.

Since the i-f center is fixed, the maintenance problems of the receiver are simplified and tuning is accomplished by adjusting the tunable crystal oscillator. A new circuit was developed, providing the necessary electronic tuning over the required range with compensation to

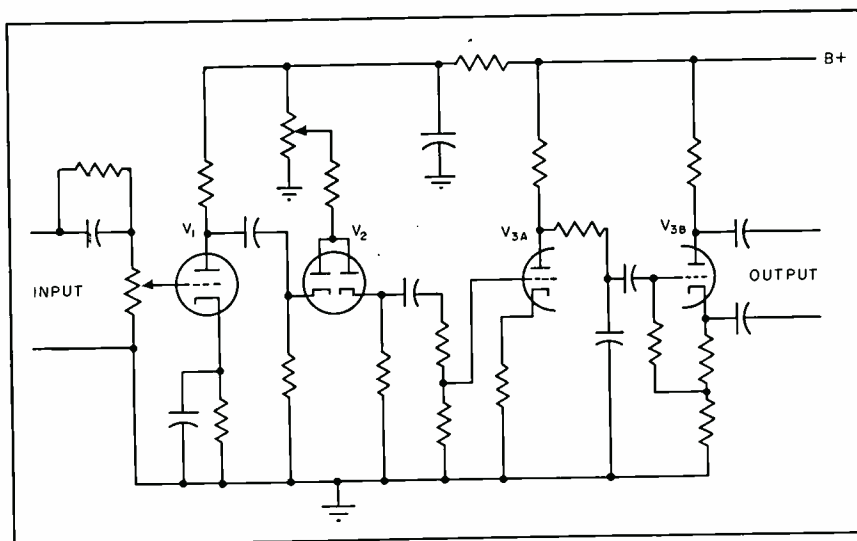

FIG. 5—Circuit diagram of the instantaneous deviation control used in the transmitter

insure stable performance over a wide temperature range. Stability must keep the signal at the center of the i-f bandpass. The crystal circuit maintains ± 1 kilocycle of the assigned carrier frequency measured at 25 C, or from ± 0.00058 percent to ± 0.00066 percent over the 152-to-174-megacycle band for the ambient temperature range of -30 C to $+60$ C.

Transmitter Design

Provision is made in the transmitter (illustrated) to supply from one to three separate crystal oscillators. Three-frequency transmitters may be provided for switching frequency without retuning the transmitter, so long as the maximum frequency change does not exceed 240 kc. The instantaneous deviation control requires two tubes. These are shown in Fig. 5 preceded by an amplifier.

The original approach to this circuit problem required that the voltage control in the compressor system be supplied through a frequency-sensitive circuit, so that the voltage would increase as a function of the frequency of the audio in the amplifier. Although this method worked, it was obviously a cumbersome device which did not lend itself to mobile communications equipment. The answer was found in the simple Winkler circuit arrangement by which the modulating wave first passed through a differentiating network, which emphasized all steep slopes or

step wave fronts, then through a clipper which automatically clipped the characteristic wave elements associated with the steep slopes, and finally through an integration network to restore the remaining audio characteristics to normal relationship. This instantaneous deviation control has no time lag and may be adjusted to provide a rigid limit to the maximum instantaneous deviation of the transmitter frequency.

Products of modulation will extend beyond the maximum excursion of the wave and, for this reason, it is desirable to hold the instantaneous deviation maximum well within the limits of the half-channel width to be occupied. In practice, a guard band of a mere two or three kilocycles will be satisfactory, since the speech sidebands producing maximum deviation are of a transient nature and the energy content of the products of modulation extending substantially beyond the limits of instantaneous deviation are low and may be neglected insofar as substantial interference to adjacent channel operation is concerned. The use of multiple-tuned circuits and circuit-isolation means holds the spurious output of the transmitter at least 70 db below the carrier output level.

Although this discussion has been concerned primarily with the 152-to-162-mc band, all of the reasoning applies equally to the bands from 30 to 50 mc.

Low-Frequency DISCRIMINATOR

A phase inverter having equal plate and cathode loads is used to drive a resistance-capacitance phase shifter. The output voltages that are developed behave as the voltages from conventional discriminators, thus this is a compact low-frequency circuit

THE NETWORK discussed herein was designed to produce the necessary deviation voltage for an automatic-frequency-control system. Through its use the separation frequency f_0 between two r-f oscillators is maintained within 10 percent of any of several selected values. The required separation in frequency lies between 20 and 500 cycles per second. Under some operating conditions, unwanted variations as great as 500 percent of values of f_0 normally occur without some such control.

Although the circuit functions as a discriminator, it differs from conventional discriminators in that it contains neither transformers nor inductors and, hence, no resonant circuits.

Discriminator Action

The circuit performance centers around a dual-purpose phase changer shown in Fig. 1, which supplies the following necessary control voltages. First, it produces two voltages 180 deg displaced from each other and of equal amplitudes; secondly, it produces a voltage which at one frequency is 90 deg displaced from the other voltages, but which at any other frequency tends to rotate towards either zero-deg phase condition or 180-deg phase condition.

The operation of the phase changer is as follows: Consider V_1 as a degenerative amplifier (part of Fig. 1A drawn in lighter lines). If R_K is made equal to R_L , the voltages developed across R_L and R_K will be equal in magnitude but

in phase opposition, one being in phase with the input voltage E_0 and the other being 180 deg out of phase with E_0 ; if the reactances of C_2 and C_1 are small compared with R_1 and R_2 over the operating fre-

quency range these same voltages can be assumed to appear as E_1 and E_2 .

Next, consider the same tube operating as a 90-deg phase shifter (part of Fig. 1A drawn in heavier lines). The special conditions of this circuit are that $R_3 = X_{C_3} = R_4 = X_{C_4}$ for some frequency f_0 . Since the reactance of $C_4 = R_4$, the voltage E_4 will lead that across R_L by 45 deg; similarly, the voltage E_3 will lag that across R_K by 45 deg. If $R_5 + R_6$ is much greater than either R_1 or the reactance X_{C_3} , the aforementioned phase relationships between E_4 and E_3 will still exist and will produce in the common load resistor R_7 a resultant current 90 deg displaced from that flowing through R_L and R_K .

The vector relationships existing at a center frequency f_0 are shown

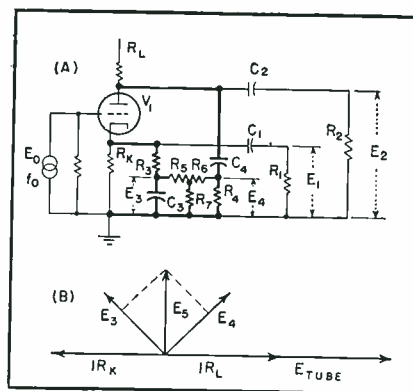

FIG. 1—(A) Phase changer acts as convenient low-frequency discriminator. (B) Phase relations in circuit

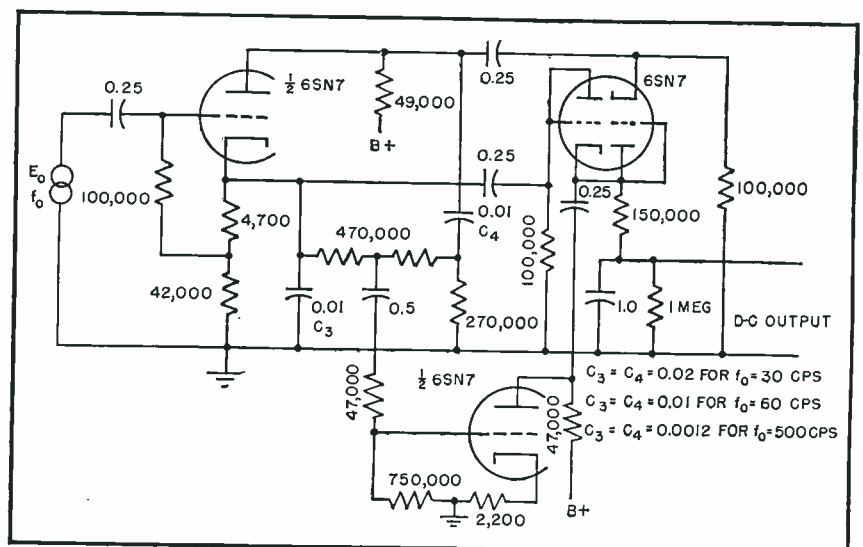

FIG. 2—Adaptation of phase changer provides amplification for weak voltage, and diode rectification, to deliver d-c proportional to shift from center frequency

By HARRY M. CRAIN

Ordnance Research Laboratory
The Pennsylvania State College
State College, Pa.

in Fig. 1B. For a frequency greater than f_0 , the magnitude of E_s increases and its phase displacement with respect to IR_L decreases; at the same time, the magnitude of E_s decreases and its phase displacement with respect to IR_K increases. The combined effect is to pull the resultant vector E_s more nearly in phase with IR_L . If the frequency becomes less than f_0 , the above effects are interchanged and the resultant vector E_s is pulled more nearly in phase with IR_K .

Circuit Performance

The desired discriminator action is obtained from a d-c comparator which compares the d-c energy components resulting from the conducting periods of two diodes. At the center frequency, each of the diodes conducts for approximately one-half cycle, and the net d-c voltage developed across the output of the diodes is zero. For any other frequency the diodes will conduct for unequal portions of a cycle and the d-c output voltage will have an amplitude proportional to the frequency deviation off the center frequency. The polarity of the output voltage will depend upon whether the frequency deviation is above or below the center frequency.

When only the basic elements of this circuit are used, the conversion efficiency, (d-c out vs a-c in times 100 percent for some frequency off center frequency), is somewhat low, being about 5 percent for a frequency departure one octave removed from f_0 . This is due to both the low amplitude of E_s and the high impedance across which this voltage must be developed. Such a low efficiency may be accepted if it is convenient to employ d-c amplification following the diode comparator. However, a cleaner approach is to employ a stage of amplification to boost the amplitude of E_s and at the same time lower

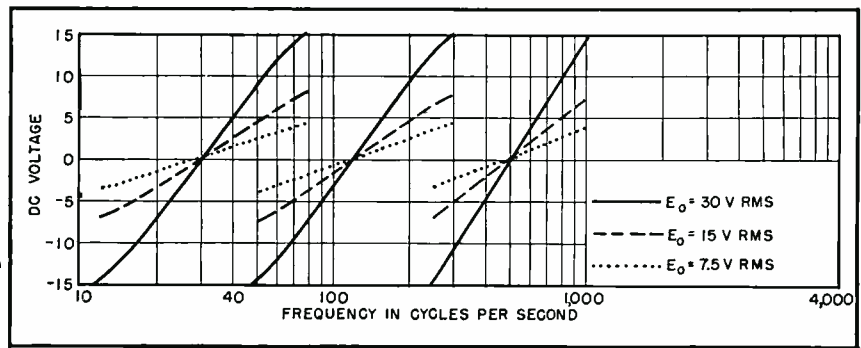

FIG. 3—Curves show discriminator action in presence of different levels of input and for different center frequencies

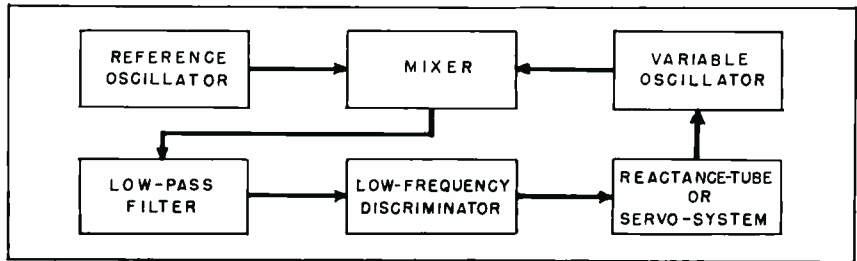

FIG. 4—To stabilize one r-f oscillator relative to the other, the low-frequency discriminator is used with a reactance tube or servo system

the impedance level. Using the latter scheme, the conversion efficiency is increased to approximately 50 percent under the conditions noted above. The final circuitry employed is shown in Fig. 2. Figure 3 shows the overall characteristic for three values of E_0 and three values of f_0 .

Oscillator Control

As previously stated, this circuit was designed to maintain a specified frequency separation between two r-f oscillators independent of circuit conditions which would normally cause the oscillators either to drift apart or lock together, the latter case being the pronounced tendency of oscillators operating on slight frequency differences.

When employed in a system as outlined by the block diagram of Fig. 4 the above purpose is accomplished, the circuit operation being as follows: If it be desired that the variable-oscillator frequency be maintained apart from that of the reference oscillator by f_0 , then the values of C_3 and C_4 would be so selected as to give zero output from the discriminator at f_0 . When the difference frequency is other than f_0 , the voltage out of the discriminator will be of such a polarity as to cause the reactance tube to cor-

rect this discrepancy. Obviously there is a definite limit to the amount of control that can be exercised by the reactance tube, so that if it is necessary to operate the two oscillators at a frequency separation several octaves away from some previously set value it is required that the variable oscillator be manually retuned somewhere within the pull-in range of the reactance tube in addition to changing the value of C_3 and C_4 .

Other practical applications of this low-frequency discriminator circuit include its use as a frequency meter and its use as the control circuit for automatically maintaining the altitude of an aircraft. As a frequency meter it is only necessary to place a microammeter in series with the diodes' load and calibrate it in terms of frequency. For aircraft altitude control it must be used in conjunction with an absolute altimeter whose output is an audio frequency proportional to the altitude. These are basically f-m systems such as the APN-1. For this application each value of f_0 would represent a given altitude, above or below which control voltages would be developed.

This work was done under the sponsorship of the U. S. Navy Dept. under Contract NOrd 7958.

Cathode-Compensated Video Amplification

Theoretical and practical development of a circuit technique that combines virtues of lower cost, simplicity, extended frequency range and improved linearity. A two-part paper; part I gives the theoretical analysis and experimental verification, while part II covers input admittance relations and summarizes advantages

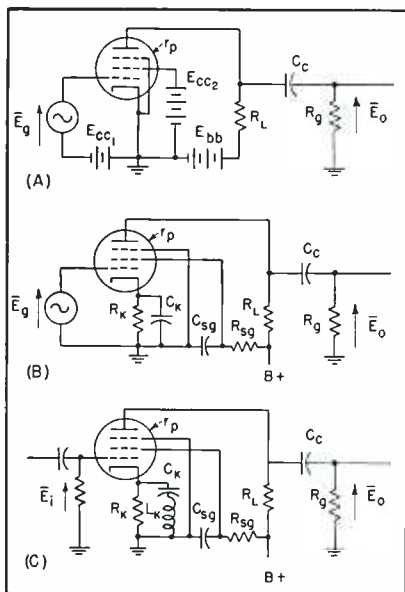

FIG. 1—Basic video amplifier circuit, cathode-biased version employed for determining proper compensation, and practical cathode-compensated circuit

IT is well known that feedback can be used to modify the frequency, gain and linearity characteristics of amplifiers. The purpose of this paper is to show how feedback, properly obtained in the cathode circuit of a video amplifier, can be used to endow the amplifier with exceptional characteristics. Some of the important features involved are simplicity, reduction in cost, improvement in linearity, and practically constant amplitude and time delay over the useful frequency range of operation.

The compensating elements are of such values that neither the series inductance of the capacitors nor the stray capacitance of the inductors has any noticeable effect on the results. These elements are incorporated in a low signal level circuit

that will result in a video amplifier with a frequency range and linearity that are superior to those of an uncompensated amplifier. The large electrolytic capacitor normally used in the cathode circuit is eliminated, thus increasing the reliability of operation. The total cost of the small mica capacitor and the inductor used for compensation is considerably less than that of the electrolytic capacitor that was eliminated.

Compensating Procedure

To make proper use of the compensation discussed in this paper the procedure indicated below should be followed:

(A) Use the circuit of Fig. 1B. It is important that the suppressor and screen be returned to ground and not to the cathode.

(B) Determine the stray plate circuit capacitance C_c . This can be

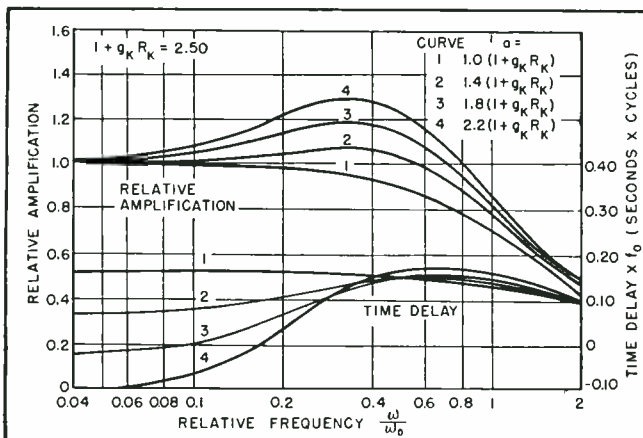

FIG. 2—Effect of variations in factor α when using only a capacitor in parallel with cathode resistor

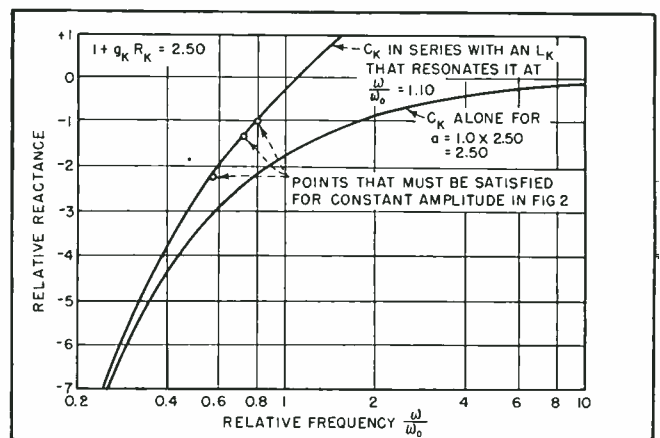

FIG. 3—Relative reactance values required to satisfy requirement of constant amplitude when using only shunt capacitor

Part I

By **ALEXANDER B. BERESKIN**

Associate Professor of Electrical Engineering
University of Cincinnati
Cincinnati, Ohio

done experimentally, if the screen and cathode are perfectly bypassed, by obtaining a gain-frequency curve for some value of R_L close to that which it is intended to use. By using the frequency f at which the gain is down 3 db from the middle frequency value and R_{eq} which is calculated from

$$\frac{1}{R_{eq}} = \frac{1}{R_L} + \frac{1}{r_p} + \frac{1}{R_v} \quad (1)$$

we get

$$C_s' = \frac{1}{2\pi f R_{eq}} \quad (2)$$

and then

$$C_s = C_s' - C_o \quad (3)$$

where C_o is the capacitance introduced by the measuring circuit.

(C) Determine the middle frequency gain when the screen and cathode are perfectly bypassed to ground and a value of R_{L1} is used such that the gain is down 3 db at the high frequency

$$f_o = \frac{1}{2\pi C_s R_{eq1}} \quad (4)$$

which is chosen for reference purposes.

Preferably this should be done experimentally, making allowance for the change in the frequency characteristic due to the capacitance introduced by the measuring circuit. The frequency can be computed analytically if g_m is known by using the expression

$$A = g_m R_{eq1} \quad (5)$$

where R_{eq1} is obtained by substituting R_{L1} in place of R_L in Eq. 1.

(D) Determine the value of R_{eq2} which, when all cathode bypass capacitance is removed, will produce the same middle frequency gain that was obtained in part (C). Use this value of R_{eq2} to determine

$$(1 + g_K R_K) = \frac{R_{eq2}}{R_{eq1}} \quad (6)$$

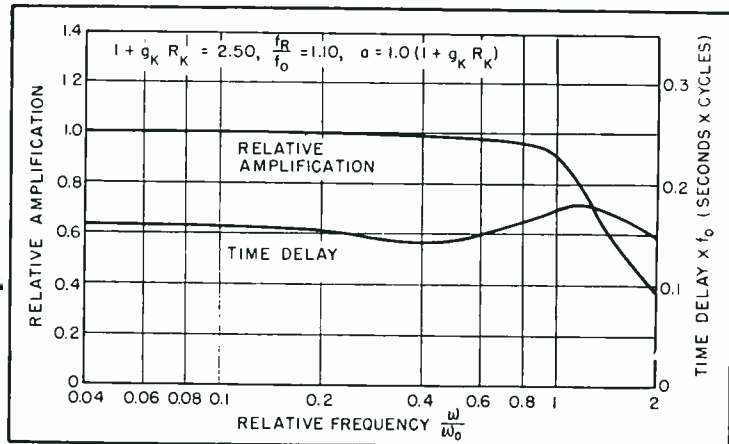

FIG. 4—Amplification and time delay characteristics for circuit constants and conditions of Fig. 3

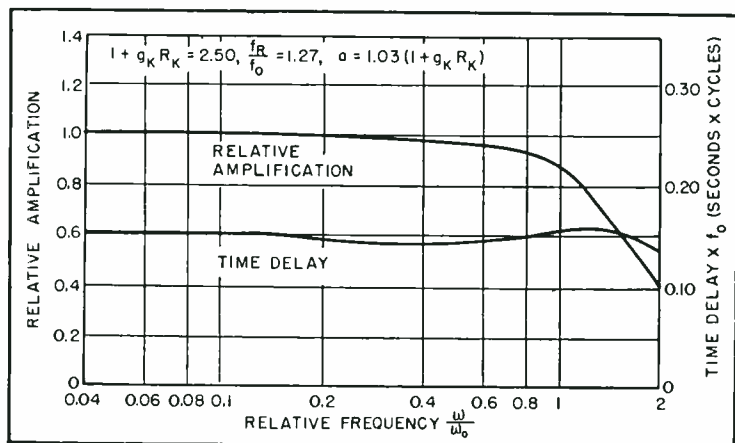

FIG. 5—Amplification and time delay characteristics for improved circuit based on curves of Fig. 6

This should preferably be done experimentally by measuring the value of R_{L2} required and substituting it in Eq. 1 to get R_{eq2} . A close approximation can be obtained analytically if

$$g_K \cong g_m + g_{c2} = \frac{\delta i_b}{\delta e_{c1}} + \frac{\delta i_{c2}}{\delta e_{c1}} \quad (7)$$

can be determined. The analytical value obtained in this manner will usually be a little low for it does not take into account the fact that g_m is reduced slightly when a higher value of R_L is used. Additional feedback also results due to the small a-c screen to cathode voltage that will be present. Both of these factors would tend to require a higher value of R_{eq2} than would be given by the analytical expression.

(E) Obtain values of $a/(1 + g_K R_K)$ and f_R/f_o from Fig. 6 for the value of $(1 + g_K R_K)$ given in (D).

(F) The cathode capacitor required is

$$C_K = \frac{a}{(1 + g_K R_K)} \frac{R_{eq2}}{R_K} C_s \quad (8)$$

and the value of cathode inductor required is

$$L_K = \frac{1}{(2\pi f_R)^2 C_K} \quad (9)$$

(G) Connect the components R_{L2} , C_K and L_K as shown in detail in Fig. 1C.

In a typical amplifier with $f_o = 3.54$ mc and $(1 + g_K R_K) = 2.13$ the required value of cathode capacitor was $C_K = 1,170 \mu\text{f}$ and the required value of cathode inductor was $L_K = 1.13 \times 10^{-6}$ henrys. The amplitude and time-delay characteristics for this amplifier are given in Fig. 8. Additional characteristics of this amplifier will be discussed in the concluding part of this paper. Its low-frequency gain will be that

which would have resulted in (C) if infinite cathode bypass capacitance had been used.

Theoretical Development

In an amplifier of the type shown in Fig. 1A the vector ratio \bar{E}_o/\bar{E}_g is known as the voltage amplification or gain and is denoted by the symbol \bar{A} . In the middle and high frequency regions this can be expressed as

$$\bar{A} = -\frac{\bar{A}}{g_m \bar{Z}_{eq}} \quad (10)$$

where \bar{Z}_{eq} is the parallel impedance of the resistances r_p , R_L , and R_g and the stray capacitive reactance X_s .

If feedback is used and the symbol \bar{A}_f is used to distinguish the voltage amplification with feedback from \bar{A} which is the voltage amplification without feedback, then

$$\bar{A}_f = \frac{\bar{A}}{1 - B\bar{A}} \quad (11)$$

where \bar{B} is the vector portion of the output to ground voltage fed back in the grid-to-cathode circuit.

The batteries E_{cc1} and E_{cc2} shown in Fig. 1A are ordinarily replaced with the resistance-capacitance combinations shown in Fig. 1B. In this circuit if C_{s1} and C_{s2} are assumed to have zero reactance there is no feedback and then $\bar{A} = -g_m \bar{Z}_{eq}$ as before.

If the parallel combination of r_p , R_L and R_g is called R_{eq} and $\omega_o = 2\pi f_o$ is so defined that

$$\frac{1}{2\pi f_o C_s} = \frac{1}{\omega_o C_s} = R_{eq} \quad (12)$$

or

$$\omega_o = \frac{1}{C_s R_{eq}} \quad (12a)$$

then $Z_{eq} =$

$$\frac{R_{eq} (-j X_s)}{R_{eq} - j X_s} = \frac{R_{eq} \left(-j \frac{\omega_o}{\omega} R_{eq} \right)}{R_{eq} - j \frac{\omega_o}{\omega} R_{eq}}$$

$$Z_{eq} = \frac{R_{eq}}{1 + j \frac{\omega}{\omega_o}} \quad (13)$$

and

$$\bar{A} = \frac{-g_m R_{eq}}{1 + j \frac{\omega}{\omega_o}} \quad (14)$$

This is the well-known relation which holds for resistance-capacitance coupled amplifiers in the middle and high-frequency ranges.

If we now assume that the reactance of C_{s1} is still zero while that of

C_{s2} is finite, then the flow of alternating plate and screen current through the parallel combination of R_K and C_K will develop an alternating voltage that appears in the grid-to-cathode circuit. In order to specify the cathode-circuit impedance in terms of the previously chosen symbols f_o and ω_o we will define a new arbitrary constant a so that

$$X_K = \frac{1}{\omega C_K} = \frac{1}{a} \frac{\omega_o}{\omega} R_K \quad (15)$$

and therefore

$$a = \omega_o C_K R_K = \frac{C_K R_K}{C_s R_{eq}} \quad (15a)$$

Using this definition of a we can express the cathode circuit impedance as

$$\bar{Z}_K = \frac{R_K (-j X_K)}{R_K - j X_K} = \frac{-j \frac{1}{a} \frac{\omega_o}{\omega} R_K}{1 - j \frac{1}{a} \frac{\omega_o}{\omega}} = \frac{R_K}{1 + j a \frac{\omega}{\omega_o}} \quad (16)$$

Since both the screen and plate alternating current flows through the cathode-circuit impedance while only the plate alternating current flows through the plate load impedance it is necessary to define a new term g_K such that

$$\bar{B} = \frac{g_K \bar{Z}_K}{g_m \bar{Z}_{eq}} \quad (17)$$

Mainly

$$g_K = g_m + g_{e2} = \frac{\delta i_b}{\delta e_{c1}} + \frac{\delta i_{e2}}{\delta e_{c1}} \quad (18)$$

but as defined in Eq. 17 it will also take care of additional minor fac-

tors such as the possibility that g_m itself might change between two conditions of operation and also that there may be other feedback effects due to the small a-c screen-to-cathode voltage. The voltage amplification with feedback is then

$$\bar{A}_f = \frac{-g_m \bar{Z}_{eq}}{1 - \left(\frac{g_K \bar{Z}_K}{g_m \bar{Z}_{eq}} \right) (-g_m \bar{Z}_{eq})} = \frac{-g_m \bar{Z}_{eq}}{1 + g_K \bar{Z}_K} \quad (19)$$

If we substitute the values of \bar{Z}_{eq} and \bar{Z}_K obtained previously in this expression for \bar{A}_f , then

$$\bar{A}_f = \frac{-g_m \frac{R_{eq}}{1 + j \frac{\omega}{\omega_o}}}{1 + g_K \frac{R_K}{1 + j a \frac{\omega}{\omega_o}}} = \left[\frac{-g_m R_{eq}}{(1 + g_K R_K) + j a \frac{\omega}{\omega_o}} \right] \left[\frac{1 + j a \frac{\omega}{\omega_o}}{1 + j \frac{\omega}{\omega_o}} \right] \quad (20)$$

Case I: If we let $a = \infty$

$$\bar{A}_1 = \frac{-g_m R_{eq1}}{1 + j \frac{\omega}{\omega_o}} \quad (21)$$

and this of course is the case when the cathode is completely bypassed to ground.

Case II: If we introduce a new value of

$$R_{eq2} = (1 + g_K R_K) R_{eq1} \quad (22)$$

this will make

$$\omega_{o2} = \frac{\omega_o}{(1 + g_K R_K)} \quad (23)$$

and then

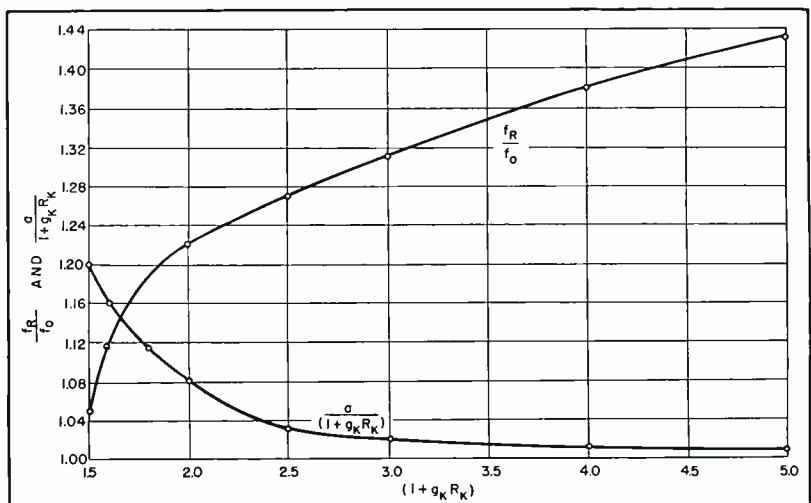

FIG. 6—Computed curves giving satisfactory constants for compensating circuit over a wide range of circuit values

$$\bar{Z}_{eq2} = \frac{(1 + g_K R_K) R_{eq1}}{1 + j(1 + g_K R_K) \frac{\omega}{\omega_o}} \quad (24)$$

where ω_o is still defined in terms of R_{eq1} . Substituting this value of \bar{Z}_{eq2} in the equation for \bar{A}_1 we get

$$\begin{aligned} \bar{A}_2 &= \frac{\left[\frac{-g_m(1 + g_K R_K) R_{eq1}}{1 + j(1 + g_K R_K) \frac{\omega}{\omega_o}} \right]}{\left[\frac{1 + g_K R_K}{1 + j a \frac{\omega}{\omega_o}} \right]} \\ &= \frac{\left[\frac{-g_m(1 + g_K R_K) R_{eq1}}{(1 + g_K R_K) + j a \frac{\omega}{\omega_o}} \right]}{\left[\frac{1 + j a \frac{\omega}{\omega_o}}{1 + j(1 + g_K R_K) \frac{\omega}{\omega_o}} \right]} \quad (25) \end{aligned}$$

If we also let

$$a = 1 + g_K R_K \quad (26)$$

then

$$\bar{A}_2 = \frac{-g_m R_{eq1}}{1 + j \frac{\omega}{\omega_o}} = \bar{A}_1 \quad (27)$$

and this is exactly the same vector voltage amplification that we obtained in the original uncompensated case except that now

$$C_K = a C_s \frac{R_{eq1}}{R_K} = C_s \frac{R_{eq2}}{R_K} \quad (28)$$

and is of the order of magnitude of 0.001 μ f instead of being 200 or 300 μ f as was required for good low-frequency response in the original case.

Case III: The fact that Case II gives the same vector voltage amplification as the original uncompensated amplifier is interesting, but

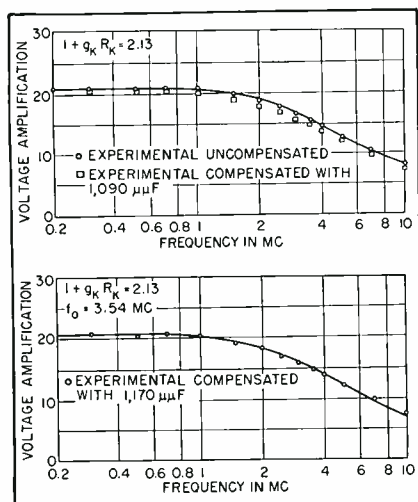

FIG. 7—Experimental verification of Case II and test of accuracy of method

not too useful. It is ordinarily desirable to improve both the amplitude and time-delay characteristics over those that are obtained with uncompensated amplifiers.

If values of a other than those indicated in Eq. 26 are used in Eq. 25 the amplitude and time-delay characteristics shown in Fig. 2 are obtained ($1 + g_K R_K = 2.50$ in this case). It will be observed from these characteristics that a wide range of performance can be obtained.

The ideal characteristic is one in which both the amplitude and time-delay characteristics are flat over the full range of operation. This requirement cannot be met but a compromise is possible in which one of the two characteristics is made as flat as possible and the other one is allowed to take care of itself.

It will be observed that the higher the value of a , the greater the value of ω/ω_o at which the amplitude characteristic crosses the $A/A_M = 1.0$ value. This would suggest that if we could make the cathode capacitance automatically vary the proper amount with change of frequency, then we could slide from curve to curve in covering the full range of operation. A similar procedure could be used with the time delay but it would probably require different values of a than those necessary for constant amplitude.

Satisfying this variable cathode capacitance requirement is not as difficult as it would appear to be at first thought. The method by which this is done is shown in the curves of Fig. 3. In this figure the circled points represent the relative capacitive reactance required at the different values of ω/ω_o . The lower of the two curves is the relative reactance of the capacitor C_K when $a = 1.0$ ($1 + g_K R_K$) [the condition required by Case II]. The upper one of the two curves is the relative reactance of a series combination of the capacitor C_{K2} corresponding to the lower curve, and an inductor L_K required to resonate this capacitor at a value of $\omega/\omega_o = 1.10$. The circled points are satisfied very nicely by the series combination of C_K and L_K chosen.

The amplitude and time delay characteristics that result from this choice are shown in Fig. 4. A more

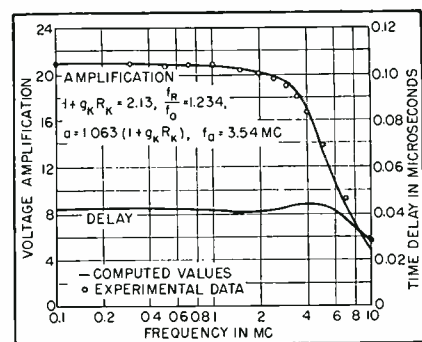

FIG. 8—Experimental verification of Case III

satisfactory choice of variables will give the response curves shown in Fig. 5. In this case the time-delay characteristic has been greatly improved with only a slight change of the amplitude characteristic.

The variables for Fig. 5 were obtained from the two curves in Fig. 6. These two curves are the key to the compensation discussed in this paper and have been designed to produce a time-delay characteristic that will dip approximately four percent to the valley and then rise about six percent to the peak. Either flatter amplitude or time-delay characteristics can be obtained with slight variations in a and f_R/f_o but it is suggested that the response to be expected should be computed in each case.

The simplest procedure for making these computations involves the use of Eq. 25, replacing a by a_{eq} which is developed in the following manner:

If X_C and X_L are self resonant at f_R so that $X_{CR} = X_{LR}$, then at any other frequency the equivalent series reactance is

$$\begin{aligned} X_{eq} &= X_C - X_L = X_{CR} \frac{f_R}{f} - X_{CR} \frac{f}{f_R} \\ &= X_{CR} \left(\frac{f_R}{f} - \frac{f}{f_R} \right) \quad (29) \end{aligned}$$

so that

$$C_{eq} = C_K \left(\frac{f_R}{f} - \frac{f}{f_R} \right) \quad (30)$$

and

$$\begin{aligned} a_{eq} &= a \frac{C_{eq}}{C_K} = \frac{a \left(\frac{\omega_R}{\omega} - \frac{\omega}{\omega_R} \right)}{\left(\frac{\omega_R}{\omega} - \frac{\omega}{\omega_R} \right)} \\ &= \frac{a}{\left[\frac{\omega_R}{\omega} - \frac{\omega}{\omega_R} \right]} \left(\frac{\omega}{\omega_R} \right) \quad (31) \end{aligned}$$

Sample computations for several of

the points in Fig. 8 are shown in Table I.

Experimental Verification

To verify experimentally the theory developed previously, the amplifier circuit of Fig. 1C, using a 6AG7 tube, was set up on a breadboard. The constants used in this circuit were:

$$\begin{aligned} R_{L1} &= 2,040 \text{ ohms} & E_{bb} &= 300 \text{ volts} \\ R_K &= 81.8 \text{ ohms} & E_{c2} &= 125 \text{ volts} \\ R_{sp} &= 22,400 \text{ ohms} & E_{c1} &= -2.68 \text{ volts} \end{aligned}$$

The screen and cathode circuits were bypassed sufficiently well for frequencies above 10 kc and no measurements were made below 100 kc. The experimental frequency characteristic, shown by the curve drawn through the circled points in Fig. 7, was obtained. From this curve it was determined that $f_o = 3.80$ mc and $C_s = 21.0 \mu\mu\text{f}$.

When the cathode bypass capacitor was removed it was found that a new load resistor $R_{Ls} = 4,440$ ohms was required to produce the same voltage amplification at 100 kc as was obtained previously. Using a value of $r_p = 125,000$ ohms and $R_p = 500,000$ ohms it was determined that $R_{eq1} = 2,000$ ohms and $R_{eq2} = 4,260$ ohms. Therefore

$$1 + g_K R_K = \frac{R_{eq2}}{R_{eq1}} = \frac{4,260}{2,000} = 2.13.$$

Analytically $g_K \cong g_m + g_{c2}$. These values can be obtained from the HB-3 series of RCA Tube Handbooks. For the operating values involved, interpolating between the 100 and 150 screen voltage curves, $g_m \cong 0.010$ mhos and $g_{c2} \cong 0.003$ mhos (obtained from the slope of the e_{c1} vs i_{c2} curves). Therefore $g_K \cong 0.013$ mhos and $1 + g_K R_K \cong 1 + 81.8 \times 0.013 = 2.06$. As was expected this value is slightly lower than the value obtained experimentally.

On this basis it was determined that

$$C_K = \frac{R_{eq2}}{R_K} C_s = \frac{4,260}{81.8} \times 21.0 = 1,093 \mu\mu\text{f}$$

When a value of $C_K = 1,090 \mu\mu\text{f}$ was used the experimental values shown by the squared points in Fig. 7 were obtained. The variation obtained was definitely outside the experimental error expected. A closer examination of the circuit showed that while R_{L1} was composed of a

Table I—Sample Calculations for Compensated Amplifiers (Data Plotted in Fig. 8)

Working Equations:

$$a_{eq} = \frac{a}{\left[\frac{\omega_R}{\omega} - \frac{\omega}{\omega_R} \right] \frac{\omega}{\omega_R}} \qquad \frac{\omega_R}{\omega} = \frac{f_R}{f_o} \times \frac{\omega_o}{\omega}$$

$$\frac{\bar{A}}{\bar{A}_M} = \frac{A}{A_M} \left| \frac{\theta}{\theta} \right| = \left[\frac{(1 + g_K R_K)}{(1 + g_K R_K) + j a_{eq} \frac{\omega}{\omega_o}} \right] \left[\frac{1 + j a_{eq} \frac{\omega}{\omega_o}}{1 + j(1 + g_K R_K) \frac{\omega}{\omega_o}} \right]$$

$$T_d = \frac{\theta}{360} \times \frac{1}{f} \text{ seconds}$$

Circuit Constants:

$$(1 + g_K R_K) = 2.13, \frac{f_R}{f_o} = 1.234, a = 1.063 \times 2.13 = 2.265$$

$$f_o = 3.54 \text{ mc}, A_M = 20.8$$

Quantity	0.03	0.1	0.3	1.0	3.0
ω/ω_o	41.13	12.34	4.113	1.234	0.4113
ω_R/ω	0.0243	0.0809	0.243	0.809	2.430
ω/ω_R	41.11	12.26	3.870	.425	-2.019
a_{eq}	2.267	2.280	2.410	6.600	-4.615
$a_{eq} \omega/\omega_o$	0.0681	0.2280	0.7230	6.600	-1.384
$1 + j a_{eq} \omega/\omega_o$	1.0023	1.027	1.237	6.68	1.710
	3.91°	12.85°	35.85°	81.38°	54.12°
$(1 + g_K R_K) + j a_{eq} \omega/\omega_o$	2.1311	2.142	2.245	6.930	2.540
	1.84°	6.11°	18.79°	72.10°	33.00°
$(1 + g_K R_K) \omega/\omega_o$	0.0639	0.213	0.639	2.13	6.39
$1 + j(1 + g_K R_K) \omega/\omega_o$	1.0020	1.022	1.188	2.352	6.46
	3.66°	12.03°	32.60°	64.82°	81.10°
\bar{A}/\bar{A}_M	0.9998	0.9994	0.987	0.875	0.222
	1.59°	5.29°	15.54°	55.54°	102.20°
T_d (microseconds)	0.0416	0.0415	0.0407	0.0436	0.0268
f (mc)	0.106	0.354	1.06	3.54	10.6

series combination of two 2-watt resistors, R_{Ls} was composed of a series combination of two 2-watt resistors shunted by a $\frac{1}{2}$ -watt trimmer resistor. This $\frac{1}{2}$ -watt resistor was used to obtain the exact value of R_{Ls} that was required. The extra resistor introduced an additional $1.5 \mu\mu\text{f}$ in the plate circuit, bringing the total stray capacitance to $22.5 \mu\mu\text{f}$. This in turn reduced f_o from 3.80 mc to 3.54 mc and changed the required value of C_K from $1,093 \mu\mu\text{f}$ to $1,170 \mu\mu\text{f}$.

The smooth curve in Fig. 7 shows the theoretical values expected under the new conditions. The circled points represent the ex-

perimental data obtained with $C_K = 1,170 \mu\mu\text{f}$. The agreement is definitely within the experimental error expected.

Stray Capacitance Effects

In the early stages of the investigation a similar circuit was used with the exception that the suppressor and screen were returned to the cathode instead of being returned to ground. While the theoretical analysis called for approximately $1,000 \mu\mu\text{f}$ compensating capacitance, it was found that the experimental value was much closer to $600 \mu\mu\text{f}$.

A more thorough investigation of

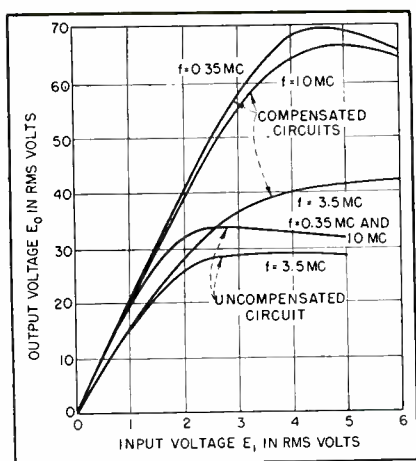

FIG. 9—Experimental characteristics showing improvement in linearity obtained with compensating circuit

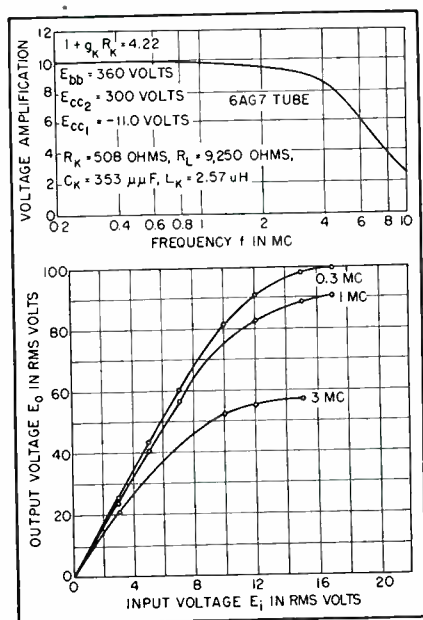

FIG. 10—Frequency and linearity characteristics of amplifier intended for high output voltages

the circuit showed that the stray cathode-to-plate capacitance acts as though it were multiplied by the voltage amplification and connected from cathode to ground. Most of this capacitance was due to the suppressor which was at cathode potential and the screen which was at cathode potential as far as the operating frequencies were concerned. The measured value of this stray capacitance was approximately 19 $\mu\mu f$ and this multiplied by the gain of approximately 21 was equivalent to the missing 400 $\mu\mu f$. This effect could be used to obtain Case II type of compensation with lower values of capacitance than those required

for C_k but if Case III type of compensation is used it simply tends to shunt the compensating circuit and make the determination of the proper element values more difficult. For this reason it is suggested that the suppressor and screen always be returned to ground. An additional advantage is that the alternating screen current then flows through R_k , producing additional feedback and requiring the use of $1 + g_k R_k$ instead of $1 + g_m R_k$. Since $1 + g_k R_k$ is greater than $1 + g_m R_k$, additional linearity benefits, which are discussed in detail below, will be obtained.

For the value of $1 + g_k R_k = 2.13$ it is found from the curves of Fig. 6 that proper Case III compensation is obtained when $a/(1 + g_k R_k) = 1.063$ and $f_r/f_o = 1.234$. On this basis we should use values of $C_k = 1.063 \times 4,260 \times 22.5/81.8 = 1,243 \mu\mu f$ and a value of $f_r = 1.234 \times 3.54 = 4.37$ mc. The theoretical amplification and time delay to be expected are shown in Fig. 8 by the smooth curves. The experimental values of amplification obtained are shown by the circled points. The agreement is well within the experimental error expected.

Additional Advantages

An additional benefit that results from the type of compensation discussed in this paper is in the linearity and voltage-handling capability of the amplifier. Since the compensated amplifier has a larger value of R_L than the uncompensated one, its load line will not be as steep, and therefore larger voltage swings can be expected before either cutoff or positive grid conditions result. In addition to that a considerable amount of negative feedback is present in the compensated amplifier and this tends to reduce the tendency toward nonlinear distortion. These effects are brought out very nicely by the experimental curves in Fig. 9. It is obvious that in the middle frequency region with compensated operation the linear portion of the curve is more than twice as long as it is for the uncompensated operation. The advantage is lessened for frequencies close to f_o . This is not believed to be too important in video amplifiers intended

for television purposes since the high-frequency components of the signal will always have lower amplitude than the middle and low-frequency components.

If it is desired to obtain a large linear range of output voltage the quantity $1 + g_k R_k$ should be made as large as is reasonably convenient. To test this condition the same 6AG7 tube was operated with the following constants:

$$\begin{aligned} R_L &= 9,250 \text{ ohms} & E_{bb} &= 360 \text{ volts} \\ R_k &= 508 \text{ ohms} & E_{cc2} &= 300 \text{ volts} \\ & & E_{c1} &= -11.0 \text{ volts} \end{aligned}$$

In this case the screen grid was operating at its rated dissipation of 1.5 watts while the plate was operating with about 3.5 watts, which is considerably below its rated dissipation. No attempt was made to determine any possible change in stray capacitance that might have resulted. The compensation was calculated on the basis of $1 + g_k R_k = 4.22$ as determined experimentally and $C_k = 21.0 \mu\mu f$ as found in the original amplifier. The compensating elements used were $C_k = 353 \mu\mu f$ and $L_k = 2.57 \times 10^{-6}$ henrys.

It can be seen from Fig. 10 that the middle-frequency gain has been reduced to about 10 but the frequency response has not been changed appreciably from the previous case. On the other hand, the linear range of operation, shown in Fig. 10, has been greatly increased. The remarkable thing about this case is that an amplifier which is relatively flat to 3.5 mc and has useful frequency response above 5 mc is able to develop a linear middle-frequency peak-to-peak output voltage of about 200 volts with less than 22 ma combined plate and screen current. Even at 3 mc the linear range is remarkably great.

The second part of this paper will cover the theoretical development of input admittance relations; and present experimental verification. Cathode compensation as developed here will be compared with other types of video amplifier circuits on the basis of cost, simplicity, disturbance of normal circuit relations, gain, frequency response, time delay, linearity and input admittance.

SPARK-PLUG TESTER—

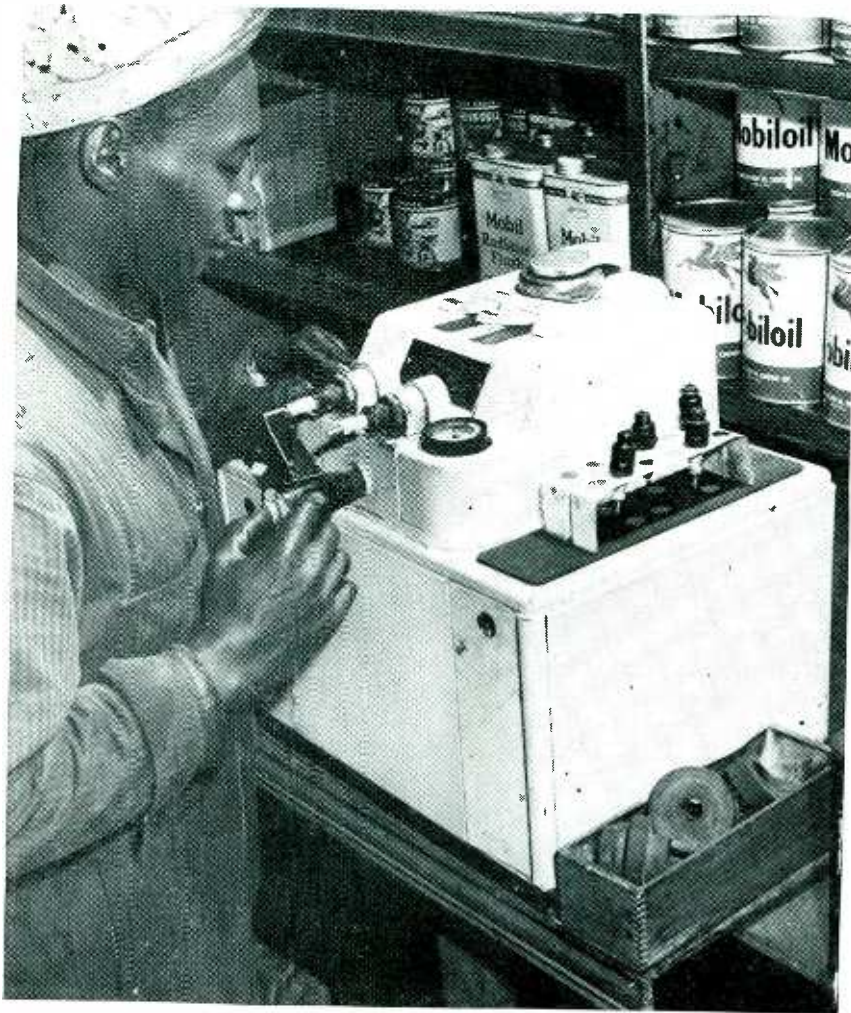

Typical spark-plug testing machine employing a compression chamber in which the plugs are fired

USING CONVENTIONAL METHODS, spark plugs are tested by comparing the sparking qualities of a plug under test with those of a new or fresh plug subjected to the same pressure and voltage.

This comparison is usually made by taking the reading at which increase of air pressure extinguishes the spark on the new plug and then switching over to the used plug and finding the point at which increasing pressure extinguishes the spark on that plug, the comparison of these values showing the relative effectiveness of the plug under test.

In these systems the necessary high voltage is provided by a magnetically operated vibrator and spark coil. The vibrators, because

of their mechanical nature, have inherent disadvantages rendering them at times uncertain and unreliable for this highly specialized application.

The circuit shown in Fig. 1 eliminates the uncertainties and provides a simple system of few parts and low cost which maintains its reliability regardless of variations in line voltage and other such conditions which are not ordinarily avoidable.

As indicated in the wiring diagram, the unit comprises a grid-controlled gaseous rectifier such as a thyatron, a resistance-capacitance network R_1C_1 to store the electrical energy until released at the proper time, a second resistance-

By **CRAIG WALSH**
and **A. L. LIVERA**
Madison, New Jersey

capacitance network R_2, R_3, C_2 to supply an out-of-phase, and variable as to phase, voltage to the control grid of the thyatron, a high-voltage output transformer T_2 and an input power transformer T_1 , for supplying heater voltage and control-grid voltage for the tube and voltage and current for the energy storing resistance-capacitance network.

Two spark plugs, the new or fresh plug which is to serve as the standard of comparison and the used or test plug, are both screwed in an air compression chamber where they will be subject to the same pressure conditions, usually just finger-tight to allow for escape of ozone created in the chamber.

A changeover switch allows for connecting first one and then the other of the plugs in the test circuit. It is usual, also, to provide a variable pressure-reducing valve and a pressure gage which, in addition to showing actual pressure, may be calibrated in terms of spark-plug efficiency.

The input power transformer is an auto-transformer connected to the line and tapped to supply heater voltage of about 6.6 volts to the 2050 thyatron, to furnish control-grid voltage of about 40 volts and to supply anode voltage of approximately 230 volts. The latter circuit contains a safety switch to control the anode voltage to the output transformer.

Circuit Operation

The fast-firing characteristics of the thyatron tube provide an extremely sudden change in the current flow through the primary winding of the high-voltage transformer. The voltage in the secondary winding W_2 of the output transformer is a function of the rate of

Electronic unit provides high voltage for testing spark plugs under compression and eliminates the magnetically operated vibrating reed commonly used. Circuit technique could be extended to ignition systems for internal combustion engines and high-voltage power supplies for Geiger-Muller and cathode-ray tubes

change of the amount of magnetic flux in the core of the transformer and this in turn is dependent upon the rate of change in the current of the primary winding W_1 of the transformer. To obtain this very rapid change in current in the primary winding, this winding is connected in series with the anode circuit of the thyatron and energy storage network R_1C_1 .

Sufficient electrical energy to operate the circuit is stored in the charging capacitor C_1 during the first quarter of the a-c cycle when the voltage across the input is rising from zero to maximum value. By proper choice of resistance and capacitance for a given input voltage, the maximum amount of energy is stored in the capacitor and a measure of this energy is the square of the ordinate of the voltage curve at any particular point during the cycle, as indicated in Fig. 2. When this energy is released by the firing of the thyatron, the current in the circuit changes from zero to its maximum value in an extremely short period of time, determined by the time required to ionize the gas in the tube after the critical grid voltage is reached and also by the inductance of the primary winding of the output transformer.

In certain newly developed tubes the ionization time is considerably reduced so that faster firing, and hence higher voltages and higher frequencies for given circuit conditions, may be obtained.

Phase Control

The time of firing of the thyatron is controlled by the application of out-of-phase voltage to the control grid so that the grid voltage reaches its critical firing value for

the anode voltage of that particular instant when it is desired to fire the tube. The maximum voltage is obtained from the circuit when the tube fires at the time the instantaneous voltage applied to the charging capacitor is at its maximum value, and therefore when the stored energy is at maximum value.

High voltage less than the maximum value is obtained by permitting the tube to fire before or after the maximum amount of energy is stored in the charging capacitor. This is done by varying the resistance R_3 or the capacitance C_2 , or both, of the phase-changing network in the grid circuit, which changes the phase of the grid voltage and therefore the time at which the critical value of grid voltage is reached, as will be clear from consideration of Fig. 2.

The voltage used in spark-plug testing is of the order of 20,000 volts. However, much higher voltage may be attained with this circuit. The output voltage is in the form of pulses of very short duration. This is because the current in the primary winding W_1 changes

very rapidly from zero to its maximum value and then, for all practical purposes, remains at that maximum value long enough for the secondary voltage to drop to zero rapidly. Actually the primary current, once it reaches the maximum value, flows through the circuit as determined by the voltage waveform, the resistance and the inductance of the primary winding. The high-voltage pulses are extremely uniform in magnitude and therefore the demarcation between a spark plug sparking and not sparking is very sharp.

Tube Operation

When the sinewave of voltage is positive, a positive voltage is applied through resistor R_1 in the storage network to the top electrode of capacitor C_1 and through the primary winding W_1 to the anode of the thyatron. Because the tube is nonconducting at the time, no current can flow through this latter portion of the circuit and the entire current flow is into C_1 , placing a positive charge on electrode E_1 . Thus, during the first half of the

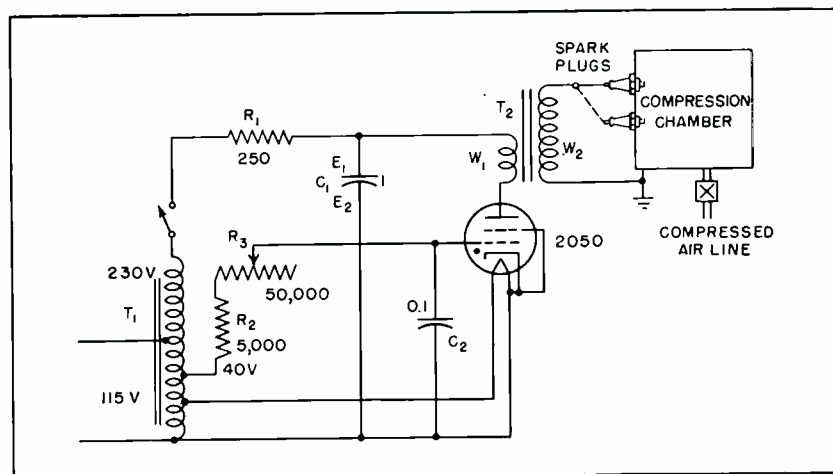

FIG. 1—Complete circuit of the electronic spark-plug tester

positive portion of the cycle, energy is stored in C_1 .

Stored electrical energy is suddenly released through the primary winding to accomplish a very rapid rate of change from zero to maximum value. The purpose of such rapid rate of change of current is that the magnitude of output voltage is a function of the rate of change of magnetic flux in the core of the transformer. This in turn is a function of the rate of change of current in the primary winding. The high rate of change of current is obtained by making the tube conductive when a suitable amount of electrical energy is stored in C_1 .

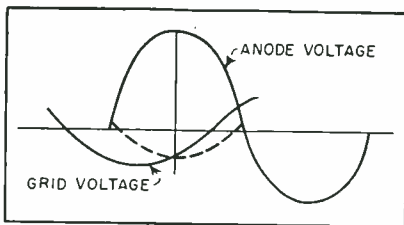

FIG. 2—Effect of the phase-shifting control

A suitable voltage, 40 volts, is impressed on the control grid of the thyatron so that the grid voltage is more negative than the critical firing voltage for the instantaneous voltage on the anode, until sufficient energy is stored in the capacitor. At this time the grid voltage is made equal to the critical firing voltage and the tube becomes conductive.

The impressed voltage is passed through the variable resistance-capacitance forming the phase-shifting network with the result that the sinusoidal grid voltage, Fig. 2, leads the sinusoidal anode voltage by an amount determined by the values of R_2 and R_3 and C_2 . Resistor R_2 is provided to limit the grid current during conduction of the tube when R_3 resistance is zero.

Voltage Control

As shown in Fig. 2, the grid-voltage wave intersects the curve of critical grid voltage. To obtain maximum output voltage it is necessary to shift the phase of the grid voltage by approximately 90 degrees because the maximum amount of energy is stored in C_1 when the volt-

age wave passes through 90 degrees.

To obtain continuously variable voltages less than the maximum available, the value of R_3 is changed so that the phase shift of the grid voltage is reduced, causing the tube to fire at a different time. Less energy is stored in C_1 and therefore the rate of change of current increase is less. The time of change is constant and determined by the ionization time of the gas in the tube and the inductance of the primary winding W_1 . With a smaller amount of energy available to produce a current in the same time, the maximum current is less and therefore the rate of change is less. Thus a lower voltage is then induced in the secondary of the output transformer T_2 .

The output voltage is produced in a series of sharp pulses at the rate of one per complete cycle of input power. These pulses are uniform in voltage because the circuit conditions are very stable. For a given setting of R_3 , the energy storage in C_1 is constant from cycle to cycle and the ionization time of the thyatron remains constant. The only variation may be caused by heating of transformer T_1 , and this is practically negligible.

The purpose of resistor R_1 is as follows: Assuming maximum conditions, after the capacitor is charged and the thyatron made

conductive, the energy escapes from the capacitor through the primary winding of T_2 and the tube. To accomplish this, the potential of the charged electrode E_1 of capacitor C_1 must drop in value. As it drops there is then a current flow in R_1 producing an IR drop equal to the drop in potential of E_1 .

If resistor R_1 were not present, the potential of E_1 would follow the voltage wave supplied by transformer T_1 and there would then be no rapid rate of change of current, as desired.

By suitable circuitry it is believed that the number of pulses per cycle can be increased. A d-c version of the circuit is practical in which the pulse rate may be made variable.

Other Uses

The unit shown was originally developed to supply the high voltage necessary to test spark plugs. A natural extension of this is to use it for the ignition systems of internal combustion engines, both the reciprocating and the jet types.

A similar arrangement may be used in television circuits to supply the high voltage necessary for the picture tube. Perhaps a more immediate use would be in the synchronizing of standard motion-picture film to transmission by television. It may also have application in radar modulation circuits and in guided missiles.

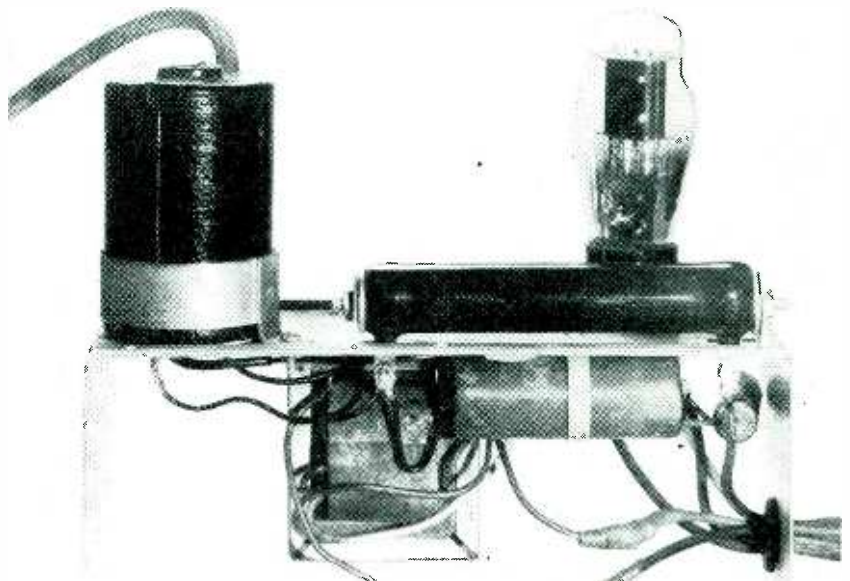

Components of the electronic high-voltage supply. The output transformer is mounted at upper left

Vector Voltage Indicator

A complex quantity is shown on the screen of a cathode-ray tube and readings are taken in polar or rectangular coordinates. Applications include testing stability of feedback amplifiers, plotting wavefronts and checking phase-shift networks

By **PETER G. SULZER**

*Engineering Experiment Station
The Pennsylvania State College
State College, Pennsylvania*

IT IS CUSTOMARY for the engineer to think in terms of vectors when he is dealing with complex quantities such as alternating currents, alternating voltages, or impedances. Unfortunately, most measuring devices do not present their information in such a convenient form.

This paper describes a comparatively simple adaptor which permits a complex quantity to be shown as a vector on the screen of an ordinary cathode-ray oscilloscope. Readings may be taken in polar coordinates (magnitude and phase angle), or they may be taken in rectangular coordinates (real and imaginary components), as desired. Although similar in function to a previously-described device^{1,2} its principle of operation is quite different.

The frequency range of the present model is 50 to 5,000 cycles, which covers the greater part of the audio-frequency spectrum. The full-scale sensitivity is variable from 1 volt to 500 volts rms, with a phase accuracy of ± 3 degrees and an amplitude accuracy of ± 10 percent of full scale.

If the voltage to be measured (referred to here as the test voltage) is applied to the vertical deflection circuit of an oscilloscope, a vertical straight line will be obtained. If the phase of a portion of that same voltage is shifted 90 degrees and applied to the horizontal deflection circuit, a circular trace will be obtained with the proper gain adjust-

ment.

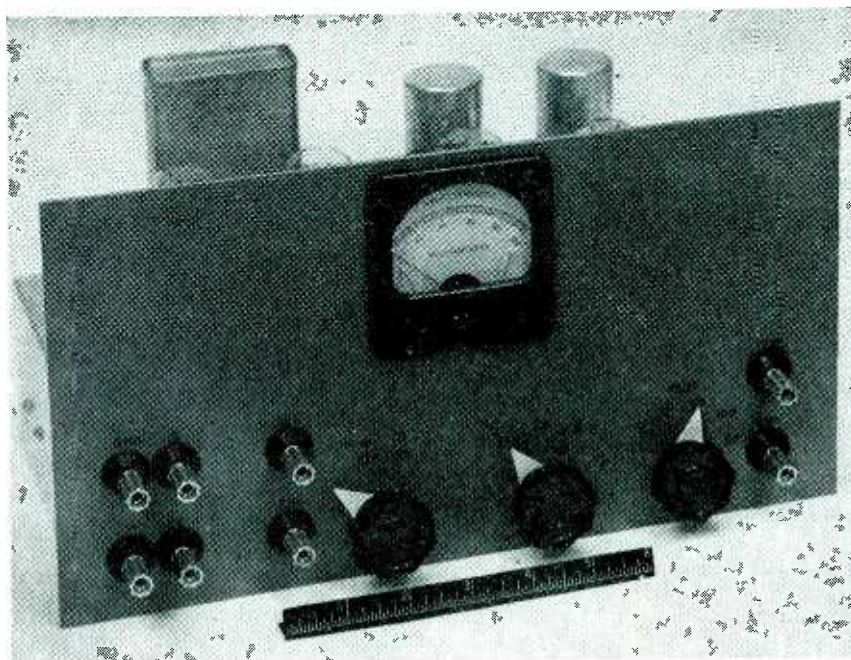

Panel controls and terminals for input and oscilloscope connections

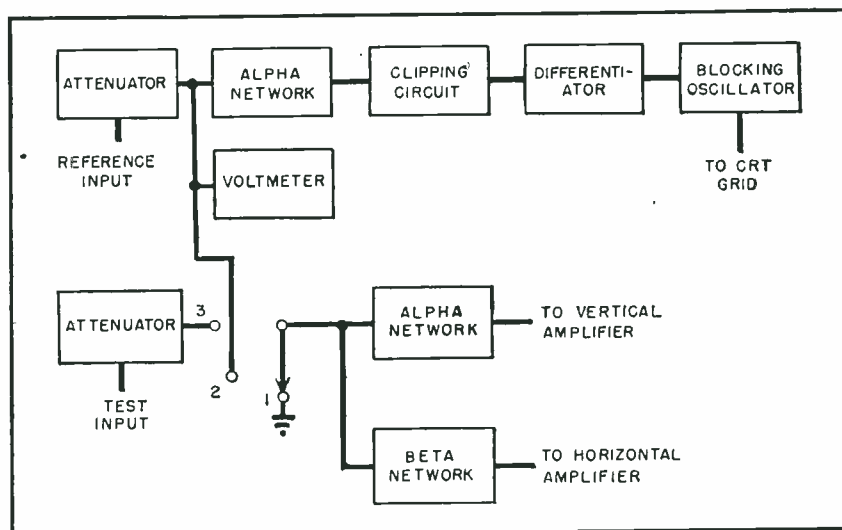

FIG. 1—Arrangement of stages in the reference and test channels

of the circle will be proportional to the amplitude of the test voltage, and hence can be used to indicate its magnitude. It is also apparent that the velocity of the spot tracing the circle will be constant, with the result that a linear phase scale will be obtained around the circle.

The position of zero phase angle on the circle must be established with the aid of some other voltage, here called the reference voltage. In practice, the reference voltage might be the input to a circuit under test, while the output voltage of the circuit would constitute the test voltage. The reference voltage is clipped and differentiated so that a pulse is obtained at its zero-degree position. With the circle blanked by means of the intensity control, the pulse is used to brighten the trace for a very short time. Therefore, the pattern consists of a single dot which denotes the tip of a vector drawn from the origin, which is placed at the center of the screen.

If a polar-coordinate scale is shown on the screen, the length of this vector indicates the magnitude of the test voltage, while its angular position from the origin is the phase angle of the test voltage with respect to the reference voltage. If a set of rectangular coordinates is used, the real and imaginary components can also be read directly.

It appears to be impossible to produce the required 90-degree phase shift directly, over a wide range of frequencies, without the readjustment of component values. It is therefore necessary to use two phase-shifting networks, referred to as the alpha and beta networks, in such a way that the difference of the phase shifts is 90 degrees. Dome³ and Norgaard⁴ have described such networks.

Circuit Details

Figure 1 is a block diagram of the equipment. The reference channel includes an attenuator and voltmeter, an alpha phase-shifting network, clipping and differentiating circuits and a blocking oscillator. The attenuator is provided so that the input to the remainder of the channel can be set to the standard value of one volt with the aid of the voltmeter.

The cathode-coupled clipping circuit provides a square wave, which is differentiated by means of a series R-C circuit and applied to a cathode-follower stage. The cathode follower responds to the positive pulse produced by differentiation, and triggers the biased blocking oscillator, which produces a positive, 2-microsecond pulse for application to the cathode-ray-tube grid.

The test channel contains a step attenuator and two phase-shifting

networks. The attenuator provides an output of one volt for inputs of 1, 5, 10, 50, 100 and 500 volts, which then become the full-scale sensitivities of the instrument. The alpha network, which drives the vertical deflection circuit, is identical to that placed in the reference channel with the result that the voltage applied to the clipping circuit is in phase with the vertical deflection. The beta network, which is also driven by the output of the attenuator, produces an additional phase shift of 90 degrees. Consequently, when the output of the beta network drives the horizontal deflection circuit a circular sweep is obtained.

A 3-position switch is provided in the test channel to permit a check of the calibration of the instrument. The first position grounds the input to the test channel so that the undeflected spot can be centered on the screen, thus establishing an origin. With the reference terminals connected to a suitable source of voltage, and the attenuator set for half-scale deflection of the meter, the switch can be turned to the second position. This connects the test channel to the reference channel, which applies an input of one volt to the test channel. The gain of the horizontal and vertical amplifiers in the oscilloscope can then be adjusted for full-scale circular deflec-

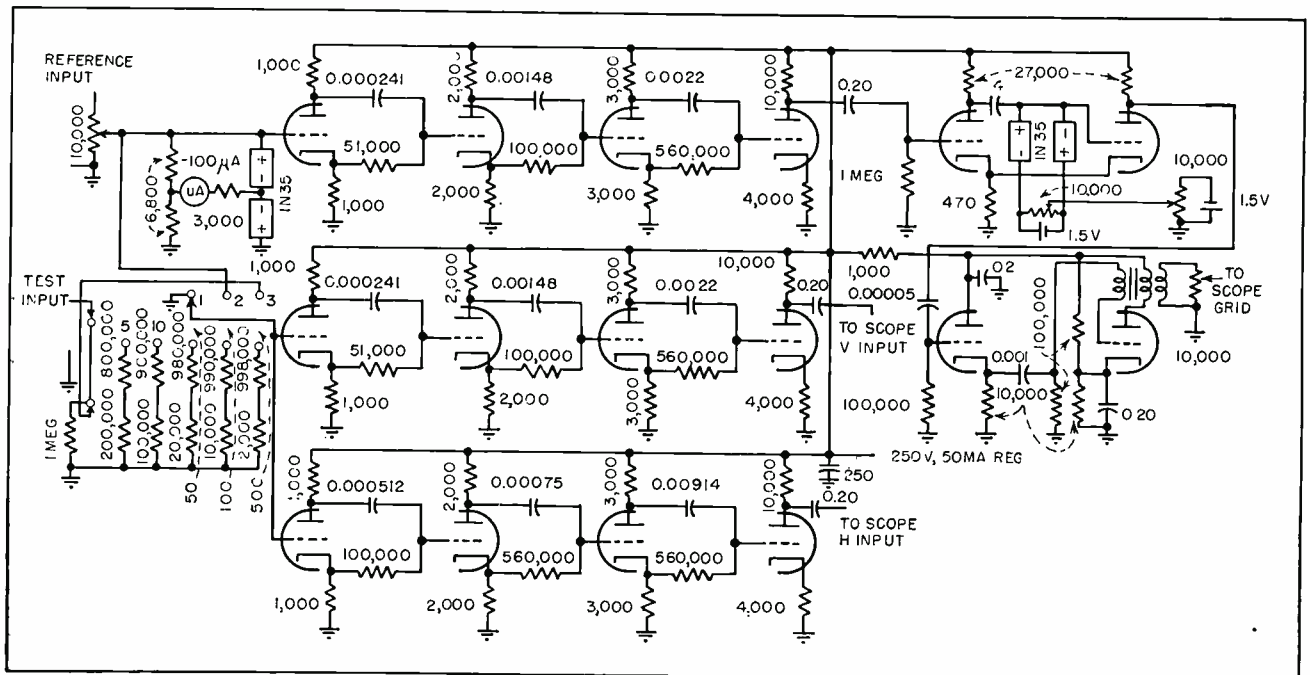

FIG. 2—Complete circuit of the instrument. All tubes are type 6SL7GT

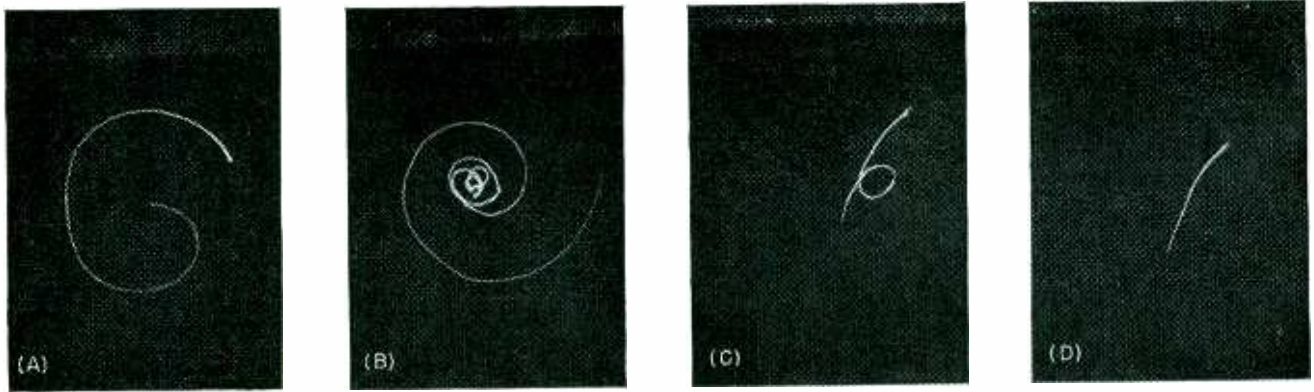

FIG. 3—Oscilloscope patterns obtained with the vector voltage indicator

tion. It is necessary, of course, to increase the intensity to obtain the entire circle. If the intensity is then turned down, a bright dot will be noted. The position of the dot denotes one volt at an angle of zero degrees, establishing the phase reference. Position three of the switch connects the test terminals to the test channel. The instrument is then ready for use.

Figure 2 is a schematic diagram which gives the details of the various circuits used. The phase-shifting networks have been fully described in the first two references, and will not be discussed in detail here. The maximum output for driving the oscilloscope deflection circuits is 0.7-volt rms. Therefore the sensitivity of the oscilloscope must be sufficient to provide full-scale deflection with this input.

The cathode-coupled clipper is of some interest, since it is a refinement of one previously described by Goldmuntz and Krauss⁵. The refinement consists of limiting the grid-voltage swing of the second tube by means of crystal-diode clippers with adjustable bias. As a result, it is possible to obtain a phase accuracy of ± 2 degrees with an input of only one volt rms. It was found necessary to adjust both the clipping ratio (ratio of positive to negative grid voltage swings) and the clipping level (total limiter bias) to obtain high phase accuracy.

The pulse generator circuit was chosen for simplicity and wide frequency range. Although a sufficiently-short pulse could have been obtained by differentiation alone, it was found that a smaller number of tubes would be used by employing a biased blocking oscillator to shorten

the pulse produced by differentiation.

A positive pulse at a maximum amplitude of 100 volts is available for application to the cathode-ray-tube control grid.

Results

Four patterns obtained with the vector voltage indicator are shown in Fig. 3. These photographs are time exposures which were made as the dot denoting the tip of the vector was swept through its locus by changing one of the circuit parameters.

Figure 3A shows the output voltage of a 500-cycle low-pass filter with constant-voltage variable-frequency input. As the frequency decreased, the vector rotated counterclockwise, indicating a phase lead and, shortened, indicating attenuation. The total phase shift through the transition range was nearly 360 degrees, which is to be expected with a two-section filter of this type.

Figure 3B was obtained by connecting a speaker to the reference voltage and using the output of a microphone as the test voltage. As the microphone was moved away from the speaker, an additional phase shift of 360 degrees was obtained for each wavelength traversed. This is indicated by each complete circuit around the origin. The increase in attenuation is also apparent. Under ideal conditions a logarithmic spiral would be obtained in an experiment of this sort. Unfortunately, reflections from nearby objects (including the writer's head) destroyed the symmetry of the pattern obtained.

Figure 3C shows a portion of the

impedance semicircle of a headphone. This measurement was made by driving the headphone with a constant current, and measuring the voltage across it. As the frequency was raised, the magnitude of the impedance increased, the locus being along a small arc of a circle. This would be expected from the electrical characteristic of the unit. However, at the mechanical resonant frequency of the diaphragm a small loop is obtained, showing the motional impedance of the electromechanical system. Figure 3D shows the impedance of the same headphone with the diaphragm blocked. Consequently, the motional impedance is absent and the headphone behaves as a series R-L circuit whose complete locus would be a semicircle.

The vector voltage indicator has been found useful for many other experiments, such as plotting wavefronts, testing the stability of feedback amplifiers, checking phase-shift networks, and measuring distance. Although its inherent accuracy is not extremely high, it is capable of providing a large amount of information in a short time.

The writer wishes to acknowledge the support and encouragement of E. A. Walker and A. H. Waynick during the progress of the work.

REFERENCES

- (1) E. A. Walker, A. H. Waynick and P. G. Sulzer, A Polar Vector Indicator, presented at National Electronic Conference, Nov. 5, 1948.
- (2) A. H. Waynick, E. A. Walker and P. G. Sulzer, Polar Vector Indicator, presented at AIEE Winter General Meeting, Feb. 1, 1949.
- (3) R. B. Dome, Wideband Phase Shift Networks, *ELECTRONICS*, Dec. 1946.
- (4) D. E. Norgaard, A New Approach to Single Sideband, *QST*, June, 1948.
- (5) L. A. Goldmuntz and H. L. Krauss, The Cathode-Coupled Clipper Circuit, *Proc. IRE*, Sept. 1948.

STANDARD

By W. H. FENN*

*Polytechnic Research and Development Co.
Brooklyn, New York*

DURING WORLD WAR II, as use of higher power levels and higher frequencies for radar systems tended to make coaxial lines impractical, the design engineer searched for other ways of transmitting microwave energy.

The logical contender was the now-familiar rectangular waveguide, available on the required short notice only in the guise of commercial rectangular architectural brass tubing or copper gutter pipe. The choice was not a bad one, since the two-to-one ratio of outside dimensions of commercial tubing resulted in a nearly two-to-one ratio for the electrically-important inside dimensions. A few handy sizes were selected for single-mode transmission.

The tolerances on tubing intended for bannister rails were much too loose to apply to tubing intended for guiding microwaves. Accordingly, the first waveguide standards undertook to restrict the possible variations in certain of the dimensions and features of the rectangular tubing. In particular, the inside dimensions were selected as of primary importance (the two-to-one ratio of outside dimensions was retained), and a tolerance was placed on the wall thickness.

The commercial standard set up by the RMA calls for close control of outside waveguide dimensions (for mechanical reasons) as well as of inside waveguide dimensions (for electrical reasons). As a result, a somewhat greater variation in wall thickness is permitted (no tolerance, as such, being specified, since this may be derived from the tolerances on inside and outside dimensions). However, an additional specification is provided which limits the deviation of the wall thickness of any particular piece of tubing at a given cross-section from the actual mean value of wall thickness at that cross-section (the mean value being one-half the difference between the measured values of out-

*Chairman, RMA Subcommittee on Microwave Transmission Lines.

side and inside waveguide dimensions). This in effect provides a sort of generalized eccentricity specification in a form permitting ready determination during inspection.

Another important feature of the standard is the specification of frequency limits for operation in the dominant ($TE_{1,0}$) mode of the various waveguides. The use of relatively narrow bands for wartime radars made unnecessary the task of specifying such frequency limits for the waveguides then in use. Broadband applications since the war make this a necessity if standardization is to be really meaningful.

The limits given are based on experience with the operation of waveguides over broad bands. The lower frequency limit is dictated by a desire to avoid the high attenuation and rapid increase in waveguide wavelength which occur as the cutoff frequency is approached. The upper limit is chosen so that the waveguide will be adequately below cutoff for the $TE_{2,0}$ mode. Each waveguide covers a band having an operating frequency ratio of approximately 1.5 to 1.

The standard consists essentially of two series of waveguide sizes, each covering a continuous, uniformly divided, but nonoverlapping band of frequencies. The sizes have been so graded in the two sets that each waveguide covers a frequency band which overlaps at approximately midrange with the band covered by each of the two adjacent sizes in the other set. This provides at least one standard size of waveguide suitable for operation over any portion of the microwave region twenty percent or less in width.

All of the waveguides currently listed in standards set up by the military services (although provided with the new system of tolerances) have been fitted into their proper places in the pattern. These sizes have been indicated with an asterisk on the RMA standard. Al-

though not all of the RMA sizes have yet been adopted by the military services, it is their stated policy to select new sizes from this list as required. In addition, action is underway to change the method of specifying dimensions in the Service Standards to that introduced by the RMA.

Where new sizes have been indicated, the two-to-one ratio has been applied to inside, rather than to outside dimensions to reduce attenuation and increase power handling capacity while still avoiding the possibility of higher modes within the specified bands. Tolerances on outside and inside corner radii have been specified to facilitate connector assembly and to minimize electrical discontinuities.

Standard Data

Mean wall thickness is one-half the difference between corresponding inside and outside dimensions at any cross-section perpendicular to the axis.

Specified frequency range assumes operation in the dominant ($TE_{1,0}$) mode. Each specified frequency range is within 62 percent and 95 percent of the cutoff frequency of the $TE_{2,0}$ mode. To permit selection of optimum waveguide sizes, two overlapping series are specified.

Bow is the departure from a straight line between any two points two feet apart on the concave external surface of the waveguide. Bow should not exceed 0.010 inch edgewise and 0.020 inch flatwise. Measurement of bow should not be altered by gravity or any other forces.

Twist about the longitudinal axis should not exceed one degree per foot on any face of the waveguide either for inside or outside surfaces. Rectangularity should conform to best commercial practice.

The interior surfaces of the finished waveguide tubing are to be as free from burrs, die marks, chatter marks, inclusions, and scratches,

for WAVEGUIDES

New commercial standard for rectangular waveguides, announced by Radio Manufacturers Association, establishes inside and outside dimensions and frequency limits for operation in the dominant mode for broad-band applications

as best commercial practice will permit. Waveguides should be commercially uniform in composition, as straight and smooth from end to end, as uniform in wall thickness, and as free from dirt, grease, scale and splinters as best commercial practice will permit. No folds or laps will be permitted.

The type designation is to be marked every six inches on one of the wide sides of each length of finished waveguide in such a way as not to deform inner surfaces.

Type designation for rectangular waveguides shall be in the following form:

W	R	770	B	D
Waveguide	Rectangular	$A \times 100$ Inches	Material and Dielectric	Method of Manufacture and Rigidity

Materials and dielectric symbols presently used are as follows:

Symbol	Material	Dielectric
A	Aluminum	Air
B	Brass or Bronze	Air
C	Copper	Air
S	Coin Silver	Air

Manufacturing method and rigidity symbols presently used are as follows:

Symbol	Method of Manufacture	Rigidity
D	Drawn	Rigid
E	Electroformed	Rigid

Table I - Dimensions, Tolerances and Frequency Range for Rigid Rectangular Waveguides

RMA Designation	Frequency Range (Kmc/s) for Dominant (TE ₁₀) Mode		DIMENSIONS IN INCHES								Maximum Inner Radius**
			Inner Dimensions			Outer Dimensions			Wall Thickness		
			A	B	Tolerance	C	D	Tolerance	Nominal	Deviation from mean	
WR770		0.96-1.45	7.700	3.850	±.005	7.950	4.100	±.005	0.125	±.005	3/64
WR650*	1.12-1.70		6.500	3.250	±.005	6.660	3.410	±.005	0.080	±.005	3/64
WR510		1.45 2.20	5.100	2.550	±.005	5.260	2.710	±.005	0.080	±.005	3/64
WR430*	1.70-2.60		4.300	2.150	±.005	4.460	2.310	±.005	0.080	±.005	3/64
WR340*		2.20-3.30	3.400	1.700	±.005	3.560	1.860	±.005	0.080	±.005	3/64
WR284*	2.60-3.95		2.840	1.340	±.005	3.000	1.500	±.005	0.080	±.005	3/64
WR229		3.30-4.90	2.290	1.145	±.005	2.418	1.273	±.005	0.061	±.005	3/64
WR187*	3.95-5.85		1.872	0.872	±.005	2.000	1.000	±.005	0.061	±.005	1/32
WR159		4.90-7.05	1.590	0.795	±.004	1.718	0.923	±.004	0.061	±.005	1/32
WR137*	5.85-8.20		1.372	0.622	±.004	1.500	0.750	±.004	0.061	±.005	1/32
WR112*		7.05-10.00	1.122	0.497	±.004	1.250	0.625	±.004	0.061	±.005	1/32
WR90*	8.20-12.40		0.900	0.400	±.003	1.000	0.500	±.003	0.050	±.005	1/32
WR75		10.00-15.00	0.750	0.375	±.003	0.850	0.475	±.003	0.050	±.005	1/32
WR62*	12.40-18.00		0.622	0.311	±.0025	0.702	0.391	±.003	0.040	±.005	1/64
WR51		15.00-22.00	0.510	0.255	±.0025	0.590	0.335	±.003	0.040	±.005	1/64
WR42*	18.00-26.50		0.420	0.170	±.0020	0.500	0.250	±.003	0.040	±.005	1/64
WR34		22.00-33.00	0.340	0.170	±.0020	0.420	0.250	±.003	0.040	±.005	1/64
WR28*	26.50-40.00		0.280	0.140	±.0015	0.360	0.220	±.002	0.040	±.003	1/64
WR22*		33.00-50.00	0.224	0.112	±.0010	0.304	0.192	±.002	0.040	±.003	0.010
WR19	40.00-60.00		0.188	0.094	±.0010	0.268	0.174	±.002	0.040	±.003	0.010
WR15*		50.00-75.00	0.148	0.074	±.0010	0.228	0.154	±.002	0.040	±.003	0.008
WR12*	60.00-90.00		0.122	0.061	±.0005	0.202	0.141	±.002	0.040	±.003	0.006
WR10		75.00-110.00	0.100	0.050	±.0005	0.180	0.130	±.002	0.040	±.003	0.006

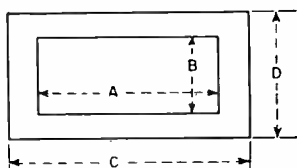

*Military standard, see text

**For all sizes: Minimum outer radius 1/64 inch
Maximum outer radius 1/32 inch

ATTENUATION in Waveguides

IN A RECTANGULAR copper waveguide with air dielectric and for the $TE_{1,0}$ mode, the attenuation is given by the equation:

$$\alpha_{\text{copper}} = \frac{0.0117}{a^{3/2}} \left[\frac{1}{2} \frac{a}{b} \left(\frac{f}{f_c} \right)^{3/2} + \left(\frac{f}{f_c} \right)^{-1} \right] \left\{ \left(\frac{f}{f_c} \right)^2 - 1 \right\}^{1/2}$$

where α_{copper} = attenuation in db per foot for copper waveguide, a and b are the larger and smaller inner dimensions in cm, f/f_c is the ratio of the frequency transmitted to the cutoff frequency.

If a metal other than copper is used, the attenuation given by the formula should be multiplied by a constant which is equal to the square root of the ratio of the resistivity of that metal to the resistivity of copper. A few values for commonly used materials are:

Aluminum. 1.27	Chromium. 1.27
Brass 2.00	Gold 1.18
Cadmium. . 2.04	Silver 0.95

In the graph, there is plotted a series of curves showing the varia-

Power-handling capabilities and attenuation for the $TE_{1,0}$ mode in the rectangular waveguides adopted as standard by the Radio Manufacturers Association

By **HENRY LISMAN**

*Yeshiva University
New York, New York*

tion of attenuation, in db per foot, with frequency for the same frequency ranges used in the power curves described below.

The maximum continuous-wave power that a waveguide can carry for the $TE_{1,0}$ mode is given by $P = (E_{\text{max}})^2 6.63 (10^{-4}) ab (\lambda/\lambda_g)$ where P = maximum power for the $TE_{1,0}$ mode in watts, E_{max} = maximum permissible voltage gradient (A value of 15,000 volts per cm has been assumed), a and b are the larger and smaller inner dimensions respectively in cm, λ/λ_g is the ratio of the free space wavelength to that in the guide.

This equation gives the theo-

retical maximum power that a waveguide can handle if the voltage standing-wave ratio is 1 and is valid for particular conditions of humidity and pressure only. Furthermore, the breakdown voltage is also affected by initial ionization, gap width, pulse width and repetition rate and surface points.

In the graph, there is plotted a series of curves showing variation of maximum power that can be transmitted through the various waveguides with frequency for the respective frequency ranges which are obtained from the condition that $1.18 < \frac{\lambda}{\lambda_g} < 1.67$.

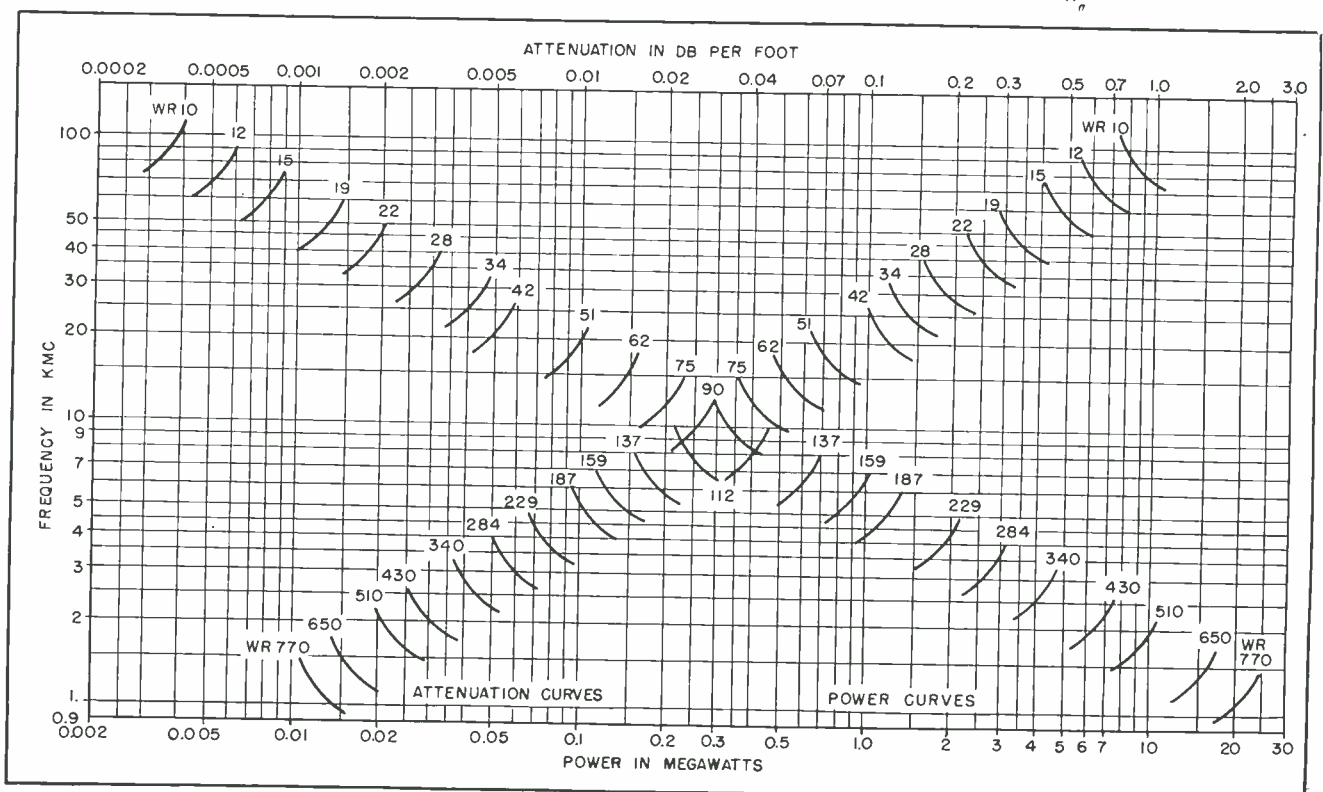



ANOTHER CINCH FIRST!

Cinch Socket Miniature for wiring
the **NEW** Photo-Conductive Cell
into any circuit

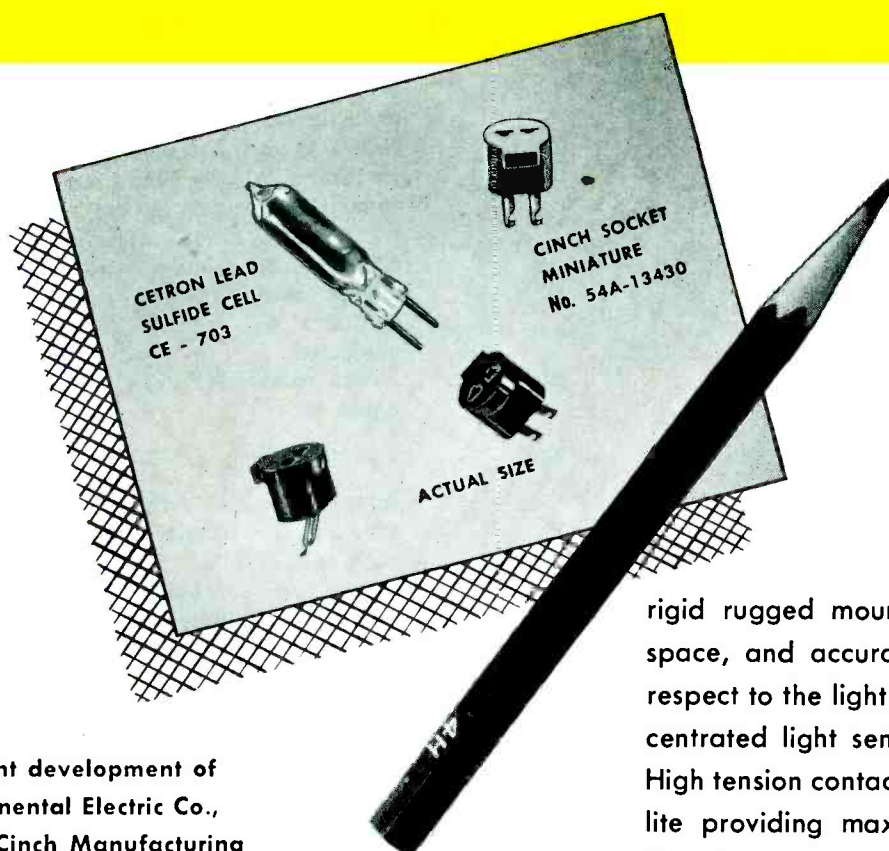

A joint development of
Continental Electric Co.,
and Cinch Manufacturing
Corporation

This Cinch Miniature Socket "First" is used where compactness of the Cell and Socket combination are advantageous. Typical application: new sound projector designs and small size counting devices where banks of photo cells are lined up within a restricted space. Maintains a

rigid rugged mounting occupying a minimum of space, and accurate positioning of the cell with respect to the light source demanded with the concentrated light sensitive area used in these cells. High tension contacts of new design, low loss bakelite providing maximum insulation and minimum high frequency loss . . . Cinch Socket miniatures also permit replacement and removing of cells.

AVAILABLE AT LEADING ELECTRONIC JOBBERS—Everywhere!

CINCH MANUFACTURING CORPORATION

2335 West Van Buren Street, Chicago 12, Illinois

SUBSIDIARY OF THE UNITED-CARR FASTENER CORPORATION, CAMBRIDGE 42, MASS.

Cathode Follower Bandwidth

Nomograph gives upper frequency limit at which bandwidth is 3 db down, in terms of output resistance and total output capacitance of the circuit

WHILE the cathode follower has come into widespread use in recent years as a major tool of the electronic engineer, and many of its characteristics are well-known, comparatively little has been published about its frequency-handling capabilities. A nomograph is given here relating bandwidth (-3 db

point), output resistance and output capacitance for cathode-follower operation. Very fast negative pulses or other signals

impressed on the grid may not allow the cathode to follow in some instances, due to the time constant of the cathode circuit. The frequency at which the response is down 3 db is

$$f_{3db} = \frac{1}{2\pi C_k R_o} \quad (1)$$

where f_{3db} is bandwidth in mc, R_o is output resistance in ohms and C_k is total output capacitance in $\mu\mu\text{f}$.

The nomograph is based on this equation. The value of C_k is determined approximately from

$$C_k \cong C_{hk} + C_{pk} + \frac{C_{pk}(C_i + C_{gp})}{C_{pk} + C_i + C_{gp}} + C_s \quad (2)$$

where C_{hk} is heater-cathode capacitance, C_{pk} is plate-cathode capacitance, C_{gp} is grid-cathode capacitance, C_{gp} is grid-plate capacitance, C_i is input-circuit capacitance, and C_s is the sum of wiring and other capacitances connected externally across the output load. In the case of pentodes C_{gp} can usually be neglected.

The value of R_o can be computed from

$$R_o = \frac{R_k}{1 + G_m R_k} \quad (3)$$

where R_k is the cathode resistance and G_m is the transconductance of the tube. The value of R_o can also be obtained from a previously published nomograph.¹

This nomograph may also be applied to uncompensated R-C amplifiers by replacing R_o with the equivalent output resistance of the amplifier plate circuit. For this case, the nomograph scales can be extended by multiplying the R_o scale and dividing the f_{3db} scale by the same number. The C_k scale then becomes the output capacitance of the amplifier.

REFERENCE

(1) Melvin B. Kline, Cathode-Follower Impedance Nomograph, *ELECTRONICS*, p 130, July 1947.

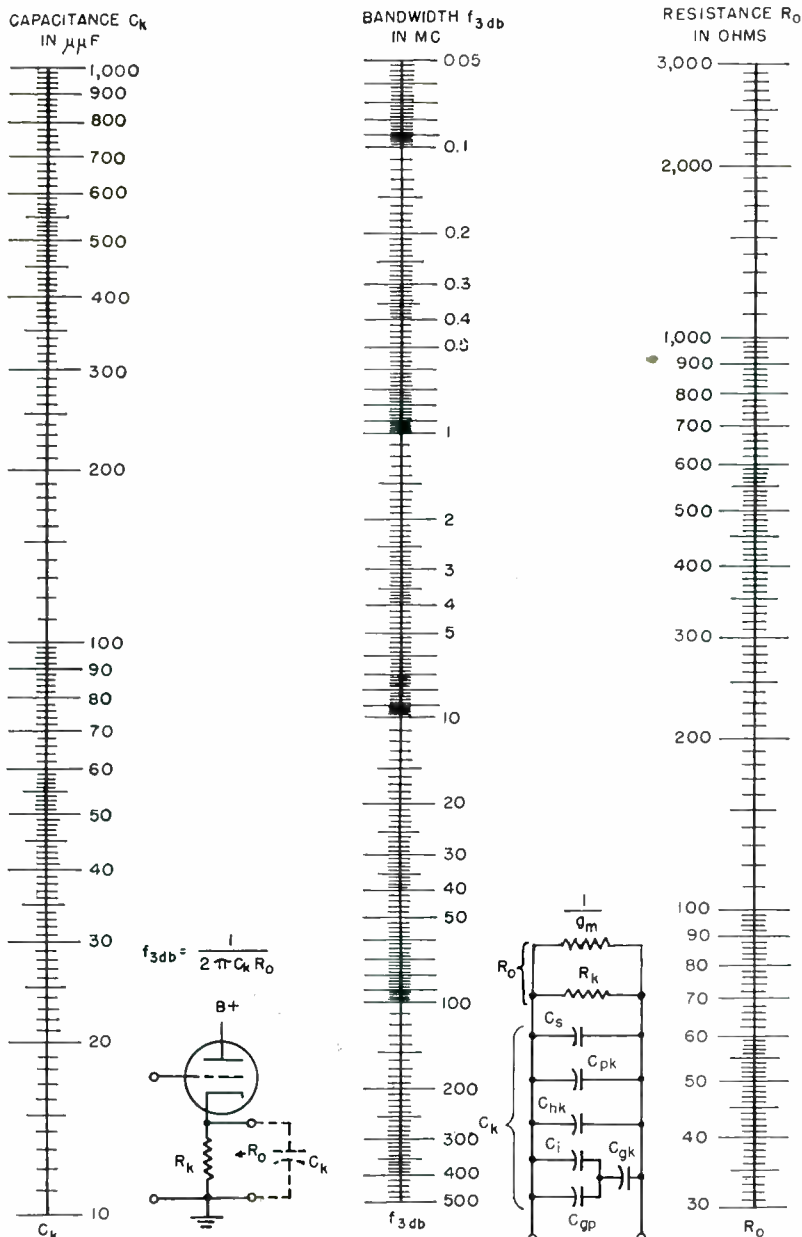

For Household
Heat Control



MALLORY PLATINUM-ALLOY CONTACTS

Serve in That Trouble-Free Thermostat on the Wall

Almost endless are the hidden tasks performed by different types of Mallory Contacts for products that make life easier and pleasanter. In the mechanism of the thermostatic heat control, for example, you'll find Mallory Platinum-Alloy Contacts doing their job with famous Mallory dependability and precision.

Mallory Platinum—alloyed for added strength, resistance to sticking, and hardness—makes a superb contact material where a high melting point, resistance to corrosion and oxidation, and retention of low contact resistance over long periods are required. Wherever a platinum alloy is needed, a Mallory Elkonium* contact material—produced under rigid controls—is available.

What's Your Problem?

You'll find Mallory Contacts in automotive voltage regulators—in electric business machines—in giant power plant circuit breakers—everywhere! Mallory has designed so many types of contacts that even if you have an unusual problem, chances are a standard Mallory contact will solve it. If not—Mallory engineers are prepared to develop the precise one for you. Consult them now.

Electrical Contacts and Contact Assemblies

P. R. MALLORY & CO. Inc.
MALLORY

P. R. MALLORY & CO., Inc., INDIANAPOLIS 6, INDIANA



For all kinds of contact materials and service, you can't beat Mallory as a dependable, experienced source.

*In Canada, made and sold by
Johnson, Matthey & Mallory, Ltd., 110 Industry St.,
Toronto 15, Ontario*

SERVING INDUSTRY WITH

Capacitors Rectifiers
Contacts Switches
Controls Vibrators

Power Supplies

Resistance Welding Materials

*Reg. U. S. Pat. Off.

TUBES AT WORK

Including INDUSTRIAL CONTROL

Edited by VIN ZELUFF

Automatic Chemical Analyzer.....	116
Packaged Electronic Control Unit.....	116
Televise Dangerous Operation.....	133
Slow-Speed Record Changer.....	136
TV Matching Transformer.....	138
High-Impedance Filament Transformers.....	140
Notes for Remote Viewers.....	144
Antennas Over Minneapolis.....	148
Tubes At Play.....	150

Automatic Chemical Analyzer

AFTER more than two years of intensive development work, the perfection of a practical instrument to supplement and extend chemical analysis and research has been announced. The instrument can analyze in a few minutes such mixtures as wood and grain alcohols dissolved in water, telling both what compounds are present and how much of each. Even complex mixtures of gasoline-like compounds obtained in refinery laboratories can be analyzed. In addition, the instrument produces records which give fundamental information about molecular structures of the chemicals analyzed. This information is of great value in research

work on the preparation of new chemicals.

This development is based on the experimental work of the Indian physicist Sir C. V. Raman who found that many compounds give off a weak light that can be used to identify them when illuminated by a powerful beam of mercury light. The sample light is passed into a spectrograph containing prisms which break up the light into its colors. Each compound gives a unique pattern of lines which can be used to identify the substance in mixtures. Because the Raman light is weak, the early Raman work was done using a spectrograph with a camera system and photographic

plates, exposures of many hours or days being required. A development of the Lane-Wells Co. of Pasadena, California, the instrument incorporates an improved mercury light source and a high-speed spectrograph so that exposures of a few minutes are now routine. In addition, this instrument now can also by-pass the photographic process altogether by using sensitive electronic tubes and amplifiers to measure the Raman light directly. The new pen-recording instrument produces directly a graph of a sample's Raman lines on a roll of chart paper. This new development has greatly improved the speed and accuracy of the analytical work. The photograph shows the instrument with the cover of the lamp house removed to show the interior.

Packaged Electronic Control Unit

BY G. C. WILSON

*G. C. Wilson & Company
Chatham, N. J.*

EXPERIENCE and numerous interviews have led to the conviction that all control engineers have at least one problem that lends itself to solution using electronic elements. This may be due to the need for speed, sensitivity, compactness or because of the measuring elements available. Whatever the reasons, the solution of many control problems dictates the use of electronic elements if equipment is available at a reasonable cost. If electronic equipment is available only after expensive and time-consuming design and development, a substitute will be used with the consequent loss in the quality of control.

The unit shown in Fig. 1, which is called the Flexitrol, was designed to provide the control engineer with a packaged electronic device for use as an element in control systems. A variety of measuring elements can be connected to its input. Its output consists of contact closures suitable for virtually any need. Sensitivity controls and variable time delays permit adjustment over wide ranges. The time delays also adapt its use to processes with small time lags or lags up to several minutes.

The unit is approximately 9 inches long and 8 inches in diame-



Chemist places vial of unknown solution into chemical analyzer which will print curves that can be interpreted to yield chemical and molecular properties of solution in a matter of minutes

SOLDERING TIPS

Recently many inquiries have been received as to the best material to use in a soldering iron tip. Below is a resume of reasons for the use of certain materials. The function of the soldering iron tip is to convey heat to the metal to be soldered, raising the temperature of the metal to a solder-alloying efficiency. The efficiency of the soldering tip depends upon its ability to transmit or conduct heat to the second metal. Silver has the greatest thermal conductivity, then copper and gold. Other known metals are far down the scale in comparison. Silver has been ruled out mainly because of its high cost. Throughout the ages, copper has remained the ideal tip material for reason of its comparatively low cost and its ability to conduct heat about twice as fast as other known metals.

Many inquiries have been received concerning the reason for the rapid wearing and pitting of soldering coppers. This very pitting denotes an efficient soldering tip. Any metal must be soluble in molten solder to function as a soldering tip; this action enables the tip to become solder-coated or tinned. The coating action continues to form and reform during the soldering operation, constantly exposing the tip to the solvent action of the solder. Constant solvent action is the cause of the pitting and must be expected if the soldering tip is to perform efficiently.

For years experiments have continued in an effort to find a coating material that would stop or slow down the solvent action of the solder on the soldering tip. Usually these experiments have resulted in a longer-wearing iron but have also resulted in an inefficient iron that would not properly transmit the heat.

"Soldering Tips" is continually on the lookout for improved methods of soldering. Recently several solder users have tried a new soldering tip plated by a formula known to the inventor only. Twice the amount of service from this tip was reported. The name of the manufacturer will be furnished on request.

"Soldering Tips" will welcome your questions concerning solder or soldering operations. Please address inquiries to "Soldering Tips", Kester Solder Company, 4204 Wrightwood Ave., Chicago 39, Illinois.

NOW AVAILABLE . . . The New Manual—"SOLDER and Soldering Technique"!

Send for this complete analysis of the properties of soft solder alloys and soldering fluxes . . . a comprehensive reference book that you will want to retain. It's yours for the asking . . . request it NOW!

(ADVERTISEMENT)

(Did you know that Kester makes over 100,000 sizes and types of flux-core solder?)

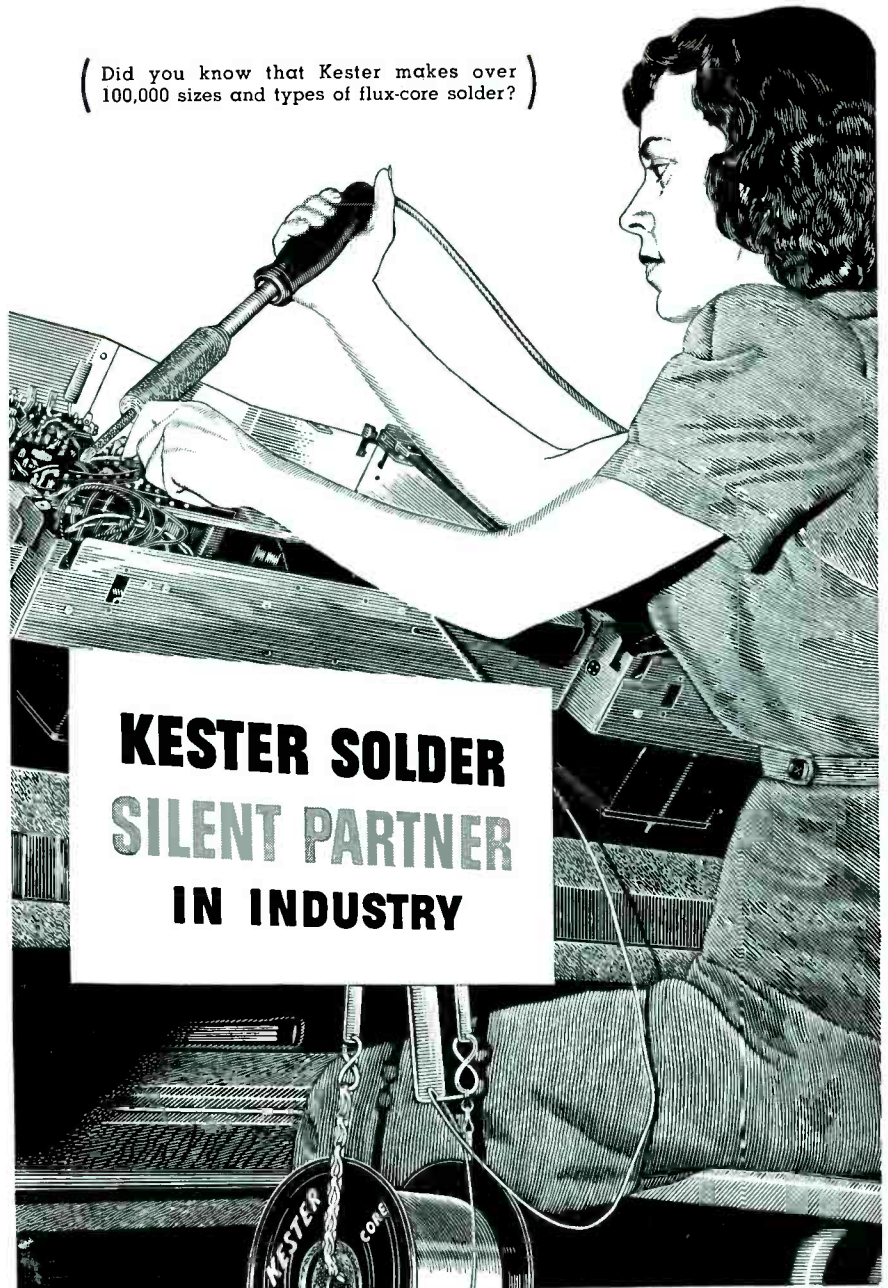

**KESTER SOLDER
SILENT PARTNER
IN INDUSTRY**

For over fifty years Kester has been concerned with producing solder for every phase of industrial work. Take advantage of this experience by consulting Kester's Technical Department on all soldering problems. There is no obligation.

FREE—Technical Solder Manual Available on Request

Send for Kester's new solder manual, "SOLDER and Soldering Technique."

KESTER SOLDER COMPANY
4204 Wrightwood Avenue • Chicago 39, Illinois

Factories also at
Newark, New Jersey • Brantford, Canada



**KESTER
SOLDER**

THE FRONT COVER



DESIGNED to fit the requirements of f-m broadcast application, the Ampex tape recorder provides a 35-minute transcribing capacity at 30 inches of tape per second. Included are precision tape drive, completely-shielded plug-in head housing with separate heads for erase, record, and playback and separate record and playback amplifiers.

Frequency response of the unit is within ± 1 db between 30 and 15,000 cps. Distortion of the overall system is 4-percent intermodulation at peak meter reading. Ten db above peak meter reading the total rms harmonic distortion does not exceed 5 percent. Unweighted noise level is 60 db below 5-percent harmonic distortion for the system as a whole—including both amplifiers, bias, erase and stray pickup. Accuracy of playback timing is ± 0.2 percent.

The battery of test gear used in final production testing of the recorder is shown in the photograph above.

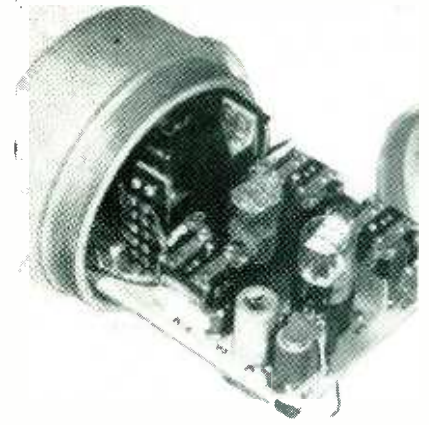

FIG. 1—Compact electronic control package in an explosion-proof housing

sistor and capacitor, and the grid charging voltage (determined by the setting of the time delay 1 control tube V_3 conducts, RE_3 operates and ends time delay 1.

When RE_3 operates, it reverses the connection of the cathode of V_4 , initiating time delay 2. This delay is determined as for time delay 1 by its time delay control and the grid resistor and capacitor. At the end of time delay 2, V_4 conducts and RE_4 operates.

Measuring Elements

Some of the measuring elements for operating the device are shown in Fig. 3. A selsyn, or autosyn, may be used to measure angular position, since its output is proportional to the angular position of its pri-

(continued on p 132)

ter. A general schematic is shown in Fig. 2. Operation is as follows: A voltage is applied to the input terminals by the measuring element. If this voltage is equal to the voltage applied at A (which is adjustable), no signal appears across the secondary of the transformer. If the input increases, a signal appears on the secondary, and V_1 conducts causing RE_1 to operate. If, on the other hand, the input decreases, RE_2 pulls in. Variable cathode resistors control the sensitivity of V_1 and V_2 . Operation of RE_1 reverses the connection of the cathode of V_4 and its grid begins to charge, initiating time delay 1. After a time delay determined by the grid-leak re-

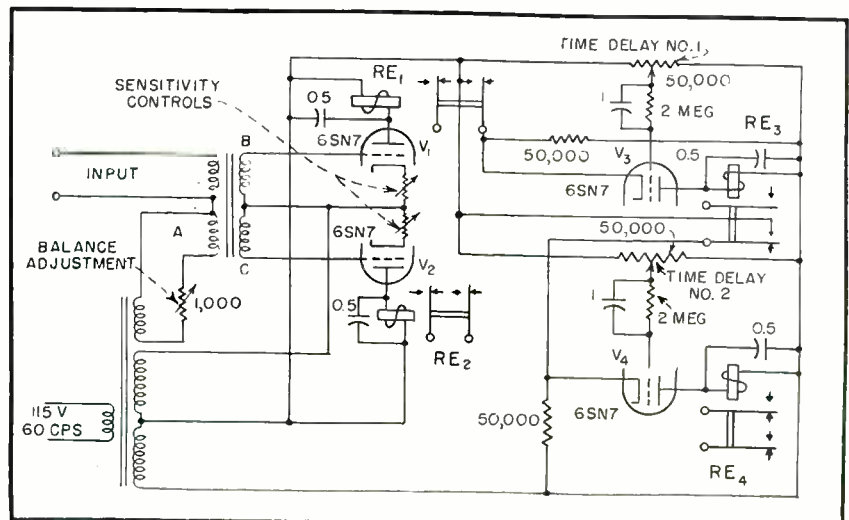
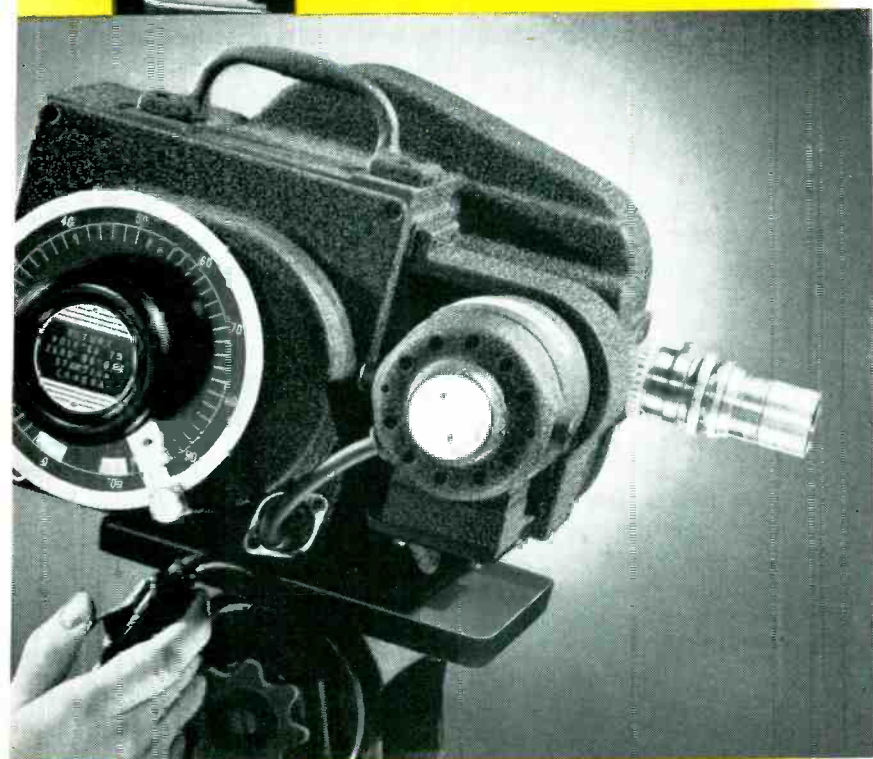

FIG. 2—Circuit diagram of control unit. Unconnected relay contacts are for external controlled circuits

It can show you
the heartbeat of a car radio—



You could cover pages with calculations about a car radio vibrator. You could fill sheets with figures on inertia and elasticity of its vibrating elements—and yet not be sure exactly how the rapidly moving parts do behave in action.

This is where high speed movies come in—the kind of “slow motion” you get from the Kodak High Speed Camera. It’s a simple, direct means to record and study high speed repetitive mechanical motion . . . the only way to see dynamically what happens in non-cyclic high speed action.

The Kodak High Speed Camera can take a second of action and spread it over three minutes. It can put flash marks along the side of the film that time the motion accurately. Its optical system gives the extra picture sharpness you need to see a vital point clearly.

This camera is a single unit with one motor, complete in itself and easy to operate. If you would like to know how it works and how it can help you, send the coupon.

EASTMAN KODAK COMPANY
Industrial Photographic Division
Rochester 4, N. Y.

the Kodak
High Speed
Camera



“Kodak” is a trade-mark.

EASTMAN KODAK COMPANY
Rochester 4, N. Y.

Gentlemen:

Please send me: your folder “Magnifying Time” which tells about the Kodak High Speed Camera. a 16mm. sample reel of high speed motion study, which I may borrow.

Name _____ Firm _____

Address _____

City _____ State _____

Kodak

THE ELECTRON ART

Edited by JOHN MARKUS

New Value for e/m	120
Angels are Flying Insects.....	122
Increasing Stability of Oscillators.....	122
Characteristics of Deltamax.....	152
Emergency Battery Chamber.....	156
Letter-Printing C-R Tube.....	160
Improved Phase Meter.....	162
Ceramic-Wall Tubes.....	168
Primary R-F Voltage Standard.....	172

New Value for e/m

ACCURATE determination of the magnetic moment of the hydrogen nucleus, or proton, by NBS scientists has resulted in a new absolute value for the electron charge-to-mass ratio e/m .

This new measurement also provides an accurate secondary standard for magnetic fields, so that magnetic fields can now be measured more accurately than electric fields. The problem of magnetic field regulation arises widely in the use of scientific apparatus such as cyclotrons, mass spectrographs and beta-ray spectrometers—and in industrial equipment such as servomechanisms and electromagnets.

Method of Measurement

A typical experimental set-up for measuring the magnetic mo-

ment includes a water sample placed in a magnetic field of 4,700 gauss and surrounded by a small r-f coil with its axis perpendicular to the magnetic field. Thus, if the coil is excited by a 20-megacycle signal, an r-f field will be produced in the sample and protons in the normal spin state will absorb r-f energy and shift to the excited state. A sensitive Q-meter can be used to detect the reduction in the Q of the coil resulting from this energy absorption by the nuclei.

If the value of the field at the sample is varied at an audio rate, the r-f voltage across the coil will change sharply as nuclear resonance occurs. Resonance can then be detected without using a Q-meter since, if the voltage pulse from the coil is rectified and amplified, the

resonance absorption line may be displayed as a stationary image on an oscilloscope screen. By including a differentiating circuit to obtain the time rate of change of the resonance pulse, the magnetic field strength can be regulated very closely through a power amplifier and feed-back circuit.

Magnetic Pull Measurement

With the magnetic field stabilized, the frequency of the r-f voltage applied to the coil enclosing the proton sample was adjusted to produce magnetic resonance. The magnetic field strength was then determined to 1 part in 20,000 by measuring the force on a known length of current-carrying wire

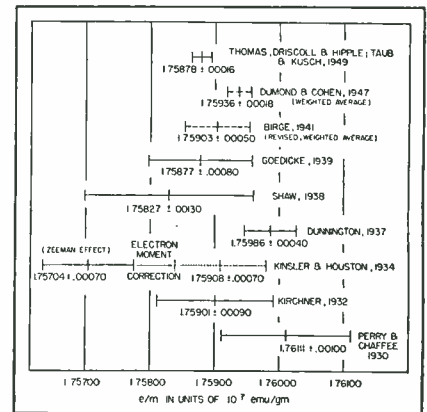

Two decades of values for electron charge-to-mass ratio e/m

placed in the field. This wire was in the form of a nine-turn coil wound on the edge of a long rectangular glass plate with its lower end in the magnetic field. The plate was supported by an analytical balance so that the force resulting from the interaction of the coil current with the magnetic field could be accurately measured. The stray field at the upper end of the coil was reduced to zero by a pair of Helmholtz coils. Since the long parallel sides of the coil did not contribute any vertical force, the chemical balance measured only the force acting on the part of the coil along the lower end of the plate.

Results

The frequency of resonance absorption was measured to a few parts per million by heterodyning the r-f generator supplying the resonance probe against the standard

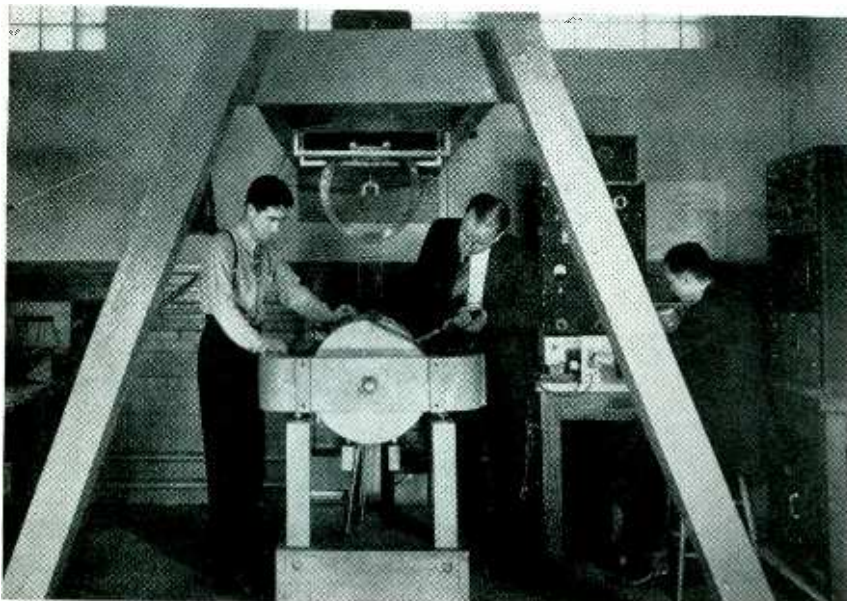

Experimental set-up for measuring the proton's magnetic moment at the Atomic Physics Laboratory of the National Bureau of Standards. Heavy wood beams provide rigid support for precision chemical balance that measures magnetic pull. Electronic equipment at right includes audio oscillator, power supplies and 20-mc r-f generator. Proton sample is ordinary tap water in glass ampule surrounded by r-f coil in magnet gap. NBS scientists working on this project are, left to right: R. L. Driscoll, J. A. Hipple and H. A. Thomas

FM SIGNAL GENERATOR

Type 202-B 54-216 mc.

Additional coverage from 0.4—25 mc.
with accessory UNIVERTER Type 203-B

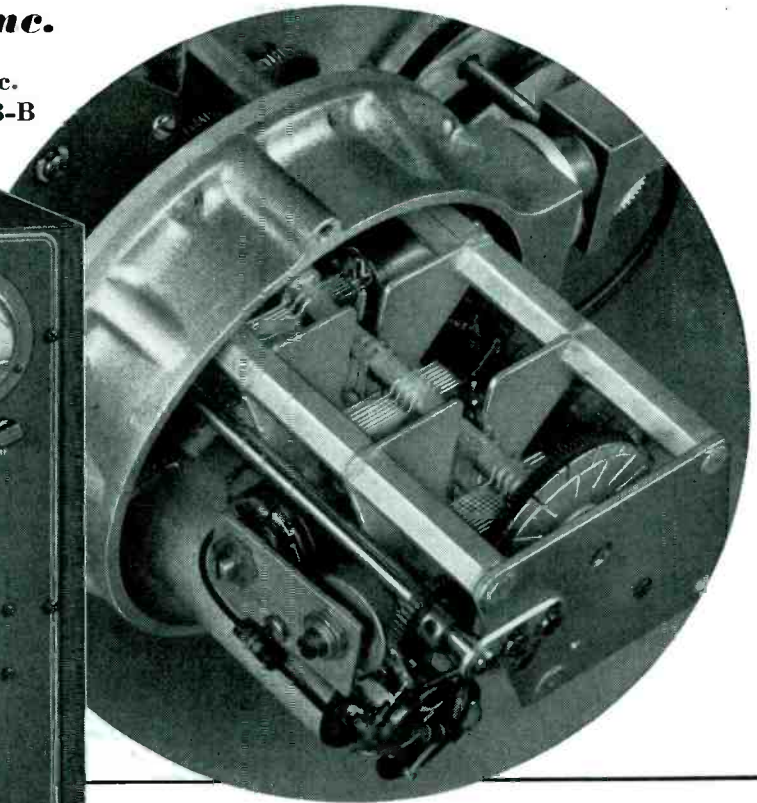

Shown above is an interior view of the 202-B Signal Generator RF assembly with shield cover removed. Heavy aluminum castings form the mounting base of this RF unit resulting in a compact and highly rigid structure. Girder type condenser frame construction, multiple rotor shaft grounding contacts, and welded interstage shield plates are but a few of the many design features of this unit which give added circuit stability.

Designed to meet the exacting requirements set forth by leading FM and television engineers throughout the country, the 202-B FM Signal Generator has found widespread acceptance as the essential laboratory instrument for receiver development and research work.

Frequency coverage from 54 to 216 megacycles is provided in two ranges, 54 to 108 megacycles and 108 to 216 megacycles. A front panel modulation meter having three deviation scales, 0-24 kilocycles, 0-80 kilocycles and 0-240 kilocycles, permits accurate modulation settings to be made.

Although fundamentally an FM instrument, amplitude modulation from zero to 50%, with meter calibrations at 30% and 50%, has been incorporated. This AM feature offers increased versatility and provides a means by which simultaneous frequency and amplitude modulation may be obtained through the use of an external audio oscillator.

The internal AF oscillator has eight modulation frequencies ranging from 50 cycles to 15 kilocycles, any one of which may be conveniently selected by

a rotary type switch for either amplitude or frequency modulation.

The calibrated piston type attenuator has a voltage range of from 0.1 microvolt to 0.2 volt and is standardized by means of a front panel output monitor meter.

The output impedance of the instrument, at the terminals of the R.F. output cable, is 26.5 ohms.

AVAILABLE AS AN ACCESSORY

is the 203-B Univerter, a unity gain frequency converter which, in combination with the 202-B instrument, provides the additional coverage of commonly used intermediate and radio frequencies.

R.F. Range: 0.4 mc. to 25 mc.

R.F. Increment Dial: ± 250 kc. in 10 kc. increments.

R.F. Output: 0.1 microvolt to 0.1 volt. Also approximately 2 volts maximum (uncalibrated).

For further information write for Catalog F



UNIVERTER
Type 203-B

BOONTON RADIO

BOONTON · N.J. · U.S.A.



DESIGNERS AND MANUFACTURERS OF THE "Q" METER . . . QX-CHECKER . . . FREQUENCY MODULATED SIGNAL GENERATOR . . . BEAT FREQUENCY GENERATOR . . . AND OTHER DIRECT READING TEST INSTRUMENTS

frequency broadcasts from WWV. These measurements of radio frequency and magnetic field establish the value of the gyromagnetic ratio of the proton as $(2.6752 \pm 0.0002) \times 10^4$. The magnetic moment of the proton in absolute units is then $(1.4100 \pm 0.0003) \times 10^{-28}$ gauss cm².

The Bureau's research on the absolute proton moment has re-

sulted in a new value for the electron charge-to-mass ratio e/m — $(1.75878 \pm 0.00016) \times 10^7$ emu/gm—with much greater accuracy than any previous measurement. In addition, this combination of results completely confirms the validity of the theoretical correction for the radiative effects of the electron's magnetic moment.

Angels are Flying Insects

MYSTERIOUS short-duration radar reflections called angels or blips, observable most frequently below heights of 3,000 feet, have been explained by scientists of Bell Telephone Laboratories. The cause: flying insects.

The tests and observations resulting in this conclusion were sponsored jointly by Bell Laboratories and the Naval Electronics Laboratory and were conducted at Gila Bend, Arizona.

In their attempts to synthesize the strange patterns on the radar scopes, the scientists exploded a small charge of nitro-starch in the air 500 feet above the radar antennas. They flew a plane low over the radar and looked for reflections from the exhaust gases. They built bonfires, upwind, so that the hot combustion gases and steam clouds formed by pouring water on heated

rocks billowed into the beam. In all these experiments, the phenomenon was never observable.

Later, working at night, they threw out a strong searchlight beam, and stationed observers at different levels of a 200-foot tower. While the observers counted insects, the radar operators counted the appearance of angels on their scopes. For example, in one fifteen-minute period, twenty were counted, fifteen of which coincided with the sighting of an insect.

Insects fit most of the descriptions which have been applied to the mysterious reflections on radar scopes. They are small, they move at a speed comparable to wind velocity, sometimes with and sometimes against the wind, they are present both day and night, and there are more of them in warm weather than in cold.

Increasing Stability of Oscillators

BY ALBERT DANZIGER

Chief Engineer, Radio Engineering Co.
Instructor, Radio-Electronics Institute
New York, N. Y.

THE USUAL PRECAUTIONS employed in oscillator and tuned-circuit design which are meant to minimize frequency drift, such as mechanically-stable tuning capacitors, a stable tank coil and high ratio of C to L , are not adequate to prevent variations in resonant frequency due to changes in tube input capacitances. The tuning ratio in a high-frequency receiver (approximately 100 mc) requires a practical value of C_{max} of approximately 20 μf ; consequently the variation in shunt capacitances introduced by the oscillator or amplifier tube becomes a significant portion of the total tun-

ing capacity of the circuit.

Since the input capacitance is made up of tuning capacitance and circuit shunt capacitance, changes in input capacitance will result from changes in either of these two parameters. If a mechanically-stable tuning capacitor is used, its changes will be relatively small compared to variations in tube input capacitances.

It is therefore seen that where the change in input shunt capacitance becomes a significant portion of the total tuning capacitance, the change in resonant frequency becomes an appreciable percentage of

the resonant frequency.

When the tube input capacitance appears across the total tank coil, as shown in Fig. 1A, the change in resonant frequency is proportional to the square root of the change in total tuning capacitance. It was determined experimentally, however, that when the tube input capacitance appears across only a portion of the total tank coil, the change in resonant frequency is proportional to the n th root of the change in input shunt capacitance, the order of the root being determined by the position of the tap.

When the variations in input shunt capacitance appear across half the tank coil, the order of the root is approximately 8, and when the variations in tube input and other shunt capacitances appear across 25 percent of the tank coil, the order of the root becomes approximately 16. Of course, an incidental effect of tapping down on the tank coil would be to utilize only a portion of the voltage. The practical applications of this circuit arrangement utilize approximately 80 percent of the tank coil.

A practical method of utilizing

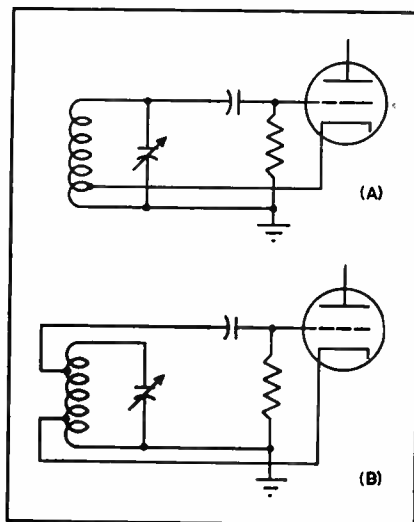

When tube input and stray shunt capacitances appear across only a portion of the tuned circuit (B) the circuit is substantially more stable than in the arrangement shown at (A)

this lowered dependency of resonant frequency on the variations in tube input and other shunt capacitances is shown in the oscillator circuit of Fig. 1B.

Modifications of this method for obtaining a high degree of stability

(continued on p 152)

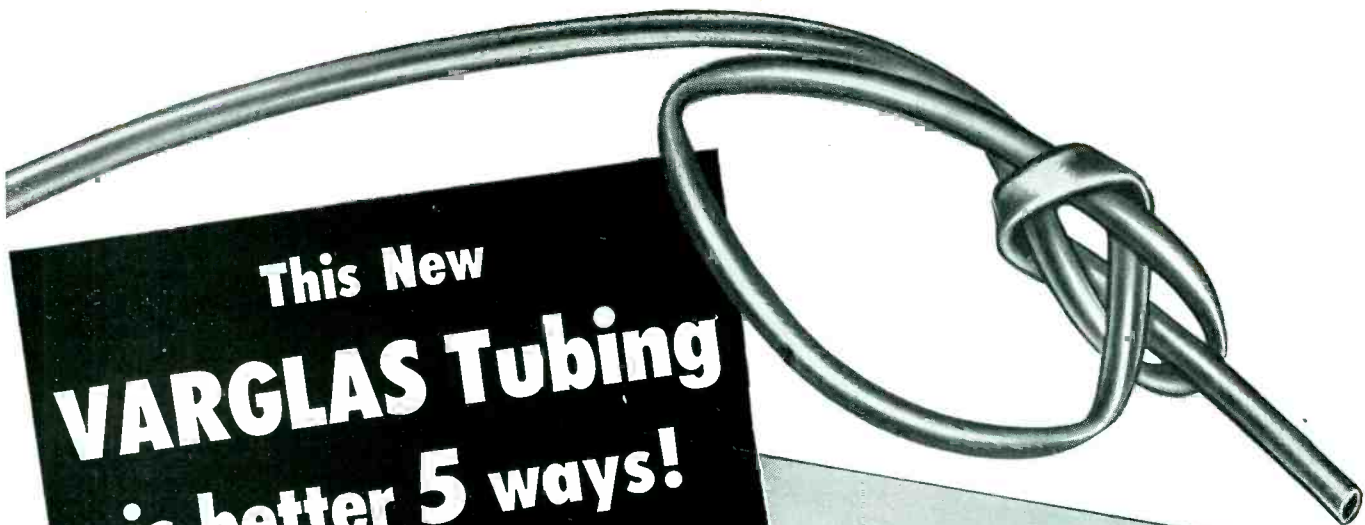

This New
VARGLAS Tubing
 is better 5 ways!

Impregnated with
 General Electric's
PERMAFIL
 for superior insulation...

Varglas Permafil Tubing excels oleoresinous and other synthetic coated tubing in several important performance characteristics. Outstanding among these are:

1 TOUGHNESS

Remains pliable even after severe flexing. This new tubing can be twisted, bent or tied in knots with no loss in its dielectric value (7,000 volts).

3 HEAT AGING

Withstands more than 2,000 hours at 105° to 110° C., 1,000 hours at 125° C. and extensive periods at 150° C.

2 SOLVENT RESISTANCE

Is relatively immune to alcohol. Petroleum and aromatic hydrocarbons have only slight effect after long exposure.

4 BAKING

Can be after-treated in baking and varnishing operations—reacts better than most oleoresinous materials.

5 AVAILABLE IN COILS

—In standard colors and wide range of sizes. Meets or exceeds all requirements of A.S.T.M. specifications.

Send for **FREE SAMPLE** and complete data.

Varflex
CORPORATION

Makers of
 Electrical Insulating
 Tubing and Sleeving

VARFLEX Corporation, 308 Jay St., Rome, N. Y.

Please send me full information as well as a free sample of your new Varglas Tubing impregnated with G.E. Permafil. I am particularly interested in samples suitable for.....

Name.....
 Company.....
 Street.....
 City..... Zone..... State.....

NEW PRODUCTS

Edited by A. A. MCKENZIE

Noise Suppression

MINNESOTA ELECTRONICS CORP., 97 E. Fifth St., St. Paul 1, Minn., has added model NSA-20 noise suppres-



sion filter amplifier to its line. The filter attenuates the noise region at the rate of more than 20 db per octave above any selected frequency from 3,500 to 16,000 cps. There is continuous variable tuning over this entire range. Frequency response is maintained between 12,000 to 20,000 cps within 0.5-db roll-off. Power output is 10 watts.

Television Ballast Tube

AMPERITE Co., INC., 561 Broadway, New York 12, N. Y., announces a television ballast tube that is hermetically sealed and filled with helium, and produced with as many

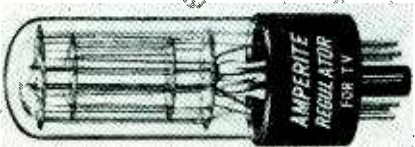

as five separate controlling elements. Some of the 2.5-watt elements are designed to withstand 40 watts, an overload of 2,000 percent. Voltage breakdown between elements is 1,300 volts d-c.

Manometer

TECHNITROL ENGINEERING Co., INC., 3212 Market St., Philadelphia 4, Pa. Model 115-1 continuous-reading Lilly manometer is an electronic blood-pressure recording device. Five ranges of pressure selected

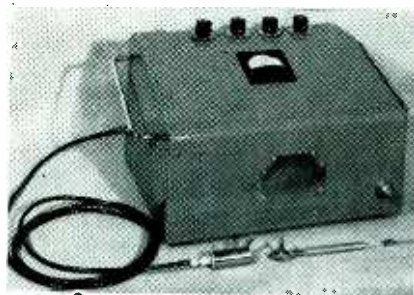

by the range switch cover from +25 to +400 mm or +25 to -400 mm of mercury. Output voltage range is -20 to +20 volts. The instrument operates on 115 v, 60 cycle a-c and consumes about 100 watts. Frequency response of the amplifier uncompensated is flat within 1 db from 0 to 2,000 cps. Volume displacement of pressure head is less than 10^{-7} ml per mm of mercury.

Tubular Twin-Lead

AMERICAN PHENOLIC CORP., 1830 S. 54th Ave. Chicago 50, Ill. Catalog No. 15-271 is a 300-ohm tubular twin lead for television and f-m



lead-ins. It holds moisture and dirt outside the concentrated field between conductors and, therefore, eliminates variation in transmission-line impedance and excessive dielectric losses.

Wide-Band Chain Amplifier

SPENCER-KENNEDY LABORATORIES, INC., 186 Massachusetts Ave., Cambridge 39, Mass. Model 202 traveling wave wide-band chain amplifier



is composed of two stages of six 6AK5 tubes, has a gain of 20 db and a bandwidth of 200 mc. With a standing wave ratio of less than 1.5 db adjusted for a pulse response, transmission characteristic is ± 1.5 db from 100 kc to 200 mc at a 200-ohm impedance level. The unit can be used in general laboratory measurements, oscillography and nuclear instrumentation.

Filamentary Pentode

RAYTHEON MFG. Co., Newton, Mass. The type 1AD4 is a new subminiature sharp cutoff pentode, shielded



for r-f applications, with a nominal mutual conductance rating of 2,000 micromhos, and an average plate current of 3 ma, with 45 volts plate and screen supply. Filament rating is 1.25 volts, 100 ma.

Klystron Control

POLYTECHNIC RESEARCH AND DEVELOPMENT Co., INC., 202 Tillary St., Brooklyn 1, N. Y. Type 801 klystron power and modulation supply can operate a wide variety of klystron oscillators. The unit provides for c-w, square-wave, or sawtooth modulation or for external

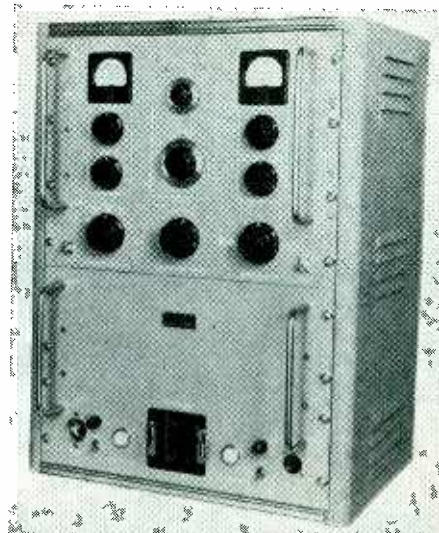

**HERE'S USEFUL AND
IMPORTANT INFORMATION
FOR You!**

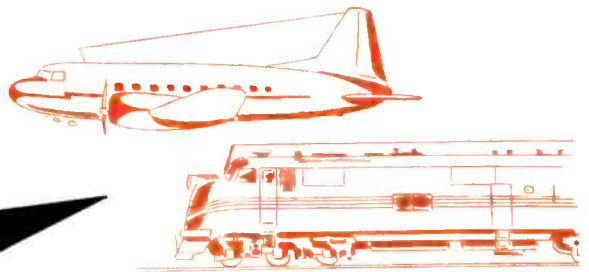

Type	Description	Typical Service	Prototype	Construction	Heater		Plate		Grid Volts	Screen		Amp. Factor	Mut. Cond.
					Volts	Amps.	Volts	Ma.		Volts	Ma.		
2C50	Dual Power Triode	Aircraft Control Equip.	—	Bantal	12.6	0.3	300	12.5	—24	—	—	9.5	1750
2C52	Dual Amplifier Triode	Aircraft Control Equip.	—	Bantal	12.6	0.3	250	1.3	—2	—	—	100	1900
6AK5W	Pentode RF Amplifier	Military Ruggedized	6AK5	7 pin miniature	6.3	0.175	120	7.5	Rk 200	120	2.5	—	5000
6AL5W	Dual Diode	Military Ruggedized	6AL5	7 pin miniature	6.3	0.3	Max. Peak Inv. 330 Volts Max.		Io 9 ma.dc.				
6AS6W	Pentode RF Mixer	Military Ruggedized	6AS6	7 pin miniature	6.3	0.175	120	5.2	—2	120	3.5	—	3200
6C4W†	RF Power Triode	Military Ruggedized	6C4	7 pin miniature	6.3	0.15	250	10.5	—8.5	—	—	17	2200
6J5WGT	General Purpose Triode	Military Ruggedized	6J5GT	Standard glass	6.3	0.3	250	9	—8	—	—	20	2600
6J6W†	Dual AF-RF Triode	Military Ruggedized	6J6	7 pin miniature	6.3	0.45	100	8.5	Rk 50	—	—	38	5300
6SA7WGT†	Pentagrid Converter	Military Ruggedized	6SA7GT	Standard glass	6.3	0.3	250	3.5	Rg 20000	100	8.5	—	450 Conv. Cond. 1650
6SJ7WGT	Pentode RF Amplifier	Military Ruggedized	6SJ7GT	Standard glass	6.3	0.3	250	3.0	—3	100	0.8	—	—
6X4W†	Fullwave Rectifier	Military Ruggedized	6X4	7 pin miniature	6.3	0.6	Max. Peak Inv. 1250 Volts Max.		Io 70 ma.dc.				
12J5WGT	General Purpose Triode	Military Ruggedized	12J5GT	Standard glass	12.6	0.15	250	9	—8	—	—	20	2600
CK5654	Pentode RF Amplifier	Commercial Aircraft Ruggedized	6AK5W	7 pin miniature	6.3	0.175	120	7.5	Rk 200	120	2.5	—	5000
CK5670	Dual Triode	Commercial Aircraft Ruggedized	2C51	9 pin miniature	6.3	0.35	150	8.2	Rk 240	—	—	35	5500
CK5686	AF-RF Output Pentode	Commercial Aircraft Ruggedized	—	9 pin miniature	6.3	0.35	250	25	Per sec. —12.5	250	3	—	2700*
CK5694	Dual Power Triode	Industrial AF-RF Amp.	6N7G	Standard glass	6.3	0.8	294	7	—6	—	—	35	3200
CK5725	Pentode RF Mixer	Commercial Aircraft Ruggedized	6AS6W	7 pin miniature	6.3	0.175	120	5.2	—2	120	3.5	—	3200
CK5726	Dual Diode	Commercial Aircraft Ruggedized	6AL5W	7 pin miniature	6.3	0.3	Max. Peak Inv. 330 Volts Max.		Io 9 ma.dc.				

†Available during the latter part of 1949.

*2.5 watts Class A output. 10 watts Class C input power.

‡Note: All dual section tube ratings are for each section.

RAYTHEON Makes All These Tough Service Tubes
— and tens of thousands of them are daily
demonstrating their superior reliability and
stamina in commercial aircraft, industrial
and military service.

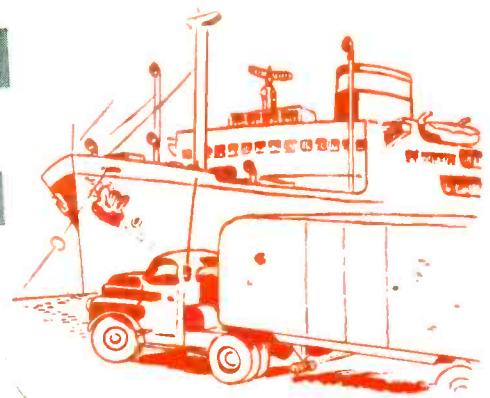

These Raytheon tubes are engineered and manufactured specifically for critical services where a single tube failure may lead to serious loss of life or dollars. We are interested in developing additional types for your tough service applications.

Over 300 Raytheon Special Purpose Tube distributors are ready to serve you on the above types. Application information on these tubes is available at Newton, Chicago and Los Angeles.

RAYTHEON

Excellence in Electronics

RAYTHEON MANUFACTURING COMPANY

SPECIAL TUBE SECTION • Newton 58, Massachusetts

SUBMINIATURE TUBES • SPECIAL PURPOSE TUBES • MICROWAVE TUBES • CATHODE RAY TUBES • RECEIVING TUBES

modulation. Beam voltage supply is adjustable in two steps from -800 to -3,600 volts d-c. Operation may be up to 1,500 volts at 65 ma or up to 3,600 volts at 25 ma. Reflector voltage is continuously variable from -20 to -750 volts.

Portable Amplifier

GENERAL ELECTRIC Co., Syracuse, N. Y. Type BA-6-A portable audio amplifier features four microphone



channels, each with an individual preamplifier, and a program amplifier which raises the signal to the level required for telephone transmission. Noise level is 70 db at normal fader positions, while distortion is less than 1 percent at 50 to 15,000 cycles. Frequency response under similar conditions is within 1 db.

Arc-Back Indicator

THE WALKIRT Co., 5808 Marilyn Ave., Culver City, Calif. Type M1111 arc-back indicator instantly identifies a failing tube since it indicates the first tube to pass inverse current and will not indicate in the

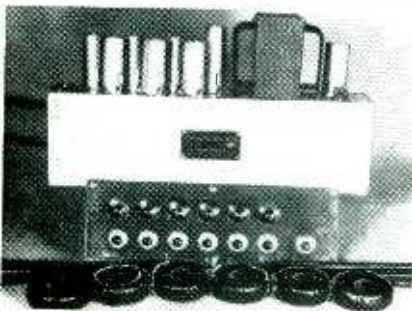

event of sympathetic arc-back in other tubes of the rectifier. It can be installed in existing rectifiers and is insulated from the rectifier for a test voltage of 45 kv rms. Circuits are included for six indicating positions. Complete information is available in a recent brochure.

Platter Recorder

PRESTO RECORDING CORP., Paramus, N. J. Type 66-G recorder has been designed for both standard and microgroove recording. It is



equipped with a dual-motor gear drive with overhead cutting mechanism and turntable of the type 6-N. List price is \$996 with \$70 additional for the microgroove feature.

UHF Interpolator

GENERAL RADIO Co., 275 Massachusetts Ave., Cambridge 39, Mass. Type 1110-A interpolator is designed for use with heterodyne frequency meters in making accurate

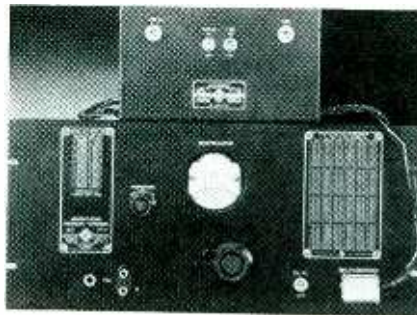

uhf measurements up to about 3,000 mc. The instrument provides a series of harmonics of a nominal 1-mc signal whose fundamental is adjustable over a range of 1 percent. When a frequency lying between 100 and 200 mc is measured approximately on a frequency meter, it can be matched and determined accurately using this unit.

Synchronous Motor

ELECTRIC INDICATOR Co., Stamford, Conn. Model GH-371 is a three-speed hysteresis-type synchronous motor for production and laboratory work. Operation is switch-con-



trolled providing clockwise or counter-clockwise rotation; it is not only reversible while running, but can also change from one speed forward to a different speed reverse. Rated at 1/100, 1/60 and 1/40 h-p, respectively, at 900, 1,800 and 3,600 rpm, the unit operates from 115 v, 60 cycle, single phase a-c. Technical data on this and nineteen other models are given in bulletin 49A.

Resonance Indicator

McMURDO SILVER Co., INC., 1249 Main St., Hartford 3, Conn. Model 915 resonance indicator is designed

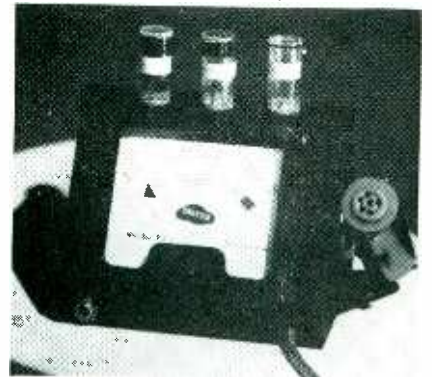

for use with model 906 signal generator. Employing three plug-in probe coils the instrument has a continuous frequency range from 100 kc through 300 mc.

Loudspeaker Safety

THE SIGNET DEVELOPMENT Co., 188 W. Randolph St., Chicago 1, Ill. Immediate applications for the fire and explosion-proof loudspeaker illustrated include mines, gasoline



(Continued on page 176)

TITANIC EARTH

TITANIUM
9th most plentiful element on earth



TITANIUM DISCOVERED

Back in 1791 an English clergyman, William Gregor, who liked to stroll and think on the beaches of Cornwall, became curious about the black sand he saw there. This gentleman of the cloth was also an amateur chemist and in this sand he discovered a new element. Almost coincidentally an Austrian named Heinrich Klaproth (also discoverer of uranium and zirconium) extracted the same thing from rutile and named it "Titanic Earth" for the mythical Titans. Hence our name Titanium.

Thereafter titanium was found in various places including the Ilmen Mountains of Russia (ilmenite) but although it is the ninth element in order of earthly abundance, it remained a mere laboratory curiosity until 1908.

TITANIUM OXIDE

At that time Dr. A. J. Rossi, expert in the reduction of metals, mixed titanium oxide with salad oil to make a white paint. In another 10 years a pure oxide was being produced which quickly won success as a pigment. Paint, false teeth, face powder, tires, shoes, glassware, textiles, inks, plastics, paper consumed an increasing tonnage of titanium oxide but still the pure metal was beyond industry's reach.

TITANIUM METAL & NATIONAL RESEARCH

Titanium is an affectionate metal, over fond of oxygen and nitrogen when at high temperatures. Even a fraction of a per cent of either makes titanium of little value as a structural material. Until recently there was no means of preparing titanium metal in a form sufficiently free of these elements to indicate any potential commercial value. Dr. W. J. Kroll of the Bureau of Mines has initiated many of the recent developments in titanium metallurgy by finding a means of preparing powdered titanium metal.

Only by exclusion of these gases can it be kept from embrittling combinations and when Remington Arms Company, a Du Pont subsidiary, laid its plans to produce metallic titanium in cast and rolled shapes, they knew that at National Research Corporation they could find the knowledge of vacuum technique that they needed.

The melting and casting of titanium was a natural for National Research. We planned the process, designed the equipment and installed it. Today this National Research Corporation pilot equipment is handling the highest quality of commercial metal — not much compared with aluminum — nothing at all com-

pared with steel — but so promising that millions will be spent by the industry within a few years to increase the quantity and lower the price.

USES OF TITANIUM METAL

Titanium stands fourth in abundance among the structural metals and there is plenty in the U. S. A. Tremendous strength, light weight, and remarkable corrosion resistance (comparable only to that of the noble metals) is a unique combination. Coming at a time when long-sighted people are viewing our metallic resources with alarm, it has an assured future. With the price pulled down to a few dollars a pound or less, titanium will be of primary importance to manufacturers of aircraft, automobiles, electric devices, gas turbines, superchargers, marine hardware, rockets, optics, jewelry.

WHAT NEXT?

So, with the help of National Research's high vacuum know-how, another material has been taken from the test tube to the factory. Where else can good men and ideas help — where can they help you? At National Research the best in brains, organization, equipment, and an unequalled accumulation of unique experience are available.

INDUSTRIAL RESEARCH PROCESS DEVELOPMENT
HIGH VACUUM ENGINEERING & EQUIPMENT
Metallurgy — Dehydration — Distillation — Coating — Applied Physics

NATIONAL RESEARCH CORPORATION

SEVENTY MEMORIAL DRIVE  CAMBRIDGE, MASSACHUSETTS

In the United Kingdom, BRITISH-AMERICAN RESEARCH, LTD., London S.W. 7, England — Glasgow S.W. 2, Scotland

NEWS OF THE INDUSTRY

Edited by WILLIAM P. O'BRIEN

FCC Issues Permanent Rules for General Mobile Radio Service

PERMANENT rules for general mobile radio services, recently announced by the FCC, become effective July 1, 1949. The new rules place short-wave radio operations of electric, gas, water and steam utilities in a new power utilities radio service, a subdivision of the FCC's industrial radio service.

Power utilities radio is assigned 42 frequencies for exclusive operation in three important bands. These include 11 exclusive frequencies in the 30 to 44-mc band, 22 in the 44 to 50-mc (former television channel No. 1) band, and nine in the 152 to 162-mc band. In addition, the service will share the 2292-kc frequency with other industrial

services; 4637.5 kc in daytime only; and 35.06, 35.10, 35.14 and 35.18 mc. The latter four frequencies are to be shared with the maritime mobile service, on a basis of no interference with the latter service.

For developmental use only, power utility radio will share 20 frequencies in the 456 to 458-mc bands, and may share 2450 to 2500 mc, 3500 to 3700 mc, 6425 to 6575 mc and 11700-12200 mc channels. Fixed stations in the power utility classification also may share the frequencies from 72.02 to 74.18 mc and 75.42 to 75.98 mc, provided they do not interfere with television on channels 4 and 5.

Present licensees in the power

utility and petroleum pipeline service may continue operations until their licenses expire, or until they request a modification. Their licenses then will be reclassified. Holders of Class 2 experimental service licenses must apply for their new classification no later than 60 days before their licenses expire, or by November 1, whichever is earlier. They may apply any time after July 1. All experimental grants in this group will expire November 1.

In addition to traditional electric, gas, water and steam utilities, the new power utility radio service will include cooperative organizations.

Petroleum pipeline radio service remains in the General Utility category under FCC's new rules. Transit utilities using short-wave communications were assigned frequencies in the Land Transportation Radio Service.

Ground Conductivity in Canada

THE ACCOMPANYING map showing ground conductivity in Canada is scheduled for inclusion by the FCC in their Standards of Good Engineering Practice Concerning Standard Broadcast Stations. The new map, prepared by the Canadian Department of Transport, is based on measured values contained in proofs of performance submitted by Canadian broadcast stations, on measurements made by CBC, and on orographical features and geo-

graphical formations.

The map represents mean values over large areas, and therefore cannot be used in making assumptions on conductivity in local areas. Where there are differences in conductivity on either side of the Canadian-U.S. border that cannot be explained by geophysical cleavages, the FCC proposes to treat such variations as real pending adjustment in U.S. and Canadian maps for such inconsistencies.

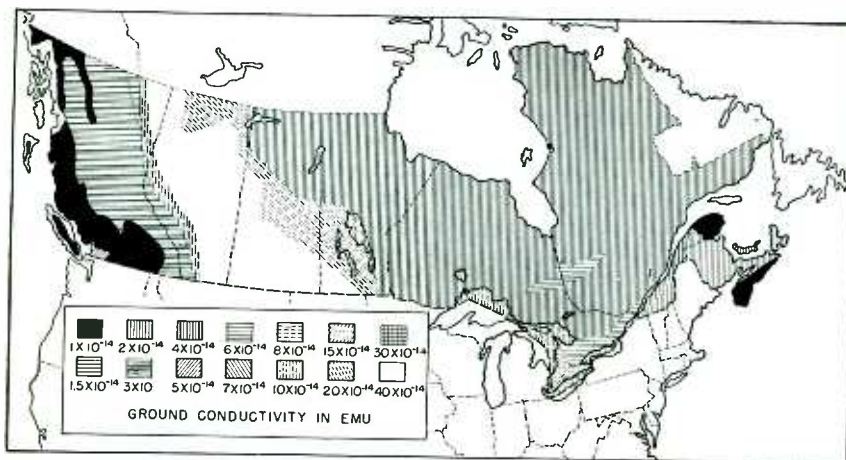

Average ground conductivity values in various sections of Canada. Conductivity in the prairie section is high, with local patches such as the Regina area going as high as 73. All lake areas appear to have values around 10

Citizens Radio Station Licenses

RULES for the licensing of citizens radio service stations were adopted by the FCC on March 30 and become effective June 1, 1949. After the effective date citizens radio licenses will be issued on a regular service basis, rather than under the commission's experimental rules as heretofore.

Under the new regulations licensing procedures are simplified, and persons desiring to operate type-approved transmitting equipment may apply on a single card form, soon to be available at the Commission's field offices and the Washington office. Generally, any citizen of the U.S. who is 18 years of age or older will be eligible. Licenses will be valid for a period of five years and are normally the only authorization required for operation of a station.

Possible uses of citizens radio stations are as communication on farms, such as between house and buildings or workers in remote locations, for outlying camps and work crews, and for industrial plants and construction projects. The service may also be used to communicate with vehicles within a limited area

115 VOLTS

regardless of line fluctuation



Automatic Voltage Stabilizers



Any piece of electrical equipment will operate better on steady input voltage. A quick, economical means of getting this is a General Electric Automatic Voltage Stabilizer. Small in size, it can easily be built into your equipment or apparatus to supply a constant 115 volts while line voltage varies from 95 to 130 volts.

There's no maintenance problem because these stabilizers have no moving parts—will operate continuously at open or short circuit without damage to themselves. Stabilization is virtually instantaneous (less than three cycles) and within ± 1 per cent for fixed, unity-power-factor loads. Ratings from 15 va to 5000 va.

Your local G-E office will be glad to help you evaluate your problem. Or we can advise you by mail if you will give us data and a description of the circuit and load. Inquiries invited about special units. For general information, ask for Bulletin GEA-3634B. *Apparatus Department, General Electric Company, Schenectady 5, N. Y.*

DO YOU MAKE— OR USE—ANY OF THESE?

Here are just a few of the applications where you may find a G-E automatic voltage stabilizer valuable:

- Radio Transmitters and radar equipment*
- Laboratory testing equipment and precision processes*
- Motion-picture projectors and sound equipment*
- Telephone apparatus*
- Precision photographic equipment and photometers*
- Phototube equipment*
- Calibration of electric devices*
- Color comparators*
- Electron-tube apparatus*
- Electro-chemical analysis*
- Rectifiers (full-wave)*
- Lighting circuits*

GENERAL ELECTRIC

and in an emergency when wire line facilities are ineffective.

Citizens radio stations will not be permitted to charge for messages, carry broadcast material or transmit directly to the public. Stations in this service will be able to communicate with each other, but not with stations in other services or with foreign stations.

Temporary operation of a station by persons designated by the licensee is permitted, but the latter must be in control of and responsible for the station at all times. Manually operated telegraphy in the service is permitted only to the holder of a radiotelegraph license.

Two types of citizens stations may be authorized, with the distinctions based on technical and operating specifications, including input power of 10 watts for one type and 50 watts for the other. All operation will be in the 460 to 470-mc band previously allocated to this service.

Eight-Station Mountain Top

SOUTHERN CALIFORNIA is experiencing a television rush, as may be verified by the photograph of the summit of Mount Wilson shown on page 139, *ELECTRONICS* for April. From this point, an area containing over $\frac{1}{3}$ of the entire population of California can be seen, and therefore reached by television. Transmission over a 130-mile radius is possible from Mount Wilson, allow-



Super turnstile antenna for KECA-TV takes its place among the clouds atop Mount Wilson 6,000 feet above Southern California

ing simultaneous transmission from Santa Barbara south to Balboa, California.

At the present time, six stations are operating from this lofty spot, and two more are under construction. All of these stations are within a half mile of each other, because of the restricted area available on the top of the mountain.

One of the newest and most modern installations on the mountain is the \$500,000 KECA-TV station for the American Broadcasting Company. As in all other Mount Wilson installations, quarters for the members of the transmitter staff are provided adjoining the transmitter building.

The transmitting antenna, which occupies the highest point on the mountain—6,000 feet above sea level, was built and erected by the C. D. Draucker Company of Los Angeles. For solid foundation support and added height, the tower is mounted on the station water supply tank. The super turnstile rests on top of the tower, some 303 feet above ground. The transmitting equipment for the KECA installation was especially designed by the General Electric company, with provisions for stepping up power without extensive changes. The transmitter employs low-level plate modulation and no high-level sideband filter is required.

It is expected that by the end of this year, all stations on the mountain will be in full operation, thus completing a television city—over a

MEETINGS

JUNE 20-24: AIEE Summer General Meeting, New Ocean House, Swampscott, Mass.

JUNE 27-29: Conference on Ionospheric Research, The Pennsylvania State College, State College, Pa.

JUNE 27-JULY 1: 1949 Annual Meeting of the American Society for Testing Materials, Chalfonte-Haddon Hall, Atlantic City, N. J.

AUG. 29-SEPT. 1: National Conference of Associated Police Communication Officers, Hotel New Yorker, New York City.

AUG. 30-SEPT. 1: Fifth Annual Pacific Electronic Exhibit sponsored by the WCEMA and the 1949 IRE western regional convention, Civic Center, San Francisco, Calif.

SEPT. 12-16: Instrument Society of America National Conference and Exhibit, Municipal Auditorium, St. Louis, Mo.

SEPT. 26-28: National Electronics Conference, Edgewater Beach Hotel, Chicago.

Nov. 14-18: 23rd NEMA Annual Meeting, Haddon Hall Hotel, Atlantic City, N. J.

mile up—overlooking Southern California.

Isotope Lecture Published

THE 1948 ASTM Edgar Marburg Lecture "Isotopes and Their Application in the Field of Industrial Materials" by Paul C. Aebersold, chief of the Isotopes Division, Atomic Energy Commission, has been published in the form of a 28-page booklet.

After some general comments on the significance and interrelation of atomic energy and industrial materials, the author discusses general research dividends, useful atomic power, induction of chemical and physical effects, and applications of radioactive and stable isotopes.

Copies of the booklet in heavy paper cover can be procured from ASTM headquarters, 1916 Race St., Philadelphia 3, Pa., at \$1.00 each.

Military Standards Agency Reorganized

Under the terms of a charter recently signed by the assistant secretaries of the three military services, the Army-Navy Electronic Standards Agency has been reconstituted as the Armed Services Electro Standards Agency. This provides for official participation by the Air Force, which became a separate component in 1947. The

(continued on page 211)

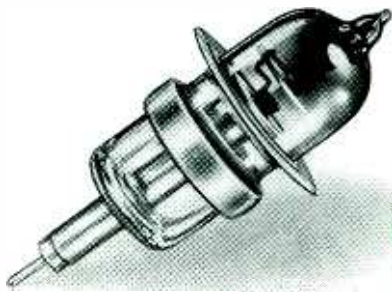

2C36
2C37
5764
5765



5766

for UHF...
Sylvania Rocket Tubes



5767

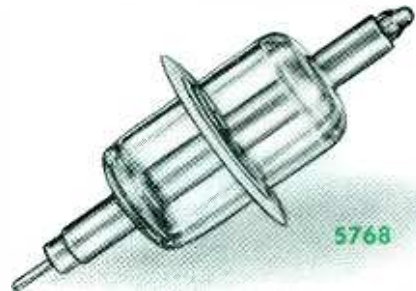

5768

Sylvania Rocket Tubes are especially designed for efficient operation at ultra-high frequencies. Whether you need amplifiers, or cw or pulsed oscillators, for operation at frequencies of 250 or 3300 mc, you'll find the types you need in Sylvania's line of Rocket Tubes.

The stretched, parallel-wire grid construction of these Sylvania tubes eliminates buckling — results in stable, uniform operation. Unique cathode design minimizes mechanical and electrical discontinuities in cathode structure. Disc-seal construction gives low inductance. Design permits continuous tuning over wide frequency ranges.

SYLVANIA ELECTRIC

ELECTRONIC DEVICES; RADIO TUBES; CATHODE RAY TUBES; PHOTOLAMPS;
FLUORESCENT LAMPS, FIXTURES, WIRING DEVICES, SIGN TUBING; LIGHT BULBS

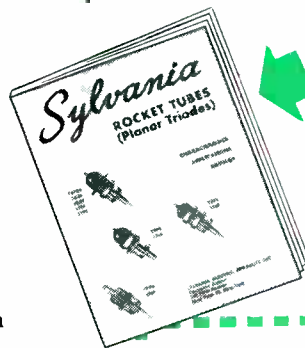

Bulletin gives characteristics, ratings and applications. Mail coupon for your copy.

Sylvania Electric Products Inc.
Electronics Division, Dept. E-2906
500 Fifth Avenue, New York 18, N. Y.

Gentlemen:

Please send me your bulletin, "Sylvania Rocket Tubes." I am also interested in receiving literature on your other products in the fields of:

- Communications, Television and Industrial Electronics
- Radioactivity Radar and Microwaves

Name.....
 Home Address.....
 City.....State.....
 Company.....
 Position.....

TWO NEW CTC TERMINALS PROMISE IMPROVED WIRING

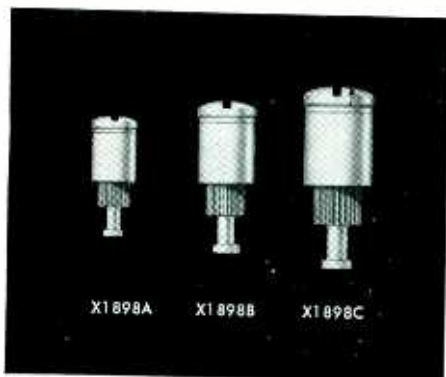

1. New Combination Terminal In 3 Sizes Has Variety of Uses

With a screw on top and a terminal lug on the bottom, this combination simplifies top and bottom wiring. Remove the screw and you can mount components directly to the screw end. Or, you can adapt this terminal to provide removable link connections at the screw end. Terminal is plated with bright alloy for corrosion resistance and ease of soldering. Mounting shank is heavily knurled for secure mounting into terminal boards.

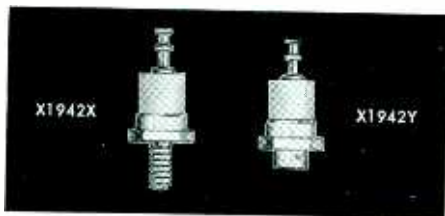

2. New Ceramic Stand-Off

The body of this stand-off is made of JAN-1-10-grade L-5 ceramic, silicone impregnated. This gives you a component with highly improved resistance to moisture and fungi, as well as higher dielectric properties. X Type has a 6-32 thread screw stud; Y Type has a rivet stud.

These and other *Guaranteed Components* are described at length in the new CTC #300 Catalog. Write for it today.

**Custom or Standard
The Guaranteed
Components**

CAMBRIDGE THERMIONIC CORP.
437 Concord Ave., Cambridge 38, Mass.

primary with respect to its secondary. An induction generator may be used as a speed measuring element; its output being proportional in amplitude to the speed of rotation of an aluminum or copper cup between an excited primary and the secondary winding.

A thermistor may be used as a temperature-measuring element; and a toroidal coil, which has a voltage output proportional to the current flowing through a wire which passes through the coil, may be used as a motor load-measuring element. Two typical complete control systems are described in the paragraphs below.

In pulverization, material is usually fed to the pulverizer by means of a motor-driven feed screw or vibrator. For obvious reasons, it is desirable to maintain maximum production without overloading the pulverizer.

Pulverizer Control

For this application, a toroidal coil is placed around one of the conductors to the pulverizer motor. The output of this coil is a voltage proportional to the pulverizer load. Referring to the circuit diagram, this coil is connected to the input terminals and, with the pulverizer motor drawing normal current, the sensitivity control is adjusted so that no voltage appears across the transformer secondary. As the load increases to overload, RE_1 operates initiating time delay 1. At the end of this delay, RE_3 operates. This latter relay is used to shut down the feed screw removing the feed to the pulverizer. (Time delay 1 prevents shut down from momentary, self-clearing overloads.) When the load

on the pulverizer drops to a prearranged value, RE_2 operates, starting the feed. If, on the other hand the pulverizer remains overloaded even after the feed is shut down, RE_1 and RE_3 remain operated and time delay 2 is initiated. At the end of time delay 2, RE_4 , which is connected to the pulverizer stop button, operates. This results in the complete shut down of the equipment.

If a variable-speed drive is connected to the feed screw, RE_3 and RE_4 may be connected to provide a floating control, using a torque motor to control the variable speed drive.

Pressure Control

In processes where considerable lag is involved, it is possible to use the time delays to provide a small correction followed by a delay corresponding to the system lag. After this delay, a further correction is provided, if the system has not returned to the control point, followed by another delay. This is continued until the system has returned to control.

This is illustrated by pressure regulation. In this process the pressure is adjustable by regulating the flow. This flow is controlled by a motor-operated valve.

The pressure is measured by an

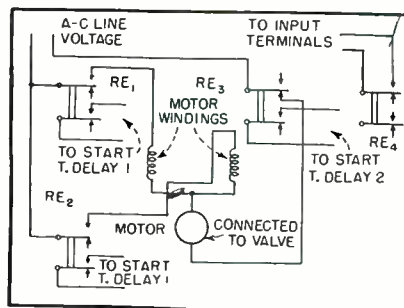

FIG. 4—Connections used for inching pressure control

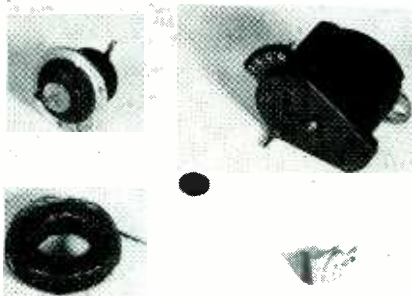

FIG. 3—Some measuring elements suitable for use with Flexi-Trol. They are toroidal coil, selsyn, induction generator and thermistor. Penny indicates relative sizes

autosyn connected to a pressure gage. The output of the autosyn is fed to the unit and the balance adjustment is rotated to give zero secondary voltage with the pressure at the control point. If the pressure increases, RE_1 operates. Referring to Fig. 4, which shows the valve motor and the relays, it will be noted that with the closure of RE_1 , the valve motor is energized. The motor continues to run until the end of time delay 1 when RE_3 operates disconnecting power from the mo-

tor. With operation of RE_3 , time delay 2 is also initiated. At the end of time delay 2, RE_1 operates. This relay is connected to short circuit the input terminals. As RE_1 operates, the input is shorted which results in RE_1 dropping out and consequently RE_3 and then RE_4 . After RE_1 has dropped out, if the pressure has not returned to the control point, the above sequence is repeated. This continues until the process has returned to the control point. For under-pressure, the operation is the same with RE_2 instead of RE_1 operating. Relay RE_2 is connected to operate the valve motor in the opposite direction and also to initiate time delay 1.

A review of the operations above will show that time delay 1 provides an inching control—in this case a motor operated valve—and time delay 2 provides a waiting period to see the effect of a correction before further corrections are undertaken. The time delays can be adjusted and range from 0.05 to 200 seconds.

Televise Dangerous Operation

ORDNANCE ENGINEERS now safely defuse, deboost, or disassemble hazardous high-explosive-filled bombs or projectiles from behind a protective barricade while keeping the operation under constant visual surveillance by means of a television viewing screen.

Personnel of the office of the Chief of Ordnance has always been confronted with the problem of how to protect individuals conducting highly technical and dangerous jobs of defusing, deboosting or disassembling explosive-filled ammunition items. All such disassemblies must be conducted with personnel behind a barricade and using tools which are manipulated from the safe side.

Early experiments involved the use of mirrors so arranged that engineers behind a barricade could observe the manipulation of the tools. These proved unsatisfactory because clear definition could not be maintained when personnel were removed to what was considered a safe distance from a potential ex-



You,
Too,

*can get
results like this*

... WHEN C. T. C.'s CUSTOM
ENGINEERING SERVICE
HANDLES YOUR PROBLEMS

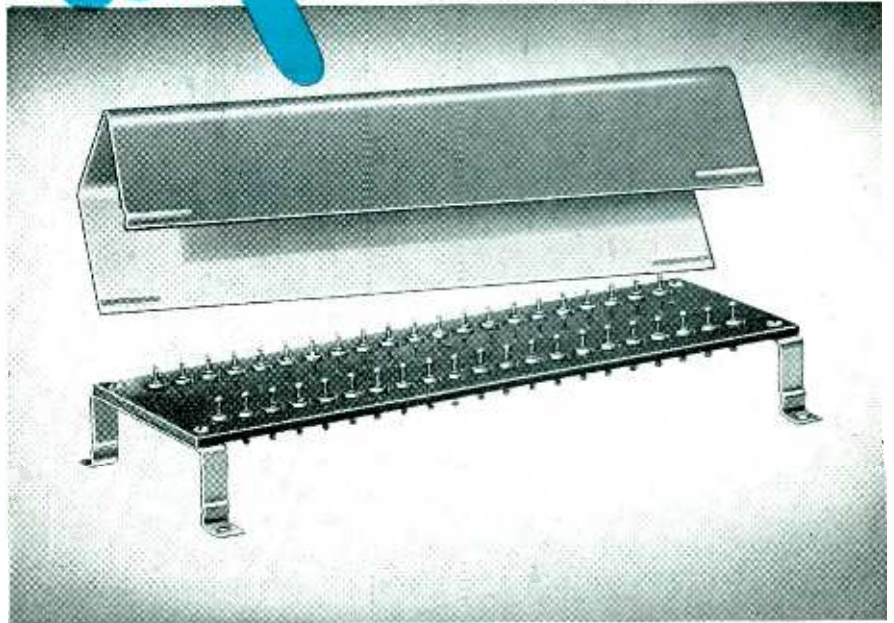

A snap-on covered multi-contact terminal board assembly constructed of approved materials to meet a client's special requirements

When one of our customers approached us with a terminal board problem a short time ago, the requirements were such that no standard board could be found to do the job.

And that's where C.T.C.'s Custom Engineering Service went to work. The result: the board you see above.

This is just one of many examples in which C.T.C. Custom Engineering has produced results for electronic and radio manufacturers. We are equipped to produce assembled terminal boards of almost any description using any approved material . . . terminal lugs designed and produced to your special requirements in any needed quantity . . . coils and chokes of whatever capacities and characteristics you may need.

C.T.C. is prepared to meet any special requirements you may have for terminal lugs.

Our engineers will gladly design lugs to fill your needs and produce them in quantity.



Hi Q oscillator coil — made to close tolerances mounts directly on band switch.

C. T. C. has helped many manufacturers in designing special coils and chokes to meet individual conditions. Can we be of service to you? We'll see your problem through from design board to production.



Combination lug. Screw on top . . . solder terminal below. Designed as a rugged swaged terminal for top & bottom wiring applications.

Custom or Standard The Guaranteed Components

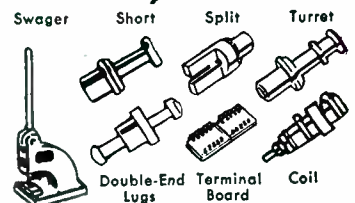

CAMBRIDGE THERMIONIC CORP.
437 Concord Ave., Cambridge 38, Mass.

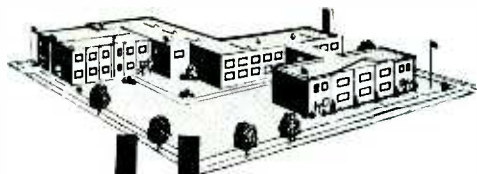

Shallcross

INDUSTRIAL RESEARCH and DEVELOPMENT

Today's complex and critical circuits frequently dictate a need for the design, development and production of highly specialized components, sub-assemblies or instruments which usually fall outside the realm of standard production.

Shallcross now makes available a group of development engineers who bring to bear a highly technical and practical approach on such problems.

Electronic, electrical, instrument, mechanical and chemical engineers make up this group. They in turn are backed by a broad experience in overcoming similar problems as well as by a wide variety of the necessary tools and equipment.

Recent assignments by leading manufacturers, public utilities and military agencies have resulted in highly unique and satisfactory products readily adapted to production requirements.

Among these can be found the following specialties:

- Rotary Switches
- Potted and Thermally
Controlled R-C Networks
- Precise Decades and Networks
for Computer Devices
- Calibrating Instruments for
Strain Gauge Bridges
- High Resistance Standards
- Critical Coil Assemblies
- Hermetically Sealed Chokes
- Potted Wheatstone Bridge Networks
- Hi-Voltage Measuring Equipment

The Shallcross Research Department invites you to submit your engineering requirement for review by this Engineering Service Group.

SHALLCROSS MFG. CO.

Engineers • Designers • Manufacturers

Dept. E-69

COLLINGDALE, PENNA.

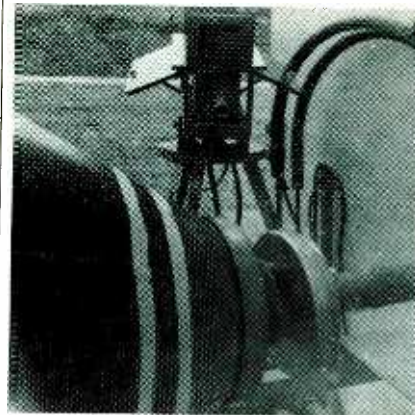

Television camera set up to view the coupling of a remotely controlled wrench to the nose of a bomb for defusing

pllosion of the projectile.

For the television method of observation, selection of the Remington Rand Vericon industrial television system was made. Construction of seven ammunition disassembly plants, using the Vericon system, has been completed and six more are under way. The system does not employ signals over the air but over a coaxial cable. The camera, receiver and power unit are all portable and require no expert or highly trained technicians to handle them. In many respects the image produced on the viewers is clearer than that of commercial television because there is no static interference in its transmission. The equipment is relatively inexpensive, both in original cost and maintenance, when compared to its commercial counterpart.

A single camera can transmit identical images to as many as ten

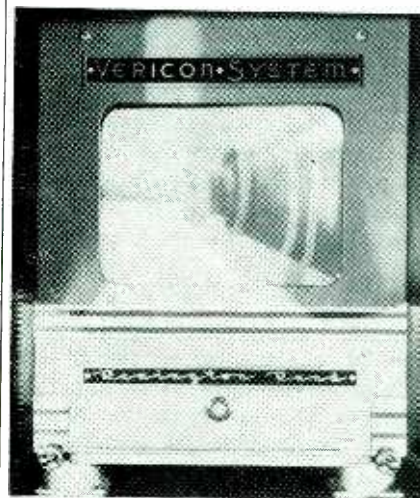

Safe in a protective shelter, the viewer sees this picture of the defusing operation on the screen of the c-r tube

DELTAMAX *-now available!*

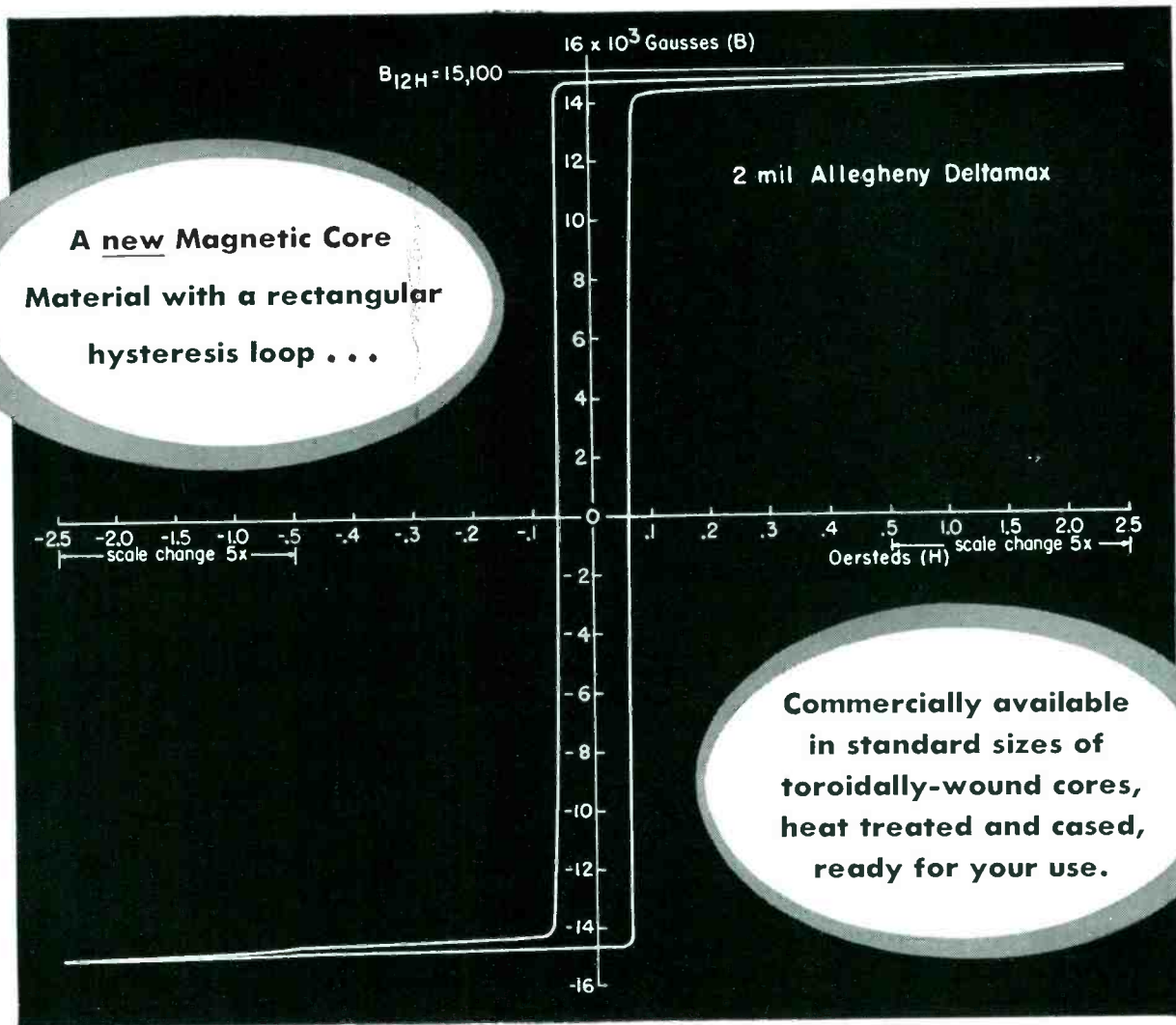

Where can YOU use a Magnetic Material with these specialized, dependable characteristics?

The properties of Deltamax are invaluable for many electronic applications, such as new and improved types of mechanical rectifiers, magnetic amplifiers, saturable reactors, peaking transformers, etc. This new magnetic material is available now as "packaged" units (cased cores ready for winding and final assembly) distributed by the Arnold organization. Every step in manufacture has been fully developed; designers can rely on

complete consistency in each standard size of core.

Deltamax is the most recent extension of the family of special, high-quality electrical materials produced by Allegheny Ludlum, steel-makers to the electrical industry. It is an orientated 50% nickel-iron alloy, characterized by a rectangular hysteresis loop with sharply defined knees, combining high saturation with low coercivity.

● *Call on us for technical data.*



THE ARNOLD ENGINEERING COMPANY

SUBSIDIARY OF ALLEGHENY LUDLUM STEEL CORPORATION
147 EAST ONTARIO STREET, CHICAGO 11, ILLINOIS

W&D 237D

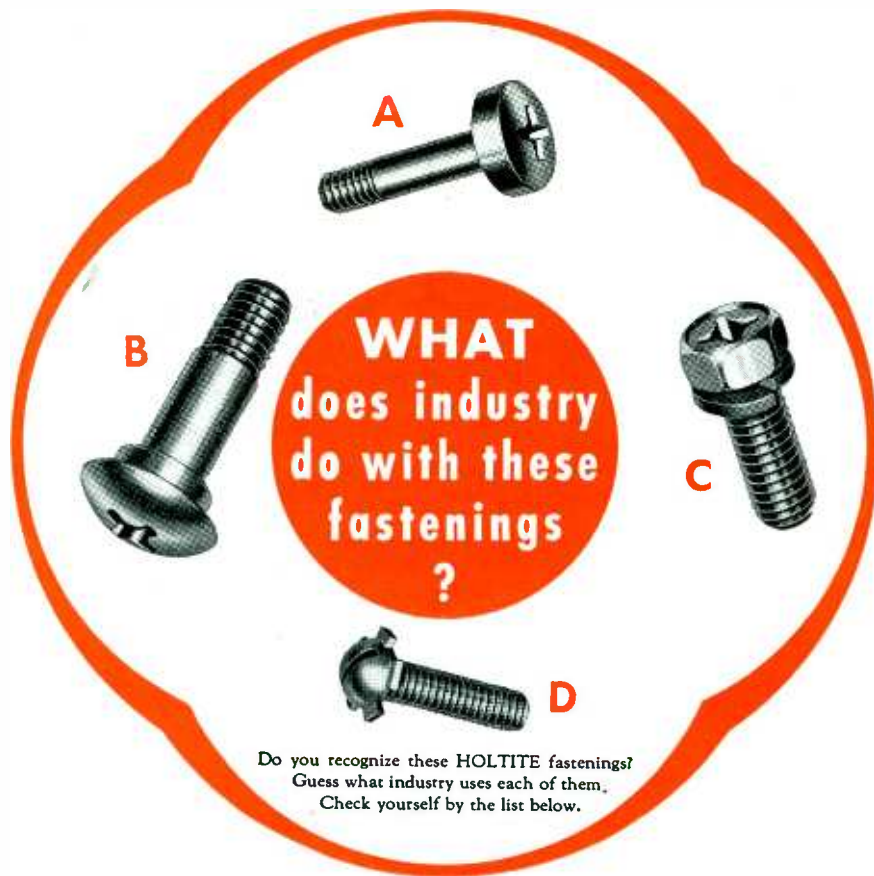

CONTINENTAL makes them all and thousands more

Of all the 400,000 varieties of fastenings that literally hold our industries together, Continental makes a large proportion marketed under the famous HOLTITE trade name. Most of them are standard — screws, nuts, and bolts for every use in every industry. Others like the well-known HOLTITE-Sems and HOLTITE-Phillips screws are patented specialties and the famous HOLTITE-Threadlock, Locktite and Tap screws were first designed and produced by HOLTITE. Sometimes a fastening engineered by HOLTITE for one industry finds an unexpected use in another. Often a HOLTITE-Engineered fastening will replace several parts that a manufacturer is using. Why not discuss your fastening requirements with a Continental Sales-Engineer. He will focus on your requirements all the broad industrial-fastening experience and ingenuity of Continental. Remember Continental is constantly improving HOLTITE products, lowering their cost and broadening service.

ENGINEERED FASTENINGS FOR PRODUCT ENGINEERS

A. This chrome plated Phillips screw used on passenger guard rails in busses has a special shaped head to dress up appearance and provide additional shear resistance.

B. A special shoulder on this unusual HOLTITE Phillips motor bus seat adjusting screw assures snug, rattle-free fit between vehicle body and driver's seat.

C. The Phillips head on this special HOLTITE-Sems bolt speeds initial driving. The hex head allows use of a torsion wrench for final adjustments and repair in the field. This unique design cuts assembly time on truck chassis by several minutes.

D. An example of a HOLTITE "Lock-Tite" screw. The screw and lock washer come in one solid piece. With but one part to handle, assembly steps up and waste drops to a minimum.

This Trademark
HOLTITE
T. M. REG. U. S. PAT. OFF.
means made by —

CONTINENTAL SCREW COMPANY

1904

NEW BEDFORD, MASS., U.S.A.

1949

TUBES AT WORK

(continued)

different viewers located at separate points. The pulse power generator can be located as far away as 100 feet from the camera. A viewer may be extended as much as a mile away from the master viewer, and the master viewer can be set up as far as 1,000 feet from the camera.

Slow-Speed Record Changer

BASIC operating details of the RCA 45-rpm record changer are illustrated in the accompanying drawing.

When the changer mechanism is actuated, the record-supporting shelves recede into the body of the spindle and, at the same time, the separator knives slide into the space between the first and second records, thereby keeping the other records on the spindle from falling. When the record to be played has fallen clear of the support shelves, these shelves again protrude and

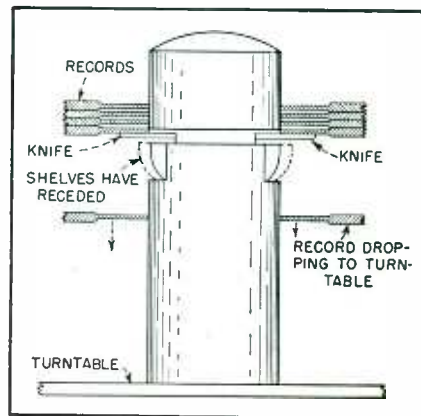

Eccentric-operated knife and shelf combination forms simple but speedy record-changer action on the 45-rpm unit

the knife separators are retracted into the spindle, allowing the remaining records to slip down onto the supporting shelves and making the unit ready for another changing operation.

Knife and shelf movement is caused by a pair of eccentrics mounted on a common shaft which runs axially through the changer spindle. This shaft is rotated at turntable speed by a small projection which mechanically couples the shaft to the turntable for one turn during the changing operation.

The spacing between records at

IN STABILINE INSTANTANEOUS ELECTRONIC VOLTAGE REGULATORS...

IT'S THE ATTENTION TO DETAIL THAT COUNTS

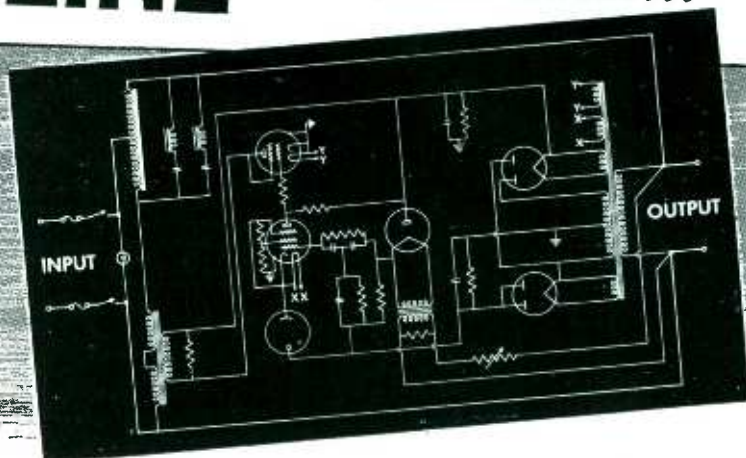

Attention to detail, from initial development to final inspection, is the "plus value" built into every STABILINE Type IE (Instantaneous Electronic) Automatic Voltage Regulator. It's your guarantee of superior performance and rugged construction. Compare these STABILINES with other voltage regulators. Your inspection will prove to you that every component of the STABILINE has been carefully selected and competently processed — from the iron core components to the black wrinkle-finished cabinet. A rigid performance test will prove that only the latest developments in circuit design — plus up-to-the-minute electronic theory and practice — have been incorporated. After a comparison we think you'll agree . . . *attention to detail counts.*

STABILINE VOLTAGE REGULATOR TYPE IE

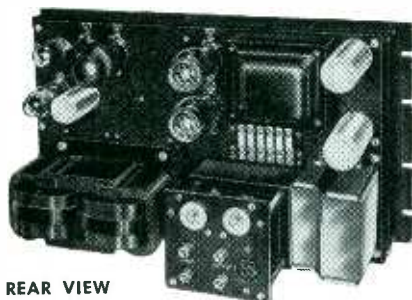

REAR VIEW

TYPE IE51005

Compact, well-organized construction — plus skillful manufacturing procedure — gives long, maintenance-free service. Superior workmanship means superior performance.

Type	Input Voltage Range	Output Voltage Range	RATINGS			
			Frequency in Cycles	Load Range in Amperes	Load Power Factor Range	Rated Output KVA
IE51002	95-135	110-120	60 ± 10%	0-2.1	+ .5 to - .9	.25
IE51005	95-135	110-120	60 ± 10%	0-4.3	+ .5 to - .9	.5
IE5101	95-135	110-120	60 ± 10%	0-8.5	+ .5 to - .9	1.0
IE5105	95-135	110-120	60 ± 10%	0-43.5	+ .5 to - .9	5.0
IE5202	195-255	220-240	60 ± 10%	0-11.0	+ .5 to - .9	2.5
IEL51005	95-135	110-120	50 ± 10%	0-4.3	+ .5 to - .9	.5
IEL52005	195-255	220-240	50 ± 10%	0-2.1	+ .5 to - .9	.5
IEL5101	95-135	110-120	50 ± 10%	0-8.5	+ .5 to - .9	1.0
IEL5201	195-255	220-240	50 ± 10%	0-4.3	+ .5 to - .9	1.0

THE NEW 250VA STABILINE TYPE IE

The new STABILINE Type IE-51002 is *portable!* It's easy to carry around the shop or laboratory. It possesses all the superior inherent characteristics found in all STABILINE IE's — self-contained in a portable 11½" x 11½" x 10¼" case.



Remember — when you have a requirement involving automatic voltage regulation — you're assured of the following characteristics only in a STABILINE Type IE and found in every standard STABILINE Type IE — "built-in" by SUPERIOR ELECTRIC: Completely electronic operation; waveform distortion *never* exceeds 3%; stabilization of ± 0.1 of 1% of preset value; regulation of ± 0.15 of 1% for any load current change from zero to full load, or any load power factor change from 0.5 lagging to 0.9 leading.

WRITE TODAY FOR COMPLETE DETAILS
4069 MEADOW STREET
BRISTOL, CONNECTICUT

THE SUPERIOR ELECTRIC CO.
BRISTOL, CONNECTICUT



POWERSTAT VARIABLE TRANSFORMERS • VOLTBOX A-C POWER SUPPLIES • STABILINE VOLTAGE REGULATORS

Ballantine's PEAK to PEAK Electronic VOLTMETER

Designed for
PULSE AMPLITUDE
MEASUREMENTS



MODEL 305

The outstanding characteristic of the Model 305 Electronic Voltmeter is its ability to provide absolute indication of transient or pulse voltages of short duration. Reliable indication of pulses a few microseconds wide repeated only 10 times per second is readily obtained with this instrument. The Voltmeter is pre-calibrated, compact, easy to operate and observe. Positive and negative peaks are registered over the range of .001 volt to 1000 volts, peak to peak. Decade ranges and a logarithmic scale output meter are characteristic features, along with a separately available high gain, wide-band amplifier.

Send for Bulletin No. 12

BALLANTINE LABORATORIES, INC.
BODNTON, NEW JERSEY, U. S. A.

TUBES AT WORK

(continued)

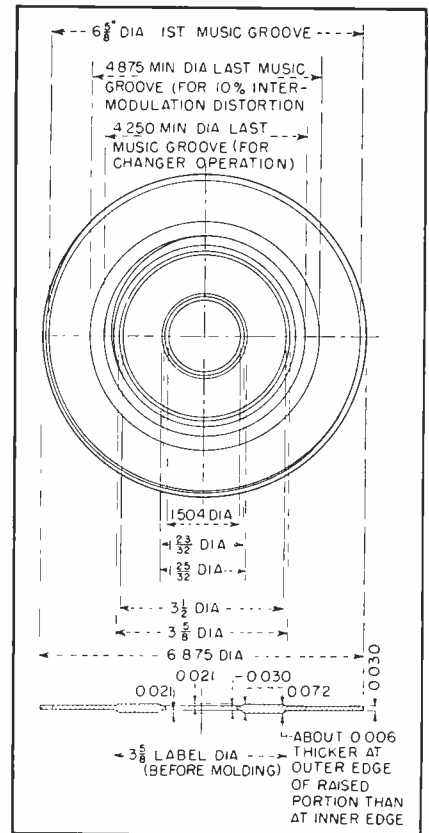

Dimensions and contours of the seven-inch record

the spindle periphery is created by a thick portion of the record which also spaces the records at the grooved portion, thereby preserving the grooved surfaces.

Complete data and dimensions of the seven-inch record are shown in the second drawing.

TV Matching Transformer

A SIMPLE solution to the 72-to-300 ohm matching problem, found so often in the television field, has been developed by The Workshop Associates, Inc., and is shown in the accompanying drawing. It is designed for use in the range of 50 to 225 mc, with vswr of 1.8 at 50 mc, 1.1 at 100 mc, and 1.3 at 225 mc. Voltage step-up is approximately 2 to 1.

The device consists of an r-f transformer with a specially designed Polyiron core. One end of the small aluminum container has a standard receptacle for RG-59/U 72-ohm coaxial cable, solderless connectors, and projecting out of the

Erie "GP" Ceramicons*

meet every demand for

**ECONOMY and
PERFORMANCE**

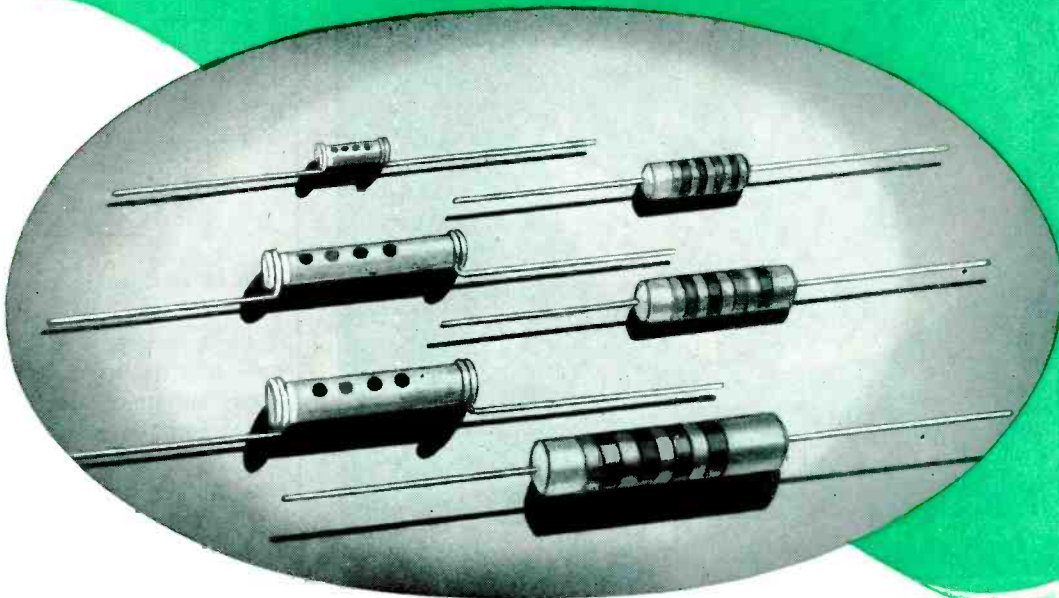

QUANTITY production of "GP" Ceramic Condensers is achieved by limiting them to definite capacity values — with a consequent saving in cost without affecting quality. For by-passing and coupling applications which are not frequency determining, "GP" Ceramicons are unexcelled in performance.

General Purpose Ceramicons are sturdy, compact. They are easy to install in small spaces and their use increases production on the assembly line. This feature is proving especially valuable in assembling TV sets.

Erie "GP" Ceramicons are made in insulated and non-insulated styles in popular capacity values up to 10,000 MMF. Write for detailed information and samples.

*"GP" and Ceramicon are registered trade names of Erie Resistor Corporation.



Electronics Division

ERIE RESISTOR CORP., ERIE, PA.
LONDON, ENGLAND TORONTO, CANADA

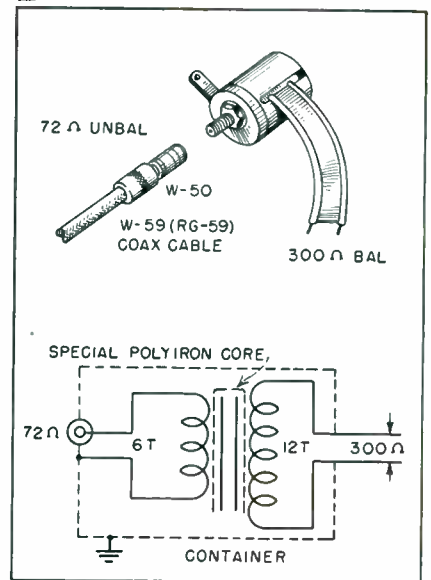

Matching transformer for television receiver antennas

side of the can is a 6-in. length of 300-ohm twin lead.

Thus receivers with 300-ohm inputs may be used with low-impedance antennas and transmission lines; and conversely, 72-ohm-input receivers may be used with balanced 300-ohm antenna equipment.

The physical shape of the device and the equivalent schematic are shown in the accompanying drawing.

High-Impedance Filament Transformers

HIGH-IMPEDANCE filament transformers are designed and manufactured to have much greater leakage inductance (or reactance) than the usual filament transformer. This type of transformer has one very useful property, it will limit the amount of current that may be drawn, particularly under short-circuit conditions.

Many transmitting tubes have filaments whose cold resistance is so low that short-circuit conditions are approached. Application of normal voltage to the cold filament would cause excessive current to flow which could damage or at least shorten tube life. The manufacturers of these tubes publish maximum values of current which should not be exceeded under any condition of operation.

High-impedance filament trans-



WARD LEONARD RESISTORS



**Resist Violent
Temperature Changes**

**because all parts are
MATCHED**

for thermal characteristics

Switch the temperature back and forth from 340 to -55°C , over and over, and still you won't affect the stability of Ward Leonard Vitrohm Resistors.

Reason is: Ward Leonard, making all components*, can control thermal characteristics so as to survive the greatest temperature variations.

Write for Vitrohm Resistor Catalog, Ward Leonard Electric Co., 31 South Street, Mount Vernon, N. Y. Offices in principal cities of U. S. and Canada.

*Vitreous enamel coating and ceramic cores formulated and made by Ward Leonard... wire drawn to Leonard's specifications.

**WARD LEONARD
ELECTRIC COMPANY**
Result-Engineered Controls

RESISTORS • RHEOSTATS • RELAYS • CONTROL DEVICES



Here's a Question

— with an unexpected answer!

Q: Can a reasonable gain be realized from a telephone repeater installed on a wire line over which a carrier system is operating *without* using a special balance network?

A: Yes—if a Kellogg Voice Frequency Telephone Repeater is used. The Kellogg Repeater with the standard No. 1 balance network will compensate for the low-pass line filter in the carrier terminal.

This is possible because of the skillfully engineered and manufactured No. 204-2 Filter Unit, which consists of two sharp cut-off, straight-walled, 300-2700 CPS band-pass filters.

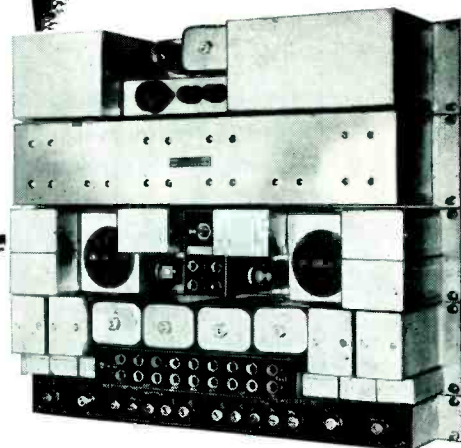
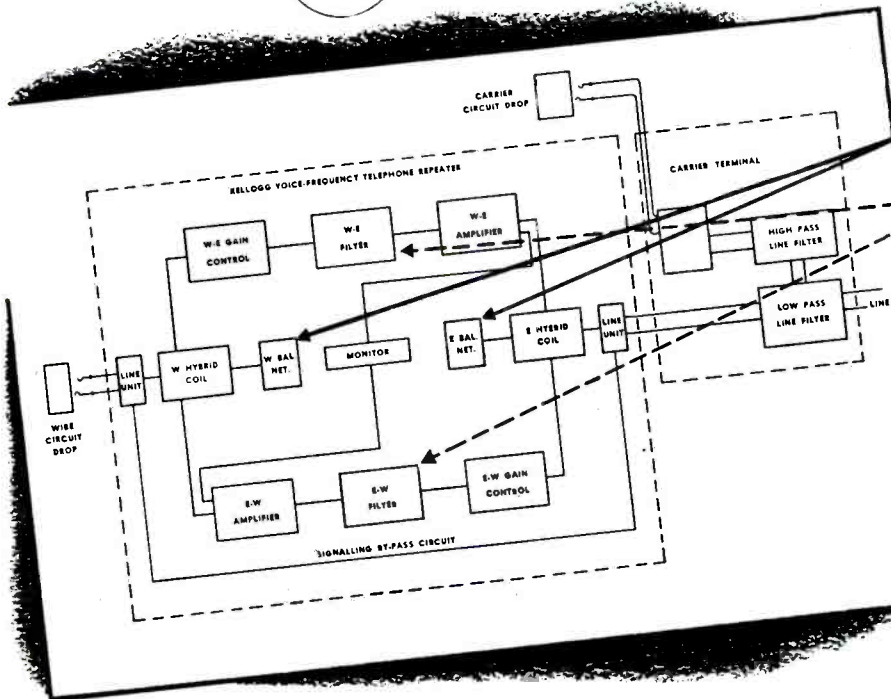

By limiting the band of frequencies to be passed and amplified, the No. 204-2 Filter allows maintaining a high degree of balance with a relatively simple network. It thus permits maximum repeater gain on circuits upon which a carrier system is superimposed and on heavily-loaded cable lines. The No. 204-2 Filter also produces a quiet circuit. Its use greatly attenuates any noise voltages outside of the pass-band, eliminates carrier leak and cross-talk and 60-cy. hum induced by adjacent power lines.

Stable balance is easily obtained with maximum ease in the Kellogg Repeater with continuously variable potentiometers and a series of small capacity steps. An ordinary screwdriver quickly makes all adjustments, with no need for strapping. Gain adjustments are accurately calibrated in 1-db steps so gain is always known without necessity for measurement.

"Unit" construction facilitates adaptation to various circuit requirements, while a variety of line units may be obtained for different circuit or signalling functions. Kellogg Repeaters are available for operation from 24V or 48V battery or from a 105-125V 60-cy. AC power source.

SEND FOR OUR REPEATER BOOKLET TODAY!

KELLOGG SWITCHBOARD AND SUPPLY COMPANY
Established 1897

6650 SOUTH CICERO AVENUE • CHICAGO

REPEATER

Kellogg Switchboard and Supply Company
6650 So. Cicero Avenue
Chicago 38, Illinois

Please send Repeater Booklet to:

NAME _____
ADDRESS _____
CITY _____ STATE _____

Wilco Tungsten Contacts and Contact Assemblies

TO MEET YOUR MOST EXACTING REQUIREMENTS . . .

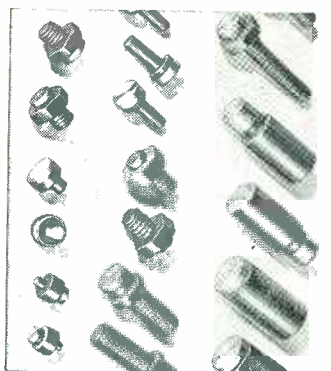

WILCO Tungsten Contacts

are made of 99.95% pure tungsten, thus assuring the highest melting point of any contact material . . . a hard, bright, oxidation-resisting finish, high density, maximum life, low vapor pres-

sure at elevated temperatures, high strength and arc-resisting properties.

WILCO Tungsten Contact Assemblies

Wilco tungsten contact assemblies are assembled to springs, blades, brackets, arms and screws (brazed, riveted, welded, spun) . . . conforming in size, shape and material to manufacturers' individual requirements . . . assuring the superfine quality found in all other WILCO contact materials.



SINTERED MATERIALS WILCO produces Sintered Metal Contacts and Contact Assemblies including Silver Molybdenum, Silver Tungsten, Silver Cadmium Oxide, Silver Tungsten Carbide and Copper Tungsten.

CONSULT OUR ENGINEERING DEPARTMENT . . . A representative of the WILCO Engineering Department will gladly help develop the proper application of WILCO materials to your products.

WILCO PRODUCTS INCLUDE: THERMOSTATIC BIMETALS: All temperature ranges, deflection rates and electrical resistivities. ELECTRICAL CONTACTS: Silver, Platinum, Tungsten, Alloys, Sintered Powder Metal. SILVER CLAD STEEL: For industrial use. NI-SPAN C* Constant Modulus alloy: JACKETED WIRE: Silver on Steel, Copper, Invar and many other combinations. SPECIAL ALLOYS: Including high conductivity, high strength Copper Alloys. ROLLED GOLD PLATE AND GOLD FILLED WIRE.

*Reg. Trade Mark, The International Nickel Co., Inc.

THE H. A. WILSON COMPANY

105 CHESTNUT STREET, NEWARK 5, NEW JERSEY
Branch Offices: Chicago, Detroit, Los Angeles, Providence



SPECIALISTS FOR 35 YEARS IN THE MANUFACTURE OF THERMOMETAL • ELECTRICAL CONTACTS • PRECIOUS METAL BIMETALLIC PRODUCTS AND SPECIAL ALLOYS

TUBES AT WORK

(continued)

formers are designed to limit the maximum current which may be drawn by the tube to values within the recommended limits. As the filament gradually comes up to temperature, its resistance increases until proper operating values are reached. The high-impedance filament transformer, during this warm-up period, allows the applied voltage to increase, with a decrease in current, until the correct operating values are obtained.

High-impedance filament transformers are generally designed with the primary and secondary coils spaced from each other and with iron shunts across the window between the coils. The spacing between coils, plus the shunts, account for the characteristics of these

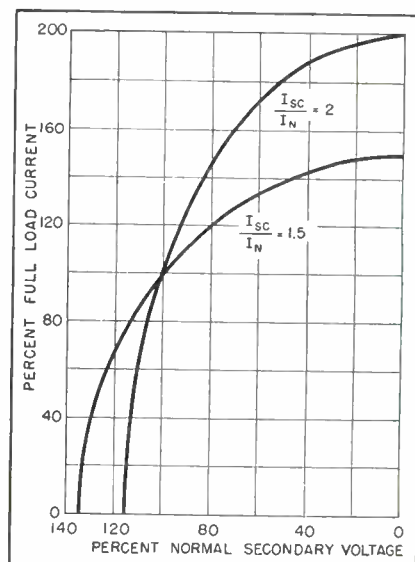

High-impedance filament transformer current-voltage characteristics for two common ratios of short-circuit current to normal load current

transformers. Such transformers are made by American Transformer Co. of Newark, N. J.

Briefly, under short-circuit conditions the flux travels through that part of the core which surrounds the primary and through the shunts, with only a small amount of flux linking the secondary turns. The small amount of flux that does link with the secondary is sufficient to cause the stated value of short-circuit current to flow. This current raises the temperature and the resistance of the filament. Due to the inherent characteristics of this type of transformer, as the load



*In a class
of its own*

**- because it's
PRECISION-BUILT**

A speaker of unique versatility. Designed and built with Goodman's tradition of excellence. Its performance and ideal frequency response have placed this unit in the forefront of medium heavy-duty loudspeakers.

SPECIFICATION

Type T2

- Overall Diameter..... 12.5/16"
- Overall Depth..... 6 3/8"
- Fundamental Resonance..... 75 c.p.s.
- Voice Coil Impedance..... 15 ohms at 400 cps.
- Maximum Power Capacity... 12 watts Peak A.C.
- Total Flux..... 145000 Lines.
- Net weight..... 12 lbs. 4 ozs.



GOODMAN'S

World-Famous

T2 12" P.M. LOUDSPEAKER
Fully Dustproof

GOODMANS INDUSTRIES LTD., Lancelot Road., WEMBLEY, Middlesex, England.

Reeves leads the field in

Servo Component Design

Designed originally for our own precision control systems, these high performance units are now available to all.

Reeves Servo Control Motors

60 cy



400 cy

Operating Directly off the output tubes of a servo amplifier, these specially designed 60 and 400 cycle control motors completely **eliminate** use of bulky output transformers . . . **eliminate** transformer losses . . . permit use of smaller amplifier tubes . . . save weight, space, cost . . . have high corner frequency . . . high torque to inertia ratio. A.C. tachometers available in combination with motors or separately.

Reeves 60 Cycle Electrical Resolvers



These newly developed units provide the most accurate and convenient means for solving trigonometric functions. The size 1 resolver, here illustrated, has over twice the accuracy of other available units — and is only $\frac{1}{3}$ the size and weight of present types! Each resolver is matched with its own small compensating booster amplifier for peak performance.

Reeves Functional Potentiometers

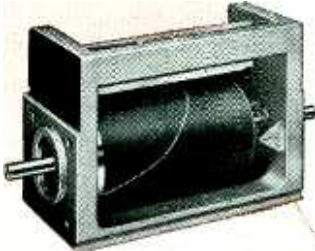

Potentiometer shaft rotation is transformed into a voltage corresponding to a rectangular or polar function. Any reasonable function may be easily installed with special function generating equipment in our plant. Function may be changed at any time by returning the potentiometer to Reeves with information on the new curve desired. Accuracy is within 0.05% at a 60° slope, and even finer at lesser slopes.

REEVES specializes in the development and manufacture of complete Electronic and Mechanical Control Systems, including Computing devices and Radar systems.

Reeves

INSTRUMENT CORPORATION

215 EAST 91st STREET • NEW YORK 28 • NEW YORK



For complete information write for catalog RICO-1A, "STANDARD INSTRUMENTATION PARTS AND SERVO-MECHANISM COMPONENTS".

impedance increases, more flux links with the secondary, thus raising the output voltage. The output voltage continues to rise and the current reduces because of increased load impedance, until proper operating values are reached. The accompanying curves show the output characteristics for the two most common ratios of short-circuit current to normal load current, that is, 1.5 to 1 and 2 to 1. In general, the physical size of high-impedance filament transformers increases as the ratio of short-circuit current to normal load current decreases.

Notes for Remote Viewers

REPORTS from readers indicate that a number of remote television viewers have been built of the types described in *ELECTRONICS* for December, 1948. Most popular are the

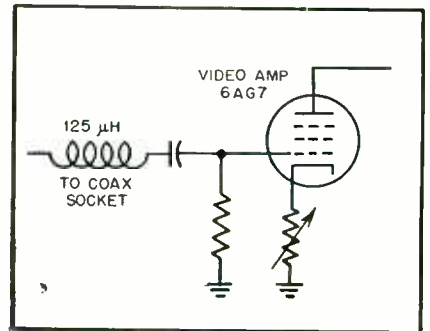

FIG. 1—When a viewer is connected to a very short cable a resistor or inductor may be needed at the input to the video amplifier to prevent oscillation

electrostatic types illustrated in Fig. 1 and 3 of that article. Further notes for the guidance of those who contemplate construction of the units for their own use are in order.

The slave viewer contains the vertical and horizontal deflection amplifiers, and these are driven by the respective oscillators at the receiver. Thus, if the receiver is turned off, the vertical and horizontal oscillators cease operating, and the slave amplifiers have no deflection-signal input. The electron beam then comes to rest at one point on the screen of the c-r tube and, if this condition should exist for a few minutes, a brown spot would probably develop on the

Airport Radio Beacon

ERCO RADIO LABORATOR-
IES, INC., Garden City, New
York. The ERCO Type 170-T

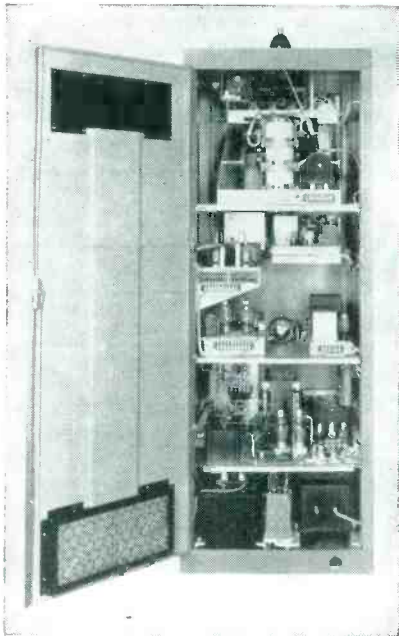

Transmitter is a versatile unit that serves as an airport radio beacon and can also be voice modulated. Indicative of the high quality of design are the 15 special KENYON Transformers used exclusively. Low hum modulation levels are assured by KENYON'S expert design of the telescopic, multi-shielded audio transformer, used in all low level stages. Ripple and regulation is always within specified limits on the power transformers and chokes. For more than 20 years KENYON Transformers have been specified by engineers for industrial, communication and electronic application. The KENYON organization is fully equipped to turn out "specials" to specification and size needs of individual jobs, at costs approaching catalog items. ERCO, too, specifies KENYON—for high quality, economy transformers.

Advertisement

Here's the "Q" in Transformers



It's **KENYON** Quality



*Custom-built
to your
Specifications*

KENYON one of the oldest names in transformers, offers you high quality specification transformers custom-built to your requirements — *practically at catalog prices!* For over 20 years the KENYON "K" has been a sign of skillful engineering, progressive design and sound construction.

KENYON "Specials" Are Designed For:

- | | |
|----------------------|---------------------------|
| JAN APPLICATIONS | AUTOMATIC CONTROLS |
| BROADCAST | AUDIO AMPLIFIERS |
| INDUSTRIAL MACHINERY | EXPERIMENTAL LABORATORIES |
| RADAR | ATOMIC ENERGY EQUIPMENT |

Among many others

Consult our engineering staff on any of your "special" problems at no obligation to you. Call or write now for our representative.

KENYON "Y's"— famous line of high quality, uniform transformers are ready for immediate delivery from stock. Our standard line can save you much time and expense. For a complete story about specific ratings on all transformers, send for your copy of the latest KENYON Catalog edition now!



KENYON TRANSFORMER CO., Inc.

840 BARRY STREET

NEW YORK 59, N. Y.

**SEND
FOR
LATEST
CATALOG
NOW!**

KENYON Transformer Co., Inc.
840 Barry Street, New York 59, N. Y.

Send me the latest edition of your new catalog without obligation.

Name..... Address.....

Position..... City..... Zone.....

Company..... State.....

We need "special" transformers —

Please have your representative call

WEBSTER ELECTRIC

Featheride TONE ARMS

That Meet the Requirements of
33 $\frac{1}{3}$, 45 and 78 RPM Records



MODEL
V1F16

Here is a new lightweight arm for playing 33 $\frac{1}{3}$, 45 and 78 RPM records. Cartridge rotates 180° to present the proper needle for standard or long-playing records, and locks in position. Tracking pressure is 7 grams in either position.

The illustration shows method of turning cartridge.

SPECIFICATIONS

APPLICATION: 33 $\frac{1}{3}$, 45 and 78 RPM record players

NEEDLE: Replaceable osmium-tipped. Single set-screw releases both needles

TRACKING PRESSURE: 7 grams on both needles

ARM CONSTRUCTION: Aluminum die-cast. Spring counterbalanced for 7 grams pressure

CARTRIDGE CONSTRUCTION: Stamped aluminum half shells with front bracket extending through front of pick-up arm to permit rotating the cartridge

TERMINALS: Pin type, grounded or ungrounded

OUTPUT: 1 volt, 1000 cps

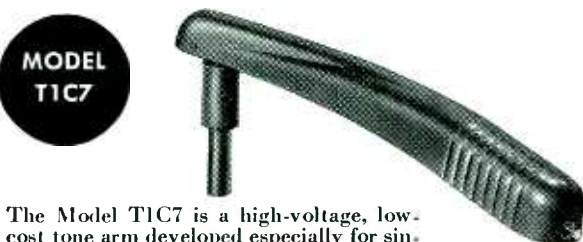

MODEL
T1C7

The Model T1C7 is a high-voltage, low-cost tone arm developed especially for single-play record players. It is streamlined in design and attractively finished. The rigid steel construction eliminates torque and resonance problems.

SPECIFICATIONS

APPLICATION: 78 RPM record players

TRACKING PRESSURE: 1 $\frac{1}{4}$ oz. minimum

OUTPUT: 3 volts, 1000 cps

ARM CONSTRUCTION: Stamped steel housing. Tinnerman fastening

COLOR: Antique copper tone

NEEDLE: Any standard type
LEAD WIRES: Plastic-covered—20 in.



MODEL
BA-1

This new tone arm of stamped aluminum, with an over-all length of 5 $\frac{1}{2}$ ", is ideally suited for use on player units designed for playing the new 7" records, either 33 $\frac{1}{3}$ or 45 RPM. It incorporates the model A-1 miniature cartridge exerting a tracking pressure of only 7 grams without use of spring counterbalance.

SPECIFICATIONS

APPLICATIONS: 7" recordings (33 $\frac{1}{3}$ or 45 RPM)

ARM CONSTRUCTION: Stamped aluminum

COLOR: Optional

CARTRIDGE CONSTRUCTION: Bakelite half shells

TERMINALS: Pin type

NEEDLES: Replaceable, osmium- or sapphire-tipped.

LEADS: Optional

TRACKING PRESSURE: 7 grams

OUTPUT: 1 volt, 1000 cps.

TUBES AT WORK

(continued)

screen. To prevent this the slave viewers should be turned off before the master unit, or better yet, the power switch on the master viewer or receiver should open the power line to the slave units.

Some difficulty has been experienced by the author when a very short video cable has been used to connect an independent electrostatic viewer. Use of one of these as a test picture unit on a bench alongside of some experimental front-end

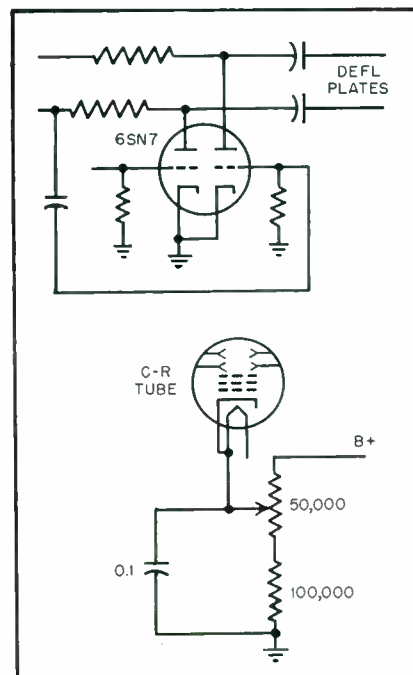

FIG. 2—Corrected circuits of the deflection amplifiers and brightness control

and i-f strips required only a five-foot length of cable. For the first five minutes of heating time oscillation was encountered in the video amplifier in the viewer.

Quite by accident it was discovered that the oscillation seriously interfered with a nearby receiver tuned to channel 7.

Search with a grid-dip oscillator disclosed that the plate leads of the video amplifier resonated around 175 mc and formed a high-Q circuit. Overcrowding of the deflection circuits around the video amplifier made it impractical to reroute leads quickly, so another solution was found.

Complete stability was achieved by insertion of a choke or a resistor between the coaxial input plug and the input coupling capacitor, as

WEBSTER ELECTRIC

RACINE



WISCONSIN

Established 1909

Export Dept. 13 E. 40th Street, New York (16), N. Y. Cable Address "ARLAB" New York City

"Where Quality is a Responsibility and Fair Dealing an Obligation"

If you manufacture Electronic Equipment...

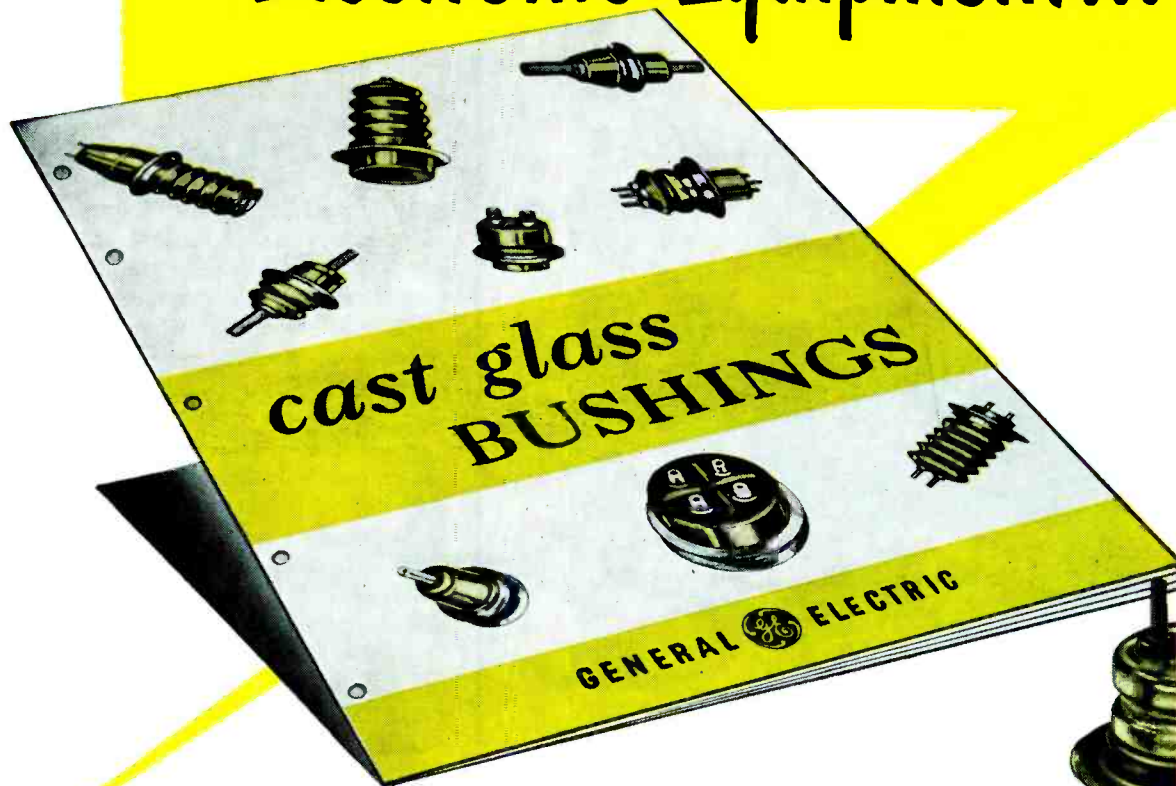

you'll want this NEW bulletin on glass bushings

General Electric is now offering to other manufacturers the cast glass bushings it has used so successfully on many types of electrical equipment.

These bushings are cast of a stable, low-expansion glass. Metal hardware is a special nickel-alloy steel, fused to the glass in casting. Bushings can be attached directly to the apparatus without gaskets—by soldering, welding or brazing.

The resulting joint between bushing and equipment is permanent, vacuum-tight, and of high mechanical strength. It is especially desirable for equipment subject to vibration, shock, attack by fungus growth or severe changes in temperature. It eliminates moisture problems and often permits more compact, light-weight design of equipment.

Our new bulletin, GEA-5093, contains a complete listing of standard designs now available—giving withstand voltages, current ratings and physical dimensions. A copy of this bulletin is yours for the asking. Just write *Apparatus Department, General Electric Company, Schenectady 5, New York.*

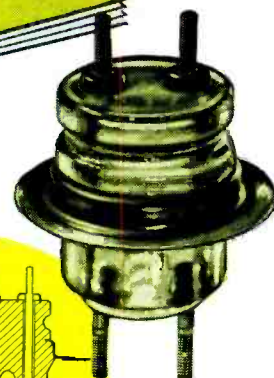
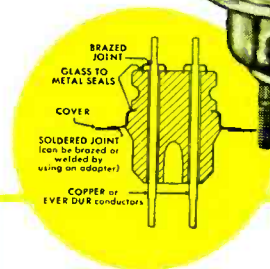

Glass bushings are currently available to meet dry, 60-cycle, flashover values of from 10 to 50 kv, and in current ratings of 25 and 50 amperes (large sizes up to 800 amperes). They may be single or multi-conductor and can be provided with a top flange to permit mounting tube sockets directly on the bushings. Diameters range from 1 5/8 to 3 3/8 inches and weight from 2 1/2 oz. to 4 lb.

GENERAL ELECTRIC

401-57

An analysis of field requirements prompted the redesign of this new beta gamma survey meter

The 263-B

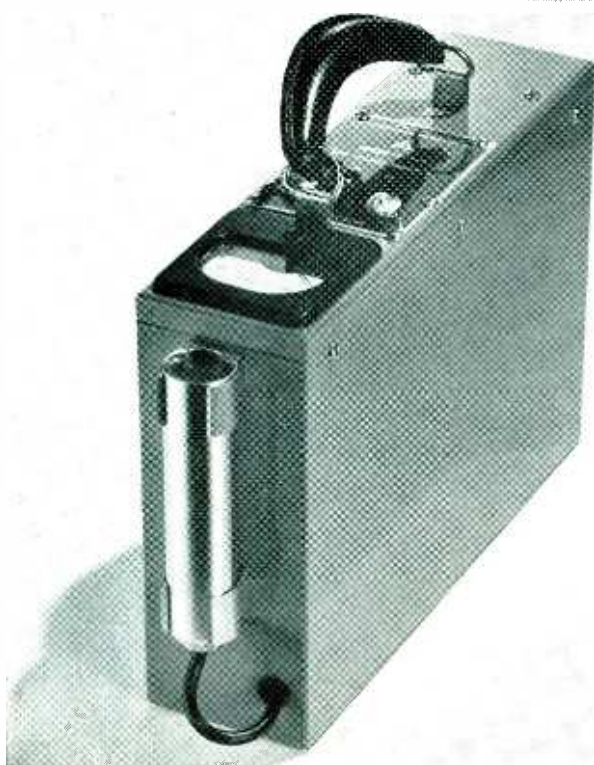

The 263-B portable beta and gamma survey meter utilizes the results of field recommendations to produce a more stable—compact—sturdy—sensitive counter.

- It uses the new 1B85 counter tube for greater uniformity.
- A new watertight probe has been added with 360° angle sensitivity.
- It uses the new 5828 vacuum tube for greater reliability.
- It has provisions for independent calibration of the three sensitive ranges.
- Calibration ranges 20.0—2.0—0.2 milliroentgens with gamma radiation from radium.
- A pulse shaping diode provides linear calibration.
- A lowered center of gravity by 1½ inches improves handling stability.

The 263-B is an instrument designed to meet the exacting demands of today.

Victoreen 5806 HOUGH AVENUE
CLEVELAND 3, OHIO

shown in Fig. 1. A resistance value from 3,000 to 20,000 ohms was satisfactory, but the inductor had the added advantage of noticeably increasing high-frequency response.

Attention must be called to drafting errors in the circuit of Fig. 3 in the original article. The plate circuits of the deflection amplifiers should be connected as shown in Fig. 2 on the preceding page. The brightness control in the cathode-ray tube circuit should connect to the B+ line and its arm should be bypassed as in the diagram.

The electromagnetic viewer (Fig. 5 of the original article) contained a 6SK7 for sync separation. With some tubes of this type sync jitter will be apparent when printed matter is received on the picture tube. Although selection of tubes may overcome the condition, substitution of a 6AC7 for this stage is an easy solution. The supply end of the 6,000-ohm plate resistor should be bypassed to ground through a 0.25- μ f capacitor. If an additional tube can be tolerated, the double-triode and diode clipper circuit used in a number of conventional receivers can also be substituted for the pentode separator. Simplified versions of afc sync that have appeared recently are also adaptable.

Antennas Over Minneapolis

OVERLOOKING MINNEAPOLIS, this combination of antennas provide seven different services without

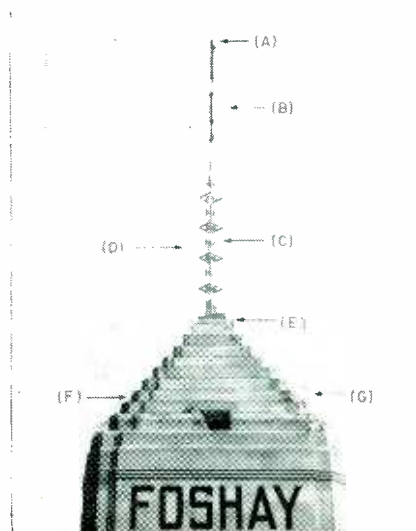

Seven different services are broadcast from this tower. See text for explanation of letters



Consider
 the possibilities of
 this combination of
**DU MONT
 CATHODE-RAY
 EQUIPMENT**

**TYPE 263-B
 HIGH-VOLTAGE POWER SUPPLY**

◆ The Type 263-B High-Voltage Power Supply is designed to complement the Type 250-H Cathode-ray Oscilloscope, a slightly modified version of the Type 250. This combination operates the Type 5RP-A Cathode-ray Tube in the Type 250-H instrument at accelerating potentials as high as 13,700 volts, permitting the photographic recording of writing rates as high as 40 inches per micro-second. The light output of the Type 250-H with the Type 263-B is 12 times greater than that of the Type 250 alone.

**TYPE 250
 CATHODE-RAY OSCILLOGRAPH**

◆ An excellent general-purpose cathode-ray oscilloscope designed for observing and recording recurrent and transient phenomena. Contains both a-c and d-c amplifiers. Linear sweeps, driven and recurrent, from 1 cycle to 150 kc with automatic beam blanking on driven sweep. Deflection factor through a-c amplifier, 0.015 rms volt/in. max.; through d-c amplifier, 2 d-c volts/in. Built-in calibrator permits quantitative measurements. The high-current Type 5CP-A Cathode-ray Tube is operated at 3000 accelerating volts in this instrument to provide brilliance adequate for nearly all laboratory work.



**TYPE 2542
 PROJECTION LENS**

◆ With the addition of Type 2542 Projection Lens, the Type 250-H becomes a projection oscilloscope capable of projecting its trace up to 30 feet for a picture size as large as 12 feet square. Advantages of such projections for lecture or demonstration work are readily apparent.

◆ Lastly, the Du Mont Types 271-A and 314-A Oscilloscope-record Cameras may be readily mounted on the Types 250 and 250-H for permanent recording.

The Types 5CP-A and 5RP-A Cathode-ray Tubes used in these instruments are manufactured by Du Mont, as are the cathode-ray tubes used in all Du Mont instruments.

DETAILED LITERATURE
 ON REQUEST
 EQUIPMENT
 DEMONSTRATED
 No obligation

© ALLEN B. DU MONT LABORATORIES, INC.

DU MONT *for Oscillography*
 ALLEN B. DU MONT LABORATORIES, INC., PASSAIC, N. J.
 CABLE ADDRESS: ALBEEDU, NEW YORK, N. Y., U. S. A.

INSTRUMENT DIVISION • 1000 MAIN AVENUE • CLIFTON, N. J.

cross-interference; and according to reports on operation, each one is doing the job for which it is intended.

The whip mounted at the very top next to the beacon light (A) and the one mounted at the base of the super-tower (E) are used by KNGL, the Minneapolis mobile broadcasting service which operates on 153.53 mc, with 50 watts of f-m. The three-bay super turnstile transmits the video and aural signals of WTCN-TV (B), while immediately below that is the WTCN f-m transmitting antenna (C). The long-wire running diagonally from the middle of the tower to the top of the building (D) is WAFY's broadcast relay transmitting antenna which operates on 1,606, 2,022 and 2,102 kc (2,758 for talkback to KNGL mobile truck) with 50 watts a-m.

The parabola on the right-hand side of the building (G) is WXXK's television relay antenna which operates in the frequency range 6,950 to 6,975 mc—power 0.01 watt. Hidden behind the building (F) is another television relay parabola which operates under the same conditions as (G). WTCN-TV, f-m and other equipment, is located on the 28th floor of the building.

Tubes At Play

RIDERS who were unfortunate enough to take a toss at the Stow Maries (Essex) Point-to-Point Meeting (fox hunt simulation) held on Easter Monday, got first-aid and ambulance service with the utmost promptitude and despatch. Ambulance men, stationed at strategic spots around the course, were equipped with Marconi walkie-talkie sets. The St. John's Headquarters has a radio-equipped ambulance and all the St. John's personnel on duty at Stow Maries were able to keep in constant touch with the ambulance and each other.

When an accident occurred, this special radio network enabled help to be summoned immediately, thus saving precious minutes which may prove vital. The ambulance service at this meeting was probably the quickest on record.

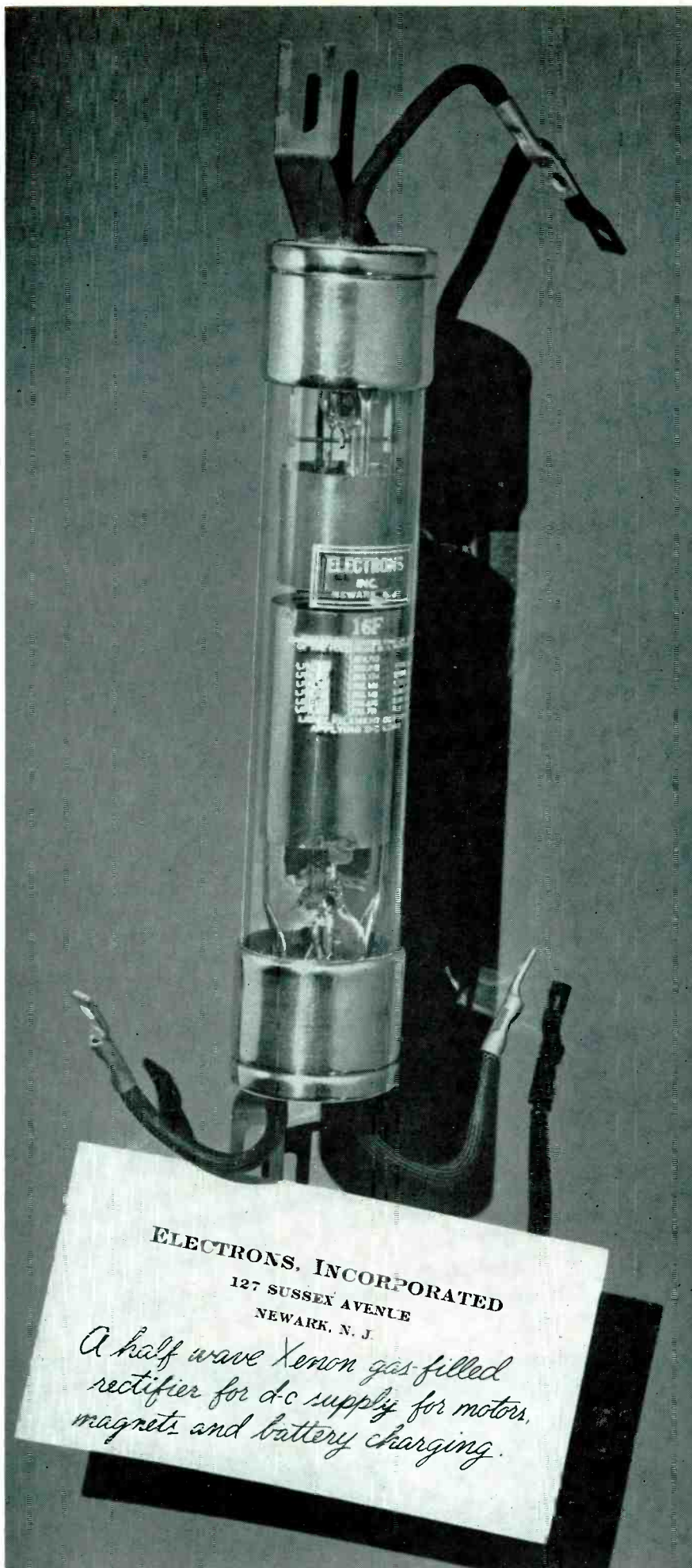

ELECTRONS, INCORPORATED
127 SUSSEX AVENUE
NEWARK, N. J.

*A half wave Xenon gas-filled
rectifier for d-c supply for motors,
magnets and battery charging.*

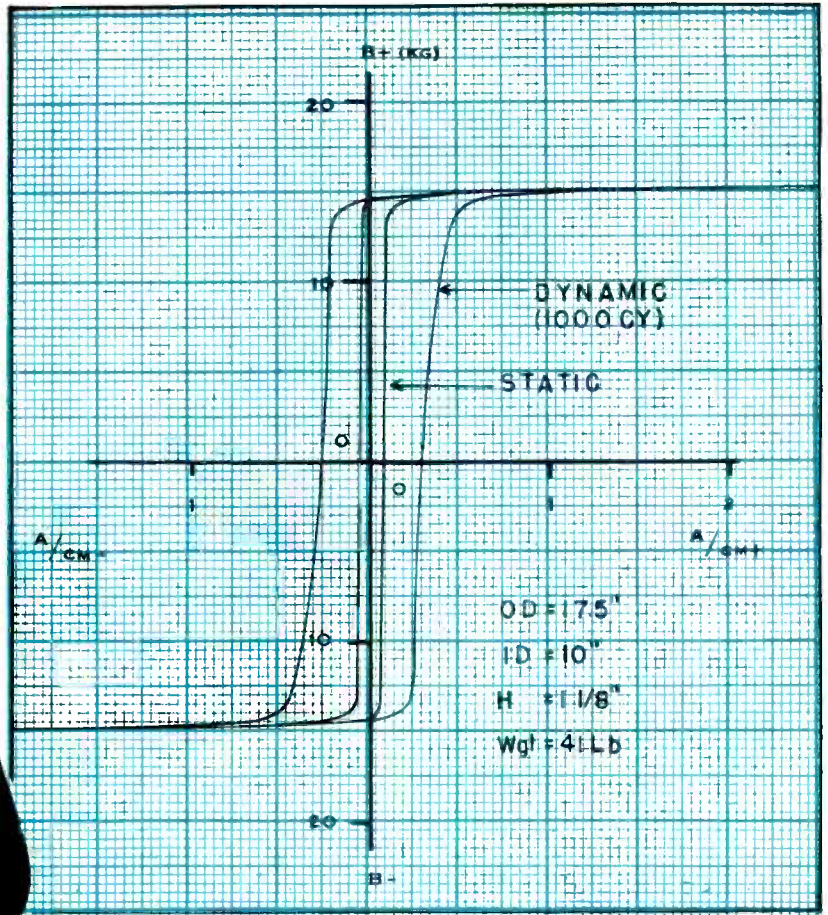

Take another look at Permeron*

... I-T-E'S NEW MAGNETIC CORE MATERIAL

Get the full significance of the static and dynamic (1000 cycle) magnetization characteristics of this new alloy. Examine the dynamic curve particularly — as this indicates how the material acts under actual operating conditions.

Note these facts:

1. Magnetic saturation is achieved with only the slightest change in magnetizing current.
2. The extremely low magnetizing current makes it possible to build smaller magnetic amplifiers of extreme reliability.
3. The knees of the saturation curve are sharp, even at higher frequencies.
4. The most important fact: all Permeron cores have identical magnetization charac-

teristics. The dynamic characteristic of each core is checked by a "Vectormeter," specially developed for this purpose. This consistency allows designers to predict amplifier performance accurately and positively.

Permeron Cores are available now

in widths of 20 mm. and 30 mm., in any specified inside and outside diameters. Cores are delivered heat treated and insulated. They are always furnished in housings designed to protect the magnetic material against deformation.

Take Another Look at Permeron — and continue to look to I-T-E to bring you better equipment and better designs . . . first!

* Formerly known as "Permanite"

For Additional Information write — I-T-E Rectifier Division or consult your local I-T-E Representative

I-T-E PERMERON

I-T-E CIRCUIT BREAKER COMPANY

19th AND HAMILTON STREETS, PHILADELPHIA 30, PA.

SWITCHGEAR • UNIT SUBSTATIONS • ISOLATED PHASE BUS STRUCTURES • RESISTORS • SPECIAL PRODUCTS • MECHANICAL RECTIFIERS

in oscillators and tuned circuits are readily applicable to receiver local oscillators, signal generators, and any other circuit where high-stability r-f energy is required.

Characteristics of Deltamax

BY W. S. SPRING
Electrical Engineer
Allegheny Ludlum Steel Corporation

TO OBTAIN optimum performance from a magnetic amplifier, the core material should saturate at as low a magnetizing force as possible to minimize control power. It should also saturate at as high an induction as possible, to reduce the size of the core since its volume will be inversely proportional to the flux density. The knees of the hysteresis loop should be as sharp as possible to develop maximum a-c voltage across the load. Since cores are generally used in matched pairs in magnetic amplifiers, it is essential that their magnetic characteristics should be as near identical as possible. In short, the core material must be consistent. The core losses must be kept at a minimum to prevent power loss and a change of output power as affected by the hysteresis loss.

A new oriented 50-50 nickel-iron magnetic core material known as Deltamax has been perfected by Allegheny Ludlum Steel Corporation to meet these stringent requirements, as evidenced by the hysteresis loop in Fig. 1. The material is being made available commercially by Arnold Engineering Company, Chicago, Illinois, in the form of toroidally wound cores suitable for applications in electronics.

Contact Converter Applications

The sharply defined knees, low coercive force, and a useful range of induction in excess of 26 kilogauses make Deltamax suitable also for choke coils of contact converters.

As a result of the development of a contact converter in Germany during World War II, a demand was created for choke cores having the magnetic characteristics described above. Because of the high range of induction required it

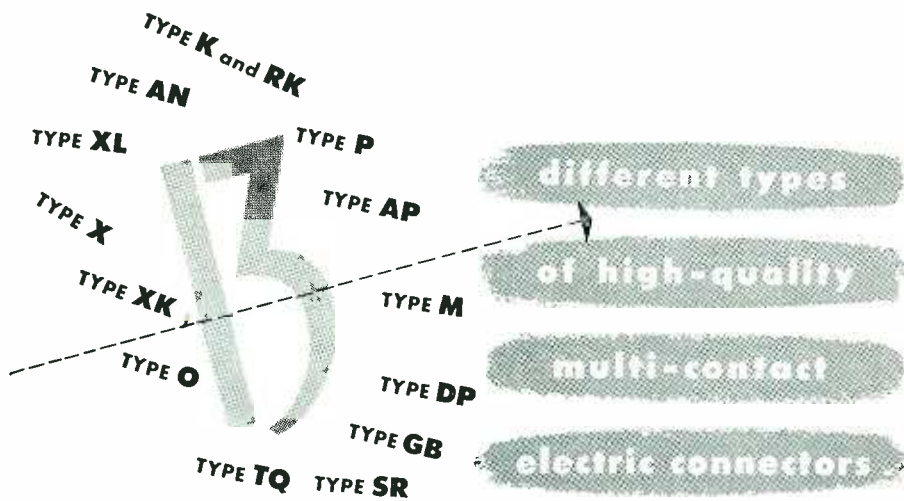

LOW - MEDIUM - HIGH

for most quick-disconnect needs

VOLTAGES - AMPERAGES

SHELLS
SHELLS of Cannon Electric Connectors are variously aluminum alloy, zinc alloy, and steel to meet the requirements of the application. For instance, a Type AN is aluminum alloy, Type P plug is steel or zinc, Type XL zinc or steel.

INSERTS
INSERTS are of good dielectric material to meet the needs of the application; and may be of melamine, Durez, Bakelite, Alkyd, etc. As new and better insulating materials are developed, Cannon Electric will have them.

CONTACTS
CONTACTS are generally brass, silver-plated, or copper, and milled. Gold-plated contacts are available for certain Type DP Connectors.

COUPLING
COUPLING means, too, vary with the needs of the application: the famous "latch-lock" for microphone applications in the "P", "XL" and "O"; AN, K, XK and AP have coupling nuts; X, TQ, SR, M and DP rely on friction hold.

Address Department F-120 for further information and a copy of 72 page "Cannon Plugs for the Electric Circuits of Industry."

CANNON ELECTRIC DEVELOPMENT COMPANY
DIVISION OF CANNON MFG. CORP.
3209 HUMBOLDT STREET
LOS ANGELES 31, CALIFORNIA

SINCE 1915

REG. U. S. PAT. OFF.

IN CANADA & BRITISH EMPIRE: CANNON ELECTRIC CO., LTD., TORONTO 13, ONT.
• WORLD EXPORT (Excepting British Empire):
FRAZER & HANSEN, 301 CLAY ST., SAN FRANCISCO

Developed by MACHLETT

ML-5667



...gives demonstrably superior performance in 889RA sockets*

Government, communications, and industrial users of "889RA-type" tubes are now rapidly switching to the Machlett-developed 5667*.

If you are not already familiar with the unique qualities of this new tube, here is an opportunity to learn exactly why and how the ML-5667 (*completely interchangeable with the 889RA*) is convincingly superior by any standard of comparison.

GET ALL THE FACTS ABOUT THESE FEATURES:

- Special anode construction and processing.
- Completely new and ruggedized structure.
- High R.F. conducting kovar seals.
- Cleaner internal parts and surfaces.
- Machlett high-voltage exhaust.
- New filament design.

* Adopted by Military Services, U. S. Government Agencies, and other large users as the standard replacement for 889RA, the 5667 is now their preferred tube type for 889RA sockets.

Use this coupon to send for your copy of "The ML-5667 Story." Mail directly to Machlett or your nearest Graybar office.



Use of the ML-5666 to replace 889A, carries the added advantage of the Machlett automatic-seal water jacket.

Machlett Laboratories, Inc., Springdale, Conn.

Please send me "The ML-5667 Story" comparing the electrical and mechanical characteristics of the ML-5667 and the 889RA.

Name _____

Company _____

Address _____

City _____ State _____

MACHLETT

OVER 50 YEARS OF ELECTRON TUBE EXPERIENCE

Another OUTSTANDING ACHIEVEMENT *by*



AIRBORNE RECEIVING EQUIPMENT

**AN/FRN-8 LOW
FREQUENCY
OMNIDIRECTIONAL
RADIO RANGE SYSTEM
DESIGNED AND
DEVELOPED BY RADIO
RECEPTOR FOR U.S.
AIR FORCE**

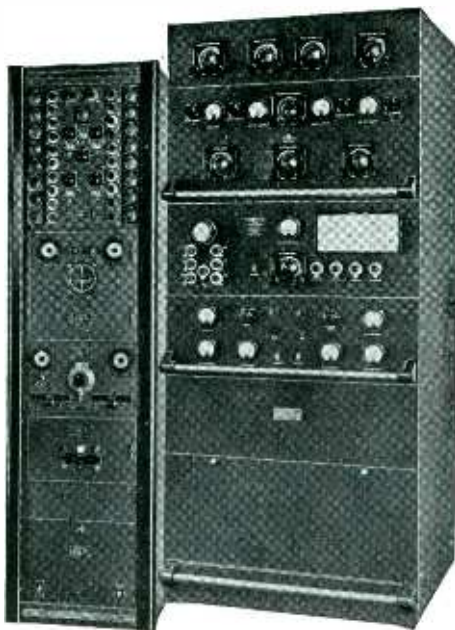

MONITOR UNIT

GROUND TRANSMITTER

Enables aircraft to navigate safely along any radial track to a ground station from distances up to 500 miles. The ground equipment is completely air transportable, permitting the expeditious setting up of a complete medium range navigation system when required.

A novel FM-AM system confines the navigational signal to a total r-f bandwidth of 60 c.p.s. permitting simultaneous voice broadcast on the same carrier. The airborne receiver employs push-button selected crystal control and has a navigational i-f bandwidth of only 150 c.p.s.

This entire project, from its original theoretical conception to final delivery to the U.S. Air Force, was undertaken by Radio Receptor. This includes preliminary research, development of the component equipments, production of a complete packaged station including transmitter, monitors, test equipment, antennas, and tuning units, production of airborne receivers and finally actual installation of the complete working system at a U.S. A. F. base.

Communications Division

RADIO RECEPTOR COMPANY, INC.

Since 1922 In Radio and Electronics

251 WEST 19th STREET
NEW YORK 11, N. Y.

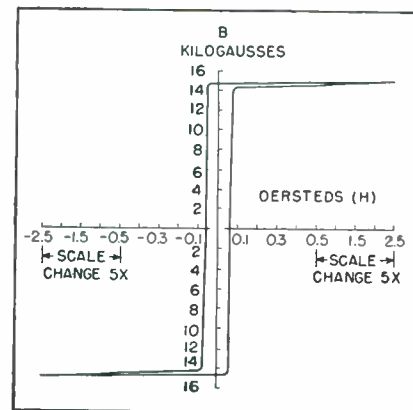

Fig. 1—Hysteresis loop of 2-mil Deltamax strip

seemed likely that an oriented nickel-iron alloy might yield the required properties because of its inherently high saturation. An alloy known as Permenorm 5000 Z was developed in Germany which had these properties. Information concerning the manufacturing process was released by the Signal Corps Engineering Laboratories in Technical Memo M1137 and by the Naval Ordnance Laboratory at its Magnetic Materials Symposium on June 15, 1948.

Manufacturing Process

The German methods were most exacting in that they required materials of extremely high purity which were subsequently melted under partial vacuum. To further reduce the impurities it was necessary to subject the material to hydrogen purifying anneals during the rolling of the material to strip. The 0.001 and 0.002-inch tape could not be slit to width in its final thickness without introducing strains which were detrimental to the required properties, hence the slitting was done at 0.014 inch and the narrow tape was then rolled to final gage.

Allegheny Ludlum undertook to develop commercial processes for producing an alloy similar to Permenorm 5000 Z. It was early recognized that there were at least two major steps in the German process which would prevent the economic manufacture of this material. These were the vacuum melting and the necessity for slitting at an intermediate thickness.

By carefully controlled practices, materials of high purity were suc-

Electric eel foiled with...

Zoo attendant says, "No more shocks for me now that I have my G-E Textolite feeding pole."

GENERAL ELECTRIC
TEXTOLITE* LAMINATED
Plastics
*REG. U. S. PAT. OFF.

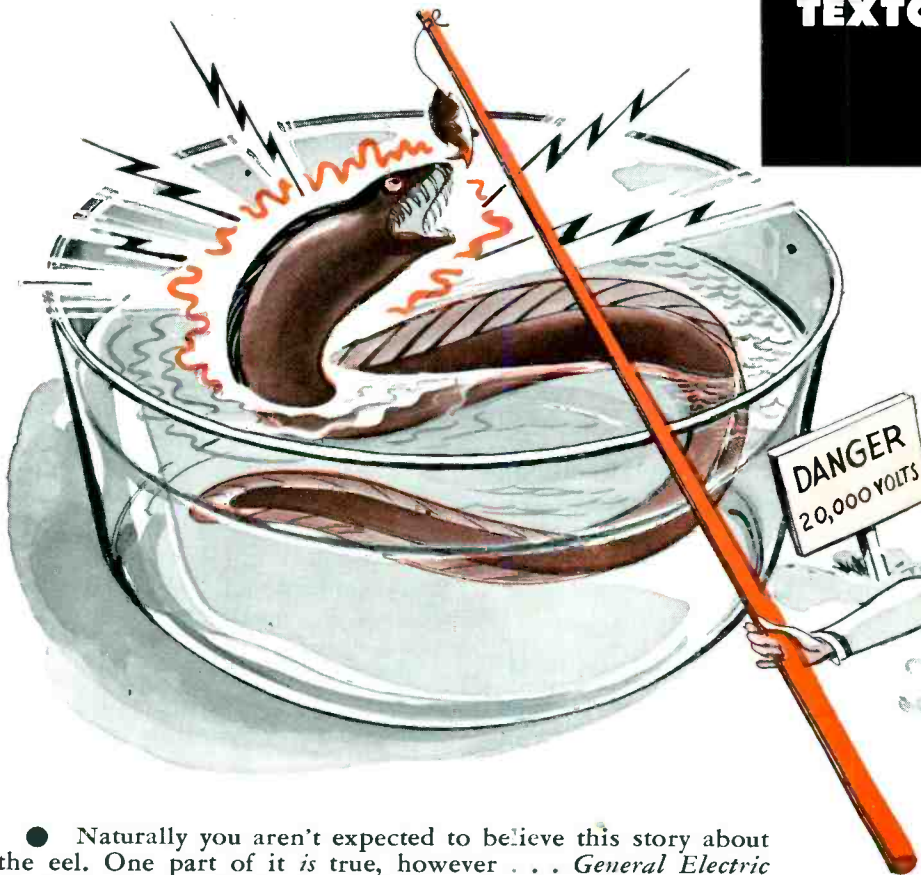

● Naturally you aren't expected to believe this story about the eel. One part of it is true, however . . . *General Electric Textolite has excellent electrical properties.* In addition, it has outstanding mechanical, chemical, and thermal characteristics.

Why not put this valuable combination to work for you. It may help you to lick your production problems—to reduce your manufacturing costs.

Versatile G-E Textolite is produced in more than fifty grades. Each of these grades has an *individual combination* of properties. None are alike. With this wide selection to choose from you are assured of getting a non-metallic material that will do your job in the most economical and satisfactory way. Plastics Division, Chemical Department, General Electric Company, Pittsfield, Mass.

For years electric eels have delighted in shocking zoo attendants. Now their game is up, thanks to the excellent electrical properties of General Electric Textolite.

G-E TEXTOLITE LAMINATED PLASTICS IS SUPPLIED IN:



LOW-PRESSURE
MOLDED PARTS



MOLDED-LAMINATED
PARTS

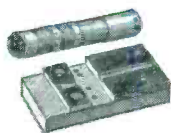

FABRICATED
PARTS



SHEETS, TUBES
RODS

**SEND FOR THIS HELPFUL BULLETIN TODAY—
IT'S FREE**

Write for your copy of "G-E Textolite Laminated Plastics." It lists grades, properties, fabricating instructions, and detailed information about Textolite industrial laminates.

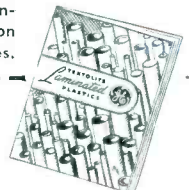

**General Electric Company
Chemical Department (8-6)
One Plastics Ave.,
Pittsfield, Mass.**

Please send me the new G-E Textolite laminated plastics bulletin

Name

Firm

Address

City State

GENERAL ELECTRIC



CD-19-J2

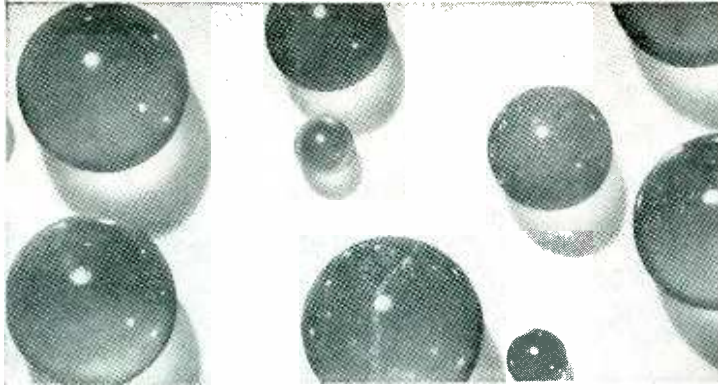

cessfully melted in the electric furnace. Subsequent improvement in annealing methods resulted in high retentivity, increased permeability and lower coercive force and permitted slitting in the final thickness. These characteristics as well as the squareness of the knees of the hysteresis loop can be further improved following the high temperature anneal by cooling the cores in the presence of a magnetic field.

Core Winding

An important sequence in the production of the toroids is the core winding technique itself. Each convolution must be separated from the next by means of a light coating of magnesium oxide to prevent sticking in the final anneal, which would cause a subsequent impairment of the magnetic characteristics. If the core is wound too tightly, strains may be introduced which cannot be removed by annealing. This will result in destruction of the rectangular hysteresis loop characteristics. Because of these limitations the lamination or stacking factor of these toroids is limited to a maximum of about 80 percent.

Strains introduced in the handling of the finished cores can result in impairment of the magnetic properties. It is recommended that the cores be encased in fiber or plastic before the electrical winding is applied. The void between the core and case can be filled with oil to act as a cushion in applications where the shock will be high.

Emergency Battery Chamber

By J. B. MULLEN

*Application Engineering Dept.
Burgess Battery Company
Freeport, Ill.*

WATER-ACTIVATED batteries are used in some signaling and emergency equipments. These silver-chloride-magnesium batteries are shipped and stored completely dry; for use they are saturated with fresh or salt water. For example, warning equipment that is powered by these batteries will produce its alarm automatically when it is flooded. The low-voltage batteries can be left in the liquid after acti-

Now **PRECISION BALLS** *of Synthetic Sapphire*

Now ... the wear, corrosion, and heat resistance of synthetic sapphire in balls polished to within 20 micro-inches of sphericity.

THESSE uniaxial spheres resist corrosion or erosion by many acids and alkalis ... possess a higher dielectric strength than glass or mica ... have a low coefficient of friction and superior hardness. In many applications, they need not be lubricated.

LINDE synthetic sapphire balls are available in 1mm, 1/16 inch, 1/8 inch, and 1/4 inch sizes. Three surface finishes are available: super-finished, semi-finished, and rough-ground blanks.

CALL or WRITE any LINDE office for information on these balls, or the other forms of LINDE synthetic sapphire.

PROPERTIES

Composition.....	Al ₂ O ₃
Coefficient of Friction.....	0.140 (Steel pivot on sapphire ring)
Hardness (Knoop).....	1525—2,000
Modulus of Elasticity in Flexure.....	50—56 x 10 ⁶ psi
Dielectric Constant.....	7.5—10
Modulus of Rigidity.....	21.5—27.5 x 10 ⁶ psi
Thermal Coefficient of Expansion.....	5.0—6.7 up to 50°C (per °C x 10 ⁻⁶)
Chemical Resistance.....	Unaffected by acids, dilute alkali.

THE LINDE AIR PRODUCTS COMPANY

Unit of Union Carbide and Carbon Corporation

30 East 42nd St., New York 17, N. Y.  Offices in Other Principal Cities

In Canada: THE DOMINION OXYGEN COMPANY, LIMITED, Toronto

The term "Linde" is a trade-mark of The Linde Air Products Company

the **TRUTH** about
HEART TROUBLE

Why an electrocardiograph tells it

All around you, men and women are enjoying life today, who might have been cut down in the prime of life. But, thanks to the electrocardiograph, their span of life has been extended. By charting any abnormality of the heart's beat-strength or functioning, the electrocardiograph supplies the vital facts from which the physician determines whether, where or how severely the heart or heart muscles have been injured. Then he prescribes the proper treatment.

THE ELECTROCARDIOGRAPH CAN'T HAVE "HEART TROUBLE"

The heart of many of these life-savers is a Telechron Timing Motor... *instantly, constantly synchronous*. Only such an accurate, trouble-free motor can be trusted to time the chart that tells the truth about heart trouble.

WHAT IS YOUR TIMING PROBLEM?

If you have a variable that must be controlled or recorded with split-second fidelity, a standard Telechron Motor, correctly applied, may be all you need. Ask a Telechron Application Engineer. He can give you the benefit of the broadest experience in the industry. The earlier in your planning you call him, the better are your chances of saving time, trouble and money. In the meanwhile, fill in and mail the coupon below for complete data on Telechron Synchronous Motors. TELECHRON INC., A GENERAL ELECTRIC AFFILIATE.

Telechron[®]



**ALL TELECHRON TIMING MOTORS ARE
INSTANTLY...CONSTANTLY SYNCHRONOUS**

Telechron Inc.
40 Union Street
Ashland, Massachusetts

Please send me information on sizes and types of Telechron Synchronous Motors. My possible application is:

- | | |
|---|--|
| <input type="checkbox"/> Instruments | <input type="checkbox"/> Air Cond. & Heat'g Controls |
| <input type="checkbox"/> Timers | <input type="checkbox"/> Communications Equipment |
| <input type="checkbox"/> Electric Appliances | Other (please fill in) |
| <input type="checkbox"/> Cost Recorders | <input type="checkbox"/> _____ |
| <input type="checkbox"/> Advertising, display items | <input type="checkbox"/> _____ |
| <input type="checkbox"/> Juke Boxes | <input type="checkbox"/> _____ |

NAME _____

COMPANY _____

ADDRESS _____

CITY _____ ZONE _____ STATE _____

HARDWICK, HINDLE Resistors

THE ELECTRON ART

(continued)

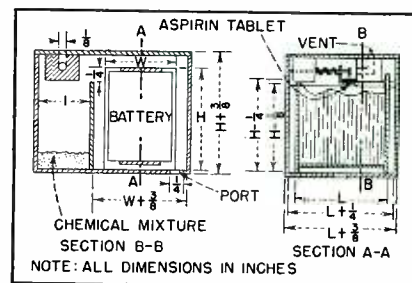
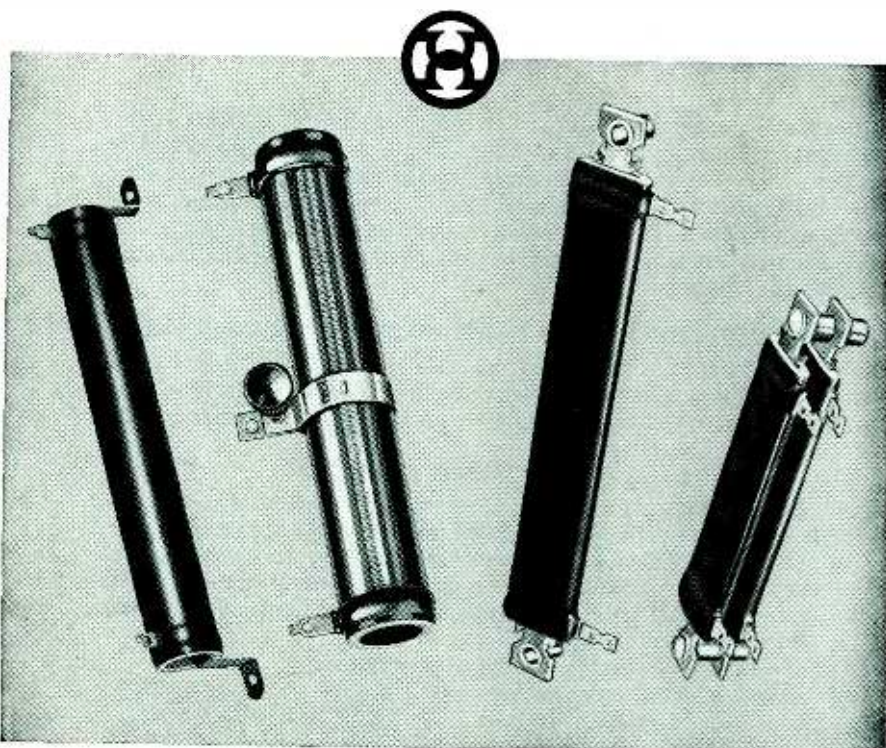

FIG. 1—Case for operating water-activated B-battery in dry atmosphere

vation, but, because of excessive leakage through the water, high-voltage batteries should be removed after 30 to 90 seconds immersion to preserve their life. A simple, reusable, two-compartment chamber, shown in Fig. 1, has been developed that provides the desirable environment for these batteries.

The chamber has vent and filling ports so that the battery compartment is flooded in 5 to 10 seconds. A filling port of $\frac{1}{4}$ -inch diameter floods a 12-cubic-inch case in this time; the vent should be of about $\frac{3}{8}$ -inch diameter and approximately $\frac{3}{8}$ -inch long. As soon as the chamber is flooded, the water overflows into a second compartment where it reacts with an effervescent chemical mixture to generate carbon dioxide. In the meanwhile, a soluble plug dissolves, releasing a spring-loaded plunger that closes the vent. (An aspirin tablet will collapse in a few seconds after becoming immersed and so can be used for the plug.) The gas then drives the excess water out of the battery compartment through the filling port. A mixture of 3-grams sodium bicarbonate and 5-grams citric acid, which will generate over 25 cubic inches of carbon dioxide, safely clears a 12-cubic-inch case. (The mixture can be heated until the citric acid fuses and presses into a solid tablet that can be held in place



BY MAINTAINING even more rigid standards than ever before in our manufacturing and inspection we offer you exceptional resistors—exceptional in their rugged and dependable performance and long life.

We show here 3 of our standard types—a fixed; an adjustable; and our flat type Blue Ribbon—the first resistor made to depart from the conventional tubular form.

As one of the oldest manufacturers of resistors and rheostats we offer exclusive advantages in many types; and an engineering service that is always at your call. Write us today.

HARDWICK, HINDLE, INC. Rheostats and Resistors

Subsidiary of

THE NATIONAL LOCK WASHER COMPANY

NEWARK 5, N. J. Established 1886 U. S. A.

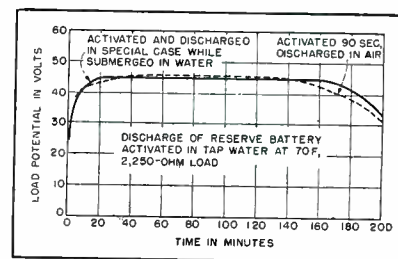

FIG. 2—Comparison of discharge of emergency battery in air and in special case



**MODEL
666-R
\$24⁵⁰**
U. S. A. Dealer Net

**A *New* TRIPLETT
POCKET-SIZE
VOLT-OHM-MIL-AMMETER
with self-contained Resistance
Ranges to 3 Megohms**



**Note the special
features of this New
handy-size tester**

- (1) **RESISTANCE RANGES** from 0-3000 Ohms (.5 Ohm low reading) to 3 Megohms, self-contained. Also A.C.-D.C. Volts to 5000, 10 ranges; and 3 Direct Current ranges.
- (2) **ENCLOSED SELECTOR SWITCH**, molded construction. Keeps dirt out, and retains contact alignment permanently.
- (3) **UNIT CONSTRUCTION**-Resistors, shunts, rectifier, batteries are housed in a molded base integral with the switch. Direct connections without cabling. No chance for shorts.
- (4) **RESISTORS** are precision film or wire-wound types, each in its own compartment.
- (5) **BATTERIES EASILY REPLACED**-Positive grip coil spring assures permanent contact. Makes replacement of batteries a simple procedure.
- (6) **STREAMLINED STYLING**, Handsomely designed, pocket-size case. Only two controls, both flush with panel.

*For Detailed Information
See your Radio Parts Distributor or write . . .*

TRIPLETT ELECTRICAL INSTRUMENT COMPANY • BLUFFTON, OHIO, U.S.A.
In Canada: Triplett Instruments of Canada, Georgetown, Ontario

RANGES:

- D.C. VOLTS: 0-10-50-250-1000-5000, at 1000 Ohms/Volt
 - A.C. VOLTS: 0-10-50-250-1000-5000, at 1000 Ohms/Volt
 - D.C. MILLIAMPERES: 0-10-100, at 250 Millivolts
 - D.C. AMPERES: 0-1, at 250 Millivolts
 - OHMS: 0-3000-300,000
..... (20-2000 at center scale)
 - MEGOHMS: 0-3
..... (20,000 Ohms center scale)
- (Compensated Ohmmeter circuit for greatest accuracy over wide battery voltage variations.)*

Precision first...to Last





STANDARD RELAYS

... thousands of available types, electrically and mechanically adapted for every-day relay applications.

SPECIAL RELAYS

... types that have never been made before—for jobs that have never been done before.

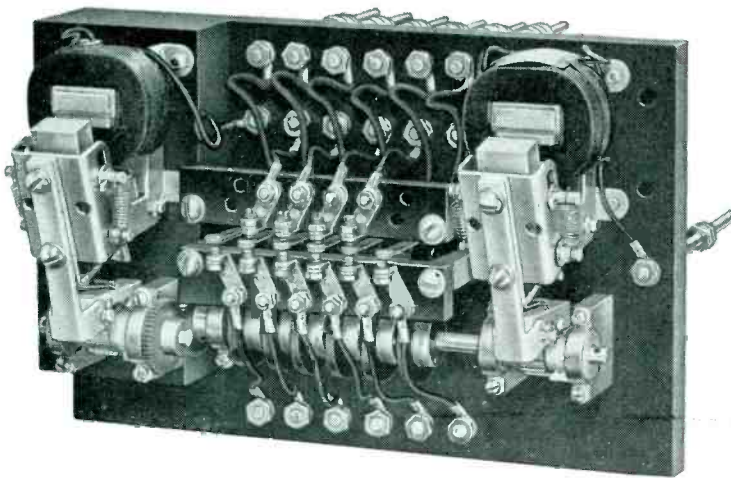
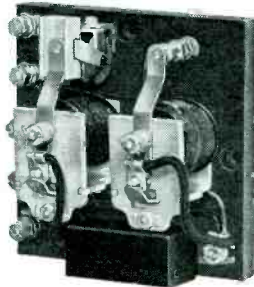

BIG RELAYS OR LITTLE RELAYS

As specialists in relay design and manufacture, Struthers-Dunn has ranged from turning out 20,000 "production relays" a week to devoting a year for the development of a single highly-specialized type.

Twenty-seven years of experience in designing and building thousands of different relay types—for as many different applications—is available to help solve your relay problems.



Write for Catalog "G"—a quick, handy guide to the most widely used Struthers-Dunn relay types.

STRUTHERS-DUNN

5,348
RELAY TYPES

STRUTHERS-DUNN, INC., 150 N. 13th Street, Philadelphia 7, Pa.

ATLANTA • BALTIMORE • BOSTON • BUFFALO • CHARLOTTE • CHICAGO • CINCINNATI
CLEVELAND • DALLAS • DENVER • DETROIT • INDIANAPOLIS • KANSAS CITY • LOS ANGELES
MINNEAPOLIS • MONTREAL • NEW ORLEANS • NEW YORK • PHILADELPHIA • PITTSBURGH
ST. LOUIS • SAN FRANCISCO • SEATTLE • SYRACUSE • TORONTO

in the case of the battery.)

The battery compartment must be enough larger than the battery (or batteries) so that drops remaining on the surfaces of the battery and compartment will not touch and form leakage paths after activation. For the above sequence of events to take place, the filling port must be at the bottom of the battery compartment and the vent at the top of the chemical compartment. Figure 2 shows the discharge of a battery in such a case.

To prevent damage by premature moistening of the battery or chemical, the case should be sealed, with tape or foil over the ports, until the equipment is put into use. Silica gel can be placed in the case before it is sealed to absorb moisture that may be present.

Letter-Printing C-R Tube

BY INSERTING between screen and gun of an ordinary c-r tube a multiple deflecting electrode arrangement for passing the beam through a character-shadowing disc, any desired combination of letters and numbers can be produced on the screen at will. As indicated in the accompanying diagram, the shadowing disc has punched-out letters or numbers, each positioned behind its own set of deflecting plates. Some plates serve to route the beam through the desired hole, and others (presumably on the other side of the disc) bend the formed beam so it

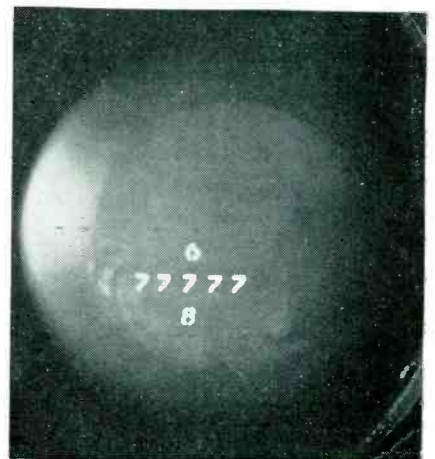

Example of numerals formed on c-r tube by passing beam in sequence through holes cut to shapes of numbers in metal shadowing disc



**Telephone Voice
Amplifiers**



**High Potency
Vitamins**

Dime Store Barrettes



...products of High Vacuum

YOU 'phone from coast to coast and converse as easily as though you were in the same room. The reason, a tiny electronic repeater tube that prevents voice fading. It works only because a high vacuum pump has exhausted air from the glass tube to a degree that closely approaches perfect vacuum.

Important vitamins for food fortification, pharmaceuticals and doctors' prescriptions are available at moderate cost because of high vacuum. Distilled under high vacuum the extract is purer—can be concentrated to high potencies.

Contrasting sharply to applications in the fields of electronics and bio-chemistry is the use of high vacuum in depositing metallic vapors on glass, wood, cloth, paper and plastics. Inexpensive but beautiful novelty jewelry, ornaments, barrettes, etc., are coated inside huge chambers from which air has been exhausted . . . a plating process that gives better results, cuts costs and permits bargain prices to a mass market.

These examples serve to emphasize the scores of different ways DPI high vacuum equipment is enabling new products and

better products to be made at lower costs.

Perhaps high vacuum can work for you: DPI can aid in research, in setting up pilot operations, and can advise on engineering and building complete installations for profitable commercial applications of high vacuum. We invite inquiry.

DISTILLATION PRODUCTS, Inc.

727 RIDGE ROAD WEST, ROCHESTER 13, N. Y.

*Distillers of Oil-Soluble Vitamins and Other Concentrates for Science and Industry;
Manufacturers of High-Vacuum Equipment.*



HIGH VACUUM RESEARCH
AND ENGINEERING

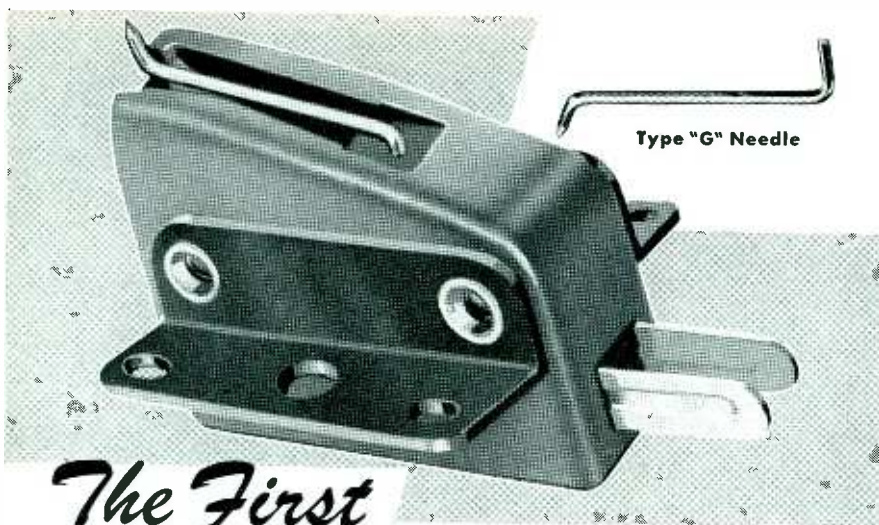

The First CERAMIC CARTRIDGE

with **CHANGEABLE NEEDLE
LIGHT WEIGHT
LOW PRESSURE**

HERE'S THE FIRST major engineering stride in phonograph pickup cartridges employing ceramic elements since Astatic first pioneered in this type unit last year. It's Astatic's tiny new gem—the "GC"—the first cartridge of its kind with replaceable needle. Takes the special new Astatic "Type G" needle—with either one or three-mil tip radius, precious metal or sapphire—which slips from its rubber chuck with a quarter turn sideways. Resistance of the ceramic element to high temperatures and humidity is not the only additional advantage of this new development. Output has been increased over that of any ceramic cartridge previously available. Its light weight and low minimum needle pressure make it ideal for a great variety of modern applications. Details of performance appear in the accompanying table.

Model	Cartridge Type	Minimum Needle Pressure	Output Voltage	Frequency Range (c.p.s.)	Needle Type	Application
GC	Ceramic	6 gr.	0.5*	50-10,000	G (1 mil tip radius)	33-1/3 and 45 RPM Records
GC-78	Ceramic	12 gr.	0.65†	50-10,000	G-78 (3 mil tip radius)	Standard 78 RPM Records

*Columbia #281 Test Record †Audio-tone Test Record



J. T. McNaney of Consolidated Vultee demonstrates his Electrontype system for producing messages or numerical results on screen of Charatron cathode-ray tube in response to coded signals applied to multiple deflecting electrodes

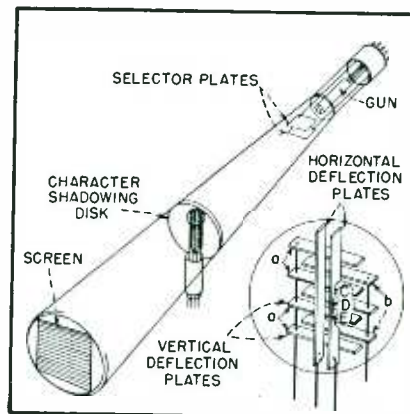

General details of character-forming c-r tube. Letters C, D and E are actually punched-out characters in character-shadowing disc

hits the screen at the desired spot.

Experimental tubes already constructed in the Radio and Electrical Laboratories of Consolidated Vultee Aircraft Corp. have successfully produced a limited number of characters. On the basis of this, it is claimed that tubes can be built for use in conjunction with motion picture film to record results of electronic calculators at speeds up to 20,000 characters per second.

Improved Phase Meter

AN ELECTRONIC PHASE METER having significant advantage over previous instruments (see for example E. L. Ginzton's meter described in *ELECTRONICS*, p 60, May, 1942) has been developed by E. F. Florman and A. Tait of the

Write for additional information





CAPACITORS

Silicone-Sealed for Life!

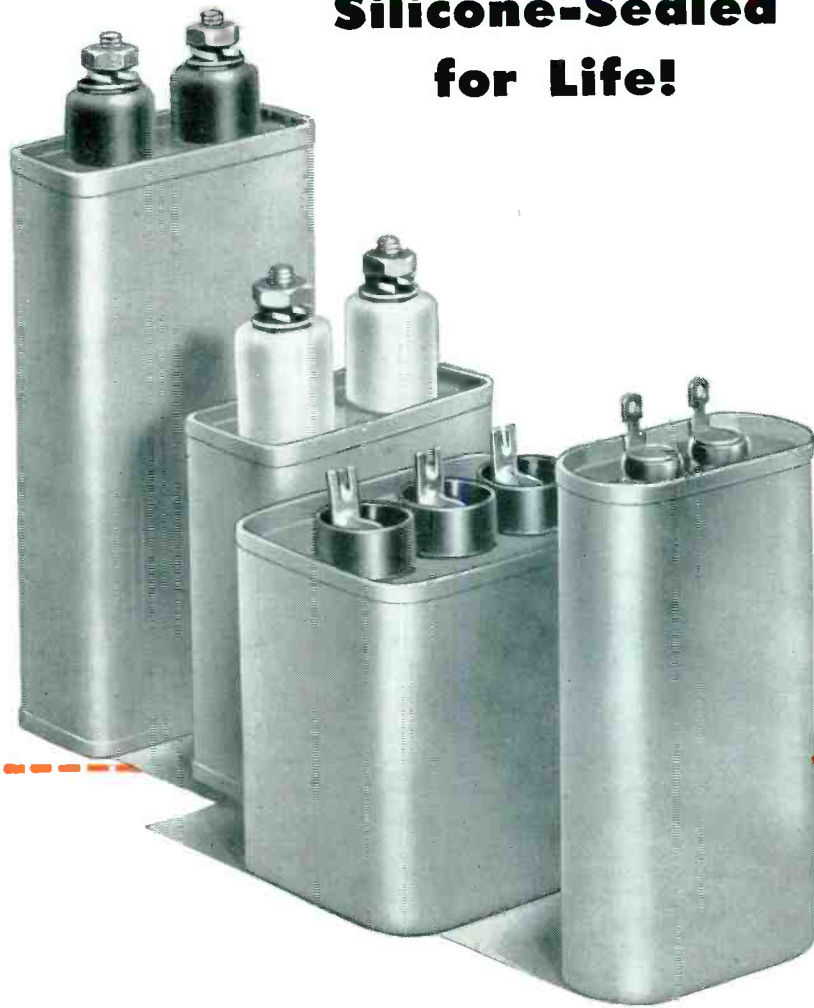

Silicone—the amazing new synthetic—made headlines when General Electric brought it out during the war. It's news again today—for G.E. has now made Silicone bushings and gaskets a *standard feature* of all its specialty capacitors up through 5000 volts.

This means that your new G-E capacitor is sealed positively, permanently—for maximum life. For Silicone seals by compression alone, without the use of contaminating adhesives. It will never shrink, loosen or pull away—it remains elastic at any operating temperature a capacitor will ever meet. Moreover, it is impervious to oils, alkalis and acids, and its dielectric strength is permanently high.

This exclusive G-E feature—with the use of highest grade materials, with strictest quality control and individual testing—make General Electric capacitors finer and more dependable than ever before. *Apparatus Dept., General Electric Company, Schenectady 5, N. Y.*

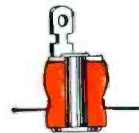

Silicone bushings used with capacitors 660-v a-c, or 1500-v d-c and lower.



Silicone bushings and plastic cups used with capacitors 660-v a-c, or 1500-v d-c and lower.

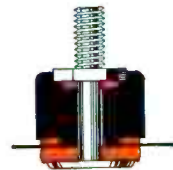

Silicone gaskets and plastic stand-offs used with capacitors rated 2000-v d-c and lower.

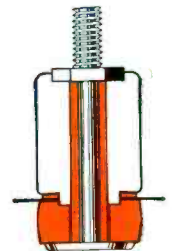

Silicone gaskets and porcelain stand-offs used with capacitors rated 2500-v to 5000-v d-c.

GENERAL ELECTRIC

Specialty Capacitors

FOR

Motors
Luminous-tube transformers
Fluorescent lamp ballasts

Industrial control
Radio filters
Radar
Electronic equipment
Communication systems
Capacitor discharge welding

Flash photography
Stroboscopic equipment
Television
Dust precipitators
Radio interference suppression
Impulse generators

AND MANY OTHER APPLICATIONS



407-159

\$1,500 inventory abolished — at a cost of \$4.46!



With more than 700 vacuum tubes needed by industry, a tube distributor would find profits consumed by 100% inventories. But by ordering tubes as needed via Air Express, he holds stocks to 25%. Example: Orders \$1,500 tube at 9 A.M. from supplier 900 miles away. Delivered to customer 6 P.M. same day. 16 lbs.: cost, \$4.46.



Remember, \$4.46 included speedy pick-up and delivery service, too. More protection, because you get a receipt for every shipment. Air Express is the world's fastest shipping service.



Your Air Express shipments go by the Scheduled Airlines direct to over 1,000 airport cities; fastest air-rail for 22,000 off-airline offices. Shipments keep moving with 'round-the-clock service.

FACTS on low Air Express rates

19 lbs. of machine parts goes 600 miles for \$3.51.
9-lb. carton of new styles goes 1400 miles for \$3.99.
(Every kind of business finds Air Express pays.)

Only Air Express gives you all these advantages: Special pick-up and delivery at no extra cost. You get a receipt for every shipment and delivery is proved by signature of consignee. One-carrier responsibility. Assured protection, too—valuation coverage up to \$50 without extra charge. Practically no limitation on size or weight. For fast shipping action, phone Air Express Division, Railway Express Agency. And specify "Air Express delivery" on orders.

SPECIFY AIR EXPRESS
AIR EXPRESS
GETS THERE FIRST



Rates include special pick-up and delivery door to door in principal towns and cities



AIR EXPRESS, A SERVICE OF RAILWAY EXPRESS AGENCY AND THE
SCHEDULED AIRLINES OF THE U.S.

National Bureau of Standards. The chief improvement in the new instrument is an arrangement whereby the phase angle between two sinusoidal input voltages is indicated without ambiguity. Previous instruments gave indications that were ambiguous about the 180-degree value, that is, the same indication was given for a phase difference of 170 or of 190 degrees. The improved phase meter, which indicates phase differences from 0 to 360 degrees with a sensitivity of 0.5 degree, is independent of frequency and has a linear phase scale within 1 degree over the range from 100 to 5,000 cps and shows only a 1-degree phase change due to abrupt changes in amplitude of the input voltages from 1 to 20 volts.

Two Methods of Indicating Phase

The accompanying diagram shows the basis of operation. The two input voltages whose phases are to be compared are converted to square waves by repeated amplification and limiting. These two square waves are then added by being applied to the grids of two tubes having a common plate resistor. The average current through this resistor is directly proportional to the phase angle between the two square waves and therefore proportional to the phase angle between the original sinusoidal input voltages. This average value is obtained by a diode rectifier, which feeds the indicating milliammeter through a balanced amplifier incorporating shunts to give several ranges centered ambiguously about 180 degrees.

A second phase measuring means is used to indicate on which side of 180 degrees the phase angle lies. For this indication, the square waves from the amplifier-limiter stages are amplified in tubes that have differentiating circuits for their plate loads. The resultant voltage spikes are applied to diode polarity discriminators which pass only the negative impulses to a flip-flop trigger circuit. A negative pulse applied to the grid of one of the pair of trigger tubes cuts that tube off, simultaneously firing the other one. When the second negative pulse arrives, it returns the trigger circuit to its

Industrial Relays by Sterling

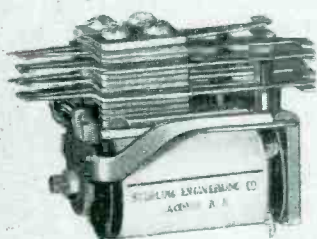
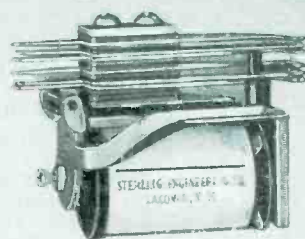
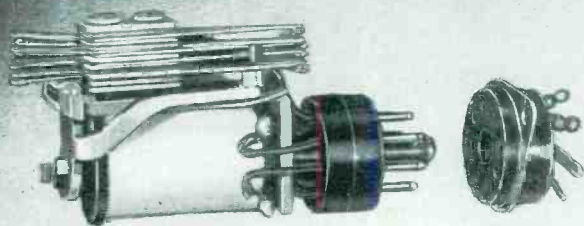

During the past few years STERLING RELAYS have been adopted as standard equipment by hundreds of satisfied customers. These include manufacturers, military and naval services along with industrial and private laboratories.

Adaptability, convenience and dependability are some of the features which explain the general acceptance of STERLING RELAYS in industry.

STERLING WILL ENGINEER AND DESIGN RELAYS FOR YOUR PARTICULAR REQUIREMENTS.

Write today for your copy of STERLING'S new Bulletin 110 on RELAYS FOR INDUSTRY.

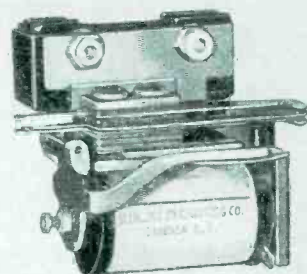

Type KS for aircraft applications



Sterling Engineering Company, Inc.
LACONIA, NEW HAMPSHIRE

CHICAGO

The Name that Makes NEWS in Transformers

TELEVISION TRANSFORMERS to fit today's leading TV circuits

A complete catalog line, made by CHICAGO—the largest single manufacturer of original equipment TV transformers. Included are power, vertical blocking oscillator, and both vertical and horizontal scanning output transformers in a range of designs that are exact duplicates of units used in the leading TV sets.

FULL FREQUENCY AUDIO TRANSFORMERS

Within $\pm 1/2$ db.,
typical response
30 to 15,000 cycles

For uniformly low distortion, for response curves that are truly flat over the full frequency range, use these CHICAGO input and output units. Get the facts on the BO-6 (P-P 6L6's to 6/8 or 16/20-ohm speaker), the BO-7 (600/150-ohm line to 6/8 or 16/20-ohm speaker), and other full frequency units.

POWER TRANSFORMERS

In 2 alternate
"Sealed in Steel"
Mountings

Exclusive features like these make this the "Engineer's Line": Plate and filament voltages to fit today's most-used tubes; in two mountings—with solder lugs or 10" leads; one series for condenser input, another for reactor input use; exactly matching reactor for each power transformer. Get complete catalog now.

HIGH Q CHOKES

for Dynamic
Noise Suppression
Circuits

Two efficient filter reactors, inductance values .8 and 2.4 henrys respectively, are designed for noise suppression circuits, but can be used in any tuned circuit requiring the given inductances. Inductance values are accurate within $\pm 5\%$ with up to 15 ma. d-c. Minimum Q of 20. Mounted in identical drawn steel cases $1\frac{1}{16}$ " x $2\frac{3}{8}$ " x $1\frac{1}{16}$ ". Write for descriptive sheet including diagram of simplified dynamic circuit.

MODULATION TRANSFORMER

for Ham and
Commercial
Transmitters

A Modulation Transformer ideally suited for use in ham and commercial speech transmitters. Will deliver 250 watts of Class B audio power from P-P 203A's, 211's, 805's, 75TL's, etc. to a Class C load with response variations not exceeding +1 db. over the speech range, 200-3,500 cycles. Primary impedances, 9000/6700 ohms; secondary impedances, 8000/6000/4000 ohms. A matching driver transformer is available.

Write for complete CHICAGO Transformer Catalogs

CHICAGO TRANSFORMER

DIVISION OF ESSEX WIRE CORPORATION

3501 ADDISON STREET • CHICAGO 18, ILLINOIS

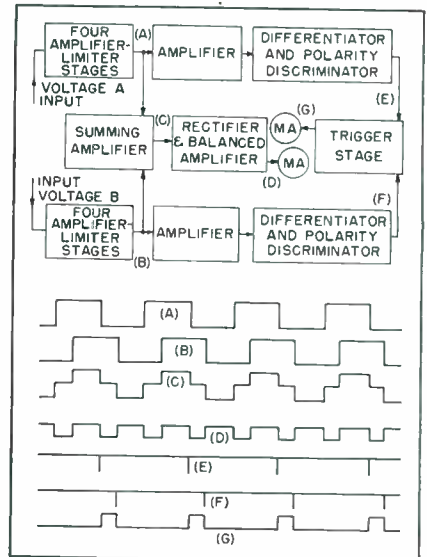

Waveshapes show operation of phase meter that gives unambiguous indication

initial condition. As a result of this process, the average current in the plate circuit of the trigger tubes is proportional to the relative phase between the sinusoidal input voltages. This average current operates another milliammeter with shunts to adjust its scale. Although the indications of this circuit are unambiguous about 180 degrees, they are inherently unstable in the neighborhood of 0 and 360 degrees because the order of firing of the trigger tubes alternates irregularly.

Wide Range of Applications

This instrument has proved to be very stable over long periods. It is thus well adapted to serve as test equipment in industrial laboratories. Other possible applications include use in electronic distance measuring devices for surveying; altitude determination for aircraft; navigation systems depending on phase changes; studies of distortion in communication cables and measurement of the phase characteristics of transmission lines, filters and transformers.

At the Bureau of Standards it is being used in studies of low-frequency radio wave propagation to obtain quantitative information on the ultimately attainable accuracy of navigation systems using these frequencies. In this work, differential phase changes caused by changes in the propagating medium are studied by analysis of the relative phases of incoming waves re-

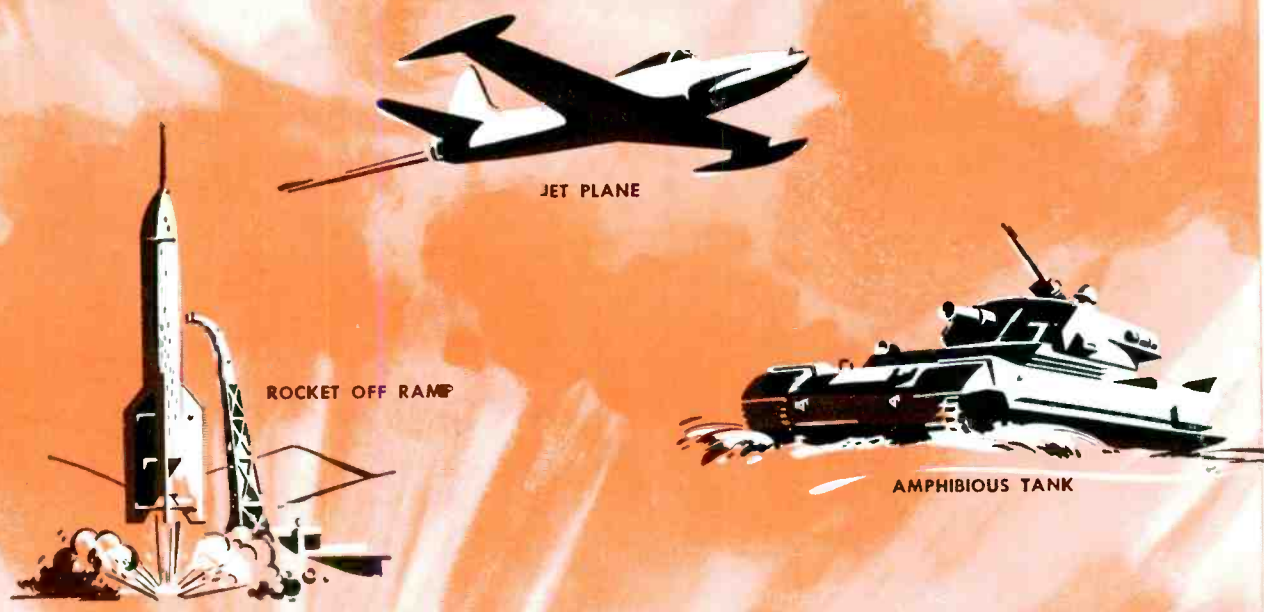

JET PLANE

ROCKET OFF RAMP

AMPHIBIOUS TANK

EXPLOSION-PROOF, REGULATED DYNAMOTOR

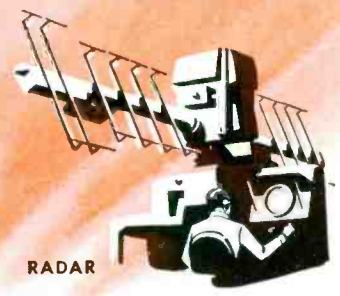

RADAR

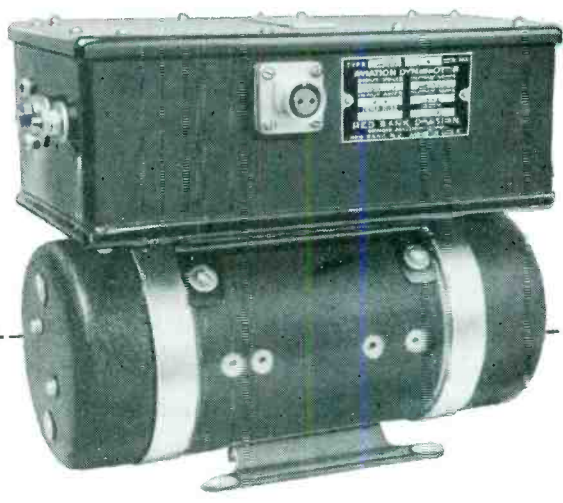

CHECK AND BE SURE

- Voltage regulation
- Frequency regulation
- Speed control
- High temperature operation
- High altitude operation
- Waterproof construction
- Noise proof (conducted and radiated)

Only Bendix can give you *all* of these important features.

Bendix realizes that today's standards are tomorrow's discards. Our research program is designed to keep *ahead* of tomorrow's needs—to produce equipment that is *ready, when* it is needed. Typical of the results achieved by this far-sighted development work are explosion-proof dynamotors, regulated dynamotors, inverters and D.C. motors* manufactured by Bendix. In addition, Bendix research has produced rotating equipment that will withstand extreme conditions of altitude, temperature, humidity, immersion, shock, and acceleration. To those members of the electronic industry engaged in the design and development of guided missiles, telemetering apparatus, radio, radar, or other electronic devices, we suggest that you call on:

*Bendix motors meet specification ANM-40.

For immediate information call our Engineering Staff—Red Bank 6-3600. • Staff Members:
 W. H. Wells, Director, Sales Engineering
 K. H. Fox, Chief Engineer
 J. J. Korzdorfer, Project Engineer.

RED BANK DIVISION of
 Red Bank, New Jersey



Dynamotors • Inverters • Converters • D. C. Motors • Carbon Pile Voltage Regulators



with STEEL CABLE

— the small extra first cost of test samples pays off in assurance of efficiency and durability of the finished structure.

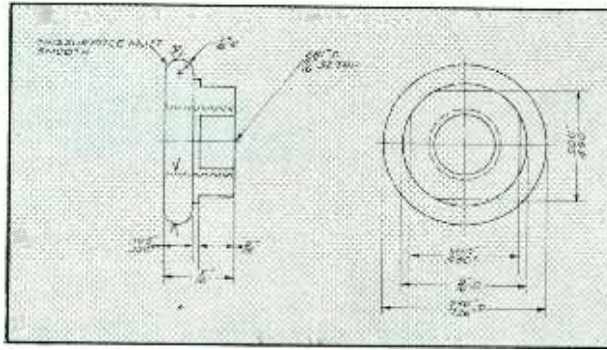

with TRACING CLOTH . . .

— the small extra first cost of Arkwright Tracing Cloth, over that of tracing paper, repays many times over in the efficiency and durability of valuable drawings.

Lines drawn on Arkwright Tracing Cloth stand out with unusual clarity — a clarity that is permanent because Arkwright does not become opaque or brittle with age. Special mechanical processing, plus sturdy uniform threads expertly bonded, protect your investment through years of service. Perishable tracing paper cannot safely promise this.

Arkwright Tracing Cloths are preferred by foresighted drafting departments for every drawing worth keeping for future use. Send for generous samples. Sold by leading drawing material dealers everywhere. Arkwright Finishing Company, Providence, R. I.

The Big Six Reasons Why Arkwright Tracing Cloths Excel

1. Erasures re-ink without feathering.
2. Prints are always sharp and clean.
3. Tracings never discolor or go brittle.
4. No surface oils, soaps or waxes to dry out.
5. No pinholes or thick threads.
6. Mechanical processing creates permanent transparency.



ARKWRIGHT

TRACING CLOTHS

AMERICA'S STANDARD FOR OVER 25 YEARS

ceived at two separate stations. For this application a phase meter with long-period stability was needed, hence this development of the meter.

Ceramic-Wall Tubes

INVESTIGATION into the possibilities of using low-loss ceramics in place of glass for envelopes of tubes was described by Roger P. Wellinger of the University of Illinois EE Department at the 1949 IRE National Convention. The three sealing techniques investigated were sintering of metal on ceramic, compression of metal on ceramic and use of titanium hydride as a flux for hard solder. Ceramics considered thus far were magnesium silicates of either the steatite or forsterite variety.

Sintered Seals

One method of metallizing ceramic parts to allow subsequent hard soldering of tube components involves painting the ceramic parts with a suspension of molybdenum powder with 1 to 3 percent iron in an organic binder and firing in tank hydrogen at 1,350 C for 20 minutes. The resulting dull-looking layer is burnished, painted with a thin layer of nickel powder, and again fired. After polishing, the metallized ceramic part is ready to be soldered to the tube parts.

Compression Seals

In directly sealing metals to ceramics by means of compression, the assembly is set in a furnace and heated to a temperature of approximately 1,000 C. The parts are then submitted to a high mechanical pressure (2,000 to 3,000 psi) to squeeze them together. The time during which pressure must be exerted varies from 2 hours for pure copper surface in vacuum or hydrogen atmosphere to 10 seconds for slightly oxidized copper surface (cuprous oxide) in pure nitrogen atmosphere. This method requires a furnace in which the atmosphere can be controlled accurately.

Plastic flow of sheet copper has been measured as a function of pressure and time. A shape factor has to be considered since the flow

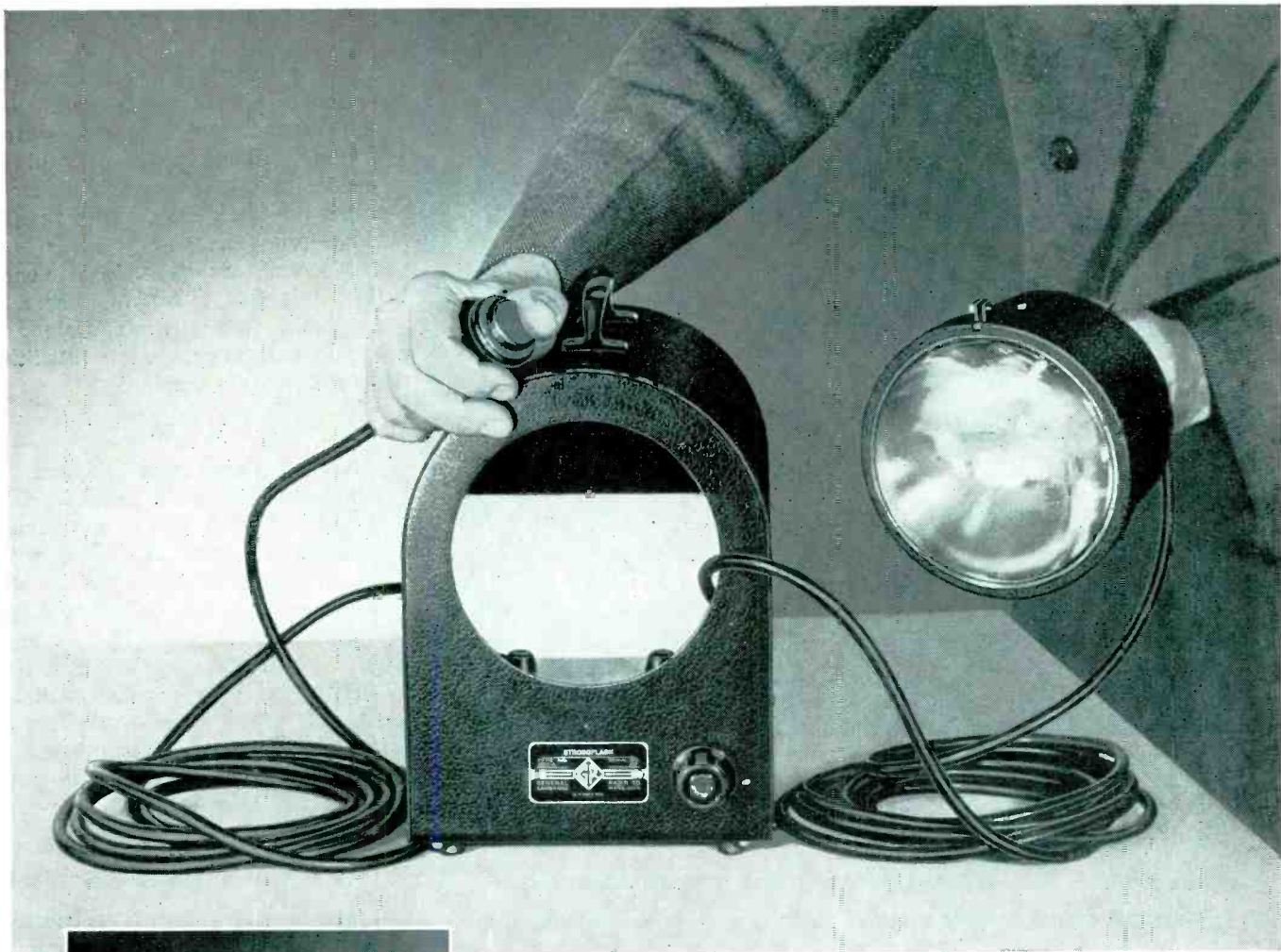

The STROBOLUME normally is housed in the power-supply case, weighing, complete, 18½ pounds. The sealed-beam lamp and its case are removable from the supply assembly for use at the end of a 10-foot cable. The lamp housing is equipped with a standard tripod socket.

TYPE 1532-A STROBOLUME \$225.00
TYPE 631-BS18 STROBOTAC (special, with flashing rate of 60 to 14,400 per minute) \$170.00

Let us send full details.
WRITE FOR THE STROBOLUME BULLETIN

for Extra HIGH Light Intensity in Slow-speed Stroboscopic Applications

THE new STROBOLUME is designed to give an extra-brilliant, short-intensity stroboscopic light for observation of very slow-moving objects or machine operations . . . much slower than can be observed with our other Stroboscopes.

It is particularly suited to single- or multiple-flash stroboscopic photography, having a flash duration of approximately ten millionths of a second . . . about *one-twentieth* of that of the average commercial "speed lamp."

The STROBOLUME can be operated in several ways. It is equipped with a cord and push-button switch for firing at hand-controlled times. With an external contactor its flashing may be timed to correspond to the speed of a rotating shaft. When so used it will flash up to 1200 times per minute.

A special slow-speed STROBOTAC is available for operation with the STROBOLUME at flashes of from 60 to 1200 per minute. The STROBOTAC alone has a speed range of 60 to 14,400 per minute.

At flashing rate up to 45 per minute, the STROBOLUME may be operated continuously. At other speeds, up to its maximum of 1200, it can be operated for short periods before a built-in automatic circuit breaker calls for a brief rest period.

Many new fields for the stroboscopic study of slow moving machines are opened to research, design and production with the STROBOLUME.



GENERAL RADIO COMPANY

Cambridge 39,
 Massachusetts

90 West St., New York 6 920 S. Michigan Ave., Chicago 5 1000 N. Seward St., Los Angeles 38

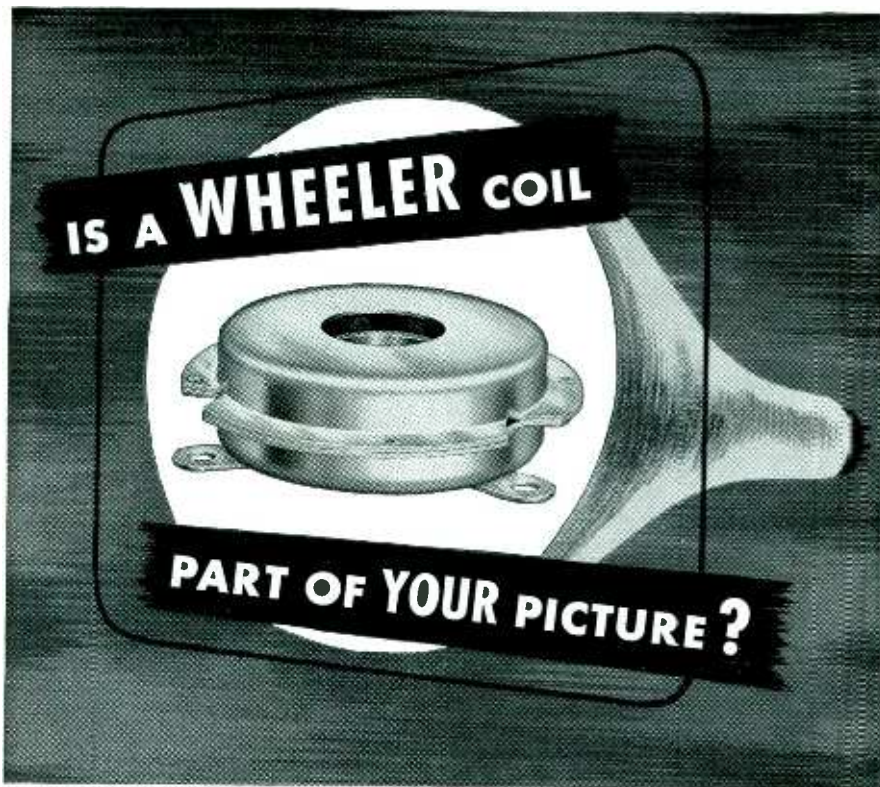

You know if the focusing coil in a television receiver isn't of first quality, the picture will leave much to be desired. We know that Wheeler focusing coils are good insurance against unsatisfactory pictures; that they play an important part in keeping television enthusiasts enthusiastic and in making new friends for this modern miracle of picture transmission and reception.

We know our coils are right because we make our own magnet wire and other components and we wind the coils ourselves. We have complete control over every step in the production of Wheeler coils. Our research, engineering and production facilities — utilized by skilled personnel — have, for many years, produced coils recognized for their quality and performance by an exacting and critical industry.

We'll be glad to place our skills and facilities at your disposal. Write today for information on Wheeler coils for your application.

THE WHEELER INSULATED WIRE CO. INC.



DIVISION OF THE SPERRY CORPORATION

1006 E. AURORA STREET
WATERBURY 91, CONN.

BALLASTS • MAGNET WIRE • COMMUNICATIONS EQUIPMENT • TRANSFORMERS

is different when the same specific pressure is applied to a solid disc or a long narrow band. The graph of this information is helpful in the design of the jig since it determines the total displacement the jig has to produce.

Disc seals are easy to realize once the equipment is set up. There is no doubt that circular seals are equally easy to realize, provided the proper jigs are employed.

Solder Seals

A seal between metal and ceramic is obtained when the ceramic part is painted with titanium hydride powder, the parts assembled with the right amount of solder and the whole assembly heated up to 1,000 C in high vacuum. The vacuum must be better than 10^{-4} mm Hg. Heating can be provided with an r-f coil, but care must be taken to avoid cracks due to uneven heating. The bond can be made with pure silver, pure copper or a silver-copper alloy.

Electrical Properties

The best location of a dielectric wall in a sealed cavity is the one at which the sum of the losses in the dielectric and those due to surface resistance of the seal interface are a minimum. Measurements of surface resistivities were confined to the region of 10,000 mc. A cavity was designed to secure the highest sensitivity. Seals encompassed both faces of the cavity. The surface resistivity was computed after the Q and the field distribution of the cavity were found.

Generally, alloys have higher resistances than pure metals. The magnetic susceptibility of alloys does not follow general rules. The minimum amount of additional metals required to secure a good bond has been determined so as to be as near the ideal conditions as possible.

A very thin nickel layer, about 0.0001 inch, deposited electrolytically on the sintered moly-iron is enough to secure a good wetting action of the solder. By reducing the amount of nickel present in the seal, it is hoped to minimize the effect of its magnetic properties.

The compression type seal can be realized either with pure copper or

YOU CAN BE **SURE**.. IF IT'S
Westinghouse

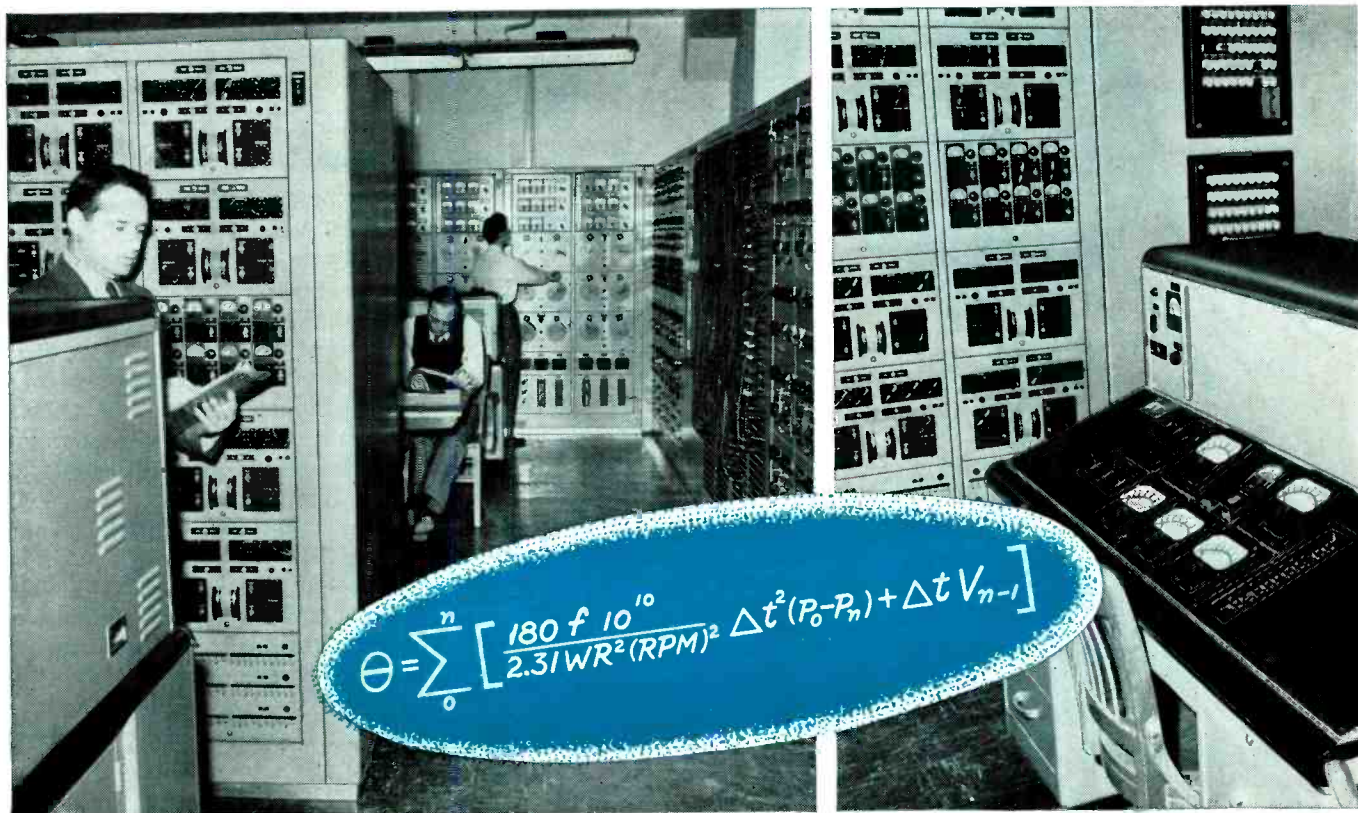

$$\theta = \sum_0^n \left[\frac{180 f 10^{10}}{2.31 WR^2 (RPM)^2} \Delta t^2 (P_0 - P_n) + \Delta t V_{n-1} \right]$$

WESTINGHOUSE INSTRUMENTS Help Solve This Equation...in Minutes!

This A-C Network Calculator, at Texas A & M College, solves complex operating and design problems such as this, in a matter of minutes or hours . . . instead of weeks or months!

Precise electrical analogies required instruments built for accuracy and *complete reliability*. Westinghouse instruments more than live up to these requirements. They also provide the co-ordinated spacesaving designs so necessary to such exacting applications.

What are your electrical measuring problems? The wide scope of the Westinghouse line, and the vast experience that backs it up, provides the electrical measuring instruments to fill *your* needs exactly . . . no matter what the problem. That's why Westinghouse

instruments have long been the choice of design engineers in every field of industry.

Westinghouse instrument specialists are available in the field for consultation. Call your nearest Westinghouse office or write Westinghouse Electric Corporation, P. O. Box 868, Pittsburgh 30, Penna. J-40372



Westinghouse
 Electrical Measuring Instruments
for Every Application

SUPERIOR SEAMLESS CATHODES

TV



are steps ahead

That the major producers of television tubes use millions of Superior Seamless Cathodes is evidence of the recognized high quality of the product.

It takes *engineered* production to make, in many standard designs, Superior Seamless Cathodes.

With these steps—

1 Selection of pure nickel (electronic grade) tubing

2 Accurate production procedures

3 Clean, non-contaminating plant conditions

4 Rigid chemical and metallurgical controls

YOU GET

Superior

CATHODES WITH

- 1** Correct operating characteristics
- 2** Freedom from seams or other obstructions—inside or outside
- 3** Less vibration in tube assembly

The size range—.010" to .121" O.D., .0015" to .005" wall is standard production—other sizes can be produced to your specification. Complete cutting and embossing facilities are available. Write for full information.

Superior

THE BIG NAME IN SMALL TUBING (.010" TO 3/8" O.D. MAX.)

SUPERIOR TUBE COMPANY
ELECTRONICS DIVISION
2500 Germantown Ave., Norristown, Pa.

▶ FOR ELECTRONIC PRODUCTS FOR EXPORT, CONTACT DRIVER-HARRIS COMPANY, HARRISON, NEW JERSEY. HARRISON 6-4800

pure silver; no problems arise here. The minimum amount of titanium in the silver necessary to secure a good bond is about 2 percent by weight. The titanium seems to activate the migration of the silver through the surface layers of the ceramic.

Primary R-F Voltage Standard

WORK in developing primary standards of voltage for radio frequencies up to several hundred megacycles is being done by M. C. Selby, under the direction of W. D. George of the National Bureau of Standards Central Radio Propagation Laboratory, as part of a broad program to develop national standards for electrical quantities at all radio frequencies.

The calibration of signal generators, field-intensity meters, radio receivers, and vacuum-tube voltmeters depends on the accuracy of available reference standards. A practical high-frequency voltage

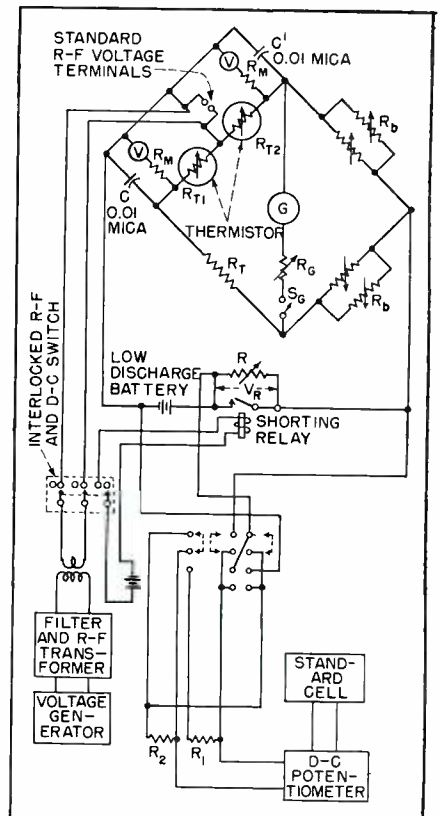

Circuit of new holometer bridge arrangement used in primary high-frequency voltage standard developed at National Bureau of Standards to provide accuracy comparable to that of standard d-c voltage cell

Complete line of metal-cased polarized dry electrolytic capacitors for filter and by-pass service... standardized into eight container sizes to simplify design and assembly problems.

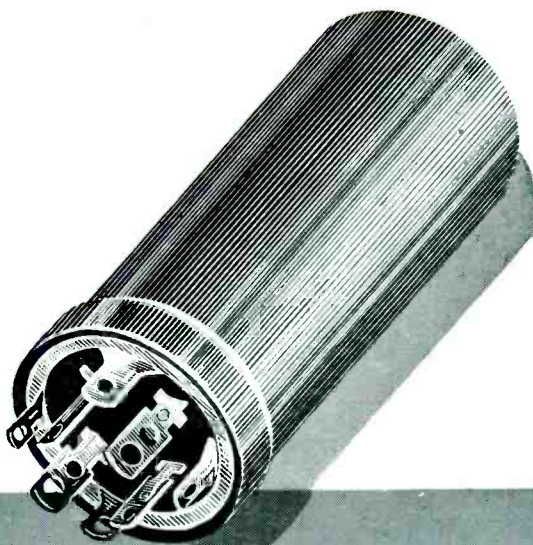

**For precision construction,
long life and dependability — specify
capacitors by **Magnavox**
finest for television**

MMAGNAVOX fabricated-plate electrolytic capacitors, designed for 85° C. operation, assure long, dependable years of corrosion-free life. These high purity anodic aluminum capacitors, with superior high-voltage surge characteristics, are compact... lightweight... economical in cost and operation. Satisfaction is guaranteed!

Pioneer-leader in the manufacturing of electrolytic capacitors, Magnavox has earned the complete confidence of America's leading engineers through years of constant research, product refinements and experience in fabricating over 30,000,000 units. When they need quality capacitors they specify Magnavox.

Write today for a free catalog and information on how Magnavox engineers will, from your specifications, design a capacitor to best meet your individual requirements. The Magnavox Company, Sales and Engineering Office, Components Division, Fort Wayne 4, Indiana.

Magnavox

has served the radio industry for over 34 years

ROBINSON *Announces*

A Great New Advance in Vibration and Shock Protection

**For Land, Sea, and Airborne Instruments
and Electronic Equipment**

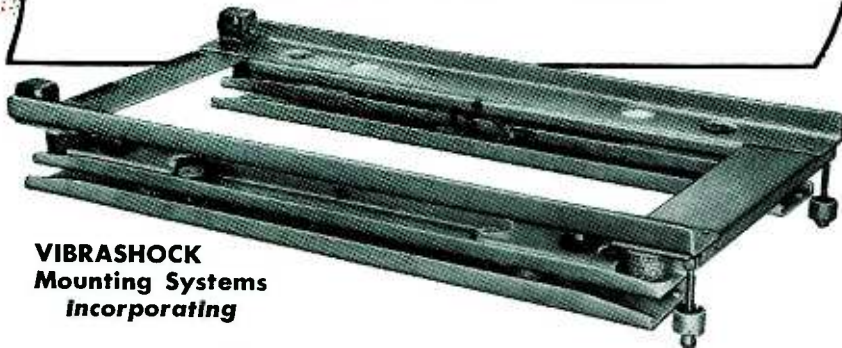

VIBRASHOCK
Mounting Systems
Incorporating

MET-L-FLEX
TRADE MARK

... a new, stainless steel
resilient cushion
that outperforms
rubber or springs

New standards of performance, durability, and load-tolerance are made possible by this major development in shock and vibration isolation systems. Based on the Robinson Vibrashock principle, already considered outstanding in the field, this System is cushioned with "MET-L-FLEX"—a new, all steel resilient material developed for Robinson Mounts.

Met-L-Flex is unaffected by temperature. It will not corrode or deteriorate. The cushions are inherently damped, regardless of altitude.

Vibration isolation specifications are exceeded by these Mounting Systems even under conditions of 35% overload or underload. And because Met-L-Flex offers increasing resistance as load is applied, the System provides a high degree of shock absorption.

Vibrashock Mounting Systems with Met-L-Flex are available in standard Form Factors and designs for special applications. See how completely they can answer your vibration control problems.

Write today for detailed literature and performance curves!

Consider These Remarkable Advantages of Vibrashock Mounting Systems Using "MET-L-FLEX"

- DUAL-PURPOSE** — Non-linear load deflection characteristics provide effective shock protection as well as vibration isolation.
- UNAFFECTED BY TEMPERATURE** — Performance is uniform under temperature extremes.
- DRIFT RESISTANT** — Less subject to permanent set.
- INHERENTLY DAMPED** — Cushion structure provides high damping action, independent of altitude.
- LOAD-TOLERANT** — Performance maintained under wide range of loading.
- DURABLE** — Not subject to aging, or deterioration in presence of oil or moisture.

ROBINSON AVIATION, INC.

53 Industrial Avenue, Teterboro, N. J.

standard must combine reliability with maximum precision and should approach as closely as possible the accuracy of the direct-current voltage standard—the standard cell. Reproducibility of results and agreement between individual primary-standard methods is required within ± 1 percent, since measurements to that accuracy are considered to be of good precision in the h-f region.

One of the techniques developed by the Bureau which satisfactorily meets the basic requirements for a primary standard is the voltage-measuring bolometer bridge, utilizing the dependence of bolometer resistance on power dissipation. In this method, a d-c bridge with a bolometer in one of its legs is first balanced on d-c, r-f power is substituted for some of the d-c power and the bridge is rebalanced. The amount of r-f power equals the difference in d-c power required for balance in each case.

A type of bolometer remarkably suited to the job was fortunately available in the form of microscopically-small thermistors (0.015 inch diameter). The careful design of a special mount for a two-thermistor arrangement eliminates frequency corrections. This type of mount reduced the temperature-time lag of the thermistors and consequently reduced the time required to obtain a bridge balance. Special switching, shorting, and interlocking circuitry was developed to replace r-f power by d-c power instantaneously. This arrangement, shown in the accompanying diagram, provides for close and frequent checking of bridge balance with and without r-f, largely eliminating interference from incidental drifts of ambient temperature and d-c voltage sources. It also allows maximum precision in the measurement of very small increments of large d-c voltage values.

The thermistor bridge has been used so far in the voltage range from 20 millivolts to 1.5 volts at all frequencies from audio to 800 megacycles. The top frequency limit may be considerably higher, but this limit will not be established until other independent methods are available at the higher frequencies.

100,000,000 WATTS

are furnished
by this



PLASTICON CAPACITOR in one microsecond

PLASTICONS are preferred for Pulse Discharge Applications because:

- At all charge and discharge frequencies, losses are lower than in mica or paper capacitors.
- Plasticon Discharge Capacitors are supplied for operation from -80°C to $+200^{\circ}\text{C}$
- Plasticon Discharge Capacitors are made for all voltage and current ratings

PLASTICON DISCHARGE CAPACITORS are used in:

- Radar modulators
- Photoflash devices
- Sonar and Loran Transmitters
- Welders
- Spectrographic Analysers, etc.

Send us your Pulse Discharge capacitor specifications.

CP **Condenser Products Company**

1375 NORTH BRANCH STREET • CHICAGO 22, ILLINOIS

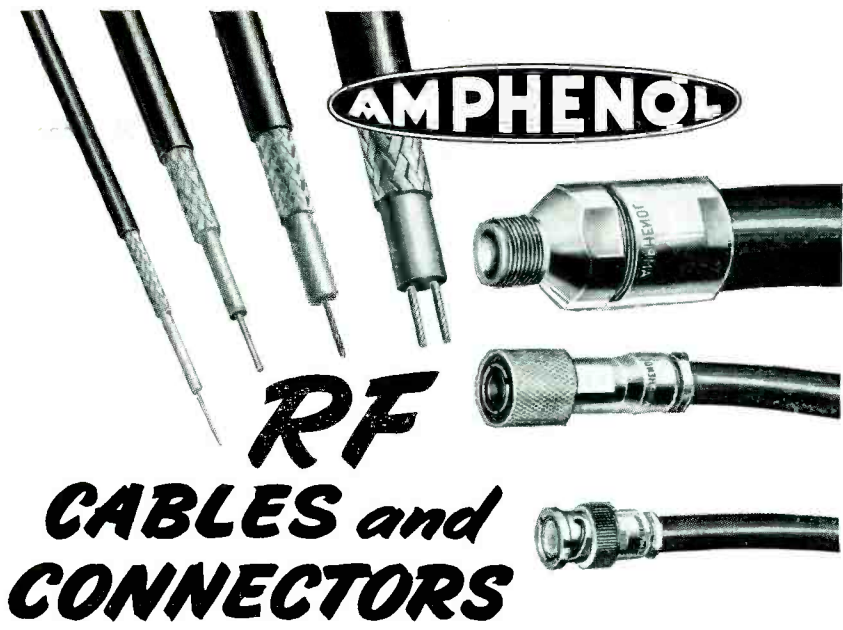

RF CABLES and CONNECTORS

Reliability, convenience, dependability . . . those are the "unseen" qualities built into Amphenol RF Cables and Connectors.

And it's those "extras" . . . combined with a tough, highly resistant vinyl outer jacket and a continuously solid and extremely uniform cable dielectric . . . that give lasting performance with minimum loss and interference.

Whatever the requirements—whether for one small part, or a million complete assemblies—nowhere are results more apparent . . . more economical . . . more important than in the use of Amphenol RF Cables and Connectors.

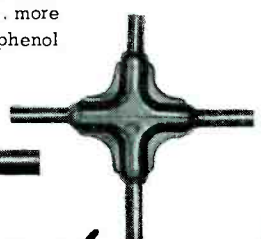
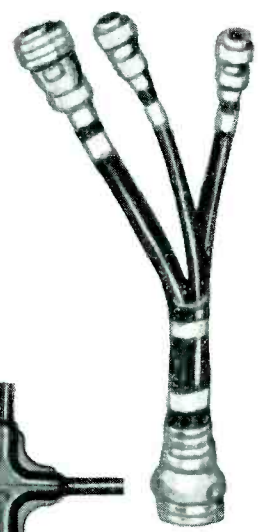

Components and COMPLETE ASSEMBLIES

Amphenol Connectors and Cables are designed in many types of construction. Thus, where connectors are to be permanent, Amphenol is ready to supply complete light-weight assemblies or harnesses with molded connections and RF Connectors, eliminating separate costly parts.

Rugged, compact, providing unsurpassed performance, each component in the assembly gives uninterrupted service and positive protection against all weather.

Catalog D-1 is a ready reference to the regular line of Amphenol RF cables and Connectors. Write on business letterhead to Department H for your copy.



AMERICAN PHENOLIC CORPORATION
1830 SO. 54TH AVENUE
CHICAGO 50, ILLINOIS

NEW PRODUCTS

(continued from p 126)

cracking plants, refineries, chemical plants and areas, and munition mills. It is incapable of igniting the gases or dust surrounding it should a breakdown in the voice-coil or field-coil occur. Units are available in both permanent magnet and electrodynamic models in sizes from 2 through 12-inch diameter, round, and also 4x6 inches and 6x9 inches oval shapes.

Tele Antenna Compass

SIMPSON ELECTRIC Co., 5200-18 W. Kinzie St., Chicago, Ill. Model 351 television antenna compass is connected by an insulation-piercing alligator clip to the video input of



the c-r tube in the receiver, and carried to the antenna site by an extension cord. With a test pattern tuned in on the area's weakest station the antenna is then rotated for maximum deflection of the compass. It also helps to peak the r-f and oscillator systems on the station itself.

All-Record Changer

GENERAL INSTRUMENT CORP., 829 Newark Ave., Elizabeth 3, N. J. A new automatic record changer plays records of all sizes and speeds with the same pickup arm. It has a con-



KAY ELECTRIC COMPANY

FOUR NEW KAY INSTRUMENTS INTRODUCED AT I.R.E. SHOW . . .

For High Frequency Laboratory Work and TV Receiver Development and Service.

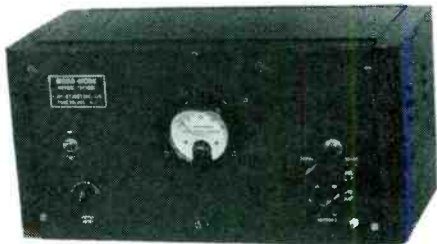

THE MEGA-NODE (NOise diODE) HELPS OVERCOME RF FRONT END PROBLEMS

- A Calibrated Random Noise Source
- Read the Noise Figure of Your Receiver Directly from a Panel Meter in db—
- Selection of Various Output Impedances by Panel Switch.

SPECIFICATIONS

Frequency Range: 1 to 220 mc
Output impedances: 50, 75, 150, 300 ohms and infinity unbalanced. 100, 150, 300, 600 ohms balanced selectable by panel switch.
Noise Figure Range: 0 to 17 db at 50 ohms
0 to 23 db at 300 ohms
Filament Voltage: Regulated d.c. used on filament of noise generating tube.
Power Supply: 117 Volts plus or minus 8 volts 60 cps
Dimensions: 8" x 16" x 8"

Price \$295.00 F. O. B. Factory



THE MEGALYZER JR. A SENSITIVE VISUAL VOLTMETER AND SPECTRUM ANALYZER ATTACHMENT

- Used in Combination with Mega-Sweep and Standard Oscilloscope as a High Frequency Spectrum Analyzer.
- With Same Combination plus Calibrated Signal Generator, Voltage Measurements over Wide Frequency Range can be Made.

SPECIFICATIONS

Frequency Range 30 to 500 mc Useful to 1000 mc.
Frequency Sweep on Display: Up to 30 mc
Frequency Resolution: 100 KC
Sensitivity: 100 to 10,000 microvolts. Range can be extended upward by external pads.

Price \$250.00 F. O. B. Factory



THE MEGALIGNER PROVIDES TUNABLE C W TYPE "BIRDIE" MARKER OR TUNABLE PIP MARKER

- A Television Marker Generator
- Covers All Present and Proposed Television IF Frequency Bands
- Pip Type Marker Does Not Go Through Receiver. Does Not Overload Receiver in Pass Band Nor Disappear in Traps.
- Accuracy .5% of Full Scale.

SPECIFICATIONS

Frequency Range: Two Bands 19 to 30 mc; 30 to 49 mc
Marker Outputs: CW "Birdie" or "Pip" Type
Power Supply: Self Contained
Amplitude Control: Both Outputs Adjustable by Panel Controls
Accuracy: .5% Full Scale
Mixing System: Self Contained Mixer System for Use with Sweeping Oscillator to Obtain "Pip"

Price \$150.00 F. O. B. Factory



THE MICROWAVE-MEGA-MATCH DISPLAYS REFLECTED ENERGY IN X-BAND

- Displays Amount of Reflected Energy Over a Wide Frequency Range
- Sweep Frequency Width on Display up to at least 30 mc
- Rapid Adjustment of Microwave Antennas and Matching Sections is possible.
- Indications of Reflection Coefficient Change Down to .02.
- Approximately 75 feet 1" x 1/2" Waveguide Occupying Space 8 feet by 1 foot by 17 inches Supplied as Delay Waveguide.

SPECIFICATIONS

Frequency Range: 8500 to 9700 mc (X-Band)
Frequency Sweep on Display: Up to at least 30 mc
Frequency Measurement: Calibrated Microwave Wave meter
Sensitivity: Reflection Coefficient Changes Indicated Down to .02.
Equipment Includes Power Supply and Control Box, Approximately 75 Ft. 1" x 1/2" Delay Waveguide in 8' by 1' by 17" space

Price \$895.00 F. O. B. Factory

FOR FURTHER DETAILS WRITE

KAY ELECTRIC CO., 25 MAPLE AVE., PINE BROOK, N. J.
Tel: Caldwell 6-4000

Manufacturers of: Mega-Sweep, Mega-Marker, Mega-Piper, Mega-MarkerSr., Mega-Match, Mega-Pulser, Megalyzer, Micro-Pulser, Kay Sound Spectrograph, Sonalator.



MOSINEE doesn't count its success in terms of big volume records. More important to us is the aid that MOSINEE "paperologists" and facilities provide our customers.

If you have a problem involving paper . . . if you require specific technical characteristics such as high tensile or tear strength, accurate caliper, density, liquid repellency or absorbency, good dielectric strength, specified pH for maximum-minimum acidity or alkalinity . . . and above all, if you want to be sure of *dependable uniformity* . . . it will pay you to specify "MOSINEE." For consultation with MOSINEE technicians, without obligation to you, please write Dept. E.

MOSINEE

"More than Paper"



MOSINEE PAPER MILLS COMPANY • MOSINEE, WISCONSIN

"Essential Paper Manufacturers"

ventional spindle diameter and has plastic adaptor buttons for 45-rpm records. Featured is a nonpulsing velocity trip mechanism which eliminates the pulsing noise which might otherwise be reproduced in the loudspeaker.

Carrier-Frequency Voltmeter

SIERRA ELECTRONIC CORP., 1211 Old Country Road, Belmont, Calif. Tunable over the carrier-frequency spectrum from 3 to 40 kc, the model



103 voltmeter measures from 77 μ v to 77 volts or -80 to +40 dbm, read on a 4-inch indicating meter. A signal is 10 db down 1 kc off resonance, 21 db at 2, and 50 at 4. The unit consumes 80 va operating from 105 to 125 volts, 60 cycles, through a built-in regulated power supply.

Servo Motor

KOLLSMAN INSTRUMENT DIVISION OF SQUARE D Co., 80-08 45th Ave., Elmhurst, N. Y., has developed a 400-cycle, 115-volt, two-phase, four-

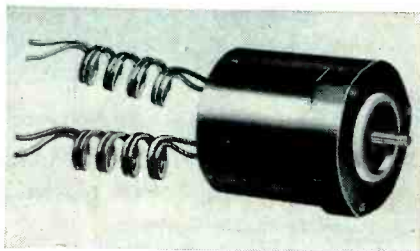

pole induction motor with a torque-to-inertia ratio of 26,300 radians per second per second. Reversal time at 11,200 rpm is 0.2 second. The unit delivers 2½ ounce-inches stall torque which varies directly with the control winding voltage.

Portable Tape Recorder

RADIO CORP. OF AMERICA, Camden, N. J. Type RT-3A portable magnetic tape recorder has a frequency response of 50 to 15,000 cycles. Designed for recording programs at remote points with the same high

The "EXTRA SOMETHING" that spells **TOP PERFORMANCE**

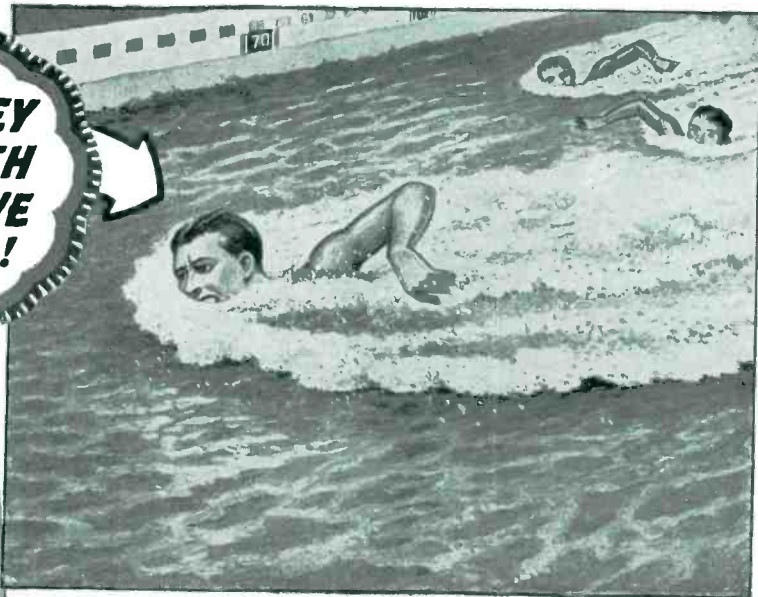
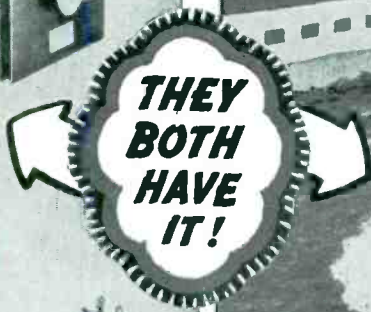
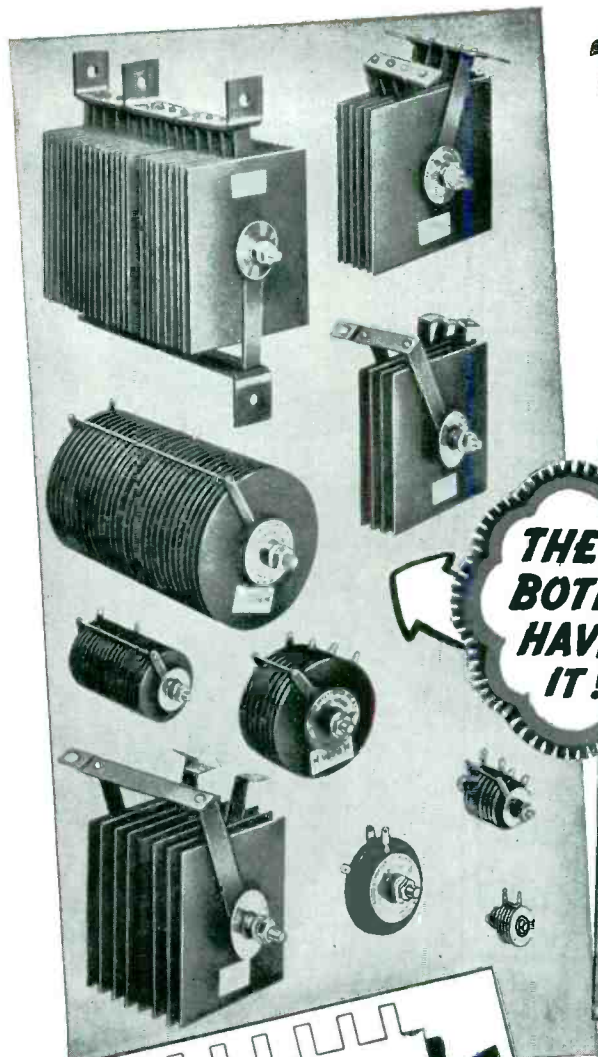

Seleton
SELENIUM RECTIFIERS

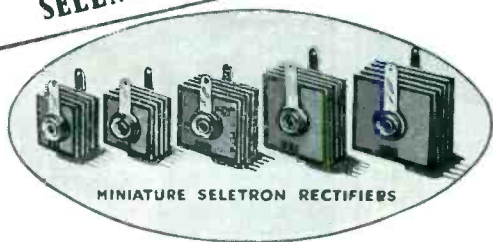

FOR ALL ELECTRONIC AND
RADIO APPLICATIONS

SPECIFY "SELETRON MINIATURES"

They insure dependable service.

Code Number	5M4	5M1	5P1	5R1	5Q1	5S1
Current Rating	75 ma.	100 ma.	150 ma.	200 ma.	250 ma.	500 ma.
Plate Height	1"	1"	1 3/16"	1 1/2"	1 1/2"	2"
Plate Width	1"	1"	1 3/16"	1 1/4"	1 1/2"	2"

SLASHING his way to victory by powerful, telling strokes the swimming champion is first at the finish line by a safe margin—a winner because he has the "extra something" in skill and endurance that spells **TOP PERFORMANCE**.

Top performance in every rectifier application is assured to users of Seleton Selenium Rectifiers by reason of the "Extra Something" we put into them.

All chemicals of high purity to meet rigid special specifications.

Precision methods in all mechanical and chemical processes plus scrupulous care in assembling give them "Extra Something No. 2."

And to clinch all, every Seleton Selenium Rectifier must pass through an uncompromising series of tests and inspections, before we give it our OK for shipment to you.

Fabricated under such rigid rules, it is easy to understand why Seleton Rectifiers have won a nation-wide reputation for long dependable service in AC to DC applications of every type.

Furnished in a variety of assemblies to cover a wide range of currents and voltages.

Write today for Catalog
Address Dept. ES-18



SELETRON DIVISION
RADIO RECEPTOR COMPANY, Inc.



Since 1922 in Radio and Electronics

251 WEST 19TH STREET, NEW YORK 11, N. Y.

DESIGNED FOR DISCRIMINATING MANUFACTURERS



Also manufacturers of high grade cotton and silk covered wires, cotton and silk coverings over enamel coated wires, and all constructions of Litz wires. A variety of coverings made to customers' specifications, or to requirements determined by our engineers. Complete design and engineering facilities are at your disposal; details and quotations on request.

Leakproof

**ENAMELED
MAGNET
WIRE**

A product, resulting from many years of research in the field of fine wire manufacture, that meets the most rigid requirements of radio and ignition coils.

A new coating method gives a smooth, permanently - adherent enameling, and mercury-process tests guarantee perfect uniformity. Great flexibility and tensile strength assure perfect laying, even at high winding speeds. If you want reduction in coil dimensions without sacrificing electrical values, or seek a uniform, leakproof wire that will deliver extra years of service, this Hudson Wire product is the answer.

Winsted
HUDSON WIRE CO.
Division

WINSTED • CONNECTICUT

*If the Specific Dry Battery You Need
Is NOT Listed in This Free Manual...*



**BURGESS ENGINEERS WILL
DESIGN A NEW BATTERY TO
MEET YOUR SPECIFICATIONS**

It's all part of the Burgess Service! This complete Engineering Manual lists *hundreds* of battery types developed by Burgess Engineers to meet new requirements. If the specific battery you need is not among them, the complete Burgess facilities, design, production, and engineering will be placed at your disposal to build the battery you need in any quantity — large or small!

Write for ENGINEERING MANUAL and CHECK SHEET

No obligation. By return mail you will receive the **FREE** Engineering Manual listing the complete line of Burgess Batteries together with specifications; also the Burgess "Check Sheet" on which you may outline your requirements in the event that the battery you need has not already been developed. Address:

BURGESS

BATTERY CO., (DEPT. E1) FREEPORT, ILLINOIS

**POLARAD
TELEVISION** *Equipment*

for studio • laboratory • manufacturer

SYNCHRONIZING GENERATOR

Model PT 101—Television

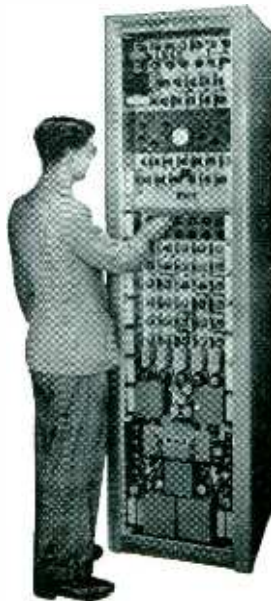

FEATURES

- Built-in 3" oscilloscope with synchronized sweeps for viewing Timing and Video Output pulse wave forms.
- Synchronized marker system for checking pulse width and rise time.
- Extreme stability, insured by deriving all pulses from leading edge of master oscillator pulse.
- Means for checking synchronizing pulses in odd and even fields.

SPECIFICATIONS

525 line, Interlocad, 60 fields, 30 frames, RMA Synchronizing pulses held to tolerance specified in the NRTPB report of 1945. Output Pulses; Synchronizing, Video Blanking, Camera Blanking, Horizontal Driving, Vertical Driving Pulses. 5 volts across 100 ohm termination. Dual output jacks. 115 volts 50/60 cps. Complete with tubes.



**TELEVISION
MONOSCOPE
SIGNAL
SOURCE**

Model PT 102

- Composite Video Signal
- Wide Band Video Amplifier, 6 DB down at 10MC
- Dual outputs for feeding two 75 or 100 lines
- Black positive or Black negative output
- Resolution greater than 600 lines

INPUT: Vertical and Horizontal Driving pulses. Camera and Kinescope Blanking Pulses.

OUTPUT: Composite Video Signal, 3 volts. 100 ohm line 115 volts 50/60 cps. Complete with tubes and including high and low voltage power units.

9 FERRY STREET
NEW YORK 7, N. Y.

Polarad
Electronics Company

Television engineers and consultants to the nation's great television stations.

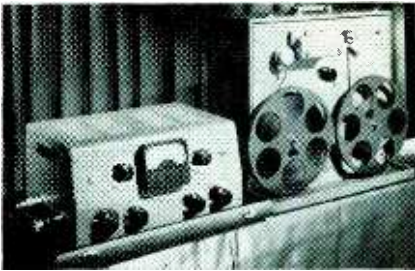

fidelity that is obtainable in the studio, it consists of two units, a tape recorder and amplifier. A synchronous motor with two windings and a speed control switch make possible instantaneous change of recording speed from 15 inches of tape per second at 15-kc response to 7½ inches per second with 7-kc response. The amplifier unit includes circuits for erase, a recording amplifier and a playback amplifier.

Spectrum Analyzer

KAY ELECTRIC Co., Pine Brook, N. J. The Megalyzer is used in combination with the Megasweep and a standard oscilloscope for



high-frequency spectrum analysis. It is used for measurement of voltages ranging from 100 to 10,000 microvolts. The range of sensitivity can be increased to include greater input voltages by attaching external pads. The instrument has a frequency range from 30 to 500 mc and a frequency sweep on display of at least 30 mc. Frequency resolution is 100 kc.

Soldering Pliers

DURST MFG. Co., 11110 Cumpston St., North Hollywood, Calif. Utility model CA-6-199 electric soldering pliers designed for wiring and soldering are especially adaptable to compact assemblies. Wires or parts to be soldered are held by the pliers, and the foot switch is depressed for an instant to heat the

Precision Engineered
for *Finest* Equipment

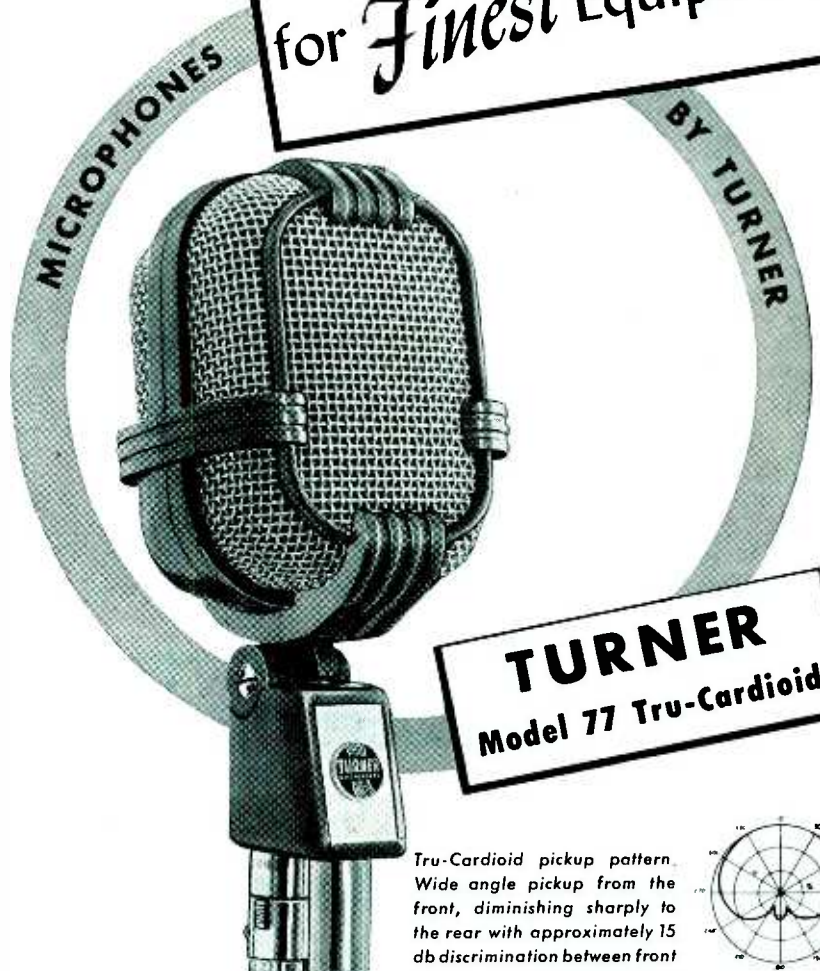

TURNER
Model 77 Tru-Cardioid

Tru-Cardioid pickup pattern. Wide angle pickup from the front, diminishing sharply to the rear with approximately 15 db discrimination between front and rear at all frequencies.

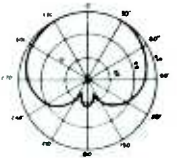

● Tru-Cardioid pickup pattern and smooth wide range response make the Turner Model 77 a truly outstanding microphone. A combination of velocity and dynamic generators produce the Tru-Cardioid pickup pattern which reduces feedback to minimum and practically eliminates extraneous sound arriving from the rear. Response is substantially flat from 70 to 10,000 c. p. s. with output of 62 db below 1 volt/dyne/sq. cm. at high impedance. Built-in switch gives instant selection of 50, 200, 500 ohms or high impedance output. Other features include 90° tilting head ¾"–27 coupler mounting, and quick-disconnect, balanced line cable set. Finished in gunmetal gray with chrome plated screen. The Model 77 Tru-Cardioid is recommended for quality recording, public address, and broadcast work.

THE TURNER COMPANY

905 17th Street N. E., Cedar Rapids, Iowa

IN CANADA: Canadian Marconi Co., Ltd.
Montreal, P. Q., and branches

EXPORT: Ad. Auriema
89 Broad Street, New York 4, N. Y.



LICENSED UNDER U. S. PATENTS OF THE AMERICAN TELEPHONE AND TELEGRAPH COMPANY, AND WESTERN ELECTRIC COMPANY, INCORPORATED

*Now Terminals Can Be
ATTACHED & SOLDERED
in ONE Automatic Operation!*

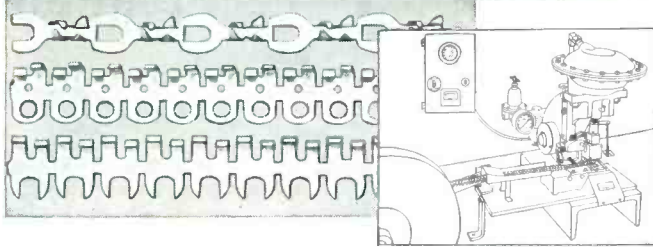

New Terminal Attaching Machine—

attaches and solders various sizes and types of pre-soldered tandem terminals (supplied on reels) at rates up to 1200 per hour. Machine cuts off, clinches and solders terminals in one instantaneous operation. Eliminates handling of loose terminals, solder and flux to increase production and lower costs on long runs. Standard types available. Strong, perfectly soldered joints are assured, as absolute control of heat is maintained. Send for detailed information, enclose sample of wire and terminal now used. Address Dept F.

For ordinary runs in moderate quantity we continue to produce
SEPARATE TERMINALS for ELECTRIC WIRES

We also make **SMALL METAL STAMPINGS**, exact to Customer's Prints. Modern Plant, Equipment and Methods. Precision Work. Moderate Die Charges. Prompt, Dependable Service.

PATTON-MacGUYER COMPANY
17 Virginia Avenue, Providence, R.I.

SYNCHRON
TRADE MARK
**TIMING MOTORS
AND
TIME MACHINES**



*Synchronous
Self-starting
Self-oiling*

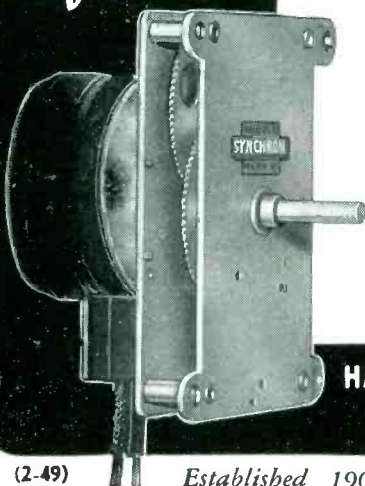

Never Need Oiling . . . Operate Efficiently In Any Position . . .

Motor is equipped with oil storage reservoir and patented oil feed to bearings. Rotor shaft, reduction train, and output shaft, all have double bearings to reduce vibration and assure quiet, efficient operation when mounted in any position.

Brass Gears Operate Against Steel Pinions—Steel Shafts Operate In Babbitt Bearings

There is no compromise for quality in the design and construction of SYNCHRON Timing Motors and Time Machines! If you have any timing design problems, SYNCHRON offers the benefit of long experience and capable design assistance. Write for catalog and engineering data.

HANSEN MANUFACTURING CO., INC.

Princeton 10, INDIANA

(2-49)

Established 1907 - a Pioneer in Synchronous Motors



One Charge

for this

**COMPLETE
dependable
shipping service!**

RAILWAY EXPRESS charges cover everything . . . pick-up and delivery in all principal cities and towns, receipt protection, automatic valuation allowance. You know where you stand when you use this dependable service. You deal with one responsible carrier, geared to meet your exact industrial and personal shipping needs with fast, economical rail-air service.

Whether you're the sender or the receiver, it's sound business judgment to say, "Ship it RAILWAY EXPRESS!"

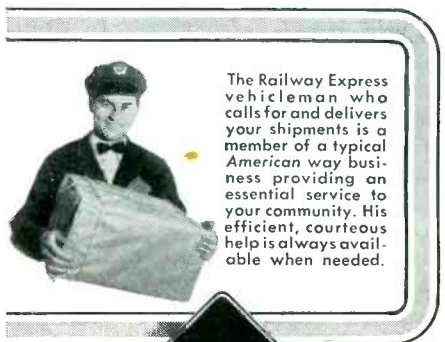

The Railway Express vehicle man who calls for and delivers your shipments is a member of a typical American way business providing an essential service to your community. His efficient, courteous help is always available when needed.



NATION-WIDE RAIL-AIR SERVICE

June, 1949 — ELECTRONICS



contact point enough to melt the solder. The current-resistance principle heats the work instantly only at the point of contact. Pliers remain cool at all times.

Flutter Meter

AMPLIFIER CORP. OF AMERICA, 398-25 Broadway, New York 13, N. Y. Model 491, type A, flutter, wow and drift percentage analyzer gives readings on various-speed discs, 16 and 35-mm sound film mechanisms, acetate film recorders,



magnetic wire and tape recorders and playback equipment. Built-in preamplifier and input attenuator will accept voltages ranging from 1 mv to 100 volts. The unit can also be used to test f-m distortion in loudspeakers. Net price is \$495. Complete descriptive literature and technical specifications are available.

Coax Switch

THE WORKSHOP ASSOCIATES, Newton Highlands, Mass., has announced Model R-4A, a single-posi-

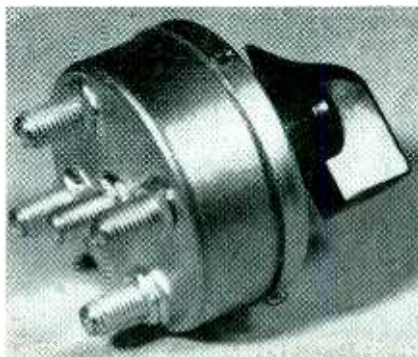

when you need
**GOOD
INSULATION**

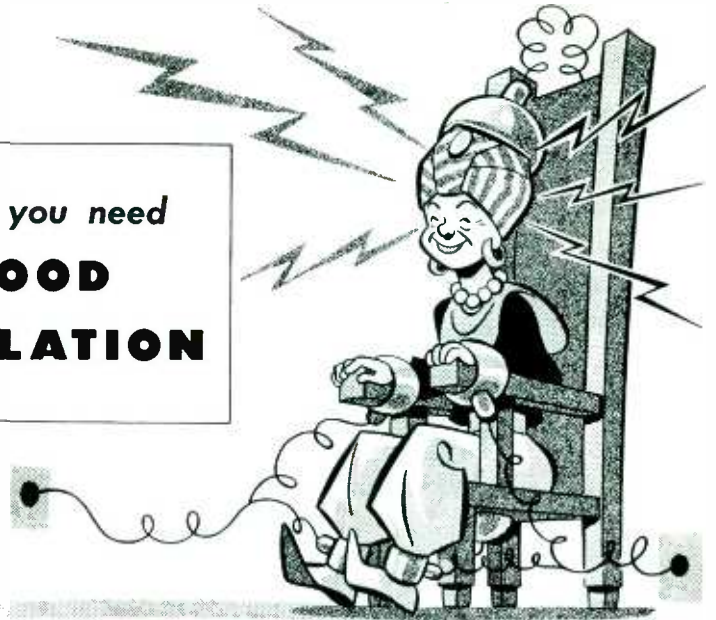

. . . to make your product sell and serve, you have only two choices so far as mica goes . . . ordinary mica, and MACALLEN MICA. And—because it is easy and economical to say MACALLEN, and hard and expensive to right the engineering wrongs that poor mica brings, you'll find that most canny production and purchasing men are forgetting that there's such a thing as plain, everyday mica. Just check on those electrical products that lead the reputation parade. You'll find that they are MACALLEN MICA insulated—one good name helping another.

PRECISION

Many engineers never connect precision with mica processing—until they become acquainted with MACALLEN MICA, with its accuracy of shape, thickness, flexibility and other qualities. Do you know it?

MACALLEN MICA

ALL FORMS, ALL QUANTITIES — ALL DEPENDABLE

when you think of MICA, think of MACALLEN



THE MACALLEN COMPANY • 16 MACALLEN ST., BOSTON 27, MASS.

CHICAGO, 565 W. WASHINGTON BLVD. • CLEVELAND, 1231 SUPERIOR AVE.

PRECISION



**POTENTIOMETER
PERFORMANCE
THAT EXCEEDS
SPECIFICATIONS**

In potentiometers, "Fairchild" and "Precision" are synonymous. Because in Fairchild Potentiometers, close-tolerance machining of all parts goes hand-in-hand with the careful selection of the right contact materials and the right resistance wire. This, plus painstaking assembly by skilled craftsmen and the exact adjustment of wiper arm pressure, adds up to potentiometer performance that assures sustained accuracy over a service life far exceeding the guaranteed 1,000,000 cycles of operation.

Fairchild engineers will be glad to help in the selection of both linear and non-linear potentiometers to meet your particular needs. Address: Dept. L, 88-06 Van Wyck Boulevard, Jamaica 1, New York.



do you know what **PAPER** can do for you?

**PAPER
HAS A FOURTH
DIMENSION**

Central Engineered Electrical Papers are among the most versatile of materials. They can be accurately controlled in thickness, porosity, Ph, weight and many other characteristics. Central Electrical Papers can also be made with anti-rust and anti-tarnish properties . . . they can be creped for easier wrapping around corners . . . they can be juted for extra strength . . . they can be water-proofed . . . or almost any combination of these properties and special treatments may be had.

The Central Paper Engineer knows his papers and is backed by laboratory facilities second to none in the industry.

**CENTRAL
PAPER
COMPANY INC.**

2446 LAKESHORE DRIVE

MUSKEGON, MICHIGAN

FIRST BASIC PICKUP ADVANCE in 10 years!

LIST PRICE \$7.50



SELL NEW TITONE PICKUP!

- **FIRST BASIC PICKUP ADVANCE IN 10 YEARS**—the original piezoelectric ceramic pickup!

- **DOES WONDERS FOR TONE!** Wider frequency range—unequaled reproduction. A genuine selling point for players. Fits all tone arms. Made by SONOTONE, famous makers of hearing aids.

- **TRANSCRIPTION TONE QUALITY!** Full frequency to 10,000 cycles! Bell-like supertone makes even old players thrilling!

- **SURE-FIRE IN HUMID CLIMATES!** Utterly unaffected by climate, moisture, fungus! Booms sales, wins back customers.

- **DOUBLES RECORD LIFE AND PLEASURE!** Gives "ordinary" records sparkling quality—revives worn favorites. Will play down to 1/2 normal pressure, NO "needle talk!"

- **RUGGED! PERMANENT!** No crystals, magnets, filaments to fail! No pre-amplifiers. Ceramic TITONE performs perfectly for years!

NO TONE LIKE TITONE

CALL YOUR JOBBER
or write to
SONOTONE

Box T-4, Elmsford, N.Y.

tion, four-throw switch designed especially for use with television transmission lines. It can also be used in r-f applications up to 350 mc and in low-level audio systems.

Marine Radiotelephone

WESTERN ELECTRIC Co., INC., 195 Broadway, New York 7, N. Y. Model 248-A is a 250-watt marine radiotelephone designed to facilitate ship-to-ship and ship-to-shore communications for ocean-going

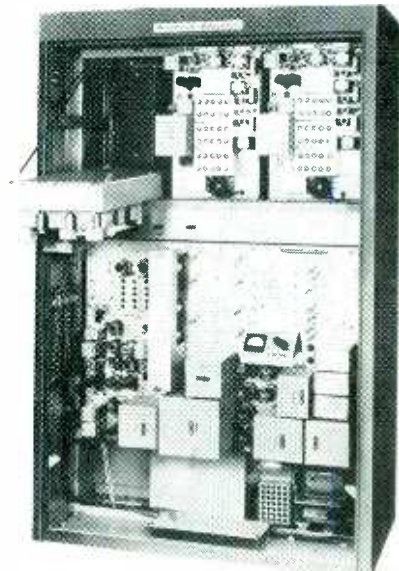

vessels. Thirty transmitting frequencies are provided, three from each of the ten marine service bands between 2,100 kc and 18,000 kc. Transmitter and receiver units pictured here are controlled from a small remote unit that can be mounted anywhere on the ship.

Printed Circuits

KENYON INSTRUMENT Co., 1345 New York Ave., Huntington Station, L. I., N. Y., announces three new processes for the fabrication of

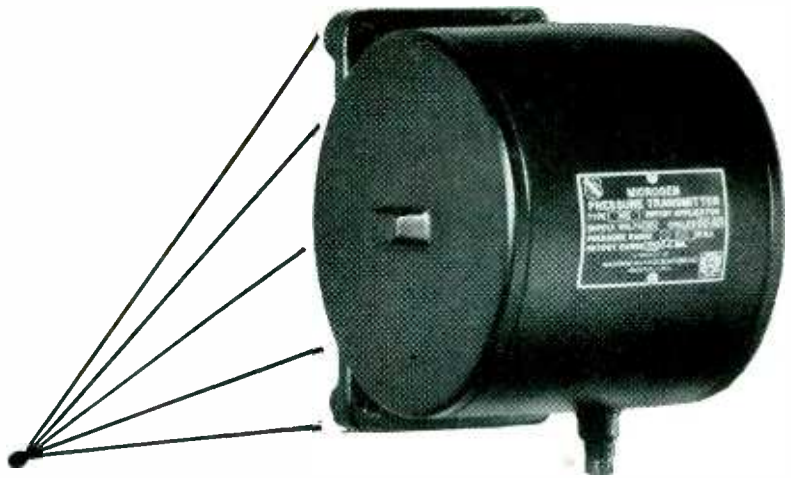
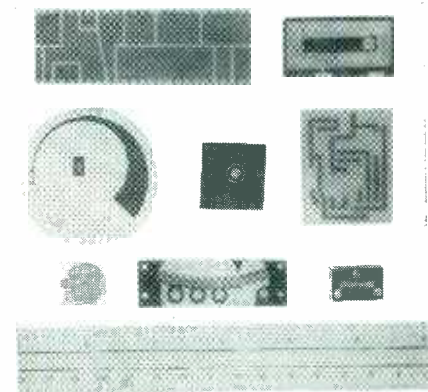

MICROSEN PRESSURE TRANSMITTER Means "ONE-POINT" Pressure Indications

An economical, efficient and accurate method of transmitting pressure indications to a central control point, through simple electrical wiring, is provided by the *new* Microsen Pressure Transmitter.

Such transmission avoids the dangers and difficulties present with long pressure lines that must pass through areas where leakage or fracture of those lines may cause serious damage.

The complete installation is simple and easy. The transmitter is connected to the pressure source in exactly the same manner as a Duragauge.

Since the power supply can be any of the normally used circuits commonly available in industry, the electrical connections are equally simple. All models are available in standard Duragauge pressure ranges.

Write for specific information.



MICROSEN PRESSURE TRANSMITTER

A Product of
MANNING, MAXWELL & MOORE, INC.
BRIDGEPORT 2, CONNECTICUT

Makers of 'American' Industrial Instruments, Hancock Valves, Ashcroft Gauges, Consolidated Safety and Relief Valves. Builders of 'Shaw-Box' Cranes, 'Budgit' and 'Load Lifter' Hoists and other lifting specialties.

Only with CO-AX

air-spaced articulated
R.F. CABLES

4mmf/ft



Patents Regd. Trade Mark.

**THE LOWEST EVER
CAPACITANCE OR
ATTENUATION**

We are specially organised
to handle direct enquiries
from overseas and can give

IMMEDIATE DELIVERIES FOR U.S.A.

*Billed in Dollars. Settlement by your check.
Transaction as simple as any local buy.*

TRANSRADIO LTD

CONTRACTORS TO H.M. GOVERNMENT
13 BA CROMWELL ROAD LONDON SW7 ENGLAND
CABLES: TRANSRAD. LONDON.

LOW ATTEN TYPES	IMPED OHMS	ATTEN db/100ft of 100 Mcs.	LOADING Mw of 100 Mcs.	O.D."
A 1	74	1.7	0.11	0.36
A 2	74	1.3	0.24	0.44
A 34	73	0.6	1.5	0.88

LOW CAPAC TYPES	CAPAC mmf/ft	IMPED OHMS	ATTEN db/100ft of 100 Mcs.	O.D."
C 1	7.3	150	2.5	0.36
PC 1	10.2	132	3.1	0.36
C 11	6.3	173	3.2	0.36
C 2	6.3	171	2.15	0.44
C 22	5.5	184	2.8	0.44
C 3	5.4	197	1.9	0.64
C 33	4.8	220	2.4	0.64
C 44	4.1	252	2.1	1.03

**HIGH POWER
FLEXIBLE**

**PHOTOCELL
CABLE**

V.L.C. ★

★ Very Low Capacitance
cable.

Available for your Data File

Valuable CATALOG

Complete Information on WASHERS and STAMPINGS

Here's a pocket edition catalog made to order for those engaged in the selection and purchase of washers and stampings . . . forty-six fact-packed pages of worth-while descriptive material, including illustrations of many of the more than 22,000 dies available in our plant to save you unnecessary die charges and delay. Write for your free copy, today. It will be sent to you without cost or obligation. Ask for Catalog No. 20.

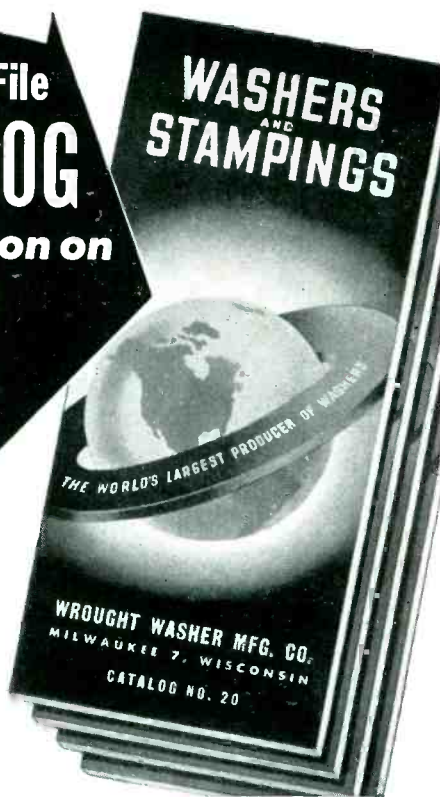

**WROUGHT WASHER
MANUFACTURING CO.**
The World's Largest Producer of Washers
2118 S. BAY ST., MILWAUKEE 7, WIS.



American Beauty

ELECTRIC SOLDERING IRONS

are sturdily built for the hard usage of industrial service. Have plug type tips and are constructed on the unit system with each vital part, such as heating element, easily removable and replaceable. In 5 sizes, from 50 watts to 550 watts.

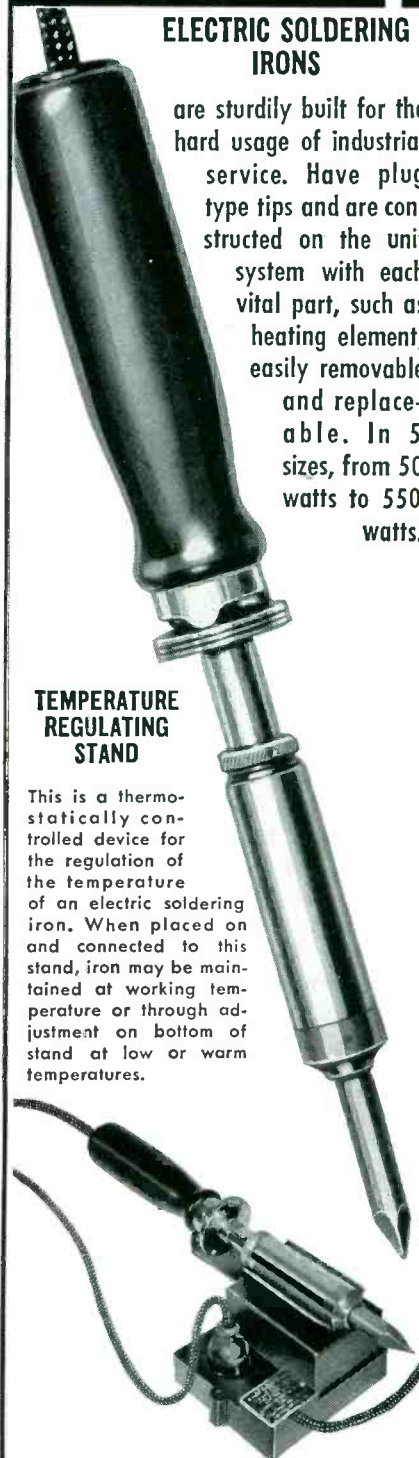

TEMPERATURE REGULATING STAND

This is a thermostatically controlled device for the regulation of the temperature of an electric soldering iron. When placed on and connected to this stand, iron may be maintained at working temperature or through adjustment on bottom of stand at low or warm temperatures.

For descriptive literature write

110-1

**AMERICAN ELECTRICAL
HEATER COMPANY**
DETROIT 2, MICH., U. S. A.

electrical, electronic, and optical parts at low cost in either small or large quantities. Principal tooling up is the production of an enlarged drawing of a part which is then reduced and duplicated by essentially photographic processes. Literature is available.

Insulated Wire

WILLIAM BRAND AND Co., 276 Fourth Ave., New York 10, N. Y. Turbotherm REL-16A insulated

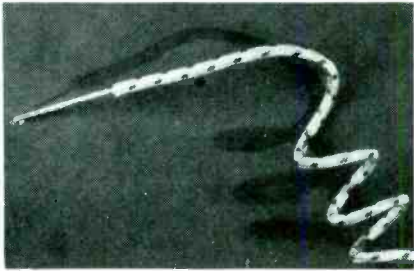

wire carries 105 C rating with continuous operation for 300 and 600 volts. It comprises a vinyl dielectric with a closely braided lacquered glass jacket. Operating range is -10 to 105 C.

R-F Step Attenuator

A. F. SMUCKLER & Co., INC., 202-208 Tillary St., Brooklyn 1, N. Y. The r-f step attenuator illustrated is of the coaxial turret type and

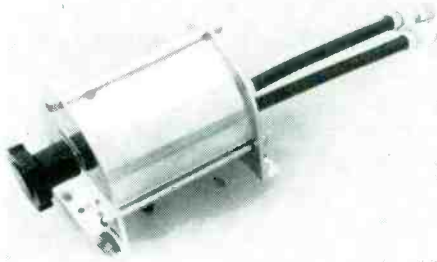

gives 80 db of attenuation in four equal steps. Input impedance is 50 ohms resistive when terminated by a 50-ohm output resistive impedance. Error due to frequency characteristics is ± 0.25 db from 0 to 600 mc.

DPDT Relay

LEACH RELAY Co., 5915 Avalon Blvd., Los Angeles, Calif. The 637-57A hermetically sealed relay is provided with a standard octal plug having a metal locating pin and



PORTABLE, LABORATORY-TYPE regulated power supply

- ✓ Continuous range from 0 to 300 volts
- ✓ No-load to full-load regulation better than 1% for voltages above 30 volts

The RCA WP-23A is a compact, portable, regulated power supply expressly designed for shop, laboratory and factory, where a reliable source of constant dc voltage is required. The output of the WP-23A is virtually independent of line-voltage and load-current variations. Ripple voltage is less than 8 RMS millivolts. Primarily intended as an extremely stable "B" supply, the WP-23A is also useful as a low-impedance "C" bias supply.

The WP-23A will deliver 120 ma over an output range of 120 to 300 volts. Two WP-23A's can be connected in series to double the output voltage. It will meet the demands of pulsed currents of short duration in excess of continuous current ratings. Auxiliary terminals on the front

panel provide unregulated outputs of 600 dc volts at 120 ma and 6.3 ac volts at 5 amperes.

For full details, ask your RCA Test and Measuring Equipment Distributor for Bulletin 2F720, or write RCA, Commercial Engineering, Section 42FY, Harrison, N.J.

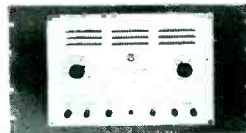

Where mounting of the WP-23A in a standard 19-inch relay rack is desired, the WS-18A Rack Adapter Panel is available on separate order.

SPECIFICATIONS

Regulated DC Output	
Voltage range (continuously adjustable)...	0-300 volts
Current range for 120-300 volts.....	0-120 ma
Current range for 60-120 volts.....	0-80 ma
Current range for 0-60 volts.....	0-60 ma
Regulation for line-voltage variation of 105 to 125 volts.....	
	Less than 1/2 per cent
Regulation above 30 volts for zero load to full load.....	
	Less than 1 per cent
Ripple voltage (RMS).....	Less than 8 millivolts
Auxiliary Unregulated DC Output	
Voltage (approx.).....	600 volts
Current Capability.....	120 ma
Ripple Voltage.....	0.1 volt
Auxiliary Unregulated AC Output	
Voltage.....	6.3 volts
Current Capability.....	5 amperes
Input Power 105/125 volts, 50/60 cycles, 175 max. watts	
Dimensions... Height, 10 ; width, 13 1/2 ; depth, 7 1/2	
Weight.....	25 lbs.

Available from your RCA Test and Measuring Equipment Distributor



RADIO CORPORATION of AMERICA
TEST AND MEASURING EQUIPMENT

HARRISON, N. J.

PIONEERS in TIMING

and MARINE RADAR

THE "MARINERS' PATHFINDER" *RADAR represents pioneering in the field

of navigation by the Raytheon Manufacturing Co. and in the field of timing by Haydon Manufacturing. The development of equipment components enabling today's ships to sail safely and on schedule in all weather is typical of Haydon's pioneering in the science of timing. Knowing that any equipment is only as good as its components, Raytheon relies on the quality of Haydon timers for dependable radar operation. In one model, a 5901 series time delay relay protects a magnetron tube by providing a 3 minute interval for tube warm-up prior to application of plate voltage. In another a Haydon timer provides a 5 second delay to allow a motor generator to attain operating speed. A third delays operation of rectifier tubes 45 seconds. In each instance engineering by Haydon and Raytheon is coupled to insure dependable operation.

For thoroughly reliable timing devices, take time to talk time with Haydon. See the Haydon insert in Sweet's File for Product Designers, or write for your own copy of the complete Engineering Catalog. An experienced field representative will be pleased to discuss your requirements and demonstrate Haydon timing at your desk.

* "Mariners' Pathfinder" is the trademark of Raytheon Manufacturing Co., denoting its commercial search radar.

WRITE 2418 ELM STREET, TORRINGTON, CONNECTICUT

HAYDON

MANUFACTURING COMPANY, INC.

TORRINGTON



CONNECTICUT

HARNESS TIME TO

YOUR PRODUCTS

SUBSIDIARY OF GENERAL TIME INSTRUMENTS CORPORATION



glass-to-metal seal on the plug pins. Equipped with a 235-ohm continuous duty coil, the new relay is double pole, double throw having $\frac{1}{2}$ -inch contacts rated at 10 amperes resistive load.

Voltage Tester

FOX VALLEY INSTRUMENT CO., Ingleside, Ill. The Polyvolttester positively identifies 110 and 220-volt lines, whether a-c or d-c, and polarity. It tests fuses, shorts and

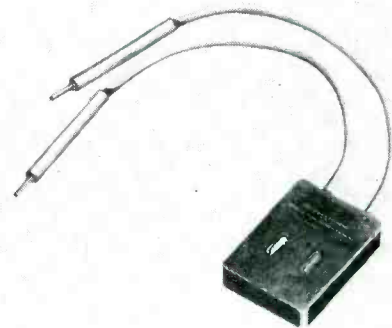

grounds. Test leads are made of wound nichrome wire protected by two vinyl coverings. Possibility of a short circuit occurring through the tester is eliminated by the 11,000 ohms resistance in the leads.

Radioactivity Detector

NUCLEAR DEVELOPMENT LABORATORY, P. O. Box 7601, Kansas City, Mo. Model PRD1 is a midget portable radioactivity detector for radi-

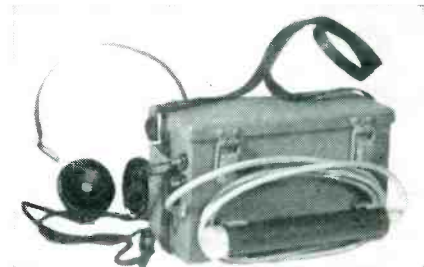

ation survey work and uranium prospecting. A waterproofed probe containing a sensitive metal-shell beta-ray Geiger counter and scaling circuit is connected to the battery box by a 5-foot flexible cable. Expected life of the counter tube is over 10⁸ counts, and life of the batteries and other components is more than 10,000 hours. Maximum radiation intensity covered is limited by the scaling ratio (25 to 1) to about 5,000 counts per minute.

Thermocouple Connector Panel

THERMO ELECTRIC CO., Fair Lawn, N. J. The panel illustrated provides a quick and flexible method for con-

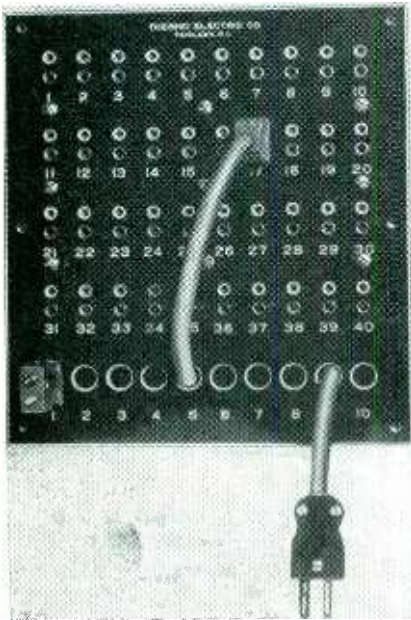

necting any thermocouples of a group to any position on multiple recorders or indicating and controlling pyrometers. It is suitable for pilot plant use or for checking temperatures in many industrial heat-treating processes, aircraft engines, chemical processes, power plants and oil refineries.

Dual Recorder

RAHM INSTRUMENTS INC., 12 West Broadway, New York 7, N. Y. Model RO2B is a dual-channel direct-recording oscillograph. It will draw an instantaneous graph of any two electrical signals within its frequency range and display their wave shape, amplitude and frequency for immediate

**YOU CAN BE SURE.. IF IT'S
Westinghouse**

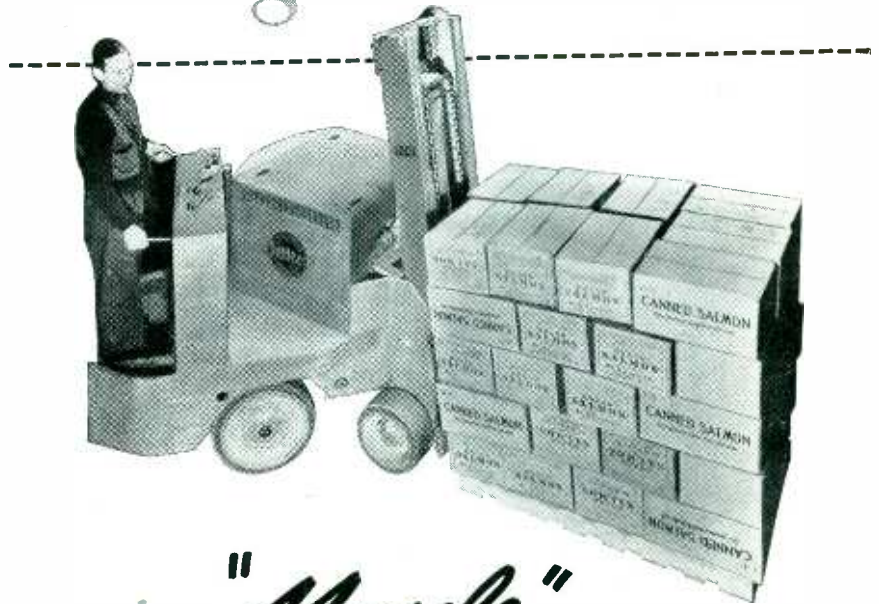

**MORE "Muscle"
FOR ELECTRICAL APPARATUS
... at no extra cost**

Your apparatus can have higher electrical stamina . . . longer operating life . . . if insulated with Westinghouse "Tuffernell" Insulating Varnishes.

Outstanding among these new varnishes are Tuffernell B-161, B-163, and B-165. All are thermosetting; and each has specific properties of high resistance to heat . . . moisture . . . centrifugal force . . . and to other enemies that break down ordinary varnishes.

It is because of these properties that Baker-Raulang, of Cleveland, chose Tuffernell B-163 for their well-known line of industrial trucks, tractors, and cranes. They like B-163's deep penetration of windings, giving better heat transfer and cooler-running motors. They have found, too, that B-163 is economical and faster to use, and stands up in rugged service.

The complete Tuffernell line includes Insulating Varnishes and Compounds for *your* application. All are described in Bulletin 65-120, available on request.

Investigate Tuffernell today for your needs. Call your nearby Westinghouse office, or write Westinghouse Electric Corporation, Dept. 36, P.O. Box 868, Pittsburgh 30, Pennsylvania.

J-06418



Westinghouse
TUFFERNELL INSULATING VARNISHES
— for every electrical need

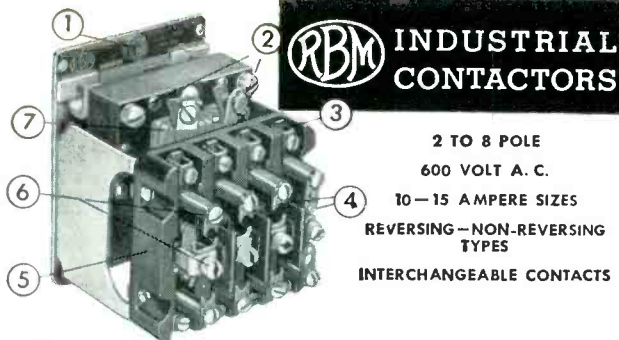

RBM INDUSTRIAL CONTACTORS

2 TO 8 POLE
600 VOLT A. C.
10-15 AMPERE SIZES
REVERSING-NON-REVERSING TYPES
INTERCHANGEABLE CONTACTS

- 1 Heavy steel base.
- 2 Coil readily replaced by removing 2 heavy screws holding E-shaped magnet frame.
- 3 Accessible solderless type terminals are conveniently located. All line terminals at top; load terminals at bottom.
- 4 Any pole can be changed from normally open to normally closed, or vice-versa, without additional parts.
- 5 Melamine stationary contact block and movable contact carrier.
- 6 Stationary and movable contacts can be readily replaced with use of screw driver only and without removing wiring.
- 7 Vacuum impregnated magnet coil designed for continuous 50/60 cycle service.

For descriptive bulletin No. 600 write Dept. D-6

R-B-M DIV., ESSEX WIRE CORP.
LOGANSPOUT, INDIANA



MANUAL AND MAGNETIC ELECTRIC CONTROLS
- FOR AUTOMOTIVE, INDUSTRIAL, COMMUNICATION AND ELECTRONIC USE

Wave guide & coaxial assemblies

- RAPID INSTALLATION
- HIGH EFFICIENCY
- UNIFORM IMPEDANCE
- COMPLETE LINE OF FITTINGS

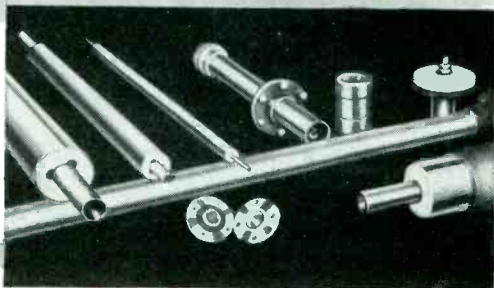

Transmission line in all types including standard RMA sizes for FM and TV

GENERAL CERAMICS Transmission Lines are available in sizes to meet any installation requirement. All lines are of the bead supported type, in standard lengths. Fabrication to close tolerance assures highest efficiency. Special "clover leaf" spacer beads effectively reduce capacity effects and arcing. Carefully designed end seals assure permanently gas-tight terminations. Pressurizing equipment, including gauges, valves, etc., impedance matching units, wave guide and coaxial assemblies for antennae and R.F. sections are supplied to exact requirements.

Our engineers are always pleased to check any project and furnish quotations.

General CERAMICS and STEATITE CORP.

GENERAL OFFICES and PLANT: 22 CROW'S MILL ROAD, KEASBEY, N. J.

MAKERS OF STEATITE, FERRAMIC ZIRCON PORCELAIN, LIGHT DUTY REFRACTORIES AND CHEMICAL EQUIPMENT

3 1/2 KW VACUUM TUBE BOMBARDER or INDUCTION HEATING UNIT



Only \$975

Never before a value like this 3 1/2 KW bombarder or high frequency induction heater . . . for saving time and money in surface hardening, brazing, soldering, annealing and many other heat treating operations. Is

Portable . . . mounted on four rubber coasters. Width 14 1/2"; depth 27"; height 42 1/2"; weight 300#.

Operates from 220 volt line. Complete with foot switch and one heating coil made to customer's requirements. Send samples of work wanted. We will advise time cycle required for your particular job. Cost, complete, only \$975. Immediate delivery.

Scientific Electric Electronic Heaters are made in the following ranges of power: 1-2-3-5-7 1/2-10-12 1/2-15-18-25-40-60-80-100-250. KW.

Scientific Electric

Division of
"S" CORRUGATED QUENCHED GAP CO.
105-119 Monroe St., Garfield, N. J.



analysis and synchronization. The unit has a 3,400-ohm impedance, center tapped. Frequency response without amplifier is flat from 0 to 70 cps; down one-half at 100 cps. Descriptive literature and price list are available.

Radiation Meter

THE NUCLEONIC CORP. OF AMERICA, 497 Union St., Brooklyn 31, N. Y. Model RM-1 radiation meter features a continuously variable high-

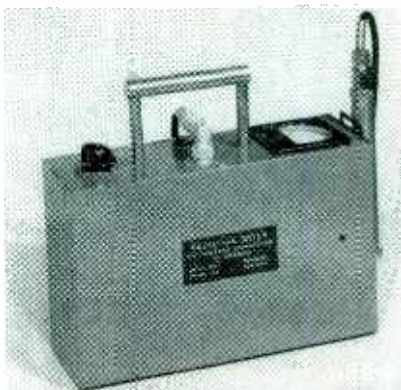

voltage supply. A meter range covers three ranges of activity—5,000, 50,000, and 500,000 counts per minute. Meter accuracy is better than 2 percent, full scale.

Tele and Lab Scope

GENERAL ELECTRIC Co., Syracuse, N. Y. Type ST-2A five-inch oscilloscope was designed for use in tele-

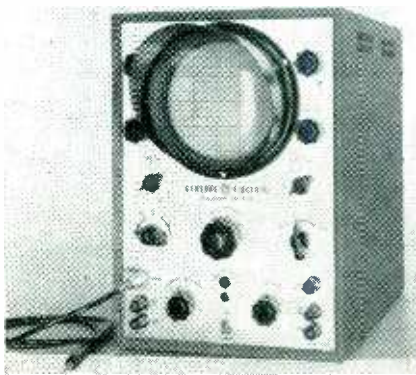

T PRECISION Transformers

FOR TODAY'S MORE EXACTING REQUIREMENTS

**POWER - - AUDIO
CHOKES - - FILTERS**

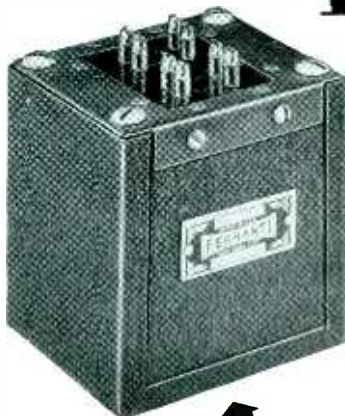

ENCLOSED CASE, compound filled, for high moisture resistance. Standard cases up to 500 VA. Wide range of standard audio transformer units.



HERMETICALLY SEALED and compound filled cases. Glass or ceramic sealed terminals. Designed to meet JAN salt water immersion tests.

For Television and all other applications where specifications are precise and the emphasis is on quality and performance, famous FERRANTI transformers offer superior value.

Into each unit goes long years of specialized experience, plus up-to-the-minute knowledge of today's improved practices and latest materials. Our large and varied stock of patterns, tools, and dies often permits us to supply "custom" requirements from standard parts, effecting worthwhile savings. We invite your inquiries.



OPEN FRAME TYPE for mass production, minimum cost and weight for enclosed equipment.

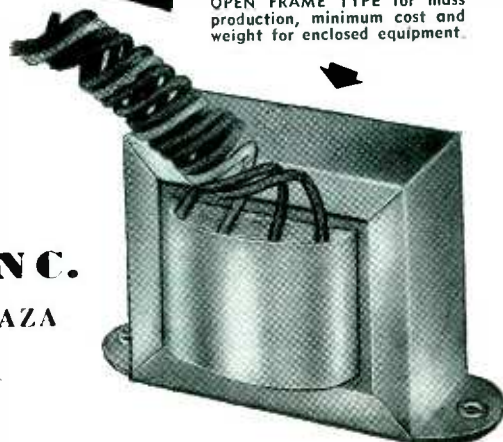

**FERRANTI
ELECTRIC, INC.**

30 ROCKEFELLER PLAZA

New York 20, N. Y.

NOTICE OF IMPORTANCE TO THE ELECTRICAL INDUSTRY

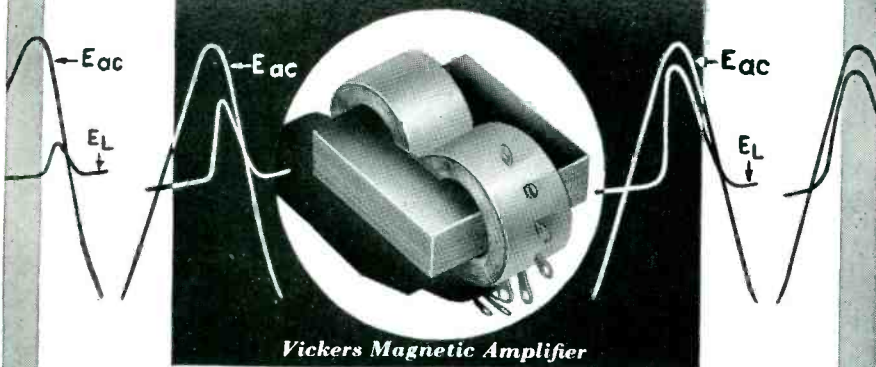

Vickers Magnetic Amplifier

VICKERS ELECTRIC DIVISION, Vickers Inc.,
Announces a complete Research and Development Section available for your technical problems in relation to the following—

**MAGNETIC AMPLIFIERS
MAGNETIC AUDIO AMPLIFIERS
STATIC VOLTAGE REGULATORS
STATIC MOTOR SPEED CONTROLS
POWER SATURABLE REACTORS
RECTIFIERS
PHOTOELECTRIC CELLS
SERVOMECHANISMS
MAGNETIC FLUID CLUTCHES
SPECIAL MOTORS AND GENERATORS
TRANSFORMERS • ARC-WELDERS
CONTROLLED POWER RECTIFIERS FOR
ELECTRO-CHEMICAL PROCESSES**

The fundamental schemes employed in many of the above involve general use of tubeless amplifier circuits—Magnetic Amplifiers.

For information regarding application of the above relative to your requirements, you are cordially invited to consult our Engineering Department.

VICKERS  **ELECTRIC**
DIVISION

1815 LOCUST ST. ST. LOUIS 3, MISSOURI

A UNIT OF THE SPERRY CORPORATION

E-6

NEW PRODUCTS

(continued)

vision and general laboratory applications. Straight resistive coupling is used to obtain its wide frequency response, and there is no positive slope to the frequency response curve, which falls off so gradually that the scope can be used on input frequencies up to 3 mc. The input attenuator to the vertical amplifier will attenuate voltages by as much as 1,000 to 1 without frequency discrimination. Intensity of the c-r beam can be modulated.

Multipurpose Oscilloscope

PRECISION APPARATUS CO., INC.,
92-27 Horace Harding Blvd., Elm-
hurst, L. I., N. Y. Series ES-500 is



a 5-inch high-sensitivity c-r oscillo-
graph with extended-range, voltage-
regulated amplifiers for multi-pur-
pose a-m, f-m and television appli-
cations. It features an extended
range vertical amplifier response to
1 mc, a 2-megohm approximate in-
put resistance, a 20- μ f input capaci-
tance and a 20-mv vertical amplifier
sensitivity. Net price is \$149.50.

Electron Diffraction

GENERAL ELECTRIC Co., Schenectady
5, N. Y. The electron diffraction
instrument illustrated uses a stream
of electrons to study a layer of
metal less than a quarter-millionth
of an inch thick in jet engine re-
search. Chemical changes invisible
to an ordinary microscope can be
detected. In operation, electrons
from a tungsten filament are
focused by a magnetic lens. The
beam is directed to a metal surface
at an angle and the tiny projections

EAD NEW!

Variable Frequency Induction Motors and Blowers

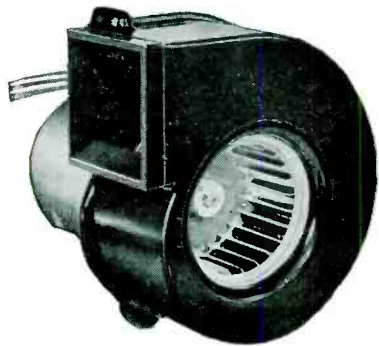

115 volts:
400-800 Cycles—140 C.F.M.
400-1600 Cycles—15-20 C.F.M.
NOW IN PRODUCTION

Other frequency ranges available
**GEAR MOTORS, AXIAL FLOW FANS
AND MOTORS ALSO FURNISHED**

These Induction Motors and Blowers are designed for use with engine driven alternators supplying variable frequency power throughout a wide range. They are very suitable for use in cooling tubes and amplifier boxes, band switching or driving mechanisms on military and electronic equipment.

**ALSO NEW
PERMANENT MAGNET**

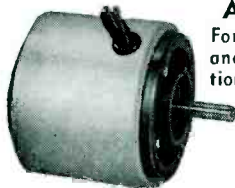

ALTERNATORS
For critical Instrument and Equipment Applications.

PURE WAVEFORM
1, 2, or 3 Phase
2, 4, 6, 8, or 12 poles

All Frequencies

*Special Types for customer needs
Standard Types Available.
Continuous Duty*

- N2A 115V, 3 Phase, 45VA, 400 cycle at 6000RPM
- N2B 115V, 2 Phase, 15VA, 60 cycle at 3600RPM
- N3C 15V, 1 Phase, 1.1VA 180 cycle at 3600RPM
- N4A 70V, 1 Phase, 10 VA, 60 cycle at 3600RPM
- N6A 45V, 1 Phase, 25 VA, 1000 cycle at 5000RPM

EASTERN AIR DEVICES, INC.
585 DEAN ST., BROOKLYN 17, N.Y.

DESIGNERS AND BUILDERS OF STANDARD
AND SPECIAL ROTATING EQUIPMENT



BLUE
PRINT

**IF IT'S
SPECIAL
SEE
PROGRESSIVE**





ENLARGED VIEW

KEEP YOUR COSTS DOWN

Progressive specializes in manufacturing special heads, threads and finishes on any metal or alloy adapted to cold upset. Please write for catalog showing many Progressive specials. Catalog includes purchasing and engineering helps.

The **PROGRESSIVE
MANUFACTURING CO.**

50 NORWOOD ST.
TORRINGTON, CONNECTICUT

ZOPHAR

Waxes, Compounds and Emulsions



Materials for potting, dipping or impregnating all types of radio components or all kinds of electrical units. • Tropicalized fungus proofing waxes. • Waterproofing finishes for wire jackets. • Rubber finishes. • Inquiries and problems invited by our engineering and development laboratories.

Zophar Mills, Inc. has been known for its dependable service and uniformity of product since 1846.

ZOPHAR MILLS, Inc.

ESTABLISHED 1846

117 26th STREET, BROOKLYN 32, N. Y.

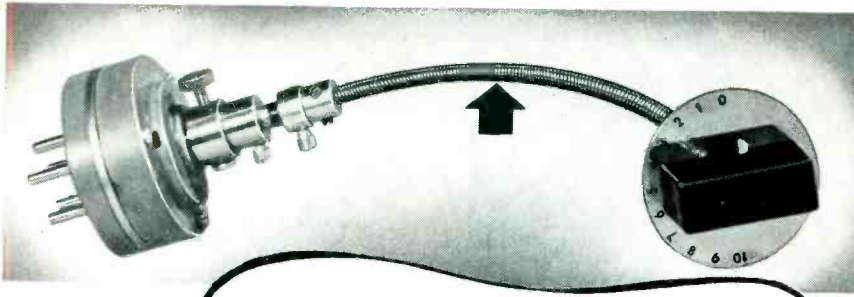

**S.S. WHITE FLEXIBLE SHAFTS
PROVIDE "FEATHER-TOUCH"
TUNING OF VARIABLE ELEMENTS**

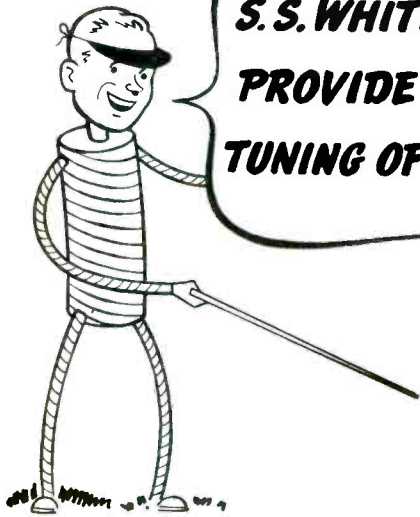

"PROVE IT YOURSELF"

"Here's a convincing test of the smooth sensitivity of S.S.White remote control flexible shafts. I call it the 'Loop Test'.

"It's really quite simple. Take an S.S.White remote control shaft—the type that's commonly used to connect variable elements to their control knobs in electronic and radio equipment. Loop it in the manner shown at the right. Then, with the loop resting on a flat surface, rotate the shaft with the fingers.

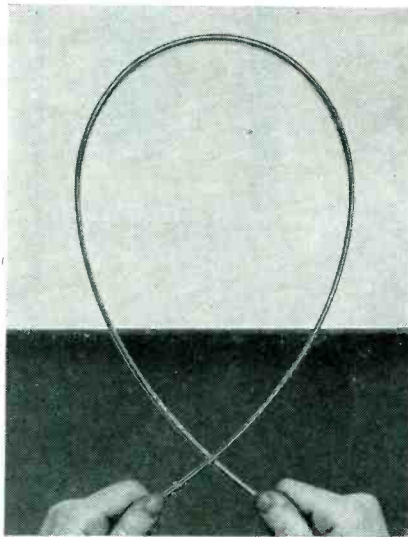

"Note how smooth and easy it turns. This responsive jump-free action tells the story of the sensitive, accurate tuning you get with S.S.White flexible shafts. The reason, of course, is that these shafts are engineered and built specifically for remote control with deflection and backlash held to a minimum".

If you would like the whole story about S.S.White flexible shafts, write for this

FREE FLEXIBLE SHAFT HANDBOOK



It contains 260 pages of facts and data on flexible shaft application and selection. A copy will be sent free if you write for it on your business letterhead.



S.S. WHITE INDUSTRIAL
THE S. S. WHITE DENTAL MFG. CO. DIVISION
DEPT. K 10 EAST 40th ST., NEW YORK 16, N. Y.



FLEXIBLE SHAFTS AND ACCESSORIES
MOLDED PLASTICS PRODUCTS—MOLDED RESISTORS
One of America's AAAA Industrial Enterprises



that are characteristic of the material or its experience form the image. Alternatively, the beam can be passed through a very thin section of metal to produce an image on a fluorescent screen or a photographic film.

Automatic Speed Control

INDUSTRIAL ASSOCIATES, 8845 W. Olympic Blvd., Beverly Hills, Calif. The Varitronic drive is a new electronic automatic speed control unit for machinery prime movers. The

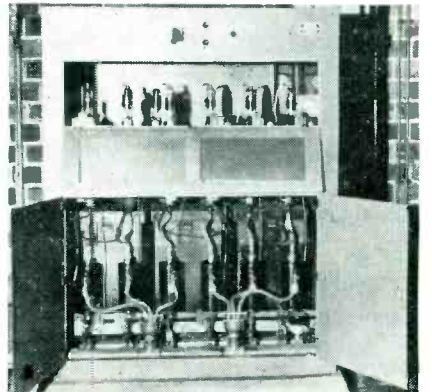

system uses the flexible performance characteristics of d-c motors but is operated from a-c. It embraces either constant torque or constant h-p, and control can be held to as close as two percent of basic speed. The unit is manufactured by Electron Equipment Corp., South Pasadena, Calif.

Soldering Aid

HYTRON RADIO & ELECTRONICS CORP., Salem, Mass. While the iron keeps the joint hot, the fork tip of the soldering aid straddles and



grips the end of the wire, and effortlessly unwraps it. Shifting to the other side of the lug, it grips and pulls wire free. A spade-type-reamer tip clears the lug hole of solder or pushes other wires aside for new wire. The fork tip guides the new wire through and around the lug, holding it in place for soldering.

Lightweight Geiger Counter

OMAHA SCIENTIFIC SUPPLY Co., 3601 N. 24th St., Omaha 10, Nebraska. The TX-8 Geiger counter

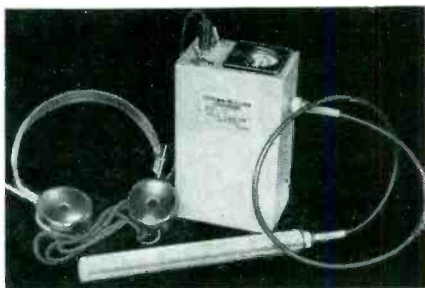

weighs less than four pounds and incorporates a rate meter. Designed especially for prospectors of radioactive minerals it has a battery life of at least six months.

Transmission Measurement

THE DAVEN Co., 191 Central Ave., Newark 4, N. J. The 11-A transmission measuring set uses only one transformer, one meter and one meter range control. Designed for

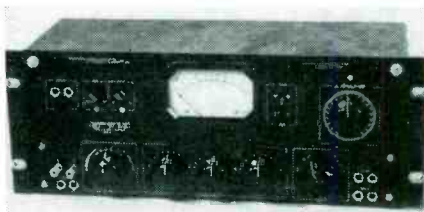

a-m and f-m broadcasting stations and laboratory use with an external audio signal generator, the set is calibrated on the basis of 1 mw into 600 ohms and utilizes the standard vu meter.

Industrial Integrator

WESTON ELECTRICAL INSTRUMENT CORP., 617 Frelinghuysen Ave., Newark 5, N. J. Model 808 integrator, designed for use in general industrial and research applications, provides means for simple and effective integration of d-c potentials or

B & W TEST INSTRUMENTS

Inexpensive . . . Accurate . . . Reliable

Built to Match Broadcast Station Requirements

Although relatively low in cost, these B & W instruments meet the exacting demands of modern research and engineering laboratories, as well as the full indorsement of many well-known broadcast stations. They combine a high degree of accuracy with outstanding durability and ease of use.

B & W AUDIO OSCILLATOR

Provides an extremely low distortion source of frequencies between 30 and 30,000 cycles. Self-contained power supply. Calibration accuracy of $\pm 3\%$ scale reading. Stability 1% or better. Frequency characteristics: output flat within ± 1 DB, 30 to 15,000 C.P.S. Size $13\frac{3}{4}'' \times 7\frac{1}{4}'' \times 9\frac{1}{2}''$ Fully portable.



\$115

MODEL 200

B & W DISTORTION METER

An ideal instrument for either laboratory or field use. Measures total harmonic distortion for the range of 50 to 15,000 cycles, and measures harmonics to 45,000 cycles. Also measures residual hum and noise up to 60 DB below any reference level. Voltmeter and DB meter range is from 30 to 30,000 cycles. Highly sensitive and accurate. Size $13\frac{3}{4}'' \times 7\frac{1}{4}'' \times 9\frac{1}{2}''$.



\$140

MODEL 400

B & W FREQUENCY METER

An accurate and convenient means of making direct measurements of unknown frequencies up to 30,000 cycles. Useful in measuring beat frequency between two R.F. signals. Integral power supply. Handy for routine checking of audio oscillators or tone generators. Highly sensitive, this unit will operate on any wave form with peak ratios under 8 to 1. Size $13\frac{3}{4}'' \times 7\frac{1}{4}'' \times 9\frac{1}{2}''$.



\$105

MODEL 300

WRITE FOR B & W CATALOG SUPPLEMENT NO. 1 . . . containing full details on these and other B & W instruments and electronic specialties.

BARKER & WILLIAMSON, Inc.

Dept. EL-69, 237 Fairfield Ave.

Upper Darby, Pa.

instantaneous

recordings from D. C. to 100 cps!

accurate

recordings of voltages, pressures, strains, vibrations and countless other phenomena!

permanent

ink on paper recordings by Brush Oscillographs make their use almost unlimited!

A.C. or D.C.

signals can be measured. Whenever desired, recordings may be stopped for notations on chart-paper!

INVESTIGATE Brush measuring devices before you buy . . . they offer more for your money. Why not have a Brush field engineer call? At no obligation, of course. Just call or write, today, you will find it worth a few seconds' time!



THE
Brush
DEVELOPMENT CO.

3405 Perkins Avenue • Cleveland 14, Ohio, U. S. A.
MAGNETIC RECORDING DIVISION • ACOUSTIC PRODUCTS DIVISION
INDUSTRIAL INSTRUMENTS DIVISION • CRYSTAL DIVISION

Canadian Representative: A. C. Wickman, (Canada) Ltd., P. O. Box 9, Station N, Toronto 14

NEW PRODUCTS

(continued)



currents with respect to time. Fundamental elements are an integrating relay, an electronic relay circuit with associated sealed reed type relays, and a counting mechanism. Literature is available.

Voltage Regulator

THE SUPERIOR ELECTRIC Co., 77 Hannon Ave., Bristol, Conn., offers the Stabiline type IE51005, a 500-va instantaneous electronic voltage regulator, with an input from 95 to



135 volts and an output adjustable between 110 and 120 volts. Stabilization is ± 0.1 percent and regulation, ± 0.15 percent of preset value. Recovery time is 3 to 6 cycles.

Power Amplifier Tube

GENERAL ELECTRIC Co., Syracuse, N. Y. Type 19BG6-G new beam power amplifier tube is especially useful in horizontal-deflection circuits of television receivers and

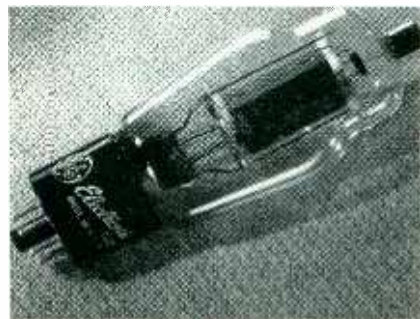

Silicone News



100% more pull per unit size

We're dependent upon mechanical muscles in the form of solenoids activated by automatic or finger-tip control. But there's a limit to the amount of work even mechanical muscles can do. That limit is set by restrictions on size or weight and by the heat stability of the insulating materials used in winding the coil.

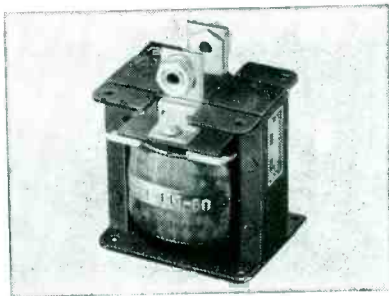

PHOTO COURTESY B/W CONTROLLER CORPORATION

Silicone insulated "Hi-Power" small space solenoids operate continuously in either 25 cycle 110 to 220 volt or 60 cycle 110 to 550 volt service.

Use of heat-stable Silicone Insulation has enabled engineers at B/W Controller Corporation of Birmingham, Michigan, to give you almost twice as much power without increasing the size or weight of their small space solenoids. For example, the new B/W "Hi-Power" solenoid has a push or pull of 32 pounds at 100% voltage compared with 17-18 pounds for a comparable Class "A" solenoid.

This increase in power per unit size is made possible by the exceptional heat stability of Dow Corning Silicone Insulation. This new class of electrical insulation gives long and continuous service at temperatures in the range of 200-260° C. "Hi-Power" solenoids operate continuously in 25 cycle 110 or 220 volts as well as in 60 cycle service up to 550 volts. DC Silicone Insulation also assures efficient operation in spite of high ambient temperatures.

And Dow Corning Silicone electrical insulation gives you more power per pound in other kinds of electrical equipment including motors, transformers, and generators. For more information, call our nearest branch office or write for our new collection of case histories on Silicone Insulation, pamphlet No. G7-N5.

DOW CORNING CORPORATION MIDLAND, MICHIGAN

Atlanta • Chicago • Cleveland • Dallas
New York • Los Angeles
In Canada: Fiberglas Canada, Ltd., Toronto
In England: Albright and Wilson, Ltd., London



Volume users
of
Special Fasteners
and allied devices
turn first to
UNITED-CARR
for cost-cutting
design engineering
service

Send us your specifications or requirements. Address Dept. 14

UNITED-CARR FASTENER CORP.
Cambridge 42, Mass.

MAKERS OF **DOT** FASTENERS



To say that repeated erasures and redrawings on tracing cloth leave *absolutely* no semblance or trace of feathers to snare the unwary pen is — well, that is a bit too strong a statement. This applies to all tracing cloth.

But we do say this, without fear of contradiction — repeated erasures and redrawings made on Holliston MICRO-WEAVE Tracing Cloth leave a *minimum* of feathering.

Exaggeration wins no customers. Modest claims — maximum uniform transparency, ready erasability, cleaner sharper blueprints, no pin holes or thick threads — are made for both MICRO-WEAVE Pencil and Ink Tracing Cloth. These qualities can easily be verified and proved on your own drawing board. Write for generous sample. Test and be convinced.

More than 50 years of leadership and experience in developing special purpose cloths for industry. With such a background of experience it is little wonder that Holliston Tracing Cloth is second to none. Try MICRO-WEAVE.



THE HOLLISTON MILLS, INC.

CHICAGO

NORWOOD, MASS.

NEW YORK



Designed for



Application



90651

**The No. 90651
GRID DIP METER**

The No. 90651 MILLEN GRID DIP METER is compact and completely self contained. The AC power supply is of the "transformer" type. The drum dial has seven calibrated uniform length scales from 1.5 MC to 270 MC with generous over laps plus an arbitrary scale for use with special application inductors. Internal terminal strip permits battery operation for antenna measurement.

**JAMES MILLEN
MFG. CO., INC.**

MAIN OFFICE AND FACTORY
**MALDEN
MASSACHUSETTS**



NEW PRODUCTS

(continued)

may be used with picture tubes operating at less than 10 kv. The d-c plate voltage is 500 v, while d-c plate current is 100 ma. Peak heater-cathode voltage is 250 v with heater positive or negative in respect to cathode.

Sealing Device

SPECTRUM MFG. Co., 540 N. 63rd St., Philadelphia 31, Pa., has announced a complete redesign of the electronic corner stayer, a device

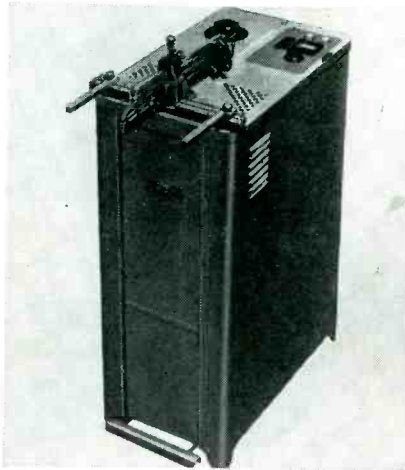

used for sealing corners of transparent boxes without cement. It may be used for the production of acetate tubes and handles any size container with maximum seam length of 5 inches. Current consumed averages under 200 watts and the unit operates on 110 volts a-c.

Tiny Resistors

WILKOR PRODUCTS, INC., 3852 W. 150th St., Cleveland 11, Ohio, is producing a line of tiny Carbofilm resistors for use in miniature electronic units. They are available in sizes $\frac{1}{4}$ to 1 watt, in values from 20



**PARABOLIC
ANTENNAS**

FOR

- FM and AM Studio-to-Transmitter Link
- Television and Facsimile Relay Work
- Multi-channel Point-to-Point Relay
- Research and Development Laboratories

The Workshop can supply parabolic antennas in a wide range of types, sizes and focal lengths, plus a complete production and engineering service on this type of antenna.

Workshop test equipment and measurements for the determination of antenna characteristics is outstanding in the industry. These facilities, coupled with the wartime experience of its engineers on high frequency antennas, assure exceptional performance.

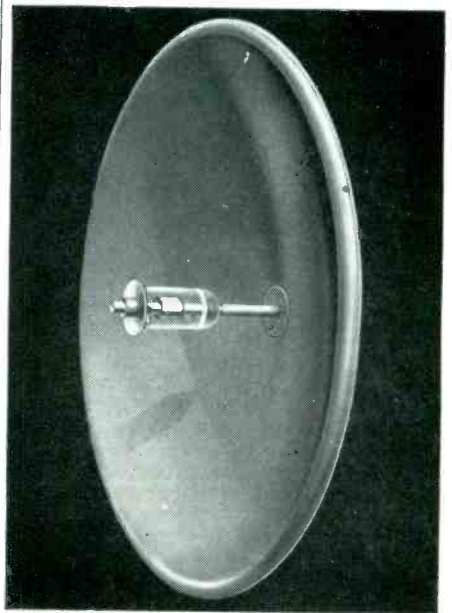

40-inch, 2000 mc. Antenna with Plexiglas radome for weather protection

SPECIFICATIONS—Model 2000

- FREQUENCY RANGE** —1990 to 2110 mc.
- INPUT IMPEDANCE** —52 ohms nominal
- V.S.W.R.** —1.05 or better at specified frequency
- POLARIZATION** —Vertical or horizontal
- REFLECTOR SIZE** —40" 48" 72"
- GAIN** —25 db. 27 db. 30 db.
- SIDE LOBES** —20 db. down or better
- INPUT CONNECTION** —Weatherproof type "N" fitting. Special fittings are available for RG-8/U, RG-17/U, or 7/8-inch copper line.
- MOUNTING** —Three types available
- WIND LOADING** —All elements will withstand an actual wind velocity of 80 m.p.h. when coated with one-half inch of ice.

Send for New Parabolic Antenna Catalog

The **WORKSHOP ASSOCIATES, Inc.**
64 NEEDHAM STREET
Newton Highlands, Massachusetts



ohms to 5 megohms and with tolerances of 0.5 to 1 percent. The smallest type measures $\frac{1}{16}$ inch diameter over caps, $\frac{3}{8}$ inch overall length, with $1\frac{1}{2}$ inch tinned copper leads.

R-F Ohmmeter

GENERAL ELECTRIC Co., Syracuse, N. Y. Type YKS-1 radio-frequency ohmmeter, designed for rapid and

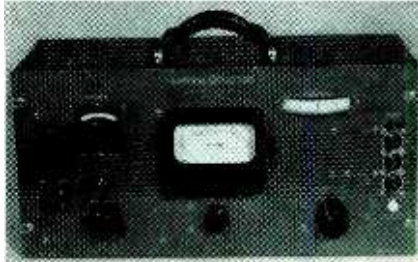

accurate measurement of r-f resistance in radio components, has a range of from 50 kc to 80 mc. A nomograph is supplied with the unit for quick conversion of power factors and Q.

BFO

MARCONI INSTRUMENTS LTD., St. Albans, Herts., England. Type TF 894 audio tester is a beat frequency oscillator calibrated directly over

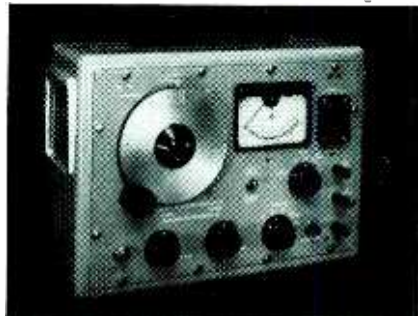

the range 50 to 12,000 cycles. Maximum output is 300 milliwatts in 600 ohms. The continuously variable level is indicated by an output meter and is made available across either the 0-to-50 db 600-ohm attenuator, or a 5,000-ohm impedance.

Dielectric Heating Unit

THERMEX DIVISION OF THE GIRDLER CORP., Louisville, Ky. Model 15R h-f dielectric heating unit is designed for preheating large rubber and plastic preforms. It will raise the temperature of 10 pounds of average material from 70 to 250 F in one minute. Oscillator, preheater and rectifier sections are contained

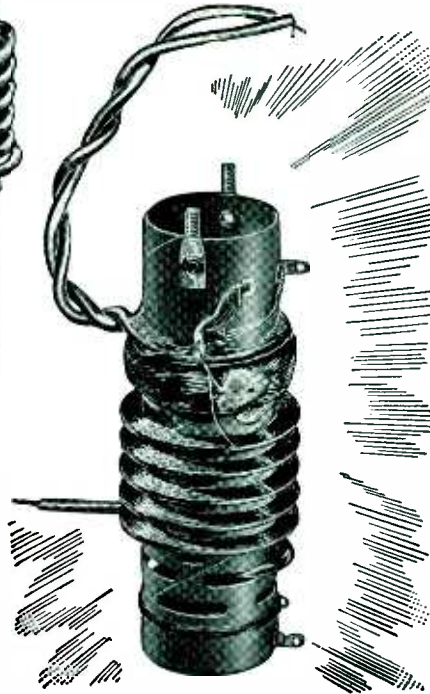

☆
2 new stars in the field



For
**TELEVISION
RECEIVERS**



Specify COSMALITE*

Cosmalite Coil Forms give exceptional performance at a definite saving in cost to you.

Punched, threaded, notched and grooved to meet your individual specifications.

Ask us about the many various punching dies we have available.

Inquiries given quick action and specialized attention.

*Reg. U. S. Pat. Off.

The **CLEVELAND CONTAINER Co.**
6201 BARBERTON AVE. CLEVELAND 2, OHIO

PLANTS AND SALES OFFICES at Plymouth, Wis., Chicago, Detroit, Ogdensburg, N.Y., Jamesburg, N.J.
ABRASIVE DIVISION at Cleveland, Ohio
CANADIAN PLANT: The Cleveland Container, Canada, Ltd., Prescott, Ontario

REPRESENTATIVES

- CANADA } WM. T. BARRON, EIGHTH LINE, RR #1, OAKVILLE, ONTARIO
- METROPOLITAN } R. T. MURRAY, 614 CENTRAL AVE., EAST ORANGE, N.J.
- NEW YORK } E. P. PACK AND ASSOCIATES, 968 FARMINGTON AVE
- NEW ENGLAND } WEST HARTFORD, CONN.



Better for every Radio and Electronic Application

SANGAMO
Type 30



Molded Tubular

These molded capacitors are easier to tie into production lines because the especially designed, flexible leads are troublefree... they resist breakage and they can't pull out. There is no wax to run when heat is applied. The thermo-setting plastic case is molded with less heat... less pressure... the element is not distorted in fabrication. This means greater dependability—no "hot spots." Try these stable, rugged, long-lived paper tubulars—used extensively by television manufacturers—you'll like them!

SANGAMO
Type PL



Dry Electrolytic

Meticulous care in manufacture protects Sangamo Electrolytic Capacitors against source contamination and assures corrosion-free elements. Positive electrodes are formed of rugged, etched-foil aluminum plate which insures longer life—greater dependability. Type PL "Twist Mount" capacitors are hermetically sealed in round aluminum cans, and are made in all standard dimensions and ratings common to the industry. Each unit is supplied with a bakelite and metal mounting plate. Bulletin 825 gives complete information.

Your Assurance of



Dependable Performance

SANGAMO ELECTRIC COMPANY

SPRINGFIELD, ILLINOIS

IN CANADA... SANGAMO COMPANY LIMITED, LEASIDE, ONTARIO



when you need resistors—

IT WILL PAY YOU TO CONSULT THE NEW

IN-RES-CO CATALOG

Included are complete descriptions and specifications on wire wound resistors of all types and sizes. Each is precision wound to close tolerance, and many feature special moisture-proofing to assure proper functioning under severest climatic conditions. INRES-CO Resistors—available for IMMEDIATE DELIVERY—are supplied in standard or custom types to meet the most unusual design or operational requirements, and are offered at prices that benefit from mass production facilities. A copy of the new INRES-CO catalog will be helpful; write for it today. Prices, samples and estimates promptly on other than standard resistors.



INSTRUMENT RESISTORS COMPANY

1036 COMMERCE AVE., UNION, N. J.

Wire Wound Resistors for Every Use in Electronics and Instrumentation

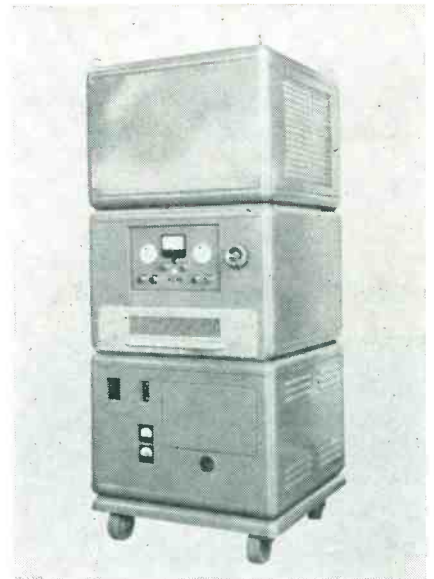

in individual cabinets, mounted one upon the other. The unit operates on either 230 or 440 volts.

I-F Aligner

KAY ELECTRIC Co., Pine Brook, N. J. The Megaliner provides a tunable c-w signal over the frequency range from 19 to 49 mc for the alignment of television and



other similar i-f amplifiers. Provision is made to place marker pips on the trace of an oscilloscope display when ancillary equipment is used with the new instrument.

Universal Bridge

MARCONI INSTRUMENTS LTD., St. Albans, Herts., England. The universal bridge type TF 868 employs



Precise RESISTANCE MEASUREMENT



... with the Rubicon WHEATSTONE BRIDGE No. 1080

A high precision instrument well suited for use as a laboratory standard as well as for routine measurements requiring exceptionally high accuracy.

- Wide range — 1 ohm, readable to within 0.0001 ohm, to 100 megohms.
- Five-dial rheostat usable as separate decade resistance box, $9 \times (1000 + 100 + 10 + 1) + 10 \times 1$ ohms. Limit of error in resistors of 1 or more ohms 0.02%.
- Plug-controlled ratio arms with resistors from 1 to 10000 ohms — limit of error 0.02% — versatile arrangement permitting numerous interchecks.
- Heavy substantial aged manganin resistors for high stability.
- Extra-heavy sturdy switches with contact resistance less than 0.001 ohm.

Fully described in Bulletin 100.



... with the Rubicon TYPE B WHEATSTONE BRIDGE

Another of the eighteen bridges listed in Bulletin 100 for nearly every type of resistance measurement . . . from high precision laboratory work to high speed production line inspection jobs. Write for your copy of the new edition of Bulletin 100 today.

RUBICON COMPANY

Electrical Instrument Makers
3757 Ridge Avenue • Philadelphia 32, Pa.

HAVE YOU EVER SEEN
PERFORMANCE LIKE THIS?

Revolutionary D. C. TIMING MOTORS with CHRONOMETRIC GOVERNORS BY A. W. HAYDON



- SPECIAL FEATURES
- EXTREME ACCURACY
 - REVERSIBLE
 - COMPACT
 - LIGHT WEIGHT
 - WIDE RANGE OF VOLTAGE, TEMPERATURE, LOAD

Send for Catalog sheet on D. C. Timing Motor with Chronometric Governor . . . Our staff is at your service.

A PRIMARY TIME-POWER SOURCE OF EXTREME ACCURACY, PRACTICALLY UNAFFECTED BY VARYING VOLTAGE, LOAD OR TEMPERATURE.

At long last an accurately controlled motor drive is available for Direct Current in a wide range of output speeds for use in computers, recorders, timers and controls.

Precision timing is obtained by the use of a temperature-compensated clock escapement which pulses the motor circuit. This synchronizes the motor electrically with the speed of the escapement.



Anti-Corrosive STAINLESS STEEL FASTENINGS DO THE JOB *Better*



In Electronics, Stainless Meets Every
Test Devised for Fastenings!

Non-magnetic, resistant to corrosion or vibration, impervious to heat or cold, permanent . . . whatever the quality you demand, count on stainless fastenings to provide the most efficient answer! Reduce maintenance and look for longer life with stainless!

7,000 Varieties

Anti-Corrosive, America's oldest and largest supplier dealing exclusively in stainless fastenings, carries this tremendous stock for your convenience . . . plus a special order service available for occasional odd sizes

Write TODAY for Folder C-49 for Further Information!

Anti-Corrosive
Metal Products Co., Inc.
Manufacturers of STAINLESS STEEL FASTENINGS
CASTLETON-ON-HUDSON, NEW YORK

TEKTRONIX PLEDGES...

To serve our customers with products and policies unexcelled in the electronics industry and limited only by the current state of the art.



Tektronix Type 511-AD Oscilloscope
\$845 f.o.b. Portland

Wide Band, Fast Sweeps

The Type 511-AD, with its 10 mc. amplifier, 0.25 microsecond video delay line and sweeps as fast as .1 microsec./cm. is excellent for the observation of pulses and high speed transient phenomena. Sweeps as slow as .01 sec./cm. enable the 511-AD to perform superlatively as a conventional oscilloscope.

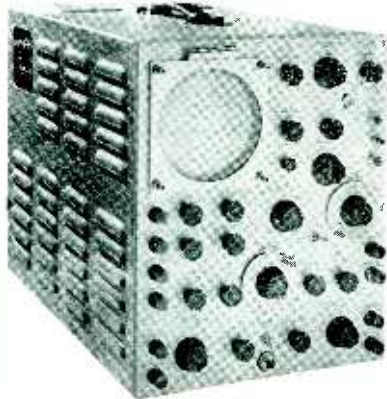

Tektronix Type 512 Oscilloscope
\$950 f.o.b. Portland

Direct Coupled, Slow Sweeps

The Type 512 with a sensitivity of 5 mv./cm. DC and sweeps as slow as .3 sec./cm. solves many problems confronting workers in the fields where comparatively slow phenomena must be observed. Vertical amplifier bandwidth of 2 mc. and sweeps as fast as 3 microsec./cm. make it an excellent general purpose oscilloscope as well.

Both Instruments Feature:

- Direct reading sweep speed dials.
- Single, triggered or recurrent sweeps.
- Amplitude calibration facilities.
- All DC voltages electronically regulated.
- Any 20% of normal sweep may be expanded 5 times.

The Tektronix Field Engineering Representative in your area will be pleased to demonstrate our instruments upon request.



Cables, Tektronix
712 S. E. Hawthorne Blvd. Portland 14, Ore.

NEW PRODUCTS

(continued)

a single dial for the direct measurement of inductance, capacitance, and resistance. The instrument incorporates three separate bridge systems, a phase-balance control, and 1,000-cycle oscillator. Inductance can be measured over the range 1 μ h to 100 h; resistance 0.1 ohm to 10 megohms. The capacitance range is 1 μ f to 100 μ f. The Q or tan δ are given directly on the phase-balance control from which power factor can be derived.

Multichannel Carrier

FEDERAL TELEPHONE AND RADIO CORP., 100 Kingsland Rd., Clinton, N. J., has developed the FTR 9-E-1 multichannel telegraph system pro-

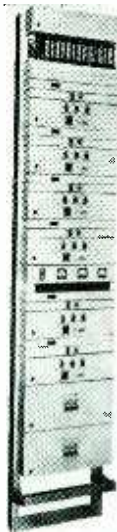

viding up to 18 duplex circuits, or speech plus 6 duplex circuits, for each 4-wire voice channel. It can be supplied either amplitude or frequency modulated. The f-m system is designed for circuits where the noise level is high and signal level changes in the transmitting medium are abrupt and great.

Vibration Dampeners

THE CONNECTICUT HARD RUBBER Co., 407 East St., New Haven 9, Conn. Shock Stops, a new type of vibration dampener with a semi-pneumatic action, reduce vibrations from 75 to 90 percent where the disturbing frequency runs between 1,000 and 3,000 cycles per minute. Effective in protecting balances, electronic devices and similar delicate equipment from vibrations coming in from the outside, they are available in square sheets as

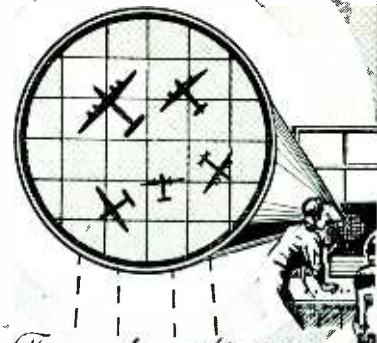

For extraordinary electrical performance

Use SILVER GRAPHALLOY*



THE SUPREME CONTACT MATERIAL

BRUSHES



CONTACTS

in BRUSHES

for high current density minimum wear low contact drop low electrical noise self-lubrication

in CONTACTS

for low resistance non-welding character

GRAPHALLOY works where others won't! Specify GRAPHALLOY with confidence.

*A special silver-impregnated graphite

GRAPHITE METALLIZING CORPORATION

1055 NEPPERHAN AVENUE, YONKERS 3, NEW YORK

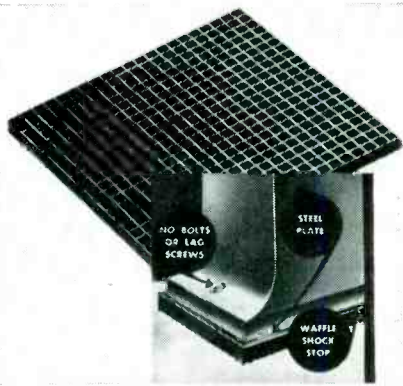

large as 18x18 inches or in round shapes either 3 1/4 in. or 2 1/4 in. in diameter.

Tube and Set Tester

PRECISION APPARATUS Co., INC., 92-27 Horace Harding Blvd., Elmhurst, L. I., N. Y. Series 654-P is a portable combination of a cathode

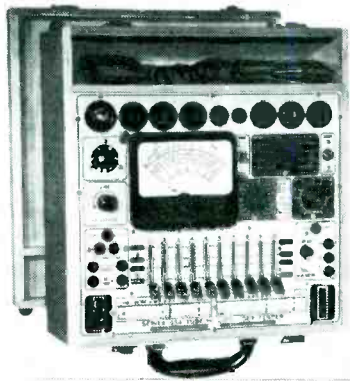

conductance tube tester, dynamic battery tester and high-sensitivity a-c and d-c circuit tester (20,000 ohms per volt). It offers full rotary selective ranges and functions and requires use of only two pin jacks for all standard ranges.

High-Voltage Probes

REINER ELECTRONICS Co., INC., 152 W. 25th St., New York 1, N. Y. The new type HVM probes, in conjunction with any vtvm, measure high voltages in television sets, x-ray machines and other apparatus. Rated for use up to 30,000 volts they contain multipliers which ex-

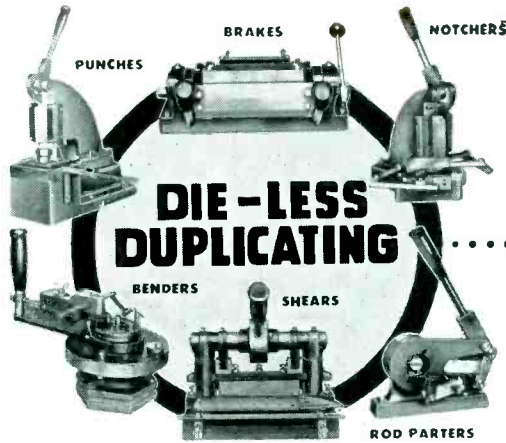

DIE-LESS DUPLICATING

.....with
di-acro
PRECISION
MACHINES

Eliminate dies . . . speed production . . . in both your experimental and quantity run duplicating operations. An unusually wide variety of both simple and intricate parts can be precision made by "DIE-LESS DUPLICATING" with the individual or co-operative application of DI-ACRO Precision Machines (see examples at right). DI-ACRO Machines are now offered in a total of six types and 21 different sizes, including two new units—a power driven Shear and a hydraulic Bender.

SEND FOR 40 PAGE CATALOG

ENGINEERS—DESIGNERS—PRODUCTION MEN should all have this informative catalog which contains technical data covering DI-ACRO Machines and our offer of "Die-Less Duplicating" Engineering Service to aid in solving design and production problems. WRITE FOR YOUR COPY TODAY.



← Pronounced "DIE-ACK-RO"

O'NEIL-IRWIN MFG. CO.

321 8th Avenue • LAKE CITY, MINNESOTA



TINY-BUT MIGHTY!

- ★ Only 15/16" dia. x 22/64" d.
- ★ With attached switch, 49/64" d.
- ★ As tough as larger controls
- ★ 500 ohms to 5 megohms
- ★ .25 watt for linear
- ★ Standard taps @ 30 and 70% rotation



CLAROSTAT SERIES 47 COMPOSITION CONTROLS

Despite midget size, these controls include the Clarostat Stabilized Element for on-the-button resistance values and maximum immunity to climatic conditions and long wear-and-tear. Use Series 47 controls with complete confidence in your crowded assemblies!

Available with factory-equipped switch, or without. Any type shaft. Standard 3/32 threaded bushing for mounting.

Remember, you sacrifice nothing in gaining that space-saving advantage with these tiny-but-mighty controls.

Ask for Bulletin No. 117.
Let us quote on your needs.



CLAROSTAT



Controls and Resistors

CLAROSTAT MFG. CO., INC. • DOVER, NEW HAMPSHIRE • In Canada: CANADIAN MARCONI CO., LTD. Montreal, P. Q. and branches

tend the range of vacuum tube voltmeters times 100; for example, a reading of 270 volts with the multiplier indicates an actual 27,000 volts. They are supplied with the proper connector ready to attach to the individual instrument specified.

Literature

Ultrasonic Measurement. Sperry Products, Inc., Danbury, Conn. Bulletin 3700 describes the theory and general application of the Reflectogage to nondestructive measurements of plate and sheet stock, tanks, boilers, pipe and other formed parts and assemblies of metals and plastics up to four inches in thickness.

Automatic Tester. Industrial Instruments Inc., 17 Pollack Ave., Jersey City 5, N. J. Description, operation and chief features of the Auto-Bridge are outlined in catalog No. 18. The instrument treated is an automatic impedance bridge operating at high speed for production testing, sorting and testing by unskilled personnel, of resistors, capacitors or other components.

Television Equipment. Polarad Electronics Co., 9 Ferry St., New York 7, N. Y. A four-page folder illustrates and gives chief features and specifications of a line of television equipment for studio, laboratory and manufacturer.

Timing Motors. Haydon Mfg. Co., Inc., Torrington, Conn. Engineering bulletin No. 1 devotes eight pages to information and technical data on the 9200 series d-c motors for timing applications. Specifications include voltages, rotation, shafts, pinions, current drain, leads, torque, weight and speeds.

Output Transformer Chart. Standard Transformer Corp., 3580 Elston Ave., Chicago 18, Ill. A handy two-page reference chart simplifies selection of the proper transformer for use as replacement in radio receivers or in the construction of audio amplifiers. Ninety tubes are listed with correspond-

TROUBLE-FREE OPERATION

Specify

N·W·L

CUSTOM-BUILT TRANSFORMERS

Over 25 years' experience in the manufacture of specials at cost that compares favorably with standard types. Built-in quality proved by years of actual use.

PROMPT DELIVERIES!



From 10VA to 300
KVA Dry-Type Only,
Both Open and Encased,
1, 2, & 3 Phase 15 to
400 Cycles.

NOTHELFER WINDING LABORATORIES

9 ALBERMARLE AVE., TRENTON 3, N. J.

MEASUREMENTS CORPORATION

Peak-to-Peak VOLTMETER

**.0005—300
VOLTS**

MODEL 67

Designed for accurate indication of the peak-to-peak values of symmetrical and asymmetrical waveforms, varying from low frequency square waves to pulses of less than five microseconds duration.

.0005-300 volts peak-to-peak,
.0002-100 volts r.m.s. in five
ranges. Semi-logarithmic, hand
calibrated scales.

Provision for connection to 1500
ohm, 1 milliamperer graphic re-
corder or milliammeter.



INPUT IMPEDANCE: 1 megohm shunted by 30 mmfd.

DIMENSIONS: Height 7½", width 7", depth 8½".
Weight 8 lbs.

POWER SUPPLY: 117 volts, 50-60 cycles, 35 watts.

MEASUREMENTS CORPORATION

BOONTON



NEW JERSEY

MICO

2 & 3-DIMENSIONAL ENGRAVER

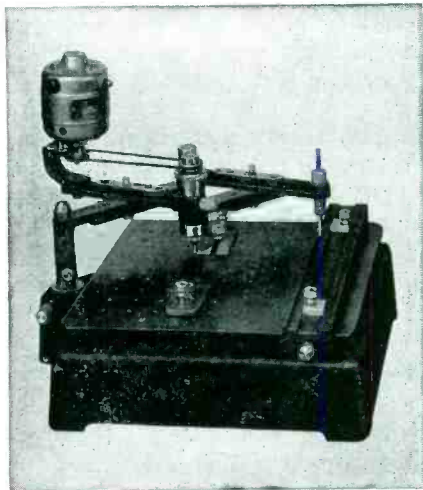

Used in making small molds and dies or engraving panels and nameplates of metal or plastic.

Permits accurate reproduction of three-dimensional master on any of four reduction ratios.

Catalog on Request

MICO INSTRUMENT CO.
76E TROWBRIDGE STREET
CAMBRIDGE 38, MASS.

Ideal for
ANTENNA CONNECTIONS
PHOTO-CELL WORK
MICROPHONE CONNECTIONS

JONES SHIELDED TYPE PLUGS & SOCKETS



P-101-1/4

S-101

LOW LOSS PLUGS AND SOCKETS FOR HIGH FREQUENCY CONNECTIONS. SUPPLIED IN 1 AND 2 CONTACT TYPES:

101 Series can be furnished with 1/4", .290", 5/16", 3/8" or 1/2" ferrule for cable entrance. Knurled nut securely fastens unit together. Plugs have ceramic insulation and sockets have bakelite. Quality construction. Fine finish. Assembly meets Navy specifications.

For full details and engineering data ask for Jones Catalog No. 17.

JONES MEANS Proven QUALITY

HOWARD B. JONES DIVISION
Cinch Mfg. Corp.
2460 W. GEORGE ST. CHICAGO 18, ILL.

The Shape and Size YOU need!

PARAMOUNT SPIRAL WOUND PAPER TUBES

All Sizes in Square and Rectangular Tubes

Leading manufacturers rely on the quality and exactness of PARAMOUNT paper tubes for coil forms and other uses. Here you have the advantage of long, specialized experience in producing the exact shapes and sizes for a great many applications. *Hi-Dielectric, Hi-Strength.* Kraft, Fish Paper, Red Rope, or any combination. Wound on automatic machines. Tolerances plus or minus .002". Made to your specifications or engineered for YOU.

SEND FOR ARBOR LIST OF OVER 1000 SIZES Inside Perimeters from .592" to 19.0" Convenient. Helpful. Lists great variety of stock arbors and tube sizes. Includes many odd sizes. Write for Arbor List today.

PARAMOUNT PAPER TUBE CORP.
616 LAFAYETTE ST., FORT WAYNE 2, IND.
Manufacturers of Paper Tubing for the Electrical Industry

For Precision Washers... For Precision Stampings...

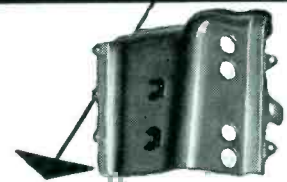
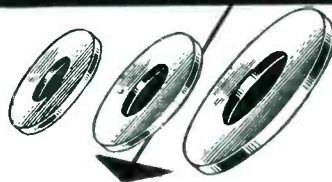

WHITEHEAD STAMPING CO.

A preferred source of precision-made WASHERS and STAMPINGS. 46 years of experience and up-to-the-minute facilities, assure highest quality and service.



EST. 1903

WHITEHEAD STAMPING CO.

1691 W. Lafayette Blvd.

Detroit 16, Michigan

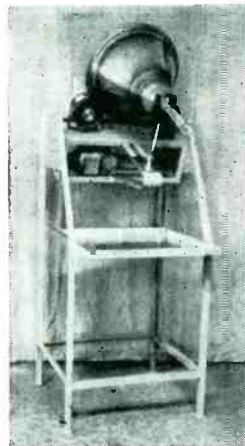

AN EASY, QUICK AND INEXPENSIVE WAY TO COAT THE INSIDE SURFACE OF TV TUBES

A New way of turning tubes for inside coating

- Takes 16" metal and 10" or 12" glass blanks with simple adjustment
- Blanks insert or remove without stopping machine
- No vacuum to operate or maintain
- No revolving chuck jaws or joints to wear out
- 3-speed cone sheave for wide speed range
- Fixed linear speed for easy brushing
- Cheaper than mechanical or vacuum chuck
- Cannot jam — eliminates tube breakage

BUCK ENGINEERING CO., INC.

37-49 Marcy St.

Freehold, N. J.

ANNOUNCING Roanwell's NEW MOBILE MIKE

THIS NEW MOBILE MICROPHONE PROVIDES CONSISTENTLY HIGHER MODULATION PERFORMANCE

Weighs a mere 7 oz. Button is riveted on face of mic; allows easy change-over from speaking to hang-up position with turn of wrist. Tough, shock-proof aluminum alloy case; dustproof and moistureproof. Switch and all other internal elements completely enclosed. Mic element cushioned in rubber makes unit shock-and-vibration proof. Suitable for replacement on all existing equipment.

**COMPACT!
RELIABLE!
HANDLES
EASILY!**

STYLE No. 737



Write for full particulars.



ROANWELL CORPORATION
662 Pacific St. • Brooklyn 17, N. Y.

AMPERITE

THERMOSTATIC METAL TYPE

Delay Relays

**PROVIDE DELAYS RANGING
FROM 1 TO 120 SECONDS**



FEATURES: — Compensated for ambient temperature changes from -40° to 110° F . . . Hermetically sealed; not affected by altitude, moisture or other climate changes . . . Explosion-proof . . . Octal radio base . . . Compact, light, rugged, inexpensive . . . Circuits available: SPST Normally Open; SPST Normally Closed.

PROBLEM? Send for "Special Problem Sheet"

Regulators

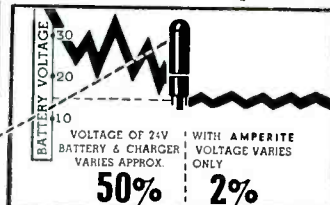

Amperite REGULATORS are the simplest, lightest,

cheapest, and most compact method of obtaining current or voltage regulation . . . For currents of .060 to 6 Amps. . . Hermetically sealed; not affected by altitude, ambient temperature, humidity.

Write for 4-page Illustrated Bulletin.

AMPERITE CO., Inc., 561 Broadway, New York 12, N. Y.

In Canada: Atlas Radio Corp., Ltd., 560 King St., W. Toronto

ing output transformers.

Picture Tube Data. Vacuum Tube Products, 302 North Clementine St., Oceanside, Calif. A one-page data sheet gives the general characteristics, typical operation and an illustration of the type 12LP4 television picture tube.

High-Vacuum Apparatus. Central Scientific Co., 1700 Irving Park Road, Chicago 13, Ill., has issued a 48-page booklet containing extensive explanatory data on various high-vacuum apparatus and a complete listing of accessories.

Tube Testers. The Hickok Electrical Instrument Co., 10527 Dupont Ave., Cleveland 8, Ohio. A new 4-page folder describes and illustrates the latest complete line of dynamic mutual conductance tube testers. Technical and exclusive features are listed.

Metallized Capacitor Paper. Smith Paper, Inc., Lee, Mass., has published a brochure dealing with the new zinc metallized capacitor paper which is space-saving, self-healing and eliminates the use of foil electrodes.

Switches. The Daven Co., 191 Central Ave., Newark, N. J., recently released a four-page circular giving general information on a line of switches for use in broadcast and communications, industrial fields and in laboratory tests.

Electronic Counters. Potter Instrument Co., Inc., 136-56 Roosevelt Ave., Flushing, N. Y. A new four-page condensed catalog covers special electronic frequency measuring and computing equipment. Also included are a discussion of the counting principle, methods and typical applications.

Resistor Catalog. Clarostat Mfg. Co., Inc., Dover, N. H. Catalog 49 presents a complete line of resistors, controls and resistance devices. Listings concentrate on universal numbers where feasible so that replacement needs will require a minimum inventory.

Variable Capacitors. E. F. Johnson Co., Waseca, Minn. Catalog

**WHAT EVER
YOU NEED!**

SPRING STAMPINGS

FROM STOCK
WHEN YOU WANT THEM

Flat springs and spring washers in whatever size or finish you need Diamond G facilities can produce them . . . and at prices usually far below your own production costs.

That's why many manufacturers "Go To Garrett's" for all small parts. Our experience has been so voluminous in producing small parts and our variety of dies and tools so extensive that most springs can be produced to fit your requirements without extra expense of special equipment.

If it's small parts you need . . . let Garrett's make them for you . . . better, quicker and at lower costs. You'll also find it worthwhile reading our new engineering catalog which shows hundreds of standard spring washer items now in stock or manufactured as standard products. Write for your free copy today . . . Catalog No. SS 51.

DIAMOND G PRODUCTS
Manufactured by
GEORGE K. GARRETT CO., INC.
1421 Chestnut St., Phila., Pa.

GARRETT

MANUFACTURERS
OF SMALL PARTS

NEW PRODUCTS

(continued)

701 covers, along with the standard variable capacitors, the new miniature air dielectric variables. It also includes data on the new type L variable with ceramic soldering and bright alloy plating.

Insulated Chokes. International Resistance Co., 401 N. Broad St., Philadelphia 8, Pa. Bulletin H-1 contains four pages of catalog data on the types CLA and CL-1 insulated chokes. Charts showing inductance, d-c resistance and current rating, along with dimensional drawings and a color coding list are included.

Tubing and Sleeving. Insulation Manufacturers Corp., 565 W. Washington Blvd., Chicago 6, Ill. Technical information on varnished tubings and saturated sleeveings is presented in a four-page folder. Three Dieflex types are covered and different grades of products are fully described. Information on inside diameters, available grades and colors, and telescoping data is given in tabular form.

Shaded-Pole Motors. Russell Electric Co., 4501 S. Western Blvd., Chicago 9, Ill. Bulletin No. 4000 describes and illustrates the type 470 six-pole motor with ratings from 1/30 to 1/2 h-p at 1,100 rpm. Also included are a performance curve and dimensional drawings.

Scaling Devices. Berkeley Scientific Co., Sixth and Nevin Ave., Richmond, Calif. Two recent pamphlets describe and illustrate the Model 2000 automatic scaler and the Model 1000-B Geiger-Muller scaler for nuclear measurements. Technical data, accessories and replacement unit information for each are given.

Coaxial Switch. The Workshop Associates, Inc., 66 Needham St., Newton Highlands, Mass. A single-page leaflet R-4AI gives detailed mounting instructions, specifications and circuits for the model R-4A coaxial switch.

VHF Radiotelephone. National Electronics Laboratories, Inc., Alexandria, Va. Complete illustrated

**AC CURRENT
Anywhere!**

ATR

STANDARD AND HEAVY DUTY INVERTERS



For Inverting D. C. to A. C.

Specially Designed for operating A. C. Radios, Television Sets, Amplifiers, Address Systems, and Radio Test Equipment from D. C. Voltages in Vehicles, Ships, Trains, Planes and in D. C. Districts.



AUTO RADIO VIBRATORS

A Complete Line of Vibrators . . .

Designed for Use in Standard Vibrator-Operated Auto Radio Receivers. Built with Precision Construction, featuring Ceramic Stack Spacers for Longer Lasting Life.

NEW MODELS NEW DESIGNS
NEW LITERATURE
ATR "A" Battery Eliminator, DC-AC Inverters, Auto Radio Vibrators
See your jobber or write factory

AMERICAN TELEVISION & RADIO Co.
Quality Products Since 1931
SAINT PAUL 1, MINNESOTA-U. S. A.

**SHOCK
and
VIBRATION**

NEWS

by
BARRY

*for assured control of shock
and vibration*

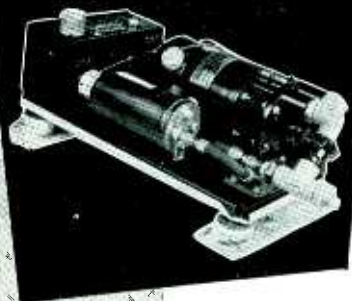

ECLIPSE-PIONEER
Division of Bendix Aviation Corp.

specifies

BARRYMOUNTS

WITH THEIR TYPE 33E00-1-A AIR PUMP AND CONTROL UNIT

At high altitudes, the performance of aircraft radar, radio, ignition, and fuel systems depends on pressurization by this Eclipse-Pioneer unit whose sensitive aneroid switch mechanism must be guarded against shock and vibration.

For this critical task, air-damped **BARRYMOUNTS** were chosen by Eclipse-Pioneer engineers after tests proved they isolate vibration with no snubber contact at any frequency — even at resonance.

The Eclipse-Pioneer unit is shown on a **BARRY** standard mounting base assembly which permits rapid installation or removal of the pump and control unit.

Whatever your vibration problem, **BARRY** experience and engineering facilities offer a sure solution. Our **FREE** catalog lists stock mountings; for special information, call our nearest office

or
write to

FOR ASSURED
CONTROL OF
SHOCK AND
VIBRATION

THE BARRY CORP.

New York Rochester Philadelphia Washington
Cleveland Dayton Chicago Minneapolis
St. Louis Los Angeles

Main Office
177 Sidney Street
Cambridge, Mass.

NEW PRODUCTS

(continued)

description and specifications for the NEL-200 Utiliphone are given in an 8-page folder. The unit described is a vhf two-way radio-telephone for communication between airport control tower and ground units employing the 121.7 or 121.9-mc range.

Television Components. Standard Transformer Corp., 3580 Elston Ave., Chicago 18, Ill., has issued bulletin DD337R giving illustrations, detailed specifications and prices of a line of television components including the recent A-8117 and A-8118 horizontal output transformers.

Thin Resistors. Ohmite Mfg. Co., 4835 Flournoy St., Chicago 44, Ill. Bulletin 138 describes the new, thin-type, wire-wound, vitreous-enameled resistors. Dimensional drawings and specific-value tables are included.

Radioactivity Measurement. Nuclear Instrument & Chemical Corp., 223 W. Erie St., Chicago 10, Ill. Catalog J consists of thirty-six pages covering instrumentation for radioactivity measurement. Included are a wide range of scaling units, counting systems, monitoring instruments, detectors and accessories, together with information about applications, manufacturing methods and other pertinent data.

Cathode-Ray Tubes. Allen B. Dumont Laboratories, Inc., Clifton, N. J. The new edition of the c-r tube booklet contains 63 pages on the history development, design and structure, and the uses of the tube, along with 68 illustrations. In addition there are chapters on the c-r oscillograph, television and radar. Price is 50¢ through jobbers.

Servo Leaflet. Duncan & Bayley, Inc., 785 Hertel Ave., Buffalo, N. Y. Two sides of a page give an illustrated description of the fluid magnetic series FM-5 proportional torque controllers. The unit described provides the servo engineer with an ultrahigh speed two-

Etched TUNGSTEN WIRE

.00015" diameter
and smaller

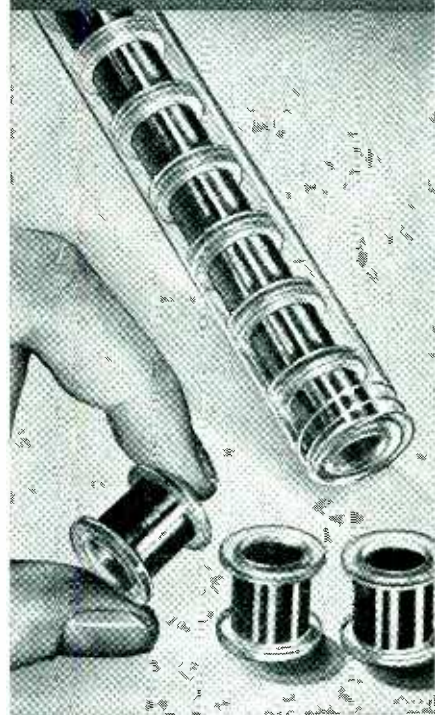

- Accurate, uniform and smooth . . .
- Also available in Molybdenum and other metals . . .

Write for details and
List of Products

SIGMUND COHN CORP.

44 GOLD ST. NEW YORK

SINCE 1901



RAWSON ELECTROSTATIC VOLTMETERS

Type 518



Now available to 35,000 VOLTS
Measure true R.M.S. values on A.C., no
waveform or frequency errors.

NO POWER CONSUMPTION

Leakage resistance greater than one million
megohms. These meters may be used
to measure

STATIC ELECTRICITY

Ideal for measuring high voltage power
supplies with zero current drain. Rugged,
well-damped movement. All elements sur-
rounded by metal shielding for accuracy
and safety.

Write for new bulletin

**RAWSON ELECTRICAL
INSTRUMENT COMPANY**

111 POTTER ST. CAMBRIDGE, Mass.

Chicago Representatives Los Angeles

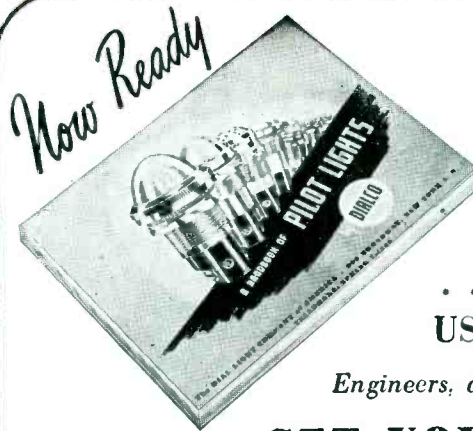

The NEW **DIALCO** HANDBOOK

... 192 PAGES of
USEFUL INFORMATION

Engineers, designers, purchasing agents —

GET YOUR COPY

You will find complete data on the lamps used in pilot lights.

And illustrations - all full size - of hundreds of items you will use.

There is a table of resistors for operation of lamps on all voltages.

Complete dimensional data on each unit.

More than 2,000 Underwriters' Listed Assemblies.

The DIAL LIGHT COMPANY of AMERICA

Foremost Manufacturer of Pilot Lights.

900 BROADWAY, NEW YORK 3, N. Y. TELEPHONE SPRING 7-1300

Write for Handbook D-149

AIRBORNE RADIO

FOR ALL CLASSES OF AIRCRAFT



Aircraft Radio Corporation

Equipment for:

- TWO-WAY VHF
- STANDARD LF RANGES
(with homing loop)
- VHF OMNI RANGES
- LOCALIZERS
- GCA VOICE
- ISOLATION AMPLIFIERS
(10 inputs — 2 outputs)

Name of nearest sales and
installation agency
on request



Aircraft Radio Corporation

BOONTON, NEW JERSEY

For Quality Pictures—

Use ZETKA 15" Tubes

For rich contrast, freedom from ion stain, long life
and dependability there is no better tube. Limited
quantity available now. Write or phone immediately.

ZETKA TELEVISION TUBES, INC.

131 Getty Ave., Clifton, N. J.

Phone: PAssaic 2-9095

Dano has made a reputation for handling even
very difficult—or the simplest coil problems
with equal efficiency. Send us your specifications
for quotation whether you require an untreated
coil or one that is vacuum preganated with wax
or varnish.

- Form Wound
 - Paper Section
 - Acetate Bobbin
 - Acetate Section
 - Bakelite Bobbin
 - Cotton Interweave
- COILS FOR HIGH TEMPERATURE APPLICATIONS
MADE TO EXACT SPECIFICATIONS
ALSO TRANSFORMERS MADE TO ORDER

Don't let
a COIL
hold up
production



THE DANO ELECTRIC CO.

MAIN ST., WINSTED, CONN.





HIGH CAPACITY TO SPACE RATIO

*With Johnson
Pressurized Capacitors*

JOHNSON Pressurized Capacitors are so carefully engineered that they provide the desired capacity and voltage rating with minimum pressure and condenser height. Because of their efficient electrical and mechanical design, they also provide the utmost in stable operating conditions.

Available as "standard" are variable, fixed and fixed-variable units — in a wide variety of capacitance and current rating. In addition, JOHNSON can build any pressure condenser to individual specifications.

FEATURES

- Low Loss
- High KVA Rating
- Shielded From External Electrostatic Fields
- Low Internal Distributed inductance
- Complete Dependability

Write For Illustrated
JOHNSON Catalog and
Prices



JOHNSON

a famous name in Radio!

E. F. JOHNSON CO. WASECA, MINN.

NEW PRODUCTS

(continued)

direction control means that serves as an amplification stage itself.

Television Components. Radio Corp. of America, Harrison, N. J. Form CTV-1004 is a 32-page booklet providing technical data including characteristics and dimensional outlines for 18 components used in receiver designs employing the new 16-inch metal-cone picture tube, 16AP4. Also included are typical deflection circuits and associated circuit of a pulse-operated, h-v supply for the same unit.

Central Station Unit. Philco Corp., Philadelphia 34, Pa. A recent four-page folder illustrates and describes with technical data a new compact central station unit for use in f-m radiophone communications systems in the 30-to-44 mc and 152-to-162 mc bands.

Timing Devices. The A. W. Haydon Co., Waterbury 32, Conn. Latest bulletin issued for insertion in the timing-device catalog covers the d-c timing motors with chronometric governor. The motor described is suited for applications such as chart drive elements for recorders in aircraft, trucks, buses and ships.

Flexible Electronic Control. Reliance Electric & Engineering Co., 1111 Ivanhoe Rd., Cleveland 10, Ohio. Bulletin K-2025 explains how the VSC electronic excitation control system provides functional adaptability for production or processing operations requiring timed-rate, smooth acceleration and deceleration. The two-page sheet also points out the unit's advantages, the ampere ratings for which it is made, the a-c supply voltages for which it is available and other data.

Spectrum Chart. Mullard Electronic Products Ltd., Century House, Shaftesbury Ave., London WC 2, England. Frequency allocations agreed upon at the Atlantic City conference are shown in color on a wall chart now available. Price is \$1.50 postpaid or \$1 each for ten or more.

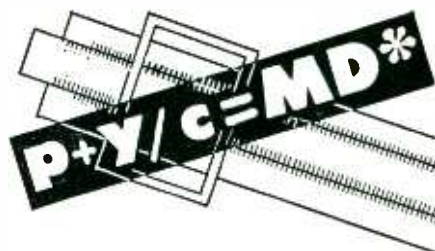

** or, PRECISION plus
YOUR COIL equals
MAXIMUM DEPENDABILITY*

The basic factor—the making or breaking of your coil is in the base. There, unseen trouble can start regardless of how perfectly the coil has been wound. Be positive of your coils—use today's standard throughout the electrical industry—



PRECISION PAPER TUBES — DI-FORMED —

Precision's control of design and precise construction make the best possible foundation. They are spirally wound and heavily heat treated under compression for greatest strength. Have the most efficient insulation—lowest moisture absorption. Precision Paper Tubes are the lightest coil bases made.

Made to your specifications—any ID, OD or length of the best quality Kraft, Fish Paper, Cellulose Acetate or in combinations.

Write today for free samples
—Mandrel List of over 1,000

PRECISION PAPER TUBE CO.

2041 W. Charleston St. Chicago 47, Ill.
79 Chapel St. Plant No. 2 Hartford, Conn.

new agency occupies five buildings outside Fort Monmouth, N. J.

The mission of the Standards Agency is fourfold: to reduce the number of styles and types of electronic components used in the manufacture of military equipment; to insure their quality and dependability; to achieve a high degree of interchangeability; and to designate approved sources of supply.

A procedure for obtaining industry agreement on proposed JAN specifications was worked out by RMA and the Agency at a meeting held in New York at the time of the IRE convention in March. Representing the RMA were W. R. G. Baker and Virgil M. Graham; the Agency, L. J. Taton and H. E. Bernstein.

Considerable progress in alleviating the war-born confusion over electronic parts is being made. For instance, three standard crystal holders, to meet any foreseeable requirement, have been adopted to replace 350 different holders which were formerly used. A single standard wire-wound resistor takes the place of 33 former non-standard types. Audio and power transformers that required more than 10,000 different sizes and shapes of cases can now be accommodated in only 22 standard containers. Measuring instruments and tubes have received the benefit of special attention. More than 37,500 types of meters have been reduced to 3,700 standard types, and 3,000 types of vacuum tubes have been cut down to 800 for replacement purposes and to about 200 for new applications.

Numerical Analysis Symposium

THE NATIONAL BUREAU OF STANDARDS is planning two symposia on the effective utilization of automatic digital computing machinery, to be held late in June 1949 at the Bureau's Institute for Numerical Analysis in Los Angeles, Calif.

Construction and application of conformal maps will be the topic of the first session. Applications in such fields as aerodynamics and electronics will be emphasized, with special attention to the current



Jerked disconnects cause many apparently excellent connectors to open or short-out quickly.

Not MINES Portable Plugs, however . . . they're designed for rough treatment! Integrally molded of Neoprene rubber and joined to their cables by tapered-neck vulcanization, they outwear and outperform molded phenolic, plastic or porcelain types. In addition, MINES Connectors can't crack or shatter, and are impervious to the ill effects of moisture, oil, acids and dust.

Write for DESCRIPTIVE BULLETIN TODAY

It will pay you to investigate the complete MINES Connector line before placing your next electrical connector order.



MANUFACTURED BY
MINES EQUIPMENT COMPANY
4265 CLAYTON AVE. **MINES** ST. LOUIS 10, MO.

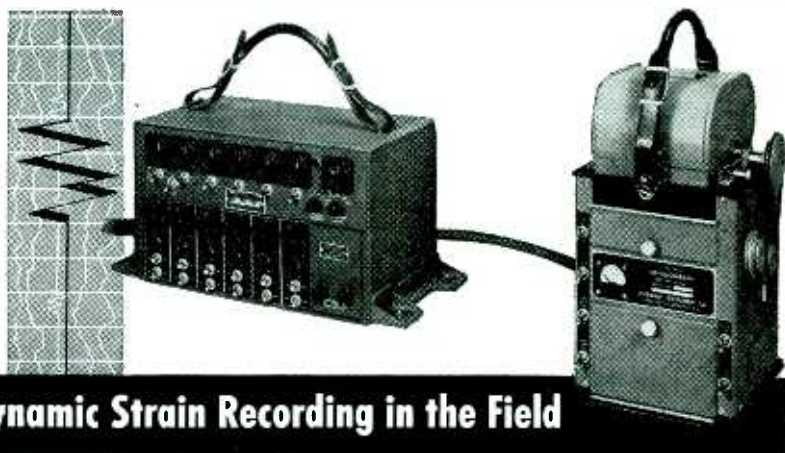

Dynamic Strain Recording in the Field

The TYPE MRC-12 6-ELEMENT SELF-POWERED STRAIN GAGE CONTROL UNIT, and the TYPE S15-A 6-ELEMENT SELF-POWERED RECORDING OSCILLOGRAPH together make up a complete dynamic strain measuring laboratory which you can carry with you for field use ANYWHERE where electrical power is not available.

With standard SR-4 resistance strain gages, a frequency response from static to 500 cycles per second can be obtained. Magnifications are adequate for all practical needs for static-dynamic strain recording on structural members and machine parts.

- Small in Size • Light in Weight • Simple to Use
- Insensitive to Vibration • Finest Instrument Craftsmanship
- Unconditionally Guaranteed

Write for Technical Bulletin SP-177G and SP-193G

Hathaway
INSTRUMENT COMPANY
1315 SO. CLARKSON STREET • DENVER 10, COLORADO

**ALTEC
LANSING**

*has the correct
answers to your
sound problems*

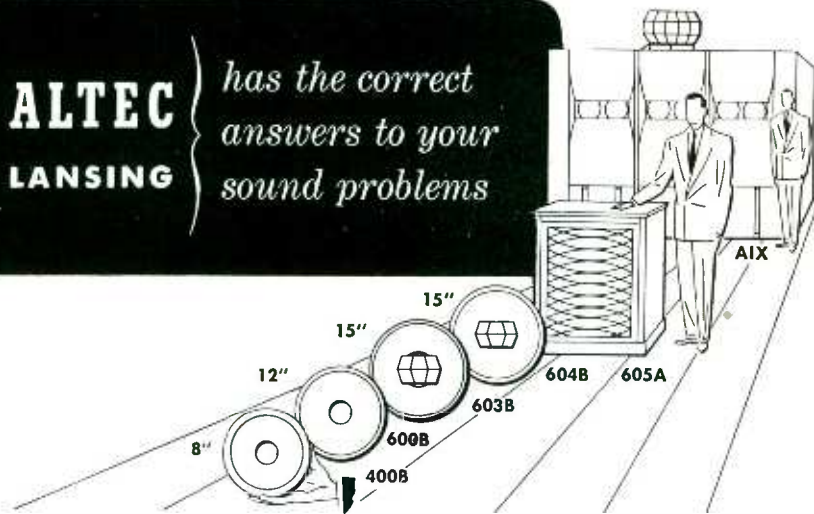

Regardless of your problem of high quality sound reproduction and distribution, you will find the solution with one or a combination of the highest quality units in the Altec Lansing line. From a small, efficient, 8-inch speaker to a huge industry approved theatre loudspeaker system, Altec Lansing manufactures over 25 different types and sizes of speakers and speaker systems. Each unit has been especially designed to adequately solve a specific sound problem. Thousands of Altec Lansing speakers are now in use in the motion picture, public address and radio in-

dustries. If your problems are sound, consult Altec Lansing. You will find the right answer to your sound problems.

Write for descriptive brochure



1161 N. Vine St., Hollywood 38, Cal.
161 Sixth Ave., New York 13, N. Y.

CUT COSTS

IN FREQUENCY CONTROL DESIGN . . .
eliminate temperature control of crystals

WITH

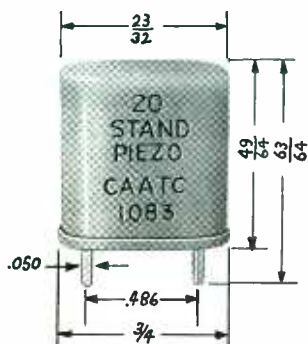

$\pm .0025\%$
 $-55^{\circ}\text{C to } +90^{\circ}\text{C}$

Improved processing of our hermetically sealed Type 20 unit has made it possible to eliminate the cost of temperature control.

Lower power requirements, reduced weight, compactness, ruggedness, and dependability in our improved Type 20 is your answer for reducing costs and increasing sales.

For complete details, write for free catalog.

needs of research workers. Particular reference will be made to the electronic machine now being designed at the Institute under Harry D. Huskey.

The second symposium will cover probability methods in numerical analysis, with emphasis on applications of the Monte Carlo method which has been used in the solution of mathematical physics problems. This session is being arranged jointly by the Institute for Numerical Analysis and the Rand Corp., with the assistance of the Atomic Energy Commission.

Anyone interested in attending either symposium may obtain further information from J. H. Curtiss, Institute for Numerical Analysis, Los Angeles 24, Calif.

Official FCC Lists Available

BIDS from private duplicating companies have been invited by the FCC for reproduction, at no expense to the government, and to offer for sale to the public, copies of radio frequency lists, call lists and other special lists prepared by the Commission for official use which are of interest to the industry and general public.

Prospective bidders may obtain forms and other information upon request to the Secretary of the FCC, Washington 25, D. C.

Electrical Indicator Standard

REQUIREMENTS for the individual sizes of panel and switchboard instruments have been presented in the new American Standard for Electrical Indicating Instruments, C39.1-1949. The standard was prepared by a committee of the national associations concerned with manufacture, use and technical development of electrical instruments, under the procedure of the American Standards Association.

One of the important contributions in the standard is the section on definitions which covers many new definitions not included before. The term "sensitivity" has been omitted and the word "loss" is used as descriptive of the energy taken to operate instruments. With special definitions this standard can

Standard Piezo Company
CARLISLE, PA.



THIS FEATHERWEIGHT WILL
**LICK
SOLDERING
FATIGUE!**



THE NEW
**HEXA CON
BANTAM**
--- **MODEL 30H**

Weight—5½ Ounces • Watts—
40 or 60 • Tip Dia.—Both ⅛" and ¼" Tips
Furnished with Each Iron • Price— **\$5.00**

So light its weight is hardly noticeable. Out-
performs any iron of equal size. Hatchet de-
sign makes it more comfortable and practical
to use than a pencil iron. No transformer re-
quired. Write for complete catalog.

HEXA CON

HEXA CON ELECTRIC CO.
130 WEST CLAY AVE., ROSELLE PARK, N. J.

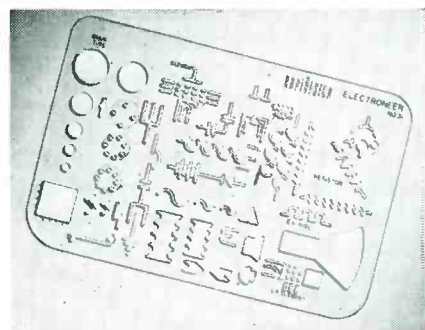

ELECTRONEER No. 31

PRICE \$3.00

The Electroneer has all electrical and industrial electronic symbols.

In addition, all diagrammatic elements of the electronic and cathode ray tubes are provided for in the template PLUS tube bases of the 4, 7 and 8 prong type. Uniform, clean-cut symbols are quickly and easily constructed.

The Electroneer is made of clear, mathematical-quality cellulose nitrate sheet of .040 thickness. Symbol cutouts are smooth beveled to assure clean, accurate lines. Actual size of instrument is 4¼" x 6½".

ORDER YOURS TODAY
FROM YOUR LOCAL DEALER
Catalog No. 49 available on request

RAPID DESIGN, INC.
BOX 592 • GLENDALE, CALIF.

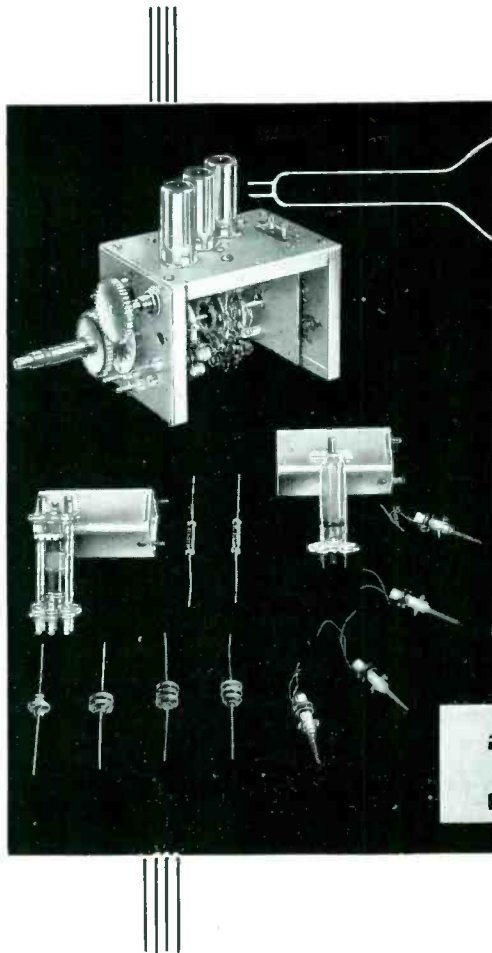

36 mcs IF
unique video
RF unit and
coil kit
minimizes
interference

Front end assembly, IF trans-
formers, peaking coils, video
choke coils, sound trap and ratio
discriminator designed for unique
stagger-tuned IF system having a
center frequency of 35.8 mcs,
instead of conventional 24 mcs.
Minimizes many forms of RF
interference. Used in National
Television sets. Write for com-
plete details.

National
EST. 1914
NATIONAL COMPANY, Inc.

MALDEN, MASSACHUSETTS

Pioneer in Radio Engineering Instruction Since 1927

CAPITOL RADIO ENGINEERING INSTITUTE

An Accredited Technical Institute

ADVANCED HOME STUDY AND RESIDENCE
COURSES IN PRACTICAL RADIO-ELECTRONICS
AND TELEVISION ENGINEERING

Request your free home study or residence
school catalog by writing to:

REGISTRAR
16TH AND PARK ROAD, N.W.
WASHINGTON 10, D. C.

Approved for Veteran Training

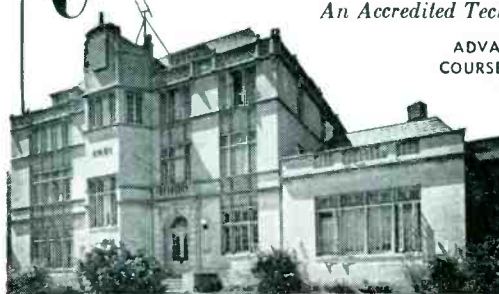

WHAT MAKES A MAILING CLICK?

for Results



Advertising men agree . . . the list is more than half
the story. McGraw-Hill Mailing Lists, used by leading
manufacturers and industrial service organizations,
direct your advertising and sales promotional efforts
to key purchasing power.

In view of present day difficulties in maintaining
your own mailing lists, this efficient personalized
service is particularly important in securing the com-
prehensive market coverage you need and want.
Investigate today.

McGraw-Hill Publishing Co., Inc.
DIRECT MAIL DIVISION
330 West 42nd Street New York 18, New York

McGraw-Hill
DIRECT MAIL LIST SERVICE

ACCURATE PHASING WITH T.I.C. METHOD OF GANGING PRECISION POTENTIOMETERS

MECHANICAL SPECIFICATIONS

- Precision machined aluminum base and cover 2" diameter, 1" depth.
- Precision phosphor bronze bushing.
- Centerless ground stainless steel shaft.
- No set screws.
- Mechanical rotation—360°.
- Clamping method of ganging permits individual adjustment of angular position.
- Temperature range —85° to +165°F.
- Rotational Life—At least 1 million complete cycles of revolution.

ELECTRICAL SPECIFICATIONS

- Winding—both linear to 0.2% and non-linear to 1% accuracies.
- Paliney contact to winding; two-brush rotor take-o assembly with precious metal contacts.
- High, uniform resolution provided by our method of winding non-linear resistances.
- Electrical rotation maximum 320°.
- All soldered connections (except sliding contacts).

This general line of precision potentiometers was developed in collaboration with the Fire Control Section of the Glenn L. Martin Company.

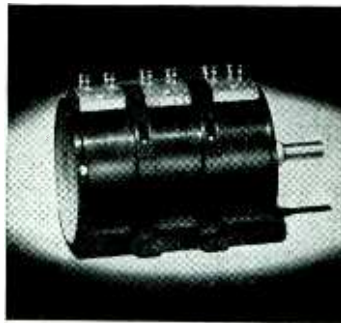

(3 gang RV-2)

Write today for bulletins on other T.I.C. products: Z-Angle Meter . . . R.F. Z Angle Meter . . . R-F Power Oscillator . . . Translatory Variable Resistors . . . Slide Wire Resistance Boxes . . . Phase Angle Meter.

TI TECHNOLOGY INSTRUMENT CORP.

1058 MAIN STREET, WALTHAM 54, MASS.

ENGINEERING REPRESENTATIVES

Chicago, Ill.—STATE 2-7444

Cambridge, Mass.—ELiot 4-1751

Canaan, Conn.—Canaan 649

Rochester, N. Y.—Charlotte 3193-J

Dallas, Tex.—Logan 6-5097



... Won't Shake Loose ... Reduce Maintenance

Invariably, when nuts loosen, they cause shutdown, loss of production, and bad tempers all around. All this can readily be eliminated by installing the one-piece, self-locking "FLEXLOC", because it positively will not shake loose and positively cuts cost of maintenance.

The all-metal, one-piece resilient "FLEXLOC" is becoming increasingly popular, because it is processed to have an exceptionally uniform torque and, because it packs a stop, lock and plain nut all in one. "FLEXLOC" accommodates itself to a wide range of thread tolerances and can be used over and over again without losing much of its torque. And, being a stop nut, it stays locked in any position on a threaded member. It is not affected by temperatures commonly met.

Available in "thin" and "regular" types—in sizes from #6 to 2" in diameter—in NC and NF thread series. Write for your copy of the "FLEXLOC" Catalog.

OVER 46 YEARS IN BUSINESS

STANDARD PRESSED STEEL CO.

Jenkintown, Pennsylvania, Box 596

Branches: Chicago • Detroit • St. Louis • San Francisco

be used to cover the various requirements. For example, a volt-meter has a "current loss" whereas a current measuring instrument has a "voltage loss." Adding "volt-ampere loss" and "power loss" in watts, the story becomes complete with no reciprocal functions involved.

Besides definitions and the detailed requirements for each type of instrument, the text includes general requirements and test requirements for temperature, effect of overload, shock, vibration, humidity and dielectric test.

The standard may be obtained from the American Standards Association, 70 E. 45 Street, New York 17, N. Y., at \$1.50 per copy.

BUSINESS NEWS

MOTOROLA INC., Chicago, Ill., recently opened a new research laboratory in Phoenix, Arizona, to be devoted exclusively to electronic research in military fields.

SYLVANIA ELECTRIC PRODUCTS INC., Towanda, Pa., is constructing a plant addition that will increase its space by approximately one third to meet increased demand for tungsten and chemical products for the television industry.

WARD LEONARD ELECTRIC Co., Mount Vernon, N. Y., has moved its general office from the factory building to a new office building at 115 South MacQuesten Parkway, Mount Vernon, N. Y.

RESISTORS, INC., manufacturer of resistors for radio and electronic



New Resistors, Inc. Plant

circuits, has moved into its new plant at 5226 W. 26th St., Chicago, Ill.

THE THEATRE OWNERS OF AMERICA has become a sustaining member of the Society of Motion Picture Engineers to explore fields of mutual

interest in theatre engineering, including theatre television.

ELECTRONIC INSTRUMENT CO., INC., Brooklyn, N. Y., manufacturers of test equipment, recently moved to new and larger quarters at 276 Newport St., Brooklyn 12, N. Y.

ELECTROVOX Co., INC., has moved its factory and general office to 60 Franklin St., East Orange, N. J., due to expanding business in the phonograph needle and television fields.

PERSONNEL

SAMUEL LUBKIN, formerly engineer-in-charge of the digital computer section of the Reeves Instrument Corp., has been appointed consultant to the Machine Development Laboratory, National Bureau of Standards.

EVERETT GILBERT, with Radio Frequency Laboratories, Inc., Boonton, N. J. as special projects engineer since 1945, has been promoted to vice-president for engineering at RFL.



E. Gilbert



R. T. Pennoyer

R. T. PENNOYER, with General Electric Company in various engineering and management capacities since 1933, was recently appointed manager of GE's Buffalo Tube Works, where television picture tubes are now the chief product.

J. GILMAN REID, former chief engineer for the Electronic Instrumentation Laboratory of the National Bureau of Standards, was recently named chief of the Bureau's Engineering Electronics Laboratory.

WILLIAM B. LODGE, vice-president in charge of engineering for CBS, has been appointed to the board of

LOOK OVER...
DON'T OVERLOOK

The Sterling Line of Indicating Meters

Write For New Catalog
No. 300

Quality Construction at
The Best Possible Price

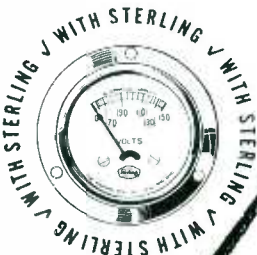

- ✓ Standard Line and Special Purpose Pocket Meters.
Ammeters — Voltmeters — Voltammeters
- ✓ Hearing Aid Battery Testers.
- ✓ Panel Meters.
Voltmeters — Ammeters — Milliammeters
- Replacement Ammeters.
- High Discharge Cell Testers.

THE STERLING MFG. CO.

9209 Detroit Avenue • Cleveland 2, Ohio

KEPCO

ANNOUNCES
NEW...
VOLTAGE
REGULATED POWER SUPPLY
FOR INDUSTRIAL AND RESEARCH USE



Regulation 1/2%
200 to 450 volts

- load variation from 0 to 200 MA
- input variation 105 to 125 volts

SPECIFICATIONS

DC OUTPUT—200 to 450 volts at currents from 0 to 200 MA, regulated

AC OUTPUT—6.3 volts at 6 amperes, unregulated

REGULATION—better than 0.5% between 200 and 450 volts for both load variation from 0 to 200 MA and input variation from 105 to 125 volts . . . OUTPUT DC VOLTAGE VARIATION is within 0.5 volts between 200 and 450 volts for load variations from 0 to 200 MA

RIPPLE VOLTAGE—less than 5 millivolts
INPUT VOLTAGE—105 to 125 volts AC., 50 to 60 cycles

POWER REQUIRED—300 watts

OUTPUT IMPEDANCE—less than 2 ohms

DIMENSIONS—height 8", width 8", length 16", weight 29 pounds

TUBES—1 5R4GY, 4 6L6, 1 6SH7, 1 VR75
MODEL—245

Kepeco
ELECTRONIC INSTRUMENTS

For complete details
Address Dept. K-E

Kepeco Laboratories, Inc.

149-14 41st Avenue
Flushing, N. Y.

ULTRA SENSITIVE D. C. AMPLIFIER



An Electronic Replacement For Sensitive Galvanometer Systems

The Model 53 Breaker-type D.C. Amplifier was developed for the measurement of d. c. and low frequency a. c. voltage in the microvolt and fractional microvolt region. It is compact, portable, and makes an excellent replacement for the suspension galvanometer. The output of the amplifier is sufficient to operate standard meters and recording devices directly.

It has been employed for the amplification of infra-red detectors, thermocouples, voltaic photocells, and the like, both in research and industrial applications.

Among the advantages of this amplifier are the following:

1. Noise level that approaches the theoretical limit imposed by Johnson noise.
2. Extremely low zero drift (less than $.005 \mu V$ after warmup).
3. Freedom from the effects of vibration such as found in moving vehicles.
4. Response characteristics permitting overall amplification flat from 0 to 10 cycles per second.
5. Reliability, as demonstrated by units which have been in continuous operation for several years.

THE PERKIN-ELMER CORPORATION

DEPT. 54, GLENBROOK, CONNECTICUT



INDUCTANCE CONTINUOUSLY VARIABLE

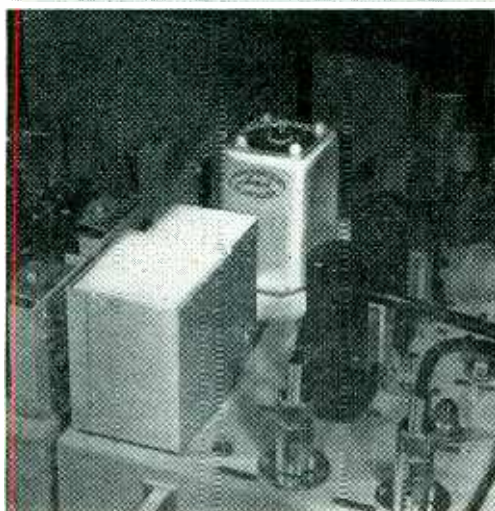

Ampex Electric Corp., manufacturer of the new Ampex broadcast-type tape recorder, uses a Lenkurt Adjustable-Core Molded Pot Assembly for peaking the erasing oscillator to required frequency. Inductance is adjustable, stepless, in a 20 per cent range up to 3 henries.

Other advantages are improved Q, simplified shielding, economy of space and weight, and the possibility of mounting parts closer together. Write for data.

Lenkurt knows how



LENKURT ELECTRIC CO.
SAN CARLOS • CALIFORNIA

NEWS OF THE INDUSTRY

(continued)

governors of the Society of Motion Picture Engineers. He is the first television engineer to receive a major appointment in this society.

STEPHEN V. HART, formerly development engineer at RCA Victor, was recently appointed to the newly-created position of chief engineer at Industrial Electronics, Inc., Detroit, Mich.

GEORGE C. SCHLETER, formerly engaged in microwave research at the Naval Research Laboratory, has been appointed to the staff of the National Bureau of Standards to conduct an engineering development program on guided missiles, including missile systems and components.

WILBUR S. HINMAN, JR., now responsible for research and development in the field of proximity fuzes at the National Bureau of Standards, has been appointed assistant chief of the Bureau's electronics division, where he will aid in directing research and development of electronic apparatus, instruments, controls, circuits, tubes and ordnance devices.



W. S. Hinman, Jr.



W. R. Patton

WILLIAM R. PATTON, former radio engineer at United Air Lines, has joined Lenkurt Electric Co., San Carlos, Calif., as a field engineer in the carrier equipment division.

NICHOLAS BALES, formerly associated with the Tungram Lamp Works of Hungary as development engineer, has been engaged as chief engineer by Electronic Essentials Corp., Jersey City, N. J., television component manufacturers.

EVERARD M. WILLIAMS, 1946 Eta Kappa Nu Award winner, has been promoted to a full professorship of electrical engineering at Carnegie Institute of Technology.

PREMAX

Why the Adjustable "V" Antenna Is Best for TV

Premax Adjustable V Dipole Antennas permit the proper vertical or horizontal adjustment of the elements to prevent, as generally happens with horizontal type dipoles, the combining of a "direct" with a "reflected" signal which results in a cancellation of both signals and poor reception.

The Premax V can be adjusted to the proper vertical or horizontal position to make the two signals combine in phase, thereby increasing rather than reducing the received signal.

Another Premax feature is that, properly mounted, it permits a sufficient signal energy at the antenna terminals to minimize the importance of the otherwise difficult task of perfect impedance matching.

Service men, installing the Premax V, find it insures optimum reception of signals from ALL of the TV stations within the line of sight.

Premax V is a low-cost antenna, easy to install and profitable to the service man. Send for details.

PREMAX PRODUCTS
DIVISION CHISHOLM-RYDER CO., INC.

4902 Highland Ave., Niagara Falls, N. Y.

Swinging-Smoothing
ALL WITH ONE

THORDARSON CHOKE!

REDUCED
RIPPLE —
BETTER
REGULATION



The greatest advance in power supply filter circuits has now been accomplished by THORDARSON engineering skill. Ripple is substantially reduced throughout the useful current range of the power supply by employing one or two of the same type universal chokes in the conventional power supply. Unlike conventional swinging chokes, these THORDARSON chokes do not waste useful inductance at higher current values.

This achievement offers the best possible filtering and regulation in a minimum size consistent with conservative rating.

One choke may be used in a single section filter with all the advantages of the radically swinging type. Two similar units may be employed in a two section filter to better advantage than the obsolete "swinging and smoothing" system — and deliver far better performance.

For complete details, write for a free copy of the new IDS6B THORDARSON Universal Choke-Reactor Technical Bulletin.

See Them at Your Jobber and
Write for the New THORDARSON
Complete Catalog



Manufacturers of Quality Electrical Equipment Since 1895
500 West Huron Chicago 10, Illinois

Kahle

specialists in custom-built, ultra-precision
ELECTRON TUBE MACHINERY

From big 20" to tiny sub-miniature tubes, from laboratory to high speed production, Kahle custom-builds the machine that does each specific job most efficiently. To assure trouble-free high precision operation, each Kahle unit is first put through exhaustive trial runs in our own plant.

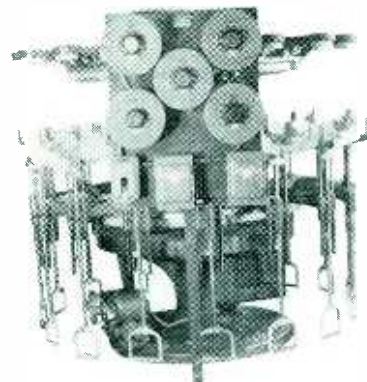

#1363 Easing Machine
For Cathode Ray Tubes

16 heads taking up to 12" tubes or 12 heads taking up to 16" tubes.

We specialize in cost-cutting, production-boosting, labor-saving equipment for complete manufacture of cathode ray tubes, standard, miniature, and sub-miniature radio tubes, sub-miniature tubes, fluorescent lamps, photocells, x-ray tubes, glass products.

Kahle ENGINEERING CO.

1309 Seventh Street North Bergen, New Jersey

Consultations Invited
Send for our new catalog.

These Kits are in use by industrial design and research labs, colleges, trade schools, repairmen, and amateurs.

NO MORE WIRES

Printed Circuit Kits

PRINTED
CIRCUITS
can be used

in every

branch of ELECTRONICS

Radio • Television • Hearing Aids • Control and Testing • Hobbies

ARE YOU
DESIGNING
PRINTED CIRCUITS
INTO
YOUR PRODUCTS?

MANUFACTURING COSTS may be reduced by as much as 60%.
SPACE AND WEIGHT may be reduced 50% to 75%.

MANUFACTURERS IN EVERY BRANCH OF ELECTRONICS are meeting and beating competition with Printed Circuits.

NOW YOUR engineers can design Printed Circuits into your products with our Super Kit, S21, of air-drying conducting and resistance paints plus our Manual "Design and Repair of Printed Circuits. Only \$7.27 from distributors or our factory.

MICROCIRCUITS CO. Dept. 7H New Buffalo, Michigan

WIDE BAND 5" OSCILLOSCOPE HIGH GAIN

COMPARE
*these
features*

- Identical Vertical and Horizontal Amplifiers
- Bandwidth 2 cycles to 450 kc (3 DB Down)
- Sensitivity .15 RMS Volts/inch
- Decade Attenuators (Frequency Compensated)
- Direct Connection to Deflection Plates
- Z Axis Input • Calibration Test Signal

IDEAL FOR TV WORK—CUTS EQUIPMENT COSTS
A QUALITY INSTRUMENT—AN AMAZING LOW PRICE

Suitable for pulse work to 1 MC., cased in hammertone grey cabinet with aluminum front panel, complete with instructions.
GUARANTEED..... Model 450-A

\$99.50
F. O. B.
N. Y.

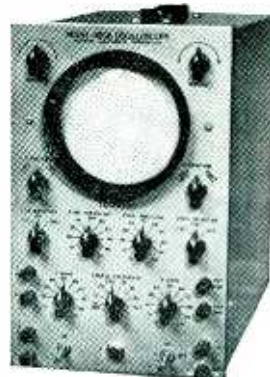

Phone: SL ocum 6-7000

TELEMARK ELECTRONICS CORP · 325 TROY AVE · BROOKLYN 13, N.Y.

BRADLEY RECTIFIERS

HIGH CURRENT SELENIUM RECTIFIERS



SE11X-Series

Bradley's exclusive Vacuum-Processed Selenium Rectifiers provide good efficiency and stability at D.C. ratings up to 18 volts per plate. Square plates afford a maximum ratio of rating to space factor. Forced cooling gives higher current per plate. Plate size up to 5" x 6". Rated up to thousands of amperes. Consult Bradley engineers for best rectifier for your need.

PHOTO CELLS

SIMPLIFY PHOTO CELL CONTROL



Luxtron* photo cells convert light into electrical energy. No external voltage is required to operate meters and meter relays directly from Bradley photo cells, improving control over your processes, reducing your costs. Housed model shown. Many different sizes and shapes, mounted and unmounted.

*T. M. REG. U. S. PAT. OFF.

Our engineers will select or develop rectifiers or photo cells to meet your needs exactly. Write for BRADLEY LINE showing basic models.

BRADLEY
LABORATORIES, INC.
82 Meadow St. New Haven 10, Conn.

NEW BOOKS

Frequency Modulation

BY NATHAN MARCHAND. *Murray Hill Books, Inc., New York, 1948, 409 pages, \$5.00*

STARTING with the assumption that the reader is already familiar with conventional a-m practice, the author in 18 well-written chapters treats the special techniques and equipment employed in f-m work. The scope and purpose of the book are such that the service man and station engineer alike will find it useful as a reference or study text. The mathematical treatment of the basic fundamentals of f-m is conventional except for the introduction of the term phasor. This is not, as might at first appear, a device or circuit used to obtain a given phase difference between two or more voltages (or currents), but rather a new name for the old familiar plane vector. As used here, the difference between the two terms is very slight and not worth the introduction of a new term that might prove confusing.

The brief explanation of Bessel Functions which the author gives in conjunction with his discussion of fidelity and bandwidth requirements should prove helpful to those who wish to thoroughly analyze basic circuit action.

Six phases of f-m are thoroughly covered. The author begins with basic concepts and methods of modulation, and then takes up f-m transmitters, including the phase-to-frequency as well as the direct frequency-modulated types. Following this, f-m receivers are discussed in considerable detail and mobile installations are treated. Installation problems, layouts and cable diagrams are included wherever this can be used to advantageously supplement the text. One chapter is devoted to transmitting antennas, and another to receiving antennas. The final phase of f-m to be discussed is the servicing of f-m receivers. Here the author is careful to point out all similarities and differences between a-m and f-m techniques and equipment.

At the close of each chapter will be found a list of the various references given in the text, and a series of questions for self-study. Answers to questions that require a calcula-

EAR and EYE TUNED



TELEVISION TRANSFORMERS

This Acme Electric 500 V.A. Power Supply Transformer for television receivers, has been carefully engineered to provide the exact electrical characteristics required for larger sets. Hum-free operation has been attained thru both riveting and bolting core and varnish impregnating entire unit.



This larger V.A. capacity transformer, permits manufacturers to use only one transformer instead of two.

From standard laminations, sizes and standard mounting cases Acme Electric engineers can design exactly the transformers you need to improve your product. We invite your inquiry.

ACME ELECTRIC CORP.
316 Water St. Cuba, N. Y., U. S. A.

Acme Electric
TRANSFORMERS

tion are located in an appendix, which also includes extra information on vectors. Throughout the book the subject matter and treatment are such that it could be used as a textbook for a course in f-m. As first pointed out, however, the student must already be familiar with radio fundamentals.—R. H. SCHAAF, *National Radio Institute, Washington, D. C.*

Waveforms

Volume 19 of the MIT Radiation Laboratory Series. EDITED BY B. CHANCE, V. HUGHES, E. F. MACNICHOL, D. SAYRE, AND F. C. WILLIAMS. McGraw-Hill Book Co., New York, 1949, 785 pages, \$10.00.

ALTHOUGH many volumes of this series have been published at about the same time as other books covering much the same material, this volume stands alone as the sole coordinated collection of circuitry in the field of waveform generation and uses. This book brings together in a well-planned form a mass of information which has existed before only in widely scattered classified reports in England and the United States, or which has appeared sketchily or in a disjointed manner in the literature. As such, one will view the book somewhat more critically than if it merely added to the existing literature.

The editors are to be commended, as usual, for the smooth flow of style—it does not read as if it were merely a collection of independent articles, but as a text with a single author. Typographic errors are practically nonexistent. The illustrations are probably one of the outstanding features of the book—almost every circuit mentioned is presented in schematic form with component values indicated. In addition, the manufacturers' type numbers have been noted on special components. These schematics will be a gold-mine for university laboratory work, as well as to the design engineer.

Whether the book may be easily used as a source book is another matter. A good reference in a field which is practically barren would be welcomed. It would seem to this reviewer that, although the concept of the volume included the desire to supply this missing link, it was not achieved. The book is for

An Electronic Stop-Watch

for the measurement of time
10 microseconds to 1 second

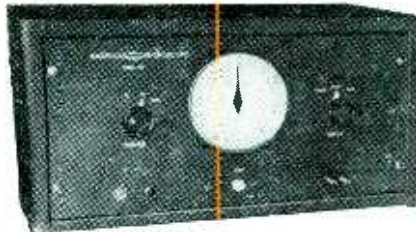

Model 100

\$375.00

- DIRECT READING
- ACCURATE
- SIMPLE

THE AMERICAN HIGH SPEED CHRONOSCOPE

DESIGNED for universal application. Four ranges—1, 10, 100 and 1000 milliseconds full scale. Accuracy is better than one scale division (1%) on any range.

INDISPENSABLE for development and production of business machines, contactors, gas tubes, relays, shutters, switches, welders and a host of other products. Write for Bulletin 100 A.

American Chronoscope Corporation

316 WEST FIRST ST.

Telephone: Mt. Vernon 4-2030

MT. VERNON, N. Y.

a  value for industry

Development and Production of

SPECIAL PURPOSE VACUUM TUBES BY ECLIPSE-PIONEER



TT-1 3000 mc Temperature Limited Noise Diode Tube.

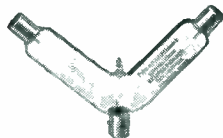

Y-Type Position Convectron—Vertical Sensing Tube.



Chronotron Thermal Time Delay Tube.

We're not in the standard vacuum tube business. But we are definitely in the business of developing and manufacturing special purpose vacuum tubes—tubes that are not generally available. During the past three years, for example, our facilities have produced, such devices as the Chronotron thermal time delay tube, the Convectron* vertical sensing tube, the TT-1 3000 mc temperature limited noise diode tube, counter tubes, glass enclosed spark gaps, and phono pickup tubes. Quantities of all these are now serving many phases of industry in a wide variety of applications. We invite your use of our facilities to develop and produce your requirements of special purpose vacuum tubes. Your inquiries concerning the scope of our facilities or details of any of our tubes will be given immediate attention.

*REG. U. S. PAT. OFF.

Eclipse-Pioneer Division of

TETERBORO, NEW JERSEY

Expert Sales—Bendix International Division, 72 Fifth Avenue, New York 11, N. Y.



High Sensitivity . . . Logarithmic AC VOLTMETER

50 MICROVOLTS TO 500 VOLTS

SELF-CONTAINED
ALL AC OPERATED UNIT

MODEL 47 VOLTMETER

An extremely sensitive amplifier type instrument that serves simultaneously as a voltmeter and high gain amplifier.

- Accuracy $\pm 2\%$ from 15 cycles to 30 kc.
- $\pm 5\%$ from 30 kc. to 100 kc.
- Input Impedance 1 meg-ohm plus 15 uuf. shunt capacity.
- Amplifier Gain 40000

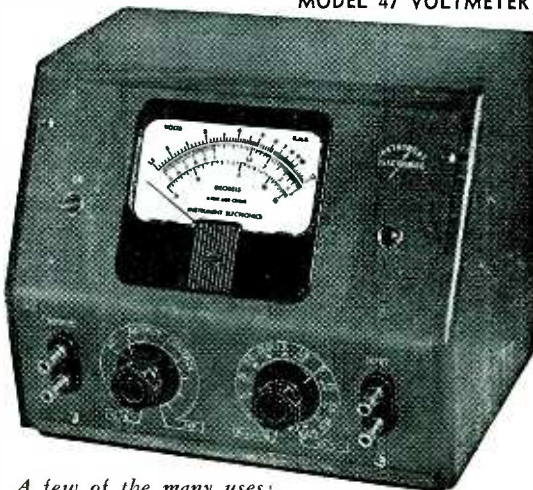

Also MODEL 45
WIDE BAND
VOLTMETER
.0005 to 500 Volts!
5 Cycles 1600 kc.

New! MODEL 49
NARROW BAND
AMPLIFIER

A few of the many uses:

- Output indicator for microphones of all types.
- Low level phonograph pickups.
- Acceleration and other vibration measuring pickups.
- Sound level measurements.
- Gain and frequency measurements for all types of audio equipment.
- Densitometric measurements in photography and film production.
- Light flux measurements in conjunction with photo cells.

Write for Complete Information

Instrument Electronics

45-17 Glenwood Street
LITTLE NECK, L. I., N. Y.

the initiate, not the neophyte; it is written from a very sophisticated point of view, which sometimes gives rigor, but more often serves only to confuse and to slow the absorption of technical material. The nomenclature is often not that familiar to the electronic engineer, but is the language of the physicist or the mathematician. This is not written derogatorily, but is a criticism of a method of attack; the book will be used predominantly by engineers and should, therefore, be written for them, if accuracy is not lost by so doing. A classic example occurs on page 42, where in discussing the indication of equality of two voltages in amplitude, they speak of "the moment of equality of the amplitude of a sinusoidal wave to a parametric voltage". It may be picayune to resent this usage, but "reference voltage" would allow the average engineer to continue reading the next sentence without having to reread the above to make sure that "reference" was really meant.

The book obviously has been put together by people who are extremely conversant with their art—in fact, have contributed many of its fundamental concepts and circuitry. But all who are not as familiar with the field as the authors will use it with some difficulty which should not have been necessary.

Taken in all, however, the book is an absolute must for those who have any connection with the design of electronic circuits.—M. T. LEBENBAUM, *Receiver Section, Airborne Instruments Laboratory, Mineola, N. Y.*

Standard Handbook for Electrical Engineers

ARCHER E. KNOWLTON, *Editor-in-Chief, McGraw-Hill Book Co., Inc., New York, 1949, Eighth Edition, 2,311 pages, \$12.00.*

AS ELECTRICAL ENGINEERING and radio merge more and more in their common meeting ground of industrial electronics, this famous handbook increases in value to the electronic engineer with each new edition.

The 26 sections distinctly show the tremendous strides made since

Developed by
TEL INSTRUMENT
FOR THE
TELEVISION INDUSTRY

New Type 12 CHANNEL R.F. SWEEP GENERATOR

- Instant Channel Selection by Push Button
- Rated for Continuous Service
- Pulse Type Markers at picture and sound carrier frequencies. Either or Both May be Turned On or Off.

No spurious markers produced.
Accuracy 0.02% Xtal controlled.

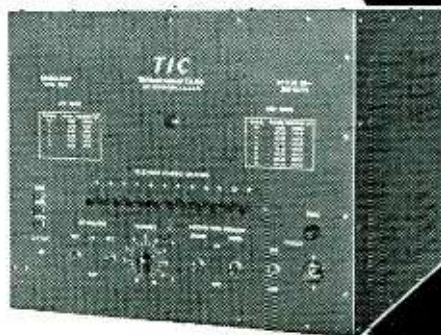

TYPE 1200

Precision Wobblator for television production line. 15 M.C. band width on all channels. Output is oscillator fundamental frequency. Zero signal output reference baseline always present. Output 1v. across 75 ohms. Attenuator range 60 Db. Monitor signal provided.

PRICE \$1330 F.O.B. E. RUTHERFORD, N. J.

Write for Full Data

Tel-Instrument Co. Inc.

50 PATERSON AVENUE • EAST RUTHERFORD, N. J.

LINKING FUNCTION to design with **ADVANCE RELAYS**



Engineers and Designers who insist on dependable components have adapted **ADVANCE RELAYS** into their control circuits. They are specifying **ADVANCE** products, and are submitting their relay problems to us. Our expanded engineering and plant facilities, plus the recognized dependability of **ADVANCE RELAYS**, make it possible for us to offer the most complete line of relays for light, intermediate and heavy duty applications. Proved and Improved relay performance through **ENGINEERED** adaptability.

Follow the Engineers
to **ADVANCE**



ADVANCE ELECTRIC & RELAY CO.
1260 WEST SECOND STREET • LOS ANGELES 26, CALIFORNIA

Lavite **STEATITE GERAMIC**

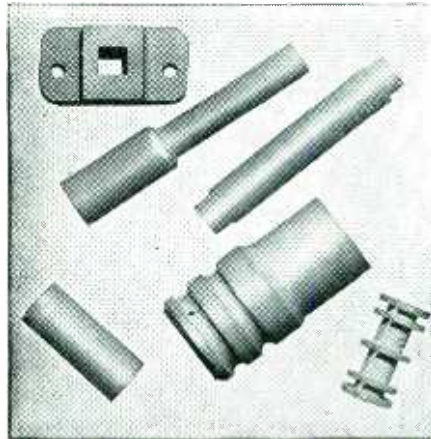

Design engineers and manufacturers in the radio, electrical and electronic fields are finding in **LAVITE** the precise qualities called for in their specifications . . . high compressive and dielectric strength, low moisture absorption and resistance to rot, fumes, acids, and high heat. The exceedingly low loss-factor of **LAVITE** plus its excellent workability makes it ideal for all high frequency applications.

Complete details on request

D. M. STEWARD MFG. COMPANY

Main Office & Works: Chattanooga, Tenn.
Needham, Mass. • Chicago • Los Angeles
New York • Philadelphia

S.S. White **MOLDED RESISTORS**

The
All-Weather
Resistors

ARE USED IN HIGH VOLTAGE "HIPOT" COUPLERS

S.S. White resistors are connected in series to permit a current flow to ground, when the "Hipot" Coupler is used to measure or to synchronize voltage of high voltage lines.

Canadian Line Materials, Ltd.—maker of "Hipot" Couplers and other transmission, distribution and lighting equipment—says—"We have always found S.S. White resistors of the highest quality". This checks with the experience of the many other producers of electrical and electronic equipment who use S.S. White resistors.

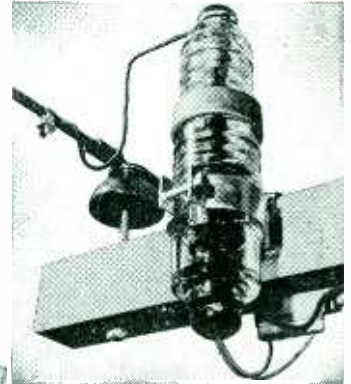

WRITE FOR BULLETIN 4505

It gives details of S.S. White Resistors including construction, characteristics, dimensions, etc. Copy with price list on request.



S. S. WHITE RESISTORS
are of particular interest to all who need resistors with *low noise level* and *good stability* in all climates.

HIGH VALUE RANGE
10 to 10,000,000 Megohms
STANDARD RANGE
1000 Ohms to 9 Megohms

S.S. WHITE INDUSTRIAL DIVISION

THE S. S. WHITE DENTAL MFG. CO. DEPT. R. 10 EAST 40th ST., NEW YORK 16, N. Y.



FLEXIBLE SHAFTS AND ACCESSORIES
MOLDED PLASTICS PRODUCTS—MOLDED RESISTORS

One of America's AAAA Industrial Enterprises

Little thought-of facts about capacitors . . .

The short time breakdown voltage of a well-made D.C. capacitor is not less than 5 to 6 times the actual working voltage at 20°—

$$E = 5 \times e \text{ min}$$

E = Breakdown voltage
e = Rated d.c. working voltage

INDUSTRIAL CAPACITORS are unvaryingly held to this formula.

Designed for maximum safety factor and the smallest possible volume, **INDUSTRIAL CAPACITORS** are the most widely used capacitor in industrial applications.

WRITE TODAY FOR DETAILED CATALOG

INDUSTRIAL CONDENSER CORP.

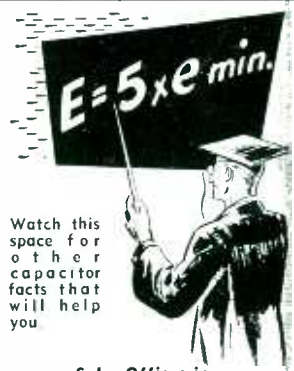

Watch this space for other capacitor facts that will help you

Sales Offices in
All Principal Cities
3243 N. California Ave.
Chicago 18, Illinois

FOR ORIGINALITY

LOOK TO **XCELITE**

Nut Driving, Screwdriving, Reaming In One Kit!



In sturdy new "Hollywood" finish metal box. Has 9 detachable nut driver blades, 7/16 to 1/2" sizes; regular 3/16-9/32" screwdriver blade; 1/4 to 5/16" reamer. **MAN-SIZE XCELITE** combination handle that fits them all! New handle fastener **UNCONDITIONALLY GUARANTEED** one year (patent pending).

Entire kit, only \$9.95 list!

(No. 1, 2 Phillips blades, other reamers, also available).

ASK YOUR SUPPLIER!
Patents Pending on Container and Contents



PARK METALWARE CO., INC.
Dept. C, Orchard Park New York

YOU CAN BE SURE IF IT'S A

GRACOIL
"One Good Turn or a Million"

Transformer

because you *TRY* before you buy . . .
with a **PRODUCTION SAMPLE!**

OPEN TYPE—STRAP MOUNTING

★ For many years, The Gramer Company has engaged in the successful design and quantity production of Gracoil Transformers and Windings, making countless thousands for big name manufacturers in American industry. Such success is due in part to Gracoil's "production sample" method of *testing in advance* for physical and electrical correctness. No guesswork. Try it.

THE PRODUCTION SAMPLE IS YOUR
GUARANTEE OF DEPENDABLE PERFORMANCE!

Write today!

THE GRAMER COMPANY

Electrical Coils and Transformers

2734 N. PULASKI ROAD

CHICAGO 39, ILL., U.S.A.

ESTABLISHED IN 1935

"Gracoil" Transformers include:
Open Types—Step-Down-Up—Fully Enclosed—Line Voltage Regulating—Filament—Audio—Filter Reactors—Isolation—to specifications.

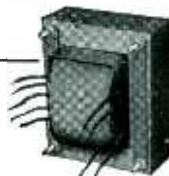

FULLY ENCLOSED

NEW BOOKS

(continued)

publication of the previous edition in 1941, by important new material on radar, microwave techniques, nuclear energy and electronic heating. Revisions and additions throughout bring the book into conformity with newly adopted standards and newly acquired practical working data on the electrical equipment that forms the basis for many industrial electronic controls.

Definitely all-electronic are Section 23—Electronics and Electron Tubes, and Section 24—Radio, Radar and Carrier Communication, by Donald G. Fink, Editor of *ELECTRONICS*, except for six pages on radio interference by M. D. Hoover and eight pages by S. C. Bartlett on electronic applications to power stations. The clear and concise coverage of both theory and practice in all these fields in slightly more than a hundred pages provides optimum reference value for electrical and electronic engineers alike.

The excellent data-filled chapters on conductors, insulating materials and magnetic materials also deserve mention for their all-around usefulness.—J. M.

• • •

Books Received for Review

THE AMPLIFICATION & DISTRIBUTION OF SOUND. By A. E. Greenlees. The Sherwood Press, Pacoima, Calif. (U. S. distributors), Second Edition, 1948, 302 pages, \$6.00. Revision, rearrangement and enlargement of original edition, with minimum mathematics and emphasis on practical considerations of interest to radio servicemen, public address engineers, and radio students. British terminology and equipment, but readily applicable to American practice.

PATENT LAW. By Chester H. Biesterfeld. John Wiley & Sons, Inc., New York. Second Edition, 1949, 267 pages, \$4.00. Extensive revision of 1943 edition to cover recent decisions, with major changes in chapters on Infringement, Disclaimers, Liability for Infringement, Trade Secrets and Double Patenting.

PATENT LAW FOR THE EXECUTIVE AND ENGINEER. By H. A. Toulmin, Jr. Research Press, Inc., Dayton, Ohio, Second Edition, 1948, 231 pages, \$2.95. Revision of 1923 edition, retaining the understandability required by the ordinary business man and nonlegally-inclined engineer who has occasion to obtain, purchase or evaluate a patent, protect himself against infringement suits, or deal with other aspects of the U. S. patent system.

INTRODUCTION TO ATOMIC PHYSICS. By Otto Oldenberg. McGraw-Hill Book Co., Inc., New York, 1949, 373 pages, \$5.00. For college students who have taken a one-year introductory physics course and are familiar with elements of chemistry. Main emphasis is on understanding, as opposed to accepting on authority, to stimulate interest of student and impress him with physical ideas rather than mathematical performance. Main divisions include Structure of Matter, Gases, Structure of Electricity, Structure of Light, Electronic Structure of Atoms, Nuclear Structure and Wave Nature of Matter.

MICROSECOND TIMING! THE NEW

1.6 mc INTERVAL TIMER

(COUNTER CHRONOGRAPH)



...measures and records time intervals with a resolution of **1/1,600,000 seconds**

This instrument determines and indicates directly the elapsed time between electrical "Start" and "Stop" signals derived from the beginning and ending of a time interval to be measured. A 1,600,000 c.p.s. crystal oscillator is used as the time base. The instrument, which is completely self contained, counts the number of cycles from this time base which occurs during the time interval measured. Price \$925.00

High Speed Electronic Counters and Precision Internal Timers for All Applications—Address Inquiries to Dept. 6-D

- ★ Extremely High Accuracy — 1.6 Megacycle crystal oscillator time base.
- ★ Direct Indication of Intervals up to one second — recycling of the counter can be observed or recorded for longer intervals.
- ★ High Resolution measures intervals in steps of 0.625 microsecond.
- ★ Retains Indication of Measurement until reset.
- ★ Easy to Actuate — positive pulses from common or separate sources can be used.
- ★ Stable — no adjustments required.

POTTER INSTRUMENT CO.

INCORPORATED
136-56 ROOSEVELT AVE., FLUSHING, NEW YORK



DUMONT GLASSITE

THE WORLD'S
FINEST TUBULAR
CAPACITORS

NEW TYPE P6M

FINEST MOULDED OIL
CAPACITOR

HIGHLY MOISTUREPROOF

NO HEAT • NO HIGH
PRESSURES • LONG
LIFE ASSURED

COST NO MORE THAN WAX
SEALED CONDENSERS

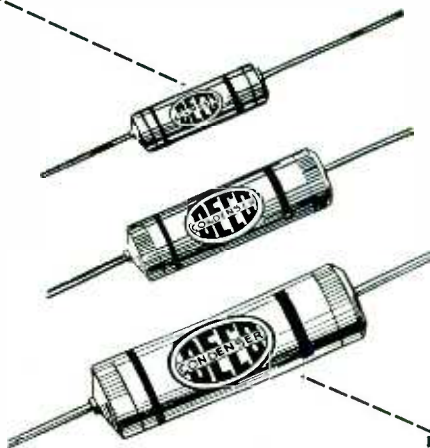

FULL RANGE
FROM .0001 TO
1.0 MFD

FROM 100 VOLTS
TO 15000 VOLTS

Send For Literature And Samples

DUMONT
ELECTRIC CORP.
MEM'S OF
CAPACITORS FOR EVERY REQUIREMENT
306 DYCKMAN ST., NEW YORK, N. Y.

Backtalk

Uhf Television

DEAR SIRs:

T. T. GOLDSMITH'S TALK before the recent IRE convention on the uhf television situation was most interesting. However, I feel that several of his statements are open to serious question. The first is with respect to his answer to a question from the floor concerning the possibility of reducing local oscillator radiation in the uhf band. He stated that there was no way in which this could be done without interfering with other services. I believe my proposal makes his position on this question untenable.

His other statements concerning receiver design are not Class A answers in my opinion. He said that double conversion receivers were not satisfactory due to heterodyne beats between the two local oscillators. Examination of the state of the art indicates that a number of double conversion receivers are in commercial use in which this difficulty has been eliminated. Inasmuch as these receivers have sensitivities of the order of one microvolt it would seem reasonable to assume television receivers could easily be built to avoid this difficulty. I would also like to point out that only two such beat notes can occur in the uhf band if 200 mc is used as the first i-f frequency.

I also believe the following to be Class A facts:

1. The higher the i-f frequency the better the image ratio and image attenuation.

2. Image attenuation must equal cochannel attenuation.

3. The greater the frequency separation between images, the easier allocation becomes and better frequency utilization follows.

4. Before any allocation plan can be made, it will be necessary to standardize on a "first i-f" frequency.

5. To be safe, the use of 40 to 60-mc i-f frequencies will require treatment of the image frequencies of local stations on an adjacent channel basis. Also allocations from 420-475 mc must be given special consideration by FCC. The use of i-f frequencies from 40 to 60 mc also poses some other problems. The use of frequencies below channel 2

NO MORE
BLIND
SOLDERING



THIS
SOLDERING
GUN
SPOTLIGHTS
THE WORK

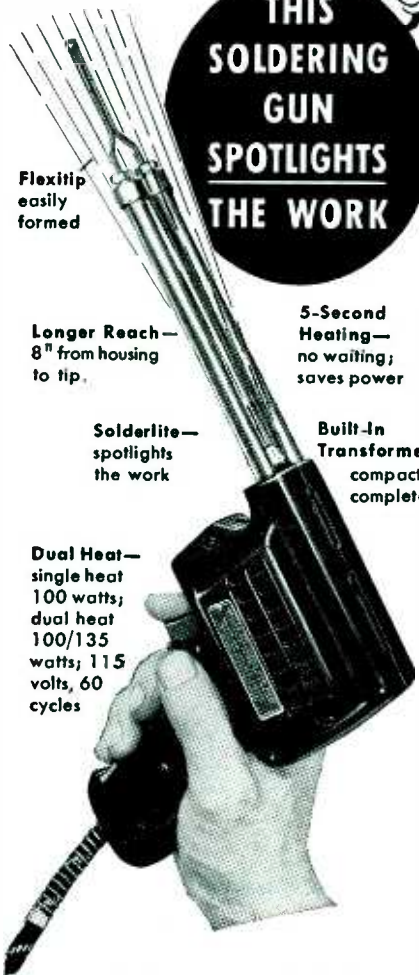

Flexitip
easily
formed

Longer Reach—
8" from housing
to tip.

5-Second
Heating—
no waiting;
saves power

Solderlite—
spotlights
the work

Built-In
Transformer
compact,
complete

Dual Heat—
single heat
100 watts;
dual heat
100/135
watts; 115
volts, 60
cycles

Just pull the trigger switch of your Weller Soldering Gun... heat and light come "on" together. The pre-focused spotlight picks out the work at once—shows you your way to faster, easier soldering.

Time-saver? Yes—but not the only advantage of Weller Soldering Guns. Check the exclusive features illustrated and you'll see what we mean. Solderlite, extra length and 5-second heating mean hours and dollars saved—your Weller Gun will pay for itself in a few months. For electrical and electronic laboratory or maintenance work, we recommend the 8" model DX-8 with dual heat; or 4" types S-107 single heat and D-207 dual heat. See your distributor or send for bulletin direct.



Be sure to get your copy —
SOLDERING TIPS, the new
Weller Handy Guide to
easier, faster soldering—20
pages fully illustrated. Price
10¢ at your distributor's or
order direct.

WELLER
MANUFACTURING COMPANY
806 Packer Street • Easton, Pa.

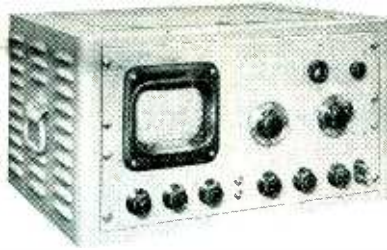

USES

- Ultrasonic Vibration Measurements
- Harmonic Analysis
- Cross Modulation Studies
- Noise Investigations
- Determining Transmission Characteristics of Lines and Filters
- Monitoring Communications Carrier Systems
- Checking Interference, Spurious Modulation, Parasitics, effects of load changes, shock, humidity, component variations, etc. upon frequency stability
- Telemetry

SPECIFICATIONS

Frequency Range: 2KC—300KC, stabilized linear scale
 Scanning Width: Continuously variable from 200KC to zero
 Four Input Voltage Ranges: 0.05V. to 50V. Full scale readings from 1 millivolt to 50 volts
 Amplitude Scale: Linear and two decade log
 Amplitude Accuracy: Within 1db. Residual harmonics suppressed by at least 50db.
 Resolution: Continuously variable. 2KC at maximum scanning width, 500c.p.s. for scanning widths below 8KC.

WRITE NOW For Complete Information, Price and Delivery

Available Now!

Easy, Fast Ultrasonic Spectrum Analysis WITH MODEL SB-7 PANORAMIC ULTRASONIC ANALYZER

An invaluable new direct reading instrument for simplifying ultrasonic investigations, the SB-7 provides continuous high speed panoramic displays of the frequency, amplitude and characteristics of signals between 2KC and 300KC. The SB-7 allows simultaneous observation of many signals within a band up to 200KC wide. Special control features enable selection and highly detailed examination of narrower bands which may contain signals separated by less than 500c.p.s. The instrument is unique in that it provides rapid indications of random changes in energy distribution.



BACKTALK

(continued)

would require double converters with existing receivers. If channel 2 were used as an i-f frequency, receivers close to channel 2 stations would be subject to serious interference problems. The same holds for channels 3 or 4. Oscillator radiation will become a serious problem throughout the uhf band.

6. If an i-f frequency of approximately 200 mc is used, the images fall outside the uhf band. This of course requires discretion on the part of FCC in frequency assignments to other services with relation to local television allocations between 375 mc, 475 mc and 890-1,080 mc. The best image attenuation will be obtained, which should make this relatively easy. The allocation can be made without consideration of image interference between television stations. No local oscillator radiation trouble will be encountered.

The use of channel 12 or 13 (depending on local use) is the only way in which a guarded i-f channel can be obtained without making the uhf allocation subject to consideration of image response on a considerable scale.

While the consideration of the problems outlined above may dwarf the importance of the sound channel, I believe that the use of present tv sound standards in the uhf band is very much a Class C question. The General Electric Company and ourselves are currently working on the problem of afc control on different models of their 1,700-mc receivers used in meteorological work by the Signal Corps. We are not yet in a position to give facts and figures, but should be able to do so in thirty days.

I wonder how many television receiver manufacturers would undertake a government contract to provide receivers with sufficient frequency stability to guarantee audio distortion of 10 percent or less in the uhf band using present tv sound standards. It would appear that frequency stability of the order of 0.001 percent would be required. The public is entitled to reasonable sound quality without continuous retouching of the tuning control. Can this be accomplished at a reasonable cost? The use of an a-m sound channel, possibly with a

ILLINOIS CONDENSER *Presents* A Greatly Expanded Line



Customer acceptance—proven by 15 years of high quality production—has made Illinois condensers one of the fastest sellers in the field. They are reliable, even in the most humid climates . . . they are long lived under brutal heat conditions . . . they are manufactured under the strictest quality control methods in the industry . . . they are backed by a one year guarantee!

From Radio To Television

There is an Illinois condenser to meet every modern need. An expanded line has been developed to serve the entire electronic field—from radio to television. A new and greatly expanded Illinois Condenser catalog is now off press.

Write for your free copy today!



ILLINOIS CONDENSER CO.
1616 NORTH THROOP STREET • CHICAGO 22, ILL.

PROFESSIONAL SERVICES

Consulting—Patents—Design—Development—Measurement

in

Radio, Audio, Industrial Electronic Appliances

THE BARRY CORPORATION

Specialists in the Control of
VIBRATION IMPACT NOISE
*Engineering Development
Manufacturing*
179 Sidney Street Cambridge, Mass.
Telephone: ELIot 0861-0140

S. BERTRAND BARNARD, LL.B., M.E.,

REGISTERED PATENT ATTORNEY
Mechanical, Electronic,
Automotive and Aircraft Patents.
PATENT ANALYSES and INVESTIGATION
29-28 41st Avenue Stillwell 4-5428
Long Island City 1, N. Y.

CROSBY LABORATORIES

MURRAY G. CROSBY & STAFF
*Specializing in FM,
Communications & TV*
Offices, Laboratory & Model Shop at:
126 Old Country Rd. Mineola, N. Y.
Garden City 7-0284

EDGERTON, GERMESHAUSEN & GRIER, Inc.

Consulting Engineers
Research, Development and Manufacture
of Electronic and Stroboscopic Equipment
Specialists in High-Speed Photography
160 Brookline Avenue, Boston 15, Mass.

ELECTRO IMPULSE LABORATORY

Consulting Physicists
Radio Interference and Noise Meters; Interference
Suppression Methods for Ignition Systems and
Electrical Devices.
P. O. Box 250 Red Bank, New Jersey
Red Bank 6-4247

ELECTRO-MECHANICAL RESEARCH INC.

Specialized Research and Manufacture
High and Low Frequency Circuit Development
Electronic Measuring and Test Equipment
Optical and Infra-Red Studies
Special Geophysical Equipment
Automatic Inspection Device
Ridgefield, Conn.

ELECTRONIC ENGINEERING CO. of CALIFORNIA

Radio and Electronic Consulting and
Designing.
2008 W. Seventh St. Los Angeles
D'Rexel 3323 California

The Trend Toward Economy—

The service of the consulting engineer is a real economy. With his knowledge of organization and production problems and his wide and varied experience, he can usually reveal the points of waste and inefficiency that are costing you money and suggest inexpensive means for their elimination.

ERCO RADIO LABORATORIES, INC.

Radio Communications Equipment
Engineering - Design - Development - Production
Pioneers in Frequency Shift Telegraph
Garden City • Long Island • New York

PAUL GODLEY CO.

Consulting Radio Engineers

GREAT NOTCH, N. J.
Est. 1926 Little Falls 4-1000

HANSON-GORRILL-BRIAN INC.

Product & Mfg. Development
ELECTRICAL - ELECTRONIC
HYDRAULIC - MECHANICAL
One Continental Hill Glen Cove, N. Y.
Glen Cove 1922

MEASUREMENT ENGINEERING LIMITED

Consultants on Special Equipment for measurements
and production tests, communications and audio
systems.
Head Office and Plant
Arnprior Canada
60 Front Street West Montreal
Toronto, Canada Canada

Eugene Mittelman, E.E., Ph.D.

Consulting Engineer & Physicist
High Frequency Heating — Industrial Electronics
Applied Physics and Mathematics
549 W. Washington Blvd. Chicago 6, Ill.
State 2-8021

NEWTON ENGINEERING SERVICE

Transformers for Electronics

Designs, prototypes and production quantities to
individual requirements. We offer a highly personal
service and fast delivery on "Breadboard
models".
84 Linden Park Street Highlands 2-1310
Boston 20, Mass. Nights—Holidays LA Salle 7-4959

PICKARD AND BURNS, INC.

Consulting Electronic Engineers

Analysis and Evaluation
of Radio Systems
Research, Development & Design
of Special Electronic Equipment
240 Highland Ave., Needham 94, Mass.

ALBERT PREISMAN

Consulting Engineer

Television, Pulse Techniques, Video
Amplifiers, Phasing Networks,
Industrial Appliances
Affiliated with
MANAGEMENT-TRAINING ASSOCIATES
3308-14th St., N.W. Washington 10, D. C.

PAUL ROSENBERG ASSOCIATES

Consulting Physicists

Main office: Woolworth Building, New York 7, N. Y.
Cable Address Telephone
PHYSICIST Worth 2-1939
Laboratory: 21 Park Place, New York 7, N. Y.

A. F. SMUCKLER & CO., INC.

Electronic and Communication

Engineers and Manufacturers
202-208 Tillary Street Brooklyn 1, N. Y.
ULster 5-5141

SPECTRUM ENGINEERS

Electronic & Mechanical Designers

540 North 63rd St., Philadelphia 31, Pennsylvania
Granite 2-2333; 2-3135

TECHNICAL MATERIEL CORPORATION

Communications Consultants
RADIOTELETYPE • FREQUENCY SHIFT
INK SLIP RECORDING
TELETYPE NETWORKS

453 West 47th Street New York 19, N. Y.

THE
REAL
VALUE

of placing your unusual problem in the hands of a competent consultant is that it eliminates the elements of chance and uncertainty from the problem and provides real facts upon which to base decisions.

Successes: 25,000! Failures: None!

Anchor Plastics' sleeve* and mounting ring* for 16" metal TV tubes—
TESTED and PROVED in SERVICE!!!

*PATS. PENDING

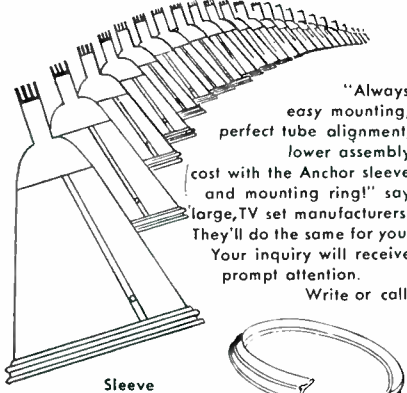

"Always easy mounting, perfect tube alignment, lower assembly cost with the Anchor sleeve and mounting ring!" say large TV set manufacturers. They'll do the same for you! Your inquiry will receive prompt attention.

Write or call.

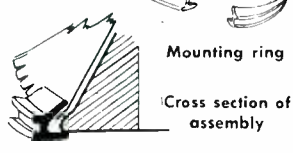

Sleeve

Mounting ring

Cross section of assembly

Custom extruders of all thermoplastics.

ANCHOR PLASTICS CO., Inc.

533-541 Canal St., New York 13, N. Y.

Telephone: Dlgby 9-1242

Address inquiries to Dept. 33

FOR EVERYTHING IN ELECTRONICS

Biggest stock of Radio Parts & Equipment in New York — speedy and courteous attention to your orders — alert salesmen who talk your language.

SOUND

Highest quality, sensibly priced sound equipment for all requirements. Ask for our big free Sound Catalog!

HAM GEAR

Radio amateurs' headquarters for all well-known lines of ham equipment.

TV

Television components, test equipment, tubes, antennas, accessories.

A HURRY?

Phone, wire, write, drop in! Terminal has it!

TERMINAL
RADIO CORPORATION

85 CORTLANDT ST., NEW YORK 7, N. Y.
Phone: WOrth 4-3311 Cable: TERMRADIO

BACKTALK

(continued)

superregenerative audio detector, might prove to be a better answer to this problem. Receiver performance on the sound channel with present vhf standards can be determined easily as it can be computed from the stability of the high-frequency oscillator. I believe television receiver manufacturers should prove their ability to produce the required stability on a mass production basis before present tv round standards are adopted.

DANA A. GRIFFIN

President
Communication Measurements
Laboratory, Inc.
New York, N. Y.

Bugaboos

DEAR SIRs:

I READ with considerable interest the article by A. P. Schreiber of Tracerlab on radioisotopes for industry (p 80, Jan. 1949) and my eye was attracted by the editorial box entitled, "Bugaboos."

Your list is good, but I feel that it is not complete. One major bugaboo that I have come across is the lack of cooperation which I have encountered in obtaining information as to the best isotopes to use in meeting a certain problem, and in developing industrial control equipment using radioactive isotopes. While my experience is very limited, it certainly indicates no desire on the part of the private isotope industry to assist persons who wish to develop industrial control equipment. The reason may be that they want to develop everything themselves, but that is hardly a way of obtaining the maximum progress.

It is probably unfair to generalize on the basis of a single experience. It may be that only one firm has the policy of impeding development by other concerns, but since these firms that distribute the isotopes have a privileged position with a Government Agency, the Atomic Energy Commission, would it not be desirable for that administration to insure and require that firms distributing isotopes also be willing to cooperate and stimulate individual application and that their privileged position be cancelled if they are unwilling to do so.

RAYMOND M. WILMOTTE
Washington, D. C.

BIRTCHEr

STAINLESS STEEL - LOCKING TYPE

TUBE CLAMPS

Stainless Steel

Corrosion Proof



83 VARIATIONS

Where vibration is a problem, Birtcher Locking TUBE CLAMPS offer a foolproof, practical solution. Recommended for all types of tubes and similar plug-in components.

More than three million of these clamps in use.

FREE CATALOG

Send for samples of Birtcher stainless steel tube clamps and our standard catalog listing tube base types, recommended clamp designs, and price list.

THE BIRTCHEr CORPORATION
5087 HUNTINGTON DR. LOS ANGELES 32

Specify GLASS JEWEL BEARINGS

for . . . Low Cost
. . . Long Life



Glass Jewel Bearings by Bird are highly accurate and surprisingly inexpensive. They're ideal for use in ammeters, volt meters, timing instruments, compasses and other instruments where large volume production and low cost must be maintained.

Of special interest to instrument manufacturers is Bird's method of mounting jewels. There's a minimum of stress and strain on the bearing itself as a result of Bird's special mounting technique. It is this special mounting feature which adds so materially to the useful life of Bird Jewel Bearings.

Whenever there's a need for jewel bearings — whether in glass or in sapphire — Bird can supply the right bearing to your specifications. Write today for more information and a quotation.

Sapphire Bearings available in all jewel styles and mountings

Richard H. Bird & Co., Inc.

1 Spruce Street
Waltham 54, Mass.

"Serving Industry with Fine Jewels
Since 1913"

CONTACTS

FOR THE FIELD OF ELECTRONICS

EISLER SPOT WELDERS

SIZES 1/4 TO 300 KVA

FOR ALL TYPES OF WELDING
BUTT-GUN-ARC WELDERS

EISLER

Specializes also in the manufacture of accessories and complete laboratory equipment for electronic and radio tubes, burners, cross fires, torches, vacuum pumps, etc.

Ask For Special Catalog

EISLER ENGINEERING CO., Inc.

CHAS. EISLER, Pres.

751 So. 13 St. (near Avon Ave.) Newark 3, N.J.



FLUXES
SODERING
BRAZING & WELDING
L. B. ALLEN CO. INC. Chicago 31, Ill.
6751 BRYN MAWR AVE.

EL-TRONICS, INC.

Research, development, and manufacture of electronic equipment—a single model to large quantities.

Specialists in Geiger-Muller equipment

2647-67 N. Howard St., Phila. 33, Pa.
Garfield 5-2026

DELIVER

your shipments faster. Save \$600 a year with Marsh Stencil Machines, Brushes, Inks! Electric and Hand Operated machines cut 1/2", 3/4", 1" letters. For sample stencil, Shippers' Handbook, prices, pin this to business letterhead with your name.

MARSH STENCIL MACHINE CO.
45 Marsh Bldg. • Belleville Ill., U. S. A.



NEW!

VITREOUS ENAMELED

ROUND RHEOSTAT

7 SIZES 50 TO 500 WATT

PROMPT SHIPMENTS

WRITE FOR CATALOG



SLIDE CONTACT
RHEOSTATS
AND
RESISTORS
6 SIZES—120 DIFF. LIMITS

REX RHEOSTAT CO.

BALDWIN, L. I., N. Y.

LOCKING TYPE
Stainless Steel

TUBE CLAMPS

Send for illustrated catalog and engineering data
THE GEORGE S. THOMPSON CORPORATION
South Pasadena, California

FINE RIBBONS
OF
TUNGSTEN and MOLYBDENUM
Quality and accuracy in our fabrication of Tungsten & Molybdenum Ribbons have characterized our service to the Electronic Industry.
A development of
H. CROSS Co.
15 Beekman St., New York 7, N.Y.

EISLER

SPECIALIZES IN EQUIPMENT FOR THE
COMPLETE MANUFACTURE OF

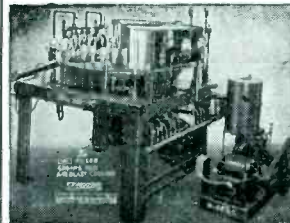

36-Head Radio Tube Exhausting Machine.

Incandescent
and
Fluorescent
Lamps,
Luminous
Neon Signs,
Radio, Cathode
Ray, Television
and Electronic
Tubes of All
Sizes

Transformers of All Types

IN SIZES FROM 1/4 TO 300 KVA

For
Lighting
Power
Welding
Phase
Changing
Auto
Testing

Special
Transformers
For Electronic
Devices

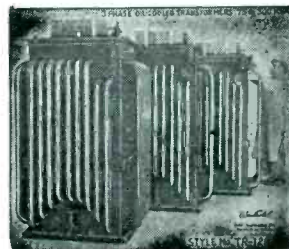

EISLER ENGINEERING CO. Inc.

751 So. 13th St.

Newark 3, N. J.

MICROMETER FREQUENCY METER

FM or AM, 100 KC to 175 MC

LAMPKIN LABORATORIES, INC.
Bradenton, Fla., U. S. A.

will
monitor
any number
of frequencies,

PRINTED CELLOPHANE

Colorful - Self Adhesive - Cellophane, processed in Rolls. Easy to buy - Easy to apply - used for Packaging - Point of Sale advertising - Parts marking and Aircraft Wire terminal identification.

TOPFLIGHT TAPE - YORK, PA.

This CONTACTS Section

supplements other advertising in this issue with these additional announcements of products essential to efficient and economical production and maintenance. Make a habit of checking this page, each issue.

Classified Advertising Division
ELECTRONICS

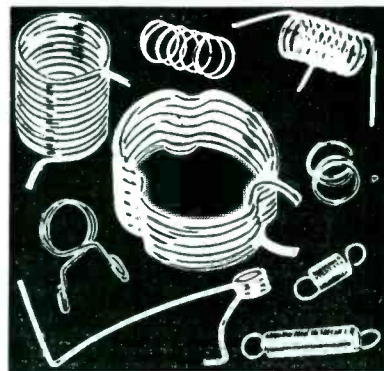

Antenna Coils, Grid Clips, Dial Cord Springs and Precision Springs of all types pertaining to Radio and Television.

Your Inquiries Invited

WEBSTER SPRING CORPORATION

176 Johnson St., U.L. ster 5-3156-7-8, Brooklyn 1, N. Y.

ONLY THE EICO MODEL 400 5" 'SCOPE...

... has
BOTH
big
features*

\$69.95



*Lowest Price
*Laboratory Precision

When COST is a factor, and QUALITY is essential—specify EICO Model 400. Not a kit, but a fully-wired, laboratory-quality 5" oscilloscope of the most advanced design and construction. Widely used in production, research, service, and education. Write for folder 5-E. Also available in kit form, complete... \$39.95

ELECTRONIC INSTRUMENT CO., INC.

276 Newport Street • Brooklyn 12, N. Y.

SEARCHLIGHT SECTION

EMPLOYMENT • BUSINESS • OPPORTUNITIES • EQUIPMENT—USED or RESALE

UNDISPLAYED RATE:

\$1.20 a line, minimum 4 lines to figure advance payment count 5 average words as a line.

INDIVIDUAL EMPLOYMENT WANTED undisplayed advertising rate is one-half of above rate, payable in advance.
PROPOSALS \$1.20 a line an insertion.

INFORMATION:

BOX NUMBERS in care of any of our New York, Chicago or San Francisco offices count 1 line additional in undisplayed ads.

DISCOUNT of 10% if full payment is made in advance for four consecutive insertions of undisplayed ads (not including proposals).

DISPLAYED—RATE PER INCH

The advertising rate is \$10.25 per inch for all advertising appearing on other than a contract basis. Contract rates quoted on request.

AN ADVERTISING INCH is measured $\frac{7}{8}$ inch vertically on one column, 3 columns—30 inches—to a page.

NEW ADVERTISEMENTS received by June 1st will appear in the July issue, subject to limitation of space available.

RESEARCH OPPORTUNITIES AT WESTINGHOUSE IN TELEVISION

Physicists and electronic engineers needed for an extensive project at the Westinghouse Research Laboratories in Pittsburgh. Excellent opportunities for specialists in electron-optical devices, optics, systems and circuits.

For application write Manager, Technical Employment

Westinghouse Electric Corp., 306 Fourth Ave., Pittsburgh, Pa.

ELECTRONIC ENGINEERS PHYSICISTS

"A leading Electronics Company in Los Angeles, California offers permanent employment to persons experienced in advanced research and development. State qualifications fully."

P 6606 Electronics
68 Post St., San Francisco 4, Calif.

REPLIES (Box No.): Address to office nearest you
NEW YORK: 330 W. 42nd St. (18)
CHICAGO: 520 N. Michigan Ave. (11)
SAN FRANCISCO: 68 Post St. (4)

SELLING OPPORTUNITY OFFERED

SALESMAN EXPERIENCED in selling in electronic field. Mechanical interest and knowledge of stamping small metal parts desirable. Preferable age 30-45 years. Must have car. Salary and expense basis. Excellent opportunity with well established New England manufacturer. Write details to SW-8723, Electronics.

EMPLOYMENT SERVICES

SALARIED POSITIONS \$3,500-\$35,000. If you are considering a new connection communicate with the undersigned. We offer the original personal employment service (39 years recognized standing and reputation). The procedure, of highest ethical standards, is individualized to your personal requirements and develops overtures without initiative on your part. Your identity covered and present position protected. Send only name and address for details. R. W. Bixby Inc., 278 Dun Bldg., Buffalo 2, N. Y.

EXECUTIVES \$3,000-\$25,000. This reliable service, established 1927, is geared to needs of high grade men who seek a change of connection under conditions assuring, if employed, full protection to present position. Send name and address only for details. Personal consultation invited. Jira Thayer Jennings, Dept. E, 241 Orange St., New Haven, Conn.

EMPLOYMENT AGENCY

OPENINGS! BROADCAST—TV (1st fone lic.); Design, Sales, Crystal, Research, Tube Development, Recording, EEs, Electronic Technicians—Engineers—Today—Consult: RRR—Radio-TV Employment Bureau, Box 413, Philadelphia.

POSITIONS WANTED

ELECTRICAL ENGINEER and Biologist, designer of AMA accepted equipment, seeks association with research institution, hospital or manufacturer. Seven years experience in biological, chemical, nuclear and electronic instrument design, power generation and distribution. Five years director of medical electrical equipment corporation. B.S. Mass. Inst. of Tech. 1936. Married. PW-8733, Electronics.

SERVOMECHANISMS AND Instrumentation Engineer. Now employed as project engineer supervising 35 men. BS MS in EE. Eight years' experience in planning and directing the research and development of servos, control systems, gyros, and computers. Patent and technical publications in these fields. PW-8851, Electronics.

WANTED PATENTABLE IDEAS

A reliable transformer company is looking for patentable ideas on transformers to manufacture.

1122 W. Catalpa Avenue
Chicago 40, Illinois

Electronic Engineers

BENDIX RADIO DIVISION

Baltimore, Maryland
manufacturer of

RADIO AND RADAR EQUIPMENT

requires:

PROJECT ENGINEERS

Five or more years experience in the design and development, for production, of major components in radio and radar equipment.

ASSISTANT PROJECT ENGINEERS

Two or more years experience in the development, for production, of components in radio and radar equipment. Capable of designing components under supervision of project engineer.

Well equipped laboratories in modern radio plant . . . Excellent opportunity . . . advancement on individual merit.

Baltimore Has Adequate Housing

Arrangements will be made to contact personally all applicants who submit satisfactory resumes. Send resume to Mr. John Siena:

BENDIX RADIO DIVISION

BENDIX AVIATION CORPORATION
Baltimore 4, Maryland



ENGINEERS

TELEVISION EQUIPMENT CORPORATION offers an unusual opportunity for qualified engineers to participate in the growth of the rapidly expanding Industrial Television field.

Experience in video, pulse, electronic display and circuit techniques with good educational background required. Several positions are available ranging from junior to project engineers.

Compensation is commensurate with ability. Opportunity to participate in company profit sharing plan.

Apply by letter to Leonard Mautner, Vice President:

TELEVISION EQUIPMENT CORP.
238 William St. New York, 7, N. Y.

SCIENTISTS AND ENGINEERS

Wanted for interesting and professionally challenging research and advanced development in the fields of microwaves, radar, gyroscopes, servomechanisms, instrumentation, computers and general electronics. Scientific or engineering degrees or extensive technical experience required. Salary commensurate with experience and ability. Direct inquiries to Mgr., Engineering Personnel, Bell Aircraft Corporation, P. O. Box 1, Buffalo 5, N. Y.

SAVE RESEARCH TIME BY CONSULTING
The Indispensable Bibliographical Reference
**ELECTRONIC ENGINEERING
MASTER INDEX**
Descriptive Literature on Request
ELECTRONICS RESEARCH PUBL. CO.,
2 W. 46th St., N. Y. 19

Time is money. Save it by referring to our
**ACCUMULATIVE INDEX FOR
ELECTRONICS BIBLIOGRAPHY**
Simple and dependable
Write for descriptive literature
TECHNICAL INDEX SERVICE
Box 632 Asbury Park, New Jersey

WANTED

WANTED, AIRCRAFT RADIOS
AN/ART-13, BC-348, RTA-1B, AN/APN-9, R5A/
ARN-7, AN/ARC-1, AN/ARC-3, BC-788-C, I-152,
NN-26, Test Sets with TS- or I- prefix, Dyna-
motors, Control Boxes, Transmitters, Receivers,
Power Supplies, etc. State quantity, condition and
best price first letter.
HI-MU ELECTRONICS
Box 105, New Haven, Conn.

WANTED

Teletypewriters complete, components or
parts. Any quantity and condition.
W-6654, Electronics
330 West 42nd Street, New York 18, N. Y.

WANTED TO BUY
Western Electric CF-1, CF-2, CF-3, CF-4,
CF-5, CF-6, H, H-1 Carrier, EE100, EE101A
ringing equipments. All models teletype.
All models RCA Marine transmitters. All
W.E. C.B. switchboards.
W-8591, Electronics
520 North Michigan Ave., Chicago 11, Ill.

WILL BUY ALL
BC-348, 28V or 11V modified
Price \$60.00 all letters except "Q"—"Q"
\$75.00. Ship via express C.O.D. subject to
inspection to
H. FINNEGAN
49 Washington Avenue, Little Ferry, N. J.

WANTED
WESTERN ELECTRIC VACUUM TUBES
Types 101F, 102F, 272A, 274A or B, 310A
or B, 311A, 313C, 323A, 328A, 329A, 348A,
349A, 352A, 373A, 374A, 393A, 394A, 121A
Ballast Lamps.
W-6641, Electronics
330 West 42nd St., New York 18, N. Y.

SELL YOUR
COMMUNICATION RECEIVER
TRANSMITTER
TEST EQUIPMENT and TOOLS
for highest cash offer
Send details to:
OVERBROOK COMPANY
Overbrook, Massachusetts

**Additional
Wanted
Advertising
on Page 250**

The continued expansion of the
NATIONAL UNION RESEARCH DIVISION
has created many fine positions for men interested in
VACUUM TUBE RESEARCH

Our laboratories are devoted entirely to research and development work on vacuum tubes. These include cathode ray, microwave, receiving, radial beam, subminiatures, and various special tube types. We are in a position to offer an interesting job, a stable future, and ideal working conditions to men who are qualified. Men with vacuum tube or similar experience and with degrees in Physics or Engineering are needed at the present time. Recent graduates without experience but with degrees in Physics or Electrical Engineering, as well as tube or circuit technicians, are invited to apply.

Before you decide on your future connection, be sure to look into the opportunities National Union has to offer.

Send Resume To: **Divisional Personnel Manager,
National Union Research Division
350 Scotland Road, Orange N. J.**

**PROJECT
ENGINEERS**

Real opportunities exist for Graduate Engineers with design and development experience in any of the following: Servomechanisms, radar, microwave techniques, microwave antenna design, communications equipment, electron optics, pulse transformers, fractional h.p. motors.

Send complete resume to employment office.

**SPERRY
GYROSCOPE CO.**
Division of the Sperry Corp.
GREAT NECK, LONG ISLAND

Engineers Wanted
MOTOROLA INC.

Location Phoenix, Arizona. Housing Available. Excellent working conditions in winter resort climate and summer air conditioned laboratory. Motorola Inc. announces the organization of a Research Laboratory in Phoenix devoted to armed service contract and company research in microwave, mobile communications, supervisory control, telemetering, miniaturization, and aviation electronics. Only fully qualified experienced inventors, engineers and scientists should apply. Send detailed statement of education and experience in first letter addressed to

D. E. NOBLE
4545 Augusta Boulevard Chicago 51, Ill.

**RADAR, COMMUNICATIONS
AND
SONAR TECHNICIANS
W-A-N-T-E-D
For Overseas Assignments**

Technical Qualifications:

- At least 3 years practical experience in installation and maintenance
- Navy veterans ETM 1/c or higher.
- Army veterans TECH/SGT or higher.

Personal Qualifications:

- Age, over 22—must pass physical examination.
- Ability to assume responsibility.
- Must stand thorough character investigation.
- Willing to go overseas for 1 year.

Base pay, Bonus, Living Allowance, Vacation add-up to \$7,000.00 per year. Permanent connection with company possible,

**Apply by Writing to
A-1, P. O. Box 3414,
Philadelphia 22, Pa.**

Men qualified in RADAR, COMMUNICATIONS or SONAR give complete history. Interview will be arranged for successful applicants.

SEARCHLIGHT SECTION

1.25 CENTIMETER PLUMBING

- "K" BAND FEEDBACK-TO-PARABOLA HORN with pressurized window.....\$30.00
- MITRED ELBOW cover to cover.....\$4.00
- TR/ATR SECTION choke to cover.....\$4.00
- FLEXIBLE SECTION 1" choke to choke.....\$5.00
- ADAPTER, rd. cover to sq. cover.....\$5.00
- MITRED ELBOW and S sections choke to cover.....\$4.50
- WAVEGUIDE 1/2" x 1/4" per foot.....\$1.00
- K BAND CIRCULAR FLANGES.....\$0.50

MISCELLANEOUS

- DEHYDRATING UNIT, 60 lb. capacity, 115 v. 60 cy. operation, 2" x 22" x 15", new and complete.....\$425.00
- F129 SPP-2. COAX WAVETRIP.....\$12.50

PULSE EQUIPMENT

PULSE TRANSFORMERS

- G.E.K.-2745.....\$39.50
- G.E.K.-2744-A 10 KV High Voltage, 2 KV Low Voltage @ 200 KV oper. (270 KW max.) 1 microsec. or 1/4 microsec. @ 600 PPS.....\$39.50
- W.E. #D166173 Hi-Volt input transformer, W.E. Impedance ratio 50 ohms to 900 ohms. Freq. range: 10 kc to 2 mc. 2 sections parallel connected, potted in oil.....\$36.00
- W.E. KS #800 Input Transformer, winding ratio between terminals 3-5 and 1-2 is 1:1:1, and between terminals 6-7 and 1-2 is 2:1. Frequency range: 380-520 c.p.s. Permalloy core.....\$6.00
- G.E. #K2731 Repetition Rate: 635 PPS, Pri. Imp: 50 Ohms. Sec. Imp: 450 Ohms. Pulse Width: 1 Microsec. Pri. Input: 9.5 KV PK. Sec. Output: 28 KV PK. Peak Output: 800 KW. Rilar: 2.75 Amp. \$64.50
- W.E. #D169271 Hi Volt input pulse Transformer \$27.50
- G.E. K2450A. Will receive 13KV. 4 micro-second pulse on pri., secondary delivers 14KV. Peak power out 100KW G.E.....\$4.50
- G.E. #K2748A. Pulse Input, line to magnetron.....\$36.00
- #9280 Utah Pulse or Blocking Oscillator XFMR. Pre-limits 790-810 cy-3 windings turns ratio 1:1:1 Dimensions 1 13/16 x 1 1/4" 19/32.....\$1.50

PULSE NETWORKS

- 15A-1-400-50: 15 KV, "A" CKT. 1 microsec., 400 PPS, 50 ohms imp.....\$42.50
- G.E. #6E3-5-2000-50P2T, 6KV, "E" circuit, 3 sections, 5 microsecond, 2000 PPS, 50 ohms impedance.....\$6.50
- G.E. #3E (3-84-810; 8-2-24-405) 50P4T; 8KV, "E" CKT. Dual Unit, Unit 1, 3 Sections, .84 microsec., 810 PPS, 50 ohms imp.; Unit 2, 8 Sections, 2.24 microsec., 405 PPS, 50 ohms imp.....\$6.50
- 7.5E3-1-200-67P. 7.5 KV, "E" Circuit, 1 microsec., 200 PPS, 67 ohms impedance, 3 sections.....\$7.50
- 7.5E4-16-60-67P. 7.5 KV, "E" circuit, 4 sections, 16 microsec., 60 PPS, 67 ohms impedance.....\$15.00
- 7.5E3-3-200-67P. 7.5 KV, "E" Circuit, 3 microsec., 200 PPS, 67 ohms imp., 3 sections.....\$12.50

DELAY LINES

- D-168184: .5 microsec. up to 2000 PPS, 1800 ohm term.....\$4.00
- D-170499: .25/.50/.75. microsec. 8 KV, 50 ohms imp.....\$16.50
- D-165997: 1/4 microsec.....\$7.50

MODULATOR UNIT BC 1203-B

- Provides 200-4000 PPS. Sweep time: 100 to 2,500 microsec. in 4 steps fixed mod. pulse, suppression pulse, sliding modulating pulse, blanking voltage, marker pulse, sweep voltages, calibration voltages, etc. Operates 115 vac, 50-60 cy. Provides various types of voltage pulse outputs for the modulation of a signal generator such as General Radio #804B or #804C used in depot bench testing of SCR 685, SCR 595, and SCR 535. New as shown.....\$125.00
- MIT. MOD. 3 HARD TUBE PULSER: Output Pulse Power: 114 KW, 12 KV at 12 amp. Duty Ratio: .001 max. Pulse duration: 5, 1.0, 0.2 microsec. Input voltage: 115 v. 400 to 2400 cps. Uses 1-715-B, 1-829-B, 3-72's, 1-73. New.....\$410.00
- APQ-13 PULSE MODULATOR. Pulse Width .5 to 1.1 Micro Sec. Rep. rate 624 to 1348 Pps. Pk. pwr. out 35 KW. Energy 0.018 Joules.....\$49.00
- TPS-3 PULSE MODULATOR. Pk. power 50 amp. 24 KV (1200 KW pk); pulse rate 200 PPS, 1.5 microsec.; pulse line impedance 50 ohms. Circuit—series charging version of DC Resonance type. Uses two 705-A's as rectifiers. 115 v. 400 cycle input. New with all tubes.....\$49.50
- APS-10 MODULATOR DECK. Complete, less tubes.....\$75.00
- APS-10 Low voltage power supply, less tubes.....\$18.50

BIRTCHEr TUBE CLAMPS

- 926-A, 926-B5, 928-A2, 926-T33,
- 926-B, 926C, 926-B1, @ 124 ea.

OTHER TYPES AVAILABLE

TUNABLE PKGD. "CW" MAGNETRONS

- QK 61 2975-3200 mc. QK 62 3150-3375 mc.
- QK 60 2800-3025 mc. QK 59 2675-2900 mc.
- New, Guaranteed.....Each \$65.00



MICROWAVE PLUMBING 10 CENTIMETER

- WAVEGUIDE directional coupler, 27 db. Navy type CABY-47AAN, with 4 in. slotted section.....\$42.50
- SQ. FLANGE to rd choke adapter, 18 in. long OA 1 1/2 in. x 3 in. guide, type output and sampling probe 1 1/4" x 5/8".....\$32.00
- "S" BAND CRYSTAL MOUNT, gold plated, with 2 type "N" connectors.....\$12.50

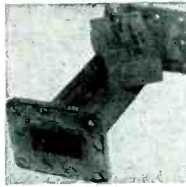

- PICKUP LOOP, Type "N" Output.....\$2.75
- TR BOX Pickup Loop.....\$1.25
- POWER SPLITTER, 726 Klystron input, dual "N" output.....\$5.00
- MAGNETRON TO WAVEGUIDE coupler with 721-A duplex cavity, gold plated.....\$27.50
- 10 CM WAVEGUIDE SWITCHING UNIT, switches 1 input to any of 3 outputs. Standard 1 1/2" x 3" guide with square flanges. Complete with 115 vac or d.c. arranged switching motor. Mfg. Raytheon. CRP 24AAS. New and complete.....\$150.00
- 10 CM. END-FIRE ARRAY POLYRODS.....\$1.75 ea.
- "S" BAND Mixer Assembly, with crystal mount, pickup loop, tunable output.....\$3.00
- 721-A TR CAVITY WITH TUBE. Complete with tuning plungers.....\$12.50
- 10 CM. McNALLY CAVITY Type SG.....\$3.50
- WAVEGUIDE SECTION, MC-445A, rt. angle bend, 5 1/2 ft. OA 8" slotted section.....\$21.00
- 10 CM. OSC. PICKUP LOOP, with male Homedell output.....\$2.00
- 10 CM. DIPOLE WITH REFLECTOR in lucite ball, with type "N" or Sperry fitting.....\$4.50
- 10 CM. FEEDBACK DIPOLE antenna, in lucite ball, for use with parabola 7/8" Rigid Coax Input.....\$8.00



7/8" RIGID COAX.—3/8" I. C.

- RIGHT ANGLE BEND, with flexible coax output pickup loop.....\$8.00
- SHORT RIGHT ANGLE bend, with pressurizing nipple.....\$3.00
- RIGID COAX to flex coax connector.....\$3.50
- STUB-SUPPORTED RIGID COAX, gold plated 5' lengths. Per length.....\$5.00
- RT. ANGLES FOR ABOVE.....\$2.50
- RT. ANGLE BEND 15" L. OA.....\$3.50
- FLEXIBLE SECTION, 15" Male to female.....\$4.25
- MAGNETRON COUPLING to 7/8" rigid coax with TR pickup loop, gold plated.....\$7.50

7/8" RIGID COAX.—1/4" I. C.

- 7/8" RIGID COAX, BEAD SUPPORT per ft.....\$1.20
- SHORT RIGHT ANGLE BEND.....\$2.50
- ROTATING JOINT, with deck mounting.....\$15.00
- RIGID COAX slotted section CU 60/AP.....\$5.00

MAGNETRONS

Tube	Freq. Range	Pk. Pwr. Out.	Price
2J31	2820-2860 mc.	265 KW.	\$25.00
2J21-A	9345-9405 mc.	50 KW.	\$25.00
2J22	3267-3333 mc.	265 KW.	\$25.00
2J26	2992-3019 mc.	275 KW.	\$25.00
2J27	2965-2992 mc.	275 KW.	\$25.00
2J32	2780-2820 mc.	285 KW.	\$25.00
2J37			\$45.00
2J38 Pkg.	3249-3263 mc.	5 KW.	\$35.00
2J39 Pkg.	3267-3333 mc.	87 KW.	\$35.00
2J40	9305-9325 mc.	10 KW.	\$65.00
2J49	9000-9160 mc.	58 KW.	\$85.00
2J34			\$55.00
2J61	3000-3100 mc.	35 KW.	\$65.00
2J62	2914-3010 mc.	35 KW.	\$65.00
3J31	24,000 mc.	50 KW.	\$55.00
5J30			\$39.50
718DY			\$25.00
720BY	2800 mc.	1000 KW.	\$50.90
720CY			\$50.00
725-A	9345-9405 mc.	50 KW.	\$25.00
730-A	9345-9405 mc.	50 KW.	\$25.00
728 A, Y, BY, CY, DY, EY, FY, GY			\$50.00
700 A, B, C, D			\$50.00
706 A, Y, B, Y, EY, FY, GY			\$50.00
Klystrons, 723A/B \$12.50; 707B W/Cavity 417A \$25.00; 2K41			\$20.00 \$65.00

MAGNETRON MAGNETS

Gauss	Pole Diam.	Spacing	Price
4850	3/4 in.	3/4 in.	\$12.50
5200	21/32 in.	3/4 in.	\$17.50
1300	1 1/4 in.	1 5/16 in.	\$12.50
1860	1 1/4 in.	1 1/4 in.	\$14.50

3 CENTIMETER PLUMBING



(STD. 1" x 1/2" GUIDE, UNLESS OTHERWISE SPECIFIED)

- TRANSITION: 1" x 1/2" to 1 1/4" x 5/8" 11 in. L.....\$8.00
- "X" BAND PREAMPLIFIER, consisting of 2-723A/B local oscillator-beacon feeding waveguide and TR/ATR Duplexer sect. incl. 60 mc. IF amp.....\$47.50
- RANDOM LENGTHS of waveguide, 6 in. to 18 in. long.....\$1.10/ft.
- WAVEGUIDE RUN, 1 1/4" x 5/8" guide, consisting of 4 ft. section with rt. angle bend on one end and 2" 45 deg. bend other end.....\$8.00
- WAVEGUIDE SECTION, 1 1/4" x 5/8" choke to choke, 4 ft. long.....\$10.00
- "X" BAND pressurizing gauge section, with 15-lbs. gauge pressurizing nipple.....\$18.50
- 45 DEG. TWIST, 6" Long.....\$16.00
- 12" SECTION, 45 deg. twist, 90 deg. bend.....\$10.00
- 11" STRAIGHT WAVEGUIDE section choke to cover. Special heavy construction, silver plated.....\$4.50
- 15 DEG. BEND 10" choke to cover.....\$4.50

5 FT. SECTIONS choke to cover. Silver Plated \$14.50

- 18" FLEXIBLE SECTION.....\$17.50
- "E" and "H" PLANE BENDS.....\$12.50
- BULKHEAD FEED THRU.....\$15.00
- "X" BAND WAVEGUIDE, 1 1/4" x 5/8" OD, 1/10" wall, aluminum.....\$5.75
- WAVEGUIDE, 1 1/2" ID, per ft.....\$1.50
- TR CAVITY for 724-A TR tube.....\$3.50
- 3" FLEX SECTION, square flange to circular flange adapter.....\$7.50
- 724 TR tube (41-TR-1).....\$2.50
- SWR MEAS. SECTION, 4" L with 2 type "N" output probes MTD full wave apart. Bell size guide, silver plated.....\$10.00
- ROTARY JOINT with slotted section and type "N" output pickup.....\$17.50
- WAVEGUIDE SECTION, 12" long choke to cover 45 deg. twist & 2 1/4" radius, 90 deg. bend.....\$4.50
- SLUG TUNER/ATTENUATOR. V.E. guide, gold plated.....\$6.50
- TR/ATR DUPLEXER section with iris flange.....\$8.00
- TWIST 90 deg. 5" choke to cover, w/press nipple.....\$6.50
- WAVEGUIDE SECTIONS 2 1/2 ft. long, silver plated with choke flange.....\$5.75
- WAVEGUIDE, 90 deg. bend E plane, 18" long.....\$4.00
- ROTARY JOINT, choke to choke.....\$17.50
- ROTARY JOINT, choke to choke, with deck mounting.....\$5.50
- S CURVE WAVEGUIDE, 8" long cover to choke.....\$3.50
- DUPLEXER SECTION for 1B24.....\$10.00
- CIRCULAR CHOKE FLANGES, solid brass......55
- SQ. FLANGES, FLAT BRASS.....ea. .55
- APS-10 TR/ATR DUPLEXER section with additional iris flange.....\$10.00
- FLEX. WAVEGUIDE.....\$4.00/Ft.
- 723 A/B Klystron Mount shielded, on X Band Guide w/rough attenuator output.....ea. \$75.00



MASTER OSCILLATOR UNITS

M.O. units designed for oper 2-18 mc TBK. Flexible plug in units using type 800 tube in ECO circuit. Tunes 2000 to 4565 kc in 6 bands. Freq. Determining elements are enclosed in shock mounted oven assembly, and has frq monitor PU link coupled to output. Net Wt: 138 Lbs. Dim: 21 in. D x 14 1/2 in. W x 25 1/2 in. H. New (with tube).....\$150.00

MICROWAVE ANTENNAS

- APS-15 Antennas. New.....\$99.50
- AN MPG-1 Antenna. Rotary feed type high speed scanner antenna assembly, including horn parabolic reflector. Less internal mechanisms, 10 deg. sector scan. Approx 12L x 4W x 3H. Unused.....\$250.00 (Cost—\$450.00)
- APS-4 3 cm antenna. Complete, 1 1/2" dish. Cutler feed dipole directional coupler, all standard 1" x 1/2" waveguide. Drive motor and gear mechanism for horizontal and vertical scan. New, complete.....\$65.00
- AN/TPS-3. Parabolic dish type reflector approx. 10' diam. Extremely lightweight construction. New, in 3 carrying cases.....\$89.50
- RELAY SYSTEM PARABOLIC REFLECTORS: approx. range: 2000 to 6000 mc. Dimensions: 4 1/4" x 5" rectangle, new.....\$85.00
- TDY "JAM" RADAR ROTATING ANTENNA, 10 cm. 30 deg. beam, 115 v.a.c. drive. New.....\$100.00
- SO-13 ANTENNA, 2 1/4" dish with feedback dipole 360 deg. rotation, complete with drive motor and selsyn. New.....\$120.00
- Used.....\$45.00
- DBM ANTENNA. Dual, back-to-back parabolas with dipoles. Freq. coverage 1,000-4,500 mc. No drive mechanism.....\$65.00
- AS125/APR Cone type receiving antenna, 1000 to 3200 megacycles. New.....\$4.50
- 140-600 MC. CONE type antenna, complete with 25" sectional steel mast, guys, cables, carrying case, etc. New.....\$49.50
- ASD 3 cm. antenna, used, ex. cond.....\$49.50

COMMUNICATIONS EQUIPMENT COMPANY

CABLE ADDRESS: COMSUPO
PHONE DIGBY 5, 4124
131 LIBERTY ST. DEPT. E
NEW YORK 7, N. Y.

C.E.C. MONEY BACK GUARANTEE, 3 MIN. ORDER.
F.O.B. N.Y.C. SEND MONEY ORDER CHECK, ONLY SHIPPING CHARGES SENT C.O.D.

SEARCHLIGHT SECTION



932 PHOTOTUBE

This tube is a gas phototube having 5-1 response, particularly sensitive to red and near infrared radiation. Can be used with incandescent light source. Send for data. PRICE\$1.25

GREAT TUBE VALUES

01-A	\$4.45	12K8Y	\$4.65	843	\$3.59
1B26	4.85	12SF7	.49	880	15.00
2C21	.69	12SR7	.72	881	40.00
2C22	.69	15P	1.40	874	1.95
2J21-A	25.00	28D7	.75	876	4.95
2J22	25.00	30 (Spec.)	.70	1005	.35
2J26	25.00	45 (Spec.)	.59	1819	.21
2J27	25.00	39/44	.49	1824	.35
2J31	25.00	35/51	.72	289	.35
2J32	25.00	227A	3.85	1961	5.00
2J38	35.00	225	8.80	9002	.65
2J39	35.00	268-A	20.00	9004	.47
2J55	35.00	355-A	19.50	CRQ 72	1.95
2J40	65.00	417A	25.00	EF 50	.79
2J49	85.00	530	90.00	GL 62	20.00
3J31	55.00	331	45.00	PC 258A	165.00
2X2/879	6.92	3.95	GL 532	7.50	
3BP1	2.25	559	4.00	FC 271	40.00
2C24	.60	562	90.00	GL 562	75.00
3C30	.70	615	.89	GL 623	75.00
3D3	.79	703-A	7.00	GL 697	75.00
3CP1	3.50	704-A	3.75	VL 100	60.00
3D21-A	1.50	705-A	2.85	QK 59	65.00
3DP1	2.25	1707-B	20.00	QK 60	65.00
3EP1	2.95	714AY	25.00	QK 61	65.00
3FP7	1.20	715-B	12.00	QK 62	65.00
3Q5	.79	720Y	50.00	QK 63	65.00
5BP1	1.95	720Y	50.00	VR 31	1.00
6BP4	4.95	721-A	3.60	VR 130	1.25
5CP1	3.75	723-A/B	12.50	VR 137	1.25
5FP7	3.50	724B	1.75	VU 120	1.00
5J30	39.50	725-A	25.00	VU 134	1.00
6G7	2.00	726-A	15.90	WN 150	4.75
6SC7	3.00	727	2.25	WN 150	4.75
7C4	1.00	801-A	1.10	WT 260	5.00
7E5	1.00	804	9.95		
7E8	.72	815	2.50		
10Y	.60	836	1.15		
12A6	.35	837	1.95		

RELAYS

Con- Type	tacts	Rating	Res. Coil	Mfg	Price
H	DPDT	24-28V (8A) vdc	170 ohms	GECCR2791B 100F3	\$1.75
H	SPDT	28 vdc	175 ohms	GECCR2791B	1.25
H	3PDT	24-28 vdc	175 ohms	GECCR2791B	1.75
H	4PST	24 vdc	180 ohms	Allied BOX-3	1.75
G	DPDT	12 vdc	44 ohms	Leach 1087-	1.45
G	SPST		490		
G	DPDT	22-28 vdc	160 ohms	Leach	1.25
D	SPST	28 vdc	250 ohms	Allied BO48	1.39
I	DPST	14 vdc	85 ohms	Price X20-A	1.50
D	3PDT	24-28 vdc	280 ohms	Allied BOX-3	3.00
H	SPST	24-28 vdc	2490	GM 12917-1	2.00
D	DPDT	24 vdc	280	Allied BO635	2.00
D	3PDT	26 vdc	280	Allied KS	1.10
D	DPDT	28 vdc	280	Allied BO	2.10
D	SPST	75MA	60	Allied KS	1.10
H	DPDT	20-30 vdc		Onuce 50XB	2.00
H	DPDT	10 14 vdc		Onuce 100AB	2.00
H	DPDT	24-28 vdc		PB21C057-A	1.75
H	3PDT	24-28 vdc		GECCR2791	2.00
H	SPDT	24-28 vdc		GECCR2791	1.75
A	DPDT	12 vdc		Onuce	2.40
A	DPDT	(6A)		CX3190	
A	SPDT	10-12V 60 cy	125	Allied CX2120	2.40
H	DPDT	27.5 vdc	400	Allied	1.10
D	DPDT	24 vdc	400	Allied	1.10
H	DPDT	24V60cy	50	Allied	1.40

ARC 3 MINIATURE RELAYS

Sealed Can SPDT 5 Prong.	GECCR2791C104	2.25			
C	SPDT	28 vdc	300 ohms	RBM55342	45¢
C	DPST				
C	6 PST	22-28 vdc	300 ohms	RBM55528	45¢
C	SPST	22-28 vdc	300	RBM55521	45¢
C	DPDT	22-28 vdc	300	RBM55531	45¢
C	DPST				
C	SPDT	22-28 vdc	300	RBM55526	45¢

RADAR SETS

RC 145 IFF SET. Consists of RC 1267 xmtr-rcvr. remote antenna controller and indicator I-221, power supply RA 105-A. 1 kw. pulse oscillator operates on 154-186 mc. Operates from 117 v., 60 cy. New \$190.00

SN RADAR-GE. low power, 5 and 25 miles ranges. Uses GL446 as pulsed oscillator, 5" "A" scope, "S" band. Extremely compact, ideal for demonstration and laboratory work. 115V 60C operation. Used. Excel. cond. \$600.00

SE 10 CM SURFACE SEARCH RADAR, W.E., 20,000 to 80,000 vds. range. 250 KW. pk. power input to 706 magnetron. Thyatron modulator, variable pulse rate. Complete set including spare parts, tubes, waveguide and fittings. Send for price and additional information.

R857PL-I RADAR RCVR. Sperry.....\$85.00

COMMUNICATIONS EQUIPMENT for your needs COMPANY



UPRIGHT OIL CAPACITORS

STANDARD BRANDS

Fig.	Mfd	Voltage	Terminals	Price
B	.25	600VDC	2	35¢ 3 for \$1.00
E	.25	400VDC	2	39¢ 3 for 1.10
E	.5	600VDC	2	35¢ 3 for 1.00
E	.1	600VDC	2	39¢ 3 for 1.10
D	2x.5	600VDC	3	49¢ 3 for 1.45
B	3x.1	600VDC	3	55¢ 2 for 1.05
B	.25	400VDC	2	39¢ 3 for 1.10
B	.5	600VDC	2	35¢ 3 for 1.00
B	.5	600VDC	2	35¢ 3 for 1.00
E	1	400VDC	2	35¢ 3 for 1.00
B	.1	400VDC	2	40¢ 2 for 75¢
B	.4	600VDC	2	39¢ 3 for 1.10
D	2x.1	600VDC	2	50¢ 2 for 85¢
B	1.75	400VDC	2	35¢ 3 for 1.00
B	.5	600VDC	2	35¢ 3 for 1.00
D	3x.1	600VDC	3	55¢ 2 for 1.05
D	2x.5	600VDC	3	49¢ 2 for 1.05
B	.1	600VDC	2	45¢ 2 for 85¢
B	.1	600VDC	2	45¢ 2 for 85¢
D	.1	600VDC	2	45¢ 2 for 85¢
B	.1	600VDC	2	45¢ 2 for 85¢

Send for Lists of Other Values



H. V. MICAS

Fig.	Mfd	Voltage	Price
D	.01	1200VVDC	50¢ 2 for 95¢
E	.00025	2500TVDC	29¢ 2 for 55¢
D	.00004	2500VVDC	39¢ 2 for 75¢
E	.000047	2500VVDC	39¢ 2 for 75¢
E	.002	500VVDC	25¢ 4 for 95¢
C	.002	3000VVDC	\$1.05 2 for \$2.00
C	.3	2000VVDC	1.50 2 for 2.90
C	.00003	2000VVDC	49¢ 2 for 95¢
C	.00009	3000VVDC	75¢ 2 for 1.45
C	.00082	3000VVDC	1.00 2 for 1.95
C	.002	3000VVDC	1.00 2 for 1.95
C	.005	3000VVDC	1.65 2 for 3.25
C	.0004	9000VVDC	1.50 2 for 2.95
C	.0006	3000VVDC	1.00 2 for 1.95
C	.0008	3000VVDC	95¢ 2 for 1.85
E	.0016	3000VVDC	65¢ 2 for 1.25
E	.000090	3000VVDC	40¢ 2 for 75¢
B	.05	1500VVDC	10.00 2 for 19.50
B	.05	2000VVDC	12.00 2 for 23.50
B	.045	2000VVDC	12.00 2 for 23.50
B	.00015	20KVDC	24.00 2 for 47.50
B	.0001	20KVDC	24.00 2 for 47.50
B	.002	15KVDC	19.00 2 for 37.50
C	.006	2500VVDC	1.45 2 for 2.85
E	.00027	3000VVDC	35¢ 2 for 65¢

Send for Lists of Other Values

400 CYCLE TRANSFORMERS

352-7273:	Pri: 115 v. 400 cy. Sec: 6.3 v. 2.5 amp; 6.3 v. .06 amp; 6.3 v. .3 amp; 5 v. 6 amp; 700 vct	\$4.75
352-7176:	Pri: 115v. 400 cy. Sec: 6.3 v. 20 amp; 6.3 v. .5 amp; 6.3 v. .5 amp; 320 v (2-6X3's). For APS-15.	\$5.25
352-7278:	Pri: 115 v. 400 cy. Sec: 2.5 v. 1.75 amp; 3500 v (2X2). For APS-15. T203, (Anode #2 5FP7)	\$5.85
352-7070:	Pri: 118 v. 440 cy. Sec: 2.5 v. 2.5 amp; 2.5 v. 2.5 amp (2000 v. ins.); 6.3 v. 2.5 amp; 1200 v. tapped at 1000 and 750 v. D/O AN/APS 15.	\$4.95
#7469105:	Pri: 115 v. 400 cy. Sec: Tapped to give 742.5 v. 50 ma; 709 v. .0477 amp; 671 v. .045 amp	\$2.95
M-7474319:	Pri: 115 v. 400 cy. Sec: 6.3 v. 2.7 amp; 6.3 v. 60 amp; 6.3 v. 21 amp	\$2.95
32332:	Pri: 115 v. 400-2400 cy. Sec: 400 vct, 35 ma; 6.3 v. 2.5 amp; 6.4 v. 15 amp	\$2.25
332-7138M:	Pri: 115 v. 400-2400 cy. Sec: 640 v. .5 ma; 2.5 v. 1.75 amp.	\$3.85
352-7179:	Pri: 115 v. 400-2400 cy. Sec: 6.5 v. 12 amp ct; 250 v. 100 ma; 5 v. 2 amp.	\$3.50
#9069:	Pri: 115/80 v. 400-2600 cy. Sec: 650 vct, 50 ma; 6.3 vct, 2 amp; 5 vct, 2 amp.	\$2.15
352-7096:	Pri: 115/80 v. 400-2400 cy. Sec: 2.5 v. 1.75 amp; 3 KV ins; 5 v. 3 amp; 6.5 v. 6.5 amp; 6.5 v. 1.2 amp	\$3.95
KS 9607:	Pri: 115 v. 400-2400 cy. Sec: 734 vct, 177 ma. 1710 vct, 177 ma.	\$3.95
D-166353:	Pri: 115 v. 400-2400 cy. Sec: 6.3 v. 0.9 amp; 7.7 v. 0.365 amp	\$2.79
#GE #7471957:	Pri: 100/110/120/130 v. 400-2400 cy. Sec: 2.5 v. 20 amp, HV ins.	\$4.65
D-163254:	Pri: 115 v. 400 cy. Sec: 6.3 v. 12 amp; 6.3 v. 2 amp; 6.3 v. 1 amp. P/O AN/APQ-5.	\$5.85
KS-9665:	Pri: 115 v. 400-2400 cy. Sec: 6.4 vct, 7.5 amp; 6.4 v. 3.8 amp; 6.4 v. 2.5 amp.	\$4.35
PLATE XFMR:	Pri: 115 v. 400 cy. Sec: 9800 v. or 8000 v. @ 32 ma dc.	\$12.50
#12033:	Plate Xfmr. Pri: 115 v. 800 cy. Sec: 4550 vct, 230 ma	\$7.95

WRITE TO C.E.C. FOR YOUR 400 CYCLE NEEDS



BATHTUB CAPACITORS

Fig.	Mfd	Voltage	Terminals	Price
D	3x.1	600VDC	3	33¢ 4 for \$1.29
E	3x.1	400VDC	3	33¢ 4 for 1.29
E	.1	400VDC	2	20¢ 6 for 95¢
C	2x.1	600VDC	3	28¢ 3 for 85¢
E	.025	600VDC	2	18¢ 5 for 85¢
E	.2	400VDC	2	40¢ 2 for 75¢
C	.1	600VDC	2	25¢ 4 for 95¢
C	2x.25	600VDC	3	29¢ 3 for 85¢
A	.5	1000VDC	2	45¢ 3 for 1.30
D	.1	600VDC	2	25¢ 4 for 95¢
E	.5	200VDC	2	20¢ 5 for 1.00
E	.05	600VDC	2	21¢ 5 for 1.00
E	.5	600VDC	2	25¢ 4 for 95¢
E	.5	120VDC	2	18¢ 5 for 85¢
E	.1	600VDC	2	20¢ 5 for 95¢
E	.4	60VDC	1	25¢ 4 for 95¢
E	.1	400VDC	2	25¢ 4 for 95¢
D	1	600VDC	2	30¢ 3 for 75¢
C	3x.1	600VDC	3	33¢ 4 for 1.29
D	2x.25	400VDC	3	27¢ 4 for 1.05
E	.5	600VDC	2	25¢ 4 for 95¢
D	2x.1	600VDC	3	29¢ 3 for 85¢
D	.5	200VDC	1	20¢ 3 for 95¢
E	2x.1	200VDC	2	20¢ 5 for 95¢
C	.5	400VDC	1	20¢ 5 for 95¢
A	1	100VDC	2	15¢ 7 for 1.00
A	.02	1500VDC	2	45¢ 2 for 85¢
C	.5	600VDC	2	25¢ 4 for 95¢
E	.5	200VDC	2	20¢ 5 for 95¢
E	.4	50VDC	2	30¢ 3 for 85¢
E	.2	50VDC	2	25¢ 4 for 95¢

Write for Lists of Other Values

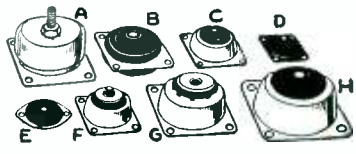

SHOCK MOUNTS

D	Lord	#1	1 1/4x1 1/4x3/8H	10¢
D	Lord	#6	1 1/4x1 1/4x3/8H	10¢
D	Lord	#5	1 1/4x1 1/4x3/8H	10¢
D	B	#4	3/4x1 3/4x5/8H	15¢
B	Lord	#12	1 3/4x1 3/4x9/16H	15¢
B	Lord	#35	2 1/4x2 1/4x1 1/2H	18¢
G	U. S.	#5150-C	2 3/8x2 3/8x1 1/8H	55¢
F	Lord	#4	1 23/32x1 23/32x1/4H	35¢
C	Lord	#10	1 11/16x1 11/16x3/4H	14¢
C	Lord	#8	2 3/8x2 3/8x1 1/16H	25¢
C	Lord	#8	2 3/8x2 3/8x1 1/16H	20¢
H	Lord	#35	3x3x1 1/2H	45¢
H	Lord	#20	3x3x1 5/8H	39¢
H	Lord	#25	3x3x1 5/8H	45¢
H	Harrite	#55	3x3x1 5/8H	49¢
H	Lord	#15	3x3x1 1/2H	35¢
H	Lord	#45	3x3x1 1/2H	49¢
A	Barry	#C2070	3x3x1 1/2H	

SAVE

**BRAND NEW
GUARANTEED**

A. C. MOTORS

5071930, Delco, 115 volts, 60 cycle, 7000 R. P. M.

Price \$4.50 each net.

36938-2, Haydon Timing Motor, 110 Volts, 60 Cycle, 2.2 Watts, 4/5 R. P. M.

Price \$3.00 each net.

Haydon Timing Motor—110 V. 60 cycle 3.2 Watts, 4 R. P. M., with brake.

Price \$4.00 each net.

45629R Haydon Timing Motor, 110 volts, 60 cycle, 2.2 watts, 1/240 R. P. M.

Price \$3.15 each net.

36938-3, Haydon Timing Motor, 110 volts, 60 cycle, 2.2. Watts, 1 1/5 R. P. M.

Price \$3.15 ea. net

Eastern Air Devices Type J33 Synchronous Motor 115 V., 400 cycle, 3 phase, 8,000 R. P. M.

Price \$8.50 each net.

Telechron Synchronous Motor, Type B3, 115 volts, 60 cycle, 2 R. P. M., 4 watts.

Price \$5.00 each net.

SERVO MOTORS

CK1, Pioneer, 2 phase, 400 cycle.

Price \$10.00 each net.

CK2, Pioneer, 2 phase, 400 cycle.

Price \$4.50 each net.

FPE-25-11, Diehl, Low-Inertia, 75 to 115 V., 60 cycle, 2 phase.

Price \$16.00 each net.

FP-25-2, Diehl, Low-Inertia, 20 volts, 60 cycle, 2 phase.

Price \$9.00 each net.

FP-25-3, Diehl, Low-Inertia, 20 volts, 60 cycle, 2 phase.

Price \$9.00 each net.

CK2, Pioneer, 2 phase, 400 cycle, with 40:1 reduction gear.

Price \$6.50 ea. net

MINNEAPOLIS HONEYWELL TYPE B Part No. G303AY, 115 volts, 400 cycle, 2 phase, built-in gear reduction, 50 in lbs. torque.

Price \$7.50 each net.

PIONEER REMOTE INDICATING MAGNESYN COMPASS SET.

Type AN5730-2 Indicator and AN5730-3 Transmitter 26 volts, 400 cycle.

Price \$40.00 per set new sealed boxes

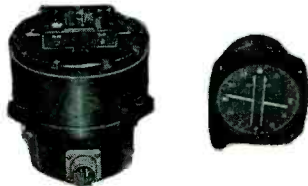

GYROS

Schwein Free & Rate Gyro type 45600. Consists of two 28 volt D. C. constant speed gyros. Size 8" x 4.25" x 4.25".

Price \$10.00 each net.



Schwein Free & Rate Gyro, type 46800. Same as above except later design.

Price \$11.00 each net.

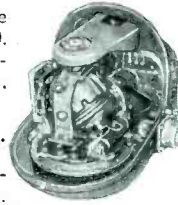

Sperry A5 Directional Gyro Part No. 656029, 115 volts, 400 cycle, 3 phase.

Price \$17.50 each net.

Sperry A5 Vertical Gyro. Part No. 644841, 115 volts, 400 cycle, 3 phase.

Price \$20.00 each net.

Sperry A5 Amplifier Rack Part No. 644890. Contains Weston Frequency Meter. 350 to 450 cycle and 400 cycle, 0 to 130 voltmeter.

Price \$8.00 each net.

Sperry A5 Control Unit Part No. 644836.

Price \$7.50 each net.

Sperry A5 Azimuth Follow-Up Amplifier Part No. 656030. With tube.

Price \$5.50 each net.

Pioneer Type 12800-1-D Gyro Servo Unit. 115 volts, 400 cycle, 3 phase.

Price \$8.00 each net.

Norden Type M7 Vertical Gyro. 26 volts D. C.

Price \$19.00 each net.

Norden Type M7 Servo Motor. 26 volts D. C.

Price \$20.00 each net.

General Electric Type 8672162 Azimuth Gyro Assembly Contains Delco Type 5067125 Constant speed motor and Signal assembly.

Price \$12.75 each net.

Allen Calculator, Type C1. Bank and Turn indicator, Part No. 21500, 28 Volts, D.C. Contains 28V. D.C. constant speed gyro.

Price \$10.00 ea. net

D.C. MOTORS

Jaeger Watch Co. Type 44-K-2 Contactor Motor, Operates on 3 to 4.5 volts D.C. Makes one contact per second.

Price \$2.00 ea. net

General Electric Type 5BA10AJ 52C, 27 volts D.C., 0.65 amps., 14 oz. in torque, 145 R. P. M. Shunt Wound, 4 lead reversible.

Price \$4.70 ea. net

D. C. MOTORS



5069625, Delco Constant Speed, 27 volts, 120 R. P. M. Built-in reduction gears and governor.

Price \$3.90 each net. A-7155, Delco Constant Speed Shunt Motor, 27 volts, 2.4 amps., 3600 R. P. M., 1/30 H. P. Built-in governor.

Price \$6.25 each net.

C-28P-1A, John Oster Shunt Motor, 27 volts, 0.7 amps., 7000 R. P. M., 1/100 H. P.

Price \$3.75 each net.

D.C. ALNICO FIELD MOTORS

5069456, Delco, 27.5 V., 10,000 RPM.

Price \$4.70 each net.

5069600, Delco, 27 V., 250 R. P. M.

Price \$4.50 each net.

5069466, Delco, 27 V., 10,000 R. P. M. Price \$3.00 each net.



5069370, Delco, 27 V., 10,000 R. P. M. Price \$4.70 each net.

5067125, Delco, 27 V., 10,000 R. P. M. With Governor. Price \$6.50 each net.

S. S. FD6-16, Diehl, 27 V., 10,000 R. P. M. Price \$3.75 each net.

S. S. FD6-18, Diehl, 27 V., 10,000 R. P. M. Price \$3.75 each net.

S. S. FD-6-21, Diehl, 27 V., 10,000 R. P. M. Price \$3.75

Sampsel Time Control Inc. Alnico Field Motor, 27 Volts D.C. Overall length 3-5/16" by 1-3/8". Shaft 5/8" long by 3/16", 10,000 RPM.

Price \$4.50 each net.

GENERAL ELECTRIC D.C. SELSYNS



8TJ9-PDN Transmitter, 24 volts.

Price \$3.75 each net.

8DJ11-PCY Indicator, 24 volts. Dial marked -10° to +65°.

Price \$4.00 each net.

8DJ11-PCY Indicator, 24 volts. Dial marked 0 to 360°.

Price \$7.50 each net.

AMPLIFIER

Pioneer Gyro Flux Gate Amplifier, Type 12076-1-A.

Price \$17.50 ea. net, with tubes

COMPLETE LINE OF AIRCRAFT THERMOCOUPLES

INSTRUMENT ASSOCIATES

Write for complete listings

U. S. Export License-2140

147-57 41st AVENUE FLUSHING, N. Y.
Telephone INdependence 3-1919

SAVE

**BRAND NEW
GUARANTEED**

INVERTERS

Wincharger Corp. Dynamotor Unit. PE-101-C. Input 13, V.D.C. or 26 V.D.C. AT. 12.6 or 6.3 Amps. Output 400 V.D.C. AT. .135 Amps., 800 V.D.C. AT. .02 Amps., 9 V.A.C. 80 Cycle at 1.12 Amps. Price \$10.00 each net

153F, Holtzer Cabot. Input, 24 volts D. C. Output 115 volts, 400 cycle 3 phase, 750 V. A. and 26 volts 400 cycle, 1 phase, 250 V. A., Voltage and frequency regulated also built in radio filter.



Price \$115.00 each net.

12117-2, Pioneer. Input 24 volts D. C. Output 26 volts, 400 cycle, 6 V. A.

Price \$20.00 each net.

NG750, Wincharger, PU 16. Input 24 volts D. C. Output 115 volts, 400 cycle, 1 phase, 6.5 amps. Voltage and frequency regulated.

Price \$40.00 each net.

149H, Holtzer Cabot. Input 28 volts at 44 amps. Output 26 volts at 250 V. A. 400 cycle and 115 volts at 500 V. A. 400 cycle. Price \$39.00 each net.

149F, Holtzer Cabot. Input 28 volts at 36 amps. Output 26 volts at 250 V. A. 400 cycle and 115 volts at 500 V. A. 400 cycle.

Price \$35.00 each net.

12117, Pioneer. Input 12 volts D. C. Output 26 volts, 400 cycles, 6 V. A.

Price \$22.50 each net.

5D21NJ3A General Electric. Input 24 volts D. C. Output 115 volts 400 cycle at 485 V. A.

Price \$12.00 each net.

WESTON FREQUENCY METER

Model 637, 350-450 cycle, 115 volts.

Price \$10.00 each net.

WESTON VOLTMETER

Model 833, 0 to 130 volts. 400 cycle.

Price \$4.00 each net.

ALL PRICES, F.O.B. FLUSHING, N. Y.

PIONEER AUTOSYNS

AY1, 26 volts, 400 cycle. Price \$5.50 each net.
Ay 14D, 26 volts, 400 cycle, new with calibration curve. Price \$15.00 each net.
AY20, 26 volts, 400 cycle. Price \$7.50 each net.



AY31, 26 volts, 400 cycle. Shaft extends from both ends. Price \$10.00 each net.

AY38, 26 volts, 400 cycle. Shaft extends from both ends. Price \$10.00 each net.

PIONEER PRECISION AUTOSYNS

AY101D, new with calibration curve. PRICE—WRITE OR CALL FOR SPECIAL QUANTITY PRICES
AY131D, new with calibration curve. Price \$35.00 each net.



PIONEER TORQUE UNITS

Type 12602-1-A. Price \$30.00 each net.
Type 12604-3-A. Price \$30.00 each net.
Type 12606-1-A. Price \$40.00 each net.
Type 12627-1-A. Price \$80.00 each net.



MAGNETIC AMPLIFIER ASSEMBLY

Pioneer Magnetic Amplifier Assembly Saturable Reactor type output transformer. Designed to supply one phase of 400 cycle servo motor. Price \$8.50 each net.

PIONEER TORQUE UNIT AMPLIFIER

Type 12073-1-A, 5 tube amplifier, Magnesyn input, 115 volts, 400 cycle. Price \$17.50 each net with tubes.
Type 12077-1-A, single tube Amplifier, Autosyn input, 115 volts, 400 cycle. Price \$49.50 each net with tube.

BLOWER ASSEMBLY

MX-215/APG
John Oster, 8 volt D. C. 7000 R. P. M. 1/100HP. Price \$2.90 each net.
Westinghouse Type, FL Blower, 115 volts, 400 cycle, 67000 R. P. M., Air-flow 17 C. F. M. Price \$4.50 ea. net.

RATE GENERATORS



PM2, Electric Indicator Company, .0175 V. per R. P. M.

Price \$8.25 each net.

F16, Electric Indicator Company, two-phase, 22 V. per phase at 1800 R. P. M. Price \$12.00 each net.

J36A, Eastern Air Devices, .02 V. per R. P. M. Price \$9.00 each net.

B-68 Electric Indicator Co., Rotation Indicator, 110 volts, 60 cycle, 1 phase. Price \$14.00 each net.

SINE-COSINE GENERATORS (Resolvers)

FPE 43-1, Diehl, 115 volts, 400 cycle. Price \$20.00 each net.
FJE 43-9, Diehl, 115 volts, 400 cycle. Price \$20.00 each net.

SYNCHROS

If Special Repeater, 115 volts, 400 cycle. Will operate on 60 cycle at reduced voltage.



Price \$15.00 each net.

7G Generator, 115 volts, 60 cycle. Price \$30.00 each net.

6DG Differential Generator, 90-90 volts, 60 cycle. Price \$15.00 each net.

2J1M1 Control Transformer 105/63 Volts, 60 cycle. Price \$20.00 each net.

2J1G1 Control Transformer, 57.5/57.5 volts, 400 cycle. Price \$1.90 each net.

2J1H1 Selsyn Differential Generator, 57.5/57.5 volts, 400 cycle. Price \$3.25 each net.

2J5S1 Selsyn Differential Generator, 105-105 volts, 60 cycle. Price \$15.50 each net.

W. E. KS-5950-L2, Size 5 Generator, 115 volts, 400 cycle. Price \$3.50 each net.

5G Special, Generator 115/90 volts, 400 cycle. Price \$15.50 each net.

5SF Repeater, 115/90 volts, 400 cycle. Price \$19.00 each net.

2J1F1 Selsyn Generator, 115 volts, 400 cycle. Price \$3.50 each net.

1CT Control Transformer, 90/55 volts, 60 cycle. Price \$25.00 ea. net

Write for complete listings

Western Union Address: WUX Flushing, N. Y.

147-57 41st AVENUE FLUSHING, N. Y.
Telephone INdependence 3-1919

INSTRUMENT ASSOCIATES



NEW LOW PRICES!

ALL BRAND NEW
STANDARD BRAND

MINIMUM ORDER \$5.00
QUANTITY PRICES ON REQUEST

WATCH THIS LISTING EACH MONTH FOR LATEST CHANGES

Type	Price	Type	Price	Type	Price	Type	Price	Type	Price	Type	Price	Type	Price
1B22	\$4.95	12HP7	14.95	841	.69	KK33	.98	304	.88	6SF5GT	.72	12X3	.98
1B23	9.50	15E	1.50	843	.69	KK34	.59	305GT	.98	6SH7	.80	12Z3	.88
1B24	4.95	15R	1.50	845/W	4.95	KK39	1.75	384	.80	6SG7	.80	14A7/12B7	.88
1B25A	4.95	23D4	.49	851	75.00	KK59	3.95	3V4	.80	6SH7	.39	14AF7/XXD	.88
1B27	4.95	24G	.98	860	3.00	KK60	.79	5A24	.50	6SJ7	.66	14B6	.88
1B29	4.95	45T	4.95	861	49.95	KK68	24.95	5R4GY	1.15	6SJ7GT	.66	14B8	.88
1B32	4.95	45SPEC	4.95	864	.49	KK72	1.95	5U4	1.28	6SK7	.66	14C5	.88
1B36	4.95	75TL	3.95	865	2.98	KK77	3.95	5V4G	.96	6SL7GT	.96	14E6	.72
1B38	49.50	100TH	12.95	866A	.99	RX120	10.00	5W4	1.06	6SNGT	.88	14E7	.88
1B40	4.95	100TS	3.00	866JR	1.19	SD8J9	4.95	5W4	1.06	6SNT	.60	14E7	.88
1B69	4.95	114A	1.25	869B	75.00	T205	1.50	5W4GT	.60	6SR7	.72	14F7	.88
1B73	1.95	117C	1.25	872A	2.95	T35	3.95	5X4G	.72	6SR7GT	.72	14F8	1.06
1S21	1.96	120	5.95	874	2.49	T200	10.95	5Y3GT	.42	6SRT	.60	14G7	.88
2AP1	3.95	121A	2.65	878	2.49	TZ20	1.50	5Y4G	.72	6SRT	.88	14H7	.88
2B4	.98	203A	16.95	884	1.49	TZ40	2.95	5Z3	1.06	6SRT	.88	14I7	.88
2C4	1.18	205B	4.50	885	.98	UH50	5.95	6A3	1.28	6SV7	.88	14J7	.88
2C2	.98	211	.98	891	110.00	V70D	6.95	6A6	1.06	6SV7	.88	14K7	.88
2C22	.28	215A	3.00	892	175.00	VR75	.98	6A7	.80	6U/5G5	.72	14L7	.88
2C26A	.98	217C	7.30	897	7.95	VR78	.75	6A8	.80	6U6GT	.72	14M7	.88
2C34	.59	218	49.50	904	9.95	VR90	.95	6BGT	1.49	6U7G	.72	14N7	.88
2C40	1.98	221A	2.95	905	11.95	VR91	11.95	6B5/6N5	.88	6V6	1.28	19T8	1.56
2C43	7.50	231D	1.49	923	.98	VR105	.98	6AB7/1853	1.06	6V6GT	.80	19T8	1.56
2C44	1.75	242C	6.95	925	1.40	VR150	.75	6AC5GT	1.16	6V7G	.88	22A	.88
2C46	7.50	249C	3.49	931A	4.95	VT127A	3.00	6AC7/1852	1.16	6X1	.60	25A6	1.06
2D21	1.18	250R	7.95	954	.98	VU111	1.19	6AD6	.88	6X3GT	.96	25A6GT	1.06
2E22	1.50	250TH	19.50	954A	.98	ZB120	6.95	6AD7G	1.28	6Y6	.88	25AC5GT	1.16
2E24	4.95	252A	19.50	955	.75	WL468	14.95	6AF6	1.25	6Z7G	1.28	25L6GT	.66
2E25	4.25	250TL	4.95	956	.75	WL532A	4.95	6AG5	1.06	6Z7G	1.28	25Y5	1.16
2E26	3.95	254	19.95	957	.75	WL562	150.00	6AG7	1.28	7A4/XXL	.72	25Z5	.60
2E30	2.99	259A	4.95	958A	.75	WL616	105.00	6AH6	1.56	7A5	.99	25Z6GT	.60
2J21A	12.95	262A/B	3.50	959	2.95	Z225	1.95	6A15	.99	7A6	.72	26	.72
2J26	8.95	274A/B	1.25	991	.75	ZP47/12DP8	14.95	6AK6	.96	7A7	.72	28D7	.39
2J31	10.95	282A/B	4.95	1608	4.95	0A3/VR75	.98	6AL5	.80	7AD7	1.06	30	.39
2J32	13.95	290A	4.95	1611	.98	0A4C	1.06	6AL7GT	1.06	7AF7	.72	31	.39
2J33	24.95	291A	4.95	1613	.75	0B2	2.05	6AO5	.80	7AG7	.88	32L7GT	1.28
2J34	24.95	294A	4.95	1614	1.75	0B3/VR90	.75	6AO6	.72	7AH7	.88	32L7GT	1.28
2J37	17.95	304B	6.95	1619	.75	0C3/VR105	.75	6AO7GT	.88	7B4	.72	33	.72
2J38	13.95	304TH	6.95	1620	1.49	0D3/VR150	1.75	6AS7G	4.95	7B5	.72	34	.38
2J49	24.95	304TL	1.49	1622	1.75	0Y4	.88	6AT6	.80	7B6	.72	35/51	.80
2J51	4.95	307A	4.95	1624	.49	0Z4	.88	6AT6	.80	7B7	.72	35A5	.72
2J54B	17.95	316A	.69	1625	.49	OZ4G	.88	6AV6	.60	7B8	.72	35B5	.80
2K23	24.95	327A	4.95	1628	4.95	0A1A	.72	6A7	1.72	7C4/1203A	1.39	35L6GT	.66
2K25	24.95	338A	24.95	1629	.69	IA3	.72	6B6G	.88	7C5	.72	35Y4	.72
2K28	24.95	339A	2.95	1631	1.50	IA4	1.28	6B7	1.28	7C6	.72	35Z3	.72
2K41	24.95	350A/B	4.93	1634	.79	IA4P	1.56	6B8	1.28	7E5/1201	1.66	35Z4GT	.60
3AP1	4.95	354C/D	19.95	1635	1.10	IA5GT	.72	6B8G	1.28	7F6	.72	35Z5GT	.80
3B22	4.95	368AS	7.95	1636	5.95	IA6	1.28	6B9	1.28	7F7	.88	36	.39
3B23	4.95	371A/B	.89	1638	9.98	IA6GT	1.80	6BG6G	1.92	7F8	1.06	38	.39
3B24	1.98	394A	7.50	1639	.98	IB3GT	1.06	6B16	.80	7G7/1232	1.06	39/44	.39
3B26	1.89	394A	7.50	1641	.79	IB4	1.56	6B2	.88	7H7	.80	41	.66
3B27	3.95	399A	3.25	1642	.98	IB4	1.56	6B3	.88	7I7	1.06	42	.66
3B28	5.95	400A	1.95	1644	1.49	IB5/25S	1.28	6B4	.39	7J7	1.06	43	.66
3BP1	3.95	401A	1.75	1645	1.06	IB6GT	1.28	6B5	.66	7K7	.88	45	.66
3C2	18.95	403A/B	1.75	1652	1.06	IC5GT	.88	6B6	.80	7L7	.88	45Z3	.60
3C23	3.95	403A	2.95	1653	1.06	IC6	1.28	6B7	.88	7M7	.88	45Z5GT	.72
3C24	4.69	434A	7.95	1656	.95	IC7G	1.28	6B8	.88	7N7	.88	46	1.36
3C30	1.50	446A/B	1.95	1659	1.19	ID5GT	1.55	6C7	1.28	7O7	1.28	47	.96
3CP1	3.00	450TH	24.95	2051	.98	ID7G	1.28	6C8G	1.28	7P7	1.06	48	.88
3D21A	1.50	527	24.50	5514	4.95	ID8GT	1.56	6C9	1.28	7Q7	1.06	49	.88
3DP1	3.95	531	24.50	5516	5.95	IE5GT	1.38	6D8	.66	7R7	1.06	50A5	.88
3EP1	3.95	532A	14.95	562	10.00	IE7G	1.56	6D9	.66	7S7	1.06	50B5	.66
3E29	4.95	575A	14.95	562	10.00	IF6	1.56	6D9G	1.06	7T7	1.06	50L6GT	.66
3FP7	3.95	701A	4.95	7193	.39	IF7G	1.06	6E5	.85	7W7	1.06	50Y6GT	1.06
3J31	49.50	703A	4.95	8003	5.95	IF8	1.06	6E6	1.06	7X7/XXFM	1.06	51A	.80
4-65A	14.50	705A	2.95	8905	4.95	IF6	1.56	6F5	.66	7Y4	.72	51B5	.66
4-125A	27.50	706CY	18.95	9011	2.95	IF7G	1.56	6F6	.66	7Z4	.72	51C5	.66
4-250A	37.50	707A/B	24.95	9012A	4.95	IG4GT	1.06	6F7GT	.66	7Z4	.72	51D6GT	.66
4A1	1.98	708A	7.95	8013A	2.95	IG6GT	1.06	6F8	.88	7Z4	.72	51E6GT	.66
4AP10	6.95	710A	2.95	8014A	24.95	IH4C	.88	6F9GT	.66	7Z4	.72	51F6GT	.66
4B24	4.95	713A	1.65	8016	1.49	IH5GT	.66	6F10	1.06	7Z4	.72	51G6GT	.66
4C35	19.95	714AY	6.95	8020	3.95	IH6G	1.28	6F11	1.28	7Z4	.72	51H6GT	.66
4E27	12.95	715A/B	9.95	8025	7.95	IH6GT	1.28	6F12	1.28	7Z4	.72	51I6GT	.66
4J26	110.00	715C	24.95	8025	7.95	IJ6GT	1.28	6F13	1.28	7Z4	.72	51J6GT	.66
5AP1	4.95	717A	12.95	8025	7.95	IK4	1.28	6F14	1.28	7Z4	.72	51K6GT	.66
5AP4	5.95	720DY	34.95	8067	1.95	IL4	1.06	6F15	1.28	7Z4	.72	51L6GT	.66
5BP1	2.95	721A/B	4.35	CK1005	.35	IL4A	1.06	6F16	1.28	7Z4	.72	51M6GT	.66
5BP2	4.95	723AB	7.95	CK1090	4.95	IL4B	1.06	6F17	1.28	7Z4	.72	51N6GT	.66
5CP1	3.95	723A/B	4.95	EP59	.79	IL5	1.06	6F18	1.28	7Z4	.72	51O6GT	.66
5CP7	13.95	725A	4.95	EL1C	4.95	IL6	1.06	6F19	1.28	7Z4	.72	51P6GT	.66
5D21	29.95	726A	23.50	EL3C	4.95	IL6G	1.06	6F20	1.28	7Z4	.72	51Q6GT	.66
5FP7	3.95	750TL	49.50	FI23A	12.95	IL7	1.06	6F21	1.28	7Z4	.72	51R6GT	.66
5GP1	9.95	800	2.25	F660	150.00	IL8	1.06	6F22	1.28	7Z4	.72	51S6GT	.66
5HP4	9.95	801A	.98	FG17	3.25	IL8A	1.06	6F23	1.28	7Z4	.72	51T6GT	.66
5JP2	11.95	802	3.75	FG27A	9.95	IL8B	1.06	6F24	1.28	7Z4	.72	51U6GT	.66
5LP1	11.95	803	8.95	FG33	8.95	IL9	1.06	6F25	1.28	7Z4	.72	51V6GT	.66
5LP5	14.95	804	12.95	FG67	12.95	IL9A	1.06	6F26	1.28	7Z4	.72	51W6GT	.66
5NP1	2.95	805	5.95	FG81A	6.95	IL9B	1.06	6F27	1.28	7Z4	.72	51X6GT	.66
6AF6G	.88	807	1.25	FG105	19.95	IL9C	1.06	6F28	1.28	7Z4	.72	51Y6GT	.66
6C21	24.95	808	1.89	FG172A	3.50	IL9D	1.06	6F29	1.28	7Z4	.72	51Z6GT	.66
6D4	2.75	809	2.93	FG235	59.50	IL9E	1.06	6F30	1.28	7Z4	.72	52A6GT	.66
6F4	5.95	810	7.95	FG288B	160.00	IL9F	1.06	6F31	1.28	7Z4	.72	52B6GT	.66
6J4	6.50	811	2.45	GL146	11.00	IL9G	1.06	6F32	1.28	7Z4	.72	52C6GT	.66
7BP7	4.95	812	2.95	GL502A	1.98	IL9H	1.06	6F33	1.28	7Z4	.72	52D6GT	.66
7C23	75.00	812H	6.90	GL530	49.50	IL9I	1.06	6F34	1.28	7Z4	.72	52E6GT	.66
7C24	80.00	813	8.95	GL559	5.35	IL9J	1.06	6F35	1.28	7Z4	.72	52F6GT	.66
7C25	90.00	814	3.95	GL697	150.00	IL9K	1.06	6F36	1.28	7Z4	.72	52G6GT	.66
9C23	250.00	815	2.95	HF1									

SAVE MONEY!

DO YOU WANT TO MAKE YOUR DOLLAR GO FURTHER?
Take advantage of this opportunity—Buy BRAND-NEW-GUARANTEED SURPLUS MATERIAL at PRICES FAR BELOW DEALERS COSTS

A. C. AMMETERS

0-30 AC A, Trip 3 1/2" rd.....	\$4.00
0-30 AC A, Trip 3 1/2" rd met cs.....	\$3.50
0-50 AC A, G.E. 3 1/2" rd.....	\$4.00
0-50 AC A, W.H. 3 1/2" rd.....	\$4.95
0-60 AC A, W.H. 4 1/2" rd surf mtd ca.....	\$8.00
0-60/120 AC A, Burl 3 1/2" w ext current transformer.....	\$7.50
0-60/120 AC A, Burl 3 1/2" less current transformer.....	\$4.50

A. C. VOLTMETERS

0-15 AC V, G.E. 2 1/2" rd bl sc 800 cy.....	\$2.50
0-15 AC V, G.E. 2 1/2" rd bl blank scale.....	\$2.50
0-15 AC V, G.E. 3 1/2" rd bl sc.....	\$3.00
0-15 AC V, Weston 476 3 1/2" rd.....	\$4.50
0-15 AC V, W.H. 3 1/2" rd.....	\$3.95
0-40 AC V, W.H. 2 1/2" rd bl sc, lum mkgs, 400 cy.....	\$2.95
0-40 AC V, Weston 517, 2 1/2" rd metal cs, 400 cycles, bl dia lum sc.....	\$3.50
0-75 AC V, Weston 2" rd met cs ring mtd.....	\$2.95
0-130 AC V, W.H. 3 1/2" rd, blank sc.....	\$3.00
0-150 AC V, Burl 2 1/2" rd.....	\$2.95
0-150 AC V, Burl 2 1/2" rd met cs.....	\$2.95
0-150 AC V, Hick 2 1/2" rd met cs.....	\$2.95
0-150 AC V, Weston 2 1/2" rd met cs bl sc, 400 cy.....	\$2.50
0-150 AC V, G.E. 3 1/2" rd bl sc.....	\$4.50
0-150 AC V, G.E. 3 1/2" rd 400 cy.....	\$4.00
0-150 AC V, Trip 3 1/2" rd.....	\$4.50
0-150 AC V, Trip 3 1/2" rd met cs.....	\$4.00
0-150/300 AC V, Trip 3 1/2" rd w res for 300 volt.....	\$5.50
0-150 AC V, W.H. 3 1/2" rd 400 cycles.....	\$4.50
0-150 AC V, W.H. 3 1/2" rd surf mtd met ca.....	\$3.00

R. F. AMMETERS

0-120 MA RF, Simpson 3 1/2".....	\$9.50
0-120 MA RF, Weston 425 3 1/2".....	\$11.50
0-1 RF A, G.E. 2 1/2" rd bl sc.....	\$2.95
0-1 RF A, G.E. 2 1/2" rd.....	\$3.50
0-1 RF A, G.E. 2 1/2" rd met cs.....	\$3.00
0-1.5 RF A, Weston 2 1/2" rd met cs bl sc.....	\$2.50
0-1.5 RF A, Weston 3 1/2" rd.....	\$8.25
0-2 RF A, Weston 3 1/2" rd.....	\$6.50
0-2 RF A, Simp 2 1/2" rd.....	\$3.50
0-2.5 RF A, Weston 3 1/2" rd.....	\$6.50
0-2.5 RF A, Simp 3 1/2" rd.....	\$4.95
0-2.5 RF A, W.H. 3 1/2" rd.....	\$5.50
0-2.5 RF A, McClintock 3 1/2" rd.....	\$4.50
0-3 RF A, W.H. 3 1/2" rd.....	\$5.50
0-4 RF A, G.E. 2 1/2" rd bl sc.....	\$2.95
0-5 RF A, Weston 3 1/2" rd.....	\$6.50
0-5 RF A, G.E. 3 1/2" rd.....	\$7.50
0-6 RF A, G.E. 2 1/2" rd bl sc.....	\$2.50
0-20 RF A, Weston 2 1/2" rd.....	\$3.50
0-20 RF A, G.E. 3 1/2" rd.....	\$4.95
0-30 RF A, Trip 3 sq w ext. leads & couple.....	\$8.00

D. C. MICROAMMETERS

0-200 DC Micro, W.H. 3 1/2" rd, 230 ohms 43 MV MK35W200DCUA.....	\$8.50
0-200 DC Micro, Super 4" Rect 500 ohms Special sc.....	\$7.50
0-400 DC Micro, Triumph 4" Rect 500 ohms, special scale.....	\$5.50
0-500 DC Micro, DeJur Amsco 2 1/2" rd.....	\$3.00
0-500 DC Micro, Gruen 2 1/2" rd.....	\$3.95
0-500 DC Micro, Simp 2 1/2" rd.....	\$3.50

0-500 DC Micro, Trip 2 1/2" rd.....	\$3.50
0-500 DC Micro, W.H. 3" sq Spec scale.....	\$4.95
0-550 DC Micro, G.E. 3" sq Spec scale.....	\$4.50

D. C. MILLIAMMETERS

0-1 DC MA, DeJur Amsco 2 1/2" rd Spec sc.....	\$2.50
0-1 DC MA, G.E. 2 1/2" rd Spec sc.....	\$3.00
0-1 DC MA, G.E. 2 1/2" rd bl sc Spec sc.....	\$3.00
0-1 DC MA, G.E. D0-41 3 1/2" rd.....	\$5.50
0-1 DC MA, McClintock @S-1811 3" sq, 65 ohms, Spec sc.....	\$3.50
0-1 DC MA, McClintock 3 1/2" rd.....	\$3.50
0-1 DC MA, W.H. 3 1/2" rd 53.7 ohms resist.....	\$7.50
0-1.5 DC MA, Hick 2 1/2" rd met cs.....	\$2.00
0-2 DC MA, R.S. 20 MV mvt Spec sc.....	\$2.50
0-2.7 DC MA, Gruen GW 587 2 1/2" bake case with Spec sc.....	\$1.95
0-3 DC MA, Gruen 2 1/2" rd.....	\$2.00
0-3 DC MA, Gruen 2 1/2" rd Spec sc.....	\$2.25
0-3 DC MA, Simp 2 1/2" rd.....	\$2.50
0-3 DC MA, Weston 2 1/2" rd met cs.....	\$2.50
5-0-5 DC MA, W.E. 3 1/2" rd fl cone style bake case cal 50-0-50.....	\$3.50
0-10 DC MA, Hick 2 1/2" rd met cs Spec sc.....	\$2.50
0-10 DC MA, McClintock 3" bake case, white sc.....	\$3.50
0-12.5 DC MA, RS 1 1/2" sq 50 MV.....	\$4.50
0-15 DC MA, Simp 3 1/2" rd.....	\$4.50
0-20 DC MA, G.E. 2 1/2" rd bl sc.....	\$3.00
0-20 DC MA, G.E. 3" sq.....	\$3.75
0-25 DC MA, Weston 3 1/2" rd.....	\$4.95
25/250 dual range Weston Model 264 Portable, Vertical reading, with test cord and plug, Press for low reading.....	\$9.00
0-30 DC MA, G.E. 3 1/2" rd.....	\$3.50
0-50 DC MA, G.E. 3 1/2" rd.....	\$3.95
0-80 DC MA, G.E. 3 1/2" rd.....	\$3.75
0-150 DC MA, Gruen 2 1/2" rd.....	\$3.00
0-200 DC MA, Gruen 2 1/2" rd.....	\$3.00
0-200 DC MA, Marion 3 1/2" rd.....	\$4.00
0-200 DC MA, Simp 3 1/2" rd.....	\$4.50
0-200 DC MA, W.H. 3 1/2" rd.....	\$4.50
0-300 DC MA, G.E. 3 1/2" rd.....	\$4.95
0-500 DC MA, W.H. 2 1/2" rd.....	\$3.95

D. C. AMMETERS

0-1.5 DC A, G.E. 3 1/2" rd.....	\$4.95
0-5 DC A, Gruen 2 1/2" rd.....	\$3.50
0-15 DC A, Sun 3 1/2" rd.....	\$4.00
0-15 DC A, Trip 3 1/2" rd.....	\$4.00
0-15 DC A, W.H. 3 1/2" rd surf mtd.....	\$3.50
0-30 DC A, Hoyt 2 1/2" rd met cs.....	\$2.50
30-0-30 DC A, Beere 2 1/2" rd met cs.....	\$2.95
30-0-30 DC A, G.E. 2 1/2" rd met cs.....	\$3.50
30-0-30 DC A, I. S. Gauge 2" met cs bl sc.....	\$1.50
0-200 DC A, Weston 506 2 1/2" rd w 50 MV shunt.....	\$7.50
0-200 DC A, G.E. D0-41 3 1/2" rd fl bake case with shunt.....	\$9.50
200-0-200 DC A, Weston 506, 50-0-50 MV mvt with external shunt.....	\$7.50
0-300 DC A, G.E. 2 1/2" rd w 50 MV shunt.....	\$7.50
0-500 DC A, G.E. DW-51 2 1/2", Special sc.....	\$3.50

D. C. VOLTMETERS

0-3 DC V, Simp 2" rd met cs ring mtd.....	\$2.00
3-0-3 DC V, W.H. 2 1/2" rd surf mtd 200 r/v.....	\$1.25
0-5 DC V, W.H. 2 1/2" rd 200 r/v.....	\$3.50

0-10 DC V, Sun 2 1/2" rd 100 r/v.....	\$2.50
0-15 DC V, Gruen 2 1/2" rd.....	\$3.50
0-15 DC V, McClintock 2 1/2" rd bl sc 1000 r/v.....	\$3.00
0-20 DC V, Weston 2 1/2" rd 1000 r/v.....	\$3.50
0-30 DC V, G.E. 2 1/2" rd 250 r/v.....	\$2.95
0-30 DC V, DE Jur Amsco 2 1/2" rd.....	\$2.50
0-50 DC V, Readrite 2 1/2" rd stamped met cs.....	\$1.00
0-15 KV DC, G.E. 3" sq 500 ua mvt, less mult.....	\$4.95
0-15 KV DC, W.H. 3 1/2" rd 1 MA mvt, less mult.....	\$4.50

MAGNAFLUX INSPECTION UNIT

440 Volt 3 phase 60 cycle input, main transformer has taps for 220 volt operation. Variable tap primary transformer to regulate D.C. output. Air cooled rectifier, 5,500 Ampere output. Magnaflex Corp. Type #CQ5.5
Brand New—In original crates—Net wt. approx. 1600 lbs.
Only Two Units available.

Each \$450.00

"VIBROTEST" INSULATION RESISTANCE and A.C. - D.C. VOLTAGE TESTER

RESISTANCE RANGE: 0-200 Megohms (at 500 volt test potential) 0-2000 ohms.
VOLTAGE RANGE: 150-300-600 Volts D.C. 150-300-600 Volts A.C.
Push button action for resistance readings. Operates from internal power supply of two #6 dry cells. Large 4" meter and knife edge pointer insure accurate readings. Complete with test leads and instructions in metal carrying case.
Associated Research Model #201.
(Slightly used—excellent condition—guaranteed).
Your Net Price \$38.00

PORTABLE CHRONOMETRIC TACHOMETER

Measures shaft speeds from 10 RPM to 20,000 RPM. Measures lineal speeds 5 FPM to 10,000 FPM. Meets Navy Spec. 1% of 1% accuracy.
With accessories and case 5" x 3 1/2" x 1 1/2". List price \$75.00. Net Price..... \$24.50

PORTABLE TACHOMETER MULTIPLE RANGE

Continuous Indicating Shaft or lineal speeds from 300-1200, 1000-4000, and 3,000 to 12,000 RPM. Meets Navy spec. 18-T-22 Type B, Class A. With accessories in case 7 1/2" x 4" x 5". List Price \$75.00. NET PRICE..... \$24.50
TACHOMETER same as above, except ranges are 300 to 1500, 1,000 to 5,000 and 3,000 to 15,000.
Your Net Price \$25.50

All meters are in round flush bakelite case with white scale and are standard in every respect unless otherwise specified. All items are Surplus—New—Guaranteed unless specified otherwise.

MARITIME SWITCHBOARD

(Worth 4-8217)

336 Canal St. New York 13, N. Y.

Orders accepted from rated concerns, public institutions & agencies on open account, others please send 25% deposit, balance C. O. D. or check with order. All prices FOB our warehouse, N.Y.C.

IMMEDIATE DELIVERY

LOW PRICES

FULLY GUARANTEED

D. C. MOTORS



**Blower Assembly
MX-215/APG**
John Oster C-2P-1L
28 v. DC. 7000 RPM
1/100 hp. #2 L-R
Blower.
Stock #SA-202.
Price \$2.95 each



Universal Electric DC
W. E. KS-5603-L02. 28 v. DC.
0.6 amps. 1/100 hp. 4 lead
shunt. Stock #SA-233.
Price \$1.95 ea. plus 15c p.p.



Delco 5069466 Motor
Alnico PM field. 27.5 v.
DC. 1" x 1" x 2" lg. Pinion
gear on shaft. Stock
#SA-65. Price \$2.95 each plus 15c p.p.



**DELCO CONSTANT SPEED MOTOR
A-7155**
1/30 hp. 3600 rpm. Cont.
duty. 2 1/2" diam. x 5 1/2"
lg. 3/8" shaft extension, 5/32" diam. 4 hole
base mounting. Stock #SA-94. Price \$4.75
each.



**Delco 5069625 Constant
Speed DC Motor, 27 v. DC.**
120 rpm. Governor
controlled. Stock #SA-
249. Price \$3.95 each. Qty. prices on
request.

ALSO IN STOCK
400 CYCLE MG SETS
AMPLIDYNES, AUTOSYNS
AC AND DC RATE GENERATORS

MICROWAVE ANTENNA



AS-217/APG 15B. 12
Cm dipole and 13
inch parabola housed
in weatherproof Ra-
dome 16" dia. 24 v.
DC spinner motor for
conic scan. Stock
#SA-95. Shipping wt.
70 lbs.

Price \$9.50 ea.



GYRO SERVO UNIT

Pioneer 12800-1-D. 115v. 400 cy. Low
inertia motor and follow-up Autosyn.
Stock #SA-160. Price \$6.95 each



DYNAMOTOR
D-101 27 v. DC in @
1.5 amps. DC out. 285
v. @ 0.60 amps. Stock
#SA-187.
Price \$1.50 each

SPECIALS



400 Cycles
Three Phase

INVERTERS

Holtzer Cabot MG-153—Input 28 volts DC
at 52 amps. Output three phase 115 volts
400 cycles at 750 va. 0.90 P.F. Also sec-
ond output of 26 volts 400 cycles at 250
V.A. Voltage and frequency regulated.
New—Perfect \$99.50 ea.
New—Surface Damages \$59.50 ea.

Leland SD-93—(10285)—Input 28 volts DC
at 60 amps. Output 115 volts three phase
400 cycles at 750 va. 0.90 P.F. Second
output voltage of 26 volts 400 cycles at
50 V.A. Voltage and frequency regulated.
Designed for use with various autopilots.
Stock #SA-209. Price \$79.50 each

Holtzer Cabot MG-149H—Similar to MG-
149F but draws 44 amps DC at 28 v. Out-
put ratings are at 0.90 P.F. Equipped with
high altitude brushes. Stock #SA-4.
Price \$34.50 each

General Electric 5D21N3A — Input 28
volts DC at 35 amps. Output 110 volts 400
cycles. 485 V.A. at 0.90 P.F. Weight 15
lbs. Stock #SA-41. Price \$12.50 each

Air Research Actuator—25080 (Manual
Flap). 24V DC. Rated Load Lbs. Stat.
2800. Ten 1750. Comp. 850. Stock #SA-264.
Price \$12.50 each.

Air Research Actuator—25040. (Automatic
Flap). Similar to above. Stock #SA-263.
Price \$12.50 each.

Air Research Actuator—25800-24 — (Air
Valve Actuator.) Rated Load Lbs. stat.
200. Ten. 75-100. Comp. 75-100. Stock
#SA-227. Price \$6.75 each.

**Bodine NYC-13 AC
Motor**
115 v. 60 cycles, 1/40
hp. 1800 rpm. Cont.
duty. .55 amps. Stock
#SA-245.
Price \$9.50 each.

SYNCHROS

Navy Types

1G, 1F, 1CT, 5C, 5F, 5CT,
5DG, 5HCT, 5SF, 5HSF,
5SDG, 6DG, 6G, 6DG, 7G, etc.

Prices on Request

RECORDER



**Brown Instrument
Co. "Elektronik Re-
corder"** 12 in. chart.
One rev. per 10 min.
Center O. 200 micro
volts DC for full
chart. Use as re-
cording galvanom-
eter, or modify for
use with strain
gauges, etc. Charts
included. Operates
from 110 volts 60
cycle line. Unit sup-
plied complete with
amplifier and tubes.
Stock #SA-261.

Price \$89.50 each

AC-SERVO MOTORS

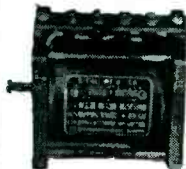

Pioneer—CK-2 and 10047-2A for 400 cy.
Kollsman—776-01 for 400 cycles.
Diehl—FP-25-3. FPE-25-11 (CDA-211052)
and ZP-105-14 for 60 cycles.

Prices on Request



Remote Position
Indicating System



6-12 v, 60 cycles 5 inch indicator with 0 to
360° dial. Heavy duty transmitter. Stock
#SA-115. Price \$9.95 per system

LP-21-LM Compass Loops



QUANTITY
PRICES
ON REQUEST

MERCURY CONTACT RELAY

W. E. D-168479
Millisecond switching
at up to 60 c.p.s.
Technical data on re-
quest. Stock #SA-
259. Price \$4.75 ea.
Special qty.
prices.

All prices F.O.B., Paterson.
Teletype PAT. 199
Phone ARMORY 4-3366
Write for Listing.



SEARCHLIGHT SECTION



TRANSFORMERS AND CHOKES

115V 60cy. INPUT
Equip. Conservatively Rated

FILAMENT TRANSFORMERS

5 Volts/6 Amp	\$2.25
F083: 6.3VCT/6A, 5V/2A	1.85
F- 2.5VCT/2A, 6.3VCT/2A	2.45
F- 6.3VCT/2A, 6.3VCT/2A	2.45
F087: 6.3VCT/1A, 6.3VCT/7A	2.75
F103: 6.3V/1A, 6.3V/1A	1.95
F123: 6.3VCT/5A, 6.3V/1A	2.25
F127: 6.3VCT/3.2A, 6.3VCT/1A	2.25
F674: 5V/1.5A	2.75
F- 5V/1.5A, 6.5/5A, 5V/3A, 6.5/6A	3.95
F414: 2 x 2.5VCT/6.5A, 5V/3A, 6.5/3A	3.25
F161: 6.3VCT/7A, 6.3VCT/5A, 5VCT/6A	3.95
2 x 6.3V/6A, 6.3V/3A	3.95
F829: 6V/2.5A	1.75
F38A: 6.3V/2.5A, 2 x 2.5V/7A	3.25
F112: 4.25VCT/6.5A, 2.5V/6.5A	4.25
F14A: 6.3/6A	1.95

PLATE TRANSFORMERS

P410: 800VCT/40MA, 760VCT/500MA	6.50
P415: 690V/450MA	4.25
P499: 2 x 300VCT/150MA	2.95
P403: 70V/1A	2.25
P413: 510VCT/150MA, 650VCT/15MA	4.95
P842: 600VCT/0166A, 250VCT/077A	2.95
P885: 1620VCT/400MA HV INS	11.95
P894: 2 x 200V/350MA, 2 x 20V/01A	1.95
P450: 2 x 150V/940MA	4.50
P371: 246VCT/830MA	3.95
P345: 1470VCT/1.2A, 3500T	24.00

COMBINATION TRANSFORMERS

C965: 78V/600MA, 6.3V/2A	\$3.95
C111: 2 x 300V/42MA, 55V/125MA	4.25
45V/3.5 Amp	3.95
C608: 880VCT/150MA, 5V/3A, 6.3V/6.25A	5.00
C931: 585VCT/86MA, 5V/3A, 6.3V/6A	3.95
C055: 525VCT/75MA, 5V/2A, 6.3V/1.8A	4.45
10V/2A	4.45
T102: 100VCT/55MA, 2 x 6.3V/2A	5.95
C848: 600VCT/155MA, 6.3VCT/5A	3.95
5VCT/3A HV Ins	3.95
C899: 2 x 110VCT/01A, 6.3V/1A	4.50
2.5VCT/7A	4.50
C760: 6.3VCT/10A, 65V/1A, 100VCT/1A, 10V/1A, 18VCT/1A, 18V-6V/1A, 6.3V/1A	5.50
C354: 825VCT/190MA, 5VCT/3A	3.95
C367: 5VCT/3A, 580VCT/040A	2.95
T160: 1120VCT/770MA, 690VCT/082A	12.75
11V Ins	12.75
C579: 24V/900MA, 770V/0025, 2.5V/3A	4.25
HV Ins	8.95
T378: 2300V/004A, 2.5V/2A HV Ins	8.95
C375: 1120VCT/60MA, 2 x 5VCT/6-2A	14.95
6.3VCT/3A, 6.3V/300MA	14.95
C364: 6.3VCT/3A, 5VCT/6A, 610VCT/330MA	4.75
11V Ins	1.95
C434: 42V/01A, 6.3V/1.25A	1.95
C383: 215VCT/300MA, 5VCT/6A	2.29
C360: 640VCT/080A, 5VCT/6A, 6.3VCT/3.2A	3.95
C821: 1500V/4A, 6.3V/6A, 2.5V/1.75A, 3500T	8.95

FILTER CHOKES

03HY/2A	\$1.25	8.5HY/125MA	\$1.50
25HY/65MA	1.00	6HY/150MA	1.50
Dual 7HY/75MA, 11HY/65MA	1.65	7HY/140MA	1.60
Dual 2.5HY/130MA, 1.25	1.16HY/150MA	4.25	
01HY/2.5A	1.45	35HY/350MA	7.25
Dual 5HY/380MA, 1.00	5HY/40MA	1.55	
2HY/200MA	.75	Dual 120HY/17MA	2.45
30HY/20MA	.85	5HY/200MA	1.45
2.1HY/200MA	1.20	2 x 2HY/35A	9.95
25HY/75MA	1.10	20HY/300MA	7.95
Dual 22HY/600MA, 44HY/400MA	1.95		
Swing 1-3HY/225-.02A, 1.75HY/225MA	2.25		
Tapped Choke 2 x 1.52HY/167MA	2.25		
033HY/7A	9.50	Dual 10HY/150MA	3.50
Dual 1.52HY/167MA, 2.49	Dual 2HY/550MA	5.95	
5HY/200MA	1.49	1.35HY/1.1A	4.95
12HY/100MA	1.75	1HY/100MA	.60
2x2.5HY/700MA	6.95	Send For Lists of Others	
3.5HY/100MA	5.95		

POWER EQUIPMENT

● Fil. Trans. 110v 60 cy in., 5vct/30A out.	\$9.95
● In 110v 60 cy out 6.3vct/20A, 6.3v/1.8A, 6.3v/60 MA	\$4.95
● In 110v 60 cy out 2x5vct/6.75A, 5vct/13.5A, 3500 Test	\$6.95
● In 110v 60 cy out 10vct/13A, 10vct/6.5A, 6.3vct/2A	\$7.95
● In 115v 60 cy out 760vct/500MA, 800vct/40MA	\$10.95
● Tapped in. 107 to 127v out 160v to 200v/700MA	\$6.95
12 Taps	\$12.95
● In 110v 60 cy out 4v/16A, 2.5v/1.75A	\$4.75
● In 110v 60 cy out 17000v/144MA, w/choke 26" x 29" x 13" oil immersed	\$65.00
● In 115v 60 cy out 2x5v/5.5A 29kv ins.	\$24.50
● In 115v 60 cy out Tapped to give 2750/2470/2240/@ 750 MA 7000v ins.	\$34.50

SPECIAL TRANSFORMERS

● In 440/220/110v 60 cy 3kva out 115v 25kv ins. 12"x12"x7"	\$40.00
● In 220v 60 cy .05kva out 5vct 34kv Test	\$24.50
● In 115v/230v 50-60 cy out 2100v/100MA, \$120.00	
● In 220v 60 cy out 220v/360MA, 3x2.5v/5A, 2.5v/15A	\$6.75
● In 220v 60 cy out 10vct/13A, 7.5vct/2.5A	\$5.25
● In 220v/440v 60 cy out 123vct/2.85A	\$7.50
● In 240v 60 cy 7000vct/900MA, 4800vct/750 MA	\$135.00
● In 210/115/20/25/30/35/240v 60 cy out 11vct/35A, 10vct/35A, 7.5vct/35A, 5vct/35A	\$37.50

COMMUNICATIONS EQUIPMENT for your needs COMPANY



DYNAMOTORS

Type	Input Volts	Input Amps	Output Volts	Output Amps	Radio Set	Prices*
PE 86	28	1.25	250	.060	RC 36	\$3.95
DM 416	14	6.2	330	.170	RU 19	15.95N
DY-2/ARR-2	28	1.1	250	.060	ARC-5	4.75N
DM 36	28	1.4	220	.080	SCR 508	8.75N
DM 53AZ	14	2.8	220	.080	BC 733	7.00N
PE 73CM	28	19	1000	.350	RC 375	N
DM 21	14	3.3	235	.090	BC 312	3.45N
DM 21CX	28	1.6	235	.090	BC 312	3.45N
DM 25	12	2.3	250	.050	BC 367	2.49LN
DM 28R	28	1.25	275	.070	BC 348	8.95N
DM 33A	28	7	540	.250	BC 456	5.50N
DM 42	14	46	515	.110	SCR 506	6.50LN
			1030	.050		
			2/8			
PE 101C	13/26	12.6	400	.135	SCR 515	5.25N
		6.3	800	.020		
BD AR 93	28	3.25	375	.150		4.95N
23350	27	1.75	285	.075	APN-1	3.50N
35X045B	28	1.2	250	.060		3.50N
ZA .0515	12/24	4/2	500	.050		3.95N
ZA .0516	12/24	8/4	12/275	3/110		5.50N
B-19 pack	12	9.4	275	.110	Mark II	9.95N
			500	.050		
D-104	12		225	.100		14.95N
			440	.200		
DA-3A*	28	10	300	.060	SCR 522	8.95
			150	.010		
			14.5	.5		
#5053	28	1.4	250	.060	APN-1	3.95N
DA-7A	26.5		1100	.400	TA-2J	25.00N
CW 21AAX	13	12.6	401	.135		17.50N
	26	6.3	500	.020		
			9	1.12		
BD 77KM	14	40	1000	.350	BC 191	N
PE 94	28	10	300	.260	SCR	15.00N
			150	.010	522	
			14.5	.5		

*N—New. LN—Like New. *Less Filter Box & Relays
Replacement dynamotors for PE-73, less filter box \$12.00

HAND GENERATORS

GN 35: 350 v, 60 ma; 8v, 2.5 A. New, with hand cranks	\$12.50
GN 45: 500 v, 100 ma; 6v, 3 amps. Slight use, ex. con., with cranks	\$12.50

MICROWAVE GENERATORS

AN/APS-15A "X" Band compl. RF head and modulator, incl. 725-A magnetron and magnet, two 723A/B klystrons (local osc. & beacon), 1B24 TR, revr-amp, duplexer, HV supply, blower, pulse xtmr. Peak Pwr Out: 45 KW appx. Input: 115, 400 cy. Modulator pulse duration 5 to 2 micro-sec. appx. 13 KV PK. Pulse. Compl. with all tubes incl. 715-B, 829B, RKR 73, two 72's. Compl. pkg., new. \$210.00
APS-15B. Complete pkg. as above, less modulator \$150.00
"S" BAND AN/APS-2. Complete RF head and modulator, including magnetron and magnet, 417-A mixer, TR, receiver, duplexer, blower, etc., and complete pulser. With tubes, used, fair condition. \$75.00
10 CM, RF Package. Consists of: SO Xmttr.-receiver using 2127 magnetron oscillator, 250 KV peak input. 707-B receiver-mixer. Rotating York PPI for above \$150.00
Modulator-motor-actuator unit for above. \$75.00
Receiver-rectifier power unit for above. \$25.00
Rotating antenna with parabolic reflector for above. New \$75.00

INVERTERS

PE 218-E: Input: 25-28 vdc, 92 amp. Output: 115 v, 350-500 cy, 1500 volt-amps. Dim: 17" x 6 1/2" x 10"	\$49.95
New, export packed	\$49.95
PE 218-H: Same as above, except size: 16 1/2" x 5 1/2" x 10"	\$49.95
PE 218-H: Used, good cond.	\$25.00
PE 205: Input: 28 vdc, 38 amps. Output: 80 v, 800 cy, 500 volt-amps. Dim: 13" x 5 1/2" x 10 1/2". New	\$25.00
GE 5D21NJ3A: Input: 28 vdc, 35 amp. Output: 115 v, 400 cy, 485 volt-amps. Dim: 9" x 4 1/2". New	\$49.95

COAX CABLE

RG 17/U. 52 ohm imp.	\$.50/ft.
RG 18/U. 52 ohm imp. armored.	.51/ft.
RG 35/U. twin coax. 125 ohm imp. armored.	.50/ft.
RG 28/U. 50 ohm imp. pulse cable. Corona min. starting voltage 17 KV.	.50/ft.
RG 57/U. 95 ohm imp. twin coax.	.35/ft.

Typewriter Desk Wells Mounted on Steel Panel for Standard Rack. 10 1/2" H x 19" W x 1/2" Thick. Well is 22" Wide, 20" Deep. Affording Full Working Space. Grey Crackle Finish. New ea. \$6.95



OIL CONDENSERS

(Standard Brands)

.0016 MFD	15000 VDC	\$8.00
.015 MFD	16000 VDC	7.00
.01-005-.005 MFD	10000 VDC	4.75
1 MFD	2500 VDC	1.25
1-1 MFD	7000 VDC	3.49
1 MFD	6000 VDC	2.97
1 MFD	7500 VDC	3.00
2 x .1 MFD	4800 VDC	3.00
15 MFD	4000 VDC	3.00
.15-.15 MFD	6000 VDC	4.00
2 x .15 MFD	8000 VDC	5.00
25 MFD	20000 VDC	17.50
25 MFD	1500 VDC	1.05
4 MFD	5000 VDC	3.00
5 MFD	1000 VDC	.70
.5 MFD	750 VDC	1.75
.5-.5 MFD	400 VDC	.60
1 MFD	1000 VDC	.49
1 MFD	2000 VDC	1.00
1 MFD	1500 VDC	.89
1.5 MFD	1500 VDC	.95
1.5 MFD	1000 VDC	.75
4 MFD	1500 VDC	1.05
4 MFD	1000 VDC	.98
6 MFD	600 VDC	1.05
6 MFD	1500 VDC	2.25
7 MFD	600 VDC	1.05
7 MFD	800 VDC	1.25
10 MFD	1900 VDC	1.95
15 MFD	220 VDC	2.29
15 MFD	1000 VDC	2.25
1.5 MFD	6000 VDC	10.00
1 MFD	15000 VDC	32.50
.5 MFD	25000 VDC	37.50
1 MFD	25000 VDC	85.00
1 MFD	10000 VDC	15.00
.06 MFD	15000 VDC	8.00
25 MFD	20000 VDC	17.50



TRANSTATS (AMERTAN)

Input: 0.115 v, 50-60 cycle. Max. output: 115 v, 100 amp. All units are new, guaranteed \$95

2 KVA: 90-130 v input, 50-60 cycles, output 115 volts.
2 KVA Type RH Amertran. \$29.95 each

CIRCUIT BREAKERS

Fig. A, 50A	28V	79¢
Fig. A, 100A	28V	79¢
Fig. A, 150A	28V	79¢
Fig. A, 10A	24V	79¢
Fig. B, 3A	117V	\$1.95
Fig. C, 100A	250V	3 Pole 6.95

CARTRIDGE FUSES

Send for C.E.C. Flyer of Fuses You Need. Do not delay. Write today.

PRECISION CAPACITORS

D-163707: 0.4 mfd @ 1500 vdc. —50 to plus 85 deg C	\$1.50
D-163035: 0.1 mfd @ 600 vdc, 0 to plus 65 deg C	\$2.00
D-170908: 0.152 mfd, 300v, 400 cy. —50 to plus 85 deg C	\$2.50
D-164960: 2.04 mfd @ 200 vdc, 0 to plus 55 deg C	\$2.50
D-168344: 2.16 mfd @ 200 vdc, 0 to plus 55 deg C	\$3.00
D-161555: 5 mfd @ 400 vdc, —50 to plus 85 deg C	\$3.00
D-166602: 16 mfd @ 400 vdc, temp comp 50 to 85 deg C	\$12.50
D-161270: 1 mfd @ 200 vdc, temp comp —40 to plus 65 deg C	\$12.50

CERAMIC CONDENSERS

\$7.50 per 100

3 mmf	±5%	60 mmf	±3%
5 mmf	±3%	67 mmf	±20%
4 mmf	±5 mmf	115 mmf	±2%
8.5 mmf	±5 mmf	120 mmf	±1%
11 mmf	±5%	240 mmf	±3%
15 mmf	±2.5 mmf	250 mmf	
50 mmf	±20%	1000 mmf	±5%

Silver-Mica Button Capacitors (Standard Brand) \$9.50 per 100

185 mmf	±2.5 mmf
175 mmf	±2.5 mmf
500 mmf	±10%

THERMISTORS

D-167332 (tube)	\$.95
D-170396 (bead)	\$.95
D-166873 (button)	

**MODEL AN/APA 10
PANORAMIC ADAPTER**

Provides 4 Types of Presentation:

- (1) Panoramic (2) Aural
(3) Oscillographic (4) Oscilloscopic

Designed for use with receiving equipment AN/AHR-7, AN/AHR-5, AN/APR-4, SCR-537 or any receiver with I.P. of 455kc, 5.2mc, or 30mc. With 21 tubes including 3" scope tube. Converted for operation on 115 V. 60 cycle source.

Includes 80 page T. M. **\$195.00**

8,000-Volt TRANSFORMERS

Primary: 115 V., 60 cycles.
Secondary: 8000 V., C.T., 800 V.A.

Brand new in sealed cans. . . . **\$27.50**

SHOCK MOUNTS

Lord #20, 3" x 3" x 1 1/2"	.40
U. S. Rubber #5150 C, 2 1/2" x 2 1/2" x 1 1/2"	.30
Lord #15, 2 1/2" x 2 1/2" x 1 1/2"	.25
Lord #10, 1 1/2" x 1 1/2" x 1"	.10
Lord #3, 1 1/2" x 1 1/2" x 1"	.10

PARABOLOIDS

17 1/2" diameter, spun magnesium dishes, 4 inches deep. Reinforced perimeter. Two sets of mounting brackets on rear. Opening at apex for waveguide dipole assembly 1 1/2" x 1 1/2".

Brand new, per pair, **\$8.75**

**SOUND POWERED TEL.
FIELD SETS**

Type TP3

For two-way signaling for voice communication. No batteries needed. May be used on metallic or grounded circuits, open-wire lines, cables or circuits using local-battery telephones, switchboards; two-way-ring-down trunk circuits of common battery switchboards, etc. Contained in treated waterproof fabric cases with adjustable carrying straps.

Brand new **\$29.50**

**25,000 VOLT
CAPACITORS STANDARD
BRANDS**

Inerteen Type FP 25,000 volts .5 MF.D. Size 1 3/8" x 1 6/8" x 4 1/2" with mounting brackets.

Brand new **\$23.50**

15,000 Volts 1MF.D. Cat. No. 1463. Size 12" x 1 6/8" x 4". With mounting flange.

Brand new **\$14.50**

**LINEAR SAWTOOTH
POTENTIOMETER**

W.E. No. KS 15138

Input 24 volts D.C. Output varies in accordance with linear sawtooth wave.

Brand new **\$5.75**

RELAY

Clare octal base Relay No. 30PMX 115V. 60 cy. 0.140 amp. Res. 75 ohms. Makes two breaks one.

Brand new **\$2.45**

**SELENIUM
RECTIFIER**

Bridge Type

Input: 36 V. A.C.
Output: 28 V. D.C., 1.1 Amps.

Brand New **\$2.75**

WESTERN ELECTRIC

**MERCURY
CONTACT
RELAYS**



TYPE D-168479

These relays are glass sealed, mercury-wetted contact switches surrounded by operating coils and encased in metal housings, mounted on an octal tube base.

TYPICAL APPLICATIONS

- High speed keying
- Tabulating, sorting and computing machines
- Relay Amplifiers
- Vibrator Power Supplies
- Servo-mechanisms

CHARACTERISTICS

- High speed of operation
- Constant operating characteristics
- Freedom from chatter
- High current capacity
- Long, trouble-free service

Single Pole, Double Throw Contacts. Two coils of 700 ohms and 3300 ohms. Operating current with coils connected in series 6.6 ma. Release current 5.2 ma. When operated under specified conditions this relay has a life expectancy of 1000 hours at 60 operations per second.

Overall length—3-3/8". Overall dia.—1-5/16"

Brand new
Priced at a fraction
of Government cost **\$4.75**

Send for 4 page Technical data.

MOTOR GENERATORS

Allis Chalmers 115V. D.C. to 120V. 60 cy. 1 Ph. 1.25 K.V.A., P.F. .80 Centrifugal starter. Fully enclosed.

New **\$97.50**

Same as above but for 230V. D.C. **\$125.00**
input

Diehl 120V. D.C. to 120V. A.C., 60 cy., 1 Ph., 2.5 K.V.A., P.F. .4. Complete with magnetic controller, 2 field rheostats and full set of spare parts including spare armatures for generator and motor.

New **\$185.00**

O'Keefe and Merritt, 115V. D.C. to 120V. A.C. 50 cycles, 2 K.V.A., Pf .9 Idles as a 3 phase synchronous motor on 208V. 50 cy.

New **\$165.00**

Electrolux Dynamotor 105/130V. D.C. at 6 amps. to 26 or 13V. D.C. at 20 amps or 40 amps, respectively. Fully filtered for radio use and complete with Square "D" lineswitch. Navy type CAJO-211444.

New **\$74.50**

RADAR EQUIPMENT

Navy Yard Spares for
Model SG Radar
Consisting of the following:

- 2—CRP-20ABM Rectifier Power Units for modulation generators.
- 2—CRP-20ABM Rectifier Power Units for Radar Receivers
- 2—CRP-35AAH Modulation Generators
- 2—CRP-46ABD-1 Radar Receivers (including R-906 Gain Controls for Range and Train Indicators)
- 2—CRP-60AAN Signal Monitors
- 2—Complete Transmitter R.F. System coupling assemblies including—10087 magnets and Duplexing tube cavity assemblies.
- 1—Complete Power Control Chassis
- 2—Complete Driver and modulator assembly including driver chassis with delay line, Modulator and Driver Rectifier Tube Assembly and Driver Rectifier Power Unit
- 2—Complete sets of equipment spare parts consisting of R.F. Assemblies, motors and accessories, switches, interlocks, fuses, fuse holders, fuse links, relays, contacts, crystals, thermostats, R.F. inductors, capacitors, sockets, test equipment, cables, resistors, etc., as listed in Navy Spare Parts List WX3885

All above in new and unused condition packed in original metal spare parts boxes.

Total price for whole lot, **\$950.00**

**THERMOSTATIC
TIME DELAY RELAYS**

Amperite type 115 No-45.

Heater voltage 115V. Normally open SPST contacts. 45 sec. delay. Contact rating 115V-3A., A.C. (or 440V., A.C. 2A.) max. voltage on contacts—1000. max voltage bet. contacts and heater—1500. Size 3 9/32 x 1 1/4" overall. Made for U. S. Navy.



New surplus **\$1.10**

RADAR COMPONENTS

CRP-23AGC Load Dividers for use with S.G. Modernization Kits. New

CBM-50AFO Navy type Radar Repeater Adapters. New and complete with 14 tubes, coax fittings, installation plans and wiring diagrams.

SO Series Radar P.P.I. Units and accessory Control Panels. New

Synchro Amplifiers. New
Type CARD 23AEK Bearing Control Units. New

Type T.D.Y., SO-1, SO-13, SO-3 Radar Antenna Assemblies. New

T.D.Y. Antenna Control Units
Radar Tubes, types 4C35, 7BP7, 3B24, 3C45, 721A, 2J62, 9LP7, 3B22, 1B24, IN21B Crystals, etc.

Radar Crystals Raytheon 98.35 KC
Type SO-11 Radar Modulator
Type SO-1 and SO-3 Transmitter Receivers

**STEPDOWN
TRANSFORMERS**



Input: 115V. 60 cycles.
Output: 20 V., at 10 amps.
Also tapped at 6V., for pilot light. Ideal for Selenium Rectifier Applications, etc.

Brand New **\$2.45**

All prices indicated are F O B Tuckahoe, New York. Shipments will be made via Railway Express unless other instructions issued.

ELECTRONICRAFT

INC.

5 WAVERLY PLACE TUCKAHOE 7, N. Y.
PHONE: TUCKAHOE 3-0044

All merchandise guaranteed. Immediate delivery, subject to prior sale.

All Prices Subject to
Change Without Notice

RELIANCE SPECIALS



UNIVERSAL JOINT ALUMINUM
 1 1/8" long x 1/2" O.D. 1/4" ID
ONLY 40c

STEEL JUNCTION BOX
 Water-tight, 14 ga. steel, 17"x25"x6 1/2". Screw type brass hinge on lid. 50 lb. Reduced to \$2.95

SELSYNS

115 V., 60 Cyc.
 3/4" dia. x 4 1/2" body
 #C78248



\$7.25 pair

DIFFERENTIAL

115 V., 60 Cyc.
 #C78249



\$2.25 ea.

Used between two #C78248's as dampener. Can be converted to a 3600 RPM Motor in 10 Minutes. Conversion sheet supplied.
 Mounting Brackets—(Bakelite) for selsyns and differentials shown above. .25¢ pair

WW PRECISION RESISTORS 1%

1/4 WATT—25c			
6.68Ω	12.32Ω	16.37Ω	123.8Ω
10.45	13.02	20	147.5
10.84	13.52	62.54	220.4
11.25	13.89	79.81	301.8
11.74	14.98	105.8	366.6
15.00			10,000
			59,148
1/2 WATT—25c			
.250Ω	11.1Ω	235Ω	4,451Ω
.334	13.15	260	5,000
.502	46	270	6,900
.557	52	298.3	6,500
.627	65	400	7,000
.76	75	723.1	7,500
1.01	97.8	2,500	8,000
1.63	125	2,850	8,500
2.04	180	3,427	10,000
2.25	210	4,000	14,825
1.01Ω	5.21Ω	1,250Ω	9,000Ω
2.58	10.1	3,300	18,000
3.39	10.9	7,000	50,000
5.95	270		75,000
1 WATT—40c			
100,000Ω	128,000Ω	180,000Ω	470,000Ω
120,000	130,000	250,000	522,000
125,000	160,000	320,000	600,000
			700,000

1 Megohm, 1 Watt, 1%—65c.; 5%—40c

CAPACITORS

POSTAGE STAMP MICAS

8.2mmf	56mmf	200mmf	560.amf	.0015mfd
18	60	220	600	.002
22	90	270	680	.003
25	100	350	800	.0039
28	140	370	.001mfd	.005
40	150	400	.0012	.007
47	160	470	.0013	.008
50	180	500	.00135	.01

Price Schedule
 8.2mmf to .001mfd 5¢ .003mfd to .008mfd 12¢
 .0012mfd to .002mfd 7¢ .01 mfd 18¢

SILVER MICAS

10mmf	125mmf	400mmf	665mmf	.0024mfd
22	150	430	700	.0025
39	180	466	750	.0027
50	200	470	800	.0027
62	240	488	820	.0033
66	250	500	.001mfd	.0039
68	330	510	.0012	.005
100	360	525	.0013	.0051
110	370	540	.0015	.0068
120	390	600	.002	.01

Price Schedule
 10mmf to .001mfd 10¢ .003mfd to .0068mfd 50¢
 .0012mfd to .0027mfd 20¢ .01mfd 65¢

CERAMICS

3mmf	10mmf	22mmf	50mmf	91mmf	200mmf
3.44	15	27	56	110	220
4.7	16	33	68	140	1000
6.8	18	40	75	150	1090
8	20	47	82	180	\$6.09 per 100

MFD	V.D.C.	OIL FILLED	MFD	V.D.C.	Price
.012	25,000	\$14.95	.1	7,000	1.75
.03	25,000	6.20	.02-.02	7,000	\$1.65
.03	16,000	4.50	.1	6,000	8.50
.375@ 16,000 and 8,000 (dual)					
.75-15	8,000	2.85	.03-.03	6,000	1.75
.1	7,500	2.25	.2	4,000	4.50
.1	7,500	8.50	.2	3,000	1.70
.1-1	7,500	1.85	(2.200	750 V.A.C.	.39
		1.95	V.D.C.)		.95
			1	1,000	.90
			2	1,000	.80
			.05	1,000	.65
			1	800	.29
			10	600	1.00
			2	600	.69
			2	600	.39
			1	500	.19
			1	500	.24



2 mfd.
 4,000
 V. D. C.
 #23F47
SPECIAL!
\$4.50

COAXIAL CABLE

RG 8/U 52 Ohm—New—On Reels
 500-999 feet 5¢ per foot
 1,000-19,999 feet 4¢ per foot
 20,000-feet and up 3 1/2¢ per foot

RG 62/U 93 Ohm—New
 200-4,500 feet 6¢ per foot
 5,000 feet and up 4¢ per foot
 RG 22/U New 12¢ per foot

COAXIAL FITTINGS

Angle Adapter 22¢ M-359 83-1AP
 Plug 28¢ PL-259 83-1SP
 Socket 28¢ SO-239 83-1R
 Hood 9¢ 83-1H

PL-259-A or 83-SPN; 28¢-83-1R; 75¢-83-1J; 65¢-83-2R; 83-2AP; UG 13/U; UG 21/U; UG 22/U; UG 24/U; UG 27/U; UG 59/U; UG 87/U; also UG 85/U and UG 281/U with short length of coax attached. EACH ONLY .50¢

PULSE TRANSFORMERS

X 124 T2, UTAH, marked 9262 or 9280, small gray case 1 1/2" high x 1 1/4" x 5/8" with two 6-32 mtg. studs. Ratio 1:1:1, hypersil core. . . \$1.50
 Spec.—10, 11, Chicago Transformer equivalent of 9262 (above) \$1.50
 7172 07, GE, core 3/4" x 1 1/4" x 3/16", 2 windings (0.6 ohm and 0.08 ohm D.C.) . . . \$1.25
 D161810, 50 Kc to 4 Mc, 1 1/4" dia. x 1 1/4" high. 120 to 2350 ohms. \$2.00
 352-7250-2A, cased 15/16" dia. x 1 1/4" high, DC 10 ohm, 3/4 ohm, 140 cc. to 175 Kc . . . \$1.25
 352-7251-2A, similar—shorter pulses . . . \$1.25
 300 KVA GE 7557296, 50 ohm pulse cable connection; 3,850 V. in., 17,300 V. out. (250 KVA @ 1/2 microsecond) \$15.00
 800 KVA G.E. K2731, 28,000 Volt pk. output. Bifilar, pulse width; one-microsecond. . \$19.50

JONES BARRIER STRIPS

Type	Price	Type	Price	Type	Price
2-140Y	\$.05	9-141Y	.42	6-142	.25
3-140 3/4W	.12	10-141	.36	8-142	.38
3-140	.10	10-141 3/4W	.47	10-142	.37
5-140Y	.19	11-141	.36	10-142Y	.64
15-140	.42	12-141	.43	10-142 3/4W	.58
2-141	.09	15-141Y	.69	12-142	.48
5-141Y	.25	17-141	.60	12-142Y	.68
7-141	.26	17-141Y	.78	17-142	.67
8-141	.27	20-141Y	.93	17-142Y	.97
8-141 3/4W	.38	5-142	.21	18-240	.35

Any order for 100 pieces—10% off;
 for 1,000 pieces—20% off.

PRECISION POTENTIOMETERS

6 WATT		4 WATT	
20,000Ω	Muter 314A \$1.70	500Ω	Centralab 48-501 \$9.00
20,000	GR 314A 2.50	50	De jur 292 .75
10,000	De jur 292 .95	50	GR 301 1.10
6,000	GR 314A 2.50	25	GR 301 1.10
6,000	De jur 260 1.70	20	De jur 292 .75
6,000	Muter 314A 1.70	20	GR 301 1.10
5,000	Muter 314A 2.50		
5,000	GR 314A 1.40	12 WATT	
5,000	GR 214A 1.40	10,000Ω	GR 471-AS15 3.50
2,000	De jur 260 1.70	10,000	GR 371T 2.50
600	GR 314A 2.25	10,000	GR 471A 3.50
200	GR 214A 1.40	10,000	Muter 371T 2.50
40	GR 214A 1.40	10,000	De jur 271T 2.00
		5,000	De jur 271T 2.00

ALLEN SET SCREWS

4-40 x 1/8 6-32 x 1/8 8-32 x 3/16
 4-40 x 3/16 8-32 x 1/8 8-32 x 5/16
 ALL SIZES \$1.50 per 100

CHROMALUX STRIP HEATER, 115 V. A. C.

60 Cyc. 750 wattcurved, 20" x 1 1/2". only 95¢

SPAGHETTI SLEEVING—Asst. sizes and colors, 3 ft. lengths. 99 feet—Only \$1.00

VERNIER DIALS—For BC221, 2 5/8" dia. 0-100 85¢

PHASE SHIFT CAPACITOR

4 Stators—single rotor—90° quadrants—
 4 taps—360° rotation.
ONLY \$2.79—Lots of 10 \$25.00

TOGGLE SWITCHES

H & H D.P.D.T.; 3A, 250 V., Molded Body, Bat Handle Only 60¢ ea.
 H & H S.P.D.T.; 6A, 125 v., Molded, Ball Handle \$50 per hundred
 C-H D.P.S.T.; 6A, 124 v., Molded, Bat Handle 30¢ ea.
 C-H D.P.S.T.; 20A., 250V., Molded Bat Handle 35¢ ea.
 H & H Power switch, D.P.D.T., 10A., 125 v., Ball Handle \$1.60 ea.
 C-H D.P.D.T.; Center Off, 20A., 125 v., Bat Handle \$1.75 ea.

115V RELAYS 60 cyc.

Mfg.	No.	Contracts	Price
SD	TD 435 (time delay)	SPST. N.O.	\$2.75
Leach	1355	DPST. N.C.	1.90
Leach	2124 SMX (Mcalux)	4PST. N.O.	3.50
Advance	965 B	DPST. N.O., 10A	2.10
Advance	SA 3000X (Isolantite)	DPLT. 10A	2.95

HANDLES—Brass 5/16" round stock, 4 1/4" long, 1 1/2" high; black, tapped 8-32. 10¢

GEAR ASSORTMENT—Experimenter's dream. Approx. 100 pieces, many stainless. \$6.50

#18 SHIELDED WIRE—65 ft., \$1; 1,000 ft., \$9.95

Glyptal Cement—5 gal. \$11, 1 gal. \$2.50, 1 qt. 75¢
 Thermal Circuit Breakers—2 Amp; 3 Amp; 5 Amp; 6 Amp. EACH 50¢
 G.E. D.C. MOTOR 1/6 H.P. shunt wound armature, 250 VDC @ 0.7 Ampere field, 60 VDC @ 0.37 Amp. \$12.00

BATHTUB CONDENSERS

4 mfd	50 VDC	.21¢	3x.1	600 VDC	.30¢
1 mfd	200 VDC	.08¢	.176	600 VDC	.21¢
2 mfd	200 VDC	.14¢	.25	600 VDC	.23¢
3x.1 mfd	400 VDC	.15¢	.5	600 VDC	.25¢
.2 mfd	400 VDC	.15¢	1	600 VDC	.30¢
.25 mfd	400 VDC	.15¢	2x1	600 VDC	.36¢
.1 mfd	600 VDC	.17¢	2	600 VDC	.36¢
.05 mfd	600 VDC	.15¢	.06	1000 VDC	.17¢
1 mfd	600 VDC	.20¢	1	1000 VDC	.25¢
2x.1 mfd	600 VDC	.27¢	1	1000 VDC	.36¢

Wrapped—BALL BEARINGS—New

Mfg.	ID	OD	Width	Price
Fafnir 55K5	3/16"	1/2"	5/32"	.25¢
ND5202C13M	1/2"	1 3/8"	1 3/8" (dual)	1.25
Fafnir 545	2 1/8"	2 5/8"	15/32"	1.00
ND 38	5/16"	1 3/8"	9/32"	.45¢
Fafnir K8A	1/2"	1 1/8"	5/16"	.60¢
ND 3201	15/32"	1 1/4"	3/8"	.60

NEEDLE BEARINGS

B88 1/2" wide	1/2"	11/16"	25¢
1408 1/2" wide	5/8"	13/16"	30¢
GB34X 1/4" wide	3/16"	11/32"	25¢

BC 1072A IFF X'MITTER

150 to 200 Mcs. 115 V. 60 Cyc.
 POWER SUPPLY gives; 0-5000 v.d.c. (variac control) 312 v.d.c., 700 v.d.c., 6.3 vac. (Also contains: 11 tubes 6J5, 826, 6SN7, 5U4G, etc.), 5 KV. meter, Blower, Condensers and many other useful parts too numerous to list. Slightly used. Shipping wt. 245 lbs.
All This ONLY \$22.50

POWER TRANSFORMER

Pri. 440/220/110 Volts, 60 cyc.
 Sec. #1, 300 V. @ 4A.
 Sec. #2, 300 V. @ 4A.
ONLY \$17.50

TRANSFORMERS

Pri., 115 V.A.C., 60 Cyc.
 Sec.; 24V., 10A.
 \$4.75 ea.—10 for \$45.00

AMMETER

Hoyt Model 515
 0-15 A. DC in metal carrying case (Mirror scale) — Test leads included.
\$3.85 ea.—10 for \$35.

MINIMUM ORDER \$3 All orders f.o.b. PHILA. PA.

RELIANCE MERCHANDIZING CO.
 12th St. Cor. Buttonwood, Phila. 23, Pa. Telephone Market 7-2401

RELAYS

FOR EVERY PURPOSE

Over a Million in Stock!

Whether you require large quantities of relays for production runs or single units for laboratory or amateur work, Wells can make immediate delivery and save you a substantial part of the cost.

Our capable engineering staff is prepared to offer assistance in the selection of correct types to suit your exact requirements.

Each relay is brand new, standard make, inspected, individually boxed and fully guaranteed.

The following list represents only a tiny portion of our relay stock. Write or wire us for information on types not shown.

STANDARD DC TELEPHONE RELAYS

Stock No.	Operating Voltage	Coil Resistance	Contacts	Manufacturer	Net Each
R-101	24V	1500.	DPST (ND)	Auto. Elec.	\$1.35
R-102	24V	400.	SPDT	Auto. Elec.	1.10
R-103	24V	DUAL-1000	3PST (NO)	Auto. Elec.	1.35
R-105	24V	600.	3PST (NO)	Clare	1.20
R-106	24V	1300.	3PST (NC)	Clare	1.25
R-152	12V	50.	DPDT-SPST (NO)	Guardian	1.10
R-153	12V	200.	SPDT-SPST (NO)	Stromberg	1.25
R-154	12V	200.	SPST (NO)	Clare	1.20
R-155	12V	100.	SPST (4NO4NC)	Auto. Elec.	1.15
R-158	6V	50	4PST (NO)	Stromberg	1.10
R-159	6V	50	DPST (NO)	Stromberg	1.10
R-160	6V	12	3PDT-3PST (NO)	Auto. Elec.	1.05
R-161	6V	10	3PST (2NC-1NO)	Auto. Elec.	.90
R-121	150V	5000	2PST (NO) SPDT	Clare	1.65
R-123	150V	6300	SPST (NO)	Clare	1.75
R-602	150V	6500	3PST (NO)	Clare	1.25
R-515	24V	750	SPST (NO)	Clare	1.20
R-517	12V	250	DPST (NO)	Clare	1.20
R-519	250V	14000.	SPDT	Auto. Elec.	1.95
R-520	250V	14000	DPDT	R. B. M.	2.10
R-521	32V	1000.	DPDT	Kellogg	1.50
R-156	24V	DUAL-200.	DPDT-SPST (NO)	Stromberg	1.20
R-168	24V	DUAL-200	4PST (NO)	Auto. Elec.	1.20
H-240	250-350V	40000	DPST (NO)	Auto. Elec.	2.95
H-241	48V	650	SPDT-SPST (NO)	Clare	1.25

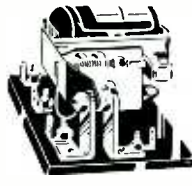

SENSITIVE DC RELAYS

Stock No.	Operating Voltage	Coil Resistance	Contacts	Manufacturer	Net Each
R-218	4-6V	1800.	SPDT	Kurman 220C	\$1.95
R-220	75V	5000	SPDT	Allied Cont.	1.15
R-221	18-24V	5000	SPST (NO)	Allied Cont.	1.15
R-174	250V	5000	DPST (NO)	G. M.	.85
R-175	350V	11000	DPDT-DPST (NO)	G. M.	2.95
R-176	24V	250	DPST (NO)	G. M.	1.50
R-177	24V	300	4PDT	G. M.	1.65
R-600	8-12V	5000	SPDT	S-Dunn-KS	2.10
R-507	24-48V	1000	SPDT-DPST (NC)	Guardian	1.15

CUTLER HAMMER HEAVY DUTY CONTACTORS



Stock No.	Operating Voltage	Coil Resistance	Contacts	Manufacturer	Net Each
R-178	24V DC	100	SPST (NO) 100A	6141H34A	\$3.85
R-179	6V DC	6.5	SPST (NO) 50A	6041H33A	3.00
R-180	12V DC	25.	SPST (NO) 50A	6041H38	3.25
R-181	24V DC	65.	SPST (NO) 100A	6041H8B	3.85
H-232	24V	55.	SPST (NO) 50A	Metal Cased	3.25
H-233	6V	15	SPST (NO) 50A	Metal Cased	3.15
H-235	24V	70.	SPST (NO) 100A	Type B6	3.85

DIRECT CURRENT AIRCRAFT CONTACTORS

Stock No.	Operating Voltage	Coil Resistance	Contacts	Manufacturer	Net Each
R-182	28V	80	SPST (NO) 25 A	Guardian	\$1.85
R-183	24V	60	SPST (NO) 50 A	Allen Bradley	2.75
R-184	28V	50	SPST (NO) 100A.	Type B6A	2.95
R-185	24V	100	SPST (NO) 50 A	Leach 5055ECR	2.75
R-186	24V	132	SPST (NO) 50 A	Leach 7220-3-243 50	2.95
R-187	24V	100	SPST (NO) 50 A	Allen Bradley	2.95
R-188	24V	200	SPST (NO) 75 A	Allied Cont.	2.95
H-234	14V	45	SPST (NO) 30 A.	—	1.65

TYPE 18 DC TELEPHONE RELAYS

Stock No.	Operating Voltage	Coil Resistance	Contacts	Manufacturer	Net Each
R-109	24-48V	4000.	SPDT	Auto. Elec.	\$1.50
R-110	24-32V	3500	SPDT	Auto. Elec.	1.50
R-112	90-120V	6500	SPST (NC)	Auto. Elec.	1.30
R-114	24V	4000	4PST (NO)	Auto. Elec.	1.30
R-603	24V	400	DPST (NO)	Auto. Elec.	1.25
H-238	24V	150	DPDT-SPST (NC)	R. B. M.	1.25
H-239	24V	180	DPST (NO)	Auto. Elec.	1.25



SEALED DC TELEPHONE RELAYS

Stock No.	Operating Voltage	Coil Resistance	Contacts	Manufacturer	Net Each
R-125	24V	300.	DPDT	Clare	\$2.75
R-126	90-120V	2000	DPDT	Clare	3.00
R-504	24-70V	2800	SPDT	GE-C103C25	3.00

V TYPE DC TELEPHONE RELAYS

Stock No.	Operating Voltage	Coil Resistance	Contacts	Manufacturer	Net Each
R-152	24-32V	1000.	SPST (NO)	W. E.	\$1.20
R-164	24-48V	3500.	DPDT	W. E.	1.50
R-513	12-24V	300	DPDT-SPST (NC)	W. E.	1.20
R-514	4-6V	60	SPDT	W. E.	1.05
R-526	6V	35	DPDT-SPST (INC-1ND)	W. E.	1.05

AC-STANDARD TELEPHONE RELAYS

Stock No.	Operating Voltage	Coil Resistance	Contacts	Manufacturer	Net Each
R-212	90-135V	—	NONE	Clare	\$0.95
R-213	5-8V	—	DPST (NO)	Clare	1.50
R-605	24V	—	3PST (NO)	Auto. Elec.	.95
R-606	24V	—	DPST (1NO-1NC)	Auto. Elec.	.95
R-607	24V	—	SPST (NO)	Auto. Elec.	.95



DIRECT CURRENT MIDGELET RELAYS

Stock No.	Operating Voltage	Coil Resistance	Contacts	Manufacturer	Net Each
R-132	24V	300	DPDT	Clare	\$1.20
R-133	24V	300	NONE	Clare	.60
R-134	24V	250	4PDT	Clare	1.20
R-135	24V	300	SPST (NC)	Clare	1.15
R-137	24V	300	SPDT	Clare	1.15
R-138	24V	300	4PST (NO)	Clare	1.15
R-139	24V	280	4PDT	Clare	1.15
R-140	24V	280	SPDT	R. B. M.	1.15
R-141	24V	280	3PST (NO)	R. B. M.	1.15
R-142	24V	400	DPDT	Allied Cont.	1.20
R-143	24V	280	SPST (NO)	R. B. M.	1.15
R-144	24V	250	SPST (NO)	Allied Cont.	1.15
R-145	24V	100	DPST (NO)	Allied Cont.	1.15
R-146	12V	126	DPST (1ND) (1NC)	Clare	1.10
R-147	9-14V	75	SPST (NO)	Clare	1.05
R-148	12V	100	DPDT-SPST (NC)	Price Bros.	1.00
R-149	6-8V	45	SPST (NC)	Clare	1.00
R-150	6V	30	SPST (NO)	E-Z Elec.	.95
R-522	2-6V	2.	SPST (ND)	R. B. M.	.65
R-523	90-125V	6500	DPDT	Clare	1.90
H-222	12V	100	DPST (NO)	P & B	.95
H-242	24-32V	300	DPDT	R. B. M.	1.20
H-243	24-32V	300	4PDT	R. B. M.	1.20

TYPE B0 DC RELAYS

Stock No.	Operating Voltage	Coil Resistance	Contacts	Manufacturer	Net Each
R-169	24V	250	SPST (NO)	Allied Cont.	\$1.95
R-171	24V	230	DPDT	Allied Cont.	2.15
R-172	5-8V	30	DPDT-SPST (NO)	Allied Cont.	1.70
R-173	2-6V	5	SPST (NO)	Allied Cont.	1.25
R-529	24-48V	1000	DPDT	Allied Cont.	2.50

TYPE BJ DC RELAYS

Stock No.	Operating Voltage	Coil Resistance	Contacts	Manufacturer	Net Each
R-204	12V	65	DPST (NO)	Allied Cont.	\$1.15
R-205	24V	260	DPDT	Allied Cont.	1.25
R-224	12V	75	SPST (NO)	Allied Cont.	1.15
H-237	27V	230	DPDT	Allied Cont.	1.25

HEAVY DUTY KEYING RELAYS

Stock No.	Operating Voltage	Coil Resistance	Contacts	Manufacturer	Net Each
R-248	28V DC	150	SPST (NO) 10A.	Guard 36471	\$1.05
R-244	75V AC	265	SPST (NO) 20A.	Leach 1327	1.75
R-206	24V DC	150	5PDT-3 AMP	P&B-KL	1.20
R-207	24V DC	210	4PDT-3 AMP	P&B-KL	1.10
R-219	50V DC	1500	DPST (NO) 15A.	P&B-SP	1.25
R-217	115 AC	600	SPDT-10 AMP	St. Dunn 1XAX2	2.25
R-525	24V DC	200	DPDT-10 AMP	Guard 34464	1.25
R-508	110 AC	600	SPDT-6 AMP	Guard 37189	1.95
R-506	24 V DC	300	DPST (NO) 6A.	—	.95
R-510	24 V DC	200	3PDT-10 AMP	Guard 516983	1.05
R-604	24 V DC	200	SPST (NO) 30A	St. Dunn B2A	1.25
H-608	115 AC	35	SPST (NO) 20A	St. Dunn IHXX25	2.25
R-620	12V DC	150	3PST (NO) 10A.	Guard Bx2	1.05
R-223	28V DC	150	SPST (NO) 40A.	Price Bros	1.20
H-230	12-24V DC	80.	SPST (NO) 10A.	Guard Bx2	1.20
H-231	24V	230.	DPST (NO) 5A	R. B. M.	1.15

DC-TYPE 76 ROTARY RELAYS

Stock No.	Operating Voltage	Coil Resistance	Contacts	Manufacturer	Net Each
R-197	9-16V	70	DPDT	Price Bros.	\$1.65
R-198	9-16V	125	DPST (3NO)	Price Bros.	1.65
R-199	24-32V	250	SPDT-SPST (NC)	Price Bros.	1.65
R-200	24-32V	275	3PDT-SPST (NC)	Price Bros.	1.65
R-201	24-32V	250	DPST (NO) SPDT	Price Bros.	1.65
R-601	9-14V	60.	(NC) DPDT	Price Bros.	1.65
			3PST (NO)	Price Bros.	1.65



DIRECT CURRENT KEYING RELAYS

Stock No.	Operating Voltage	Coil Resistance	Contacts	Manufacturer	Net Each
R-190	12V	65	DPDT 10 AMP	Advance Elec.	\$1.15
R-191	28V	125	DPDT 10 AMP	Type 2000-A	1.20
R-192	12V	44	3PDT 10 AMP	Guardian	1.35
R-193	5-8V	11	DPDT 10 AMP	Type NBS	1.35
R-194	24V	265	SPST (NO)	Leach	1.05
R-195	6V	32	DPST (NO) 10 AMP	Type 1027	1.05
R-196	12V	-50	DPST (NO) 10 AMP	Type 1054SNW	1.25
R-195	6V	32	DPDT 3 AMP	G.E. Co.	1.15
R-242	24V	170	DPDT 10 AMP	Guardian	1.15
H-236	5-8V	18.5	SPDT 10 AMP	Type 1253DEW	1.25
				Leach-HFM	1.05

ANTENNA CHANGEOVER RELAYS

Stock No.	Operating Voltage	Coil Resistance	Contacts	Manufacturer	Net Each
R-192	6 1/2V DC	44	2PDT 10 AMP	Allied-NBS	\$1.35
R-231	12VDC	100.	DPDT 6 AMP	G. E.	1.95
R-256	24-32V DC	—	SPDT-DPST (NC) 1KW	Guardian	1.45
R-501	110 AC	4	DPDT (1KW)	G. E.	2.45
R-503	12-32V DC	100	SPDT-5PST	G. E.-500 W.	1.95

COMBINATION PUSH BUTTON AND REMOTE RELAY

Stock No.	Operating Voltage	Coil Resistance	Contacts	Manufacturer	Net Each
H-244	12-24 V DC	Dual-60	SPDT	CR2791-R106C8	\$1.65

ADJUSTABLE TIME DELAY RELAY

Stock No.	Operating Voltage	Coil Resistance	Contacts	Manufacturer	Net Each
R-246	115 AC	—	SPST (NO) or (NC) 10 AMPS	R. W. Gramer 1-120 Sec.	\$8.95

DC MECHANICAL ACTION RELAYS

Stock No.	Operating Voltage	Coil Resistance	Contacts	Manufacturer	Net Each
R-245	12V	25.	4' Lever	G. M.	\$0.95
R-527	6-12V	200.	2' Lever	G. M.	.95

TYPE C.M.S. RELAY

Stock No.	Operating Voltage	Coil Resistance	Contacts	Manufacturer	Net Each
R-511	24V DC	200	CONTACTS MICRO-SW. SPST (NO)	Clare	\$2.45

DC CURRENT REGULATOR

Stock No.	Operating Voltage	Coil Resistance	Contacts	Manufacturer	Net Each
R-509	6-12V DC	40	SPST (NC)	G. E.	\$0.85

LATCH AND RESET RELAY

Stock No.	Operating Voltage	Coil Resistance	Contacts	Manufacturer	Net Each
R-500	12V DC				

SEARCHLIGHT SECTION

ANNOUNCING!
Greater Values Than Ever Before in Our
New Larger Store at 137 Greenwich St.,
N. Y. 7. (Come in and Browse Around)
Formerly 63 Dey St.



LUCKY "7"

TWO-SPEED PLANETARY DRIVE

Auxiliary Speed Reducer fits on Condenser Shaft back of panel or on dial knob shafts. Ratios 5 to 1 and 1 to 1. Fits any 1/4 inch round shaft.

57c Each—Two for .97c

PERMALLOY SHIELDS for CATHODE RAY TUBES

3" Shield \$1.47
5" Shield 1.97

TRANSMITTING KEY

General purpose transmitting key on a heavy die cast base, all mounted on a swinging bracket thigh clamp. 3/8" pure silver contacts. Key can be easily removed from clamp. Adjustable bearings. Supplied with 5-foot cable and PL-55 phone plug.

Brand New. Each 57c

SELENIUM RECTIFIERS Full Wave Bridge Type

INPUT		OUTPUT		
up to 18v AC	up to 12v DC	1/2 Amp.	\$1.47	
up to 18v AC	up to 12v DC	1 Amp.	1.97	
up to 18v AC	up to 12v DC	5 Amp.	5.27	
up to 18v AC	up to 12v DC	10 Amp.	8.97	
up to 18v AC	up to 12v DC	15 Amp.	11.57	
up to 18v AC	up to 12v DC	30 Amp.	22.57	
up to 36v AC	up to 28v DC	1 Amp.	3.47	
up to 36v AC	up to 28v DC	5 Amp.	8.57	
up to 36v AC	up to 28v DC	10 Amp.	14.57	
up to 36v AC	up to 28v DC	15 Amp.	22.27	
up to 115v AC	up to 100v DC	.25 Amp.	2.57	
up to 115v AC	up to 100v DC	.6 Amp.	5.27	
up to 115v AC	up to 100v DC	5 Amp.	22.57	
up to 115v AC	up to 100v DC	3 Amp.	17.97	

OIL CONDENSERS NATIONALLY ADVERTISED BRANDS All Ratings D. C.

2x.1mfd. 900v	\$0.37	1mfd. 2000v	\$0.97
.25mfd. 900v	.37	2mfd. 2000v	1.27
.5mfd. 900v	.37	4mfd. 2000v	3.77
1mfd. 900v	.37	8mfd. 2000v	3.47
2mfd. 900v	.37	15mfd. 2000v	4.87
4mfd. 600v	.57	4mfd. 2500v	3.87
5mfd. 600v	1.07	2mfd. 2500v	2.37
10mfd. 600v	1.17	1mfd. 2500v	1.47
3x.1mfd. 1000v	.47	.25mfd. 2500v	1.77
.25mfd. 1000v	.47	.5mfd. 2500v	1.77
1mfd. 1000v	.57	.05mfd. 3000v	1.97
2mfd. 1000v	.67	.25mfd. 3000v	2.67
4mfd. 1000v	.87	1mfd. 3000v	2.87
8mfd. 1000v	1.97	12mfd. 3000v	6.97
10mfd. 1000v	2.07	2mfd. 4000v	4.87
15mfd. 1000v	2.27	1mfd. 5000v	4.97
20mfd. 1000v	2.97	.1mfd. 7000v	2.97
24mfd. 1500v	5.27	3mfd. 4000v	3.37
.1mfd. 1750v	.87	2mfd. 3000v	3.47
.1mfd. 2000v	.97	2x.1mfd. 7000v	3.27
.25mfd. 2000v	1.07	.02mfd. 12000v	9.97
.5mfd. 2000v	1.17		

HIGH CAPACITY CONDENSERS

10,000 mfd.—25 WVDC	\$4.97
2x3500 mfd.—25 WVDC	3.47
2500 mfd.—3 VDC	.37
3000 mfd.—25 WVDC	2.47
2x1250 mfd.—10 VDC	1.27
1000 mfd.—15 WVDC	.97
200 mfd.—35 VDC	.57
100 mfd.—50 WVDC	.47
4x10 mfd.—40 VDC	.87
4000 mfd.—18 WVDC	1.97
4000 mfd.—25 WVDC	2.47
4000 mfd.—30 WVDC	2.97

PHONE DIGBY 9-0347

RADIO TUBES

NEW! STANDARD BRANDS!

1B24	\$4.87	802	\$2.97	OZ4	\$.67
1B26	3.97	803	4.87	1A5GT	.47
1B29	3.47	804	6.57	1A7GT	.67
1B32	1.97	805	3.87	1H5GT	.57
1N21	.67	807	1.07	1L4	.67
1N23	.77	808	1.57	1LC6	.87
1N34	1.37	809	2.47	1LD5	.77
1P24	.87	810	5.97	1LE3	.97
2A1P	3.27	811	1.97	1LH4	.77
2C21	.27	812	2.47	1LN5	.67
2C22	.17	813	6.47	1N5GT	.57
2C26A	.27	814	2.67	1R5	.67
2C34	.27	815	1.87	1S4	.67
2C40	3.57	816	1.07	1S5	.57
2C44	.77	826	.47	1T4	.57
2C46	6.87	829B	5.97	2A3	.97
2D21	1.07	830B	3.57	3A5	1.37
2J21	9.87	832A	4.57	3S4	.67
2J22	9.87	833A	29.97	3Q4	.67
2J26	9.87	836A	.97	3Q5	.67
2J48	19.97	837	1.27	3T4	.47
2J54B	23.97	838	2.87	5U4G	.47
2K25	23.97	841	.47	5V4	.87
2K28	11.57	843	.37	5V4	.67
2V3G	.97	845	4.17	5X4	.57
2X2	.37	851	24.97	5Y3	.37
3AP1	3.97	860	18.87	5Y4	.47
3B22	2.97	861	10.87	5Z3	.47
3B24	1.87	862A	497.47	5Z4	.77
3B26	1.47	864	.47	6A7	.67
3BP1	1.37	865	.97	6A8GT	.67
3CP1	2.67	866A	1.17	6AK5	.77
3C21	3.97	866JR	1.17	6AC7	.77
3C23	2.47	869B	27.57	6A5	.87
3C24/24G	.47	872A	1.47	6AG7	1.17
3C30	.37	874	.57	6AJ5	.87
3C31	1.47	876	.67	6AK5	.87
3D21A	1.47	878	1.27	6AL5	.67
3D21	1.97	879	1.27	6AQ5	.67
3E29	5.97	885	.77	6AQ6	.67
3GP1	4.97	902P1	4.97	6AT6	.47
4AP10	2.97	905	1.87	6AU6	.77
4B24	2.27	923	.87	6B4C	.97
4E27	12.97	927	.87	6BG6G	.97
5A3	3.97	928	.37	6BE6	.67
5BP1	1.47	956	.37	6B8	.87
5BP4	2.47	957	.27	6C4	.27
5CP1	1.97	958A	.27	6C5	.27
5CP1A	8.97	1613	.57	6C6	.57
5D21	34.97	1614	.87	6D6	.47
5E27	1.97	1619	.27	6F6	.57
5JP2	11.97	1624	.77	6F7	.57
5LP1	13.97	1625	.37	6G6	.77
5NP1	8.97	1626	.37	6H6	.47
5RA4Y	1.17	1629	.27	6J5	.47
6C21	24.97	1630	1.87	6J6	.47
6L4	5.87	1636	3.97	6J7	.67
9GP7	9.97	1638	1.47	6K6	.47
9J1P	3.57	1641	.57	6K7	.57
9L7P	3.57	1654	1.97	6L6	1.17
10Y	.37	1851	.97	6L8G	.97
12DP7	12.97	1860	2.97	6L7	.87
12GP7	12.97	2050	.47	6N7	.77
15E	1.97	2051	.67	6Q7	.67
15R	.77	8011	1.27	6S7	.47
15D7	.37	8012A	1.47	6SCT	.67
30 Spcec.	.27	8013A	1.87	6SF5	.57
45 Spec.	.47	8016	.97	6SG7	.67
75TL	2.87	8020	1.47	6SH7	.47
100R	1.47	8025	3.57	6SK7	.47
100TH	9.97	9001	.37	6SL7	.57
100FS	2.37	9002	.37	6SN7	.57
227A	2.27	9003	.37	6SQ7	.47
249C	2.57	9004	.37	6V6GT	.67
250R	9.97	9006	.27	6Z5Y5G	.87
250TH	19.47	C6J	3.97	12A6	.17
250TL	19.47	CK5007AX	1.47	12AT6	.57
294A	4.97	ML1001	1.37	12C6	.37
304TH	3.47	CK1090	1.27	12J5GT	.57
304TL	.97	E1148	.67	12SA7GT	.57
305A	12.47	EF50	.47	12SK7GT	.57
307A	3.97	F123A	9.97	12S87GT	.57
316A	1.67	F128A	17.97	12SL7GT	.67
327A	2.97	F128A	39.47	12SQ7GT	.57
350B	1.47	F660	39.47	12SR7GT	.57
368AS	3.27	F862A	497.47	14A7	.87
371B	.97	FG17	2.87	14Q7	.57
378A	1.97	FG81A	3.97	24A	.67
434A	3.27	FG95	8.97	25P6GT	.57
446A	.67	FG105	9.97	25Z5	.47
450TH	18.47	GL697	29.47	27	.47
451	1.47	HY619	.37	35/51	.57
530	22.57	HY615	3.97	35L6GT	.57
551	4.97	ML1001	1.37	35Z5	.47
582	2.87	ML101	29.47	45	.57
559	.87	ML502	39.47	50B5	.67
575A	12.97	RK59	1.97	50L6GT	.57
703A	3.27	RK60	.57	56	.47
705A	1.97	RK72	1.37	76	.47
706GY	18.97	RK73	1.67	77	.47
707B	8.47	RK75	3.97	80	.47
708A	1.97	RK705	1.97	83	.77
718A	1.27	RX21	3.27	84/6Z4	.67
715B	7.57	RX120	9.97	117Z3	.57
715C	34.97	S836	2.97	117Z6GT	.87
717A	.67	VR75	.97		
721A	1.97	VR78	.37		
723AB	12.97	VR90	.67		
725A	12.87	VR105	.67		
726A	7.97	VR150	.57		
750TL	44.97	VU127A	2.37		
800	.97	VU111	.37		
801A	.47				

NOW AVAILABLE

1000 KC Crystal \$2.97
Socket07

RF VACUUM SWITCH GE-1S21

9200 volts peak, 8 amps. Used as antenna switch in Collins Art 13.

Brand New \$2.47

TRANSFORMER—115 V. 60 Cy. HI-VOLTAGE INSULATION

2500v @ 15 ma	\$4.97
2150v @ 15 ma	3.97
2100v @ 10 ma	4.87
1800v @ 10 ma; 6.3v @ 2A; 2.5v @ 2A	4.97
1750v @ 4 ma; 6.3v @ 3A	4.27
1600v @ 4 ma; 700v CT @ 150 ma; 6.3v @ 9A	6.47
525-0-525v @ 60 ma; 925v @ 10 ma; 2x 5v @ 3A; 6.3v @ 3.6A; 6.3v @ 2A; 6.3v @ 1A	6.97
500-0-500v @ 25 ma; 262-0-262v @ 55 ma; 6.3v @ 1A; 2x5v @ 2A	4.47
500-0-500v @ 100 ma; 5v CT @ 3A	3.97
450-0-450v @ 300 ma; 140-0-140v @ 100 ma; 36v @ 1A, 6.3v @ 5A, 5v @ 3A, 110/220 Dual, Pri	7.97
400-315-0-100-315v @ 200 ma; 2.5v @ 2A; 5v @ 3A; 6.3v @ 9A; 6.3v @ 9A	5.97
385-0-385-550v @ 200 ma; 2 1/2v @ 2A; 5v @ 3A; 3x6.3v @ 6A—PRI. 110/220	6.27
340-0-340v @ 300 ma; 1540v @ 5 ma	4.97
300-0-300v @ 65 ma; 2x5v @ 2A; 6.3v @ 2 1/2A; 6.3v @ 1A	3.47
150-0-150v @ 80 ma; 150v @ 40 ma; 6.3v @ 3.5A; 6.3v @ 1A	1.97
120-0-120v @ 50 ma	.97
80-0-80v @ 225 ma; 5v @ 2A; 5v @ 4A	3.97
24v @ 6A	3.47
13.5v CT @ 3.25A	2.97
3x10.3 @ 7A; CT	7.97
6.3v @ 12v; 6.3v @ 2A; 115v @ 1A	

GUARANTEED GOVT SURPLUS

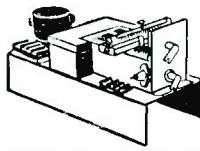

420-750 MC OSCILLATOR.

Compact, beautifully built line oscillator employing two W.E. 368AS (703A) "door-knob" tubes in push-pull. Exceptionally stable. 5W output at 420mc, 2W at 700mc. Independent grid and plate tuning. Adjustable output coupling and tuning assembly. Coaxial output connection. Built-in blower may be operated from 110VAC. Power requirements: 300VDC/150ma, 1.2V/4A, 1.2V/4A. 5 1/2"x6 1/2"x11 1/2". 7 lb. Supplied complete with tubes. Ideal for 420mc amateur operation or for use in the 460-470mc citizens radio band. **Stock No. APO-66. \$8.95**
Spare 368AS/703A tubes.....\$1.69 ea.



UHF 50 OHM COAXIAL POWER MEASURING ASSEMBLY. Panel mounting, silver-plated assembly with integrally coupled crystal mount. Type "N" UG-58U female receptacle (easily replaced by SO-239). Originally designed for power measurement at frequencies up to 700mc. **Stock No. APM-89 \$3.95**
MATING TYPE "N" MALE PLUG. For use with above. **Stock No. PCM-17. \$0.49**

SPERRY MODEL 12 KLYSTRON TUNER for use with 2K39, 2K42, 2K43, 2K44, 417A. **Stock No. VKT-27. \$1.95**
MAGNETRON MAGNET 1900 GAUSS. Pole dia. 1-1/8". Gap 1 1/2". **Stock No. UMM-21. \$5.75**
MAGNETRON MAGNET 4800 GAUSS. Pole dia. 1-1/8". Gap 0.635". **Stock No. UMM-18. \$7.00**

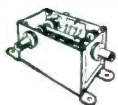

50 OHM COAXIAL RELAY. Double coil actuating relay operates from either 12VDC/120ma or 24VDC/60ma. May be operated in plate return circuits to provide automatic transmitter-receiver antenna changeover. Supplied with British type connectors which are easily replaced by standard SO-239 (83-1R) receptacles or soldered to directly. Completely enclosed in compact housing. 2-3/4" x 3" x 4-3/4". An outstanding buy at \$2.49. **Stock No. KDC-725.**

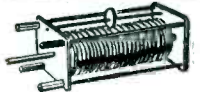

VARIABLE INDUCTOR. 67 microhenries max. Minimum near zero. Wheel type sliding short. Ceramic insulation. Quality construction. Barker-Williamson #1585. Originally used as transmitter plate tank coil to tune from 1 1/2 to 20mc. Ideal for pin-networks, antenna tuners and plate tanks. **Stock No. LRF-32. \$1.95**

APC AIR TRIMMER. 35 mmf max. Screw slot adjustment. **Stock No. CAV-105. 10 for \$1.00**

APC AIR TRIMMER. Two separate trimmers on ceramic base. Shield between sections. Each section 25 mmf max. **Stock No. CAV-104. 10 for \$1.00**

AIR CAPACITOR 100 MMF MAX. 1/4" dia. shaft. Receiving type. Ceramic insulation. Standard Brand. Similar to MC-100-M. Straight-line capacity. **Stock No. CAV-15. \$0.72**

SUPER-FLEXIBLE PIGTAIL WIRE. Sperry Special. Part No. P55357. Consists of 350 strands of 0.002" diameter soft copper wire. Total diameter: 1/32". Useful in applications where electrical connection is to be made to moving parts, e.g., variometers, variable capacitors, motor-brushes, etc. **Stock No. WFP-350. 10 foot rolls. \$0.69 per roll.**



750 CPS BANDPASS TRANSFORMER. Center frequency adjustable over a small range. Input 23,000 ohms. Output 225,000 ohms. Triple alloy shielded. 1 1/2" x 1 1/2" x 2". **Stock No. ZBP-750. \$2.49**

BLOCKING OSCILLATOR TRANSFORMER. Two winding 1.35:1. Ideal for television sweep oscillators. Compact. **Stock No. TFF-64. \$0.95**

NON-INDUCTIVE CERAMIC RESISTOR. 350 ohms/24 watt. Standard Brand. **Stock No. RCF-52. 8 for \$1.00**

Tube Specials

1A7GT	\$0.72	6Q7	.72	215A	.95
1G6GT	.49	6SA7GT	.60	301TH	7.75
1V	.49	6SC7	.69	304TL	1.95
2A3	.98	6SF7	.72	316A	.89
2C4	.95	6SH7GT	.39	350A	2.95
2C21/1642	.29	6SJ7GT	.59	417A	14.95
2C34/RK34	.29	6SK7GT	.49	555	1.19
2C40	1.98	6SK7	.72	705A	2.95
2C44	.75	6SL7GT	.69	723A/B	9.95
2D21	1.49	6SN7GT	.79	725A	14.95
2J26	14.95	6SR7	.67	730A	12.50
2J38	14.95	6SU7GT/Y	1.25	801	.79
2J48	15.95	6V6GT	.79	803	8.95
2J55	39.75	6V6	1.09	805	3.95
2K28	12.95	6X4	.69	807	1.19
2X2	.69	6X5GT	.63	811	1.95
3B7/1291	.39	6Y6G	.88	813	7.95
3C23	2.95	6ZY5G	.81	814	3.95
3D21A	1.95	7C7	.81	815	1.95
3E29	3.49	7E6	.72	836	.89
3FP7	1.95	7G7	1.06	837	1.49
3Q4	.69	7H7	.72	861	15.00
4A1	.49	7O7	.72	866A	.95
5BP1	1.95	7V7	.72	872A	1.69
5CP1	1.95	7Y4	.72	874	.59
5R4GY	1.09	7Z4	.72	902A	3.95
5U4G	.65	12SF7	.59	931A	3.95
5V4G	1.09	12SG7	.59	954	.39
5Y3GT/G	.49	12SH7	.59	955	.39
6AC7	.79	12SJ7	.59	956	.49
6AE5GT	.79	12SL7GT	.79	957	.39
6AG7	1.29	12SQ7	.65	958A	.39
6AK5	1.29	12SR7	.72	959	.39
6AU6	.95	14F7	.72	991/NE-16	.29
6C4	.49	14H7	.79	1625	.49
6C8G	.72	14X7	.72	1626	.39
6F8	.89	RK21	.72	1629	.29
6F8G	.89	Z5Z5	.59	1641/RK60	.95
6G6G	.49	25Z6GT	.59	2050	.79
6H6	.49	35W4	.49	8013	1.49
6H8GT/G	.29	46	.72	9001	.39
6J5	.57	6F50	.49	9002	.39
6L6	1.15	RK69	1.49	9003	.39
6J7	.69	RKR72	1.49	9004	.39
6K8GT/G	.65	RKR73	.39	9005	.79
6K8	.88	80	.45	9006	.39
6L6	1.28	85	.72	VR90	.69
6L6GA	.89	9Y	.54	VR105	.69
6L7	.98	117Z6GT/G	.88	VR150	.59
6N7	.95	FG178	1.95		
6N7GT	.79	211	.69		

Wide Range Butterfly Wavemeter & Oscillator Elements

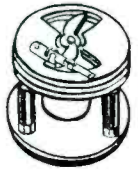

Precision wide range butterfly circuit elements. Sturdily constructed. Mounted in ball bearings. Suitable for motor drive. Ideal for use as wavemeters and oscillators (see description below).

Stock No.	Freq. (mc.)	Notes*	Unit Price
TN-20	105-330	1, 3	\$2.95
TN2A	75-330	1, 4	2.95
TN-30	135-155	2, 3	3.95
TN3A	300-1000	2, 6	4.95

*NOTES: 1) Aluminum construction

- 2) Silver-plated brass
- 3) Designed as oscillator element (955 acorn triode)
- 4) Has diode socket mounted on unit (955 as diode)
- 5) Has crystal diode mount for 1N21 crystal

BILLEY SMC-100 100 AND 1000KC CRYSTAL. Regularly sells for \$8.75. **Stock No. QCM-19. \$5.95**

HAMMARLUND CERAMIC ACORN SOCKETS. 5 contact. Silver-Plated. **Stock No. XRT-25. 20 for \$1.00**

CINCH MICA FILLED OCTAL SOCKETS. 1" dia. 1-5/16" mtg ctrs. **Stock No. XRT-20. 20 for \$1.00**
1-1/2" dia. 1 1/2" mtg. ctrs. **Stock No. XRT-40. 20 for \$1.00**

DELAY LINE. 2 microsecond (one direction). 1500 ohms. Bandwidth 1mc. 8 section tapped. **Stock No. ZAL-22. \$1.69**

DELAY LINE. 1 1/2 microsecond (one direction). 1500 ohms. Bandwidth 1mc. 6 section tapped. **Stock No. ZAL-13. \$1.49**

DELAY LINE. 5 microsecond (one direction). 1500 ohms. Bandwidth 1/2mc. **Stock No. ZAL-14. \$0.89**

4200 VOLT TELEVISION OR SCOPE TRANSFORMER. Primary: 115V/60c. Secondary: 3000VRMS (4200 Volts Peak) 10ma. Hermetically sealed. 4 1/2"x4-3/4"x5 1/2". **Stock No. TFF-83. \$5.95**

HV TFMR. 10,000-0-10,000 VOLTS @42 MA. Oil-filled, hermetically sealed. 11"x13"x6". Pri. 115V/50-60cy. **Stock No. TFF-451. \$29.95**

FILTER CHOKES

Stock No.	Description	Price
LFF-45	10H/120ma/600 ohms	\$0.95
LFF-21	20H/30ma/125 ohms/5000V	0.95
LFF-144	21H/700ma/16 ohms/1500V	4.95

MULTIPLIER PHOTOTUBE HOUSING. Cast aluminum cylindrical housing containing a submagnal 11 pin socket (for 931A, 1P21, 1P22) and a dynode voltage divider network. Moisture proof construction. An integral 6 volt pilot lamp provides light source when used as a noise generator. A window may be drilled in the housing for use with an external light source. Operates with approximately 700 volts at 3-4ma. 2" dia. x 4" long. Supplied less phototube. **Stock No. AMP-65. \$3.95**

PRECISION HIGH TORQUE TYPE 5 SELSYNS. Bronze housing 4 1/2" dia. x 5" long. 115V/60c operation. Brand new in original packing. **Stock No. SEL-44. \$4.95 each**

110/60CPS/0.38A BLOWER

Exceptionally quiet. 50 cu. ft. min. **Stock No. BLR-344. \$8.95**



3" SCOPE INDICATOR

3BP1 cathode ray tube mounted in a mu-metal housing with an adjustable light shield. May be mounted on a panel, tabletop or clamped to a bar. When mounted on a table top or wall, the scope housing may be tilted at any angle up to 45° from the mount for comfortable viewing. Ideal for remote scope indicators. An outstanding buy at \$5.95. **Stock No. ASI-35.**



OIL-FILLED CAPACITORS

Mfd	Rating	Price	Mfd	Rating	Price
2-2	600 VDC	\$0.75	0.1	5000 VDC	\$1.95
4	600 VDC	.84	2	5000 VDC	7.30
7	600 VDC	1.15	1	6000 VDC	6.95
10	600 VDC	1.37	1-1	7000 VDC	1.95
50	330 VAC	4.95	05	7500 VDC	1.75
2	1000 VDC	.95	2	7500 VDC	11.95
4	1000 VDC	1.19	.02	10 KV DC	2.95
8	1000 VDC	1.71	1	15 KV DC	19.95
0.25	250 VDC	1.06	0.25	20 KV DC	15.95
2	4000 VDC	4.95	15	440 VAC	
3	4000 VDC	5.95		1500 VDC	2.95

Note: 10 or more capacitors of a type 10% dis.

RF and DC PANEL METERS

Stock	Description	Price
MAD-251	0-2 ma DC Westinghouse 3 1/2" round	\$3.95
MAD-262	0-20 ma DC Westinghouse 3 1/2" round	3.95
MAD-265	0-80 ma DC W.E. 3 1/2" round	3.49
MAD-503	0-100 ma DC Deur 3 1/2" round	3.95
MAD-276	0-30 ADC GE 2 1/2" round	2.95
MRT-355	0-100 ma RF Weston 425 3 1/2" round	11.95
MRT-372	0-120 ma RF Weston 507 2 1/2" round	8.95
MRT-367	0-1A RF GE 2 1/2" round	2.95
MRT-394	0-20A RF GE 3 1/2" round	6.95

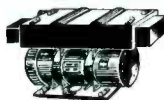

INVERTER PE 218D.

Output 115V/400 cps/1500VA/lph. Input 24-28 VDC. Made by Winchester. Complete with starting delays, hash filters, voltage and speed regulators.

regulators. 5 1/2"x11"x15". Brand new in original packing. **Stock No. GAC-10. \$27.50**

Delivery: Inmed. from stock (subj. to prior sale). Minimum Order: \$5.00. Terms: Rated organizations (U. S. and Canada). Open account. Others: Cash with order, or 20% with order, balance C. O. D. Foreign: Payment in U. S. funds with order or irrevocable letter of credit payable against documents in U. S. funds at New York. Condition of material: The major portion of the material listed above is brand new. Some of the items have been removed from new equipments. We guarantee material to be clean and in perfect operating condition. All prices above are quoted domestic packed f.o.b. our warehouse, Corona, New York.

DUBIN

Tel. Hickory 6-3066-7-8 Cable: "Dublectron, New York". We will be pleased to send our bulletins to you regularly. Write or phone Dept. E-6 for our latest catalog.
ELECTRONICS CO. INC., 103-02 NORTHERN BLVD., CORONA, N. Y.

Finest of Surplus PEAK ELECTRONICS CO. Fraction of Cost

H.V.-H. CURRENT PLATE TRANS.

1500-0-1500 volts at 1.5 amps. Tapped at 1350 and 1250. Pri. 110/220 volts 50/60 cycles in 2 Separate windings. Built to rigid Navy specs by Amertran. Suitable for broadcast transmitters, induction heating, etc. Continuous duty. 10 x 10 x 7. swt 125 lbs.



New only39.50

BARGAIN OF THE MONTH

As illustrated above. 1500-8-1500 volts at 600 ma. Pri. 110/220 v. 50/60 cycles. 8 x 8 1/2 x 7 s.w.t. 78 lbs. Made by Amertran. Only19.95

HIGH CURRENT TRANSF. 820 Volts CT at 775 Ma. Pri. 110/220 Volts 60 cycles. Fully Cased6.95

SELSYN MOTOR

115 volts 60 cycles. Made mitters only. \$6.95 per by Bendix and Diehm. pair. Large size—Type 5. Trans.

UTC type PA 5000 ohm plate to 500 ohm line and 6 ohm voice coil. 10 watts. 60 to 10,000 cps ±1 DB. GREAT VALUE.....ea. \$2.75

THORDARSON PLATE TRANSF. 2370 volts CT at 250 MA tapped at 300-0-300 volts, plus 215 volts 55 MA bias winding. 110 volt 60 cy. pri. Fully shieldedea. \$11.95

GENERAL PURPOSE TRANSFORMERS

Ideal for Bias. Filament, Isolation, Stepdown, etc. 2 isolated 110v. pr. sec. 110v at 900 ma plus 6.3 @ 2 amps. Fully casedNow \$1.49 ea.

SCOPE TRANSFORMERS

Pri 110V 60CY — Hermetically Sealed

2500V @ 12ma\$3.95
2300 @ 4Ma. 2.5 Volts @ 2 Amp4.95
1050V @ 20Ma. 20V 4.5A. 2.5V 5A.4.75
4500V @ 4 Ma.8.50

SOLA CONSTANT VOLTAGE TRANS.

Pri. 95-125 Volts 60 Cy See 115V. 120VA.....17.95

PLATE AND FIL. TRANSF. PRI 110V 60 cy. sec. 1120 volts CT @ 600 ma. 6.3V CT # 3A. 2x5VCT @ 6A Hermetically sealed.\$9.95 ea.

1500, 5000 Ohm 100 Watt Ferrule Resistors. 20,000 Ohm 50 Watt Ferrule Resistors. Any Types only .10 ea. Min. order 50.



HS 30 HEADPHONES

250 ohms imp. Can be used for sound power Telephones.

Brand new69 ea.
LARGE QUANTITY AVAILABLE

STEPDOWN TRANSFORMER

220/110 volts. 100 watts. Fully enca.ed. 5/8 x 4/4 x 5/8. 110V. 60 cycle.....\$2.49 each

PHASE SHIFT CAPACITOR



4 Stator Single Rotor. 0-360 Degrees RotationOnly \$2.95 each

ODDS AND ENDS BARGAINS

.004 4000 VDC Micacs9 for .99
.01 600 VDC Mica Cond.9 for .99
GE 24V DC Relays5 for .99
.02 400 V DC Tubulars15 for .99
1000 MFD 25 Volt Electrolytic2 for .99
25 MFD 25 Volt Elect. Tubular6 for .99
JAN 6CX Tubes, New, Boxed4 for .99
3-1 PP Input. Hermetic Seal.2 for .99
.05 600 VDC Oil Tubular10 for .99
10 MMF Midget Variable Cond.4 for .99
Heinemann 5 Amp 110 VAC CKT Breaker99
Heinemann 25 Amp 110 VAC CKT Breaker1.49
2 MFD 250 VAC Oil Cond.5 for .59
Solar .02 600 VDC Dominoes9 for .99
Erie .0005 N750D Ceramicons15 for .99
1x.1 2 KV DC Oil-Condenser79
H&H SPST P.E. Switch N.O.5 for .99
Weston 507 PF Meters, Less Thermo99
1/40 Amp (25 Mz) Littlefuses15 for .99
.25 MFD 600 V. Tubulars6 for .99
C-D 1 MFD 400 V Oil Tubulars9 for .99
Butterfly Cond 2-11 MMF Ball Bearings2 for .99
50 MFD 50 Volt Elect. Tubulars5 for .99
.0015 5% Silver Micacs9 for .99
Midget Closed CKT Jacks.7 for .99
CD Type 4 .001 600 VDC Micacs50 for 4.99

A FEW SUPER SPECIALS

10 Mfd 600 VDC Oil Cond.89 ea.
CD .025 2500 VDC Mica69 ea.
50,000 ohm 1% Precision Wire Wound Resistors7 for .99

PANEL METERS—BRAND NEW

2" WESTON .0-1 Ma Dc 26 ohms res.\$3.50
2" GE 0-1 Ma Dc (volt scale)2.05
2" GE 0-5 Ma DC (amp scale)1.95
2" WESTINGHOUSE 0-10 Ma DC2.45
2" GE 0-500 Ma DC1.95
2" GE 0-10 Volts AC2.50
2" GE 0-30 Volts DC 1000Q/v2.50
2" WESTON 0-250 Volts DC2.50
2" WESTON 150-0-150 Microamps DC3.49
2" GE 0-30 Amps DC2.45
2" GE 0-1 Amp RF (Internal Thermo)2.45
2" WESTON 0-1 Amps RF (Internal Thermo)2.70
3" McCLINTOCK 0-1 Ma DC. (MA Scale)3.95
3" WESTINGHOUSE 0-2 Ma DC3.95
3" GE 0-15 Ma DC (Square Case)3.95
3" WESTERN ELECTRIC 0-80 Ma DC2.95
3" DEJUR 0-100 Ma DC2.95
3" GE 0-200 Ma DC3.95
3" WESTINGHOUSE 0-50 Amps AC3.95
3" WESTON 0-50 Amps AC4.95
3" TRIPLETT 0-75 Amps AC2.95
3" WESTINGHOUSE 0-20 Ma DC3.95
3" WESTINGHOUSE 0-150 Volts AC3.95

2" GE 0-200 MICROAMPS

Model DW51\$4.50 ea.

FILAMENT TRANSFORMERS

110V 60CY Pri. Fully Cased.\$2.75
5 Volt 15 Amp3.49
2.5 Volt 10 Amp4.75
2.5 Volt CT 21 Amp1.89
6.3 Volt 10 Amp1.89

MULTIPLE SECONDARIES

5 1/2 V CT 21A, 7.5V 6A, 7.5V 6A\$4.95
6.3V 21 Amp, 6.3V 2A, 2.5V 2A3.95
5 Volt 4A, 6.3V, 3A2.45
2.5V CT 20A, 2.5V CT 20A6.95
2.5V CT 10A, 10V 3A, 5V 3A, 5V 3A3.95

CHOKE BARGAINS

6 Henry 50 ma 300 ohms3 for \$0.99
6 Henry 80 ma 220 ohms2 for .99
8 Henry 180 ma 140 ohms99
1.5 Henry 250 ma 72 ohms3.75
6 Henry 300 ma 65 ohms5.99
4.3 Henry 620 ma 42 ohms6.95
Swing. Choke 1.6/12 Henry 1 Amp/100 ma 15 ohm19.95
10 Henry 7 amps .5 ohm4.50

U. H. F. COAX. CONNECTORS

831AP-UG12U—UG21U-UG-14U-831 R-831SP .39 ea.

FEDERAL ANTI-CAPACITY SWITCH. Double Pole. Double Throw85¢ each; 10 for \$7.50

MEG OHM METER

Industrial Instruments model L2AU 110/220 volts 60 cycle input. Direct reading from 0-100000 megohms on 4" meter can be extended to 500000 megohms with external supply Sloping hardwood Cabinet 15"x8"x10". Brand new with tube; plus running spare parts including extra tubes. Great value Only \$69.50.



VARIABLE CERAMICONS

1.5 to .7 MMF21 4 to 30 MMF24
3 to 13 MMF24 7 to 45 MMF24

FIXED CERAMICONS

Capacity in MMF: 1-2-3-4-5-8-10-12-15-17-18-20-25-30-35-40-50-60-85-120-200-500. Your cost any capacity09 ea.

ADVANCE D.P.D.T. ANTENNA RELAY

110 V. 60 cycle coil Steatite insulation. Only \$1.95 each.

As above but 3 P D T\$2.75

DUNCO RELAY 6 volt 60 cycle coil DPST.....\$1.39
DPDT\$1.69

WIRE WOUND RESISTORS

5 Watt type AA. 29-25-50-200-470-2500-4093 ohms09 ea.
10 watt type AB. 25-40-84-400-470-1325-1900-2000-4000 ohms15 ea.
20 watt type DG. 50-70-100-150-300-750-1000-1500-2500-2700-5000-7500-10000-16000-20000-30000 ohms20 ea.

30 WATT WIRE WOUND RESISTORS

Ohms: 100-150-1500-2500-3k-4k-4500-5k-5300-10k-15k-18k-40k15 ea. 8 for .99

ADJUSTABLE RESISTORS

20 Watt: 1, 5, 50 Ohms25
50 Watt: 80, 100, 500 Ohms35
75 Watt: 40, 80, 100, 150, 200 Ohms39
100 Watt: 20, 50, 75, 120, 180 Ohms49
150 Watt: 50, 100 Ohms59

1% PRECISION RESISTORS

2000-2500-5000-8500-10,000 ohmsea. .25
50000-95000 ohmsea. .29
10000-750000-1 megea. .69

Precision 15 Meg. 1% Accuracy Resistor. Non-inductive, 1 watt, hermetically sealed in glass. .29 ea. 10 for\$2.50

50 megohm 35 watt Resistor with mount...\$1.95 each; 10 for \$15.00

W. W. POWER RHEOSTATS

25 Ohms 25 Watt49
150 Ohms 50 Watt59
250 Ohms 50 Watt59
300 Ohms 50 Watt59
Dual 200 Ohms 50 Watt79
8 Ohms 150 Watts1.79

HIGH VOLTAGE—CURRENT MICAS



MMF	VDC	Price	MMF	VDC	Price
D .001	600	\$.18	C .0005	5 KV	\$.85
E .01	600	.24	C .0015	5 KV	1.60
E .02	600	.26	C .003	5 KV	1.90
E .027	600	.26	C .005	5 KV	2.50
D .039	600	.30	B .007	5 KV	2.75
C .01	1 KV	.45	B .002	8 KV	3.50
C .056	1 KV	.50	B .003	8 KV	3.75
C .07	1 KV	.55	A .004	8 KV	4.95
D .02	1200	.35	B .006	8 KV	4.25
C .024	1500	.65	B .0085	8 KV	2.90
C .033	1500	.75	B .001	8 KV	3.25
C .015	2 KV	.80	B .002	8 KV	4.00
C .02	2 KV	.90	B .003	8 KV	4.75
D .002	2500	.45	B .004	8 KV	5.50
E .005	2500	.55	B .005	8 KV	5.75
C .025	2500	1.25	A .006	15 KV	26.50
C .001	3 KV	.90	A .0098	15 KV	32.50
C .002	3 KV	.95	A .0059	18 KV	28.50
D .005	3 KV	.70	A .005	20 KV	33.50
C .005	3 KV	1.24	A .0013	30 KV	36.50
C .006	3 KV	1.50	A .00025	35 KV	26.50
D .002	3 KV	.70	A .0001	10 KV	4.95
C .0001	5 KV	.76			

OIL CONDENSERS

20 mfd 330 vac—1.85
5 mfd 150 vac—.49
1 mfd 600 vac—.29
2 mfd 600 vac—.39
4 mfd 600 vac—.59
6 mfd 600 vac—.79
3/3 mfd 600 vac—.79
2 mfd 1000 vac—.79
4 mfd 1000 vac—.95
15 mfd 1000 vac—2.95
2 mfd 1500 vac—1.25
6 mfd 1500 vac—2.95
1 mfd 2000 vac—1.45
2 mfd 2000 vac—2.25
4 mfd 2000 vac—3.65
6 mfd 2000 vdc—3.95
2 mfd 4000 vdc—1.95
1 mfd 5000 vdc—1.50
1/2 mfd 7000 vdc—2.25
1 mfd 7500 vdc—1.95
1 mfd 7500 vdc—9.25
.01/.01 mfd 12 kv vdc—5.75
.005/.01 mfd 12 kv dc—5.50
.015 mfd 16 kv dc—5.75
.05 mfd 12,500 vdc—12.95
.75/35 mfd 8/16 kv—7.95
2 mfd 18 kv dc—59.50

WESTINGHOUSE

Type MN Overcurrent Relay, Adjustable from 250 ma. to 1 amp. External Push Button Reset. Enclosed in glass case. Hand calibrated adjustments, only \$6.75



Tremendous stocks on hand. Please send requests for quotas. Special quantity discounts. Price f.o.b. N. Y. 20% with order unless rated, balance C. O. D. Minimum order \$5.00.

PEAK ELECTRONICS CO.
188 Washington St., New York 7, N. Y.
PHONE CO-7-6443
DEPARTMENT EA
SEND FOR BULLETIN

LIFE
ELECTRONICS
Offers

AVAILABILITY THAT MEANS SERVICE AT PRICES THAT MEAN SAVINGS

Lee Machig
Seymour Schweber



ALLEN BRADLEY POTENTIOMETERS

Allen Bradley type 'J' Pots Available in the following values from stock.

VALUE,	OHMS,	SINGLE
50	2000	35000
60	2500	50000
150	3000	60000
200	5000	70000
250	6500	100000
400	10000	200000
500	15000	250000
600	20000	500000
1000	22000	600000
1300	25000	1 MEGOHM
1500	30000	

PRICE EACH \$.50

DUAL POTS.

10,000	100,000
25,000	500,000
50,000	1 MEG.
	5 MEG.

PRICE EACH \$1.50

Specify whether regular or screwdriver shaft is required.

Crystal Diodes

1N21	.50
1N21B	1.00
1N23A	1.50
1N23B	2.00
1N34	1.35



The TX-6 GEIGER COUNTER

LIGHTEST AND MOST ECONOMICAL GEIGER COUNTER AVAILABLE

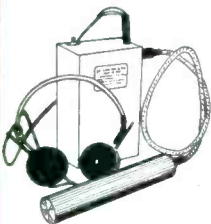

- Light Weight
Approx. 4 Pounds
- Rugged Construction
Aluminum Case
- Simple To Operate
One Control
- Carries On Belt
No Straps
- Economical
In Cost and Use

The TX-6 is a lightweight, sensitive Geiger Counter. Extensive field tests have proven it the most practical Counter yet devised for rough field work. It is just as sensitive as larger units, yet costs less. Operation of the TX-6 is simple. Just switch on—clicks in the headphones indicate the presence of radioactive minerals. There is no guess-work with the TX-6. It will react to radioactive ores instantly.

Each TX-6 is completely waterproofed. It can be used any place. Batteries are self-contained, and can be changed easily. A special electronic circuit incorporated in the unit assures long battery life.

PRICE \$100.00

"UHF" COAXIAL CABLE CONNECTORS



No.	AN No.	Description	Each	Per C
83-1SP	(PL259)	Plug	.35	.28
83-168	(UG176U)	Adapter	.15	.12
83-185	(UG175U)	Adapter	.15	.13
83-1SPN	(PL259A)	Adapter	.35	.28
83-776	(UG203U)	Plug	.61	.55
83-1R	(S0239)	Recept.	.35	.28
83-1RTY		Recept.	.66	.60
83-1H	(UG106U)	Hood	.12	.10
83-765	(UG177U)	Hood	.31	.25
83-1AC		Cap & Chain	.61	.50
83-1BC		Cap & Chain	.38	.34
83-1T	(M358)	T Connect.	1.12	.98
83-1AP	(M359A)	Angle Adapt.	.35	.28
83-1J	(PL258)	Junction	.85	.70
83-1F	(PL274)	Feed-Thru	1.12	.98
83-22SP	(UG102U)	Twin Plug	.50	.40
83-22R	(UG103U)	Twin Recept.	.50	.40
83-22AP	(UG104U)	Twin Adapt.	.98	.80



UG TYPES CONNECTORS

Deduct 10% from prices shown on orders of 100 or more per type

UG 30/U

AN #	Price ea.	AN #	Price ea.
UG-9/U	\$.95	UG-96A/U	\$1.45
UG-10/U	1.56	UG-97/U	3.50
UG-11/U	1.45	UG-98/U	1.55
UG-12/U	1.14	UG-100/U	2.34
UG-13/U	1.56	UG-101/U	2.95
UG-14/U	1.45	UG-107/U	2.25
UG-15/U	.95	UG-108/U	1.75
UG-16/U	1.56	UG-109/U	1.75
UG-17/U	1.45	UG-114/U	1.50
UG-18/U	.99	UG-115/U	1.35
UG-18A/U	1.05	CW-123/U	.45
UG-18B/U	.99	UG-155/U	.40
UG-18/U	1.28	UG-194/U	5.35
UG-19A/U	1.38	UG-155/U	5.35
UG-19B/U	1.45	UG-156/U	4.25
UG-20/U	1.17	UG-160/U	1.90
UG-20A/U	1.26	UG-160A/U	1.55
UG-20B/U	1.41	UG-167/U	3.00
UG-21/U	.95	UG-178/U	.30
UG-21A/U	1.05	UG-178/U	.15
UG-21B/U	.99	UG-188/U	.95
UG-22/U	1.08	UG-201/U	1.83
UG-22A/U	1.38	UG-202/U	2.75
UG-22B/U	1.34	UG-206/U	1.02
UG-23/U	.99	UG-208/U	28.50
UG-23A/U	1.24	UG-212/U	4.50
UG-23B/U	1.29	UG-213/U	4.50
UG-27A/U	2.25	UG-216/U	3.35
UG-28/U	2.34	UG-216/U	8.70
UG-29/U	1.22	UG-213/U	3.10
UG-30/U	1.75	UG-218/U	6.50
UG-32/U	20.00	UG-225/U	35.00
UG-33/U	20.00	UG-231/U	2.00
UG-34/U	17.50	UG-236/U	11.75
UG-35A/U	16.00	UG-241/U	2.20
UG-36/U	16.00	UG-242/U	2.50
UG-37/U	16.00	UG-243/U	2.75
UG-37A/U	16.00	UG-244/U	2.50
UG-37/U	.99	UG-245/U	1.25
UG-57/U	.65	UG-246/U	1.45
UG-58/U	.65	UG-252/U	4.50
UG-59/U	2.75	UG-254/U	1.82
UG-59A/U	1.70	UG-255/U	1.85
UG-60/U	1.90	UG-280/U	.99
UG-60A/U	1.30	UG-281/U	.95
UG-61/U	2.05	UG-282/U	1.05
UG-61A/U	1.80	UG-289/U	2.60
UG-61/U	28.00	UG-273/U	1.50
UG-83/U	1.50	UG-274/U	1.98
UG-85/U	1.65	UG-290/U	.85
UG-86A/U	1.69	UG-291/U	1.05
UG-87/U	1.40	UG-306/U	2.03
UG-88/U	1.17	UG-333/U	4.70
UG-89/U	.95	UG-334/U	5.75
UG-90/U	1.05	UG-352/U	6.00
UG-91/U	1.25	UG-287/U	5.25
UG-91A/U	1.05	UG-270/U	6.50
UG-92/U	1.10	UG-259/U	4.10
UG-92A/U	1.35	UG-279/U	2.40
UG-93/U	1.25	UG-167/U	4.25
UG-93A/U	1.45	MX-196/U	.75
UG-94/U	1.25	UG-197/U	5.00
UG-94A/U	1.05	UG-235/U	28.50
UG-95/U	1.10		
UG-95A/U	1.35		
UG-96/U	1.25		

UG 290/U

UG 306/U

UG 352/U

COAXIAL CABLES



No.	Impedance	Price per M ft.
RG5U	52.5 ohms	\$70.00
RG6U	76.0 ohms	120.00
RG7U	97.5 ohms	70.00
RG8U	52.0 ohms	55.00
RG9U	51.0 ohms	135.00
RG9AU	51.0 ohms	135.00
RG10U	52.0 ohms	125.00
RG11U	75.0 ohms	103.00
RG12U	75.0 ohms	190.00
RG13U	75.0 ohms	125.00
RG18U	52.0 ohms	320.00
RG19U	52.0 ohms	350.00
RG20U	52.0 ohms	450.00
RG22U	95.0 ohms	120.00
RG24U	125.0 ohms	240.00
RG25U	48.0 ohms	125.00
RG27U	48.0 ohms	290.00
RG29U	53.5 ohms	50.00
RG34U	71.0 ohms	175.00
RG39U	72.5 ohms	180.00
RG41U	67.5 ohms	575.00
RG44U	58.0 ohms	65.00
RG44A	58.0 ohms	75.00
RG47U	95.0 ohms	100.00
RG58U	53.5 ohms	55.00
RG59U	73.0 ohms	45.00
RG62U	93.0 ohms	50.00
RG71U	93.0 ohms	175.00
RG74U	52.0 ohms	185.00

Minimum quantity 500 ft. per type. For cut lengths add 50% to prices shown.

UPRIGHT TRANSMITTING CAPACITORS

National Manufactures

Stock No.	Capacity	Voltage	Price each
TJU6005	0.5	600	\$.85
TJU 6010	1.0	6000	1.05
TJU 6020	2.0	600	1.30
TJ 6040	4.0	600	1.65
TJU 6050	5.0	800	1.90
TJU 6060	6.0	600	2.50
TJU 6100	10.0	600	2.75
TJU 10005	0.5	1000	.90
TJU 10010	1.0	1000	1.15
TJU 10020	2.0	1000	1.50
TJU 10040	4.0	1000	1.90
TJU 20010	1.0	2000	1.65
TJU 20020	2.0	2000	1.95

FUSES AND FUSE POSTS

3AG Fuses 32 Volts		4AG Fuses	
	Price ea.		Price ea.
5 Amps.....	\$.03	1/2 Amps.....	\$.05
10 Amps.....	.03	1 Amps.....	.05
20 Amps.....	.03	2 Amps.....	.05
		3 Amps.....	.05
		5 Amps.....	.05
		10 Amps.....	.05
		15 Amps.....	.05
		20 Amps.....	.05
		30 Amps.....	.05
		40 Amps.....	.10
		1/2 Amps.....	.07
		1 Amps.....	.04
		2 Amps.....	.04
		3 Amps.....	.03
		2 Amps.....	.03
		5 Amps.....	.03

FUSE EXTRACTOR POSTS

3AG Post-Finger Grip Type	\$.18
3AG Post-Screw Driver Type	.18
4AG Post-Finger Grip Type	.20
4AG Post-Screw Driver Type	.20

TUBE SPECIALS

2K25	\$24.95	807	\$1.25
2K28	15.00	813	6.95
2J32	24.00	861	24.95
2J61	39.00	866A	1.25
725A	15.00	3AP1	4.95
1B22	3.00	872A	2.50
4C35	29.95	5BP4	4.95
350B	2.50	304TL	1.75

FREE!

Send for our bulletin L-500

LIFE ELECTRONIC SALES

91 GOLD STREET, N. Y. 7 N. Y. DIGBY 9-4154-5



SPECIAL SURPLUS BROADCAST OF OUR SUPER SPECIALS!!!

VIBRATOR POWER SUPPLY (PE 204A)

Used with Telephone Repeater EE-99A. Input 12 VDC. Output 2 windings @ 4.3 VDC @ 50 MA; 2 @ 45 VDC @ .5 MA; 2 @ 85 VDC @ 5 MA. Loaded with parts. New\$1.00

I. F. F. TRANSMITTER ASB-7A

Uses 2 transmitting UHF tubes, 15E and contains 400 cycle blower unit, etc. Freq. range 500 MCS. 18x8x7 1/2 \$12.95

DECK ENTRANCE INSULATORS

(Bowl and Flange Type)

Mfd. by Ohio Brass Co. heavy galv. metal flange 10 1/2" D. bore, bowl set in rubber gaskets. Top bell 7 3/4" D. brass feed thru rod 10 1/2" L. Insul. dist. between top bell and flange 6 1/4". \$2.50

BATTERY CHARGING PANEL

Mfd. by Price Bros. Two Trumbull 3PDT Knife Switches mounted on 8 x 10 x 1/2 masonite panel. Wired to heavy duty metal comm.\$2.00

DC SERVO MOTORS

White Rodgers Elec. Co. (6905X-46). 24 VDC @ .85 Amps. Torque 50 in./lbs. 1/2 RPM reversible, comp. w/limit switch, relays and selenium rectifiers on top of motor, to keep AC out of motor. 3x3x4 \$7.75

6904X-27, 24 VDC @ 1 Amp., 150 in./lbs. torque. 2 1/2" RPM reversible. Complete w/limit switch, relays and selenium rectifiers same as above.\$7.35

DAVEN SOUND ATTENUATORS

Type 350-A. Network, ladder, linear, imped. 30/30 ohms. 2DB attenuation. 10 W dissipation. Brand new.\$2.50

UNDERWATER SOUND EQUIPMENT

Model QBE driver rectifier, 30 W. Emission A 1. Freq. 18-25 KC., supply 115/1/60. 19x13x10. \$32.50

Type CBM 46169. Receiver amplifier, P/OF QBE-1. Freq. 18-25KC.. Input 115/1/60. 75 lbs. 19 x 13 x 10 1/2.\$26.50

Type CBM 55081 Indicator Unit—p/of QBE-1. Ranges 0-1000 yds. and 0-5000 yds., input 115/1/60. 20 x 16 x 8 1/2.\$25.00

SPERRY A-5 VERTICAL GYRO UNIT

#644841. 115 V. 400 CY 3 phase. Contains gyro assembly, erection motor, erection relay assembly, pick-off assembly, elevator and alleron limit switches, and roll axes. 15 x 12 x 9. New.\$27.50

WESTINGHOUSE FLEXARC WELDERS

Type WC-2, trans. type for single oper. Style 361117. Pri. 550/440 v. 60 cy. 1 ph. Welding current output 300 amps. Cont. for 1 hr. Load volts 40. Rotating handle on top for current adj. Self cooling. Built in circuit breaker to deenergize the welder and give overload or short circuit protection. 37" H, 18" D, 26" W.\$100.00

GENERAL PURPOSE TANK

Ideal for holding 5 gal. any liquid. Easy to handle. Aluminum construction. 19" L x 9" D\$1.00

BATTERY CHARGER

Ideal for your car, for the serviceman and hain. Selenium—transformer type, 7 1/2 x 4 1/2 x 4 1/2. Portable metal container. Input 115 VAC output 7.5 V @ 6 amps.\$8.00

TRANSTAT VOLTAGE REGULATOR

Amertran type R11. Input: 115 V. 400 cy. 0.5 KVA, 5.5 max. amps. Output: 92-115 V. 5 1/2x4 1/2x3 1/4. \$1.95

WESTINGHOUSE MOTORS

24 VDC, 1/4 HP, 6.5 A., 5800 RPM. Series W. Cont. duty 4-3/4" L x 3-1/4" D. Shaft 1-1/2" L x 5/16" D.\$5.00

W. E. HIGH VOLTAGE POWER SUPPLY

RA50-A, used with SCR 206A. Secondary of hi voltage trans. supplies 20,000 volts @ 45 MILS to two 705A'S; the filaments are heated from 5 V. 10 A. trans. Also 0.05 mfd 12,500 V. cond. 21 1/2 x 17 x 11 1/2.\$49.95

INDUCTION VOLTAGE REGULATOR

Type IRT, form M, 1.64 KVA, 3 phase, 60 cycles, cont. duty. Outdoor service. Primary: 208 V., 10.5 load amps. Oil-filled. Wgt. 365 lbs. 33 x 17" x 14".\$53.50

G. E. MOTOR CONTROLLED VOLTAGE

Cat. #837625, Type 'Airs', Form M, .568 KVA, cont. duty, 60 cy., primary volts 115. Load Amps 16.2. Indoor service. Voltage controlled by mtr. 120/1/60.1/40 HP.\$34.50

DYNAMOTOR GENERATOR

Model 3975-1. Electric Sprayit Co., p/ov "Gibson Girl". Input 28 VDC @ .175 amps. Output 300 VDC @ .040 amps. 7" L. 3 1/2" D.\$1.00 ea.

RCA TRACK LIGHTING & CONTROL PANEL

Model 713-AS, comp. wire ready for immed. oper. Controls the filament volt. on vacuum tubes in the process of being exhausted on rotary turn table equip. 7" H, 15" D, 32" W. Units complete with meters, variac dist. transformers, switches, rheostats, etc.\$275.00

FITCH CRYSTAL DUPLICATOR

(Calibrates crystal plate of unknown freq. against standard plate of desired freq. Consists of standard and test oscillators whose outputs are mixed to produce an amplified beat note; the freq. is shown on 500, 5000, 50,000 cycle meter. Metal cabinet w/hinged cover. 9" H x 13" W x 19" L. Comp. w/4" sq. activity and frequency meter \$22.50

MILLIAMETERS

150-0-150 MA DC. Accuracy 1/2 of 1%. Scale length 4 1/2". Wt. 3 1/2 lbs. 6" x 2 1/2" x 4 1/2". L. N.\$2.50

TRANSTATS

11.5 KVA 50/60 cy. Com-mutator range 0-115 V. Max. Amps 100. Reconnection diagram available for 230 V. 50A. Brand New.\$100.00
25 KVA Fixed winding 115/1/60. Oper. Brand New.\$9.45
Commutator range 103-126 V. 2.17 Max Amps.\$9.45

RETARD CHOKE COILS

Amertran, Disc Type. Lne voltage 15,000; ripple freq. 120. Oil-filled; .020A DC @ 900H @ 48% ripple, 52A DC @ 25H @ 48% ripple. 17"x17"x22" w/term. 10" above case. 40°C temp. rise.\$34.00

NEW SWITCH INTERLOCKS



Cory Type B857, Single Key Oper. Interlocking of doors, vaults, reactor or resistor enclosures, oil circuit breakers, etc.\$1.98
Cory Type B986, Single Key Oper. 51ST SW w/Yale Cy. Lock 60A tumbler lock.\$2.49
Cory Type B1536, Supervisory Oper. 2 key type.\$2.95

E. C. 604 F. M. TRANSMITTER

Wide or narrow band FM. 30 watt power output. Excellent possibility for ten or eleven meter exciter. Freq. 20-27.9 MC. Working space permits modification. 7/2 tubes but less power supply and xtals. LN \$11.50. Complete with Crystals \$27.50

ALLIS CHALMERS MOTOR GENERATORS

Input: 115 VDC at 14 amp, 3600 RPM. Ball Bearings. Output: 1.25 KVA. 80% E.F.F.; 120 VAC 60 cy. 1 ph. 10.4 Amp. Resistive control of voltage output and freq. built-in. Centrifugal automatic controller permits line-start oper. Fully enclosed. BRAND NEW! \$100.00. Same machine for 230 V.D.C. Operation.\$120.00
Spare parts kit of brushes, brushholders, ball bearings, field coils, etc., in steel case for above M/G's\$10.00

AMERTRAN HEAVY DUTY TRANSFORMERS

Pri.: 115/230 VAC 60 cy. Sec.: 4730/2365 V. 1.66KVA. RMS. 12 KV. Wgt. 150#. 11"x11"x9". 700 Ma. New\$27.50

Standard Brand RHEOSTATS

High shock rheostats, four 13" plates, 100 ohms 8-2A, 175-345 V connected in series. Assembled for back of board mtg. or by reversing the supporting brackets for floor or table oper. New\$19.75

INTER COMMUNICATION SETS

Mfd. by Dictograph. Designed to bring to homes and offices the conv. of two-way conversation w/o the use of telephone, household electric current, or radio. Efficient up to 800 ft. off flashlight batteries. New Pair.\$9.95

SELECTOR SWITCHES

Heavy duty, U. S. N. Control any type of multi-circuit devices. Removable contacts enabling any comb. of closed and open circuit. The following available: 5 section-10 pole or 10 section-20 pole, \$1.50 ea. Case lots of (8) \$8.00 or (5) cases, special.\$32.50

MARATHON MOTOR GENERATORS

Input at 110 VDC Output 110VAC, 1 phase, 60 cy. 500 V.A. Marine Type with voltage regulator and frequency controller. Rebuilt LN.\$65.00
Same unit as above with 32 VDC Input and 300 V Output\$54.00

KATO ROTARY CONVERTERS

Type 1205A Model 26KA54. Input: 24 VDC, 28A, 1800 RPM. Output: 115 VAC 1 phase 60 cy. 1 KVA. Compact and ruggedly built for cont. duty oper. Filtered. L. Shock mounted. New.\$90.00

MINE DETECTOR SCR 625

Detects metallic objects (ferrous or non-ferrous) to a depth of approx. 6 ft. Find outboard motors on the bottom of lakes, locate underground piping, treasure, metallic fragments in lumber, etc. New, complete with inst. book, \$65.00. Used "like new"\$45.00

SPERRY A-5 AMPLIFIER RACK

#644890, contains Weston Model 833 Voltmeter 0-130 and Weston Model 637 Frequency Meter 350-450 cycles. Several 24 VDC relays, transformers and condensers. New\$12.95

ALL PRICES F.O.B. BOSTON. ORDERS ACCEPTED FROM RATED CONCERNS ON OPEN ACCOUNTS NET 30 DAYS. MINIMUM ORDER \$3.00



110 PEARL ST., Dept. E6, Boston 10, Mass. . . . Liberty 2-5589 . . . HAncock 6-5069

SELENIUM RECTIFIERS

AND SPECIALIZED ELECTRONIC COMPONENTS

VACUUM CAPACITORS



Standard Brands

12 Mmfd 20 Kv.....	\$4.95
50 Mmfd 20 Kv.....	4.95
50 Mmfd 32 Kv.....	5.95

SILVER CERAMIC TRIMMERS

Type 820-Z, 5-20 Mmfd Zero Temp	24¢
Type 822-N, 5-20 Mmfd Neg. 300	34¢
Type 822-AZ, 4-5-25 Mmfd Zero Temp	24¢
Type 823-AN, 20-125 Mmfd Neg. 650	33¢

FENWAL THERMOSWITCH

Normally closed. Opens with temp. rise Adjustable from -40° to +400°F **\$1.25**

OIL CONDENSERS

2 Mfd 200 VDC Bathtub.....	20¢
5 Mfd. 400 VDC.....	20¢
2 Mfd 400 VDC Bathtub.....	30¢
2x. 1 Mfd 600 V.....	39¢
6 Mfd 600 VDC w/mtg clamp.....	79¢
10 Mfd 440 VAC/1500 VDC.....	1.55
8 Mfd 660 VAC/2000 VDC.....	3.50
2x. 15 Mfd 8000 VDC.....	3.95

ELECTROLYTIC CONDENSERS

Cap	WV DC	Each	10	100
100 Mfd	50	.27	2.20	19.00
40 Mfd	150	.23	1.80	17.50
8-8-20 Mfd	350/150	.40	3.50	30.00
20-20 Mfd	400/250	.35	3.00	25.00
10 Mfd	450	.30	2.50	20.00
15 Mfd	450	.30	2.50	20.00
40 Mfd	450	.50	4.20	36.00

GRAIN of WHEAT LAMPS



Used for illuminating meters, compass dials, airplane instruments, etc. Soldering iron removes lamp from base to use in models, doll houses, miniature trains, Xmas trees, etc.

Mazda G.E. 323 3V. 19 A Mazda G.E. 328 6V. 2 A

Photo, actual size. Glass Bulb 1/8"x3/8" type doz. **\$1.50** 75.00 per M.



MARKTIME
5 HOUR SWITCH
A 10 amp timing device. Pointer moves back to zero after time elapses. Ideal for shutting off radios and TV sets when you go to bed. Limited supply at this special PRICE **\$3.90**

Also available in 15 min.-30 min.-1 hr. at \$6.55

D.P.S.T. LEACH RELAY
Split coil 12 or 24 V.D.C. 10 amp. 45¢ each, 3 for \$1.00, 7 for \$2.00, 15 for \$4.00. Min. shipment. \$1.00

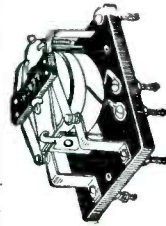

ISOLATION TRANSFORMER
Nat. known Mfrs. 50 watt 2 windings. 115 V. to 115 V. 60 cy. Ideal to prevent shocks from small radios and medical and electronic devices. Shipping weight 5 lbs. Other sizes and 220-110 in stock. **\$1.95**

A newly Written (1948) Book on Photoelectric (Electric Eye) Circuits..... 10 for \$7.50 **\$1.00**

Kilowatt Demand Meter Totalizer containing heavy-duty telechron B-7, 1 RPM motor and hundreds of watch size gears, clutches, springs, etc. Shipping weight 2 lbs. 5 for \$10.00. **\$2.50**

We are Authorized Wholesalers for Micro Switch Corp. and carry the largest stock of Allen-Bradley Solenoids, Potter & Broomfield Relays, Guardian Electric Co. Solenoids and Relays and Haydon Clock Motors in all speeds.

EST. 1923 BLAN EST. 1923

Experimenters and Inventors Supplies
64P Dey St., New York 7, N. Y.

Full Wave Bridge Types

Input 0-18VAC	Output 0-13*VDC	Type#	Current	Price
B1-250	250 MA.			\$.98
B1-500	500 MA.			1.95
B1-1	1 AMP.			2.49
B1-1X5	1.5 AMP.			2.95
B1-3	3 AMP.			3.49
B1-5	5 AMP.			5.95
B1-10	10 AMP.			9.95
B1-15	15 AMP.			13.95
B1-20	20 AMP.			15.95
B1-30	30 AMP.			24.95
B1-40	40 AMP.			27.95
B1-50	50 AMP.			32.95
B1-60	60 AMP.			36.95
B1-80	80 AMP.			44.95

Full Wave Bridge Types

Input 0-18VAC	Output 0-40*VDC	Type#	Current	Price
B3-150	150 MA.			\$1.25
B3-250	250 MA.			1.95
B3-600	600 MA.			3.25
B3-5	5 AMP.			13.95
B3-10	10 AMP.			24.95

Input 0-74VAC	Output 0-54*VDC	Type#	Current	Price
B4-600	600 MA.			\$3.95
B4-3	3 AMP.			14.95
B4-5	5 AMP.			17.95
B4-10	10 AMP.			32.95

Full Wave Bridge Types

Input 0-36VAC	Output 0-26*VDC	Type#	Current	Price
B2-150	150 MA.			\$.98
B2-250	250 MA.			1.25
B2-300	300 MA.			1.50
B2-450	450 MA.			1.95
B2-1	1 AMP.			3.95
B2-2	2 AMP.			4.95
B2-3x5	3.5 AMP.			6.95
B2-5	5 AMP.			9.95
B2-10	10 AMP.			15.95
B2-15	15 AMP.			24.95
B2-20	20 AMP.			27.95
B2-30	30 AMP.			36.95
B2-40	40 AMP.			44.95

Three Phase Bridge Types

Input 0-126VAC	Output 0-138*VDC	Type#	Current	Price
3B7-4	4 AMP.			\$32.95
3B7-6	6 AMP.			48.90
3B7-15	15 AMP.			70.00

Input 0-234VAC	Output 0-251*VDC	Type#	Current	Price
3B13-4	4 AMP.			\$56.00
3B13-6	6 AMP.			81.50
3B13-15	15 AMP.			120.00

Input 0-115VAC	Output 0-110*VDC	Type#	Current	Price
B6-150	150 MA.			\$1.95
B6-250	250 MA.			2.95
B6-1	1 AMP.			7.95
B6-3x5	3.5 AMP.			18.95
B6-5	5 AMP.			24.95
B6-10	10 AMP.			36.95

Input 0-234VAC	Output 0-180*VDC	Type#	Current	Price
B13-600	600 MA.			\$12.95
B13-1	1 AMP.			16.95
B13-3	3 AMP.			35.95
B13-5	5 AMP.			54.95
B13-10	10 AMP.			69.95

CENTER TAPPED TYPES

Input 12-0-12VAC	Output 0-8*VDC	Type#	Current	Price
C1-10	10 AMP.			\$6.95
C1-20	20 AMP.			10.95
C1-30	30 AMP.			14.95
C1-40	40 AMP.			17.95
C1-50	50 AMP.			20.95
C1-80	80 AMP.			26.95
C1-120	120 AMP.			34.95

* Select Proper Capacitor From List Shown Below, to Obtain Higher D. C. Voltages Than Indicated

RECTIFIER MOUNTING BRACKETS

For Types B1 through B6, and Type C1.....	\$.35 per set
For Types B13.....	.70 per set
For Types 3B.....	1.05 per set

RECTIFIER CAPACITORS

CF-13	6000 MFD	10VDC	\$2.49
CF-14	3000 MFD	12VDC	1.69
CF-15	6000 MFD	12VDC	2.95
CF-1	1000 MFD	15VDC	.98
CF-2	2000 MFD	15VDC	1.69
CF-20	2500 MFD	15VDC	1.95
CF-3	1000 MFD	25VDC	1.25
CF-4	2x3500 MFD	25VDC	3.45
CF-5	1500 MFD	30VDC	2.49
CF-6	4900 MFD	30VDC	3.25
CF-7	3000 MFD	35VDC	3.25
CF-8	100 MFD	50VDC	.98
CF-9	500 MFD	50VDC	1.95
CF-16	2000 MFD	50VDC	3.25
CF-9	200 MFD	150VDC	1.69
CF-10	500 MFD	150VDC	3.25
CF-11	100 MFD	350VDC	2.25
CF-12	125 MFD	350VDC	2.49

Rectifier Transformers

All Primaries 115VAC 50/60 Cycles

Type#	Volts	Amps.	Price
XF15-12	15	12	\$3.95
TXF36-2	36	2	3.95
TXF36-5	36	5	4.95
TXF36-10	36	10	7.95
TXF36-15	36	15	11.95
TXF36-20	36	20	17.95
NFC17-10	17	10	4.95

All TXF Types are Tapped to Deliver 32, 34, 36 Volts. XFC Type in Primary Tapped to Deliver 15, 16 or 17 Volts Center-Tapped.

RECTIFIER CHOKES

Type	Amps.	Price
HY2 .03 Hy	2	\$2.25
HY3 .03 Hy	3	2.95
HY5 .02 Hy	5	3.25
HY8X5 .02 Hy	8.5	7.95
HY10 .02 Hy	10	9.95
HY12 .02 Hy	12	12.95
HY15 .015Hy	15	13.95

VARIABLE AIR TRIMMERS

Standard Brands—Screw Driver Adjustment

	Lots of 10	Lots of 100
7.5 MMF	\$2.90	\$27.00
25 MMF	3.19	29.00
50 MMF	3.30	31.00
100 MMF	4.10	39.00
140 MMF	4.90	47.00

METERS

O-15 M.A.D.C. Wes.on #506 2" Rd.....	\$2.95
O-6 A.D.C. Vane-type 2 1/2" sq.....	2.49
O-12 A.D.C. Vane-type 2 1/2" sq.....	2.49
O-120 A.D.C. West. w/shunt. 2 1/2" Rd., aircraft type.....	4.95
O-15 V.D.C. Vane-Type 2 1/2" sq.....	2.49
O-30 V.D.C. West. 2 1/2" Rd., aircraft type.....	2.95
O-300 V.D.C. 2 1/2" Rd., Bakelite Case Basic O-1 Ma.	2.95

To avoid shipping errors, kindly order by type #. All prices subject to change without notice.

ATTENTION !!!

INDUSTRIALS, EXPORTERS, SCHOOLS GOVT AGENCIES, LABORATORIES Our engineering staff is at your service to facilitate the application of rectifiers to your specific requirements. Write for quantity discount on company letterhead.

Minimum order \$3.00. No C.O.D.'s under \$25.00. 25% deposit on C.O.D. Add 10% for Prepaid Parcel Post and handling. Terms: Net 10 days to rated concerns only.

Orders Promptly Filled From Our Stocks All Prices F.O.B. Our N.Y.C. Warehouse

OPAD-GREEN COMPANY
71 Warren St. Phone: BEekman 3-7385 New York 7, N. Y.

LABORATORY SURPLUS

RCA 100 KC CRYSTALS, 140 brand new hermetically sealed high precision standards in Mfg. cartons, \$3.35 ea., 10 for \$27.00. RESISTANCE DECADE BOXES, 0.1% accurate, low Res. silver-contact switches, oak boxes, engraved panels, used but perfect; 5 boxes, 10 ohms to 10 meg in 10 ohm steps, \$30.00 ea.; 5 boxes, 1 to 9 meg in 1 meg steps, \$7.00 ea.; 1 large 30-decade box, 5 separate branches each 0.1 ohm to 0.1 meg in 0.1 ohm steps, \$75.00. GALVANOMETERS: 4 Weston #440, 15 microamps, \$9.00 ea. **FREQ. METER**; perfect BC-221 with set of spare tubes, built-in regulated power supply and heavy fabric carrying bag, \$55.00.

G. V. HILL
210 Park Drive Norman, Oklahoma

Dear Dick
Send me
your price list.

Yes Sir! the
HOTTEST LIST
in the LAND. brim full of
electronics, hydraulics, air-
craft parts, gadgets
Rush me your name TODAY

AC/DC SELSYN SYSTEM

Here's the perfect remote position indicating system—very accurate—operates from 6-12 volts d.c. or 110 a.c. with 75 ma. half wave rectifier and resistor. Diag. furnished.



Per set \$4.95

MIDGET SELSYNS



AY type operates from 6-12 V. 60 cycle. (26 V 400 cycle) use for either transmitter or receiver ea. 98c

500 CYCLE GENERATOR



4 KVA 110 Volt single phase p/f 1 3400 RPM. Just the thing to hook up to a 60 cycle motor as a power source to operate surplus 400-500 cycle equipment. Has 1 1/2" keyed drive shaft. Built in exciter and separate DC output of 14 volts @ 40 amps. OD 25 1/2" x 12" dia. Wt. approx. 200 lbs. Brand New. FOB EVERETT OR MID WEST. ea. \$79.95

AMPLIDYNE



GE #5AM31N9A 28 VDC input 60-0-60 VDC output at 8.8 Amps. 1 watt field power controls 530 watts output power. The ideal DC motor speed control & AC generator voltage control. Brand New ea. \$2.95

CONTROL CABLE

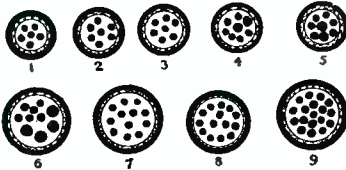

1. 6 cond. #18 stranded, shielded, rubber covered .440 OD ft.8c
2. 7 cond. #20 stranded, shielded, rubber covered. .440 OD ft.8c
3. 7 cond. #16 stranded, plastic covered ft.9 1/2c
4. 8 cond. (2 #14, 6 #20) stranded, shielded, plastic covered ft.9 1/2c
5. 8 cond. (2 #16, 6 #20) stranded, shielded, plastic covered. ft.10 1/2c
6. 10 cond. (4 #12, 2 #16, 4 #18) stranded, shielded, plastic covered. .730 OD. ft.14c
7. 12 cond. #18 stranded, shielded, plastic covered. ft.15c
8. 16 cond. #18 stranded, shielded, plastic covered. ft.16c
9. 18 cond. (2 #16, 16 #20) stranded, shielded, plastic covered, ft.16c

All conductors color coded. Write for other sizes and types of control cable.

Include return address. Satisfaction Guaranteed or your money back. Hundreds of bargains in our free illustrated list.

DICK ROSE ERECO
2912 Hewitt Ave. Everett 20, Wash.

INDUSTRIAL POWER SUPPLY EQUIPMENT
for worthwhile savings to you

10 KW 0-15 KV OUTPUT RECTIFIER POWER SUPPLY

NEW RA-38 HIGH VOLTAGE POWER SUPPLIES: 0-15,000 volts d-c @ 500 ma. Ripple 1/4% @ 100 ma; 3% @ 500 ma. Regulation 15,800 volts @ 100 ma, 15,000 volts @ 500 ma; 6,800 volts @ 100 ma, 5,000 volts @ 500 ma. Input 115 volts 60 cycle single phase. Full wave bridge rectifier using 4 371B tubes is utilized. Units are designed for continuous duty operation. Units have a full complement of controls, meters and safety devices. A remote control and spare set of tubes is included with each unit. Units are assembled in steel cabinets 62 1/2" long by 53 3/4" wide by 56 3/4" high. The cabinets are rubber shock mounted on skids. Weight 2040 lbs. Priced at less than 25% Government acquisition cost. Complete detailed information on request.

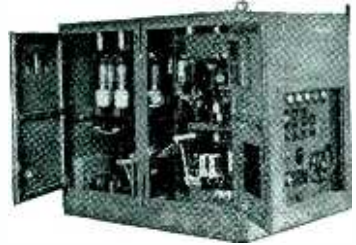

ASD RADAR TRANSMITTER

3 centimeter, complete w/725A magnetron, cavity, two 723A/B klystrons, RKR #3, four 72's, 715B, 829B, two 724B's, two 6AC7's, IN23 crystal diode, high voltage supply, cooling blowers, etc. Input: 115 v 400 c. N-2 condition \$110.00

PARTS FROM ABOVE EQUIPMENT

Pre. Amp. Assembly: includes plumbing, two 723A/B Klystrons, two 6AC7's, two 724B's, IN23 crystal diode etc.\$37.50
Power transformer: D9178, two 2.5 volt windings, 6.3 volt winding and high voltage winding, 115 v, 400 cy. Pri. \$11.50
725 Magnetron 12.50
Magnet for 725A. Pole dia. 3/4", spacing 5/8" 4850 Gauss. 7.50
Tubes, filaments guaranteed: CRP 72, \$1.10; RKR173, \$1.30; 715B, \$5.25; 829B, \$2.50
Capacitor: Vitamin Q, .30 mfd @ 2,000 v d-c85
Capacitor: Vitamin Q, 2 x .15 mfd @ 8,000 v or .075 mfd. @ 16,000 volts 2.90
Telephone Type Relays: #1 DPST normally open; #2 same as #1 plus a SPDT contact; 1,000 ohm coils both mounted in metal case 3/4 x 3/4 x 4 1/4 2.50
Motor blowers: 28 v a-c/d-c. 2.95

NEW CAPACITORS STANDARD BRANDS OIL

2 mfd 600 v d-c tubular: \$.30 each
10 for \$2.50
3.5/.5 mfd 1000 v d-c.90 each
4 for 3.00
3 x 1.0 mfd 3 kv d-c test, 1.2 kv d-c wk. Isolated sections, 1.20
1.25/.125 mfd 7.5 kv d-c or .625 mfd 15 kv d-c Pyranol.12.50
.25/.25 mfd 6 kv d-c or .125 mfd 12 kv d-c. 3.75
1.0 mfd 25 kv d-c; 65 lbs net; Pyranol 36.00

ELECTROLYTIC
500 mfd 200 mv d-c, insulated terminals95

MICA
.001 mfd 25 kv d-c; 25 a @ 3,000 kv, 18 a @ 1,000 kv, 11 a @ 300 kv 25.00

VACUUM
50 mmfd 32 kv d-c; tubular 4.95

SPECIALS

WESTINGHOUSE METER MULTIPLIER: 1 meg; 1/4% accuracy; wire wound; noninductive \$1.25
RUNNING TIME METER: R. W. Cramer Type RT3H; 220 v 60 c; 3" square face; 5 figure indicator. (new) 6.95
FILAMENT TRANSFORMER: Constant current type, pri. 110/220 v 50/60 c, sec. 21.5 v 40.5 amps.17.50
TUBE WL 386/ML-3W; 125 kv X-ray rectifier; oil immersion type; filament; 10 v @ 11.6 amps.32.00
CRAMER TIME DELAY RELAY type TD2 120S; 0-120 seconds 115 v 60 c; synchronous motor driven; contact rating 10 amps 115 v; single pole normally open 4.95

VOLTAGE REGULATORS

TRANSTAT: 115 v 50/60 cycle input; 0-115 v 100 amps 11.5 KVA output \$95.00
TRANSTAT: 115/230 v 50/60 c input; 0-280 v output @ 2.5 amps.\$21.50
TRANSTAT: 115 v 50/60 c input; 0 to 130 v output @ 10 amps.\$24.50

METERS

Weston or Westinghouse
3" 0-120 a-c amps, w/current transf \$ 8.50
3" 0-20 kv d-c w/precision multiplier 18.00
3" 0-4 kv d-c w/precision multiplier 9.50
3" -10 to +6db, 6 mm 600 ohms 6.50

CONSTANT VOLTAGE TRANSFORMERS SOLA

95 to 125 volt 50 cycle single phase input; 115 volt output:
60 va ... \$ 8.40 380 va ...\$27.00
120 va ...13.20 500 va ...34.00
250 va ...18.00
190 to 250 volt input; 220 volt output:
60 va ... 8.40 250 va ...18.00

RAYTHEON

198 to 242 volts 50/60 cycle single phase input; 220 volt 500 watt output \$38.00

POWER FACTOR Correction
9:12 mfd 1265 v a-c, 60 c, 1 ph, 5 kilovolt amps reactance. New G.E. Pyranol\$17.50

TUBES

NOTICE: All Tubes are New, of Standard Mfg. in original boxes

Type	Price
1B22	\$5.75
1B23	9.75
1B24	4.75
1B25	1.25
2162	47.50
3B22	2.75
3B24	1.75
3C23	3.75
4B28	2.75
6Q5G	1.25
1B5	1.25
250R	7.50
250TH	19.50
250TL	19.50
*304TL	7.50
307A/RK75	4.50
316A	.75
371B	1.25
388A	2.75
450TH	22.50
700A	37.50
701A	4.75
702A	3.75
703A	4.75
704A	2.25
705A	2.25
706BY	17.50
706EY	19.50
707A	14.75
707B	16.50
708A	4.75
713A	1.25
714AY	5.75
715A	9.50
717A	.75
721A	2.75
722A	13.75
725A	17.50
730A	19.50
750TL	47.50
811	1.75
830B	4.75
872A	2.25
921	1.25
931A	1.75
C5B	8.50
C6A	8.50
C6J	9.50
FG81A	4.75
WE-203A	4.75
WL-531	17.50
WL-533	17.50
WL-534	17.50

*Includes 115 v 60 c H.V. ni. trans & socket.



T-102—Filament Transformer, American Transformer Co. Spec. 29106, Type WS .050 KVA, 50/60 cye. Single phase; 35 KVA test, 12 KV D.C. operating. Primary 115 V., secondary 5 V., 10 amps with integral standoff insulator and socket for 250 T, 371, 872 and 8563, etc. rectifier tubes \$12.50 Net Wt. 15 1/2 lbs. Dim 6 1/2" W x 6" D x 12" H.O.A.

MOTOR GENERATORS

G.E. Type CC-21991 input 115 v d-c., @ 5.7 amps. Output 115 v a-c 60 cycle, single phase 350 V.A. @ 85% \$58.00
G.E. Type CC-21990 input 32 v d-c., @ 22 amps. Output 115 v a-c 60 cycle, single phase, 350 V.A. @ 85% P.F.\$63.00
Leland Type CLL-21985 input 115 v d-c @ 4.2 amps. Output 115 v a-c 60 cycle, single phase 240 V.A. @ 88% P.F.\$47.00

All merchandise in "as new" condition. Add approx. 20% to net weights for estimated shipping weights. Terms are 30% with order, balance C. O. D. All prices f.c.b. Los Angeles Warehouse. Write for additional detail information on any of the above items and for special quantity discounts. Telephone MADison 6-5391

1527 E. SEVENTH ST.

EPCO

LOS ANGELES 21, CALIF.

ACORN

SERVES LABS,
SCHOOLS, INDUSTRIALS,
—SAME DAY SERVICE.

JENSEN 10" SPEAKER
P10T—ST119. Perfect for PA work and monitoring. Voice coil 6-8 ohms imp. Each **\$4.49**

JENSEN 12" SPEAKER—PM 12SH Extended range 5.0 to 10,000 cy. 6-8 ohms v.-c. Each **\$8.45**

MAGNAVOX SPEAKER
8" PM—22 oz. magnet. Voice coil—8 ohms imp. Not surplu. Each **\$2.99**

STANCOR POWER TRANSFORMER
115v-60 cy. Pri. 800v ct. @ 200 mils 6.3 @ 6 amp. 5.0 v @ 6 amp. Upr. mt. **\$4.79**

HEAVY DUTY POWER TRANSFORMER
Pri. 116/220 volts 60 cy. Sec. No. 1—410-0-410 @ 400 mil. No. 2—6.3v @ 3 amps. No. 3—6.9v @ 13.5 amps. No. 4—5v @ 3 amps. No. 5—2.5v @ 1.7 amps. Dimensions H-6 1/2", W-6 1/2", D-5 1/2". Wt. 33 lbs. Made by GE for U. S. Navy. A Tremendous Value. Each **\$7.49**
3 for \$20

ALLEN-BRADLEY CONTROLS

Ohmage	Shaft	Bushing
50	5/8" reg.	3/8" L.B.
500	3/8"	1/4"
500	1/4" s.s.	3/8"
1000	3/8"	3/8"
1000	3/16" s.s.	1/2" L.B.
2000	1/8" mill	1/4"
2500	3/8" reg.	3/8"
3000	1/2" mill	1/4"
5000	2 13/16"	1/2"
5000	1/8" s.s.	1/4"
6500	1/8" s.s.	1/4"
10,000	1/8" s.s.	1/2" L.B.
15,000	1/8" s.s.	1/4"
20,000	1/8" s.s.	1/2" L.B.
25,000	1/8" s.s.	1/2" L.B.
40,000	1/8" s.s.	1/2" L.B.
50,000	5/8" reg.	1/2" L.B.
50,000	1/8" s.s.	1/2" L.B.
50,000	1 3/16" mill	3/8"
50,000	3/8" reg.	1/4"
60,000	1/2" mill	1/4"
100K	1/8" s.s.	1/2"
250K	1/8" s.s.	1/4"
500K	1/4"	1/2"
500K	1/2"	1/4"
1 meg.	1/8" s.s.	3/8"
1 meg.	1/8" s.s.	1/4"
6.25 meg.	3/8"	1/4"

69c each 100 for \$55.

ERIE TS2A & CENTRALAB SILVER CERAMIC TRIMMERS

1/2 to 7 mmfd.	23c ea.
2 1/2 to 6 mmfd.	
4 to 30 mmfd.	10 for \$2.19
4 to 20 mmfd.	
7 to 45 mmfd.	
20 to 125 mmfd.	
35 to 55 mmfd.	

STANCOR FILTERCHOKE
15 Henry 250 mils—55 ohms DC. Upr. **\$2.79**

NPO ERIE CHASSIS MOUNT SILVER TRIMMERS
5 to 25 mmfd. **23c ea.**
8 to 50 mmfd. **10 for \$2.19**
3 to 12 mmfd.

SFRAGUE PULSE NETWORK
15 A-1-400-50. H-500. 15,000 volts. 50 ohms imp. 1 microsecond delay. 400 G. pulses per sec. ea. **\$12.95**

Standard Brand Button Condensers
30 mmfd. **24c each**
280 mmfd. **10 for \$2.21**
500 mmfd.
1000 mmfd.

230 V.DC to 120 V.AC 60 Cycles, 7 1/2 KVA Output MOTOR GENERATORS at Sensationally LOW PRICE!

NEW, UNUSED, mfd. by Star Electric Motor Company of Bloomfield, N. J. Motor volts—230 DC, 7 1/2 HP, compound wound, 1800 RPM, equipped with 8" large flat contact field rheostat. Generator—7.5 KVA at 1800 RPM, 120 volts, single phase, 60 cycles, equipped with 13" large flat contact field rheostat. Ideal for ships, shipyards, industrials or wherever DC to AC conversion is desired. Domestic packed, FOB warehouse NYC. EACH..... **\$345.00**
Substantial Discount on Quantity!

TELEMARINE COMMUNICATIONS CO.
280 NINTH AVE., N. Y. 1, N. Y.
Telephone LOnacre 4-4490

D. C. MICROAMMETERS

0-100 ua 4" sq. G.E. DO 58.....	\$12.00
0-100 ua 4 1/2" round Weston 643...	14.00
0-50 ua 4 1/2" round Weston 643...	15.00
0-200 ua 3" sq. G.E. DO 50.....	8.00
0-50 ua 3" sq. G.E. DO 50.....	12.00

R. F. MILLIAMMETERS

0-100 Ma 3 1/2" r. Weston 425	\$11.00
0-120 Ma 3 1/2" r. Weston 507	7.00
0-10 Ma 4 1/2" r. Weston (vacuum)	22.00
0-2 Ma 4 1/2" r. Weston (vacuum)	26.00

A. C. VOLTMETERS

0-300 v 3 1/2" r. Weston 476.....	\$8.00
-----------------------------------	---------------

Precision Electrical Instrument Co.
146 Grand Street New York 13, N. Y.

BC-348 RECEIVERS, with shock mtg. BRAND NEW in original cases

DAK-3 RADIO DIRECTION FINDERS, BRAND NEW in original cases

TUBES brand new: 801A, 12A6, 10Y, 15R each .29, RK60—65, 2X2/879—39, 814—\$2.75 837—\$1.49 each.

H. E. NEY RADIO
612 West 144 Street
NEW YORK 31, N. Y.

VACUUM PUMP SALE

CENCO MEGAVAC PUMPS—\$89.00 each
CENCO HYPERVAC PUMPS—\$159.00 each
Slightly used, guaranteed perfect operating condition. Write or call:
AMERICAN ELECTRICAL SALES CO.
67 E. 8th St. New York 3, N. Y.

SHEET METAL MACHINERY
NEW and Used — Brakes — Shears
Forming Rolls — Folders — Punches — Di-Acro, Pexto, Niagara & Whitney Equipment.
R. D. BROOKS CO., INC.
Han. 3226
361 Atlantic Ave., Boston, Mass.

AIRCRAFT RADIO PARTS
We stock condensers, resistors, transformers, other parts for most surplus radio sets. Flexible tuning shafts, AN connectors, shock mountings also available. Inquiries invited.
LONG ISLAND RADIO CO.
164-21 Northern Blvd. Flushing, N. Y.

FP CONDENSERS — STANDARD BRANDS

SINGLE SECTION			TRIPLE SECTION		
Cap.	Volt.	Each	Cap.	Volt.	Each
2,000	15	\$7.79	90-90-20	200-200-50	\$8.89
1,000	25	.74	30-15-10	350-300-25	.59
10	450	.34	10-10-20	350-350-25	.51
20	450	.39	20-15-10	350-300-300	.69
20	475	.47	15-10-10	400-400-350	.62
30	450	.49	15-10-10	350-350-250	.64
			40-40-20	400-300-250	.89
			10-10-20	450-450-25	.69
			15-15-10	450-400-350	.73
			30-15-10	450-450-300	.79
			30-30-10	450-450-25	.89
			60-20-20	450-450-400	1.19
				QUADRUPLE SECTION	
			80-30-100-40	150-150-25-25	.79
			40-40-20-200	150-150-50-10	.79
			40-50-20-20	300-250-25-25	.79
			10-30-20-20	350-300-25-25	.69
			40-20-10-40	300-300-300-250	.89
			20-20-20-20	450-450-450-450	1.29
			20-20-20-20	475-475-475-450	1.34

OIL CONDENSERS

Cap.	Volt.	Each
4	600	\$.59
5	600	.69
6	600	.79
7	600	.89
2	1000	.79
4	1000	.99
8	1000	1.29
8x1	1000	1.39
10	1000	1.69
15	1000	2.89
24	1500	1.95
25	3000	1.19
1.0	3000	1.95
0.1	3500	.79
.15	4000	1.49
0.5	5000	1.99
2	5000	5.95
30	90v AC	3.95
	3 Phase	

PHONE WORTH 4-3270

ACORN ELECTRONICS CORP.
76 Vesey St., Dept. E-6, New York 7, N. Y.

TERMS: 20% cash with order. Balance C.O.D. unless rated. All prices F.O.B. our warehouse in New York City. No orders under \$2.50.

BRAND NEW — GENUINE

WESTERN ELECTRIC

DRIVER UNIT with REFLEX PROJECTOR

WAY BELOW MANUFACTURERS' COST

\$19.95

F.O.B. N.Y.C.

4 FOR \$75.00

A Blast-Proof, Blare-Proof Reflex Speaker, with a Projector especially designed for use with the famous WESTERN ELECTRIC DRIVER UNIT.

Heavy gauge metal construction throughout, including the main trumpet section, gives you peak performance without blaring or blasting.

Excellent for Concessions—Ball Parks—Schools—and P.A. Work.

SPECIAL! 25% DEPOSIT WITH ORDER, BALANCE C. O. D.

MANUEL KLEIN 72 CORTLANDT ST. NEW YORK 7, NEW YORK



ELECTRO IMPULSE LABORATORY

Attention!!
Schools, Laboratories,
Exporters!

SN RADAR

made by G-E



Operates on 110V, 60 cycle AC. Power supply is built-in. Two ranges, 5 or 25 miles. Operates in "S" band . . . co-ax output for use with standard VHF antenna . . . ideal for instruction or demonstration purposes.

Good, used condition . . . an outstanding price. Complete . . . \$250.00

SN RADAR UNIT ONLY

Less stand and antenna. Good, used condition . . . \$150.00

MOTOR GENERATOR UNIT

115V, DC input . . . 115V, 60 cycle AC output. Has frequency regulator. Highly desirable for all-round radio use . . . can be used with above radar . . . NEW! \$60.00

1 MFD., 15,000 WV OIL-FILLED CAPACITORS



A very husky HV unit suitable for welders, power-factor, transmitters, schools, labs . . . New, individually boxed for export. . . \$12.45

TDE TRANSMITTERS

Frequency range, 300kc to 18,100 kc. A1, A2, A3 emission. 110V, DC or 220V, DC models available. Good condition . . . with tubes . . . \$295.00

ART-13 TRANSMITTERS

Excellent condition . . . \$250.00

SIGMA SENSITIVE RELAY

8000 ohm coil, SP-DT. 5 prong, plug-in type . . . A real buy at . . . \$1.95

A very large variety of transmitting tubes . . . Magnetrons . . . Klystrons . . . write us stating your requirements.

815 tubes . . . \$1.95
833A . . . \$25.00

BC-348Q RECEIVERS

The best of the series. . . \$125.00

HIGH-POWER AUDIO AMPLIFIER

150 watts audio output . . . uses four, 807's in output . . . has speech compressor . . . 110V, 60 cycle AC power supply . . . 866 rectifiers, excellent condition. . . \$165.00

All items subject to prior sale . . . prices subject to change without notice. Terms: 20% with all orders, balance C.O.D.

MARKET RADIO SUPPLY CO.

1240 Market Street, San Francisco, Calif.

TS-125/AP CALIBRATED S BAND POWER METER.

ECHO BOX CUO-14AAAY FOR OBU-RADAR

TS-110/AP S BAND ECHO BOX.

APR-1 RADAR SEARCH RECEIVER, complete with tuning units for range of 80-4000 mc, 30 mc I.F., 2 mc wide.

TUNING UNITS FOR APR-1 or APR-4 RECEIVERS (can be used with any 30 mc amplifier):

TN-16, range 30-90 mc
TN-17, range 30-300 mc
TN-19, range 1000-2000 mc
TN-54, range 2000-4000 mc

A LOW COST SUBSTITUTE FOR APR-4 RECEIVER, consisting of an APR-4 power supply and 30 mc I.F. with video amplifier chassis of 3C8000AH, complete with tubes and necessary schematic. Equipment is new, but requires minor changes in wiring. . . complete. . . \$60.00

ANOTHER POSSIBLE SUBSTITUTE consists of 30 mc I.F. and video amplifier chassis, plus power supply, 115 V, 60-800 cps, of APR-5 radar receiver. Bandwidth is 10 mc. Complete with tubes, new . . . \$90.00

X BAND VSWR TEST SET TS-12/AP, complete with linear amplifier, direct reading VSWR meter, slotted wave guide with gear driven traveling probe, matched termination and various adapters, with carrying case, new.

X BAND POWER METER (TS-36/AP, 8700-9500 mc, .1 to 1000 milliwatts.

X BAND PICK-UP HORN AT-48/UP, with coaxial fittings. . . \$5.00

S BAND SIGNAL GENERATOR CAVITY with cut-off attenuator, 2700-2950 mc, 2C40 tube, with modulator chassis \$30.00

TEST SET TS-278/AP, for AN/APS 13, synchronized, delayed pulse signal generator, 400-430 mc, calibrated waveguide below cut-off attenuator, synchronized marker generator, 115 v 60 cps, new complete

HIGH PASS FILTER, cut-off at 1000 mc, coaxial, 50 ohms. . . \$12.00

MICROWAVE TEST CABLE, RG-9U cable with UG-21U connectors, 4 1/2 feet long . . . \$3.00

NOISE FIGURE METER, 10-400 mc, measures N.F. to 30, for 50 ohm impedance. 7d and 270 impedance also supplied.

MUTUAL INDUCTANCE ATTENUATOR, CALIBRATED; frequency range .1 to 1000 mc by means of plug-in coils, attenuation range 120 db. . . \$100.00

MUTUAL INDUCTANCE OR PISTON TYPE ATTENUATOR, type N connectors, rack and pinion drive, attenuation variable 120 decibels, calibrated 20-120 db, frequency range 300-2000 mc. . . \$32.00

LOSSY LINE ATTENUATOR, consisting of RG-21/U cable rolled in metal box with UG-10/U connectors, furnished in any attenuation up to 20 db at 3000 mc . . . \$15.00

SHIPBOARD RADAR—SQ, SN, SD-3 and SA-1

GENERAL RADIO PRECISION WAVE-METER, type 724A, range 16 kc to 50 mc, 0.25% accuracy, V.T.V.M. resonance indicator, complete with accessories and carrying case, new. . . \$175.00

RDF EQUIPMENT DP-15, 100-1500 kc, for ship use, complete with pedestals, azimuth scale, loop assembly, used 110 v 60 cps . . . \$250.00

TRANSFORMERS, 115 volts, 60 cps primaries:

1. 6250, 3250 and 2000 volts, tapped primary, voltage doubler, 12.5 kv lns . . . \$14.00
2. 6250 volts 80 ma, ungrounded, G.E. voltage doubler, 12.5 kv lns . . . \$12.00
3. 2 secondaries at 500 volts 5 amps each, wt 210 pounds. . . \$50.00

PULSE INPUT TRANSFORMER, permalloy core, 50 to 4000 kc impedance ratio 120 to 2350 ohms. . . \$3.00

PULSE TRANSFORMER, UTAH 9280 . . . \$1.50

PULSE TRANSFORMER, GE 68G, 828G-1 . . . \$5.00

PULSE TRANSFORMER, Westinghouse 145-EWP . . . \$10.00

HYPERSIL CORE CHOKE, 1 Henry, Westinghouse L-422031 or L-422032 . . . \$3.00

PULSE FORMING NETWORK, 20 kv, .92 microsecond, 50 ohms, 800 p.p.s. . . \$40.00

Clough Brengle Resistance Capacity Bridge, model 230A, new. . . \$50.00

Audio Signal Generator, Hickok 198, RC tuned 20-20,000 cps. . . \$45.00

CONNECTORS:

UG-10/U80	UG-190/U1.00
UG-12/U80	UG-201/U2.00
UG-21/U80	UG-245/U60
UG-22/U80	SO-23928
UG-24/U80	PL-25928
UG-25/U80	(for small cable)
UG-27/U50	M-35928
UG-29/U1.00	UG-2661.00
UG-30/U1.00	
UG-30/U special1.00	
UG-58/U60	PL 5410
UG-59/U1.00	PL 8150
UG-83/U1.00	AN-3102-148-5P25
UG-86/U1.00	AN-3102-148-2P25
UG-167/U2.00	BC-10066-20-1P50

METERS:

0-350 VOLTS, WESTINGHOUSE NX-35 METER, 1000 ohms per volt, 3 1/4" . . . \$4.50

0-8 AMPS R.F. SIMPSON IS-89, 2% to 10 mc . . . \$4.50

0-10 AMPERES, TRIPLETT 327-A, 3" square . . . \$4.00

CAPACITORS:

Feed thru, ceramic, 55 mmfd, 1000 VDC, threaded . . . \$10 each
Feed thru, silver mica, disc type, 300 mmfd, 500 v. . . \$20 each
Ceramic double cap, 55 mmfd, 10,000 v . . . \$50 each

Mica, .005, 2500 W.V. DC. . . \$10 for 5.00

TRANSMITTING OIL-FILLED CAPACITORS:

2 MFD 600 WVDC ROUND CAN 10 for \$2.
2 Mfd 1000 WV 1.00
1 mfd 2500 WV 1.50
.25 mfd 4000 WV90
.15 mfd 4000 WV 1.00
2 mfd 4000 WV 5.00
.1 — .1 mfd 7000 WV 2.00
.075 — .075 mfd 8000 WV 2.00
1 mfd 15000 WV 25.00
.2 mfd 10000 WV 25.00

AB26CR MAST EQUIPMENT COMPONENTS such as Anchor screws, coupling units, base plates and guy cables, designed for 72 ft transportable mast. New Equipment.

ELECTRO IMPULSE LABORATORY

P. O. Box 250 Eatontown 3-0768 Red Bank, N. J.

F.M. RADIOTELEPHONE

For mobile or stationary use

For two communications, radio link or broadcast relay, the SCR-52S manufactured by Western Electric Co., is still proving itself to the hundreds of our satisfied accounts. Its ruggedness, its dependable 35 watts FM output, its flexibility of application, PLUS its overall VALUE, makes it a leader in surplus offerings. These units include new transmitter, receiver with speaker, control box, interphone amplifier, all tubes, crystals, dynamotors, antenna whips, mike, headset, mountings and other accessories all EXPORT PACKED, weight 217 lbs. Our price is far LESS than total advertised price of each component! Available in 12 or 24 Volts DC. Specially designed AC power supplies also available.

Descriptive pamphlet gladly sent on request.

TRANSMITTERS

A WIDE VARIETY OF UNITS OF KNOWN MANUFACTURERS IN ALL POWER OUTPUTS, IN NEW AND NEAR-NEW CONDITION—ALL COMPLETE. SEE OUR CATALOGUE.

TOWERS

THESE DURAL TOWERS ARE MAKING A HIT WITH ITS SIMPLE INSTALLATION AND LIGHT & DURABLE CONSTRUCTION. IN 10 TO 100 FOOT GUYED OR SELF SUPPORTED MODELS. FULL DESCRIPTION IN CATALOGUES.

HANDY TALKIES—WALKIE TALKIES

OUR STOCKS OF BOTH TYPES OF PORTABLE UNITS IN NEW AND NEAR-NEW CONDITION AVAILABLE. ALL ARE COMPLETE, CHECKED AND OPERATIVE.

VIBRAPACKS & CONVERTERS

AVA-126A VIBRAPACKS, MFGED. BY RCA FOR AIRCRAFT USE. DELIVERS 330 VOLTS AT 100 MA TO RUN AVT-112A TRANSMITTER & AVR-20A RECEIVER. SUPPLIED WITH 6 AND 12 VOLT VIBRATORS, OZAGT RECTIFIER, STEEL CASE AND BAG OF HARDWARE. COMPACT WITH 3 BUILT-IN RELAYS & FILTERS. PRICE.....\$14.95
 G.E. MODEL SD & SA TELETYPE MOTOR GENERATORS FOR 110 V. AC TO 110 V. DC. PRICE.....\$14.75
 ESCO & JANETTE CONVERTERS IN 110 VDC TO 110 VAC AND 32 VDC TO 110 VAC. PRICE.....\$29.50

RADAR

SD-4 COMPLETE WITH TRANSMITTER, RECEIVER, DUPLEXING UNIT, ANTENNA, TUBES AND SPARE PARTS. FOR 110 V. AC USE. EXPORT PACKED, NEW, PRICE.....\$900.00
 SL COMPLETE, MFGED. BY WESTERN ELECTRIC, PLUS 12 WAVE GUIDE, ASSEMBLIES, 120 FEET ARMORED CABLE, SPARE PARTS CHEST, EXPORT PACKED, NEW, PRICE.....\$1600.00

SPECIAL DEVICES

PORTABLE AND FIXED POWER SUPPLIES FOR INFRA RED IMAGE CONVERTER TUBES, ALSO LOW PRICED LENSES & FILTERS. SPECIAL PURPOSE TUBES IN STOCK IN QUANTITIES.

Our NEW Catalogue mailed on request.

Cable: Communivex
 Tel: AD-4-9277

COMMUNICATION DEVICES CO.

2331 TWELFTH AVENUE

NEW YORK 27, N. Y.

Subject to prior sale.
 FOB: WHSE

WAR SURPLUS BARGAINS

GIGANTIC MAIL SALE!

- ELECTRONICS
- RADIO
- ELECTRICAL APPARATUS

Sale extended to midnite July 1st.

Amazing values. Opportunity for home experimenters, laboratories, schools, etc., to get fine new, or new condition guaranteed equipment at fraction of original cost. We pay all freight or postage. Typical items are listed below.

- 3000-watt, 115-volt, 60-c Power Plants \$299.50
- Wheatstone Bridges (0 to 11,110 ohms.) 59.50
- Weston Air Port Photo-Light Control Units 29.00
- Weston Model 689-1F Industrial Ohmmeter and case 12.90
- W. E. Desk or Wall C.B. Telephones and ringer (complete) 4.99
- RCA (3", 3" and 2") Cathode Ray Tubes 3.55
- RCA Light, burglar alarm kit. Consists of rectifier, photo cell, thyatron, relay, sockets, etc. 5.49
- Flexible shaft with Mandril and emery stone (31") 1.29
- Burglar Alarm Units—Protect home and business 6.99
- High Pressure Steel Bottles (1800 lb.) 5.69
- Chromalux Heating Elements (21"—806-W) 2.19
- Selsyn Motors—Cost Gov't. \$90—110 V—50-C. Pair 4.99
- DeLuxe, Outstanding Electrical-Radio Home Lab Kit—80 pieces 6.77
- Carbon Pile Regulator. Dozens of uses 99
- Miniature Multi-Station Telephones. Fine for office-residence inter-comm. Secret Line. A four star value. Pair 7.89
- G. E. Power Midget pocket drill (10-V, 60-C 5.95 With Chuck 6.90
- Capstan Winch 5000# Capacity 29.90

Order from ad or send card for bargain laboratory, experimenter and amateur catalog. Satisfaction guaranteed. Our reference—National Bank of Commerce.

LECO ENGINEERING CO.

BOX 908 LINCOLN, NE-BASKA

SURPLUS HIGH SPEED DRILLS MICROMETERS



- 0-1" capacity . . . each \$2.25
- 1-2" capacity . . . each 3.50
- 2-3" capacity . . . each 3.50
- 3-4" capacity . . . each 6.50

Chrome plated, precision engineered and carefully lapped to give long life. All new.
 All New Drills! Orig. value \$15. 30 assorted sizes and lengths \$3.50

SEND FOR FREE DESCRIPTIVE CATALOG
 Send check, money order or cash. 25% deposit required on C.O.D. orders. All prices F.O.B. Culver City, Calif.

AIRBORNE SALES CO., INC. DEPT. EL. CULVER CITY, CALIF.

ROTARY STEPPING SWITCHES

THIS IS THE LAST AD
 When These Are Gone That's the End The Automatic Electric Steppers Are Already Sold Out



We Still Have a Few Clare Stepping Switches. Type SD-14 20 steps, 6 levels. Coil 12V, D.C. Lists at \$40.26; our low price \$13.07. All brand new in original boxes, not war surplus.

NEOMATIC, INC.
 938 W. Washington Blvd.
 Los Angeles, 15, Calif.
 Phones RI-9363 or AR-34897

HEAD PHONES

Schools, Laboratories, Industrial Users: We have available genuine Western Electric type 716-B laboratory-type head phones, complete and new. Don't confuse these with surplus military offerings. Worth \$15, cost you \$3.90.

THE OVERBROOK COMPANY
 Overbrook, Massachusetts



TELEPHONE HANDSET HANGER

NEW LOW \$149 POST PAID PRICE

Fits most types on market. Made of heavy duty aluminum casting. Excellent for desk, mobile or marine use. BRAND NEW.
ALVARADIO, Dept. E-2
 4274 S. Broadway, Los Angeles 37, Calif.

WANTED

(Additional Wanted Advertising on page 229)

WANTED

TELEPHONE CARRIER EQUIPMENT (Western Electric) types, C, CF-1, CF-3, CF-4, CF-5, H, H-1.

TELEGRAPH CARRIER EQUIPMENT (Western Electric) X-61822A, CF-2, CF-6, 40AC1, 40C1

TELETYPEWRITERS—All Models

TELEPHONE SWITCHBOARDS—Manual and automatic.

RADIO TELEPHONE LINKS — AN/TRC-1, AN/TRC-3, AN/TRC-4, T-14/TRC-1 Transmitters, R-19/TRC-1 Receivers, Antennas.

W-8482, Electronics
 330 W. 42nd St., New York 18, N. Y.

WANTED

TN-18-APR-4 TUNING UNITS
 RANGE 300 TO 1000 MC.
 IN ANY CONDITION

W-8301, Electronics
 330 West 42nd St., New York 18, N. Y.

COMPUTER CONDENSERS

LOW RETENTIVITY - LOW TEMPERATURE COEF. 1.0 MF. PRECISION POLYSTYRENE CONDENSERS

Made By Well Known Manufacturer

FS-8844, Electronics.
 330 West 42nd St., New York 18, N. Y.

SURPLUS BARGAINS - - NOW ! !

L & N MICROMAX

—D. C. POTENTIOMETER

Model S INDICATING & RECORDING CONTROLLER

Rebuilt, Reconditioned, Adjusted Electrically and Mechanically.

Single Point, Curve-Drawing, Continuous Line, Set H-C-L Contacts. 115 V 60 cy. Motor.



\$210.00

Ranges:

- 0—1200° F C/A
- 0—1500° F C/A
- 0—1800° F C/A
- 200—2000° F C/A
- 1000—2000° F C/A
- 1000—3000° F Plat.
- 10% R

STEP DOWN TRANSFORMERS SPECIAL

Made by GE, heavy duty, considerable over-design, open frame, ideal for rectifier application, size: 3 1/2" x 3 1/2" x 4". PRI—115 Volts 60 Cycles SEC—15 V at 12 Amps **\$3.75**

HIGH VOLTAGE CAPACITORS

1 MFD 20 KV DC 18"x13 1/4"x55"	\$25.00	
1 MFD 25 KV DC 13"x7"x4"	9.85	
.001 MFD 50 KV DC 5 1/4"x7 1/4"x4" Insulators 4" dia. x 7" high	12.50	
Cap. Vols	Price	
Mfd. D.C.	Height Width Length	
10 1000	6-7/8 x 1-3/4 x 3-7/8	\$1.85
4 1000	5-7/8 x 2-3/4 x 1-1/4	.85
1 1000	3-5/7 x 2 x 1-1/16"	.50
1 500	2" x 1-1/4" x 1-1/16"	.25
.25 1000	1-1/2 x 1" x 3/4"	.25

RACK PANEL CABINET

42" H x 22" W x 16 1/2" D

Heavy Gauge Metal, Black Wrinkle Finish, shipped knocked down, ready to assemble with rear door and hardware. Front Panel not included. Panel size 19 1/2" x 36 3/4". Shipping weight 99 lbs. **NEW! A REAL BUY \$17.50**

PANEL METERS

Code—R-Round, S-Square, B-Bakelite, M-Metal, F-Flush, SF-Surface, FS-Full Scale

A. C. VOLTS

Weston 517	0-10	2" R-M	2.95
Weston 517	0-15	2" R-B	2.95
Weston 517	0-150	2" R-B	3.50
Whse RA35	0-7.5	3" R-B	3.95
Weston 476	0-8	3" R-B	3.95
Trpltt 331JP	0-150	3" R-B	4.50
Whse RA37	0-300/600	4" S-B	9.75
w/2 to 1 Potential Transformers			

AC AMPS

Trpltt 332JP	0-30	3" R-M	4.95
Weston 642	0-75	4" R-M SF or F	7.50
Whse RA37	0-75/150	4" S-B	9.75
w/external Current Transformers			

DC MICROAMPS

Weston 301	0-100	3" R-B	12.50
------------	-------	--------	-------

DC MILLIAMPS

McClntk 2001	0-1	2" R-B	3.95
GE DW41	0-25	2" R-B Wide Flange	3.50
Simpson 25	0-1	3" R-B Spec Scale	4.50
GE DO41	0-1	3" R-B Black Spec Scale	4.50
Weston 301	0-1	3" R-B Spec Scale	7.50
Weston 301	0-25	3" R-M	5.95
Weston 301	0-200	3" R-B	6.50
Weston 301	0-300	3" R-B	6.50
Weston 301	0-500	3" R-B	6.50

DC AMPS

Weston 506	50-0	50MV 2" S-B Spec Scale	3.95
GE DO50	50MV	3" S-B Spec Scale	2.95
Weston 301	0-1	3" R-M	6.50

DC VOLTS

Sun 378	0-3	2" R-B	2.50
Simpson 125	0-35	2" R-M	2.50
Weston 301	0-150	3" R-M Blk Scale	5.95

ALL PRICES FOB OUR WAREHOUSE NYC. INCLUDE SUFFICIENT FOR POSTAGE

CIRCUIT ANALYZER



NEW! \$57.50

WESTON Model 772, Type 6 with televiewer to extend DC range to 5000 V.

SENSITIVITY—
20,000Ω/V-DC
1,000Ω/V-AC

RANGES: (All self contained) AC & DC Volts—2.5/10/50/250/1000
DC Amps—1/10 A
DC MA — 1/10/50/250
MA MICRO A — 100

MICS RESISTANCE—3000/30
K/3 Meg/30 Meg Db—6
Ranges from —14 to +54
In handsome wood case

WHSE PORTABLE GALVANOMETER



Type PX-12, Movement 7 MA, special scale, solid connecting terminals, contains a 1 Volt internal cell which can be easily removed for conversion to DC AMMETERS & VOLTMETERS, with leather case and canvas carrying strap.

A buy at \$14.95

DUMONT Model 164-E 'SCOPE



Used! Guaranteed

3" CRT operates at accelerating potential of 1100 V—brilliant well-defined trace
Vert amp voltage gain approx 43, horiz amp voltage gain approx 55. Freq. range vert. & hor. amp both uniform ±3 DB from 5-100,000 CPS Input impedance 1 megohm vert., 8 megohm hor. Operates 115 V, 40-60 cycle.

**Price New \$115.00
Your Cost \$77.50**

POWERTRON

117 LAFAYETTE STREET

Electrical Equipment Co.

Phone: WOrth 4-8610

NEW YORK 13, N. Y.

UNUSUAL VALUES



HI-FIDELITY AUDIO TRANSFORMER, W.E. #D167120; turns ratio 50:1, impedance ratio 2500:1, nominal input impedance 100 to 250,000. Impedance is a maximum at 1800 cps, at which primary AC loss is 1600 cps. Above & below 1800 cps, imped. drops off almost linearly. PERMALLOY CORE. Nominal frequency response 50 cycles to 20 Kc. In case 1-5/8" dia. x 1-7/8" hi, with 2 projecting 8-32 screw studs for mounting. This makes an excellent transformer for hi-fidelity audio & experimental work; ideal for seismic amplifiers **\$2.50**

VIBRATOR, HI-freq. extra-heavy duty, Rauland #JV-0014; Input 6, 12 or 24 volts; output 200 cycles ±1%; 20 extra-heavy contacts, rated at 35 amps continuous duty, each brought to separate base pin. In case 2-1/2" x 2 1/2" x 5 1/2". **BRAND NEW, in orig. boxes 4.95**



ANTENNA SWITCH, SPDT, extra-heavy contacts porcelain stand-offs; on base 7" x 8" x 1/4"; Insulators alone worth more than price of switch.
Per dozen12.00
EACH1.19

VIBRATOR, Mallory 538C 6-volt vibrator for BC-1335 FM Transceiver 27 mc to 38 mc.....2.45
BELL, 23v AC or DC; 3" dia. with self-contained ringer coils & hammer; external flange for mounting. New, boxed.
Each.....1.00
CHROME PLATED, 10 for \$10. Each.....1.25

TERMS: Postage extra. Please, minimum order \$2.00. Net Cash, 25% deposit on C.O.D.'s. **FREE LIST.**

ELECTRONIC SUPPLIES

219 East First Tulsa, Oklahoma

SAVE WITH GUARANTEED SURPLUS

POWER RHEOSTATS

(nationally known mfrs)



ohms	watt ea.	ohms	watt ea.
5	50	1.24	378
5	150	2.74	431
6	25	.98	500
6	50	1.24	500
7	25	.98	585
7.5	100	2.25	750
8	50	1.24	750
10	25	.98	1000
12	25	.98	1200
15	25	.98	1250
16	25	.98	1250
22	50	1.24	1500
25	25	.98	2000
50	25	.98	2000
50	50	1.24	2500
60	25	.98	3000
75	150	2.74	3000
80	50	1.24	3500
80	500	4.95	5000
100	50	1.24	5000
125	25	.98	7500
150	50	1.24	7500
200	25	.98	10000
250	25	.98	10000
350	25	.98	20000

(Discounts to Quantity Users)

ALLEN-BRADLEY

"J" "JJ" "JJJ"

Potentiometers

also
other famous makes
carbon and wirewound

Large Variety of Bargain Prices
Send us your specs. Let us quote.



GE Model 8K2A6 Cat No 94X895 measures elapsed time up to 100,000 hours. 230v/60cy. for conduct mtg. 4 1/2" diam. 3" deep \$8.49



OIL CONDENSERS

FAMOUS MAKES

most with ceramic pillar insulators.

.1 Mfd	—3000 vdw	\$0.75
.25 Mfd	—3500 vdw	1.15
1.0 Mfd	—500 vdw28
1.0 Mfd	—600 vdw35
2.0 Mfd	—400 vdw35
2.0 Mfd	—600 vdw39
4.0 Mfd	—500 vdw59
4.0 Mfd	—600 vdw69
6.0 Mfd	—400 vdw75
6.0 Mfd	—600 vdw79
10.0 Mfd	—600 vdw98
14.0 Mfd	—600 vdw	1.75
15.0 Mfd	—600 vdw	1.98
15.0 Mfd	—1000 vdw	2.25
4-4 Mfd	400 vdw 3 sec. 4 prong plugs in can 4 1/2" high x 3" Dia.	\$1.49



BATH TUB CAPACITORS

FAMOUS MAKES

.033/400	V-174	1.0/230	V-234
.05/200	V-134	1.0/600	V-354
.05/400	V-194	2.0/600	V-454
.05/600	V-214	2x.05/1500V	-334
.1/200	V-174	2x.1/600	V-234
.1/400	V-204	2x.1/1000	V-314
.1/600	V-224	2x.16/600	V-284
.15/600	V-234	2x.25/600	V-234
.25/200	V-194	2x.5/600	V-344
.25/400	V-214	3x.05/600	V-304
.25/600	V-234	3x.1/600	V-334
.5/200	V-204	3x.25/600	V-384
.5/400	V-234	3x1.0/100	V-354
.5/600	V-254		
4.0/50V	—134	200/12V	—254
25/25V	—274	300/3V	—354
25/50V	—284	2x10/25V	—254
25/75V	—304	2x200/9V	—404
50/25V	—284		

SELECTOR SWITCHES

NATIONALLY KNOWN MFRS.

Total Poles	Total Pos	Total Decks	Type	Price
1	12	1	ceramic	\$0.45
1	21	3	bakelite	.55
2	11	2	bakelite	.50
4	11	4	bakelite	1.17
6	11	6	bakelite	1.68
18	5	9	ceramic	1.90

OTHER TYPES AVAILABLE

TERMINALS BOARDS

(heavy duty)
Black Bakelite



Westinghouse
1 1/2" wide x 1 1/2" high
5 terminal—4 1/4" long..... 49¢
8 terminal—6 1/4" long..... 79¢
12 terminal—9 1/4" long..... 1.19

AMPHENOL "AN" CONNECTORS

LARGE VARIETY AVAILABLE
AT GREAT SAVINGS

Send your specs and let us quote



LEVER SWITCH

DPDT 10-amp. standard heavy duty contacts—Mossman #4101 momentary lever action, norm open and norm closed circuits..... \$1.49

Many Other Types Available

Open Accounts to Rated Concerns
Prices net FOB our whse NYC

ALEXANDER MOGULL CO., INC.

161 Washington St., N. Y. 6, N. Y. WOrth 4-0865

SEARCHLIGHT SECTION

SERVO OUTPUT TRANSFORMERS

PP 6L6 to Servo mechanism with 10% feedback winding. MU metal core.

\$3.25 ea. Dual unit PP. 6V6 to Servo mechanism with 10% feedback winding and 6SN7 to Servo mechanism. Both in 1 can, ea. **\$3.95**

EVERYTHING U WANT AT 50% LESS!



220-110V Step-down Auto Transformer

300 W., open frame...\$4.25 ea.
250 W., open frame...\$3.75 ea.

RELAYS

Clear Sensitive 3500 ohms MA SPDT 8 amp contacts

No. R30 \$1.10 ea.



6.3V Filament Transformer 8 Amp. 7000 V Insl. Ship Wt. 6 lbs. No. T90 \$1.95



THORDARSON T-70R62 PWR TRANS

115v 50-60 cy. pri 700v C.T. @ 145 ma, 6.3 v. C. T. @ 4.5 ma, 5v. @ 3a \$4.25 ea.

CONNECTORS

SO 239 (83-1R) "UHFI" COAX

Sample 28¢ ea. \$25/C \$220/M

AN-3108-40-9S — 69¢ ea.
AN-3108-36-15S — 69¢ ea.
AN-3108-18-1P — 39¢ ea.

HI-SPEED KEYING RELAY

DPDT 24 v D.C. 300 ohms. Betts & Betts. Vacuum sealed, plug-in type. Fits standard octal socket. \$1.95.

FREE data, circuits designed by ROBT. G. HERZOG

Universal general corp. Prices Net FOB Our Plant Walker 5-9642

365 Canal St., New York 13, N. Y. Min. Order \$2.50

RADAR EQUIPMENT

APS-3 & APS-4 3cm search sets complete
SO-12 complete w/trailer & gas driven supply
SO-9 10cm shipborne search set compl. w/spares

APR-1 Receivers	750.00
QBF Sonar Sets	15.00
SO-9 Pulse Networks 1 microsec. 15 Kwatt	15.00
SO Pulse transformers	30.00
AY-101D Autosyn w/calibration	40.00
Weston mod. 45 0-25 amp. DC	2.00
2J1G1 Selsyn motor	25.00
PR-112 Power unit	75.00
APQ-2 Transmitter & Power unit	22.50
Westinghouse Freq. Met. 58-62 CY	5.00
G.R. Type 471A 50,000 ohms Selenium rectifier, full-wave 115vAC 250ma, DC	1.20
BC-77 Dynamotor	9.50

Vacuum tube pump station complete w/pumps, manifold, ionization gauges, oven, etc.

Tubes: 350	1.50	803	5.00
715B	15.00	RK72	1.30
723A/B	10.00	726A	12.50
725A	12.50	3BP1	2.50

Write for listings of other surplus bargains.
LERU LABORATORIES, INC.
360 Bleecker St. New York 14, New York

SPECIAL OFFERING

RG 18/U COAXIAL CABLE

Braided armor overall, otherwise same as RG 17/U. 52 ohms OD .920 efficient solid dielectric cable. A REAL BARGAIN 40¢ per foot

MARLAN CORPORATION Dept. E.
162 N. Clinton St. Chicago, Illinois

UNUSUAL PRICES

PERFECT JAN. & STANDARD MAKE TUBES

Magnetron	715A..... 6.00	885..... 1.45	719A..... 14.95	450TH..... 19.95	1624..... .69
2J26..... \$18.00	715B..... 9.00	Rectifier	866A..... 1.50	WL468..... 8.95	1625..... .25
2J27..... 18.00	5D21..... 29.95	2X2..... 5.45	872A..... 2.50	801A..... .75	802A..... 1.93
2J31..... 18.00	Thyratron	2X2A..... .75	899S..... 29.95	703A..... 1.80	8025..... 3.93
2J40..... 54.00	C1B..... \$3.95	371B..... 1.25	1616..... 1.95	802..... 4.25	Accorn.....
2J49..... 36.00	3C23..... 3.95	5R4GY..... 1.25	8020..... 2.95	803..... 5.25	1A3..... \$2.29
2J50..... 45.00	3C31..... 3.95	RK72..... 1.25	Power	807..... 1.35	954..... .45
2J61..... 45.00	393A..... 3.95	RK73..... 1.75	2C40..... 1.80	815..... 6.95	955..... .45
2J62..... 45.00	394A..... 3.95	795A..... 1.25	2C44..... .75	814..... 2.95	956..... .45
714A..... 4.00			350B..... 2.40	832A..... 3.95	957..... .35
725A..... 15.00			368AS..... 1.80	845..... 3.23	958A..... .45
730A..... 12.00			388A..... 1.80	849..... 29.95	959..... .55
Klystron			446A..... 1.80	861..... 19.95	9001..... .55
2K25..... \$24.95					9002..... .35
2K28..... 19.95					9003..... .45
707A..... 9.95					9004..... .5
707B..... 9.95					9006..... .35
Pulse					C. R. Tubes:
527..... 8.95					5BP1..... 2.75
701A..... 6.00					5BP4..... 4.75



LIBERTY ELECTRONICS, INC.
135 LIBERTY STREET NEW YORK 6, N. Y.
PHONE WORTH 4-8262
ASK FOR FREE CATALOG

EXCEPTIONAL VALUES

Surplus and Standard lines. Test Equipment, Meters, Rheostats, Oil Filled Condensers, Switches, Co-ax connectors, Resistors, Shielded Cables, Multi Conductor Cables, Fuses and Holders, Sockets, Crystals, Variable Condensers and many quality items too numerous to mention. Send for our latest 12 page flyer "E".

Special get acquainted offer!! 250MM Precision Vernier Caliper in fitted case. \$50 Value; our price \$13.95.

STANDARD RADIO—ELECTRICAL PRODUCTS

2260 WASHINGTON AVENUE
NEW YORK 57, NEW YORK

Good Values - Large Stocks - Prompt Service

POWER SUPPLIES:
0-15,000 v.—.5 amp. d.c. output—110 v. a.c. input..... \$395.00
0-15,000 v.—.035 amp. d.c. output—110 v. a.c. input..... \$215.00
1000 v.—350 ma. d.c.—14 v.—a.c.-d.c. output 110-220..... \$95.00

SWITCHES—S.P.D.T.—motor operated 110 v. a.c.—will handle 15 kv. @ 1.5 amp.—oil filled—small size—ideal for switching any h.v. output.... \$47.50

LABORATORY POTENTIOMETERS—20 k. ohms.-10 v. a.c. reversible motor SG Selsyn—accuracy better than 1%—oil filled..... \$55.00

TELEVISION TUBES—We are in the center of the C.R. tube industry and can supply 7-10-12-15-16-20 inch tubes at low prices. Also tuners, chassis and complete sets.

RADAR—See us for test sets. Plumbing—Co-ax—T.R. units—antennas, magnetrons, Klystrons. Special 3 cm. test dipole..... \$4.75

TRANSFORMERS—From 1v to 100 kv.—5 w. to 75kw. all sizes and types of power, filament, audio, modulation, pulse, supersonic, etc.

LET US KNOW YOUR NEEDS—WE CAN FILL THEM NOW

VETSALCO Inc.

FOR ELECTRONICS
78—21ST. AVE. PATERSON, N. J.
ARMORY 4-4435

An Investment !

Productive advertising is an INVESTMENT rather than an EXPENDITURE.

“Searchlight” advertisers almost invariably report prompt and satisfactory results.

BE CONVINCED—
send us your advertisement TODAY.

Address
Classified Advertising Division
ELECTRONICS
330 W. 42nd St., N. Y. 18. N. Y.

FOR SALE

TUBE MAKING EQUIPMENT

for

- Cathode Ray Tubes
- Transmitter Tubes
- X-Ray Tubes

**HIGH VACUUM MERCURY PUMPS • TRANSFORMERS
POWER CONTROL EQUIPMENT • HIGH VOLTAGE CONDENSERS
• GAS OVENS**

All Manufactured by the General Electric Co.

ATLANTIC BUILDING SUPPLY Co. 650 BROAD ST. LYNN . . . MASS.
TEL. LYNN 3-5502

SURPLUS

Laboratory Equipment

GENERAL RADIO

107-M Variable Inductors.....\$35.00
616D Het. Freq. Meter
726A V.T.V.M.
775-A Frequency Limit Monitor
(1.6 to 45 Mc).....\$125.00

FERRIS

16-C Std. Signal Generator 50 Kc to 28 Mc
33A Crystal Calibrator
34-A U.H.F. Crystal Calibrator...\$175.00
18-C V.H.F. Signal Generator

RUBICON

3404H DC Spotlight Galvanometers \$40.00
1050 Wheatstone Bridge.....\$70.00

GRAY

E3108 Wheatstone Bridge.....\$70.00

L & N

5430A Wheatstone Bridge.....\$80.00

WESTERN ELECTRIC

RA-90A H.V. Power Supplies, New
+ 4900-1000V: Input 110V 400 CPS.\$15.00
TS5/AP Range Calibrators, New...\$50.00

WESTON

Model 45 (0-75 V.D.C. ± 0.5%).....\$35.00
796 Megohmmeter (0-200 Megohms).....\$50.00

MULTIFLEX

MG3 Spotlight Galvanometer.....\$125.00
.00254 μ amp per MM

BOONTON

110-A Beat Frequency Generator...\$350.00
(20 Cps to 5 Mc ± 2%)

155-A F.M. Signal Generator.....\$350.00
(1 To 11 Mc and 38 to 50 Mc)

110-A QX CHECKERS

120-A V.H.F. Circuit Checkers.....\$95.00
(3 Ranges—210 Mc.) For TV &
FM Testing

DUMONT 208B RCA Audio Freq. Meter
MEAS. CORP. 78B, 80 Sig. Gen. 62
V.T.V.M.

SYLVANIA 1342 Polymeter
ALL PRICES F.O.B.
N.Y.C. WAREHOUSE SUBJECT TO
PRIOR SALE

THE NATIONAL INSTRUMENT CO.
FAR ROCKAWAY, N. Y.

Cable Address NATINSTRU, NEW YORK
TELEPHONE FAR Rockaway 7-1123

ASB YAGI ANTENNA

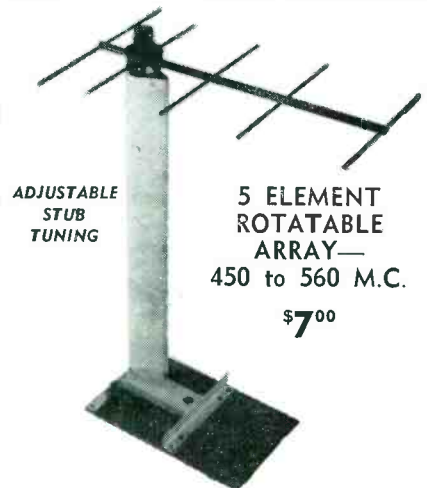

ADJUSTABLE
STUB
TUNING

5 ELEMENT
ROTATABLE
ARRAY—
450 to 560 M.C.

\$7⁰⁰



RCA HI-VOLTAGE
TRANSFORMER

Pri—115/230V, 60Cy
Sec—6000V—80 MA
\$11.80

GENERAL
ELECTRIC
FG-172
THYRATRONS
\$14⁵⁰ EA.

\$10⁰⁰ EA.

IN LOTS OF 10
BRAND NEW
ORIGINAL CARTONS
FULLY
GUARANTEED

WESTINGHOUSE HYPERSIL TRANSFORMER



PRI-115V. 60CY 3/4 KVA
SEC #1 - 240V - 1.56A
Sec #2 - 240V - 1.56A
WT. - 30 LBS.
\$1150 EACH

\$1000 ea. Lots of 10



200 w. WIRE WOUND FERRULE RESISTORS
Fixed taps at each 10% of full resistance value.
25 ohms 200 ohms 500 ohms 2000 ohms
50 ohms 300 ohms 1500 ohms

77c Each 10 for \$6.10

YAGI ANTENNA

DOUBLE STACKED
6 ELEMENT

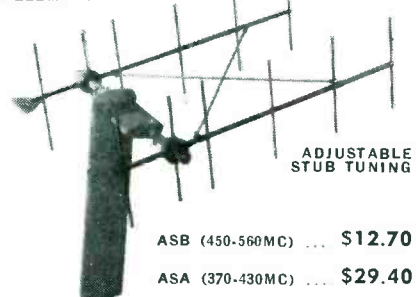

ADJUSTABLE
STUB TUNING

ASB (450-560MC) ... \$12.70

ASA (370-430MC) ... \$29.40

LECTRONIC RESEARCH LABORATORIES

1021-23 Callowhill St.

—New Location—

Phila. 23, Pa.

Telephones: Market 7-6590 and 6591

SEARCHLIGHT SECTION



AMPLIFIER KITS—10 Watts HIGH FIDELITY \$14.95 SUPER HI-FIDELITY 24.95
WRITE FOR COMPLETE DATA

POWER PACKS—Basic Kits!

Medium Power Kits for Your Rig—110V/60cyc 250VDC/60Ma & 6.3V/4A; USN XrM Hivins Herm Sid 3 $\frac{1}{2}$ Hx 3 $\frac{1}{2}$ dia PLUS rect. Tube & sckt 2-10mfd electrolytics & 15 HY CHOKE\$2.98
350VDC/125Ma. Fils 2x6.3V/2A, 5V/2A & 115 V/100M
MaisolXFM Rwdg FEDERAL Test Herm Sid 5x5x3 $\frac{1}{2}$ " PLUS 5Y3G
Trect&sckt, 2-10mfd electrolytics & 10Hy Choke. "Tab" Special \$4.49



TV Components

- A. Utah 9318 H'BiKu Osc Xfmr H'Sid 6.98
- B. UTC 8862 V/Battery Osc Xfmr H'Sid 98 2.99
- C. Yoke MagnDeflec C. Yoke MagnDeflec
- C. Yoke MagnDefl RCA 201D1 4.23
- D. Ion-Trap RCA 263D4 2.79
- E. FocusCoil Magn Kines cps 3.79
- F. HV Flybak H'OutXfmrSims RCA211H 5.28
- H. V'OutXfmr RCA 204T2 5.28
- I. Erie Cndsr 500mm/10KV 4.0
- J. Jeffers Cndsr 500mm/20KV 7.5
- L. TWINEX 300ohmTVcable100ft \$2.25; 1000 ft \$17.50

Television Cable Tacker

Twinex Cable Installation\$3.98
5000 Boxed Staples 2.98

Ask for "TAB" SPECIAL PRICES—RCA TV COMPONENTS Incl. SIXTEEN-INCH PARTS!

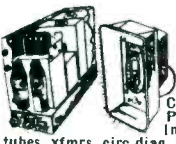

BASIC PHOTO FLASH KIT

Complete Pwr Supply Incl. endrsrs. tubes, xfms, circ diag, all instructions & FOTOFASH lamp & reflector. For 115 VAC Only. \$29.95
STUDIO KIT—Famed Air Corps 1503 Set for 115V AC or battery w/2 lamps & rolls \$53.95
FLASH CONDENSERS mid/2500 VDC/21.9 Watt-Sec. \$2.75, 5 for \$12.50
15mf/330VAC/1800VDC int. \$3.99
25mf/330VAC/1800VDC int. \$5.95
18mf/660VAC/2800VDC int. 6.49
16mmPAN500mGSAP Cam 54 rolls \$25.95

AMGLO Electronic Flash Lamps

- 5804X100 W-Sec/15-32mfd. \$13.50
- 54R4X/200W-Sec/15-80mfd. 14.50
- 48U4X/600W-Sec/80-260mfd. 15.50
- 68R9M/200W-Sec/15-80mfd. 14.50
- 78P9M/300W-Sec/20-100mfd. 13.50



HAYDON CLOCK MOTOR & SWITCH

Synchronous 60to10VAC/60cyc/24RPM & Switch 98c: 12 for \$10
SYNC IRPM/115V/60cyc \$2.49



MOTOR HOLTZER CABOT

IHP/lor3ph/115 V 60cyc/3450RPM Ball Bearing/cont duty removed from gun control -LN. \$9.98
1/40HP/1 or 3 ph/115V 60cyc/3450 RPM GE/Deico/Diehl w/capacitor Cont Duty % shaft \$3.98
GE 211G SELSYNS w/data 24V or 110V/60cyc oper Used Tested PAIR (2) for \$1.49



SWITCHES

- Micro, Mu. Toggle, etc.
- A. LeafSw3 $\frac{1}{2}$ "DPNG&NC/15A 98
- B. PinPlungerSPDT/10A 54
- C. MicroSwPlungerSPDT/10A 59
- D. MicroSwPlungerSPNO/10A 59
- E. ArrowHKHPlungerSPNO/6A 39
- F. MicroSwRollerSPNO/10A 89
- G. A.H.&H ToggleSPDT/6A 304
- H. MicroSwPlungerSPNO 'NC 59
- I. Mu.&MicroSwSPDT/W 65
- J. MicroSw Button SPDT 69
- K. MicroSwSPNC/30A 98
- L. SwitchetteDPNO&NC 304
- SPNO 25
- SQ'D Start&Stop PushButton 98



CRYSTALS—Mtd FT243 exacting S. C. Specs
3525Kc 4190Kc 5235Kc
3735Kc 4780Kc 5485Kc
3980Kc ea. 98c, 2/\$3

Hi Accy Xtal Frequency Standards
100Kc\$5.98 5000Kc\$3.98
200Kc\$3.98 4700Kc98
500Kc12.98 81.95Kc1.98
1000Kc Useable in BC2212.97
Mica Cndsr .012Mfd/25000VDC. \$145 List.\$4.98

BATTERIES Storage & Dry

- A. BB206U 2V/11AH Willard S'B \$1.89
- A. NT6/BB214U 6V 6AH Willd S'B 1.98
- B. BB54 2V/27AH Willd S'B 1.89
- C. Willd 4V/45AH TBY S'B 5.95
- D. 6V/25AH 7 $\frac{1}{2}$ x2 $\frac{1}{2}$ x5 $\frac{1}{2}$ 3.98
- D. Willard 6V/40AH/ER40-6 6.98
- E. BR18/BB52 5oz/36Vmin S' Battery, 98c; 12/10.00
- F. Burgess 3V/F2BP '47.8/1
- G. Eveready Hvy Duty Minimax BA43 p/o SCR284 90/45/1 $\frac{1}{2}$ V Late '47, ea.\$1.89
- 80 Hydromer Kit & Box 1.99
- Baty Acid (R'Exp Only) 1 pt. 19c
- HEINEMANN Magn C'Bkrs. for AC and DC operation: AM-PERES .01, 2, 3, 7, 9, 15, 20, 30, 35, 80, 180 and 220 Amps. S'OLA Pk. Each \$1.49; 10 for \$12.98; 100 for \$120. KLIXON Thermal Push-Button Type C' BKRS AMPERES: 5, 10, 15, 30, 35 Amps. Each 79c
10 for \$5.98; 100 for \$45.00
- SQUARE-D Toggle Switch AN Type C' BKRS AMPERES: 5, 10, 15, 20, 25 Amps. Each 89c
10 for \$7.98; 100 for \$69.00

CONSTANT VOLTAGE REGULATORS

NEW RAYTHEON in 95-130V/60 cyc; Output 115V/60 W Csd \$10.95
RAYTHEON in 198 to 242 V/50-60 cys; Output 220V/500 Watts; 0.5% Raltu Back mtrg\$36.00
SOLA USN Cased in 95 to 190V/50-60 cys; Output 115 or 220V 2 KW/17.4 Amps/Constant Duty 1% Reg. LN\$130
Same NEW cost \$389. Only \$162
SOLA Pk 192/198 Vdc. Sec. 1 for 1.95
/26.1A/3KVA. NEW \$185
GENERAL ELECTRIC 57-63 cyc. KVA .780 at 80 PP. 95/130 line volts, 113/115/117 Volts out. Used Gtd., \$54; NEW \$79
SOLA In 105to125V/60cyc; Out 115V/80Watt New 16.95

DYNAMOTORS

6Vin/240Vout/100ma or 12&24V in/500V50ma; PM USN\$3.49
28Vin/540Vout/250ma LN 2.50
12&24Vin/275V/110ma PM 1.95
28Vin/250Vout/60ma 2 for 1.98
12&24Vin/220V/100ma & 440V/200ma 5.95
PE94A. Same Above NEW w/Fitrs & Start 9.95
Dyn-Inverter GE 27Vin 115V/35A out 485KV A 2 for 1.98
SVC14A 200C/660 Watt/C. 135V GR 15.98

RECTIFIERS

Selen FEDERAL 100 Ma. 72c; 200 Ma 98c; 10 for \$8.80
Selen CT 18Vin/12out 1.50
Selen Full-Wave for Relays or Pwr. 40 mf/115VDC rated 39c; 10/\$3.49; 100/\$27.49

BRIDGE TYPE

In	Out	Amps	Price
18	14	3.5	3.29
18	14	5	4.25
18	28	3.5	6.49
36	28	5	7.25

LAMPS, LIGHTS

Tungar* Bulbs Aviation Lights 20X672* 2.95 C1249/12VGR 199988* 2.95 25 for 1.00
18948* 2.50 Sealed Beam
18948*GE 3.49 4560/60W 3.50
MAZDA PL** 4522/250W 1.49
44**Box 10.50 NEON BULBS
47**Box 10.50 NE2-Qty100 3.98
49**Box 10.60 NE16/991 25
64**C07 NE5/421 24
S6/T4* 15 NE2/102 07
10 for 1.39 Qty100 \$5.00
100W/20V** TEL. Slide Lamps
313/28V** 25 6.24 30V ea 18c
323/3V** 10 100 for \$15

MICA CONDERS—Lo Loss

.001mfd Cd Type9/1000VTest 20c
.006mfd Cd Type 8/1000VTest 25c
.01mfd Cd Type 4LS/1000VTest 30c
.03mfd Cd 4LST/1KVTest 98c
.001mfd 6KV 2.5KVTest 30c
.0006mfd 8KV Cd 664-59H 4.98
Write for Complete Mica Listing

TUBES . . . New Standard Types

1A3 \$ 59	6A3 98	10Y 61	80P 1.50	1641/RK60 75
1A4 1.26	6AB7/1854 84	12A6 23	810 6.95	2050 67
1A7GT81	6AC7 69	12A1H7GT 87	811 2.20	2051 45
1B3/801681	6AG5 85	12C8 65	813 6.95	7193/2C22 18
1B21/471 2.95	6AJ7 1.27	12H6 36	814 2.98	8012A 1.49
1B23 4.90	6AL5 85	12K8 85	815 1.10	8013A 3.95
1B24 4.95	6AK5 85	12S7GT 50	826 6.90	8020 3.49
1B27 29.95	6AL5 79	12SG7 69	832 2.45	9001 39
1C4 1.26	6AS6 1.79	12S17 64	836 1.12	9003 29
1D5GP 1.25	6AT6 49	12SK7GT 58	838 3.98	9006 25
1G6GT98	6B4G 1.15	12SL7GT 86	845 4.50	9006A 9.95
1L469	6BR659	15-4 Ballast 49	860 1.97	C6J 4.95
1N5 7.39	6BE659	24G/3C24 69	861 11.90	CK1005 25
1NSGT69	6C427	25Z5 53	865 1.00	CRD72 1.85
1P5GT86	6C671	28D7 39	872A 2.45	FG17 2.98
2B22/GL59 73	6CG8 1.05	37 78	872 5.45	FG27A 9.90
2C26 25	6D4 1.25	38 39	902 4.89	FG105 11.95
2C34/RK34 55	6E571	39/44 37	930 4.89	FG166 49.00
2C40/464A 1.49	6F6X/1613 55	41 58	931A 3.95	GL434 3.90
2C43/464A 7.39	6F8G 1.04	43 66	954 1.16	HY115/145 89
2C44 1.69	6H6GT38	45 Spec. 30	955 16.95	REL36 9.4
2C46S/GL465A 6.16	6J556	83V 81	1000VHF 59.95	VR90 2.75
2D2198	6K6GT69	84/GZ4 72	95633	VR92 2.3
2E22 1.34	6K7G64	205B/VT2 1.98	95725	VR105 90
2E25/HY65 2.48	6K886	211 1.04	959 1.04	VR150 65
2J21 11.98	6L685	215A 13	1614 1.50	WL460 11.98
2J31 9.95	6L785	249C 75	1619 25	WL531 9.95
2J33 14.50	6N7/1635 85	250TH 19.49	1625 1.95	WL531 9.95
2J34 18.95	6P5G94	304TH 5.95	162958	WL632A 8.98
2J38 13.89	6SA7GT49	304TL 1.98		
2J42 29.85	6S760	327A 2.90		
2J48 45.00	6SF778	350A 1.45		
2J50 45.00	6SH769	350A79		
2J61 39.95	6SJ772	388A 40		
2J62 39.95	6SL7GT94	450TH 18.98		
2K29 24.95	6SN7GT69	527C1M 11.95		
2V3G 1.05	6S0739	531 1.80		
2V3049	6L5/G65 81	534 1.80		
3B7/1291 95	6U6GT 1.49	VT12A 2.45		
3B24 1.79	6U7G58	575A/975 14.50		
3B25 4.48	6V6GT69	601B 1.95		
3C23 2.95	6X5GT58	701A 3.95		
3D6/1299 85	6Y6GT 65	702B/702B 3.49		
3E29/829B 4.50	6Z7G 1.23	705A/8021 65		
4B27 2.49	7A470	707B 8.95		
4J47 45.00	7B570	710A/8011 75		
5J29 17.98	7C4/1203A38	717A69		
5R4Y 1.05	7E5/1201 89	722A/287A 9.95		
5U4G46	7L786	723 4.95		
5W446	7Q786	803 7.95		
5Y3GT38	7V7 1.04	805 4.50		
5Z381	1067	817 1.15		

XFMRS—115V 60 Cyc Inpt Plate & Filament

TV TRANSFORMER—ALL VOLTAGES & Filaments for 16, 12, 10" Tube Delivers 500V DC/5mA (10VasDbr) PLUS 300 VDC/275ma rectified outd & fil's. 6.4V/10.3A, 5.4V/8A, 2.5V/3A, 5V/3A Weco Hyspirc Core Oil-filled Herm Sid USN specs Hvinstd thruout 29lbs Govt Cost \$108. ONLY\$12.95
1000V/200ma, 6V/5A, 5V/6A Hadley Fully Encl w/90V bias tap & 16V/.55A outd 6.95
5VCT/150 to 120Vins 10A/nt 10VCT/19A 6VCT/3A, 6.3VCT/2A USN Csd Hivins 3.98
650VCT/175ma, 5V/3A, 6.3V/1.2A Csd Hivins JeffElec/Stancor 3.29
420VCT/85ma, 6.3V/9A also Prf 6-12-24-115 VDC & 230VAC Univ Vib Xfmr Csd \$2.39
2 for \$4.39; 10 for 19.98

Plate Transformers

2X330VCT/10ma (660VCT/10MA) HV Csd 1.49
1200VCT/300ma & 18V/1A wndg Csd HV 6.95
1800V/4ma USN Csd Alter/GE Hivins 3.29
2100V/10ma Csd Hivins STANCOR 3.98
3000V/10ma Chitrans/W.E. Csd Hivins 4.50
5000V/10ma (for Tube 2X2) Csd 7.95
7500V or 15000V Dblr/035A 17.95
10800 VCT/.095A Csd RAYTHEON 19.95

Filament Transformers

2.5V/1.75A, 4V/16A 20KVIns Csd \$4.95
2.5V/2A Hivins (2X2) 69c; 10/\$5.98; 100/\$49
2.5VCT/20A @100to120Vins or 5VCT/20A @ 200-220-240VInpt 10KV ins Csd Hmt Sid \$5.98
5VCT @150 to 120Vins 10A/nt 10VCT/19A @ 200-220-240VInpt H.V. ins Csd Hmt'sid. \$5.98
5VCT/60A KENYON HV ins 6.95
5V/115A KENYON HV ins 12.95
6.3VCT/7A USN Csd Hivins 1.39
6.3VCT/3A, 7.5V/6.5A Csd UtC S-69 3.49
6.3VCT/4A (quad to 6.5A) Csd Hivins 1.69
6.3VCT/1A 6.3VCT/2.5A Csd Hivins 1.98
12.6VCT/2A H'Sid Hivins 1.49; 2/2.79

CIRCULAR SLIDE RULE

12" Equiv—Only 2 $\frac{1}{2}$ " Radius FULLY LAMINATED—PRINT STAYS ON—Multiply, Divide, Squares & Cubes & Roots. Logs & Decimal equiv. scale. Data & Case 98c

RADIOSONE AN/AMQ-1

72.2 Mc Xfmr w/3A5 FM HF ALL PARTS Orig Carton less Batty NEW \$4.49

Xtal Diodes—Thermistors

IN34 \$1.15; 2/\$2.20; 10/\$10.49
IN21, 21A, 22, 23, 23A ea. \$1; 12/\$10
IN21B, IN27 ea. \$1.75; 10 for \$14.98
IN23B, IN26 \$3.00; 10/\$27.50
DI68391, Therm Compensator \$2; 3/\$5
DI70396 HF pwr meas. 90c 3 for \$2.50
DI78190 Time Delay 90c 3 for \$2.50
Varistor 38C USN CW20259 2.98

5 MA Tuning Meter

While They Last! GE 2 $\frac{1}{2}$ " 98c Bklt Csd SPECIAL

20KV Precision Resistor & Meter—20 Meg/20 KV SPRAGUE Precision Resistor. With 0/10 Meter 3 $\frac{1}{2}$ " Bklt Cased \$4.48
1/2 Ma DC Miniature DIPPER Meter 1.49
120 Ma RF Weston 3 $\frac{1}{2}$ " B' Csd to 65Mc's 12.95
300 Ma RF Weston 3 $\frac{1}{2}$ " B' Csd to 65 Mc's 12.95
10&40Ma 2in1 HiDamping 4" Weston 1/2" 12.95
0-200 & 100-0-100 Microamp Twin MvtAn 2.98
Same cracked glass 3.95
25&2 5Ma GE Galvnmtr zero cir. 3.95
1 Amp RF 2 $\frac{1}{2}$ " GE Bklt Csd 2.49
9 Amp RF 2 $\frac{1}{2}$ " Wstgths B' Csd 2.49
15 Amp DC 2 $\frac{1}{2}$ " Csd Hoyt 2.95
240 A DC 50 MV 2 $\frac{1}{2}$ " AN Wstgths 1.29
7.5 Volt AC 3" Bklt Sq. RA35 Wstgths 3.98
15 Volt AC 3 $\frac{1}{2}$ " Bklt Sq. Weston 476 4.95
30 Volt DC AN 2 $\frac{1}{2}$ " B' Csd Wstgths 2.49
200or500V DC 1000 ohms/V 3 $\frac{1}{2}$ " W.E. 4.95
150 Volt AC 25-125cyc 2 $\frac{1}{2}$ " Wstg&GE 3.69
150 Volt AC 25-125cyc 3" Bklt Sq. 4.98
1000VDC DC 1 ma basic 3 $\frac{1}{2}$ " B' Csd 10.95
360' 1-82 Bendix Autodyn. 4.95
—10-16DB Wstgths DB Mtr 3 $\frac{1}{2}$ " B' Csd 9.95
Test Leads & Clips 8 ft Insul 30 amps 49c
Test Leads Red & Blk insl Prods HiQual 49c

BLOWERS—Cool that Tube!

40 CFM/28VACDC/LR Type \$3.49
100 CFM/12VACDC 5.95
100 CFM/28VACDC 4.95
Xfmr 12 or 28V to 115VAC 1.98
250 CFM/28VACDC 8.95
250 CFM 28/115VAC Xfmr 10.95
150 CFM/110VACDC, Hvy Duty 7.95

Ceramics, Hi Q Cndrs.

2, 3, 4, 7, 5, 7, 10, 11, 22, 25, 33, 43, 47, 50, 60, 75, 100, 120, 200, 1000, 6200 mmf CER-AMICONS "TAB" SPECIAL. Each 8c; 10 for 69c;

INDEX TO ADVERTISERS

Acheson Colloids Corp.	46	Instrument Resistors Co.	200
Acme Electric Corp.	218	International Resistance Co.	8, 9
Adams & Westlake Co.	10	Irvington Varnish & Insulator Co.	42
Advance Electric & Relay Co.	221	I-T-E Circuit Breaker Co.	151
Aeronautical Communications Equip- ment, Inc.	38	Jensen Manufacturing Co.	53
Aerovox Corp.	28	Johnson Company, E. F.	210
Aircraft Radio Corp.	203	Jones Div., Howard B. Cinch Mfg. Corp.	205
Allen Co., Inc., L. B.	227	Kahle Engineering Co.	217
Allen Mfg. Co.	62	Karp Metal Products Co., Inc.	33
Allied Control Co., Inc.	44	Kay Electric Co.	177
Altec Lansing Corp.	212	Kellogg Switchboard & Supply Co.	141
American Chronoscope Corp.	219	Kenyon Transformer Co., Inc.	145
American Electrical Heater Co.	186	Kepec Laboratories, Inc.	215
American Phenolic Corp.	176	Kester Solder Co.	117
American Smelting & Refining Co.	27	Lampkin Laboratories, Inc.	227
American Television & Radio Co.	207	Lenkurt Electric Co.	216
American Time Products, Inc.	50	Linde Air Products Co.	156
Amperex Electronic Corp.	Third Cover	Macallen Company	183
Amperite Company	206	Machlett Laboratories, Inc.	153
Anchor Plastics Co., Inc.	256	Magnavox Co.	173
Anti-Corrosive Metal Products Co., Inc.	201	Mallory & Co., Inc., P. R.	64, 115
Arkwright Finishing Co.	168	Manning, Maxwell & Moore, Inc.	185
Arma Corporation	35	Marion Electrical Instrument Co.	2
Arnold Engineering Co.	135	Marsh Stencil Machine Co.	227
Astatic Corporation	162	MB Manufacturing Co.	47
Audak Company	253	Measurements Corporation	204
Ballantine Laboratories, Inc.	138	Mica Insulator Co.	85
Barker & Williamson, Inc.	195	Mica Instrument Co.	205
Barry Corporation	208	Microducts Co.	217
Bell Telephone Laboratories	6	Millen Mfg. Co., Inc., James	198
Bendix Aviation Corp.		Mines Equipment Co.	201
Eclipse-Pioneer Div.	219	Mitchell-Rand Insulation Co., Inc.	56
Pacific Div.	256	Mosinee Paper Mills Co.	178
Red Bank Div.	167	Myalex Corp. of America	7
Bird & Co., Inc., Richard H.	226	National Company, Inc.	213
Bircher Corporation	226	National Research Corp.	127
Blaw-Knox Co.	16	North American Phillips Co., Inc.	51
Boonton Radio Corp.	121	Notthelfer Winding Laboratories	204
Bradley Laboratories, Inc.	218	Ohmite Manufacturing Co.	16A, 16B
Brush Development Co.	196	O'Neil-Irwin Mfg. Co.	203
Buck Engineering Co., Inc.	205	Panoramic Radio Products Inc.	224
Burgess Battery Co., Inc.	180	Paramount Paper Tube Corp.	205
Burnell & Co.	19	Park Metalware Co., Inc.	221
Cambridge Thermionic Corp.	132, 133	Patton-MacGuyver Co.	182
Cannon Electric Development Co.	152	Perkin-Elmer Corp.	216
Capitol Radio Engineering Institute	213	Perkin-Elmer Electronics Co., Inc.	150
Central Paper Co., Inc.	184	Potter Instrument Co., Inc.	222
Centralab, Div. Globe-Union Inc.	14, 15, 21	Precision Apparatus Co., Inc.	255
Chicago Transformer, Div. of Essex Wire Corp.	166	Precision Paper Tube Co.	210
Cinch Manufacturing Corp.	113	Premax Products, Div. Chisholm-Ryder Co., Inc.	217
Clarostat Mfg. Co., Inc.	203	Presto Recording Corp.	43
Cleveland Container Co.	199	Progressive Mfg. Co.	193
Cohn Corporation, Sigmund	208	Pyramid Electric Co.	60
Collins Radio Co.	52	Radio Corp. of America	187, Back Cover
Condenser Products Co.	175	Radio Receptor Co., Inc.	151, 179
Confidential-Diamond Fibre Co.	34	Railway Express Agency	182
Confidential Screw Co.	136	Railway Express Agency, Air Express Div.	164
Cornell-Dubiller Electric Corp.	40	Rapidesign, Inc.	213
Cornish Wire Co., Inc.	24	Rawson Electrical Instrument Co.	213
Cross Co., H.	227	Raytheon Manufacturing Co.	125
Dano Electric Co.	209	Reeves Instrument Corp.	144
Dial Light Co. of America	209	Revere Copper & Brass, Inc.	20
Distillation Products, Inc.	161	Rex Rheostat Co.	227
Dow Corning Corp.	197	Richardson Company	148
Driver-Harris Co.	23	Roanwell Corporation	206
Dumont Electric Corp.	223	Robinson Aviation, Inc.	174
Du Mont Laboratories, Inc., Allen B. 54.	149	Rubicon Company	201
Eastern Air Devices, Inc.	193	Sangamo Electric Co.	200
Eastman Kodak Co.	119	Schenectady Varnish Co., Inc.	59
Elsler Engineering Co., Inc.	227	Scientific Electric, Div. of "S" Corru- gated Quenched Gap Co.	190
Eitel-McCullough, Inc.	57	Shallcross Manufacturing Co.	131
Electrical Reactance Corp.	25	Sigma Instruments, Inc.	63
Electronic Instrument Co., Inc.	227	Sonotone	184
Electronics, Inc.	150	Sorenson & Co., Inc.	26
El-Tronics, Inc.	227	Sprague Electric Co.	13
Eric Resistor Corp.	139	Stackpole Carbon Co.	17
Essex Wire Corp.	39	Standard Piezo Co.	212
Essex Wire Corp., R-B-M Div.	190	Standard Pressed Steel Co.	214
Falchild Camera & Instrument Corp.	181	Standard Telephones & Cables, Ltd.	22
Federal Telephone & Radio Corp.	12	Sterling Engineering Co., Inc.	165
Ferranti Electric, Inc.	191	Sterling Mfg. Co.	215
Fusite Corporation	61	Steward Mfg. Co., D. M.	221
Garrett Co., Inc., Geo. K.	207	Struthers-Dunn, Inc.	160
General Ceramics & Stentite Corp.	199	Superior Electric Co.	137
General Electric Co.		Superior Tube Co.	172
Apparatus Dept.	36, 37, 129, 147, 163	Sylvania Electric Products, Inc.	131
Chemical Dept.	155	Technology Instrument Corp.	214
Electronics Dept.	3, 11, 30, 31, 48, 49	Tektronix, Inc.	202
General Radio Co.	169	TEL Instrument Co., Inc.	220
Goodmans Industries Ltd.	143	Teledron, Incorporated	157
Gramer Company	222	Telemark Electronics Corp.	217
Graphite Metallizing Corp.	202	Terminal Radio Corp.	226
Hansen Mfg. Co., Inc.	182	Thompson Corp., George S.	227
Hardwick, Hindle, Inc.	158	Thordarson	217
Hathaway Instrument Co.	211	Titanium Alloy Mfg. Co.	32
Haydon Co., A. W.	201	Topflight Company	227
Haydon Mfg. Co., Inc.	188	Transradio, Ltd.	186
Hewlett-Packard Co.	5	Triplet Electrical Instrument Co.	159
Hexacon Electric Co.	213	Turner Company	181
Holliston Mills, Inc.	197		
Hudson Wire Co.	180		
Illinois Condenser Co.	224		
Indiana Steel Products Co.	58		
Industrial Condenser Corp.	221		
Instrument Electronics	220		

**20 Millivolts
Vertical Sensitivity
PRECISION
SERIES ES-500
5" OSCILLOSCOPE**



NET PRICE **\$149.50**

Complete with light shield, calibrating screen and operating manual. Size 8 1/4 x 14 1/2 x 18".

• • IMPORTANT FEATURES • •

- ★ Wide Range High Sensitivity Vert. Amplifier Response to 1 Megacycle
2 Megohms input resistance
- ★ Vertical Input Step Attenuator. x1, x10, x100. Additional continuous vernier control Cathode follower input circuit
- ★ Extended Range Horizontal Amplifier Response to .5MC. 1/2 meg. input resistance
- ★ Linear Multi-Vibrator Sweep Circuit 10 cycles to 30 KC. Improved circuits assure unusual linearity thruout range.
- ★ Amplitude Controlled Synch. Selection
- ★ "Z" Axis Modulation terminals
- ★ Phasing Control
- ★ Audio Monitoring phone jacks plus direct access to Hor. and Vert. plates
- ★ Light Shield and Calibrating Screen Removable and rotatable
- ★ Tube Complement 1 each type 6J5, 6AK5, 7N7, 6X5, 2X2. 2 each type 7W7, 5CP1/A CR tube.
- ★ Fully Licensed under patents of A.T. & T. & W.E.
- ★ PLUS many "Precision" refinements that must be seen to be appreciated.

See the new Precision 5" Oscilloscope and Series E-400 Sweep Signal Generator on display at leading radio equipment distributors. Write for catalog fully describing the complete line of selected test instruments for all phases of AM, FM, and TV.

**PRECISION
APPARATUS CO., Inc.**
92-27 Horace Harding Blvd.
Elmhurst 10, N. Y.

Export Division: 458 Broadway, N. Y. City, U. S. A.
Cables: MORHANEX

Audax
Trade Mark

reproducers



for
Microgroove Discs
Standard Discs
Vertical Discs

*The Standard by Which
Others Are Judged
and Valued*

It is futile to buy the most modern records, if you do not give them the very BEST pick-up to bring out their built-in excellence!

There is so much in present-day discs, that even a mediocre pick-up is bound to bring something out of them. However, to obtain the fullest results of which these discs are capable, they must be reproduced with the finest reproducer for that purpose—the AUDAX.

Remember, two singers may both be able to hit "high C" . . . yet one will please the ear—the other not at all. There is much more than mere WIDE-RANGE to quality reproduction. AUDAX reproducers deliver not merely WIDE-RANGE, but also all vital factors essential to highest quality of musical performance and unequalled

EAR-ACCEPTABILITY

Write for complimentary pamphlet on life of permanent points

AUDAX COMPANY
500 Fifth Avenue
New York 18, N. Y.

"Creators of Fine Electronic-Acoustical Apparatus since 1915"

Union Carbide & Carbon Corp. 156
United-Carr Fastener Corp. 197
United Transformer Co. . . Inside Front Cover

Variflex Corporation 123
Vickers Electric Div., Vickers, Inc., a Div. of the Sperry Corp. 192
Victoreen Instrument Co. 148

Waldes Kohinoor, Inc. 29
Ward Leonard Electric Co. 140
Webster Electric 146
Webster Spring Corp. 227
Weller Manufacturing Co. 223
Western Electric Co. 4
Westinghouse Electric Corp. 45, 171, 189
Wheeler Insulated Wire Co., Inc. 170
White Dental Mfg. Co., S. S. 194, 221
Whitehead Stamping Co. 205
Wilson Company, H. A. 142
Worcester Pressed Steel Co. 41
Workshop Associates, Inc. 198
Wrought Washer Mfg. Co. 186

Zetka Television Tubes, Inc. 209
Zophar Mills, Inc. 193

PROFESSIONAL SERVICES 225

SEARCHLIGHT SECTION
(Classified Advertising)

EMPLOYMENT
Positions Vacant 228, 229
Selling Opportunities Offered 228
Positions Wanted 228
Employment Services 228

SPECIAL SERVICES 229

BUSINESS OPPORTUNITIES
Offered 228

EQUIPMENT
(Used or Surplus New)
For Sale 230-254

WANTED
Equipment 229, 250

ADVERTISERS INDEX

Acorn Electronics Corp. 248
Airborne Sales Co. 250
Alvaradio Supply Co. 250
American Electrical Sales Co., Inc. 248
Atlantic Building Supply Co. 253
Bell Aircraft Corp. 228
Bendix Aviation Corp. 228
Blau 246
Brooks Inc., R. D. 248
Communications Devices Co. 250
Communications Equipment Co. 230, 231, 237
Dubin Electronics Co., Inc. 242
Electro Impulse Laboratory 249
Electro Sales 245
Electronicraft Inc. 238
Electronic Supplies 251
Electronic Research Publ. Co. 229
EPCO 247
Ereco, Dick Rose 247
Finnegan, H. 229
Hi-Mu Electronics 229
Hill, G. V. 246
Instrument Associates 232, 233
Klein, Manuel 248
Leco Eng. Co. 250
Lectronic Research Laboratories 253
Loru Laboratories, Inc. 252
Liberty Electronics Inc. 252
Life Electronics Sales 244
Long Island Radio Co. 248
Market Radio Supply Co. 249
Marlan Corporation 252
Maritime Switchboard 235
Mogull Co., Inc., Alexander 251
Motorola, Inc. 229
National Instrument Co. 253
National Union Radio Corp. 229
Neomatic Inc. 250
Ney, Herbert 248
Niagara Radio Supply Corp. 234
Opad-Green Co. 246
Overbrook Company, The 229, 250
Peak Electronics Co. 243
Powell, Harold H. 246
Powerton Electrical Equip. Co. 251
Precision Electrical Instrument Co. 248
Radio Ham Schack Inc. 241
Reliance Merchandising Co. 239
Servo-Tek Products Co., Inc. 236
Sperry Gyroscope 229
Standard Radio-Electrical Products 252
TAB 254
Technical Index Service 229
Telemarine Communications Co. 248
Television Equipment Corp. 228
Universal General Corp. 252
Vetsalco Inc. 252
Wells Sales Inc. 240
Westinghouse Electric Corp. 228

TIME-TESTED
REMOTE INSTRUMENTATION
WITH THIS

Bendix Pacific

SUB-MINIATURE
TELEMETERING
TRANSMITTER



The Bendix-Pacific Model TXV-2A Transmitter for 209 to 227 mc operation measures only 2" in diameter, 5 1/8" in length and weighs .875 pounds.

Engineered for precise remote instrumentation on guided missiles, aircraft and for industrial uses, this new transmitter as well as all other Bendix-Pacific sub-miniature telemetering components are made to function accurately under extreme vibration and shock.

Complete telemetering facilities are available at Bendix-Pacific. In addition to the manufacture and supply of components, they also include installation and application engineering, field operations, data reduction and engineering consultation. Additional information on the TXV-2A Transmitter or other telemetering components or services is available upon request from qualified companies.



Eastern Engineering Office: 475 Fifth Ave., N. Y.
TO MEASURE - TO INDICATE - TO WARN - AT A DISTANCE

If your reserve tube is ready for active service in your THERMONIC equipment... it will pay you to put another tube on your shelf... the tube designed to our specifications, for your THERMONIC UNIT...

because we have been keeping an accurate check on tube performance life... and find that even though the manufacturer guarantees a minimum of 1,000 hours of operating life...

we can safely extend that guarantee to **1500 HOURS!**
at a new LOWER PRICE!

... by purchasing your THERMONIC tube replacement through us, you now can be assured of

50% more
for your "efficient operation" dollar.



INDUCTION HEATING CORPORATION
181 WYTHE AVENUE • BROOKLYN 11, N. Y.

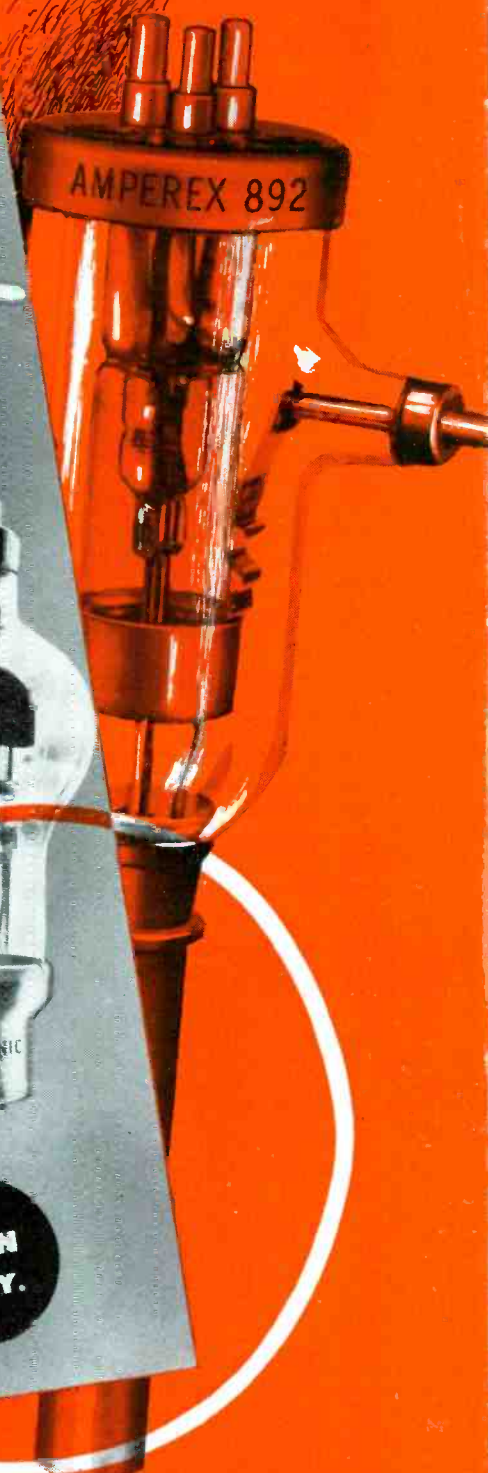
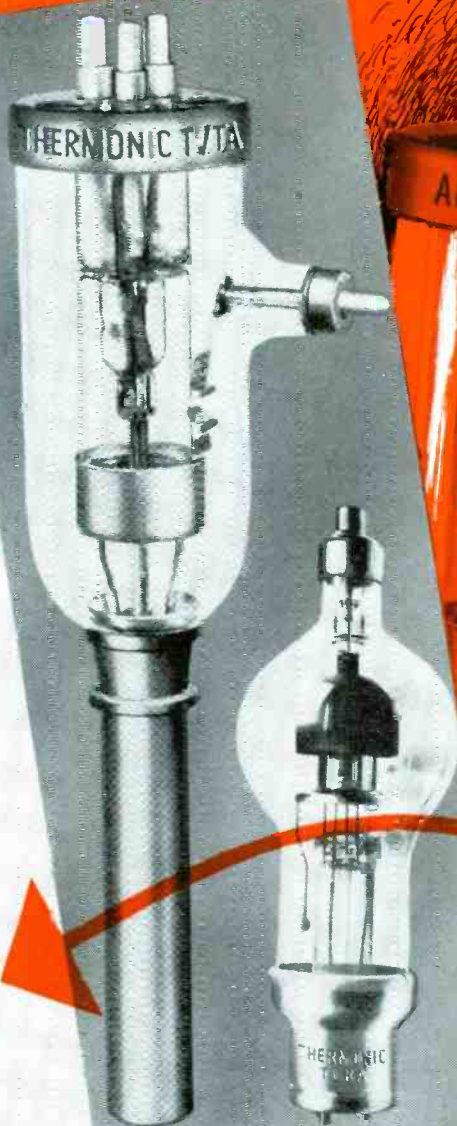

... More People Find That They Get MORE out of AMPEREX Electronic Tubes... Whatever the Application—it Will Pay You to...

Re-tube with AMPEREX

AMPEREX ELECTRONIC CORP.

25 WASHINGTON STREET, BROOKLYN 1, N. Y.

In Canada and Newfoundland: Rogers Majestic Limited
11-19 Brenklife Road, Leaside, Toronto, Ontario, Canada



Now in Stock

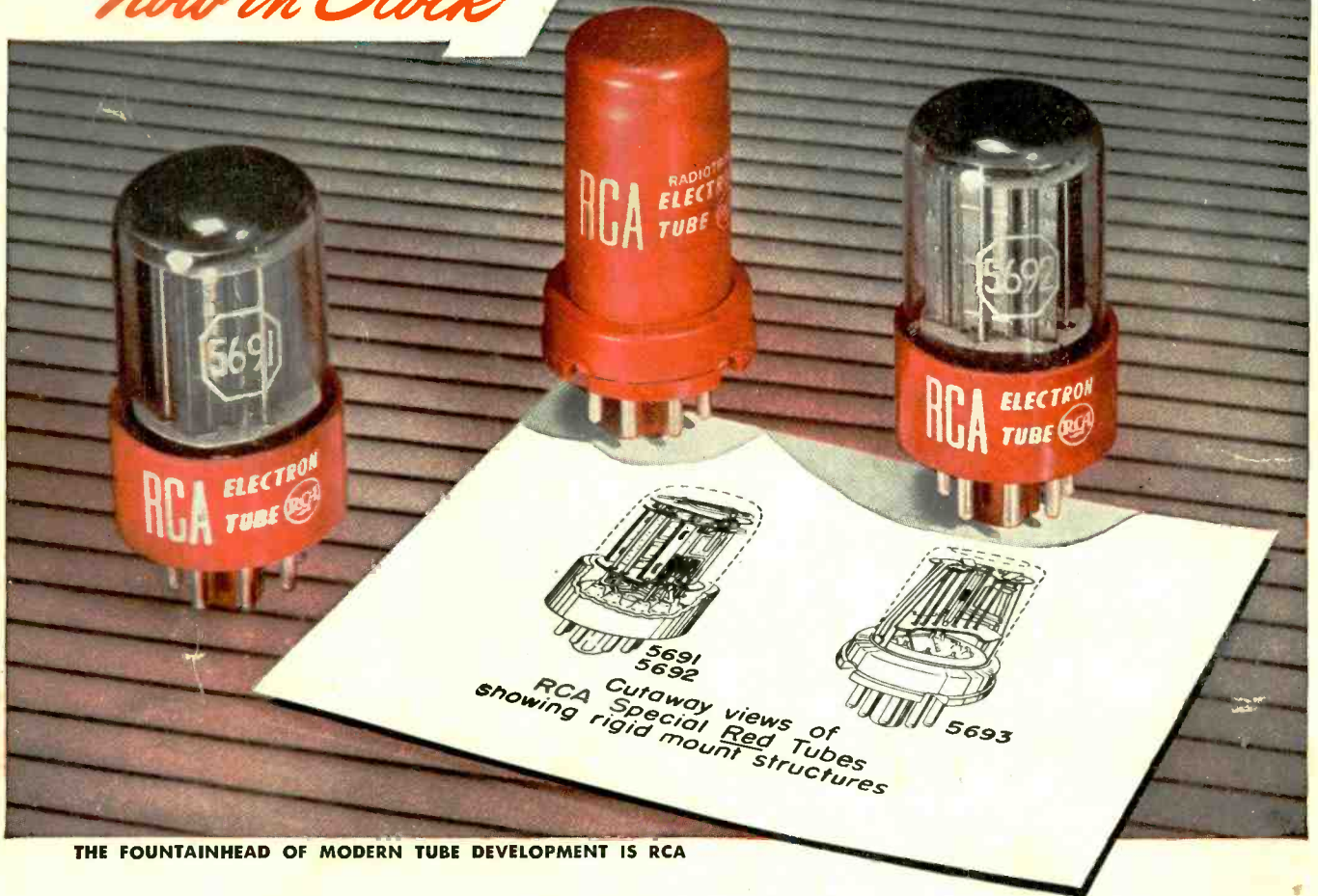

THE FOUNTAINHEAD OF MODERN TUBE DEVELOPMENT IS RCA

RCA SPECIAL RED TUBES

Minimum life - 10,000 hours!

• *Another RCA First* . . . these new Special Red Tubes are specifically designed for those industrial and commercial applications using small-type tubes but having rigid requirements for reliability and long tube life.

As contrasted with their receiving-tube counterparts, RCA Special Red Tubes feature vastly improved life, stability, uniformity, and resistance to vibration and impact. Their unique structural design makes them capable of withstanding shocks of 100 g for extended periods. Rigid processing and inspection controls provide these

tubes with a minimum life of 10,000 hours when they are operated within their specified ratings. Extreme care in manufacturing combined with precision designs account for their unusually close electrical tolerances.

RCA Application Engineers will be pleased to co-operate with you in adapting RCA Special Red Tubes to your equipment. Write RCA Commercial Engineering, Section 42FR, Harrison, N. J. For RCA Special Red Tubes to be used as replacements in equipment now in use, see your local RCA TUBE DISTRIBUTOR.

TABLE OF RECEIVING-TYPE COUNTERPARTS

5691 (0.6 A. heater)	65L7GT (0.3 A. heater)
5692	6SN7GT
5693	6SJ7

RCA Special Red Tubes can be used as replacements for their counterparts in equipment where long life, rigid construction, extreme uniformity, and exceptional stability are needed.

SEND FOR FREE BULLETIN—Booklet SRB-1002 provides complete data on RCA Special Red Tubes. For your copy write to RCA, Commercial Engineering, Section 42FR, Harrison, N. J.



TUBE DEPARTMENT

RADIO CORPORATION of AMERICA

HARRISON, N. J.